

*

UMASS/AMHERST

*



312066 0333 2751 5

LIBRARY

OF THE



MA TTS

A PER RAL

SF
521
B47

SOURCE.

unds...

1893

v.6

JAN. 10, 1893.



ADVERTISING RATES.

All advertisements will be inserted at the rate of 15 cents per line, Nonpareil space, each insertion: 12 lines of Nonpareil space make 1 inch. Discounts will be given as follows:—

On 10 lines and upwards, 5 times, 5 per cent; 6 times, 15 per cent; 9 times, 25 per cent; 12 times, 35 per cent.

On 20 lines and upwards, 3 times, 10 per cent; 6 times, 20 per cent; 9 times, 30 per cent; 15 times, 40 per cent.

On 30 lines and upwards, 3 times, 20 per cent; 6 times, 30 per cent; 9 times, 40 per cent; 12 times, 50 per cent.

Clubbing List.

I will send the REVIEW with—		
Gleanings,.....	(\$1.00).....	\$1.75.
American Bee Journal.....	(1.00).....	1.75.
Canadian Bee Journal.....	(1.00).....	1.75.
American Bee Keeper.....	(.50).....	1.40.
Progressive Bee Keeper.....	(.50).....	1.40.
Bee Keepers' Guide.....	(.50).....	1.40.
Apiculturist.....	(.75).....	1.65.
Bee-Keepers' Magazine.....	(.50).....	1.40.

Honey Quotations.

The following rules for grading honey were adopted by the North American Bee-Keepers' Association, at its last meeting, and, so far as possible, quotations are made according to these rules.

FANCY.—All sections to be well filled; combs straight, of even thickness, and firmly attached to all four sides; both wood and comb unsoiled by travel-stain, or otherwise; all the cells sealed except the row of cells next the wood.

No. 1.—All sections well filled, but combs uneven or crooked, detached at the bottom, or with but few cells unsealed; both wood and comb unsoiled by travel stain or otherwise.

In addition to this the honey is to be classified according to color, using the terms white, amber and dark. That is, there will be "fancy white," "No. 1 dark," etc.

CHICAGO, Ill.—The market is not brisk. Dealers that laid in a holiday stock, still have the same on hand. There is but little fancy white comb; such brings 18 cts. Most of the white, grades No. 1, and sells at 16 to 17 cts. Amber and dark comb brings from 10 to 15 cts. Extracted brings from 6 to 9 cts., according to quality. Beeswax, 20 to 25 cts.

R. A. BURNETT & CO.,
Jan. 11. 161 So. Water St., Chicago, Ill.

CINCINNATI, Ohio.—There is no fancy white on the market. No. 1 white brings 14 to 16 cts. in a jobbing way. For extracted honey, the demand from manufacturers was slow for the last few weeks. The demand from consumers is fair. There is a fair demand for beeswax at 23 to 25 cts. for good to choice yellow.

CHAS. F. MUTH & SON.,
Jan. 12. Cincinnati, Ohio.

CHICAGO, Ill.—Fancy white is scarce and the demand is good at 17 cts. No. 1, white, 15 to 16 cts. Dark comb sells very slowly at 13 to 14 cts. Light Extracted, 8½; dark, 6 to 7 cts. Wax, 23 to 25 cts.
J. A. LAMON,
Jan. 10. 44 & 48 So. Water St., Chicago, Ill.

BUFFALO, N. Y.—Market is quiet except for strictly fancy s ock which brings 16 to 17 cts. Dark and No. 1 white are moving very slowly at prices ranging from 12 cts downward. Wax, 25 to 28 for best quality. Supply light.

BATERSON & CO.,
Jan. 11. 167 & 169 Scott St., Buffalo, N. Y.

NEW YORK, N. Y.—The demand for comb honey of all kinds is very limited. While fancy white is pretty well cleaned up, the market is well stocked with amber, mixed and buckwheat, and prices on these grades is declining. We quote, fancy white (1 lbs.) 15 cts., No. 1 white, 13 to 14 cts.; amber, (1 lbs.) 12 cts. Mixed and buckwheat, (1 lbs.) 8 to 10 cts. Extracted honey is in good demand and stocks are light. It finds immediate sale at 8 to 8½ for basswood and white clover; 7 to 7½ for amber; 6 to 6½ for dark and buckwheat. Southern, 70 to 75 cts. a gallon. Wax is dull at from 25 to 27, according to color.

HILDRETH BROS. & SEGELKEN,
Jan. 11. 28 & 30 West Broadway New York.

MINNEAPOLIS, Minn.—The demand for fancy white honey is very good, and better prices are expected. The supply is not one-half what it has been in previous years. We quote fancy white, 1 lb. sections, 19 to 20. No. 1 white, 16 to 17. Dark, 12 to 14. Extracted in kegs, 10 to 11. In barrels, 7 to 8.

J. SHEA & CO.,
14 Hennepin Ave., Minneapolis, Minn.

ALBANY, N. Y.—Honey market is slow on account of cold weather, but stocks are also light. We have less than 50 cases of honey on hand, and only one barrel of extracted. We usually have 1,000 cases of honey in stock. For honey not granulated in the comb, we quote, fancy white (small combs) 15 to 18. Mixed, 13 to 14. Dark, 10 to 11. Large combs and double glass sell at from 1 to 2 cts less. White extracted, 8½ to 9. Amber, 7½ to 8. Buckwheat, 7 to 7½.

H. R. WRIGHT,
Jan. 13. 326 Broadway, Albany, N. Y.

ESTABLISHED 1876.

S. T. FISH & CO.,

COMMISSION MERCHANTS.

Dried Fruit, Honey and Farm Products.

189 SOUTH WATER ST., CHICAGO.

We make a specialty of our honey department and ask for your consignments and correspondence. Reference, any bee-paper. 9-92-ft

WHITE POPLAR

SECTIONS.

We have New Steam Power, and New Buildings, and are now ready to furnish White Poplar Sections, Clamps, Crates and Wood Sides at short notice. Workmanship, Quality and Price unsurpassed. Send for sample and price list.

PRIME & GOVE,

1-90-ft

Bristol, Vermont.

YOUR PROFITS

Next season will depend largely upon how your bees come through the winter. Many bee-keepers believe that after bees are put into winter quarters nothing more can be done for their welfare until spring has come. All who believe thus, and all who believe that care is needed, but are a little uncertain as to what that care should be, ought to buy the book "ADVANCED BEE CULTURE" and read the chapter entitled "Care of Bees in Winter." Remember, too, that the book contains 31 other chapters.

Price of the book, 50 cts.; the REVIEW one year and the book for \$1.25. Stamps taken, either U. S. or Canadian.

W. Z. HUTCHINSON, Flint, Mich.

New as Well as Valuable IMPROVEMENTS

IN BEE-HIVES, SMOKERS,
FOUNDATION FASTENERS,
SECTION PRESSES AND FEEDERS.

Special prices given to parties who will take hold of and push the sale of these goods. For circulars and particulars, address

LOWRY JOHNSON,
Masonstown, Pa.

Western BEE-KEEPERS' Supply Factory.

Largest Business of the kind in the West.



We manufacture Bee Keepers' supplies of all kinds, best quality at lowest prices. Dovetailed Hives, Sections, Foundation, Extractors, Smokers, Crates, Veils, Feeders, Clover Seeds, Buckwheat, etc. Imported Italian Queens, Queens and Bees. Sample Copy of our Bee Journal, "The Western Bee-Keeper," and latest Catalogue mailed Free to Bee-Keepers. Address JOSEPH NYSWANDER, DES MOINES, IOWA.

Now, I've Got You

Just read our wonderful offer—nothing like it heard of before in bee-publishing. We give FREE to every new subscriber to the WEEKLY

AMERICAN BEE JOURNAL

who sends \$1.00 for a year's subscription on a copy of "Newman's"

BEEES AND HONEY

—a \$1.00 book FREE. Has 225 pages, 200 illustrations, bound in heavy, tinted paper. Just the book for the beginner or expert. YOU ought to have it. Send us 2 new names at \$1.00 each for the Bee Journal one year & get the book as a premium; we also send it to each of the 2 subs. Sample Journal free

GEO. W. YORCK & CO.
199 E. Randolph St.,
CHICAGO. - ILL.



EXTRACTORS ! EXTRACTORS !!
MORE THAN EVER, BETTER THAN EVER.



We are making a specialty of HONEY EXTRACTORS. We make Novice's 2 and 4 frame; Cowan's Reversible 2, 4, and 6 frame, and Stanley Reversible, 2 and 4 frames. Nearly all the dealers handle these goods. Write for discounts to the trade.

Sawed Wood Separators
CHEAP.

Instead of slicing them we are now sawing them. They are dry, won't shrink, and won't roll up.

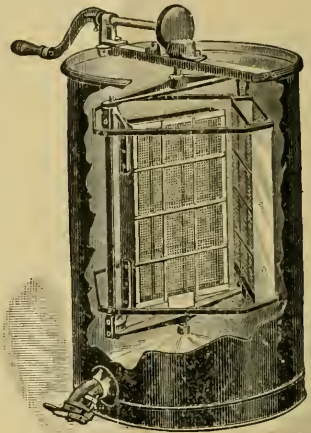

ROOT'S FOUNDATION FOR 1893.

Made from BRIGHT YELLOW WAX, and the workmanship unexcelled. For prices and particulars of all goods, send for our 1893 Catalogue of 52 pages, free.

A. I. ROOT, Medina, Ohio.



TO REDUCE STOCK.

From now until March 1st only, we will sell No. 1, One-Piece Sections at \$2.75, and No. 2 at \$2.00 per 1,000. Other supplies in proportion. On all cash orders of \$5.00 or more, from within 100 miles of us we will pay the freight.

J. J. GRADNER,
 Marion, Grant Co., Ind.

1-93 2t. Please mention the Review.

ON HAND NOW.

THE MOST COMPLETE STOCK OF BEE HIVES, SECTIONS AND SUPPLIES IN THE NORTHWEST.

W. H. PUTNAM,
 RIVER FALLS, WIS.

1-93-12t. Please mention the Review

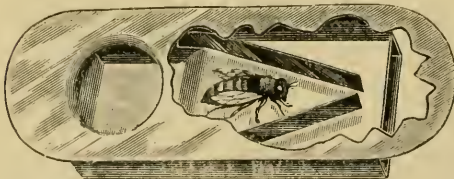

Porter's Spring Bee-Escape

Saves temper, time and bees. PROF. COOK says: "No bee-keeper can afford to be without them." WM. M'EVROY, foul brood inspector of Ont., Can., says: "They should be used in every bee yard in the whole wide world."

THOS. PIERCE, Pres. Eastern N. Y. B. K. A. says: "The time will soon come when all bee-keepers will use them."

Send for circular and testimonials, and read what others say of them. PRICES: Each, by mail, with full instructions, 20 cts. Per doz., \$2.25. If, after three months' trial, they are not found superior to all other escapes, and satisfactory in every way, return them and we will refund your money. For sale by dealers.

R. & E. C. PORTER, Lewistown, Ill.

The Bee-Keepers' Review.

A MONTHLY JOURNAL

Devoted to the Interests of Honey Producers.

\$1.00 A YEAR.

W. Z. HUTCHINSON, Editor & Prop.

VOL. VI. FLINT, MICHIGAN, JAN. 10. 1893. NO. 1.

Notes from the Pacific Coast.—Some of the
Needs and Necessities of California
Bee-Keeping.

JNO. H. MARTIN.



YOUR leader in relation to what bee-keepers most need attracted my attention, and, although I shall not agree to write a best article, I will write a short one, and perhaps in that respect it will be the best. Without going

into preliminaries and reviewing the past, I will apply my observations to things of the present. You are aware that I have had quite a long field if not a wide one for cultivation, and the most striking feature in relation to the permanency and success of bee-keeping is the intermittent nature of the work, and the further west we go the longer the intermission. Here in California, after an apiary has been established and our honey yield secured and disposed of, then, from August to the next March, the bees need but little attention. The apiarist usually has some other business in which he gets so much interested that the bees are neglected, and if the season is a poor one the neglect amounts to the shameful.

The only remedy at present, perhaps, is the practice of migratory bee-keeping wherever it can be practiced, and California is perhaps one of the best fields for the practice of this method. Commencing at the sea coast and gradually moving back into the mountains the season would be drawn out several months, but at present the energies of the bee-keepers and the appliances are not equal to the occasion and it is not practiced. There are several points however to be considered should any desire to put this plan into practice. If we migrate we are liable to interfere with another man's field and that would not be just. Then every move adds to the cost of production and with extracted honey at five cents and comb at ten cents per pound, such additions would be ruinous. It would seem almost impossible to reduce the cost of production, but I think it could be done with the perfection of present appliances.

The queen excluding honey board and bee-escape are helps but they do not work with the perfection we wish, for queens will get through not only once in a while, but twice in a while, and the bee escape works the same way in clearing extracting supers. The perfection of the swarm catchers, and the fact of having at last a non-swarming apiary would be another step in the reduction plan. Another very important point especially applicable in this climate and not thoroughly considered, is a better plan for rearing and having on hand at all times an unfailling supply of extra - good queens. That

MAY 19 1916

Per
v.6
1893

point alone would make a great difference in the honey yield of hundreds of apiaries on this coast as well as farther east.

Another object to be attained is to make a certainty from our uncertainty for there is nothing more discouraging than to patiently and laboriously hold your dish right-side up all through the season and at the end find it empty. As long as this condition of things lasts honey will never become a staple article like butter or flour which can be depended upon year after year. Speaking from a California stand point we have more difficulties to contend with than our Eastern brethren: but I am not sure, if sugar honey is to be the honey of the future, but we stand in a good position to supply the world with that, as we could call it *beet* honey. The feeding of the beet sugar would occupy a good share of the year, and that would overcome the intermissions of the present method, and put bee-keeping upon a sure footing.

These great subjects are, however, all for the future to answer and in these articles we can only speculate upon the probable results. I would, however, advise no one to abandon bee-keeping but try to improve and keep pace with the progress and if the sugar cloud seems dangerous to some of us, and fraught with dire consequences, there *may be* a silver lining to it. Let us hope and wait and see.

REDLANDS, Calif.,

Dec. 3, 1892.



Writers Ought to be More Sure of Their Premises, and go More Into Details.—Bee Keeping is Drifting into Specialty.

W. C. FRAZIER.

WITHIN the last forty years apiculture has made a vast stride forward. Forty years since, movable frame hives were unknown or nearly so. The habits of the bee were a mystery, even to those who were the foremost in the bee world and the improvement of bees by the introduction of new blood, through queens, was hardly begun, in fact the idea was pretty generally prevalent that the drones layed the eggs.

Such ideas are now seldom met with and when they are found, serve only to cause a smile upon the face of the apiarist, such as is found upon that of the relic hunter when

he finds some very rare and "ancient relic of the past."

That we have now a new system of keeping bees and that this new system *must* be followed if the apiarist would continue in the business, experience and observation will affirm.

That in time to come other improvements and advances in the art (for art it is), will be made, there remains not the shadow of a doubt.

To mark out the course which inventive genius will take would possibly be considered presumption in any one man; but if each one would show in what direction he thinks improvement and advancement would be necessary great good might follow.

It would be desirable, if the writer on apicultural subjects would enter more into detail in describing their methods; while no one can imitate the methods of another, in all respects, with success, yet many describe practices and inventions in which it is hardly possible to follow them or in any manner to imitate.

If the leaders would take pains to advocate nothing which they had not tried and found superior, their followers would be spared a world of pains and worry in trying to imitate them only to find that the plan or invention had been given out prematurely, and while in all reason and by all theories it should have been perfection, yet for some reason unforeseen the thing would not work as it was designed. While examples may not be in order, yet the Hoffman brood frame as used in the dovetailed hive and the self-hiver are fair samples of this. While they both will no doubt be so improved in time so as to fill the places perfectly for which they were intended: yet at present there cannot be said to be on the market a self-hiver that can be depended upon to hive a swarm, at least none that is backed by practical experience, although there are many, that by all theories and in all reason should accomplish this, the end for which it was designed.

The Hoffman frame was intended to be a frame on which the bees would not build brace or burr combs. But somehow the bees could not see it in this light: they build burr combs from the frames to the patern slats, and from the frames to the covers so as to make it almost impossible to separate them, and the frames are as badly joined together by brace combs between the top bars, as the

ends of the frames are securely fastened together by propolis.

The drift of apiculture seems to be, as in almost all other things, to specialty.

If he is a honey breeder, he will not find it convenient to take or attend to a large crop of honey; and if he is a supply dealer it will very much interfere with either honey or queens. But the production of, and caring for, the honey the bees produce should be the object of all apiarists, that is the fundamental principle on which apiculture rests.

This country could easily spare some of its *Bee-Keepers*. It needs more *Apiarists*.

To increase the production of honey should be the aim of every true apiarist.

To do this requires his utmost skill and constant vigilance, and he must provide for the honey harvest months ahead, if he would have his dish right side up when the honey flow comes. He must have a strong colony of young bees, well provided with wholesome stores at the beginning of winter; they must also have a queen that is *good*, young and vigorous. By good we mean a queen that is from a pure mother, let her be mated as she may. Queens should always be reared from a mother that is pure, be it Italian, Carniolian or Cyprian, and the mother should be selected for her honey qualities, without reference to her propensity to produce highly colored bees, only seeing that her bees are all similarly marked and have the characteristic marks of her race. In fact, to see that she is purely mated. While the daughters of such a queen will give the highest satisfaction as honey gatherers without reference to how they are mated, yet the mis-mated queens should never be allowed to produce queens. If they do the apiary is sure to have a downward tendency. A mis-mated or hybrid queen is no more fit to breed from than a mule would be, were such a thing possible.

There are a great mass of bee-keepers in this country that need to be reached; how to reach them is the problem? While they are following to some extent the practices of modern apiculture, yet many of them are following far in the wake. They have only adopted such things as supers and sections, because they find it is to their advantage to do so, as it makes their honey bring them more money; and many there are, very many, that still produce "chunk" honey and strange as it may seem they find a sale for their product. The best thing the apiar-

ist can do with one of this class is to induce him to purchase one of the standard works on bee-keeping or to subscribe for one of our numerous and excellent journals on bee-culture. This will have the effect of elevating him or breeding him up, if you please, as much as using a pure bred male does on the flock or herd. This will have the effect on him, in time, if he has the mental ability to back him, of making him a better bee-keeper, if not indeed a thoroughbred.

ATLANTIC, Iowa.

Dec. 14, 1892.



The New "K. D." Hive and Super.—How They are Made and Their Advantages.

R. C. AIKIN.



With what interest did I look for and peruse the December REVIEW! It was too short by far. Had it contained one hundred articles from as many apiarists and parts of the country, how it would have revealed the condition,

wants and necessities of the pursuit. Amen, Bro's Doolittle and Miller; there are millions in apiculture, *but not to those who seek filthy lucre alone.*

Friend Doolittle, you can make a success by taking at least half the crop of your out-apiaries in comb honey. This article will not tell you how in specific terms, but I think it will throw a ray of light on the subject.

But R. L. Taylor, y-e-s and B. Taylor too, but especially the former, almost deters me from telling how.

Bro. Taylor, there are some things apiarists "want," and must have, and there are both "necessity," and "possibility." Furthermore, I want to say to you, that "inventions" in the way of apicultural appliances have not yet reached the top. That "contrivance" I "have been planning so long," I am going to "drop" right into the "camp" by means of this article.

Before entering into details I want to say that we expect opposition and charges of

stealing other inventions; no good thing ever met with no opposition. 'Tis true, too, that but for the thoughts and inventions of others, we would not have developed what we now have, but, by much thought, and by combining many old features with some new ones, we have "brought forth" what we call our

"K"AY "D"EE HIVE.

Now, what is it? First, a combined bottom board and feeder. This is reversible, and has a $1\frac{1}{2}$ inch rim, deep side up, for feeding and wintering, the other side up during honey flow.

The brood chamber is 10-frame, reversible, 9 x 15 x 17 inches in size. The frame is a wide-end bar, close fitting, standing frame, 9 x 17. The capacity is about that of 9 L. frames. The outer case is not nailed at the corners, but is supplied with metal corner pieces, screwed or nailed to the sides. Through these corner irons are passed two rods (one at either end of the hive) having a thumb nut at one end. These are so arranged that the tightening of the thumb nut gives compression upon both ends and sides. The frames are reversible singly, or *en masse* by reversing the chamber.

The super is $4\frac{1}{2}$ x 15 x 17, and in construction is identical with the brood chamber case, save that the ends have a recess or inset to receive the ends of the separator. The only inside pieces, are three tin separators. The super sides and separators, are provided with "spurs, edgers, or points," so that when the sections are in, and the compression brought to bear, the "spurs" imbed themselves in the section edges. The *compression* and *spurs*, are the means of supporting the sections. The super holds 32, $1\frac{3}{8}$ x $4\frac{1}{4}$ x $4\frac{1}{4}$ sections. The super sides support the sections adjoining them, while the separators are placed between each alternate row of sections, so that all are supported, and each section will have one straight side because adjoined by either the super side or a separator. There are neither T tins, section holders, patern slats, followers nor wedges, in either super or brood chamber, and in both brood chamber and super, we have compression from both side and end.

The hive has two covers: a thin, plain cleated-corner cover; and a flat, rimmed cover, about $1\frac{1}{2}$ inches deep. The rim is rabbeted $\frac{3}{8}$, and telescopes that much.

With the hive is a wood zinc slatted queen excluding honey board, and a queen trap.

There is no provision for an entrance in the hive proper. The honey board has a bee space in each side, and has the hive entrance in its edge, and carries the alighting board. This board remains on the hive the whole year. The entrance is double, *i. e.*, one opening directly beneath the excluder, and one immediately above it: a piece of sheet iron separates the entrances. Thus we have a free passage for the bees to either brood chamber or super, without passing through the hive.

The trap is adjustable to either entrance. When placed on the lower one its top side is level with the bottom of the upper entrance, and practically serves as one alighting board. This arrangement permits the bees to work direct to the super without passing through excluding metal, but will trap the queen should she attempt to leave the hive. At mating time the trap is placed at the upper entrance, leaving the brood chamber entrance free; but it blocks the queen from going into the super.

Now, briefly, some of the advantages we claim.

The entrance being at the top of the brood chamber will facilitate packing for winter; it is out of the grass, weeds and snow, and above toads. (Here, toads are as "thick as hops.") The entrance being so near the super, in fact directly into it, causes work to begin there earlier, and progress more rapidly.

The arrangement of the trap and entrance, permits us to keep swarms from absconding.

The means of compression is simple but firm, and permits of reversing the brood nest at will and leaves no place to propolize in either brood chamber or super, and reduces to a minimum the opportunity for burr combs. No sections can "kick up" or get out of place.

In wintering we have "top ventilation," which we are prepared to prove is necessary to safe wintering.

The hive will be NAILED and PAINTED at the factory and shipped "K. D." You have only to put the brood frames together, put the starters in them, and your hive is ready for use.

No hive ever offered to the public combines so many valuable features with so few pieces and parts. It is simple, easily handled, and durable; and to obtain equal results with any other known hive, will cost double what this hive will cost.

Now, Mr. Editor, I have very briefly described our hive, and some of its advantages; to fully explain its good features and make plain its construction, would take many pages and numerous illustrations, but we hope ere long to have it fully described and illustrated.

Associated with myself, as a joint inventor, is Mr. Harvey Knight of Littleton, this State. Mr. Knight has been for years one of our leading honey producers in this State and has for two years been manufacturing supplies, although now out of the manufacturing business. He has also been Secretary of our State Association for several years.

We have applied for a patent on some of the new features. We do not expect to become wealthy on royalties, but by thus protecting ourselves we hope to receive partial remuneration for our labors. We honestly believe that our invention is worthy, and will be a grand help to the pursuit.

LOVELAND, Colo.

Dec. 28, 1892.



That Air Blast Article [Page 269.]—Where the Extra Energy Comes From to Make a Stronger Blast.

S. CORNELL.



REPLYING to Mr. Hasty's letter, page 300, I have to say that I understand the blast of a smoker to be the air in motion as it passes out of the nozzle, and the more rapid the motion of this air the stronger is the blast; also, the greater the quantity of air

driven through the nozzle in a given time the more rapid the motion, and consequently the stronger the blast. In all the smokers I have seen in which the "cut off" was applied, more or less of the current is dissipated between the bellows and fire barrel, owing partly to bad construction, and partly to want of information on the part of the maker. By the improvements I have suggested *all* the air contained in the bellows and fire barrel is driven through the nozzle, and in addition thereto there is the large

quantity induced to join the current, and enter the fire barrel, without passing through the bellows. To drive this increased volume of air through the bellows, without loss of time, it is not necessary to either "attack" or "contradict" the doctrine of the conservation of the energy, as Mr. Hasty seems to suppose, because there is abundant energy, and to spare, stored up in the muscles of the operator's hand to do the additional work required. As there is a very much larger quantity of air driven through the nozzle, in the same space of time, a little consideration should make it plain to every one that the blast must be stronger. By having two new smokers, one having my suggested improvements, and the other of the ordinary Bingham type, but of exactly the same capacity in every respect, and discharging the air of each one, say 25 or 40 times against the windwheel of an anemometer, the register of the instrument will show exactly the relative strength of the two blasts. Before long I hope to have an opportunity of making such a test. I have no doubt as to the general result, but I want to know how much per cent. one blast is stronger than the other.

LINDSAY, Ont.

Dec. 10, 1892.



Something About the Markings and Color of the Golden or Five-Banded Italians.

S. F. TREGO.

FRIEND H.:—I noticed your editorial on five-banded bees in last Oct. REVIEW and will say I have had much the same experience in getting five-banded bees; but I have one queen that gets bees with the first four segments *all* yellow and about one-half of them have the fifth segment about one-fourth yellow, and once in a while I see a bee with a very narrow stripe on the sixth segment. They are really *not* banded bees at all, but are *all* yellow on the first three segments of the abdomen and the rest black. It would be nearer right to call them *two-banded*, one yellow and one black band.

The great trouble with the queens sent out by some is that they do not produce even good three-banded bees. I received some queens from the South some months ago that were sent to one of our customers for us and they were actually not good leather colored Italians. The party who sent them booms his *cheap* queens.

I do not think there is a breeder who warrants the untested queens he sends out to get more than three-banded bees.

For the coming season my bees will be divided into five grades, viz. : Warranted, Tested, Selected Tested, Breeders and *Best*.

The warranted will be untested, but warranted to get bees with no less than three bands. Tested, get three-band bees and some of them may show a few four and five-banded bees. Selected tested, will show probably one-half of her bees four and five-banded, the rest three-banded. Breeders, will show mostly four and five-banded. *Best*, will show *all* four and five-banded bees. All queens to be reared from one of the best grade.

I am not writing this to boom the yellow bees for they seem pretty well boomed already : but will say that I was at the Illinois State Fair this fall and noticed that the Golden Italians were always quiet while the other races : Syrian, Cyprian, Black, Punic, etc., were everlastingly tearing around trying to get out.

The colony that got the first premium was about like the fifth grade above (Breeders), and belonged to a Mr. Short, of Peoria, Ill.

SWEDONA, Ill.

Nov. 1, 1892.



The Diversity of Southern Bee-Keeping, as Compared with that of the North, is Very Great, and That is why a Southern Bee Journal Cannot Succeed.

O. O. POPPLETON.

[Every little while somebody at the South complains that the bee journals are of little value to Southern bee keepers, and it was with a view to remedying this deficiency that I asked our old friend, O. O. Poppleton, to write a series of articles on Southern bee-keeping, making them seasonable for the South. He did not think it would be possible for him to do so, but the letter that he sent in explanation is of so much interest that I have obtained his permission to publish it. Among other things he says :—]

I WILL try and take time to explain to you some of the peculiar conditions of Southern bee-keeping, but I doubt whether I can be full or clear enough to give you a good understanding of it.

In the North the difference between the seasons, so far as bees are concerned, is sharply defined : that is, they pass quickly from the working season to the one of entire quiet and cessation from all work, even that

of brood rearing, and from that condition during the winter almost at one bound into the full activity of spring work. Very little surplus honey is obtained outside the four months of June to September. As we go Southward the seasons more and more insensibly shade into each other, and the possible honey season commences earlier and lasts later. Thus, at my old location in northern Iowa, my bees rarely ever commenced gathering surplus honey before June 15th, and seldom any after Sept. 1st, while in extreme south Florida, where my bees are now, the conditions are exactly reversed, the bees getting more or less honey every month in the year except June and July, and during those two months I move the bees to this place (Hawk's Park) in middle Florida where we get quite a large surplus during June and July only. The bee-line distance between my two locations is about 125 miles, and yet the flora of the two localities is entirely different.

North of the Ohio conditions of bee-keeping vary but little in different localities. Time of surplus honey flow ; kinds of flowers yielding same, etc., are much alike. The main reliance for surplus honey is on few if any more than half a dozen different kinds of flowers. In the South, conditions in different localities vary much more than in the North, and the number of kinds of flowers yielding surplus honey is many times more. Even the one State of Florida has at least four widely differing conditions in her limits, viz., the swamp region of north Florida, which Mrs. Harrison visited last winter, the orange region of the State, the few small and isolated black mangrove locations, and the extreme Southern part of the State where the wild pennyroyal and other plants flourish.

Bee-keeping in the Cumberland Mountains and north Georgia is very different from what it is in the hills of middle Georgia, and there again it differs from that of the piney woods of south Georgia. All again differ from the conditions in which friend Blanton keeps bees in Mississippi or Mrs. Atchley in Texas.

The central idea which I wish to convey is that owing to the different flora, and differing surplus honey seasons in so many differing localities in what is known as "the South," makes it impossible to formulate any "Monthly Needs" for Southern beekeepers that would be of value in any large

part of the South. This is, I think, the real reason why a distinctively Southern bee-paper never has, and probably never will, succeed.

Another thing: I have always aimed to write only what I have actually done, or opinions formed from actual experience. If I were to attempt to write anything on Southern bee-keeping in general, I would have to do so largely from hearsay and theory. Only two other bee-keepers in the world, so far as I know, are working bees under the same conditions as I am. You will appreciate this if I give you a brief account of my season by months.

August. A light flow of honey the first few days of the month, after which we move the bees from this to the lower location, 150 miles south.

Sept. Bees gather just about what honey they use. More brood is raised this month than last.

Oct. Similar to Sept. except brood-rearing begins to lessen.

Nov. Same as Sept. and Oct. except brood-rearing almost ceases.

Dec. Surplus honey commences the first of the month from wild pennyroyal and soft maple. Gain during month from 10 to 25 lbs. per colony, according to weather. Brood rearing commences strongly about Christmas.

Jan. Same as Dec. except an increased amount of brood.

Feb. Same as Jan. Swarming commences last of the month.

March. Wild pennyroyal goes out of bloom early in the month, but yield from other sources is enough to keep bees going and thriving. All artificial increase should be completed this month.

April. Saw palmetto flow commences early in the month and continues until last of May. Our apiary work these two months is extracting, building up all colonies and replacing poor queens.

June. We move our bees up to this location (Hawk's Park) in time for commencement of black mangrove honey flow, which commences about 15th of the month.

July. Black mangrove usually yields during this entire month.

It will not pay for any of our papers to take up the matter of doing work as I am doing it, because the locations where such work can be done in exceedingly limited and already occupied. Neither is it best for me

to attempt to write about such work as I have never done, either here or in Cuba, and that is just what I would have to do if I were to attempt to write about Southern bee-keeping.

Now, friend H., I hope I have given you a slight idea of the situation in our South-land. If so, all right.

HAWK'S PARK, Fla.

Dec. 1, 1892.



A Review of the Dec. Review.—Out-Apiaries.—Implements.—Experimental Stations.—“Digested Nectar.”—Handling Bees in Winter.—House-Apiaries.—Cellars.

J. A. GREEN.



WHEN I came to read the REVIEW for Dec. 10th, I felt almost glad that I had not written anything for it, because I could express my appreciation of it and the character of its writers, to others, so much more

comfortably than if I had had a part in the making of it. What helpful advice for humanity there is in the articles of friends Doolittle and Miller. What sound, practical advice for bee-keepers in others.

Now I want to review this REVIEW a little, as there are some points I would like to touch upon, without writing an article on each or attempting to cover the ground as a whole.

Doolittle believes in out-apiaries run for extracted honey. I am glad to see it. I had begun to believe him wedded to comb honey and in favor of almost incessant manipulation. If we once get him out on the wide sea of extracted honey and out-apiaries, there is no telling what reports we may hear from him one of these days. I would not like to have every bee-keeper go to raising extracted honey, because the market for that article is so much more easily overstocked than that for comb honey that a large crop would bring but low prices to many, unless they could have a new dispensation granted

them in the matter of selling honey. Moreover, in the light of recent developments I am afraid that it is going to be still harder to sell extracted honey in the future than it has been in the past. Still, looking at the question from the standpoint of immediate economy, I know of no better advice to give the apiarist desirous of increasing his profits and rendering them surer, than to establish out-apiaries of moderate size in the unoccupied fields near him and run them for extracted honey.

There is much in hives and implements. There is more in methods. Don't be satisfied with poor ones in either. The man who attempts to meet modern conditions with the implements and methods of long ago will surely fail. Throughout the seasons, good and bad, remember that the specialist, the man who keeps his business well in hand, has the advantage. He can make money if anyone can and when the distance between profit and expense is but short, he will be found on the right side.

Dr. Miller's plea for government experiment stations should receive the earnest attention of every bee-keeper. I know that I have spent hundreds of dollars in experiments. I have no doubt that there are many others who can say the same. Many of us have been going over just the same ground in these experiments and yet I fear the results we have attained have not been as accurate and valuable as might have been attained by a single experimenter working under circumstances that permitted a closer attention to details and a wider range of conditions. I believe, at the same time, the greater part of the expense would be done away with. I believe that if we could ask loud enough and long enough, we could secure the help we need in this direction.

The difference between W. F. Clarke and Prof. Cook is only one of terms. Prof. Cook does not claim that nectar, in the process of transformation into honey, passes through all the stages of digestion, nor does friend Clarke deny that in this process it passes through some of these changes. Why should they quarrel about this difference in degrees? If the word "digested" offends the nice taste of our Canadian friend, or others, let them invent some more appropriate term. Really though, I cannot see why the thought of eating nectar that has been changed by the action or addition of the glandular secretions of the bee, should be any more offensive than the thought of using

milk, which is entirely a glandular secretion of the cow. The bee is the cleaner animal, by far. The general public, for the most part, believe that honey is a secretion and a large proportion of them are so confirmed in this belief that they believe that honey is being produced in the hive at all times, regardless of the state of the weather or the time of year.

Friend Hasty's observation, on page 321, accords with my experience. I have lately had occasion to handle a number of colonies of bees in cold weather, part of the time with the mercury below zero. The promptness and thoroughness with which those colonies would rouse up from their quiescent state would be a revelation to those that believe that bees hibernate, and the amount of heat that they developed when thoroughly aroused was astonishing even to me. Although I believe it better to do all work with bees at a time when they can fly, I should not hesitate, with my present light on the subject, to handle them whenever they really needed it. Although if it were very cold I would take them into a moderately warm room for the purpose, allowing them to cool off gradually after I was through. In this way I have hunted up queens and done other work of that character in the coldest weather and with the loss of very few bees.

H. R. Boardman gives expression to a very common experience when he says that two cellars that seem exactly equal in all the requisites of a cellar, may be very unequal for wintering bees. This is a matter that might stand considerable investigation. At present no one can be sure it will pay him to winter bees in his cellar until he has given it a thorough trial for himself. Friend Boardman's experience with a repository above ground seems a little remarkable when we consider how often failure has been reported with this method.

R. L. Taylor's advice is all so good that it would take an entire article to comment satisfactorily on its many good points. In one respect only can I take issue with him. Great inventions are not always made to order. It very often happens that they do not even "fill long felt wants." Many times a really meritorious invention must struggle long before it finds appreciation. If inventors always waited for a clamorous need, I fear much of the world's richness would be yet undreamed of. While it does seem that nothing further in the way of great inven-

tions is to be the lot of apiculture, the very next thing to appear may be something so valuable and yet so startling in its simplicity that we will all wonder that we did not see the want and supply the need.

I think very favorably of the house apiary idea and I believe another season will find me with one in operation.

I am not going to say anything about the rest of the number, not even of that charming picture of the life of the editor, because it would prolong this article beyond reasonable limits, but I just want to express my appreciation of the way it is made up and the changes of management suggested.

OTTAWA, Ill.

Jan. 4, 1893.

Bee-Keepers' Review.

PUBLISHED MONTHLY.

W. Z. HUTCHINSON, Ed. & Prop.

TERMS:—\$1.00 a year in advance Two copies, \$1.90; three for \$2.70; five for \$4.00; ten, or more, 70 cents each. If it is desired to have the REVIEW stopped at the expiration of the time paid for, please say so when subscribing, otherwise it will be continued.

FLINT, MICHIGAN, JAN. 10, 1893.

"THE WEST" is a great country and its bee-keeping partakes of this greatness, but it is said that the bee-keeping of the West is somewhat different from that of the East, and to make the REVIEW more helpful to the Western brethren, Jno. H. Martin, better known as the "Rambler," will write a series of articles for the REVIEW for 1893, in which the needs and necessities of Western bee-keepers will be given particular attention. His first article appears in this issue.

THIS ISSUE of the REVIEW is late on account of my being away to conventions. Bee conventions usually come at the wrong time of the year for the publisher—just when he has the most work to do—but to keep up with the times and out of the ruts, a publisher must mingle as much as possible with his fellows. I presume that nothing will again take me from my post for several months, and I am going to work hard to "catch up" and have the REVIEW out earlier in the month. Correspondents can help me much in this matter by sending in their articles as soon as possible.

THE REVIEW for January 1889, is all sold and a customer wishes this No. to complete his set of back Nos. Any one having a copy of this issue to sell will please write to this office, stating the price.

"THE MOST HONEY with the least labor" is what I believe R. L. Taylor secures in as successful a manner as any man I know. In the face of this he has had foul brood to contend with. During the coming year he will tell the readers of the REVIEW how he manages. His first article will be in the next REVIEW.

G. T. SOMERS is the name of a pleasant, nice looking young man who has been editor of the *Canadian Bee Journal* for the last year. I met him last week at the Ontario Bee-Keepers' Convention. Practically, Mr. D. A. Jones has nothing more to do with the C. B. J.

The *American Bee Journal* is bound not to fall behind. Each issue is to contain a portrait and biographical sketch of some apicultural celebrity. There is nothing like a face to face meeting and the hearty hand clasp, but even these are rendered still more pleasant by having first seen the portrait and read the sketch.

The *Progressive Bee-Keeper* is again on deck, its pages a little reduced in size but with just as much reading matter, as it has some new type that is not quite so large as the old. I think it is Brevier, and, to my way of thinking, that is about the neatest size type for a magazine.

E. E. HASTY is a well-educated man, a practical bee-keeper, and, as a writer he is the most bright, piquant, and original in expression of any in our ranks. These gifts are to be employed the coming year in helping make the "Extracted Department" of the REVIEW. He is to have all of the journals, read them carefully, and then criticise, commend and condemn their contents in that inimitable style of his. The REVIEW is to come in for its share of criticism. "Hasty's Review" will probably be one of the most interesting and valuable features of the REVIEW for 1893. His first batch of criticisms will appear in the next issue.

THE SUGAR HONEY DISCUSSION HAS GONE FAR
ENOUGH AT PRESENT.

I said I had more articles on sugar honey that would be published in due time. Perhaps their authors are wondering why they are not. The reason is that the bee-keeping public is opposed to the discussion. An editor has an opportunity that is accorded to no other, to place his finger upon the public pulse. In the hundreds and hundreds of letters that have come to me in the past month, and from the bee-keepers that I have met at three conventions of a National character, I have learned that there is a strong opposition against even the discussion of the raising of honey by feeding sugar to bees. In some instance this opposition amounts to a *bitter rage*. Some of you may remember the pains that I have taken in the past to learn what course in the getting up of the REVIEW would be the most acceptable. Well, when it has been shown to me so clearly that this discussion is distasteful to the majority, what folly to force it upon these unwilling readers. I have several most excellent articles upon this subject. One from Mr. Daggitt, in which he calls attention to the fact that it is the floral *flavor* of honey that gives it its chief value. Illustrations and evidence are given at length. Again, this very morning, I have received from Frank S. Aby, Director of the Histological Laboratory of the Iowa State University a most able paper discussing the question most thoroughly from scientific ethical and economic standpoints. He supports Prof. Cook and says that the opposition comes from the ignorance of beekeepers on chemical and physiological points. It seems a pity that this subject cannot be thoroughly and calmly discussed in all of its bearings, but with the present feeling, its continuance would only stir up bitterness, and I think that the best thing that can be done is to drop it right where it is, at least, for the present.

—●—
THE CRANE AND BINGHAM SMOKERS.

At the Mich. State Bee-Keepers' Convention, held in Lansing, a little more than a month ago, Mr. Bingham showed a smoker of exactly the same size as the one Mr. Crane sent me. It also had a bellows the same size as the Crane. His object was to show me that his smoker had a stronger blast than the Crane. The Bingham smoker certainly had the stronger blast. Mr. Bingham's idea is that the friction of the air in the tube, and

the two turns that it is compelled to make, robs the air of its force. It seemed to me that if all of the air in the bellows were forced into the fire barrel, the blast would be just as strong, although there might be more expenditure of force by the operator in overcoming the friction. The fact remained, however, that the blast of the Bingham was the stronger. It seemed to me that this was scarcely a fair test, as a smoker is used filled with ashes, coals and fuel. When the air is called upon to overcome this obstruction, I felt sure there would be a re-action from the Bingham, through the "cut off," and that the blast from the nozzle would be weaker. We stuffed the barrels of each smoker with wads of paper, and yet the blast of the Bingham was the stronger. Of course these tests were not exact. There was no instrument with which to test the strength of the blasts, and the Bingham smoker was new, while the Crane was old and composed of parts of several smokers put together, the obstruction caused by filling the smokers with paper could not have been exactly the same, the barrel of the Crane was rough from being covered with soot, while that of the Bingham was new and smooth. Allowances ought to be made for all of these things, yet the fact that the Bingham gave the stronger blast in all the conditions ought not to be overlooked. Mr. Bingham attributes the stronger blast to the lack of friction caused by the tube and turns of the Crane and to the air that is drawn in by the current in its passage from the bellows to the fire barrel.

I took the Crane and Bingham smokers with me last week over to the Ontario Bee-Keepers' convention and let Mr. Corneil take them. He is going to try and secure the use of an instrument for testing the force of blasts of air and test them together with a smoker of his own that is arranged with tubes between the bellows and the fire barrel after the manner illustrated in the October REVIEW, page 259. He will make a new barrel for the Crane, so that the soot will not have any effect in the trial.

I suggested that the smokers ought to be filled with planer shavings the same as when in use. Mr. Corneil admitted that that would be the fairer way were it not that it would be impossible to fill the smokers exactly the same, that is, so that the obstruction would be exactly the same in each. I will admit that this is true, but the obstruction would be so *nearly* the same, that in

actual practice there would be so little difference, and considering that this is the manner in which smokers are used, I wish that Mr. Corniel would try them in this way as well as empty.

After all, the best test for a smoker is actual use in the apiary. I have believed that the principle of the Crane is ahead of the cut-off, or Bingham principle, but if it isn't, I know that no one is more anxious than Mr. Crane to know it.

I expected to illustrate in this issue a smoker with a double bellows, one that would throw a continuous stream of smoke, but the cut did not come in time.



THE TRIP TO WASHINGTON AND SOMETHING ABOUT THE CONVENTION.

Christmas evening I took the train for the journey to attend the convention at Washington. Between here and Toledo I fell in with a commercial traveller. What good company these knights of the grip usually prove to be. They have been everywhere and seen everything, and know how to tell of it. And what stories they can tell. They know which are the best hotels. Not necessarily the highest priced ones, but those where a man can get the most comfort for his money. I would reach Toledo about midnight, and could not go on until morning. When I mentioned the fact, my companion told me without a moment's hesitation at which hotel to pass the remainder of the night. I found that I lost nothing by following his advice. When passing through Aurburndale (a suburb of Toledo) the temptation was very strong to leave the train and route out Dr. Mason and ask him how it would be about furnishing me with good company while on my journey. I knew the Doctor's good nature, but I disliked to get him up at midnight to ask a favor that might be answered in the negative.

7:30 the next morning found me in the last car of a train bound for Mansfield, Ohio. The steam pipes were frozen up and it seemed as though the brakeman would never get the coal fires to burn. After about two hours fruitless endeavor to get heat, the conductor decided to take the cold car for a smoking car. He said to the ladies: "Come into this car where it is warm." To the gentlemen he said: "If you wish to smoke, please go in the rear car." Nobody complained and everything was lovely.

Reached Mansfield about noon. The regular train to Pittsburg was four hours behind. A special train was put on, but there was no time to get any dinner. Half a dozen bananas of the train boy stayed my stomach until I reached Pittsburg in the evening, but I would not give much for the profit that was made off my supper.

The time of this trip was during the holiday rates on the railroads, and the cars were terribly crowded during the middle of the day. In such crowds it is interesting to one of a philosophical mind to see the exhibitions of human nature. It seems as though those who are travelling but a short distance make the most fuss over any little inconvenience, while those going long distances, or who are experienced travellers, seem willing to put up with a little inconvenience for the sake of keeping peace in the family.

Eight o'clock in the evening found me on board a Pullman sleeper at Pittsburg with no more changes to be made until I should step out in Washington the next morning. There is no way in which I so delight to travel as in a Pullman sleeper. The car is so nicely furnished and upholstered, has double glass in the windows to make it warmer and to keep out the noise. Then the ventilation and heat seem to be so excellent, and the car rolls along so smoothly. The gentle motion and the low monotonous noise has a soporific effect—something like a mother rocking her baby to sleep. The Pullman sleeper practically annihilates time and space. One goes to sleep in one city and wakes up in another 300 miles distant. The expense is not so very great. A room at a good hotel costs at least \$1.00, and a berth in a sleeper only \$2.00, and it must be a pretty poor business man whose time is not worth at least \$1.00 a day. There is one little thing that I don't like, and that is the fee that you are expected to give the porter. I don't mind the "quarter" so very much, but I object to the principle. If a man wishes his shoes blacked, and clothes brushed, and his grip carried, etc., it is all right to pay the porter for these services, but suppose that he does not care for these services, a custom that compels him to accept and pay for them is wrong, and I "kick;" I hide my shoes so that the porter can't find them, and when he comes around in the morning and asks to "brush me down," I say: "No, thank you, I can brush my own clothes."

"Why do I mention all these little things?" Because I am a little peculiar in this respect. When I am with a great crowd going to see some "show" I am always on the lookout for, and delight in finding, some little bypath or object that the crowd misses. For instance when in the great capitol building I happened to look down an open door into a basement room, and there I saw a workman with his dinner spread out before him, and I at once fell into a train of thought as to what kind of a home he had, and the loving hands that probably put up that lunch, etc. When Frank Benton was reading his paper he paid a glowing tribute to his wife. told how she stood by him through thick and thin, I could see the veins stand out on his forehead like whipcords, and there was a huskiness in his voice. It was a little thing, but it spoke volumes and put the man still higher in my estimation. It was the same when Mrs. Eugene Secor, who had stopped over one day at Baltimore to visit friends, came into the convention room, and a hearty hand shake a sort of confidential smile that passed between her and her husband showed how happily they must live.

But I must hasten on. What about Washington? Well, it isn't Chicago with its tall buildings, and the hustle and bustle of its commerce and manufactories, but it is a beautiful, clean, residence city. Its streets are wide and most of them covered with asphalt pavements, and oh, how clean they are kept! Men with great, wide, iron shovels, shovels that remind one of a huge dustpan with a long handle, are constantly busy on the streets. The moment that a bit of filth is seen upon the pavement it is at once scooped up and carried away. I even saw men busy with brooms *sweeping* the pavements. Washington is the paradise of bicyclers. Thousands and thousands of these silent travellers glide hither and thither over the smooth pavements. Nowhere have I seen more elegant "turnouts;" that is, fine horses, with silver mounted harnesses, glittering coaches, and colored drivers dressed in broadcloth and heads covered with "tall" hats. A view of Pennsylvania Avenue reminded me very much of scenes that I had seen in pictures.

The next morning after the convention was over a party of fifteen or twenty started out to "do" the sights. Of course the first thing was the capitol building. It is upon a rise of ground, and surrounded by stone ter-

aces and everything is so well proportioned that its great size is not so apparent. The building, as is the case with most if not all of the government buildings, is wholly of stone, marble and metal. Some of the rooms are simply elegant, with their pillars of variegated marble, floors of grey and white marble, walls of white marble interspersed with mirrors. Upon the walls in many places are historical paintings, showing the figures life-size. It is also interesting to visit the senate chamber and the house of representatives and see the spot where the laws of this great nation are passed. Many sought out the desk of the congressman from their district and had the pleasure of occupying his seat for a moment. I am so little of a politician that I actually did not know who was the representative from my district. From the steps of the capitol one gets a fair view of the city, while the clatter of the thousands of hoofs on the pavements comes up in a subdued roar that reminds a bee-keeper of the roar heard in an apiary at the close of a prosperous day's work at honey gathering.

From the capitol we went through the greenhouses with their various plants and trees gathered from all parts of the world.

The next place visited was the U. S. fish commission. Here is carried on the hatching of fish and sending them away to stock distant waters. To most visitors the most interesting feature is the "Deep Sea Grotto." This is a long room in which most of the light comes in through the aquariums ranged along its sides. The bottom of each aquarium is covered with pure white sand and gravel, then pebbles, pieces of rocks, shells, etc., are put in, and among them are marine plants and leaves of a long, thread-like nature. The plants are mostly of bright colors, such as green or crimson. In each aquarium are placed one or two varieties of fish. Some are quite peculiar. For instance the "flounder," that lies flat upon the bottom, and it requires sharp eyes to distinguish it from the gravel and sand at the bottom. Then there are shell-fish, toad-fish that resemble a toad without legs but furnished with a fish-tail. Here, I for the first saw some eels.

We next went to the National Museum and the Smithsonian Institute. Here are gathered together the most interesting things that it has been my lot to see. A dress suit of Washington, his writing desk and chair, etc., seemed to bring the past so near to the present. All the commissions received by Gen-

eral Grant may be seen. One of these was signed by Jefferson Davis. Different kinds of stones and their uses are shown, then the crystals are in another group, the metals in another, etc., etc. The different races of the world and their dress are illustrated by wax figures. Then there are groups of insects, of birds, of animals, etc. I was pleased to notice that the growth of a bee from the egg to the full grown bee was shown by specimens preserved in alcohol. A virgin queen and one just mated were shown. I must mention one specimen among the birds, that of the Rhinoceros Hornbill. It is a black bird as large as a good sized rooster. It has a red topnot and a long crooked bill that probably gives it its name of hornbill. It builds its nest in an opening in the side of a tree, the same as does our American wood-pecker. And now comes the peculiar part. When the female begins sitting, the male stops up the opening with mud, leaving a hole large enough for the prisoner to thrust out her bill. She, of course, must be fed by the male. The supposition is that the opening is closed to protect the nest and its contents from enemies. All this is illustrated by a model in wax, except that I think the bird on the outside, that was in the act of feeding his mate, was probably a stuffed specimen. Just as we were about to leave the building, one of the Washington friends who very kindly volunteered to show us about, said: "Mr. Root, wouldn't you like to see something from the other world?" "Certainly." He then led the way to where lay a specimen of an aerolite. It looked like a cross between a piece of cast iron and a lump of anthracite coal. It was marked: "1400 lbs." If this is its true weight, it is the heaviest substance I ever saw.

Our next visit was to the Treasury Department. It reminded me of a prison. There were the massive walls of stone, the low arched passageways, the grated iron doors, etc. The money is counted so many times, and passes through so many hands, each one doing only a small part in its manufacture, that theft is impossible. The redemption and destruction of mutilated or worn out currency is interesting. It is counted and re-counted, then large holes are punched through it, then it is counted again, then the bills are cut in halves, then each half counted separately by different persons, and at last it is put into a vat for maceration, and new bills issued in place of the old ones.

We went down into the vault where in one pile lay \$93,000,000 in silver dollars. They were in rough pine boxes, each holding a little more than half a bushel I should judge. These boxes were stacked up in a pile perhaps forty or fifty feet square and eight feet high. Around the pile was a grating of iron or steel. A narrow alley around the outside allowed one to walk around the pile. Through the courtesy of one of the officials, we were shown the room where the U. S. bonds are kept, and for the space of perhaps half a minute, the fingers that are now manipulating the keys of the type writer, held in their grasp U. S. bonds worth \$1,000,000!

The next visit was to the Art Gallery. The paintings and statuary were exceptionally fine. Among the latter I stood the longest before two little twin girls perhaps a year and a half old lying asleep, their curls intermingling, the head of one upon the shoulder of the other and her chubby arm throw over her sister. Two little feet peeped from under the covering that lay in folds so natural that I could almost imagine that it rose and fell from an imaginary breathing beneath it. The faces were alike but the crowning beauty was the expression of sweetness and innocence seen only in a sleeping child. The man who can put such expression into cold, white marble, is worthy of the name, *artist*. The painting from which I derived most satisfaction was the "Forester's Home." A room in a house built of logs. Guns, axes, and rude implements upon the wall. The forester, a man with a flowing grey beard, sits at the head of the table, a long pipe in his mouth, his head partly supported by a brawny hand, the elbow of that arm leaning upon the table. Upon the face an expression of extreme weariness enjoying a well-earned repose. Before a blazing fire in a fire-place knelt the wife attending to the roasting of some game, or something of that sort. At her side lay a dog, and the interested, earnest, "doggish" expression upon the dog's face was brought out so strongly by the bright firelight that it was hard to realize that it was only a picture. The effect of the ruddy glow upon the woman's face and on the folds of her dress was simply perfect.

The last place visited was the Washington Monument. I believe this is the tallest structure in this country—520 feet in height. I should judge it was fifty feet square at the base. Inside there is a winding stair way,

also an elevator that will take up thirty persons at once. It nearly always goes up full and leaves more waiting. It requires half an hour to make the round trip. I went up in the elevator and came down the stairs. The noise of the city does not reach the observer at the top. I never before realized the immense amount of "nerve" that it must require for an aeronaut to make a "drop" from a balloon. The people skating out on the Potomac looked like ants standing on their hind legs. Some fish ponds that seemed to come almost up to the foot of the monument, were found to be at least forty rods away. Railway trains going out of the city seemed to move at a snail's pace, but the motion of the side-rods to the engine showed that they were making fair speed. I suppose there was no danger in this aerial trip, yet I experienced a feeling of relief when I again placed foot upon mother earth.

Mr. A. I. Root and wife and Ernest Root and myself all started for home the same evening by the Pennsylvania route. When in the station I happened to think that that was the place where Garfield was shot. I asked the policeman about it and he pointed out the spot. Inlaid in the floor is a silver star about five inches in diameter.

Unfortunately, I passed through the beautiful mountain scenery of Pennsylvania, both in going and returning, in the night. We arrived at Pittsburg about nine in the morning. I had often heard this city called the "smoky city," but I was not prepared to find the smoke quite so thick. Switch lanterns are kept lighted all of the time as the gloom is so great that the signals cannot otherwise be seen. We passed near a church and I noticed that the top of the spire was scarcely visible. I suppose people living here are happy, but it does not seem as though I could be.

At Alliance, Ohio, Mr. Root's car branched off for Cleveland. I reached Mansfield at about four P. M. I found that my train would not be along until nearly midnight, and, as I was so tired, I stopped all night and went on the next day, reaching home without incident, at about nine in the evening.

As I caught a glimpse of my own humble home nestled in behind the evergreens, and saw my wife watching at the window, it seemed as though my trip away had been a dream from which I was just awakening. The baby stared at me in a surprised way for a moment, then broke out with a smile of

recognition. I was now enjoying the pleasant part of the trip—that of getting home.

What of the convention? As I expected, it was not largely attended. It was too far to one side of the country. It was like locating an apiary on the banks of Lake Michigan—the supply of nectar is cut off from one side. The attendance was mostly of prominent bee-keepers and the meeting was very interesting and profitable.

That old, knotty question of "grading of honey" was brought out and discussed with old-time vigor. When there seemed to be no chance for an agreement it was laid aside and then taken up at some future session.

There seems to be no use in having a superfine grade—one that is perfection. The dealers say they don't want, don't need it, and that it will work against the sale of the ordinary No. 1 honey. Two grades are a plenty, say the dealers, and after an almost endless discussion in which the matter was carefully gone over in detail, a modification of the Chicago grading was adopted. It reads as follows,—

FANCY.—All sections to be well filled; combs straight, of even thickness, and firmly attached to all four sides; both wood and comb unsoiled by travel stain, or otherwise; all the cells sealed except the row of cells next the wood.

No. 1.—All sections well-filled, but combs uneven or crooked, detached at the bottom, or with but few cells unsealed; both wood and comb unsoiled by travel-stain or otherwise.

In addition to this the honey is to be classified according to color, using the terms white, amber and dark. That is, there will be "fancy white;" "No. 1 dark," etc.,

I do not consider the above perfect, but I do think that it is the best system that has had the endorsement of the North American.

Self-hivers were discussed and it was brought out most clearly that any hive to be a success must allow the bees to return to the old entrance. E. R. Root had tried about a dozen last season. They were of the Pratt style in which the bees are hived in a hive below the old hive, the bees passing through this lower hive when at work, before they swarm. These hivers can be furnished for fifty cents. They will live the bees all right, but what *can* be done and what can be *profitably* done are two things. Mr. Root was not yet ready to encourage bee-keepers to invest largely in them until they had given them an extended trial.

"Adulteration of honey" was brought to the surface by a paper from Prof. Cook, in which he showed how the adulteration of honey by glucose or by cane sugar could be detected, but that the feeding of sugar to bees, or rather the bees, when sugar is fed to

them, change it to honey, and hence, he claimed, that this was not adulteration—that the product was truly *honey*—that the chemist could not detect it from floral honey. Prof. Wiley was present and took issue with the views of Prof. Cook. He admitted that he had not yet been able to detect "sugar honey," but asserted that he *could* do so. It would be done with the polariscope. Sugar syrup, at a certain temperature (just below the boiling point, I believe the Prof. said), is inactive in the polariscope. That is, it does not turn the polarized ray of light to either the right or the left. He was positive that the feeding of honey to bees would not change *this* characteristic. I cannot help wondering why the Prof. did not put to use this method. He was not prepared to accept Prof. Cook's definition of honey. He (Wiley) was not prepared to give a definition, but he felt sure that one characteristic should be that it came from the flowers. He admitted that the bees did change the cane sugar of nectar to the invert sugar of honey, but asserted that nectar was often composed partly of invert sugar. He agreed with the views put forth by Mr. Heddon at the late Michigan State convention, that commercial glucose is *healthful*. The objection to its use in adulteration is that it increases the amount of honey on the market and thus tends to lower the prices. He said that an ordinary person could not by the use of litmus paper or any ordinary process determine if honey is adulterated. It is a most delicate operation—one requiring high training, skill and proper apparatus. Prof. Riley said that considering the varied sources from which bees gather substances, and the difficulty of always knowing *exactly* what are these sources, he doubted if it would be possible to decisively settle some of these fine points.

Frank Benton very carefully and fully went over the ground of the introduction of Italian bees into this country. According to his statements, the U. S. government should have the credit for their importation. He gave an account of his journeyings in the East and his experience with the different races of bees. Then he gave the characteristics of the different varieties. These are so well known that I believe I will not take space to enumerate them. I will say, however, that Mr. Benton went into details more fully than I have known him to do on other occasions.

Last year, at Albany, a committee was appointed to see what could be done in the way of securing government aid to apiculture. This committee reported asking the following:—

1ST. That the section of apiculture in the Division of entomology, in the Department of Agriculture be raised to an independent Division.

2ND. That in connection therewith there be an experimental apiary established at Washington, having all the appointments necessary to a first-class, experimental station.

3RD. That the appropriation for this Division be sufficiently large so that work may not be embarrassed by the lack of funds.

C. V. Riley, government entomologist, read a lengthy paper showing what the government had done and what it could do for apiculture. He reviewed what had been done and said that much more might have been done if bee-keepers had put forth a united effort in bringing home to the head of the Department, and to those in charge of the general appropriations, the needs and just demands of the industry. He said, in substance, that what the government *can* do will depend greatly upon what sums Congress may see fit to appropriate for such investigations, and this will depend in turn, to some degree, upon what representations as to the needs of the industry and the possible benefits to the material interests of the country, are made to the head of the Department, to the committee on Agriculture, and to other members of Congress by their constituents. This is the matter in a nut shell, and in my opinion it is a matter for the Bee-Keepers' Union to take hold of. Prof. Riley's advice was that we make friends of the incoming Secretary of Agriculture and show him the importance and needs of Apiculture.

The scope of the Bee-Keepers' Union has been too narrow. Most of the men who put in their dollars never expected a cent of benefit in return. Last summer it was proposed to change its constitution so that its money and influence could be used in fighting adulteration. Soon it was seen that money might be needed to secure legislation favorable to bee-keeping. As *new* needs would be continually springing up, it was proposed to so change the constitution that the money and influence of the Union could be used for *any* purpose thought advisable by the advisory

board. The convention approved this change. There was not one dissenting voice.

Wm. F. Clarke sent a letter protesting against the incorporation of the North American. The grounds of his protest have been gone over so frequently in the journals that I will not repeat them. E. R. Root said that as the proposed change in the Bee-Keepers' Union, if adopted, would enable the Union to do the work that had been in view when the North American was incorporated, it might be well, inasmuch as incorporation had alienated us from our Canadian brethren, to have the incorporation abandoned. But this was an important subject and ought not to be decided hastily, hence he moved that the matter be laid on the table until the next meeting with a view of giving it favorable consideration at that time. Carried.

Dr. C. C. Miller was elected President; J. E. Crane Vice President; Frank Benton Secretary; and Geo. W. York Treasurer. The next meeting is to be in Chicago. Most excellent men have been elected as officers; the place of meeting could not well have been elsewhere, and in all probability the next convention will surpass all previous ones. It is proposed to hold it early in October.

EXTRACTED.

How to Use the Solar Wax Extractor, and How to Get the Wax Out of the Residue, or "Slumgum."

To be able to get all of the wax out of all kinds of combs is quite a trade, and all such articles as the following written by R. C. Aikin, and published in *Gleanings*, ought to be read and studied by all who have much wax to render:

"I read with interest H. R. Boardman's article on p. 771, also the offer you make in your foot-note. I want you to make your test thorough. Surely much wax remains in the refuse when it makes so good a fire. Sometimes, however, its burning quality might come from propolis, which is almost equal to wax for fuel.

Last spring we had a lot of stocks to transfer, both with and without frames; also a like lot of hives in which the bees winter-killed. In all these the honey was from one-fourth to three-fourths candied. Nearly all of them were old combs, some very old, and many with pollen. Then the query was, how to get this separated into feed honey, wax,

and slumgum. We could not feed the honey by letting the bees carry it out of the combs, for they would waste the bulk of the candied honey by 'kicking it out of doors.' The honey thus wasted would be worth more than the combs or wax. To render by steam or water applied directly would waste much honey; so dry heat, by means of solar wax-extractor, seemed the best way to do it.

My heart was set on having a jumbo solar (it's set yet, only more so than before); so, early in April I bought some double-strength glass, cut from broken store-windows, show-cases, and such. It cost me \$2.50 at the price of single-strength glass, and made a sash about 2 ft. 10 in. x 6 ft. 6 in., and I very soon had a solar wax-extractor at work in the yard. The thing is built on wheels, two at one end and one at the other, one of them being pivoted like a bed-castor. This makes it convenient to pull about, and to wheel into the honey-house to unload and reload when robbers are bad. From April to October that extractor has been at work, and has turned out over 300 lbs. of wax and over 1000 lbs. of feed honey that was mostly candied in the combs. The wax is No. 1 in quality.

After accumulating two or three barrels of the refuse I experimented on it. Some was soaked four weeks in water, and cooked by steam applied direct. Some was soaked several days in a mixture of water and concentrated lye, so strong it was a slick, soapy mass, and it was cooked by steam applied direct, with the mass in a bran-sack. I used steam under pressure, and turned a jet of steam into the center of the mass. I tried first by having a false bottom made of slats about six inches from the bottom of the barrel, and the sack in this, so the wax would drip below and run out at the bottom. This brought out some wax, but left plenty to make a good fire. I then plugged the hole at the bottom of the barrel, and filled the barrel with water, so that the whole mass was submerged. I then applied the steam-jet as before—that is, to the center of the mass in the sack. The jet was applied for nearly half a day, with stirring, turning, and prodding the sack. As fast as wax would accumulate on the water it was skimmed off, until it seemed that scarcely a bit could remain in that sack. I then took the sack out. At first it contained about four bushels of the slumgum: but now it was reduced by washing out pollen, etc., until it was about a bushel. I then put it under moderate pressure. This caused the wax to flow "from every pore," resulting in one or two pounds more of wax. I then again put the whole mass into cold water, when the wax appeared in small grains throughout the whole mass, about as butter does just as it begins to gather when being churned. I now have a barrel of this refuse soaking in lye-water, and will experiment to see what wax can be gotten from it.

The refuse used in these experiments was the result of rendering over 200 lbs. of wax, using mostly those old combs and hive-scrapings, etc. The result was something over 20 lbs. of wax that was much darker than the first, as gotten by solar heat. Both because we had to keep the solar extractor

going in order to get our comb all rendered, and because we expected to subject the refuse to the second process, it was not as thoroughly drained in the solar as it might have been. However, the wax received from it paid about \$2.00 a day for the time engaged in putting it through the process.

I am confident that neither the solar nor steam process comes near getting the wax all out. Old combs, pollen-filled, together with dead bees and such, make such a mass of refuse that a great amount of wax is retained in it, in spite of all my efforts so far to remove it. I find, however, that we need a large solar extractor, and then not load it too heavy. If the refuse be drawn back to the upper end, and spread out thinly on a rather steep incline, and left there a few days in the hottest weather, and for about four weeks when not so warm, very much wax will eventually be drained out that cannot be gotten out in two or three days' time. If the solar extractor be large enough, and the stuff left in it long enough, I think more wax will be extracted than by steam or water. The feed honey alone that can be obtained by using a solar extractor abundantly pays for the instrument, besides the other points of advantage. But what I want to know is an equally cheap method of getting the rest of that wax out of the slumgum.

R. C. AIKIN.

Loveland, Col., Nov. 7, 1892.

The editor of *Gleanings* comments as follows:

[Your experiments are interesting and valuable, and we believe the results at which you arrived are correct, as they confirm to a very great extent our own. From old tough and black combs it is exceedingly hard to get the wax all out. The Dadants recommend first pulverizing them during cold freezing weather. At that time, being very brittle, they will work up very fine. Now, then, the best way to render this, so far as we know, is to spread this pulverized comb thinly over the bottom of a large solar wax-extractor. Allow it to stand that way for several days in the hot sun, stirring it occasionally in the mean time, so as to present new surfaces to the sun. After it seems to have drained out all the wax there is in the slumgum, clean out the extractor, put the contents into the slumgum box or barrel, and be sure to cover it tightly, because the moth-worms will very soon begin to work on it. After a barrel or so has accumulated, put it into a cheese-cloth (or, preferably, burlap) bag, as large as can conveniently be put into a receptacle in which it is to be further treated with hot water slightly acidulated with sulphuric acid. Get the water to boiling, and with a stick punch the sack under water; and as the wax rises, skim it off on the surface of the water. Last of all, remove the sack with its contents from the boiling water; quickly place it in a press; squeeze it, putting on all the pressure possible, and considerably more wax will ooze out in small pellets.

The solar wax-extractor will take out perhaps nine-tenths of the wax; but there is yet

that tenth, which must be removed, as far as possible, by the agency of hot water, sulphuric acid, and the wax-press. Even then there is a little left that may be removed by continually working at it, but it is a question whether it is worth the time consumed in doing it.

THE RESULT OF THE EXPERIMENT ON THE BOARDMAN SLUMGUM.

Referring to the slumgum of H. R. Boardman, and our challenge to him to send on a couple of bushels and we would prove there was wax in it, we have this to say: He sent on the slumgum, and by the scales it weighed about 25 lbs. We put it through the "mill"—that is, sulphuric-acid treatment—in connection with the wax-press. Well, how much wax do you think we secured? *Just one pound!* We scarcely know whether Mr. Boardman or ourselves have the better of the argument. He may be surprised that we got so much, and on the other hand we are surely disappointed in getting no more. On this basis we should get about 3 lbs. of virgin wax from perhaps a barrel of Mr. Boardman's slumgum. If there is one thing that we have proven, it is that Mr. Boardman's large solar wax-extractors do the work very much more thoroughly than we had supposed; and we can account for the stuff making such good fuel, only on the ground that it must have contained a large amount of propolis, as Mr. Aikin suggests above. It is well known that propolis melts at a much higher temperature than wax, and it is possible that the heat of the solar wax-extractor is not sufficient to have any perceptible effect on it. It is, therefore, left nicely distributed through the refuse.]”

Civilization Versus Apiculture.

Oh, that inimitable Hasty! What a bright, fresh, original, unique way he has of putting things. A great many times we have been told in the straight-forward, indicative mood that after civilization had reached a certain stage, its onward progress was in opposition to that of bee-keeping, but how much clearer is the truth when brought out in that figurative, picturesque, *Hasty*-language found in the following clipped from the *C. B. J.*:

“The axe of civilization cuts down the trees, and *presto*, the basswood honey is gone, the tulip honey is gone, and the game is gone; and the Indian and the bee-keeper have a polite hint to go elsewhere. The Indian goes; the bee-keeper looks ruefully after him, but thinks that, as for himself, he will hang on a little longer. Civilization puts the pasture lands under the plow; the flocks and herds ‘go west’ like the poor Indian; likewise the helianthus and the fireweed, the thistle and the golden-rod, prepare to fold up their tents like the Arabs and silently steal away! Civilization brings in fertilizers and improved methods, ‘makes two

blades of grass grow where only one grew before—all very fine; but, alas, those two blades of rank grass pinch out the white clover so that it has no place to spread its crystal banquet for the bee. Then, indeed, the bee-keeper begins to wonder how his good prototype, 'Lo, the poor Indian' is getting along out west, anyhow. But civilization is not done with her incursions. The relentless jade whispers to the farmers that so many fences are expensive and useless, and directly three-quarters of them disappear. No more the face of nature is mapped off with latitude lines and longitude lines of nodding wild flowers. The fence-rows were the Indian reservations of our bees, and the cruel white woman takes them away. To make a clean sweep she whispers again to the farmer, and says, 'Now the fences are out of the way, why not slick up the roadsides, and exterminate the weeds that grow there?' 'Sure enough,' says the submissive farmer, and proceeds to run his mowing machine up and down the roads two or three times each summer, while the bee-keeper looks on with impotent wrath.

What are we going to do about it, brethren? go on the warpath with knives and tom-kawks? pull out the axle pins of the car of progress, and break the axle? What shall we do? Shall we think to restore matters by scattering seeds, and introducing new honey plants? Where shall our new honey plants find a place to grow, pray tell, when the commons and pastures are all under plow? Shall we find a honey plant with vim enough to grow in the farmer's cultivated fields in spite of him? If we find it, will we be wicked enough to introduce it? If we are wicked enough to introduce it, will not the dogs of the law be after us? In regard to botanical efforts of all sorts. I think the faith of intelligent apiarists is getting weak. We have accomplished but little, and that little is spoken against; and in the immediate future we are likely to accomplish still less.

Is it giving away seed of alsike and buckwheat that we will place our hopes upon? Too costly; and our profits, either present or prospective, are not equal to the requirements. Moreover, while one bee-keeper can largely increase the amount of buckwheat raised in a particular neighborhood, bee-keepers as a whole cannot very largely increase the buckwheat average as a whole. The laws of demand and supply are going to regulate that in spite of us. And immense areas of country find buckwheat a plant which yields very little honey, save in exceptional years and at long intervals. In regard to alsike, matters are on a somewhat different basis. Alsike reciprocates with common clover—the more alsike the less clover—and it could be very largely increased if an advantage could be proved. Where farmers find alsike much the more advantageous of the two they will raise it—but where's that, pray? The clovers are wanted mostly as manure plants—nitrogen traps—and alsike can hardly compete with red clover in the amount of roots which it furnishes to rot in the soil?

Shall we look to the red clover as our help, and hope to modify its tubes, and so secure

its treasures of nectar? That scheme is indeed alluring, and my name has been associated with it more or less. But I for one am not getting on very fast; and I hear of no one doing any better. I have a clover that bees can probe to the bottom, but it almost totally refuses to bear seeds; and the seedlings, when I get them, most of them backslide and become mere ordinary clovers. Furthermore, we don't know whether the clover insects are going to hold the fort like the potato bug, or whether they will let up after a while. They seem capable of preventing any honey, or any bloom either, on the clover. At best our hope from this source is slender and distant.

Then how about alfalfa? No go, is to be feared, for moist climates—grows poorly, and the blossoms have no honey in them. Shall we look forward to the time when public and private plantations of trees will have to be made, and try to have honey trees preferred? Long while to wait. When the time comes it looks as though the pine would be planted rather than the basswood and tulip, the oaks rather than the maples and gum trees, and the black walnut rather than the wild cherry. Agitation at the right time, by the right persons, might avail something toward having the right kind of trees planted; but how often is the proper time and proper influence let slip! This anchor is rather too much like an anchor in Amsterdam, when the good ship is drifting on the rocks near by.

What else have we to look to? There are the roadsides. We might get some basswoods planted along the roads if we tried hard; but not many, I fear, now the new methods have come in; be in the way of the farmer's mowing-machine, and shade his border. 'The blues,' did I hear the editor say? Yes, this is a blue article; but when a fellow looks for a few moments through blue spectacles why not have them as blue as ever he can. You, Canadians, up there are one tribe, and we down here in Ohio are another tribe. Your tribe has not as yet suffered as much from the incursions of the 'white woman' as ours has; but your turn is right at hand. She'll never be 'asy' till she has the last honey weed exterminated and the last white clover supplanted by some better forage plant. And she'll hardly make haste to plant a basswood tree till she has the last old one down. There's no peace for us unless we flee to the mountains, where she cannot run her plow, else go to the alfalfa regions, else do—something desperate. Shall we do something desperate then? The 'to bee' and 'not to bee' seems a trifle inclined to hover around that question.

E. E. HASTY.

RICHARDS, Ohio.

Nov. 7th, 1892.'

There is truth as well as poetry in the foregoing. It may be an unpleasant truth, and that is why it is so ignored. We never admit an unpleasant truth until forced to do so. Men who have made a grand success of bee-keeping in years past and gone, still cling to it in the same loved spot long after the bass-

woods have been cut away and white clover pastures have given way to the corn field or potato hill. No wonder their nopes are blasted. The few poor years that we have been having of late cannot be wholly attributed to civilization, as the supply was cut off too squarely. The results of civilization come about gradually. The man who has had good crops for many years in succession, with perhaps an occasional failure, up to five years ago, and has not had a good one since, cannot ascribe his failure to civilization, unless some radical changes have been made in his vicinity during that time.

The man who is trying to make a success of bee-keeping as a specialty in an old settled country where nearly all of the woods have been cut away, and the country almost wholly given up to cultivated crops, with no swamps, no river bottoms, no mountains (that cannot be plowed up) near, is soon destined to reach that point where, as friend Hasty puts it, something "desperate" must be done. I do not wonder that the fertile brain of Bro. Hasty suggested the raising of "sugar-honey."

Bees at the World's Fair.

Bro. Hill of the *Guide* makes some very sensible suggestions as to how bees ought to be exhibited at the World's fair. Among other things he says:--

"It is our opinion that the only way to exhibit bees and make it at all convenient and educational is to use single comb observatory hives, confining the bees as long as they are bright and healthy and then change for a fresh comb and bees. Possibly wire cloth would be better than glass, or perhaps glass on one side with wire cloth on the other would be advisable during hot weather. The people could then see the queen, drones and workers, brood in all stages, eggs and pollen, while the experts accustomed to these sights could judge of quality by comparing the contents of different hives. A good light will be of the greatest importance. A lot of large observatory hives, arranged along the wall of a building in such a manner that the bees could pass through the wall and fly out over the heads of the people would hardly be satisfactory or safe. A colony of bees can easily and safely be taken away from their natural stands, away from home, and be opened up and exhibited in a crowd of people. But to place a lot of bees permanently and bring the people up near or under them would certainly be quite risky. Each colony would probably contain 40,000 workers and there would be a number of colonies. Enough bees, if they got mad, and wanted to do it, to take possession of the whole fair and run it to suit themselves. When a bee is mad and at home or defending its home, it is not at all

particular about distance, and might go a number of rods to sting some one. The safe way is to confine all the bees. To show the quality and beauty of the light colored bees it would be nice to have the specimens confined between wire cloth and glass with no comb at all. By looking through the cages towards the light the best kind of a view and test of color and markings could be had. No doubt all the queen breeders in the United States, who breed especially good stock, would be glad to furnish a fresh sample by mail every ten days, or as often as it would be necessary to keep them bright and fresh, if some one was engaged to receive exhibits under the owner's name and care for the bees. Such a plan would be without expense to the fair association."

Advantages of Shallow Sections.

Bee-keepers have pretty generally settled down to the use of the $4\frac{1}{4} \times 4\frac{1}{4}$ section. Is this the best size? It was first used that eight sections might exactly fill a wide frame of the Langstroth size, but that method of using them is now but little used, and the only reason for continuing that size is for the sake of uniformity. Are there enough advantages in some other form or size to warrant a change? Bro. Hill of the *Guide* has been using a long, shallow section, and here is his opinion:--

"We have been experimenting the past season and have all our honey in sections $3\frac{1}{2}$ deep by $6\frac{1}{4}$ inches wide and we find so many advantages with this shape over the square $4\frac{1}{4} \times 4\frac{1}{4}$ section that we have gotten clear off the track both in regard to shape and width. We favor the narrow section without separators. The three inch deep pound section has the advantages over the four inch in the following particulars: It is longer on top and gives more support to the foundation starters. A $2\frac{1}{2}$ inch piece of thin foundation stays better than a $3\frac{1}{2}$ inch piece. It makes one less division in the surplus department. When tiered up a three inch lift is better than a four inch because four inches all over the top of the live is too much space to give a working colony at one time. The three inch section is finished and capped over quicker, can be taken off quicker and this insures nicer and whiter honey. The three inch section has such a long firm hold on the top and being more shallow stands shipping better. Customers seem to choose the long section in preference to the square one when buying honey. We are so well pleased with this shape and its advantages are so great that we would not use a $4\frac{1}{4} \times 4\frac{1}{4}$ inch section in our apiary if some one would donate them free. It would be more profitable to pay for the three inch ones. The above facts seems too bad, just as we have established the $4\frac{1}{4} \times 4\frac{1}{4}$ section as the standard shape and only propose to discuss the width. It may be best to consider the whole question."

ADVERTISEMENTS

Quigley's Golden Queens are bred for business. Try one. Circular of Queens and Bee Supplies ready Feb. 1st. Send for it and a free Sample Copy of the "PROGRESSIVE BEE-KEEPER."

Address, E. F. QUIGLEY,
Unionville, Mo.

DON'T SEND

Across several States after Goods that can be bought just as cheaply near home, but write to

GREGORY BRO'S & SON,

Ottumwa, Iowa, for their large, 12-page, illustrated catalogue of everything needed in the apiary—Hives, Sections, Shipping Cases, Smokers, Foundation, Bees, Queens, Bee Veils, etc., etc., etc.

HUNT'S

FOUNDATION

FACTORY.

Send for free samples of foundation and sections; warranted good as any made. Dealers, write for special prices and the most favorable conditions ever offered on foundation. Send for new, illustrated, free price-list of a full line of supplies.

M. H. HUNT,
Bell Branch, Mich.
1-93-tf

Early Queens From Texas,

From my choice golden stock. My bees are very gentle, good workers, and beautiful. Safe arrival and satisfaction guaranteed. One untested queen, April and May, \$1.00; six for \$5.00; later, 75c. Orders booked now; money sent when queens are wanted. Send for price list.

J. D. GIVENS,
Lisbon, Texas.
1-93-9t. Please mention the Review.

Muth's HONEY EXTRACTOR
PERFECTION
Cold-Blast Smokers,
Square Glass Honey Jars, Etc.

For Circulars, apply to CHAS. F. MUTH & SON,
Cor. Freeman & Central Aves., Cincinnati, O.
Send 10c. for Practical Hints to Bee-Keepers.

1-93-tf. Please mention the Review.



Interesting Monthly for
The Family and Fireside
Welcome in every Home.
—o—
Large Premiums for Clubs.
Sample Copy sent Free.
—o—
THOMAS G. NEWMAN,
147 South Western Ave.,
CHICAGO, ILLS.

Please mention the Review.

Leather Colored

HONEY QUEENS, from Imported Mother, warranted purely mated, after June 10th, at \$1.00 each; six at one time, \$5.00. Untested queens, 75c. each. Address

C. A. BUNCH,
Nye, Marshall Co., Ind.
1-93-7t.

Please mention the Review

—If you are going to—

BUY A BUZZ-SAW,

write to the editor of the REVIEW. He has a new Barnes saw to sell and would be glad to make you happy by telling you the price at which he would sell it.

ITALIAN QUEENS

Bred for Business. Gentleness and Beauty. Untested, 80c. each; three for \$2.25; six for \$4.00; 12 for \$7.50. Tested, \$1.25. Select tested, yellow to the tip, breeder, \$1.50. Will commence shipping April 15th. On all orders received before March 1st, accompanied by the cash, 10 per cent discount. Safe arrival guaranteed.

G. E. DAMSON,
Carlisle, Sonoke Co., Ark.
1-93-2t.

Please mention the Review.

If You Wish Neat, Artistic

PRINTING,

Have it Done at the Review.

ITALIAN QUEENS AND SUPPLIES FOR 1892.

Before you purchase, look to your interest, and send for catalogue and price list.

J. P. H. BROWN,
Augusta, Georgia.
1-88-tf.

Please mention the Review.

Names of Bee - Keepers.

TYPE WRITTEN.

The names of my customers, and of those asking for sample copies, have been saved and written in a book. There are several thousand all arranged alphabetically (in the largest States), and, although this list has been secured at an expense of hundreds of dollars, I would furnish it to my advertisers at \$2.00 per thousand names. A manufacturer who wishes for a list of the names of bee-keepers in his own state only, or, possibly, in the adjoining states, can be accommodated. Any inquiry in regard to the number of names in a certain state, or states, will be answered cheerfully. The former price was \$2.50 per 1000, but I now have a type writer, and, by using the manifold process, I can furnish them at \$2.00. W. Z. HUTCHINSON, Flint, Mich.

Queen Dealers,

Write for prices on fine, golden, Italian Queens from Mar. 15 to Nov. 15, 1893. Best colonies last year gave 200 lbs. Average this year was 125 lbs. per colony, besides drawing heavily on them for queen rearing. J. B. CASE, Port Orange, Fla. 11-92-tf

Please mention the Review.

EVERY one in need of information on the subject of advertising will do well to obtain a copy of "Book for Advertisers," 368 pages, price \$1.00. Mailed, postpaid, on receipt of price. Contains a careful compilation from the American Newspaper Directory of all the best papers and class journals; gives the circulation rating of every one, and a good deal of information about rates and other matters pertaining to the business of advertising. Address ROWELL'S ADVERTISING BUREAU, 10 Spruce St., N. Y.

IMPORTANT TO BEE-KEEPERS!

To make a success of bee keeping, you want bees that will give the very best results. My *Golden Italians* have gained a good name on their own merits. Those who have tested them with other bees say "they are the best honey gatherers, cap their honey the whitest, as gentle as butterflies, beautiful to look at, are the largest and strongest bee of all the races." Queens bred from mothers that produce uniformly marked

FIVE-BANDED WORKERS

In March, April and May. \$1 25 each, 6 for \$6.00; June, \$1 00 each, 6 for \$5.00; July to Nov., \$1.00 each, 6 for \$4.50. Special prices on large orders. For full particulars send for descriptive circular. 12-92-tf

C. D. DUVAL.

Spencerville, Montg. Co., Maryland.

Please mention the Review.

Have You Seen Our Big Blue Cat-

ALOGUE FOR 1893? Seventy illustrated pages Sent FREE to any bee-keeper. **BEE-SUPPLIES**, at retail and wholesale. Everything used in the apiary. Greatest variety and largest stock in the West

1-93-tf. E. Kretchmer, Red Oak, Iowa.

Please mention the Review.

DO NOT GIVE YOUR ORDER FOR SECTIONS UNTIL YOU GET OUR PRICES ON THE

"BOSS" ONE-PIECE SECTION



We are in better shape than ever to fill orders promptly. Also,

DOVETAILED HIVES, - - - - -

- - - FOUNDATION, SMOKERS, ETC.

Write for Price List.

J. FORNCROOK & CO.

WATERTOWN, Wis., Jan. 1, 1893.

1-93-tf.

THE

COMET

DID NOT STRIKE

THE AMERICAN APICULTURIST nor the BAY STATE APJARY; but it strikes us that every reader of this will find each copy of the API worth \$5 in 1893. Yet we send twelve copies and one of our latest IMPROVED DRONE TRAPS, by mail, for \$1.10.

Send your address for a free sample copy of the API and read about the good things in store for those who subscribe.

REMEMBER that every subject connected with bee culture is treated in the API, by the ablest authors.

Our 18-page Circular now ready to mail. Circular will tell you all about the PERFECTION SELF-HIVER that automatically hived two swarms of bees for the editor of the REVIEW in 1892. Address

HENRY ALLEY, Wenham, Mass.

THE CANADIAN

Bee Journal,

Poultry Journal,

EDITED BY D. A. JONES

ED'TD BY JNO. GRAY.

\$1.00 a Year.

\$1.00 a Year.

These are published separately, alternate weeks; edited by live, practical men and contributed to by the best writers. Both journals are interesting and alike valuable to expert or novice. Both illustrated and improved. Under new management. Address BEETON, ONT., Canada.

Please mention the Review.

Barnes' Foot and Hand Power Machinery.



This cut represents our Combined Circular and Scroll Saw, which is the best machine made for Bee Keepers' use in the construction of their hives, sections, boxes, etc.

8-91-16t

MACHINES SENT ON TRIAL.

FOR CATALOGUE, PRICES, ETC.,

Address W. F. & JNO. BARNES CO., 384 Ruby St., Rockford, Ills

IF YOU WANT THE

BEE BOOK

That covers the whole apicultural field more completely than any other published, send \$1.00 to Prof. A J. Cook, Agricultural College, Mich., for his

Bee-Keepers' Guide.

Liberal Discounts to the Trade.

Closing Out Sale.

No. 1 Sections \$2.50 per 1,000. Full colonies bees in 8 frame, L hives, with plenty of stores. \$4.00. Everything cheap W. D. SOPER, 11-92-tf Jackson, Mich.

We have a large lot of

DOVETAILED HIVES

which we will sell for 50 cts. each, including supers, section holders and brood frames. This offer is limited to this lot of hives. 1-92-12t

WM. H. Bright, Mazeppa, Minn.

HATCH CHICKENS BY STEAM
With the Improved **Excelsior Incubator.**



Simple, Perfect, Self-Regulating. Thousands in successful operation. Guaranteed to hatch a larger percentage of fertile eggs at less cost than any other hatcher. Lowest priced first-class hatcher made.

GEORGE H. LARUE, Quincy, Ill.

Circulars free. Send 6c. for Blue Book.

\$1.00 HIVE.

A Complete Hive for Comb Honey, including Six Section Holders, Eight Thick Top-Bar Frames, Half-Story Body, Bottom Board and Cover, \$1.10 each; in flat, \$1.00 each.

Hoffman Frames, Sections, Foundation, and a Full Line of Bee-Keepers' Supplies.

A 20-page Price List Free. 12-92-12t J. M. KINZIE, Rochester, Oakland Co., Mich.

Please mention the Review.

TYPEWRITERS.

Largest like establishment in the world. First-class second-hand instruments at half new prices. Unprejudiced advice given on all makes. Machines sold on monthly payments. Any instrument manufactured shipped, privilege to examine. EXCHANGING A SPECIALTY. Wholesale prices to dealers. Illustrated Catalogues Free.

TYPEWRITER } 31 Broadway, New York.
HEADQUARTERS, } 186 Monroe St., Chicago.

Please mention the Review.

PATENT. WIRED, COMB FOUNDATION

HAS NO SAG IN BROOD FRAMES.

THIN, FLAT BOTTOM FOUNDATION

HAS NO FISH BONE IN SURPLUS HONEY.



Being the cleanest is usually worked the quickest of any foundation made.

J. VAN DEUSEN & SONS, (SOLE MANUFACTURERS), 3-90-tf Sprout Brook, Mont. Co., N.Y.

IF you wish to advertise anything anywhere at any time write to GEO. P. ROWELL & CO., No 10 Spruce St., N. Y.

Please mention the Review.

Cheap Freight and Quick Transportation.

Being located at the most central point of railroad and express companies enables us to furnish bee keepers with supplies at less cost to themselves than any house in the country. We furnish everything needed in the apiary, as low as the lowest and as good as the best.

COOK'S COMPLETE HIVE combines all the most approved methods of hive making. It is a complete arrangement for out-door wintering and is equally well adapted to producing comb or extracted honey. Send for circular. Fine lot of **Bees for Sale** cheap.

J. H. M. COOK, (SUCCESSOR TO KING & ASPINWALL) 78 Barclay St., New York City.

HILL'S SMOKER and FEEDER.

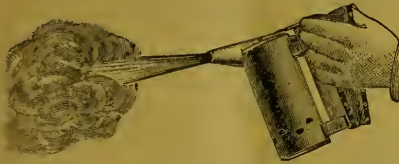

Smoker burns hard wood chips without special preparation. Very reliable. Greatest smoking capacity. Easiest to start. Cheapest because it saves time. Price, \$1.20. By mail, \$1.40. Per dozen, \$10.80.



Best Bee - Feeder. Most convenient. Saves feed. No daubing or drowning. Two to seven feeders full may be given a colony at one time which will be stored in the combs in ten hours. Price, per pair, 30c.; by mail, 40 c.; per doz., \$1.60. Has a sale of 2,000 per month. Address A. G. HILL, Kendallville, Indiana.

These smokers and feeders are kept in stock by Thos. G. Newman & Son, Chicago, Ill. G. B. Lewis & Co., Watertown, Wis. W. H. Bright, Mazeppa, Minn. Chas. Dadant & Son, Hamilton, Hancock Co., Ill. E. Kretschmer, Red Oak, Iowa. H. McWilson & Co., 202 Market St., St. Louis, Mo. F. H. Dunn, Yorkville, Ill. W. D. Soper & Co., Jackson, Mich. Chas. A. Stockbridge, Ft. Wayne, Ind. A. F. Fields, Wheaton, Ind. W. S. Bellows, Ladora, Iowa. E. F. Quigley, Unionville, Mo. Gregory Bros., Ottumwa, Iowa. Miller Bros., Bluffton Mo. G. K. Hubbard, Ft. Wayne, Ind. Theodore Bender, 18 Fulton St., Canton, Ohio. Muth and Son, Cincinnati, Ohio. Levering Bros., Wiota, Cass Co., Iowa.

“FLORIDA.” — 300.

LEATHER-BACK ITALIAN QUEENS.

By my special method of taking a crop of honey by the “**Migratory**” system, I shall have **300 tested** queens for delivery about March 20th. Prices \$10 per dozen. None over six months old. My crop the past season from one yard of 42 colonies, spring count, was 10,800 pounds and increased to 150.

A. F. BROWN,

Huntington, Putnam Co., Fla.

1-93-4t

Please mention the Review.



QUEEN CAGES

Are my specialty. I make the Benton cage in many styles and sizes. A light cage saves postage; a neat cage creates a favorable impression; one properly arranged carries its occupants safely in either hot or cool weather; and my special machinery and large trade enable me to furnish extra nice cages, having all these advantages, at a very low price. Sample cages and prices on application.

C. W. COSTELLO, Waterboro, Me.



Bingham's Perfect Safety SMOKER.

Pat. 1873; Re-issued 1882. Pat. 1892

No more soiled sections, burned fingers, or burned Apiary. Any large advertiser of Bingham Smokers will send you a Perfect Doctor, Perfect Conqueror, or Perfect Large Smoker, if you will send to him 25 cts. more than the regular mail price, and ask for either of the three sizes mentioned.

Bingham & Hetherington, Abronja, Mich.

Bee Hives and Section Boxes.

Simplicity, Langstroth-Simplicity, Standard Langstroth, Dovetailed and Champion Chaff Hives, Supers, One Piece Sections and Shipping Cases. Foundation, Smokers, etc., etc. Send for 16-page Circular.

1-92-tf

PAGE & KEITH, New London, Wis.

Please mention the Review.

BASSWOOD HONEY, Extra Quality.

USUAL LOW PRICES.

Address

JAMES HEDDON,

Dowagiac, Michigan.

QUEENS, QUEENS, QUEENS.

—:O:—

Have you tried my Italians? I have the finest bees you ever saw; they are leather colored Italians, and as honey gatherers they can't be excelled. Try them and be convinced. They are very gentle and hardy and good winterers. Untested queens, \$1.00 each, or \$9.00 a dozen. Tested, \$1.50 each, or \$12.75 a dozen. Safe arrival and satisfaction guaranteed. On all orders received before March 1st, accompanied by the cash, a discount of 15 per cent. will be given. Send for price list of Italian Queens and Bee-Keepers' Supplies M. H. DE WITT, Sang Run, Garrett Co., Md.

1-93-9t.

Please mention the Review.

Great Reduction.

SECTIONS AT GREATLY REDUCED PRICES.

HIVES, SHIPPING CASES, &c., AT BED-ROCK PRICES.

WRITE FOR FREE, ILLUSTRATED CATALOGUE AND PRICE LIST.

G. B. LEWIS & CO., Watertown, Wis.

1-93-tf. Please mention the Review.



For Simplicity and Durability

Bingham Patent Smokers,

AND

BINGHAM & HETHERINGTON

Honey Knives,

ARE WITHOUT QUESTION

THE BEST ON EARTH!

Doctor Smoker,	3/4 inch,	2.00
Conqueror Smoker,	3 "	1.75
Large Smoker,	2 1/2 "	1.50
Extra Smoker,	2 "	1.25
Plain Smoker,	2 "	1.00
Little Wonder Smoker,	1 1/4 "65
Bingham & Hetherington	Knife,	1.15

Upon receipt of price, Smokers or Knives will be sent postpaid. Descriptive Circular and Testimonials sent upon application.

BINGHAM & HETHERINGTON,

1-90-tf. Bronia, Michigan

1893.

ELEGANT CALENDAR FREE.

We will send one to every bee-keeper asking for our New Illustrated Catalogue for 1893 and a copy of

THE AMERICAN BEE-KEEPER,

If you mention this paper.

Samples of the **Falcon Sections** for 2c. stamp.

THE W. T. FALCONER Mfg. CO.,

Jamestown, N. Y.

BERRIES.

Friends, I can furnish you with all kinds of Berry Plants, at about one-half the usual price. Plants warranted. Bank references Satisfaction guaranteed.

Address
1-93 2t.

EZRA G. SMITH,
Manchester, N. Y.

Illustrated Advertisements Attract Attention.



Cuts Furnished for all illustrating Purposes.

1852.

REDUCTION ON THE PRICE OF

1891.

Langstroth on the Honey Bee.

(REVISED.)

PRICE BY MAIL, \$1.40: BY EXPRESS OR FREIGHT WITH OTHER GOODS \$1.25.

By its copious indexes, by its arrangement in numbered paragraphs, including reference numbers on any question in bee culture, any information can be instantly found. This book is the most complete treatise on bee keeping yet published. A FRENCH EDITION JUST ISSUED.

1875. DADANT'S COMB FOUNDATION. 1891.

More than Ever. Better than Ever. Wholesale and Retail.

Half a Million lbs. Sold in 13 Years.

Over \$200,000 in Value.

It is THE BEST, and guaranteed every inch equal to sample. All dealers who have tried it have increased their trade every year. Samples, Catalogue, free to all. Send your address.

We also make a specialty of Cotton and Silk Tulle of very best grade for bee-veils. We supply A. I. Root and others. 7,000 Yards just received. Prices Very Low. Samples Free.

Smokers, Honey Sections, Extractors, Tin Pails for Honey, Etc. Instructions to Beginner with Circulars Free.

4-92-12

Mention Review.

CHAS. DADANT & SON, Hamilton, Hancock Co., Ills.

FEB. 1893



THE BEE-KEEPERS'
REVIEW
Published Monthly

W. E. WOODS - DETROIT

ADVERTISING RATES.

All advertisements will be inserted at the rate of 15 cents per line, Nonpareil space, each insertion: 12 lines of Nonpareil space make 1 inch. Discounts will be given as follows:—

On 10 lines and upwards, 5 times, 5 per cent; 6 times, 15 per cent; 9 times, 25 per cent; 12 times, 35 per cent.

On 20 lines and upwards, 3 times, 10 per cent; 6 times, 20 per cent; 9 times, 30 per cent; 15 times, 40 per cent.

On 80 lines and upwards, 3 times, 20 per cent; 6 times, 30 per cent; 9 times, 40 per cent; 12 times, 50 per cent.

Clubbing List.

I will send the Rvw with—		
Gleanings.....	(\$1.00)	\$1.75.
American Bee Journal.....	1.00	1.75.
Canadian Bee Journal.....	1.00	1.75.
American Bee Keeper.....	.50	1.40.
Progressive Bee Keeper.....	.50	1.40.
Bee Keepers' Guide.....	.50	1.40.
Apiculturist.....	.75	1.65.
Bee-Keepers' Magazine.....	.50	1.40.

Honey Quotations.

The following rules for grading honey were adopted by the North American Bee Keepers' Association, at its last meeting, and, so far as possible, quotations are made according to these rules:

FANCY.—All sections to be well filled; combs straight, of even thickness, and firmly attached to all four sides; both wood and comb unsoiled by travel-stain, or otherwise; all the cells sealed except the row of cells next the wood.

No. 1.—All sections well filled, but combs uneven or crooked, detached at the bottom, or with but few cells unsealed; both wood and comb unsoiled by travel stain or otherwise.

In addition to this the honey is to be classified according to color, using the terms white, amber and dark. That is, there will be "fancy white," "No. 1 dark," etc.

CHICAGO, Ill.—The supply of all grades, except that of fancy white, is liberal. For this grade there is some inquiry and it brings 18. No. 1 white, 15 to 16. Dark or amber is of slow sale and prices are from 10 to 12. Extracted brings from 6 to 9. Beeswax is steady at 22 to 25.

R. A. BURNETT & CO.,

Feb. 14. 161 So. Water St., Chicago, Ill.

CHICAGO, Ill.—There is good demand for fancy white, but there is none in the market and but very little of No. 1 white. White extracted is scarce, owing to the high prices of butter and the severe cold weather. This has been a favorable winter for the sale of honey and the markets are almost bare of honey of any kind. We quote as follows: Fancy white, 18 to 19; No. 1 white, 6; No. 1 amber, 13; fancy dark, 12; No. 1 dark, 10; beeswax, 22 to 25.

J. A. LAMON,

Feb. 13. 44 & 48 So. Water St., Chicago, Ill.

MINNEAPOLIS, Minn.—There is a good supply on hand but it is mostly dark. This stock is slow, but what little white there is on the market moves readily. We quote fancy white, 17 to 18; two pound combs, 16 to 17; buckwheat, 15 to 16; extracted honey, 10 to 11.

J. SHEA & CO.

Feb. 13. 14 Hennepin Ave., Minneapolis, Minn.

ALBANY, N. Y.—Stock of honey very light. Prices well sustained. Demand will be better as the weather warms up. We quote as follows: Fancy white, 15 to 17; No. 1 white, 14 to 15; mixed, 12 to 14; fancy dark, 11 to 12; No. 1 dark, 10 to 11; white extracted, 8½ to 9½; amber extracted, 7 to 7½; dark, 6½ to 7. Beeswax, 28 to 30.

H. R. WRIGHT.

Feb. 13. 326 Broadway, Albany, N. Y.

KANSAS CITY, Mo.—The supply of extracted honey is light, the demand good. The supply of comb is fair and the demand the same. We quote fancy white, comb, 16 to 17; No. 1 white, 15 to 16; fancy amber, 15 to 16; No. 1 amber, 14 to 15; fancy dark, 12 to 13; No. 1 dark, 10 to 12; white extracted, 8; amber 6 to 7; beeswax, very scarce and brings 22 to 25.

CLEMONS-MASON CO.,

Feb. 13. 321 Walnut St., Kansas City Mo.

BUFFALO, N. Y.—Stock of honey very light. Demand moderate. There is no doubt that all honey will clean up with satisfactory prices. As a rule, there is a very excellent demand in our market through March and April. We advise those having honey, to market it now, so that it will be in the hands of dealers when the trade does improve. We quote as follows: Fancy white, 17 to 18; No. 1 white, 15 to 16; fancy amber, 13 to 14; No. 1 amber, 12 to 13; fancy dark, 10 to 11; No. 1 dark, 8 to 9; beeswax, 25 to 30.

BATTERSON & CO.

Feb. 11. 167 & 169 Scott St., Buffalo, N. Y.

CINCINNATI, Ohio.—There is a good demand for extracted honey from the jobbing trade for family use, but the demand from manufacturers is slow. We never had as small a stock on hand as we have now, and unless unlooked for shipments arrive we shall be unable to fill our orders for March. We solicit early shipments from our friends in the South, as freight rates are now the same on honey as they are on syrups and molasses. No. 1 dark comb brings 10 to 12; extracted honey 6 to 8. Demand for beeswax is good at 23 to 25 for good to choice yellow wax.

CHAS. F. MUTH & SON.,

Feb. 14. Cincinnati, Ohio.

NEW YORK, N. Y.—The stock of comb honey on our market is gradually becoming less. Fancy and No. 1 white are pretty well cleaned up, and there is a fair demand for these grades. We would advise the shipment of these grades, as they will find ready sale during the next 30 days. There is considerable amber and dark on the market and the demand is light. Beeswax is scarce and prices are advancing. We quote as follows: Fancy white, 14 to 16; No. 1 white, 13 to 14; fancy amber, 12 to 13; fancy dark, 10; No. 1 dark, 9; beeswax, 28 to 29.

HILDRETH BROS. & SEGELKEN,

Feb. 13. 28 & 30 West Broadway New York.

AFTER YOUR BEES

Have passed the rigors of winter, then comes spring with its mixture of balmy days and storms, its few short honey-flows interspersed with rain, frost and mayhap an occasional snow storm. How best to bring the bees through this trying period in such a manner that, notwithstanding adverse weather, they will gain steadily in numbers and be ready to go forth as an army to gather in the spoils when the main harvest comes, is taught in one of the opening chapters of "ADVANCED BEE CULTURE."

Price of the book, 50 cts.; the REVIEW one year and the book for \$1.25. Stamps taken, either U. S. or Canadian.

W. Z. HUTCHINSON, Flint, Mich.

WHITE POPLAR SECTIONS.

We have New Steam Power, and New Buildings, and are now ready to furnish White Poplar Sections, Clamps, Crates and Wood Sides at short notice. Workmanship, Quality and Price unsurpassed. Send for sample and price list.

PRIME & GOVE,

1-90-tf Bristol, Vermont.

Please mention the Review.

BEE-KEEPERS SUPPLIES



BEST GOODS **LARGEST OIL SUPPLY HOUSE IN THE WEST**

LOW PRICES **LARGE STOCK**

ITALIAN QUEENS AND BEES A SPECIALTY.
CLOVER SEEDS BUCKWHEAT

SAMPLE OF OUR BEE JOURNAL THE WESTERN BEEKEEPER ALSO OUR CATALOGUE FREE!

JOS. NYSEWANDER. DES MOINES, IOWA.

2-93-tf Please mention the Review.

ON HAND NOW.

THE MOST COMPLETE STOCK OF BEE HIVES, SECTIONS AND SUPPLIES IN THE NORTHWEST.

W. H. PUTNAM,

1 93-12t.

RIVER FALLS, WIS.



Spray
your
Fruit
Trees
and
Vines

Wormy Fruit and Leaf Blight of Apples, Pears, Cherries and Plums prevented; also Grape and Potato Rot—by spraying with **Stahl's** Double Acting Excelsior Spraying Outfits. Best in the market. Thousands in use. Catalogue, describing all insects injurious to fruit, mailed Free. Address

WM. STAHL, QUINCY, ILL.

EXTRACTORS ! EXTRACTORS !!

MORE THAN EVER, BETTER THAN EVER.



We are making a specialty of HONEY EXTRACTORS. We make Novice's 2 and 4 frame; Cowan's Reversible 2, 4, and 6 frame, and Stanley Reversible, 2 and 4 frames. Nearly all the dealers handle these goods. Write for discounts to the trade.

Sawed Wood Separators

CHEAP.

Instead of slicing them we are now sawing them. They are dry, won't shrink, and won't roll up.

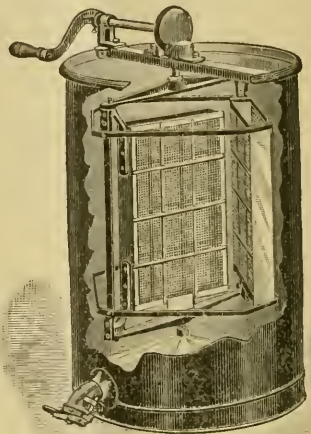

ROOT'S FOUNDATION FOR 1893.

Made from BRIGHT YELLOW WAX, and the workmanship unexcelled. For prices and particulars of all goods, send for our 1893 Catalogue of 52 pages, free.

A. I. ROOT, Medina, Ohio.

FOR ALL KINDS OF BEE-KEEPERS' SUPPLIES.
 ADDRESS LEAHY MFG. CO. HIGGINSVILLE, MO.

Here is your chance—Two for the Price of one.

BEES AND HONEY

By Thos. G. Newman, ex-editor of the American Bee Journal, is a book of over 200 pages, that we send **FREE** to every new subscriber who mails us \$1.00 for a year's subscription to the old

AMERICAN BEE JOURNAL,

The Largest, Best, Cheapest, and only weekly bee-paper in all America. 32 pages; established 1861. Send for a free sample copy with description of book offer **GEO. W. YORK & CO., CHICAGO, ILLS.**
 56 Fifth Avenue.

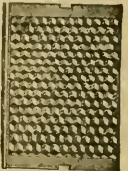

To New Subscribers: The Journal Alone Sent for Three Months for 20 Cents.

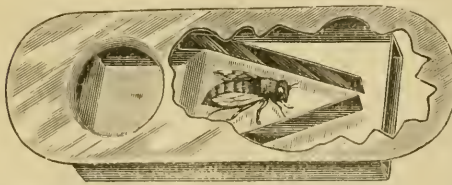

Porter's Spring Bee-Escape

Saves temper, time and bees. **PROF. COOK** says: "No bee-keeper can afford to be without them."

WM. M'EVROY, foul brood inspector of Ont., Can., says: "They should be used in every bee yard in the whole wide world."

THOS. PIERCE, Pres. Eastern N. Y. B. K. A. says: "The time will soon come when all bee-keepers will use them."

Send for circular and testimonials, and read what others say of them. **PRICES:** Each, by mail, with full instructions, 20 cts. Per doz., \$2.25. If, after three months' trial, they are not found superior to all other escapes, and satisfactory in every way, return them and we will refund your money. For sale by dealers.

R. & E. C. PORTER, Lewistown, Ill.

The Bee-Keepers' Review.

A MONTHLY JOURNAL

Devoted to the Interests of Honey Producers.

\$1.00 A YEAR.

W. Z. HUTCHINSON, Editor & Prop.

VOL. VI. FLINT, MICHIGAN, FEB. 10, 1893. NO. 2.

Special Topic of Next Issue Will be

Self - Hivers.

TIMELY TOPICS.

No. 1.

R. L. TAYLOR.

"To everything there is a season."



THIS is the period of good resolutions. One is more likely to do well throughout the year if he begins the year right. To do this is not only a great satisfaction, it is great economy. To keep one's work in front of him saves steps and accidents and

mistakes and loss and anxiety. Though no doubt in some degree presumptuous, I have thought to aid bee-keepers in laying hold of this advantage by a timely notice of those things which the duty of every day requires in bee-keeping and by urging their reasonable execution.

It is to be supposed that the work incident to the last year's crop, such as putting up and disposing of the honey, the proper se-

curing of all combs, whether in brood frames or sections, and the rendering of waste combs and bits of wax has been attended to. If not, it should be attended to now and in such a way that it will be beyond its power to distract the attention again. Any comb honey on hand should be kept continually in the warmest place available so it is not so warm as to endanger the stability of the wax. Herein is the secret of keeping comb honey. Kept in a dry place at a pretty high temperature it will never deteriorate but rather grow better. If empty combs have been neglected they should be so no longer. It is better if they can be kept where they will not freeze, but by all means secure them against any possibility of injury from mice.

Turning now to the future, every one readily comprehends that success during the coming year depends largely upon the welfare of the bees, and particularly upon their welfare during these midwinter months, so it is well to have an eye to their comfort. It is not well to be anxious, but what needs to be done should be done promptly. If they are in a cellar or otherwise housed, the temperature of the receptacle should not be allowed to remain long above 45° F. nor below 40° F. Artificial heat by means of a lamp, oil stove or a kettle of coals, may be necessary in extreme cases, but avoid it if possible. Packing the outside door and the windows upon the outside with leaves or chaff, will greatly aid in keeping up a proper degree of warmth. If the bees are on their

summer stands beware of any combination of circumstances that may tend to the accumulation of moisture in the brood chamber or on the packing. The entrance should be large and kept entirely free from snow, ice and dead bees. Snow around the hive may do no harm, and indeed, even be an advantage while it is dry, but unless every thing is favorable and the bees in good heart, I should remove it when it gets soft and damp. Unless the ground is quite dry, I should prefer to have the hives raised up from it a few inches.

Now is the time to perfect plans and make preparation for the coming season of activity. Ordinary common sense would dictate that every thing possible should be done in the present season of comparative leisure that will help to relieve the pressure then. There is also another reason for this course; exertion that would be grievous toil in June is a keen pleasure in these days of frost and snow. Besides whether success or failure is to attend the operations in the apiary the coming season may very likely turn on whether proper preparation is made now. If every thing is left to be done in June some things will not be done at all, and among these we may be sure of finding the work pertaining to the apiary.

On account of the uncertainty attending the wintering of bees, some may hesitate to enter upon these preparations fearing lest there may yet be such a loss of bees as to render their efforts at timeliness bootless. But with February half gone there need be little danger of that if the bees are still quiet, closely clustered and free from disease, provided of course they have plenty of stores. If on the other hand they are active, failing to cluster and give evidence of being affected by the usual winter disorder, plans for the future should still be matured, but their execution need progress at such a pace only as the condition of the bees from time to time seems to warrant, for it is altogether likely that the demand for new hives to house new swarms in and for new cases to receive the surplus, will be somewhat limited.

Let it be supposed, however, that the condition of the bees is good and gives promise that the winter will be passed without any serious loss among them, what provision then should be made in the way of hives, brood-frames, cases for sections, and shipping crates? I include the last item because

including all of a kind in one lot is a great economy of care, steps, time and money. One trip to the lumber-yard should secure all the lumber that is to be worked for a year, whether that work is to be done at home or at a mill. For shipping crates provision should be made for enough to contain the largest crop that is possible, for what are not wanted will keep. When the lumber for these is all cut it must be kept closely piled in a dry clean place and nailed only as required. I prefer the Heddon crate to hold 14 sections, 7 to the foot, with a 2x9 glass in one end. For this the lumber for sides, strips to hold glass and the pieces for the back end should be about one-half inch, that for covers and bottoms one-fourth inch. For cases there should be provision for at least two to each colony, spring count. Where the honey flow is great, the old Heddon case is good enough, but for poor years the single tier wide frame is better. With these, in such a season, the sections are kept cleaner and better filled and a larger proportion of those begun is completed. In cutting the tops and bottoms of these frames, instead of making the cut straight through the block, if it is allowed to be somewhat curved, the pieces will appear bent, and if nailed up with the convex side in, the frames will clasp the sections much more closely. Norway, or more properly red pine, is excellent for these. As to the number of hives to be prepared that will depend on circumstances. Do not think to accept more than one swarm from each colony, and the number of empty hives provided may be as much less than that as is desired, and the apiarist is then to depend on the prevention of swarming and doubling up to keep the increase within the measure of his preparation. By all means have the brood frames wired.

Costly lumber should not be got for this work. Except for the frames and covers, white pine shipping calls are good enough.

I shall close this article by offering two items of counsel which I would make as emphatic as possible:

Let no one be lightly lured into the adoption of a hive that is not approved by a respectable number of successful bee-keepers.

In cutting up the stuff for hives, etc., let no piece pass muster that is not *exactly* of the size and shape desired.

The Pacific Coast, its Magnitude and Honey Pasturage.

"RAMBLER."

"A good land; a land of wheat, and barley, and wines, and pomegranates; a land of oil olive; a land flowing with milk and honey."



RECENTLY there has been an item going the rounds of the California papers showing the estimate English people have of the size of our

country. Having in mind their little sea girt Island, the same scale is applied to the measure of other countries. An Englishman having a friend in Denver and another in San Francisco, wrote to the Denver friend that seeing he lived so near the S. F. friend he wished he would run in some day and see him.

Although not quite so far off in relation to distance, our Eastern friends often get things sadly mixed, and fail to appreciate the vast empire we have upon this coast. For several years past the bee-keeping world has had its attention almost wholly called to the wonderful honey yields of California, until this State seems to be the only El Dorado for honey as well as for gold.

California is indeed a great commonwealth and worthy all of the songs of praise bestowed upon it, and is every year growing in power and wealth.

But instead of confining our range of vision to this State alone, let us broaden it and take in the whole Pacific Coast. This view would embrace all of that country beyond the great central basin of Utah, and extend from the British possessions to the extreme end of lower California, a distance of nearly 3,000 miles, or nearly equal to the distance from New York to San Francisco. The northern portion of this great area may not be very prolific in its honey production but if there is any deficiency caused by humidity or cold, it is made up the further we move toward the south; and when we get down well into Mexico we find a bee pasturage that would rival the famous fields of Cuba. The honey resources of this immense region are as varied as the climate itself which gives

frost and snow and perpetual summer. Of Washington and Oregon we have but limited statistics in relation to honey production, but enough has been given to prove that bees do well for their owners, gathering a fine quality of honey.

Northern California and especially the north-east part is as yet an undeveloped country and rich in nectar secreting flowers that waste their sweetness from the lack of bees to gather it. The rail roads and the tide of emigration have been directed further south, and this portion of the State has been neglected; but, recently, attention has been called to the Honey Lake region and we may expect to hear that bee-keepers as well as fruit men are going up to possess the rich fields. Western Nevada and eastern California give us the beautiful alfalfa honey, and it is here that stock raising and honey production go hand in hand and the respective herders of bees and cows live in harmony together. In these rugged valleys of the Sierras alfalfa has proved its efficiency as a honey plant, and wherever it is grown under irrigation, the crop never failing, and if there is any business that looks promising for the future it is in the raising of alfalfa for the above purposes. We claim Arizona also as in the Pacific Coast region and alfalfa is commencing to play an important part there for the production of a beautiful grade of honey. For southern California the sages will not play so important a part as they have in the past. Large areas are being cleared up for agricultural purposes and the mountains alone will not furnish a supply to compete with the other grades. Just now lower California is attracting attention to its abundant honey flora and the enormous yields wherever the fields have been developed (and the further into Mexico we go the better the field seems to be) cause us to look for a great development of those fields in the near future.

The Pacific Coast is eminently noted for its great enterprises. Bee-keeping has never been able to cope in a business view with these enterprises and bee-keeping since the palmy days that followed the first introduction of the honey bee has been to many a slow method of securing a fortune. Bee-keeping, however, plays an important part as a stepping stone to something higher, for there is no business into which a person can enter with so little capital and be sure of such quick returns. But just as soon as the

returns become a few hundred dollars they are invested in some of those sure and continuous great enterprises and the bees are turned over to some new comer who, like his predecessor, has no love for the business only so far as it brings him dollars and cents, and a chance to step into something else.

The number of bee-keepers upon the Pacific Coast run up into the thousands, but the bee-keeping world has heard of but few of them. These few are the enthusiastic lovers of the bee and will have bees around them as long as they live. Owing to the above facts the Pacific coast cannot, or has not, supported a bee paper of its own and but indifferently supported bee conventions.

In order therefore to bring bee-keeping up to a higher standard on this entire coast, we need more enthusiasm for the bee and less for the dollars; more care and less slipshod methods; more conventions and more stir, so that the rest of the world may know that we are alive. That a portion of these things will come in due time is the abiding faith of the

RAMBLER.

REDLANDS, Calif.

Jan. 14, 1893.



Queen-Excluders. — Hoffman Frames and Burr-Combs.—Experiments.—Testing Smokers.

C. C. MILLER.



JANUARY REVIEW is a good one. Bro. Martin discourages me somewhat with regard to queen excluders. I have hopes of queen excluders, but have an uncomfortable feeling all the while that they're an unsolved problem. Still, the fact that they have

failed in one or more cases is not conclusive, for there have been excluders with different sizes of perforations, and it may be that the failures belong with too large perforations. If, however, Bro. Martin is right in saying they fail twice in a while, or even if they fail only once in a while with the best sized perforations, if that while includes not more

than 25 colonies, then excluders are not so valuable.

One trouble about deciding as to their efficiency consists in the fact that in probably a great many cases they have been considered excluders when they have not excluded. For example, I don't count that they have excluded in cases where the queen has not tried to go through them, and would not go through, were the perforations twice as large. In general, queens do not go up into my supers. Now if I should put excluders under the supers and then find the queens stayed down, it would be no proof that the queens *could not* go up.

And if queen excluders do not exclude, away go our chances for success with self-hivers, at least with virgin queens. For all self-hivers, so far, depend on confining the queen and letting the workers go free.

Bro. Frazier is right in thinking writers ought to go more into detail, and I will add that they ought to give us more of the *little* things in bee-keeping. But I hardly think he's right in saying the Hoffman frame was intended to prevent brace or burr-combs. The main intention was to have something that would allow rapid handling with practically fixed frames. But will not brace and burr-combs be prevented with Hoffman frames as well as any other if the right requirements are followed? If the top-bar is too thin, or the space between top-bar and section too small, or any one of several other things be wrong, brace or burr-combs will be built, whether the frames are Hoffman or not.

The first case I ever knew anything about where success in the prevention of these objectionable combs was attained without having anything between top-bars and sections, was that of J. B. Hall, and he claimed that the sole requirement was a top-bar an inch thick. Why not stick to that as long as it proves efficient?

Bro. Green's article suggests the thought that it would be of real value if every one would report all his experiments that are failures. I know it isn't pleasant for me to report that I've been a fool, but if by reporting it I can prevent half a dozen others from making fools of themselves, I ought to be willing to stand the exposure. But if we can get all our experiments made at experiment stations, then we can give up playing the fool, and spend our time getting big crops of honey.

I congratulate you heartily, brother Hutchinson in getting Hasty into the review business. I think you'll find that in that line Hasty will be—well, he'll be Hasty.

Anent the smoker business, I think Mr. Cornell is right, that you could not be sure of having two smokers filled alike with planer shavings, but if each were filled *times enough* the trial might be fair.

Now if I've touched on any point covered by Hasty, you have a pencil.

MAKENGU, Ill.

Jan. 26, 1893.



Some Novel Hints on Smoker Construction.—
A Double Bellows that will Throw
a Continuous Stream.

E. A. DAGGITT.

HAVE not read all the articles on smokers, but find them interesting. So far, I do not take any fancy to the Crane smoker, although it is an ingenious affair. Neither do I take much interest in the improvements of the Bingham smoker. Both have the bellows on upside down. If Bingham would put the bellows on his, right end up he would make the biggest improvement he has made yet. I have been studying smokers for years. Three or four years ago, when putting on the nozzle of my Bingham Conqueror smoker, I carelessly or thoughtlessly put the bottom of the smoker against my breast and spoiled a good vest. I there came to the conclusion that the barrel ought to be covered with some non-conducting material; and I have wondered if asbestos felt would not answer the purpose. It is non-combustible and I think a poor conductor of heat. Then I have often felt a want—and I suppose you have too—for a smoker that will throw a steady stream of smoke—not by puffs as the smokers now do. I studied on this, and hit on the idea of using a double bellows,—one half to give force to the air and the other to act as an air chamber and give elasticity to the current of air and give a steady stream of it. I got this idea of a double bellows from a blacksmith's bellows. You will find that such a bellows will work easier than a single one. Of course the main bellows will use a spring to *expand* it and the second one will use one to *contract* it. This smoker will require two self-closing valves, and I think these, and the

spring of the second bellows can be so adjusted as to give a steady, or approximately steady, stream of smoke if the first bellows is properly worked. The inner board or plate of the first bellows, which is stationary, must run below this bellows and have a

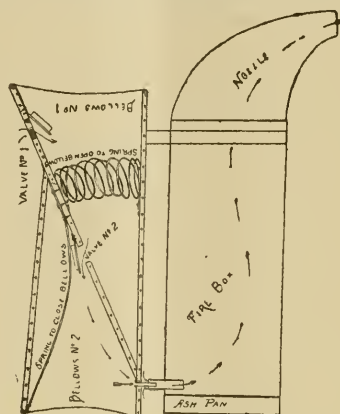

DAGGITT DOUBLE-BELLOWS SMOKER.

piece tacked on it at the bottom on the side next to the second bellows to contain the exhaust valve. The second bellows must not be over $\frac{2}{3}$ or $\frac{3}{4}$ as large as the first one, but it should lap it in such a way as to put a large and a small end of each to each other except that the second bellows should extend below the first as far or nearly as far as the extension of the plate of the first, but not far enough up to prevent grasping the first by the hand at the top. The supply valve can be put just above the top of the second bellows and the second valve can be put just below the top of the bellows. The exhaust valve should be ball or cone shaped so as to give the least obstruction to the air as it issues towards the barrel. This second bellows idea does away effectually with the trouble from smoke entering the bellows; for there can be no back action of air into it. You know how effectively the principle works in a blacksmith bellows. You will notice in the drawing of the smoker that I have added Mr. Cornell's ventilating idea to my smoker. I have been wondering if the addition of this same idea to the nozzle would not be an improvement. Sometimes the smoke becomes very hot and it seems to me that it would be a good idea to mix air with it. The nozzle could be in two parts,—the upper end of the lower part could be corrugated and have the lower end of the other

part slip partly over the corrugated part. This almost brings us to the cold blast smoker. By the way, Hill's smoker has impressed me more favorably than any made so far. He has made a long step in advance by bringing out a smoker that can be used right end up. To my smoker I have added an ash pan. This is nothing but a simple cover on the end of the barrel. This will be an improvement. In fastening the barrel, a bed piece should be attached to the main bellows plate and to this should be attached bands that can be easily loosened. To keep the barrel from slipping up or down it should be ribbed just above the upper band, and the lower end should be ribbed at the ash pan or cap, just as is done in making Royal Baking Powder boxes. What do you think of this design of a smoker? If you think it of sufficient value you may illustrate in the REVIEW. If you do, get the perspective right and the whole properly proportioned. This smoker is intended to be used by grasping the main bellows at the upper end—either at the corners or middle.

WHITE HOUSE STA., N. J., Nov. 28, 1892.



Scraps From a Visiting Letter in Which its
Writer Mentions the House Apiary and
Tells How He Enjoys Himself.

B. TAYLOR.

"A touch of nature makes the whole world kin."



I HAVE NOT yet completed my new house apiary. The weather has been very cold for three or four weeks so that work on it was impossible. It is warmer now and I resumed work in it to-day. I do not wish to describe it until completed, as

I am trying to make it very perfect. I find the 8x16 building will hold 38 hives without crowding in the least. I have invented a hive especially for house use and shall not use the long ones as first intended. It is a double brood chamber and holds the same combs as my double walled hive, and the hives used on the revolving stand. It is so

arranged that any of the four sides will make the front.

The bees in the old house seem to be wintering finely this cold winter. The house apiary is going to be O. K.

I have received a letter of six pages from Mr. Langdon, of E. Constable, N. Y., with drawings describing his new house, 11 by 100 feet. It is nearly identical in principle with my own but I would not have made so large a one until experiments had demonstrated the best plans.

Friend H., give me your hand for your life sketch of yourself in last REVIEW. In nearly all respects it is so nearly my own history and experience that it stirs my feelings deeply. How I do wish we lived nearer together. You mention your love for machinery. O, dear, me! Last spring I sold much of my nice machinery (nearly \$500 worth) and this winter I am making new machines for my shop, and I am so happy at it that I can scarcely take time to speak or write to friends. I do not know whether I shall ever use these machines so as to get pay for them in the vulgar money sense, but I get *supreme pleasure*, and who gets better pay than that? I expect this to be my last work of this kind and I am determined to make everything as near perfection in working quality, as well as finish, as my skill will permit. Every thing is entirely original in design, and finished equal to the finest parlor furniture; all hard wood, finished in oil. I have invented a new parallel bar for saw tables that beats anything I have seen. You can move it to either side of the saw in two seconds without removing a single bolt or screw of any kind and can set it for any width of sawing from 1-32 to 16 inches, without using a measure of any kind. When you come to Minnesota I will take great pleasure in showing it to you, and you shall come some time, and don't you forget it.

I contemplate writing an article for the February REVIEW, taking the December REVIEW and its contributors for a subject. What do you think of it? Will write up the house apiary as soon as completed, which will depend upon the weather in a large degree.

There, brother H., this long letter is written to you and your family. Please shake, for us, the hand of Mrs. H., the twins and all the little H.'s whose pattering feet you describe so tenderly in last REVIEW.

FORESTVILLE, Minn.

Jan. 23, 1893.

More About the "K. D." Hive.—Top Ventilation and its Importance.

R. C. AIKIN.



THE query of Mr. Thompson, of Denver, together with your permission to reply to it, just received. Here is the query. "How will the top ventilation and consequent letting off of a certain amount of heat accord with

the greatest possible amount of brood-rearing in the cold nights of spring?"

Here is another query from Newport, R. I., just received: "I presume the hive is not intended to winter bees on the summer stands as the location of the entrance for brood chamber allows the free escape of the heat generated by the bees?"

The friends are both mistaken. We claim the top-entrance-hive better for both in and out door wintering. Neither will there be any detriment in the matter of brood rearing in spring.

In "Advanced Bee Culture," page 80, the 2nd and 3rd paragraphs read thus: "Whether bees can be successfully wintered in a damp cellar, depends largely, almost wholly, upon the temperature of the atmosphere. 'If the repository be damp, a degree of temperature higher in proportion to the dampness should be maintained.'—N. W. McLAIN. Referring to this statement Mr. Frank Cheshire says: 'The reason being that water has an enormous capacity for heat (specific heat) whether in the liquid or vaporous form; the latter abstracts heat from the bees and intensifies their struggle.' Dr. Youmans says: 'Air which is already saturated with moisture refuses to receive the perspiration offered it from the skin and lungs and the sewage of the system is dammed up.' A moist air very readily absorbs heat, and more quickly robs the bees of that element so essential to life; hence it will be seen why a moist atmosphere must also be a warm one if disastrous results are to be avoided."

Now, suppose a temperature in the open air of 40°, and the atmosphere at rest, and dry. I go out in my shirt sleeves and work with perfect comfort. Two hours later with the temperature the same and the atmosphere in motion at the rate of 12 to 15 miles per hour, I am obliged to wear my coat to keep warm. Now saturate this air with moisture with the same temperature and motion and I must wear my overcoat to keep warm. You will now see what I mean.

Read four chapters in "Advanced Bee Culture," viz.; "Out Door Wintering," "Ventilation of Bee Cellars," "The Relation of Moisture to the Wintering of Bees," and "Influence of Temperature in Wintering of Bees."

The entrance at the top, no doubt, will permit the escape of some heat; but with weak colonies, or in winter, we want the entrance contracted. Suppose it be $\frac{3}{8}$ x 1 inch, there being no other opening sufficient to cause a direct draft through the hive, there cannot be any perceptible motion or current of air within the hive, yet there will be a gradual change taking place, thus freeing the hive of moisture laden air that would necessarily accumulate in a close top.

Just last week we built a fire in our house cellar where we have over 100 colonies of bees; and with the temperature above 50° I saw moisture condense on the hive fronts just over the lower entrance (these colonies have no top entrance), showing a very moist air escaping from the hive. Keep the hives free of moisture and we don't need so high a temperature. But in order to help the colony in the matter of heat, we strongly advise the use of packing that will absorb the heat of the sun and bees by day, and give it off at night thus helping to equalize the temperature.

But the idea that a small upper vent, with none below to permit a draft, will allow of an undue escape of heat necessary to brood rearing is incorrect.

One of Colorado's foremost apiarists, Mr. W. L. Porter, of Arvada, after seeing the K. D. hive at our State convention, went home and looked through his apiary. He found every hive having a vent at the top dry and healthy; but those with no top vent were damp and in much worse condition. Not only were the top-ventilation colonies drier, but they had more brood.

Mr. Knight has, since the convention, inspected for foul brood an apiary of 60 colonies. All were breeding and every colony had the brood nest at or near the entrance, and all having a top vent, *i. e.*, holes in the quilts, were in much the best condition.

When it comes to spring brood rearing, the colony does *not* depend on the temperature of the air in the *hive* for the necessary heat, nor are they able to get the necessary heat in the chamber until such time as the colony becomes strong enough to fill the whole hive. Until such strength is obtained, they depend for brood rearing upon the heat generated within the cluster.

This principle is fully illustrated in a valuable article by G. M. Doolittle in A. B. J. for Dec. 15th last, page 791. A careful perusal of the whole article will be worth dollars to any one who is not already familiar with these principles. I quote from it as follows: "If we have a natural swarm of bees in a large box, * * * * we find that they suspend themselves from the top in a compact form, appearing like an inverted cone, which, to all appearances, is nearly motionless, so that it will appear as if the bees were idle; while the fact is, that these apparently idle bees are the colony proper, and inside this, active work is going on building comb, etc. This is easily seen by passing a wire suddenly and horizontally through the cluster, letting the lower half drop. Outside the living hive, or crust of bees, the temperature is often not more than 50°, while just inside, they are working wax nicely with the temperature at 90° to 95°, as I have found by making careful tests with a thermometer.

* * * * * It takes some time for these crust bees to become lively enough to fly; but the inside force can do so at a moment's notice, in any colony I ever experimented with; thus showing that the material enclosing this living home had little to do with the heat of the cluster, that being controlled by the walls of the living hive."

Friends, this top-entrance business will solve some of the problems in wintering and springing bees and more too, the K. D. hive will largely solve the problem of the control of swarming. These features we will make public with an illustrated circular as soon as printed.

LOVELAND, Colo.

Feb. 7, 1893.

Bee-Keepers' Review.

PUBLISHED MONTHLY.

W. Z. HUTCHINSON, Ed. & Prop.

TERMS:—\$1.00 a year in advance. Two copies, \$1.90; three for \$2.70; five for \$4.00; ten, or more, 70 cents each. If it is desired to have the Review stopped at the expiration of the time paid for, please say so when subscribing, otherwise it will be continued.

FLINT, MICHIGAN, FEB. 10, 1893.

TEXAS BEE-KEEPERS will hold a convention March 5th and 6th at the home of Mrs. Jennie Atchley, one mile north of the court house, in Greenville. No hotel bills and everybody is invited.

The Bee-Keepers' Guide has raised its price to 75 cents a year, has added a neat tinted cover, and is going to use more illustrations, pay for correspondence, and endeavor in every way possible to make itself worthy of its name.

"WHAT IS HONEY?" is asked in *Gleanings* by Dr. Miller who is writing the apicultural part of a dictionary and wishes to give a correct definition of honey. Those definitions that say honey is the nectar or juice of flowers collected by the bees and stored by them in the comb cells in the hive are correct so far as they go, but they are incomplete in that they omit to mention the transformation that nectar undergoes before it becomes honey. They give the impression that honey already exists in the flowers, when the fact is that they contain only the *material* from which honey is *manufactured*.

CHEAP QUEENS.

In the last REVIEW Mr. Trego mentions an unsatisfactory deal that he had with a Southern queen breeder that advertised cheap queens. As Mr. C. B. Bankston of Chrisman, Texas, is advertising cheap queens, he fears that some may think that *he* is the breeder to whom Mr. Trego referred. Such is not the case. I believe the breeder of whom Mr. Trego complained has gone out of the business. Mr. Bankston very justly says that breeders at the South can afford to sell queens cheaper than can Northern breeders. At the North the season is too short to allow low prices,

HOW THE BEES ARE WINTERING AT THE HOME

OF THE REVIEW.

As I had several times noticed that bees near the floor in a cellar did not winter so well, I, last fall, had some platforms or tables made out of scantling in my cellar. The tops of these platforms are 18 inches above the cellar bottom. The hives are placed upon these platforms. One hive is placed on the platform; a two inch block is placed at each corner on the top of the hive, then another hive set on those blocks. This gives plenty of ventilation and allows the dead bees to drop away from the cluster. I have a three-burner oil stove in the cellar. Over the top of the stove is a sort of hood made of tin and in the top of the hood is a tin pipe three and one-half inches in diameter that passes up through the floor and connects with the pipe of the coal stove. Whenever the mercury shows a disposition to go below 40° I light the oil stove. The pipe carries off all of the gases of combustion. Besides this, the draft from the coal stove causes a *constant* draft through the pipe whether the oil stove is being used or not. This furnishes abundant ventilation. I am not certain whether this ventilation is needed, or not, but it is a great comfort to know that it is not *doing any harm*. The bees never wintered better than they have done so far, and the absence of that "beey" smell in the cellar is a source of considerable comfort and satisfaction to myself.

SELLING GLASS AT THE PRICE OF HONEY.

At both the Albany and Washington meetings of the North American I heard Mr. Segelken of the firm of Hildreth Bros. & Segelken express his surprise that so few bee-keepers, especially those at the West, did not glass their sections. The reason, so far as the West is concerned, is that the Western markets do not seem to take kindly to such packages. In New York, glassed sections find a more ready sale and sometimes even bring higher prices, notwithstanding that the glass is weighed with the honey and paid for at the price of the honey. If the New York market demands glassed sections, why don't bee-keepers furnish it put up in that shape? Fifty feet of glass will glass about 325 pound sections on both sides. The glass costs \$3.00, and weighs 60 pounds. So, for the work of glassing, the bee-keeper would re-

ceive the price of 60 pounds of honey, less the cost of the glass, and this work can be done by cheap labor or by the bee-keeper after the busy season is over.

A WOODEN QUEEN EXCLUDER THAT IS A SUCCESS.

Some of the readers of the REVIEW may know that the G. B. Lewis Co. has for several years been making a wood queen excluder. How well these wooden boards are answering the purpose is shown by the following from the Secretary of the Company: "In looking over your book, *Advanced Bee-Culture*, we notice what you say on page 19 about our all-wood queen excluder. When we first began to make these excluders we made them of basswood $\frac{1}{8}$ of an inch in thickness, but we soon learned that it would be better to make the material thinner; we then and since have been making them of birch and maple 1-16 of an inch thick, and have heard no complaints from them, but on the contrary more are ordered every season, and they are well spoken of. They used to say down East that 'the proof of the pudding is in chewing the string:' those customers who have been 'chewing the string' seem to be well pleased with the pudding as they order more each year. Hence we conclude that our all-wood honey board is a very good thing.

(Of course we can readily see how you failed in the manufacture of these as you made your slots running lengthwise of the grain, and it is well known that all lumber, with the exception of red wood, shrinks sidewise, but none, except red wood, shrinks endwise; so, when we cut a slot across and through the grain, we obtain a perforation that does not change; and since we have used a material 1-16 of an inch thick, we have heard no complaint of bees plugging up the holes."

ARE THE WASHINGTON RULES FOR GRADING HONEY UNFAIR?

In another place in this issue, Mr. Hasty pays his respects to the rules for grading honey that were adopted at the Washington meeting of the North American. From the very first I have plead for a grade that should be perfection, but the dealers say, no, we don't want any such grade. There will be very little honey of this kind, and the slight advance at which it will be sold will be more

than counterbalanced by the reaction that it will have upon the price of the next lower grade into which the great mass of the honey must be placed. In other words, the dealers say, don't sort out the very finest by itself. Leave it in with what has usually passed for No. 1 honey. I do not know that the dealers are particular that the highest grade shall be called "fancy." Perhaps they would be willing that it should be called "No. 1." The point is that they do not want any grade made above that in which must be placed the great mass of honey. They prefer to have the upper grade, if there is one above this, placed *in with it* and all called *one grade*, but I do not know that they would wish to give a grade of honey a higher name than it is really and fairly entitled to receive. It is true that the matter of "travel-stain" is not touched upon in the rules. But it was discussed, and there was so much trouble to arrive at any agreement that I believe it was omitted simply because it seemed almost impossible to arrive at some decision, and the difficulty was temporarily gotten over by simply leaving this point for some other convention to argue over. This may have been cowardly, but the question was discussed until the members were simply at their wit's end in trying to agree. You may notice that I am trying to give the rules a practical test by giving the market reports in conformity to the rules. A year's actual use of the rules will do more than any amount of argument in showing the points wherein they are lacking.

THE EVOLUTION OF THE SELF-HIVER.

The easiest and simplest way in which bees can be controlled when they swarm, is through their queen. This was attempted long ago through the use of what was called a "queen-yard." It was a sheet of tin, with its edges turned up and slightly in, laid in front of the hive. A laying queen takes wing with some difficulty and hesitation. Those who have watched the issuing of a swarm know that she seldom takes wing until she reaches the edge of the alighting board, where she can "jump off" and thus get a start. The queen-yard idea was that the queen would continue trying to climb the slippery walls of tin that slanted in slightly and would continue this fruitless endeavor until the swarm returned. I believe it was occasionally successful, but usually the queen would get her enthusiasm worked up to such

a pitch that she would fly from the flat surface of the tin. This is the way the matter comes to me from reading about it years ago. If I have not told it quite as it is, it will at least answer to give an idea of the principle and somebody can correct me if I am wrong.

There may have been other attempts at controlling the queen, but they were not successful until somebody, I don't know who, proposed to make sure work of it by clipping the queen's wing. In this case some one must be present and catch the queen as she crawls about on the ground in front of the hive. Before she can be caught she must be found, and if the grass is not kept cut short, and the looking for done at exactly the right moment, the finding is the cause of no little anxiety and nervousness. Another point: some objected to mutilating their queens thinking that it had an injurious effect upon them and caused the bees to look upon them with disfavor. Whether or not these views are correct is another story.

Along about these days, as the almanacs used to say, perforated, queen excluding metal was invented. Soon after this Mr. Henry Alley combined the metal with the old, cone-fly-trap principle and made a trap that would catch queens and drones. I do not know for which purpose the trap was primarily intended, to trap drones or queens, perhaps both, but it is certainly a success at both.

A drone-trap in front of each colony having undesirable drones in a queen-rearing apiary, means only desirable drones in the air. I presume that most of my readers know how a drone trap is made, but for fear that some may not I will say that it is simply a small box put in front of the entrance of the hive. The front of the box is covered with perforated, queen-excluding metal. These perforations allow the workers to come and go at will, but restrain the queen and drones. At the top of the box is an opening over which is placed a cone made of wire cloth. The apex of the cone points upward. The queen and drones have no difficulty in finding and passing through this opening into another box placed above the first, but do not find the small opening in the cone by which to return. In short, they are trapped.

When a swarm issues the queen attempts to go with the bees, but is stopped by the queen-excluding metal in front. She crawls up through the cone and is trapped in the

upper part of the trap. If a swarm is seen when issuing, the operator moves the old hive to one side, puts a new one in its place, and as the bees are entering the hive, having returned to the old location, the queen is allowed to join the swarm. If the swarm is not seen when issuing, the queen is trapped just the same and remains in the trap, a small cluster of workers remaining with her and feeding and protecting her. When a queen and a cluster of bees are found in a trap it is known that the colony has swarmed and the apiarist can divide the colony or treat it as he thinks best. (That is another story.)

Now, friends, don't you see that there is but a single step from this queen trap to the putting of an empty hive by the side of the old one, connecting the two by means of a tube in which is placed a cone, then when the queen in her attempts to follow the swarm will enter this tube and crawl along until she comes to the entrance of the new hive which is in waiting. Of course the entrance to the new hive is also covered with queen-excluding metal so that the queen cannot escape. To Mr. Alley also belongs the honor of taking this "next step."

top. This remedied one trouble but not the last one. When bees swarm and their queen is not with them they return to the old location. They will go back to *exactly* the same spot. Even though the queen is found at the entrance of a hive near by, only a *portion* of the bees will join her. As a rule, I presume that the queen is not discovered until the swarm returns, and when the bees make up their minds to return they often come back with a rush, and tumble pell mell into the entrance of the old hive before they even have time to discover the queen that is behind the bars at the entrance of the neighboring hive.

This was the fault of self-hivers, that they secured only a small portion of the swarm, when Mr. E. L. Pratt conceived the idea of having the new hive placed in front of the entrance of the old hive, the bees passing through this hive when on their way to and from the old hive.

Right here I think that I can do no better than to copy from *Gleanings* an illustration of the Pratt hiver and a portion of the accompanying description as given by Mr. Pratt:

"The hive to receive the swarm is placed in front of the colony expected to swarm. The front ends of both bottom-boards are abutted so as to form a continuous passage from the swarming colony through the new hive. A little block is placed into the open space between the two hives, so that the bees cannot escape from that way. By covering this space with wire screen, the ventilation of the hives will be sufficient for the strongest colonies.

With this arrangement the bees are forced to go and come through the new hive with their honey and pollen. A triangular zinc bee-escape is now placed on the bottom-board inside the new hive, with its open base close up against the entrance of the colony expected to swarm. This escape is made of perforated zinc, and has a hole in its apex for the queen to escape through. The outside entrance to the new hive is covered with an ordinary excluder, so that the queen can not escape from within the new hive after she passes the zinc escape.

When the swarm issues, the bees rush pell mell through the zinc escape and empty hive into the air. The queen on finding she can not get through the zinc at the entrance, will pass down the escape, and is led through the hole in the apex, when she will quickly enter the new hive, where she will be effectually trapped. All the exits to the new hive being covered with excluding zinc, the queen is made a prisoner inside the new hive: and as soon as the bees that have swarmed into the air miss their queen, back they will come to the old entrance, as their instinct dictates, thus automatically hiving themselves in the

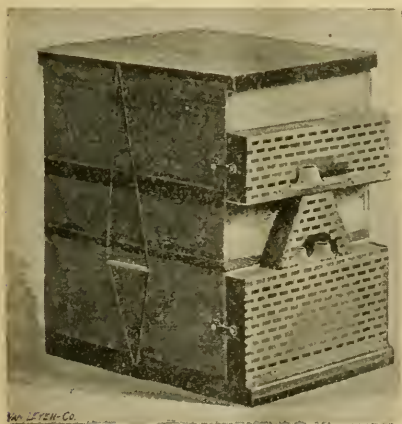

DIBBERN SELF-HIVER.

Every bee-keeper knows of the inclination of bees to climb *upwards*. In trying to climb *up*, the queen sometimes wasted so much time that the swarm returned before she had found and entered the tube at the side. To remedy this difficulty, Mr. C. H. Dibbern placed the new hive on *top* of the old one and formed a passage way from the front entrance of the old hive to the new one on the

new hive. A few of the older bees will work back into the parent hive, but the bulk of the swarm will remain with the queen. If empty frames have been inserted they will start at once to build comb and set up house-

arrangement over that of placing the new hive in front is that only one bottom board is required and there is less difficulty in adjusting the hives so that they will be perfect-

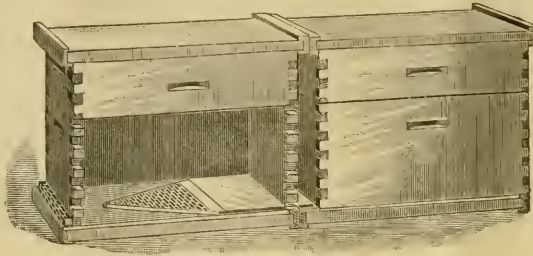

THE PRATT SELF - HIVER.

keeping in the new hive. If left in this position eight or ten days, a large number of young bees that have hatched from the parent colony will work out into the new hive. If the supers were shifted on the new hive, a considerable quantity of honey would be carried there. The bee-keeper now has the option of increase or not, for there are thirteen days before more swarming, which gives him a chance to manipulate the old colony as he sees fit. If he desires increase he can set the new swarm back on the old stand and place the old colony on a new stand, after shaking the bees off one or two combs to give the swarm sufficient strength to store box honey. If he does not desire increase it will do no harm to allow the hives to stand as they are a few days, when he can either cut out all the cells or place the old hive on top of the new one, with a bee-escape or zinc honey-board between, or leave them until a day or two before the young queens hatch, when he can shake off all the bees and place the extra combs around on other hives."

It might be well to add that Mr. Alley now places *his* hiver in front of the old hive.

Last season, Mr. Pratt, somewhat at the suggestion of Mr. E. R. Root, placed the new hive *under* the old one. Between the two hives is placed a thin board, having a rim around the edges to give it a "bee-space." This board is perforated with two or three holes in its center. On its under side and communicating with the openings, is a triangular, zinc, bee-escape. This is so arranged that the bees can pass up and down very readily, but the queen can pass only *one* way—downward. When at work, the bees pass through this hive just the same as they do through a hive when it is placed in front of the old colony. It has been advised that one or two combs be placed in the lower hive to furnish the bees with a sort of ladder upon which to ascend and descend. The advantage of this

ly bee-tight. When the bees swarm they pass down through the new hive, the queen going with them, she finding her way through the apex of the triangular bee-escape that is made of perforated zinc. She is unable to find the entrance to return, remains in the lower hive, the bees return and find her, remain in the lower hive and begin their labors there. It will be seen that, wonderful as it may seem, the bees—the whole swarm—*hive themselves*. But they require some attention afterwards. The whole arrangement of the hives and supers is not what it would be if the bee-keeper had been at hand when the

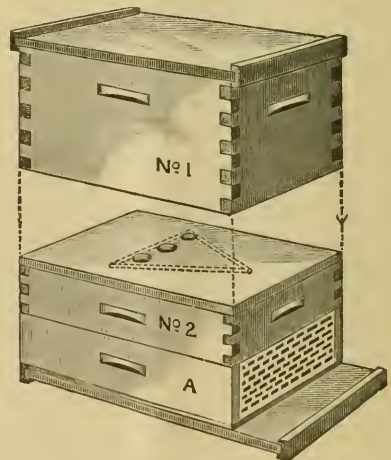

SELF-HIVER WITH NEW HIVE UNDER OLD.

swarm issued. But *this* much is accomplished, the apiary can be left alone not only during the middle of the day, but it can be left alone *several* days. One great item in

the cost of honey is the necessity of keeping some one constantly on the watch for swarms during two months of the year. It is the greatest obstacle in the way of establishing out-apiaries. If self-hivers prove to be the success that they promise to be, a visit once in three or four days, possibly once a week in some instances, to arrange the colonies that have swarmed, will be all that is necessary.

In the commencement of this article it was mentioned that the queen, accompanied by a "body guard" of workers would remain in a queen trap after a swarm had issued from a hive having a trap in front of it. Mr. R. L. Taylor takes advantage of this fact to enable him to manage his bees without close attention and yet dispense with the use of a self-hiver. He has found that a queen can safely be left three or four days in a trap and that he can manage by visiting an apiary once in that length of time and dividing those colonies that have swarmed. He says that he has no use for a self-hiver, the queen trap answering every purpose. It seems to me that the use of the trap would do away with the labor of dividing. The division would be already made and there would be only the work of placing the old colony on a new stand, cutting out the cells, and transferring the supers to the new swarm, or performing whatever manipulations the bee-keeper found necessary. There is one point in favor of the Taylor-plan, there would be no break in the work being done in the sections, whereas, by the self-hiving arrangement, work is stopped in the supers until the apiarist appears to make the changes necessary to get the bees at work again in the supers.

I should be glad to have Mr. Taylor, or any one who has had experience, write upon this point or upon any other connected with this important subject and we will make a "self-hiver number" of the March Review.

Since the above was written there is another point occurs to me that ought to be considered, and that is the trouble arising from two or more swarms issuing at the same time and uniting in the air. The larger the apiary, the greater becomes this drawback. This same difficulty, however, has to be contended with in any system of management that allows the bees to fly in the open air when they swarm. In a large apiary, requiring an attendant constantly during the honey harvest, a swarm catcher is away ahead of a self-hiver.

EXTRACTED.

Wintering Bees Under the Snow.—It is Likely to be a Failure.

Every little while some one asks if it is advisable to keep the snow away from the hives in the winter, or let it cover them over. Mr. Doolittle, in *Gleanings* says, well, here is the vital part of what he says:

"I have found that, if the hives are covered two-thirds the way up the brood-chamber, it is a great advantage; but if the hives are covered two-thirds the way up the cap or cover, or completely over, it is a positive damage to the bees, and worse than no snow at all.

The difficulty seems to be that, as soon as the hives are covered with snow, the warmth of the ground, combined with the warmth of the bees, makes it so warm that the bees become uneasy, go to breeding, consume large quantities of honey, thus distending their bodies and using up their vitality, causing them to die of old age during February, March, and April, while the young bees have not the usual strength and vitality of bees hatched in September and October to withstand the rigors of winter, so spring dwindling and death are the result."

Why the Younger Bees Cling to Their Hive Even if it is Moved.

Some of the readers of the REVIEW may remember that Mr. B. Taylor did not make the success of the revolving non-swarmers that he had hoped. One thing that he had expected was that it would equalize the colonies—make the strong weaker and weak stronger. As it turned out, the colonies strong in the spring remained so.

The Heddon method of preventing after-swarming, by leaving the old colony by the side of the newly hived swarm for a week and then placing it upon a new stand, is not always a success. Why these things are thus and so, Mr. Doolittle explains as follows in *Gleanings*:

"In 'Stray Straws,' found in the December 15th issue of *Gleanings* for 1892, I find this: 'A common error is to suppose that, in setting a weak colony in place of a strong one in order to strengthen it, it is important that the change be made when the largest number of bees are out. There will be just as much gain if the change is made at midnight.' Usually we find Dr. Miller saying 'I guess so,' or 'I shouldn't wonder,' or 'I don't know;' but here is a positive statement, made under his name, and, strange to say, that, in dropping his usual discreetness, he has fallen into an error which he could not have fallen into had he been so discreet

as to say, 'I don't know.' But I imagine I hear him saying, 'That is all right; let Doolittle prove wherein I am wrong.' Well, that is just what I am going to try to do, doctor.

When a colony is in a normal condition, the young bees go out to take their first airing at the age of six days, if the weather is favorable; and in so doing they mark their location to a certain extent, but not to an extent great enough so but that the subsequent flights have a greater impression on their memory, for we find them taking these markings anew at every flight till they are sixteen days old, when they leave the hive for gathering supplies for the first time, after which they take no more markings during the working season, unless it be in case of a swarm, or some rude disturbance of their home. If the hive is moved at midnight, as Dr. Miller suggests, then, on the coming morning, all the bees over sixteen days old, upon going to the field, leave in a straight line, and, having the old location established in their memory, and not taking any markings that morning, come back to the spot where the old entrance used to be; consequently they go into the hive having the weak colony, if such has been placed on the old stand, or are lost, if no such provision has been made. But let us wait till about 2 o'clock P. M., at which time all of the bees under sixteen days old, and over six days old, will fly, if the weather is fine, and we shall find that these young fellows head toward the hive the same as they did the last time they were out before, hence notice the change which has been made, and, instead of going to strengthen the weak colony which has been placed on the old stand, they return to the spot last marked, hence do nothing toward the desired strengthening. Now, had Dr. M. waited about this changing till these young bees were in full flight, and moved the hives when the most of these young bees were in the air, he would have caught these also, in addition to all those which were over sixteen days old. Then, 100 of these young bees are worth fully 300 of the older ones for strengthening weak colonies, inasmuch as they are just commencing life, instead of being near its close, as many of the field-bees are. While I had known that bees less than sixteen days old would not return to the old stand, if a colony in normal condition were removed at any time other than when they were flying, yet it was not fully forced upon me till I tried preventing after-swarms by the Heddon plan. In trying this I found that, if I moved the parent colony at any time I was ready, it would more often than otherwise swarm again; but if I moved it when the young bees were out to play I had a sure thing of it, for the colony was then so depopulated that it *never* undertook to swarm again that season."

I think that Mr. Doolittle is at least partly correct in his views as regards the occasional failure of the Heddon method of preventing after-swarming. There is, however, another and more important point that he has not touched upon and that is that a sort of swarm-

ing mania sometimes seems to seize upon the bees of an apiary, and they will swarm before the first queen cell is capped, and the result is that the first after-swarm does not issue on the eighth day after the prime swarm. I have known the time to be as much as twelve or thirteen days. If the old hive is moved at the seventh day, and a queen does not hatch for five days more, enough bees hatch in that time to so reinforce the numbers of the colony that swarming will almost always result. I think I never had a colony cast a second swarm within two or three days of the time of giving it a new location.

Why Frames Need Wiring.

How any one can use full sheets of foundation satisfactorily in the brood nest without the frames or foundation being wired has always been a puzzle to me. In a late issue of *Gleanings* Mr. Hewes of California, so clearly expresses my views on the subject that I copy his article.

"As I have sat at my bench on rainy days, wiring frames, I have sometimes wondered how many of my fellow bee-keepers practice that mode of strengthening their foundation comb, and Dec. 1st *Gleanings* answers the thought by telling me that enough of them do so to use up, even in a poor season, two tons of wire. This wiring of frames is a little tedious, but I wish that all the work I do paid me as well for the trouble as it does. Some years, owing to laziness, or a like inexcusable cause, I put a good deal of foundation in frames that are not wired, and always regret it afterward, when, on initiating them to the extractor, I see many combs fall from the frames, and pile up in a sticky mass on the bottom of the can. Besides giving strength to the combs, wiring makes them more shapely and better, yet prevents sagging and the consequent two-inch strip of drone comb along the top of the frame. The limitation of drone comb in my hives is a hobby with me, and I would wire my frames were its restriction the only thing gained. I can not see what objection some have to wiring frames. The satisfaction of knowing combs will result, when giving a swarm on wired foundation, is of itself worth more than the cost of the wire, while the work entailed by wiring is not so great as that which is required to look after unwired foundation to see that it has not fallen down, nor is being drawn out wavy with kinks and curls.

Comb foundation is used very extensively in California, but I believe only a comparatively small proportion is fastened to wired frames. The practice most in vogue here is to use strips of foundation only about half the depth of the frame. This is not so apt to break down or sag; but of that last it matters

not, for, though the upper half of the comb may have cells of worker size, the addition put on by the bees is most apt to be of drone size, especially if honey is coming in fast when the comb is built. In every apiary, I suppose, there is some natural comb built, and much of this will be drone. I make it a point to watch for all such combs; and where the drone-cells are only in patches I cut them out and fit worker comb in the places; or, if honey is coming in, and comb-building going on, put the pruned frames in some hive which will patch them up with worker comb. Hives having young queens recently commenced laying will always do this if the comb to be worked upon is placed in the center of the brood-nest; so, too, will any weak stock having a vigorous queen. But hives with old played-out queens, or colonies on the point of swarming, will generally build drone comb."

The Superiority of the Porter Bee Escape.

This is a little early in the season to begin talking about bee escapes, but when the time comes to use them it is well to know which is the best and where to get it. I had supposed the Hastings escape as good as the Porter, perhaps better, as it has four exits, but a correspondent of *Gleanings*, Mr. S. A. Shuck, says the Porter is superior, and gives his reasons in the following extract from *Gleanings*.

"In *Stray Straws* for Nov. 1, Dr. Miller asks: 'Will an escape make quicker work in daytime or at night?'"

With your permission, Mr. Editor, I will try to answer Dr. Miller's inquiry; and, for the benefit of all parties concerned, give some of the details of the experiments with bee-escapes, and the facts gleaned thereby.

Many of the readers of *Gleanings* remember that the writer had the pleasure of testing what has proven to be the only practical and convenient bee-escape now before the public (the Porter spring bee - escape), before it was placed upon the market. All the forms of escapes known at that time were tried, and all, except the one so widely known now, from the defect of the little machines or the peculiar habits of the bees, proved to be unsatisfactory. The spring escape was tried in all conceivable forms—perforated tin tops and bottoms; two or more exits; with springs closing up to side walls or partition in the escape, similar to the so-called Hastings escape. Several escapes were placed in one board to ascertain whether or not the bees would leave the supers quicker through several exits than through a single one. These tests were made both night and day, through good and bad weather, both cold and hot, and when there was an abundance of nectar in the flowers, and when there was neither nectar nor flowers; and the facts gleaned from these experiments, I believe, will ever remain unchanged.

The present form of the Porter spring escape is the best that can be devised for thorough, practical work. Escapes with single springs pressing against the side walls or partitions in the escape clog up with dead bees, where double springs do not, simply because the double springs give a larger opening with less pressure than can be had with single springs. To an observing mind it would naturally appear that escapes with several openings, or perforated tops and bottoms, would give better satisfaction in the matter of ventilation; but many practical tests in this direction show that a single exit, together with the cracks at the joints of the hive, made by adjusting the escape-boards, give all the ventilation that is necessary or desired.

As to the rapidity of the working of escapes, when they work best, etc., I give the following from a small circular published by the Messrs. Porter:

"Owing to the varied disposition of the bees of different colonies under the same conditions, there is a great difference in the length of time occupied by them in passing from the super; and with the bees of the same colony, the size of the super, the time of the day, the state of the weather, the presence or absence of a honey-flow all have their influence to vary this time. As a rule they pass out most rapidly when all conditions are such that they are naturally the most active."

As bees are more active during daytime than at night, they leave the supers more readily during the daytime. Bees, too, that, under the influence of a good honey-flow, would leave the supers in a few hours, may, in a time when there is no nectar, and the weather is cool and cloudy, be as many days in deserting the supers. Thus it will be seen that those who wish to accomplish the most that is possible with the best escapes must work when all things combine to their interest.

As to the difference of time occupied by the bees of one colony passing from a super through a single escape, as compared with several escapes, it is not discernible. A whole colony could pass through a single escape in less than one hour, if their anxiety to move out could be awakened to such a degree as to cause them *all* to want to get out in that time. But as there is no way by which such an anxiety can be awakened, the only thing to be done is to allow them their own good pleasure; and in this direction a single escape is better than a dozen, as there is less heat from below through one opening than through several."

A Condensed View of Current Bee Writings.

E. E. HASTY.

"My writings flow from no satiric vein,
Contain no poison, and convey no pain."

There will be a preface, but not here; people do not heed prefaces when so unwisely

located; so I will put it in subsequently, after you get to reading. The first to come to my table for the new-born year is—

APICULTURIST.

Really looks as though editor Alley perceives that improvement of contents is the word that has been going round. It opens with—

"I reared five-banded bees as far back as 1883. They were a cross between the Italian and Cyprians. * * I never had better bees in my apiary. * * Friend of mine sent me some five-banded Italians. * * I know them just as a man is supposed to know his brother. There are certain marks about them that identify them so plainly that the running man may read."

G. W. DEMAREE.

"Told you so." Some that offer them for sale may not know this, preferring to cling to the queen-breeders "rot" that secret crosses with drones from afar seldom or never take place.

Next comes the Mocco Stingless Bee, a queer chap, the size of a grain of wheat, which—

"Makes its nest only in the ground, boring into the hard red soil like the ants. The nest is pear-shaped, of the capacity of about three gallons; contains very little comb, but a gallon or more of liquid honey at the bottom, slightly acid, good eating. The nest is lined with wax, and the entrance is a small narrow spout, less than one half of an inch in diameter, which projects about an inch above the ground, and has an ingenious sort of flexible lid of wax."

H. A. WOLFF,

Baberton, South Africa.

Here's richness, indeed! Don't believe any insect that preserves honey by putting acid in it can quite touch the level of a civilized city market; but what a boon for colored boys and girls in Texas and Florida! The fact that the Mocco digs the cave for its own domicile is a pretty strong hint that a single female begins the establishment bumble-bee fashion, the children enlarging the hole and building up into a nation. Before Uncle Sam spends some thousands in the desperate effort to import that wild open-air savage *Apis Dorsata*, he had better carve out by the roots and bring to Texas a few Mocco colonies. What pleasure to lie in the shade and suck honey with a straw direct from the cistern of its unsuspecting owners!

Along amidships we find the editor has been reading his back numbers, and finding valuable articles which the present subscribers never saw, he proposes to reprint them. Not a bad idea.

Four pages are given to the opening of what appears to be a new book, to be first

published as a serial. (How the serial idea spreads, doesn't it?) The title is "Practical and Profitable Bee-keeping," By a practical bee-keeper. A Bluenose might so blunder as to suppose the P. B. friend Alley himself incognito. The quality and diction is fair; but some of the statements sound rather reckless for a standard work, as—

"All who intend to make the keeping of bees their only means of gaining a living will soon come to grief."

"The bee flies swiftly—at the rate of about a mile a minute."

Next, aged 32, comes the Dean of delegation—

AMERICAN BEE JOURNAL,

And editor York thinks the two portraits of our editor in the December REVIEW almost illustrate the theory of evolution. Middling fair, friend Y.; go and do likewise.

Hello! Here's our esteemed comrade B. Taylor in the evolution business too, at the head of an interesting life sketch. Finished off the inside of a church when he was seventeen. And later on he saw his bees finish off 26,000 lbs. of sections in one season.

Compliments to Jennie Atchley, who is worthily trying to give the southern subscribers something which is their very own, and the fruit of their own soil.

Soon the Michigan convention opens out. President R. L. Taylor notes a general unrest among bee-keepers and regrets it. Golden age gone by. Expect nothing, and be blest in getting it. But he just hits the mark when he tells how far nature has carried the improvement of the bee already and how hard it is to carry the work much further. Prof. Cook gets back at him to the effect that (in the right way) bee folks ought to be dissatisfied in the direction of finding some remedy for the unendurable. One of the most remarkable of remarkable speeches was James Heddon's plea for letting alone adulteration and adulterators. Perhaps it might as well be left in its entirety to just weigh its own weight. Condensation would be very apt to show the bias of the condenser. Our hatred will not keep truth from being true. Per contra, sin has no power of its own to strut in martyr white. Soon W. Z. patiently explained once more the sugar-honey muddle, too familiar to present company to need comment, except to commend the plucky vigor of this one sentence, which takes a disagreeable bull right by his naughty horns—Tut, tut! Don't you wish you knew,

now? Subject's closed. The sentence was on the other side; and if my side cannot be heard I'm not going to expedite the enemy's cannon balls for him.

In the third number for 1893 editor York announces that one side of the sugar-honey matter may be heard in his columns but not the other. No comments from me. My readers can imagine what I think of that performance without my telling them.

In the Contributions department, G. M. Doolittle writing in his usual able way concerning winter work brings out this idea about warming honey to extract in cold weather. Warm room, of course, but put it on a high shelf. Nothing warms readily near the floor in winter. True as a die.

J. A. Green restates his excellent method of packing—and it amuses me to see that he has this year got among the late packers, like me.

GLEANINGS.

Here's a journal so broad and long that a reviewer can't very well talk all over it. How queer that some of you should be waiting to hear me tell what *Gleanings* is like! It always begins with "Stray Straws," little nuggets of truth, fun, gossip, warning or conundrum by Dr. Miller. Then Father Langstroth in his ripe autumn, gives us a section of his reminiscences. After bees fried, bees roasted, and bees "biled" recess comes, and Rambler makes us laugh with outrageous pictures. More fried, roasted and "biled," and then senior editor Root begins to heave in sight with endless "garden sass," and interesting travels, and good earnest Christian preaching, all interleaved and lit up with splendid illustrations. Lastly, to end off with, Ernest tries his prettiest to get his last leaf up even with Miller's first leaf—two unbroken colts pulling at an even-er. You perceive at once that *Gleanings'* theory of success is not "Bees exclusively" but bees "till you can't rest," and lots of other attractive things too. It's rather a taking theory; yet none of its cotemporaries can wrestle with it on that basis. They have not the space to do it in, else "can't spell able"—mostly both.

As to this number, whereabouts have we a portrait and biography that we can afford to put beside Miss Leah Atchleys? Old maid, eh? Six years old Dec. 16th, and had reared with her own hands a number of queens. First word she ever spoke was "Bees!"

She looks to me like a come-outer. Let us pray God she may never (come-outer girls of the South have done the like already) never take a rifle in her deft little hands, and fight for the lives of her people, and her faith, against the great Juggernaut that wears the livery of heaven in these days. Her hot speech to the older brother that meddled with her bees sounds a little like battle. He had doubled up the bees without asking permission—"Youngster, you let my bees alone or I will double you up." Mother must do a lot of rubbing in the "Suffereth long, and is kind," as well as *leaving in* the dauntless energy.

Now here's a little of that preface. I think I must be excused from the articles on general subjects, even though of great excellence, barring the few cases where it seemeth me good to make exception. Ditto of the humorous bee articles. Fun seldom makes good hash even if good when fresh.

So that stilted pack of scientific lies about each pound of honey representing millions of miles of bee travel came to grief in England. Requires 275 lbs. of working bees per colony to haul in a 22 lb. run. Same thing printed in A. B. J. and none of us took pains to get after it.

Fortunately we do not thus let alone the mistakes of a recognized bee writer. Edwin France, one of the best bee-keepers in the world, and the editor both get after me for the dangerous error of putting bees above their stores for winter. In Wisconsin weather the cluster is not always able to follow down. My defense is I didn't say so. Dr. Miller misquoted me just one important word. I said stores *behind* them, meaning toward the rear of the hive when on shallow frames.

Gleanings No. 1 looks rather like a sugar-honey special; but in No. 2 the gates are banged and bolted again. Perhaps, the most remarkable thing about it is Prof. Cook's "Right About Face." He does not base it to any great extent on change of opinion, but on disposition to yield to the popular clamor. Well, well, comrades, the wheels have stopped; and we are sitting on the safety-valves now nice and heavy—but *the water is still bilin*.

More preface. It is hardly best to review articles in which a queen-breeding editor puffs his queens and their race, or those in which the supply editor puffs his supplies. Not all, by any means, of this kind of writ-

ing is down to the level of that familiar "yawp" in which the auctioneer cries his wares; but there are obvious reasons for letting interested editorials alone. Don't talk back to a book agent. This is not aimed at *Gleanings* especially although dropped down in *Gleanings'* territory. Wanted some objectionable fellows to stand next to the dangerous boiler, you know.

SKIPPED.

How would the above word do for the inscription on the door of a repentance closet in which all the sleepy "young uns" among the journals should be cast in by name—to be kept there till they should think up a thought worth repeating? Hardly answer. The strong ones would kick on the door inside and say things. And the weak ones that are liable to die any time must not be put in dungeon. I do not aspire to be a Herod. But obviously something has got to be skipped else this department will die of chronic abbreviation. I will try not to skip any new idea of commanding importance—culling at large part of the time, and reviewing more minutely part of the time. The journals must take turns in being reviewed *in extenso*—and also when the turn of *Gleanings* or A. B. J. comes their review will be liable to "bob off" most anywhere from sheer lack of space.

MORE OF GLEANINGS.

I can scarcely do more than note by title Doolittle's "Bees Under the Snow," and Manum's anti-swarm tactics, and France's trapping of our enemy the skunk, and Watkins' California Flora, all well worthy of attention. Must cry out a little at one item in the latter, the quiet introduction of the Cuban Bell Flower into California—no honey, but grows in Cuba nicely. I have the impression that it is a great nuisance in Cuba; will it become such in its new home? 'Specks the law might as well assign stern penalties for this sort of impertinent monkeying.

"Bees leave their supers more readily during the day time."

S. A. SHOOK.

Soak, soak, soak your wax-material before you heat it; for if the dirt and fiber first get soaked with melted wax you can't unsoak it. And—

"Never pour water into the acid (sulphuric) but pour the acid slowly into the water."

ARTHUR C. MILLER.

O. R. Coe presents a wax method of which the principal new point is a perforated metal basket hung over a boiling tank. Well soak-

ed mess hot in basket, hot water continually poured on, and *shake it*.

Charles F. Haas, of Canal Dover, Ohio, is trying to teach us a better process, a cold process, of making sugar-syrup that will not granulate. Percolation through a sponge. Something may come of it yet.

But the taking new idea of this *Gleanings* is a bee escape remarkably easy to use, and costing nothing. Interpose an empty super, partly covered with slats. Place on this a sheet of paper with a few holes carefully punched in downward. Then put on the super of bees and honey. Succeeded 75 times with no failure. Until some one else scores 75 failures and no success this must be regarded as promising. For this we are indebted to John Handel, Savanna, Illinois.

This paper is too long already for REVIEW to be reviewed this time, but I must congratulate our editor on his Washington notes. Most of mankind seem fated not to see or hear the things worth noticing, and to tell a lot of stuff of no use to any human being. We are happy in having an editor who is one of the rare exceptions.

Having a lot of gall and vinegar about to be left over I think I must pour it upon that Washington system of graded honey. A mess of mendacity without a truthful spot in it from beginning to end. First by a little silent fib the fancy grade of honey is abolished. This is to make room for the second and plainly audible fib of calling No. 1 honey "Fancy." This in turn makes room for the third and thundering fib of calling No. 2 honey No. 1. Lastly (as Satan would say if he were a minister) honey somewhat travel-stained, just as good as any except to the eye, is ruled out entirely; thus making sure that the producer or some one after him, will try to get it in as No. 1 honey—seeing there is no lower grade. Definition. Christian. A man who does not want his customer to be deceived in regard to anything he buys. If this is correct how can good men give their assent to a system which foreordains nearly every man who buys a section of honey in the regular channels of trade to be cheated by supposing he has a higher grade than he has? Let every brother who respects clean-cut truth meditate a little on this. And more especially let us meditate, those of us who love that radiant Christ—that refiner's-fire Christ—who came to bear witness to the truth.

RICHARDS, Lucas Co., O., Jan. 27, 1893.

ADVERTISEMENTS

I HAVE FOUR SINGLE-COMB

OBSERVATORY HIVES

That I wish to dispose of. They are finely made of "quartered" oak and polished. They cost \$5.00 each, but I am out of the show business and am open to offers

ARTHUR C. MILLER,
Box 575, Providence, R. I.

2-93-tf.

HUNT'S

FOUNDATION

FACTORY.

Send for free samples of foundation and sections; warranted good as any made. Dealers, write for special prices and the most favorable conditions ever offered on foundation. Send for new, illustrated, free price-list of a full line of supplies.

M. H. HUNT,
Bell Branch, Mich.

1-93-tf

No. 1 SECTIONS \$2.50.

No. 2 SECTIONS \$1.60.

DOVETAILED HIVES 75c. UP.

Smokers, Foundation, Feeders, Bee Veils, and all things needed in the Apiary. Wholesale and retail. Send for Reduced List. Free.

W. D. SOPER,
Jackson, Mich.

2-93-tf.

Please mention the Review

Early Queens From Texas,

From my choice golden stock. My bees are very gentle, good workers, and beautiful. Safe arrival and satisfaction guaranteed. One untested queen, April and May, \$1.00; six for \$5.00; later, 75c. Orders booked now; money sent when queens are wanted. Send for price list.

J. D. GIVENS,
Lishon, Texas.

1-93-9t.

Please mention the Review.

Muth's HONEY EXTRACTOR PERFECTION Cold-Blast Smokers,

Square Glass Honey Jars, Etc.

For Circulars, apply to CHAS. F. MUTH & SON, Cor. Freeman & Central Aves., Cincinnati, O. Send 10c. for Practical Hints to Bee-Keepers.

1-93-tf.

Please Mention the Review.



Please mention the Review.



Interesting Monthly for
The Family and Fireside

Welcome in every Home.

Large Premiums for Clubs.

Sample Copy sent Free.

THOMAS G. NEWMAN,
147 South Western Ave.,
CHICAGO, ILLS.

Please mention the Review.

Leather Colored

HONEY QUEENS, from Imported Mother, warranted purely mated, after June 10th, at \$1.00 each; six at one time, \$5.00. Untested queens, 75c. each. Address

C. A. BUNCH,

1-93-tf.

Nye, Marshall Co., Ind.]

Please mention the Review.

—If you are going to—

BUY A BUZZ-SAW,

write to the editor of the REVIEW. He has a new Barnes saw to sell and would be glad to make you happy by telling you the price at which he would sell it.

ITALIAN QUEENS

Bred for Business, Gentleness and Beauty. Untested, 80c. each; three for \$2.25; six for \$4.00; 12 for \$7.50. Tested, \$1.25. Select tested, yellow to the tip, breeder, \$1.50. Will commence shipping April 15th. On all orders received before March 1st, accompanied by the cash, 10 per cent. discount. Safe arrival guaranteed.

G. E. DAWSON,

1-93-12t.

Carlisle, Sonoko Co., Ark.

Please mention the Review.

If You Wish Neat, Artistic

PRINTING,

Have it Done at the Review.

ITALIAN QUEENS AND SUPPLIES FOR 1892.

Before you purchase, look to your interest, and send for catalogue and price list.

J. P. H. BROWN,

1-88-tf.

Augusta, Georgia.

Please mention the Review.



"K. D."

Is the name of our New Hive.

**New,
Novel,
Radical.**

A combination Bottom Board and Feeder.
A Reversible Brood Chamber.
Self-spacing Frames.
Combination Honey Board.
Double Entrance and Queen Trap.
Bees go direct to brood chamber, or super, or both, at will of apiarist.
Super holds 32 Sections and 3 Separators, and supports the sections by compression and spurs.
Both side and end compression on both frames and sections.
No T's, slats, followers or wedges.

CONTROLS SWARMING

without dequeening or frame manipulation. The Hive is "K. D.," always Knocked Down when not in use. We Nail and Paint the Hive and ship it "K. D.," You set up the Brood Frames and put in the Starters, and the Hive is ready for use.

AIKIN BROTHERS & KNIGHT,

Loveland, Colo. 2-93-tf

Please mention the Review

5-BANDED }
3-BANDED } **BEES.** Circular Free.
Nucleus Colonies.

2-93-tf. J. F. MICHAEL,
German, Ohio.

Please mention the Review.

IMPORTANT TO BEE-KEEPERS!

To make a success of bee keeping, you want bees that will give the very best results. My *Golden Italians* have gained a good name on their own merits. Those who have tested them with other bees say "they are the best honey gatherers, cap their honey the whitest, as gentle as butterflies, beautiful to look at, are the largest and strongest bee of all the races." Queens bred from mothers that produce uniformly marked

FIVE-BANDED WORKERS

In March, April and May, \$1.25 each, 6 for \$6.00; June, \$1.00 each, 6 for \$5.00; July to Nov., \$1.00 each, 6 for \$4.50. Special prices on large orders. For full particulars send for descriptive circular.

12-92-tf C. D. DUVALL,
Spencerville, Montg. Co., Maryland.

Please mention the Review.

THE ODELL TYPE WRITER.

\$20 will buy the **ODELL TYPE WRITER** and **CHECK PERFORATOR**, with 78 Characters, and **\$15** for the **SINGLE CASE ODELL**, warranted to do better work than any machine made.

It combines Simplicity with Durability, Speed, Ease of Operation, wears longer without cost of repairs than any other machine. Has no ink ribbon to bother the operator. It is Neat, Substantial, nickel plated, perfect and adapted to all kinds of type writing. Like a printing press, it produces sharp, clean, legible manuscripts. Two to ten copies can be made at one writing. Any intelligent person can become a good operator in two days. We offer **\$1,000** to any operator who can equal the work of the Double Case Odell.

Reliable Agents and Salasmen wanted. Special inducements to Dealers.

For Pamphlet giving Indorsements, &c., address

ODELL TYPE WRITER CO.,
358 Dearborn St., Chicago, Ill.

FREE TO ALL

SAMPLE COPIES EITHER OF THE

Canadian Bee Journal

OR

Canadian Poultry Journal,

Or both, will be sent FREE to applicants who desire them, upon receipt of their names and addresses.

These papers are both of them edited and arranged by practical men, admittedly the most experienced in their particular lines to be found on the continent, and the Journals may therefore be regarded as authoritative upon the several subjects of which they treat.

Address **BEETON PUBLISHING CO.,**
Beeton, Ontario.

FOR SALE.

SEVENTY COLONIES ITALIAN : : : :
: : : : : : : : BEES AND FIXTURES.

Also, a lot of new and second-hand Hives at a bargain. Write for particulars.

2-93-tf. **WILLIAM IDEN,**
Etna Green, Ind.

Quigley's Golden Queens are bred for business. Try one. Circular of Queens and Bee Supplies ready Feb. 1st. Send for it and a free Sample Copy of the "PROGRESSIVE BEE-KEEPER."

Address, **E. F. QUIGLEY,**
Unionville, Mo.

Names of Bee - Keepers.

TYPE WRITTEN.

The names of my customers, and of those asking for sample copies, have been saved and written in a book. There are several thousand all arranged alphabetically (in the largest States) and, although this list has been secured at an expense of hundreds of dollars, I would furnish it to my advertisers at \$2.00 per thousand names. A manufacturer who wishes for a list of the names of bee-keepers in his own state only, or, possibly, in the adjoining states, can be accommodated. Any inquiry in regard to the number of names in a certain state, or states, will be answered cheerfully. The former price was \$2.50 per 1000, but I now have a type writer, and, by using the manifold process, I can furnish them at \$2.00.

W. Z. HUTCHINSON, Flint, Mich.

Queen Dealers,

Write for prices on fine, golden, Italian Queens from Mar. 15 to Nov. 15, 1893. Best colonies last year gave 200 lbs. Average this year was 125 lbs. per colony, besides drawing heavily on them for queen rearing. J. B. CASE, Port Orange, Fla. 11-92-tf

Please mention the Review.

We have a large lot of

DOVETAILED HIVES

which we will sell for 50 cts. each, including snipers, section holders and brood frames. This offer is limited to this lot of hives, 1-92-12t

WM. H. BRIGHT, Mazeppa, Minn.

PATENT. WIRED, COMB FOUNDATION

HAS NO SAG IN BROOD FRAMES.

THIN, FLAT BOTTOM FOUNDATION

HAS NO FISH BONE IN SURPLUS HONEY.

Being the cleanest is usually worked the quickest of any foundation made.

J. VAN DEUSEN & SONS,

(SOLE MANUFACTURERS),

3-90-tf Sprout Brook, Mont. Co., N. Y.



Have You Seen Our Big Blue Catalogue

FOR 1893? Seventy illustrated pages. Sent FREE to any bee-keeper. BEE-SUPPLIES, at retail and wholesale. Everything used in the apary. Greatest variety and largest stock in the West

1-93-tf. E. Kretchmer, Red Oak, Iowa.

Please mention the Review.

DO NOT GIVE YOUR ORDER FOR SECTIONS UNTIL YOU GET OUR PRICES ON THE

"BOSS" ONE-PIECE SECTION

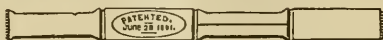

We are in better shape than ever to fill orders promptly. Also,

DOVETAILED HIVES, - - - - -

- - - FOUNDATION, SMOKERS, Etc.

Write for Price List.

J. FORNGROOK & CO.

WATERTOWN, Wis., Jan. 1, 1893. 1-93-tf.

Please mention the Review

BERRIES.

Friends, I can furnish you with all kinds of Berry Plants, at about one-half the usual price. Plants warranted. Bank references Satisfaction guaranteed.

Address EZRA G. SMITH, Manchester, N. Y. 1-93 2t.

Please mention the Review.

Illustrated Advertisements Attract Attention.



Cuts Furnished for all illustrating Purposes.

REAR YOUR OWN QUEENS!

QUEEN-REARING MADE EASY—ANYONE CAN REAR THEM.

An important discovery relative to Rearing Queens was made by me in the season of 1892, and will be given in the MARCH ISSUE OF THE AMERICAN APICULTURIST. It tells you how to rear queens in a full colony without removing or disturbing the queen—how to have queen cells started and completed in the same hive which has a fertile queen; in fact, it is just the information that thousands of bee-keepers have long desired to know. The above copy of the American Apiculturist is worth ONE HUNDRED DOLLARS to any live bee-keeper. Yet it will be mailed to any address for 25 cents; or the 12 copies for 1893 for 75 cents. In order to make our book on Queen-Rearing (Thirty Years Among the Bees) complete in one volume, all the matter in the March issue of the Apiculturist will be bound in one book. Mailed, per copy, at 50 cents; or the book (72 pages), The Bee-Keepers' Directory (138 pages), and the American Apiculturist one year, all for \$1.00.

Address

H. ALLEY, Wenham, Mass.

Barnes' Foot and Hand Power Machinery.



This cut represents our Combined Circular and Scroll Saw, which is the best machine made for Bee Keepers' use in the construction of their hives, sections, boxes, etc.

8-91-16t

MACHINES SENT ON TRIAL.

FOR CATALOGUE, PR ICS, TC.,

Address W. F. & JNO. BARNES CO., 384 Ruby St., Rockford, Ills.

IF YOU WANT THE

BEE BOOK

That covers the whole apicultural field more completely than any other published, send \$1.00 to Prof. A. J. Cook, Agricultural College, Mich., for his

Bee-Keepers' Guide.

Liberal Discounts to the Trade.

Please mention the Review.

ESTABLISHED 1876.

S. T. FISH & CO.,

COMMISSION MERCHANTS.

Dried Fruit, Honey and Farm Products.

189 SOUTH WATER ST., CHICAGO.

We make a specialty of our honey department and ask for your consignments and correspondence. Reference, any bee-paper. 9-92-6t

Please mention the Review.

HATCH CHICKENS BY STEAM
 With the Improved **Excelsior Incubator.**



Simple, Perfect, Self-Regulating. Thousands in successful operation. Guaranteed to hatch a larger percentage of fertile eggs at less cost than any other Hatcher. Lowest priced first-class Hatcher made.

Circulars free. Send 6c. for Illus. Catalogue.

GEO. H. STAHL, Quincy, Ill.

\$1.00 HIVE.

—:O:—

A Complete Hive for Comb Honey, including Six Section Holders, Eight Thick Top-Bar Frames, Half-Story Body, Bottom Board and Cover, \$1.00 each; in flat, 90 cts each.

—:O:—

Hoffman Frames, Sections, Foundation, and a Full Line of Bee-Keepers' Supplies.

—:O:—

A 20-page Price List Free.

12-92-12t

J. M. KINZIE.

Rochester. Oakland Co., Mich.

TYPEWRITERS.

Largest like establishment in the world. First-class Second-hand Instruments at half new prices. Unprejudiced advice given on all makes. Machines sold on monthly payments. Any instrument manufactured shipped, privilege to examine. EXCHANGING A SPECIALTY. Wholesale prices to dealers. Illustrated Catalogues Free.

TYPEWRITER { 31 Broadway, New York
 HEADQUARTERS, { 186 Monroe St., Chicago.

COMB FOUNDATION AND SECTIONS.

—:O:—

CAUTION.

Do not buy a thick, heavy base comb foundation for use in your sections when you can get 14 to 16 square feet to the pound. Also be sure and buy your sections where you can get a nice box at a low price. Send me your address and I will be pleased to send you a sample section, a sample of the

THINEST COMB FOUNDATION MADE,

And prices at which they may be bought.

W. H. NORTON,

2-93-14.

Skowhogan, Me.

Please mention the Review.

Cheap Freight and Quick Transportation.

Being located at the most central point of railroad and express companies enables us to furnish bee keepers with supplies at less cost to themselves than any house in the country. We furnish everything needed in the apiary, as low as the lowest and as good as the best.

COOK'S COMPLETE HIVE combines all the most approved methods of hive making. It is a complete arrangement for out-door wintering and is equally well adapted to producing comb or extracted honey. Send for circular. Fine lot of Bees for Sale cheap.

J. H. M. COOK, (SUCCESSOR TO KING & ASPINWALL) 78 Barclay St., New York City.

Great Reduction.

SECTIONS AT GREATLY REDUCED PRICES.

HIVES, SHIPPING CASES, &c., AT BED-ROCK PRICES.

WRITE FOR FREE, ILLUSTRATED CATALOGUE AND PRICE LIST.

G. B. LEWIS & CO., Watertown, Wis.

1-93 1f. Please mention the Review.

TO REDUCE STOCK.

From now until March 1st only, we will sell No. 1, One-Piece Sections at \$2.75, and No. 2 at \$2.00 per 1,000. Other supplies in proportion. On all cash orders of \$5.00 or more, from within 100 miles of us we will pay the freight.

J. J. BRADNER,
Marion, Grant Co., Ind.

1-93-2t. Please mention the Review.

New as Well as Valuable

IMPROVEMENTS

IN BEE-HIVES, SMOKERS,

FOUNDATION FASTENERS,

SECTION PRESSES AND FEEDERS.

Special prices given to parties who will take hold of and push the sale of these goods. For circulars and particulars, address

LOWRY JOHNSON,
Masontown, Pa.

1-93-ft.

"FLORIDA." — 300.

LEATHER-BACK ITALIAN QUEENS.

By my special method of taking a crop of honey by the "Migratory" system, I shall have **300 tested** queens for delivery about March 20th. Prices \$10 per dozen. None over six months old. My crop the past season from one yard of 42 colonies, spring count, was 10,800 pounds and increased to 150.

A. F. BROWN,
Huntington, Putnam Co., Fla.

1-93-4t



BINGHAM PERFECT
BEE SMOKER
Pat'd 1878, 1882, & 1892.
Cheapest & Best on Earth.
Send Card for Circular to
Bingham & Hetherington
ABRONIA, MICH.

Bee Hives and Section Boxes.

Simplicity, Langstroth-Simplicity, Standard Langstroth, Dovetailed and Champion Chaff Hives, Supers, One Piece Sections and Shipping Cases, Foundation, Smokers, etc., etc. Send for 16 page Circular.

1-92-ft PAGE & KEITH, New London, Wis.

SECOND HAND SUPPLIES CHEAP.

I have given up the bee business for the practice of law. I have a lot of supplies on hand, both used and unused, which I will make it an object for any one needing them to buy. There are about 80 of the New Heddon Hives, over 250 T supers, 36 new 60-lb. honey cans, honey extractor, glass for 12-lb shipping cases, sections, surplus foundation, queen-excluding honey-boards and almost everything to be found in a large apiary. No circulars. Write me what you want and I will let you know condition and price. All these goods are at Newton, Jasper Co., Iowa, and will be shipped from there in April by my brother. Address WM. L. DREW, 122 Oxford St., North Cambridge, Mass.

QUEENS, QUEENS, QUEENS.

Have you tried my Italians? I have the finest bees you ever saw; they are leather colored Italians, and as honey gatherers they can't be excelled. Try them and be convinced. They are very gentle and hardy and good winterers. Un-tested queens, \$1.00 each, or \$9.00 a dozen. Tested, \$1.50 each, or \$12.75 a dozen. Safe arrival and satisfaction guaranteed. On all orders received before March 1st, accompanied by the cash, a discount of 15 per cent. will be given. Send for price list of Italian Queens and Beekeepers' Supplies
M. H. DE WITT,
1-93 6t. Sang Run, Garrett Co., Md.

QUEEN CAGES

Are my specialty. I make the Benton cage in many styles and sizes. A light cage saves postage; a neat cage creates a favorable impression; one properly arranged carries its occupants safely in either hot or cool weather; and my special machinery and large trade enable me to furnish extra nice cages, having all these advantages, at a very low price. Sample cages and prices on application.

C. W. COSTELLOW, Waterboro, Me.



OUR
 "Falcon" Sections
 Better than any.
 Cheap as many.

Our No. 1 Sections
 Equal to many.
 Cheaper than any.

Any Size. Any Quantity.
 At Any Time.

Also, all styles HIVES and BEE-FIXTURES Cheap. New catalogue and price list free. Samples of Falcon Sections for 2c. stamp.

W. T. Falconer Mfg. Co.,
 JAMESTOWN, N. Y.

Golden,
 5-Banded,
 Italian Queens

My Bees are as good honey gatherers as there are in the country, while for Golden Beauty they cannot be excelled in the world.

Warranted Queens, 75 cents each.

Tested, \$1.00 each.

Breeding Queens, \$2.50 to \$3.00.

Ten per cent discount on orders for five or more queens. Satisfaction guaranteed. Make money orders payable at Caldwell, Texas. Address

C. B. BANKSTON, Chrismar, Texas.

2-93-1f

Please mention the Review.



I TELL you what, Jones, Levinger Bros. sell the best goods and at the lowest prices of any one I've struck yet. The largest and best equipped

Bee-Hive Factory

In the West. The Dovetailed Hive and New Hoffman self-spacing frame a specialty. Everything used by practical bee-keepers by wholesale and retail. Send for their free Illustrated Price-List, and save money. Supply Dealers, send for their Wholesale List. Address

LEVERING BROS.,

WIOTA, Cass Co., Iowa.

2-93-6.

If you wish to advertise anything anywhere at any time write to GEO. P. ROWELL & CO., No 10 Spruce St., N. Y.

1852.

REDUCTION ON THE PRICE OF

1891

Langstroth on the Honey Bee

(REVISED.)

PRICE BY MAIL, \$1.40; BY EXPRESS OR FREIGHT WITH OTHER GOODS \$1.25.

By its copious indexes, by its arrangement in numbered paragraphs, including reference numbers on any question in bee culture, any information can be instantly found. This book is the most complete treatise on bee keeping yet published. A FRENCH EDITION JUST ISSUED.

1875. DADANT'S COMB FOUNDATION. 1891.

More than Ever. Better than Ever. Wholesale and Retail.

Half a Million lbs. Sold in 13 Years.

Over \$200,000 in Value.

It is THE BEST, and guaranteed every inch equal to sample. All dealers who have tried it have increased their trade every year. Samples, Catalogue, free to all. Send your address.

We also make a specialty of Cotton and Silk Tulle of very best grade for bee-veils. We supply A. I. Root and others. 7,000 Yards just received. Prices Very Low. Samples Free.

Smokers, Honey Sections, Extractors, Tin Pails for Honey, Etc. Instructions to Beginners with Circulars Free.

4-92-12.

Mention Review.

CHAS. DADANT & SON, Hamilton, Hancock Co., Ills.

MAR. 1893



At Flint, Michigan.—One Dollar a Year.

ADVERTISING RATES.

All advertisements will be inserted at the rate of 15 cents per line, Nonpareil space, each insertion: 12 lines of Nonpareil space make 1 inch. Discounts will be given as follows:—

On 10 lines and upwards, 3 times, 5 per cent; 6 times, 15 per cent; 9 times, 25 per cent; 12 times, 35 per cent.

On 20 lines and upwards, 3 times, 10 per cent; 6 times, 20 per cent; 9 times, 30 per cent; 15 times, 40 per cent.

On 30 lines and upwards, 3 times, 20 per cent; 6 times, 30 per cent; 9 times, 40 per cent; 12 times, 50 per cent.

Clubbing List.

I will send the REVIEW with—		
Gleanings,.....	(\$1.00).....	\$1.75.
American Bee Journal.....	(1.00).....	1.75.
Canadian Bee Journal.....	(1.00).....	1.75.
American Bee Keeper.....	(.50).....	1.40.
Progressive Bee Keeper.....	(.50).....	1.40.
Bee Keepers' Guide.....	(.50).....	1.40.
Apiculturist.....	(.75).....	1.65.
Bee-Keepers' Magazine.....	(.50).....	1.40.

Honey Quotations.

The following rules for grading honey were adopted by the North American Bee Keepers' Association, at its last meeting, and, so far as possible, quotations are made according to these rules:

FANCY.—All sections to be well filled; combs straight, of even thickness, and firmly attached to all four sides; both wood and comb unsoiled by travel-stain, or otherwise; all the cells sealed except the row of cells next the wood.

No. 1.—All sections well filled, but combs uneven or crooked, detached at the bottom, or with but few cells unsealed; both wood and comb unsoiled by travel stain or otherwise.

In addition to this the honey is to be classified according to color, using the terms white, amber and dark. That is, there will be "fancy white," "No. 1 dark," etc.

BUFFALO, N.Y.—Fancy is in good demand and stock is light; dark is dull with a liberal supply on hand. We quote as follows: fancy white, 18 to 19; No. 1 white, 16 to 17; fancy dark, 10 to 11; No. 1 dark, 9 to 9½; white extracted, 9 to 10; amber extracted, 8½ to 9; dark extracted, 7 to 8; beeswax, 25 to 30.

BATTERSON & CO.

Mar. 6 167 & 169 Scott St., Buffalo, N. Y.

CHICAGO, ILL.—The long winter, being favorable to the honey business, has left our markets almost bare of the best grades of both comb and extracted honey, and we are having a better demand and obtaining better prices than at any previous time this season. Dark comb honey is a poor article for this market and we would advise its disposal in the home markets where the producer will not have to contend with the idea that dark comb honey is not so pure as the white. We quote as follows: fancy white, 18; No. 1 white, 16; fancy amber, 14; fancy dark, 13; white extracted, 9; amber extracted, 8½; dark extracted, 7 to 7½; beeswax, 22 to 25.

J. A. LAMON.

Mar. 6. 44 & 48 So. Water St., Chicago, Ill.

MINNEAPOLIS, Minn.—There is a good supply on hand but it is mostly dark. This stock is slow, but what little white there is on the market moves readily. We quote fancy white, 17 to 18; two pound combs, 16 to 17; buckwheat, 15 to 16; extracted honey, 10 to 11.

J. SHEA & CO.

Feb. 13. 14 Hennepin Ave., Minneapolis, Minn.

CHICAGO, Ill.—The offerings of the best grades are light, and those having any to sell should forward it at once. We quote as follows: fancy white, 18; No. 1 white, 16 to 17; fancy amber, 13; No. 1 amber 10 to 12; fancy dark, 10; white extracted, 7 to 9; amber extracted, 7 to 8; dark extracted, 6 to 7; beeswax, 22 to 25.

R. A. BURNETT & CO.,

Mar. 6. 161 So. Water St., Chicago, Ill.

ALBANY, N. Y.—Stock of honey very light. Prices well sustained. Demand will be better as the weather warms up. We quote as follows: Fancy white, 15 to 17; No. 1 white, 14 to 15; mixed, 12 to 14; fancy dark, 11 to 12; No. 1 dark, 10 to 11; white extracted, 8½ to 9½; amber extracted, 7 to 7½; dark, 6½ to 7. Beeswax, 28 to 30.

H. R. WRIGHT.

Feb. 13. 326 Broadway, Albany, N. Y.

NEW YORK.—There is a fair demand for comb honey, and supplies are light. Fancy white and No. 1 white would find ready sale this month. Beeswax is scarce and in good demand. We quote as follows: No. 1 white, 13 to 14; fancy amber, 12 to 13; fancy dark, 10; No. 1 dark, 9; amber extracted, 7 to 7½; dark extracted, 6 to 6½; beeswax, 28 to 30.

HILDRETH BROS. & SEGELKEN,

Mar. 6. 28 & 30 West Broadway New York.

KANSAS CITY, Mo.—The demand for extracted honey is good and the supply light. The supply of comb honey is fair and the demand the same. Shipments of No. 1 would meet with very ready sale. We quote as follows: No. 1 white, 16 to 17; fancy amber, 15 to 16; No. 1 amber 13 to 14; fancy dark, 12 to 13; No. 1 dark, 10 to 11; white extracted, 6½ to 7; dark extracted, 5 to 6; beeswax, 22 to 25.

CLEMONS-MASON CO.,

Mar. 6. 521 Walnut St., Kansas City Mo.

CINCINNATI, Ohio.—There is a good demand for extracted honey from the jobbing trade for family use, but the demand from manufacturers is slow. We never had as small a stock on hand as we have now, and unless unlooked for shipments arrive we shall be unable to fill our orders for March. We solicit early shipments from our friends in the South, as freight rates are now the same on honey as they are on syrups and molasses. No. 1 dark comb brings 10 to 12; extracted honey 6 to 8. Demand for beeswax is good at 23 to 25 for good to choice yellow wax.

CHAS. F. MUTH & SON.,

Feb. 14. Cincinnati, Ohio.

BEES FOR SALE

My bees have never wintered more perfectly than they have thus far this season—not a sign of dysentery, and when I swept up the dead bees in the cellar the other day for the first time, there was only half a pint of dead bees to the colony. I have more bees than I can care for and run the REVIEW, and I should be glad to sell a few full colonies in the new Heddon hive at \$6.00 per colony; 5 for \$28.50; 10 or more, \$5.50 each. All queens are pure Italians of last year's rearing. W. Z. HUTCHINSON, Flint Mich.

AFTER YOUR BEES

Have passed the rigors of winter, then comes spring with its mixture of balmy days and storms, its few short honey-flows interspersed with rain, frost and mayhap an occasional snow storm. How best to bring the bees through this trying period in such a manner that, notwithstanding adverse weather, they will gain steadily in numbers and be ready to go forth as an army to gather in the spoils when the main harvest comes, is taught in one of the opening chapters of "ADVANCED BEE CULTURE."

Price of the book, 50 cts.; the REVIEW one year and the book for \$1.25. Stamps taken, either U. S. or Canadian.

W. Z. HUTCHINSON, Flint, Mich.

173
79
258
132

WHITE POPLAR SECTIONS.

We have New Steam Power, and New Buildings, and are now ready to furnish White Poplar Sections, Clamps, Crates and Wood Sides at short notice. Workmanship, Quality and Price unsurpassed. Send for sample and price list.

PRIME & GOVE,

Bristol, Vermont.

1-90-tf

Please mention the Review

ON HAND NOW.

THE MOST COMPLETE STOCK OF BEE HIVES, SECTIONS AND SUPPLIES IN THE NORTHWEST.

W. H. PUTNAM,

RIVER FALLS, WIS.

1 93-12t.

BEEKEEPERS SUPPLIES

BEST GOODS
LOW PRICES
LARGEST STOCK

ITALIAN QUEENS AND BEES A SPECIALTY
CLOVER SEEDS BUCKWHEAT

SAMPLE OF OUR BEE JOURNAL THE WESTERN BEEKEEPER, ALSO OUR CATALOGUE FREE!

JOS. NYSEWANDER, DES MOINES, IOWA.



Spray
your
Fruit
Trees
and
Vines

Wormy Fruit and Leaf Blight of Apples, Pears, Cherries and Plums prevented; also Grape and Potato Rot—by spraying with Stahl's Double Acting Excelsior Spraying Outfits. Best in the market. Thousands in use. Catalogue, describing all insects injurious to fruit, mailed Free. Address
WM. STAHL, QUINCY, ILL.

2 93-tf

Please mention the Review,



"K. D."

Is the name of our New Hive.

New,

Novel,

Radical.

A combination Bottom Board and Feeder.
 A Reversible Brood Chamber.
 Self-spacing Frames.
 Combination Honey Board.
 Double Entrance and Queen Trap.
 Bees go direct to brood chamber, or super, or both, at will of apiarist.
 Super holds 22 Sections and 3 Separators, and supports the sections by compression and spurs.
 Both side and end compression on both frames and sections.
 No T's, slats, followers or wedges.

CONTROLS SWARMING

without dequeening or frame manipulation. The Hive is "K. D.," always Knocked Down when not in use.
 We Nail and Paint the Hive and ship it "K. D." You set up the Brood Frames and put in the Starters, and the Hive is ready for use.

AIKIN BROTHERS & KNIGHT,

Loveland, Colo.

2-93-tf

Please mention the Review

Pratt's Automatic or Self-Hiver,

Ready for use, Sent Postpaid to any Address for 75 cts. Address E. L. PRATT, BeverJy, Mass.

Special Terms to Agents.

IMPORTANT

TO BEE-KEEPERS!

To make a success of bee keeping, you want bees that will give the very best results. My *Golden Italians* have gained a good name on their own merits. Those who have tested them with other bees say "they are the best honey gatherers, cap their honey the whitest, as gentle as butterflies, beautiful to look at, are the largest and strongest bee of all the races." Queens bred from mothers that produce uniformly marked

FIVE-BANDED WORKERS

In March, April and May, \$1.25 each, 6 for \$6.00; June, \$1.00 each, 6 for \$5.00; July to Nov., \$1.00 each, 6 for \$4.50. Special prices on large orders. For full particulars send for descriptive circular.

12-92-tf

C. D. DUVALL,

Spencerville, Montg. Co., Maryland.

THE ODELL TYPE WRITER.

\$20 will buy the ODELL TYPE WRITER and CHECK PERFORATOR, with 78 Characters, and **\$15** for the SINGLE CASE ODELL, warranted to do better work than any machine made.

It combines Simplicity with Durability, Speed, Ease of Operation, wears longer without cost of repairs than any other machine. Has no ink ribbon to bother the operator. It is Neat, Substantial, nickel plated, perfect and adapted to all kinds of type writing. Like a printing press, it produces sharp, clean, legible manuscripts. Two to ten copies can be made at one writing. Any intelligent person can become a good operator in two days. We offer **\$1,000** to any operator who can equal the work of the Double Case Odell.

Reliable Agents and Salesmen wanted. Special inducements to Dealers.

For Pamphlet giving Indorsements, &c., ad dress

ODELL TYPE WRITER CO.,
 358 Dearborn St., Chicago, Ill.

FREE TO ALL

SAMPLE COPIES EITHER OF THE

Canadian Bee Journal

OR

Canadian Poultry Journal,

Or both, will be sent FREE to applicants who desire them, upon receipt of their names and addresses.

These papers are both of them edited and arranged by practical men, admittedly the most experienced in their particular lines to be found on the continent, and the Journals may therefore be regarded as authoritative upon the several subjects of which they treat.

Address BEEON PUBLISHING CO.,
 Beeton Ontario.

FOR SALE

SEVENTY COLONIES ITALIAN : : : : :
 : : : : : BEES AND FIXTURES.

Also, a lot of new and second-hand Hives at a bargain. Write for particulars.

2 93-tf.

WILLIAM IDEN,
 Etna Green, Ind.

Quigley's Golden Queens are bred for business. Try one. Circular of Queens and Bee Supplies ready Feb. 1st. Send for it and a free Sample Copy of the "PROGRESSIVE BEE-KEEPER."

Address, E. F. QUIGLEY,
 Unionville, Mo.

Names of Bee-Keepers.

TYPE WRITTEN.

The names of my customers, and of those asking for sample copies, have been saved and written in a book. There are several thousand all arranged alphabetically (in the largest States) and, although this list has been secured at an expense of hundreds of dollars, I would furnish it to my advertisers at \$2.00 per thousand names. A manufacturer who wishes for a list of the names of bee-keepers in his own state only, or, possibly, in the adjoining states, can be accommodated. Any inquiry in regard to the number of names in a certain state, or states, will be answered cheerfully. The former price was \$2.50 per 1000, but I now have a type writer, and, by using the manifold process, I can furnish them at \$2.00. W. Z. HUTCHINSON, Flint, Mich.

Queen Dealers,

Write for prices on fine, golden, Italian Queens from Mar. 15 to Nov. 15, 1893. Best colonies last year gave 200 lbs. Average this year was 125 lbs. per colony, besides drawing heavily on them for queen rearing. J. B. CASE, Port Orange, Fla. 11-92-tf

Please mention the Review.

We have a large lot of

DOVETAILED HIVES

which we will sell for 50 cts. each, including supers, section holders and brood frames. This offer is limited to this lot of hives. 1-92-12t
WM. H. BRIGHT, Mazeppa, Minn.

PATENT. WIRED, COMB FOUNDATION

HAS NO SAG IN BROOD FRAMES.

THIN, FLAT BOTTOM FOUNDATION

HAS NO FISH BONE IN SURPLUS HONEY.

Being the cleanest is usually worked the quickest of any foundation made.

J. VAN DEUSEN & SONS,

(SOLE MANUFACTURERS),

3-90-tf Sprout Brook, Mont. Co., N. Y.



Have You Seen Our Big Blue Cat-

ALOGUE FOR 1893? Seventy illustrated pages Sent FREE to any bee-keeper. BEE-SUPPLIES, at retail and wholesale. Everything used in the apiary. Greatest variety and largest stock in the West

1-93-tf. E. Kretschmer, Red Oak, Iowa.

Please mention the Review.

DO NOT GIVE YOUR ORDER FOR SECTIONS

UNTIL YOU GET OUR PRICES ON THE

"BOSS" ONE-PIECE SECTION



We are in better shape than ever to fill orders promptly. Also,

DOVETAILED HIVES, - - - - -

- - - FOUNDATION, SMOKERS, ETC.

Write for Price List.

J. FORNCROOK & CO.

WATERTOWN, Wis., Jan. 1, 1893.

1-93-tf.

Please mention the Review

QUEENS,

A large number of fine ones on hand; yellow and prolific; ready April 15th; warranted queens, \$1; 6 for \$4.50; select tested, yellow to the tips, suitable for breeders, \$2 each. Reference, A. I. Root. 3-93 tf
W. H. LAWS, Lavaca, Seb Co. Ark.

Please mention the Review.

Illustrated Advertisements Attract Attention.



Cuts Furnished for all illustrating Purposes.

REAR YOUR OWN QUEENS!

QUEEN-REARING MADE EASY—ANYONE CAN REAR THEM.

An important discovery relative to Rearing Queens was made by me in the season of 1892, and will be given in the MARCH ISSUE OF THE AMERICAN APICULTURIST. It tells you how to rear queens in a full colony without removing or disturbing the queen—how to have queen cells started and completed in the same hive which has a fertile queen; in fact, it is just the information that thousands of bee-keepers have long desired to know. The above copy of the American Apiculturist is worth ONE HUNDRED DOLLARS to any live bee-keeper. Yet it will be mailed to any address for 25 cents; or the 12 copies for 1893 for 75 cents. In order to make our book on Queen-Rearing (Thirty Years Among the Bees) complete in one volume, all the matter in the March issue of the Apiculturist will be bound in one book. Mailed, per copy, at 50 cents; or the book (72 pages), The Bee Keepers' Directory (138 pages), and the American Apiculturist one year, all for \$1.00.

Address

H. ALLEY, Wenham, Mass.

**Low Freight Rates
And no Delays.**

places according to the varying needs of each locality. Write to the place nearest you for list with prices, and when you write give a list of the goods you want, and mention this paper.

QUITE a full line of goods are sold at factory prices by F. A. Salisbury, Syracuse, N. Y.; H. G. Acklin, 1024 Mississippi St., St. Paul, Minn.; Jos. Nysewander, Des Moines, Iowa. A good assortment is also kept for the far West by Bartelede & Co., Denver, Col. For California by G. G. Wickson & Son, San Francisco and Los Angeles. For Oregon and Washington by F. L. Posson & Son, Portland, Oregon. For the Southeast Atlantic coast by Baltimore Farm Implement Co., Baltimore, Md.; and for the Far South by J. M. Jenkins, Wetumpka, Ala.

A smaller assortment, consisting chiefly of Dovetailed hives, sections, smokers, foundation, and extractors is also kept by the following:

Henry F. Hagen, Rocky Ford, Colo.; W. K. Ball, Reno, Nev.; W. O. Victor, Wharton, Tex.; Jno. Nebel & Son, High Hill, Mo.; Thos. G. Newman, Chicago, Ill.; Walter S. Powder, Indianapolis, Ind.; Vicker Bros., Evansville, Ind. Our Hives, Comb Fdn., Smokers, Extractors, Perf. zinc, etc., are furnished by a multitude of other dealers too numerous to mention. If you want to buy goods made at the Home of the Honey Bees, you can get them as cheap as you can anywhere when you consider quality and workmanship, and your orders will be taken care of promptly. Don't expect to get all the goods we advertise, from any of the above dealers, and don't expect to get goods they do not agree to furnish; but find out what they agree to furnish, and at what price, by writing to address nearest you.

Please Mention Review.

**A. I. ROOT,
Medina, Ohio.**

FOR A KINDS OF BEE KEEPERS SUPPLIES.
ADDRESS LEAHY MFG. CO. HIGGINSVILLE MO.

Here is your Chance — Two for the Price of one.



BEES AND HONEY

By Thos. G. Newman, ex-editor of the American Bee Journal,
is a book of over 200 pages, that we send **FREE to every new**
Subscriber who mails us \$1.00 for a year's subscription to the old

AMERICAN BEE JOURNAL,

The Largest, Best, Cheapest, and only **weekly** bee-paper in all
America. 32 pages; established 1861. Send for a **free sample**
copy with description of book offer **GEO. W. YORK & CO.,**
56 Fifth Avenue, CHICAGO, ILLS.



To New Subscribers: The Journal Alone Sent for Three Months for 20 Cents.

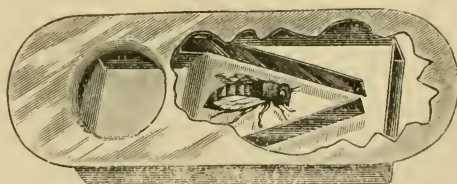

Porter's Spring Bee-Escape

Saves temper, time and bees.

PROF. COOK says: "No bee-keeper can afford to be without them."

WM. M'EVROY, foul brood inspector of Ont., Can., says: "They should be used in every beehive in the whole wide world."

THOS. PIERCE, Pres. Eastern N. Y. B. K. A. says: "The time will soon come when all beekeepers will use them."

Send for circular and testimonials, and read what others say of them.

PRICES: Each, by mail, with full instructions, 20 cts. Per doz., \$2.25. If, after three months' trial, they are not found superior to all other escapes, and satisfactory in every way, return them and we will refund your money. For sale by dealers.

4-92-4f Mention Review.

R. & E. C. PORTER, Lewistown, 111

The Bee-Keepers' Review.

A MONTHLY JOURNAL

Devoted to the Interests of Honey Producers.

\$1.00 A YEAR.

W. Z. HUTCHINSON, Editor & Prop.

VOL. VI. FLINT, MICHIGAN, MAR. 10, 1893. NO. 3.

The Special Topic of This Issue is
Self - Hivers.

TIMELY TOPICS.

No. 2.

R. L. TAYLOR.

"Soon blustering March will shake you up,
and whisper loud of spring."



AFTER the nailing of hives and cases, the painting should be attended to if one has a warm place where it can be done, otherwise it must be deferred till mild weather. Two coats of white paint should be applied to all such

work if for no other reason than as a protection to the combs and bees against the mid-summer sun. Special attention should be given to the covers. All old covers, also, that are in anywise defective should be gathered in and carefully painted. Careful painting, with the use of some putty it may be, will make fair covers though made of defective lumber.

Provision should be made at once for a supply of foundation and sections sufficient to meet all requirements and there can be

no better time than this to wire brood frames and to fill them and enough sections with foundation to furnish a case for each strong colony at the opening of the honey season.

Always look out for waste. When profits fail to appear that is generally the place to look for them. But especially guard against *waste in labor*. Make your head save your heels. It is so easy to be thoughtless and go once to the shop for each tool when once should serve for the whole kit. The danger of this kind of waste is especially great in handling sections. Most persons, if they could have their own way, would handle them at least twice as often as necessary. When a section is put together set it directly where it will not need to be touched again till it is to start for the foundation fastener. I take the body of a hive and set it on its cover, then as the sections are put together I set them into it in an orderly manner, but not tightly. Then as the hives are filled I pile them one above another where they are out of the way and the sections secure from dust. When ready to put in foundation I set each hive, as wanted, on the bench by the foundation fastener (with my machine several hives at a time) then I gently raise the body of the hive leaving the sections standing on the cover. From the foundation fasteners they go directly to the cases.

For the cutting of foundation I use a board with proper stops and gauges on which foundation is very rapidly cut to just the right size. Thin honey or weak lye should always be at hand with which frequently to

moisten the knife while used in the cutting of foundation.

Space would not allow the description of devices for wiring frames, imbedding wires, and nailing hives and frames and of others in the same line, as a general thing, but I must make an exception of the device I employ for the fastening of foundation into

now a square piece, "C," that will just nicely slide in the groove, cut it 3 inches long and then, after cutting $\frac{3}{8}$ of an inch from "B" and bringing the end to an edge by a bevel on the smoother side, firmly fasten "C" lengthwise to the side of "B" equally distant from each edge, one end of "C" being even with the unbeveled or back end of "B" so

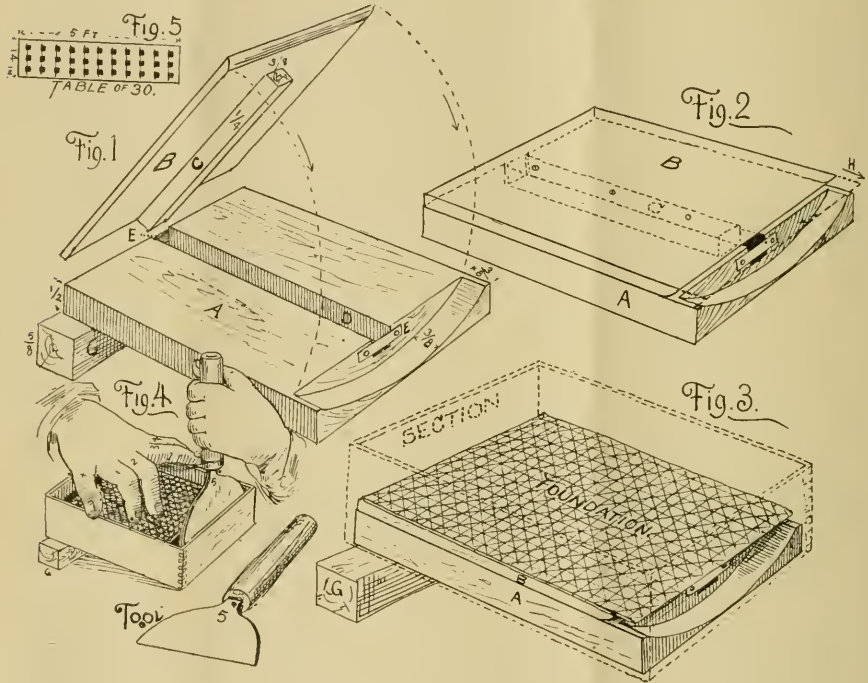

R. L. TAYLOR'S FOUNDATION FASTENER.

sections. It is this: Take a piece of $\frac{7}{8}$ inch thick board, $3\frac{3}{8}$ in square, split it with the saw so that one piece "B" is about $\frac{1}{4}$ inch thick leaving the other "A" about $\frac{1}{2}$ inch thick. Now drop one end of the smoother side of "A" on to a wabbling saw in such a way as to cut out a $\frac{3}{8}$ inch piece at the end running nearly through at the middle of the end but shallower at the edges of the block. This furnishes a space into which any melted wax dropping will be out of the way. Then with a wabbling saw or otherwise, cut a groove lengthwise of the same side of "A," equally distant from the edges, and of a convenient size, say about $\frac{1}{4}$ inch wide and deep, and neatly tack a bit of light tin across each end of this groove for stops. By lengthwise I mean the way the grain runs. Make

that when "B" is placed on "A" with "C" in the groove it will slide easily back end forth nicely covering "A" as nearly as its size will permit. Now duplicate this device repeatedly till you have, say thirty. These are to be fastened at convenient distances on a board or plank with the back end of each slightly raised. For thirty the board should be about 14 inches wide by 5 feet long. Put them three abreast leaving as much space between them as may be and yet get them all on the board. To raise the back end of the blocks use pieces about $\frac{5}{8}$ inch square and as long as the board is wide for they are to hold up one end of the section as well. The thickness of the blocks given is about right for sections seven to the foot. Now provide two irons like wide, short chisels, the

blade to be as wide as may be and yet slip readily into the sections. They may be cut out of rather heavy sheet iron and should have handles of wood. Provision must be made to heat them. A gasoline stove is best but any of several other ways will do.

When ready to use it place the board of blocks with the raised ends to your left on a bench, and have plenty of sections and piles of foundation cut before hand, each piece flat, rigid with cold, and free from the others. See that the "B" blocks are all drawn back. Now take a "foundation" by opposite edges with the thumb and finger of the left hand and at the same time with the right hand seize a section by the edge of the top piece, adjust the foundation to the block even with the back and sides (however at all events it should extend about $\frac{3}{8}$ in. beyond the front end of "B") and as the section is coming slip the fingers of the left hand through it on to the foundation to hold it in place till the section drops over it. In this way fill the board. Now with an iron well heated in your right hand, having the first and second fingers of the left hand on the foundation, and the thumb and last two fingers on the edges of the section, slip the iron inside the top of the section, straighten the first and second fingers of your left hand to push the foundation on to the iron which, as soon as the foundation touches, is to be quickly withdrawn, but the foundation is kept moving till pressed against the top of the section where it will stay till heat melts it loose again. I have used this device for several years and I find it decidedly the best for the purpose of anything with which I am acquainted. With two or three more boards, and sufficient help to put on and take off the sections, an active person may fill 1,500 sections per hour, and the foundation is fastened in such a manner as to leave nothing to be desired in that respect. I follow a similar plan in putting foundation into brood frames.

[Descriptions of mechanical contrivances are sometimes quite difficult to understand. One man may not understand one description, yet another description may be perfectly plain to him, while some other man may better understand the other description. Then, again, the reading of two descriptions, as given by a different person, thus getting a view from two different points, as it were, often makes all plain. It is for these reasons that I here introduce a description that

I gave, in the July number of the REVIEW for 1888, of this very same foundation fastener, feeling sure that both descriptions combined with the illustrations will certainly make all plain.—ED.]

"We spent the last day of June very pleasantly and profitably, in the company of Prof. Cook and his nephew, at the home of R. L. Taylor. Among other things, Mr. Taylor showed us an arrangement of his for fastening foundation into sections. It works upon the hot-iron-melted-wax plan. Attached to the upper surface of a board, are perhaps twenty little, nearly square, blocks of wood, each exactly large enough for a section to slip down over it and leave a $\frac{3}{8}$ space at one side. We may be getting a little ahead of our story, but we may as well say, right here, that when a section is placed over a block it is so placed that the $\frac{3}{8}$ space comes next to the top bar. The upper surface of these blocks is not level; one side of each block being perhaps half an inch higher than the opposite side. Upon the upper surface of each block is a little sliding platform $\frac{1}{4}$ of an inch in thickness and nearly as large as the block. When one of these little platforms is slid, it 'slides down hill' upon the slanting surface of the block underneath. To keep these little platforms in place, a $\frac{3}{8}$ square strip of wood is tacked to the bottom of each. Each strip of wood extends nearly the whole width of a platform, and fits into a corresponding groove cut in the block beneath.

The work of fastening foundation into sections is performed as follows: Upon each of these platforms is placed a square piece of foundation that will nearly fill a section. After putting on a piece of foundation, a section is slipped on over the block; and the height of the block and platform combined is such at the lower edge that when the fingers are placed upon the foundation, and the foundation and platform 'slide down hill,' the lower edge of the foundation comes in contact with the center of the underside of the top bar of the section. Before the sliding operation is performed, however, a piece of hot iron, shaped something like a broad, thin chisel, or square-pointed trowel, is slipped down between the top bar of the section and the edge of the foundation: then the latter is pressed against the iron, and, as the iron is quickly withdrawn, the melted edge of the foundation is brought in contact with the top bar of the section. By the time the twentieth piece of foundation is fastened, the operator can begin at No. 1, and remove the sections in the same order that the foundation was put in, placing them in the supers. The irons for melting the edge of the foundation are two in number, one being heated over a gasoline stove while the other is being used. Each iron is nearly $\frac{1}{2}$ of an inch thick, as wide as the inside of a section, and furnished with a handle. To each iron is also added, upon the back side, a stop that strikes the edge of the top bar of the section, thus preventing the iron from being pushed down too far which would keep the wax in

contact with it for too great a length of time during its withdrawal.

This lengthy description might lead one to suppose that fastening in foundation upon this plan would be slow and tedious; such is not the case, however, it being very quickly, neatly and securely fastened. Mr. Taylor assures us, and showed us, that he could do the work more rapidly than with any other method he had tried; while the foundation is fastened most securely, with great exactness, and but little waste of wax."

In all probability, before another number of the REVIEW appears, spring will be upon us and the charm of the glad hum of the bees as they eagerly gather in the new pollen will again thrill us. I must therefore say a word with regard to the course to be pursued with the bees prior to that time. I aim to get my bees out of the cellar early, although I know I run counter to the generally received opinion in so doing. By "early" I do not mean before winter is gone, but only that I should not be careful to wait for the blooming of the soft maple and the willows. By that time some of the days when bees would likely be carried out become very warm about midday causing the bees to become too much excited so that often they come out with a rush and many failing to mark their location are lost. Robbing is apt to become rife and is hard to detect; and swarming out and general disorganization become altogether too imminent. Taking them out in the cool of the day—at night or in the morning is not always a prevention. Any one of an observing turn can foresee as the time approaches about when the willows will blossom:—get the bees out five or six days before this when the temperature is likely to be between 50° and 60° and if it is cloudy, all the better, then they will settle down, retain their self-possession and be less liable to disorganization. There is then no brood to be chilled, so I think the chance of harm is very small. I take out a part of them at a time and scatter them over the yard as far apart as possible and allow them to become settled before another lot is taken out. Then when more are taken out I distribute them in the vacant places, still observing to place those taken out contemporaneously as far apart as may be.

After trying different methods of carrying hives of bees, they have all been discarded except the primitive one of placing the hands under the bottom board and the back end of the hive against the central front of the carrier's "anatomy" and moving on. On the

whole this way is the easiest, quickest and least disturbing to the bees.

If any spring protection is to be given it should be got ready beforehand and applied as soon as possible after the bees are on their stands.

While carrying out the bees I am careful to learn all I can of the condition of each colony in so far as that can be done without opening the hives, and this is generally with reference to two points: lack of stores and queenlessness. Most persons with a little experience can readily say on lifting the hive whether there is a short supply or plenty. Where there appears to be danger from want the hive is marked and further attended to as soon as circumstances permit. At this time the signs of queenlessness to be observed are the presence of the remains of immature drones among the dead bees which have dropped from the cluster and a continued humming kept up in the hive after it is placed on its stand when removed colonies have become quiet, which may be readily observed at the approach of evening. The former is a sure, the latter a useful indication. Such colonies are also marked and as soon as the indications can be verified and the weather permits, they are united with the weaker colonies having queens.

LAPEER, Mich.

Feb. 23, 1893.



Prominent Points Caught in a California Convention.

"RAMBLER."



THE California beekeepers held their second annual convention Feb. 7th and 8th, in Los Angeles. "Rambler" was there and had the kindness to

send the REVIEW a nice long report, but there are so many things demanding attention this month that I am compelled to pick out what seem to me the most important points and give them as they appear below.—ED.

Inyo Co., in southern California depends entirely upon alfalfa, and in this respect it rivals Nevada and Arizona in both quality and quantity.

Reports from the northern portion of the State show that there are large areas of unoccupied fields that would furnish bountiful yields.

The honey flow is largely dependent upon the rainfall and this has been quite abundant over most portions of the State.

The only unfavorable symptom reported in regard to the bees was loss of queens. Progressive California bee-keepers practice re-queening often. A queen ought not to be allowed to survive the close of the second year. A two-year-old queen, if spared for the next year, usually fails early in the season.

The State Entomologist, Prof. C. W. Woodworth, from the State University, was present, and gave bee-keepers to understand that the University would meet bee-keepers more than half way in its endeavors to advance bee-keeping. Hereafter, if nothing is done in regard to bee-keeping at the University, it will clearly be the fault of the bee-keepers themselves. A course of study in apiculture will be given if students desire it. This department of the University desires to keep in touch with bee-keepers and it is desired that they make known their needs and desires.

Economy in bee-keeping was touched upon. No one can realize how much is wasted in small things in a California apiary until he begins to look up the small things.

California bee-keepers are beginning in some localities to think about the improvement of their pastures by scattering the seeds of the sages, sweet clover, mustard, etc., in waste places.

Hives came in for their share of the discussion. It is evident that a bee-keeper who produces extracted honey must use a large hive, while the comb honey producer must have a hive with a small brood chamber.

In certain localities of the State, foul brood is quite prevalent, and, as a rule, heroic measures were advocated. During the discussion it came out that the supervisors did not appoint foul brood inspectors because they (the supervisors) were opposed to having bees in the county. In one instance the supervisor said that he wished that the bees would all die of the foul brood.

It was learned, however, that if a certain number of bee-keepers apply for the appointment of an inspector, the supervisors are obliged to make the appointment.

The act of the Illinois legislature appropriating \$500 for the State Association to use in getting out its report was read and a similar one drafted for appropriating \$300 in California to be used in promoting the interests of apiculture, and Mr. W. A. Pryal commissioned to present the desires of the bee-keepers to the proper committee at the State capitol.

The matter of making an exhibit of honey at the World's Fair was discussed and several said they were going to send both comb and extracted honey, some intimating that they would make a fancy display, hence it is evident that California will have a creditable display at the coming Exposition.

The subject of using glucose and adulterating honey came up and was most strongly condemned.

This is only the second meeting that the Society has held, yet there were 100 in attendance. After two days very profitably and pleasantly spent, the bee-keepers gave the parting grip and departed for their homes under dripping skies.

RAMBLER.



The Pratt Self-Hiver.—Its Arrangement, Management and Advantages

E. L. PRATT.

THE self-hiver question has been so thoroughly discussed of late that by this time it is quite generally granted that a thoroughly practical device is forthcoming and the day not far distant when such an appliance will be considered indispensable in the profitable and pleasant management of bees, either on a large or small scale.

How often do we read of the progress the bees are making in some well regulated yard for the production of comb honey until, alas, they commence to swarm. The apiarist is now on pins and needles while the bees seem to put their entire energy into the business, and, "though the heavens fall," they must swarm. Cast after cast is sent out, ladders, poles, baskets, cages, smokers, men, water, sweat, and a hundred other

things are pitched out for "*the bees are swarming!*" They cluster high and low, apart and together, near and far; some are lost forever. Great excitement and loss reign, until the best part of a honey flow is over and gone for ever.

The automatic hiver will abolish all this confusion and leave the apiarist with time on his hands during the swarming season.

"Prevention of increase" has been a problem of no mean importance in years past. There have been many pages devoted to this question year after year, but the hiver is to settle it all.

With a perfect hiver one man can care for a large number of colonies in several different yards and employ help only at super and harvest times. He will be entirely free from the worry and care of swarms and can handle his bees, as so many bees in so many hives.

For the farmer and small bee-keeper, who cannot devote time to the work, the hiver will be a genuine boon, add profit to the work in larger quantities of honey and fewer starving nucleus swarms.

Phenomenal yields of honey will follow in the wake of the self-hiver. With the hiver it will be optional with the bee-keeper whether he shall increase his colonies or not. If he desires increase, simply lift off the upper hive and place on a new stand; if not, let them remain tiered up.

Re-queening, queen-rearing, and all that sort of work, will be under the thumb as it never was before. In fact, the self-hiver will be the cure-all of the ills of bee-keeping.

[For illustrated description of the latest arrangement of the Pratt self-hiver, see the Extracted Department.—Ed.]

This arrangement also keeps the zinc out of sight of the incoming bees. There is not the least confusion or hindrance at the entrance. The entrance is wide and unobstructed in outward appearance and the bees will fly to and from it with the same freedom that they enter an ordinary open slot.

In the usual manner of applying zinc (perpendicularly on the outside) they seldom use more than the two lower rows of perforations, but as I have it here they may use the entire surface and it being after they have entered their hive that they pass the zinc, there is practically no more obstruction than with a honey-board. Bees are used to crawling through small passages *inside* their hives, but not in entering it.

Right here, let me say that the tiered up method of applying the hiver is the best plan by a] odds. Hivers that allow the queen to pass back into the parent colony at any time will never do the work of an *automatic swarmer*; besides, it is a poor plan to isolate the new hive so far from the parent colony as to place it either in front or at the side on a separate stand, as a *full swarm* can not be held together for many days, especially if the nights are cool or the weather becomes rainy. The bees will abandon the new hive and the queen will be left behind; they will turn their attention to one of the young queens and swarm again on the first pleasant day after hatching.

With the new hive set under the parent colony all the desirable conditions are present; it is neither too hot nor too cool; they will not abandon the queen and if they gather no honey for days they will hold together and boom along with the vigor of a new swarm, building comb and rearing brood—the swarming mania perfectly satisfied. Even a week of bad weather will make no difference as they will borrow a living from the stores in the upper hive and pack it away in the combs they are building below.

It is well to have at least two frames with foundation starters in the lower hive so as to satisfy the comb building instinct and save the wax that might go to waste.

I think Mr. Root is mistaken when he says "a hiver should not cost more than the expense of hiving the swarm in the old-fashioned way." Taking into consideration the time, worry, loss of honey and bees and the cost of help, the bee-keeper could afford the expense of quite an elaborate outfit for doing the work, and, as it will last for years, is it logical to count the first cost, providing this first cost is within reason?

Mr. R. L. Taylor says "he can manage very well with queen traps. The colonies that have swarmed he picks out by finding the queen and a small bunch of bees in the trap. He then divides those that have swarmed." This is just as I have always done, but I found it such hard work and it took so much time that it always set me to thinking of automatic hivers in a longing way. By dividing the bees in this manner, the *vigor of a new swarm* is lost; it is not natural and does not satisfy the swarming mania. The bees will often sulk for days and all the time the queen is in the trap they are idle, dissatisfied and ill tempered, often

killing the queen when she is allowed to go back with the bees. The drone trap is an excellent device, but it is not an automatic hiver. My idea of a self-hiver is a contrivance that can be adjusted in the spring and can be left to care for itself until the bees are overhauled in the fall. In fact, I have some colonies arranged for swarming now upon their winter stands, as an experiment; besides keeping out the mice, I am in hopes that the hiver can be worked on these colonies as a permanent fixture. I found they had filled four sets of brood frames solid full of honey, so I concluded to allow them to stand as they were and note the result in the spring. One thing I am sure of, tremendous colonies of bees can be held together with the hiver, and with tremendous colonies of bees immense quantities of honey will be gathered, whether it be in comb or extracted form.

BEVERLY, Mass.

Feb. 21, 1893.



The Self-Hiver Not Only Hives Swarms
but Discourages Swarming by
Killing Off the Drones.

O. J. BARBER.

HAVE an out-apiary and a home apiary, and I began the season by putting 20 self-hivers in my out-apiary. My experience with them has been very satisfactory, as they were a complete success in hiving the swarms in good shape. I visited the apiary in about ten days after first placing the self-hivers on the hives, and found nearly all the drones in the yard dead, and most of the entrances to bottom hives badly clogged with dead drones. The queen excluders on front of hive were made of lath, covered on one side with perforated zinc, and were $1\frac{1}{2} \times 1\frac{1}{2} \times 12\frac{1}{2}$ inches. This did not allow space enough for dead drones, so I enlarged the space making it as large again. I had no further trouble with dead drones clogging the entrance.

I also found that one swarm that had started queen cells when I put on the self-hivers, had destroyed the queen cells and given up swarming. On my first examination after placing self-hivers, I had considerable trouble in satisfying myself as to whether the bees had swarmed or not, as I had placed

in the bottom hive a full set of comb, but I found that by putting in a set of frames with starters only, I had less trouble to tell whether or not they had swarmed.

Having some other hives in the same yard that had on no self-hivers, I watched them carefully to see if I could detect any difference in the work of the colonies, but as far as I could see the colonies with the self-hivers did just as well as those without. Of those colonies with self-hivers I do not think that more than three or four swarmed during the whole season. If the self-hivers are placed on the hives early in the season I consider them almost non-swarmer, because they keep the drones killed off.

I have never yet in my experience found the apex of the self-hiver clogged with dead bees. I use a hive set upon a loose bottom, with cleats nailed across the upper ends concealing the ends of the frames. I remove one of these cleats from the front of the hive and in its place put a piece of queen-excluding zinc, directly in front of the apex of the hiver and I find that about one-half the bees pass through this zinc, and the other half go out and in at the usual place.

In the fall I found a queen below, and no sign of one above. The queen must have either gone below without swarming, or killed the young queens, for there were no signs of queen cells above. From my experience with the "Pratt" self-hiver during the past season, I think that if rightly managed it will save the labor of one man in the apiary, at least nine-tenths of the time as far as watching for swarms is concerned,

In my out apiary I had 14 colonies on which I did not use self-hivers. As they were getting strong and about to swarm, and I did not want to stay with them, I thought I would try an experiment. I placed queen-excluding boxes in front of the hives, large enough to give room for dead drones. I made these boxes $3 \times 3 \times 12\frac{1}{2}$ inches. I consider this size as about right. This appeared to kill off the most of the drones. These boxes I left on the hives during the rest of the season, except when I visited the yard, (about once in ten days) when I removed them and left them off while I was in the yard, in order to let virgin queens have a chance to become fertilized. I always replaced them when I left the yard. This plan kept the colonies strong, and so far as I could see worked satisfactorily. I always give my bees plenty of upper hives and comb to work

in. Of the 14 hives treated on this plan, I found one hive without a queen in the fall.
 RODNEY, IOWA. Jan. 23, 1893.



Self-Hivers Versus Queen Traps.—The Former are too Costly and Cause too Much Labor, Loss and Risk.

R. L. TAYLOR.

 S an article to sell what a great thing a self-hiver would be! It would be far ahead of the moth trap. To talk of bees living themselves is like real magic, not mere slight of hand; for without doubt bees can be made to hive themselves in a way. And herein is the danger. They are sure to be bought and disappointment and loss are sure to follow, at least until further improvements are made.

I have been accustomed to look upon the struggles of the half dozen inventions of self-hivers as a source of amusement, but when the editor of the REVIEW goes so far as only to say: "If self-hivers prove to be the success they promise to be," I am a little startled and feel like inquiring where is there any promise? Not in the fact that the queen can be trapped and some bees secured with her, surely. That is easy. But at this point the trouble begins.

What do we want a hiver for? Not as a curiosity. It must be of some practical advantage. Unless it will pay for itself and some little more it will be of no utility. It must effect a saving somewhere, either in time, money, care, or labor, without a counterbalancing loss in the same items or in the amount of surplus secured.

The self-hiver has no standing at all unless at the very outset it practically secures the entire swarm every time. That it does even this, judging from what the inventors say of each others device and the known perversity of bees in not conducting themselves as the apiarist thinks they ought to, is not yet by any means certain. But until it does this it must fall in competition with the queen-trap which prevents the loss of swarms at much less expense with the additional advantage that it more readily gives up the secret that a swarm has passed through it. But for the sake of the argument let it be admitted that the hiver will do all that is claimed for it and that it will practically secure the entire swarm every time, how does it stand then in comparison with the queen-trap?

At the outset the cost of the traps is perhaps but about one-twentieth of the cost of the hivers for, of course, no one would think of using them where they are liable to be inhabited by bees for three or four days before discovery, without furnishing them each with a full set of combs or frames of foundation.

The trap is adjusted in a moment perfectly, while the adjustment of two hives to the same level and to each other, is a most critical operation, even so expert an apiarist as Dr. Miller, let his queen get out; or if one hive is put on top of the other, difficulties actually insurmountable are encountered.

If there has been swarming, where traps are used, the apiarist by walking rapidly along the rows of hives discovers at a glance where it has been, but how is it with the hivers? Suppose you have an out-apiary of 150 colonies you must raise at best 150 covers to determine where the swarming has occurred, or if the Pratt hiver, the one that seems to be in the lead, is used, you must lift 250 old hives with the supers, heavily laden, as they are likely to be, to determine from which hives swarms have issued, for the hiver is put under the old colony; and this every time the apiary is visited if justice is done. The editor of *Gleanings* says of Pratt's tiering-up hiver: "The lifting of the upper story is no great objection." Whew! I feel exhausted at the very thought of it. And then suppose three or four or five swarms had come out at the same time and had united, as they would surely do if they were at all like mine, and had gone into one of the hives together, you would be sure the hiver was a great success, but you would be quite oblivious of the three or four queens hid away in the corners of as many other hives with a teaspoonful of bees each. The old queens being shut out of their hives and the young queens soon to be hatched being shut in, the colony is doomed to speedy destruction unless the sharp eyed apiarist discovers that all is not right. With the trap there is no such risk or uncertainty.

Again, in the absence of the apiarist, in the hives having traps whence swarms have issued, the storing in the supers has gone on without abatement, while in the hiver, not only has nothing been stored in sections, but the brood-chamber has in all probability been put into such shape that the bees will be loth to enter the sections when they are put on.

Of course if the hive has caught the entire swarm the rest of the manipulation necessary is not difficult nor is it much more so to dispose of the colony with the trap. You have the queen and you put the supers from the old hive upon the new, then set the old hive, without the bottom board, upon the uncovered sections and drive the bees down with an abundance of smoke leaving only enough to care for the brood, or sufficient bees may be shaken out of the old hive or from its frames in front of the new hive—not a difficult thing to do, far preferable to the task of adjusting two hives together on the same level so that the queen could not escape, to say nothing of three sets in that manner which would be about the usual proportion here. And then with traps it is easy to adjust one to each of the two hives for a few days till the danger of the swarm forsaking its new quarters or of an after swarm coming from the old hive is past, but if you used hivers would you have a supply so as to adjust one to each of the hives, or would you take the chances?

Then you have a large number of furnished hives to keep over the winter, dead capital, besides requiring for their safety, watchfulness and care.

Another serious objection to all hivers yet suggested, is the fact that it is not an infrequent thing, in large apiaries, that young queens are reared by colonies without any intention of swarming, to replace queens that have become old or have met with accident, and when these undertake their wedding flight they are caught in toils from which only accident is likely to relieve them and their ruin means the ruin of the colony.

Yes, as I said at our late State convention, self-hivers mean too much money, too much labor, too much loss, and too much risk.

LAPEER, Mich.

Feb. 21, 1893.



How Multiple Tubes May Assist in the Ventilation of Rooms, Cellars or Mines.

C. H. MURRAY.

I WISH to say a good word for Mr. Corneil's ventilating scheme as presented in the October number of the REVIEW, but, in this device, volume is increased at the expense of velocity. There is no delusion, or notion of a creation of additional energy, as implied by one of your correspon-

dents. The scheme is in active operation in many mines of the west for the purpose of ventilating the mines, by drawing the foul air through the shaft by means of the escape pipe of the engine at the surface of the mine. It is also applied to facilitate the discharge of water from a pipe. Mr. C. has not presented the most effective form of the apparatus. [Mr. Corneil did not furnish the illustration. It was arranged by myself from looking at an illustration found in a report of a committee in regard to lighting, heating and ventilating the Capitol at Washington, D. C.—ED.] It is now made as a series of enlarging truncated cones superimposed one above another, the draught entering the smallest one. By carefully conducted experiments made at Washington City, it was found that a jet discharging in a series of five cones was fifty-two per cent. more effective than if it discharged without them. Each sectional cone should partly enter the one above it. Bad drawing chimneys can be remedied by this device being placed on top of them. This could be applied to a bee-smoker and would greatly increase the volume of smoke.

ELKHART, Ind.

Feb. 24, 1893.



Working the Bees of Two Queens in One Set of Supers and Thereby Preventing Swarming.

B. TAYLOR.

[The following was written to me as a private letter, its author intending to experiment another year before giving the plan to the public, but I urged upon him the greater certainty with which the matter could be settled, as regards the profitableness of the scheme, by having hundreds instead of one or two experimenting, and he has consented to allow me to publish it now.—ED.]



I HAVE been working eight years trying to perfect a non-swarming, and work the bees of two or more queens together during the main honey flow. I have had good success in part in working out the problem. I have been working on the plan of set-

ting two hives together, facing the same way, and at the commencement of the main

honey flow turning one hive with its entrance to the rear, thus throwing all the bees into the other hive; then in six or seven days changing it back and turning the *other* hive in the same way.

I have learned many new and strange facts about bees in this work; facts that upset many old notions. I found that swarming could be prevented with the greatest certainty by this method, that is, by simply changing the hives every six days and removing queen cells. But the unsealed bees would sometimes die and turn black in the hive thus robbed of its working bees. In nice warm weather there would be no trouble, but many times in bad weather there would be great loss of unsealed larvæ. My idea in making the revolving hive stand was to avoid this trouble. My experience in moving hives led me to believe that daily changing the bees would so upset all calculations that preparations for swarming would never be commenced, but last year's trial proved that this plausible theory was not true, as the bees, although changed to a new hive and a new queen, kept right on building queen cells, and swarmed all the same as those left undisturbed. But I made an important discovery in this revolving experiment that I now expect to utilize in making a non-swarmer system, and that discovery is that the bees in *any* number of hives can be worked as *one colony* in perfect, old-fashioned, socialist style, without the least disturbance of peace, and I have now invented a hive to utilize this fact and make it possible to work all the bees of two queens together as one swarm, and prevent swarming by changing the bees every six days and removing the queen cells from the depopulated hive. Generally the bees will tear down the cells themselves, but I have proved that it will not do to *depend* on them in all cases.

My hive is a double one for two colonies with a thin board partition between them. There is an entrance the whole width of both hives, both front and rear, and these entrances are closed by heavy blocks extending the whole length of the width of each hive, two in front and two in the rear of each hive.

When the bees are set out in the spring the rear blocks will be moved together until the rear of the hive is entirely closed. The front ones will be placed so as to have the entrance for both hives in the center of the double

hive with only the $\frac{3}{8}$ inch partition that divides the two colonies between them. The bees of both colonies thus use, as it were, the same entrance, and will go into either hive just as they happen to alight, and all work as one colony so far as the bees are concerned. This is not theory; I know it to be a *fact*.

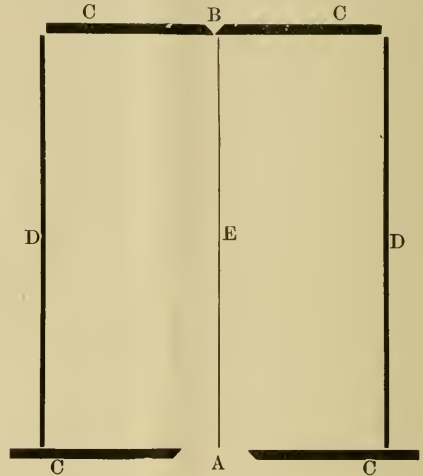

A, front entrance (open).
B, back entrance (closed).
C, entrance blocks.
D, side walls of hive.
E, thin division board.

At the blossoming of white clover I will push one entrance block up and entirely close the entrance to that side of the hive, compelling all the flying bees to go into one hive. The supers, if any, being all moved to that hive. At the same time the rear block will be moved back and an entrance made to the *closed* hive at the rear. On the morning of the sixth day I will move the supers to the *other* hive, open the entrance in front, close it in the rear and close the entrance to the other side in front and open it at the rear, and when this colony is deserted by its working bees, look for and destroy queen cells, and repeat in six days, thus keeping both queens laying all the time, and work their bees in an undivided colony during the season.

The hive with only a thin board between the colonies is intended to keep the deserted hive warm and keep the brood from getting chilled which was the main trouble heretofore.

You will see that in this plan I have no traps of any kind, the hive is just a simple box with movable frames.

Changing the supers may seem like too much work, but with my supers on top of queen excluding honey boards I can make the change in less than one minute to each hive, changing entrances and all.

Now, Mr. H., I *do* say that I can do just what I have here outlined, but do *not* say that it will prove profitable; that is what is yet to be proved.

You know I never had any confidence in any kind of non-swarming traps or self-hivers; they will never give practical satisfaction, and I do not know as my own will, but I shall follow it to failure or success.

And, now, Brother Hutchinson, I will close this by admitting that I am so much interested in my experimental work for the apiary that I have laid in my bed and studied *all night* without going to sleep at all. I know I shall not make money by it, but I pity the man that has nothing nobler to do than to make money.

FORESTVILLE, MINN. Jan. 30, 1893.

Bee-Keepers' Review.

PUBLISHED MONTHLY.

W. Z. HUTCHINSON, Ed. & Prop.

TERMS:—\$1.00 a year in advance Two copies, \$1.90; three for \$2.70; five for \$4.00; ten, or more, 70 cents each. If it is desired to have the REVIEW stopped at the expiration of the time paid for, please say so when subscribing, otherwise it will be continued.

FLINT, MICHIGAN, MAR. 10, 1893.

H. P. LANGDON, of East Constable, N. Y. has sent an excellent description of his "largest house apiary in the world." The article will appear soon—probably in the next issue.

SELF-HIVERS, of anything approaching a practical nature, are of comparatively recent introduction, hence, it is difficult to find many bee-keepers who can write of them from experience. If any points in their construction and management have been overlooked in the present discussion, I should be glad to be informed in regard to them before giving a "summing up" in the next issue.

BRO. YORK, of the *A. B. J.*, has my thanks for a kindly notice of the REVIEW and its editor, in which he vouches for the honesty of the latter and calls attention to the wide awake, valuable character of the former.

TEXAS BEE-KEEPERS will hold their convention April 5th and 6th (instead of March as given in last REVIEW) at the home of Mrs. Jennie Atchley, one mile north of the Court House, in Greenville.

"HASTY'S REVIEW is good and will be a great feature," so writes J. A. Green; while E. R. Root writes: "Hasty is a good reviewer, and you are to be congratulated on your good judgment in selecting him."

UNFINISHED SECTIONS, those filled or nearly filled with drawn comb, left over from last year, are very valuable to give the bees a start in the spring. In my experience they are worth nearly as much as sections filled with honey. The objection has been urged against them that their comb-surface is uneven and that when filled and sealed they do not have the smooth, clean appearance that we so admire in combs newly built from foundation. To remedy this unevenness, some have pared down the surface of the combs with a knife. This is a slow, unpleasant and pattering job, but Mr. B. Taylor has invented an inexpensive arrangement whereby the cells can be shortened and the combs brought to a level as rapidly as the sections can be handled. It will be illustrated and described in the next REVIEW.

Mr. Taylor's new house-apiary, also, will probably be illustrated and described in the next issue.

THE BEE-KEEPERS' UNION, 348 strong, has elected the following officers; President, R. L. Taylor; Vice Presidents, C. C. Miller, G. M. Doolittle, A. I. Root, A. J. Cook, and G. W. Demaree. Secretary, Treasurer and General Manager, T. G. Newman. The constitution has been amended so that the Union can use its influence and money for any purpose that is thought best by the advisory board. Beginning with Jan. 1892, the General Manager will receive, as his salary, 20 per cent of the gross receipts. Thus

broadened in scope, if the Union is only managed with the same wisdom that has characterized its past career, it will become a power in the land.

By the way, the Union has already scored one victory the present year. A bill was introduced in the Missouri legislature for the enactment of a law prohibiting the keeping of bees in any city, town or village, nearer than 50 feet from the line of any real estate owner. An appeal was sent to the Union, and copies of the decision of the Supreme Court of Arkansas, in the case where a bee-keeper was prosecuted for refusing to move his bees from a city, were sent to the members of the legislature, and letters were written to them, and when the bill came up in the lower house it was promptly *killed*.

THE WELLS SYSTEM.

"Two souls with but a single thought; two hearts that beat as one."

Our bee-keeping friends across the Atlantic are now greatly interested in what is called the Wells system of managing bees. In one point it resembles the plan described by Mr. Taylor in this issue of the REVIEW. It resembles the Taylor plan in that the bees of two queens are worked together in one hive and one set of supers, but the division board between them is of perforated, queen-excluding metal instead of being a thin, solid board. There is also a queen excluder between each brood nest and the super above it; thus each queen is kept on "her side of the fence." There is no attempt at preventing swarming, the great advantage claimed being that populous colonies and large yields are secured. This arrangement is not called two colonies in one hive, but one colony with two queens, and in one sense it is an acknowledgement that the "queen power" is not sufficient to run a hive of the size used—two queens are required to keep the population of one hive at the profitable point. It is really an argument in favor of smaller brood nests. There is one point, however, that ought not to be overlooked: there may be a mutual benefit in the combined heat of the two colonies. If the bees of two queens will thus work together in harmony, then it would be the same with three, the same with *any* number, and we could, if we wished, have a great long hive with a dozen queens, each being kept in her proper sphere

by queen-excluding metal. What a remedy for weak colonies! I must confess that this idea looks more novel than practical, but so many things are being done now days that there is no knowing what *may* be done next.

AFTER-SWARMING PREVENTED BY THE USE OF THE BEE-ESCAPE.

Frank Coverdale writes me that he has prevented after-swarming by hiving the swarm on the old stand, then placing the old hive by its side with its entrance near that of the newly hived swarm. The old hive is then closed except that a bee-escape is placed in the entrance on the side next to the new hive. Of course, every bee that leaves the old hive never gets back, but finds its way into the new swarm. All of the working force, and all of the young bees when they come out to play, are thrown into the new swarm. In seven or eight days the old hive can be given a new stand, the same as in the Heddon plan, but it will be completely robbed of all the bees except the young, downy, just hatched ones, which is not the case with the Heddon plan, as was explained in the Extracted Department (Doolittle's article) last month, and after-swarming will positively be prevented in *every* case. If no increase is desired the escape can be left in place for a longer period, 21 days if the weather is warm, or, if it is cool, it may be taken away at the end of two weeks. When the bees have all hatched out, the few remaining may be shaken off in front of the new swarm and the honey extracted from the combs, or they can be used in any way thought best. Or the matter may simply be carried to such an extent that the old colony will be so weakened that not only will it not swarm but it will not be sufficiently populous for winter, but will still be able to care for and protect the combs until fall, when the two colonies may be united, the better queen being preserved.

EXTRACTED.

The Pratt Self-Hiver a Success in the Hands
of E. R. Root.

At the Washington meeting of the North American, Mr. E. R. Root read an essay on self-hivers and their use. As the manner in

which the hivers were arranged and managed was given in my leader of last month, I will not repeat it here, but I will copy two or three paragraphs from the essay, showing the extent and success of his experience.

"The following summer, we rigged up some 10 or 15 hives, on the principle before stated; and although I was sanguine of success in the very beginning, the result greatly exceeded my expectations. If I remember correctly, there was not a single failure. The colonies were not only automatically hived in every case, but they went to work in their new quarters, building comb, storing honey just as they would have done had they been hived in the old-fashioned way in a new location.

By way of experiment, some of the colonies were left from three weeks to a month, to see what the final result would be. Young bees hatched in the parent colony, and finally began to add their numbers to the swarm. The latter, in the mean time went to storing honey to the extent of 50 or 60 pounds in two or three instances; and one in particular had stored it to the phenomenal amount, for these poor seasons, of 150 pounds.

I am not prepared to say that the Pratt automatic hivers will prove to be as successful in the hands of others, because bees do not always follow an invariable rule, especially when their owners try to make them do just as they plan they ought to do, or as they do for others under like circumstances; so it will probably take another year or so before we can speak definitely with regard to its success in the hands of bee-keepers in general."

Conditions Under Which Bees Gather the Most Honey.

What bee-keeper has not noticed that when everything seemed to be apparently equal, some colonies stored a much larger surplus than others? It often happens that a colony weak in numbers stores more surplus than the most populous colony in the yard. Even in some poor seasons some colonies store a fair surplus. Last year, one of my colonies stored more than 75 pounds of comb honey, while the average was less than 40 pounds. Some colonies did not go much over 20 pounds each. Who hasn't noticed these things and wondered why? If we could discover the why and wherefore, and apply the remedy so that all colonies would come up to the high water mark what a stride it would be. Mr. C. J. H. Gravenhorst of Germany is trying to solve the problem. The Rev. C. Spaeth, of Berne, Mich., sends me a translation of an article upon this subject that has appeared in the bee

journal published by Mr. Gravenhorst, and from it I make the following extract.

"There are not many attentive bee-keepers of long experience who have not noticed that in so-called poor seasons one or more of their colonies not only stored enough honey for its own use but perhaps even a surplus; while the majority of colonies may not have secured even sufficient for their winter stores. Likewise, in a good season it must have been noticed that some colonies give an astonishing surplus in comparison with others.

These results are the more striking if all the colonies had access to the same pasture, and if the work was carried on under seemingly exactly the same domestic conditions as regards combs, hives, strength of colonies, etc.

Even in the beginning of my business as a practical bee-keeper, it often happened in a poor season that three or four of my colonies in the round straw hives with no frames had more than enough for winter, while the majority, often stronger in bees, had not sufficient for winter. Then in a good honey flow I often observed that some of the small colonies went far ahead of the stronger ones. I have had four-frame nuclei give me from ten to twenty pounds of extracted honey in a season, while others of the same strength, and stronger ones, gave me scarcely as much. Still more remarkable seemed the fact that small queen-rearing colonies that had in the aggregate not more comb than one full sized frame, little by little at a time, would finally yield five or six pounds, or more, of honey, while others in apparently the same condition gathered only their daily supply. In the face of all this, the assertion is frequently heard that only strong colonies yield a surplus!

When such results come about with the colonies, comb, hives and pasturage apparently the same, there must be other factors not so easily discovered. By repeated examination and observation I have learned that there exists a certain *condition* under which a colony will gather the most honey whether it be strong or weak. If this condition has not yet been reached, or if it has been passed, the storing of surplus will be neglected or at least carried on only moderately.

That being the case, the question naturally arises, what is this condition? By an exact examination there will be found five central points. Three of these are well-known to first class bee-keepers, and they are mentioned only that I may be able to give a complete statement, and in my second part be able to refer to them if desirable.

1—The ideal colony must have a faultless queen; hardy, sound of body and, above all things, fertile, and her progeny distinguished by diligence.

2—Nevertheless, such a queen alone does not make an ideal colony. At the right time, that is, when honey is coming in freely there must be plenty of empty comb that no time nor honey be lost in building comb.

3—Our ideal colony must swarm at the right time or not at all. It swarms at the

right time when it swarms so early that the queens of the after-swarm, if such are allowed, become fertile, and the first or prime swarm has its combs completed, before the opening of the main harvest.

4—The ideal colony must not be over-populous. A hive is over-populous when its working force is too great in comparison to the dimension of the hive and to the number of wax-building bees.

Such a condition is intolerable to the bees and they try to help themselves by loafing. Their instinct teaches them to begin this loafing even before the hive is over-populous. The bees seem to see that the combs are filled and capped, that bees are daily hatching and that they will soon be crowded. A colony in such a condition will never perform the wonders in gathering honey that we may expect from one less populous. Such a colony feels instinctively that its abode will soon be too small, and the swarming fever sets in, and we know that when that is awakened the bees will continue to loaf. At the most, only as much honey will be gathered as is needed for making the swarming preparations. A colony with the swarming fever is of little value as a honey gatherer.

5—The best honey gathering colonies are not kept at home during the best honey flow by the nursing of too much brood. If there is too much brood in proportion to the working force, most of the honey gathered will be consumed by the brood. The bee-keeper whose bees rear a large amount of brood during the main honey harvest, or near its close, will find, as he stands before his colonies at the close of the harvest, that although they are strong in bees and the combs faultless, the latter will be empty and will stay so."

Mr. Cravenhorst has promised to tell in the next issue of his paper how, by taking advantage of the foregoing points he has swelled his harvest to the very highest notch; and Mr. Spaeth has promised to furnish the REVIEW with a translation.

The Latest Improvement in Self - Hivers.

The bees being compelled to pass through an empty hive before reaching their own, when the Pratt self-hiving plan is used, is regarded as an objection. Of course, a little time is needed for the bees to pass through the empty hive, and to that extent it is objectionable, but even that objection is in a fair way to be removed, as shown by the following article from Mr Pratt published in *Gleanings*.

"I am sending you by mail one of the 1893 patterns of the Pratt automatic hiver. You will see that I have greatly cheapened the construction, and attached it to a honey-board, all in complete condition to put di-

rectly on a hive when received. Many of the purchasers last season did not understand how to attach the hiver to their hives, and there were some who could not understand, although it was explained to them very carefully. I therefore deem it necessary to supply the escape-board and excluder all complete, with directions to place on the hives in the simplest form.

With these facts in view I have endeavored to construct the device complete in itself, and you will readily understand the advantage this hiver I am sending you has over all the others.

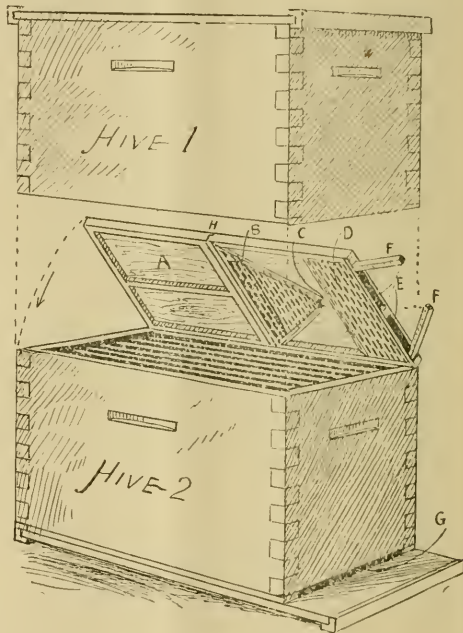

THE LATEST, PRATT, SELF - HIVER.

First, you will notice that it is in two parts (divisible at H), making it convenient to pack and mail at a very moderate cost. These two parts intersect and form the honey (or escape) board to cover an eight-frame Dovetailed hive, and can be fastened together by the receiver with three or four nails or not, as he sees fit. As you notice, it is a cheap and light board. I have reduced the escape triangle (H, C) to two simple pieces of $\frac{3}{8} \times \frac{3}{8}$; also the zinc surface that covers the triangle is less than half that of the original. The entrance through the board, connecting the triangle with the colony, can be as I have it, or three or four $1\frac{1}{2}$ inch holes, as you see fit to make them.

You will also see that I have attached the excluder D to the front end of the board, with entrance there, and discarded the old-style separate piece. This is much better, as it not only does away with loose parts but affords better ventilation. It is impos-

sible for this to become clogged by drones or rubbish. Drones will work to the extreme front end, and fuss there out of the way until they become exhausted and fall down on the bottom-board, to be scooped out occasionally through the lower entrance G, which is kept blocked up tight. It matters not how many drones a hive may contain, the excluder will never be found so stopped up that there is not ample passage for the full working force, and for complete and perfect ventilation.

Another advantage in having the excluder as it is here is this: A free and open entrance, with no zinc to pass until the bees are inside the hive (a great advantage, I find), affording excellent opportunity for rapid passage to and from the hive, besides aiding perfect ventilation and a direct and short path to either hive.

The little strips of wood, F, F, shoved into the entrance, are on pivots, to open like gates, as shown. These are to support the zinc and wood while in the mail, and are to contract the entrance for any cause when necessary. After a swarm has been hived, these gates can be closed entirely, and the lower entrance opened to them, when the board will act as a bee-escape to reinforce the swarm as the young bees hatch out.

E. L. PRATT.

Beverly, Mass., Jan. 10.

The editor of *Gleanings* comments as follows upon the foregoing.

"When Mr. Pratt first sent the new device for 1893 we were not favorably impressed with it, and wrote him to that effect. How ever, we instructed our artist to make a picture of it, and the result is shown above. Subsequently, in following the description through more carefully, we found that Mr. Pratt had still preserved the vital principle of his other hivers, that were so successful with us last summer; viz., that the bees on returning go back through an entrance to which they have long been accustomed, but into a different hive, preceded by the queen. If the reader will understand that the lower entrance, G, is supposed to be *closed*, he will readily see that the bees are obliged to use the entrance E only. Of course, before they have swarmed they pass through the entrance E *upward* to hive No. 1. After swarming they return to the same entrance, and thereafter pass *downward* to hive No. 2, because the main attraction—the queen—has gone down below, into an empty hive, affording those conditions that are supposed to satisfy the swarming mania.

The device above differs from the one of last year, in that the perforated zinc in front of the entrance, as at D, was, in the 1892 hiver, placed before the entrance G. This seemed to be objectionable to some (although we never so regarded it), that the bees should travel through an empty hive every time in order to get to the brood-nest in hive No. 1, from which it was expected they would swarm. Mr. Pratt, contemplating this objection, has, in the 1893 hiver, placed the entrance centrally, so that it affords equal access to both hives.

Although Mr. Pratt says nothing about it, we assume that the apiarist, at his convenience, after the swarm has issued, say within two or three weeks, removes the parent or upper hive, opens the entrance G, and for a time at least allows the bees to have access to both entrances. After they have become partly accustomed to the lower entrance, this special swarming-device is to be removed, and the cover replaced, when of course the entrance G will be used exclusively. There will be, of course, a little confusion for a day or two, but the bees will very readily adapt themselves to the change.

We see no reason why this latest pattern should not work as well as the one of last year; and as it is simpler, and avoids the long bee travel, it will doubtless be preferred to the others. The queen also will be more likely to get into the lower hive because the light from the entrance E is so close to the apex C of the zinc cone. This may make all the difference between success and failure."

A Condensed View of Current Bee Writings.

E. E. HASTY.

How many words of reading matter, by actual count, did the several journals place before their January readers? To be sure this is not the weightiest consideration in judging relative merit; but it is usually one consideration. I say *usually*, because if a journal *succeeded* in keeping its matter far above the average in quality many readers would prefer a medium quantity, so they could read it all, to the difficult job of culling to get the best in a "Benjamin's mess" of five times the amount. As matters now stand, however, the journals that furnish the least quantity are quite as apt to be low in quality as the big ones are; and it would be almost stretching things to say that any journal is keeping its columns entirely clear of matter which the reader might skip without serious loss. Moreover the little-end-of-nothing-whittled-out journalism if extinct is not sure to stay so. At any rate let us for the moment inspect the actual amount of "gold and silver, wood, hay and stubble" set before us. The pronouncing class will now come forward,

TOES ON THE MARK.

	Bee Matter.	Total Reading
Am. Bee Journal.....	58,675	Same
Gleanings.....	42,229	64,655
Canadian B. J.	24,254	Same
Guide	16,566	18,316
Review.....	15,099	16,836
Apiculturist.....	9,205	Same
Am. Bee Keeper.....	7,093	7,770
Progressive.....	5,959	Same

So *Gleanings* has pronounced the most words, but the A. B. J. has pronounced the most words about bees, and thereby stands at the head of the class. Attention to other topics, for which *Gleanings* gets its ear warned sometimes, amounts to 22,456 words, a little over one-third of its total matter. Exactly what the size of the model journal should be is a difficult problem. Certainly it should be nowhere near the bed-blanket character of our daily newspapers. Probably also down below 10,000 words a month is not the place to stay, except temporarily while getting strength to go higher. Yet I suppose there is a class of readers who take a journal from a queer sort of sense of duty, and they like the one best which they can scramble over the quickest. They know their system requires a dose, but they want the smallest dose possible.

THE GUIDE.

When a new bee-paper is born the old established ones can well afford to be polite in speech toward it (soon die any way, you know) but if it forgets to die, and refuses to be reminded of that interesting duty, it may have thick slices of pretty cold shoulder to feed on for many years. It looks rather sad to me that such steady, patient merit and perseverance as the *Guide* has shown for sixteen years should have realized no more than it has toward making it a good paying piece of property. 'Pears like I have noticed, for say a year back, that the leading papers carry a little more sister-like air toward it, as if they thought so too—as if they would say, "Sister *Guide*, you don't die worth a cent, come in out of the snow, and sit in the sitting-room a spell." The *Guide's* strong point is the ability with which it selects. Doolittle's "Living hive," and Mackenzie's foul-brood report, and our comrade R. L. Taylor's "Funny little mouse" article, and Prof. Cook's "Sugar Syrup Honey" are conspicuous examples of its January loot. Specially interesting things not pertaining to bees are also continually drawn on. Among its original matter Wm. Camm reconnoiters scarlet clover, the Dadants discuss feeding and feeders, and Demaree gives a strong article "kind 'o scattering round" some of the shot whizzing quite close to the sugar-honey "shebang." The Dadants are very competent authority, and they give almost unbounded recommend to the simple inverted fruit-can feeder, with muslin tied over it.

Let it stand in a dish a little while for the excess to drain out.

"I once thought I knew a great deal about the CAUSES favorable and unfavorable to nectar flow. But I know mighty little now."—G. W. DEMAREE.

The *Guide* holds on with both hands to the symposium method of answering apicultural questions, which is being abandoned in some quarters. Four questions, covering nine columns, appear in this number. Good thing to hold on to, if respondents can be held to a real interest in it, and not get to regarding the whole thing with thinly disguised disgust.

THE CANADIAN BEE JOURNAL

Is one of the journals that honestly tries to be "worth its keep" to the subscriber. Over six pages of its new year's number are occupied by a report on foul-brood by the government Bacteriologist, J. J. Mackenzie. Original investigations of this sort are so few in number that we cannot afford to neglect them when set before us in intelligible shape. The modesty of this scientist is remarkable. Witness below—

"I certainly would not be prepared to 'spot' foul-brood in an apiary, although I certainly think I can under the microscope."

There are slight shades of difference in the appearance of our enemy, the bacillus, as seen by Cheshire in England, and by Mackenzie in Canada. Here is the latter's view—

"It is a bacillus similar to that of Cheshire in size, produces spores which are somewhat thicker, giving the bacillus a clubbed appearance. On agar jelly it grows rapidly, so as to cover the whole surface. In gelatine its growth is very peculiar, shooting out from the infected point in all directions. On potato it produces a yellow growth."

To throw light on the solemn question whether foundation can communicate foul-brood a great harvest of spores were raised and stirred into melted wax, taking care not to have the wax very hot. Wax from the *under side* of this infected cake would start a luxuriant growth of the bacillus. With wax from the upper side of the cake he had no success. With ordinary wax from foul-broody combs he had repeated failures, and only one success. But that one success is sufficient to send a shiver down the spine of the foundation-user who doesn't want the disease.

My own opinion and confidence all along have been that melted wax had of itself power to kill the germs, just as melted grease kills flies, without regard to the degree of heat

required to kill them. My theory seems to go to smash under these experiments. The remarkable immunity which foundation users have certainly had (for the most part) seems to rest mainly on the fact that live spores are very heavy, and go to the bottom. But just think how easily a little of the dregs *might* be bungled into one of the dark colored sheets.

Our enemy is a salamander. In wax kept at the boiling point he held out two hours. Two and a half hours finished him. When the heat was moderated to 194° it took three hours. He laughs at germicides. Put in a two per cent. solution of carbolic acid, he was at the end of six days still "holding the fort." One per cent. of Beta Naphthol put in the hot wax had little or no effect in hastening his death. So far as drug remedies go, the upshot seems to be that they *temporarily stop the germs from growing*, and in the interim the bees themselves (and nature) may get the upper hand. As the best that can be done, where frames and hives are to be cleansed without prolonged boiling, Mackenzie advises ten per cent. of soft soap in water, or a strong solution of washing soda. Either, if used thoroughly enough, and hot enough, is declared better than five per cent. of carbolic acid.

A windfall joke occurs on page 311. Manager Newman telling how hard he is going to work for the new Union against honey mixers, tries to say he will send his letter to every bee-paper and endeavor to *get the views* of the editors; but the wicked types make him say "endeavor to *pet the views* of the editors." Not a bad idea, from a worldly point of view. If you want to get anything out of an editor pet his views.

Canadian No. 2 is mainly occupied with an excellent report of the Washington convention, and No. 3 with the Ontario convention. The Dominion folks got so entranced with our editor that they said he would pass for a Canadian anywhere. On page 341 friend Dibbern thinks a home-made brick furnace eight inches thick (doors from an old cook-stove) the proper thing to warm a cold wintering cellar—gives such a steady heat, and holds it so long. McEvoy's plan of wintering on early sealed combs from the super, and holding the late honey and stuff from below in reserve for spring, seems splendid tactics for the bees. Takes a good location to be able to afford it. I would also amend by allowing one outer comb with pollen in

it. Bees get to be cannibals when they have no pollen, if I am right—break up the bodies of the dead and suck the juices. In visiting 184 apiaries the foul-brood inspector found about a thousand cases. His office is not a sinecure, certainly.

THE GENERAL ROUND UP.

That is a wonderfully spirited engraving of Doolittle in A. B. J. No. 7. You could not tell from the look of him whether he was a Major General or the Commander in Chief. I don't believe he *is* quite so ferocious. Since Jan. 1st we have had also a fine picture of Dr. Miller, tolerable ones of Elwood and James A. Green, and poor ones of B. Taylor, Adam Grimm and Eugene Secor.

Baldensperger in *Gleanings*, page 53, gives valuable and rare records of the fertilization of queens, one the first day after leaving the cell, two the second day—and so on to one which was fertilized the 30th day, and did pretty well. A medal to our brother from the Holy Land. But possibly unusual blood had something to do with these unusual facts.

"The average time is six or seven days."—DADANT.

Cases of impregnation at 40 days, and 46 days given on page 48 of *Gleanings*.

Wanted. The *usual* time when a queen passes beyond hopes of fertilization.

Dr. Miller in *Gleanings*, page 47, says of the emerging of queens, "Thirty years ago sixteen days was not the orthodox time. It was 17 or 18." And now often 15.

Is it just barely possible that the accelerated development of queens, as compared with workers, is a *recent* development? and still going on? and much more manifest in bees manipulated for several generations than in neglected ones?

In order to get *young bees* to shift their quarters, as Doolittle shows, the hive must be moved while they are out at play.

Edwin France saw bees working across a lake six miles wide. A. B. J., page 83.

The compression of getting into a worker cell is *not* what determines that an egg shall be worker and not drone. Mrs. Atchley in repeated cases of eggs laid in her hand has made her bees rear workers from them—never drones. Even the ones reared in drone cells were workers. Medal for Jennie. Also she finds that Cyprian workers lay multitudes of eggs inside of 48 hours from the removal of the queen. See A. B. J., page

108. She longs for a government grant, that she might go to an island and settle lots of things. Alas, governments usually employ mediocrities, and I'm "afeerd" Mrs. Atchley is not one!

The new work that is running in the *Apiculturist* more than maintains its character; and Alley owns up to the authorship. Directions given for opening a hive are especially able; but, mercy! who wants to keep at all bees that need to be scientifically besieged fifteen minutes before you dare open them? Lead 'em off, friend Alley, and give us some civilized kind.

"When I have been stung and have taken the trouble to examine, I have found that in nearly every case it was done by quite a young bee."
—ALLEY.

My opinion has been that it was usually hardened old wretches, who had adopted war as a profession, doing nothing else than hang round the entrance like cross dogs. An idle bee would keep its fur better than a laboring one.

RICHARDS, Lucas Co., O., Feb. 18, 1893.

ADVERTISEMENTS

HIVES

Twenty of Root's Dovetailed Hives, all made up and furnished with six section holders and eight brood frames, only 90 cts. each. Twenty of Root's story and a half, chaff hives, made up and furnished with eight brood frames, and a case to hold twenty sections, only \$1.25 each. (Regular price, \$1.75.) Twenty chaff hives with one movable side, and furnished with nine brood frames and a case holding six section holders, only \$1.50 each. (Regular price \$2.00.) I also have fifty colonies of

BEEES

For sale. They are in eight and ten (L.) frame story and a half hives. Colonies in ten-frame hives, \$4.00 each; in eight-frame, only \$3.50. If five or more are taken at one time, a five cent discount will be given. Bees are in good condition and hives new. A discount of ten per cent will also be given on section holders, brood frames and shipping cases until May 1st.

J. M. KINZIE, Rochester, Mich.

TYPEWRITERS.

Largest like establishment in the world. First-class Second-hand Instruments at half new prices. Unprejudiced advice given on all makes. Machines sold on monthly payments. Any instrument manufactured shipped, privilege to examine. EXCHANGING A SPECIALTY. Wholesale prices to dealers. Illustrated Catalogues Free.

TYPEWRITER { 31 Broadway, New York.
HEADQUARTERS, { 186 Monroe St., Chicago.

\$1.50

Will buy a good two story Chaff Hive. Shall I send you one? Send a card and I will mail my price list. Geo. A. Kirkpatrick, Union City, Ind.

DOVETAILED HIVES.

Frames, Sections, Honey Crates, Foundation and Apiarian Supplies of all kinds. Catalogue free.

E. L. KINCAID, Walker, Mo.

HUNT'S

FOUNDATION

FACTORY.

Send for free samples of foundation and sections; warranted good as any made. Dealers, write for special prices and the most favorable conditions ever offered on foundation. Send for new, illustrated, free price-list of a full line of supplies.

M. H. HUNT,

1-93-tf

Bell Branch, Mich.

Take Notice!

If you are looking for the bees that give the most profit, and are the most gentle, try the

ALBINO.

I can also furnish the golden Italian, but my preference is the Albino. Send for circular and price list and see what others say of them and how cheaply I sell them. I also manufacture and deal in Hives, Sections, Foundation, Extractors, and other apiarian supplies.

3-93-2t

S. VALENTINE,

Hagerstown, Md.

Bee Literature For Sale.

GLEANINGS—Vols. 8-9-10-11-12-16 bound in "red goat" Vols. 17-18-19-20 unbound.

AM. BEE JOURNAL—Vols. 22-23-24 bound in black leather, and Vols. 25-26-27 and 28 unbound.

APICULTURIST—Vols 1 to 7, inclusive, unbound.

GUIDE—Vol. 12, unbound.

Each of the following lack one or two numbers of being complete.

ADVANCE—Vols. 17 and 18.

CANADIAN B. J.—Vol. for 1888.

BRITISH B. J.—Vols. for 1888-1890 and 1891.

CAN. HONEY PRODUCER—Vols. for 1887-1888 and 1889. Also odd numbers of all the above journals.

How much am I offered for any or all of the above?

ARTHUR C. MILLER,

Box 575,

Providence, R. I.

WILL SACRIFICE
SUPPLIES. WRITE FOR LIST.

I also have "office helps" for sale. 3-93-tf
JNO. C. CAPEHART, St. Albans, W. Va.

I HAVE FOUR SINGLE-COMB
OBSERVATORY HIVES

That I wish to dispose of. They are finely made of "quartered" oak and polished. They cost \$5.00 each, but I am out of the show business and am open to offers

2-93-tf. ARTHUR C. MILLER,
Box 575, Providence, R. I.

Please mention the Review.

FREE QUEEN.

Send for circular giving particulars, telling how to introduce queens and giving the price of hive protectors and nucleus col's.

2-93-4t J. F. MICHAEL, German, Darke Co., Ohio

Please mention the Review.

No. 1 SECTIONS \$2.50.

No. 2 SECTIONS \$1.60.

DOVETAILED HIVES 75c. UP.

Smokers, Foundation, Feeders, Bee Veils, and all things needed in the Apiary. Wholesale and retail. Send for Reduced List, Free.

2-93-tf. W. D. SOPER,
Jackson, Mich.

Please mention the Review.

Early Queens From Texas,

From my choice golden stock. My bees are very gentle, good workers, and beautiful. Safe arrival and satisfaction guaranteed. One untested queen, April and May, \$1.00; six for \$5.00; later, 75c. Orders booked now; money sent when queens are wanted. Send for price list.

J. D. GIVENS,
Lisbon, Texas.

1-93-9t *Please mention the Review.*

Bee Hives and Section Boxes.

Simplicity, Langstroth-Simplicity, Standard Langstroth, Dovetailed and Champion Chaff Hives, Supers, One Piece Sections and Shipping Cases. Foundation, Smokers, etc., etc. Send for 16 page Circular.

1-92-tf PAGE & KEITH, New London, Wis.

Please mention the Review.

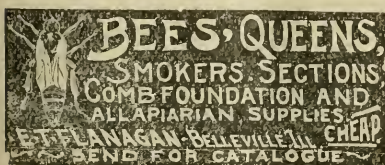

Please mention the Review.

HONEY ALMANAC AND BEE BOOKS,
OF ALL KINDS,
A LARGE STOCK.



MY NEW ILLUSTRATED
Catalogue and Price List of Supplies for the Apiary will be sent free to all who may apply. Send a postal card for it, writing your name and address plainly. For every Order of \$10.00 and over, I will make you a present. The Catalogue tells you all about it.

T. G. Newman, 147 So. Western Ave., Chicago.

Please mention the Review.

Leather Colored

HONEY QUEENS, from Imported Mother, warranted purely mated, after June 10th, at \$1.00 each; six at one time, \$5.00. Untested queens, 75c. each. Address

C. A. BUNCH,
Nye, Marshall Co., Ind.

1-93-7t.

Please mention the Review.

—If you are going to—

BUY A BUZZ-SAW,

write to the editor of the REVIEW. He has a new Barnes saw to sell and would be glad to make you happy by telling you the price at which he would sell it.

ITALIAN QUEENS

Bred for Business, Gentleness and Beauty. Untested, 80c, each; three for \$2.25; six for \$4.00; 12 for \$7.50. Tested, \$1.25. Select tested, yellow to the tip, breeder, \$1.50. Will commence shipping April 15th. On all orders received before March 1st, accompanied by the cash, 10 per cent. discount. Safe arrival guaranteed.

1-93-12t.

G. E. DAWSON,
Carlisle, Somoke Co., Ark.

Please mention the Review.

If You Wish Neat, Artistic

PRINTING,

Have it Done at the Review.

ITALIAN QUEENS AND SUPPLIES
FOR 1892.

Before you purchase, look to your interest, and send for catalogue and price list.

J. P. H. BROWN,

1-88-tf.

Augusta, Georgia.

Please mention the Review.

Barnes' Foot and Hand Power Machinery.

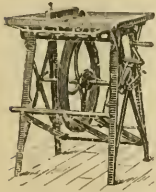

This cut represents our Combined Circular and Scroll Saw, which is the best machine made for Bee Keepers' use in the construction of their hives, sections, boxes, etc.

11-92-16t

MACHINES SENT ON TRIAL.

FOR CATALOGU, PR ICES, TC.,

Address W. F. & JNO. BARNES CO., 384 Ruby St., Rockford, Ills

IF YOU WANT THE

BEE BOOK

That covers the whole apicultural field more completely than any other published, send \$1.00 to Prof. A. J. Cook, Agricultural College, Mich., for his

Bee-Keepers' Guide.

Liberal Discounts to the Trade.

Please mention the Review.

Warranted Purely Mated.

Italian honey queens. They are very prolific and their workers cannot be excelled in gentleness and industry. Nothing but the choicest queens sent out; try me and see. Send your order at once. Single queen, 80 cts; 3 for \$2.00; 6 for \$4.00; 12 for \$7.75. Ready April 30th. 1-98-6t

M. H. DeWITT, Sang Run, Md.

Please mention the Review.

HATCH CHICKENS BY STEAM
With the Improved **Excelsior Incubator.**



Simple, Perfect, Self-Regulating. Thousands in successful operation. Guaranteed to hatch a larger percentage of fertile eggs at less cost than any other Hatcher. Lowest priced first-class Hatcher made.

Circulars free. Send 6c. for Illus. Catalogue.

GEO. H. STAHL, Quincy, Ill.

3 & 5 Banded Queens

AND

2 & 3 Frame Nuclei

— A SPECIALTY.

	April	May
One untested queen,	\$1.00	\$1.00
Six " queens,	5.00	5.00
One tested queen,	2.00	1.50
Three " queens,	5.00	4.00
Select tested queen,	2.50	2.50
Two-frame nucleus with any queen \$1.50 each, extra. Three-frame nucleus with any queen \$2.25 each, extra. Safe arrival guaranteed.		

W. J. ELLISON,

3-93-3t

Catchall, S. C.

New as Well as Valuable

IMPROVEMENTS

IN BEE-HIVES, SMOKERS,

FOUNDATION FASTENERS,

SECTION PRESSES AND FEEDERS.

Special prices given to parties who will take hold of and push the sale of these goods. For circulars and particulars, address

LOWRY JOHNSON,
Masontown, Pa.

1-93-1f.

COMB FOUNDATION

AND SECTIONS.

—:O:—

CAUTION.

Do not buy a thick, heavy base comb foundation for use in your sections when you can get 14 to 16 square feet to the pound. Also be sure and buy your sections where you can get a nice box at a low price. Send me your address and I will be pleased to send you a sample section, a sample of the

THINEST COMB FOUNDATION MADE,

And prices at which they may be bought.

W. H. NORTON,

2-93-14.

Skowhegan Me.

Please mention the Review.

Cheap Freight and Quick Transportation.

Being located at the most central point of railroad and express companies enables us to furnish bee keepers with supplies at less cost to themselves than any house in the country. We furnish everything needed in the apiary, as low as the lowest and as good as the best.

COOK'S COMPLETE HIVE combines all the most approved methods of hive making. It is a complete arrangement for out-door wintering and is equally well adapted to producing comb or extracted honey. Send for circular. Fine lot of **Bees for Sale** cheap.

J. H. M. COOK, [SUCCESSOR TO KING & ASPINWALL] 78 Barclay St., New York City.

HILL'S SMOKER and FEEDER.



Smoker burns hard wood chips without special preparation. Very reliable. Greatest smoking capacity. Easiest to start. Cheapest because it saves time. Price, \$1.20. By mail, \$1.40. Per dozen, \$1.80.



Best Bee-Feeder. Most convenient. Saves feed. No daubing or drowning. Two to seven feeders full may be given a colony at one time which will be stored in the combs in ten hours. Price, per pair, 30c.; by mail, 40 c.; per doz., \$1.60. Has a sale of 2,000 per month. Address A. G. HILL, Kendallville, Indiana.

These smokers and feeders are kept in stock by Thos. G. Newman & Son, Chicago, Ill.
 G. B. Lewis & Co., Watertown, Wis.
 W. H. Bright, Mazeppa, Minn.
 Chas. Dadant & Son, Hamilton, Hancock Co., Ill.
 E. Kretchmer, Red Oak, Iowa.
 H. McWilson & Co., 202 Market St., St. Louis, Mo.
 F. H. Dunn, Yorkville, Ill.
 W. D. Soper & Co., Jackson, Mich.
 Chas. A. Stockbridge, Ft. Wayne, Ind.
 A. F. Fields, Wheaton, Ind.
 W. S. Bellows, Ladora, Iowa.
 F. F. Quigley, Unionville, Mo.
 Gregory Bros., Ottumwa, Iowa.
 Miller Bros., Bluffton Mo.
 G. K. Hubbard, Ft. Wayne, Ind.
 Theodore Bender, 18 Fulton St., Canton, Ohio.
 Muth and Son, Cincinnati, Ohio.
 Levering Bros., Wicota, Cass Co., Iowa.

Please mention the Review.

Great Reduction.

SECTIONS AT GREATLY REDUCED PRICES.

HIVES, SHIPPING CASES, &c., AT BED-ROCK PRICES.

WRITE FOR FREE, ILLUSTRATED CATALOGUE AND PRICE LIST.

G. B. LEWIS CO., Watertown, Wis.

1-93-tf.

Please mention the Review.



QUEEN CAGES

Are my specialty. I make the Benton cage in many styles and sizes. A light cage saves postage; a neat cage creates a favorable impression; one properly arranged carries its occupants safely in either hot or cool weather; and my special machinery and large trade enable me to furnish extra nice cages, having all these advantages, at a very low price. Sample cages and prices on application.

C. W. COSTELLOW, Waterboro, Me.



BINGHAM PERFECT BEE SMOKER Pat'd 1873, 1882, & 1892.

Cheapest & Best on Earth.

Send Card for Circular to Bingham & Hetherington ABRONIA, MICH.

Muth's HONEY EXTRACTOR PERFECTION Cold-Blast Smokers, Square Glass Honey Jars, Etc.

For Circulars, apply to CHAS. F. MUTH & SON, Cor. Freeman & Central Aves., Cincinnati, O. Send 10c. for Practical Hints to Bee-Keepers.

1-93-tf.

Please Mention the Review.

SECOND HAND SUPPLIES CHEAP.

I have given up the bee business for the practice of law. I have a lot of supplies on hand, both used and unused, which I will make it an object for any one needing them to buy. There are about 80 of the New Heddon Hives, over 250 T supers, 36 new 60-lb. honey cans, honey extractor, glass for 12-lb shipping cases, sections, surplus foundation, queen-excluding honeyboards and almost everything to be found in a large apiary. No circulars. Write me what you want and I will let you know condition and price. All these goods are at Newton, Jasper Co., Iowa, and will be shipped from there in April by my brother. Address WM. L. DREW, 122 Oxford St., North Cambridge, Mass.

"FLORIDA." — 300.

LEATHER-BACK ITALIAN QUEENS.

By my special method of taking a crop of honey by the "Migratory" system, I shall have 300 tested queens for delivery about March 20th. Prices \$10 per dozen. None over six months old. My crop the past season from one yard of 42 colonies, spring count, was 10,800 pounds and increased to 150.

A. F. BROWN, Rockledge, Fla.

1-93-4t

OUR "Falcon" Sections

Better than any.
Cheap as many.

Our No. 1 Sections

Equal to many.
Cheaper than any.

Any Size. Any Quantity.
At Any Time.

Also, all styles HIVES and BEE-FIXTURES cheap. New catalogue and price list free. Samples of Falcon Sections for 2c. stamp.

W. T. Falconer Mfg. Co.,
JAMESTOWN, N. Y.

Golden,



5-Banded,



Italian Queens

My Bees are as good honey gatherers as there are in the country, while for Golden Beauty they cannot be excelled in the world.

Warranted Queens, 75 cents each.

Tested, \$1.00 each.

Breeding Queens, \$2.50 to \$3.00.

Ten per cent discount on orders for five or more queens. Satisfaction guaranteed. Make money orders payable at Caldwell, Texas. Address

C. B. BANKSTON, Chrisman, Texas.

2-93-tf

Please mention the Review.



I TELL you what, Jones, *Levering Bros.* sell the best goods and at the lowest prices of any one I've struck yet. The largest and best equipped

Bee-Hive Factory

In the West. The Dovetailed Hive and New Hoffman self-spacing frame a specialty. Everything used by practical bee-keepers by wholesale and retail. Send for their free Illustrated Price-List, and save money. Supply Dealers, send for their Wholesale List. Address:

LEVERING BROS.,
WIOTA, Cass Co., Iowa.

2-93-6.

IF you wish to advertise anything anywhere at any time write to GEO. P. ROWELL & CO., No 10 Spruce St., N. Y.

1852.

REDUCTION ON THE PRICE OF

1891

Langstroth on the Money Bee

(REVISED.)

PRICE BY MAIL, \$1.40: BY EXPRESS OR FREIGHT WITH OTHER GOODS \$1.25.

By its copious indexes, by its arrangement in numbered paragraphs, including reference numbers on any question in bee culture, any information can be instantly found. This book is the most complete treatise on bee keeping yet published. A FRENCH EDITION JUST ISSUED.

1878. **DADANT'S COMB FOUNDATION.** 1891.

More than Ever. Better than Ever. Wholesale and Retail.

Half a Million lbs. Sold in 13 Years.

Over \$200,000 in Value.

It is THE BEST, and guaranteed every inch equal to sample. All dealers who have tried it have increased their trade every year. Samples, Catalogue, free to all. Send your address.

We also make a specialty of Cotton and Silk Tulle of very best grade for bee-veils. We supply A. I. Root and others. 7,000 Yards just received. Prices Very Low. Samples Free.

Smokers, Honey Sections, Extractors, Tin Pails for Honey, Etc. Instructions to Beginners with Circulars Free.

Mention Review.

CHAS. DADANT & SON, Hamilton, Hancock Co., Ills.

APRIL, 1893.



At Flint, Michigan.—One Dollar a Year.

ADVERTISING RATES.

All advertisements will be inserted at the rate of 15 cents per line, Nonpareil space, each insertion: 12 lines of Nonpareil space make 1 inch. Discounts will be given as follows:

On 10 lines and upwards, 3 times, 5 per cent; 6 times, 15 per cent; 9 times, 25 per cent; 12 times, 35 per cent.

On 20 lines and upwards, 3 times, 10 per cent; 6 times, 20 per cent; 9 times, 30 per cent; 15 times, 40 per cent.

On 30 lines and upwards, 3 times, 20 per cent; 6 times, 30 per cent; 9 times, 40 per cent; 12 times, 50 per cent.

Clubbing List.

I will send the REVIEW with—		
Gleanings,.....	(\$1.00).....	\$1.75.
American Bee Journal.....	(1.00).....	1.75.
Canadian Bee Journal.....	(1.00).....	1.75.
American Bee Keeper.....	(.50).....	1.40.
Progressive Bee Keeper.....	(.50).....	1.40.
Bee Keepers' Guide.....	(.50).....	1.40.
Apiculturist.....	(.75).....	1.65.
Bee-Keepers' Magazine.....	(.50).....	1.40.

Honey Quotations.

The following rules for grading honey were adopted by the North American Bee-Keepers' Association, at its last meeting, and, so far as possible, quotations are made according to these rules:

FANCY.—All sections to be well filled; combs straight, of even thickness, and firmly attached to all four sides; both wood and comb unsoiled by travel-stain, or otherwise; all the cells sealed except the row of cells next the wood.

No. 1.—All sections well filled, but combs uneven or crooked, detached at the bottom, or with but few cells unsealed; both wood and comb unsoiled by travel-stain or otherwise.

In addition to this the honey is to be classified according to color, using the terms white, amber and dark. That is, there will be "fancy white," "No. 1 dark," etc.

CHICAGO, Ill.—We quote as follows: Fancy white, 17 to 18; No. 1 white, 14 to 16; fancy amber, 11 to 13; fancy dark, 10; white extracted, 7 to 9; amber extracted, 7 to 8; dark extracted, 6 to 7; beeswax, 23 to 25.

R. A. BURNETT & CO.,
161 So. Water St., Chicago, Ill.

KANSAS CITY, Mo.—The demand for extracted honey is good and the supply light. The supply of comb honey is fair and the demand the same. Shipments of No. 1 would meet with very ready sale. We quote as follows: No. 1 white, 16 to 17; fancy amber, 15 to 16; No. 1 amber 13 to 14; fancy dark, 12 to 13; No. 1 dark, 10 to 11; white extracted, 6½ to 7; dark extracted, 5 to 6; beeswax, 22 to 25.

CLEMONS-MASON CO.,
Mar. 6. 521 Walnut St., Kansas City Mo.

CINCINNATI, Ohio.—There is no choice comb honey on the market. A fair article brings 14 to 16 in a jobbing way. The demand is good for extracted at from 6 to 8 cts. There is a good demand for choice yellow wax at from 24 to 27 cts.

CHAS. F. MUTH & SON.,
Cincinnati, Ohio.

April 1.

MINNEAPOLIS, Minn.—There is a good supply on hand but it is mostly dark. This stock is slow, but what little white there is on the market moves readily. We quote fancy white, 17 to 18; two pound combs, 16 to 17; buckwheat, 15 to 16; extracted honey, 10 to 11.

J. SHEA & CO.,
Feb. 13. 14 Hennepin Ave., Minneapolis, Minn.

BUFFALO, N. Y.—Demand somewhat easy and stock light. The prospects are that honey will clean up with satisfactory prices. Extracted is in light demand. Beeswax is firm for choice lots. We quote as follows: Fancy white, 17 to 18; No. 1 white, 15 to 16; fancy dark, 10 to 11; No. 1 dark, 8 to 9; beeswax, 28 to 30.

BATTERSON & CO.,
April 1. 167 & 169 Scott St., Buffalo, N. Y.

CHICAGO, ILL.—We anticipate slow sales on all grades of honey for the balance of this season. There is a poor demand for extracted at present. Beeswax is in good demand. We quote as follows: Fancy white, 16; No. 1 white, 15; No. 1 dark, 12; white extracted, 8½; dark extracted, 7; beeswax, 15 to 26.

J. A. LAMON,
April 1. 44 & 48 So. Water St., Chicago, Ill.

NEW YORK.—The market is bare of comb honey. Fancy white could be sold at 14 to 15; fancy amber at 12; and dark at 10. The market is quiet on extracted and no movement. Large lots of West India and Mexican are arriving and the market is well supplied. This class of honey sells at from 65 to 75 cts. per gallon. Beeswax is quiet but firm at from 27 to 29.

HILDRETH BROS. & SEGELKEN,
April 3. 28 & 30 West Broadway New York.

ALBANY, N. Y.—Stock of honey very light. Prices well sustained. Demand will be better as the weather warms up. We quote as follows: Fancy white, 15 to 17; No. 1 white, 14 to 15; mixed, 12 to 14; fancy dark, 11 to 12; No. 1 dark, 10 to 11; white extracted, 8½ to 9½; amber extracted, 7 to 7½; dark, 6½ to 7. Beeswax, 28 to 30.

H. R. WRIGHT,
Feb. 13. 326 Broadway, Albany, N. Y.

DOVETAILED HIVES.

Frames, Sections, Honey Crates, Foundation and Apiarian Supplies of all kinds. Catalogue free.

E. L. KINCAID, Walker, Mo.



4-93-1f

Don't Monkey

with cross bees or poor goods. Send for our circular of bees, queens and bee-keepers' supplies.

JNO. NEBEL & SON,
High Hill, Mo.

Please mention the Review.

THE LOSS OF ONE

Queen in introducing means a loss greater than the cost of a copy of "ADVANCED BEE CULTURE," which has one entire chapter devoted to "The Introduction of Queens." It shows when the cause of failure lies with the colony, when with the queen, and points out the *conditions* necessary to success. Although *one* infallible method is given, but little attention is given to the setting forth of exact rules and methods, the subject being treated with a view to teaching *principles* that may be followed to success.

Price of the book, 50 cts.; the REVIEW one year and the book for \$1.25. Stamps taken, either U. S. or Canadian.

W. Z. HUTCHINSON, Flint, Mich.

WHITE POPLAR SECTIONS.

We have New Steam Power, and New Buildings, and are now ready to furnish White Poplar Sections, Clamps, Crates and Wood Sides at short notice. Workmanship, Quality and Price unsurpassed. Send for sample and price list.

PRIME & GOVE,

1-90-tf Bristol, Vermont.

Please mention the Review.

BEE-KEEPERS SUPPLIES



BEST GOODS. LARGEST BEE SUPPLY HOUSE IN THE WEST.

LOW PRICES. LARGE STOCK.

-ITALIAN QUEENS AND BEES A SPECIALTY-
-CLOVER SEEDS AND BUCKWHEAT-

-SAMPLE OF OUR BEE JOURNAL THE WESTERN BEEKEEPER ALSO OUR CATALOGUE FREE!
-JOS. NYSEWANDER, DES MOINES, IOWA-

ON HAND NOW.

THE MOST COMPLETE STOCK
OF BEE HIVES, SECTIONS AND
SUPPLIES IN THE NORTHWEST.

W. H. PUTNAM,

1-93-121. RIVER FALLS, WIS.



Spray
your
Fruit
Trees
and
Vines

Wormy Fruit and Leaf Blight of Apples, Pears, Cherries and Plums prevented; also Grape and Potato Rot—by spraying with Stahl's Double Acting Excelsior Spraying Outfits. Best in the market. Thousands in use. Catalogue, describing all insects injurious to fruit, mailed Free. Address

WM. STAHL, QUINCY, ILL.

2-93-tf Please mention the Review.

Names of Bee-Keepers.

TYPE WRITTEN.

The names of my customers, and of those asking for sample copies, have been saved and written in a book. There are several thousand all arranged alphabetically (in the largest States) and, although this list has been secured at an expense of hundreds of dollars, I would furnish it to my advertisers at \$2.00 per thousand names. A manufacturer who wishes for a list of the names of bee-keepers in his own state only, or, possibly, in the adjoining states, can be accommodated. Any inquiry in regard to the number of names in a certain state, or states, will be answered cheerfully. The former price was \$2.50 per 1000, but I now have a type writer, and, by using the manifold process, I can furnish them at \$2.00. W. Z. HUTCHINSON, Flint, Mich.

We have a large lot of

DOVETAILED HIVES

which we will sell for 50 cts. each, including supers, section holders and brood frames. This offer is limited to this lot of hives. 1-92-12t
WM. H. BRIGHT, Mazepa, Minn.

HAVING PURCHASED the entire stock and business of W. D. Seale, at Jackson Mich., I am now prepared to furnish Apian Supplies to all who have usually purchased of Mr. Sopor, and to all others who wish Apian goods at the lowest prices. Orders filled promptly. Send for price list and circular.
E. H. TRUMPER,

1-93-3t Bankers, Mich.

Alley's Drone and Queen Trap.

A RELIABLE SELF HIVER. 100,000 IN USE.

Adjustable to any style hives without alteration of hive or trap. Guaranteed to live every swarm, catch every queen and drone, or the money will be refunded. Trap mailed for 65 cents; or, AMERICAN APICULTURIST one year, including queen-rearing number, and sample trap, for \$1.00. Panic Italian and golden Carniolan queens ready to mail May 20. Purity and safe arrival guaranteed.
HENRY ALLEY,
Wenham, Mass.

PATENT. WIRED, COMB FOUNDATION

HAS NO SAG IN BROOD FRAMES.

THIN, FLAT BOTTOM FOUNDATION

HAS NO FISH BONE IN SURPLUS HONEY.



Being the cleanest is usually worked the quickest of any foundation made.

J. VAN DEUSEN & SONS,
(SOLE MANUFACTURERS),

3-90-tf Sprout Brook, Mont. Co., N.Y.

Have You Seen Our Big Blue Catalogue

FOR 1893? Seventy illustrated pages. Sent FREE to any bee-keeper. **BEE-SUPPLIES**, at retail and wholesale. Everything used in the apiary. Greatest variety and largest stock in the West

1-93-tf. **E. Kretschmer,** Red Oak, Iowa.

Please mention THE REVIEW.

DO NOT GIVE YOUR ORDER FOR SECTIONS UNTIL YOU GET OUR PRICES ON THE

"BOSS" ONE-PIECE SECTION

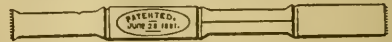

We are in better shape than ever to fill orders promptly. Also,

DOVETAILED HIVES, - - - - -

- - - FOUNDATION, SMOKERS, ETC.

Write for Price List.

J. FORNGROOK & CO.

WATERTOWN, Wis., Jan. 1, 1893. 1-93-tf.

Please mention the Review

QUEENS,

A large number of fine ones on hand; yellow and prolific; ready April 15th; warranted queens, \$1; 6 for \$1.50; select tested, yellow to the tips, suitable for breeders, \$2 each. Reference, A. I. Root. 3-93 tf
W. H. LAWS, Lavaca, Seb Co. Ark.

Please mention THE REVIEW

Down They Go!

To induce you to try them I now offer my beautiful, 8-to-the-foot, all in one piece, white poplar sections at \$1.50 per crate of 500. Also 7 to-the-foot basswood sections at same price. My sections fold up square and firm. Beeswax worked into foundation by the pound. Samples of sections, foundation and wire d. price list free.

O. H. TOWNSEND,

1-93-1t Alamo, Kan. Co., Mich.

Reference, Editor REVIEW.

Please mention the Review.

Illustrated Advertisements Attract Attention.



Cuts Furnished for all illustrating Purposes.

FLORIDA

Leather - Back, Italian

500 YOUNG QUEENS

Ready for delivery April 20th to May 16th. \$10 per dozen; special prices on three dozen or more. Safe arrival guaranteed. The 300 queens mentioned in last advertisement are all sold.

A. F. BROWN,

1-93-tf Huntington, Fla.

Dadant's Comb Foundation.

Wholesale and Retail. Even our competitors acknowledge that our goods are the STANDARD of their kind. **Langstroth on the Honey Bee, Revised.** New edition. Bee Veils; and veil material at wholesale. Bee Supplies, Sections, Smokers, etc. Samples of Foundation and veil stuff with circular free. Instructions to beginners. Send your address to

CHAS. DADANT & SON, Hamilton, Ills.

1-93-12t Please mention the Review.

TESTED QUEENS

\$1.00 Each.

Light, large and prolific Italian queens reared in Jan 1892, by the most improved methods. Orders filled by return mail.

J. W. K. SHAW & CO.,

1-94-7t Loreauville, La.

Great Reduction.

SECTIONS AT GREATLY REDUCED PRICES.

HIVES, SHIPPING CASES, &c., AT BED-ROCK PRICES.

WRITE FOR FREE, ILLUSTRATED CATALOGUE AND PRICE LIST.

G. B. LEWIS CO., Watertown, Wis.

1-93-tf. Please mention the Review.

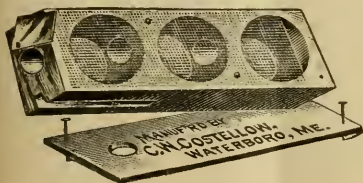

QUEEN CAGES

Are my specialty. I make the Benton cage in many styles and sizes. A light cage saves postage; a neat cage creates a favorable impression; one properly arranged carries its occupants safely in either hot or cool weather; and my special machinery and large trade enable me to furnish extra nice cages, having all these advantages, at a very low price. Sample cages and prices on application.

C. W. COSTELLOW, Waterboro, Me

Second Hand Supplies.

Of the second hand supplies that I have been advertising in the REVIEW, the following remain unsold:—

100 old-style, Heddon surplus cases at 20 cts. (as a non-separated case, they have no superior); 25 slatted honey boards at 10 cts.; 40 "dummies" for contracting the brood nest, 3 cts.; 20 Heddon feeders at 40 cts.; 25 Alley queen and drone traps at 25 cts., and half a dozen single-comb nuclei for exhibiting bees at fairs. They have glass sides, removable covers and are painted a bright vermilion. They cost \$2.00 each, but will be sold at half-price. All these are practically as good as new.

I also have 2,000 new, four-piece, white poplar sections at \$3.00.

W. Z. HUTCHINSON, Flint, Michigan.

Printing Presses

— AND —

Printing Materials.

Circulars Free. Specimen Book of Type, Etc., 10 Cts.

JOS. WATSON,

25 Murray St., New York City.

Muth's HONEY EXTRACTOR PERFECTION Cold-Blast Smokers,

Square Glass Honey Jars, Etc.

For Circulars, apply to CHAS. F. MUTH & SON, Cor. Freeman & Central Aves., Cincinnati, O. Send 10c. for Practical Hints to Bee-Keepers.

1-93-tf. Please Mention the Review.

**Low Freight Rates
And no Delays.**

WHEN you are considering where to send for your supplies the coming season, get prices and a list of goods on hand, from one of the following dealers, who handle **ROOT'S GOODS** in carload lots, thus securing them at lowest cost. Most of them, except those far distant, sell goods to users at factory prices while those far distant ad approximately only the carload rate of freight so that you will **SAVE TIME AND MONEY** by buying your supplies of one of these dealers. We cannot give here a list of goods kept, as it varies some at the different

places according to the varying needs of each locality. Write to the place nearest you for list with prices, and when you write give a list of the goods you want, and mention this paper.

QUITE a full line of goods are sold at factory prices by F. A Salisbury, Syracuse, N. Y. ; H. G. Acklin, 1024 Mississippi St., St. Paul, Minn.; Jos. Nysewander, Des Moines, Iowa. A good assortment is also kept for the far West by Bartheledes & Co., Denver, Col. For California by G. G. Wickson & Son, San Francisco and Los Angeles. For Oregon and Washington by F. L. Posson & Son, Portland, Oregon. For the Southeast Atlantic coast by Baltimore Farm Implement Co., Baltimore, Md.; and for the Far South by J. M. Jenkins, Wetumpka, Ala.

A smaller assortment, consisting chiefly of Dovetailed hives, sections, smokers, foundation, and extractors is also kept by the following :

Henry F. Hagen, Rocky Ford, Colo. ; W. K. Ball, Reno, Nev. ; W. O. Victor, Wharton, Tex.; Jno. Nebel & Son, High Hill, Mo. ; Thos. G. Newman, Chicago, Ill. ; Walter S. Ponder, Indianapolis, Ind.; Vicker Bros., Evansville, Ind. Our Hives, Comb Fdm., Smokers, Extractors, Perf. zinc, etc., are furnished by a multitude of other dealers too numerous to mention. If you want to buy goods made at the Home of the Honey Bees, you can get them as cheap as you can anywhere when you consider quality and workmanship, and your orders will be taken care of promptly. Don't expect to get all the goods we advertise, from any of the above dealers, and don't expect to get goods they do not agree to furnish; but find out what they agree to furnish, and at what price, by writing to address nearest you.
Please Mention Review.

**A. I. ROOT,
Medina, Ohio.**

FOR ALL KINDS OF BEE-KEEPERS SUPPLIES.
ADDRESS LEAHY MFG. CO. HIGGINSVILLE MO.

Here is your Chance—Two for the Price of one.
BEES AND HONEY



By Thos. G. Newman, ex-editor of the American Bee Journal, a book of over 200 pages, that we send **FREE to every new subscriber** who mails us \$1.00 for a year's subscription to the old

AMERICAN BEE JOURNAL,



The Largest, Best, Cheapest, and only **weekly** bee-paper in all America. 32 pages; established 1861. Send for a **free sample copy** with description of book offer **GEO. W. YORK & CO. CHICAGO, ILLS.**



To New Subscribers: The Journal Alone Sent for Three Months for 20 Cents.

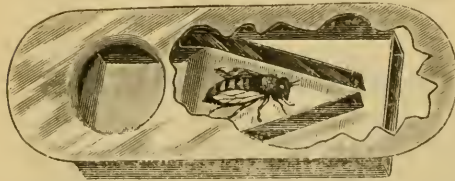

IT IS NO LONGER

A question of whether you shall use a bee-escape, but of **WHICH ONE**. You want an escape through which the bees can pass **READILY**, through which they cannot return, and one that never clogs. There is no escape possessing these characteristics that works more easily than the **PORTER**. The reason is that each of two springs can be bent slightly more easily than one spring can be bent twice as far. You run **NO RISK** if

you buy of the manufacturers, as, if the escapes do not prove superior to all others, and satisfactory in every respect, they may be returned and the money will be refunded. Send for circular and testimonials and read what others say of them. **PRICE**, 20 cents each, by mail; per dozen, \$2.25.

R. & E. C. PORTER, Lewistown, Ills.

The Bee-Keepers' Review.

A MONTHLY JOURNAL

Devoted to the Interests of Honey Producers.

\$1.00 A YEAR.

W. Z. HUTCHINSON, Editor & Prop.

VOL. VI. FLINT, MICHIGAN, APRIL 10. 1893. NO. 4.

TIMELY TOPICS.

No. 3.

R. L. TAYLOR.

"Come gentle Spring, ethereal mildness come."



THIS is an excellent season for the cultivation of the new bee-keeper's powers of observation with respect to the weather. In looking back to former seasons before he became interested in bees, he remembers that the last half of

April was crowded with rapturous, ethereal days, but, somehow, the possession of bees has lessened both their numbers and their quality: so the novice, like a lovelorn youth, goes about dejected, casting glances at his silent hives and cursing the weather. It may not be amiss, then, for us to say, for the benefit of all such, that it was always thus. If the bees get out of their hives in this latitude on more than two or three days per week, on the average, at this season of the year, it is owing to unusually favorable weather; besides, this, and similar things, bring with them certain compensations. If all things were at all times favorable, turning out as we would be likely to wish them to, if there were no obstacles to overcome and no dangers or evils to guard against,

how small would be the encouragement to the prudent and energetic. The careless and indolent could not be excelled by the active and vigilant, but all would be alike successful, and attention and prudence would no longer be at a premium. Happily there is no immediate danger of any such chaos. The long, severe winter just passed will prove of great advantage to the skillful, alert bee-keeper. By the destruction of the bees of neglectful and incompetent owners, competition will be decreased and prices enhanced and greater yet will be the affirmative result of labor and care well bestowed during April and May, and this, naturally enough, will be principally in the line of food and clothing—stores and protection.

These matters should be attended to without delay and should be pursued with thoroughness and certainty. If not already done, the condition of each hive with respect to stores should be determined on the first day possible. The great majority can be safely "diagnosed" as either being easily heavier than necessary, or too light, by "weighing" them in the hands—those near the dividing line may either be put on the scales or opened and examined. If the hives are alike, and one knows the average weight of hive and combs, and allows two or three pounds for bees, but few hives need be opened. Then the needy ones should be supplied, and I should always aim to give an abundance, and a *superabundance* would be preferable to the *least danger* of a deficiency. Combs of honey or combs filled with syrup can be exchanged for empty combs and this

is a safe and practical way of supplying stores and is the safest way if the colonies are weak—strong colonies will take supplies from feeders.

Next in importance to feeding is the matter of protection. In the first place the location should be a protected one. A wind break of trees, a rise of ground, a tight high board fence, buildings, or a hedge on the north and west, would secure the proper provision. But without doubt the bee-keeper may profitably go farther than this. Stock men have come to the unanimous conclusion that it is more economical to keep their stock warm by means of well-walled quarters than by means of fodder and grain. The same rule must hold true in the apiary. The most obvious means of protection, and perhaps the most effective compared with the expense, if one has a supply of empty hives or empty supers without divisions like the old Heddon case, is to place such hive or case over the brood chamber, spread any kind of a cloth over the frames, pack with four or five inches of chaff, sawdust or leaves, and put the cover over all. Good division boards used for closing the bees up on as few combs as possible, especially if the hives are large and the colonies not very strong, I have found quite advantageous, and if used with packing above, leaves little to be desired. A rim large enough to cover the entire hive, leaving room for two or three inches of packing on all sides and on top, protected by a good cover, is largely employed, and, on the whole, perhaps nothing is better. Other simple methods may be used and will occur to anyone. If bees have been in the cellar the danger is that all methods will be neglected in the hope that there will be no more weather so severe as to be harmful to bees. But almost, if not quite, every year proves this to be a vain hope, and he is a wise man who judges by former seasons and not by the temperature of the day on which he removes his bees from the cellar. Whatever protection is to be given should be ready before hand and applied *at once*, or half the possible advantage will be lost.

There is not much necessity, even at this time of the year, of opening hives and handling combs, and this should not be indulged in to any great extent if one's time is of any special value; and never except the need is very pressing, unless the weather is warm enough to permit the bees to fly freely, but

when hives are opened make the most of the operation. Straigten crooked combs, replace empty combs that are materially defective by perfect ones, gather and save the pieces of burr combs and keep an eye out for the condition of the queen and the colony. In doing this work don't bend over the hive standing on your feet, not so much on account of the present discomfort as on account of the danger of permanent injury that is likely to result. Always carry and use a light seat fitted to hold the necessary tools, fuel for the smoker, the pieces of wax gathered, queen cages, &c.

I want to say in conclusion that with the foundation-fastener described in the March number of the REVIEW, pieces of foundation as large as are desirable can be put into sections without any inconvenience, and I would have them large enough so as barely to clear the section at the sides and come within a quarter of an inch or less of the bottom, as this secures the thorough fastening of the honey to the section on all sides.

LAPPEER, Mich.

April, 1883.



Why Bee Escapes, Ought to be of Greater Capacity.

R. C. AIKIN.



IS there yet room for improvement in bee escapes? The Porter seems now to lead, and I have no doubt is the best yet produced, yet I am confident we can and will have escapes as far in advance of the present Porter, as it is ahead of those of five years ago; and the object of this article is to aid the inventors. Will the Porters and other escape men please take note of the points I shall set forth.

The first condition necessary to the success of the escape, is to make the bees that are to escape feel that they are cut off from the queen. Suppose I set a super off the hive, but leave it within a few inches of the alighting board. Usually within thirty min-

utes the bees in the super realize that they are cut off from the colony. Perhaps some will remain separate from the colony for more than a half hour before they realize that they have lost their queen. But many will realize the loss in fifteen minutes, or less; so we will give thirty minutes as approximating the average time.

The loss discovered, the first act of those bees is to hunt every part of that super in search of the queen. After a thorough search of the super, they next hunt for an opening to get out. Of course they readily find this, since I have placed the super in the open air beside the hive, and they now take up their march for the hive.

Now, should the super be right on the alighting board, *i. e.* in direct communication with the hive and colony, the news of the "lost is found" is soon known in that super, and the bees therein will cease to "travel;" but if the connection is entirely broken between the colony and super, great hustle will be made to vacate the latter.

Suppose the super has been placed on a board with a Porter escape in it, and set upon the hive. As described above, the bees soon realize their separation from the queen and colony—not separation alone, but a *complete loss*—and after hunting the super over they want to get out, and "want badly."

Now, friends, note right here, this: I claim that within an hour from the time of separation, the highest pitch of excitement is reached: but that from fifteen to thirty minutes will elapse before there is a *decided move* to vacate the super. I claim, too, that right at this time, just when the *intense* desire to find "mamma" has possession of the bees, is the time the escape should do its work. Right at this point is where the Porter fails, just as a small bit of a hole will fail to successfully hive a swarm. A large, free entrance will permit the swarm to rush in when the "excitement is on;" but the little hole takes so long that the swarm will settle down to quietude before they can all get inside. Just so the escape fails; the bees not being able to pass when the excitement has possession of them, they begin to "settle down to their fate," and thereafter will pass through very slowly. I believe that, after the first hour and a half to two hours, but few bees go out except as they want to take a fly or go to the fields.

We find, then, that the Porter escape lacks capacity, and I think I can make this very

plain. Suppose a congregation of 600 people in a building—reasonable creatures too, that know their wants and where they are going. They begin to file out, single file, through a narrow door with a spring behind it that compels each one to push for himself. How long do you think it will take them to vacate? I will just practice a bit by myself and find out. Well, I have just taken a walk, and find I took 100 steps per minute. 600 people in a solid line, bodies practically touching each other, would not take over fifty steps per minute and would vacate the room in twelve minutes. A line of bees can pass in single file through a hole at the rate of about 150 per minute, or 9,000 per hour. But to get through at this rate they must almost go on a run in solid file. Now I have watched bees passing through both cone and spring escapes and I very much doubt their passing faster than an average of fifty per minute for any length of time. That means 3,000 per hour; 15,000 in five hours. A bee usually tries those springs from one to five times before she passes.

Now if a super contains many bees, it is almost a physical impossibility to free the super in the time of the usual excitement that arises upon the bees finding themselves separated from the queen, and, beyond that time, I think there will be no question that the movement will be very slow.

Now, friends, put these figures, and the statements of those who have tried the escapes and reported, together; and see if I am not correct. Some report supers cleared in two to three hours. Such contained not more bees than could pass in that time. I made a trial escape (I had poor springs, however), having six or more openings. Over the springs I placed glass. Over this escape I put an extracting chamber—brood chamber hive—and watched the bees pass out. About one hour cleaned it out. Some of the springs worked poorly—were too stiff or close. Then, too, there was not more than one-third to one-half the number of bees in the chamber that is usually in an extracting chamber. The same escape on stronger colonies did not do the work in less than three to ten hours. The limited extent of my experiments proved but little.

Give me an escape that makes the bees feel that they are completely separated; that will allow and favor the passage of 10 to 15,000 bees per hour when they are *anxious to get out*, that will *keep* them out when they

are out, and I will go out in the country in the morning with escapes, put them under extracting chambers before noon, and load the same chambers on the wagon and bring them home in the evening with but few bees—perhaps some of the tender ones—in them.

Now who will give us such an escape for this year's use? 1893 will show many improvements in appliances. Shall not the escape be one of them?

LOVELAND, Colo.

March 7, 1893.



Some Phases of California Bee-Keeping.—
Rise and Fall of a Bee-Hive.—The
Present Opportunity for Califor-
nia Bee-Keepers.

“RAMBLER.”



THE question of a standard hive and a standard frame has in the past had no end of agitation in the East and has at length been dropped; if not as a dead

issue at least as a hopeless attainment. However, on this side of the continent, I find the old subject coming up occasionally; and perhaps California is in better shape to-day to secure this desideratum than any other portion of the country. Although, at present, this State is getting a diversity of sizes, there has been a time when bee-keepers had the pleasure of handling bees in a standard hive, for, from Oregon to Mexico, the Harbison hive knew no rival. When Mr. Harbison came to California in 1857 with bees, he had previously had a brief acquaintance with the newly invented Langstroth hive. The acquaintance seems to have been too brief, for it led him to seek an improvement and the result was the hive that bears his name and which has been little known outside of California. The California section box was also invented about the same time and comb honey was the exclusive product.

The invention and introduction of the honey extractor, however, marked a new era

in honey production, and the new commercial product found favor, and *great* favor, among producers in this State. It was then discovered that the rejected, loose-frame Langstroth had merits for this purpose far ahead of the Harbison, and its introduction was quite rapid. Mr. Harbison never gave the extractor much toleration, believing that comb honey should be the only product: but in spite of some little opposition the loose frame hive became the leading one, and now the Harbison is found only in isolated localities and among those who raise comb honey.

The Harbison hive has been used, in a measure, for extracting, by being modified. The ordinary hive is sawed off just above the frames and an extracting super attached. The frames, however, being fixed into mortices, were often torn apart, causing both delay and vexation. Owing to this quality, many apiaries are found where, amongst the sage brush and the rocks, the Harbison and the Langstroth seek a rivalry—one runs for comb honey and the other for extracted.

Wherever I have been in California and have been through a Harbison hive apiary, a serious objection appeared at the first glance. A new hive would probably look well and work finely, but age and a neglect of paint causes the long rear door to warp, and I have seen whole apiaries where the bees were flying out and in at various cracks. When the cracks become too large, a rag is stuffed in; and when crowded for room, a clumsy, ill-fitting super is mounted on top, making the hive still more elevated and clumsy.

The original Harbison hive had a permanent cover which precluded tiering up, but to make use of this plan the hive was made much larger, which gave it the appearance of an attenuated wardrobe.

At present, as far as my observation goes, the variety of frames in use here is not large, the regular L. is used and a modification measuring about 10x14. Many use the latter because they like the size for extracting. Probably the L. frame predominates: and the idea is expressed in many quarters that, being so *near* a standard frame why not adopt one? But a loose frame and a box to put it in admit of the manufacture of so many different sizes, that I am not looking for any great change until we have another radical improvement.

Although there is much comb honey produced in California, the State and the Pacific coast may be termed a *greater* producer of extracted honey, and all of the improvements of the times, it seems to me, point in the direction of another radical improvement in the near future.

The queen excluder, and the bee escape, shorten the road and cheapen the labor of production, and point out the way for the other improvement that will complete the series. That improvement will be a standard, all-round-hive, equally adapted to comb and extracted honey, and will admit of easy and rapid manipulation. Rapid work means that we handle a less number of frames while extracting. If we reduce one frame in a hive it makes quite an item in a large apiary, but if we could handle *all of the frames in a super as one frame* it is easy to understand the advantage gained. Perhaps the next radical improvement will be in this line. Be that as it may, no portion of the country is better prepared for such an improvement, or even the adoption of a standard frame, than is California.

RAMBLER.

REDLANDS, Calif.

Jan. 14, 1893.



A Defense of the Self-Hiver and Some Criticisms on R. L. Taylor's Use of the Queen Trap Instead of a Hiver.

O. H. DIBBERN.

"The mountain torrent is deep and wide—
But loud the clarion voice replied,
Excelsior!"

I HAD expected a much more thorough discussion of the self-hiver question, than appeared in the March number of the REVIEW. I deem the hiver of paramount importance in modern apiculture, not excepting the invention of the movable frame, and believe that any one able to add anything to make this important invention the perfect success that it soon promises to be, will confer a boon on the pursuit.

When some writer in the *Apiculturist*, some three years ago, called Mr. Alley's attention to the possibilities of such a device, he evidently recognized its great importance, and at once replied that such an invention could not be made a success without restraining the queen, which would "infringe" on his patent for catching drones. But what we have wanted, and still want badly, is the perfect self-hiver, without any

reference to any one's patents. When a simple hiver is possible, that will have large swarms, and is without serious objection, that point can be easily settled. At any rate, I have nothing to do with that matter here.

At the time mentioned, I was confronted with the problem of being over-stocked with bees—having 250 colonies in a territory affording profitable pasturage, in a good season, for not over 150 colonies. I decided to start an out-apiary, but the difficulty of getting a capable man, willing to stay alone for five or six weeks, in a lonesome place, in the woods, besides the expense; was quite a serious matter. It is not to be wondered at that I quickly became intensely interested in the hiver as a probable solution of my difficulties. In a short time Mr. Alley brought out his original invention, and I had him send me a sample, but was not entirely pleased with it, and soon had one of my own on a modified plan. That year, 1890, I had 100 in use at the out-apiary, but as the empty hive was at the side, it proved a hiver in theory only. The trouble appeared to be that the queen failed to go through the escapes and tubes sidewise. After studying over the matter, I concluded, for the next year, 1891, to remodel my hivers so as to place the empty hive on *top* of the swarming hive, thus compelling the queen to run in a natural direction, *upward*. This promised to solve the difficulty, but after watching a few swarms, another difficulty appeared. While there was no difficulty in getting the queen in front of the new hive, only very small swarms could be secured. Of course, where one could give immediate attention, by exchanging hives, etc., good swarms could be made. At the out-apiary, I could pretty certainly detect hives that had swarmed, and by exchanging hives and shaking enough bees off the combs of old hives, very good swarming could be made. I used some 200 hivers that year, at both apiaries, and while I felt greatly encouraged, I also felt that the hiver was not perfect.

For the season of 1892, both Mr. Pratt and Mr. Alley came out with some new devices that promised to lessen if not solve the difficulty. After studying them over for a while, I decided that neither was perfect, and concluded to confine my changes to experiments with these and other untried devices. I also tried several new devices of my own the past season, with good success. One plan is to put the new hive in front of

the one expected to swarm, over a queen excluding honey board, allowing the bees to pass under it, with two rows of zinc at the entrance. When the bees swarm, the queen and drones pass up through the wire tubes, and by cutting off the two lower rows of zinc by placing a square stick in front while the swarm is out, all the bees will be compelled to enter the new hive when they return. I believe I was the first one to suggest this plan, as well as that of putting one hive on top of the other in this connection.

Mr. Pratt, in his latest device, has made important progress, and I am willing to admit that his device is the nearest perfection of any now known; of the unknown, the future only can tell. I have some new ideas that promise good results, but until I have proven them by experiment, will say nothing further.

The past season I had about 150 hivers in use, and had something over 100 swarms issue from them, and perhaps 200 swarms while I have used hivers. If any one has experimented on a larger scale on this line, I am not aware of it.

My general conclusions are, that the hiver is being perfected by gradual stages, and that it will soon be all that any one could desire.

I was a good deal amused by some of the criticisms in the last REVIEW. It is somewhat singular that such a man as R. L. Taylor should still hang on to the drone trap, for hiving purposes. He tries to make a great point in the increased cost of the hiver over the trap, but in fact one can be made about as cheaply as the other. In fact, the cost of hivers is a very small item when their advantages and saving of hired help, or time in watching for swarms, is considered. The only strong point Mr. Taylor makes against the latest Pratt device is the difficulty of deciding which hives have swarmed, where one is not present, without lifting off hives and supers. In a large apiary that would be a *weighty* question indeed. However, I have a plan for overcoming even this difficulty that may prove successful. It is to bore, say one-inch holes in opposite sides of the hive, and cut holes through the foundation or combs, so one can look through it. A small glass and drop pieces can be used to close the holes. If the new hive is used *a la* Hutchinson, with starters only, one could easily tell if any swarming had taken place. Really, the *real* objections to the new Pratt

hivers are disappearing so fast that I may yet adopt them myself.

In the Taylor drone-trap-management suppose he is running several out apiaries that he can visit but once in four or five days, and swarming takes place the following day or two, and the queen and drones with a few bees are caught in the trap as per program, a heavy, cold rain sets in, and perhaps he is unable to reach the apiary in even the usual time, what condition do you think his queen would be in when he discovers her? Again, I do not see how his drone-trap would be any less fatal to a young queen, in case of superseding, than a hiver. Again, Mr. Taylor gets off that "old chestnut" about swarms, without any queens, doubling up in the air, or in trees. Well, suppose they do. They will not generally stay doubled up long, but will very generally return each to their own hives. I have had hundreds of swarms issue through the hivers, sometimes from three to five at once, and do not now remember a single case of doubling up by all going to one hive. There may be exceptions, of course, but I think the rule is well established. There are some other points that I would like to notice, but space forbids.

Some have objected to hivers on account of their bothering the bees in crawling through the zinc, and imagine that the yield is thereby lessened. When a considerable space has to be traveled over, as where one hive is placed in front of the other, the same objection has been raised. I do not think that either is valid, as some of the best yields I have had during the past two seasons, were produced from hives under just such conditions.

MILAN, Ill.

March 20, 1883.



A Few More Words of Explanation and Defense of the Pratt Self-Hiver.

E. L. PRATT.

"But his neighbor cometh and searcheth him."

MR. HUTCHINSON:—I have only just now read the leader in the February REVIEW and I wish to say a few words more in regard to self-hivers. On page 44 you say " * * But they require some attention afterwards: the whole arrangement of the hive and super is not what it would be if the bee-keeper had been at home when the swarm issued," giving the impression that the hive must be changed at once

after the swarm has been hived. This is not so with my '93 pattern, for they may be left the entire season or until every bee hatches out of the upper story. Work will go along in the hive just as well, besides the bees will fill the combs in the upper story as fast as the young bees hatch out of them, thus giving eight frames of honey that would have otherwise been lost. I have had hives tiered two stories high, having more or less brood in both, and the bees were at work in boxes at the top of them.

You made a great mistake when you said: "There is one point in favor of the Taylor plan, there would be no break in the work being done in the sections, whereas, by the self-hiving arrangement, work is stopped in the super until the apiarist appears to make the change necessary to get the bees at work again in the super."

There would be no break in the work in the supers with the '93 pattern: on the contrary it would be resumed with the vigor of a new swarm.

It matters not how many swarms cluster together, if *there is no queen among them* they will separate and return to their different hives. I have had many swarms cluster in this manner and I find that when they would not separate, a queen of some kind was with them. I have seen a little virgin, so small that she could pass the zinc, hold two or three swarms together.

P. S. You perhaps had in mind my front method of self-hiver, which *would* require changing at once, but with the 1893 self-hiver the above is true of its workings.

BEVERLY, Mass. March 10, 1893.



[As I wished, if possible, to finish up in this number the discussion of self-hivers, I sent a proof of the articles of Messrs. Dibbern and Pratt to Mr. Taylor. His reply will be found below.—ED.]

Some Strong Arguments in Favor of Queen-Traps Versus Self-Hivers.

R. L. TAYLOR.

"These newly hatched inventions.
May fascinating be,
But 'Moses and the prophets'
Are good enough for me."

I HAVE examined the article of Mr. Dibbern and also that of Mr. Pratt which were submitted to me for comment and I am greatly surprised at some of the argu-

ments used. Mr. Pratt surely cannot be serious where he speaks of the bees filling the combs of the hive from which a swarm has descended: "Thus giving eight frames of honey that would otherwise have been lost." The fact is, if the bees had been properly hived that honey would have gone into the *sections*, and you may be sure none would go into the sections while there was room in the brood combs, and to that extent there would be a break in the work in the sections.

My assertion that swarms coming out at the same time in the same yard will unite and return to the same hive, Mr. Dibbern refers to politely as an "old chestnut," but neither its age nor its being a "chestnut" prevents it being *true* in these parts. Mr. Pratt also seems to think I am at fault here: out in my apiaries, although no queens are out, the *one* thing that I can rely on above every thing else, is that two or more swarms out at the same time will unite and return to some hive together unless prevented. The hiver to be practical must provide against the idiosyncracies of all bees in all seasons.

Then, as to the trap, why should I not cling to it, so long as it does *all* that Mr. D. claims his hivers do, without a tithe of the expense, fussing and labor. He admits he has to exchange hives, shake off bees " &c." to get good swarms, and I, at most, do no more.

Yes, suppose a swarm issues from a hive with a trap which is not visited for four or five days, why a sufficient cluster protects the queen for that time beyond peradventure. I have never known a case in which drones were sufficiently numerous or rains sufficiently cold to do any injury; and a trap is less fatal to a virgin queen because she is discovered at once and the proper remedy applied.

It is a significant comment on the success of the hiver that Mr. Dibbern seems to give up his own invention, his own child as it were, and puts his reliance on the Pratt "'93 pattern." Mr. Pratt does the same, and yet the '93 pattern has *never been tested!* It seems to me that it will not prove to be so good as the old pattern, for Mr. Dibbern well says the "natural direction" of the queen is upwards. In the old pattern she was carried down with the swarming bees, but in the new one, if she goes *down*, she must practically go alone which I should expect her generally to fail to do. But if it works as Mr. Pratt desires, it still preserves

the old queens and sacrifices all young ones whether reared for swarming or for superseding. Who could long stand this item of cost?

LAPEER, Mich.

March 21, 1893.



Old Combs, in Sections Left Over, Made Level and Better Than New.

B. TAYLOR.



FRIEND H., you know that the use of old sections of comb left over has caused much discussion among bee-keepers. All agree that they are of great value to give the bees to re-fill during a good honey flow. The objection to their use

being that they cannot be made into first-class goods. The nearly universal failure to secure fine sections when old combs are used has led a large number of our best bee-keepers to decide that they had better be thrown away. The last three years I have had a large number of unfinished sections at the end of the season. I extracted the honey and used them the following year and they proved very profitable so far as getting them finished up was concerned: in fact, nearly all the finished section honey I have secured the last two seasons was of this kind. I had shaved the combs down with a knife as even as possible, but the honey was still unsatisfactorily uneven and of bad color, and I set about searching for a remedy. I have found it. It consists of a little machine made of tin or sheet iron bent so as to make a square cup, D, the size of the inside of the sections and two inches deep. This is turned upside down in another pan, C, like a square pie tin with sides one inch high. This latter pan has a hole three inches in diameter cut in its center and the edge of tin around the hole is turned up one inch and the first square cup, D, is soldered open side down on the bottom of the larger pan over the three inch hole. The pan is then set on a suitable box, A, to allow a small lamp to be set under it with the chimney directly under or rather up in the hole in the bottom of pan. We now

light the lamp, turn up the wick so as to heat our small square box, D, just right to melt the combs in the sections which are pressed first on one side and then on the other on the hot iron, D. (By the way the tendency is to heat the center of D too hot, while the edges are not hot enough. For this reason a tin cone is fastened to the center of the underside of D, and it completely remedies the difficulty.) A stop at each end of D allows the section to go down just far enough. When the section is pretty full, put the wide sides on the stops, and when the comb is thin, put the narrow sides on the stops.

The perfect way in which the surface of the combs is melted down smooth and level is worth coming from Michigan to Forest-

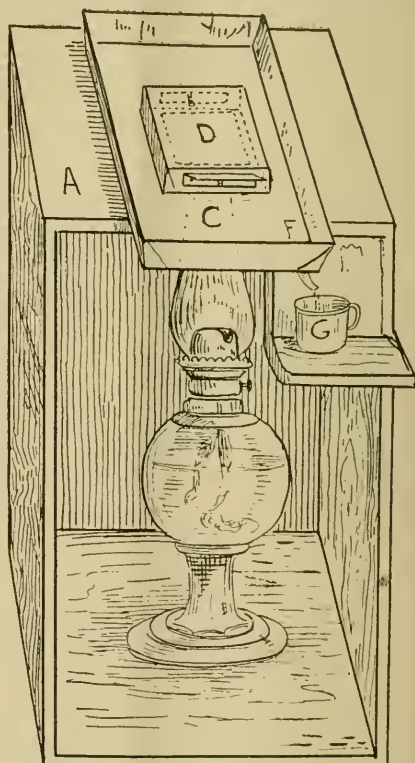

TAYLOR'S COMB LEVELER.

ville to see. The comb is not only leveled, but the thick, dark wax on the ends of the cells is melted away and the cell edges left thin and white, and all is done as fast as you can pick the sections up and lay them down again.

I first made the arrangement with a hole, F, in one corner of the tin C to allow the melted wax to run out into a cup G, but I have now dispensed with this and simply empty the tin, C, when it gets full. A little water is kept in the pan C. Have a common table knife to scrape the comb refuse from the top of the iron D.

Friend H., this is not theory. I used it on many hundreds of sections last year; in fact, all the honey (about 1,500 pounds) that I got finished was in these prepared sections, and a nicer, whiter lot of combs you never saw. It brought 18 cents here as soon as crated.

I am making machinery to make them and shall claim a moral patent, at least. Every bee-keeper that has seen it says, "Yes, I want one."

FORESTVILLE, Minn.

Feb. 12, 1893.



A Description of the "Largest House-Apiary in the World," and its Successful Management.

H. P. LANGDON.

"E pluribus unum."



IN telling my bee-keeping friends about the largest house-*apiary* in the world, let me, first of all, thank all those who, during the past ten years, have written through the bee journals anything in regard to the

house-*apiary* question; as it is only through their experience that I have been able to make my house what it is. I took each point under careful consideration, then took a little here and a little there from all these different articles, to make a perfect whole that would suit me. So, although friend B. Taylor's advice on page 38 of the *REVIEW* is good, all these experiments had demonstrated the plans that would suit me best. That is why I built so large for the first one.

The house, 11x100 feet, stands a few degrees W. of S. on a good stone and mortar wall, with ventilating openings on each side. The sills are two pieces of 2x4; the lower joists are 2x8, two feet from center to center,

and the same distance as the studding. The floor is double $\frac{7}{8}$, both layers planed, with a strip of sheet-iron between, close to the boarding and around the studding, to prevent mice from gnawing up through. A platform, 12 inches high and the width of a hive, runs lengthwise of the building, in the center of the room, except that a space of eight feet is left at each end and six feet in the middle. This platform is for holding extra hives, supers, etc., that the alley on each side may be left clear. It is a great convenience. On each side of the platform every six feet are openings 6x22 inches for bottom ventilation.

The studding is 2x4 and of such a length as to make the top of the plate (2x4, two pieces) come $8\frac{1}{2}$ feet from the floor, and the upper joists ($1\frac{1}{2}$ x8) are nailed across the rafters one foot above the top of the plate, thus making the room $9\frac{1}{2}$ feet in the clear.

The roof has the common pitch for this width, and is well shingled.

On the floor at each side of the room is a platform the length of the room, three inches high and three inches wider than the hive, which stands upon it flush with the inside edge of the studding. This platform is permanently stuffed with planer shavings. I use the Root simplicity hive, square joint, flat cover, and it stands on this platform, sidewise to the wall, two feet from center to center, thus bringing the ends but $3\frac{3}{4}$ inches apart.

The entrance in the boarding is nearly on a level with the floor, then rises on a slant to the top of the platform, and opens into the hive four inches from its outer side. This leaves a space for dead bees to accumulate, so I think no rim will be needed under the hive in winter. Over this space, between the hive and wall, level with the bottom of the hive, is a loose cover with an inch hole in it. Then, over this, nearly to the top of the hive, is another cover, resting on cleats on the studdings. This forms a sort of box (4x22x9 deep) between the hive and the wall, and is just the thing to get rid of bees that must be shaken off the covers, combs or other things. By tipping this little cover back against the wall, shaking the bees in, dropping the cover in place, and letting them go down through the inch hole and up into the hive at their leisure, one troublesome feature of most house-*apiaries* is avoided. These two platforms provide for 100 hives.

Above these platforms, $4\frac{1}{2}$ feet from the floor, is a shelf, formed by nailing an arm of

inch stuff, twenty inches long, on each side of each studding, with a brace 2x4x24 nailed between them at their outer ends, and spiked on the edge of the studding below. These brackets are floored over just like the lower platform, entrances and all, and packed for winter in the same way.

To work these upper shelves, there will be a track of inch square hard wood laid on the floor in each alley, with a platform truck $2\frac{1}{2}$ x8 feet to run on it, with the top at a convenient height, and a couple of steps at each end. This is not built yet, but is as is intended for working these shelves.

For the wall boarding I bought second quality spruce at \$7.50 per thousand and made shiplap of it in my shop, to go on horizontally, the best for the siding, next for ceiling, floor and roof boards.

Right here let me say, I cut nearly every piece, except the frame, siding and roof boards, to pattern, in the shop, so all I had to do after the frame was up, was to nail them on, without any hand work of high priced carpenters, which made quite a difference in the price.

The windows are one light, 14x20, with the sash set into the wall without casings, and screwed to a cleat on each side, that is nailed inside the boarding. There is a window in front of every third hive, of both lower and upper rows, with the bottom of the sash six inches above the top of the hive. This gives three hives to each window and makes the question of light perfect. It would be a useless expense and labor to make the windows so they would open, as ventilation is provided for and the space in front of each hive gives the needed conditions for shaking bees off covers, comb, etc. A hole is bored through the top sash *close* to the edge of the glass and around each opening the wood is cut away on each, inside, to lead out all bees that fly to the window. I had no trouble with their coming back, but I think a small wire cone ought to be in each to be *sure* to keep them out in a honey famine.

Just above the level of the cover of each hive is a two inch hole bored through the wall, with a wire cone in each. These are the *bee-escapes proper* of the house. All windows, except the one nearest the hive being manipulated, should be curtained quite dark, or the bees do not leave the room well. Also, instead of using an escape board on the hive to rid filled supers of bees, set the filled cases across the cover cleats of any

hive, close to the wall, cover the cases with a cover and the bees will all leave promptly through this cone, leaving the case to be set back on to the middle platform without opening the hive again to remove an escape board. This makes a big difference in taking off the honey from a large number of hives. I removed 75 cases (1,800 pounds) in this way in four hours, and put back as many empty ones. The next morning they were all free from bees.

Upper ventilation is obtained by three shafts 8x8 (I shall put in four more) through the ceiling and roof into a cowl over each on the roof. Both these and the openings below can be closed in cool weather. The draft is so strong most of the time that it will draw up a piece of paper, consequently no trouble is experienced by reason of smoke in the room.

The side walls are painted five different colors of as much of a contrast as could be made, six feet of each in rotation. This brings a window of each upper and lower row into the center of each color, also three entrances to each color. It works admirably in helping the bees locate their hives. Some bee-keepers say that bees cannot tell colors, but if they could see the way this plan works with fifty entrances in a row, two feet from center to center, they would be obliged to admit that they are not color blind.

Each entrance has an alighting board the same color as the wall above.

For wintering, a cleat $5\frac{1}{2}$ feet long is screwed to the edge of the platform and shelf, with a wide board running lengthwise on the inside. This makes four troughs 100 feet long, with 50 hives standing in each. Planer shavings are then packed around the hives, both sides and ends and over the top, and the bees are then ready for winter.

Up to date, they have had three or four nice flights which they could not have had if the hives had stood on the ground. I expect to lose a few light ones as they did not have proper care, as building the house went me behind all summer, so that I did not get them all packed until very late. However, I know I can winter bees packed in single hives, and I am sure that this plan is better still, on account of their being up high and dry.

If I were going to build again, I know of but one thing I would change, and that is, I would make the building twelve feet in width, instead of eleven, especially as all

crating and sorting of honey will be done there instead of in a separate honey-house at one end, as I first intended; and my advice to any one thinking of giving a house a trial, would be, not to build too small. *Don't be cramped* or you won't ever be suited with it.

In conclusion I might name a few of the advantages of a house-apiary, but as Mr. B. Taylor has done so well in his articles on pages 324, 325, 326, of December REVIEW, I will only add that I indorse every word that he says in favor of them, only he does not praise them enough.

Swarming did you say? Oh! yes, sure enough; but I must leave this for another chapter, as this article is long enough already. But in the meantime, if you are thinking of building a house-apiary, don't let the fear of swarming hinder you, as that can be *very satisfactorily* settled. I am astonished that some of our *headlights* should think and say that bee-keeping has reached the climax of perfection, or "reached the end of the rope." Why, last year came self-hivers, and next will come non-swarming without extra work, and with more and a better quality of honey, THIS I KNOW TO BE A FACT. Watch for it.

EAST CONSTABLE, N. Y. March 8, '93.



Some Experiments and Arguments Showing that Multiple Tubes do not Increase the Blast in a Bee Smoker.

LOWRY JOHNSON.

IN reference to Mr. Corneil's theory of increasing the draught from a smoker, I have to say that I have just completed a series of experiments with his multiple tubes, as illustrated in the October number, page 259, of the REVIEW, and find that, other things being equal, there is no increase of draught or blast by that means over the ordinary method of using a continuous tube or discharging the air directly into the fire box as in the Bingham smoker.

A light thin board was suspended so that it could vibrate freely; a blast from a smoker bellows having the multiple tubes, as suggested by Mr. Corneil, was directed against this suspended board and the distance it vibrated was noted. This was done several times, the board being first brought to a rest each time. Each time the board swung the same distance. Then these multiple

tubes were removed and a simple continuous tube used and the same operation performed again. The board swung or vibrated the same distance as when the multiple tubes were used, thus proving that there was no increase of the blast.

Not being entirely satisfied, I again affixed the multiple tubes and directed the blast against the board five times in succession as the board returned, and noted the distance that it was caused to swing. Then, removing the multiple tubes, I again inserted a simple continuous tube and performed the same operation and the distance the board was caused to swing noted, and I found it just the same as when the multiple tubes were used, thus proving conclusively to my mind that there can be no increase of the blast by a series of tubes, one discharging into a larger one.

Mr. Corneil seems to have overlooked the fact that the inertia of the greater amount of air in the larger tubes must be overcome, together with the friction of the same. While the *volume* of air in motion is greater, the *speed*, from the above cause, is necessarily less, so that the velocity of the air from the smaller tube multiplied by its transverse area is equal to the transverse area of the larger tube multiplied by the velocity of the air from it.

In the case of ventilation, it is quite different from a smoker. The heated air expands and becoming lighter, has a tendency to rise of its own accord and not from any increased draught from these multiple tubes.

MASONTOWN, Pa.

Feb. 13, 1893.

Bee-Keepers' Review.

PUBLISHED MONTHLY.

W. Z. HUTCHINSON, Ed. & Prop.

TERMS:—\$1.00 a year in advance Two copies, \$1.90; three for \$2.70; five for \$4.00; ten, or more, 70 cents each. If it is desired to have the REVIEW stopped at the expiration of the time paid for, please say so when subscribing, otherwise it will be continued.

FLINT, MICHIGAN, APRIL. 10, 1893.

IN THIS AGE of progress and improvement, when men are cutting loose from old lines and establishing new, when every day brings to our ears tidings of some new discovery or invention, bee-keepers may well ask themselves, "what has the future in store for us?"

THE SCRAPS of quotations that appear at the head of some articles, furnishing a sort of index to the character of what is to follow, are placed there by the editor; they are not always of his choosing, however.

EIGHT EXTRA PAGES in this issue are the result of the usual press of advertising at this time of the year, and of the large amount of unusually interesting correspondence with which the REVIEW has of late been blessed.

"OUT-APPIARIES." This is the answer given by J. H. LARRABEE, in the *A. B. J.*, in his reply to the query: "What shall we plant for honey?" Seldom is so much unexpected wisdom found in so few words.

THE APICULTURIST for March probably contains more information on queen rearing than was ever before put into a single copy of a bee journal. By the way, too, somebody is deserving of praise for the mechanical neatness with which the *Api.* is always gotten up.

THE "Nameless Bee Disease," or bee paralysis, is a trouble that may become more troublesome. A bee-keeper in N. Y. writes that his bees are troubled with it now, and he thinks it is often the cause of winter losses. Who knows what causes it and what is the remedy?

PREVENTING AFTER-SWARMING by the use of the bee-escape as practiced by Frank Coverdale and reported in last REVIEW has also been tried by H. P. Langdon. He writes: "I can endorse, to the letter, all that Frank Coverdale says about the prevention of after-swarming by the use of the bee-escape, as I gave it a good trial two years ago."

C. H. DIBBERN has sent me a sample of his latest bee-escape. It is a series of spurs made of perforated tin and all point out towards the opening. In short, they might be described as like the Porter, only they have stationary "springs" or spurs of perforated tin with their outer ends so far apart that a bee can pass the points. If a bee should attempt to return she would likely run up against a "snag."

DRONE COMB, built by bees having a caged queen is an indication that the bees would not accept her were she released, while the building of worker comb is an indication that she is regarded favorably. This is the assertion of Mr. Gravenhorst. I must confess that I have never made any observations in this direction, but if there is "anything in it," it is well worth knowing.

"QUESTIONS AND ANSWERS," is to be the heading of a new department in the *A. B. J.* It is not designed to take the place of "Queries and Replies," but the editor says there are some questions that can be just as satisfactorily answered by one as by twenty-five persons, and the reply can be given sooner by not being obliged to wait for the numerous experts to answer the queries. This department is to be principally editorial. Bro. York is certainly working hard to make his journal "worth its keep," as friend Hasty says.

THE TYPE used in the headings of Hasty's review is too light - faced to suit Dr. Miller, who thinks it looks "as though it needed to be fed up." Aside from this, the Doctor thinks Hasty's review is tip top, A, I, "just what he expected." I suspect that the Doctor made this little criticism simply to show how hyper-critical one must be to find any fault with Hasty's review, but now that the subject of light-faced type is brought up I wish to say that neat, artistic, light-faced type is a hobby of mine. I greatly prefer it to the bolder, black-faced, heavier styles that make a page, especially an advertising page, look like a circus poster.

SEALED COVERS, especially in a severe winter, with bees in the open air, do not seem to be just the thing. At Medina, Ohio, they "got a black eye," last winter, as "E. R." says in *Gleanings*. I have never seen bees wintered more successfully out of doors than with a space a foot square left open to the outer air, right over the cluster. There were six inches of chaff between the bees and this opening, and the opening was protected from storms. This was in Northern Michigan. Mr. B. Taylor is very much opposed to sealed covers. He writes that he has visited a man who takes the covers entirely off his bees in the cellar, and they winter well.

CONSUMPTION OF HONEY by bees when in their winter quarters, the amount and proportion according to the season, may be determined by keeping colonies on the scales while in the cellar. Last fall, Nov. 20, I put my bees in the cellar, and set three colonies, in 8-frame-Langstroth hives, on a pair of scales. The gross weight was 153 pounds. They were weighed frequently, and there was an average loss of two pounds per colony, each month, but I could not detect that there was any difference between one month and another in regard to the amount consumed. They were placed on their summer stands April 5, having lost, on an average, nine pounds per colony during their four and one-half month's confinement.

—●—
THE PROGRESSIVE BEE-KEEPER, ITS NEW EDITOR AND SOMETHING ABOUT HIS BUSINESS.

"Great oaks from little acorns grow."

Of the newer bee journals there were none showing greater promise than the *Progressive Bee-Keeper*. Bro. Quigley was a practical bee-keeper and had the "knack" of getting up a good paper. But his office was destroyed by fire, and there was a lack of means to put in a new outfit, and the result is that the paper has been sold to the Leahy Manufacturing Co., of Higginsville, Missouri. As most of our readers know, Mr. R. B. Leahy is at the head of the firm, and, as he has now become editor, it will be interesting to know something of his past life.



R. B. LEAHY.

Mr. Leahy was born 36 years ago, at Port Richmond, N. Y. At the age of two years his mother died and the family moved to a farm on Long Island. Here he knew what it is to have a mother not his own, and he spent much of the time on the beach watching the ships pass to and fro and seeing the breakers roll in and dash upon the sand-lined coast. His father was a sea captain, and was drowned when the boy was ten. Then he felt that he was nobody's child and wandered away to the nearest seaport town where he was found in tears by some big

hearted fellow who took him aboard his ship; and this was the beginning of a seafaring life that lasted until he was 21; three years being spent in the U. S. navy.

When between 21 and 22 he took Horace Greeley's advice and finally settled down to work on a farm in Illinois, where in two or three years he married Miss Henrietta Braeutigam. They have had one child only and that died in its infancy. They had much sickness to contend with. Finally drifted into bee-keeping. Ten years ago he went to Higginsville, Mo., to secure an unoccupied field. Here a partner was taken in and the supply business added to bee-keeping. It was started in small way with a Barnes saw in a one story building 14x24. The business has grown with wonderful rapidity until it has developed into a stock company with a capital of \$19,000. Perhaps one secret of this success has been the liberal use of printers' ink. \$1,000 were spent last year in advertising and as much more will be spent this year. The addition of a journal will undoubtedly help the supply trade and the supply trade will probably not injure the journal.

It is very pleasant to know that, notwithstanding Mr. Leahy's success he still wears the same size hat that he did several years ago.

—●—
SELF-HIVERS.

There are self-hivers that will hive all of the swarm. There is question about this point. One objection to their use is the cost, not only of the hiver, but an empty hive must be furnished for each colony that may swarm, while one-half of the colonies may not swarm. Another objection is the labor and annoyance necessary to learn if a colony has swarmed. With a few colonies this fault does not appear, but in a large apiary it would be quite a task to loosen up and even turn around "cat-a-cornered," as E. R. Root says he does, all the hives. By the way, in the last REVIEW the types made Mr. R. L. Taylor say "lift 250 hives with their supers" in an out-apiary of 150 colonies. Of course it should have read "lift 150 hives." I have seen the time when half of my colonies would have three supers each nearly filled with honey. To lift these alone is no light task. Then add to this the weight of the colony itself. It is evident that those who find in this lifting of hives but a slight objec-

tion have never been extensively engaged in comb honey production where good crops could be secured. Mr. Dibbern suggests a "peep hole" in each side of the hive. I should not mind so very much the getting down on the hands and knees and peeping through if the self-hiver gave any decided advantages over the use of the queen trap, but I must confess that I see none. Any doubts that I had on the subject have been swept away by the clear, practical reasoning of Mr. R. L. Taylor. If there must be manipulation after a swarm has been hived with a hiver, and the queen trap allows us to accomplish the same ends with no more manipulation—yes, less—what is gained by using the hiver? The idea that a hiver can be adjusted to a hive and left without further manipulation, even though a swarm issued, might possibly answer for the raising of extracted honey, but every practical comb honey producer knows that it would not answer his purpose.

With me, as a rule, swarms without queens do not cluster; but if one or more unite in the air, the great mass of the bees will follow the first few that return to their hive. A few stragglers will return to their own hive, but at least four-fifths will be in, or on the outside, of one hive. I do not see, however, that this has any bearing on the question of hivers versus traps, except that with the traps it is easy to learn which have swarmed, by the presence of the queens in the traps, while with the hiver this is impossible without a careful search of the hivers. The simple twisting around of the hive and looking into it would not answer, as the queen and a few bees might not be discovered without a careful examination.

EXTRACTORS AND EXTRACTING.

If a bee-keeper is going to buy an extractor, what kind shall he buy? If he is a bee-keeper in a small way, and expects to remain such, it will not pay him to invest in automatic-reversible machines, or any thing of that kind. A plain, simple, cheap, but substantial extractor is all he needs. For the money, I know of nothing better than the Novice, made by Mr. Root.

For the average bee-keeper, the one with from 50 to 100 colonies, the Cowan would probably answer as well as any. This machine is reversible, although it does not reverse automatically. The operator has to swing the baskets by hand, but this is more

quickly and easily done than to remove the combs to reverse them.

There are several practical, reversible honey extractors, those in which the combs may be reversed without removing the combs from the baskets. Some of these extractors are automatic as well as reversible; that is, the baskets reverse by simply stopping the machine and reversing it quickly with a sort of a jerk that throws the baskets around in the opposite direction. The Stanley and the machine made by Goold, Shapley & Muir Co., of Ontario, Canada, are of this style, but I doubt if invention will stop short of a machine that can be reversed automatically while in *full motion*. I do not know that such a machine has been made, but Mr. E. A. Daggitt, of White House Station, New Jersey, has sent me drawings of two or three arrangements by which this may be accomplished. I give an illustration of the one that seems to me to be the best. The engraving makes all so clear that almost no explanation is needed. By pressing down on the lever A, the bar B is forced downwards. The lower end of the bar is bent at right angles and its point enters a groove cut in a collar C, through which passes the main shaft. (By the way, there are two points that the engraver did not make quite correct. He has shown the handle A, with too short a leverage and with a piece of cord attached. I presume *his* idea was to have this cord attached to a pedal to be operated by the foot. This would be all right for reversing in *one* direction, but how about the other? Then he has shown the collar C, *square* in shape when it should have been *round* with a groove around its circumference, and the lower end of B would constantly remain in the groove, and force the collar up or down as the handle A was raised or lowered. On the whole, however, he has done well and has shown the *idea* so that I think it will be understood.) To the collar is attached a piece of metal D, having cogs upon one side. These cogs fit into the cogs on the circumference of the wheel F. To the opposite end of the shaft to which the wheel F is attached is a beveled-gear cog wheel that turns the wheel G, and this is attached to the upper end of a shaft that passes through the center of the comb basket below. It will be readily seen that a depression of the handle A, will force down the collar C, and the cogs on D will turn the wheel F, and the result will be that the comb basket below the wheel G will

be reversed. Below the wheel G, upon the same shaft, is another wheel H, in the circumference of which are notches or cogs, and into these cogs fit the links of a steel chain that passes around similar wheels upon the tops of the shafts passing through the centers of the other comb baskets. It will be seen that when one comb basket reverses, all four must reverse. Only one comb bas-

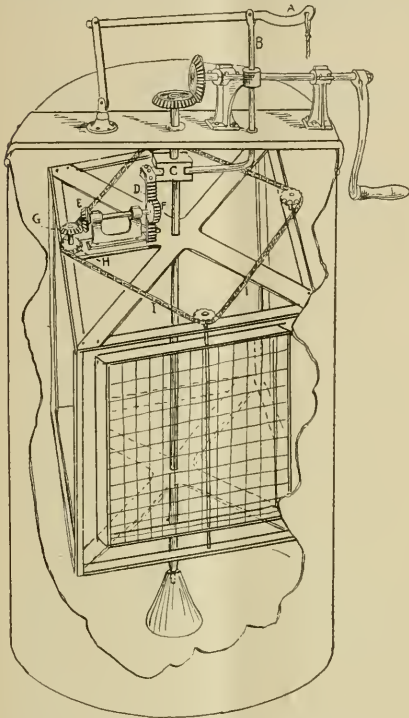

DAGGITT, AUTOMATIC, REVERSIBLE EXTRACTOR.

ket is shown in the drawing, as the production of all of them would make a confusion of lines. To such an extractor should be added a brake that can be operated by the foot.

It will be readily seen that reversing combs upon their centers instead of at the edges will give a much smaller can.

The use of bee-escapes is going to do away with that most disagreeable part of raising extracted honey—the brushing and shaking of bees in the hot sun. Supers of extracting combs will be brought into the extracting room just as supers of comb honey are now brought in. Unless the honey is left on until late in the fall, it never extracts

more readily than when first taken from the hives, before it has lost its natural heat. Of course it would extract just as easily if warmed, but if extracted at once the trouble of warming is avoided.

Just how extracting should be conducted depends upon circumstances. With a large apiary, or with out-apiaries, and basswood yielding at its best, with a limited number of supers and combs, it would require a "gang" of workmen to keep things cleaned out. I should prefer an abundance of combs and supers so that the honey could remain on the hive a little while and the work be done a little more leisurely. I should think that three would ordinarily make a good extracting "team." One to get the honey off the hives and return the empty combs, one to uncup and one to run the extractor. With an extractor such as is illustrated here, I should suppose that one man could extract as fast as two could uncup—perhaps faster.

By the way, it seems to me that inventors ought to turn their attention towards discovering some more rapid method of uncapping combs. I believe they have machines in England for uncapping combs. At least I have seen them illustrated and described, but I have an opinion that they are not practical. Mr. B. Taylor, who describes in this issue an arrangement for leveling the combs in sections kept over from the preceding year, has tried uncapping sections of honey in this same way, viz., by the use of heat. He has tried using steam for heat, but says that it does not give a sufficiently high temperature for the rapid uncapping of honey. If we could discover some way of uncapping combs as rapidly as we could pick up a comb and press it against a heated surface, the discovery would be of more importance than an automatically, reversible honey extractor, as more time is consumed in uncapping than in reversing the combs by hand.

I would be obliged for hints, suggestions, and the relation of experience upon this subject with a view to giving in the May REVIEW a special discussion of this topic.

EXTRACTED.

The "Old Reliable" is Fairly Booming.

There is no one who notices so soon the presence or absence of editorial work in a paper as the editor of a similar journal. I

have several times noticed the large amount of editorial work done by Bro. York, of the *A. B. J.*, but I doubt if I could have expressed myself quite so nicely on this point as has Bro. Root in *Gleanings*. He says:—

“G. W. York is making the old reliable *American Bee Journal* fairly boom. Every page shows that he is putting a good deal of hard work on it, and we hope that his subscription list may roll up strong; for we have always noticed that, when any of our rival publications are booming well, it helps boost along *Gleanings*; so you see we are interested from a selfish point of view. Why is it that editors of publications in other lines fail to see this? They look upon a successful rival as dangerous to their own success, and then write more like an idiot than a responsible being. But perhaps a point should be made here: An editor who takes no interest in his own publication but to get out copies of his paper filled with ‘stuffing’ will almost surely suffer if there is an energetic rival in the field. He who is jealous of a rival, confesses the weakness of his own efforts in the journalistic line, and he had better step down and out. Such kind of editors are not wanted, and sooner or later they are obliged to step down and out.”

The Strengthening of Weak Colonies in Spring.

What to do with weak colonies in spring is often a puzzle. It may not be best to unite. How shall they be strengthened and made to “pull through” is what we would all like to know. From an article contributed to *Gleanings* last June by Mr. Gravenhorst I make the following extract that has a bearing on this point. Speaking of the manner in which German bee-keepers manage their bees in the spring, he says:—

“In April and May, on some fine days he visits his bees to look them over with the utmost care for three or four days. As he has mostly colonies with young queens of the previous year, he has seldom to unite queenless colonies with others. Weak colonies, if he has such, he provides with bees from his best colonies. This is accomplished in the following manner: When the bees are flying best, he sets a weak colony in the place of a stronger one, but never a very weak one in place of a very strong one, because the queen of the weaker one would be killed.

Another way to build up a very weak colony is this: Toward evening he puts a flat feeding-trough, with honey, under a strong colony. As soon as the bees cover the food, upon which he has put some shavings or straw, he takes the trough, with all the bees, and sets it under the weak colony. This he repeats for three or four evenings. In this manner he goes on in April and May till he

has equalized his colonies. If the honey-flow in these two months is very good, then he does not feed; but if not, he will feed very liberally for three or four days. By equalizing and feeding the colonies at the right time he shortens the swarming season. All his first swarms will issue, according to the weather, within eight, nine, or ten days, and those colonies that do not swarm at this time he will swarm artificially by driving. Most of the natural swarms he takes in swarm-catchers to prevent missing the swarms and killing the queens.”

How to Make Bees Stay in Their Hives While Being Carried From the Cellar to Their Summer Stands.

One of the disagreeable features of cellar wintering is that of carrying out the bees and placing them on their summer stands. The admission of fresh air and the excitement stirs them up and they come rushing out and sting the one who is carrying them. Besides this, they have been in the hive so long that their old location is forgotten, and wherever they leave the hive there they seem to “hang around,” and assault anything that comes near. When the bees are wintered in hives with the bottoms removed these troubles are aggravated. Mr. Doolittle, in an article in *Gleanings*, tells how he overcame these difficulties. From this article I make the following extract:—

“One day I thought of the spring wheelbarrow, so I tried setting them on that and wheeling them to their stands. This was much easier for me: but there was a certain amount of jarring to it, in spite of the springs, that irritated the bees so that they were ready to rush out *en masse* when I was lifting the hive from the barrow to the stand; and often the bottom of the barrow would be covered with the bees which had come down before the stand was reached. This saved all the bees, as they all marked the right spot, but did not do away with the stinging from the bees which flew in the air before the hive was on the stand. I next took an old sheet and wet it, and, after doubling, put that on the bottom of the wheelbarrow and up over the front end-board. This took off all the jar, and also kept the few bees which might straggle down on to the bottom of the barrow from staying there: for as soon as they came in contact with the wet sheet they would run back.

I now went into the cellar, took a hive of bees, and placed it on the sheet, tipped it up a little in front so as to blow under three or four puffs of smoke, lowered it to its place, and put a wet rag down in front over the entrance, when I had the thing just as I wanted it, for I could wheel them wherever I wished, without their apparently breaking

the cluster at all. The wet sheet gave a chill to the air inside of the hive so the bees did not feel the warmth, and the wet rag at the entrance excluded the light, so that they apparently did not realize but that they were still in the cellar till they were safely on their stands. I now have no dread of setting the bees out of the cellar, and they also are not in such a hurry to rush out but that they properly mark their entrance, thus saving the mixing of bees so frequently occurring in the old way, by which some colonies have more bees than they should, and others being deficient."

The Influence by Which Bees are Actuated When Pasing Through a Bee Escape.

Mr. R. C. Aikin, in another column, advances the theory that the controlling influence leading bees to desert the supers when the bee escape is used, is their desire to get back to the queen from which they find themselves cut off. Mr. Halley advances the same idea in *Gleanings*. He says:—

"I find that no one in *Gleanings* has yet given the true principle upon which the bee-escape is supposed to work. The super from which it is desired to rid the bees being shut off from the heat of the hive, it would seem that, when the weather got cool, the bees would go down much faster; but such is not the fact. It may then take days instead of hours for the sections to be cleared. The true reason is, that, when the bees find they are separated from the queen, they get panicky, and leave forthwith in pursuit of the queen. It is a mistake to suppose that the ragged edge of the tin or paper prevents the bees from going back into the sections; but the fact is, the cause that induced them to leave prevents them from going back. Now for the proof: You will find inclosed a piece of tin. This was formed over a 20-penny wire nail. This I tack over a hole on the under side of a board. This is my bee-escape. It will be seen that the bees can go one way as well as the other. My section-cases all have glass. I put on the escape in the morning, so I could watch them, which I did closely. Some will miss the queen very soon, and the sections will be cleared in two or three hours. Others will remain quiet for several hours; but when they discover their isolated position they will be seen in a perfect panic, which they keep up until the last bee leaves the sections. Among others I put sections, containing about 60 lbs. of honey, over a board fixed with three of these tins. The next morning when I took off my sections I found bees enough to make a fair swarm, clustered all over under the board. There were many bees deep over the tins. They had commenced comb-building; but not a bee had gone into the sections. I have used these tins through the past season with unvarying results. In no case did the bees go back into the sections.*

I believe that a zinc queen-excluder, if placed on an empty section-holder, and the zinc

all covered up but a narrow strip, would make a good bee-escape.

WILLIAM HALLEY.

Rockton, Ill., Jan. 23.

The editor of *Gleanings* comments as follows:

[It is very possible that you may be right, and we hope those of our readers who have made observations in regard to the actual workings of the bee-escape will let us know what they think about it. Another summer shall not go by without our fixing up an observatory hive, to watch the actual operation of the various bee-escapes. However, even if your point is true, would it not be better to have something like the Porter, so the bees will actually be prevented from going back, even if they should desire to do so? The Porters, who have conducted a long series of experiments along this line, will doubtless be able to give us some information.]

The Wax in Comb Honey is Indigestible but not Injurious or Unwholesome.

"My son, eat thou honey because it is good; and the honeycomb, which is sweet to thy taste."

Mr. Henry M. Hawley writes as follows to *Gleanings*:

"I desire to say that I am surprised to find a dyspeptic advocating the use of *comb* honey, as, in all lessons learned or teachings taught, the prime principle is that the *comb* is indigestible. I judge, if you eat 'Schumacher' graham gems for a few months the bran will be sufficient irritant for the stomach without the comb that will not digest nor melt in the stomach."

Those are in error who imagine that because wax is indigestible its consumption in comb honey is attended with injurious results, or that it is in the least unwholesome. Ten years ago, Prof. Hasbrouck, in the *Bee-Keepers' Magazine*, explained most fully the philosophy of this subject. He said:—

"So much is said now-a-days by such influential men as King, Dadant, Jones, and many others, to 'boom' extracted honey, that it seems necessary that something should be said to recall the claims of comb honey, that its virtues may not be forgotten and its production neglected. It may be that, for the present, more money can be made in running bees for extracted honey—five dollars to one, as Jones says; but I think I can see reasons why, with increased production, we may expect extracted honey to depreciate in price much faster than comb honey. Extracted honey must always compete with similar sweets; such as sugar, molasses, syrups, and glucose, and its principal recommendation will be its novelty or cheapness; while it is weighted in the race for popularity by its inconvenient tendency to candy, and if it does not candy, it is immediately exposed to the suspicion of being

adulterated. On the other hand, comb honey stands without a rival—a thing *sui generis*—captivating to the eye—the symbol of sweetness—a royal luxury. But so industriously have they who ought to know better, talked about the enormity of eating 'indigestible wax,' that the proper use of comb honey is almost a 'lost art.' People struggle to reject every flake of wax, or else eat their hot biscuit and honey as a forbidden indulgence, dazed with full expectation of gripes and nightmare as a penalty. The fact is, that honey comb is one of the most wholesome foods ever eaten. It will make hot biscuit and fresh bread easily digestible. These alone are rightly considered much harder of digestion than stale bread, from the fact that they pack, in chewing, into masses impermeable to the solvent juices of the digestive organs. But when they are eaten with honey comb, the delicate flakes of wax prevent the packing, while the honey pervading the whole mass, is readily dissolved out, leaving free access for the gastric juice to all parts of the food. The scales of wax, though indigestible, are soft and smooth, and will not irritate the most delicate membrane.

But besides being a delicious and wholesome article of food, I regard comb honey as a specific cure for many difficulties of digestion and irregularity of the bowels. In our day, drugs are at a discount for the treatment of chronic diseases, and people are generally seeking health from a proper selection of foods instead of medicines. For a long time Graham bread and bran crackers have been prescribed by the medical faculty for dyspeptic affections and obstinate constipation; but the doctors are about finding out that these things will ruin the digestion of anything but a horse, as the rough, silicious scales of bran irritate and lacerate the delicate membranes of the digestive organs, to their speedy ruin. I can assure all persons whose digestion needs a little assistance, that they will find in comb honey, eaten wax and all, just the thing to help them—and a very agreeable medicine to take, it is, too.

The flakes of wax furnish a gentle stimulus to the digestive membranes, without in any way injuring them. To bee-keepers I would say, produce extracted honey by all means, if you can make more money by it; but for your own bread and butter, and hot biscuit and hot cakes: use comb honey, without being anxious to save all the wax to make up into foundation, and see if it isn't the best way to eat honey."

Barnet Taylor's Latest House Apiary.

Mr. Taylor has finished his house apiary, and I copy the following illustration and description from *Farm, Stock and Home*. It will be seen that the arrangement is almost exactly that of the Langdon house apiary described in another column.

"We illustrate herewith a sectional view of our new house apiary and give as plain a des-

cription as possible. It is very important to have these buildings right in every detail at the start, as they cannot well be altered after occupied by bees. In constructing it we have used our past experience to make it as near perfect as possible.

This house is 16 feet long, 8 feet wide and 8 feet high to ceiling. The roof is 12 feet wide, projecting 2 feet on each side, protecting the hive entrance from rain or snow. Its capacity is 32 swarms without crowding. There are four shelves, 2 feet wide, running the length of the house, for holding hives; the bottom ones are raised 6 inches above the floor, and the two upper ones placed midway between them and the ceiling, and are constructed to have a space under them packed with pine leaves to keep the bottom of the hives warm in winter. Sawdust or chaff may be used for packing, but as it is to be permanent the dry pine leaves, when procurable, are best, as they will not become damp. The packing under the bottom shelves is 8 inches thick, and that at the top 4 inches. This is the only permanent packing about the building.

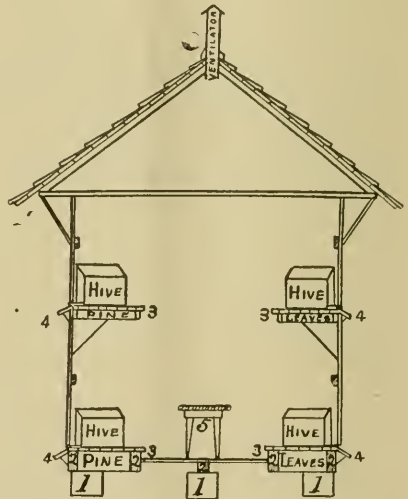

(1) Foundation posts. (2) Ends of sills. (3) Platform for hives. (4) Entrances—Alighting boards. (5) Table for handling hives.

The hives are two feet apart from center to center, and set 3 inches from the outer walls. There are 8 inches space between the hives and 5 inches between back of hives and back of shelves. At the back of shelves there are movable walls 22 inches high to hold the winter packing (sawdust) in place. When the hives are packed for winter there are 3 inches of sawdust in front, 8 inches between, 5 inches at the back, and 8 inches on top of them. If properly done this will winter the bees with safety in a severe winter.

□ We pack the bees at the first approach of freezing weather in the fall, and leave it on

until all cold weather is over in the spring. When unpacking, the movable walls are taken from the back of the hives, the sawdust shoveled into gunny sacks and piled overhead under the roof, to be kept dry and handy for use again.

Any hive can be used in the house, but we have made a special one for house use that has many advantages and is plain and cheap. The entrances through the sides of building are 14 inches wide and one-half inch deep, and the alighting boards are 8x16 inches, and are so constructed as to receive the swarm catcher.

The building is sided with good stock boards 12 inches wide, and the cracks neatly battened. But if we were building again we would use matched flooring for the sides and leave battens off. The roof is shingled and the ventilator is a galvanized chimney suitable for receiving a stovepipe if one should ever be required. The passage way from the walls of house to hives is covered by a movable strip of suitable thin wood. The door is in the west end and hung on the outside. In the east end there is a sliding sash of six lights of glass, 10x14, on the inside; on the outside there is a revolving wire cloth screen for ventilation, and to let bees out when handling swarms. There are escapes to let bees out at all times.

In the alley between the hives there is a movable table, 2x6 feet, to work on in handling hives. There are also shelves in suitable places to hold the queen excluding honey boards, bee escape boards, and all other things needed in the house management. We intend to have six swarms in the attic—three in each gable, but will not recommend this feature until we have used it a while.

This building will cost about two dollars a colony for each swarm, and is built and painted in a neat and thoroughly lasting manner. A much less costly house would answer every practical purpose. We intend to build one or more cheap ones, for out apiaries, this season, and when we get one of them finished will describe it.

The house foundation is ten cedar posts set 3 feet in the ground and projecting an average of 16 inches above ground. The house stands southeast by northwest, so as to let the sun shine on both sides."

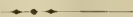

The Conditions Under Which Bees Gather the Most Honey, and How we Can Make This Knowledge the Most Profitable.

It will be remembered that in the last REVIEW was given an extract from an article by C. J. H. Gravenhorst, published in his paper in Germany. In this article were pointed out the five requisites of an ideal colony for storing honey. These requisites were a faultless queen; plenty of empty combs; swarming at the proper time or not at all; not too many bees and not too much unsealed brood during the harvest. In the

next issue of his paper Mr. Gravenhorst tells how he takes advantage of this knowledge, and I have condensed somewhat the translation furnished by Mr. Spaeth and present it below:

"A queen may be faultless in the fall, and fail in the spring. To discover this failure early in the spring and give the colony another queen is all-important. To introduce a queen with no danger of loss, remove the poor queen and all of the combs, giving the latter to some colony that can care for them temporarily. Allow the bees three or four frames with starters only. Give them the new queen in a cage. Watch closely and see what kind of comb they build. If it is drone comb they will not accept the queen. Cut it out and let them start again. If no honey is coming in they must be fed. When they begin building worker comb it is a sign that they have accepted the queen and it is safe to release her. The second day after her release three or four of the brood combs are returned. The remainder are given the next day. As a rule, queens are not kept after the second year. If the colony with the newly given queen does not prove diligent, exchange three or four of its combs for the same number of combs of sealed brood taken from the most industrious colony in the yard.

The second point is that of supplying colonies with abundance of empty combs. When the bees build their own combs there is not only the loss of the honey that is consumed to furnish the wax for comb building, but the bees that are secreting the wax and building the combs could be gathering honey were they not thus employed. I have always worked with all my power to have on hand a sufficient supply of comb, but I must admit that I have sometimes wished that I had more. At such times I would have given much if I could have gotten Warnstorff's combs, but his discovery is of recent date and I was obliged to use foundation which is a great help, but not the equal of completed combs. (The Warnstorff combs with full depth cells, cannot be used for raising comb honey as they are twice as heavy as natural comb, but they are excellent, strong combs for use in extracting.)

The third point is that the bees swarm at the right time—that the mother colony has a fertile queen and the young colony has its brood combs completed before the main harvest comes. Colonies that make preparations for swarming at the height of the harvest, or towards its close, miss the best opportunity for honey gathering. A swarm that comes late can but build its combs and secure a store of honey for winter, while the parent colony will not become sufficiently populous until the harvest is past and gone. At the end of the season the bee-keeper will stand before his colonies and complain of the average season, or, perhaps, the poor season. The only strange thing about it is that colonies "X" and "Z" have done all that could be wished. At least, they have gathered twice as much as the others. By close searching after the causes of these

things the bee-keeper will find that in nine cases out of ten, the colonies that are starving in the spring swarmed at the wrong time, while "X" and "Z" swarmed at the right time. If swarming at the wrong time is the cause of a small crop, then the bee-keeper will not doubt a moment as to what he ought to do. The only point is *how* it shall be done. Of course, we want early swarms, not simply individual swarms, but we want the *whole apiary* to swarm early. To accomplish this, that is, have the whole apiary swarm early and within a period of a week or ten days, those colonies that are in the rear must be helped at the expense of those that are too far advanced. This is done by the exchange of combs. From the time the bees are wintered until the opening of the main harvest, I work with this end in view, that of having them all enter the field equally strong. During this preparatory period, many of them build combs. Of course, if colonies are too far in the rear it may be best to leave them to themselves or unite them. There are other means than exchanging combs for equalizing colonies but they must be practiced with great caution. If some of the colonies do not swarm when it seems they ought to, they can be divided. An artificial swarm that is made like a natural swarm and at the right time, will work with the same energy as a natural swarm, and in some conditions is to be preferred. To get early swarms, the bees must have protection and an abundance of stores. In the province of Hanover, where bee-keeping has been made a specialty for a few hundred years, stimulative feeding is practiced, and it is only by this plan that an early and short swarming season can be secured. I use a swarm catcher and would not think of doing without one.

To remove the trouble from over-populousness we have only to have a hive that is large enough, or that can be made large enough, and see that it is enlarged before it really becomes too populous. If we have a hive that cannot be enlarged, then we must remove some of the sealed brood and give it to some colony that is not so populous. Managed in this way, the whole apiary will be in the best condition to take advantage of the honey flow when it comes, instead of having in it a few giants surrounded by dwarfs.

Lastly, is the point of having too much unsealed brood in proportion to the number of workers. To remedy this some of the unsealed brood is taken away and given to some colony having more bees in proportion to its unsealed brood. Empty combs are given in place of the brood removed. The empty combs are placed at the side of the brood nest. If there is danger of weakening the colony too much, capped brood may be given in place of the unsealed that is removed."

I believe that Mr. Gravenhorst is correct in his views as to the conditions under which bees gather the most honey, and that by following his instructions those conditions may be secured, but I doubt whether such a course is always profitable. It might be in some

conditions. If a man has a few colonies, and plenty of time in which to make the manipulations, well and good, but instead of this, if a man has the capital I believe it will pay him better to have more bees and do less manipulation. It is really a question of "Bees Versus Manipulation." I don't know but that would be a good topic for special discussion. I say don't fuss with weak colonies. Have enough bees so that you will have enough if some of them do die. Don't fuss with changing combs so that every colony will step across the swarming line like a platoon of soldiers on dress parade. Many of our most successful bee-keepers do not see the inside of the brood nests of their colonies from one year's end to the other. It is well to know the conditions so well laid down by Mr. Gravenhorst in regard to when bees store the most honey, and to take advantage of them when it can be done in some wholesale, short-cut manner, but everlasting puttering makes costly honey.

A Condensed View of Current Bee Writings

E. E. HASTY.

"It seems like a story from the world of spirits When anyone obtains that which he merits, Or merits that which he obtains."

I felt pretty sober over the proposition that I should include the REVIEW and its writers in my criticisms. It is not usually thought desirable that a child should wield the rod over his fellow children, much less over his "dad." I'll try and remember that criticising those who have equal or superior right to be criticising me is rather peculiar business. If I forget then my brothers must privately remind me. But, on the other hand, if I make these papers a mere wholesale distribution of taffy the reading public will spew me out of their mouths.

THE REVIEW.

The REVIEW's theory of what a bee journal should be is *concentration*. Concentrate the really valuable things scattered through many pages in many papers, and let the residue go. Apply the same principle to the collection of original matter: focus things by taking up one topic at a time; call out the writers who know most about that topic; let them feel that facts and actual experiences are what is wanted; and so serve up

for the reader a real, helpful, concentrated food. If a writer has humor or style, all right, if made subservient to the main object, but all wrong if an attempt gets started to palm off humor or fine writing as a substitute for fact and experience.

The interest which topic concentration aroused rather overgrew the first part of the plan for a while, insomuch that our editor is used to having his ear warmed with the question, "Why don't the REVIEW review?" but he has not abandoned any part of his theory, and is getting around to a fuller realization of it. Not to praise Mr. Hutchinson a little would be mere affectation of judicial loftiness. It is but just to give him his due—or a part of it. In a time when everything favored a decline and loss of interest in bee literature, as well as in everything else pertaining to bees, he has pushed up his own work, and compelled nearly everybody else to push up theirs. Our bee papers, some of them (I wish I could say all of them) are edited by men quick to notice and "scratch around" if some one else in the class makes movements and improvements for which they have no equivalent. Mr. Hutchinson has long been the one chief provocative to "scratching around" all along the line. The good he has done inside his own paper is but a fraction of what he has done apicultural journalism as a whole. Unless this can be denied, surely our rank and file ought to remember it in their subscriptions. Take the REVIEW, and your other favorite paper will doubtless be kept wide awake. Had the REVIEW died three years ago the whole field would have been dull and spiritless compared with what it is now. Take the REVIEW even if it has not the cash just yet to spend on splendid illustrations—it will have some day if merit has its proper reward—and you are not looking out for the interests of our craft if you let it be pinched down by lack of support. You know in ancient times they had priests to conduct the worship, and prophets to make the priests' tend to their business. W. Z. is a prophet.

What is the REVIEW's most conspicuous fault? Not sure but it is that the editor writes so little for it himself—pays good cash to somebody else to fill columns; when the reader would like them better if filled by the editor. Hutchinson's calm, clear, pellucid style, with little attempt at ornamentation, is like good bread; one can eat a good deal of it every day without getting

tired of it—as compared with that other fellow that is ginger snaps, and that other one that is "floating island" inflated with big words, and figures of speech, and classical allusions.

How about the matter of free advertising in the reading columns? Most first-class journals shut down on it completely, refuse to tolerate anything that even smells of it, no matter if the public interest does occasionally suffer, and good things die unborn for want of notice. This is far the easiest way to do it. Some line must be drawn, else half the paper would be filled perpetually with advertising that brings no revenue. Among bee journals, however, *Gleanings* set the pace many years ago that really valuable things unknown to the public, and liable to stay so, were to be brought forward and set before the people. Why should a really valuable invention be used in only one apiary, or a few apiaries, because the inventor don't believe it would pay expenses to make and advertise it for sale? This is a right sentiment, but difficult to carry out properly: and this critic thinks the REVIEW, just at present, has sailed across the danger line. What would it do if each advertiser should proceed now to send in an able article describing his wares?

Now for the *seriatim* of the February number. If comrade R. L. Taylor is as good as he looks we may safely trust in him. He gives the junior class this time a comprehensive talking to. He does not all the time keep clear of disputed points, but holds well away from counsels that are risky and dangerous. The climax items are very good—

Don't marry an unproved hive, my dear;
Don't bungle things when you "carpentear."

Wish I could obey that last command myself.

Next comes "Rambler,"—Ah, he's been trading off his umbrella for a three-legged hoss; and now if he gets after me on the hop-aty-hop I may have to drop that sugar-honey, and "pike it" down the road at a very undignified rate of speed. The news is quite newsy which he gives us about Mexican California—the honey flow getting better and better the further one goes down into it. But 'pears to me I remember that drouth gets more and more the rule as one goes south. And so young men in California make their *first* capital at bees, and then step out into some other business. Ho, ho! Few vocations offer so good a ladder for en-

terprise and bare brown hands. Catch your swarms instead of buying; make your own fixtures, and go in.

I'll cheat Dr. Miller out of part of his dues this one time, as he happens at the same trade as myself, reviewing, and kindly reviews me in advance. If I review him in return, and then we reciprocally review each other a few more times, our reciprocations might get as reiterative as the nursery story of the kid that would'nt go; and the REVIEW, on a candid review of our mutual reviews might wish itself out of the whole business "an hour and a half ago." By the way what is the famous Stray Straw page but a review of all beedom, boiled down to its most concentrated, vivid, sparkling form?

The Daggitt smoker certainly looks promising. If a satisfactory double bellows can be constructed of suitable size it promises a royal cure for an arch-nuisance, soot and tar just where they are least wanted. But many a winning idea lingers for years for lack of a winning body to mate its soul. Only when concrete and tested can we proclaim it *the* smoker. If this bellows were put upon the Clark smoker would not the Clark continue to work in the same delightful way it usually does when new? The smoker is our most important tool; a poor one is the plague of one's life; the best possible one is greatly to be longed for; and now we have smoker on the carpet let's keep it there till something to our profit materializes.

B. Taylor seems specially near to us because we do not often see him spread around in the other journals. He just belongs to our own ingle-side. As a writer he has one captivating quality to an unusually high degree. What to call it I hardly know, unless we call it transparency. When he is telling something he is intensely interested in, his interest becomes visible and contagious; and yet he seems to be unconscious of it, somewhat as the glow-worm is of his shining. In the present letter something of this appears where he tells of the joy in making over again the machinery he sold for nearly \$500 last spring. A parallel bar that will move anywhere without delay, fuss, or mistake is indeed a valuable addition to a saw. May it prove all that is hoped for it, and come into general use.

R. C. Aikin is one of our REVIEW children too; and this time with K. D. arguments he is defending his Knock-Down hive—just as most of us would do if standing in his shoes.

This number is a "good number" in having nine columns editorial. See how I tell my "pa" to do things after he has already begun to do them! News to me is that funny kink about the California red-wood—shrinking endwise, and holding its lateral dimensions true. Cheers for that oil stove arrangement. Cellar air is quite poor enough without defiling it with the products of combustion. So let the hood of tin come well abroad and down to catch the vitiated air, and the stove-pipe junior run up to join the big stove-pipe above—just as it ought to be.

And now with shame I shall have to review my review, and own up to the fib I told. My memory was positive that I said bees with stores behind them, meaning toward the rear of the hive. My pencil-slip says so (I usually write first in pencil and then copy with ink for the printer), but somewhere between my pencil and the finished print a change got in. It was printed "stores below them:" and already the ghosts of dead colonies begin to "shake their gory locks" at me.

Wanted to "polish off" two journals in this article, but can't come it. Its already high time to prepare for the close by calling—

THE GENERAL ROUND UP

Hear once how C. F. Muth in the *Guide* goes back on sweet clover:

"Infernal melilot. * * The English sparrow is a daisy to compare with it."

Sparrow was brought over to eat insects. It does. Never enough to amount to anything. Sweet clover was introduced to yield honey. It does. Does it often add many pounds to anybody's surplus? Many men of many minds.

"May it not be that the heating of the wax at two distinct times renders the spores [of foul brood] harmless?"—J. H. LARRABEE in A. B. J.

May be that's it. Half kill a fellow, then make him wait a few weeks without any chance to recuperate, then half kill him again. The professors must experiment on this also. In such an important matter we want all the points covered.

The vote for Mr. Heddon as President of B. K. Union is quite surprising. R. L. Taylor 141, James Heddon 136. Heddon's speech for letting alone the rogues the Union is about to sail into was fresh in print if not in mind at the time. It would be interesting if we could know how far this vote represents views of policy, and how far mere personal liking for the individual.

On page 245 A. B. J., Dr. Miller tells of a colony that swarmed out because he gave them a full set of drone combs. I wonder if a like result would always follow.

Manum fights robbers with peppermint water. *Gleanings*, page 81.

Baldensperger (*Gleanings*, page 83) had ten virgin queens all fail to be fertilized with ten colonies about a mile distant. Proving too much is often all the same as not proving anything. Few can believe that queens could not go a half mile and meet drones coming a half mile in the other direction. Honey flow bad, I reckon: drones mostly killed, and survivors so badly used as to have no enterprise. Friend B's experience with drone playgrounds in the Holy Land is that they are never more than a half mile away, and sometimes in sight as one stands in the apiary. Page 121.

Three days steady jarring was sufficient to candy Mr. Hutchinson's show honey at the Detroit Exposition. *Gleanings*, page 87.

Ernest Root tasted himself sick in the interests of science over mixtures of honey and glucose. (Page 102.) Presume that was one cause of the illness. There is a difference, however, between prolonged tastings, with rinsings of the mouth and try it again, and merely eating some of the article and done with it. The stomach that would stand the latter well enough might be unable to bear the former. The rules arrived at for detecting mixtures seem valuable. Practice on known glucose till its exact flavor fully soaks into you. Then hold the suspected sample on the tongue thirty or forty seconds; and if glucose is there you'll hear from it. Having to call in the doctor next day might be considered a slight drawback.

So Huber, keen as he was, did not find out that queenless bees always built drone comb. Langstroth in *Gleanings*, page 116.

And German Gravenhorst confronts all our wise Yankee bee authorities, and dares to say "not overcrowded with bees" as one of the prime conditions of the best honey gathering. Stray Straw, Feb. 15. How doctors do disagree! Dr. Miller, couldn't you prove somehow that both parties are wrong?

"With a temperature of less than 60° brood is liable to be chilled in handling."—G. M. DOOLITTLE.

We don't often catch Doolittle in a practical error. If not an error this is important, and somebody ought to be more careful.

Baldensperger after these years comes back upon us like a new broom. His tables of a colony's gathering and consumption of honey, though of foreign bees in a foreign land, are a valuable addition to our scanty stock. The rapid eating when a batch of brood was being reared, and the almost no eating at all for a week (presumably when brood rearing had a rest) seem nicely illustrated. Also his itemized table of the actual cost of honey has few like it to compare with. He got 12,000 pounds at a cost of four cents a pound and sold for eight cents. This was at Joppa in the Holy Land. *Gleanings*, page 120.

The A. B. J. comes out with a new department. German investigation and accuracy is to be heard by the pen of a German in German land, H. Reepen, of Jugenheim. His get-to-business air is suited to make a very good impression on us slip-shod Americans.

RICHARDS, Lucas Co., O., March 8, 1893.

ADVERTISEMENTS

WILL SACRIFICE 
SUPPLIES. WRITE FOR LIST.

I also have "office helps" for sale. 3-93-tf
JNO. C. CAPEHART, St. Albans, W. Va.

I HAVE FOUR SINGLE-COMB

OBSERVATORY HIVES

That I wish to dispose of. They are finely made of "quartered" oak and polished. They cost \$5.00 each, but I am out of the show business and am open to offers.

ARTHUR C. MILLER,
2-93-tf. Box 575, Providence, R. I.

Ready to Mail, ITALIAN QUEENS,

Tested, at \$1.50; 6 for \$7.50. Untested, after April 1st, \$1.00 each, or 6 for \$5.00. Safe arrival guaranteed. Bees, Drones and Supplies. Circular free. **J. N. COLWICK,**
4-92-tf Norse, Bosque Co., Texas.



Barnes' Foot and Hand Power Machinery.



This cut represents our Combined Circular and Scroll Saw, which is the best machine made for Bee Keepers' use in the construction of their hives, sections, boxes, etc.

17-92-76t

MACHINES SENT ON TRIAL.

FOR CATALOGUE, PR IOS, TC.,

Address W. F. & JNO. BARNES CO., 384 Ruby St., Rockford, Ills

IF YOU WANT THE

BEE BOOK

That covers the whole apicultural field more completely than any other published, send \$1.00 to Prof. A J. Cook, Agricultural College, Mich., for his

Bee-Keepers' Guide.

Liberal Discounts to the Trade.

Please mention the Review.

Warranted Purely Mated.

Italian honey queens. They are very prolific and their workers cannot be excelled in gentleness and industry. Nothing but the choicest queens sent out; try me and see. Send your order at once Single queen, 80 cts; 3 for \$2.00; 6 for \$4.00; 12 for \$7.75. Ready April 30th. 1-93-6t

M. H. DeWITT, Sang Run, Md.

Please mention the Review.

HATCH CHICKENS BY STEAM
With the Improved **Excelsior Incubator.**

Simple, Perfect, Self-Regulating. Thousands in successful operation. Guaranteed to hatch a larger percentage of fertile eggs at less cost than any other Hatcher. Lowest priced first-class Hatcher made. **GEO. H. STAHL, Quincy, Ill.**

Circulars free. Send 6c. for Illus. Catalogue.

3 & 5 Banded Queens

AND

2 & 3 Frame Nuclei

A SPECIALTY.

	April	May
One untested queen,.....	\$1.00	\$1.00
Six " queens,.....	5.00	5.00
One tested queen,	2.00	1.50
Three " queens.....	5.00	4.00
Select tested queen,.....	2.50	2.50
Two-frame nucleus with any queen \$1.50 each, extra. Three-frame nucleus with any queen \$2.25 each. Safe arrival guaranteed.		

W. J. ELLISON,

3-93-3t

Catchall, S. C.

New as Well as Valuable IMPROVEMENTS

IN BEE-HIVES, SMOKERS,

FOUNDATION FASTENERS,

SECTION PRESSES AND FEEDERS.

Special prices given to parties who will take hold of and push the sale of these goods. For circulars and particulars, address

LOWRY JOHNSON,
Masonstown, Pa.

1-93-tf.

COMB FOUNDATION

AND **SECTIONS.**

—:O:—

CAUTION.

Do not buy a thick, heavy base comb foundation for use in your sections when you can get 14 to 16 square feet to the pound. Also be sure and buy your sections where you can get a nice box at a low price. Send me your address and I will be pleased to send you a sample section, a sample of the

THINEST COMB FOUNDATION MADE,

And prices at which they may be bought.

W. H. NORTON,

Skowhegan Me.

2-93-t4.

Please mention the Review.

THE PROGRESSIVE BEE - KEEPER

Has Changed Hands. It is now Published by the **LEAHY MANUFACTURING CO.,**

Higginsville, Missouri.

Money, Experience and Enterprise will not be lacking to make it all that its name indicates. Send for Free Samples and Copy of 28-page Catalogue of Apiarian Supplies.

Bee Hives and Section Boxes.

Simplicity, Langstroth-Simplicity, Standard Langstroth, Dovetailed and Champion Chaff Hives, Supers, One Piece Sections and Shipping Cases, Foundation, Smokers, etc., etc. Send for 16 page Circular.

1-92-tf PAGE & KEITH, New London, Wis.

Golden Italians.

My bees are large and great honey gatherers. 1 untested queen, 80 cts.; 3 for \$2.00. 1 warranted queen, \$1.00; 3 for \$2.50. 1 tested queen, \$2.00; selected, tested, \$2.50. Satisfaction guaranteed or money refunded. 4-93-tf

C. M. HICKS, Hicksville, Md.

BEE - KEEPERS'

SUPPLY HOUSE

J. H. M. COOK, 78 Barclay St., N. Y. City.

(SUCCESSOR TO A. J. KING.)

4-93-tf

Send for illustrated Catalogue.

FREE QUEEN.

Send for circular giving particulars, telling how to introduce queens and giving the price of hive protectors and nucleus col's.

2-93-4t

J. F. MICHAEL, German, Darke Co., Ohio

HIVES

Twenty of Root's Dovetailed Hives, all made up and furnished with six section holders and eight brood frames, only 90 cts. each. Twenty of Root's story and a half, chaff hives, made up and furnished with eight brood frames, and a case to hold twenty sections, only \$1.25 each. (Regular price, \$1.75.) Twenty chaff hives with one movable side, and furnished with nine brood frames and a case holding six section holders, only \$1.50 each. (Regular price \$2.00.) I also have fifty colonies of

BEES

For sale. They are in eight and ten (L.) frame story and a half hives. Colonies in ten-frame hives, \$4.00 each; in eight-frame, only \$3.50. If five or more are taken at one time, a five cent discount will be given. Bees are in good condition and hives new. A discount of ten per cent will also be given on section holders, brood frames and shipping cases until May 1st. 12-92-12t

J. M. KINZIE, Rochester, Mich.

TYPEWRITERS.

Largest like establishment in the world. First-class Second-hand Instruments at half new prices. Unprejudiced advice given on all makes. Machines sold on monthly payments. Any instrument manufactured shipped, privilege to examine. EXCHANGING A SPECIALTY. Wholesale prices to dealers. Illustrated Catalogues Free.

TYPEWRITER { 31 Broadway, New York.
HEADQUARTERS, { 186 Monroe St., Chicago.

FOR SALE.

SEVENTY COLONIES ITALIAN : : : : :
: : : : : : : : BEES AND FIXTURES.

Also, a lot of new and second-hand Hives at a bargain. Write for particulars,

WILLIAM IDEN,

Etna Green, Ind.

2 93-tf.

HUNT'S

FOUNDATION

FACTORY.

Send for free samples of foundation and sections; warranted good as any made. Dealers, write for special prices and the most favorable conditions ever offered on foundation. Send for new, illustrated, free price-list of a full line of supplies.

1-93-tf

M. H. HUNT,

Bell Branch, Mich.

Please mention the Review

Take Notice!

If you are looking for the bees that give the most profit, and are the most gentle, try the

ALBINO.

I can also furnish the golden Italian, but my preference is the Albino. Send for circular and price list and see what others say of them and how cheaply I sell them. I also manufacture and deal in **Hives, Sections, Foundation, Extractors** and other apicultural supplies.
S. VALENTINE,
3-93-2t Hagerstown, Md.

Bee Literature For Sale.

GLEANNINGS—Vols. 8-9-10-11-12-16 bound in "red goat" Vols. 17-18-19-20 unbound.

AM. BEE JOURNAL—Vols. 22 23 24 bound in black leather, and Vols. 25-26-27 and 28 unbound.

APICULTURIST—Vols. 1 to 7, inclusive, unbound.

GUIDE—Vol. 12, unbound.
Each of the following lack one or two numbers of being complete.

ADVANCE—Vols. 17 and 18.

CANADIAN B. J.—Vol. for 1888.

BRITISH B. J.—Vols. for 1888-1890 and 1891.

CAN. HONEY PRODUCER—Vols. for 1887-1888 and 1889. Also odd numbers of all the above journals.

How much am I offered for any or all of the above?

ARTHUR C. MILLER,

Box 375,

Providence, R. I.

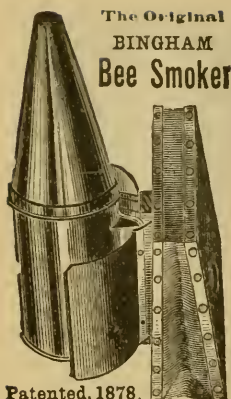

The Original
BINGHAM
Bee Smoker

To make an immense smoke lots of fuel and lots of fire is needed in a smoker, as elsewhere. Such a fire makes lots of heat—and wide shields are a great comfort. We are practical bee-keepers—our tools were invented for our own use. We use no others. We have all other kinds, however, but they are so complicated we can't afford to use them.

Prudent Franklin said "time is money"—Bingham smokers go themselves. The new handle makes them easy and safe to refill, and the turned cap easiest and safest

to use. Our other inventions do the rest and do it best. No one but Bingham has ever improved a Bingham bee smoker or a Bingham & Hetherington uncapping knife, or ever will. Hundreds have tried but all have failed—"History repeats itself." We make a line of smokers so that no bee-keeper need buy a poor, unscientific bee smoker on account of price. Our Little Wonder is not only the best low priced, but the lowest priced bee smoker made, and with sound, dry stove wood for fuel, it is a wonder and a delight.

Until our embodiment of the direct draft and blast principle in bellows bee smokers, fire, even of rotten wood, could not be depended upon. Just when most needed, Lo, and behold! no fire—no smoke remained in the smoker. Dr. C. C. Miller, in March number of Gleanings in Bee-Culture states that "Smokers heretofore have either had the cut off or else sucked smoke into the bellows." The Dr. has told in few words just what the state of bellows bee smokers was prior to our invention, and, casually, what all other bee smokers now do, but the Dr. omitted saying how much hard, creosote varnish coated the inside of the leather, the blast tube, the valve and the springs, if in the inside of the bellows.

It does not seem that it would need an experiment to understand what the effect of smoke would be when sucked into a bellows composed of leather soft and pliable as buckskin and having a valve which, to be valuable, must work freely in all positions. The features that enabled us to do what had never been done before, and what no other bee smoker does now, we had patented. From time to time we have improved our original smoker and had the improvements patented.

Our designs and improvements in uncapping knives and bellows bee smokers mark an epoch in the apiculture, and have revolutionized the tools of the apiary and the management of bees. The record of our bee smokers and knives is simply phenomenal. Thousands of the smokers have been in use in all kinds of apiaries and in all countries from five to ten years and are yet serviceable. The knives will last a lifetime, and no one, it is safe to say, will ever improve them. They do perfectly the work required of them, which is also true of our smokers. Tools that do perfectly the work required of them are never changed materially.

We make six kinds and sizes of bee smokers. The four higher priced have wide shields to protect the hands and bellows from heat; the two lower priced have narrow shields to protect the bellows. All are made on the same principle and have the strongest draft and blast of any smokers made. Our invention enables us to burn sound stove wood and chips, bark, rags, rotten wood, tobacco, shavings, hay, or anything combustible without fussing or loss of fire. Our

"Doctor" and Conqueror smokers are the largest, most perfect, most valuable and most economical bee smokers ever used by bee-keepers. They cost perhaps a dollar more, but that dollar represents only ten cents per year for ten years of ease, comfort, satisfaction and instant, certain, and absolute control of the most vicious colonies of bees without fear or favor or fussing with lost fire. The ten cents per year would be saved in matches to say nothing of stings and lost temper incident to unscientific bee smokers.

The least pressure of a Bingham smoker bellows moves the smoke so gently and in such a soft soothing cloud that the bees hardly realize that they have a master whom they must obey. Every particle of air that a Bingham smoker bellows contains, and much more, is forced through the smouldering fuel and utilized. No snapping of the bellows, no squeaking springs, no nervous haste frightening the bees into remote corners, or balling the queen. With a Bingham smoker the bee-keeper may smoke much or little just as he pleases. He is master of the smoker—not the smoker master of him.

To soothe and control is the office of a Bingham bee smoker and it does that perfectly, either side up, in all positions alike, in season and out of season. Such a smoker inspires the confidence and respect not only of the bee-keeper, but of the bees.

Our latest smoker invention consists of a movable cap or hood which deflects or turns the blast of smoke nearly at a right angle to the stove; and a coiled steel wire handle firmly attached to the tapering nozzle by which the nozzle is removed and replaced, even when the smoker is red hot, without inconvenience or danger. The handle may be used without the hood. These peculiar features were very thoroughly tested by many noted and extensive bee-keepers last season and pronounced valuable inventions. We do not put them on any smokers unless so ordered, as we charge twenty-five cents extra for them. We send them per mail, post-paid, with printed directions how to put them on Bingham smokers now in use, provided the order specifies the size of the smoker to be fitted and contains 25 cents.

Bingham & Hetherington Uncapping Knife.



Patented May 20, 1879.

Price of Bingham bee smokers and uncapping knives, per mail, post paid: The Doctor, the largest bee smoker made, has a stove 13x3½ inches, \$2.00; Conqueror, 13x3, \$1.75; Large, 11½x2½, \$1.50; Extra, 11¼x2, \$1.25; Plain, 11x2, \$1.00; Little Wonder, 10x1¼, 65 cents. Bingham & Hetherington uncapping knife, \$1.15.

To sell again, send for dozen rates.



BINGHAM PERFECT
BEE SMOKER

Pat'd 1878, 1882, & 1892.

Cheapest & Best on Earth.

Send Card for Circular to

Bingham & Hetherington
ARRONIA, MICH.



Interesting Monthly for
The Family and Fireside

Welcome In every Home.

Large Premiums for Clubs.

Sample Copy sent Free.

THOMAS G. NEWMAN,
147 South Western Ave.,
CHICAGO, ILLS.

Please mention the Review.

Leather Colored

HONEY QUEENS, from Imported Mother, warranted purely mated, after June 10th, at \$1.00 each; six at one time, \$5.00. Untested queens, 75c. each. Address

C. A. BUNCH,

Nye, Marshall Co., Ind.

1-93-7t.

Please mention the Review.

—If you are going to—

BUY A BUZZ-SAW,

write to the editor of the REVIEW. He has a new Barnes saw to sell and would be glad to make you happy by telling you the price at which he would sell it.

ITALIAN QUEENS

Bred for Business, Gentleness and Beauty. Untested, 80c. each; three for \$2.25; six for \$4.00; 12 for \$7.50. Tested, \$1.25. Select tested, yellow to the tip, breeder, \$1.50. Will commence shipping April 15th. On all orders received before March 1st, accompanied by the cash, 10 per cent. discount. Safe arrival guaranteed.

G. E. DAWSON,

Carlisle, Sonoke Co., Ark.

1-93 12t.

Please mention the Review.

If You Wish Neat, Artistic

PRINTING,

Have it Done at the Review.

ITALIAN QUEENS AND SUPPLIES FOR 1892.

Before you purchase, look to your interest, and send for catalogue and price list.

J. P. H. BROWN,

Augusta, Georgia.

1-88-tf.

Please mention the Review.

IMPORTANT

TO BEE-KEEPERS!

To make a success of bee keeping, you want bees that will give the very best results. My *Golden Italians* have gained a good name on their own merits. Those who have tested them with other bees say "they are the best honey gatherers, cap their honey the whitest, as gentle as butterflies, beautiful to look at, are the largest and strongest bee of all the races." Queens bred from mothers that produce uniformly marked

FIVE-BANDED WORKERS

In March, April and May, \$1.25 each, 6 for \$6.00; June, \$1.00 each, 6 for \$5.00; July to Nov., \$1.00 each, 6 for \$4.50. Special prices on large orders. For full particulars send for descriptive circular.

12-92-tf

C. D. DUVALL.

Spencerville, Montg. Co., Maryland.

Please mention the Review.

TESTED

Queens are usually sold for \$2.00. I will explain why I wish to sell a few at less than that. As most of my readers know, I re-queen my apiary each spring with young

QUEENS

From the South. This is done to do away with swarming. If done early enough it is usually successful. It will be seen that the queens displaced by these young queens are never more than a year old; in fact, they are fine, tested, Italian queens *right in their prime*: yet, in order that they may move off quickly, and thus make room for the untested queens, they will be sold for only

\$1.00.

Or I will send the REVIEW for 1893 and one of these queens for only \$1.75. For \$2.00 I will send the REVIEW, the queen and the book "Advanced Bee Culture." If any prefer the young, laying queens from the South, they can have them instead of the tested queens, at the same price. A discount given on large orders for untested queens. Say how many are wanted, and a price will be made.

W. Z. HUTCHINSON, Flint, Mich.

FREE TO ALL. 

SAMPLE COPIES EITHER OF THE

Canadian Bee Journal

OR

Canadian Poultry Journal,

Or both, will be sent FREE to applicants who desire them, upon receipt of their names and addresses.

These papers are both of them edited and arranged by practical men, admittedly the most experienced in their particular lines to be found on the continent, and the Journals may therefore be regarded as authoritative upon the several subjects of which they treat.

Address **BEETON PUBLISHING CO.,**
Beeton, Ontario.

*Please mention the Review.***Pratt's Automatic or Self-Hiver,**

Ready for use, Sent Postpaid to any Address for

75 cts. Address **E. L. PRATT, Beverly, Mass.****Special Terms to Dealers.***Please mention the Review.***Early Queens From Texas,**

From my choice golden stock. My bees are very gentle, good workers, and beautiful. Safe arrival and satisfaction guaranteed. One untested queen, April and May, \$1.00; six for \$5.00; later, 75c. Orders booked now; money sent when queens are wanted. Send for price list.

J. D. GIVENS,
Lisbon, Texas.

1-93-9t.

*Please mention the Review.***THE ODELL
TYPE WRITER.**

\$20 will buy the **ODELL TYPE WRITER** and **CHECK PERFORATOR**, with 78 Characters, and **\$15** for the **SINGLE CASE ODELL**, warranted to do better work than any machine made.

It combines Simplicity with Durability, Speed, Ease of Operation, wears longer without cost of repairs than any other machine. Has no ink ribbon to bother the operator. It is Neat, Substantial, nickel plated, perfect and adapted to all kinds of type writing. Like a printing press, it produces sharp, clean, legible manuscripts. Two to ten copies can be made at one writing. Any intelligent person can become a good operator in two days. We offer **\$1,000** to any operator who can equal the work of the Double Case Odell.

Reliable Agents and Salesmen wanted. Special inducements to Dealers.

For Pamphlet giving Indorsements, &c., ad dress

ODELL TYPE WRITER CO.,

358 Dearborn St., Chicago, Ill.

Michigan Bee-Keepers,

You will consult your own interest, by sending for my catalogue and price-list of Root's Supplies. Beeswax and white extracted honey wanted.

CLARK A. MONTAGUE,

4-93 3t Archie, Grand Traverse Co, Mich.

*Please mention the Review***BEEES FOR SALE.**

As mentioned in the last REVIEW, my bees have wintered well. They are now on their summer stands, most of them being packed in sawdust. They will be fed if necessary and every attention given necessary to keep them in the best possible condition. I have more bees than I can manage in connection with the REVIEW, and I should be glad to sell part of them. They are in the New Heddon hive, but purchasers not having the right to use this hive will be furnished free with a permit from Mr. Heddon. I will sell one colony for \$6.00; 5 for \$28.50; 10 or more at \$5.50 each. With each colony will be sent a bottom board, cover and one section case. The bees are all pure Italians and the queens of last year's rearing. Shipments will be made immediately at the close of fruit bloom when the weather will be neither too cold nor too hot and there will be a supply of freshly-gathered honey from which the bees can supply themselves with water while on their journey.

W. Z. HUTCHINSON, Flint, Mich.

The "K. D." Non - Swarming, Reversible Hive.

No. 1 is a reversible bottom board and feeder. Deepside up for winter and feeding. No. 2 is the brood chamber. It takes a closed-end standing frame 9x17. The bee spaces are in the bottom board and honey board. Both sides and ends are compressed upon the frames by the nuts and rods. When released for manipulation, the frames rest upon the bottom board rim ends. The chamber is reversible.

The lighting board (5) is a part of and attached to the honey board (4) while the entrances (8 and 9) lead respectively under and above the honey board. The queen trap (7) covers the brood chamber entrance. No. 10 is the super, held together by the rods—neither super nor brood chamber are nailed at the corners—and both sides and ends compressed upon the sections. By compression and spurs, the super sides and separators support the sections perfectly, without T's, slats, followers, or wedges. The 8 and 10 frame hive supers take respectively 2 and 3 separators and 24 and 32, 1 1/8 wide sections. They may be full separated by adding plain wood or tin separators, or by spur separators. For extracting, the super takes 8, 1 1/8 inch thick frames in place of the sections Nos. 12 and 13 in the inner and outer covers.

THE "KAY DEE" HIVE is also a non swarmer. We meant to have this arrangement illustrated here, but have been disappointed in getting the cut ready. We have also been holding back to perfect some of the details. We have at last gotten all according to our notion, and now present you a brief description, and if you will drop us a card we will mail you an illustration.

Two "Kay Dee" brood chambers, each containing a colony, are placed one above the other, with a separating board between. Like the honey board, this also has a double entrance in its edge. In this entry way is placed an alternator—a cheap, simple device. The bees of the upper colony fly from the top of their chamber through the honey board entrance, while those of the lower hive fly from the top of THEIR chamber through the alternator, and when they return to the point of exit, are led into the upper hive; thus they leave one chamber, and, returning, enter in a natural way the other not two inches from the point of exit. This puts the working force of the lower colony into the upper, and of course into the supers above.

Once a week the super should be examined; while doing this, remove the honey board with the supers, place a bottom UPON the hive, and reverse the two colonies EN MASSE. To accomplish the reversing we make a pair of clamps and a hoisting appliance that will cost about \$2.00 per apiary, so that the hives are clamped together, elevated, and rolled over as you would turn a wheel on its axis.

Reversing puts the depopulated hive on top, and the populous one below, and queen cells, if any, pointing up.

The alternating again takes the bees from the lower hive to the upper, with no interruption of work. Alternate them once a week until swarming time is over.

It will be seen that there are two colonies in one hive, and only one set of supers. They are

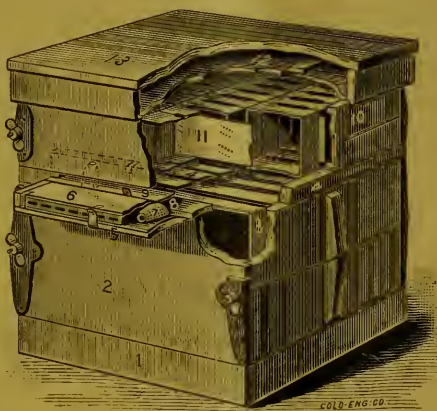

made to depopulate one chamber this week, the other next week; yet all is done in a simple, easy manner. You can't afford to miss trying this plan this year.

Send 20c. and get our illustrated pamphlet giving detailed description, method of management, and much valuable information. The pamphlet free to purchasers of hives.

The hive goes out nailed and painted but "K. D." at following prices, F. O. B. Brood frame starters are included, but no sections:

	Eight frame.	Ten frame.
ONE SUPER WITH EACH HIVE.		
A single hive as in cut 1.....	\$2 50	\$2 75
Same with plain bottom and cover	2 15	2 40
Two colony non-swarmer hive...	3 80	4 15
Same with plain bottom and cover	3 40	3 80

HIVE PARTS.

Combined bottom and feeder ...	35	40
Plain bottom.....	20	25
Brood chamber, including frames,	70	80
Brood frame f'd'n starters	10	10
Honey board and queen trap.....	45	50
Super with spur separators	50	50
Inside cover.....	10	10
Outside cover.....	30	35
Separating board, equalizers and alternators	50	50
Plain Cover.....	20	25
Shallow extracting frames, 1 1/8 in. wide, per set.	12	15

Address

AIKIN BROTHERS & KNIGHT,
Loveland, Colorado.

OUR
"Falcon" Sections

Better than any.
Cheap as many.

Our No. 1 Sections

Equal to many.
Cheaper than any.

Any Size. Any Quantity.
At Any Time.

Also, all styles HIVES and BEE-FIXTURES cheap. New catalogue and price list free. Samples of Falcon Sections for 2c. stamp.

W. T. Falconer Mfg. Co.,
JAMESTOWN, N. Y.

Golden,
5-Banded,
Italian Queens

My Bees are the best honey gatherers there are in the country, while for Golden Beauty they cannot be excelled in the world.

Warranted Queens, 75 cents each.
Tested, \$1.00 each.
Breeding Queens, \$2.50 to \$3.00.

Ten per cent discount on orders for five or more queens. Satisfaction guaranteed. Make money orders payable at Caldwell, Texas. Address

C. B. BANKSTON, Chrisman, Texas.

2-93-tf Please mention the Review.

GRAY CARNIOLANS
— AND —
GOLDEN ITALIANS.

Bred from pure mothers and by the best known methods. Send for price list. 4-93-tf

For Carniolans to
JOHN ANDREWS,
11 Patten's Mills, N. Y.

For Italians to
L. E. BURNHAM,
Vaughns, N. Y.



BIG OFFER.

To any person sending me his order for ten

CHAFF HIVES

in April or May I will mail one of J. F. Michael's Golden Queens in June. Write for price list, sent free. 4-93-1t

GEO. H. KIRKPATRICK, UNION CITY, IND

Please mention the Review.



I TELL you what, Jones, *Levering Bros.* sell the best goods and at the lowest prices of any one I've struck yet. The largest and best equipped

Bee-Hive Factory

In the West. The Dovetailed Hive and New Hoffman self-spacing frame a specialty. Everything used by practical bee-keepers by wholesale and retail. Send for their free Illustrated Price-List, and save money. Supply Dealers, send for their Wholesale List. Address

LEVERING BROS.,

2-93-6.

WIOTA, Cass Co., Iowa.

Gomb Leveler.

Sections full of comb kept over from last year, when used to induce the bees to begin work in the supers, are worth nearly as much as sections filled with honey. The only objection to their use is that the comb is often uneven and gives the honey a rough appearance. By the use of Taylor's Handy Comb Leveler the combs can be brought to a level as rapidly as the sections can be handled, and the comb of honey, when finished, will have all the fine appearance of that produced with fresh foundation. Price of the leveler (except the wooden box in which to set the lamp) 60 cts. by mail. Box and all, \$1.10 by mail; by express, \$1.00.

B. TAYLOR, Forestville, Minn.

"Golden" Florida.

Nearly all of my full colonies have selected tested, breeding, "golden" queens. Untested queens, April and May, \$1.00 each; 6 for \$4.75; one doz., \$8.50. June and later, 75 cts.; 6 for \$4.00; one doz., \$7.50. Tested, \$1.50; selected, tested, \$2.00; breeder, \$2.50; best, \$3.00. All reared by the Doolittle method. Safe arrival and satisfaction guaranteed. 11-92-tf

J. B. CASE, Port Orange, Vol. Co., Fla.

Please mention the Review.

MAY, 1893.



At Flint, Michigan.—One Dollar a Year.

ADVERTISING RATES.

All advertisements will be inserted at the rate of 15 cents per line, Nonpareil space, each insertion: 12 lines of Nonpareil space make 1 inch. Discounts will be given as follows:

On 10 lines and upwards, 3 times, 5 per cent; 6 times, 15 per cent; 9 times, 25 per cent; 12 times, 35 per cent.

On 20 lines and upwards, 3 times, 10 per cent; 6 times, 20 per cent; 9 times, 30 per cent; 15 times, 40 per cent.

On 30 lines and upwards, 3 times, 20 per cent; 6 times, 30 per cent; 9 times, 40 per cent; 12 times, 50 per cent.

Clubbing List.

I will send the REVIEW with—		
Gleanings.....	(\$1.00).....	\$1.75.
American Bee Journal.....	(1.00).....	1.75.
Canadian Bee Journal.....	(1.00).....	1.75.
American Bee Keeper.....	(.50).....	1.40.
Progressive Bee Keeper.....	(.50).....	1.30.
Bee Keepers' Guide.....	(.50).....	1.40.
Apiculturist.....	(.75).....	1.65.
Bee-Keepers' Magazine.....	(.50).....	1.40.

Honey Quotations.

The following rules for grading honey were adopted by the North American Bee-Keepers' Association, at its last meeting, and, so far as possible, quotations are made according to these rules:

FANCY.—All sections to be well filled; combs straight, of even thickness, and firmly attached to all four sides; both wood and comb unsoiled by travel-stain, or otherwise; all the cells sealed except the row of cells next the wood.

No. 1.—All sections well filled, but combs uneven or crooked, detached at the bottom, or with but few cells unsealed; both wood and comb unsoiled by travel stain or otherwise.

In addition to this the honey is to be classified according to color, using the terms white, amber and dark. That is, there will be "fancy white," "No. 1 dark," etc.

CHICAGO, Ill.—We quote as follows: Fancy white, 17 to 18; No. 1 white, 14 to 16; fancy amber, 11 to 13; fancy dark, 10; white extracted, 7 to 9; amber extracted, 7 to 8; dark extracted, 6 to 7; beeswax, 23 to 25

R. A. BURNETT & CO.,
April 3. 161 So. Water St., Chicago, Ill.

KANSAS CITY, Mo.—The demand for extracted honey is good and the supply light. The supply of comb honey is fair and the demand the same. Shipments of No. 1 would meet with very ready sale. We quote as follows: No. 1 white, 16 to 17; fancy amber, 15 to 16; No. 1 amber 13 to 14; fancy dark, 12 to 13; No. 1 dark, 10 to 11; white extracted, 6½ to 7; dark extracted, 5 to 6; beeswax, 22 to 25.

CLEMONS-MASON CO.,
Mar. 6. 521 Walnut St., Kansas City Mo.

CINCINNATI, Ohio.—There is no choice comb honey on the market. A fair article brings 14 to 16 in a jobbing way. The demand is good for extracted at from 6 to 8 cts. There is a good demand for choice yellow wax at from 24 to 27 cts.
CHAS. F. MUTH & SON.,
Cincinnati, Ohio.

April 1.

MINNEAPOLIS, Minn.—There is a good supply on hand but it is mostly dark. This stock is slow, but what little white there is on the market moves readily. We quote fancy white, 17 to 18; two pound combs, 16 to 17; buckwheat, 15 to 16; extracted honey, 10 to 11.

J. SHEA & CO.,
Feb. 13. 14 Hennepin Ave., Minneapolis, Minn.

BUFFALO, N. Y.—Demand somewhat easy and stock light. The prospects are that honey will clean up with satisfactory prices. Extracted is in light demand. Beeswax is firm for choice lots. We quote as follows: Fancy white, 17 to 18; No. 1 white, 15 to 16; fancy dark, 10 to 11; No. 1 dark, 8 to 9; beeswax, 28 to 30.

BATTERSON & CO.,
April 1. 167 & 169 Scott St., Buffalo, N. Y.

CHICAGO, ILL.—We anticipate slow sales on all grades of honey for the balance of this season. There is a poor demand for extracted at present. Beeswax is in good demand. We quote as follows: Fancy white, 16; No. 1 white, 15; No. 1 dark, 12; white extracted, 8½; dark extracted, 7; beeswax, 15 to 26.

J. A. LAMON,
April 1. 44 & 48 So. Water St., Chicago, Ill.

NEW YORK.—The market is bare of comb honey. Fancy white could be sold at 14 to 15; fancy amber at 12; and dark at 10. The market is quiet on extracted and no movement. Large lots of West India and Mexican are arriving and the market is well supplied. This class of honey sells at from 65 to 75 cts. per gallon. Beeswax is quiet but firm at from 27 to 29.

HILDRETH BROS. & SEGELKEN,
April 3. 28 & 30 West Broadway New York.

ALBANY, N. Y.—Stock of honey very light. Prices well sustained. Demand will be better as the weather warms up. We quote as follows: Fancy white, 15 to 17; No. 1 white, 14 to 15; mixed, 12 to 14; fancy dark, 11 to 12; No. 1 dark, 10 to 11; white extracted, 8½ to 9½; amber extracted, 7 to 7½; dark, 6½ to 7. Beeswax, 28 to 30.

H. R. WRIGHT,
Feb. 13. 326 Broadway, Albany, N. Y.

Foundation Reduced.

Deduct three cents per pound from prices given in my Illustrated Price List for 1893.

M. H. HUNT, Bell Branch, Mich.

ON ANOTHER PAGE is an advertisement wherein I offer for sale some pure Italian bees in new Heddon hives. I wish to add that I have a few colonies on Langstroth frames, and customers preferring them, can have them at the same price "as long as they last." I also have a few colonies of Carniolans to spare. W. Z. HUTCHINSON.

THE LOSS OF ONE

Queen in introducing means a loss greater than the cost of a copy of "ADVANCED BEE CULTURE," which has one entire chapter devoted to "The Introduction of Queens." It shows when the cause of failure lies with the colony, when with the queen, and points out the *conditions* necessary to success. Although *one* infallible method is given, but little attention is given to the setting forth of exact rules and methods, the subject being treated with a view to teaching *principles* that may be followed to success.

Price of the book, 50 cts.; the REVIEW one year and the book for \$1.25. Stamps taken, either U. S. or Canadian.

W. Z. HUTCHINSON, Flint, Mich.

WHITE POPLAR SECTIONS.

We have New Steam Power, and New Buildings, and are now ready to furnish White Poplar Sections, Clamps, Crates and Wood Sides at short notice. Workmanship, Quality and Price unsurpassed. Send for sample and price list.

PRIME & GOVE,

1-90-12f Bristol, Vermont.

Please mention the Review



BEEKEEPERS SUPPLIES

BEST GOODS
LOW PRICES
LARGE STOCK

LARGEST BEE
SUPPLY HOUSE
IN THE WEST

ITALIAN QUEENS AND BEES A SPECIALTY.

CLOVER SEEDS BUCKWHEAT

SAMPLE OF OUR BEE JOURNAL THE WESTERN BEEKEEPER ALSO OUR CATALOGUE FREE!

JOS. NYSEWANDER. DES MOINES, IOWA.

2-93-12f Please mention the Review.

ON HAND NOW.

THE MOST COMPLETE STOCK OF BEE HIVES, SECTIONS AND SUPPLIES IN THE NORTHWEST.

W. H. PUTNAM,

1-93-12f.

RIVER FALLS, WIS.



Spray
your
Fruit
Trees
and
Vines

Wormy Fruit and Leaf Blight of Apples, Pears, Cherries and Plums prevented; also Grape and Potato Rot—by spraying with Stahl's Double Acting Excelsior Spraying Outfits. Best in the market. Thousands in use. Catalogue, describing all insects injurious to fruit, mailed Free. Address

WM. STAHL, QUINCY, ILL.

HONEY ALMANAC AND BEE BOOKS, OF ALL KINDS, A LARGE STOCK.



MY NEW ILLUSTRATED Catalogue and Price List of Supplies for the Apiary will be sent free to all who may apply. Send a postal card for it, writing your name and address plainly. For every Order of \$10.00 and over, I will make you a present. The Catalogue tells you all about it.

T. G. Newman, 147 So. Western Ave., Chicago.

Please mention the Review.

Leather Colored

HONEY QUEENS, from Imported Mother, warranted purely mated, after June 10th, at \$1.00 each; six at one time, \$5.00. Untested queens, 75c. each. Address

C. A. BUNCH,
Nye, Marshall Co., Ind.

1-93-7t.

Please mention the Review.

—If you are going to—

BUY A BUZZ-SAW,

write to the editor of the REVIEW. He has a new Barnes saw to sell and would be glad to make you happy by telling you the price at which he would sell it.

ITALIAN QUEENS

Bred for Business, Gentleness and Beauty. Untested, 80c. each; three for \$2.25; six for \$4.00; 12 for \$7.50. Tested, \$1.25. Select tested, yellow to the tip, breeder, \$1.50. Will commence shipping April 15th. On all orders received before March 1st, accompanied by the cash, 10 per cent. discount. Safe arrival guaranteed.

G. E. DAWSON,
Carlisle, Sonoke Co., Ark.

1-93-12t.

Please mention the Review.

If You Wish Neat, Artistic

PRINTING,

Have it Done at the Review.

ITALIAN QUEENS AND SUPPLIES FOR 1892.

Before you purchase, look to your interest, and send for catalogue and price list.

J. P. H. BROWN,

1-88-tf.

Augusta, Georgia.

Please mention the Review.

IMPORTANT

TO BEE-KEEPERS!

To make a success of bee keeping, you want bees that will give the very best results. My *Golden Italians* have gained a good name on their own merits. Those who have tested them with other bees say "they are the best honey gatherers, cap their honey the whitest, as gentle as butterflies, beautiful to look at, are the largest and strongest bee of all the races." Queens bred from mothers that produce uniformly marked

FIVE-BANDED WORKERS

In March, April and May, \$1.25 each, 6 for \$6.00; June, \$1.00 each, 6 for \$5.00; July to Nov., \$1.00 each, 6 for \$4.50. Special prices on large orders. For full particulars send for descriptive circular.

12-92-tf

C. D. DUVALL.

Spencerville, Montg. Co., Maryland.

Please mention the Review.

TESTED

Queens are usually sold for \$2.00. I will explain why I wish to sell a few at less than that. As most of my readers know, I re-queen my apiary each spring with young

QUEENS

From the South. This is done to do away with swarming. If done early enough it is usually successful. It will be seen that the queens displaced by these young queens are never more than a year old; in fact, they are fine, tested, Italian queens *right in their prime*; yet, in order that they may move off quickly, and thus make room for the untested queens, they will be sold for only

\$1.00.

Or I will send the REVIEW for 1893 and one of these queens for only \$1.75. For \$2.00 I will send the REVIEW, the queen and the book "Advanced Bee Culture." If any prefer the young, laying queens from the South, they can have them instead of the tested queens, at the same price. A discount given on large orders for untested queens. Say how many are wanted, and a price will be made.

W. Z. HUTCHINSON, Flint, Mich.

GRAY CARNIOLANS. GOLDEN ITALIANS.

WE are headquarters in the United States for **GRAY CARNIOLANS**. A full description of this *wndefl* and *hardy* race of bees is given in our price list for 1893. Our **GOLDEN ITALIANS** are as good as the best. Each race is bred for business, in a separate apiary near no other bees. Get our prices before ordering, as we can save you money. Descriptive price list free. 5-93-tf

F. A. LOCKHART & CO., Lake George, N. Y.

30 Thirty Year's Experience, 30

Try Our Hardy Strains of Bees.

Leather colored Italians and golden Carniolans. Qualities: extra honey gatherers, long-lived and hardy. To each customer we present our latest method of queen rearing. Catalogue free. Queens \$1.00 each. H. ALLEY, Wenham, Mass.

Queens,

13. Catalogue free. 5-93-tf

3 or 5-banded, \$1.00 each, 6 for \$5.00. Nucleus colonies cheap. Eggs for hatching; B. P. Rock and Brown Leghorn. \$1.00 per CHAS. H. THIES, Steeleville, Ill.

NOTICE OUR PRICES.

No. 1 Sections \$2.75 per 1,000 Thin, surplus foundation, best quality, 50 cts per pound. A full line of supplies, including Root's Dove-tailed Hives, on hand. Send for circular and free sample of foundation 5 93-tf

J. H. & A. L. BOYDEN,

Saline, Mich.

HUNT'S

FOUNDATION

FACTORY.

Send for free samples of foundation and sections; warranted good as any made. Dealers, write for special prices and the most favorable conditions ever offered on foundation. Send for new, illustrated, free price-list of a full line of supplies. M. H. HUNT, Bell Branch, Mich.

Please mention the Review.



Don't Monkey With Cross BEES or Poor Goods. Send for our Catalogue of Bees, Queens and Bee-Keepers' supplies. JOHN NEBEL & SON, 4-93-tf HIGH HILL, Mo.

GOLDEN ITALIAN QUEENS

Now ready for \$1.00 each. Do not order your supplies until you see our circular for 1893. For the price, we have the best spraying outfit made. Send \$1.50 and get one. Wm. H. BRIGHT, 1-93-12t Mazeppa, Minn.

Are You Tired

of New Bee Journals? Send 15 cts for 3 month's subscription to that bright, new bee paper, "The Bee-Keepers' Enterprise," and receive FREE the Enterprise Souvenir — a Work of Art

That will rest Your Eyes.

Burton L. Sage, New Haven, Conn.

LEININGER BROS.

Will sell Italian queens and nuclei cheap the coming season. Write for special prices. 5-92-tf FT. JENNINGS, OHIO.

Ready to Mail, ITALIAN QUEENS,

Tested, at \$1.25; 12 for \$13.00. Untested, after April 1st, \$1.00 each, or 6 for \$5.00. Safe arrival guaranteed. Bees, Drones and Supplies. Circular free. J. N. COLWICK,

4-92-tf

Norse, Bosque Co., Texas.

Please mention the Review.



New Crane Smoker Now Ready.

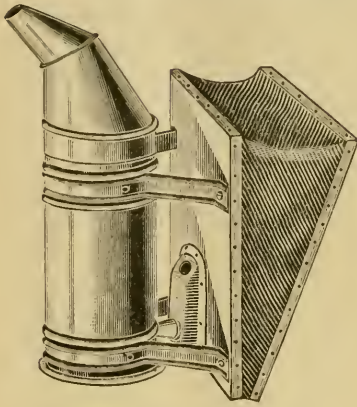

Smoking Capacity and
Strength of Blast
Simply Amazing.

The New, Non-Smoke-Sucking Check-Valve, by which a great blast is secured and the bellows kept clean, and the Double Lining of Asbestos, and Sheet-Steel, by which the fire-cup and nozzle are kept from becoming uncomfortably hot during usage, are **DISTINCTIVE** and **VALUABLE** features alone possessed by the new implement. It would be impossible to tell all of its unique features, and so we say, try it and fall in love with it.

Price, with a 3 $\frac{1}{2}$ -inch fire cup and curved nozzle, by mail, \$2.00; by express, \$1.75. If your nearest dealer in supplies does not keep it, write to the authorized manufacturer,

A. I. ROOT, Medina, Ohio.

N. B. Don't forget that we are headquarters for all kinds of bee-keepers' supplies. Our new 1893 catalogue of 52 pages now ready for mailing.

FOR **A. I. ROOT'S** KINDS OF **KEEPERS SUPPLIES.**
ADDRESS **LEAHY MFG. CO. HIGGINSVILLE MO.**

Free! 200-Page Bee-Book!

TO EVERY NEW YEARLY SUBSCRIBER TO

The Weekly American Bee Journal

32 pages, \$1.00 a year. Send for FREE Sample Copy with full description of Book.

Address, **GEORGE W. YORK & CO., 56 Fifth Ave., CHICAGO, ILL.**

To New Subscribers: The Journal Alone Sent for Three Months for 20 Cents.

PORTER BEE ESCAPES

Are used and pronounced the best, and highly recommended as great labor-saving implements by Chas. Dadant & Son, Prof A. J. Cook, Chas. F. Muth, Jno. S. Reese, J. H. Martin, Jno. Andrews, F. A. Gemmill, Wm. McEvoy, A. F. Brown, Thos. Pierce, and many other prominent bee-keepers. Descriptive circular and testimonials mailed free. **PRICES:** each, postpaid, with directions, 20 cts.; per doz., \$2.25.

RETURN THEM AND GET YOUR MONEY BACK AFTER TRIAL, IF NOT SATISFIED. For sale by dealers. MENTION THE REVIEW. Address **R. & E. C. PORTER, LEWISTOWN, ILL.**

The Bee-Keepers' Review.

A MONTHLY JOURNAL

Devoted to the Interests of Honey Producers.

\$1.00 A YEAR.

W. Z. HUTCHINSON, Editor & Prop.

VOL. VI. FLINT, MICHIGAN, MAY 10, 1893. NO. 5.

TIMELY TOPICS.

No. 4.

R. L. TAYLOR.

"Sowing in the morning, sowing in the sunshine,
Sowing in the noon-tide and the dewy eve;
Waiting for the harvest, and the time of reaping;
We shall come rejoicing, bringing in the sheaves."



MAY should be a very happy month for the bees, for, though there are frequent exceptions, yet, generally, warm, bright days have become the rule, and such days, with the abounding bloom of willows, dandelions,

sugar maples and all manner of fruit trees, invite the bees to an almost continual, although unclaying, feast; and to the bee-keeper, too, if his bees have survived the winter in a condition of vigorous health, this should be a time of cheer; for, though it is not a season of harvest it is a seed-time that, if duly observed, gives promise of abundant harvest in due course.

This is the seed-time because every thing depends on what is accomplished during this month. Honey and other food supplies are the seed and it is not every planting that produces as abundantly; not, indeed, directly in kind, but in bees which must be depended on to gather in kind a little later.

Much may be gathered now but large quantities are needed, and if everything should not prove auspicious, the amount gathered may come far short of what is required. Judicious management and abundant stores now may easily double the future crop, and care and food these days tell more decidedly on the profits of the year than the efforts of any other period; so the apiarist must now, if at no other time, be on the alert to detect the necessities of the apiary and prompt to supply them.

Each colony should be as snug as possible and possessed of a good working queen and an abundance—what would generally be called a superabundance of stores. No colony will do well on the hand to mouth method. It is not easy to account for all the good effects of a superabundance of stores. In taking my bees from the cellar in April I was struck with the fact that those colonies having last fall from forty to fifty pounds of stores seemed to be twice as strong in bees as those having but twenty-five pounds and this condition as a rule will continue. Does it produce a sort of contentment that preserves vigor and longevity? I think so; and the solid walls of honey it may be are just the kind of protection the bees need, and perhaps also when there is so much honey there is not sufficient empty comb for the bees to cluster on and so they are actually compelled to keep warm the honey for their daily use, so that they partake of it without hesitation when needed while those having plenty of empty comb cluster there and have only the cold honey outside the cluster to go

to for food and so actually suffer and maybe starve from reluctance to go outside the cluster. However this may be, it is unquestionably profitable to supply food without stint, not for winter only, but more especially during the six weeks prior to the appearance of white clover. A fear of want on the part of the bees is about as disastrous as an actual want. If one's time is valuable the amount necessary for this work may be reduced within very small limits and if one has time to spare he may, I believe, profitably try stimulative feeding during any periods from the first of May to white clover when honey is not being gathered. Keep all colonies prosperous and get them strong as soon as possible.

If in the natural order of things one has a prospect of more colonies than one desires, about the first of June is the ideal time for reducing stock by uniting those that are not very strong. To put it in another way, if I had two hundred colonies and desired to keep no more than that number, I would gladly have one-half of them cast swarms every year, or more if they would do it early, which I would hive and then reduce to the desired number the following year by uniting, say ten days, before the opening of the early honey season. I have no desire for a race of non-swarmer bees: I want a fair amount of swarming and I want it *early*. It is from such colonies that the large amounts of surplus come. I would not willingly forego the advantage to be derived from the large reinforcement of vigorous young queens that may be had at swarming time for almost nothing, to be relieved of the labor involved in caring for the swarms.

If necessary to be certain of having all the young queens I can use, I remove the colony from which a swarm has issued from beside the hive containing the swarm to a new stand before the queens are due to hatch, and divide it into from two to four nuclei taking care that each has one good cell. In a few days the queens are laying and can be used to replace old queens that are still coming out with swarms or otherwise and the nuclei reunited or given ripe cells and allowed to rear another batch of queens.

Although at times during the spring considerable honey may be coming in, yet there are always some bees on the lookout for honey that can be got in an easier way than the honest way, therefore continual watchfulness during this entire month, if there are

weak colonies in the apiary, is necessary if robbing is to be prevented; indeed, watchfulness should begin at the very opening of spring. Perhaps there is no other item in the management of the apiary that requires the same degree of skill as this, and the difficulty, especially with beginners, is rather in its detection than in stopping it when discovered. Where it is suspected, the most decisive measures should be used to learn the facts, and if it exists to discover and thwart the offending colonies. These matters may best be determined by visiting the apiary just before and just after the bees engaged in honest industry are on the wing. Like human beings, the bees are more in earnest in the doing of evil than in the doing of good; so those engaged in deviltry are busy both earlier and later than those honestly employed. A few minutes at such a time will reveal the whole situation. Ordinary care will prevent danger from robbing except where there are colonies that will not defend themselves. The weakest colonies can protect themselves when so disposed if the entrance to their hive is sufficiently contracted, and every careful apiarist will see that they have at least this much assistance, but when the bees will not defend their hive, contracting the entrance is no remedy. In such cases the only satisfactory method of dealing with them is to exchange the hives, *i. e.*, to put the hive of the robbers in place of that of the robbed and *vice versa*. By this plan the weak colony is strengthened and that by bees that will vigorously defend their new home. And the robber colony—it is laughable to see how completely it is nonplussed by the new arrangement. The altered situation seems beyond the power of their little heads to comprehend. With me nothing but good effects have resulted from the use of this plan while every other is more or less a failure.

It is now time that all preparations for the early honey season should be approaching completion, and, among the rest, plans for securing swarms should be matured. In the first place, I would have all queens clipped, especially would I advise it in the case of beginners, even if queen traps are also to be used, it is such a source of convenience and security. Then I would have at least a few queen traps. Even when one is to have his apiary watched during the swarming time as a rule, yet there are many times when this might be inconvenient and in the early part

of the forenoon and during most of the afternoon this would be hardly necessary; so, during the time when the first few straggling swarms of the season are appearing, a sufficient number to bridge over such times as these I consider indispensable. If one can make them himself the expense is very small and in such case he may well secure a full supply.

LAPEER, Mich.

April 14, 1893.



Successful Wintering of Bees in the Cellar With No Covers on the Hives.—A Bountiful Crop From Alsike.

B. TAYLOR.

"The sea of knowledge with its din
Before us breaks, and we—
We thrust our little dippers in
And think we've drained the sea."



HERE is a bee-keeper, Hitt by name, living at Dover, Minn., who has a local reputation for wintering bees successfully. Having a curiosity to learn his method, I made him a visit last March, and found him to be a retired blacksmith

of about 65 years. The first glance around the premises established the fact in my mind that the owner was a man of more than ordinary good taste. The plain buildings showed neatness without and comfort within.

I at once opened the discussion on the question of bee-keeping by asking if he was engaged in apiarian pursuits, to which he replied "Yes, I still keep bees, but I have been trying for fifteen or twenty years to get out of the business." I asked if it had failed to be profitable. "Oh, no, I never earned better pay than by working with bees, but I am getting old and have too much work to do and will have to give up something and it would be the bees; but I never could get out of the business." He said that several times he sold nearly all his colonies, but in a few years he would have more than ever. They would increase at a wonderful rate and but few ever died. One time he sold all of his *own* swarms, but a neigh-

bor had left a swarm in his care, and when this friend found that he had found a market for all his colonies he was greatly disappointed that Mr. Hitt had not included *his* single colony in the sale; and to pacify him he offered to keep and care for the bees for half the honey and half the increase. In two years he had some thirty colonies again, when he told his friend that he could not stand the trade any longer, that he would give him ten pounds of honey each year for every colony then on hand or he must take his bees away and care for them himself. But after a time they increased beyond his ability to care for them and they were taken away.

I listened to this story in a half amused and interested way, for Mr. Hitt had already told me that he had never read a book on bee-keeping, had never taken a bee journal, but my distrust of his ability to accomplish what he claimed quickly gave place to confidence when I began to question him in regard to his method of wintering. "What is your idea of the key to successful wintering?" I asked. "Well, in my past life," said Mr. Hitt, "I have made it a sacred duty to give all life entrusted to my care an abundance of necessary food. I always made it a rule as fall approached to see that each colony had from twenty-five to forty pounds of sealed honey in its hive, and then I put them all in the cellar on the first approach of real cold weather." "How did you prepare your hives for cellar wintering?" was my next question. Mr. Hitt answered with a look of surprise. "Why, I didn't prepare them at all; I just set them in the cellar in single tiers one or two feet from the cellar bottom. When they became quiet I just took the top off every hive and then let them alone until time to return them to the summer stands again in the spring. No, I never *prepare* my bees for winter at all. I just winter them, and that is all there is of it." "Do you mean to say you leave your hives entirely uncovered all winter?" "Yes, sir; I do not use even a cloth or paper cover. Just leave the top of the hives entirely open, and my bees have wintered with scarcely any loss for the last twenty-five years, and never have a mouldy comb."

Now, Mr. Editor, here was an entirely unlearned man, so far as books or journals are concerned, who was filling the whole requirements of successful wintering. You will yet see, by looking over back numbers

of the REVIEW, that in two articles I wrote a year or more ago, protesting against the, to me, very near criminal advocacy of "sealed covers," by leading bee journals. Such teaching, at this late day of experimental knowledge, raises the question in my mind sometimes whether the bee journals had not, in their well-meaning but careless teaching of unnatural and unproved theories, done more harm than good. Now, if this man had been reading the journals, he, like myself, would have been led to distrust his own practices, as thousands of others have, greatly to his loss; and I have no doubt that this pernicious tampering with sealed covers recommended by so-called great lights, has caused the loss of tens of thousands of colonies in the winter just passed. I see the leading journals are calling for the fullest reports in regard to the success of sealed covers the past hard winter and this is greatly to their credit as showing an honest desire to find the truth. Bee-keepers should make full and careful reports in regard to the comparative results of sealed covers and other methods, and then be *very careful* in the future to recommend nothing as truth until well established experiments have demonstrated the facts. I see Mrs. Axtell, in a late number of *Gleanings*, speaks of their fine success in wintering four colonies, in box hives, but she mentions the fact of their abundant stores and also that other important fact of there being four holes, three by four inches in diameter, in the top of each hive. Here was, I contend, all the "law and the prophets" of the prime conditions for successful wintering.

Those that have read the early writings of M. Quinby will remember that before he adopted the moveable frame hive, that he wintered his box hives by turning them upside down in a dark room and leaving them entirely uncovered, and I say it is an equally good plan to winter frame hives in the same way. How absurd to believe that box hives have any superior quality for wintering, except what accident has given them. Let me here mention that Mr. Hitt uses frame hives.

My own method of covering the hives with one thickness of building paper has some features to recommend it over entirely open hives, viz., equal dryness and a better retention of the heat of the bees. But my present feeling is that a single thickness of cotton sheeting over the hives placed in a warm cellar furnishes first-class conditions for

safe wintering when joined with the indispensable abundant stores.

Last fall, however, I prepared sixty hives as follows and placed them in one division of my new cellar. I gave each colony two sections of my double hive; I removed two combs from each section, leaving eight combs in each. These eight combs were spread to fill the 10-frame hive. The hives were raised two inches from the bottom board. When all was quiet, a square of light cotton cloth was spread over each hive, and on top of this was placed a shallow box three inches deep, full of sawdust. The entrances at the bottom were left open the entire width of the hive, front and rear. Now, remember, these swarms were each left on sixteen combs in two sections of a shallow hive, thus making very roomy quarters. Each had large stores of sealed honey, mostly in upper sections. The temperature was about 42° without 2° of variation.

These bees have remained quieter the entire winter than any like quantity I ever knew, and I examined them to-day (April 6th) and the colonies are all alive and *absolutely quiet*. There is not a speck of dysentery on one of the white hives, and there has been less dead bees on the cellar bottom than I ever had from a like number of colonies. These bees are still in the cellar, and at present it looks like a case of *perfect wintering*; but it does not prove that they might not have wintered equally well without covers of any kind and with less work in preparing. I shall use these bees to fill my new house-apiary which is now being given the finishing touch of painting, and it looks, to my mind, to be as perfect as one could ask. I have managed to find room in the little building (8x16) for forty-six colonies without extra crowding. I shall not remove the bees into it until the soft maples are in bloom and will not pack the hives in sawdust this spring, just cover warmly with sawdust in shallow boxes. I will feed each colony two or three ounces of honey each day, for a month or more, regardless of the supply in the hive. This feeding will be done at the rear of the hive at the bottom, in new feeders that I have made especially for house use, although they are equally good for yard use, in which I can feed the forty-six colonies in thirty minutes without seeing, hurting or exciting a single bee. Now, if this is a good honey year, and I don't get a good crop from the house apiary, then they are

not good, and I have laid myself liable to be condemned for the same fault that I have scolded others, viz., recommending a thing I did not know to be good.

Before I quit, I must report another very interesting fact learned by friend Hitt. He said that several years ago there were forty acres of alsike clover four miles from his bee yard and that his bees made thirty pounds of fine comb honey per colony from it in two weeks. I asked how he knew the honey was made from that field. Well, said he, "I do not *positively* know that they did; but at daylight the bees would fly in immense numbers in that direction, would keep returning from the same direction until dark, the clover was full of bees and there were no other colonies of any account in the neighborhood, the honey flow in my yard stopped when the clover was cut, and it seemed reasonable that they got the honey from that field of alsike, as there was no other visible supply."

FORESTVILLE, MINN.

April 6, 1893.



Experiments to Test the Blast of Smokers.

S. CORNEILL.

"It cannot be, and yet it is."



I N making tests to determine the relative strength of the blast in different smokers, a principal object I had in view was to ascertain which gives the stronger blast, a smoker having an open space between the exit tube in the bellows and the fire

barrel, giving an induced current, as in the case of the Bingham, or one in which the current of air passes through an enclosed passage from the bellows to the fire barrel, as in the case of the Crane. In favor of the latter method it is contended that all the air driven from the bellows passes through the fuel, without any part of it being lost by a reverse current, and that this quantity of air will give a stronger blast, and therefore more smoke, than can be obtained in any other way. Mr. Root says that on account of the "cut off" in the Bingham, the blast

is considerably weakened, and Mr. Bingham does not deny the accuracy of his statement. It is contended by others, however, that smokers of the Bingham pattern have a stronger blast in consequence of the large quantity of air induced to join the current as it passes from the bellows through an open space into a larger tube behind the fuel, even though a portion of the air under pressure in the air chamber "bounds back," as it certainly does, when the barrel is charged with very closely packed fuel.

Mr. Hutchinson, of the REVIEW, kindly furnished me with a Crane smoker and a Bingham smoker, both being of the same capacity in every respect, and I made one of my own of the same size as the other two. Mine differs from the Bingham in having a double "cut off," that is, the air passes from the exit tube in the bellows, through an open space into a larger tube attached to the leg, and from this tube through another open space into a still larger tube, which extends into the fire barrel about half its diameter, preventing the possibility of ashes or cinders falling into the bellows. The fire barrel is supported on legs two and a quarter inches above the bellows, about an inch higher than in the case of the Bingham.

The fire barrels were all new and clean. I removed the barrels and tested the bellows for leakages. The Bingham and my own were air tight, and after making some little repairs the Crane was air tight also, except at the junction of the air passage in the checkvalve with the covered passage to the fire barrel. At this point there is a little leakage which I could not see any way to prevent.

Instead of testing the Crane against the other two to decide the merits of the enclosed current as against the induced current, I decided to temporarily convert the Bingham and my own into enclosed current smokers, by connecting the bellows with the fire barrels by means of tubes well cemented at both ends; and after testing them in this way, removing the tubes, and testing them as induced currents smokers, all the other conditions, as to capacity and obstructions, being the same for both tests. By placing the hand over the mouth of the fire barrel, and pressing the bellows, I found that, after the tubes were cemented, I had two air tight smokers, having enclosed currents.

It has been contended that, in order to have a fair test, the fire barrel should be

filled with planer shavings. To overcome the difficulty of packing three fire barrels equally tight, I made a cylinder of wire cloth, four meshes to the inch, and over one end I sewed on a cap of eight meshes, to prevent the fuel from wasting. I then put in basswood planer shavings, packing them down with the handle of a hammer, till it was within half an inch of being full. In correspondence with Mr. Crane he expressed the opinion that his smoker would give a stronger blast through a charge of fuel, particularly if there happened to be a layer of spent fuel on the grate. To get a layer, offering an obstruction equal to this layer of spent fuel, I first laid a large piece of cheese cloth over the shavings in the cylinder, and on this I packed enough fine sawdust, from beneath the table of my foot power saw, to fill the cylinder. I next doubled over several thicknesses of cheese cloth, and over all I sewed on a grate, having legs as in the Bingham. To make the cylinder a tight fit in the fire barrels I wrapped around it, and sewed fast some four or five thicknesses of cheese cloth, making it so tight that it required considerable pressure to send it down in the barrels, and requiring a bail to draw it out.

In my experiments I first put this cylinder in one barrel and noted the result. I then withdrew it and placed it in another barrel, and so on. In this way I had exactly the same obstruction in each case.

I wish to say in passing that I now think I overdid the matter in packing the fuel so tight. I believe that an examination of the cylinder, now in Mr. Hutchinson's possession, will show that the obstruction is greater than ever occurs in practical work. In consequence, the Bingham smoker and my own, which had most to lose by a reverse current, showed up to worse advantage than they would have done with an ordinary charge.

To enable me to hold the nozzles firmly at the same distance from the instrument, I bored a hole in a board to take the nozzles, and nailed the board to brackets, so that I could fasten it down on edge.

With these preparations I went to Toronto and was fortunate in there meeting with Mr. Gemmill, president of the O. B. A., who kindly assisted me in the experiments, which lasted over two hours. I am under obligations to Messrs. Smead, David & Co., for the use of their anemometer.

After some preliminary trials we decided that after each stroke of the bellows we

would wait till the force came to a dead stop before giving another puff, and that in each experiment one of us should give four puffs, and note the result, then the other four puffs, and note the result again. The figures below show the distance travelled by the indicator as the result of four puffs on the fan.

EXPERIMENT NO. 1.

Enclosed currents in each smoker. Empty fire barrels. Distance from anemometer 17 inches.

Smoker.	Operated by		Ave.
	Corneil.	Gemmill.	
Bingham	18	21	19½
Crane	10	12	11
Corneil.....	36	36	36

EXPERIMENT NO. 2.

Enclosed current. Fire barrels loaded. Distance 12 inches.

Smoker.	Operated by		Ave.
	Corneil.	Gemmill.	
Bingham	16	18	17
Crane	10	10	10
Corneil.....	30	30	30

EXPERIMENT NO. 3.

Bingham and Corneil smokers with induced currents, the connecting tubes being now removed. The Crane as before. Fire barrels empty. Distance 17 inches.

Smoker.	Operated by		Ave.
	Corneil.	Gemmill.	
Bingham	28	22	25
Crane	11	10	10½
Corneil	52	50	51

EXPERIMENT NO. 4.

Air currents same as in No. 3. Fire barrels loaded. Distance 17 inches.

Smoker.	Operated by		Ave.
	Corneil.	Gemmill.	
Bingham	10	10	10
Crane	6	7	6½
Corneil	12	12	12

Comparing the average in No. 1 with the average in No. 3 we have

	Enclosed currents.	Induced currents.
Bingham	18½	25
Crane	11	—
Corneil	36	51

Unfortunately through an oversight, which I did not discover till after I returned home, experiments Nos. 2 and 4 were conducted at different distances. On this account we cannot make an accurate comparison in the case of the Bingham and the Corneil smokers, with enclosed and induced currents, when the barrels were loaded. I regret this very much. The Crane was in the same condition in both experiments, except as to distance. At 12 inches the distance travelled by the indicator is represented by 10 (see experiment 2), and at 17 it is 6½ (see experiment 4). Supposing the results in the cases of the other two smokers to

vary in the same proportion as they did in the case of the Crane, the result of experiment No. 4 at 12 inches would have been as follows:

Bingham.....	15	5-13
Crane.....	10	
Corneil.....	18	6-13

Substituting these figures for those in No. 4, and comparing Nos. 2 and 4, we have

	Enclosed current,	Induced current.
Bingham	17	15 5-13
Crane.....	10	
Corneil.....	30	18 6-13

The foregoing experiments show that, with fire barrels loaded with very closely packed fuel, the induced current is weaker in the Bingham and in the Corneil smoker than it is in the same smokers with an enclosed current, such as these smokers had had; and it shows that the enclosed current in the Crane smoker is weaker than either the induced or enclosed current in the other two smokers. How much of this weakness should be attached to the slight leakage above mentioned it is difficult to say, but I am of the opinion that, considering the expenditure of force required to open the checkvalve, and the loss through friction in a long air passage, and in turning a right angle, it is not possible to construct a Crane smoker, having a blast as strong as that of the Bingham, when each is loaded with an ordinary charge of fuel. The experiments show also that in every case the blast in the Corneil smoker is stronger than it is in either of the others. The greatest volume of smoke necessarily accompanies the strongest blast, when the fuel is properly managed.

The relative strength of the blast of two smokers may be tested approximately, without an instrument, by placing a handful of heavy tacks or light wire nails on a table and blowing upon them with one of the smokers, at such a distance that the current will disturb them just a little. Then try placing the nozzle of the other smoker at the same point, and blowing, it can easily be seen which blast is the stronger

The three smokers and the cylinder of fuel, just as they were, when I made them, are now in the possession of Mr. W. Z. Hutchinson, of the REVIEW, who, I am sure, will willingly lend them to anyone wishing to repeat my experiments.

LINDSAY, Ont.

April 6, 1893.

[After reading Mr. Corneil's article I was quite a little puzzled to comprehend why there should be so much difference between

the Corneil and Bingham smokers when both were used with enclosed currents. Both had the same size of bellows and fire barrel, and with a tube passing from the bellows to the fire barrel it seemed to me that they were *exactly identical*. There was only one point in which I could conceive that there might be a difference, and that was in the size of the openings for the blast to leave the bellows. I wrote to Mr. Corneil for an explanation, and found it was as I suspected. It is impossible to give Mr. Corneil's explanation in full in this issue, although I may do so at some future time, but I will try and give the gist of it. Among other things he said:

"The tube in the Corneil bellows is 42-100 of an inch in diameter. I have not measured the tube in the Bingham so accurately, but I believe it is about 5-16, making a difference of less than 1-8 of an inch in the size of the tubes. * * * * I do not believe that delivering a bellows full of air against the fan in the time required by the Corneil, instead of the longer time required by the Bingham, affords a complete explanation. When testing the smokers for leakages, I found that if the pressure was continued and the vent kept closed, only a short time was required to close the bellows, although there was no perceptible escape of air. The air must escape through the walls of the bellows. Since the time required for discharging the air of the Bingham bellows is greater, a correspondingly greater proportion of the air would escape through the walls of the bellows. * * * * In using the size of tube that I did it never occurred to me that its differing in size from that of the Bingham would effect the result, but I can see that a blast *might* be reduced, by using a small vent, to such a state of attenuation that it would not reach the fan at all, at 17 inches, but would be overcome by the resistance of the air between the nozzle and the instrument. To a slight degree the Bingham blast may be affected in this way, but it is hard to believe that it accounts for the whole of it. * * * * There is now an element of uncertainty as to how much I gain by my induced currents. I may try the whole thing over again. You see when we commence to experiment we never know what may be revealed."

When I met Mr. Bingham last winter at our Michigan State convention, we talked smokers long if not loud, and he called my attention to the fact that the size of the vent in his smoker bellows was the result of careful experiments. If smaller than it is, the blast would be too weak; if larger, it would be so strong that fire and sparks would be driven out at the nozzle. The present size is the "golden mean."

Of course, the true test of a smoker is actual work in the apiary. If it suits there, if

it does the work with the greatest satisfaction, that is the smoker that is wanted. At the same time, when it is asserted that such and such a smoker has the strongest blast, it is only by such tests as Mr. Corneil has taken the trouble to make that the truth can be known. I sincerely hope that Mr. Corneil will repeat his experiments, and that he will guard against every possible uncertainty. It may seem unimportant, but I think the smokers ought all to be *new* throughout. I presume that Mr. Root would be glad to furnish a new Crane made exactly the size that is needed to compete fairly with the others.—ED.]



How California Bee-Keepers Might Secure Better Prices for Their Honey.

“RAMBLER.”

“Through wisdom is a house builded; and by understanding it is established.”



WHILE the questions of the best bees, the best all purpose hives and the best bee pasturage are agitating the best thoughts of the California bee-keepers,

there is the still greater question of the most profitable marketing of the product, which not only interests California bee-keepers, but all bee-keepers as well. The first 400 lbs. of honey obtained in California sold for \$1.50 to \$2.00 per lb. This was comb honey and obtained in not particularly fancy style, the mere fact that it was comb honey and of limited amount boomed the price.

The rapid increase of bees, however, soon enabled the producer to ship honey to the eastern markets, and in 1873 the first full car load was sent across the continent.

The first shipments of honey resulted in good profits to the producer. California honey was a novelty to eastern people. The amount was limited and the price had an upward tendency. Larger shipments, however, had a tendency to equalize the markets, though up to the time of the introduction of

the honey extractor, it is claimed that the California comb honey shipments were highly remunerative, and many of the older bee-keepers regret that the extractor was ever introduced, claiming that when extracted honey was sold on the coast at 3 and 3½ cents per lb. that it in like manner deteriorated the price of comb honey. The extractor is, however, in the field to stay and the distribution of our honey at a fair price is the problem.

The same problem of distribution and sale at remunerative prices confronts the fruit grower, and more intensely, from the fact that the product is increasing rapidly every year, and when shipped direct from the tree or vine it is of a *perishable nature*. The distribution, like that of honey, has been through commission houses. The results, too, are not wholly satisfactory and new methods are sought after. Along these lines fruit and honey have a common interest, and the plans that will benefit the fruit grower will also benefit the honey producer.

Fruits and honey have heretofore been massed in large quantities in a few trade centers from which distribution takes place with all of its attendant good and many evils, when applied particularly to honey. As the production becomes greater, radical changes in methods of distribution become a necessity and several plans are outlined by fruit growers. They consist mainly in sending fruits in car lots to the large cities to be distributed direct to the consumer by salesmen and in such a manner as to advertise the section of country from which the fruit is shipped. These plans if carried out in our large trade centers would result in antagonizing the commission men, and there might be a rivalry that would defeat the end sought for. A better plan, it seems to me, would be to combine interests and ship car load lots of fruits, nuts and honey to the smaller towns that are not likely to be supplied and instead of working from the center out and competing with the commission men, work from the circumference toward the center and thus between the commission houses and this plan the whole country would be covered. The more of our products we could sell to the outlying towns would so far relieve the pressure upon the great centers of distribution and better prices would be sure to follow.

The success of this plan when applied to the distribution of honey would necessitate

a radical change in the style of package, especially for extracted honey. While the 60 lb. can is the standard for wholesale shipments from California, smaller packages of ten and five lbs. would have to be used. In this matter of distribution in small packages we have a very good example in the way maple syrup is put upon the market, and of small packages for honey I find California remarkably free. A small standard package for this State and the sale properly pushed would result in a large home demand for our product.

The small package in connection with the larger wholesale package would give our product a wider application in trade and would enable the producer to sell his honey direct to the consumer under his own label or trade mark. If bee-keepers themselves would put their honey upon the market in this way instead of allowing the adulterator to repack it for him, there would be less dissatisfaction with the honey markets.

In studying the fruit and bee-keeping industries of California and comparing their past history, present condition and future prospects, I believe that the bee-keeper has less external obstacles to contend with than the fruit grower. Fruit production is enormously on the increase and a greater amount is thrown upon the market every year. Honey production on the other hand fluctuates, and if the production has not already attained its highest point it will do so in the near future unless a cultivated honey plant comes to the front. The sterile mountains do not yield honey in amount equal to the fertile valleys, and the rank growth of honey plants in the valleys, where our tons of honey have been distilled, is being rolled under by the plow of the home-seeker, and the bee-keeper is compelled to fold his tent and depart.

The proper distribution of honey is not only of vital interest to the California bee-keeper, but it has an equal bearing upon the eastern producer. It is a well known fact that towns of 10,000 population and under, that are remote from the great centers of distribution, seldom have upon their markets honey from California. It is also a fact that thousands of towns of 5,000 population and less are inadequately supplied with honey of any kind.

The first movement then toward the development of a new and better method of distribution and sale is a thorough organiza-

tion of bee-keepers; next is the working up of the home markets; next the outlying unsupplied markets; these points attended to, the great centers will take care of themselves. At this stage of bee-keeping it is time to give the problem of distribution more attention. Let us heed the signs of the times and be up and doing.

RAMBLER.

REDLANDS, Cal.

March 16, 1893.



Criticisms on the B. Taylor Plan of Preventing Swarming and the Offering of a Substitute.

H. P. LANGDON.*



WHAT bees can be worked as commoners without fighting as Mr. B. Taylor says on page 71 March REVIEW, is a settled fact, and thereon hinges the key to the important question of non-swarming. Mr. Taylor says

he sometimes had great loss of unsealed brood by exposure in trying to work two colonies together. This has not been my experience in running bees from one hive to another; but supposing this does occur, why is it any worse than caging or removing the queen *entirely* for *two or three weeks* at the beginning of the honey season, as do Manum, Elwood, Hetherington and a score of other head lights? They claim it to be an

* Herbert P. Langdon is 30 years of age and has always lived in Constable, his native town. His father and grandfather, who were farmers, having kept a few bees, and he, being more of a mechanical turn of mind, than a "born farmer," became interested in them, and when they finally got down to one swarm "fussed" it to death. In 1882 his father purchased him eight colonies, from which he has increased to 175, and in 1882, just over the Canadian line where his out-apiary was located in 1890, he built the largest house apiary in the world. Bees have been the means of bringing him the greatest happiness of his life, as they have some other bee-keepers, for he was married to the daughter of a prosperous Scotch Canadian farmer in 1892, and an acquaintance comically said: "What is the difference between Sampson and 'Herb.' Langdon? One found the honey while he was going to see his best girl, while the other found his best girl while going to see to his honey." He was elected and ordained to the office of Ruling Elder in the Presbyterian church at the early age of 26.

advantage and *prove* it, too, by their honey yields. To the idea of unqueening I was converted almost against my will by an impartial trial of it. I thought the queen, like an engine in a shop, must be kept going; but, like friend Taylor, I have been looking for something better than hunting queens and cutting cells.

I have no doubt the plan outlined by the use of the double hives will work, as far as non-swarmer is concerned, *provided* the cells *are* cut once a week, but, according to my experience, there are objections that will make it impracticable.

A double hive need not be used for a trial of this; simply place two hives side by side with both entrances in front. Before swarming time comes, turn one hive with the entrance to the *rear*. This throws the flying bees into the other hive, which holds the supers for the two hives. One week later turn the reversed hive back to the front, cut out cells, if any, shift the supers to this hive and turn the entrance of the other hive from front to back.

So far, this *may be* all right, as friend Taylor says, but a week after *this*, when the shift is again made, the trouble begins; for during these two weeks a force of bees nearly as strong in numbers as those in front, and being constantly added to, have become located at the *rear* of the hives, and they simply jump from each closed hive—which holds the supers—to the other with their loads of honey, just where they are not wanted.

In fact, they act just like a "teeter board," for while the force in front jumps from one hive to the other, following the supers, the rear force also jumps to the hive just reversed, thus keeping the hives equalized with bees cocked and primed for swarming, which is only prevented by cutting out cells at each transfer of supers. The rear force is also storing honey all this time in the brood combs, *instead of the supers* on the hive from which they are excluded.

However, the working of two *whole* forces of bees in the same super is a grand good one.

There are also good points in favor of self-hivers mentioned in the same number, if nothing better could take their place, but as has been said by some one in the journals. "No self-hiver will be a success, that catches the queen and allows the swarm to go into the air and return to any hive they choose." This is self-evident from the fact, that,

sometimes, in a large yard, half a dozen swarms seem determined to enter the same hive on returning. This is my experience.

Dr. C. C. Miller said in one of his late "Straws" in *Gleanings*, that I had a plan whereby bees had not even the *desire* to swarm, and said the "proof of the pudding was in the eating." So I have, and I ate quite a slice of this "pudding" last season in the shape of an extended trial of 100 colonies, so I know whereof I speak. There are no hives moved, no queens hunted, no cells cut out, no combs handled or even the opening of brood chambers—and all this *without discouraging the bees*. It meets the requirements of the editorial on page 301, November, 1892, more fully—especially when combined with the house-apiairy—than any other invention in apiculture since the frame hive came into use.

EAST CONSTABLE, N. Y. March 28, '93.

[For a description of the non-swarmer arrangement referred to by Mr. Langdon, see the "Extracted Department."—ED.]



Vital Points in the Construction of Honey Extractors.—How They May be Reversed While in Motion.

E. A. DAGGITT.

IN this age of advancement, no progressive bee-keeper will remove the honey from the combs in the old antiquated way of crushing the combs and draining and straining out the honey, often giving a composite product of honey and bee-bread, to which is sometimes added the juice of crushed bee-larva and wax worms. Even if these objections did not exist, the waste of valuable comb would be both foolish and extravagant. An extractor will, of course, be used for the purpose, for by a proper use of it we save the combs and get only pure honey.

This machine should be strong and durable and as light as possible consistent with these necessities. It should do its work with efficiency and rapidity. The tendency in getting up this machine has been in the direction of cheapness rather than utility. This is a mistake, for it should be as perfect in its sphere as a locomotive in its.

Since its invention the extractor has been greatly improved, but ample room is left

for still further improvement. Indeed I am confident that it can be so far improved, that its capacity can be almost if not quite doubled, and at the same time be more easily operated. How it can be improved I will endeavor to show, but before doing so I wish to call attention to two of the most important improvements in it.

The first is the invention of a reel without a shaft, that revolves on gudgeons, as in the duplex and hollow reels of the U. S. honey extractor, and that allows the combs to be reversed without removing them from the reel; and, second, the invention of the reversible extractor that reverses the combs without handling them. If the first has not been as successful as it should have been, it is because it has not been properly made and put on the market, and shows that it is not best for any one person to have a monopoly of manufacture and sale of any one article.

The oldest invention of a reversible extractor that I ever saw, was in the *American Agriculturalist* of about 1873. I believe the time will come when all extractors will be reversible and those for small honey producers will also embody the hollow reel principle.

Extractors should be neatly finished and attractive. They should be strong and durable, yet as light as possible without sacrificing these necessities. A stand should constitute a part of every extractor. The reel shaft should run down through the stand and have its lower boxes attached to it. In large extractors at least, there should be attached to the stand a frame work to support the standard or cross bar that contains the upper reel box. This arrangement takes all strain from the can as it should be, and allows it to sit in loose.

The gearing to revolve the reel should have the crank at the side of the machine. The crank should be slip-g geared with its shaft, and should move in a vertical plane. The rest of the gearing may be at the top of the machine, but I think it best to have it at the bottom and sides—horizontal shaft and spur gear at the bottom and sprocket wheels and chain belt at the sides.

The brake should be applied directly to the reel shaft or an enlargement of it, at the bottom. It may be a simple lever operated by the foot, the small arm pressing against the shaft. It would be better to use two such levers placed horizontally with each other

and have their longer arms pressed apart by a toggle joint, while the small arms grasp the shaft.

The reel should be stiff and strong and made of steel. The material should be put in such forms as will give the greatest strength with the least amount of material, so as to secure lightness. The proper working of the machine depends more on this part than on any other. That I may be more clearly understood hereafter, I will say that by reel, I mean the whole revolving frame work which carries the combs, and its attachments within the can; in a complete reel consisting of shaft, or gudgeons as in hollow reels, a top and bottom horizontal frame work, which for convenience I will call spiders, posts or uprights, comb baskets or pockets, and reversing apparatus when the machine is reversible. The parts of a spider are: hub, spokes or arms, and side bar.

The most important improvement yet to be made in the extractor is the addition of a device for reversing the combs while the reel is in full motion or nearly so. This improvement would so increase the capacity of the extractor that few bee-keepers will require a larger one than a four frame, and I think it can be added to the machine without much increasing its cost. An illustration of such a device is given in the leader on the present topic in the last issue of the REVIEW. The device shown is what I call the horizontal shaft device. The principle on which it works is shown by the engraving and the explanations of it in the leader, but not as clearly as it should be; so I will try and make the matter plainer. A round collar should have been shown on the reel shaft and the cogged upright that gears with the spur wheel on the inner end of the horizontal shaft, should have been set to one side and attached to the collar by a flange so as to allow the horizontal shaft to be set in line with the diameter of the spider. The cogged upright could be attached directly to the collar and the horizontal shaft set out of line of the diameter of the spider, but such an arrangement does not look so well. The collar should have a perpendicular groove in the inside of it to receive a pin attached to the reel shaft so that it will revolve with the shaft. It should have a neck to it above the flange and cogged upright. In this neck should be a horizontal groove to receive a band made in two parts and joined together at opposite sides of the collar. At these two

points of junction of the band two arms of a bar should be attached. This bar should run up through the standard or cross bar close to the horizontal bevel wheel on the reel shaft and should be joined to the lever by a link. The lever should be attached to a fulcrum that is rigidly attached to the standard.

If preferred a hollow reel shaft can be used and the collar and its attachments can be moved up and down by a core or rod in the shaft. This core has a cross pin attached to it that passes through slots in the reel shaft and into the collar. The core is joined to the reversing lever by a revolving joint and link connection. My first idea was to move the core by having a revolving cap like those used on carpenter braces, attached to it. The lever fulcrum and guide can be attached to a circular bed plate that surrounds the shaft and is held in place by a collar. This will allow the lever handle to be placed in the position that best suits the operator. The reel shaft should be thicker where the slots are cut into it, and the lower journal should be solid and pass into the hollow part of the shaft. This, I think, will make a nice arrangement, especially if the gearing to give motion to the reel is at the sides and bottom of the machine.

WHITE HOUSE STA., N. J. April 17, '93.

(To be continued.)



If the Porter Escape Lacks Capacity, Experiments Have Not Proved It.

R. & E. C. PORTER.

MR. AIKIN'S theories regarding bee-escapes, as given in the last issue of the REVIEW, although plausible, as such, are not in accord with the facts in the case as we find them in actual experience. While, on first thought, it seems reasonable to suppose that enlarging the exit capacity, or increasing the number of outlets of an escape, would proportionately increase the rapidity of its working, yet extensive and pains-taking experiments, made by ourselves and others, during several seasons of practical work in the apiary, with a view to determining this very question, have satisfied us that nothing is gained in time by the use of more than one properly constructed

it.

Experiments to prove any thing regarding different forms of escapes must, necessarily, be comparative and made with great care, under precisely the same conditions, or erroneous conclusions will be reached, especially as there are so many influences, aside from those any particular characteristic of the escapes themselves may possess, that have their effect to vary the length of the time occupied by the bees in passing through them. The time of the day the escapes are put on, the state of the weather, the presence or absence of a honey-flow, the different dispositions or traits of the bees of the different colonies, or whether or not they have unsealed brood or a queen below, all these have their effect.

Limited tests, made with but one form of escape, as were those made by Mr. Aikin, can prove nothing regarding any *other* form.

It seems almost needless to add that the reason the Porter escape, which, by the way, is not, as some seem to suppose, merely a particular or specific form of escape, but which, on the contrary, embraces all forms in which one or more laterally yielding or leaf springs are used (see the Porter patent application filed Aug. 10, '91, issued Jan. 10, '93), is on the market in the form that it is, is because, after having been carefully tested for an entire season by several expert bee-keepers in a large number of different forms, embracing those in which the bees pass out *under* the springs, those in which they pass out *over* them, those in which they pass out *between* them, those in which they pass out between them and the *sides of the escape*, those having exits varying from one to a dozen, and those in which perforated tin was used for the tops, also for both tops and bodies, this one (the one adopted) proved in every way the best. The universal favor with which it has been received after extensive use in both America and Europe, the sale of thousands with the privilege of being returned and having money refunded, if, after trial they are not found superior to all other kinds of escapes and satisfactory in every way, but not one returned nor a word of complaint from any one, and the scores of complimentary letters received, lead us to think that we have made no serious mistake in the matter. Yet, even this will not cause us to remit our endeavors to improve.

LEWISTOWN, Ill.

April 22, 1893.

Bee-Keepers' Review.

PUBLISHED MONTHLY.

W. Z. HUTCHINSON, Ed. & Prop.

TERMS:—\$1.00 a year in advance Two copies, \$1.90; three for \$2.70; five for \$4.00; ten, or more 70 cents each. If it is desired to have the REVIEW stopped at the expiration of the time paid for, please say so when subscribing, otherwise it will be continued.

FLINT, MICHIGAN, MAY 10, 1893.

MAN GROWS as higher grow his aims.

(ONE MAN'S STORY is no story at all—hear both sides.

THE LAMBTON (Ont. Canada) Bee-Keepers' Association will meet in the Town Hall, at Sarnia, on Friday, May 19. As this is on the line between the two countries, a special invitation is extended to the United States bee-keepers to attend the meeting. This will also be an excellent opportunity to visit that triumph of engineering skill, the St. Clair tunnel. The editor of the REVIEW expects to be present.

"THE ENTERPRISE" is to be the name of a new bee journal that is to be published monthly at New Haven, Conn. Burton L. Sage is the editor and proprietor. I have not yet seen a copy, as the first issue is not to appear until the 15th of this month, but, judging by the prospectus sent, I can agree with Bro. Root in saying that it will rival in appearance any of the journals now published.

"BEE-KEEPING FOR PROFIT," is the title of a little book by Dr. G. L. Tinker, of New Philadelphia, Ohio. When the book was first brought out, three years ago, it was given an extensive review in these columns. Geo. W. York & Co., of Chicago, Ill., have now re-published the work, adding a chapter on "Pasturage a Necessity," taken from Mr. Newman's book, "Bees and Honey." Some additions have been made to the work, particularly in regard to perforated zinc and its uses.

"THE PROGRESSIVE" comes out with a new title page engraving which, among other things, shows the evolution of the bee-

hive. At the bottom is the straw hive, next the log gum, then the old style of Langstroth, next the Dovetailed, and at the top the "hive we prefer," or the "Higginsville Hive," which is a dovetailed hive with a raised cover. The last number gives an illustration and write-up of some of the leading smokers. A department for beginners is to be added, and this is to be printed in German. The *Progressive* is living up to its name.

EIGHT EXTRA PAGES again this month, and still there are several articles that it seemed *must* go in. I could only commence the discussion of "Extractors and Extracting," and I have articles from such men as E. France, Frank McNay and Dr. Miller. I commenced on the one sent by Mr. Daggitt as it was so long that it could not all have been given in the next issue. I have always rather prided myself on the small size of the REVIEW. I have felt that it should be small but *good*. When it was enlarged to 28 pages I said to myself, "This is the last time it shall be enlarged," yet this is the third time within the last six months that I have been *compelled* to add eight extra pages. Is it possible that another permanent enlargement is actually *forcing* itself upon the REVIEW?

MR. R. C. AIKIN writes that he would be glad to have bee-keepers try his plan of running two colonies together and preventing swarming, and that it may be done without buying his hive. Almost any ordinary hive may be used by fastening the frames so that the hives may be inverted, or the hives may be alternated, but with the alternating plan the queen cells would not be inverted, and whatever advantage, if there is any, that may be gained from their inversion would be lost. If hives were used that had no space at the bottom, the separating board would need a bee space on each side. The equalizer and alternator are a little difficult to describe, and samples are needed to work from. They can be mailed for 15 cents.

PREVENTION OF SWARMING by shifting the field force, and with it the supers, from one hive to the other, is certainly a new idea, and it appears to be an important one. There are different methods of accomplishing this, that of turning the hives end for end, as de-

scribed by B. Taylor, that of using one hive above another and reversing or alternating them and using a peculiar device at the entrance that will conduct the returning bees into the upper hive, as brought out by Mr. Aikin, and the use of bee-escapes and passageways to keep the bees out of one hive and turn them into another, as invented by Mr. Langdon. The latter has stood the actual test of one season's work with 100 colonies. There may yet be some details that will need remodeling with any of these plans, but the fundamental principle of shifting the bees from one hive to another is one that I believe will eventually settle the swarming problem. The freest criticism and fullest discussion is invited in the REVIEW.



A MODERN BEE FARM—NEW EDITION.

This first number of the REVIEW contained a review of this work by S. Simmins of England. A copy of a new and revised edition lies on my desk. I will notice briefly some of the points not found in the first edition.

All may gain health and pleasure in bee-keeping, but only the few who have special qualifications may expect to find fortunes.

Honey in the comb will ever remain a luxury, but extracted honey is destined ere long to be found in general use in almost every family in the land. (Comb honey is nearer a staple than is extracted, and I think it will remain so. Extracted has to compete with cheap syrups and the like.—Ed.)

Extracted honey is more profitable to produce than is comb honey. (Don't agree. No one industry, or branch of an industry, is more profitable than another. If it were, it would soon be overdone and brought down to its proper level. It is the *man* and the environments that make one business more profitable than another.—Ed.)

Bees can always be united without fighting if they are first made queenless.

The use of supers with no space or passageway between the tiers of sections is recommended. How a practical bee-keeper can recommend such an arrangement is beyond my comprehension. The increased amount of propolis used and the killing of bees in replacing supers are enough to condemn the arrangement.

If porous covering is used above the cluster in winter, a small entrance is allowable;

if "sealed covers" are used, then the entrance should be generous. "Sealed covers" should always be covered with some warm material.

With the Simmins non-swarming system as now used, the comb built in the lower frames is not cut out and fitted into the sections, but foundation is fitted into the sections, or, rather, half-sections (sections one-half the width of regular sections) and when sufficiently drawn the sections are placed in the supers.

Bee escapes ("bee-traps" they are called) are condemned. They were much in vogue some fifteen years ago, says Mr. Simmins, but fell into disuse, and he is greatly surprised that advanced apiarists should be entrapped into thinking there is anything to be gained by re-adopting this old and discarded fad. (The bee escapes of *America* have come to stay.—Ed.) The instructions for removing sections are to give a few puffs of smoke which will generally send all (?) the bees below. If this fails, take out the combs one at a time and brush off the bees with a feather. I fail to see any health or pleasure in removing sections one at a time and brushing off the bees, and there is certainly no profit. A whole case at a time, and no bees in it, is the way to remove honey. It is urged, and truly, too, that the work of taking them off one at a time, must be done quickly, or the bees will bite holes in the cappings to get a sip of honey, particularly if it is after the honey season. The bee escape is objected to on these very grounds, that the disturbance will cause the bees to bite the holes in the cappings. I fear that Mr. Simmins cannot have had experience along this line. This is one very *strong* argument in favor of escapes, as everyone knows who has removed honey late in the season. The putting in of the escape board is a very slight disturbance compared to taking the sections out one at a time and brushing off the bees with a feather. An escape board can be put in place so quickly that the bees will scarcely look upon it as a disturbance.

Sections of honey that are a little "off" in color can be whitened by exposing them to the light and air. I knew that wax could be bleached in this manner, but it never occurred to me that combs of honey might be whitened in this way.—Ed.)

The Simmins method of direct introduction of queens by the fasting plan is to keep the queen confined without food at least half

an hour before she is to be released. She is then to be allowed to run down from the top of the hive after darkness has set in, using a lamp to see to do the work. It makes no difference how long or short a time the colony has been queenless, or if it has brood or not, or queen cells in any stage of development. The colony must be left undisturbed two days. This method is almost invariably successful. If a queen dies in a cage it is from lack of food or because she has been injured by the bees outside the cage. To remedy the latter fault, have the meshes of the wire cloth not larger than a pin head.

The Wells system of working two queens in one hive with a division of perforated metal between them, or with a solid division but a union of force in the supers, is not supported by Mr. Simmins. He says that it simply shows that at the right time, viz., at the main harvest, there should be a large force of workers in proportion to the amount of brood. Here he agrees with Gravenhorst. He says that at the close of the season a permanent division must be made between the two colonies or the bees will all join one queen and allow the other to perish. He says that queens once fertilized never fight. He has had as many as a dozen fertile queens in one compartment with no injury to any of them. I had always supposed that fertile queens would fight, but come to think of it, I do not know as I have seen them fight. It is the workers that get up a row

EXTRACTED.

Effectiveness of Smoke From Propolis.

"And out of their mouths issued fire, and smoke, and—propolis."

When at the Washington convention I heard Mr. J. E. Crane mention the very pungent quality of smoke that comes from the burning of cloths covered with propolis. He covers his bees with burlap, and when the covers become too "stuck up" to be handled with ease, he uses them for fuel. Mr. Manum, in one of his chats with a neighbor, as related in *Gleanings*, "gets off" the following:—

"What is it you are burning in your smoker, that smells so strong?"

It is particles of propolis sprinkled over the fuel in the smoker-barrel. Mr. J. E.

Crane told me of this when he was here a few days ago; and I tell you, Charles, it is worth knowing. I never tried any thing that would just drive the bees out of the way as nicely as this will. I think it would be a good plan to melt up a lot of propolis and dip pieces of wood into it, and keep them handy by, to be used whenever the bees are troublesome, for it will quiet them in a moment."

A Novel and Inexpensive Feeder.

Many bee-keepers would probably try feeding bees in spring, before the beginning of the regular honey flow, were it not for the trouble and expense of getting feeders. Those who wish to give it a trial need not be deterred for this reason, as here is a feeder, described by Mr. F. S. Comstock, in *Gleanings*, that costs almost nothing. Here is what Mr. Comstock says:—

"Having 70 colonies we bought 70 one-quart tin cans. In the bottom of these cans, with a smooth awl, and from inside out, we punched a hole large enough to drop a $\frac{3}{8}$ inch, flat, smooth-headed wire nail in easily, but leaving a good catch for the head. All our hive boards have a two-inch hole in the center, covered with a block which becomes glued, and these give us no trouble when not in use. We place these cans over these holes; carry a faucet can of 70 lbs. of honey to the center of the yard, and, by the use of a coffee-pot, we have, in 20 minutes, fed 70 colonies a pound each, more or less, as desired, and not seen a bee, nor chilled one either. The wire nail makes the feeder work automatically. By looking into the can after feeding, you will see the head of the nail shaking about. This is caused by the bees. It regulates the flow, and keeps any sediment from clogging the feeder."

Around many houses may be found empty tin cans in which fruit or vegetables have been bought, that could be used for this kind of feeders.

An Artificial Watering-Place After Nature's Ways.

"The very law which moulds the tear,
And bids it trickle from its source."

My old apiary at Rogersville was near a small stream. On warm days in early spring, and again in August after the honey flow from basswood was past, I have seen the sand along the edges of this stream fairly alive with bees sucking water. I am reminded of this by reading the following in *Gleanings*.

"Observant people will notice that bees, while drinking at a branch or pool, never sip the water, but abstract it from the sand close by, through which, by the way, it has

filtered by capillary attraction. Trying always to get close to Nature's ways I built me a watering-place for my bees. A trough of wood 14 inches square and one inch deep was filled up with clean sand, and a three-gallon demijohn filled with water was inverted over it, its mouth resting on a thin block half an inch under the sand. The surrounding sand soon absorbed moisture, and little air-bubbles could be seen, displacing slowly the water in the jug, as the water in the sand exhausts. By scooping out a little hole in the sand, enough water will gather to furnish the poultry. Put syrup in the vessel, and you will have the best outside feeder I know of, for there is no end to the extent of the sand surface you may use, and the sand does not foul, as water or syrup would if given alone. In order to introduce this to the bees I put a piece of comb honey on the sand. After they had carried off the honey they looked about for more, and, discovering the water, have found out that it is a near and good thing. The principle of this watering device is well known, but I have not heard of the use of sand in that connection. Please give this a trial, if you have not such in use, for there is nothing new under the sun. To hold up the jug or bottle, bore four holes in the bottom board, and put in pegs, or, better still, nail a half-hoop of tin or strap iron against a wall or board fence, and put the jug mouth down through it.

ARTHUR T. GOLDSBOROUGH.

Washington, D. C., Sept. 1."

An Easy Method of Transferring and Getting the Honey out of the old Combs.

No one who has ever transferred bees by cutting out the combs and fastening the crooked, uneven things into frames, fancies the job. It is not only unpleasant, but it is wasteful. Several years ago Mr. Heddon gave a method whereby this might be avoided. It consisted in driving out the bees, or most of them, and hiving them on a set of frames filled with foundation. Three weeks later, when all of the brood had hatched in the old hive, the bees were again driven out, the young queen hunted out and killed and the bees given to the swarm that was first driven out. This left the old combs free of brood, and the honey could be strained or extracted, and the combs melted into wax. Warm weather was necessary for this plan, otherwise the brood in the old hive would be chilled. The editor of *Gleanings* tells in his journal how he used a modification of this plan, even carrying it so far as to compel the bees to carry the honey out of the old combs after the brood was hatched out. This plan also has this advantage over the Heddon, it can be put in practice even if the weather is not warm. Here

is the description of the plan and of the circumstances that led to its use.

"Along in the early part of the summer we purchased some twelve or fifteen colonies that we really did not want, but took them because we had partially agreed to do so. The reason that we did not really want them was because the combs were built in loose frames, said frames having been spaced so unequally that the combs were decidedly crooked, to say nothing of being bulged out of all decent proportions. The bees purchased were placed at the out-yard, and the boys were instructed to select one of the best combs of each colony containing unsealed larvae, and place it in a new hive, together with a full complement of Hoffman frames of wired foundation. Another hive with the old combs was placed on top with a perforated zinc honey-board between. The bees and the queen were then shaken off in front of the entrance, and allow to crawl in. This plan was pursued, with all the colonies. As the queen could not go above, of course no more eggs were laid in the old combs. In two weeks' time we went down and found that the frames of foundation below were being drawn out, particularly next to the frame of brood of old comb. In the mean time the young bees in the upper story were hatching out and coming below to take care of the young larvae in the lower hive. In about a month's time the bees had taken up their quarters more or less below, while the upper combs, crooked and undesirable, were emptied of brood, and filled, to a greater or less extent, with honey. The drone brood (and there was a good deal of it) was uncapped at the time the hives were changed. The honey season came on rather before we expected it in the out-yard; and the result was, that most of the crooked combs were filled with honey. These we expected to extract, and melt up the old comb; but circumstances so transpired that we did not; and finally, toward the end of the season, we took off such combs and placed in a stack of Dovetailed hives piled six or eight high. The entrance at the bottom hive was contracted so that only about two bees could get out or in at a time. Virtually we allowed the bees to rob the honey out; but it was so slow an operation that it made no commotion in the apiary.

With little or no labor we had the bees all transferred on Hoffman frames, filled with nice beautiful worker comb made from foundation on horizontal wires; and all that remained was a lot of crooked combs which were soon converted into wax, the home-made frame stuff making excellent fire-wood for the boiler-furnace.

Now, there is nothing particularly new in any of this. The plan of transferring is simply a modification of Heddon's short way, mentioned in the ABC book. The scheme of emptying the honey out of old crooked combs was nothing more nor less than what was described by Dr. Miller some two or three years ago. It works so well that we shall never again leave a lot of combs stored here and there with a little honey in them to tempt robbers."

How Young Queens are Lost in Queen Rearing.

"Mother, dear mother, come home."

Mrs. Jennie Atchley, that veteran queen breeder of the "Sunny Southland," writes as follows to the *C. B. J.*

"I have discovered that queens do not often get lost on the mating trip; but, upon their return, are apt to enter the wrong hive and get killed. As we keep several hundred nuclei together, or in adjacent yards, we have had scores of queens return to the wrong hives, which, being queenless most of the time, they were accepted. But she always destroys the cell that is in the nucleus. I noticed that where there are only one or two hives apart by themselves the queens do not get lost. Even the drones in the drone hive will scatter all over the yard, and queens act pretty nearly the same way. Who ever found a queenless bee-tree? I do not believe that one queen in a hundred gets lost or is captured by birds; they simply return to the wrong hive and get killed. If I had time I could tell you a long story of what I have learned of queen mating."

I agree entirely with Mrs. Atchley. I have often noticed that when a nucleus stood off by itself, or was in some peculiar hive, there was no loss of young queens. Don't set your nuclei in regular, prim rows. Scatter them about, the more promiscuously the better. If they can be situated in a grove, or among buildings, so that the queens can have something as a landmark, so much the better.

Bee Journa's and the Supply Business.

"For the gift blindeth the wise, and perverteth the words of the righteous."

It would seem that some apicultural editor had been bragging that *he* didn't deal in supplies, if we are to judge from the following which appears in the *Progressive Bee-keeper* for March.

"It seems that some of our editors are trying to make capital out of the fact that they are not in the supply business. If they are so narrow and contracted that they cannot give good honest advice for fear it would hurt their business, it is well for them that they are not. If we look back over the field of bee journalism we will see that the editors and founders of our best journals, were dealers, and the same editors are to-day giving us the best journals we have devoted to bee culture."

It seems scarcely possible that the foregoing was aimed at the *REVIEW*, as that journal has done very little crowing over its lack of a supply trade. In fact, its editor has come so near being in the supply business that he couldn't consistently say very much.

When the *REVIEW* was started, its editor was in the queen trade and he has not yet dropped it. When he gave up the production of honey as a business, he advertised the fixtures on hand. Several times it has become necessary to take goods in payment for advertising, and then it became equally necessary to advertise and sell them.

From actual experience I have learned that it is very difficult for the editor and proprietor of a bee journal to never offer anything for sale except his journal; and perhaps there is not so much praiseworthy in keeping bee journalism entirely free from trade as some of us have imagined. Yes, I know that the most of us poor mortals are more or less given to bias and prejudice in favor of our own wares, and I would not for a moment ignore this point, but, on the other hand, the dealer is more in touch with the consumer, he knows what practical men are buying and using, and this experience has its influence upon his journal. If he uses his journal, or rather *misuses* it, to boom his goods at the expense of truth, or at the expense of space that ought to have been used in giving good, valuable reading matter, there will be a reflex action—it will become a boomerang.

Class journals are a little peculiar in this respect. The men who have had experience in some lines of business are the ones in position to make valuable journals pertaining to these kinds of business. A nurseryman can make an excellent horticultural journal. An advertising agent can get up the best journal devoted to advertising; yet he deals in advertising; while the other man sells fruit trees.

Another point, in making a financial success of a journal, a dealer or manufacturer can sell his journal at a very low price because it advertises his goods.

While I have no desire to engage in the supply business, preferring simply the *REVIEW* and a small apiary, with peace, quietness, happiness and contentment, in place of a large business with its hurly burly, even if accompanied with greater financial success, yet I have had no quarrel, and shall have none, with the man who prefers the latter; as I fully believe that the brightest journal, the one filled with the freshest and most practical ideas, the one with "a touch of Nature" upon its pages, can be made amid the hum of bees and buzz saws.

The Langdon, Non-Swarming Device.

For several months I have known that Mr. H. P. Langdon, of East Constable, N. Y., last year devised and put into successful practice a device for preventing swarming. It was used in connection with his house apiary described in the last REVIEW. It is not until now that Mr. Langdon's arrangements for patenting have reached that stage where he is ready to publish a description. The following is an extract from an article written by Frank Benton and printed in Vol. V, No. 4, of *Insect Life*, a journal published by the Agricultural Department at Washington, D. C. I hereby thank this journal for courtesies extended in the way of furnishing advance proofs and cuts.

"Although the self-hiver in its more perfected form has scarcely been subjected to a

The immediate condition which incites a colony of bees to swarm has been quite well recognized as its general prosperity—its populousness, the abundance of honey secretion, and crowded condition of the brood combs, or, in general, such circumstances as favor the production of surplus honey especially surplus comb honey, and it has of course been taken for granted that honey could not be secured if these conditions were changed. Nor would it, without any knowledge of the system proposed by Mr. Langdon, be easy for experienced bee-keepers to believe that all it proposes to do could be accomplished without much manipulation and perhaps also the use of some complicated device. I was, however, agreeably surprised at the whole simplicity of Mr. Langdon's plan, when, in December last, he made it known to me and sent a non-swearer for purposes of illustration. And in answer to the request as to what I thought of it, I wrote him at once that I was of the opinion that he had made one of the most valuable additions

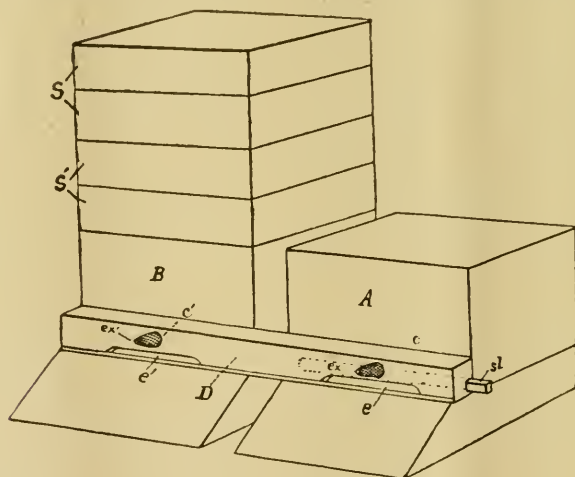

Fig. 31.—Bee Hives with Langdon non-swearer attached: A, B, hives; S, S' supers; D, non-swarming device; e, e' entrances corresponding to hive entrances; sl, slide for closing entrance; c, c', conical wire cloth bee escapes; ex', exits of same.

thorough test it promises to do all that has been expected of it. But it will not take away the desire to swarm.

This is exactly what Mr. H. P. Langdon, of East Constable, N. Y., says he can do by the use of the non-swarming attachment invented by him and now for the first time made public. Moreover, he keeps all of the field force of his colonies storing surplus honey under the most favorable conditions as long as there is any honey to be obtained in the field or forest, and simplifies to such an extent the work of the apiary during this portion of the year that he can attend to several times as many colonies as under the old way.

to the list of apiarian inventions that had appeared in a long time—one that, after the frame hive, would rank equal with or ahead of the honey-extractor and comb-foundation machine.

Mr. Langdon has applied for letters patent on his device in this and other countries, and with the specifications as a basis, a copy of which he has kindly sent to me, together with permission to make the matter public, I have written the following description of the device and system.

At the beginning of the honey season the non-swarming device D, shown in Fig. 31, is placed at the entrance of two contiguous hives each of which contains a queen and

full colony of bees. The continuous passageways, *e* and *e'*, on the under side of the device, correspond to the entrances of the hives A and B, respectively. The bees will then pass, quite undisturbed, out of and into their respective hives through these passageways. By inserting the slide, *sl*, in the end of the non-swarmers until it occupies the position indicated by the dotted horizontal lines the passageway leading to hive A will be closed at its juncture with the hive-entrance, preventing any bees from entering said hive. The wire-cloth cone exit, *ex*, still permits flight-bees to come out of hive A, as a hole *h*, Fig. 33, through the non-swarmers

non-swarmers by the bees at the entrance, *e*, and with these bees will enter hive A, thus bringing about in hive B the same conditions as were previously induced in hive A by closing the latter. At the same time the field-bees of both hives are working continuously in the supers on the hive A, the entrance of which is open, and the flight-bees in hive B are escaping through the cone exit, *ex'*, and joining those of hive A.

In about a week the supers are again placed upon hive B the entrance to which is then opened while that of hive A is closed. In another week another transfer is made, and so alternately during the flow of honey.

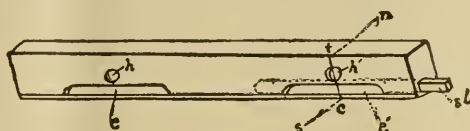

Fig. 33.—Langdon non-swarming device; rear view, showing apertures (*e*, *e'* and *h*, *h'*) corresponding to similar openings in the fronts of hives.

connects the cone exit, *ex*, with a corresponding hole, *h*, Fig. 32, in the front of hive. The super cases *S* of hive A are then placed on those of hive B.

The flight bees of hive A finding their hive-entrance closed on their return are, upon alighting at the entrance *e*, Fig. 31, attracted along the gallery shown at *g*, in the cross-section, Fig. 34, by the buzzing of the bees at the entrance *e'* of hive B, and enter said hive. This withdrawal of the field-bees from hive A leaves this hive so depopulated and so disconcerts the nurse bees left therein that they will not swarm; meanwhile work is going on without interruption in the supers on hive B by the field force of both hives.

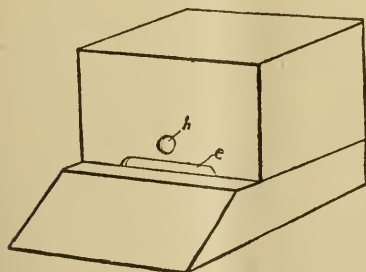

Fig. 32.—Hive showing entrance (*e*) and hole (*h*) corresponding to like apertures on back of non-swarmers.

At the expiration of eight or ten days, thus before the bees of hive B have made preparations to swarm, the super, *S* and *S'*, Fig. 31, on this hive are all transferred to hive A, the slide, *sl*, is withdrawn from entrance *e*, thus opening this hive, and is inserted in the opposite end of the non-swarming device so as to close the entrance *e'*, to hive B. The bees thus excluded from hive B will be called along the gallery, *g*, Fig. 34, of the

This alternate running of the field-bees from one hive to another and back again, and the simultaneous transfer of the supers, so disturbs the plans of the nurse-bees and temporarily depopulates the hives successively closed, that organization for swarming is not effected, hence, *no swarms issue, and the field-bees of both hives work unitedly and without interruption throughout the entire gathering season.*

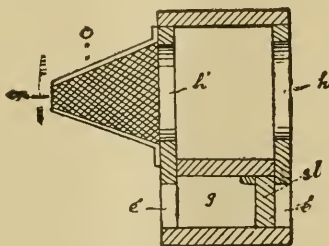

Fig. 34.—Langdon non-swarming device; cross-section at sectn. (Lettering as before)

The experienced bee-master will not only readily see that this meets the requirements mentioned in the first part of this article as advantageous to secure, but also that in many other ways it is likely to prove a system of great value in the apiary. Mr. Langdon has mentioned some of these and I will therefore quote from his letter:

- (1) Two light colonies that would not do much in sections if working separately make one good one by running the field forces of both into the same supers.
- (2) No bait sections are needed, as the bees can be crowded into the sections without swarming.

(3) The honey will be finished in better condition, that is, with less travel-stain, because the union of the field forces enables them to complete the work in less time.

(4) There will be fewer unfinished sections at the close of the honey harvest, for the reason just mentioned.

(5) Also for the same reason honey can be taken off by the full case instead of by the section or holder full.

(6) Drones will be fewer in number, as a double handful will often be killed off in the closed hive while the other is storing honey rapidly.

(7) Artificial swarms and nuclei can be more easily made, as combs of brood and bees can be taken from the closed hive in which the queen can be found very quickly.

As there is in carrying out this system of swarm prevention no caging of queens, cutting out of queen cells, manipulation of brood combs or even opening of the brood chambers at all during the honey season, and all the vexatious watching for swarms and the labor and time involved in securing these are done away with, and instead of this a simple manipulation attended to not oftener than once a week is substituted, it is plain that very many more colonies can be managed by one person, and, indeed, Mr. Langdon informs me that he 'can care for 200 colonies with one day's work in a week with no help, instead of working all the time with 100 colonies.' It will, therefore, prove a great boon to all having numerous out-apiaries.

One of the greatest advantages over any plan for the prevention of swarming yet proposed, which Mr. Landon's system will have, should it prove on further trial all that it now promises, is that it will not only prevent more effectually than any other the actual issuance of swarms, but, while not requiring any manipulation antagonistic to the known instincts of bees, it will prevent all desire to swarm, will completely do away with the 'swarming fever,' so fatal to the hopes of the comb honey producer. Another great feature of it will be the more rigid selection of breeding stock, which it will facilitate. Intelligent selection can accomplish for this pursuit as much as it has done for the breeders of our larger domestic animals. Furthermore, a strong natural inclination to swarming on the part of any race of bees, otherwise possessed of very desirable traits, will not, under this system, oblige the rejection of such race. Eventually the disposition to swarm must through constant suppression become less, or, in time it may even disappear, giving us the long-sought non-swarming strain.

A brief statement of the success which has attended Mr. Langdon's practical test of his system during 1892, will be of interest in this connection. In a letter dated December 24, 1892, he wrote:

Last season I tried the device on 100 hives. Except in one instance the bees did no fighting. Why they do not fight when united in this way I cannot say. It certainly did not discourage them in honey gathering, for my yield from the 100 hives was 6,000 pounds of comb honey or an average of 60 pounds per hive, some pairs yielding 150 pounds, and it has been counted a poor season for bees in my locality this year. After one season's trial of the device and plan I do not know of a single fault or objection to it.

A Condensed View of Current Bee Writings

E. E. HASTY.

It seemed like going to extremes for Prof. Cook to declare, as he did a bit ago, that he knew of no literature less in need of improvement than that pertaining to apiculture. His point seems to be well taken however. There is grumbling enough at our papers, to be sure; but the real trouble in most cases is lack of enthusiasm on the part of the reader. What ever can an editor do for the man who is disgusted with the *subject* of apiculture? Nothing, except he plunge deeper into comicalities and side issues; and this, although it may temporarily stop the grumbling, makes matters worse in the end. Yes, we would gladly see our papers better, but they are already better than those devoted to most other specialties. I wanted one day an example of how *not* to write—wanted an article spending the opening one-third of its space in explaining why the reader need not expect anything worth reading, or some equally idiotic trash—and I did not find one. They used to be common enough. This high grade of excellence which our average paper has reached is liable to be a stumbling block to the editor who reads outside literature much and bee papers little. He thus unconsciously judges himself by a standard which is too low.

AMERICAN BEE - KEEPER.

This paper is edited by one of the most gentlemanly and excellent of men, and therefore its reviewer finds it quite unpleasant to say that it seems of late to be getting down in *relative* merit, and going below its classmates. The fact seems to be that its large supply business gives it great advantages in obtaining and holding subscribers, and it leans on these advantages too hard—good paper though, if we could only refrain from comparing it with its cotemporaries. Perhaps I forget that we should not expect as many strawberries for 50 cts. as we get for a dollar. And I'll try to disprove my own position by working hard at the *seriatim* of the March number.

Friend De Witt, who appears each month, does a very fair job at posting the beginners.

Order your supplies in spring; and read your bee paper, if you have one.—(S. E. ИТЧНСОК.)

"Sometimes I think the poor seasons when we have to study and work for the benefit of our bees, are the best ones in the end." Mrs. Hollenbeck.

Next Franklin Thorn, a New Jersey school teacher, keeping some bees for his health, rather turns the dial back for us to the time when it was not unusual to be *interested* in bees.

"Anything but a desirable race of bees. (Punics.) * * * Have you ever noticed how much quicker a light in the cellar will disturb the Italians than the Carniolans? * * * A few years ago I noticed that the colonies that had all buckwheat honey for winter stores came out of winter quarters in better condition than those that had white honey. * * * Buckwheat honey does not become thin and sour when in the cellar nearly as quickly as white honey." F. A. Lockhart.

The same writer advises asparagus tops slightly wet with kerosene to cover the doorway of a colony that is being robbed. Friend Lockhart seems to be a man of ideas, and a person we shall be willing to hear from any time anywhere.

C. F. Teel of Elmont, Texas, rather pathetically illustrates how *not* to do things when foul brood is around. But it generates itself, foul brood does.

The selection of copied articles is Demaree's "Outlook," and a chat of H. D. Stewart's from the *Guide*, and Jennie Atchley's very excellent transferring article from *A. B. J.*, and a picture and life sketch of John F. Gates from the *Canadian*.

The February number swallows the nonsense about a single ounce of honey representing millions of miles of travel; but older papers have done the same.

T. R. Common (page 20) seems to add somewhat to the knowledge of drone playgrounds. He locates them on the lines where workers are passing back and forth. I think he is wrong however in supposing that the fertilization of workers is anything more than an extremely rare occurrence. A worker bee rudely seized by its fellows puts out a tiny drop of honey if it has any, as a ransom for its life perhaps. If it is true that drones habitually seize workers on the wing I suspect it is because they have learned this as an easy way to get refreshments. Perhaps it is only play, or idle wantonness of which they expect nothing. Awaiting final judgment let us have more witnesses as to the exact facts.

The initial article of the year by C. J. Robinson is an extra good one. And Dr. Tufts, on page 5, gives valuable observations on fertile workers as below.

"Although I have many times seen them in the act of depositing eggs in the cell, I never could detect that the other bees paid them any particular attention. I have at various times caught and killed a bee when I found her depositing eggs. I could not see, however, that it decreased the egg production in the hive to any extent, which surely ought to be the case if only one was concerned in egg laying."

Mrs. Henze, on page 7, gives a singular case of the effect of stings on her baby. Badly stung on Thursday, swelling did not occur to marked extent at the time; but the next Monday both ears swelled to twice their natural size.

On page 8 what seems to be very pestilent advice is given to beginners about winter tactics. It is indeed said to disturb as little as possible; but still the idea is conveyed that to pull the hive up from the bottom board, and to open it and look in at the bees from the top, are proper things to be done every week if desired—just the naughty tricks beginners are too much inclined to do any way.

THE PROGRESSIVE.

This is our baby, and it's sold to Higginville: so any comments on the cut of its editorial jib would be out of date. By waiting a bit we shall find out how its present master, Mr. R. B. Leahy, sets a jib. Apparently its family of correspondents is not to be very much changed and we will sample them as below—

"Have to pry and pull and sweat to get the first frame or dummy out." Jennie Atchley's compliments to the Hoffman frame, page 3.

"Two crops of about 100 lbs. as an average per colony, so far this season, * * * with prospects for a third one. * * * I am the last man located up the St. Lucie river, [Florida] 10 miles from a neighbor, 50 from a store; * * * baching it. * * * 'Tis sweet here among the mosquitoes and sand flies." A. F. Brown, page 4.

"Plenty of honey and a good tight hive will do more toward getting bees ready to gather the harvest than any other method, and it is perfectly safe for a beginner." Editor Quigley, page 17.

There, now! We might have known that Mrs. Atchley was a man in disguise, with a Jennie glued on to his name. Listen to him once.

"I will just let him have the little lick and quit, rather than argue too far." Page 18.

Such disguises are more certain to get out than murder is, Mr. Jennie.

"You will find there the crank, the bore and the talkative person, the agreeable man, the thinker and the modest person; but in no other place will you meet such genuine cordiality." Bee convention as seen by E. R. Garrett, page 19.

"O'er all the world a golden ray
Of peace and happiness is cast,
While nature's myriad voices say,
Old winter grim and cold, is past."
W. W. Mitchell, page 38.

"Well! Here we are, but we don't know as much about running a bee journal as we did a month ago." New editor, page 50.

By the way, *Progressive* hardly got a fair show in my comparative count. The January number was mostly taken up with the report of a bee convention, all chopped up into little short paragraphs, and thereby it missed words, missed more than a thousand of them. In fairness we should accept the February count, 7,124, instead of January with 5,959. Also *A. B. J.* calls attention to the fact that its count was not full justice, owing to the fact that five numbers a month come in four times a year. Allowance for this would raise its monthly total from 58,675 to 63,564.

THE GENERAL ROUND UP.

'Nother baby to spank, there's going to be. It expects to arrive in this baby-devouring world May 15th; and Burton L. Sage, New Haven, Conn., will rock it. The youngster's name is *The Bee-Keepers' Enterprise*. But no undertakers need apply just yet, as the editor claims to see his way clear for two years ahead without asking baby to pay board.

Saul among the prophets! Demaree comes out in the *Guide* with a new kind of sugar-honey. We shall almost expect to see Bro. Newman putting an improved glucose on the market now.

An interest seems to be developing in the beautiful Italian clover that may result in advantage to the bee fraternity in some localities. I believe I saw no bees visiting mine; but I had only a very few, and long ago.

Weygandt, a German, thinks he has success in supplying bees with pulverized wax inside the hives. He reduces the wax to powder with alcohol. *A. B. J.*, 268. A Yankee might guess that those bees simply blew the powder away, and then drew on their own pockets for the wax.

An isolated case of a drone mating with a worker bee is said to be proved up in Germany. *A. B. J.*, 268.

During one fall and winter Mrs. Atchley had 100,000 pounds of honey retailed in the two cities of Dallas and Fort Worth. *A. B. J.*, 301. Looks like biz. And she tells us not

to sell the dark honey, but to eat it ourselves. Not right. With some of us half the crop is dark; and it takes me several months to eat 50,000 pounds of honey. With both on the wagon, and a reasonable concession in price, I find the dark honey sells as readily as the best.

"Years of experience have proved to me that each of the united colonies would often pull through alone, while if united [in early spring] all would perish." Doolittle. *A. B. J.*, 306.

Hear the *Canadian* on the difficulty of reporting conventions with satisfactory accuracy—

"The best reporter on the face of the earth will make mistakes; if he doesn't the speaker whom he is elaborating will; if either or both forget this plain part of their duty they may rest confident that the compositor will attend to it."

If anybody has thought Rambler's vein exhausted he should read *Ramble* 79 in *Gleanings*. He is still quite able to get into queer situations, and "sling English" without being troubled with a lame arm. Notice how the skies change from blizzard to Indian summer when a season-footed resident drives up and lends them a whiffletree.

"Here we are, ten miles from a house, in a howling wilderness, with bears, wildcats, coyotes, and a broken whiffletree—its all your fault.
* * Blessed be the name of Joe Beals and his Spanish wife. Blessed be his dozen (more or less) half breeds; and blessed be his horses and oxen, his dogs and his bees."

Next I think I must read *Gleanings* a little lecture. It not only inserts the following rank nonsense, but actually heads it "sensible words." Page 178.

"In England a fruit grower was surprised to find that, in one corner of his garden, in which were placed colonies of bees, the trees were heavily laden with fruit, while those more remote had set very sparingly. Then he called to mind the circumstance of its being very dark and foggy during the blooming of the trees, so that the bees flew but a short distance from their hives."

Of course if the fog and darkness were such that bees could not find the way from one tree to another throughout a garden they would not come out at all. Moreover they show no preference for flowers near the hive over those 40 rods away—probably prefer a moderate fly. How easy it is to attack wrong statements when they are of no profit to us, and yet cravenly take the advantage of misconceptions when they happen to be in our favor! By the way isn't the above yarn an old customer that we have been dealing with for the last 25 years? Brethren, let us straighten up.

Bees were not carried to Tahiti, south Pacific, till 1870. Thousands of colonies there now.

And now the idea is pushed that we don't need any bee escape at all, beyond a simple orifice or tube.

"The cause that induced them to leave prevents them from going back." William Halley, *Gleanings*, 173.

Glad to see once more J. H. Nellis, the old "boss" after whom thou and I, friend Hutchinson, used to ride years ago. He brings out the singular fact that although *now* bees snowed under deep all winter are spoiled by over breeding and loss of vigor, it didn't use to be so previous to 1870. *Gleanings*, 172.

That accidental bee candy of Miss Wilson's that kept in perfect condition for more than a year, may possibly prove a very valuable discovery—if they can find out *why* the process that contemplated cake-frosting turned out soft candy that would not dry. Quite possibly the syrup underneath kept it moist at first, until the egg, without spoiling, took a changed character, seasoned and impervious, which prevented loss of moisture at last. I hear that eggs do not beat up well the same day they are laid—so their virtues are a varying quality. See *Gleanings*, page 167.

Vogel in Germany says the workers and not the queen are the reigning element in the hive. *Gleanings*, page 169. I should say *public sentiment* reigns in a bee hive; and *sometimes* the feelings of the queen count more in forming public sentiment than the votes of many hundred workers could do.

The Germans are also digging earnestly into the facts in regard to the queen's spermatheca. Metzger finds, as might be expected, that the immense number of sperm cells required are not all developed in the beginning and kept on hand; but the development of them goes on steadily during the season of laying.

That scale record on page 103 of last REVIEW surprises me, and knocks one-half of the appetite for cellar wintering out of me. There must be something weak and rotten in the system if bees are going to eat two pounds a month in November and December. That is double the normal consumption—weather being moderate. Kind o' smell that they are in a strange place, and prisoners, and worry a trifle about it, 'pears like.

RICHARDS, Lucas Co., O. April 19, '93.

ADVERTISEMENTS

WILL SACRIFICE
SUPPLIES. WRITE FOR LIST.

I also have "office helps" for sale. 3-93-tf

JNO. C. CAPEHART, St. Albans, W. Va.

Please Mention the Review.

BEE-KEEPERS'
SUPPLY HOUSE

J. H. M COOK, 78 Barclay St., N. Y. City.

(SUCCESSOR TO A. J. KING.)

4-93-tf

Send for illustrated Catalogue.

Please mention the Review.

Bee Hives and Section Boxes.

Simplicity, Langstroth-Simplicity, Standard Langstroth, Dovetailed and Champion Chaff Hives, Supers, One-Piece Sections and Shipping Cases. Foundation. Smokers, etc., etc. Send for 16-page Circular.

1-92-tf PAGE & KEITH, New London, Wis.

Please mention the Review.

HAVING PURCHASED the entire stock and business of W. D. Soper at Jackson Mich., I am now prepared to furnish Apiarian Supplies to all who have usually purchased of Mr. Soper, and to all others who wish Apiarian goods at the lowest prices. Orders filled promptly. Send for price list and circular.

E. H. TRUMPER,

4-93-3t

Bankers, Mich.

Please mention the Review.

Muth's HONEY EXTRACTOR
PERFECTION
Cold-Blast Smokers,

Square Glass Honey Jars, Etc.

For Circulars, apply to CHAS. F. MUTH & SON, Cor. Freeman & Central Aves., Cincinnati, O. Send 10c. for Practical Hints to Bee-Keepers.

1-93-tf.

Please Mention the Review.

TYPEWRITERS.

Largest like establishment in the world. First-class Second-hand Instruments at half new prices. Unprejudiced advice given on all makes. Machines sold on monthly payments. Any instrument manufactured shipped, privilege to examine. EXCHANGING A SPECIALTY. Wholesale prices to dealers. Illustrated Catalogues Free.

TYPEWRITER { 81 Broadway, New York.
HEADQUARTERS, { 186 Monroe St., Chicago.

Please mention the Review.

Barnes' Foot and Hand Power Machinery.



This cut represents our Combined Circular and Scroll Saw, which is the best machine made for Bee Keepers' use in the construction of their hives, sections, boxes, etc.

11-92-76t

MACHINES SENT ON TRIAL.

FOR CATALOGUE, PR ICS, **SYTO.**,

Address W. F. & JNO. BARNES CO., 384 Ruby St., Rockford, Ills.

IF YOU WANT THE

BEE BOOK

That covers the whole apicultural field more completely than any other published, send \$1.00 to Prof. A J. Cook, Agricultural College, Mich., for his

Bee-Keepers' Guide.

Liberal Discounts to the Trade.

Please mention the Review.

Warranted Purely Mated.

Italian honey queens. They are very prolific and their workers cannot be excelled in gentleness and industry. Nothing but the choicest queens sent out; try me and see. Send your order at once Single queen, 80 cts; 3 for \$2.00; 6 for \$4.00; 12 for \$7.75. Ready April 30th. 1-93-6t

M. H. DeWITT, Sang Run, Md.

Please mention the Review.

TESTED QUEENS

\$1.00 Each.

Light, large and prolific Italian queens reared in Jan 1892, by the most improved methods. Orders filled by return mail.

J. W. K. SHAW & CO.,

4-94-7t

Loreauville, La.

Please mention the Review.

3 & 5 Banded Queens

AND

2 & 3 Frame Nuclei

A SPECIALTY.

	April	May
One untested queen,.....	\$1.00	\$1.00
Six " queens,.....	5.00	5.00
One tested queen,.....	2.00	1.50
Three " queens,.....	5.00	4.00
Select tested queen,.....	2.50	2.50
Two-frame nucleus with any queen	\$1.50 each,	
extra. Three-frame nucleus with any queen	\$2.25 each, extra.	Safe arrival guaranteed.

W. J. ELLISON,

3-93-3t

Catchall, S. C.

New as Well as Valuable

IMPROVEMENTS

IN BEE-HIVES, SMOKERS,

FOUNDATION FASTENERS,

SECTION PRESSES AND FEEDERS.

Special prices given to parties who will take hold of and push the sale of these goods. For circulars and particulars, address

LOWRY JOHNSON,

1-93-tf.

Masontown, Pa.

COMB FOUNDATION

AND SECTIONS.

—:O:—

CAUTION.

Do not buy a thick, heavy base comb foundation for use in your sections when you can get 14 to 16 square feet to the pound. Also be sure and buy your sections where you can get a nice box at a low price. Send me your address and I will be pleased to send you a sample section, a sample of the

THINEST COMB FOUNDATION MADE,

And prices at which they may be bought.

W. H. NORTON,

2-93-t4.

Skowhegan, Me.

Please mention the Review.

THE PROGRESSIVE BEE - KEEPER

Has Changed Hands. It is now Published by the **LEAHY MANUFACTURING CO.,**

Higginsville, Missouri.

Money, Experience and Enterprise will not be lacking to make it all that its name indicates. Send for Free Samples and Copy of 28-page Catalogue of Apiarian Supplies.

HILL'S SMOKER and FEEDER.

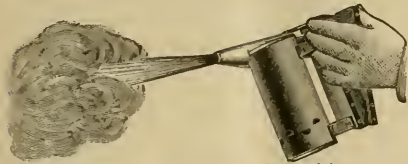

Smoker burns hard wood chips without special preparation. Very reliable. Greatest smoking capacity. Easiest to start. Cheapest because it saves time. Price, \$1.20. By mail, \$1.40. Per dozen, \$10.80.



Best Bee-Feeder. Most convenient. Saves feed. No daubing or drowning. Two to seven feeders full may be given a colony at one time which will be stored in the combs in ten hours. Price, per pair, 30c.; by mail, 40 c.; per doz., \$1.60. Has a sale of 2,000 per month. Address A. G. HILL, Kendallville, Indiana.

These smokers and feeders are kept in stock by Thos. G. Newman & Son, Chicago, Ill
 G. B. Lewis & Co., Watertown, Wis.
 W. H. Bright, Mazepa, Minn.
 Chas. Dadant & Son, Hamilton, Hancock Co., Ill.
 E. Kretschmer, Red Oak, Iowa.
 H. McWilson & Co., 202 Market St., St. Louis, Mo.
 F. H. Dunn, Yorkville, Ill.
 W. D. Soper & Co., Jackson, Mich.
 Chas. A. Stockbridge, Ft. Wayne, Ind.
 A. F. Fields, Wheaton, Ind.
 W. S. Bellows, Ladora, Iowa.
 E. F. Quigley, Unionville, Mo.
 Gregory Bros., Ottumwa, Iowa.
 Miller Bros., Bluffton, Mo.
 G. K. Hubbard, Ft. Wayne, Ind.
 Theodore Bender, 18 Fulton St., Canton, Ohio.
 Muth and Son, Cincinnati, Ohio.
 Levering Bros., Wiota, Cass Co., Iowa.

Please mention the Review

QUEENS, A large number of fine ones on hand; yellow and prolific; ready April 15th; warranted queens, \$1; 6 for \$4.50; select tested, yellow to the tips, suitable for breeders, \$2 each. Reference, A. I. Root 3-93 tf
 W. H. LAWS, Lavaca, Seb Co., Ark.

Please mention the Review.

DO NOT GIVE YOUR ORDER FOR SECTIONS UNTIL YOU GET OUR PRICES ON THE "BOSS" ONE-PIECE SECTION

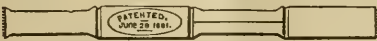

We are in better shape than ever to fill orders promptly. Also,

DOVETAILED HIVES, - - - - -
 - - - FOUNDATION, SMOKERS, ETC.

Write for Price List.

J. FORNCROOK & CO.

WATERTOWN, Wis., Jan. 1, 1893. 1-93-tf.

Please mention the Review

BINGHAM PERFECT
BEE SMOKER
 Pat'd 1878, 1882, & 1892.
Cheapest & Best on Earth.
 Send Card for Circular to
Bingham & Hetherington
 ABRONIA, MICH.

Sections Still Lower!

8-to-the-foot, one-piece, white poplar, and
 7 " " " and 1 7/8, one-piece basswood,
 all 4 1/4 x 4 1/4 square. Sample of either and price list free. Satisfaction and good measure guaranteed. O. H. TOWNSEND,
 4-93-tf Alamo, Kal., Co.; Mich.

Reference: EDITOR REVIEW.

Have You Seen Our **Big Blue Cat-**

ALOGUE FOR '1893? Seventy illustrated pages. Sent FREE to any bee-keeper. BEE-SUPPLIES, at retail and wholesale. Everything used in the apiary. Greatest variety and largest stock in the West
 1-93-tf. E. Kretschmer, Red Oak, Iowa.

DOVETAILED HIVES.
 Frames, Sections, Honey Crates, Foundation and Apiarian Supplies of all kinds. Catalogue free.
E. L. KINCAID, Walker, Mo.

Names of Bee-Keepers.
 TYPE WRITTEN.

The names of my customers, and of those asking for sample copies, have been saved and written in a book. There are several thousand all arranged alphabetically (in the largest States). and, although this list has been secured at an expense of hundreds of dollars, I would furnish it to my advertisers at \$2.00 per thousand names. A manufacturer who wishes for a list of the names of bee-keepers in his own state only, or, possibly, in the adjoining states, can be accommodated. Any inquiry in regard to the number of names in a certain state, or states, will be answered cheerfully. The former price was \$2.50 per 1000, but I now have a type writer, and, by using the manifold process, I can furnish them at \$2.00. W. Z. HUTCHINSON, Flint, Mich.

LANGDON'S



Non-Swarming



SYSTEM.

This is the first perfect and practical NON-SWARMING plan that has ever been brought to completion.

"If we can entirely prevent swarming, and keep all the bees at home storing honey all the season, we shall get enormous crops from a single hive" (A B C of Bee Culture, 1891, page 289.)

Remember, I worked this plan on 100 colonies last season, and my average yield, per colony, of comb honey, was 60 lbs., increase 50 per cent; hence it will be seen that I am not talking at random in making the following statements, as each point has been fully tested and tried.

(1) Two light colonies that would do but little in the sections if worked separately, do excellent work by running the field force of both into the same set of supers. (More honey.)

(2) No bait combs are needed, as the bees can be crowded into the sections without their swarming. (No coaxing.)

(3) The honey will be finished in better condition, that is, with less travel-stain on the honey or propolis on the sections, because the union of the field forces completes the work in less time. (More shekels.)

(4) There will be fewer unfinished sections at the end of the honey harvest, for the reason just mentioned. (Less waste.)

(5) Crowding the supers with bees induces them to begin and finish all the sections in each case at about the same time, thus permitting the removal of the case with no unfinished sections in it, instead of being obliged to take the sections out as fast as finished to keep them clean. (Saves time.)

(6) Drones will be fewer in numbers, as they are killed off in the closed hive while the bees of the other are storing honey rapidly. (More honey.)

(7) There is no hunting or caging of queens, no cutting out of queen cells nor manipulation of brood combs, and no MOVING or LIFTING of hives or even the opening of brood chambers during the honey season. (Saves your muscle.)

(8) With everything in readiness, one man can get a crop of honey from 200 colonies with only one day's work each week. (Lowers cost of production.)

(9) All the vexatious watching for swarms and the labor and time involved in securing them are done away with. (Less cost and loss of temper.)

(10) Combining the field forces gives better comb building facilities in the supers on account of economizing the heat during cool nights. (More honey.)

(11) For this reason more honey will be stored in the sections without resorting to contraction of the brood nest. (More honey.)

(12) A larger field force leaves the hives than if they had full possession of both brood chambers. (MORE HONEY.)

(13) All bees old enough to go to the field are not discouraged or hindered in the least. (MORE HONEY.)

(14) Artificial swarms and nuclei can be more easily made, as combs of bees and brood can be taken from the closed hive in which the queen can be found very quickly. (Easy increase.)

In fact, to the man who is willing to keep his eyes open and attend to things at the proper time (no slipshod bee-keeper need apply), this system offers a new era in bee-keeping, and he

who does not make use of it in these days of low prices will not "keep up with the procession." You cannot afford to let the opportunity pass without giving the plan a trial. Letters patent have been granted in Canada, and have been applied for in the U. S. and foreign countries. The device will be put on the market within the reach of all, and, if your dealer is not yet ready to supply them, they may be ordered of me at the following prices:

Complete, by freight or express, 75 cts. each; \$5.00 for ten, or \$40.00 for 100. By mail, 35 cts. extra for each.

Notice that one device works two hives, hence, when ten are purchased at one time, the cost is only 25 cents per hive. None genuine that do not bear my stamp. Circulars free. Send for one.

H. P. LANGDON,

East Constable, N.Y.

Please mention the Review.

HIVES

Twenty of Root's Dovetailed Hives, all made up and furnished with six section holders and eight brood frames, only 90 cts. each. Twenty of Root's story and a half, chaff hives, made up and furnished with eight brood frames, and a case to hold twenty sections, only \$1.25 each. (Regular price, \$1.75.) Twenty chaff hives with one movable side, and furnished with nine brood frames and a case holding six section holders, only \$1.50 each. (Regular price \$2.00.) I also have fifty colonies of

BEES

For sale. They are in eight and ten (L.) frame story and a half hives. Colonies in ten-frame hives, \$4.00 each; in eight-frame, only \$3.50. If five or more are taken at one time, a five cent discount will be given. Bees are in good condition and hives new. A discount of ten per cent will also be given on section holders, brood frames and shipping cases until May 1st. 12-32-12t

J. M. KINZIE, Rochester, Mich.

Please mention the Review.

Illustrated Advertisements Attract Attention.



Cuts Furnished for all illustrating Purposes.

Please mention the Review.

FLORIDA

Leather - Back, Italian
500 YOUNG QUEENS

Ready for delivery April 20th to May 16th. \$10 per dozen; special prices on three dozen or more. Safe arrival guaranteed. The 300 queens mentioned in last advertisement are all sold.

A. F. BROWN,
New Smyrna, Box 16, Fla.

1-93-tf

Dadant's Comb Foundation.

Wholesale and Retail. Even our competitors acknowledge that our goods are the STANDARD of their kind. **Langstroth on the Honey Bee, Revised.** New edition. Bee Veils; and veil material at wholesale. Bee Supplies, Sections, Smokers, etc. Samples of Foundation and veil stuff with circular free. Instructions to beginners. Send your address to

CHAS. DADANT & SON, Hamilton, Ills.

4-93-12t

Please mention the Review.

Great Reduction.

SECTIONS AT GREATLY REDUCED PRICES.

HIVES, SHIPPING CASES, &c., AT BED-ROCK PRICES.

WRITE FOR FREE, ILLUSTRATED CATALOGUE AND PRICE LIST.

G. B. LEWIS CO., Watertown, Wis.

1-93-tf.

Please mention the Review.

Bee Hives, Root's Dove-tailed, nailed up all complete for comb honey, only \$1 00. An **Italian Queen** free on a \$10.00 order. All supplies cheap.
A. F. McADAMS,
Columbus Grove, Ohio.

5-33-tf

Second Hand Supplies.

Of the second

hand supplies that I have been advertising in the REVIEW, the following remain unsold:—

100 old-style, Heddon surplus cases at 20 cts. (as a non-separated case, they have no superior); 25 slatted honey boards at 10 cts.; 20 Heddon feeders at 40 cts.; 25 Alley queen and drone traps at 25 cts., and half a dozen single-comb nuclei for exhibiting bees at fairs. They have glass sides, removable covers and are painted a bright vermilion. They cost \$2.00 each, but will be sold at half-price. All these are practically as good as new.

I also have 2,000 new, four-piece, white poplar sections at \$3.00.

W. Z. HUTCHINSON, Flint, Michigan.

Bee Literature For Sale.

GLEANINGS—Vols. 8-9-10-11-12-16 bound in "red goat" Vols. 17-18-19-20 unbound.
AM. BEE JOURNAL—Vols. 22 23 24 bound in black leather, and Vols. 25-26-27 and 28 unbound.
APICULTURIST—Vols. 1 to 7, inclusive, unbound.
GUIDE—Vol. 12, unbound.
Each of the following lack one or two numbers of being complete.
ADVANCE—Vols. 17 and 18.
CANADIAN B. J.—Vol. for 1888.
BRITISH B. J.—Vols. for 1888-1890 and 1891.
CAN. HONEY PRODUCER—Vols. for 1887-1888 and 1889. Also odd numbers of all the above journals.

How much am I offered for any or all of the above?

ARTHUR C. MILLER,
Box 575, Providence, R. I.

Hastings' Lightning Ventilated Bee Escape.

AGRICULTURAL COLLEGE, Mich. Febr. 17, '92.
"I have used the Lightning Bee Escapes you sent and find them certainly the equal of the Porter, and their superior for the reason that they will empty a super more rapidly."
Yours respectfully, J. H. LARRABEE.
"It is our opinion that you have the best Bee Escape ever introduced."
A. I. ROOT, Medina, Ohio.

HONOLULU, Hawaiian Islands, April 25, '92.
"Please send me by return mail 5 Lightning Ventilated Bee Escapes. I have the Porter, and the Dübber and they both eloz."
Yours truly, JOHN FARNSWORTH.
Price, by mail, each, 20c. per doz. \$2.25.



"IT LEADS THEM ALL."
Read Testimonials of a few successful Bee-keepers.
Send for Sample and after a trial you will use no other.
Catalogue sent on application.

CHEERY VALLEY, N. Y., March 20, '93.
"I shall take pleasure in recommending them as the best I have ever used."

Truly yours, J. E. HETHERINGTON.
"We believe you have an Escape that 'dovens' the Porter."

T. PHILLIP & CO., Orillia, Ont., Canada.
"Your Escape knocks out all competitors."

A. J. LINDLEY, Jordan, Ind.
"They did not clog, and cleared the supers rapidly. In fact it is the best Escape I have yet used. I cannot speak too highly of it, and consider it a great boon to bee-keepers."

W. E. CLARK, Oriskany, N. Y.
M. E. HASTINGS, NEW YORK MILLS, ONEIDA CO., N. Y.

FREE TO ALL.

SAMPLE COPIES EITHER OF THE

Canadian Bee Journal

OR

Canadian Poultry Journal,

Or both, will be sent FREE to applicants who desire them, upon receipt of their names and addresses.

These papers are both of them edited and arranged by practical men, admittedly the most experienced in their particular lines to be found on the continent, and the Journals may therefore be regarded as authoritative upon the several subjects of which they treat.

Address BEETON PUBLISHING CO.,
Beeton, Ontario.

Early Queens From Texas,

From my choice golden stock. My bees are very gentle, good workers, and beautiful. Safe arrival and satisfaction guaranteed. One untested queen, April and May, \$1.00; six for \$5.00; later, 75c. Orders booked now; money sent when queens are wanted. Send for price list.

J. D. GIVENS,
Lisbon, Texas.

1-93-9t.

Please mention the Review.

PATENT. WIRED, COMB FOUNDATION
HAS NO SAG IN BROOD FRAMES.

THIN, FLAT BOTTOM FOUNDATION
HAS NO FISH BONE IN SURPLUS HONEY.



Being the cleanest is usually worked the quickest of any foundation made.

J. VAN DEUSEN & SONS,
(SOLE MANUFACTURERS),
3-90-tf Sprout Brook, Mont. Co., N. Y.

Golden Italians.

My bees are large and great honey gatherers. 1 untested queen, 80 cts.; 3 for \$2.00. 1 warranted queen, \$1.00; 3 for \$2.50. 1 tested queen, \$2.00; selected, tested, \$2.50. Satisfaction guaranteed or money refunded. 4-93-tf

C. M. HICKS, Hicksville, Md.

FREE QUEEN.

Send for circular giving particulars, telling how to introduce queens and giving the price of hive protectors and nucleus col's.

2-93-4t

J. F. MICHAEL, German, Darke Co., Ohio

Take Notice!

If you are looking for the bees that give the most profit, and are the most gentle, try the

ALBINO.

I can also furnish the golden Italian, but my preference is the Albino. Send for circular and price list and see what others say of them and how cheaply I sell them. I also manufacture and deal in Hives, Sections, Foundation, Extractors and other apian supplies.

S. VALENTINE,
Hagerstown, Md.

Michigan Bee-Keepers,

You will consult your own interest, by sending for my catalogue and price-list of Root's Supplies. Beeswax and white extracted honey wanted.

CLARK A. MONTAGUE,

4-93 3t

Archie, Grand Traverse Co, Mich.

Please mention the Review

BEEES FOR SALE.

As mentioned in the last REVIEW, my bees have wintered well. They are now on their summer stands, most of them on their summer stands, and every attention given necessary to keep them in the best possible condition. I have more bees than I can manage in connection with the REVIEW, and I should be glad to sell part of them. They are in the New Heddon hive, but purchasers not having the right to use this hive will be furnished free with a permit from Mr. Heddon. I will sell one colony for \$6.00; 5 for \$28.50; 10 or more at \$5.50 each. With each colony will be sent a bottom board, cover and one section case. The bees are all pure Italians and the queens of last year's rearing. Shipments will be made immediately at the close of fruit bloom when the weather will be neither too cold nor too hot and there will be a supply of freshly-gathered honey from which the bees can supply themselves with water while on their journey.

W. Z. HUTCHINSON, Flint, Mich.

The "K. D." Non - Swarming, Reversible Hive.

No. 1 is a reversible bottom board and feeder. Deepside up for winter and feeding. No. 2 is the brood chamber. It takes a closed-end standing frame 9x17. The bee spaces are in the bottom board and honey board. Both sides and ends are compressed upon the frames by the nuts and rods. When released for manipulation, the frames rest upon the bottom board rim ends. The chamber is reversible.

The lighting board (5) is a part of and attached to the honey board (4) while the entrances (8 and 9) lead respectively under and above the honey board. The queen trap, (6) covers the brood chamber entrance. No. 10 is the super, held together by the rods—neither super nor brood chamber are nailed at the corners—and both sides and ends compressed upon the sections. By compression and spurs, the super sides and separators support the sections perfectly, without T's, slats, followers, or wedges. The 8 and 10 frame live supers take respectively 2 and 3 separators and 24 and 32, 1½ wide sections. They may be full separators, or by spur separators. For extracting, the super takes 8, 1½ inch thick frames in place of the sections Nos. 12 and 13 are the inner and outer covers.

The two-colony, non swarming, combination brood chambers (B and C cut No. 2) each contain a colony of bees. K is the separating board dividing the colonies. J is the alternator that passes the bees out from the lower hive and returns them to the upper, thus working two colonies in one set of supers. To prevent swarming both colonies are reversed EN MASSE once a week in the swarming season. The hives are clamped together by the appliance M, elevated by the hoister (L) and revolved as a wheel on its axis. Thus, once a week the queen cells are upst and the bees alternated. The clamp and hoisting appliance for reversing, costs \$2.00.

Send 20c. and get our illustrated pamphlet giving detailed description, method of management, and much valuable information. The pamphlet free to purchasers of hives.

The hive goes out nailed and painted but "K. D." at following prices, F. O. B. Brood frame starters are included, but no sections:

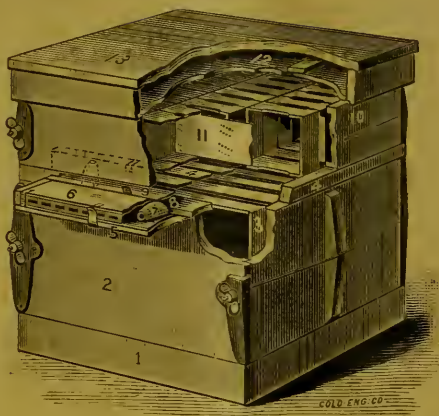

	Eight frame.	Ten frame.
ONE SUPER WITH EACH HIVE.		
A single hive as in cut 1	\$2 50	\$2 75
Same with plain bottom and cover	2 15	2 40
Two colony non-swarming hive	3 80	4 15
Same with plain bottom and cover	3 40	3 80

HIVE PARTS.

Combined bottom and feeder	35	40
Plain bottom	20	25
Brood chamber, including frames,	70	80
Brood frame f'd'n starters	10	10
Honey board and queen trap	45	50
Super with spur separators	50	50
Inside cover	10	10
Outside cover	30	35
Separating board, equalizers and alternators	50	50
Plain Cover	20	25
Shallow extracting frames, 1½ in. wide, per set	12	15

Address

AIKIN BROTHERS & KNIGHT,
Loveland, Colorado.



OUR
"Falcon" Sections

Better than any.
Cheap as many.

Our No. 1 Sections

Equal to many.
Cheaper than any.

Any Size. Any Quantity.
At Any Time.

Also, all styles HIVES and BEE-FIXTURES cheap. New catalogue and price list free. Samples of Falcon Sections for 2c. stamp.

W. T. Falconer Mfg. Co.,
JAMESTOWN, N. Y.

Golden,
5-Banded,
Italian Queens

My Bees are the best honey gatherers there are in the country, while for Golden Beauty they cannot be excelled in the world.

Warranted Queens, 75 cents each.
Tested, \$1.00 each.
Breeding Queens, \$2.50 to \$3.00.

Ten per cent discount on orders for five or more queens. Satisfaction guaranteed. Make money orders payable at Caldwell, Texas. Address

C. B. BANKSTON, Chrisman, Texas.

2-93-tf

Please mention the Review.

GRAY CARNIOLANS
— AND —
GOLDEN ITALIANS.

Bred from pure mothers and by the best known methods. Send for price list. 4-93-tf

For Carniolans to
JOHN ANDREWS,
Patten's Mills, N. Y.

For Italians to
L. E. BURNHAM,
Vaughns, N. Y.



BIG OFFER.

To any person sending me his order for ten

CHAFF HIVES

in April or May I will mail one of J. F. Michael's Golden Queens in June. Write for price list, sent free. 4-93-1t

GEO. H. KIRKPATRICK, UNION CITY, IND

Please mention the Review.



I TELL you what, Jones. *Levering Bros.* sell the best goods and at the lowest prices of any one I've struck yet. The largest and best equipped

Bee-Hive Factory

In the West. The Dovetailed Hive and New Hoffman self-spacing frame a specialty. Everything used by practical bee-keepers by wholesale and retail. Send for their free Illustrated Price-List, and save money. Supply Dealers, send for their Wholesale List. Address,

LEVERING BROS.,

2-93-6.

WIOTA, Cass Co., Iowa.

Comb Leveler.

Sections full of comb kept over from last year, when used to induce the bees to begin work in the supers, are worth nearly as much as sections filled with honey. The only objection to their use is that the comb is often uneven and gives the honey a rough appearance. By the use of Taylor's Handy Comb Leveler the combs can be brought to a level as rapidly as the sections can be handled, and the comb of honey, when finished, will have all the fine appearance of that produced with fresh foundation. Price of the leveler (except the wooden box in which to set the lamp) 60 cts. by mail. Box and all, \$1.10 by mail; by express, \$1.00.

B. TAYLOR, Forestville, Minn.

"Golden" Florida.

My location enables me to rear good queens NOW as cheaply as they can be reared in the North at anytime. Untested queens, 75 cts. each; 6 for \$4.00; one dozen, \$7.50. Last year's tested queen, \$1.25; select, \$1.75; breeder, \$2.50. Safe arrival and satisfaction guaranteed. 11-92-tf

J. B. CASE, Port Orange, Vol. Co., Fla.

Please mention the Review.

JUNE, 1893.



At Flint, Michigan.—One Dollar a Year.

ADVERTISING RATES.

All advertisements will be inserted at the rate of 15 cents per line, Nonpareil space, each insertion: 12 lines of Nonpareil space make 1 inch. Discounts will be given as follows:

On 10 lines and upwards, 3 times, 5 per cent; 6 times, 15 per cent; 9 times, 25 per cent; 12 times, 35 per cent.

On 20 lines and upwards, 3 times, 10 per cent; 6 times, 20 per cent; 9 times, 30 per cent; 15 times, 40 per cent.

On 30 lines and upwards, 3 times, 20 per cent; 6 times, 30 per cent; 9 times, 40 per cent; 12 times, 50 per cent.

Clubbing List.

I will send the REVIEW with—	
Gleanings,..... (\$1.00).....	\$1.75.
American Bee Journal..... (1.00).....	1.75.
Canadian Bee Journal .. (1.00).....	1.75.
American Bee Keeper .. (.50).....	1.40.
Progressive Bee Keeper... (.50).....	1.30.
Bee Keepers' Guide..... (.50).....	1.40.
Apiculturist..... (.75).....	1.65.
Bee-Keepers' Magazine... (.50).....	1.40.

Honey Quotations.

The following rules for grading honey were adopted by the North American Bee-Keepers' Association, at its last meeting, and, so far as possible, quotations are made according to these rules:

FANCY.—All sections to be well filled; combs straight, of even thickness, and firmly attached to all four sides; both wood and comb unsoiled by travel-stain, or otherwise; all the cells sealed except the row of cells next the wood.

No. 1.—All sections well filled, but combs uneven or crooked, detached at the bottom, or with but few cells unsealed; both wood and comb unsoiled by travel-stain or otherwise.

In addition to this the honey is to be classified according to color, using the terms white, amber and dark. That is, there will be "fancy white," "No. 1 dark," etc.

CHICAGO Ill.—The bulk of the offerings in comb honey now consist in dark lots that are difficult to sell. Pure beeswax is in good demand. We quote as follows: Fancy white, 18; No. 1 white, 15 to 16; fancy amber, 12 to 13; No. 1 amber, 10; fancy dark, 12; beeswax, 23 to 25.

R. A. BURNETT & CO.,

May 25. 161 So. Water St., Chicago, Ill.

CHICAGO, Ill.—The honey season is practically over for the year. The cold spring has been the cause of working off what honey has been shipped to this market. There will be a clean market to work on by the time new honey arrives, and we anticipate quick sales with good prices. We quote as follows: Fancy white, 15 to 16; No. 1 white 14; fancy amber, 13; fancy dark, 10; beeswax, 22 to 25.

J. A. LAMON.

May 25. 44 & 48 So. Water St., Chicago, Ill.

CINCINNATI, Ohio.—There is no choice comb honey on the market. A fair article brings 14 to 16 in a jobbing way. The demand is good for extracted at from 6 to 8 cts. There is a good demand for choice yellow wax at from 24 to 27 cts.

CHAS. F. MUTH & SON.,

Cincinnati, Ohio.

April 1.

MINNEAPOLIS, Minn.—There is a good supply on hand but it is mostly dark. This stock is slow, but what little white there is on the market moves readily. We quote fancy white, 17 to 18; two pound combs, 16 to 17; buckwheat, 15 to 16; extracted honey, 10 to 11.

J. SHEA & CO.,

Feb. 13. 14 Hennepin Ave., Minneapolis, Minn.

BUFFALO, N. Y.—Honey market is very quiet and stock light. A limited amount of fancy could be handled to good advantage, but the commoner grades are hard to move. Beeswax is wanted and would sell well. We quote as follows: Fancy white, 17 to 18; No. 1 white, 15 to 16; fancy dark, 8 to 10; No. 1 dark, 6 to 7; beeswax, 25 to 30.

BATTERSON & CO.,

May 25. 167 & 169 Scott St., Buffalo, N. Y.

KANSAS CITY, Mo.—The demand for extracted honey is good and the supply light. The supply of comb honey is fair and the demand the same. Shipments of No. 1 would meet with very ready sale. We quote as follows: No. 1 white, 16 to 17; fancy amber, 15 to 16; No. 1 amber 13 to 14; fancy dark, 12 to 13; No. 1 dark, 10 to 11; white extracted, 6½ to 7; dark extracted, 5 to 6; beeswax, 22 to 25.

CLEMONS-MASON CO.,

Mar. 6. 521 Walnut St., Kansas City Mo.

NEW YORK.—The market is bare of comb honey. Fancy white could be sold at 14 to 15; fancy amber at 12; and dark at 10. The market is quiet on extracted and no movement. Large lots of West India and Mexican are arriving and the market is well supplied. This class of honey sells at from 65 to 75 cts. per gallon. Beeswax is quiet but firm at from 27 to 29.

HILDRETH BROS. & SEGELKEN.

April 3. 28 & 30 West Broadway New York.

IMPORTED ITALIANS

Queens reared from the above, \$6.00 a doz.

PERCY COVINGTON, Appleton, Md.

Please mention the Review.

Illustrated Advertisements Attract Attention.



Cuts Furnished for all illustrating Purposes.

Please mention the Review.

THE LOSS OF ONE

Queen in introducing means a loss greater than the cost of a copy of "ADVANCED BEE CULTURE," which has one entire chapter devoted to "The Introduction of Queens." It shows when the cause of failure lies with the colony, when with the queen, and points out the *conditions* necessary to success. Although *one* infallible method is given, but little attention is given to the setting forth of exact rules and methods, the subject being treated with a view to teaching *principles* that may be followed to success.

Price of the book, 50 cts.; the REVIEW one year and the book for \$1.25. Stamps taken, either U. S. or Canadian.

W. Z. HUTCHINSON, Flint, Mich.

WHITE POPLAR SECTIONS.

We have New Steam Power, and New Buildings, and are now ready to furnish White Poplar Sections, Clamps, Crates and Wood Sides at short notice. Workmanship, Quality and Price unsurpassed. Send for sample and price list.

PRIME & GOVE,

1-90-tf

Bristol, Vermont.

Please mention the Review.

ON HAND NOW.

THE MOST COMPLETE STOCK OF BEE HIVES, SECTIONS AND SUPPLIES IN THE NORTHWEST.

W. H. PUTNAM,

193-12t.

RIVER FALLS, WIS.

MAKE MONEY While You Sleep.

STAHL'S EXCELSIOR FRUIT DRIER

Evaporates Fruit DAY and NIGHT. Catalogue free upon application.

Address

WILLIAM STAHL EVAPORATOR COMPY., QUINCY, ILL.

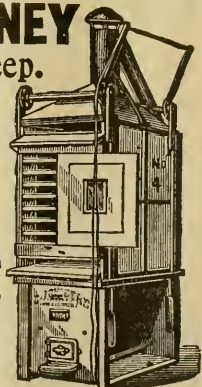

BEE KEEPERS SUPPLIES

BEST GOODS. LOW PRICES. LARGE STOCK. LARGEST BEE SUPPLY HOUSE IN THE WEST.

ITALIAN QUEENS AND BEES A SPECIALTY. CLOVER SEEDS. BUCKWHEAT.

SAMPLE OF OUR BEE JOURNAL THE WESTERN BEEKEEPER ALSO OUR CATALOGUE FREE!

JOS. NYSEWANDER. DES MOINES, IOWA.

2-93-tf Please mention the Review.



Interesting Monthly for
The Family and Fireside
 Welcome In every Home.
 Large Premiums for Clubs.
 Sample Copy sent Free.
THOMAS G. NEWMAN,
 147 South Western Ave.,
CHICAGO, - - ILLS.

Leather Colored

HONEY QUEENS, from Imported Mother, warranted purely mated, after June 10th, at \$1.00 each; six at one time, \$5.00. Untested queens, 75c. each. Address

C. A. BUNCH,
 Nye, Marshall Co., Ind.

Please mention the Review.

Dadant's Comb Foundation.

Wholesale and Retail. Even our competitors acknowledge that our goods are the STANDARD of their kind. **Langstroth on the Honey Bee, Revised.** New edition. Bee Veils; and veil material at wholesale. Bee Supplies, Sections, Smokers, etc Samples of Foundation and veil stuff with circular free. Instructions to beginners. Send your address to

CHAS. DADANT & SON, Hamilton, Ills.

4-93-12t Please mention the Review.

IMPORTANT

TO BEE-KEEPERS!

To make a success of bee keeping, you want bees that will give the very best results. My *Golden Italians* have gained a good name on their own merits. Those who have tested them with other bees say "they are the best honey gatherers, cap their honey the whitest, as gentle as butterflies, beautiful to look at, are the largest and strongest bee of all the races." Queens bred from mothers that produce uniformly marked

FIVE-BANDED WORKERS

In March, April and May, \$1.25 each, 6 for \$6.00; June, \$1.00 each, 6 for \$5.00; July to Nov., \$1.00 each, 6 for \$4.50. Special prices on large orders. For full particulars send for descriptive circular. 12-92-tf

C. D. DUVALL,
 Spencerville, Montg. Co., Maryland.

Please mention the Review.

FREE QUEEN.

Send for circular giving particulars, telling how to introduce queens and giving the price of hive protectors and nucleus col's.

2-93-4t J. F. MICHAEL, German, Darke Co., Ohio

Bee Hives, Root's Dove-tailed, nailed up all complete for comb honey, only \$1.00. An **Italian Queen** free on a \$10.00 order. All supplies cheap.
A. F. McADAMS,
 Columbus Grove, Ohio.

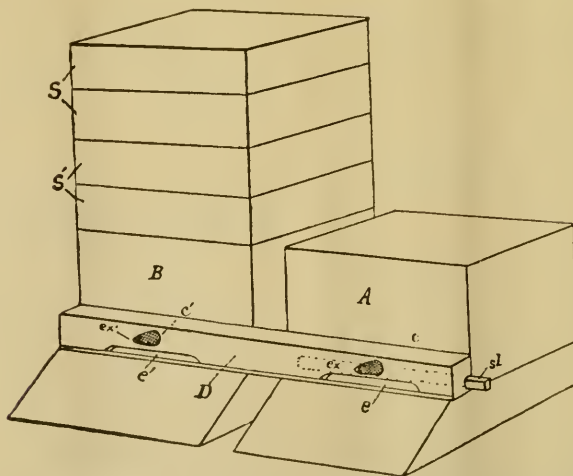

Langdon's Non - Swarming Attachment. (Patent Allowed.) "You Push the Slide; Nature Does the Rest." If Your Dealer Does not Keep Them, Send for Circular to H. P. LANGDON, East Constable, New York.

Great Reduction.

SECTIONS AT GREATLY REDUCED PRICES.

HIVES, SHIPPING CASES, &c., AT BED-ROCK PRICES.

WRITE FOR FREE, ILLUSTRATED CATALOGUE AND PRICE LIST.

G. B. LEWIS CO., Watertown, Wis.

1-93-tf. *Please mention the Review.*

HAVING PURCHASED the entire stock and business of W. D. Soper, at Jackson Mich., I am now prepared to furnish Apiarian Supplies to all who have usually purchased of Mr. Soper, and to all others who wish Apiarian goods at the lowest prices. Orders filled promptly. Send for price list and circular.

E. H. TRUMPER,

4-93-3t Bankers, Mich.

Please mention the Review.

Muth's HONEY EXTRACTOR
PERFECTION
Cold-Blast Smokers,
Square Glass Honey Jars, Etc.

For Circulars, apply to CHAS. F. MUTH & SON, Cor. Freeman & Central Aves., Cincinnati, O. Send **10c.** for Practical Hints to Bee-Keepers.

1-93-tf. *Please mention the Review.*

—If you are going to—

BUY A BUZZ-SAW,

write to the editor of the REVIEW. He has a new Barnes saw to sell and would be glad to make you happy by telling you the price at which he would sell it.

Foundation Reduced.

Deduct three cents per pound from prices given in my Illustrated Price List for 1893.

M. H. HUNT, Bell Branch, Mich.

Hastings' Lightning Ventilated Bee Escape.

AGRICULTURAL COLLEGE, Mich. Sept. 17, '92. "I have used the Lightning Bee Escapes you sent and find them certainly the equal of the Porter, and their superior for the reason that they will empty a super more rapidly."

Yours respectfully, J. H. LARRABEE.

"It is our opinion that you have the best Bee Escape ever introduced."

A. I. ROOT, Medina, Ohio.

HONOLULU, Hawaiian Islands, April 25, '92. "Please send me by return mail 5 Lightning Ventilated Bee Escapes. I have the Porter, and the Dibern and they both clog."

Yours truly, JOHN FARNSWORTH.

Price, by mail, each, 20c. per doz. \$2.25.



"IT LEADS THEM ALL."

Read Testimonials of a few successful Bee-keepers.

Send for Sample and after a trial you will use no other.

Catalogue sent on application.

Second Hand Supplies.

OF

the second

hand supplies that I have been advertising in the REVIEW, the following remain unsold:—

100 old-style, Heddon surplus cases at 20 cts. (as a non-separated case, they have no superior); 25 slatted honey boards at 10 cts.; 20 Heddon feeders at 40 cts.; 25 Alley queen and drone traps at 25 cts., and half a dozen single-comb nuclei for exhibiting bees at fairs. They have glass sides, removable covers and are painted a bright vermilion. They cost \$2.00 each, but will be sold at half-price. All these are practically as good as new.

I also have 2,000 new, four-piece, white poplar sections at \$3.00.

W. Z. HUTCHINSON, Flint, Michigan.

ITALIAN QUEENS

Bred for Business, Gentleness and Beauty. Untested, 80c. each; three for \$2.25; six for \$4.00; 12 for \$7.50. Tested, \$1.25. Select tested, yellow to the tip, breeder, \$1.50. Will commence shipping April 15th. On all orders received before March 1st, accompanied by the cash, 10 per cent. discount. Safe arrival guaranteed.

G. E. DAWSON,
Carlisle, Sonoko Co., Ark.

1-93-12t,

Please mention the Review.

BEE-KEEPERS'

SUPPLY HOUSE

J. H. M. COOK, 78 Barclay St., N. Y. City.

(SUCCESSOR TO A. J. KING.)

4-93-tf

Send for illustrated Catalogue

CHERRY VALLEY, N. Y., March 20, '93.

"I shall take pleasure in recommending them as the best I have ever used."

Truly yours, J. E. HETHERINGTON.

"We believe you have an Escape that 'downs' the Porter."

T. PHILLIP & CO., Orillia, Ont., Canada.

"Your Escape knocks out all competitors."

A. J. LINDLEY, Jordan, Ind.

"They did not clog, and cleared the supers rapidly. In fact it is the best Escape I have yet used. I cannot speak too highly of it, and consider it a great boon to bee-keepers."

W. E. CLARK, Oriskany, N. Y.

M. E. HASTINGS, NEW YORK MILLS, ONEIDA CO., N. Y.

New Crane Smoker Now Ready.

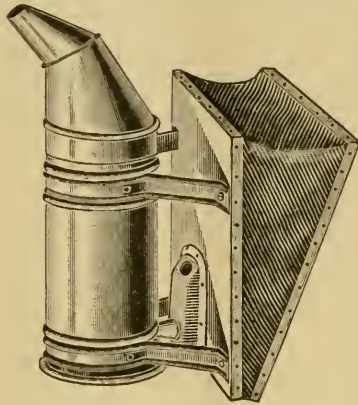

Smoking Capacity and
Strength of Blast
Simply Amazing.

The New, Non-Smoke-Sucking Check-Valve, by which a great blast is secured and the bellows kept clean, and the Double Lining of Asbestos, and Sheet-Steel, by which the fire-cup and nozzle are kept from becoming uncomfortably hot during usage, are **DISTINCTIVE** and **VALUABLE** features alone possessed by the new implement. It would be impossible to tell all of its unique features, and so we say, try it and fall in love with it.

Price, with a 3½-inch fire cup and curved nozzle, by mail, \$2.00; by expres, \$1.75. If your nearest dealer in supplies does not keep it, write to the authorized manufacturer,

A. I. ROOT, Medina, Ohio.

N. B. Don't forget that we are headquarters for all kinds of bee-keepers' supplies. Our new 1893 catalogue of 52 pages now ready for mailing.

FOR ALL KINDS OF BEE-KEEPERS SUPPLIES.
ADDRESS LEAHY MFG. CO., HIGGINSVILLE, MO.

Free! 200-Page Bee-Book!

TO EVERY NEW YEARLY SUBSCRIBER TO

The Weekly American Bee Journal

32 pages, \$1.00 a year. Send for FREE Sample Copy with full description of Book.

Address, **GEORGE W. YORK & CO., 56 Fifth Ave., CHICAGO, ILL.**

To New Subscribers: The Journal Alone Sent for Three Months for 20 Cents.

PORTER BEE ESCAPES Are used and pronounced the best, and highly recommended

as great labor-saving implements by Chas. Dadant & Son, Prof A. J. Cook, Chas. F. Muth, Jno. S. Reese, J. H. Martin, Jno. Andrews, F. A. Gemmill, Wm. McEvoy, A. F. Brown, Thos. Pierce, and many other prominent bee-keepers. Descriptive circular and testimonials mailed free. **PRICES:** each, postpaid, with directions, 20 cts.; per doz., \$2.25.

THEM AND GET YOU MONEY BACK AFTE TIAL, IF NOT SATISFIED. For sale by dealers.

MENTION THE REVIEW.

Address **R. & E. C. PORTER, LEWISTOWN, ILL.**

The Bee-Keepers' Review.

A MONTHLY JOURNAL

Devoted to the Interests of Honey Producers.

\$1.00 A YEAR.

W. Z. HUTCHINSON, Editor & Prop.

VOL. VI. FLINT, MICHIGAN, JUNE 10, 1893. NO. 6.

TIMELY TOPICS.

No. 5.

R. L. TAYLOR.

"A little house (brood nest) well filled."



WE have now almost arrived at the very summit of the year. The fields are already whitening to the harvest, the point for which our labors for many months past have been preparing. Happy is he who has not

to say: The laborers are few! But on account of the untoward character of the season, many will not have this blessedness, for most colonies have not arrived at the swarming stage and strength. However, by prompt energy, there may still be time to retrieve the situation. To accomplish this there are two principal points to which I now direct especial attention: First, to increase the amount of the brood to the utmost, up to the point of time beyond which eggs laid by the queen will be of little benefit except so far as they may be necessary to keep up the life of the colony, and, secondly, at that time to have the brood confined in as *small a space* as possible. In this locality the best seasons of honey gathering last till about the first of August. An easy calculation

makes it safe to say that any *extension* of the brood nest after the 25th of June would prove unprofitable; before that, extension may yield a profit. Before that time I secure all the brood possible. To begin with, the usual warm weather of June is favorable; then I make certain that stores are plentiful and that room is given when necessary. I strengthen a weak colony with brood sometimes when safe and there is no danger of spreading disease. At this time of the year, if there should be a dearth or a period of bad weather, a little judicious feeding helps mightily. Often both the spreading of brood and feeding may be well done by inserting in the brood nest an uncapped comb of honey. But judgement must be exercised both in what is done and when it is done as well as in the amount of time expended. One must weigh his time against the possible advantage of gain in surplus. There is a limit to the amount of labor that can be profitably employed in this manner. There must be a margin greater or narrower according to the value one puts on his time.

Then, secondly, it is hardly less important for the best results in the production of comb honey that the brood be as *compact* as possible. What is done should be done with a view to getting combs with brood *full* of brood. Breaking the cappings of the honey in such frames will conduce to this. This is important, because, by confining the bees to such combs as will be almost entirely occupied by brood by the 25th of June, the surplus honey they gather *must* go into the sec-

tions where it is doubly valuable. The small number of frames into which the brood is compressed should not occasion alarm. Five L. frames may easily contain what is often spread over ten, while the former means forty pounds of comb honey and the latter none at all; the five additional combs secure part of the possible surplus in the brood combs and convert the rest into *valuable* bees. In a poor season a colony confined to comb equal to that of five L. frames gave me fifty pounds of section honey—more than twice the average of the apiary—and this though all the time it was afflicted with “foul brood.”

To meet the difficulties of this second point I find the new Heddon hive convenient. Some fill one section only of the hive with brood, others may need a little help to do even that. All such are of course confined to the one section. Others fill more than one, and others still, nearly two. By a little manipulation, every colony is confined either to one or to two sections of the hive which in either case is substantially full of brood by the 20th of June and each hive presents the same top surface for the reception of sections.

As to the time of putting on the first case of sections I follow one simple rule. When the bees are found lying above the honey board in considerable numbers, say a pint or less, they are ready for work above, and the sections go on at once. There is nothing like the incoming of nectar to expand a colony and they hardly ever lie above the honey board in the early part of the season unless there is considerable nectar to be gathered. When a second and succeeding cases should be put on depends on various circumstances. The strength of the colony, the prospective length of time before the end of the run of nectar and the amount of work done in the case last adjusted, must all be weighed in the determination of the question. On the one hand the danger of loss from too much crowding, and, on the other, too many unfinished sections consequent on giving too much room, are the Scylla and Charybdis to be shunned. Early in the run a colony rather weak in bees may be allowed to nearly complete the first case before another is given; a medium one should be supplied with a second when the first is about half filled and a strong one that crowds the first case should be furnished with a second as soon as the first is fairly started.

These are to be taken as general directions if everything is favorable for a good honey flow. Each succeeding case should be placed under the last one, *i. e.*, immediately upon the honey board, until towards the probable end of the honey flow, when it is better to place it above the one that is still unfinished to make the completion of those already begun more certain. As the season advances more and more caution must be exercised in the adding of sections. In the height of the season, I aim to give the bees at least as many sections as they will occupy and work on, and as the end of the flow approaches I allow the space where work is to be done to become more and more contracted so that at the last there may be few sections containing honey that are not completed and fit for market. During a good season, some colonies may have completed five cases each and some only one. It will be of great assistance in forming a sound judgement in the matter of putting on sections to have regard to the condition and probable continuance of white clover, which depends largely upon the amount and frequency of the rains. One must also observe the time of the blooming of basswood and know the usual time during which it lasts in one's locality.

I am in no haste to take off the hives even finished cases of honey. They can be in no better place for the ripening of the honey and there need be no fear of travel stains so long as honey is coming in and there is room lower down in unfinished sections for the bees.

It only remains to speak of swarming and the manipulation incident thereto. As a preparation I have the queens clipped, the entrance of each hive guarded by a queen trap, and a sufficient supply of hives for the reception of swarms. The hives consist each of a single section of the Heddon hive furnished with comb, or, preferably, foundation, besides bottom, cover and queen excluding honey board, and are kept in a cool place in the yard where they are convenient of access. A swarm is seen issuing; I take a hive to the spot, turn the old hive around out of its place and replace it with the new one. I then watch to see if the queen is safely in the trap. When I see her I place the trap at the entrance of the new hive and remove the sections from the old hive to the new one. In some seasons a few swarms cluster on trees but return soon. In that

case, as soon as they are entering the hive rapidly I release the queen and let her run in, and replace the trap leaving it for a few days at least, to be certain that the swarm does not gratify a desire to abscond. If two or more swarms are out at the same time, care must be taken by the use of sheets to cover the hives, aided by a good smoker, to see that they are properly divided. When swarms are given to clustering, I entice them to do so on some convenient branch, and when the cluster is once formed, swarm after swarm will join it, so that it is an easy matter to divide them by shaking a sufficient quantity for a swarm into a basket and hiving it as in the former case. A trap is also placed at the entrance of the old hive, unless the colony is divided to save young queens, and by two or three movements in the course of a week it is brought side and side with the new hive and in a day or two it is removed to a new stand, leaving most of the field bees to join the swarm where they will be of the greatest use. The trap on the old hive prevents the absconding of after-swarms and also prevents the young queen from locating her hive until it is removed, which should be done when the hive is placed on its new stand.

If the swarm issues quite early, I would not strip the old hive to such an extent of the field bees, for by removing one section of the hive in twenty-one days, when the young queen should be laying, and giving the colony a case of sections, it should do good work in storing a surplus.

Of course, in all these matters there are details which want of space forbids my mentioning, but the thoughtful person will have no difficulty in working them out.

LAPEER, Mich. May 23, 1893.



Conveniences and Arrangements Needed to Make the Work of Extracting Pleasant and Profitable.

FRANK M'NAY.

"Man reaches truth only by passing through all possible phases of error."

ANY work that may be done without the trouble of learning, by careful instructions, is seldom well done; and the greatest obstacle in the way of thorough work in regard to extracting, is the fact that it can be and is done with but

little if any instructions. This is a great mistake, for there is a right way and several wrong ways of doing most kinds of work, and one seldom hits upon the right way by chance—it must either be by experience or from instructions.

The neglect to provide the proper conveniences for extracting, make it a very disagreeable task and often causes trouble in the apiary by inciting robbing and causing the bees to become irritable and cross. Much may be done to make extracting pleasant work by purchasing proper conveniences for doing the work in a neat and practical manner.

The first requisite is a room to extract in. This may be small and plain, but it must be perfectly bee-tight and should be provided with double screen windows, *i. e.*, two wire screens, one on each side of a frame, so as to prevent bees on the outside from coming in reach of those on the inside, for there are always a few bees carried in on combs, that will go to the windows to escape. It is a good plan to have each window hung on a pivot at the center so it can be reversed quickly to let out bees.

The extractor should be firmly secured to the wall to prevent shaking, and it should be high enough to let honey run from the gate into a large pail.

For a strainer I prefer a large barrel with the head removed, also with the upper hoop removed. I lay a cheese cloth over the top of the barrel letting it sag down in the barrel about a foot, then replace the hoop which will hold the cloth securely and make it perfectly tight.

By having a honey gate in barrel near the bottom and setting the barrel on a stand of sufficient height, the honey can be run from the gate into barrels or any other receptacles.

I would also urge the necessity of a tight bottom in the box in which the combs are carried from and to the hives. This is to prevent dripping honey about the apiary. I have known this dripping of honey to excite robbing so that work had to be suspended.

In getting bees off the combs, I find that a slight trembling motion will dislodge them much more quickly than a severe shake, and for sweeping the balance off I find a common household whisk broom, cut down to about one-third the usual thickness, is the best thing that I have ever tried.

Never store honey in a cellar. Many suppose it should be kept in a cool place, but

this is a mistake, as heat will improve instead of injuring either comb or extracted honeys.

There are several other conveniences that I might describe, but I fear it would take too much space to make them understood without cuts.

MAUSTON, Wis.

April 22, 1893.



Is an Automatic, Reversible Extractor Really Worth the Effort Being Expended in Its Invention?—Uncapping Machines a Greater Need.

C. C. MILLER.

"Alas, the slender spigot stream we stay,
While from the bung the cider runs away."



I THINK you've struck the truth pretty straight, Mr. Editor, in thinking that the matter of uncapping really needs more attention than does something to save the few seconds of time necessary to turn a frame in an extractor; for, unless

the honey is pretty thin, there will be much more time employed in uncapping than in running the extractor.

Of late years I have extracted very little, and have never had anything but the Peabody extractor, and while I have sometimes longed for something better I have felt that for the little extracting I do it doesn't make a great deal of difference.

In working the extractor, I don't mind the turning, nor putting in the combs, and not so very much taking out the combs, but turning the combs in the extractor, with the attendant liability to get honey daubed over every thing, is the part that makes extracting especially disagreeable. Anything to help that is a desideratum.

So I don't wonder at the desire for something to reverse the combs automatically. But isn't a little too much stress put on the "automatic" part? How much would you give for an automatic spoon to carry your soup to your mouth? If you had one you would still have to give your attention to

having your mouth at the right place and opening it at the proper time, and as your hand is at the time unoccupied with anything else it may just as well be holding the spoon. The simple fact that there is some automatic part about an extractor may amount to nothing, and it is no better than another extractor unless it will save time or labor.

Now let us see what we really want? I mean more particularly the great mass of beekeepers who have only a moderate amount of extracting to do. The first thing is to get rid of the "dauby" part of reversing the combs. If we can have the inside of the extractor so constructed that the comb can be reversed, without taking it out of the extractor, than I think the worst part of the trouble is overcome. Nothing automatic is needed for that. As to methods, that is best which does it with the least time and labor, whether it be automatic or not. As I said, I have never owned anything but the Peabody, but I have tried others to a considerable extent, and I must say that I can hardly see how an automatic reversing can be any better than such a one as is accomplished in the Cowan. You slow up the motion, just as you must do with an automatic, then a little push with the left hand reverses the combs, and on you go again, without stopping the motion or the *direction* of the motion. Now what better would it be to have it work automatically? With the Cowan you can turn either way or both ways in succession, and I think it a bit easier to turn in the same direction all the time, whereas with all automatics yet brought out the machine must not only slow up but actually stop to reverse and then turn in the opposite direction. The left hand is not occupied at anything else, and may just as well do the reversing, and if you take account of the labor of the left hand it is offset by the fact that less labor is required on the part of the right hand, for it certainly takes less force to slow the machine than to stop, and it is better to have the labor divided than to have it all put on one hand. To say the least, I think the Cowan can be reversed in as little time as though automatic, so I think it has no disadvantage either as to time or labor.

Please don't understand me as opposing automatic appliances. In the majority of cases they may be very advantageous, only it must not be understood that in all cases

a thing is necessarily better simply because it is automatic. But some day we may be startled by some genius bringing out an extractor that will automatically do the turning and reversing, with a tithe of the time and labor now required. He will be hailed with delight. In the meantime, I do not believe it is worth while to lament very much over the few seconds employed in reversing, with the advance already made.

Why may not the uncapping machines of England be practical? A slaw cutter is considered a good thing, and it works on the same principle. One trouble is that combs must be true and adapted to it, but it would not surprise me to see all difficulties overcome, so that a comb would be less time in the hands of the uncapper than in the extractor. As you say, beekeepers may well ask themselves, "What has the future in store for us?" and a perfect uncapping machine may be one of the things.

MARENGO, Ill.

April, 15, 1893.



Reversing Combs on Their Centers; Some of the Difficulties to be Overcome and the Advantages That May be Expected.

E. A. DAGGITT.

"And through the sandy waste of cogitation
We seek beyond a land of habitation."

[Last month Mr Daggitt told us of several vital points to be considered in the construction of honey extractors. After this, in the article that he sent, he described several different methods whereby combs might be reversed without stopping the machine. I could not see that they possessed any particular merit over the one already given in the REVIEW, so I decided not to illustrate and describe them, at least not for the present. After finishing a description of the different plans for reversing, he continued as follows:—ED.]

After inventing some of these devices for reversing the comb baskets of reversible extractors, I became very much impressed with the disadvantage of having such large reels as were being used in reversible extractors, so I went at work to see if there was not a way to overcome this disadvantage, when I conceived the idea of oscillating the comb baskets upon their centers when reversing them. This principle is shown in the engraving accompanying the leader, but both the editor of the REVIEW and the artist have fallen into the error of representing the comb baskets as running on *hafts* in-

stead of *gudgeons*, as they should. But the trouble was, how to get the combs in and out of the comb baskets. My first idea was to have a bottom bar and gudgeons at the bottom of each basket, while at the top of each basket was to be an arrangement something like this: on each side at the front and equally distant from the edges of the basket was to be a segment of a disc having in its upper surface a circular groove to receive a flange on the under surface of a disc that projects from the reel spider. This disc was to be made in such a way that that part of it over the inner segment on the basket shall be fixed and its flange remain in the groove of the segment at all times, while the other part is to be hinged to it so that it can be thrown inward to allow the combs to be put in or taken out of the basket.

Afterward, while studying how to get the combs in and out of these baskets that reverse on their centers, I conceived the idea of doing this by making the basket sides *movable*, or by having the baskets in a reversing frame. This plan of putting in and reversing the combs allows a top bar and gudgeon to be used at the top of each basket and permits the reversing apparatus to be at the top of the reel. As most combs have to be reversed twice, or when this is not necessary it can be done easily by the reversing apparatus, only one basket side will need to be movable, and if the comb rest is attached to the movable side, the comb will come out with it when it is brought outward. The side may be hinged at the bottom, and the top be tilted outward, or it may be made so that it can be "jumped" or swung out at both top and bottom at once. If the first method is employed, the side should be self-fastening when the top is pushed to its place, and be put on so that the top will spring outward when the fastenings are detached. By means of a simple device the fastenings can be detached by the simple pressure of a finger. If the second method is employed in removing the side, an arrangement will be necessary that will detach the side and also fasten in position when brought out and closed against the basket uprights. If the basket is put in a revolving frame it will need to be arranged in a similar way as the latter method of arranging the movable basket sides.

This plan of reversing comb baskets by oscillating them on the center, if practicable, will settle the question of the size of reel²

for in those having four or more comb baskets there is no loss of space at the corners of them, as is the case with those that reverse their combs by swinging them from one side of the reel to the other, for the edges of the baskets are brought close together; while by combining this principle with the hollow reel principle we can get a two-frame reel as small as any reel should be.

This new style of reel has some other important advantages besides size of reel. They can be made stronger with less material. They can be started and stopped more easily and can be run with less labor. The combs can be reversed more easily, and with less danger of injuring them. And the baskets are not liable to sag.

Any of my reversing apparatus can be applied to those that use a reel shaft and possibly also to those with a hollow reel. By means of them the comb baskets can be held at any angle, while the reel is in motion, either by hand or by means of ratchets and pallets. The baskets may be self-fastening as soon as they reverse, and the fastenings can be detached by giving the wheels on the basket gudgeons some independent motion so that they will start a little before the baskets do and detach the fastenings.

The second form of the lever device I think could be applied to a two-frame hollow reel of this kind. The pins in the wheel on the reel gudgeon would have to be so placed that one basket will start at the proper time before the other, and they will have to be detachable from the levers in one direction. The slotted ends of the lever could be bent in the proper direction to secure this. If the baskets are not self-fastening, the levers would have to be in one direction, and the fastenings could be detached by the wheel when the pin re-enters the lower slot. Probably the same detachable principle can be applied to all the devices at the cog gears, especially at the inner gear of the horizontal device as illustrated in the leader.

While studying on the subject of smaller reels I "hit on" the idea of swinging the comb baskets from side to side in a hollow reel when reversing them. Several months afterwards I found out that the same principle was embodied in the Cowan extractor. "Honor to whom honor is due," should be the motto of all, so I will say that I believe the inventor of the Cowan machine is entitled to the honor of being the first inventor of reversing combs in this way.

Now I wish to say that I have not the facilities to give the different reversing apparatus and new style of reel a proper trial, and if any one wishes to do so and make for sale extractors embodying any of them, he will please inform me of the fact.

Before closing, I wish to say a few words on inventions. The creations of a man's brain are as much his property as anything he possesses, and any one who appropriates another's invention to his own use without his consent does the inventor an injustice and takes what does not belong to him. It matters not whether the invention is patented or not. Patents are issued by the government to protect inventors in this right, but this often fails as in the cases of Whitney, Goodyear, Langstroth, and many others. Thos. A. Edison, the great inventor, says that he has already spent over a million of dollars in defending his patents. Besides, it is doubtful if one invention in four ever pays the inventor. Now if it should be an established rule among those interested directly, or indirectly, in our pursuit that the rights of every inventor in any invention he shall make will be recognized, it would no doubt be a great incentive to improvement. I believe such a rule is recognized by all our leading manufacturers of bee-keepers' supplies, and if there are any that will not recognize it, they should be treated accordingly by bee-keepers.

WHITE HOUSE STA., N. J., May 2, 1893.



Reversible Extractors. — Bee - Escapes No Help in Running Out - Apiaries for Extracted Honey.—Ten Hands Make a Good Extracting Team.

E. FRANCE.

I HAVE never seen a reversible extractor, and, in view of our past poor seasons, I can but wish that I had a crop as big as I could extract with a non-reversible extractor. With a good honey-flow, one man can extract 5,000 pounds in a day with a non-reversible extractor. Still, if we could get a good, handy, easy-running, reversible machine it would save work, and that is what we want. I have studied over the matter a great deal—tried several plans—but none of them proved satisfactory. I can make a machine in which I can reverse all

the baskets at once, but I have to stop the machine to do it. I don't like so much machinery to be started and stopped every time we extract a set of combs. The heavier the load, the longer it takes to start it and stop it. It could be stopped with a brake.

As to the use of bee-escapes to rid the extracting combs of bees, I don't want any. The most of my hives are single story hives, so I must sweep off the bees. In my home yard I work the hives three stories high, and I can drive the bees down into the lower stories, have the upper set of combs out and every bee off in *two minutes*, and not a bee killed by putting in an escape board. Perhaps there may be some combs in the second story that I will want to take out and extract, and I drive the bees down with smoke and finish with a very thin brush-broom. As I understand the workings of bee-escapes, it takes 24 hours or more for the bees to get out of an upper story, after the escape is put on; that won't do at all for an out-apiary. We start from home and get there and get ready to go to work about 9 a. m. We want to start the extractor just as soon as we can get the combs. By the time that basswood is in bloom we are likely to have from 80 to 100 colonies to work—will some one tell me how we can save time by using escapes? You say you would prefer to have an abundance of combs and supers, so the honey could remain on the hives a little while so you could take your time for it, etc. You would find that extracting honey after the honey-flow is no fun—bees are cross and steal for all they are worth.

You think *three* would make a good extracting team. One to get the honey off the hives and return the empty combs, one to uncap, one to run the extractor. That just made me smile! Of course, you have never done much extracting. When we go to an out-apiary with a full team of *ten* hands, and go through 100 colonies in a day, go from home six or eight miles and back again and extract sometimes from 2,000 to 3,000 pounds of honey, *one man* does all the extracting, strains all the honey and puts it in the barrels; and one man does all the uncapping. The other eight hands do the field work, get the combs into the tent and back into the hive again, make new colonies, cut out queen cells, etc. In fact, they do all that has to be done, except the tent work. Of the eight hands in the field, one is the boss of the whole outfit and has no set place to work;

he looks after everything—in the tent and in the field—and sees that everything is done in a proper manner. The other hands are divided up two or three in a team. Two can work to good advantage, but three can work together in good shape, two to open hives and brush bees, while the third hand carries the combs to the tent and brings back others to fill the hive again, puts the combs into the hive and shuts the hive.

No hive ever gets its own combs back again. Each team of boys, when they commence in the morning, take out all the combs that need extracting, then shut up the hives without combs until the yard is finished. Then the first extracted gets the last combs.

The boss looks after all the hives, balances up the brood according to the strength of the colonies, and when he has a surplus of brood combs, more than can be safely left in the old colony to prevent the old one from swarming, he makes new colonies with the surplus brood, putting frames of foundation in the old colonies in place of the brood combs taken away.

PLATTEVILLE, Wis.

April 24, 1893.

[I was well aware that one man could run the extractor faster than one could take honey off the hives in the old fashioned way and return the combs, but I did not suppose that *eight* men would be required to get the honey off and the combs back again as rapidly as one man could run the extractor. It seems, however, that with Mr. France's management these eight men are supposed to do something besides simply getting the honey off the hives and the combs back in place. They are to make up artificial colonies, cut out cells, equalize the brood, etc. If these things are to be done I do not dispute that while the crew is there extracting, is the time to do such work, but when I mentioned three is a good extracting team, I did not have in mind any work except that of extracting, and I still think that one man might do the outside work; especially, if, as Mr. France says, only *two minutes* will suffice to free the combs of the upper story from bees. Mr. France has had a long experience in raising extracted honey, hence it is with some little deference that I ask if time might not be saved by sending two of those boys to each apiary a day in advance of the extracting crew, and have them put bee escapes under the upper stories? If upper stories are not used, would it not pay to use them?

When I referred to the more leisurely work that might be done when there was an abundance of empty combs, I did not intend to convey the idea that the extracting might be deferred until the season was over, *a la* Dadant, although I think that by the use of bee escapes the work could then be done with little annoyance from robbers, but what I had in mind was the *temporary* respite that might be gained by the use of empty combs. If all of the colonies of one apiary can be given an abundance of empty combs, a little time is gained in which to extract the honey at some other apiary.

I am well aware that when a man has developed some system of management and followed it for years, it may not be profitable to add some new feature, like the use of bee escapes. His system may not be adapted to the change, and it may not be advisable to make the changes necessary to bring in the new invention, but each man should look the situation over carefully, considering all things, and then follow the course that appears the best. In some cases it may be well to do some experimenting before coming to a final decision.—Ed.]



Winter Losses of Bees in California.

“RAMBLER.”

“And every prospect pleases
And only man is vile—
Enough to let his ‘bees es’
In winter die the while.”



HERE is a great difference in the management of bees where the hives surround the home, and are arranged in a tastefully kept yard, and where they are

kept in some remote mountain glen, and visited only when care is absolutely needed. The Eastern bee-keeper, if he is a lover of the business and something of an enthusiast, will be found, even after the work of the honey season is over, wending his way to the apiary, and, with a friend, or even without, looking at the qualities of his latest bred Italians, or, if any unusual commotion is

heard in the apiary, his eyes and his ears are open to catch its signification. If the bees are put in the cellar during the winter, he is often found in their cosy quarters listening to the quiet hum, and allowing his olfactory organs to test the condition of the air, and if any thing is going wrong it is instantly remedied if possible.

Bees are as much of a pet, collectively, to the enthusiastic apiarist as the hand-raised colt or sheep is to the family, but the colt or the sheep turned out to pasture ten miles away is a pet no longer, and while the former pet enjoys unrestrained freedom, the owner in a measure forgets it. The balmy climate of southern California allows the bees to fly every month in the year and the necessities of the occupation of the bee-keeper, or the conditions of the pasturage in a great majority of cases, results in turning the bees into a distant pasture, with but little pride as to arrangement or beauty of hives, if the outfit will only bring in the dollars. The months of greatest rest to the bees and the bee-keeper are October, November and December. The conditions change with different portions of the State, for nearly all climates are enjoyed, and though we find rigorous weather in the mountains, there is no place where protection is deemed necessary. In such a climate one would suppose that the winter losses would be slight, but it may surprise some to learn that the winter losses are as great if not greater than in the East. Let us see: I know of several apiaries of about 200 colonies each, which, during the past winter have lost on an average of 50 colonies each, and there is at least one instance where about 1,200 colonies were reduced to less than 400. A loss of so many would seem to be irretrievable, but the owner takes courage and says, “never mind, with one good honey season I will fill every hive again.” The question will now naturally arise, what is the cause of all these losses? As far as my observation goes, which is only for two years, there is but one answer—criminal carelessness. Although bees gather so much honey and pollen in this climate, it is just as necessary to leave winter stores, as it is in the East. In fact, the same principle of having enough honey in the hive at all times for a winter supply is just as applicable here as in any other portion of the country. If all of the honey is taken away up to the last of June, the possibilities are that a later flow will give the bees enough to winter upon, but the getting of

this later honey depends upon the late rains which are very liable not to put in an appearance. The apiary being several miles away is neglected and many colonies starve even before the late rains are expected. Many of the losses are laid upon the shoulders of the helper who has gone beyond his instructions and extracted too close and too late. Heavy feeding is resorted to in many instances and the bees saved, but even feeding at a late date does not leave the bees in as good shape as a good supply of natural stores. The best method of feeding ever devised for California, or any other country, is to have good sealed combs of honey. I think the losses would be much less were the apiaries located near the home of the bee-keeper, for wherever we find them so we find the most successful results. Another source of loss is the bee moth; the ravages of this pest of the bee hive are not so great as one would expect in this warm climate, but a little neglect of keeping good queens in every hive results in many ruined colonies. The past two years that have come under my observation may be exceptional years, but from the careless methods generally pursued by many of the California bee-keepers, there is more or less useless loss every year, and closer attention to business would result in the saving of a great waste and give a better reputation to the bee-keeping industry.

ON THE BEE RANCHO, Calif., April 28, '93.



**A Combined House Apiary and Self-Hiver,
and a Combined Hive and Self-Hiver.**

C. W. DAYTON.



SOME eight or ten years ago, in June, I experimented with house apiaries. One difficulty that I could not overcome was the loss of young bees when brushing them off the comb inside; but the bee escape has almost entirely done away with the brushing of combs. Another thing, the

wind and chilly air on the sides of the house away from the sun, on cloudy days, or late in the afternoon, caused many bees to remain out over night and perhaps never get into the hives again. All these, and more, prevented my using a larger structure than for four or six colonies. These were very satisfactory.

Here in California there is little wind, so, if the bee house is located in a warm place, or not on the north side of a hill or mountain, the bees have no trouble in getting into the hives.

Summer nights in California are much colder than they are in any Eastern States. They are really very chilly; so much so as to drive all the bees down out of the sections into the brood nest. Then the middle of the days are very hot, and it is seldom an unshaded hive gets through the summer without its combs melting down.

These difficulties, and others, have turned my attention toward bee houses in California as being as beneficial as in any country, and I have read and re-read the articles published in regard to them. We need them to keep the hives warm nights, and cool days.

Another very useful feature of the house plan is in locating an apiary. Good locations where the bee hives may be spread over a space of 100 feet square are scarce here. There are thousands of acres of unoccupied land but it is nearly always mountainous and rocky. If it is level some one has fruit or grain on it or it will be where the sun does not shine favorably, and bees want all the sun there is during January, February, March, April and May, because these months here are all alike, and are about like May in Iowa or Wisconsin on the 43 parallel. I always dislike to have hives on uneven ground, as it makes the work much harder—if you use a stool in examining hives it is slanting; the smoker will tip over; if a hive gets off its foundation it may roll over, etc. Now, in using a bee house a level place 16x20 feet may be made with pick and shovel against the side of a hill or mountain out of the way of everybody and in a warm sunny position, and I have, accordingly, constructed two after the plans of Messrs. Taylor and Langdon.

Here there is no need of packing of any kind, so I have left that part out; nor is there any need of Mr. Taylor's wide eaves to keep off snow and sleet, but just common eaves.

the brushing of combs.

Mine are roofed with tin and there are escapes and ventilators in the gable ends. Instead of windows, as Mr. Langdon uses, I have constructed the outside boarding in sectional parts, and when light is wanted a section 2x3 feet above the hives may be removed in the opposite side of the building from the hive I am manipulating. There is need for all the light we can get when examining for eggs in a comb.

I have adopted a new frame, also; and that after using, heretofore, about an equal number of Langstroth and Gallup frames. In localities where nights are cold and days hot it causes the brood to be located toward the front ends of a frame as long as the Langstroth (if the hives face the north), so that Mr. Aikin, of Colorado, said in his article on dequeening a year ago, that he spread brood by changing ends with each alternate frame. While I have for years practiced spreading brood, I do not think I have ever gained a bee thereby, and I am *certain* that brood has been destroyed. According to this conclusion and the conditions of the brood nest in so long a frame as the Langstroth, it almost compels this needless, and as I said on page 566 of the *A. B. J.* "cruel," practice, so I have adopted a frame the same depth of the Langstroth but $4\frac{1}{4}$ inches shorter. In this frame the brood circles touch the top, bottom, and side bars. By using ten frames in a hive there is the same capacity as the eight frame Langstroth, if not more, considering the more thorough occupancy of the combs. My hives are $14\frac{1}{4}$ inches both ways, inside measure. I studied long as to whether the frames should approach the entrance endwise or sidewise. In lifting out the frames when they are sidewise the brood face of the comb comes before our eyes at once but the other plan has its advantages that caused me to adopt it. Mr. Langdon uses them sidewise and he may be right. A shallower frame than the Gallup is better for comb honey and a smaller frame than the Langstroth allows of more manipulation and leading of the bees along into the upper stories more gradually than when too much space is given, and Mr. Hill is right when he says that a super three inches deep is more readily occupied than one $4\frac{1}{4}$ inches deep. Then my frame hangs in the extractor the same as in the hive and a shallow frame can be taken out to reverse about as quickly as a long frame put in endwise can be manipulated and extracted in a

reversible extractor. And again there is not the danger of the comb breaking out and piling up on the bottom (as Mr. Hughes spoke about some time since) when they hang in the extractor. A frame of this length admits of a hive, two of which may be placed crosswise of a wagon bed, requiring no special racks for moving. In moving bees I much prefer piling them up several deep than to spread them out over a large surface and this one advantage in handling the hives will outweigh all the special features of a 17-inch frame.

On page 99, Mr. Langdon says "the entrance in the boarding is nearly on a level with the floor, then rises on a slant to the top of the platform, and opens into the hive four inches from its outer side." In mine the entrances in the boarding are $2\frac{1}{2}$ inches below the floor of the hive and rise on a slant the same to the hive, eight inches from its outer side. The hive entrances are $\frac{3}{4}$ inch deep and have a strip of two-rowed perforated zinc nailed over them the whole width of the hive. In this strip of zinc is arranged a cone to allow drones and queens to pass outward. Also in this slanting space is a strip of perforated zinc 2x14 inches tacked to the slanting floor and sloping outward and upward and rests against the boarding above the outside entrance. This is to prevent the escape of queens and drones and completes a trap. My studding are the right distance apart so that brood frames, including projecting arms, will go in between them parallel with the front of the hive and are 1x8 inches. Over this sloping space in which the zinc is arranged and on a level with the rabbets in the hive are tacked cleats against the studding for frames to hang upon. I always leave a $\frac{3}{8}$ space at the rabbets behind the projecting arms of the frames for bees to pass around the ends—that is, my rabbets are $\frac{3}{4}$ inch deep and $\frac{3}{4}$ inch wide. In fact, my hives do not have a real rabbit but a rest for the frame is formed on the whole thickness of the boards by nailing a cleat on the outside. To form this frame-rest, the cleats are $\frac{3}{4}$ inch in thickness. Above these cleats, and even with the top of the hive, are two more thin cleats to support a light cover. This forms a box eight inches by the other dimensions of my hive and holds six frames. In the outer side of this box against the boarding is hung an empty comb and between this and the hive are five frames with $\frac{1}{2}$ inch foundation starters. When a swarm

issues or the queen comes along and sticks her head into one and then another of the perforations, its sloping feature leads her up against the bottom bar of the empty comb or else she makes a failure of getting back into the hive and the bees find her outside on returning. This top cover is loose and may be raised and the inside of the box easily and quickly seen. When the drones are trapped this sloping floor may be removed by unhooking it from below the hive and the drones emptied into a pan and carried out.

This forms a sort of combination of the inventions of Pratt, Alley, Langdon, Taylor, Dayton, etc., and I can run this house apiary by visiting it about once a week. A building not only protects the bees and admits cheaper and more lasting hives, but suffices for a honey house and extracting room.

PASADENA, Calif.

May 10, 1893.

Since mailing my communication on the hive I have adopted, I have had some farther experience with my hiving contrivance by its hiving two swarms that were not in the bee house. Some time ago I made fifty new hives and of these six were provided with my swarming arrangement. I have been in the habit of making the front and rear boards of my hives of $\frac{3}{4}$ inch lumber and the sides of $\frac{1}{2}$ inch and the sides were nailed on to the ends of the fronts and backs. You understand my hive is $14\frac{1}{4}$ inches long and $14\frac{1}{4}$ wide inside. In making the six above mentioned hives the sides were enough longer to project $7\frac{1}{4}$ inches forward of the front board of the brood chamber like a Laugstroth portico, and an additional front board put in making a sort of ante room before entering the brood chamber proper. The sides were also increased to $\frac{3}{4}$ inch in thickness so as to bear rabbeting $\frac{5}{8}$ inch back on the part of the board opposite the ante room. This $6\frac{1}{2}$ inches space was to accommodate five brood frames. An entrance was provided under both of these front boards and a strip of perforated zinc tacked over each on the outside. To permit the drones and queen to pass the inside zinc a boring $\frac{1}{2}$ inch deep was made with a two inch bit directly under it in the bottom board. Then another hole still farther into the ante room was made with a one inch bit. Another of $\frac{5}{8}$, and still another of $\frac{3}{8}$ which last was located about three inches from the perforated zinc. All the holes cut into each other to allow the passage of bees. Over all these holes except the $\frac{3}{8}$ and the half of the two inch hole in-

side the brood nest was tacked wire cloth. This was a substitute for a cone which came in the way of the brood frames hanging in the ante-room. Besides it seemed to possess an advantage over a cone as it caused the queen to travel on foot all the way through and across the ante-room. When the bees swarm and return on account of the retention of the queen, they don't rush quickly into the hive, but stand on their heads and fan before the entrance and all the way along into the brood nest, in which case they will be quite sure to find the scent of the queen and track her up like hounds after a fox, so I endeavored to have the tracks close by their noses. The upper stories go on the same as the portico Langstroth, and the ante-room has a small cover for itself and which may be raised about as we raise the falling door when we drop a letter in a street mail box. I do not think my contrivance can be adapted to any hive that is not square, because in the brood chamber proper the frames run from front to rear and in the ante-room the other direction. While others have studied to hive colonies on full sets of combs, and Mr. R. L. Taylor uses the drone and queen traps with no combs at all, so, also, some have experimented with reversible frames and others with reversible hives, I use the $\frac{1}{2}$ medium number of five combs in the "queen restrictor" and also use a medium of five in a hiver. Like Mr. B. Taylor I claim a moral right to my square hive and hiver. For me a hiver can be provided for less than fifteen cents per hive, and my hive is perfectly adapted to the one pound section in all its various manipulations.

PASADENA, Calif.

May 18, 1893.



The Bee and Honey Exhibits at the World's Fair and how they are Progressing.

ALLEN PRINGLE.

EDITOR REVIEW; Dear Sir—In response to your favor of 20th inst., I may say the apiarian department of the World's Fair, like almost every other department, is in a very backward condition. The honey cases, which were constructed under contract from the Agricultural Department of the Fair, were only completed the other day, and as some of them required much inside work of shelving etc. after, they came from the contractor's hands, it

will readily be seen that the backward state of the department is not altogether the fault of the apiarian officials or superintendents. As for myself, although I have been here some six weeks my exhibit is not yet installed. But, I have more inside or extra work on my case than any of the others, for the reason that no other exhibitor, so far, has so much honey on hand to get into one case.

There are, I believe, three State exhibits completely installed, viz., that from Wisconsin, Nebraska, and Ohio. That from Iowa is well under way as well as that from New York. The Minnesota exhibit arrived a day or two ago and is being installed by Mr. Cooper, from that State, who is Secretary of the State Association. He was not present it seems when the exhibit was unloaded from the car and deposited in the Agricultural Building and he found his exhibit greatly damaged. Nearly all the comb honey, most unfortunately, is quite unfit for exhibition, as it is badly broken and leaking.

I have had the pleasure since coming here of meeting and making the acquaintance of several American apiarists with whom I had never before had the pleasure of personal acquaintance. Among these are Dr. Miller and Miss Wilson who have very tastefully arranged Mr. A. I. Root's fine exhibit of apiarian appliances; Dr. Mason, who has charge of the Ohio exhibit, accompanied by Miss Mason; Mr. Whitcomb of Nebraska who has charge of the exhibit from that State; Mrs. Whitcomb; Messrs Hatch and Wilcox who installed the Wisconsin exhibit; Mr. Hill from Kretschmer of Iowa, who installed the Iowa Exhibit and also an exhibit of appliances; Mr. Hersheiser from New York State, which sends a large exhibit of honey, occupying 3 or 4 cases, and supplies also, I believe, and others whose names I am not able to recall. I had also the pleasure of meeting Mr. York the genial and industrious editor of the old *A. B. J.* and its former editor Mr. Newman, who, I was glad to hear, as, no doubt, all will be, is rapidly recovering his health and strength.

As near as I can judge from the present appearances, the apiarian and all other departments of the great Exposition will be completed about the middle of June.

CHICAGO, Ill.

May 24, 1893.

[Mr. H. D. Cutting, of Tecumseh, Mich., writes me that at a late day Michigan has appropriated \$500 for the purpose of making

an apiarian exhibit at the great show at Chicago. Mr Cutting is to have charge of the exhibit, and would be glad to correspond with bee-keepers who can furnish anything for exhibition. Illinois bee-keepers have also received recognition at a late day, and those who can help in the matter should write Hon. J. M. Hambaugh, Spring, Ill. —Ed]



Some More Smoker Experiments.

J. E. CRANE.

"One man's story is no story at all—hear both sides."



HERE seems to be a good deal of misunderstanding in regard to the relative merits of the Bingham and Crane smokers. I had hoped that Mr. Cornell's experiments might throw some light upon the subject, but

his report is in some respects, so different from my experiments and experience that I fear the average reader will be more confused than ever unless some explanation is offered.

Some time in February I received a letter from Mr. Cornell saying that an experiment was soon to be made to test with scientific accuracy the relative strength of an enclosed blast as in the Crane smoker,—a single cut off as represented in the Bingham smoker,—and a double cut off as represented in the Cornell smoker.

It was not to be a war of smokers, but simply a test of principles. He wrote me further that the Crane smoker he had received was in bad shape owing to some accident and would not probably be used in the trial. He also asked me for any suggestions I might have to offer.

In my reply I made no suggestions as I remember further than to say that the trial would be of more value if made with loaded fire barrels. I also stated my entire confidence in his fairness and ability to conduct such an experiment.

Now if these trials or this test of principles had been made with a single smoker,

alternating the connections between the bellows and fire barrel for this purpose, this scientific test would have been very interesting, although so far as I can discover of very little practical value. As it is, in summing up the results of his experiments Mr. Corneil says: "The foregoing statements show that, with fire barrels loaded with very closely packed fuel, the induced current is weaker in the Bingham and in the Corneil smokers than it is in the same smokers with an enclosed current." The figures which he gives for the Corneil smoker is 30 for the enclosed current, and 18 for the induced current, which tallies quite closely with some experiments I have made.

The Crane smoker does not appear in these scientific tests to have cut a very handsome figure, nor could I or any one have expected it would who knows all the circumstances in the case.

This particular smoker was not made for the purpose of testing scientific principles or to be put to any scientific tests. It was one of two or three smokers that I made with wooden valves for experimental purposes and I sent this one to the editor of the REVIEW to show that a most excellent smoker could be made with an enclosed blast, which was strong enough to satisfy the most exacting requirements of the bee-keeper and yet keep the bellows free from sparks and smoke. I was well aware that the check valve was imperfect, which had a tendency to weaken the blast. To remedy this defect, I made my bellows larger and thus secured as strong a blast as necessary.

Now what was the Bingham smoker? Was it such as he is accustomed to sell as a three inch smoker? Not at all, as I understand it, but one constructed especially for this purpose with a bellows two or three times the usual size, and, of course, two or three times the power. I say two or three times the usual size. I had in my shop an old three inch Bingham smoker and by actual measurement I found the bellows only about one-third the capacity of the bellows I have been in the habit of using. I may, however, have been in error in regard to the size of the Bingham bellows as the original leather was ruined by sparks being drawn into the bellows and the bellows had been covered with a new leather which may have been smaller.

In Mr. Corneil's report he speaks of the tests as those of the Bingham smoker or the

Crane smoker, etc., and it might look as though there was a war of smokers on, and I fear it would be very misleading if it were not understood that the bellows attached to the Bingham smoker in these trials was very much larger than what he ordinarily uses while the Crane smoker had the same size of bellows.

After reading the report of Mr. Corneil, I found myself saying, "It can not be and yet it is," or something of that sort, or wondering if the same natural laws hold good in Canada and the United States. The next morning found me at work in my shop as soon as up. With one stroke of the hatchet I split the Bingham bellows and soon had the barrel separated and ready to place on the same size of bellows as a Crane smoker. In all my experiments I had never tested a Bingham cut off blast with my own size of bellows. I measured the two bellows and found the Crane nearly three times the size of the Bingham. I was surprised. Can it be that I have been fooling myself all these years? I took out the blast tube very carefully. Whew! I found it nearly full of creosote, and so hard I could not dig it out safely with iron or steel until I had soaked it in water to soften it. What a fool I have been! I wished I had never bothered my head about smokers. No wonder my Bingham smoker had failed to give a strong blast! Should I ever have the courage to admit that I had been in error! But I determined to know for myself just what the difference was. Soon I had a Bingham fire barrel and cut off blast wed to a Crane bellows. So far as I could see the union was perfect. I gave this smoker a new nozzle, "bright and shiny," that just fitted it.

Now then, taking a Crane smoker that had a fire barrel that had seen service, for I wished to show no partiality, I gave one to my hired man, who has been with me for many years, "Now let us see which can throw smoke the farthest." Many trials were made, frequently changing smokers with each other.

These tests seemed to indicate very clearly that the Crane smoker had decidedly the stronger blast, but how much, who could tell. I had no anemometer at hand. One must be made. I took a smooth board. A line across one end indicated the point beyond which the end of the smoker must not go. Now placing a very light, small box just in front of this line, let us see how far

we can drive this box on the board from the line. Many trials were made. With a Bingham fire barrel and cut off wed to a Crane bellows, I could drive the box just seven inches from the line, while my servant Daniel could, with the same instrument, drive the box $7\frac{1}{2}$ inches. Then taking a Crane smoker, I could drive the box 14 inches, while Daniel could drive it $14\frac{1}{2}$ inches. Many experiments or tests were made with substantially the same results. In these last trials the fire barrels were empty. I was surprised that it did not turn out exactly the opposite after reading Mr. Corneil's report. Queer, isn't it? And science is sometimes queer, too. Chemists tell us that a diamond is nothing but carbon, and yet who would not rather have one hand full of diamonds than both hands full of lampblack?

Now the blast of either of the above smokers with which I experimented is ample for all the needs of the apiarist. If one or the other was not sufficient, how easy to increase it by increasing the size of the bellows a little. There is no patent on the size of a bellows one may use.

Just a few words in regard to that "golden mean" blast tube. For years, if I mistake not, Mr. Bingham has advised the use of hard wood, split fine, for smoker fuel, that the blast of his smokers would be strong. Now we are told that a medium size blast tube is used that the blast will not be too strong and blow fire and sparks out of the nozzle, as though the average bee-keeper did not know enough to add more fuel or work the bellows slower. My experience is that a large blast tube or bellows if worked freely will draw fire and sparks out of the other end of the smoker from the nozzle in a very uncomfortable way.

After experimenting the other day with a Bingham and Crane smoker with my assistant, we looked over a yard of bees. I left him to select a smoker for use. I noticed he used a Crane smoker. I said to him later, "Why did you not take the Bingham smoker?" "I have had all the clothes burned with a Bingham smoker years ago that I care for," was his prompt reply. Queer! that Mr. B.'s trouble comes from one end of the cut off blast smoker and mine from the other, isn't it, when the blast is very strong.

These experiments correspond exactly with my experience extending over many years with the Bingham cut off blast and many cut off blast smokers made by myself

of different patterns. If I had had a new Bingham smoker throughout, it might have made some difference, although I do not see how. I hope Mr. Root or some one who has the conveniences, will try the experiment of how far you can blow a small box upon a smooth table with different smokers and note the results. It is real fun. If I were a sporting man I would bet all the tobacco pipes I ever owned against Mr. Bingham's Thomas cat, that the enclosed blast is the stronger. But I won't bet. "It is against my principles."

After all is said, what is all this ado for? The Bingham smoker with a bellows one-half the size of the one I have been using, will do good work when new and clean. Who says it will not? Not I. The difficulty is not here. But after it has been used awhile the blast tube becomes clogged with creosote and the blast greatly weakened. Note what I said in an article written at your request last summer for the REVIEW. Now if a "scientific test" of the blast of a Bingham and Crane smoker as they come from the manufacturers could be made, and other tests after each had been in use for three or six months, it might be of some real service to the bee-keeping public. The true test of a soldier is on the battle field rather than on dress parade. But when one takes a Crane smoker poorly constructed and the invention not even perfected, and pits it against one fully perfected with a bellows two or three times its normal size, to test, without so much as saying to the inventor of the new smoker, "by your leave, sir," it looks at this distance as though it was a deliberate attempt on the part of some one to strangle the Crane smoker as soon as born. It still lives, however, and since Mr. Root has adopted "the infant" its breath is stronger than ever, and if Mr. Bingham or any one else is anxious to test the actual merits of the two smokers as above so that bee-keepers may know just which is best, I have no doubt they can arrange with Mr. A. I. Root for such a trial.

And now in closing, Mr. Editor, I will say if these scientific tests and smoker discussions shall serve to improve the various brands of smokers manufactured in this country, they will not, after all, be useless.

P. S. Mrs. C. says she does not like what I have written about betting on tobacco pipes; that I haven't got any pipes and never had, and she doesn't want anybody to think

that I ever smoke, and so I will take it all back.

MIDDLEBURY, Vt.

May 26, 1893.

[I am sorry that when speaking of the size of the Bingham bellows, Mr. Crane should refer to it as "two or three times the size of his ordinary bellows." It is evident that Mr. Crane has not seen a modern Bingham, or even one of a moderately late date. I have a Conqueror bellows ten years old, and it is seven inches long, five wide, and three inches across the wide end when the bellows is distended. I have a new Doctor and the bellows is the same size, except that it is half an inch longer. It is true that the bellows to the smoker used in this trial was a little larger than Mr. Bingham uses upon the regular size. It is six inches wide, $8\frac{1}{4}$ long and $3\frac{1}{2}$ across the wide end when the bellows is open. It was given these dimensions that it might be of the same size as the one on the Crane.

That the blast from an enclosed current is stronger when there is the obstruction of fuel to overcome, is shown by the experiments of Mr. Corneil. In both the Bingham and the Corneil, a stronger blast is secured with enclosed currents when the smokers are loaded, while the reverse is true when they are empty. This is as I should expect to find it. In the tests that Mr. Corneil made it is evident that the Crane was not "in it," in any of the phases. It can be attributed to only two things, either to the imperfection of the implement itself, or to the friction of the air in making two turns. What is needed is a correct decision in regard to principles. If we work upon the right principle, the minor imperfections will eventually be overcome.

I have a new Bingham of the Doctor size. I also have a new Crane as now sent out by Mr. Root. The barrels are very nearly of the same size. They are the same on the outside, but the asbestos lining in the Crane takes up a little room. The Bingham nozzle is a trifle taller, but it is more tapering. Each bellows is the same length, but the Crane is half an inch wider. I made a little paper "snuff box," as we children used to call them, and laid it on the smooth surface of my imposing stone. I filled both smokers with planer shavings. I took the Bingham and tried to see how far I could drive this box over the marble surface. I tried it repeatedly, and the average distance to which it was driven was two feet. I tried the Crane

in the same way, and the average distance was three feet. The old Crane smoker that Mr. Corneil used in his test would drive the box only 18 inches.

Of course, the blast of a smoker is not the only thing to be considered; to remain free from clogging by dust and creosote is an important point.

I have no interest in smokers aside from a desire to find out which is best and let beekeepers know it. The fullest discussion will be allowed so long as it is courteous. And right here I wish to say that I think Mr. Crane is mistaken in thinking that there has been any attempt to "strangle" his smoker.—Ed.]



Non-Swarming Plans.—A Brief Outline of a Year's Work in the House Apiary.

B. TAYLOR.

"Do what thou doest with thy might,
And toil and happiness unite."



I HAVE at length got the new house apiary filled with bees. To say that I am greatly pleased with it, is to speak tamely. If you were here to see me feeding the twenty-four colonies that are in it in five minutes by the watch, you would feel the ground of

my enthusiasm. I give each colony a little feed every evening without lifting a cover, or seeing a bee.

This is the worst spring I ever knew for bees. I never got my bees from the cellar until May 8th to 12th. Thirty-three per cent. were dead. Ninety-five per cent. with sealed covers were dead. I am not discouraged, but regard this as a first-rate chance to make bees pay. I have many fine colonies and shall give them better attention than I ever gave bees before. I don't believe we do one-half as well with bees as we could. We have too much windy talk and too little earnest practical work.

The non-swarming idea embraced in the double hive arrangement is receiving great attention. I shall give it my best thoughts

this season. I had intended to start for Chicago in one week, but fear that absence now might interfere with my experimental work, and this must not be. I will be at the bee-keepers' meeting in October if well enough to go.

I will have a photo. taken of the new house apiary when I can get an artist here. Will give a full description and my latest experience with the house plan to readers of the *Review*.

I shall make it my special business this year to finish my eight years' work on the non-swarmers. I am confident that the plan that has no traps of any kind, holds the trumps. I have tried a large number of devices, and always found that some obstacle would turn up. The revolving stand proved to me that none of them were needed. I regard the revolving stand as clearing away more fog than any experiment I ever tried. It led to the practicability of a single entrance for two swarms in a single hive. I now have the partition of wire cloth, two sheets $\frac{1}{4}$ inch apart; the idea is to have the *warmth* of both colonies for the entire hive at all times. This is what I claim as my discovery, two swarms in a single hive with one entrance for both, and to be worked as a single colony without swarming. I claim this and will let others have all queen catching traps. I see in *May Review* that friend Langdon kindly criticises my plan. He seems to think that my way makes it necessary to always cut queen cells. I expect to work my hives before there are any queen cells started, and then there will probably never be any started, but if there are, with hives depopulated of bees, and with my wire end frames which can always be lifted without any tools except the fingers and put instantly in their place again, it will be but a few moment's work to clip queen cells; and I will here say that there will be no more likelihood of queen cells in my plan than in friend Langdon's. The only thing that I do not like in my plan is it does not work in the house apiary, and I have not yet seen my way clear to adapt it to house use. I shall try to solve the problem and as I have never been stalled in getting out of mechanical difficulties, I hope to succeed in this. Friends Aikin and Langdon are both younger than I am and have more of their lives ahead of them, and success to them means much more than to me. Here brothers Aikin and Langdon is my hand, and my hearty wishes

for your success. I assure you there shall be no jealousy between us on my part.

To say that this has been a very disastrous winter and spring to bee-keepers in the Northwest, is but to tell the truth. The Forestville apiary has lost thirty-three per cent., while many have lost all. One man near here lost seventy-five out of seventy-eight; another in Olmsted county, every colony (253), and so it goes generally. At this date, May 15th, the fruit trees are not in blossom. The box alders, soft maples and willows are not fully in bloom, and the buds are hardly swelled on the trees, but the clover is starting as never before. I anticipate a good honey crop for those that keep their bees booming.

The good swarms in the house apiary wintered in as perfect a condition as you could possibly ask. Many of the bottom boards are as clean as in summer; the combs dry and entirely free from mold, and now warmly covered with sawdust boxes, in each of which is one of my new feeders with which the feed is taken directly into the brood nest without the bees leaving the cluster and where I can, and have for some time, been giving each colony one-half pound syrup each evening, without lifting a cover and in less than two minutes time. The bees are just booming while those outside are getting weaker each day. Do you wonder that I am filled with enthusiasm?

I shall give each colony $\frac{1}{4}$ pound of syrup each night regardless of the honey they may have in the hive. This I shall continue until white clover blooms.

I will at the time of such blooming, have the hives just booming with bees, and then with more than 150, 24-section supers, each filled with 12 sections filled with leveled combs and the other 12 filled with thin foundation; I am going to get some honey if the flowers are not entirely dry. At the end of basswood I will take off all the sections, crate all finished ones and immediately extract all unfinished ones, and sell, as I did last year, this extracted honey for at least $12\frac{1}{2}$ cents per pound, and I will get the highest market price for the comb honey, and make some money if any can be made from bees in Minnesota in 1893. With one of the handy comb levelers I will immediately level the empty combs to equal size, set them away in a clean, safe place to use in the year 1894.

I will now give each colony an extra hive filled with nice straight empty brood combs exactly like the brood combs in the hive below. I will raise up the extra hive, under which is a queen excluding honey board, and as fast as nearly filled with honey and put an empty one under it. This I will repeat as often as needed until the end of the honey flow for the year 1893. I will now take off all surplus hives, examine each colony, and give to each at least thirty pounds of honey from the best filled combs in the extra hives, set up the partitions at the rear of hives and fill with dry sawdust level with the top of the hives. I will now let them stand until the usual time to put bees in the cellar. At this time I will remove the covers from all hives and place one of the shallow boxes of sawdust, with a feeder in it, on each hive, and cover all with six inches of dry sawdust that is to remain until cold weather is over in the spring. During the winter, if the weather is very severe, I will, once or so each month, after January 1st, build a good fire in the ample stove that will stand ready in the house, and thus thoroughly warm the whole building to let the bees remove a supply of honey from the sealed combs to the brood nest. In the spring, about April 1st, I will remove all the top packing, level with the top of the sawdust covers. This will leave the feeders exposed, and I will feed each colony $\frac{1}{4}$ pound of syrup each evening as before.

About May 1st, I will take down the partitions at the back of the hives, shovel the sawdust into sacks, pack them over head ready to use again in the fall. The sawdust boxes will still remain with the feeders on the hives, and the light stimulative feeding will continue until time to put on supers again, when the feeders will be taken off and a super prepared with half drawn and leveled combs be put on and the last year's work repeated again.

This work will all be done in a comfortable house where I can work equally well in good or bad weather without getting bedraggled in wet grass, with no bee yard to care for with its never ending demands, the hives all free from any danger of molestation from thieves, skunks, or other intruders, and where I can do all the work in more comfortable surroundings and in less than one-half the time required to do the same in an open yard.

FORESTVILLE, MINN., May, 15, 1893.

Bee-Keepers' Review.

PUBLISHED MONTHLY.

W. Z. HUTCHINSON, Ed. & Prop.

TERMS:—\$1.00 a year in advance Two copies, \$1.90; three for \$2.70; five for \$4.00; ten, or more 70 cents each. If it is desired to have the REVIEW stopped at the expiration of the time paid for, please say so when subscribing, otherwise it will be continued.

FLINT, MICHIGAN, JUNE 10, 1893.

EIGHT EXTRA PAGES.

Gleanings did eventually notice and describe the Weed artificial comb. (See Hasty's article.)

ABSORBING CUSHIONS, *with ventilation above them* (italics mine) are preferable to sealed covers over the bees in winter. *Gleanings* says this is shown by scores of letters received.

THE NORTH AMERICAN Bee-Keepers' Association will meet in Chicago, October, 11, 12 and 13. It was a wise policy that fixed the date so early, that those from a distance may make their plans in advance to be present at what will probably be the largest gathering of bee-keepers ever witnessed.

AS AGRICULTURE is at the foundation of all other kinds of business, so everything connected with bee culture rests upon honey production. When that ceases to be profitable, queen rearing, the manufacturing and sale of supplies and the publication of apicultural literature will be dropped. Profitable honey production is the basis.

UNCAPPING MACHINES are being talked of. "Rambler" once suggested uncapping by means of a wire heated by electricity. No scheme for uncapping will be a success that does not remove the cappings from the comb. Simply cutting them loose will not answer. The Bingham honey knife is superior because its beveled edge raises the cappings from the comb. A thin knife slips under the cappings leaving them adhering to the comb, from which they must be poked.

FOUL BROODY hives, that is, hives in which there has been foul brood, may be used again without any scalding or disinfecting, yet the disease will not be communicated to any healthy brood that may be placed in the hive; at least, so writes Mr. McEvoy, foul brood inspector for Canada, in an article contributed to the A. B. J. Many who have had large experience with foul brood have found it *otherwise*, and a matter that may be so easily accomplished as the disinfecting of hives ought not to be neglected even if there may be grounds for doubts regarding its necessity.

MR. BINGHAM writes that he had demonstrated what Mr. Corneil calls "induced air currents" before bee-keepers had ever heard of a Bingham bee-smoker. He says that the direct draft, upon which *all* smokers now depend, is his invention, and the more direct and straight the draft, the better the smoker. He has received many letters suggesting blast features, and reads about continuous blasts, etc., and while it could be easily shown why they are not adapted to bee smokers, he does not think it worth while to use space for the purpose. In the fourteen years that he has made and sold his smoker he has received only one complaining letter, and that came indirectly through interested parties. He wishes to express his gratitude to the REVIEW, Mr. Corneil, and to the bee-keepers, and promises that in the future, as in the past, their interests shall be his interests.

THE BEE-KEEPERS' ENTERPRISE AND ITS EDITOR.

"Thrice welcome new born stranger
O'er this wide world a ranger;
May he who filled the manger
Make plain the path for thee."

According to promise, the *Bee-Keepers' Enterprise* came to hand promptly on the 15th of May. As might be expected, when we know that its editor is a practical printer, it is very neat in its mechanical make up. Reaching from the top to the bottom of the front page is a twig from an apple tree. Bees are flitting about and working upon the blossoms. Across the center of the page upon a sort of a spider web back ground appears the title of the paper. In one lower corner is a section of honey with a circle drawn upon its center and in the circle is a sectional hive. Taken all in all, it is rather

a unique and striking design. The editorial department and "Gleanings from our Neighbors' Wheat Fields," are the most interesting. In the latter may be found very short, but very reasonable, extracts from the correspondence of other journals. For the first issue I think the *Enterprise* is good—the editorial instinct for getting hold of good things and setting them forth in a bright way, crops out quite strong.

And while we are waiting to see what Bro. Sage will do next, it may be interesting to know what kind of a looking man he is and something of his past life, so I will tell you that Burton L. Sage was born 35 years ago in the town of Sandisfield, Massachusetts. Three years later his parents moved to Pittsford, N. Y. When he was 10 years old they moved back to



BURTON L. SAGE.

Sandisfield and settled on an old farm that was good for nothing except to raise rabbits on. The next five years were passed in hunting rabbits and partridges, fishing for speckled trout and extracting honey from the nests of bumble bees. When he reached his 15th year, the family moved to Colebrook, Conn. Here he worked out summers and attended school winters. At the age of 24 he purchased a milk route in New Haven. A year later he bought a lot, and with his own hands built a two-story cottage, and when it was finished and furnished, just nine years ago this month, he brought to this home a wife—one of England's fair daughters, then only 16 years old. Soon after a small printing office was set up in one of the rooms of the home, and while on his milk route he took orders for printing and the young wife did the work. Six years later the milk route was sold and the printing office moved to 730 Chapel St. Side by side husband and wife worked at the case until a little girl, now old enough to say "up a da, da," came to claim all of the mother's spare moments.

Mr. Burton's interest in bees dates back to 1878, when the post-master, by mistake, handed him a copy of *Gleanings*. It opened up a new world to him. Since then his in-

terest has grown until he feels that he would like to have a journal of his own. The result is the *Enterprise*, which is well named. Pleasant indeed are such pictures of success from humble beginnings, as the result of perseverance and enterprise.

—●—

MICHIGAN IS TO HAVE AN EXPERIMENTAL
APIARY.

At several of the bee-conventions that I have attended there have been resolutions passed asking that the general government or that the State Experiment Stations do some experimental work in the bee-keeping line. At one or two of them a committee was appointed to try and secure the desired action. If this is all that is done, no experimental apiary will be established.

At the last meeting of the Michigan State Bee-Keepers' Association, this subject was discussed and a committee appointed to try and induce the State Board of Agriculture to secure the services of a competent bee-keeper for managing the State apiary in an experimental way, for, be it known, Michigan was already the possessor of an apiary. The Hon. R. L. Taylor, the Hon. Geo. E. Hilton and myself were the members of the committee. As chairman of the committee I addressed a letter to each member of the State Board of Agriculture.

I called their attention to the fact that of the \$15,000 received by each State from the general government for experimental work, almost nothing was devoted to apiarian research; I pointed out the fact that each State ought to conduct experiments in the lines that would benefit the industries of that State. Experiments in cotton growing would not be appropriate in Michigan. Experiments in bee-keeping would. Not only is bee-keeping important for the wax and honey produced, but for its benefit to the fruit grower and horticulturist. Without bees, these two industries would languish.

I then called attention to the different experiments that ought to be made, and in the name of the bee-keepers of Michigan I most respectfully but most earnestly urged that they give the matter an early consideration.

I then had circulars printed showing what I had done and urging the recipient to write to the members of the Board and ask that bee-keeping be recognized by the appointment of an apiarist for doing experimental work. These were sent to about 100 of the

most prominent bee-keepers of the State. I also wrote about twenty personal letters urging these friends to write. Mr. Hilton also wrote and sent out circulars. All this was done shortly before a Board-meeting, and when the Board met, Mr. Taylor and myself went before it and urged our case. The matter was urged almost solely upon the ground that bees were a benefit to other pursuits; that the honey and wax were of less consequence than the benefits derived from the bees by other pursuits. Mr. Taylor said that bee-keeping was looked upon by many as a small business, as one beneath the dignity of a man—a bee-keeper was looked upon as a sort of a "hen-wife." If the State would recognize and encourage it, it would add dignity to the pursuit, and lead to more extensive keeping of bees.

The Board then wanted to know what were the experiments that bee-keeping so much needed. Said one member: "The sheep and dairy men, and those from other industries, come before us just as you have done and say 'do something for us,' and when we ask what, they are at a loss to answer. Tell us what experiments you want done and we will try and see that a man is found to do the work."

I then went to work and prepared a list of perhaps a dozen different experiments that I considered the most important, and, as none of the members were practical bee-keepers I went into details and explained each point so that the importance of the work could be understood even by one not a bee-keeper.

It was then asked if a bee-keeper could not do this work cheaper in his own apiary, than he could come to the College and do the work. I replied that he could. I thought he could do the work for half the money that he would need if he were obliged to move to Lansing and pay rent. The next question was, "How much pay ought a man to receive for conducting experiments in his own apiary?" I thought \$500 a year a fair compensation.

To make a long story short, \$500 a year has been appropriated for paying a man to conduct experiments in apiculture, and the Hon. R. L. Taylor, of Lapeer, has been appointed to do the work. He has had experience, he is careful, methodical and conscientious, and it is no disparagement to other bee-keepers to say that probably no better man could have been chosen for the work.

An early issue of the REVIEW (if not the July, then the August issue) will probably be devoted to a special discussion of "Experimental Apiculture," and Mr. Taylor will thereafter have charge of a department in the REVIEW headed "Work at the Michigan Experimental Apiary." In this department he will tell what he has done, is doing, and hopes to do. Readers will be invited to say what experiments they would like conducted, or how they would like particular experiments conducted, to criticise, commend and encourage. Mr. Taylor would be thankful for suggestions of any kind by letter at once, touching work that can be done to advantage only during the swarming season. Of all the good things that have come to bee-keepers through the REVIEW, I firmly believe that this will prove second to none.

I have been explicit as to the methods employed in securing the appropriation, because I thought it might help bee-keepers in other States in their efforts to secure recognition at the hands of the State Board. Somebody has got to go ahead and do some hard earnest work, and there will be some expenses for printing, postage, car-fare and hotel bills in going to visit the Board; but these expenses ought to be borne by the bee-keepers of the State—perhaps be paid out of the funds of the State Association. There is *no use* in trying to avoid this expense; for, as one of the board wrote me after the meeting was over, "All of the talk and writing would have amounted to nothing, had not you and Mr. Taylor come before us in the proper spirit; then the thing went through like a charm, without a dissenting voice, and with the most hearty good feeling."

EXTRACTED.

How to Introduce Queens by the Hatching Brood Method.

When one has a valuable queen to introduce, the plan of letting her loose on combs of just hatching brood, combs from which all the bees have been brushed off, is sometimes resorted to. Of course, the hive is closed for several days, until there are sufficient bees hatched to form a cluster and defend the hive. One trouble, unless it be very warm weather, is the danger of loss from chilled brood. In *Gleanings*, Dr.

Miller gives a plan that is ahead of that. He says:—

"When I get an imported queen I generally use the plan of having two or three or more frames of hatching brood, if possible having no unsealed brood. Doolittle speaks of this plan, and seems to think it's all right, except that sometimes one may forget to bring it in at night, or it may not be warm enough in the house, and so there's a chance for chilling. Let me tell you how I manage so there is no danger of chilling. I bore in the bottom of a hive a two-inch auger-hole. On the inside of the hive I nail over this hole a piece of wire cloth. Turning the hive upside down I nail on the hole another piece of wire cloth. Then this hive is placed over another hive containing a strong colony. Nothing is between the two hives, so that the heat from the lower hive goes directly through the auger hole up into the hive above. In the upper hive I put the frames of hatching brood, make sure that every thing is bee-tight, put the queen on top of the frame, and quickly put on the cover. In five days the upper hive is allowed an entrance large enough for the passage of one bee at a time, and I have seen those five-day-old babies bringing in loads of pollen. In a few days more the hive can be removed to a new location. It would be better, I think, to have the hole larger, so that the heat would pass up more readily. The hole being doubly covered with wire cloth, there is no chance for the bees below to communicate with the ones above, so there is no danger of their hatching mischief. I have, however, sometimes used an upper hive without any bottom board with a single sheet of wire cloth between the two hives."

Some of the Things I Wouldn't do.

Bro. Alley, in the *May Api.*, gives about three columns to mentioning some of the things he wouldn't do and some that he would do. I give a few of those that he wouldn't do.

"I wouldn't introduce a new queen for the sake of changing the race of any prosperous colony of bees. Those who do so will be the losers in the end. After the swarming and honey season are over, then change queens if necessary.

I wouldn't put sections on a hive no matter how populous the colony, till I could see that the bees are gathering some honey and had started to build brace combs between the top bars of the frames. Then I would put a few sections on, but not over one set of twenty-four sections at a time.

I wouldn't use a section case that is non-reversible. When sections are half full, or even quite full, if reversed the bees will attach the combs solidly to all sides of the section. Honey so stored can be shipped a long distance without breaking or leaking. I have no section cases for sale, nor am I puffing my own goods. Don't misunderstand me.

If two or even three swarms should issue at the same time, and all settle on the same limb, or other object, I wouldn't separate the bees, nor even look for a queen, unless they are valuable ones. I would put all the bees in one hive and give them all the sections they could work in to advantage. Whew! what a pile of section honey such a horde of bees would store. I have had two swarms that united, fill the brood-chamber and 100 one-pound sections in less than three weeks.

I wouldn't bother about wiring brood frames if I could purchase the Van Densen wired brood foundation. This celebrated foundation is made by placing the wire between two thin sheets of wax and then the wax is subjected to powerful pressure. The wire never works out, nor do the bees ever gnaw the wax off the wire as they do in all cases where the frames are wired, instead of the foundation."

Empty Brood Combs.—Their Most Profitable Use.

In some parts of the country bees have died quite extensively the past winter, and many bee-keepers will find themselves the possessors of large numbers of empty combs. Before deciding to hive swarms on them it would be well for them to read carefully and consider well the following advice given by J. A. Green in the *A. B. J.*:

"Sooner or later every bee-keeper is apt to find himself the possessor of a number of empty brood-combs. If he seeks information from authorities as to the best way to utilize them, he is liable to receive very contradictory advice.

Some will tell him that these combs are very valuable; 'as good as money in the bank;' 'the sheet anchor to success,' etc., while others will say that the best thing he can do with them is to melt them into wax. As usual, the truth will be found to lie somewhere between the extremes. Their value for use in the hives will depend very much upon circumstances. At times they are very valuable, and at other times they might better be thrown away than used.

The most natural and common use is to hive swarms upon them. We know that a new colony must have brood-combs before it will do much at storing honey, and nothing could be more natural than to suppose that by giving them these combs already built, they will be greatly helped and enabled thereby to commence sooner the profitable work of filling sections.

But if we experiment carefully, we will often find that what looks so plausible in theory, does not turn out so well in practice. The colonies that we had supplied with full sets of ready-built combs somehow do not give as great a surplus of honey as those which had to build their combs anew. There are several reasons for this. One is, that bees, as well as human beings, will often take more time to patch up an old thing than to

make a new one. Combs usually require considerable fixing over before the queen will lay in them.

The most serious objection to their use in this way is, that the bees will begin to fill them with honey at once, and will do little or nothing in the surplus department until the brood-combs are full of brood or honey. Very often they are filled first with honey, and unless the queen is an unusually smart one, this honey stays there, reducing the brood-rearing capacity of the hive, weakening the energy of the bees for storing in the supers, and lessening decidedly the amount of marketable honey. If there are empty combs enough, they may have just as much honey put into them as would be put into the supers—perhaps more—but this honey will not be worth nearly as much as if it had been stored in sections.

As previously stated, the value of combs depends upon circumstances. There are times when combs may be very profitably used in hiving swarms, while under other circumstances we may find that we have used them at a loss. To use them advantageously, certain rules must be followed.

In the first place, if honey is coming in freely, and this honey-flow is not likely to last more than a month, which is the case nine times out of ten, too many combs should not be given. Nothing could be more fatal to the chance of securing a large yield of comb honey, than to hive the swarm in a large hive filled with finished combs.

Ordinarily the swarm issues during the early part of the honey-flow, which does not last more than two or three weeks longer—often a shorter time. At such a time the brood-chamber should be contracted to a space equal to five Langstroth frames, and I think the fewer finished combs are used the better.

On the other hand, if swarms issue very early, before the main honey-flow begins, it will be found profitable to give them as many combs as the queen will occupy with brood before they are filled with honey.

As the honey-flow draws toward its close, it again becomes profitable to hive swarms upon finished combs, as otherwise the colony may not be able to build sufficient combs for its needs, in which case brood-rearing is restricted, and the colony rapidly dwindles. At this time, too, all colonies that have been hived in a contracted brood-chamber should be looked over; and empty combs added as fast as they can utilize them. In this way colonies weak in numbers may often be brought up to good working strength in time for the fall crop.

The time when empty combs are most valuable, is when it is desired to increase the number of colonies as rapidly as possible. With vigorous, prolific queens, plenty of empty combs, and judicious feeding when pasture is short, an apiary may be increased in numbers at a very rapid rate, and it is this very elasticity—the ability to recover quickly from heavy losses—that relieves bee-keeping of much of the uncertainty and risk that would otherwise make it a much more precarious occupation than it is."

A Condensed View of Current Bee Writings.

E. E. HASTY.

Mistress Mary,
Quite contrary,
How does your garden grow?

The above jingle, dear to the ear of childhood, suggests one chief pleasure of gardening critical, as well as of gardening floral and vegetarian, the pleasure of seeing something changed for the better, of seeing something grow. We now take up the journals for the second time. How much have they grown since the present year begun? One that has grown is—

THE APICULTURIST.

It has put off its dingy red and put on that delicate pale green which makes so artistic a back ground for anything put upon it. Its face is made up with taste, and not crowded—rather a rare merit. As the journals lay side by side which is the best looking, supposing that outside looks were all? The jury would disagree doubtless, but I feel sure that some good judges would give the *Api*. the first place. The *Apiculturist* is also growing confirmed in the style of being almost wholly an editorial paper. As friend Alley outranks most of his correspondents this is, for the present, an improvement—and yet a little like climbing an easy side spur of the mountain while your rivals are striving for up the main peak—have to climb down from there eventually, else get left. At present editor Alley can say, the *Api*. is myself. And it has lots of—

“This rock shall fly
From its firm base as soon as I;”

especially when earnest friends privately labor with it to have those Punic bees put overboard. (See page 47.) Bump of self-esteem? Yes—

“We strive to pronounce as many practical ideas as all the other papers combined.” Page 74.

But this 'ere “Mary” is so contrary that she will not concede the full success of that laudable effort just yet. But even Mary will concede that the queen-rearing number is a valuable thing to have in the house. And here is “Queen Rearing” boiled clear down to cracklings. Feed—Warm weather—Nearly new comb—Queenlessness 24 to 48 hours—Care in getting the bees off—Hot room to operate in.—Thin, sharp knife kept hot—

Pencil record on the top bar—Old comb $\frac{1}{8}$ cut away to wax the egg strips upon—Don't cook the eggs—Two quarts of queenless bees, shut in with wire portico—Keep cool 24 hours, then to a strange location and let fly—Leave only two cells—Two days later give another quart of *not* queenless bees *at night*. This is nucleus rearing.

A doubt is expressed whether the up-chamber method, which utilizes a full colony with queen, and at work storing honey, turns out *quite* as good cells and queens. The object in view is the saving in bees and time. In this method the queen is kept below by perforated metal, and all the combs of brood except one for a nest-egg, are put above every 21 days. Such a top story does not usually start cells; but if supplied with cells 24 hours old they will work steadily at the business of finishing them all the season—and store honey too. While Doolittle makes the cups, and puts in larvæ by hand, Alley seems to prefer having a queenless colony first do 24 or 36 hours work on each set.

The whole thing can be done however by one colony. Have but a few inches of perforated metal in the chamber floor, the rest being thin board; and fix a tin slide capable of shutting the chamber up tight; and ventilate through wire netting above. With 18 hours of this they will be willing to build. Then give eggs, stop the top ventilation, open a fly hole in front, and fix a board in front to make them return right. But although one colony *will* do all the work thus, it is still economy to make one such hive start the cells and another finish them.

When we read that after August 10th nearly every colony made queenless for old style work will perish in winter, the need of a more merciful and less expensive way appears quite evident. The season's work of a good colony by the new method is immense, 300 cells, panning out (with the help of fertilizing nuclei, of course) 250 queens. Colonies with old queens do the best work.

THE TOPIC OF THE HOUR.

Mary is quite hasty to have that young phenomenon, H. P. Langdon, under manipulation, and weed his little garden bed for him. Needless to say that nothing of equal promise has been proposed for many a year. Even the “forbidden fruit” of sugar-honey is in danger of being forgotten if out-apiries can be planted without fear of swarm losses. Fine stroke of enterprise in the Review to

be the first to promulgate the thing. As by the REVIEW came the scratches, even so by the REVIEW came the ointment to cure it. The general lines of thought and effort are similar to those followed by Taylor, Aikin, Wells, Coverdale, and probably others; but Langdon's method has a finished, practical, licked-into-shape appearance to which the others will probably bow with the best grace they can command. "Beat the drums, here the conquering hero comes," having won the first campaign of a season's work in a large apiary. Mary herself (on different lines) has been a hard fighter against the swarming nuisance—licked every time—and now without tears she takes off her bonnet and walks behind the victor's chariot—example for the rest of you who have got left. And what a lot of schemes and dreams, self-hivers and self-everythings, queen-traps and rattle-traps are now invited to go amiably to the rubbish heap! Still the hero of the first campaign is not *sure* to turn up president at the close of the war. But the method will have a great run no doubt. In localities where the honey season is short, sharp, early and sure it hardly looks possible for it to fail. Where swarming and surplus are both possible for four or five months it may yet run against some unforeseen stump. Mary will venture the guess that it has come to stay in nearly all comb honey out-apiaries, but that many home yards will discard it after awhile.

Bee-keepers incline to be æsthetic in feeling; and they have greatly decried the old bee-keeping, with its brimstone pit, for cruelty. It is in order therefore to remember that the new plan is a cruel one—much more cruel than extinguishing once for all half the colonies in autumn. All the same I suppose we must have the new plan, cruelty and all, if it works. With experience we may learn practical ways to mitigate the severities so that only the young queens and drones will be starved, or at most only part of the young workers. Water fount inside, and wire grating to let the nurses on the plenty side share the nectar they are holding with the distressed nurses on the famine side, look feasible. But if we should mitigate *all* the cruelty the baby queens would not be destroyed, swarming would follow, and the whole thing "bust up."

In a normal colony there are often several pounds of partly grown larvæ. Several pounds of substance, largely water, *must* be

forthcoming within three or four days to complete the growth. Slide closes and not a drop of water or a pellet of pollen can enter for a week. Honey cannot possibly fill but part of the need. There is some pollen on hand, and some cells of diluted nectar food. Then the nurses can probably draw on the juices of their own bodies to a certain extent. Next the larval drones are torn up and their juices sucked out. Then, if the worker brood are not grown, the full bitterness of famine and death has come—not pleasant to contemplate. The society for preventing cruelty to animals has already arrested a man for dehorning his cows; and his fellows are preparing to chip in and run the thing up to the highest court. If that powerful and popular society should summon friend Langdon to come up to the captain's office they would have a much stronger case than can be made against the dairymen.

THE GENERAL ROUND UP.

We must keep a sharp eye on that Rambler, and the plan he proposes in last Review, page 134. Outwardly we cannot very well howl "Swindle! fraud! dishonesty!" but how some of us will ruminate these words inwardly, if he sends a car load of California fruits, nuts and honey to each of our county towns! In fact man is so got up that he thinks whatever pinches his individual corns *must* be a fraud—no further argument needed, or tolerated. But, from a California point of view, the wisdom of using commission men instead of antagonizing them, and then sprinkling car loads all through the territory they do not cover, is superb.

S. E. Miller in the *Progressive* addresses his chief as "Mr. Higginville," because he neglects to run up his name. Right. Hit him again. In specialist journalism when an editor wants to hide his personality often than not it is because he is ashamed of his work—or lack of work. Make him avow himself and he'll do a better job.

The last *American Bee-Keeper*, with a quiet dignity that sounds like an editorial from some other world than this, says of sugar-honey—

"We are perfectly willing to have the subject thoroughly discussed through our columns."

Doolittle in the *American Farmer*, quoted in the *Guide*, page 70, proves the point that bees do not always die from losing their stings. Somewhere, not long since we had seemingly reliable observations of the num-

ber of hours in which such bees *did* die in several cases.

What kind of beings are we all any way? Such a distinguished apiarist as Simmins would hardly assert that fertile queens never fight unless he had something to back him up. Yet that we should have all jumped to a false conclusion without any proof seems very improbable too. Market for the man who has *seen* a fertile queen fight. (REVIEW, page 147.)

Dr. Miller in *Gleanings*, page 259, gets in an unanswerable dig at the scientific doctrine that stings are modified ovipositors. He wants to know if queens once had two ovipositors.

Doolittle has not had a nucleus robbed since he found out the right way to have things. Have the nucleus at one side of a full sized chamber, with the outer entrance *at the other side*, so the bees must first come in and then travel across to destination. (*Gleanings* page 251.)

One part ordinary floral honey shaken with three parts pure alcohol and left 15 minutes will be clear. *If there is glucose in it it will look milky.* (*Gleanings*, 355 and 275.)

The world moves, *Gleanings* included. When Weed was at artificial comb-making it preserved a silence that could be cut into chunks with a knife. I think the REVIEW was about the only journal that frankly told right out all it could get hold of to tell. But now Warnstorf is at work at the same job, Dr. Miller and the editor chat freely over the matter, and neither shows the slightest consciousness that they are perpetrating wickedness. Well, if people will only get into the right shape we will not grumble if they do forget quickly their absurd past. Very earnest folk have two very different ways of looking at new things and an editor's duty concerning them. One brother is solemnly impressed that the public must be defended from hearing all but the most orthodox and doubly guaranteed news. He would defend them as vigilantly as little girls are defended from hearing obscene talk. The poor, dear, unsophisticated, public! How cruel to let doubts and fears and disputings get started among them! And their business sometimes suffers if immature and awkward news and doctrines get loose. The other brother vehemently says, That man—nay that "critter" who in this dawn of the twentieth century wants a conspiracy of silence organized on *any subject whatever*—I

don't want him killed exactly; but if nothing worse happens to him than to have his business broken up he'll get but few tears from me. I called this latter individual, brother, but possibly he is a nearer relative. Might see him when I look in the glass.

How far behind I am getting in the desperate effort to "lecture" on all the meaty topics the journals bring up. On *A. B. J.* especially, I am many leagues in arrears. This is partly because it has its innings the next one, and I was hoping to reach it in the present number. It will have to go over to next time, excepting two of the more interesting points in the number for May 4th.

Dathe, a German sent to Ceylon after *Apis Dorsata*, after many trials in the general style of Frank Benton, hit upon a short cut which is worthy of a Yankee. The *Dorsata* is very migratory; and by scattering honey around he succeeded in making them pull up sticks and come to him, How nice to return at eve and find your colonies all emigrated to your neighbor's apiary because, forsooth, he feeds more liberally than you do! Yet, for all its queer ways, quite likely this giant bee would be a "hummer" if we could get him started once in the forests of Florida. Might take Blackstone and his whole family to straighten out the questions of meum and tuum that would arise. The *Dorsata* will not feed the brood of ordinary bees it seems. Looks as though they would have to be transported outright without mixing in any other race to help on. We learn these things at the hand of H. Reepen the new German itemist. Friend Reepen lives in Grossherzogthum. And do the children there sing—

Grossherzogthum my happy home
Name ever dear to me?

Doolittle gives an excellent solution of the so-called queen cramp on page 564. Most of us have seen a horse get the lines under his tail, and then make a fool of himself hanging on and resisting all attempts to get them out. It seems queens are just so, only a great deal more so. When a queen is captured and held up by the wings we can hardly blame her for squirming and gyrating her members about. It seems that occasionally a foot gets thrust into the forceps-like extremity of the body. When this occurs she excitedly hangs on to it for all she's worth; and her puzzled owner thinks she is having a mortal spasm of some sort.

RICHARDS, Lucas Co., O., May 16, 1893.

30 Thirty Year's Experience, 30

Try Our Hardy Strains of Bees.

Leather colored Italians and golden Carniolans. Qualities: extra honey gatherers, long-lived and hardy. To each customer we present our latest method of queen rearing. Catalogue free. Queens \$1.00 each. H. ALLEY, Wenham, Mass.

Please mention the Review.

DOVETAILED HIVES.
Frames, Sections, Honey Crates, Foundation and Apiarian Supplies of all kinds. Catalogue free.

E. L. KINCAID, Walker, Mo.

Please mention the Review.

WILL SACRIFICE SUPPLIES. WRITE FOR LIST.

I also have "office helps" for sale. 3-93-tf

JNO. C. CAPEHART, St. Albans, W. Va.

Please Mention the Review.

QUEENS, A large number of fine ones on hand; yellow and prolific; ready April 15th; warranted queens, \$1; 6 for \$4.50; select tested, yellow to the tips, suitable for breeders, \$2 each. Reference, A. I. Root. 3-93 tf
W. H. LAWS, Lavaca, Seb. Co., Ark.

Please mention the Review.

DO NOT GIVE YOUR ORDER FOR SECTIONS UNTIL YOU GET OUR PRICES ON THE "BOSS" ONE-PIECE SECTION



We are in better shape than ever to fill orders promptly. Also,

DOVETAILED HIVES, - - - - -
- - - FOUNDATION, SMOKERS, Etc.

Write for Price List.

J. FORNCROOK & CO.

WATERTOWN, Wis., Jan. 1, 1893. 1-93-tf.

Please mention the Review

If You Wish Neat, Artistic

PRINTING,

Have it Done at the Review.

3 & 5 Banded Queens

AND

2 & 3 Frame Nuclei

A SPECIALTY.

	April	May
One untested queen,	\$1.00	\$1.00
Six " queens,	5.00	5.00
One tested queen,	2.00	1.50
Three " queens,	5.00	4.00
Select tested queen,	2.50	2.50
Two-frame nucleus with any queen \$1.50 each, extra. Three-frame nucleus with any queen \$2.25 each, extra. Safe arrival guaranteed.		

W. J. ELLISON,

3-93-3t Catchall, S. C.

Michigan Bee-Keepers,

You will consult your own interest, by sending for my catalogue and price-list of Root's Supplies. Beeswax and white extracted honey wanted.

CLARK A. MONTAGUE,

4-93 3t Archie, Grand Traverse Co, Mich.

Please mention the Review

New as Well as Valuable IMPROVEMENTS

IN BEE-HIVES, SMOKERS, FOUNDATION FASTENERS, SECTION PRESSES AND FEEDERS.

Special prices given to parties who will take hold of and push the sale of these goods. For circulars and particulars, address

LOWRY JOHNSON,
Masontown, Pa.

1-93-tf.

ITALIAN QUEENS AND SUPPLIES FOR 1892.

Before you purchase, look to your interest, and send for catalogue and price list.

J. P. H. BROWN,

1-88-tf. Augusta, Georgia.

Please mention the Review.



Don't Monkey

with cross bees or poor goods. Untested, Italian queens, 75 cts each. 3 for \$2.00. Best stock. Send for catalogue of supplies.

JNO. NEBEL & SON, High Hill, Mo.

Barnes' Foot and Hand Power Machinery.



This cut represents our Combined Circular and Scroll Saw, which is the best machine made for Bee Keepers' use in the construction of their hives, sections, boxes, etc.

11-92-76t

MACHINES SENT ON TRIAL.

FOR CATALOGUE, PRICES, ETC.,

Address W. F. & JNO. BARNES CO., 384 Ruby St., Rockford, Ills.

Please mention the Review.

IF YOU WANT THE

BEE BOOK

That covers the whole apicultural field more completely than any other published, send \$1.00 to Prof. A J. Cook, Agricultural College, Mich., for his

Bee-Keepers' Guide.

Liberal Discounts to the Trade.

Please mention the Review.

Early Queens From Texas,

From my choice golden stock. My bees are very gentle, good workers, and beautiful. Safe arrival and satisfaction guaranteed. One untested queen, April and May, \$1.00; six for \$5.00; later, 75c. Orders booked now; money sent when queens are wanted. Send for price list.

J. D. GIVENS,
Lisbon, Texas.

1-93-9t.

Please mention the Review.

TESTED QUEENS

\$1.00 Each.

Light, large and prolific Italian queens reared in Jan 1892, by the most improved methods. Orders filled by return mail.

J. W. K. SHAW & CO.,

4-94-7t

Coreauville, La.

Please mention the Review.

Have You Seen Our Big Blue Cat-

ALOGUE FOR 1893? Seventy illustrated pages. Sent FREE to any bee-keeper. BEE-SUPPLIES, at retail and wholesale. Everything used in the apiary. Greatest variety and largest stock in the West

1-93-tf. **E. Kretchmer**, Red Oak, Iowa.

Please mention the Review.

TESTED

Queens are usually sold for \$2.00. I will explain why I wish to sell a few at less than that. As most of my readers know, I re-queen my apiary each spring with young

QUEENS

From the South. This is done to do away with swarming. If done early enough it is usually successful. It will be seen that the queens displaced by these young queens are never more than a year old; in fact, they are fine, tested, Italian queens *right in their prime*; yet, in order that they may move off quickly, and thus make room for the untested queens, they will be sold for only

\$1.00.

Or I will send the REVIEW for 1893 and one of these queens for only \$1.75. For \$2.00 I will send the REVIEW, the queen and the book "Advanced Bee Culture." If any prefer the young, laying queens from the South, they can have them instead of the tested queens, at the same price. A discount given on large orders for untested queens. Say how many are wanted, and a price will be made.

W. Z. HUTCHINSON, Flint, Mich.

THE PROGRESSIVE BEE - KEEPER

Has Changed Hands. It is now Published by the
LEAHY MANUFACTURING CO.,

Higginsville, Missouri.

Money, Experience and Enterprize will not be lacking to make it all that its name indicates. Send for Free Samples and Copy of 28-page Catalogue of Apiarian Supplies.

GRAY CARNIOLANS. GOLDEN ITALIANS.

WE are headquarters in the United States for **GRAY CARNIOLANS**. A full description of this *wonderful* and *hardy* race of bees is given in our price list for 1893. Our **GOLDEN ITALIANS** are as good as the best. Each race is bred for business, in a separate apiary near no other bees. Get our prices before ordering, as we can save you money. Descriptive price list free. 5-93-tf

F. A. LOCKHART & CO., Lake George, N. Y.

NOTICE OUR PRICES.

No. 1 Sections \$2.75 per 1,000 Thin, surplus foundation, best quality, 50 cts per pound. A full line of supplies, including Root's Dove-tailed Hives, on hand. Send for circular and free sample of foundation 5-93-tf

J. H. & A. L. BOYDEN,
Saline, Mich.

HUNT'S

FOUNDATION

FACTORY.

Send for free samples of foundation and sections; warranted good as any made. Dealers, write for special prices and the most favorable conditions ever offered on foundation. Send for new, illustrated, free price-list of a full line of supplies. **M. H. HUNT,**
Bell Branch, Mich.

Names of Bee-Keepers.

TYPE WRITTEN.

The names of my customers, and of those asking for sample copies, have been saved and written in a book. There are several thousand all arranged alphabetically (in the largest States) and, although this list has been secured at an expense of hundreds of dollars, I would furnish it to my advertisers at \$2.00 per thousand names. A manufacturer who wishes for a list of the names of bee-keepers in his own state only, or, possibly, in the adjoining states, can be accommodated. Any inquiry in regard to the number of names in a certain state, or states, will be answered cheerfully. The former price was \$2.50 per 1000, but I now have a type writer, and, by using the manifold process, I can furnish them at \$2.00. **W. Z. HUTCHINSON,** Flint, Mich.

GOLDEN ITALIAN QUEENS

Now ready for \$1.00 each. Do not order your supplies until you see our circular for 1893. For the price, we have the best spraying outfit made. Send \$1.50 and get one. **Wm. H. BRIGHT,**
1-93-12t Mazeppa, Minn.

Are You Tired

of New Bee Journals? Send 15 cts for 3 month's subscription to that bright, new bee paper, "The Bee - Keepers' Enterprise," and receive **FREE** the Enterprise Souvenir—a Work of Art

That will rest Your Eyes.

Burton L. Sage, New Haven, Conn.

LEININGER BROS.

Will sell Italian queens and nuclei cheap the coming season. Write for special prices. 5-92-tf
FT. JENNINGS, OHIO.

Ready to Mail, ITALIAN QUEENS,

Tested, at \$1.25; 12 for \$13.00. Untested, after April 1st, \$1.00 each, or 6 for \$5.00. Safe arrival guaranteed. Bees, Drones and Supplies. Circular free. **J. N. COLWICK,**
4-92-tf Norse, Bosque Co., Texas.

Please mention the Review.



**BEES, QUEENS,
SMOKERS, SECTIONS,
COMB FOUNDATION AND
ALLAPIARIAN SUPPLIES.**

E. T. FLANAGAN, BELLEVILLE, ILL. CHEAP
SEND FOR CATALOGUE

HILL'S SMOKER and FEEDER.

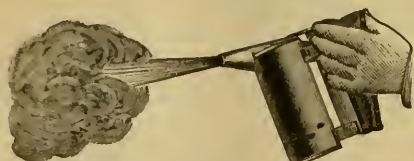

Smoker burns hard wood chips without special preparation. Very reliable. Greatest smoking capacity. Easiest to start. Cheapest because it saves time. Price, \$1.20. By mail, \$1.40. Per dozen, \$10.80.



Best Bee-Feeder. Most convenient. Saves feed. No daubing or drowning. Two to seven feeders full may be given a colony at one time which will be stored in the combs in ten hours. Price, per pair, 30c.; by mail, 40 c.; per doz., \$1.60. Has a sale of 2,000 per month. Address A. G. HILL, Kendallville, Indiana.

These smokers and feeders are kept in stock by Thos. G. Newman & Son, Chicago, Ill.
 G. B. Lewis & Co., Watertown, Wis.
 W. H. Bright, Mazeppa, Minn.
 Chas. Dadant & Son, Hamilton, Hancock Co., Ill.
 E. Kretschmer, Red Oak, Iowa.
 H. McWilson & Co., 202 Market St., St. Louis, Mo.
 F. H. Dunn, Yorkville, Ill.
 W. D. Soper & Co., Jackson, Mich.
 Chas. A. Stockbridge, Ft. Wayne, Ind.
 A. F. Fields, Wheaton, Ind.
 W. S. Bellows, Ladora, Iowa.
 E. F. Quigley, Unionville, Mo.
 Gregory Bros., Ottumwa, Iowa.
 Miller Bros., Bluffton Mo.
 G. K. Hubbard, Ft. Wayne, Ind.
 Theodore Bender, 18 Fulton St., Canton, Ohio.
 Math and Son, Cincinnati, Ohio.
 Levering Bros., Wiotia, Cass Co., Iowa.

Please mention the Review

MICHIGAN

Sections Still Lower!

8-to-the-foot, one-piece, white poplar, and 7 " " " and 1%, one-piece basswood, all $4\frac{1}{4}$ x $4\frac{1}{4}$ square. Prices: 500, either kind, \$1.50. 1,000, \$2.75. 2,000, \$5.25. 3,000 to 5,000, \$2.50 per 1,000. 5,000 or more, \$2.40 per 1,000. Satisfaction guaranteed. Sample free. Please give the size you want.

O. H. TOWNSEND,

4-93-tf Alamo, Kal., Co.; Mich.

Reference: EDITOR REVIEW.

Golden Italians.

My bees are large and great honey gatherers. 1 untested queen, 80 cts.; 3 for \$2.00. 1 warranted queen, \$1.00; 3 for \$2.50. 1 tested queen, \$2.00; selected, tested, \$2.50. Satisfaction guaranteed or money refunded. 4-93-tf

C. M. HICKS, Hicksville, Md.

PATENT. WIRED, COMB FOUNDATION

HAS NO SAG IN BROOD FRAMES.

THIN, FLAT BOTTOM FOUNDATION

HAS NO FISH BONE IN SURPLUS HONEY.



Being the cleanest is usually worked the quickest of any foundation made.

J. VAN DEUSEN & SONS,

(SOLE MANUFACTURERS),

3-90-tf Sprout Brook, Mont. Co., N.Y.

For \$1.50 I will send the Review for 1893 and a fine, young, laying, Italian queen.

Queen alone, 75 cts. For \$1.75 I will send the Review, the queen and "Advanced Bee Culture." Tested queens, \$1.00. The Review and

a tested queen \$1.75 A discount on large orders. W. Z. Hutchinson, Flint, Mich.

REVIEW

QUEENS



Bingham Perfect Smokers.
Cheapest and Best on Earth.
Patented 1878, 1882 and 1892.

zles, coiled steel wire handles and inverted Bingham bellows with Bingham, cleated joints. The Bingham & Hetherington Uncapping Knife belongs in the perfect series also. Perfect in principle, perfect in detail, and 14 years the standard in every country—price \$1.15 by mail. Our smaller smokers—"original, unimproved, Bingham, bee smokers"—are as we have always made them. Little Wonder, 1½-inch stove, narrow shield, 65 cts. Plain, narrow shield, 2-inch stove, \$1.00. Extra, 2-inch stove, wide shield, \$1.25. For further description and ¼ doz. (or more) rates, address the original inventor and only maker of them,

T. F. BINGHAM, Abronia, Mich.

Bingham, Perfect Smoker Series.

The Doctor, 3¼-inch stove, largest smoke and fuel capacity made, price \$2.00. The Conqueror, 3-inch stove, price \$1.75. The Large, 2½-inch stove price \$1.50. These prices include postage. These smokers all have wide shields, movable bent nozzles, coiled steel wire handles and inverted Bingham bellows with Bingham, cleated joints. The Bingham & Hetherington Uncapping Knife belongs in the perfect series also. Perfect in principle, perfect in detail, and 14 years the standard in every country—price \$1.15 by mail. Our smaller smokers—"original, unimproved, Bingham, bee smokers"—are as we have always made them. Little Wonder, 1½-inch stove, narrow shield, 65 cts. Plain, narrow shield, 2-inch stove, \$1.00. Extra, 2-inch stove, wide shield, \$1.25. For further description and ¼ doz. (or more) rates, address the original inventor and only maker of them,

T. F. BINGHAM, Abronia, Mich.

JUNE 25

By my system of dequeening at the opening of of the harvest, I will have **300 TESTED QUEENS** of the leather back strain of Italians, for delivery about June 25th, at 75 cts each or \$7.50 per dozen. These queens are all young and prolific—none over **ONE YEAR OLD**. Book your orders now and pay when the queen arrives. None will be sent at these prices before June 20th nor after July 10th. First come first served. **A. F. BROWN,**
1-63-tf Box 16, New Smyrna, Fla.
(Formerly at Huntington, Fla.)

Please mention the Review.

FREE TO ALL

SAMPLE COPIES EITHER OF THE

Canadian Bee Journal
OR
Canadian Poultry Journal,
Or both, will be sent **FREE** to applicants who desire them, upon receipt of their names and addresses.

These papers are both of them edited and arranged by practical men, admittedly the most experienced in their particular lines to be found on the continent, and the Journals may therefore be regarded as authoritative upon the several subjects of which they treat.

Address **BEETON PUBLISHING CO.,**
Beeton, Ontario.

Please mention the Review.

Take Notice!

If you are looking for the bees that give the most profit, and are the most gentle, try the

ALBINO.

I can also furnish the golden Italian, but my preference is the Albino. Send for circular and price list and see what others say of them and how cheaply I sell them. I also manufacture and deal in **Hives, Sections, Foundation, Extractors** and other apianian supplies.
S. VALENTINE,
3-93-2t Hagerstown, Md.

Please mention the Review.

THE LARGEST

Establishment in Michigan devoted exclusively to the manufacture of bee-keepers'

SUPPLIES.

Snow white sections \$3.00 per 1,000. No. 2 sections. \$2.00 per 1,000.

A complete hive for comb honey, consisting of bony, half story, six section holders, eight brood frames, bottom board and cover, all nailed up, for only \$1.00; in the flat, 90 cts. A chaff hive, with movable side, all complete, for only \$2.00. A full line of bee-keepers' supplies. 20-page price list free. **J. M. KINZIE,**
12-92-12 t Rochester, Mich.

Bee Hives and Section Boxes.

Simplicity, Langstroth-Simplicity, Standard Langstroth, Dovetailed and Champion Chaff Hives, Snipers, One Piece Sections and Shipping Cases. Foundation. Smokers, etc., etc. Send for 16-page Circular.

1-92-tf **PAGE & KEITH,** New London, Wis.

Please mention the Review.

Queens,

3 or 5 banded, 75 cts each, 6 for \$4.25. Nucleus colonies cheap. Eggs for hatching; B. P. Rock and Brown Leghorn \$1.00 per

13. Catalogue free.
5-93-tf

CHAS. H. THIES,
Steeleville, Ill.

TYPEWRITERS.

Largest like establishment in the world. First-class Second-hand Instruments at half new prices. Unprejudiced advice given on all makes. Machines sold on monthly payments. Any instrument manufactured shipped, privilege to examine. **EXCHANGING A SPECIALTY.** Wholesale prices to dealers. Illustrated Catalogues Free.

TYPEWRITER { 31 Broadway, New York.
HEADQUARTERS, { 186 Monroe St., Chicago.

Please mention the Review.

FOUNDATION

 Six Cents a Pound

less than formerly. Also other bee supplies at lowest rates. Send for illustrated catalogue and price list, also copy of the **AMERICAN BEE-KEEPER**.

(ESTABLISHED 13 YEARS.)

W. T. FALCONBR Mfg. CO., Jamestown, N. Y.

Golden,
 **5-Banded,**
 **Italian Queens**

My Bees are the best honey gatherers there are in the country, while for Golden Beauty they cannot be excelled in the world.

Warranted Queens, 75 cents each.

Tested, \$1.00 each.

Breeding Queens, \$2.50 to \$3.00.

Ten per cent discount on orders for five or more queens. Satisfaction guaranteed. Make money orders payable at Caldwell, Texas. Address

C. B. BANKSTON, Chrisman, Texas.

2-93-tf

Please mention the Review.

GRAY CARNIOLANS
— AND —
GOLDEN ITALIANS.

Bred from pure mothers and by the best known methods. Send for price list. 4-93-tf

For Carniolans to

JOHN ANDREWS,

Patten's Mills, N. Y.

For Italians to

L. E. BURNHAM,

Vaughns, N. Y.



BIG OFFER.

To any person sending me his order for ten

CHAFF HIVES

in April or May I will mail one of J. F. Michael's Golden Queens in June. Write for price list, sent free. 4-93-1t

GEO. H. KIRKPATRICK, UNION CITY IND

Please mention the Review



I TELL you what, Jones, *Levering Bros.* sell the best goods and at the lowest prices of any one I've struck yet. The largest and best equipped

Bee-Hive Factory

In the West. The Dovetailed Hive and New Hoffman self-spacing frame a specialty. Everything used by practical bee-keepers by wholesale and retail. Send for their free illustrated Price-List, and save money. Supply Dealers, send for their Wholesale List. Address:

LEVERING BROS.,

2-93-6.

WIOTA, Cass Co., Iowa.

Comb Leveler.

Sections full of comb kept over from last year, when used to induce the bees to begin work in the supers, are worth nearly as much as sections filled with honey. The only objection to their use is that the comb is often uneven and gives the honey a rough appearance. By the use of Taylor's Handy Comb Leveler the combs can be brought to a level as rapidly as the sections can be handled, and the comb of honey, when finished, will have all the fine appearance of that produced with fresh foundation. Price of the leveler (except the wooden box in which to set the lamp) 60 cts. by mail. Box and all, \$1.10 by mail; by express, \$1.00.

B. TAYLOR, Forestville, Minn.

"Golden"  Florida.

My location enables me to rear good queens **NOW** as cheaply as they can be reared in the North at anytime. Untested queens, 75 cts. each; 6 for \$4.00; one dozen, \$7.50. Last year's tested queen, \$1.25; select, \$1.75; breeder, \$2.50. Safe arrival and satisfaction guaranteed. 1-92-1f

J. B. GASE, Port Orange, Vol. Co., Fla.

Please mention the Review.

GOLDEN CARNIOLANS.
A Faultless Strain of Bees.

One queen, \$1.00
Three queens, 2.75
Six " 5.50
Twelve " 10.00

Leather Colored Italians
same prices. Satisfaction guaranteed.

HENRY ALLEY,

Wenham, Mass

JULY, 1893.



At Flint, Michigan.—One Dollar a Year.

ADVERTISING RATES.

All advertisements will be inserted at the rate of 15 cents per line, Nonpareil space, each insertion: 12 lines of Nonpareil space make 1 inch. Discounts will be given as follows:

On 10 lines and upwards, 3 times, 5 per cent; 6 times, 15 per cent; 9 times, 25 per cent; 12 times, 35 per cent.

On 20 lines and upwards, 3 times, 10 per cent; 6 times, 20 per cent; 9 times, 30 per cent; 15 times, 40 per cent.

On 30 lines and upwards, 3 times, 20 per cent; 6 times, 30 per cent; 9 times, 40 per cent; 12 times, 50 per cent.

Clubbing List.

I will send the REVIEW with—

Gleanings,.....	(\$1.00).....	\$1.75.
American Bee Journal....	(1.00).....	1.75.
Canadian Bee Journal....	(1.00).....	1.75.
American Bee Keeper....	(.50).....	1.40.
Progressive Bee Keeper....	(.50).....	1.30.
Bee Keepers' Guide....	(.50).....	1.40.
Apiculturist.....	(.75).....	1.65.
Bee-Keepers' Magazine....	(.50).....	1.40.

Honey Quotations.

The following rules for grading honey were adopted by the North American Bee-Keepers' Association, at its last meeting, and, so far as possible, quotations are made according to these rules:

FANCY.—All sections to be well filled; combs straight, of even thickness, and firmly attached to all four sides; both wood and comb unsoiled by travel-stain, or otherwise; all the cells sealed except the row of cells next the wood.

No. 1.—All sections well filled, but combs uneven or crooked, detached at the bottom, or with but few cells unsealed; both wood and comb unsoiled by travel-stain or otherwise.

In addition to this the honey is to be classified according to color, using the terms white, amber and dark. That is, there will be "fancy white," "No. 1 dark," etc.

NEW YORK—The new crop of extracted from California and the South is arriving very freely. There is a limited demand and prices have a downward tendency. We quote as follows: White extracted, 6½ to 7; Amber, 6 to 6½; Dark, 5½ to 6. Beeswax, 25 to 27.

HILDRETH BROS. & SEGELKEN,
July 7. 28 & 30 West Broadway New York.

CHICAGO, ILL.—There is not any of the new crop of comb honey on the market at present. What few shipments have come in have sold at about 16 to 17 cts. We expect some now daily, and if it is choice it will bring 17 cts. Extracted is very dull and selling prices are nominal. Parties who want, buy for immediate use, paying from 6 to 7 cts, in a small way. Beeswax, from 23 to 25.

R. A. BURNETT & CO.,
July 6 161 So. Water St., Chicago, Ill.

KANSAS CITY, MO.—We cannot give any quotations, as there is no new comb or extracted honey in the market. No. 1, white comb would bring about 16 or 17 cts.

CLEMONS-MASON CO.,
July 7. 521 Walnut St., Kansas City Mo.

CINCINNATI, Ohio.—There is no choice comb honey on the market. A fair article brings 14 to 16 in a jobbing way. The demand is good for extracted at from 6 to 8 cts. There is a good demand for choice yellow wax at from 24 to 27 cts.

CILAS. F. MUTH & SON.,
April 1. Cincinnati, Ohio.

MINNEAPOLIS, Minn.—There is a good supply on hand but it is mostly dark. This stock is slow, but what little white there is on the market moves readily. We quote fancy white, 17 to 18; two pound combs, 16 to 17; buckwheat, 15 to 16; extracted honey, 10 to 11.

J. SHEA & CO.
Feb. 13. 14 Hennepin Ave., Minneapolis, Minn.

BUFFALO, N. Y.—Too early to sell brisk. In due season we can place almost unlimited amounts of all kinds of honey as well probably as it can be sold in any market in the United States. We quote as follows: Fancy white, 15 to 16; No. 1 white, 14 to 15; Fancy Amber, 11 to 12; Fancy Dark, 8 to 10; No. 1 Dark 7 to 8; white extracted, 7 to 8; Amber, 5 to 6; Dark, 4 to 5. Beeswax, 20 to 25.

BATTERSON & CO.,
July 6. 167 & 169 Scott St., Buffalo, N. Y.

CHICAGO, ILL.—Old stock of honey is entirely cleared up and market in good condition for the coming season. Our experience has been that honey sent to the early market brings the best price. We received our first new comb honey this week and quote as follows: Fancy white, 18; No. 1 white, 17; Fancy Amber, 15; No. 1, Amber, 12½; Fancy Dark, 12½; No. 1, Dark, 10; White Extracted, 8; Amber, 7½; Dark, 6. Beeswax, 22.

J. A. LAMON,
July 6. 44 & 48 So. Water St., Chicago, Ill.

IMPORTED ITALIANS

Queens reared from the above, \$6.00 a doz.
PERCY COVINGTON, Appleton, Md.

Please mention the Review

Illustrated Advertisements Attract Attention.



Cuts Furnished for all illustrating purposes.

Please mention the Review.

FEEDING BACK

Honey to secure the completion of unfinished sections can be made very profitable if rightly managed during the hot weather of July and August. In "ADVANCED BEE CULTURE" may be found complete instructions regarding the selection and preparation of colonies, preparation of the feed, manipulation necessary to secure the rapid capping of the combs, time for removing the honey, and how to manage if a few sections in a case are not quite complete; in short, all of the "kinks" that have been learned from years of experience and the "feeding back" of tons of honey.

Price of the book, 50 cts.; the REVIEW one year and the book for \$1.25. Stamps taken, either U. S. or Canadian.

W. Z. HUTCHINSON, Flint, Mich.

ON HAND NOW.

THE MOST COMPLETE STOCK OF BEE HIVES, SECTIONS AND SUPPLIES IN THE NORTHWEST.

W. H. PUTNAM,

193-121.

RIVER FALLS, WIS.

MAKE MONEY

While You Sleep.

STAHL'S EXCELSIOR FRUIT DRIER

Evaporates Fruit DAY and NIGHT. Catalogue free upon application.

Address

WILLIAM STAHL
EVAPORATOR COMP'Y,
QUINCY, ILL.

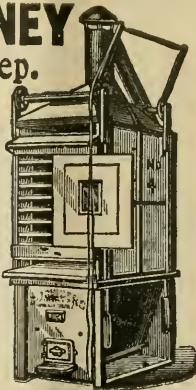

Oh, Mamma!

Have you heard of the **FREE**

200-Page Bee-Book

given to every **NEW** Subscriber to the old

AMERICAN BEE JOURNAL?

Oldest, Largest, Best, Cheapest and the only **Weekly Bee-Paper** in America. 32-pages; \$1 a year. *Sample free*

GEO. W. YORK & CO

56 Fifth Avenue, CHICAGO, ILL.

To New Subscribers: The Journal Alone Sent for Three Months for Twenty Cents.

QUEENS, A large number of fine ones on hand; yellow and prolific; ready April 15th; warranted queens. \$1; 6 for \$4.50; select tested, yellow to the tips, suitable for breeders, \$2 each. Reference, A. I. Root. 3-93 tf
W. H. LAWS, Lavaca, Seb. Co., Ark.

Barnes' Foot and Hand Power Machinery.

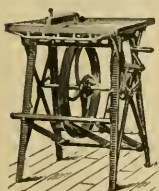

This cut represents our Combined Circular and Scroll Saw, which is the best machine made for Bee Keepers' use in the construction of their hives, sections, boxes, etc.

11-92-16t

MACHINES SENT ON TRIAL.

FOR CATALOGUE, PRICES, ETC.,

Address W. F. & JNO. BARNES CO., 384 Ruby St., Rockford, Ills

Please mention the Review.

IF YOU WANT THE

BEE BOOK

That covers the whole apicultural field more completely than any other published, send \$1. 00 to Prof. A J. Cook, Agricultural College, Mich., for his

Bee-Keepers' Guide.

Liberal Discounts to the Trade.

Please mention the Review.

Early Queens From Texas,

From my choice golden stock. My bees are very gentle, good workers, and beautiful. Safe arrival and satisfaction guaranteed. One untested queen, April and May, \$1.00; six for \$5.00; later, 75c. Orders booked now; money sent when queens are wanted. Send for price list.

J. D. GIVENS,
Lisbon, Texas.

1-93-9t.

Please mention the Review.

Ready to Mail, ITALIAN QUEENS,

Tested, at \$1.25; 12 for \$13.00. Untested, after April 1st, \$1.00 each, or 6 for \$5.00. Safe arrival guaranteed. Bees, Drones and Supplies. Circular free.

J. N. COLWICK,

4-92-tf

Norse, Bosque Co., Texas.

Names of Bee-Keepers.

TYPE WRITTEN.

The names of my customers, and of those asking for sample copies, have been saved and written in a book. There are several thousand all arranged alphabetically (in the largest States) and, although this list has been secured at an expense of hundreds of dollars, I would furnish it to my advertisers at \$2.00 per thousand names. A manufacturer who wishes for a list of the names of bee-keepers in his own state only, or, possibly, in the adjoining states, can be accommodated. Any inquiry in regard to the number of names in a certain state, or states, will be answered cheerfully. The former price was \$2.50 per 1000, but I now have a type writer, and, by using the manifold process, I can furnish them at \$2.00. W. Z. HUTCHINSON, Flint, Mich.

HUNT'S

FOUNDATION

FACTORY.

Send for free samples of foundation and sections; warranted good as any made. Dealers, write for special prices and the most favorable conditions ever offered on foundation. Send for new, illustrated, free price-list of a full line of supplies. M. H. HUNT,
1-93-tf Bell Branch, Mich.

BEE-KEEPERS'

SUPPLY HOUSE

J. H. M. COOK, 78 Barclay St., N. Y. City.

(SUCCESSOR TO A. J. KING)

4-93 tf

See for illustrated Catalogue

CATCHALL

The orders for untested queens at 75 cts each; six for \$4.00. Tested queens, \$1.50 each, three for \$4.00. Two-frame nucleus with any queen \$1.50 each, extra. Safe arrival guaranteed. 7 93-1t

W. J. ELLISON, Catchall, S. C.

THE PROGRESSIVE BEE-KEEPER

Has Changed Hands It is now Published by the
LEAHY MANUFACTURING CO.,

Higginsville, Missouri.

Money, Experience and Enterprise will not be lacking to make it all that its name indicates. Send for Free Samples and Copy of 28-page Catalogue of Apiarian Supplies.

Great Reduction.

SECTIONS AT GREATLY REDUCED PRICES.

HIVES, SHIPPING CASES, &c., AT BED-ROCK PRICES.

WRITE FOR FREE, ILLUSTRATED CATALOGUE AND PRICE LIST.

G. B. LEWIS CO., Watertown, Wis.

1-93-tf. *Please mention the Review.*

The Golden Beauties. ☺

Our five-banded Italian queens, warranted purely mated, at 75 cts each; two for \$1.25.

Tested, \$1.00 each; two for \$1.50 Safe arrival guaranteed **C. B. BANKSTON,**
2-43-tf (Chrisman, Texas.)

Please mention the Review

Muth's HONEY EXTRACTOR PERFECTION Cold-Blast Smokers,

Square Glass Honey Jars, Etc.

For Circulars, apply to CHAS. F. MUTH & SON, Cor. Freeman & Central Aves., Cincinnati, O. Send **10c.** for Practical Hints to Bee Keepers.

1-93-tf. *Please mention the Review.*

—If you are going to—

BUY A BUZZ-SAW,

write to the editor of the REVIEW. He has a new Barnes saw to sell and would be glad to make you happy by telling you the price at which he would sell it.

Foundation Reduced.

Reduced three cents per pound from prices given in my Illustrated Price List for 1893

M. H HUNT, Bell Branch Mich.

Hastings' Lightning Ventilated Bee Escape.

AGRICULTURAL COLLEGE, Mich. Sept. 17, '92.
"I have used the Lightning Bee Escapes you sent and find them certainly the equal of the Porter, and their superior for the reason that they will empty a super more rapidly."
Yours respectfully, J. H. LARRABEE.

"It is our opinion that you have the best Bee Escape ever introduced."
A. I. ROOT, Medina, Ohio.

HONOLULU, Hawaiian Islands, April 25, '92.
"Please send me by return mail 5 Lightning Ventilated Bee Escapes. I have the Porter, and the Dibbern and they both close."
Yours truly, JOHN FARNSWORTH.

Price, by mail, each, 20c. per doz. \$2.25.



"IT LEADS THEM ALL."
Read Testimonials of a few successful Bee-keepers.
Send for Sample and after a trial you will use no other.
Catalogue sent on application.

M. E. HASTINGS, NEW YORK MILLS, ONEIDA CO., N. Y.

Second Hand Supplies.

OF the second hand supplies that I have been advertising in the REVIEW, the following remain unsold:—



100 old-style, Heddon surplus cases at 20 cts. (as a non-separated case, they have no superior); 25 slatted honey boards at 10 cts.; 20 Heddon feeders at 40 cts.; and half a dozen single-comb nuclei for exhibiting bees at fairs. They have glass sides, removable covers and are painted a bright vermilion. They cost \$2.00 each, but will be sold at half-price. All these are practically as good as new.

W. Z. HUTCHINSON, Flint, Michigan.



Don't Monkey

with cross bees or poor goods. Untested, Italian queens, 75 cts each. 3 for \$2.00. Best stock Send for catalogue of supplies.

JN^o. NEBEL & SON, High Hill, Mo.

Please mention the Review.

Are You Tired

of New Bee Journals? Send 15 cts for 3 month's subscription to that bright, new bee paper, "The Bee-Keepers' Enterprise," and receive **FREE** the Enterprise Souvenir—a Work of Art

That will rest Your Eyes.

Burton L. Sage, New Haven, Conn.

Please mention the Review.

CHEBBY VALLEY, N. Y., March 20, '93.
"I shall take pleasure in recommending them as the best I have ever used."

Truly yours, J. E. HETHERINGTON.
"We believe you have an Escape that 'dowms' the Porter."

T. PHILLIP & CO., Orillia, Ont., Canada.
"Your Escape knocks out all competitors."

A. J. LINDLEY, Jordau, Ind.
"They did not clog, and cleared the supers rapidly. In fact it is the best Escape I have yet used. I cannot speak too highly of it, and consider it a great boon to bee-keepers."

W. E. CLARK, Oriskany, N. Y.

A Grand Success.

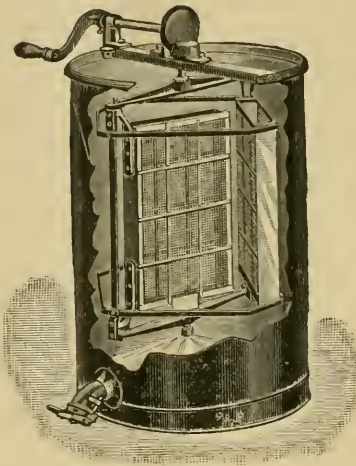

Mention Review.

New Cowan Reversible HONEY EXTRACTOR.

May be Reversed Without Stopping the Machine.

Strong, well made in every respect, light, and of convenient size. The can is built larger than that of the Novice. The gears are beveled and covered by an iron shield, and the crank outside the can. Frank McNay, of Mauston, Wis., a bee keeper who produces tons and tons of extracted honey, says of it:

"After carefully examining and trying the Cowan Extractor, I have failed to find a weak part, and I do not hesitate to say that it is the best Extractor made, both in regard to convenience and durability, and I shall replace all of my five machines with the Cowan as soon as possible."

It is endorsed also by J. F. McIntyre, an extensive extracted honey producer of California; by W. Z. Hutchinson, Dr. C. C. Miller, and others.

Price all Complete, Japanned and Lettered, for L. Frame, \$10.

A. I. ROOT, Medina, O.

JUNE 25

By my system of dequeening at the opening of the harvest, I will have **300 TESTED QUEENS** of the leather back strain of Italians, for delivery about June 25th, at 75 cts each or \$7.50 per dozen. These queens are all young and prolific—none over **ONE YEAR OLD**. Book your orders now and pay when the queen arrives. None will be sent at these prices before June 20th nor after July 10th. First come first served. A. F. BROWN, 1-63-11 Box 16 New Smyrna, Fla.

(Formerly of Huntington, Fla.)

GRAY CARNIOLANS — AND — GOLDEN ITALIANS.

Bred from pure mothers and by the best known methods. Send for price list. 4-93-tf

For Carniolans to JOHN ANDREWS, Patten's Mills, N. Y.	For Italians to L. E. BURNHAM, Vaughns, N. Y.
--	--

FOR ALL KINDS OF BEE KEEPERS SUPPLIES ADDRESS LEAHY MFG. CO. HIGGINSVILLE, MO.

PORTER BEE ESCAPES

Are used and pronounced the best, and highly recommended as great labor-saving implements by Chas. Dadant & Son, Prof. A. J. Cook, Chas. F. Muth, Jno. S. Reese, J. H. Martin, Jno. Andrews, F. A. Gemmill, Wm. McEvoy, A. F. Brown, Thos. Pierce, and many other prominent bee-keepers. Descriptive circular and testimonials mailed free. **PRICES:** each, postpaid, with directions, 20 cts.; per doz., \$2.25.

RETURN THEM AND GET YOUR MONEY BACK AFTER TRIAL, IF NOT SATISFIED. For sale by dealers.

MENTION THE REVIEW.

Address **R. & E. C. PORTER, LEWISTOWN, ILL.**

The Bee-Keepers' Review.

A MONTHLY JOURNAL

Devoted to the Interests of Honey Producers.

\$1.00 A YEAR.

W. Z. HUTCHINSON, Editor & Prop.

VOL. VI.

FLINT, MICHIGAN, JULY 10, 1893.

NO. 7.

TIMELY TOPICS.

No. 6.

R. L. TAYLOR.

"What shall the harvest be?"



THE work of this month is largely a continuation of that of June. Care must be taken that the bees have sufficient room for storing what they are able to gather but greater heed than ever must be given that only neces-

sary room is allowed them, for too much space now means an unnecessarily large number of unsalable sections which proper vigilance will prevent. As aids in this matter one should have a thorough knowledge of the sources of one's honey, and constantly cultivate a close acquaintance with the condition of those sources. As having a bearing upon the probable continuance of the honey flow the weather must be observed. Hot, dry weather not only hastens the opening of bloom but also its disappearance. The bloom of white clover is greatly prolonged by copious and frequent showers, while drought cuts it short. The bee-keeper who desires the greatest success must keep wide awake and preserve a judicial state of

mind in all these matters. He must not be pessimistic and so become disheartened without reason nor must he allow his eyes to see everything in the future clothed only in a rosy hue.

Swarming may continue to some extent and young queens are mature from previous swarming. Make the most of them. They are the apiarist's most valuable property; save as many as can be used. Pinch the heads of all two year olds and have them replaced by those reared under the swarming impulse. It may be possible to rear better queens than those produced under that impulse, but in ninety-nine cases in a hundred the latter are the better. An apiarist can get all of these he needs for almost nothing, so it cannot pay him to attempt to rear them otherwise. Two combs with a pint of bees at this season supplied with a choice cell taken from a colony that cast a swarm a week ago will give you a better laying queen in a few days than you generally get for a dollar, and the same pint of bees may be made to repeat the operation several times. Dividing the combs of the colony, from which a swarm has issued, into two or three parts with a good cell in each and giving each part a separate hive for a few days is an easy way to get plenty of good queens.

Besides the necessary attention to be given as suggested above, there is little else to require much labor during this month except the gathering of the harvest. In the June number of the REVIEW I advised that there be no haste in taking the surplus from the

hives, but there comes a time during this month when that advice would be changed and that time is towards the close of the white clover and basswood season. Watch carefully for signs of the approach of that period and before it comes rush off all cases that are completed. Take this course because it can then be done without interference from robber bees, and therefore with much less labor. When the honey flow is excellent bees will pay no attention to honey in comb whether sealed or not, when the yield is only fair they will take honey from unsealed cells, but will not take the trouble to uncap honey, so that when the honey flow is fair or better, finished comb honey may be removed and freed from bees without the use of tents, bee-escapes or other contrivances. At such a time simply drive the bees down from the completed cases with two or three puffs of smoke, remove the cases, replace the cover, and set the cases on end, on the top of the hive, flush with the front of the hive or a little more. Give them two or three puffs of smoke, when the remaining bees will begin running down the front of the hive to the entrance and the honey will soon be entirely free from them except perhaps now and then a robber looking for an open cell of honey. What remains should be removed promptly on the cessation of the white honey season for it will very soon receive injury in its appearance after that time. All the bees cannot be conveniently gotten out of this lot without piling it up open to the light under a tent, or in a room having an exit for the bees, but no entrance, or in some other of several well known ways. Of course no reader of the REVIEW will ever think of removing honey from the hive by pulling out of the case one section at a time and brushing the bees off it with a feather and replacing it with an empty one.

After the honey is off the hive it is highly important that it should be well cared for. I pile it up on end, *i. e.*, put the cases on end so as to be fully open to the circulation of the air in a warm dry room—the warmer and drier the better so that it is not warm enough to cause the wax to yield. Unless one allows the wax moth to breed extensively about the premises I think there need be no fear of its doing injury to the comb honey. I never knew any injury from this cause when disposed as I have indicated above. I consider it important also that it be allowed to remain in the cases until it is to be put

on the market. It is better there than inclosed in shipping crates, besides the comb is more liable to injury than when it becomes thoroughly ripened and the weather somewhat cooler.

It is always timely in warm weather to utter a warning against the danger of injury to combs from the wax moth. They may be safely kept for a time in a very cool cellar. If kept where it is warm they must be kept separated an inch or more and where the air has free circulation, but on hives where bees can care for them is the best place of all.

LAFEEER, Mich.

June 21, 1893.



A Mammoth, Solar and Furnace-Heat, Wax Extractor.

R. C. AIKIN.

"Profit or loss very often turn on those things which may be saved, but which oft are wasted."



LAST year we made a portable, solar, wax extractor. Its size was 3x6 feet. It could be wheeled into the honey house to load or unload it; shifted to face the sun; or moved about for any purpose. Between the effects of

heat and moving, the lumber became split and warped until it refused to do good work. Better lumber and workmanship would have remedied this trouble. As it was, we got about 300 pounds of wax through it and then did not get all melted.

In order to get the best results the refuse should be allowed to drain for days, yes, even weeks. So we decided to rebuild and make some improvements. We will try and make plain our new solar extractor and show the advantages it possesses. We will make some rude drawings to illustrate it that will be much better than a lengthy description in making it plain to the reader.

Cut No. 1 is the ground plan. The walls and partitions are of brick set on edge. A small furnace is arranged to give heat from beneath when desired. The partition divid-

ing the fire chamber part way, throws the heat forward. At about 12 to 16 inches high a sheet iron covering is laid in the brick work from the back to the partition dividing the wax chamber from the fire chamber. The iron being laid into the brick work, completely closes in the fire chamber from the other compartments, so no smoke can get into the extractor.

stir the combs, or to draw all back near the highest point.

The drip pan is made of two boards about 4½ feet long and six or eight inches wide, having four bars of iron (we used old buggy tire) with the ends bent up at right angles. The boards we screwed to the uprights, or ends, of the iron bars. In this skeleton is placed a tin bottom nailed to the side boards and having about a two inch "turn up" at the upper end. This drip pan can be drawn right out at the door behind, very much as you would draw out a bureau drawer.

In hot weather no fire is needed in the furnace, but a fire will help us out in the fall and spring when we have work to do. Yesterday (June 13) we melted 32 lbs. of wax, some of it being comb, but the bulk was cakes of wax broken up to remelt.

Being built right on the ground, and having brick walls, it holds heat through the whole night. This morning when I removed the 32 lb. cake of wax, it was so warm on the under side that the wax was quite soft.

We used less than 150 brick and laid them in mud mortar. The sheet iron to cover the furnace cost \$1.00. Tin about 50c., glass \$2.50. This makes a cost of about \$5.00 for material. A much better and larger one could be made for \$10.00, or less.

Candied honey can be melted very rapidly in it. You would only have to see it in operation to say it is a good thing. I think, with an apiary of 100 and more colonies an apiarist could profitably afford a solar on this plan. A little extra room in a solar comes very handy now and then.

I forgot to mention that the furnace is made of the "running gears" of an old, small sized, heating stove, a coal burner. No patent on any part of this.

LOVELAND, Colo.

June 14, 1893.



Working Three Colonies in One Set of Supers and Preventing Swarming.

GEO. R. WELLES.

" Beautiful schemes, beautiful schemes,
How they prosper in our dreams!"

THE May REVIEW is very good. I wish the eight extra pages were permanent, if quality would not be sacrificed for quantity; many golden grains of apiarian knowledge I lose, most unwillingly, because

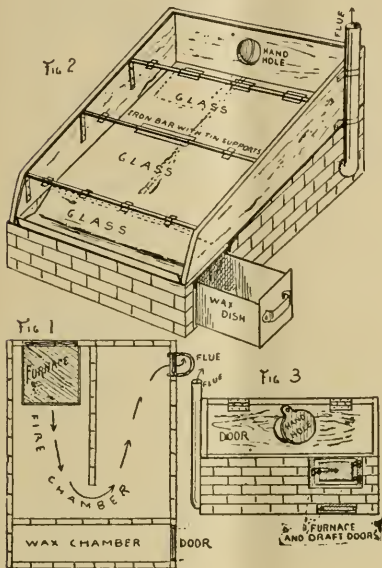

AIKIN'S SOLAR AND FURNACE - HEAT WAX EXTRACTOR.

Fig. 2 shows the front and one side wall, and the wood and iron sash. The sash is set on the brick work in mortar and is not to be removed. The wax chamber door opens in from the side and is just large enough to allow the wax pan to slip in endwise. The pan is about ten inches wide and deep by about 28 or 30 long. The outside measure of the extractor is about 4x6 feet. The bars that support the glass have T tins wired on to them and make the glass rest on rabbets.

Fig. 3 is a back view and shows the furnace door and draft opening and the flue. At the top is a door hinged at the top, and extending clear across the end. This door is to put in combs and to remove the refuse. The hand hole near the center is to insert the hand and arm with a stick or scraper to

I have not time to sift them from among the mass of rubbish, in which they are buried.

Messrs. Langdon, Taylor, Aikin and others have made marked progress along the non-swarming lines on which many beekeepers are working and they deserve great credit. However, the same results can be accomplished, at less cost, and with some marked advantages, by three hives being worked together in place of two. Place three hives, fronts in line, as close together as possible, arrange two boards with escapes so they will close the entrances, cover the entrances of the escapes with perforated metal, with these close the entrances of the two *outside* hives and place sufficient surplus cases on the center hive for the prevailing honey flow. All workers must return to the center hive. At the end of four or five days, change places with the center and one of the outside hives, place an escape board under the surplus cases, as they having the attention of the workers from three hives will be about completed, remove them when clear of bees, place other cases over the hive *now* in the center, and, after four or five days change places between the center and the *other* outside hive; care for the surplus, and arrange other cases over the hive *now* in the center. Repeat the programme as long as the honey flow continues,

In all these manipulations it is understood that the outside entrances are closed, except that bee escapes allow the bees to leave the hives, but they are compelled to enter the center hive.

By this arrangement each hive will be cleaned of all extra bees alternately, for a period of from eight to ten days, which will effectually repress all desire to swarm, yet each is boomed with all the bees for only four or five days at one time; consequently the swarming fever will not develop as it would if they were boomed for eight or ten days. Observe, the workers do not have to change entrances every time a change is made, but work at the center entrance all the season, nothing patentable is used, no extra, that need cost a nickel.

The perforated metal behind the escapes is important. If a young queen should be raised and took her mating flight through an escape, she must return to the wrong hive and be lost, the metal will confine her, not longer than eight or ten days when she will have a chance to leave the center hive, and it being in a group of three, she cannot miss

it on her return. In house apiaries the manipulation will be easier than out of doors.

So many workers thrown together will result in extra surplus, in extra fine shape. Truly we are "getting there" in good style.

To the special self hiving number of the REVIEW, and subsequent articles, belong the credit of getting together the accumulations of experience on these lines, so it could be sifted, and we would know where we were, and be thereby the better enabled to work out further improvements. "May it live long, and prosper."

BERLIN, Mo.

May 22, 1893.

[It is possible that the above plan would work satisfactorily. One objection is that the hives would need lifting about, which is now not the case with the Langdon method. Then, again, I am not *sure* that such a great mass of bees works to the best advantage. Possibly they are in one another's way. It is one of the things that I confess I "don't know." It is an experiment that could be easily tried and would not be expensive. A few months ago, Mr. R. L. Taylor said it would be desirable if all the bees in the apiary could be induced to store their honey in one common pile of supers. When we get three colonies to work satisfactorily in one set of supers, we are, as Mr. Weller says, "getting there."

Since the foregoing was written I have received a letter from Mr. Corniel in which he suggests placing two hives side by side with the supers all on one hive and the entrance to the other hive closed with the exception of a bee escape opening outwardly. The workers will pass out through the bee escape, and, upon their return, they will eventually find their way into the adjoining hive. In a few days, simply change places with the hives, always keeping the supers upon the hive standing, say, at the right, and the entrance of the hive standing at the left closed with a bee escape. As the workers will always be in the habit of returning to the hive at the right, there will be no confusion. To this plan there is the objection of having the hives to handle.

LATER—Since the above was put in type I have visited the Michigan, Experimental Apiary and learned that such a great mass of bees as the working force of even *two* colonies thrown together is quite likely to swarm. See Taylor's report of work in Michigan, Experimental apiary.—ED.]

There is a Lack of Queen Breeders on the Pacific Coast.

"RAMBLER."



IN looking over the advertising pages of the bee journals, I find that the majority of those who advertise queens for sale are located in the

Middle or far Eastern States, and, although many of the breeders live in States that produce but little honey, and would seem to turn to queen rearing for a livelihood, still many of those in the queen business are in good honey producing districts. It is a fact, however, that the great honey producing States and islands, like California, Florida and the island of Cuba, have but few who turn their attention to queen rearing. Speaking more particularly of California there is not one that advertises in any of our journals, and only one that advertises in one of the agricultural papers of this coast. One would suppose that if queen rearing would pay in the small honey producing State of Mass. that it would pay better in a large honey producing State like Calif., not only large in honey production but also large in area, and where there is more need of requeening than in any of the Eastern States, where, owing to the shorter honey season, the usefulness of the queen is not impaired so quickly as in a climate where the breeding goes on uninterrupted for many months in the year. In the semi-tropical climate of southern Calif. the only rest for the queen is a short time during the fall months. In Jan. there is usually a good amount of brood; in Feb. the amount increases; in Mar. it is still further accelerated, and from that time until Aug. she is kept under high pressure work. The majority of bee keepers know the state of affairs and remedy it during the dull season by raising queens and thus keeping their apiaries in the highest working order, others not so provident allow the bees to supersede the worn out queen at their own convenience, and as usually happens in such cases many swarms do not requeen at the right time, and there is consequently

many weak colonies at the commencement and even all through the honey season, and many that are altogether queenless and subject to the appearance of fertile workers which are quite a common thing in Calif. apiaries. The importance of this requeening and its effect upon the honey yield was recognized and discussed at the last meeting of the Calif. Bee Keepers' Association, and those who have the best success in getting large yields of honey are the ones who pay attention to this important feature in bee-keeping. This point was thought of so much importance by a bee-keeper in Inyo County that he journeyed several hundred miles to look up the queen rearing resources of the coast counties, and to find where he could get a supply of virgin queens with which to requeen his entire apiaries in the early spring months, before he could rear queens in his own higher and colder climate. Young queens early mean vigorous colonies for the gathering of honey as soon as the season opens, not only in the higher altitudes is this the case but the rule holds good in more favored localities. Much honey is lost from the bees not being strong enough in numbers to secure the honey from the early flowers. This gentleman was level headed enough to see where the profits came in and was in search of the remedy and I have no doubt but that he found it, for there are many localities on this coast where queens can be reared in every month in the year, there are also islands where queens can be bred in great purity from selected strains, but thus far no one has made much of an effort to build up a queen rearing business on this Coast and for our select strains we depend largely upon the Eastern breeders. Queens from nearly every portion of the East are found here. We find those who favor Mr. Alley and his various races of bees and living praise to Punic and Carniolans. Doolittle and others come in for their share of commendation, while many prefer queens reared in the south, thinking them more adapted to our climate. The mail facilities are so great now that it makes but little difference where the breeder is located if the strain of bees is satisfactory to the purchaser. It is evident that honey production is of more profit on this coast than queen rearing, except as it is carried on for the purpose of requeening one's own apiary, and the honey producer is willing to secure his choice queens from old, established, and time tried

sources. The honey producer is also in no fit mood to rear queens for the trade during or after a very busy season of several months of hard work with the bees, he prefers to hie away to the sea coast or the mountain for a rest. The only remedy for our backward state in the queen rearing industry is for some Jennie Atchley to take it in hand and even us up with the other States of the Union.

REDLANDS, Calif.

June, 25, 1893.



Extracting—Bee - Escapes—Wide Top Bars Prevent Brace Combs.

C. W. DAYTON.

"That which is rightly done is easily done. Flurry, fume and perspiration simply show that we have not found the right way."



IT was with fear and trembling that I came lugging a self - hiver into the June REVIEW, thirty or sixty days late, when our editor had arranged to finish the discussion in a previous number.

I have been oscillating between two apiaries seven

miles apart, running them for extracted honey and increase. It takes four days to do an apiary, and then I fold my tent at two to three o'clock in the afternoon and arrive at the other apiary an hour or so before sundown.

My plan of using the bee escape is to put a dozen in place on the evening of arrival, and wheel the upper stories into the extracting room the next morning before breakfast. From then until noon is required to extract this honey and put the combs back on the hives. After dinner the old plan of brushing the bees off the combs is followed, and five or six more stories extracted. If I were in any way rushed, I should use more escapes, and perhaps extract thirty or forty stories in a day, but, as I have never handled enough colonies to be rushed, escapes were used merely as an experiment, and, from my little experience, I believe nearly twice as much work can be done with as without them.

If one makes increase and evens up colonies by exchanging brood as Mr. France does, or admits brood into the upper stories during the extracting season, I can see that escapes would be of little use.

When there are prospects of there being honey to gather, my plan is to bank the forces by giving the brood to the strongest colonies. In putting the extracting stories on the strongest colonies I fill them with brood taken from weaker colonies, giving empty combs to the weak colonies which I expect only to build up for wintering. This lessens the number of hives to be manipulated and the combs are filled more thoroughly. If the brood chambers are not too large the best colonies will occupy the upper stories some time before the harvest, so, when they are ready to extract the first time, the brood will be hatched out of these extra combs that were placed in the upper stories, and escapes may be used.

A dozen escapes can be put on in as many minutes, but half an hour ought to be used.

I am of the same opinion as Mr. Aikin—that there is something lacking in the present forms of escapes or the manner in which they are fastened in the escape boards. When they have been on a few hours the escape-board is covered with slivers which have been gnawed from the corners where the escape-board and upper story come together. In listening, there may be heard a crackling noise not unlike that heard when the entrance is too small. The bees at such an entrance are pulling and biting at the wood to enlarge it, and the angles become rounded. While the bees above the escape may be anxious to find their queen, which I very much doubt, their first move would not be to get into the dark hive below, but to take wing in the open air.

How aggravating it is when we raise the upper story to put an escape under, to have some of the of the lower combs raise also, and when they are well up, drop and slide back into the hive with a thud. This is a first class way to smash and anger bees. There may be some who would object to escapes on this account and who, for this reason, would remove and brush the combs one at a time, but, even then, the brace combs will not neglect to set the honey running, and as the brush is plied it is soon too much daubed for pleasure.

The building of brace combs is governed to a large extent by the width of the frame

material. From '82 to '86 my frames were of $\frac{7}{8}$ stuff; '86 to '89, one inch; '90 and '91, 1-16. As mentioned in the June REVIEW, my hives now are $14\frac{1}{4}$ inches inside, and contain ten frames. There are many hives of that width containing ten frames, but I have never seen 50 frames outside my own hives that were more than $\frac{7}{8}$ wide. My frame material is cut $1\frac{1}{8}$ wide and $\frac{3}{8}$ thick. If the width is right it does not matter about the thickness. Ten frames take up $11\frac{1}{4}$ inches, leaving three inches for the 11 bee passages between the top bars—a trifle more than $\frac{1}{4}$ for each passage. Ten frames $\frac{7}{8}$ wide are $8\frac{3}{4}$, leaving $5\frac{1}{2}$ inches, or $\frac{1}{2}$ inch for each bee space.

In the brood nest I use ten frames, but in the extracting story the number is reduced to eight. This is done to cause more honey to be stored in a comb, which lessens the labor of uncapping and of extracting, and the depth of the cells prevents the queen from laying in them. Eight, $1\frac{1}{8}$ -frames equal 9 inches, leaving $5\frac{1}{4}$ for the spaces between the top bars, or 1-44 of a space less than the space between $\frac{7}{8}$ top bars with ten frames in the hive. I have 50 or more colonies in this way: ten frames in the lower story and eight in the upper with a $\frac{3}{8}$ space between the upper and lower frames. There is also a $\frac{3}{8}$ space between the top bars of the extracting combs and the cover.

Now for results: In raising the 50 upper stories three times they have not disturbed a frame in the lower story. In raising the cover to the extracting story 200 times, I do not think there was once but from one to six combs were raised. Then I have ten colonies where there are eight combs in each story and the combs of the lower story often raise and slide and drop with a thud. In 25 single story hives containing ten combs each there are no brace combs whatever. In the same number of similar hives with only eight combs I am obliged to raise the cover a little and insert a knife or chisel to separate the frames from the cover every time they are opened.

This brace comb business is one of the most fruitful sources of dauby work in extracting. In producing comb honey over narrow top bars it will usually pull the bottoms off the sections, which makes a very expensive experiment.

Another cause of daubing honey all around is putting the combs into the extractor endwise where the lower end comes up always

dripping. This may be remedied by hanging them in the extractor the same as in the hive. Automatic reversion will not cure this. If we can prevent brace combs also, nearly everything we handle will be dry.

Where we can keep up with the bees and extract as soon as the combs are two-thirds capped I would use only eight combs, but if they go long enough to cap the honey all the way down, they will extend pieces of comb out past the side bars against the hive. To avoid this it will require nine combs, if not ten, in the hive.

In 1889 I ordered 1000 all-wood brood frames of one of our most extensive manufacturers. In about a month he wrote me that the size I ordered (1 inch) was difficult to furnish and $\frac{7}{8}$ was the customary width, so I wrote that I would try the $\frac{7}{8}$ width. One hundred were tried during the season beside the others (1-16) which I sawed out with a Barnes saw. The next spring the remaining 900 were used to kindle the fire.

One other point in favor of frame stuff $1\frac{1}{8}$ inch wide in a $14\frac{1}{4}$ inch wide hive is the ease with which the frames are spaced, as if one space is left a little wider than the others another bee space will be filled with propolis. It is far easier to leave just room enough for a bee pass between each two top bars than to make the spaces alike when the spaces are the width of three bees. Any type setter will vouch for this truth as a bee space (the width of a bee) is to bee keeping what the 3-em space is to type setting.

PASADENA Calif.

June 27, 1893.

Bee-Keepers' Review.

PUBLISHED MONTHLY.

W. Z. HUTCHINSON, Ed. & Prop.

TERMS:—\$1.00 a year in advance. Two copies, \$1.90; three for \$2.70; five for \$4.00; ten, or more 70 cents each. If it is desired to have the REVIEW stopped at the expiration of the time paid for, please say so when subscribing, otherwise it will be continued.

FLINT, MICHIGAN, JULY 10, 1893.

THE BLAST TUBE in the Crane smoker is, I believe, about twice as large as in the Bingham. I did not mention this when making the report in the last REVIEW of my experiments. It is perhaps but fair that this point be mentioned.

TEN TONS of honey from 180 colonies, and a good prospect of getting a few more tons, is the report that "Rambler" sends me.

"BEES ARE BOOMING," is the report that comes from all parts of the country. E. R. Root writes me that it is the same story that comes to Medina. We are having a good flow from white clover here at Flint.

E. R. ROOT asks if the lifting of supers does not apply as an objection to the Langdon, non-swarmer system the same as it does to the use of the Pratt self-hiver. Yes, it does, so far as the *supers* are concerned, but with the Pratt hiver we have the *hive* to lift in addition to the supers and this doubles the load.

OLD BEE BOOKS are being written of in an interesting manner by the proof reader of *Gleanings*, and his writings printed in that journal, but he says that the "awful darkness in which those writers lived render their works to-day of no practical benefit aside from literary curiosities."

MRS. ATCHLEY'S apiary of 400 colonies, among which are sprinkled the members of the Texas Bee-Keepers' Convention, is nicely shown in *Gleanings* by a full page illustration. The tall, sprangley oaks make a splendid back ground. As a "picture," it is as good as *Gleanings* has shown in sometime.

PAPER CARTONS, for enclosing sections of honey that are sent to market, do not receive much endorsement from the two dozen prominent apiarists that answer the "queries and replies" in the A. B. J. The long and short of it is, if it pays to use them in your market, use them; if it does not, then let them alone.

ALSIKE CLOVER is being cultivated to a much greater extent in Michigan than was formerly the case. In a ride of twenty miles the other day on the railroad I saw several fields that were masses of bloom from the pink-white blossoms of the alsike. I frequently hear farmers say: "I have sowed a field of alsike this year." An insect pest is making such havoc with the red clover that it is proving unprofitable. "It is an ill wind that blows nobody any good." This extensive cultivation of alsike will be a boon to bee-keepers.

THE BEE-KEEPERS' GUIDE has suspended publication. Bro. Hill writes that he has been running his journal, the bee hive business, the bees, etc., without competent help, and he is overworked. The Kendallville bank has failed, times are hard, Mr. Hill's health is failing under the load he has been carrying, and he finds himself compelled to give up something, and that something proves to be the *Guide*. The unexpired subscriptions will be filled out by the REVIEW.

E. R. ROOT, made a trip of 400 miles down East, one year, and I believe that A. I. has been to California once or twice. One object in making these trips was to secure interesting matter for *Gleanings*. And now they have discovered that within four miles of them was a first-class, most successful bee-keeper of whose existence they did not know. His name is Burt and he is to make some practical experiments for the Roots. One thing learned from a visit to his apiary was how successfully sheep could be made to answer the place of a lawn mower for keeping the grass down in an apiary. I know from experience that it is no small task to keep the grass down with a lawn mower. In the busy season there is a temptation to neglect it.

THE LANGDON, non-swarmer arrangement has not proved a success with Mr. Taylor as will be seen by reference to his report. When I was over there I saw a swarm issue from one of them. Frank Coverdale of Iowa also writes me that he is having swarming with them. It is not the depleted colony that swarms, but the one that gets the double dose of bees. It seems that such a great mass of bees will swarm even without making preparations for swarming. I must confess that I am disappointed. I thought that this arrangement was certainly going to enable us to do away with swarming. It seems that it did work all right last year with Mr. Langdon. He used it in the house apiary. Whether this would have a bearing I do not know. There is also a difference in seasons. I shall be glad to get reports from others who have used them.

OLD BEES DO NOT LOCATE THEIR HIVE WHEN THEY SWARM.

I had a little experience this season that would seem to prove the truth of the above

title. I was practicing the Heddon method of preventing swarming, that of leaving the old hive by the side of the swarm for seven or eight days, and then moving it away. I neglected to move one hive until the ninth day in the afternoon. Within half an hour after the removal a second swarm issued. The queen did not go with the bees; probably she was too young to fly. According to the rules, the bees should have returned to the hive from which the issued. About one-third of them (probably those that had never before left the hive) returned to the hive from which they had swarmed, and the rest of them went back to the old location and joined the swarm that was hived nine days before on the old stand.

THE SIMMINS METHOD OF INTRODUCING QUEENS

—IT IS NOT ALWAYS SUCCESSFUL.

I have been trying the Simmins method of introducing, or rather of releasing queens. The central idea, and it is a good one, is to keep the queen away from the bees without food for half an hour, and then allow her to run down from the top of the hive just at dusk, or a little later, when a lamp must be used. I made up ten nuclei and left them queenless three days, then gave each a caged queen and allowed her to remain in the cage one day. Just at dusk the queens were removed and each put in a box by itself, the boxes being numbered and the hives also, so that no mistake would be made in returning the queens. As it was cool the queens were taken in the house and kept there from one-half an hour to nearly an hour. Then they were introduced by lamp light. Without using smoke, one corner of the quilt was carefully turned back and the queen allowed to run down into the hive. There was no running or squealing. The first bee she met, out came her tongue—she was hungry and humble—and soon there was a crowd around her offering her homage and pabulum, and it is in this manner she slowly passed down between the combs. Every queen was accepted—I presume they would have been if they had been released without the fasting, but, of course, I do not know. Mr. Simmins says it makes no difference as to how long the bees have been queenless, nor whether the queen has previously been caged among them, so I tried making four nuclei in the forenoon and in the evening releasing in

them queens that had not been previously caged in the hive. Two queens were accepted and two were killed. I think it is a good way to release queens, but I doubt if it is any better than allowing the bees to do the work by eating out candy from the entrance of the cage.

LOOSE BOTTOM BOARDS.

We frequently see inquiries and discussion in regard to the desirability of loose bottom boards compared with those fastened to the hive. The advantage of the fast bottom board is apparent when we wish to ship bees. It is also easier to pick up a hive and carry it to some part of the yard when the bottom is fast to the hive. Of course, we can reach under the hive and hold the bottom board fast to the hive as we carry it along, but this is not so convenient as to grasp a rim of wood nailed around the hive near its top, or to insert the fingers in hand-holes in the sides near the top. A hive may be removed from the bottom board when it is carried, but it is usually stuck fast with propolis, and the loosening of it irritates the bees and they come rushing out and make it interesting. If we depend upon the propolis to hold the bottom board fast to the hive, it usually proves a case of misplaced confidence, the bottom tumbles off on the ground with a "dull thud," throwing a lot of enraged bees into the air. These are the objections to loose bottom boards.

The advantages of loose bottom boards are that two colonies can be very easily united by simply setting one above the other. If the hives can be raised two inches from the bottom in winter, all rubbish and dead bees drop away from the combs, and if there is an entrance at the top of the rim put under the hive, it can never be clogged with dead bees. In cellar wintering there seems to be a decided advantage in wintering the bees with no bottoms to the hives. When bees die in winter, or, if the colony does not perish wholly, only there are a large number of dead bees in the bottom, they will be wet and mouldy and the combs stuck together with filth if the bottom board is close to the combs. In order to clean out the hive, the combs must all be lifted out and the debris shoveled out. With loose bottom boards this may all be avoided. In raising extracted honey upon the tiering up plan, the same kind of a hive body answers either for brood

nest or upper story. If the bottom boards are fast, and we run short of upper stories, we cannot utilize any lower stories that we may happen to have, as they have bottoms on them and cannot be used for supers. I prefer loose bottoms.

EXPERIMENTAL APOICULTURE.

"Could we but surely know
 Aught of those untried fields and meadows low
 Who would not go?"

All of our bee journals are published simply to tell of new things, of those not before known, or, at least, not generally known. From whence come these facts? From experience; from experimenting. Scattered all over the land are bee-keepers. In the spring each one starts in with a more or less definite plan of how he will manage his apiary that season, but many times during the season must he make a choice of several different methods. Some of them may be of minor importance, others may make all the difference between a fair crop and being obliged to feed the bees for winter. Suppose the bees are in the cellar; how early shall they be taken out, shall they be protected when taken out, shall they be fed to stimulate them, shall swarming be allowed, shall foundation be used in the brood nest in hiving swarms, shall there be an effort to make the number of unfinished sections, at the end of the season, as small as possible or shall abundant room be given to the end of the harvest, and then feeding back be resorted to for completing the unfinished sections? These, and many more questions, would bee-keepers like answered.

The trouble with the average bee-keeper is that he is likely to choose some one of these plans and carry it out with his *whole apiary*. No comparative work is done. If he gets a good crop with the plan adopted he reports it as a success. Perhaps some other plan might have been *more* successful. A writer in a recent issue of the *A. B. J.*, in criticising my advice not to hive swarms on drawn comb at the height of the honey harvest, when working for comb honey, mentioned two or three instances where he had done so, and, by the way, one was where he had put two swarms together, and secured good results. If he tried hiving swarms on starters only in the brood nest, he does not mention it. If he did not try it, he does not know that it would not have been more prof-

itable. Mr. Doolittle, a few months ago, mentioned in the REVIEW an experience of his in stimulative feeding in the spring. A part of his apiary was fed and went booming ahead at such a rate that it was a great temptation not to feed all of the colonies. As a result of resisting the temptation, he learned that in that instance, at least, not much was gained by the feeding. It is in such ways as this that experiments ought to be conducted.

It is not every bee-keeper that is "cut out" for an experimenter. It needs a person of a judicial cast of mind, one that is perfectly willing, so speak, that an experiment shall prove the truth. Too many of us are inclined to make a decision *first*, and then go to work and try to prove what we already believe. This will not answer. An experimenter ought to be wholly disinterested in the results, that is, be willing that an experiment proves either side of the question.

It costs money, time and bees to experiment. The average bee-keeper cannot afford to spare much of these without a reasonable supposition that there will be a money return. If he desires to experiment he is confronted with the query, will it pay? Unless there are fair prospects of a money return, it must be abandoned.

The foregoing are not the only reasons why it would be advisable to have competent bee-keepers employed by the government to take charge of experimental apiaries. There is another reason that perhaps but few have thought of, viz., that such a person would be clothed with authority. What he said or did would be looked upon with respect by the outside world. For instance, when queen bees were thrown out of the mails, it was mainly through the efforts of Prof. Cook that they were readmitted. Last year a duty was placed upon queen bees imported into this country. Again it was through the instrumentality of Prof. Cook that this duty was removed. Prof. Cook told me himself that as an *individual* he could never have accomplished these results, but, as Professor of entomology in the Agricultural College of Michigan he was heard and his arguments given consideration. Cases like these are liable to come up at any time, and a good man at the head of a State Experimental apiary would be a power for good.

It seems as though no arguments are needed to show that an experimental apiary in each State would be a great benefit. We all

know that there are many questions connected with bee-keeping that are unanswered, and that the correct answer to them would make of bee-keeping a more safe and profitable pursuit. Frank Benton writes me that there are about twenty different lines of experimental work that he would like to take up, in some of which he has already planned the experiments that he would conduct, and he considers some of them of more importance than his climatic mailing cage and food for shipping queens, but he has no opportunity to make these experiments at present.

Not only this, but there are new problems continually coming up that will need to be solved. One man, working in a careful methodical way, having bees, appliances and means at his command, can do more to settle the knotty problems of apiculture, than can all of the bee-keepers of the State working in a hap hazard manner. If each State and Territory had an experimental apiary manned by a competent person and the reports of the work published in the journals, so that bee-keepers could read and criticise and suggest as the work is going on, "climb up in chairs and help," as friend Hasty puts it, bee-keeping would receive another boom and such a one as would help those already in the business. The REVIEW is going to work to try and have bee-keeping recognized at the State Experimental Stations. Each State and Territory receives from the general government \$15,000 annually to carry on experiments in agriculture, horticulture and the like. You do not need to be told that bee-keeping has been almost entirely neglected at these stations. Dr. Miller gives as reasons for this neglect that the directors of the Stations or the State Boards of Agriculture, are uninformed in regard to the importance and needs of apiculture, and that bee-keepers have been too modest in asking for their rights. I think he is correct. I feel confident that the bee-keepers of any State can have an experimental apiary if they will only go to work to secure it. But, as I said last month, passing resolutions and appointing committees at conventions will not do it; there must be some *work* done by some one. The resolutions and committees are all right as preliminary moves. The State Board of Agriculture will listen to a committee from the State Association of bee-keepers when it would pay very little attention to individual requests. Put the right

men on the committee. Men of experience and good sense. Another thing: raise some money, even if you have to do it by subscription, to pay the expense of the committee in meeting with the State Board of Agriculture. Of course the expense may not be very heavy, but the individual members of the committee ought not to be asked to bear it. Perhaps the funds of the bee-keepers' Union might be used to advantage in helping to bear the expenses of such committees. If the Union would bear half of such expenses I believe it would be money well spent. What does its manager and others think?

After a State Board has decided to use money for apicultural experimental work, let bee-keepers look to it, and look sharp, too, that the work is placed in the right hands. This is the most important point of all. Let the bee-keepers select the man. Perhaps it would be a good plan to select him by a vote at a meeting of the State Association. Let him be a practical bee-keeper, one who has raised some honey and managed a good sized apiary. There is nothing like actual work in a good sized apiary to enable a man to comprehend what bee-keepers really need to know. Don't get simply some theoretical writer for the press. Get a man to whom bee-keepers will look with confidence. I could name half a dozen men in as many different States, who, I know, would fill the bill.

The August REVIEW is to be devoted to a discussion of "Experimental Apiculture," and I shall be glad of articles on the subject. Send in suggestions as to the establishment of experimental apiaries, the selection of the apiarists, experiments that ought to be conducted, how the work should be done, etc., etc.

A VISIT TO THE MICH. EXPERIMENTAL APIARY.

I have just returned from a visit to Michigan's experimental apiary which is now in full blast. Mr. Taylor has put the State apiary right in with his own and will devote more or less of the whole 300 colonies to experimental work. As shown by the cut on the next page, the apiary is very pleasantly located. The ground slopes toward the East and the numerous trees give an abundance of shade. In fact, about one-half of the hives are hidden from view in the picture by the trees. In the background may be seen the top of the wind-mill and the roofs and

gables of the house, barn, honey house and shop. The bees are wintered in the cellars under the residence and honey house.

From eight o'clock in the morning until half past one in the afternoon (when I left for home) there was scarcely a moment when there was not a swarm in the air, and sometimes two or three. There were queen traps on almost all the hives. As two or more swarms would unite and then go piling into one hive, perhaps one from which a swarm had not issued, Mr. Taylor would remark, with a smile, "I wonder what Mr. So and So (mentioning some man who had said that bees always go back to their own hive when the queen is not with them) would say if he were here now."

It did me good to see the enthusiasm, thoroughness and extensiveness with which

experiments were being conducted. Swarms and hives and cases were weighed, etc., etc. The note book was kept right in the yard and everything jotted down on the spot; there was no waiting until the day was over and then depending upon the memory.

I found a large solar wax extractor in operation. Mr. Taylor told me he should render some combs infected with foul brood and then make the wax into foundation without heating it any hotter than it was heated by the sun, and then use the foundation and see if foul brood would result from its use. But I must not forestall Mr. Taylor, as he has promised to tell us all that he does: and I will close by saying that, as an experimental apiary it comes up to my ideal—it is the realization of a dream that I once feared might never come true.



MICHIGAN, EXPERIMENTAL APIARY. LOCATED AT LAPEER.

Work at Michigan's Experimental Apiary.

E. L. TAYLOR, APIARIST.

IN this first article concerning the work at the Michigan Apicultural Experiment Station, I must confine myself briefly to a statement of some of the items of work already undertaken, and to indicating some

of the benefits which it is hoped may be derived from them, only briefly alluding to results so far as they yet appear, without entering into details.

It must be remembered that I have been plunged into the midst of the work of the Station at the most important as well as the busiest season of the year, by an appointment as director only a short time before the opening of the honey season—an appointment which I had previously not the remotest thought of receiving—and so no

doubt many of the methods pursued will prove cruder than they might have done had I had the advantage of time for previous thought directed to the maturing of plans best calculated to secure the clearest results in some of the still unsolved matters that are of especial interest to bee-keepers; indeed, I already see more than one point where improvement could have been made. It is to be noted also that thus far I have been left to my own resources for the selection of points to be investigated in conducting the work, but it is to be hoped that in the near future direction may be given in this respect by a committee appointed by those who on account of their vocation or avocation are specially interested.

FOUNDATION FOR COMB HONEY.

No intelligent, well-informed, practical apiarist can avoid the rising of numerous questions with regard to the comb-foundations prepared for use in sections, some of which are: Are those of all makers equally good? Do the bees have a choice and consequently work more readily upon some than upon others? Has the thinner any advantage or disadvantage as compared with the heavier? Is that long made equally as good as that just out of the machine? Are all kinds in equal danger of a well founded accusation of leaving a "fish bone?"

With the hope of throwing some light upon some of these I procured a variety of foundations, to the number of eight, distinguished from each other either by weight, make or age. Each kind for the purposes of the experiment was distinguished by a letter of the alphabet and the number of feet to the pound of each carefully determined, all of which was made a matter of record. Each was then cut to the same size and fastened into sections. Twenty-eight sections of each were used for the purpose of the experiment and each section was plainly marked on the top with the letter used to designate the kind of foundation with which it was filled. These sections were then put into cases without separators, alternately, each case, after the first, beginning with a section marked with a letter immediately succeeding the letter used in marking the final section of the previous base. These cases thus prepared have been adjusted to colonies best fitted by their character and condition to work in all parts of the case equally. What valuable results, if any, can be expected? Worked out under such circumstances can those least liable to

produce the "fish bone" be determined by comparing the combs? Can those most profitable to the apiarist be determined by comparing the weights of the comb honey produced from each? I shall later desire the assistance of a few of the most competent apiarists in making comparison of the septums of comb built from these different kinds of foundation.

IS COMB FOUNDATION PROFITABLE IN THE BROOD-CHAMBER?

This is an old but still unsettled question. To obtain some definite information if possible on this matter I prepared four sets of hives, each hive being one section of the new Heddon. Each set consists of three hives—one filled with drawn comb, one with foundation, and one with frames furnished with narrow starters only. The sets are numbered 1, 2, 3 and 4 and those furnished with comb, foundation and starters are designated by the letters A, B and C respectively. A record is made of the weight of each hive and of the cases adjusted at the time of hiving each swarm, and, also, of the bees in each swarm. Each hive with its cases and bees was again weighed upon the morning of the day succeeding the hiving to determine as far as possible the extent of change which had taken place in the denizens of the hives by their going from one hive to join another as they frequently do when there has been any commingling of bees in swarming. It will be seen that at the end of the honey season I can easily determine the increase in weight both of the brood-chamber and of the supers and so be able, I hope, to draw some solid conclusion with reference to the comparative value of comb, starters and foundation for use in the brood-chamber.

These sets of hives, it has occurred to me, are well adapted to throw light upon another question which perhaps is not given the consideration it deserves, viz: Do colonies produce results in proportion to their strength, or is there a golden mean in this respect and is it true that when that is either exceeded or come short of, there is less relative profit? How the above mentioned sets of hives may help to elucidate this question will be evident when I mention the fact that swarms put into 1 C, 2 C, 3 C and 4 C weighed respectively $7\frac{1}{2}$, $10\frac{3}{4}$, 5 and $4\frac{1}{4}$ pounds. Among the swarms hived upon combs and among those hived upon foundation there was also a considerable difference in weight,

though not to the same extent. I am looking with great interest for the results insofar as they may have a bearing upon this point and much care will be taken that the exact facts shall be arrived at.

PRATT'S HIVERS.

Five of these hivers were procured and adjusted to as many hives, and as I must be brief I shall now only mention results thus far by giving an outline history of No. 2, deferring further mention till another time. To this hive the hiver was adjusted June 17 upon the issuing and return of a swarm. After this adjustment the queen was of course in the old brood-chamber, notwithstanding which, the swarm did not issue again till June 29th when it was allowed to return. On July 2nd it again issued and became mingled with other swarms so that it was necessary in making a division to allot the proper portion which was returned to the hive. This colony, though furnished with a case of sections filled with well drawn comb, has done comparatively nothing in it.

LANGDON'S NON-SWARMING ATTACHMENT.

Lack of space will permit but a few words touching this invention by way of closing this article. Five of the attachments were adjusted to double the number of hives, on the 22nd day of June, since which time seventeen swarms have issued from these hives; in each instance thus far the queen was returned to her own hive and the swarm to the sister hive, although it quickly became evident that it was worse than useless to do so.

Full details of this line of work may be looked for in my next article from which I think any intelligent apiarist may easily determine the reason why the attachment has failed in these cases to honor its first name and whether it can be made practical anywhere.

LAPEER, Mich.

July 4th, 1893.

EXTRACTED.

What to Do When Stung a Great Number of Times.

"And every earthly ill doth serve in fact
Some other equal ill to counteract."

The time of year is now here when an accident may cause a person or animal to re-

ceive a great number of stings. I am a temperance man, but I believe that the advice given by Bro. Hill of the *Guide*, is correct. Here is what he says:—

"Britton, Mich., Sept. 5, 1892. A valuable pair of horses belonging to L. Lowe, a prominent farmer, was stung to death Friday. The boy who was plowing near the apiary, left the team standing while he went for a drink of water. The horses upset a hive and the angry bees pitched into them, stinging them so badly that both died in a short time. Mr. Lowe was also badly stung while trying to help the horses. This drink of water cost Mr. Lowe about \$200.

[We have had some experience in severe cases of stinging like the ones mentioned above, and fully believe that if large doses of whisky be given at once or as soon as it can be procured, dose every half hour, there would be no deaths from bee stings. The use of cold water is, in our judgment, the very worst thing to use, or even wetting the skin or hair, because it chills the surface and causes the blood and poison to concentrate in the interior vital organs, heart and lungs, and causes death. If we give whisky it stimulates the heart and lungs to resist the poison, throwing off the effects of it and the whole surface of the body will become very red and warm, which is necessary, or nature's method of relieving the patient of the effects of poison. If we wet and cool the skin we simply shut the poison in and prevent the escape by natural methods, and we believe the cold water, not the bee stings, kills the patient.

We do not advise whisky to be used for every bee sting, but only when the case is so severe that the heart and lungs are affected. Smoke is the only effectual thing to frighten bees with in such emergencies. It can be gotten ready quickly. Coals from a stove put in a pan, and covered with chips or straw, a whole box of matches may be used to light some cloth, shavings or straw, making a smudge that if held on the windward side will soon drive the bees away. After the battle is over carefully scrape off the stings, or pull them out. Give whisky and keep the animal or person in a cool shady place, not allowing any working or moving of muscles until the effects of the poison have passed, which will be from twelve to forty-eight hours.]"

How the Robbing Propensity of Bees May Be Used to Advantage.

"The highest art consists not in obeying rules but in breaking them properly."

The propensity of bees to rob has been looked upon as an unmixed evil; beginners are always cautioned (and rightly, too) against allowing robbing to get started, and yet there are instances in which the bees may be allowed to indulge their disposition to

carry away honey already stored, and only good results will follow. Dr. Miller tells in *Gleanings* what he has done in this line, and then the editor follows with his experience. As the robbing season will soon be here I think it will be well to copy the whole article:

"FRIEND ROOT:—That item of your experience on page 782 is quite interesting reading, and I think you are somewhat at fault that you do not give us more of the details of your own apiary, particularly the bad things. I am glad you have learned that, under proper management, robbing is not such a dangerous thing. It is hard to know just what is the right ground to take in this respect; for few young bee-keepers, until they have had some sad experience, have any just conception of the danger connected with robbing.

I would give something to make my assistant as afraid of robbing as I am. In former years I had such a severe breaking-in that the sight and sound of a single robber when I am at work strikes me with alarm. But Emma has not had the same experience, and can work on placidly with the music of robbers about her. I say to her, 'You must be very careful or the robbers will get the start of us.'

'Oh! I guess not. I haven't seen any yet.' 'Why, don't you see them there this very minute, right under your very nose?' and the emphasis I give is perhaps not as pleasant as it ought to be; for if there is any thing that demoralizes me it is to have robbers offer their assistance when a brood-chamber is open. So it is that it is considered not the orthodox thing to say any thing in favor of allowing bees to do the least thing in the line of robbing. Too often, however, it is the interference of the officious bee-keeper that makes most of the trouble. A weak, queenless colony is attacked; and the only thought in his mind is, that that thing must be stopped. So the hive is taken away, perhaps put in the cellar for a time, and the robbers, not finding their prey in its proper place, pounce upon the nearest hives, which, in their turn, are taken away and thus the trouble spreads.

On another occasion a similar case occurs, but the bee-keeper is in blissful ignorance of it; and the first thing—in fact, the only thing—that he knows about it is, that the hive is completely cleaned out—cleaned out several days before he noticed it. In that case no harm is done. The colony was not worth saving, and perhaps it was a good thing to have the honey transferred where it would do more good.

I very much doubt the correctness of the time-honored tradition, that, if a bee once does any thing in the line of robbing, she will never return to honest labor afterward. You know very well, that when, by reason of bad weather, the honey flow suddenly stops, care must be taken not to start robbing; and if by some carelessness it is started, and perhaps 20 pounds of honey robbed, thousands of bees being engaged in the plunder, if the

next morning opens up clear and bright, honey yielding freely, every bee in the apiary will seem to be hard at work. Where are the thousands that yesterday were robbers? Don't tell me that none of them have gone back to honest ways.

Last spring the disastrous losses left a large number of hives untenanted; and the combs, numbering more than a thousand, had more or less honey in them. The fuller combs were convenient to put in colonies needing them, but a great many had only a little honey in them. What was to be done with them? They might stand as they were, but on the whole it was perhaps better that they should be emptied out. Perhaps you may remember that they were hung overhead in the cellar. Well, the door of the cellar was left open and the bees were invited to take possession. They promptly accepted the invitation.

Now, there were two things that surprised me. One was, that it took the bees so short a time to clean out those combs. Another was, that it took them so short a time to settle down quietly after they got through the job. For a half a day or a day after the honey was gone there were more or less bees searching through the cellar, and at the end of that time there was nothing in the apiary to indicate that anything unusual had been going on.

Another thing, if you allow a section of honey to stand out, the bees will tear it all to pieces. These combs I have been telling about were not torn at all. Whether it was that they were tougher, or that the bees had so large a surface to work over, I do not know; but I am inclined to the opinion that bees do not tear old combs so badly.

When the clover harvest closed, what little there was of it, all sections were taken off. A goodly number of supers had so little done in them that the best thing was to have the bees clean them out. A somewhat large experience in trying to get bees to empty sections on or under the brood-chamber made me dissatisfied with that sort of thing. So one day a number, perhaps 15, of such supers were piled up in the cellar in such a way that not a very large number of bees could enter at a time. They were promptly cleaned out; and 24 hours after the work was finished, there was no commotion in the apiary. The same thing was repeated with a larger number, and with the same result.

Now I'll tell you what I think. If you had allowed the bees to work on these combs that you had piled up, without restricting their entrance so much, the result would have been the same, provided you did not take the combs away till after the bees had emptied them, and had got discouraged working over them. The whole matter lies just in this: If bees get to robbing you must not take away every thing they are working at, but leave them to work on the very same spot until they are satisfied that they have finished up the work themselves. Perhaps it may do to empty out a hive they are working at, providing the hive itself is left, and nothing about its appearance changed; but I think I would rather leave some comb in the hive for

them to work at. I fancy I see A. I. R. shake his head when he reads this, saying, 'That's dangerous. We can't be too careful about the matter of robbing, and hardly ought to publish any thing of the kind.' Yet the whole truth ought to be known. I'm just as much afraid of robbers as you are; but I believe it is well to be posted on all points; and with that never-failing safeguard, the footnote, I feel sure all will be well.

C. C. MILLER.

Marengo Ill.

[We indorse every thing you say; and, like yourself, we are afraid of robbing, and only wish that our helpers regarded it with the same fear. We can not ourselves endure to have even a single robber hovering over the frames, while our helpers think nothing of it to have as many as half a dozen. To use a colloquial phrase, we have been 'through the mill,' and know the bad results of allowing the bees to pilfer from hive to hive. While we hold robbing in great fear, we are inclined, on the other hand, to let the bees, under *certain* circumstances, help themselves. A year ago last summer, at the Shane yard, as a result of transferring the bees on to Hoffman frames, we had a quantity of old crooked combs in home-made loose frames—too crooked to be used in new frames. Instead of transferring these we carried them a few rods from the apiary and laid them in the shade of a tree; but, mind you, we did not expose them until we had finished work in the yard. On one or two occasions we waited long enough to witness the result. The bees pounced on to the combs in a perfect storm, and speedily emptied them of every thing sweet. The next day we returned and found the apiary comparatively quiet, nor were there any dead bees at any of the entrances, as a result of previous conflict. One time, we remember very distinctly of setting a couple of combs under a tree a few rods away, while we were in the midst of our work. All at once the bees began to be cross, and to pilfer over the top of the hive. The first incoming laden bees notified those already in the hives that honey was to be had *somewhere*. As we have noticed many times before, they began to hunt around, and, very naturally, turned to the hives where we were working, because they had not yet discovered the source of honey from which the first supply was obtained. It is needless to say we stopped right then and there.

MORE ABOUT THAT STACKED-UP-HIVE FEEDING.

Now, we would by no means advise the scattering of partially filled combs a few rods from the apiary where it is located near dwelling-houses; but in out-yards situated as the one mentioned, nearly a quarter of a mile away from buildings, it may be done at times to advantage. The plan that can always be pursued safely where it is desired to empty out combs containing a little honey, is, to place them in hives stacked up two or three high, with a small entrance, as explained in our editorial on page 782. While these stacks of hives, we know by ex-

perience, can be placed right near the driveway, and yet horses and persons can go by without the least interference, we would not recommend it.

This plan of feeding creates an artificial condition of things during a dearth of honey—that is, a dearth from natural sources—much like that when honey is coming in freely from the flowers in nature's own way. Instead of robbers flying around and stealing, they are given something to do; and the result is, that we have been able, during the past few days, to go on with our work of uniting, etc., in the apiary, with very little interference from robbers. And, again, we observe the honey itself is being distributed throughout the apiary, not, as we should naturally suppose, in the strongest colonies, but with a very fair and even distribution throughout all the hives. Our Mr. Spafford said that he could see the result of this open air feeding in the hives. Queens were beginning to breed, and every thing was going on just as if nature had taken a sudden boom. Nearly every apiarist every spring has a few combs containing a little honey; and what a good effect this kind of out-door feeding may have in stimulating brood-rearing at the time of year we most desire it, with so little labor, the reader can figure out for himself. Besides the increased amount of brood-rearing, he will have a lot of nice, clean, dry combs, no more tempting to robbers later on in the season.

We are sure that bee-keepers have not yet experienced the many advantages that may accrue from this kind of feeding. They have known of it, it is true, but have not as yet utilized it. Now, doctor, while we may be at fault for not giving more details of the work in our own apiary, we hope we have redeemed ourselves, at least temporarily.

P. S.—A. I. R. has witnessed the results of this stacked-hive feeding *a la* Miller, and acknowledges that it is a success in more ways than one. At first he felt a little skeptical about it, and was slightly alarmed lest we 'boys' might be getting ourselves into trouble.]”

The caution that the Doctor gives about taking away whatever bees are working upon and leaving nothing for them to work upon, is excellent. I have noticed a great many times that if robbers were allowed to go on and “clean out” what they are at work upon no trouble follows, but if they are suddenly “robbed of their prey,” something else will have to suffer. One season, after the main harvest was over, I allowed the bees to clean up the cappings that had accumulated. They were taken out a painful at a time and spread out in large tin cans a few rods from the apiary. In ten minutes from the time a pail of cappings was placed in the cans, the bees would be in full flight from almost every hive. The bees went straight to the “feeding place” every time. Within an hour all would be

quiet, except a few bees might be seen hovering over the cappings. I have had combs of honey emptied as the Doctor relates, and I have had sections cleaned up in the fall, and I have frequently fed in the open air, and no trouble has resulted. My principle objection to the plan of out door feeding is that the feed is not equally divided. Some colonies get a great deal more than their share. But, for getting things cleaned up I know of no better plan.

A Condensed View of Current Bee Writings.

E. E. HASTY.

The idea brought down from the last number is the recent growth of our papers. Most of us have well in mind the need of avoiding that stolid, unprogressive, knot-on-a-log character which "organs," when they think they have a sort of mortgage on their patrons' support, so readily fall into. Our journals, most of them, seem to be no longer in danger in that direction. At present they have need to remember (just a little bit) that there is a second and opposite danger, restless, tom-tinker fussiness of change. Changes which are made just for the sake of changing are not always wise. I am very glad to reach at length the turn of the

AMERICAN BEE JOURNAL.

I find I have sixteen numbers not finally laid away; and the task of properly reviewing such a volume of literature is so enormous that I just give up the most of it. Friend York, your bed in the garden is like the State of Illinois—so big that your small reviewer can't weed it all over. The new master of *A. B. J.* is great on starting new departments and chopping things up fine. The department of General Questions is, I believe, the youngest and is designed for dealing with such questions as it is not thought best to have answered by the symposium method. The symposium which was hailed as the best thing out, and which has been very useful for a long time, shows decided signs of decline. In one department at least the *A. B. J.* is not choppy but thorough, and has a clear lead of the host, that is the Biography Department. And its excellence is no doubt the result of much and patient editorial hard work. By the way outsiders mostly think that editorial work is

all, or most all, in writing editorials. The fact is that of successful editors some write much editorial matter and some write very little; but all have to have tact and industry and persistence in getting other people to do their best. Friend York evidently works hard at getting the right writers to write right in these personal sketches. The pictures too, although we are still treated to occasional poor ones, average quite tolerably, with few very bad. Of these interesting memoirs I will refer to but one, Ralph Benton, youngest member of the North American; not yet nine, earned the money for his initiation fee by apiary work. Hurrah for aristocratic Washington and woolly Texas, as represented by their child bee-keepers, Ralph Benton and Leah Atchley! And should they some day both get into the same State, that reputed best State in the Union—well, at least we will not come around at the untimely midnight hour and make such music as is appropriated for bees a-swarming.

Editor York also takes the liberty, perfectly proper when properly confessed as this is (page 520) to ask other suitable persons to write editorial notes. But an editor so doing needs to "watch out" real sharp lest time and carelessness trap him into letting things he is not exactly willing to be responsible for disport themselves under his editorial robe.

On page 438 for April 16th, is the oldest article I will at this time refer to. This is friend McGuire's record of a colony on the scales. Well kept records of this kind are not plenty by any means; and it is desirable that they should be encouraged, especially such as are *not* enormous or exceptional. The monstrous things are all very well to notice; but the average realities of nature are of much more importance to us. In this record the best day's run is $9\frac{1}{2}$ pounds on May 30; the season is nine weeks long; and the total at the runs is $115\frac{1}{2}$ lbs., well distributed through the rather long season.

On page 462 for April 13th, friend Collins tells us how to get the start of the midnight skunk, and his deeds of darkness. It isn't a very tidy way, but it is evidently effective—just pile the entrance with boulders too big for his ill-savored majesty to move with ease.

According to the German itemist Reepen, most of the bee-masters of Germany hold that honey dew is *sometimes* a direct exudation of the leaves and not an insect secre-

tion. One would think that the more logical way would be to use two terms—exudation honey and insect honey. But then if the two are so much alike that common folks cannot tell which is which perhaps one term will have to answer for a spell longer. It seems that in the Black Forest and in the Vosges mountains there was an immense yield of honey dew last season—345 pounds of it extracted from one hive. And by the way I have not yet given sufficient credit to the *A. B. J.* for the solidity and excellence of its German department. It is a notable evidence of its recent growth. One cannot say that the "Old Reliable" is very badly affected with the pop-gun disease when he considers how much that is thorough its columns contain. And June 1st we are reminded that the present hand has held the tiller just one year that day. Honestly a good deal has been well done during that year.

Turning now to the latest number, June 15th, we invoice it as two pages of editorial notes (thirteen of them crowded in) three columns of general queries and answers, $4\frac{1}{2}$ columns biography of Dr. Mason, four columns of Jennie Atchley's Southland, a page of Query 875, eleven columns of contributors' articles (six articles) and four columns of letter box clippings.

That was meant for a very fine picture of Mason, but it errs, as his pictures are quite apt to do, in having a too sober and slightly moribund look, quite foreign to the good Dr. as viewed when he is alive. The sketch is O. K.—and written by a person whose first object certainly was not to get the job finished and out of mind.

Sunny Southland is getting to strike me as a little too much like a journal within a journal. I would not lay much stress on this remark, as perhaps it is a mere notion of mine, not shared by the reading public. I certainly do not object to Mrs. A. when she takes the field and says things herself. And as her space in this number is wholly filled with two of her own best articles boiled into one, my criticism is a little like complaining in dog-days at an ancient snow storm. Her theme is queen-rearing, a science of which herself and Alley and Doolittle are "professors." Let us dip in. Twenty strong colonics and *ten* queens—and the queens jumped back and forth every time a batch is finished. And, here's a royal point—extending a favorite breeding queen's life by confining her on three combs, though all the

time in a powerful colony, kept so by combs of brood from outside sources. The breeding drones are localized in one colony, and this kept from swarming by holding it queenless most of the time. (Not so sure of the absolute correctness of that practice.) And so introducing virgins is N. G. They waste time in the virgin state, while home-born ones get immediately to biz.

Going to say something naughty about Query 875 and a previous one; but I won't say it now.

And now those six contributors have got to bed with a spunk apiece. Friend Latham skirmishes nimbly over the question of the queen control of the sex of her eggs, but leaves matters on the field about as he found them. Friend Common says

"I am convinced that the bees will give double the surplus honey if hived on drawn combs, if rightly managed."

Me too. But the opposite practice no doubt works well good years in first rate locations.

Montreal thinks winter bee-diarrhea can be cured by a few drops of spirits of peppermint spilled underneath them. Well, at least he will not be prosecuted for crnel malpractice if he doctors thus—and his out door wintering plan is not bad.

Friend Dayton went to bed in a buggy locality and discovered that fifteen thicknesses of paper all over and projecting a few inches all round the bed circumvents the un-circumventable B. B.

Friend Getaz thinks queen trap practice to control swarming is unsatisfactory to both bees and bee-keepers, and results in the death of queens. Me too.

Friend S. E. Miller's article was not written primarily for *A. B. J.*, but is none the worse for that. He seems to "argy" it a critical matter to know just when to put on the supers. I suppose we are to infer that the wise man will hit it, and the blunderhead miss it. 'Specks I'm wise enough to know that I have some that ought to be gone in this minute—and here I am writing.

THE GENERAL ROUND UP

The most important thing since last "surround" is doubtless the establishment of the Michigan experiment station. We will tolerate the Michigan Committee in wearing pretty good sized feathers in honor of their diligence and success. We shall look with much expectation to that new department in the REVIEW. The really good work that is

done under National and State auspices seems to be about half lost to the general public just from the lack of intercommunication between the workers and those who would really like to know what is going on. When we were boys we found that watching the evolution of the doughnut was a wonderful appetizer for doughnut. We hope therefore that experimenter Taylor will let us climb up in chairs and "help"—and see everything from the sifting of the flour to the hanging up of the spider, as the Michigan doughnuts are evolved.

It will do no harm, though, to look at the matter from another direction. Experimenting in quest of valuable discoveries is very like raising new seedlings in quest of valuable new varieties. Many thousand strawberry seedlings are carefully raised for every one new strawberry that comes into general cultivation. Even so, many sets of experiments may be wisely planned and ably executed before we all get rich and go to the World's Fair on the proceeds. But even if our doughnuts do all turn out unedible mud-pies in the end, we want to have the fun of seeing them made.

The *Canadian*, having encountered a little racket in rough waters, is recovering and catching up.

Gleanings pleads not guilty about the Weed comb. Looks like a bad case of blundering on my part. I must investigate dates a little (when bees are not swarming) and if the description was promptly given, before people had largely learned the thing from other sources, I will eat "humble pie" as if I liked it. Humble pie is good for hasty folks any way, only it don't taste good.

The *Progressive* gives the REVIEW and myself the very high compliment of commencing a new department on the same general lines as this Condensed View. I am specially pleased to see that the writer repeats and earnestly seconds my estimate of Mr. Hutchinson's work. The opening article is illustrated, thus going the REVIEW "one better." The REVIEW appears in the illustration as at the head of the race: but W. Z., do you when you go a biking ride a three wheeled concern, like an elderly physician whose sands of life have well nigh run out?

The department is signed "Somnambulist;" and who Somnambulist is will be a first-class conundrum for a bit. But when we look closely it appears as if his tracks were not entirely covered. If he has a lady

assistant in his apiary—and if he has rustled around for "straw" till the surrounding fields yield scarce enough to make a peewit's nest—and if he has a lower estimate of Stray Straws than any one but the modest author is likely to have—why then possibly we can locate him. Dear Somanambulist don't make your nest upon one of those lofty pinnacles at the World's Fair. Remember that somnambulist go in lofty places with perfect safety so long as they are sound asleep; but the minute they wake up they fall and break all to pieces. 'Hist! I shall wake him.

The *Progressive* also has a picture and biography, apparently intending to "follow suit" on A. B. J.'s strongest department. Altogether the *Progressive* seems quite metamorphosed. And editor Leahy (his name is run up this time) I guess we may set him down as one of those fellows who will make a horn spoon or teetotally spoil the horn, and a good jack-knife too.

There, I'm going to let the rest of the drove go, and see if I cannot stop my swarmy bees from being driven to still hotter swarm fever by lack of place to put their honey.

RICHARDS, Lucas Co., O., June 20, 1893.

ADVERTISEMENTS

BEES QUEENS,
SECTIONS, SMOKERS,
COMB FOUNDATION
And all Apiarian Supplies. Send for Catalogue.
E. T. FLANAGAN, Belleville, Ill.

Bee Hives and Section Boxes.

Simplicity, Langstroth-Simplicity, Standard Langstroth, Dovetailed and Champion Chaff Hives, Supers, One Piece Sections and Shipping Cases. Foundation, Smokers, etc., etc. Send for 16 page Circular.

1-92-tf PAGE & KEITH, New London, Wis.

If You Wish Neat, Artistic

PRINTING,

Have it Done at the Review.

NO ORDERS.

Mr. G. E. Dawson of Carlisle, Ark., is a NEW advertiser of fine Italian queens. While some old advertisers have stopped their ads. because they were overburdened with orders. Mr. Dawson complains that, although he has advertised since Jan., he has received **NO ORDERS.** He raises good queens as I know from some he has sent me. Now, will some of the brethren who want queens send him an order and thus show him that the REVIEW is a good advertising medium? His prices are as follows: Untested, 75 cts each, three for \$2.00, six for \$3.50, twelve for \$6.00. Tested, \$1.25; select tested, yellow to the very tip, \$1.50.—ED. REVIEW.

Please mention the Review.

NOTICE OUR PRICES.

No. 1 Sections \$2.75 per 1,000 Thin, surplus foundation, best quality, 50 cts per pound. A full line of supplies, including Root's Dove-tailed Hives, on hand. Send for circular and free sample of foundation 5 93-tf

J. H. & A. L. BOYDEN,
Safine, Mich.

LEININGER BROS.

Will sell Italian queens and nuclei cheap the coming season. Write for special prices.

5 92-tf FT. JENNINGS, OHIO.

GO TO HEAD QUARTERS

FOR 4 AND 5 BANDED

QUEENS

Special, breeding queen,	\$5.00
Best, select, tested,	3.00
Tested,	2.50
Untested,	1.00
" per dozen,	9.00

L. L. HEARN,

7-93-tf Oakvale, W. Va.

Please mention the Review.

GOLDEN ITALIAN QUEENS

Now ready for \$1.00 each. Do not order your supplies until you see our circular for 1893. For the price, we have the best spraying outfit made. Send \$1.50 and get one. Wm. H. BRIGHT, 1-93-12t Mazeppa, Minn.

Please mention the Review.

ITALIAN QUEENS AND SUPPLIES FOR 1892.

Before you purchase, look to your interest, and send for catalogue and price list.

J. P. H. BROWN,

1-88-tf. Augusta, Georgia.

Please mention the Review

For \$1.50 I will send the Review for 1893 and a fine, young, laying, Italian queen.

Queen alone, 75 cts. For \$1.75 I will send the Review, the queen and "Advanced Bee Culture." Tested queens, \$1.00. The Review and

a tested queen \$1.75 A discount on large orders. W. Z. Hutchinson, Flint, Mich.

REVIEW

QUEENS

The Champion Smoker.

The ORIGINAL curved nozzle, steel lined, Bellows Smoker. The fire-chamber is 3 $\frac{1}{2}$ x7 inches with a corrugated steel lining, which allows a cold current of air to pass between lining and outside shell; keeps the outer shell cool and more than doubles the durability of the Smoker. It has a FORCE draft, and SPARK-ARRESTING CONE connection between bellows and fire-chamber; a base-valve to either keep or extinguish the fire at pleasure; and a removable spark-arresting GRATE in the curved nozzle.

Price, by mail, \$1.90; by express, \$1.65

If your supply dealer cannot supply you, write to the manufacturer,

E. KRETCHMER, Red Oak, Iowa.

See Supply Catalog of 70 Illustrated Pages, free.



FREE TO ALL

SAMPLE COPIES EITHER OF THE

Canadian Bee Journal

OR

Canadian Poultry Journal,

Or both, will be sent FREE to applicants who desire them, upon receipt of their names and addresses.

These papers are both of them edited and arranged by practical men, admittedly the most experienced in their particular lines to be found on the continent, and the Journals may therefore be regarded as authoritative upon the several subjects of which they treat.

Address **BEETON PUBLISHING CO.,**
Beeton, Ontario.

IMPORTANT

TO BEE-KEEPERS!

To make a success of bee keeping, you want bees that will give the very best results. My *Golden Italians* have gained a good name on their own merits. Those who have tested them with other bees say "they are the best honey gatherers, cap their honey the whitest, as gentle as butterflies, beautiful to look at, are the largest and strongest bee of all the races." Queens bred from mothers that produce uniformly marked

FIVE-BANDED WORKERS

In March, April and May, \$1.25 each, 6 for \$6.00; June, \$1.00 each, 6 for \$5.00; July to Nov., \$1.00 each, 6 for \$4.50. Special prices on large orders. For full particulars send for descriptive circular.

12-92-tf C. D. DUVALL,
Spencerville, Montg. Co., Maryland.

Dadant's Comb Foundation.

Wholesale and Retail. Even our competitors acknowledge that our goods are the STANDARD of their kind. **Langstroth on the Honey Bee, Revised.** New edition. Bee Veils; and veil material at wholesale. Bee Supplies, Sections, Smokers, etc. Samples of Foundation and veil stuff with circular free. Instructions to beginners. Send your address to

CHAS. DADANT & SON, Hamilton, Ills.

4-93-12t Please mention the Review.

New as Well as Valuable

IMPROVEMENTS

IN BEE-HIVES, SMOKERS,

FOUNDATION FASTENERS,

SECTION PRESSES AND FEEDERS.

Special prices given to parties who will take hold of and push the sale of these goods. For circulars and particulars, address

LOWRY JOHNSON,
1-93-tf. Masontown, Pa.

TYPEWRITERS.

Largest like establishment in the world. First-class Second-hand Instruments at half new prices. Unprejudiced advice given on all makes. Machines sold on monthly payments. Any instrument manufactured shipped, privilege to examine. EXCHANGING A SPECIALTY. Wholesale prices to dealers. Illustrated Catalogue Free.

TYPEWRITER { 31 Broadway, New York.
HEADQUARTERS, { 186 Monroe St., Chicago.

Please mention the Review.

HONEY ALMANAC AND BEE BOOKS, OF ALL KINDS, A LARGE STOCK.



MY NEW ILLUSTRATED Catalogue and Price List of Supplies for the Apilary will be sent free to all who may apply. Send a postal card for it, writing your name and address plainly. For every Order of \$10.00 and over, I will make you a present. The Catalogue tells you all about it.

T. G. Newman, 1-17 So. Western Ave., Chicago.

FOUNDATION

Six Cents a Pound

less than formerly. Also other bee supplies at lowest rates. Send for illustrated catalogue and price list, also copy of the **AMERICAN BEE-KEEPER**.

(ESTABLISHED 13 YEARS.)

W. T. FALCONBR Mfg. CO., Jamestown, N. Y.

THE LARGEST

Establishment in Michigan devoted exclusively to the manufacture of bee-keepers'

SUPPLIES.

Snow white sections \$3.00 per 1,000. No. 2 sections, \$2.00 per 1,000.

A complete hive for comb honey, consisting of body, half story, six section holders, eight brood frames, bottom board and cover, all nailed up, for only \$1.00; in the flat, 90 cts. A chaff hive, with movable side, all complete, for only \$2.00. A full line of bee-keepers' supplies. 20-page price list free. **J. M. KINZIE,** 20-92-12 t Rochester, Mich.

Please mention the Review.

PATENT. WIRED, COMB FOUNDATION

HAS NO SAG IN BROOD FRAMES.
Thin, Flat - Bottom Foundation



HAS NO FISHBONE IN SURPLUS HONEY.
Being the cleanest, it is usually worked quicker than any fdn. made.

J. VAN DEUSEN & SONS,
(SOLE MANUFACTURERS),

3-90-tf Sprout Brook, Mont. Co., N. Y.

Please mention the Review.

Italian Queens

From imported mother, warranted purely mated, \$1.00 each; six at one time, \$5.00. Untested queens, 75 cts each.

C. A. BUNCH,

Nye, Marshall Co., Ind.

7-93-2t

Please mention the Review.

"Golden" Florida.

My location enables me to rear good queens **NOW** as cheaply as they can be reared in the North at anytime. Untested queens, 75 cts. each; 6 for \$4.00; one dozen, \$7.50. Last year's tested queen, \$1.25; select, \$1.75; breeder, \$2.50. Safe arrival and satisfaction guaranteed. 11-92-4f

J. B. CASE, Port Orange, Vol. Co., Fla.

Please mention the Review.



I TELL you what, Jones. *Levering Bros.* sell the best goods and at the lowest prices of any one I've struck yet. The largest and best equipped

Bee-Hive Factory

In the West. The Dovetailed Hive and New Hoffman self-spacing frame a specialty. Everything used by practical bee-keepers by wholesale and retail. Send for their free Illustrated Price-List, and save money. Supply Dealers, send for their Wholesale List. Address **LEVERING BROS.,** 2-93-6, WIOTA, Cass Co., Iowa.

Comb Leveler.

Sections full of comb kept over from last year, when used to induce the bees to begin work in the supers, are worth nearly as much as sections filled with honey. The only objection to their use is that the comb is often uneven and gives the honey a rough appearance. By the use of Taylor's Handy Comb Leveler the combs can be brought to a level as rapidly as the sections can be handled, and the comb of honey, when finished, will have all the fine appearance of that produced with fresh foundation. Price of the leveler (except the wooden box in which to set the lamp) 60 cts. by mail. Box and all, \$1.10 by mail; by express, \$1.00.

B. TAYLOR, Forestville, Minn.

Golden Italians.

My bees are large and great honey gatherers. 1 untested queen, 80 cts.; 3 for \$2.00. 1 warranted queen, \$1.00; 3 for \$2.50. 1 tested queen, \$2.00; selected, tested, \$2.50. Satisfaction guaranteed or money refunded. 4-93-tf

C. M. HICKS, Hicksville, Md.

Please mention the Review.

Just Splendid

Mr. Alley—The queen I got of you last fall is just splendid! She is the best queen in an apiary 150 colonies. I would not take \$10 for her. John A. Pense, Moravia, Calif.

Price of such queens is \$1.00 each.

HENRY ALLEY,

Wenham, Mass.

Please mention the Review.

AUG., 1893.



At Flint, Michigan.—One Dollar a Year.

ADVERTISING RATES.

All advertisements will be inserted at the rate of 15 cents per line, Nonpareil space, each insertion: 12 lines of Nonpareil space make 1 inch. Discounts will be given as follows:

On 10 lines and upwards, 3 times, 5 per cent; 6 times, 15 per cent; 9 times, 25 per cent; 12 times, 35 per cent.

On 20 lines and upwards, 3 times, 10 per cent; 6 times, 20 per cent; 9 times, 30 per cent; 15 times, 40 per cent.

On 30 lines and upwards, 3 times, 20 per cent; 6 times, 30 per cent; 9 times, 40 per cent; 12 times, 50 per cent.

Clubbing List.

I will send the REVIEW with—

Gleanings.....	(\$1.00)	\$1.75.
American Bee Journal....	(1.00)	1.75.
Canadian Bee Journal ...	(1.00)	1.75.
American Bee Keeper ...	(.50)	1.40.
Progressive Bee Keeper...	(.50)	1.30.
Bee Keepers' Guide.....	(.50)	1.40.
Apiculturist.....	(.75)	1.65.
Bee-Keepers' Magazine....	(.50)	1.40.

Honey Quotations.

The following rules for grading honey were adopted by the North American Bee-Keepers' Association, at its last meeting, and, so far as possible, quotations are made according to these rules:

FANCY.—All sections to be well filled; combs straight, of even thickness, and firmly attached to all four sides; both wood and comb unsoiled by travel-stain, or otherwise; all the cells sealed except the row of cells next the wood.

No. 1.—All sections well filled, but combs uneven or crooked, detached at the bottom, or with but few cells unsealed; both wood and comb unsoiled by travel-stain or otherwise.

In addition to this the honey is to be classified according to color, using the terms white, amber and dark. That is, there will be "fancy white," "No. 1 dark," etc.

NEW YORK—The new crop of extracted from California and the South is arriving very freely. There is a limited demand and prices have a downward tendency. We quote as follows: White extracted, 6½ to 7; Amber, 6 to 6½; Dark, 5½ to 6. Beeswax, 26 to 27.

HILDRETH BROS. & SEGELKEN,
July 7. 28 & 30 West Broadway New York.

CHICAGO, Ill.—Fancy white clover in the comb, with every thing perfect about it brings 16 to 17. No. 1 white brings about 15. The darker grades are unsalable at present. White extracted brings 6 to 7, amber and dark, 5 to 6, beeswax, 18 to 22. There is very little activity in the market just now. Some lots of the new crop of honey are arriving which present a very fine appearance and the quality is also excellent.

R. A. BURNETT & CO.,
Aug. 1, 161 So. Water St., Chicago, Ill.

KANSAS CITY, MO.—We cannot give any quotations, as there is no new comb or extracted honey in the market. No. 1, white comb would bring about 16 or 17 cts.

CLEMONS-MASON CO.,
July 7. 521 Walnut St., Kansas City Mo.

CINCINNATI, Ohio.—There is no choice comb honey on the market. A fair article brings 14 to 16 in a jobbing way. The demand is good for extracted at from 6 to 8 cts. There is a good demand for choice yellow wax at from 24 to 27 cts.

CHAS. F. MUTH & SON.,
April 1. Cincinnati, Ohio.

MINNEAPOLIS, Minn.—We think honey will sell much lower later on and now is the time to market it. We quote as follows: Fancy white, 18 to 20; No. 1 white, 17; fancy amber, 16; No. 1 amber, 14; fancy dark, 13; No. 1 dark, 11; white extracted, 8 to 9; amber, 7 to 8; dark, 6½. Beeswax is unsalable

116 First Ave., North, Minneapolis, Minn.
Aug. 1,

CHICAGO, Ill.—The warm weather checks the sale of honey. We are looking forward to a good season with good prices for fancy stock. Dark and damaged comb honey is a poor seller. We quote as follows: Fancy white, 17; No. 1 white, 16; fancy amber, 14; White extracted, 8 to 8½; amber extracted, 7 to 8; dark, 5½ to 6. Beeswax, 21 to 22.

J. A. LAMON,
Aug. 1. 44 & 48 So. Water St., Chicago, Ill.

BUFFALO, N. Y.—We cannot advise the shipment of honey to this market at present, nor for perhaps several weeks. There is too much fruit arriving to handle honey to advantage. At present there are a few small sales of fancy, one pound combs at about 14 to 15. The lower grades sell from 12 downward. There is no sale at present for extracted. Later on, during the proper season, we can handle many tons of honey as satisfactorily as it can be handled in any market in the United States, and we shall be glad at that time to correspond with those having honey to sell.

BATTERSON & CO.,
Aug. 1. 167 & 169 Scott St., Buffalo, N. Y.

BEE - KEEPERS' SUPPLY HOUSE

J. H. M COOK, 78 Barclay St., N. Y. City.

(SUCCESSOR TO A. J. KING.)

4-93 tf

Send for illustrated Catalogue

Illustrated Advertisements Attract Attention.



Cuts Furnished for all illustrating Purposes.

FEEDING BACK

Honey to secure the completion of unfinished sections can be made very profitable if rightly managed during the hot weather of July and August. In "ADVANCED BEE CULTURE" may be found complete instructions regarding the selection and preparation of colonies, preparation of the feed, manipulation necessary to secure the rapid capping of the combs, time for removing the honey, and how to manage if a few sections in a case are not quite complete; in short, all of the "kinks" that have been learned from years of experience and the "feeding back" of tons of honey.

Price of the book, 50 cts.; the REVIEW one year and the book for \$1.25. Stamps taken, either U. S. or Canadian.

W. Z. HUTCHINSON, Flint, Mich.

ON HAND NOW.

THE MOST COMPLETE STOCK
OF BEE HIVES, SECTIONS AND
SUPPLIES IN THE NORTHWEST.

W. H. PUTNAM,

1 93-12t.

RIVER FALLS, WIS.

Barnes' Foot and Hand Power Machinery.

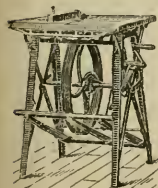

This cut represents our Combined Circular and Scroll Saw, which is the best machine made for Bee Keepers' use in the construction of their hives, sections, boxes, etc.

11-92-76t

MACHINES SENT ON TRIAL.

FOR CATALOGUE, PRICES, ETC.,

Address W. F. & JNO. BARNES CO., 384 Ruby St., Rockford, Ills

Please mention the Review.



Oh, Mamma!

Have you heard of the
FREE

200-Page Bee-Book

given to every **NEW**
Subscriber to the old

**AMERICAN
BEE JOURNAL?**

Oldest, Largest, Best,
Cheapest and the only
Weekly Bee-Paper
in America. 32-pages;
\$1 a year. Sample free

GEO. W. YORK & CO

56 Fifth Avenue, CHICAGO, ILL.

To New Subscribers: The Journal Alone
Sent for Three Months for Twenty Cents.

QUEENS, A large number of fine ones on hand; yellow and prolific; ready April 15th; warranted queens, \$1; 6 for \$4.50; select tested, yellow to the tips, suitable for breeders, \$2 each. Reference, A. I. Root. 3-93 tf

W. H. LAWS, Lavaca, Seb. Co., Ark.

A Grand Success.

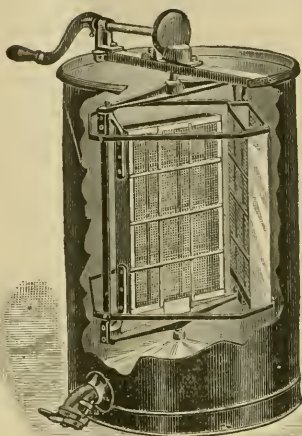

Mention Review.

New Cowan Reversible HONEY EXTRACTOR.

May be Reversed Without Stopping the Machine.

Strong, well made in every respect, light, and of convenient size. The can is but little larger than that of the Novice. The gear is beveled and covered by an iron shield, and the crank outside the can. Frank McNay, of Mauston, Wis., a bee keeper who produces tons and tons of extracted honey, says of it:

"After carefully examining and trying the Cowan Extractor, I have failed to find a weak part, and I do not hesitate to say that it is the best Extractor made, both in regard to convenience and durability, and I shall replace all of my five machines with the Cowan as soon as possible."

It is endorsed also by J. F. McIntyre, an extensive extracted honey producer of California; by W. Z. Hutchinson, Dr. C. C. Miller, and others.

Price all Complete, Japanned and Lettered, for L. Frame, \$10.

A. I. ROOT, Medina, O.

Foundation Reduced.

Deduct three cents per pound from prices given in my Illustrated Price List for 1893

M. H. HUNT, Bell Branch, Mich.

LEININGER BROS.

Will sell Italian queens and nuclei cheap the coming season. Write for special prices.

5-92-tf

FT. JENNINGS, OHIO.

Please mention the Review.

GRAY CARNIOLANS

— AND —

GOLDEN ITALIANS.

Bred from pure mothers and by the best known methods. Send for price list. 4-93-tf

For Carniolans to

JOHN ANDREWS,

Patten's Mills, N. Y.

For Italians to

L. E. BURNHAM,

Vaughns, N. Y.

FOR **ALL KINDS** of **BEE-KEEPERS SUPPLIES.**
ADDRESS **LEAHY MFG. CO. HIGGINSVILLE, Md.**

PORTER BEE ESCAPES

Are used and pronounced the best, and highly recommended as great labor-saving implements by Chas. Dadant & Son, Prof. A. J. Cook, Chas. F. Muth, Jno. S. Reese, J. H. Martin, Jno. Andrews, F. A. Genmill, Wm. McEvoy, A. F. Brown, Thos. Pierce, and many other prominent bee-keepers. Descriptive circular and testimonials mailed free. **PRICES:** each, postpaid, with directions, 20 cts.; per doz., \$2.25.

RETURN THEM AND GET YOUR MONEY BACK AFTER TRIAL, IF NOT SATISFIED. For sale by dealers.

MENTION THE REVIEW.

Address

R. & E. C. PORTER, LEWISTOWN, ILL.

The Bee-Keepers' Review.

A MONTHLY JOURNAL

Devoted to the Interests of Honey Producers.

\$1.00 A YEAR.

W. Z. HUTCHINSON, Editor & Prop.

VOL. VI. FLINT, MICHIGAN, AUG. 10, 1893. NO. 8.

Work at Michigan's Experimental Apiary.

R. L. TAYLOR, APIARIST.

LANGDON'S NON-SWARMING ATTACHMENT.



AS stated in my former article, five of these attachments were adjusted to hives on the 22nd day of June last, and that the conditions may be understood as fully as possible. I must explain that at that date

swarming to a moderate extent, had been going on in the apiary for a week or ten days; the hives employed also varied in capacity, three sizes being used, viz., the single story, new Heddon, double story, new Heddon, and the eight - frame dovetailed. The hives of course are used in pairs and for convenience each pair is designated by a number. Nos. 1 and 5 were each composed of one double and one single Heddon, No. 2 of two single Heddon, No. 3 of two double Heddon and No. 4 of two dovetailed hives. I wish to explain here also once for all that in this line of experiments wherever a swarm issued it was never returned to the hive from which it

came but always to the other member of the pair.

The details of the swarming are as follows: No. 1 cast a swarm June 24th, 28th, 30th and July 4th and 10th, five times; No. 2 cast a swarm June 23rd, 24th, 25th and 26th and July 1st, 4th and 7th, seven times; No. 3 cast a swarm but once, on June 30th; No. 4 cast a swarm June 27th and July 2nd, twice; No. 5 cast a swarm June 24th, 26th and 29th and July 4th and 10th, five times. In other words, No. 1, consisting of one single and one double story Heddon hive; swarmed five times, three times from the single story and twice from the double story; No. 2, consisting of two single story Heddon hives, swarmed seven times; No. 3, consisting of two two story Heddon hives, swarmed once only; No. 4, consisting of two dovetailed hives, swarmed twice; and No. 5, consisting of one single story and one double story Heddon, swarmed five times — three times from the single and twice from the double story, that is, it appears, the larger the hive the longer are the bees able to resist the inclination to swarm.

It will be observed that there was little opportunity to operate the attachment for the purpose of throwing the bees from one hive to the other (except as swarms issued) and it was only practiced in the cases of Nos. 3 and 4, twice in No. 3 and once in No. 4. In each of these this was done on June 26th, the fourth day after the attachment was put in place. But it will be noticed that the very next day, June 27th, No. 4 cast a swarm,

and No. 3 cast a swarm on the 30th, indicating that when other conditions are favorable very little if any preparation at all in the way of queen cells is required before the bees feel at liberty to swarm.

One hive of No. 2 lost its queen which was replaced by a fine young queen which had been laying but a few days, yet this young queen came out with a swarm within four days, and within a week was lost, apparently destroyed by the bees.

As might have been expected under such circumstances the bees of these colonies did not do very good work, but those that did the most swarming did fully as well as the others. As I estimate it, these bees yielded about 65 to 75 per cent. of the surplus they would have yielded had they been managed in the ordinary way. What especially surprised me was the remarkable slowness shown by these strong colonies in capping their surplus honey.

It was always very evident that the desire to swarm was thoroughly eradicated from the colony from which the bees had been thrown—this was frequently very soon shown by the casting out of immature drones. I could not see that worker brood suffered materially.

Why was it that the inclination to swarm was not also removed for a time from the working force of the two colonies thrown together into a hive in which there was no beginning of preparations for swarming?

I have hereinbefore remarked that it appears that the larger the hive the longer the bees are able to resist the inclination to swarm. But the size of a hive is a relative matter and the largest one becomes small if too many colonies are united and put into it.

The theory of the Langdon attachment is that the prevention of the *completion* of the usual course of preparation for swarming common in normal cases will prevent swarming in all cases. The mere statement reveals the fault in the reasoning. The attachment answers completely to the theory but the theory is wrong. It is not an infrequent occurrence that swarms issue without leaving a sign that there had been a thought of preparation, and this is only on the line between the normal and the abnormal. If several swarms are out at once and unite and are hived after an unequal division the colony having an unduly large proportion of the bees will generally persist in the desire to swarm. That condition is abnormal and

creates dissatisfaction. To unite the working force of two strong colonies when the swarming fever is in the air is highly abnormal, and if this is done, this abnormal condition must be provided against if swarming is to be prevented. At least the result of the experiments thus far seems to point that way.

If a course of operations creates abnormal conditions it should be required to make efficient provision to cope with those conditions.

LAPPEER, Mich.,

July 27, 1893.



TIMELY TOPICS.

No. 7.

E. L. TAYLOR.

ALL cases of sections containing the product of white clover and basswood were safely housed some time ago and these of course contained most of the sections which had been adjusted to the hives but undoubtedly there were some cases in which little or no honey was stored and there is a temptation to allow them to remain in the hope that they may be filled in September, but it is a mistake to do so. The bees have now a month's vacation and they use it in making the best preparation they may for the approaching bleak half of the year. Every thing must be made snug—as wind and water-proof as wax and gum can make it. It is interesting to observe at this season the little masons on the outside of the hive with their pollen baskets filled with propolis assisting those within to effectually close some crack that is calculated later in the year to minister to their discomfort. Wax they find makes fairly good mortar and finding it ready at hand hanging useless in the sections they do not scruple to cut it out to eke out their more laboriously gathered propolis. Then, apparently for the purpose of preventing moisture from finding a lodgement even in the woodwork of their home, they varnish the whole with their wonderful, spicy gums while the mid summer sun makes them spread and adhere well. Of course the new white sections invite the first and fullest attention so that by the advent of the equinoxes they could no longer be recognized as the same. Their value has departed and if in the mean time they are

filled with honey it has doubly departed. The careful apiarist will therefore not fail upon the falling of the petals of the basswood blossom to remove them from the hive and to store them where they will be secure from moisture, vermin and dust.

Taking a hint from the concern which the bee has exhibited in her use of propolis for the continued prosperity of her family, the apiarist will next turn his attention to the needs of the individual colonies. That the owner is more liable to neglect the necessary preparations for winter than the bee herself, is a startling commentary on human energy and intelligence! During the pending period of dearth the utmost alertness should be exhibited that no opening be left any where for robber bees. No honey should be exposed and nuclei and small colonies furnished with the effectual means of self-defence which a small entrance supplies. It should be remembered too that during the month of August almost all the eggs are deposited from which the bees that are to start house-keeping anew next spring are to come, and since this is so, too much care cannot be exercised as to the condition of each colony now as regards its ability to produce a considerable amount of brood in the near future. The life and vigor of a queen, now two years old, are highly uncertain, and if depended on are liable to fail when most needed. If any good degree of certainty in wintering and in a prosperous opening of the next spring is desired, all such must be at once replaced by young laying queens reared from cells produced during the late swarming season. The lame and those otherwise injuriously defective should share the fate of the aged. To make this work easy, each of my hives carries a simple record indicating the age and the peculiarity, if any, of the queen employed within. The clipping of the queen's wings is also so done as to make her age known at sight. Sometimes it may be necessary to have a care that stores are not wanting, but in some districts where the fall honey flow is very abundant, that care should be directed to the giving of sufficient room to the bees that they may not be compelled to unload their fresh nectar into cells destined for brood and so circumscribe the domain of the queen. Enough good stores being granted, plenty of brood in August and a vigorous young queen are prime requisites for successful wintering and prosperous building up the following spring. In con-

nection with this work all required uniting of colonies should be attended to, and for the highest success in it all care and dispatch are needed that robber bees may not interfere injuriously. To circumvent these it may be necessary to choose the early hours of morning or the late hours of the afternoon for the work. The novice may even require a tent, while the adept will do so quickly what is required to be done with any particular hive that it is closed by the time the robber appears. Well planned, quick work, not too long continued at one time, will prevail.

If attended to at once the careful apiarist may profitably secure the completion of sections that the close of the basswood bloom left not quite ready for market by collecting them in cases, putting them on populous colonies of hybrid bees and feeding extracted honey copiously for a few days. Two to four cases may be put on to a hive at once and more added later, but the brood chamber should be contracted to about the capacity of five L frames. The honey resulting should be marketed and consumed at once, as a candying is likely to ensue on the approach of cool weather.

It only remains to be said that where a crop of fall honey may be expected, preparations should be made to receive it, for it is sometimes very abundant. Unless it is liable to be white or nearly so, as it sometimes is where the white aster abounds, it is doubtless more profitable to secure it in combs for extracting. It is in such cases that ready drawn combs especially reveal their value. Whether combs or sections are used, let them be adjusted promptly as soon as the nectar begins to come in.

LAPEER, Mich.

July 22, 1893.



With Energy and the Right Management
Bee-Keeping Need Never be a
Failure in California.

WM. G. HEWES.

Let not thy dish be upside down
When showers of honey strike the town.

IN many parts of California were it not that brains and energy are lacking one could not do otherwise than make a success at bee-keeping. We have a country in which four or five hundred hives may be

profitably kept in one place*, and, although poor seasons are common, good ones are not rare. Seasons of total failure are very few.

Our climate is such that there need never be any loss of colonies except that occasioned by the death of queens during the fall and winter months.

A specialist should own at least 500 hives. If he has the requisite knowledge to manage them intelligently and the energy to do most of the work himself, there are comparatively few seasons in which he would not get liberal returns from the capital invested and the labor performed, and occasionally there comes one of those extraordinarily bountiful years when the bees bring in honey as though there were lakes of it from which to gather. In such seasons an intelligent apiarist should clear ten dollars to the hive, which, if there are 500 or 1,000 hives, gives him a snug little sum with which to tide himself and bees over the years of absolute failure. Instead, however, of feeding the bees when the years of absolute failure do come, a majority of the apiarists get discouraged and neglect them at the very time when the most attention is needed. The past two seasons have been poor ones, and owing to neglect, two-thirds of all the bees in this district have perished. If the coming season (1893) should be a bountiful one, (It is—Ed.) but few of the apiarists will have bees enough left to be in a position to profit much by the opportunity.

Another reason why so many bee-keepers realize but little from the apiary is because they know but little about the management of bees. They own no bee books and take no papers relating to the pursuit. Putting a swarm in a box and taking the honey therefrom when it has been filled constitute about all they know. Some, too, have such exaggerated ideas of the amount of help required to run an apiary that a good part of the proceeds from the crop has to go to pay for the harvesting of it. On visiting some apiaries the proprietor and his dollar-a-day helper will often be found comfortably seated in some shady nook killing time by talking politics and swapping yarns, yet believing that they are at work, because now and then a glance is bestowed upon the apiary to see if any swarms are out.

* In 1884 an apiary of 700 hives, belonging to Mr. Robt. Wilkin, averaged 130 pounds of extracted honey and that too when surrounding them within one and two miles distant were apiaries aggregating 1,200 hives more.

Sometimes two men are employed to assist in extracting a crop which, if the owner had been energetic, he could easily have taken alone.

As I think over the bee-keepers of my acquaintance I do not recall one (myself included) who, I believe, gets, by a third, one year with another, as much honey as he should. The reasons for which are, we keep too few bees and do not give even these few the best attention.

To sum up—the best advice I can give bee-keepers, with the help of the bee-book and papers learn how to do the right thing at the right time, then banish laziness and do it.

NEWHALL, Calif.

Dec. 5, 1892.



Uncertain Behavior of Great Masses of Bees. — Problems for Experiment.— Escapes That Turn Bees Into the Open Air.

R. C. ATKIN.

"One boy is a boy, two are half a boy, and three no boy at all."



POSSIBLY, one, two and three colonies of bees are the same, yet I am by no means ready to give it up—that a great mass of bees can be profitably worked together. I know that I have never had *all* the colonies in my apiary

do good super-work even the *best* of seasons. In fair seasons perhaps one or two colonies in ten give me *satisfactory* work.

Where we have a *full* honey flow we can mass bees far beyond what we do in a summer flow, and no swarming results.

I believe that we *can* and *will* control swarming, although I am not sure that we have all the details yet. Cut out cells once and prevent swarming, do it two or three times until the fever is on good and strong, and the bees will often the next day after *every cell is destroyed!*

Last year we could do but little in the way of experiments. This year is still worse. Not two per cent of our bees have even tried to swarm. For two years the "far-famed"

alfalfa has failed to "give down." Red clover has kept us alive. We did get a little honey, but only from the strongest colonies and such as we had doubled up. The best single colony has not finished one super. Three or four that were doubled and trebled have finished a super each on an eight-frame dovetailed hive.

When dividing was first practiced, we over did it; will we now go to the other extreme?

By dequeening I have held together colonies equal to two average colonies, and they worked successfully in as many as five or six supers at once, but I want to know how to do it with less labor. Friend Taylor, can't we put our bees all in shallow chambers, and before the flow and swarming comes, slip an excluder between the two chambers; then, eight or nine days later, the one 'tother side from the queen will have only sealed brood, can't build cells, you see, then use one or two sealed brood chambers on the old stand for the honey gatherers, and make a new colony with the one having the queen; then, three or four days later, put a cell or a virgin queen in the honey gathering colony having the sealed brood? If I live and get a good year I shall try it.

For extracted honey I am not sure which would pay best, to make 10 colonies into 20 before the time for swarming (shallow brood chambers would be best), to hold the 10 together, or to run them as five colonies. I think likely the first plan would give the best results in raising extracted honey, and the last when comb is produced.

Another problem for experiment is to get 200 more queens to do service where now but 100 are used: say a queen to each shallow chamber or its equivalent, so instead of pushing our queens, they, instead, will push, and completely fill, each their chamber, which means lots more workers. The queens, not being over worked, will last longer. A queen must do her best to get enough workers to do good super work in a summer flow. Even Doolittle robs his weaker colonies to help out the average queens in getting enough bees.

But to have these extra queens to use, they must be wintered over, and how? Or they must be reared in April or May. This is too expensive. Give me two queens through the period of April 15th to June 15th and I will almost if not quite double my surplus.

The State, or a combination of apiarists, could find out these things; a bread and

butter winner cannot, and men of competence do not care to—so we plod.

branches, that is, different locations. This might be helped out somewhat by local apiarists. The winter problem, the getting of the workers in the spring, and the control of them after they are gotten are the main things to determine. Settle these, then we can give our attention more to the "use and abuse" of foundation and the like.

Friend Dayton, when your bees get to making the "splinters" fly after you have some escapes under the supers, just lift the cover and see how quickly they will take wing in the open air. If the escape had a big window before it so the bees could see where it is, how they would "git for it." But all is new and they are just crazy, and they begin to gnaw at any crevice, and that's the time they ought to be let out, and they would get out, too, if they knew how and where and had a chance. It's one of two things, or both, to find the queen, or get out of prison. (I think the latter.—ED.)

Last year I made some cone escapes in parts of old hives, then removed extracting chambers and placed them on these entirely away from the hives. Almost invariably, 15 to 20 minutes would put the bees into a great excitement, and if they were all old bees, one to two hours found them gone.

Young bees would not leave so soon, and would return if they did. Bees from a colony that has been dequeened and all the brood hatched, and all of the bees some days old, leave very quickly. Bees in a colony with a large proportion of very young bees are slow in passing through our escape, yet they will go in search of their queen fairly well. Now, how can we help them out?

LOVELAND, Colo., July 27, 1893.

[In the same mail that brought the foregoing article came a letter and a sample bee escape from Mr. R. J. Stead, of Lanark, Ont., Canada. The escape consists of a half a dozen light gates made of metal and arranged side by side. If they were all raised at one time it would furnish an opening $\frac{3}{8}$ x 3 inches. The bees push against the gates, which raise and let the bees pass out, then they drop back by their own weight. I do not know as there is any thing new in this principle, but the escape is adjusted a little differently from the fashionable escape of

the day. Instead of conducting the bees back directly into the brood chamber, it is placed in an opening in the rim that surrounds the escape board and forms the bee-space, thus turning the bees into the *open air*. As Mr. Aikin suggests, this is all right so far as the old bees are concerned, but Mr. Stead overcomes the objections as regards the young bees, by having the opening in the escape board come over the regular outside entrance of the hive. Besides this, he does not allow the bees to pass out when the escape is *first* put in place, but lays a piece of iron rod on the gates until the bees are terribly excited in their efforts to escape, which time usually comes in about half to three-fourths of an hour, when the weight is removed and the bees come rushing out very much like a swarm, thus freeing the super very quickly. The old bees go to the entrance and set up a buzzing which soon calls all the young bees into the hive. I should fear that the gates would become waxed or propolised were it not that they are on the hive so short a time. Mr. Stead has applied for a patent.

I do not know how much experimenting there has been with escapes that turn the bees into the open air, but it strikes me that allowing light to enter the super through the escape would be a very important point. It also seems that all trouble from young bees might be avoided in such a manner as that practiced by Mr. Stead.—ED.]



Old-Time Bee-Keeping in California.—Some
Appreciative Words for *Gleanings*
and the Review.

ISAAC RUMFORD.

—"Could be happy with either, were 'tother dear charmer away."

EVER since receiving the copies of the REVIEW I have felt like sending my thanks for the offering of such a publication to the public. Between 1880 and 1884 I was in the honey producing business to the extent of one hundred hives; having built up from two swarms by increase and purchase as I learned to manage the little musicians and make their labor profitable. It was the way that the Lord opened to enable me to earn a living for my family and pay a debt of over a thousand dollars that

had been eight years outlawed. During that time I wrote "Beginnings in Bee-Keeping" for the *Royal Press*, and considered *Gleanings* as the bee journal, par excellence. How we all loved to get that journal. When it came from the office in Bakersfield, some eight miles away, all work was put aside until it was read from cover to cover. We wired our frames, made our own foundation and filled every frame full; made our own extractor out of an old barrel, and one season produced 13,000 lbs.; an average of about 150 lbs. to the hive; getting 300 lbs. from some. How we worked and loved the work and what a joy it was to see all those debts paid by the little workers. Is it not natural that I should love those little workers?

About 1884 the Lord called me into an exclusively spiritual field and I have seen no more of the bees nor read any bee literature until last year I subscribed for *Gleanings* for my son who has about 25 stands and at present I am permitted to help him care for them. I wanted the most advanced thoughts of the age on particular parts of the subject, and thank the Lord here comes the REVIEW to fill the bill. I don't have to buy papers half full of all about keeping bees through a hard winter. (We raise oranges here.) I wanted a paper full of all about the special subject under consideration. Say, one about smokers. That decided me to send for a Crane; and we like it the best of any we have tried. It fills the bill. One about wax extracting. Another on producing the most extracted honey and retaining the flavor of comb honey; and we found it. I tell you that plan of making one number represent one subject is right up to the times. The REVIEW has almost opened the way for us to do without *Gleanings*; would if our dear friend Root did not put in so many good hints on the subject of gardening and we like some of his old fashioned sermons. I would suggest that you keep to the plan of one subject for each number, then when there is a new article on the subject comes up, print it as a supplement so it can be taken out and stitched into the old number; or if the subject should be so thoroughly reviewed as to fill up another number they could be tacked together. You might reserve a few pages in the back of each number to note important passing subjects just as Root puts in about gardening and Our Homes.

Los Gatos, Calif.

May 5, 1893.

Congratulations for the Experimental Apiary. —Prejudiced Enthusiasm of Some Inventors.—Costly Experiments.

JAMES HEDDON.



ALLOW me to express myself as highly pleased with our success in getting even the small appropriation of \$500 a year for apiarian experiments, and not less pleased over the selection of Senator Taylor as superintendent.

As I look at the matter, the salary is small, when we consider the work to be performed; a work which we all know Bro. Taylor will do, if he loses money as a result. I would suggest that bee keepers aid the splendid and valuable effort by donating such implements as they believe of value, and desire should gain the reputation they merit.

I am looking for much amusement arising from tests of articles that no one but the inventors can find to be practicable. Much the same may be looked for along the line of processes. Perhaps, it sometimes occurs that a discoverer may partially succeed with an implement, or method, with which no one else can, but if there are any such instances, they are so rarely met with, that we hardly experience one in a life time. It is usually the case that the inventor is of an impractical turn, and certain it is that his inventions and devices are of no value in the hands of the practical, successful bee keeper.

Most experiments to be of value must be made upon a more comprehensive scale than the small bee keeper can conduct or the successful honey producer can usually afford. Fifteen to twenty years ago, when we had little bee literature, I had one or two large apiaries, and my thirst for knowledge in place of the wild theories I found in journals, was such that I made some comprehensive experiments, and I found out then what it cost. The price was high, but I had to have it in my business. If you desire, I will write two or three articles for the REVIEW, detailing the results of some of these experiments. I will leave others to discuss this subject, trusting that perhaps I have touched one point that few others will.

I desire to be placed on record as predicting most satisfactory results from our experiment station. Let each and every one of us aid Bro. Taylor all we can.

[Certainly, friend H., if those old experiments have a practical bearing upon the bee-keeping of to day, we should all be glad to hear of them. We would also like to have you and others say what experiments you would be pleased to have taken up by experimenter Taylor.—ED.]



Frolicking Drones and Their Trysting Places

W. A. PRYAL.

"Theirs not the reason why,
Theirs but to do and die."

AS it is yet a mooted question whether drones congregate in certain spots and there hold high carnival, as it were, while they await the advent of a queen who would a wooing go, I think I will attempt to throw a little light upon the subject.

There is a spot on a hill about a hundred feet high and not more than 300 yards from where my bees are located, where, for almost as long as I can remember, drones have gathered in the afternoon. The air would be full of them and the buzzing they would make was something that could be heard for quite a distance away. Their buzz was more musical, if I may so express myself, on this occasion than when they were flying about the apiary. We are all quite familiar with the buzz of these lazy fellows when they are near their own doorstep, but I should judge, from what I have seen in the bee journals, that few have heard drones enjoy a dizzy dance in mid air. It is truly a dance of death to many of them, as after results often prove.

This place I speak of is in what may be called the thermal belt on the hills to the north of the apiary. I should think that the several currents of air that circulate about the hill and the little valleys formed by these hills, meet here and form a gentle whirlwind which, while warm, is inviting to the drones. I am the more convinced of this belief for the reason that there is another spot where the same sort of a drone picnic-ground is maintained. This second place is at the southwest base of the aforesaid hill. The spot is noted for being one where a warm

current of air is to be encountered at almost any time. Persons who have been riding in a vehicle perceive the change of air as soon as they strike this spot.

Many a time I have watched the drones thus enjoying themselves: at first I thought they were young bees, but observation proved that they were male bees.

This question presents itself to me, does the young queen, through natural intuition, fly to those localities where the atmospheric conditions are such that they are a safe place for the two sexes to carry on their connubial relations? It seems to me that these queens know this: that the drones will be at a trysting-place appointed by Nature, and there the queen goes, provided she is not stopped by some lusty drone who attacks her on the "king's highway," as it were. It may be fellows like this that have been seen assaulting queens while flying about the apiary, who knows?

NORTH TEMESCAL, Calif. March 6, '93.



Fads and Fancies.

WALTER S. POWDER.

Everybody, good or bad,
Has a fancy or a fad;
Has the best red clover queen,
Or an automatic bee-machine,
Has a great invention to reveal,
Or likes to ride astride a wheel;
In fact, no matter what his rank,
Every body is a crank.

BEE-KEEPERS are given to whims and fancies more than any other clan of workers; they have their own ideas, their own inventions and their own peculiar way of accomplishing a certain piece of work, and all the world couldn't change them.

With the amateur this is different, he is ready to try every new thing that comes under his observation, besides experimenting and going over ground that has been gone over by others. His first and highest ambition is to attain *numbers* of colonies, and of course this increase is at the expense of the honey season and no surplus is obtained: still worse, feeding has to be resorted to in order to pull them through the winter. He knows that some of the bee fraternity are making lots of money for he sees proof of it in stacks of beautiful honey at the commission houses, honey stores, groceries, etc.

The watchword of the amateur is progress; his first hobby—to increase to a certain number—is an expensive undertaking, and one that usually contains many disappointments. Those with experience tell us that the greatest amount of bee-money is made in the yard that is run for the exclusive production of honey. The beginner thinks that he sees something that has been overlooked by the expert, viz., a small fortune in queen rearing. At once he begins to equip himself for the new hobby and the expense attached is not a small affair, for the whole yard must be brought up to a standard of purity, expensive advertising must be resorted to, and—what a pity it is that the people are afraid to send to the unknown advertiser for a queen. The chances are that sales will not amount to enough the first year to pay advertising bills. I do not mean to infer that queen rearing can not be made profitable; on the other hand I know that it can be made to pay, but it requires patience, long continued business, prompt dealing and a high grade of stock. I say it requires patience for it is only those who "stick to it" and keep their names constantly before the public who succeed.

The next rank to which the knight of the apiary aspires is that of the supply dealer. It is important that he should be an experienced bee-man; that he may know how to cater to the wants of the honey producer. Supply dealers are numerous which is an advantage to producers, as they can get supplies near home, and competition has reduced the price on many articles, thus saving money for the toiler of the bee-yard. Again, the supply business flourishes for about five months in the year, therefore his time must be devoted to another calling the remaining seven months. This is usually dealing in honey, which can be made profitable and a very great advantage to producers, as the dealer can find an outlet for the over-production and dispose of it where there is a scarcity.

The next craze liable to attack the "bee-crank," is to edit a bee paper; and like the supply dealer, failure is much more common than success, and those who start with pomp and fashion are sure to have their downfall sooner or later. The successful ones have all started at the humble bottom round of the ladder, and climbed slowly from an economical basis.

INDIANAPOLIS, Ind.

Feb. 2, 1893.

Bee-Keepers' Review.

PUBLISHED MONTHLY.

W. Z. HUTCHINSON, Ed. & Prop.

TERMS:—\$1.00 a year in advance. Two copies \$1.90; three for \$2.70; five for \$4.00; ten or more, 70 cents each. If it is desired to have the REVIEW stopped at the expiration of the time paid for, please say so when subscribing, otherwise it will be continued.

FLINT, MICHIGAN AUG. 10, 1893.

“A CALIFORNIA NUMBER,” is what this issue might almost be called.

ALL HUMANS have a strong love for inherited ideas no matter how cumbersome or obnoxious modern science may prove them to be.

EUGENE SECOR has been appointed judge of the apiarian exhibits at the World's Fair. Both Mr. Secor and the exhibitors are to be congratulated.

THE *Progressive* and the *Enterprise* are making rapid strides. I tell you the man who starts a bee journal in these days has got to hustle if he succeeds.

MR. E. A. DAGGITT suggests that the leather to smoker bellowses be treated with some substance that will fill the pores and thus stop the escape of air in that direction.

LOOSE BOTTOM BOARDS may be held on by means of hooks, as suggested by a Minnesota correspondent, but this plan always seemed too expensive and too much rigging.

GLUCOSE BAREELS, second-hand from the candy factories, is what A. N. Draper uses to ship honey in, and he has found nothing cheaper or better; so he writes to the *American Bee-keeper*.

E. KRETCHMER'S PICTURE (a good one) and a sketch of his life written by his twelve year-old daughter, appear in the last *Progressive*. There is something peculiarly pleasant in reading the life of a man written by his little girl.

H. P. LANGDON writes to *Gleanings* that his non-swarmier has not worked satisfactorily in every instance in his own apiary this season.

R. C. AIKIN says in the *Progressive*, that he has asserted for years, that not more than one-third more extracted than comb honey can be secured. He now doubts if we get even that much more. I think much depends upon the management.

C. W. DAYTON, in referring to the fact that bees do not tear combs to pieces when only a small opening is given them into the hive, says that he thinks it is *darkness* that prevents their tearing comb. He gives several illustrations to show the correctness of his views.

THE ENERGY of a newly hived swarm is more apparent than real; so writes R. C. Aikin in the *Progressive*. There is no brood to care for—nothing to do but to gather honey and build comb—hence the apparent energy and the great rapidity with which stores accumulate.

WHITE GLUE is used by a Mr. Hunt, of California, for fastening foundation in sections. For applying the glue he uses an arrangement similar to the one used by R. L. Taylor, and described in a recent issue of the REVIEW. “Rambler” describes the Hunt plan in *Gleanings*.

“PULLED” QUEENS is the name given queens that are helped out of the cells by man. It is easy to get these by opening a hive just as the young queens are hatching. Dr. Miller says in *Gleanings* that the giving of one of these young queens to a colony having fertile workers is a sure cure of the trouble.

THAT FOUL BROOD may generate from dead brood is believed by the editor of the *Nebraska Bee-keeper* because he sent some decomposing brood to a person who claimed to be something of an expert with foul brood, and this person said it was foul brood. Dead brood that isn't foul brood has been mistaken for such in so many instances that it would be much more satisfactory in this case if we knew how good an authority this unknown expert is.

BLACK BEES and half-depth frames in the supers enable Mr. G. L. Head of La Valle, Wis., to dispense with bee escapes and brushes. He simply shakes the bees off. He has driven ten miles to an out-apiary and extracted 1,000 pounds of honey in a day. So far this year he has extracted 9,000 pounds from 109 colonies and increased to 165.

HOW MUCH HONEY IS RAISED IN THE UNITED STATES?

As I was at work in the shop the other day putting foundation in sections it occurred to me that if every manufacturer of sections would report how many sections he had sold during the year we could get something of an estimate as to how much honey was produced in a year, something as the number of queens sold last year was estimated. I went into the house and found *Gleanings* on the desk, and in looking over the editorials I found that its editor had thought of the same thing in advance of me. Let each section manufacturer report to *Gleanings* at the end of the season, how many sections he has sold during the year, and we can guess *somewhere* near how much honey was produced this year.

BE YOURSELF.

There is one idea expressed in E. E. Hasty's article this month that it would be well for young writers to bear in mind, that of being natural, of writing "from the inside." How well I remember my first composition, how I tried to write just as folks did in books. Frequently I might have written of some interesting fact, and probably in an interesting manner if I had written in a straight-forward, simple way of my own, but I forbore because "other folks didn't write of such things in such a way," forgetting, or not knowing, that the man who is different from the others may be the most interesting man in the crowd. Be yourself. Be natural. Don't strain after some style that you may happen to admire and thereby ruin what *might* otherwise be a better style than the one you are striving to imitate.

DEAD BROOD THAT IS NOT FOUL BROOD.

When I was over at the Michigan Experimental Apiary, Mr. Taylor showed me a colony in which at least one-fifth of the brood was dead. I presume a novice would have pronounced it foul brood. There were

sunken, perforated cells, and dark, brown, coffee-colored dead larvæ. But two of the characteristics of foul brood were lacking: the thick ropiness and the odor. The skin to a dead larva was tough and held its contents as a rubber sack would hold water. And, by the way, the contents were often watery, the thick ropiness was lacking. It certainly was not chilled brood as it was in July. Mr. Taylor admitted that he did not know what was the cause of the malady.

"BIRDS OF MICHIGAN," is the title of Bulletin 94 prepared by Prof. Cook, of the Michigan Agricultural College. It contains 150 pages, is freely illustrated and handsomely bound, and is bringing forth deserved praise from high authorities. It is sent free to all Michigan people who apply. Others who are interested should write to the College to learn upon what terms they can procure copies.

THE CANADIAN BEE JOURNAL TO BE PUBLISHED BY THE GOOLD, SHAPLEY & MUIR CO.

As mentioned in another place, the *Canadian Bee Journal* has been burned out; but a communication from Mr. R. F. Holterman informs me that the Goold, Shapley & Muir Co. has bought the subscription list and will continue the publication of the journal. It will be enlarged, changed to a monthly, better paper used and an effort made to fill it with first class material. The first issue will be out in September. Mr. Holterman is to be the editor. There is certainly room in Canada for a bee journal, and as Mr. Holterman is not without experience, the firm has capital, and the journal will start out with a good subscription list, I do not see why it need not be a success. I hope it will.

SUPERS may be taken off when robbers do not trouble by smoking out most of the bees and then placing the super where the few remaining bees can run out into the entrance of the hive. Mr. Taylor speaks in a recent article of setting the super on top of the hive. This is all right where the super can be left long enough, but the bees will get out more quickly if one corner of the super is leaned against the alighting board of the hive. Although the basswood season is past and the bees are gathering nothing, I took off a doz-

en supers the other evening and freed them from bees by setting them at the entrance of the hives. The supers were taken off just as the bees had nearly stopped flying. A few enterprising bees came around to see what was "in the wind," but it was soon too dark for them to fly.

EXPERIMENTAL APICULTURE.

I am a little disappointed at the small amount of correspondence that has come in on this subject. It does not seem possible that bee-keepers have no interest in the subject. Possibly the leader of last month contained all that needed to be said on the subject: if so, well and good. There is one point, however, that I wish emphasize, and that is the necessity of being able to use good arguments before the State Boards of Agriculture. Unless you can do this, unless you can make a point, there is no use in going. The arguments used before our State Board have already been given, and I would call attention to those used in Dr. Miller's article in this issue, as being very good. If a copy of this article could be placed in the hands of each member of a Board previous to the meeting it would be a good move.

One thing more. Haven't you some suggestions as to what experiments you would like tried? The experiments in regard to wintering can be taken under consideration none to soon. Let's hear from *you* as to what they shall be and how they shall be conducted.

EDITORIALS ARE NEVER PAID FOR.

Sometimes when sending in an advertisement the sender will ask that he be given an editorial notice. If one advertiser is granted this favor, all are entitled to the same, and if each were given a notice, where would be the advantage? Samples of implements are sometimes sent with the intimation that an editorial notice would be the proper thing to give in return. Others even go so far as to say right out fair and square, "Give me a good editorial notice and I will pay you anything reasonable." I wish it distinctly understood that I have no editorial opinion for sale. I do not mean that I shall never notice and give praise to articles that are for sale. On the contrary I think it is an editor's business to learn which are the best things and then to say so, but what he says should come about as the result of his own judgement—

should come out spontaneously without solicitation. I do not mean that a dealer, manufacturer or inventor must never call an editor's attention to the superiority of his wares: far from it, that is all right and proper, and then let the editor use his own judgement as to what he shall say, if he says anything at all, but let it be understood that what is said editorially is said freely with no money consideration in connection with the saying. I believe that our bee journals are almost wholly, if not entirely, free from this fault.

BEE-PARALYSIS INHERENT IN THE QUEEN.

When discussing bee-paralysis with Mr. Taylor this season he mentioned one fact that goes to show that it comes from the queen. A neighbor called and wanted a queen. Mr. Taylor had none to spare except the one in a colony affected with paralysis. He was going to replace this queen and told the man he might have her until he could spare some other queen. If she turned out all right, well and good—if not he would replace her. When her bees began to hatch out in the colony to which she was introduced, and to take their places in this work-a-day-world, the colony became affected with paralysis.

WHY SWARMS DO NOT ALWAYS RETURN TO THEIR OWN HIVES.

E. R. Root quotes what I said last month in reference to the swarms going together over at the Michigan Experimental Apiary and all returning to one hive. He closes by saying: "Nevertheless, Mr. So and So doesn't give up yet but that swarms are more apt to go back to the old location." Yes, bees are more likely, almost certain, to go back to their own hive if only one swarm is in the air at the same time, but when more than one issues at the same time they are almost certain to unite unless water is used freely to keep them apart. When two or more swarms unite, they become, to all intents and purposes, a single swarm, and behave very much as one swarm would behave. A very few of the bees will eventually return to their respective hives, but the great mass of them will go together, somewhere. Some of the bees of one of the swarms will usually begin returning to their old location, then nearly the whole mass of bees will "follow my leader" into this

hive. That is, they will if allowed to do so. It is not usually best to allow this, but what shall be done is "another story," and one that will bear considerable variation according to the circumstances.

LOOK AFTER YOUR INSURANCE.

Within the past few weeks two of our bee-keeping friends have suffered severe losses by fire. The office of the *Canadian Bee Journal* has been burned up entirely; loss about \$5,000 with light insurance. Levering Bros. of Wiota, Iowa, have sustained a loss of about \$30,000 with only \$3,000 insurance. Of course, these friends have our sympathy, but it will make their burdens no heavier if their losses are used as a warning to others. Is your insurance exactly what you would have it if you knew that your buildings were to be burned tomorrow? If not, then attend to it at once, *to day*. To toil for years and then see the results swept away in an hour, to begin life anew with nothing but the bare hands, is a bitter experience. Many bear it bravely as becomes a man, but it can be so easily avoided, while at the same time there is the comfortable feeling that comes from the possession of protection together with the knowledge that the small sums paid out go to relieve the distress of others who have met with losses.

CANADA'S FOUL BROOD INSPECTOR.

Mr. McEvoy is foul brood inspector of Ontario, Canada. He believes that foul brood originates from dead brood. He also believes boiling hives in which there has been foul brood is unnecessary. He cures foul brood by taking the combs away from the bees, allowing the bees to build comb four days (long enough to use up or store in the combs any foul broody honey they may have in their sacs) then cutting out the combs and allowing the bees to go on and build more combs. This frees that colony of the disease. He is doing a great and good work, and it is a pity that he is so given to sneering at science and to riding his *assertions*, whip and spur, over his critics. In justice to him I must say that his having cured so many cases of foul brood without boiling the hives should not be passed over lightly. When I was over to the Michigan Experimental Apiary, I asked Mr. Taylor what he thought of this. He said it was possible that

the only source of contagion about hives might be honey that adhered to them. If this should be true, it will be seen that with Mr. McEvoy's plan of cutting out the combs in four days, it is possible that such hives would not communicate the disease, as the bees would lick up all spots of honey and use it. Mr. Taylor said he had always boiled the hives and considered it a safe thing to do. Let's hear from others on this point.

INTERESTED IN PHOTOGRAPHY.

Few are the dollars that I have spent in amusements—so-called. My own life, my own work, have been so interesting to me that I have cared little for what the world calls amusements. This summer, however, I have spent a little time and money in what might, in this instance, be called amusement. That word "amusement" does not seem to me the right word to use. It does not seem to me that the enjoyment, the happiness, the interest, that come from the studying of a science (I am learning to use the camera) should be called "amusement." To learn the effects of light and shadow, to decide upon the best point of view for the most artistic effect, to learn how to give sharpness of outline or "detail" to a picture, or to have instead a delicate softness, to use the judgement in regard to length of time that shall be given in making each "exposure," to learn how to correct when "developing" the plate any errors that may have been made in "timing," to make "pictures" of the bee yard, of the grand old trees about the home, of the old school house among the maples where my children first went to school, and the children themselves, (baby Fern in her cab was my first attempt) have aroused my enthusiasm to a pitch that I did not suppose it would ever again reach. It is the same as it was with bee-keeping and the art of printing. Of course, I do not expect to make any money out of it, it is the one thing I do simply for doing. It *may* turn out to my financial advantage, as it will probably improve the REVIEW by increasing the number of illustrations. That cut of the Michigan Experimental Apiary was made from a photo. of my taking. In order to get the exact point of view that I wished, it was necessary to build a high platform out in a wheat field, but I was determined to get exactly the view that I thought was best.

INDIVIDUAL CHECKS—THEY ARE EXPENSIVE TO THE RECEIVER.

Many people who have a bank account (fortunate mortals) pay almost every bill with a check. This furnishes a record of where the money goes and each check is the same as a receipt for the money paid. To a person living in the city where the bank is located at which an individual check is payable, such a check is as good as the currency, as all he has to do is to step into the bank and have the check cashed at its face value. When the check is sent to a distant city and presented at a bank for payment it must be returned for collection to the bank at which it was issued. For making this collection the bank charges from 10 to 25 cents according to the distance and locality of the issuing bank. The amount paid for collection is called exchange and the one who presents the check for collection is paid that much less money. I have presented a check for 49 cents and found the exchange to be 15 cts. Twice have I received a check of \$1.00 from Florida and found the exchange to be 40 cts. These are unusual, but only a short time ago I presented four checks amounting in the aggregate to \$36.00 and had to pay \$1.00 exchange. It may be thoughtlessness on the part of the makers of these checks, but there is certainly an unfairness about it. Of course the amounts are small and one does not feel like complaining to a good customer, but the amount in the aggregate for a year is quite a sum. It is of so much importance that some business houses have a notice in their bill heads that says: "We pay no exchange." A man who has a sum of money to send to a distance, and wishes it to go safely, ought not to thrust the expense of the safety upon the one to whom it is sent. A draft on New York or Chicago, for any ordinary sum, can be bought at an expense of ten cents and will be paid at its face value at any bank. If a man prefers to use his individual check in order to have a complete record in one place of the money paid out, then let him add at least 15 or 20 cents to the amount to pay for collection.

BE PROMPT IN YOUR CORRESPONDENCE.

Only a business man fully realizes the annoyance and loss that arises from procrastination in the matter of correspondence. I remember having an order for a dozen queens early one spring from a customer in an Eastern State. It was before I had raised

any queens of my own that year, and I sent the order to a Southern breeder to fill, and informed my customer what I had done. This breeder had usually filled orders promptly, but he didn't this time. My customer complained because the queens didn't come and I wrote to see what was the matter and to learn when they *would* come. No reply came. This matter of complaint and inquiry was kept up for nearly a month, when I sent my customer queens from some other source and told my Southern friend that he need not send the queens. *Then* he wrote that he could send the queens; he had been kept back by cold, wet weather, and the reason why he had not replied was that he could give no definite answer as to when they could be sent, as he did not know himself, and he wanted to wait until he *could* tell me positively when he could send them. If he had told me as much in the first place all would have been well. If you cannot give a correspondent a definite answer, write and tell him so, and give the reason why; let him know as much as you do about it. Even when I only wished to think the matter over a little before answering a letter I have written my correspondent that his proposition was received and would be given consideration and when I had decided I would let him know. Perhaps this is carrying it a little too far, but my idea of the matter is that for every letter received requiring an answer, some sort of an answer ought to go back by return mail, even if nothing more than an acknowledgement of its receipt. Men who get letters by the hundreds each day answer promptly; men who get one letter a week make you wait that long for an answer. I am aware that where enough letters are received so that the answering of them becomes part of the business of the day, they are more likely to be answered promptly than when the writing of a letter is only an occasional "task," as some people call it, but there is no excuse for allowing a letter to remain unanswered day after day—yes, in some instances, week after week.

There is another phase of this matter that I must touch upon. A man writes and asks you to trust him, saying when he can pay. You accommodate him. When the time of payment comes he does not pay. Finally he is written to. He may answer and say why he could not send the money, and say when he will send it. The time of payment comes around again, but no money comes. He is

again written to. No reply. Weeks and months pass and no money comes. The man is written to repeatedly, but there is no reply. Nothing is much more aggravating. There may be good reasons why the man cannot pay. If so, why not write and say so? Such men often pay up after awhile and then explain *why* they have not paid before and apologize for their neglect. How much better to have explained before. I have frequently been obliged to ask a creditor to wait, and I have never yet been refused such leniency, but I have always answered all requests for pay, and explained exactly how I was situated and what were the prospects for payment. Most of us are willing to grant favors to our fellow men, but when we ask for favors in return, and these requests are completely ignored, feelings are roused that might better have slumbered.

EXTRACTED.

"Somnambulist" and the Apiculturist.

The *Progressive Bee-Keeper* has a very bright correspondent that writes under the *nom de plume* of "Somnambulist." "Way-side Fragments" is the title given to these somnambulist writings, and they are a bright, fresh, sprightly review of bee journals, bee men and bees; something after the manner that friend Hasty gets up his department in the REVIEW. Here is a characteristic paragraph:

"And now let's wheel right off from Bro. York's biographical sketches, and take notice of Henry Alley. Did you ever see any one hump himself as he has done this summer? (Apicultural editors *have* to hump themselves now-a-days, Mr., Mrs., Miss, or whatever you are, Somnambulist.—ED. REVIEW.) Don't he remind you of a widower looking up a new wife? He has wheeled that vehicle by which he conveys his thoughts to the public, and which he calls the *Apiculturist*, into line, and brightened it up surprisingly. Therein one's eyes meet 'cells, cells, cells,' but after all the paper, I'll warrant you, is no *sell*."

Honey Analyses.

"The sharper the rat the better the cat."

Prof. Cook of the Michigan Agricultural College has for years been securing honey from different sources. That gathered in

different localities from different sources and under different conditions. Some of this was gathered very rapidly and some of it was honey dew. Some, also, was sugar honey. The object in making this collection was to try and learn of the different characteristics of honey with a view to deciding whether the chemist could say positively whether a given sample of honey was adulterated. As has been previously stated in these columns these 56 samples of honey were submitted to three able chemists for analysis. One of these was Prof. H. W. Wiley, the government chemist; another was Prof. M. A. Scovell, Director of the Experiment Station at Lexington, Kentucky, and the other was Dr. R. C. Kedzie, Prof. of Chemistry at the Michigan Agricultural College. Prof. Cook has now gotten out a bulletin of 16 pages in which all of the facts and particulars, the whys and the wherefores are given. I am sorely tempted to give the Bulletin in full, but, as it would use nearly all of one issue of the REVIEW, the idea must be dismissed with simply giving the summary which reads as follows:

"1. That chemists can easily detect adulteration of honey by use of glucose, in all cases where it is likely to be practiced. The same would be true if cane sugar syrup was mixed with the honey.

2. That a probable method to distinguish honey dew from honey adulterated with glucose has been determined by these analyses. The right-handed or slight left-handed rotation together with the large amount of ash, and small amount of invert sugar indicate honey dew honey. As honey dew honey will never be put upon the market, this question is of scientific rather than practical importance.

3. As yet the chemist is unable to distinguish between cane sugar syrup honey—by which we mean cane sugar syrup fed to the bees and transformed by them into honey, and not cane syrup mixed with honey, which is adulteration pure and simple, though a kind not likely to be practiced—and honey from flowers. As the best cultivated taste cannot thus distinguish, this seems of slight importance. If it should prove to be important to be able to distinguish them it is probable that the chemist will discover the means, as chemistry has very delicate eyes, and can usually search out very slight differences.

We see that there are yet unsolved problems in this direction. And it is desirable to follow up the investigations. Prof. H. W. Wiley is desirous to do so till the last fact is discovered. To better accomplish this he desires samples of three or four pounds each of honeys from any *known source*, especially honey dew honey, and that gathered very rapidly. Sugar syrup honey will also be very

acceptable. Such samples may be sent to Prof. H. W. Wiley, Division of Chemistry, Department of Agriculture, Washington, D. C. The express will be paid by the Department of Agriculture.

I wish to thank the three distinguished chemists who have rendered such able assistance in determining these valuable results.

A. J. COOK."

AGRICULTURAL COLLEGE, MICH., }
June 29, 1893. }

Prof. Cook will send this Bulletin (96) free to all who ask for it. I presume there are but few bee-keepers in Michigan who have not already received it, as it has been sent to a list of 1,200 that I furnished the Secretary of the State Board of Agriculture for that purpose. I wish that every bee-keeper in the land might read it. Send for the Bulletin if you have not already received it and then if you can help in the way of furnishing samples for further work, do so.

Experiments in Apiculture Made at the Michigan Agricultural College in 1892

by J. H. Larrabee.

Mr. Larrabee's report of his work at the Michigan Agricultural College Apiary has been out for a month or more but lack of space has prevented me from noticing it. I can do but little more now than give a summary of the results.

Removing the queen during 13 days of the honey harvest was tried with one colony and compared with another colony of equal strength. The colony having a laying queen gained 46 pounds in weight during this period and the queenless one gained 37 pounds. If five pounds were deducted from the one having the queen to represent the weight of the brood, only four pounds extra would be left as the gain resulting from the presence of the queen.

An experiment upon a larger scale would be more satisfactory. By the way, I have the same criticism to make in regard to several of the experiments made.

Two colonies were fed honey to learn how much honey is used in the consumption of wax. Eight pounds of honey were required in the secretion of 15½ ounces of wax.

The planting for honey experiments were brought to a close with the conclusion that "no results have been obtained with any plant sown or planted for honey alone

that will warrant the bee-keeper in spending money or labor in this direction."

One of the most interesting experiments was that of evaporating thin or unripe honey. I quote as follows from the report:

"There were constructed a series of six shallow pans 19 by 28 inches in size, with partitions 2 inches in height, open on alternate ends, similar to the partitions in a maple-syrup evaporator. These were arranged in a cabinet, one above the other, so that honey entering at the top was obliged to flow some 75 feet before passing out at the bottom. An oil stove was placed beneath the whole, and a pipe at the top caused a current of heated air to pass upward over the honey. The fumes of the stove were carried off by means of a second pipe, in order to avoid all danger of their injuring the flavor of the honey. Honey of average body with 10 per cent. by weight of water added was reduced again to the normal condition by passing twice through the pans at a temperature of 120°, and about 100 pounds per day were evaporated at that temperature. Thin nectar, extracted from the hives very soon after being gathered, was evaporated to the thickness of good honey at about the same rate. This apparatus was kept in operation about ten days upon honey of various thickness and upon clear water with the above definite results. The flavor of the first honey was injured—probably by the first acid action of the honey upon the outer coating of the tin. Afterwards this was not as apparent. The color was also somewhat affected.

The heat of the sun was also tried for purposes of evaporation. A shallow pan 28 by 54 inches in size was filled 3 inches deep with thin honey. This was covered with glass 6 inches above the honey and left in the sun for four days, when about five per cent. of moisture was evaporated. As the honey lies at rest the water rises to the top, somewhat aiding evaporation. The flavor and color are not affected as much as by the method of running through pans. In this way honey with 30 per cent., and even 40 per cent., of water added was evaporated to the consistency of very thick honey in three weeks' time, so thick that it has not at this date showed any signs of granulation. During favorable periods of sunshine a temperature of 155° was reached. By this method a tank 4 by 6 feet, with 6 inches of honey and weighing 1,300 pounds, should be evaporated 10 per cent., or from the consistency of freshly gathered honey to that of average body, during about two weeks in July or August.

The common method of exposing to the air in open vessels in the warm upper story of a building was also tested with honey to which 10, 20, 30, and 40 per cent. of water had been added. That having 40 per cent. added became strongly fermented in a week's time, while only a slight change had taken place in the 30 per cent. dilution, and at the end of a month it tasted like a very poor quality of commercial extracted honey or like honey dew. The 20 per cent. dilution

was not nearly as bad, and the honey, with only 10 per cent. of water added, was during the month returned to the consistency of very fair honey.

Nectar extracted two or three days after the combs were placed in the hives contained, during the dry weather of July and August, from 10 to 15 per cent. of water above the amount always found in honey that has been sealed in the comb by the bees. This was determined by evaporating in test tubes in hot water.

Summary.—(1) The method at present promising best results for artificial evaporation is that by solar heat under glass well ventilated. A small portion of a greenhouse or forcing-house arranged for conserving the heat of the sun, and so located that honey could be run into the shallow vats directly from the mouth of the extractor and drawn off from the bottom of the vats into marketing receptacles, should give good practical results.

(2) Very thin honey or nectar will not sour as quickly as supposed by many, and may be safely kept during any period of cloudy weather we may have during the hot summer months.

(3) The method of exposing to the air in a warm room can not be depended upon to ripen very thin honey, although it may be serviceable for evaporating a very small percentage of water.

(4) The method of evaporating by artificial heat of stove or furnace is expensive and troublesome, requiring constant watching and care and not giving as good results as had been hoped for.

(5) The possibilities in the line of evaporating honey for the purpose of increasing the yield and preventing granulation are very great. A series of experiments to determine the increase in production by extracting freshly gathered honey would be next in order and value. When the utility of this method is fully demonstrated supers with fixed frames and extractors holding whole cases will be used and other apparatus conformable to the needs of the new system."

Feeding back honey to secure the completion of unfinished sections at the close of the harvest was also tried with five colonies. From the feeding of 338 pounds there was a gain in weight of 254 pounds. There was also an aggregate gain of 36 pounds in the brood chambers. With extracted honey at 8 cents and comb honey at 14 cents there was a profit of \$11.20. Feeding honey where there were no partly finished combs to give and the bees were obliged to build combs from foundation was not profitable. It was tried with only two colonies and 133½ pounds fed. 79½ pounds of honey and an increase in the weight of the brood nests amounting to 16½ pounds was the result. Only \$1.81 for the trouble. The honey was thinned with 12 per cent. of water and fed warmed.

Why Bee-Keeping is Neglected at the State Experiment Station.

The bee, like charity, begins to hum,
Of that sweet nectar, Solons, give me some.

The following article by Dr. Miller was written for the Illinois, State Bee-Keepers' Convention, and I copy it from the *A. B. J.*

"Many thousands of dollars are annually spent in agricultural experiments, the money therefor being taken from public funds. To prove the wisdom of this, needs no very extended argument. Only by actual experiment can a farmer ascertain many things necessary for the profitable prosecution of his calling. If in each township one farmer should make experiments for all the rest, the cost would thereby be greatly reduced; and if a single set of men at one place, having all the requisite appliances, with the power to command the most favorable surroundings, make the experiments for all the farmers in the State, then the cost is reduced to a minimum *per capita*.

Perhaps, however, the simple fact that in the different States these experiment stations are continued year after year, funds being freely voted for such purpose, is the strongest proof of the wisdom and economy of such outlay.

It is a notorious fact that with very few exceptions the interests of bee-keeping are utterly ignored in all the experimental stations. In our own great State of Illinois, I do not know that a single dollar of public money has ever been spent in apicultural experiments.

The utter neglect of this branch of agriculture can only be justified, if it can be justified, at all, on one of two grounds. First, on the ground that the products of bee-keeping are too insignificant to warrant an outlay for experiments. Let us look at this.

Suppose that throughout the 55,000 square miles of the State all the various vocations are nicely adjusted, so that all are full, just the right number of farmers, merchants, blacksmiths, etc., for the highest welfare of the State, only there are no bee-keepers. Now suppose a bee-keeper be dropped on each 10 square miles of territory with 100 colonies of bees. Then suppose an average crop of 50 pounds per colony, at an average price of 12½ cents per pound. The 5,500 beekeepers would produce 27½ million pounds of honey, worth in round numbers \$3,500,000. Is that amount of clean-cut addition to the total resources of the State not worth considering?

The census of 1880 shows the potato crop of that year in the State of Illinois to be 10,365,707 bushels. At 25 cents per bushel, the value is \$2,591,427. Our estimated honey crop is worth about a third more than this. Of buckwheat there were raised 178,859 bushels. At 75 cents per bushel, \$134,143—not one twenty-fifth the value of our estimated honey crop. Were there no experiments on behalf of potatoes and buckwheat? Of cheese, in 1880, Illinois produced 1,035,069 pounds. Figured at the same price as honey, that makes \$129,384. Multiply by 26,

and it does not come up to honey. Do the cheese-markers have no attention at the experimental station?

Add together potatoes, buckwheat and cheese, and you must increase the combined value by half a million dollars to make it equal the honey. In view of the outlay made, and very properly made, for experiments relating to the three articles mentioned, it can hardly be said the products of bee-keeping are too insignificant to warrant an outlay for experiments.

If it be objected that the products mentioned—potatoes, etc.—are the actual products of a year, while the amount of honey mentioned is only a possible product, please remember that experiments are made on the basis of possibilities, with the view of something different from what has been.

Or, it may be said, "If possibilities, are to be figured on, then estimate potatoes not by the actual but the possible, and the crop will assume one hundred times its present importance, for 100 times the number of bushels *might* be raised." Please go back to our supposition, and that was that all the vocations were nicely adjusted so as to secure the greatest good to the greatest number, and in that case there will be just the right number of potatoes raised, for the general good. If you increase the number of potatoes raised, it must be at the expense of some other crop, the additional potatoes raised will take the ground otherwise occupied with corn or something else. So there will only be a change of products, and as we have supposed a perfect adjustment, any disarrangement of this adjustment will make a decrease instead of an increase of wealth. But in the case of the honey, it will be quite different. Any increase in the honey crop will not mean a decrease in any other crop, but as before said, will be a clean-cut addition to the total resources. Indeed, it will be more than the addition of the honey crop, for according to good authorities, honey is only a by-product of the bee, its chief use being the fertilization of flowers. The value of the beeswax produced is also an item worth considering.

It seems, then, pretty clear that the neglect of the bee-keeping interests does not arise from the fact that the products are too insignificant to warrant any outlay for experiments.

The second ground on which the neglect might seem to be justified, is the fact, if it be a fact, that everything pertaining to bee-keeping is already so fully understood that there is no room for experiment. The very suggestion of such a thing will bring a smile to the lips of any practical bee-keeper. If there is any set of men that are exceptionally noted to be always on the strain in the investigation of some unsettled point, lying awake nights over some unfinished problem, losing every year considerable parts of the crop in seeking some better way, surely they may be found among bee-keepers. It is idle to pursue further such a thought.

What, then, is the reason that so far nearly all that has been done has been a matter entirely of private enterprise? Is it not be-

cause those who have in charge such matters have not been fully awake to the importance to the public interest of bee-keeping, and that bee-keepers have been too modest to assert their claims?

In view, then, of the importance of an industry that adds to the general wealth in a double way without detracting from anything else, and in view of the fact that bee-keepers are largely engaged everywhere in experiments that could be more economically and more satisfactorily carried out at a place fully equipped for the purpose, there seems only one answer to the question whether bee-keepers need an experiment station.

As to the details of carrying out anything of the kind, I will make no suggestion except the single one, that whoever is at the head of such an experimental station should be a bee-keeper through and through—one in touch with the mass of bee-keepers, knowing their needs and in entire sympathy at all points with the work. To such a one they would look hopefully for light, and cheerfully render all the aid in their power."

Marengo, Ill.

A Condensed View of Current Bee Writings.

E. E. HASTY.

Like Paul "I magnify my office." The true critic's office is a very high and rare one. It may seem "cheeky" in me to try and fill it; but I'm in for it now, and I reflect that failure in trying is not so bad as failure for lack of trying. It is easy to distribute taffy to every one you touch, and shut eyes to all faults; but what's the use of that kind of criticism? It interests for a little while, and then gradually becomes disgusting to every one—the recipient of taffy included. The approbation of a critic who will praise by the half column the emptiest scribbler who ever drove a quill just as freely as he would praise Homer—who can receive his praise without making up a wry face on the sly? On the other hand there is the old-bloody-Tom sort of criticism, which banks entirely on the popular fondness for seeing somebody minced up. Some critics, as well as some readers seem to enjoy it; but where do morals come in in such wicked sport? The true critic's bearing toward those whom he reviews is like that of a noble teacher toward a scholar—no malignity at all—a preference for praise, yet perfect fearlessness of dispraise, even toward the strongest and most irascible. One editor thanks a critic

for his adverse judgment, and another, for a dozen years, makes him feel that he has an enemy on his track; yet the true critic must be just to both, and keep sweet through it all. Moreover the true critic must see and mention the shortcomings and flaws even in very able papers and writers. The true teacher does this for his ablest scholars. It is a sad damage to a scholar to think that there are no defects in his work which mortal man can discover. Ability to see faults does not necessarily imply superiority, or even equality. Man criticises cake without being able to make cake at all. Had I lived in Homer's day I think I could have told him, moderate as my own literary capital is, that his terrific and ingenious gloating over human slaughter, while indeed increasing his popularity with the crowd in his own generation, would lower him a little in the estimation of all good men for all coming time. And so I think I'll take courage and mention the defects of the big papers and writers just when they think they have none. Any man that lives may utterly mistake in such work, and surely so may I, but here goes all the same.

BEE-KEEPERS' ENTERPRISE.

The *Enterprise* has a very fair stock of juvenile merit. If we should take its first number and compare it with the initial numbers of *Gleanings. A. B. J.* and *REVIEW*, these leaders in the class might some of them look a little abashed. Our last baby's strongest merit seems to be *individuality*, a way of doing very commonplace things in such a style that they almost seem unique. The selection of a large amount of quoted matter from other bee papers is a commonplace affair; but the style in which it is done in the department called "Gleanings from our Neighbor's Wheat Fields," gives it an interest, and gives us an interest in the doer of it. Most papers wishing to quote my count of words in the various bee journals would just chop it out unchanged. Not so editor Sage. He adds up the totals and then comments on the results of his own work. This sort of art and industry, which makes into practically original matter the things which are quoted is very valuable either in an editor or any other writer, and it promises well for the future of the journal. A lazy editor don't put editorial elbow grease into clippings.

There is also a plainly visible inclination (shown by Mumm's Visit on the first page)

to draw strongly on the editor's own personal experiences. This is an excellent remedy to prevent that unnaturalness which is the curse of so much of modern writing. We can all find "a touch of nature" by looking inside; yet few seem to have wit enough to do that.

I'm not sure about the wisdom of giving up part of the rather scanty space to children's letters. The cartoon on A. I. Root is a decided hit; yet I'm not sure it looks just right to see so youthful an urchin guying his grandpa. A. I. Root is to apiculture what Horace Greeley was to the Republican party; and as in the other case the business of poking fun at him is considerably overdone. The favorite source of quotation seems to be Mrs. Harrison. Might have chosen a worse one surely. Brother Pratt opens the second number with a stray straw sort of article which is very good, only lacking the humor of its prototype. Yet one bushel of his "sound grain" seems to me to be unsound—where he gives *unqualified* preference to cotton string for transferring. All right when honey is coming in freely; but sometimes bees are transferred when they are secreting no wax, and rather disinclined to work with wax at all; yet all the while they may be A No. 1 at nibbling up string.

There is nothing juvenile about the *appearance* of the *Enterprise*—fresh and bright as a new pin, or a prosperous journal ten years old.

THE MICHIGAN BULLETIN.

Bulletin 96 of Michigan Agricultural Station is devoted to honey matters, and written by Prof. Cook. It is a matter of regret that it cannot be fully reviewed without reviving the dead snakes of the sugar honey quarrel; but I think part of its valuable contents are available. Bonnier is cited as a specially valuable authority on the composition of the nectar of flowers. He clears up matters somewhat by arranging the different sugars found in nectar into two *classes*, glucoses and saccharoses. Cane sugar stands as the principal one of the saccharoses. And here I would predict that chemistry will eventually divide what is now known as cane sugar into a *group* of sugars. There are three things which determine chemical diversity; (1) Different ingredients, (2) Different proportions with the same ingredients, and (3) The different ways in which the atoms are put together

when ingredients and proportions are the same. This last is a somewhat recent discovery of chemistry but is well established. It is not surprising at all. No one would expect two machines to be identical just because each contained the same number of ounces of wood and the same number of ounces of iron. The putting together often makes a world of difference. So I say that the sugars, already a numerous group, are likely to stand as much more numerous when chemistry has completed its work. The best authorities in England have long protested vigorously against the use of white sugar from the beet for bee feeding purposes. When chemistry finally owns up that the main saccharose of beet sugar and the main saccharose of sugar from the cane plant are not identical then we shall begin to get our house founded on the rock. If I am right the taste of the two is not identical. And how about the behavior of the two under the candy maker's art, is there not a difference? So the claim that the two results when these sugars are used as bee diet are not identical has outside support—and this 'ere Czar of all wisdom advises chemistry to own up at once. But let us get back from our digression. Beside the division into glucoses and saccharoses there is a cross division into dextroses (turning light to the right) and levuloses (turning light to the left) but, if I infer rightly, all the saccharoses yet recognized fall in the dextrose class. By the way I am not sure that chemistry yet admits that there is but one levulose. Sugars are also classified into reducing sugars and non-reducing sugars, according to their behavior toward the salts of copper. The reducing sugars are in the main the same as those known as glucoses; but whether these two classes are exactly the same as to each individual member is not made entirely clear to my noddle. Lots of chances to get confused in the jabber of different chemists about the sugars.

The examination of the nectar of nine kinds of flowers is given. In fuchsia, Claytonia, honeysuckle (*Lonicera*) and lavender the sugars known as cane are more than half the total; while in red clover, everlasting pea, vetch, monkshood and crown imperial the opposite state of things prevails. Fuchsia seems rather to stand by itself for its richness in cane sugars, more than three quarters of the total, while the red clover is pretty strongly the other way, just about one-

third to two-thirds. The usual proportion of water is stated as between 60 and 65 per cent.—yet sometimes 95 per cent., and what is most surprising, sometimes almost no water at all. Extra floral nectars, that is those which the plant puts out elsewhere than from within a flower, are stated to have a generally less proportion of cane sugar than the floral nectars. I supposed it was the other way. The remarkable fact is given that a plant cannot *assimilate* sugar in the saccharose form any more than an animal can. The plant often *stores up* sugars in the saccharose form, but when the time comes for them to be assimilated they are changed into the glucose form. This explains why maple syrup will not granulate after the growth of the buds gets well started, glucose in it.

Now as to the finished honey. Bonnier notes that although in general there is but a faint proportion of cane sugar left in it, that produced in mountain regions sometimes has considerable. Prof. Cook suggests that such samples are gathered too rapidly for bees to have time to change it all. It seems that the ugly fact is confessed, both in Europe and America, that the honey from insect secretions (from the pine especially) is quite similar to floral honey adulterated with glucose. At length the chemists rather timidly think that they can discriminate. In Prof. Cook's test of the chemists by sending them 56 samples of diverse honeys and frauds, numbers 12, 27 and 45 which were mainly of insect origin passed unsuspected of being anything else than good honey. A rogue's mixture of commercial honey and commercial glucose, or one of honey and sugar syrup is easily detected—which is something to be thankful for. I think Prof. Cook flagrantly wrong in saying that honey dew will never be put upon the market. Strikes me we had plenty of very mean barklouse honey on the market not many years ago. The *Bulletin* is sent free to Michigan folks—guess if you tell 'em you take a Michigan bee paper that will make you a Michigan folk—enough to fetch it. Address, The Secretary, Agricultural College, Michigan.

THE GENERAL ROUND UP

The most striking things in the surround this time are the failures. Simmins' theory that fertile queens never fight is knocked out; and so (more is the pity) is Langdon's

anti-swarmling device. Brother Alley rather wins the honors in the former knock out—and promises to keep queen “bull fights” on tap for bee folks who may properly wish to see them. Brother Simmins was fooled by the fact that queens fully distended with eggs generally will not try to fight, sure enough. They hold off because they realize that they are too clumsy for any such exercise. But only reduce them to moderate dimensions by a few days' caging and most of them will fight very readily. Jennie Atchley sent four in one cage directed to the Roots. When the cage arrived two were lively and two were “kilt.”

But this is only one of the minor matters of apiculture—alas for our prime discovery that gets knocked out too! Any roof is dry when it does not rain. Any pebble is a genuine mad-stone to cure hydrophobia when the dog was not mad. Last year bees did not want to swarm any way. My apiary which is X X X on swarming did not give me as many swarms as I wanted to have. But this year swarming is epidemic, and our great invention, next to comb foundation and the extractor in magnitude, where, O where! Two moons ago it was—

“Here the conquering hero comes,”

Now it is—

“Poor old soldier
They drummed him out
Because he would not soldier.”

At least his nice little do-funny would not. Never mind, friend Langdon; as misery loves company, we'uns who swallowed the plan so prematurely, we have got to go shares with you in your discomfiture now. And next time we'll all look a little out.

And so the Simmins fasting method of introducing queens fails sometimes—failure No. 3.

And our persevering friend the *Guide* suddenly passes away—failure No. 4.

And the *Canadian* gets burned out of house and home—not quite a failure we hope, but too much a crow of the same nest.

The *American Bee Journal* has got a new forehead on its face—That's not a failure, sure, for it is a good one. The old chunk of comb had foul brood in it: and the letters, some fat visitor had squashed them by sitting down on them before they were baked.

Likewise the *Review* has a new R. L. Taylor. The old one was a gentlemanly lawyer after dinner. The new one is a bee man after dinner time—but he has'nt been able to get, so many swarms.

Rather late, but better late than never, another section of the report of the Michigan Experiment Station appears in the *American Bee Journal*, page 52. Sweet clover gets a black eye. Three acres of it employed the bees, but seemed to have no effect on the results. And the old, tough, elusive, ever-being-corrected problem of wax secretion, friend Larrabee evidently thinks that a rather slightly guarded experiment ought to be accepted as conclusive in regard to it. He admits that the results are different from last year's at the same station, that the bees had queens just given them (very likely a little sullen over the change) and that honey was fed instead of nectar. No, friend Larrabee, not till we can have entirely natural conditions, and the bees at work on natural supplies, can this venerable stumbling block of problems be regarded as complete. I freely admit that the line of experiment is an interesting one, and that the whole is a commendable piece of work, all except the running it for more than it is worth. It should be repeated with variations, especially with two second swarms of the same day's issuing, and with too little feed for any temptation to waste it.

RICHARDS, Lucas Co., O., July 21, 1893.

ADVERTISEMENTS

EVAPORATING FRUIT

STAHL'S EXCELSIOR EVAPORATOR.
Best, Cheapest & Most Reliable on the market. Catalogue free. Address Wm. Stahl Evaporator Co., Quincy, Ill.

—If you are going to—

BUY A BUZZ-SAW,

write to the editor of the *REVIEW*. He has a new Barnes saw to sell and would be glad to make you happy by telling you the price at which he would sell it.

Muth's HONEY EXTRACTOR PERFECTION Cold-Blast Smokers,

Square Glass Honey Jars, Etc.

For Circulars, apply to CHAS. F. MUTH & SON,
Cor. Freeman & Central Aves., Cincinnati, O.
Send **10c.** for Practical Hints to Bee-Keepers.

1-93-tf.

Please Mention the Review.

Names of Bee-Keepers.

TYPE WRITTEN.

The names of my customers, and of those asking for sample copies, have been saved and written in a book. There are several thousand all arranged alphabetically (in the largest States) and, although this list has been secured at an expense of hundreds of dollars, I would furnish it to my advertisers at \$2.00 per thousand names. A manufacturer who wishes for a list of the names of bee-keepers in his own state only, or, possibly, in the adjoining states, can be accommodated. Any inquiry in regard to the number of names in a certain state, or states, will be answered cheerfully. The former price was \$2.50 per 1000, but I now have a type writer, and, by using the manifold process, I can furnish them at \$2.00. W. Z. HUTCHINSON, Flint, Mich.

Are You Tired.

of New Bee Journals? Send 15 cts for 3 month's subscription to that bright, new bee paper, "The Bee-Keepers' Enterprise," and receive **FREE** the Enterprise Souvenir—a Work of Art

That will rest Your Eyes.

Burton L. Sage, New Haven, Conn.

Great Reduction.

SECTIONS AT GREATLY REDUCED PRICES.

HIVES, SHIPPING CASES, &c., AT BED-ROCK PRICES.

WRITE FOR FREE, ILLUSTRATED CATALOGUE AND PRICE LIST.

G. B. LEWIS CO., Watertown, Wis.

1-93-tf.

Please mention the Review.

Hastings' Lightning Ventilated Bee Escape.

AGRICULTURAL COLLEGE, Mich. Sept. 17, '92.
"I have used the Lightning Bee Escapes you sent and find them certainly the equal of the Porter, and their superior for the reason that they will empty a super more rapidly."
Yours respectfully, J. H. LARRABEE.

"It is our opinion that you have the best Bee Escape ever introduced."
A. I. ROOT, Medina, Ohio.

HONOLULU, Hawaiian Islands, April 25, '92.
"Please send me by return mail 5 Lightning Ventilated Bee Escapes. I have the Porter, and the Dibbern and they both clog."
Yours truly, JOHN FARNSWORTH.

Price, by mail, each, 20c. per doz. \$2.25.



"IT LEADS THEM ALL."

Read Testimonials of a few successful Bee-keepers.
Send for Sample and after a trial you will use no other.
Catalogue sent on application.

M. E. HASTINGS, NEW YORK MILLS, ONEIDA CO., N. Y.

Second Hand Supplies.



Of the second hand supplies that I have been advertising in the REVIEW, the following remain unsold:—



100 old-style, Heddon surplus cases at 20 cts. (as a non-separated case, they have no superior); 25 slatted honey boards at 10 cts.; 20 Heddon feeders at 40 cts.; and half a dozen single-comb nuclei for exhibiting bees at fairs. They have glass sides, removable covers and are painted a bright vermilion. They cost \$2.00 each, but will be sold at half-price. All these are practically as good as new.

W. Z. HUTCHINSON, Flint, Michigan.

The Golden Beauties.

Our five-banded Italian queens, warranted purely mated, at 75 cts each; two for \$1.25. Tested, \$1.00 each; two for \$1.50. Safe arrival guaranteed C. B. BANKSTON, 2-93-tf Chriesman, Texas.

Dadant's Comb Foundation.

Wholesale and Retail. Even our competitors acknowledge that our goods are the STANDARD of their kind. **Langstroth on the Honey Bee, Revised.** New edition. Bee Veils; and veil material at wholesale. Bee Supplies, Sections, Smokers, etc Samples of Foundation and veil stuff with circular free. Instructions to beginners Send your address to

CHAS. DADANT & SON, Hamilton, Ills.

4-93-12t

Please mention the Review.

CHERRY VALLEY, N. Y., March 20, '93.
"I shall take pleasure in recommending them as the best I have ever used."

Truly yours, J. E. HETHERINGTON.
"We believe you have an Escape that 'downs' the Porter."

T. PHILLIP & CO., Orillia, Ont., Canada.
"Your Escape knocks out all competitors."

A. J. LINDLEY, Jordan, Ind.
"They did not clog, and cleared the supers rapidly. In fact it is the best Escape I have yet used. I cannot speak too highly of it, and consider it a great boon to bee-keepers."

W. E. CLARK, Oriskany, N. Y.

Cut the Price.

This is what Mr. G. E. Dawson of Carlisle, Ark., writes me. You may remember that he is the man who got no orders. He is raising good queens and is bound that they shall be tried, hence he offers them as follows: Untested, 65 cts.; three for \$1.75; six for \$3.00; twelve for \$5.00. Tested, \$1.25. Select tested, yellow to the very tip, \$1.50.
—ED. REVIEW.

Please mention the Review.

If You Wish Neat, Artistic

PRINTING,

Have it Done at the Review.

NOTICE OUR PRICES.

No. 1 Sections \$2.75 per 1,000. Thin, surplus foundation, best quality, 50 cts per pound. A full line of supplies, including Root's Dove-tailed Hives, on hand. Send for circular and free sample of foundation 5 93-tf

J. H. & A. L. BOYDEN,
Saline, Mich.

GO TO HEAD QUARTERS FOR 4 AND 5 BANDED QUEENS

Special, breeding queen, \$5.00
Best, select, tested, 3.00
Tested, 2.50
Untested, 1.00
" per dozen, 9.00

L. L. HEARN,

7-93-tf Oakvale, W. Va.

Please mention the Review.

GOLDEN ITALIAN QUEENS

Now ready for \$1.00 each. Do not order your supplies until you see our circular for 1893. For the price, we have the best spraying outfit made. Send \$1.50 and get one. Wm. H. BRIGHT, 1-93-12t Mazeppa, Minn.

Please mention the Review.

ITALIAN QUEENS AND SUPPLIES FOR 1892.

Before you purchase, look to your interest, and send for catalogue and price list.

J. P. H. BROWN,

1-88-tf. Augusta, Georgia.

Please mention the Review.

For \$1.50 I will send the Review for 1893 and a fine, young, laying, Italian queen.

Queen alone, 75 cts. For \$1.75 I will send the Review, the queen and "Advanced Bee Culture." Tested queens, \$1.00. The Review and

a tested queen \$1.75 A discount on large orders. W. Z. Hutchinson, Flint, Mich.

REVIEW

QUEENS

The Champion Smoker.

The ORIGINAL curved nozzle, steel lined, Bellows Smoker. The fire-chamber is 3½x7 inches with a corrugated steel lining, which allows a cold current of air to pass between lining and outside shell; keeps the outer shell cool and more than doubles the durability of the Smoker. It has a FORCE draft, and SPARK-ARRESTING CONE connection between bellows and fire-chamber; a base-valve to either keep or extinguish the fire at pleasure; and a removable spark-arresting GRATE in the curved nozzle.

Price, by mail, \$1.90; by express, \$1.65

If your supply dealer cannot supply you, write to the manufacturer.

E. KRETCHMER, Red Oak, Iowa.

Bee Supply Catalog of 70 Illustrated Pages, free.



CATCHALL

The orders for untested queens at 75 cts each; six for \$4.00. Tested queens, \$1.50 each, three for \$4.00. Two-frame nucleus with any queen \$1.50 each, extra. Safe arrival guaranteed. 7 93-14

W. J. ELLISON, Catchall, S. C.

Bee Hives and Section Boxes.

Simplicity, Langstroth-Simplicity, Standard Langstroth, Dovetailed and Champion Chaff Hives, Supers, One-Piece Sections and Shipping Cases. Foundation, Smokers, etc., etc. Send for 16 page Circular.

1-92-tf PAGE & KEITH, New London, Wis.

Please mention the Review.

HUNT'S

FOUNDATION

FACTORY.

Send for free samples of foundation and sections; warranted good as any made. Dealers, write for special prices and the most favorable conditions ever offered on foundation. Send for new, illustrated, free price-list of a full line of supplies.

M. H. HUNT,

Bell Branch, Mich.

TYPEWRITERS.

Largest like establishment in the world. First-class second-hand instruments at half new prices. Unprejudiced advice given on all makes. Machines sold on monthly payments. Any instrument manufactured shipped, privilege to examine. EXCHANGING A SPECIALTY. Wholesale prices to dealers. Illustrated Catalogues Free.

TYPEWRITER { 31 Broadway, New York.
HEADQUARTERS, { 186 Monroe St., Chicago.

Please mention the Review.

IMPORTANT

TO BEE-KEEPERS!

To make a success of bee keeping, you want bees that will give the very best results. My *Golden Italians* have gained a good name on their own merits. Those who have tested them with other bees say "they are the best honey gatherers, cap their honey the whitest, as gentle as butterflies, beautiful to look at, are the largest and strongest bee of all the races." Queens bred from mothers that produce uniformly marked

FIVE-BANDED WORKERS

In March, April and May, \$1.25 each, 6 for \$6.00; June, \$1.00 each, 6 for \$5.00; July to Nov., \$1.00 each, 6 for \$4.50. Special prices on large orders. For full particulars send for descriptive circular.

12-92-tf

C. D. DUVALL.

Spencerville, Montg. Co., Maryland.

New as Well as Valuable

IMPROVEMENTS

IN BEE-HIVES, SMOKERS,

FOUNDATION FASTENERS,

SECTION PRESSES AND FEEDERS.

Special prices given to parties who will take hold of and push the sale of these goods. For circulars and particulars, address

LOWRY JOHNSON,

Masontown, Pa.

1-93-tf.



Interesting Monthly for
The Family and Fireside

Welcome in every Home.

Large Premiums for Clubs.
Sample Copy sent Free.

THOMAS G. NEWMAN,
147 South Western Ave.,
CHICAGO, ILLS.

SHIPPING — AND — WINTER CASES,

— PASTEBOARD BOXES OR CARTONS, —

Everything used by Bee-Keepers. Catalogue and Price List free. Ask for a copy of the AMERICAN BEE-KEEPER (50 cts. a year) especially for beginners

The W. T. FALCONER MFG. CO., Jamestown, N. Y.

PATENT. WIRED, COMB FOUNDATION

HAS NO SAG IN BROOD FRAMES.

Thin, Flat - Bottom Foundation

HAS NO FISHBONE IN SURPLUS HONEY.

Being the cleanest, it is usually worked quicker than any fdn. made.

J. VAN DEUSEN & SONS,
(SOLE MANUFACTURERS),

3-90-1f Sprout Brook, Mont. Co., N.Y.



Ready to Mail, ITALIAN QUEENS,

Tested, at \$1.25; 12 for \$13.00. Untested, after April 1st, \$1.00 each, or 6 for \$5.00. Safe arrival guaranteed, Bees, Drones and Supplies. Circular free.

J. N. COLWICK,

4-92-1f

Norse, Bosque Co., Texas.

Italian Queens

From imported mother, warranted purely mated. \$1.00 each; six at one time, \$5.00. Untested queens, 65 cts each.

C. A. BUNCH,

7-93-2t

Nye, Marshall Co., Ind.

"Golden" Florida.



My location enables me to rear good queens NOW as cheaply as they can be reared in the North at anytime. Untested queens, 75 cts. each; 6 for \$4.00; one dozen, \$7.50. Last year's tested queen, \$1.25; select, \$1.75; breeder, \$2.50. Safe arrival and satisfaction guaranteed. 1-92 1f

J. B. CASE, Port Orange, Vol. Co., Fla.

Early Queens From Texas,

From my choice golden stock. My bees are very gentle good workers, and beautiful. Safe arrival and satisfaction guaranteed. One untested queen, April and May, \$1.00; six for \$5.00; later, 75c. Orders booked now; money sent when queens are wanted. Send for price list.

J. D. GIVENS,

Lisbon, Texas.

1-93-9t.

Please mention the Review.

IF YOU WANT THE BEE BOOK

That covers the whole apicultural field more completely than any other published, send \$1.00 to Prof. A. J. Cook, Agricultural College, Mich., for his

Bee-Keepers' Guide.

Liberal Discounts to the Trade.

Please mention the Review.

BEES QUEENS, SECTIONS, SMOKERS,

COMB FOUNDATION

And all Apiarian Supplies. Send for Catalogue.

E. T. FLANAGAN, Belleville, Ill.

Please mention the Review.

Just Splendid

Mr. Alley—The queen I got of you last fall is just splendid! She is the best queen in an apiary 150 colonies. I would not take \$10 for her. John A. Pease, Moravia, Calif.

Price of such queens is \$1.00 each.

HENRY ALLEY,

Wenham, Mass.

THE PROGRESSIVE BEE - KEEPER

Has Changed Hands. It is now Published by the
LEAHY MANUFACTURING CO.,

Higginsville, Missouri.

Money, Experience and Enterprise will not be lacking to make it all that its name indicates. Send for Free Samples and Copy of 28-page Catalogue of Apiarian Supplies.

SEP., 1893.



At Flint, Michigan.—One Dollar a Year.

ADVERTISING RATES.

All advertisements will be inserted at the rate of 15 cents per line, Nonpareil space, each insertion: 12 lines of Nonpareil space make 1 inch. Discounts will be given as follows:

On 10 lines and upwards, 3 times, 5 per cent; 6 times, 15 per cent; 9 times, 25 per cent; 12 times, 35 per cent.

On 20 lines and upwards, 3 times, 10 per cent; 6 times, 20 per cent; 9 times, 30 per cent; 15 times, 40 per cent.

On 30 lines and upwards, 3 times, 20 per cent; 6 times, 30 per cent; 9 times, 40 per cent; 12 times, 50 per cent.

Clubbing List.

I will send the REVIEW with—	
Gleanings,.....	(\$1.00).....\$1.75.
American Bee Journal.....	(1.00).....1.75.
Canadian Bee Journal.....	(1.00).....1.75.
American Bee Keeper.....	(.50).....1.40.
Progressive Bee Keeper.....	(.50).....1.30.
Bee Keepers' Guide.....	(.50).....1.40.
Apiculturist.....	(.75).....1.65.
Bee-Keepers' Enterprise.....	(.50).....1.40.

Honey Quotations.

The following rules for grading honey were adopted by the North American Bee-Keepers' Association, at its last meeting, and, so far as possible, quotations are made according to these rules:

FANCY.—All sections to be well filled; combs straight, of even thickness, and firmly attached to all four sides; both wood and comb unsoiled by travel-stain, or otherwise; all the cells sealed except the row of cells next the wood.

No. 1.—All sections well filled, but combs uneven or crooked, detached at the bottom, or with but few cells unsealed; both wood and comb unsoiled by travel-stain or otherwise.

In addition to this the honey is to be classified according to color, using the terms white, amber and dark. That is, there will be "fancy white," "No. 1 dark," etc.

KANSAS CITY, Mo.—Honey is selling at the following prices: fancy white, 17; No. 1 white, 16; fancy amber, 15; No. 1 amber, 14; fancy dark, 12; No. 1 dark, 10; white extracted, 7½; amber, 6½; dark, 5 to 6. Beeswax, 20 to 22.

CLEMONS-MASON CO.,
Sep. 4. 521 Walnut St., Kansas City Mo.

BUFFALO, N. Y.—The demand for fancy No. 1, pound combs is improving, and we can soon satisfactorily place liberal quantities. All honey for the Buffalo market should be unglazed—that is, glass on only the outside of the cases. We quote as follows: fancy white, 14 to 15; No. 1 white, 12 to 13; fancy amber, 8 to 10; No. 1 amber, 7 to 8; fancy dark, 8 to 10; No. 1 dark, 7 to 8; white extracted, 6 to 6½; amber 5 to 5½; dark, 4 to 4½. Beeswax, 24 to 25.

BATERSON & CO.,
Sep. 4. 167 & 169 Scott St., Buffalo, N. Y.

CHICAGO, Ill.—Choice white comb honey is selling at 15 cts. Some fancy brings 16. The market is not very active, but, so far, we have been able to sustain these prices. Extracted remains unchanged at from 5 to 7, according to quality, flavor, and style of package. Beeswax, 20 to 22.

R. A. BURNETT & CO.,
Sep. 2. 161 So. Water St., Chicago, Ill.

MINNEAPOLIS, Minn.—We think honey will sell much lower later on and now is the time to market it. We quote as follows: Fancy white, 18 to 20; No. 1 white, 17; fancy amber, 16; No. 1 amber, 14; fancy dark, 13; No. 1 dark, 11; white extracted, 8 to 9; amber, 7 to 8; dark, 6½. Beeswax is unsalable.

116 First Ave., North, Minneapolis, Minn.
Aug. 1,

NEW YORK—The new crop of extracted from California and the South is arriving very freely. There is a limited demand and prices have a downward tendency. We quote as follows: White extracted, 6½ to 7; Amber, 6 to 6½; Dark, 5½ to 6. Beeswax, 26 to 27.

HILDRETH BROS. & SEGELKEN,
July 7. 28 & 30 West Broadway New York.

CINCINNATI, Ohio.—The demand is fair for extracted honey at from 5 to 8 cts., with a good supply on hand. Quite a number of small arrivals of nice comb honey found a ready sale during the past few weeks. The demand is fair. The close money market causes slow collections and makes itself felt in the demand for all merchandise, honey included. There is a fair demand for beeswax at from 20 to 23 cts. for good to choice yellow.

CHAS. F. MUTH & SON.,
Aug. 23. Cincinnati, Ohio.

CHICAGO, Ill.—The market is rapidly declining on all honey. Fancy white is offered in quantities, by outside parties, at 14 cts.; but we think this will not last long. We look for better prices after small fruits are out of the way. The early shipments of Southern honey, and the low prices at which it was afforded, tempted buyers who heretofore never used it; however, this is about used up, and Western stock is beginning to move. We quote as follows: fancy white, 15; No. 1 white, 14; fancy amber, 12½; white extracted, 7 to 7½; beeswax, 16 to 20.

J. A. LAMON,
Sep. 2. 44 & 48 So. Water St., Chicago, Ill.

CHICAGO, Ill.—Honey this year is being placed on the market earlier than last season, but the demand is restricted and will be light until small fruits are out of the market: and with the prospect of a large crop, buyers will be particular as to quality, and the best will find ready sale upon arrival. No. 1 comb, 16; extracted, as to quality, 5 to 7. Beeswax, 22 to 24.

We extend to all bee-keepers who visit the city an invitation to call on us, likewise to make use of our office, in care of which they can have their mail addressed, and from which they can write their letters. Hotel accommodations secured.

Aug. 18. S. T. Fish & Co.,
189 So. Water St., Chicago, Ill.

WINTER LOSSES

Are not always the result of the same cause. They may come from starvation; from poor food; from improper preparations; from imperfect protection; from a cold, wet, or possibly a poorly ventilated cellar; etc., etc. Successful wintering comes from a proper combination of different conditions. For clear, concise, comprehensive conclusions upon these all-important points, consult "ADVANCED BEE CULTURE." Five of its thirty-two chapters treat as many different phases of the wintering problem.

Price of the book, 50 cts.; the REVIEW one year and the book for \$1.25. Stamps taken, either U. S. or Canadian.

W. Z. HUTCHINSON, Flint, Mich.

ON HAND NOW.

THE MOST COMPLETE STOCK
OF BEE HIVES, SECTIONS AND
SUPPLIES IN THE NORTHWEST.

W. H. PUTNAM,

193-12t.

RIVER FALLS, WIS.

Barnes' Foot and Hand Power Machinery.

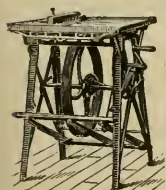

This cut represents our
Combined Circular and
Scroll Saw, which is the
best machine made for
Bee Keepers' use in the
construction of their hives,
sections, boxes, etc.

11-92-76t

MACHINES SENT ON TRIAL.

FOR CATALOGUE, PRICES, ETC.,

Address W. F. & JNO. BARNES CO., 384 Ruby St., Rockford, Ills.

Please mention the Review.



Oh, Mamma!

Have you heard of the

FREE

200-Page Bee-Book

given to every **NEW**

Subscriber to the old

AMERICAN

BEE JOURNAL?

Oldest, Largest, Best,

Cheapest and the only

Weekly Bee-Paper

in America. 32-pages;

\$1 a year. Sample free

GEO. W. YORK & CO

56 Fifth Avenue, CHICAGO, ILL.

To New Subscribers: The Journal Alone

Sent for Three Months for Twenty Cents.

BEE-KEEPERS'

SUPPLY HOUSE

J. H. M. COOK, 78 Barclay St., N. Y. City.

(SUCCESSOR TO A. J. KING.)

4-93-tf

Send for illustrated Catalogue

A Grand Success.

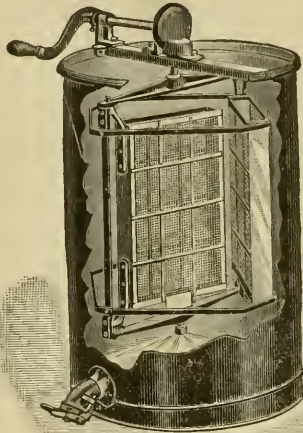

Mention Review.

New Cowan Reversible HONEY EXTRACTOR.

May be Reversed Without Stopping the Machine.

Strong, well made in every respect, light, and of convenient size. The can is but little larger than that of the Novice. The gear is beveled and covered by an iron shield, and the crank outside the can. Frank McNay, of Mauston, Wis., a bee keeper who produces tons and tons of extracted honey, says of it:

"After carefully examining and trying the Cowan Extractor, I have failed to find a weak part, and I do not hesitate to say that it is the best Extractor made, both in regard to convenience and durability, and I shall replace all of my five machines with the Cowan as soon as possible."

It is endorsed also by J. F. McIntyre, an extensive extracted honey producer of California; by W. Z. Hutchinson, Dr. C. C. Miller, and others.

Price all Complete, Japanned and Lettered, for L. Frame, \$10.

A. I. ROOT, Medina, O.

CANADIAN

BEE JOURNAL.

Enlarged. Improved. Monthly. R. F. HOLTERMAN Editor. Sample Copies rec. Address the Publishers, GOULD SHAPLEY & MUIR CO., Ltd., Brantford, Ont., Canada.

Please mention the Review.

SHIPPING CASES.

To hold twelve, 1½ sections, or fourteen 7-to-the-foot, at \$6.00 per 100—with glass, \$6.65. They are of fine material, and the workmanship is of the best. Send for free price list of everything needed in the apiary. 9-93-1f

M. H. HUNT, Bell Branch, Mich.

Please mention the Review

FOR ALL KINDS OF BEE KEEPERS SUPPLIES.
ADDRESS LEAHY MFG. CO. HIGGINSVILLE MO.

PORTER BEE ESCAPES

Are used and pronounced the best, and highly recommended as great labor-saving implements by Chas. Dadant & Son, Prof A. J. Cook, Chas. F. Muth, Jno. S. Reese, J. H. Martin, Jno. Andrews, F. A. Gemmill, Wm. McEvoy, A. F. Brown, Thos. Pierce, and many other prominent bee-keepers. Descriptive circular and testimonials mailed free. PRICES: each, postpaid, with directions, 20 cts.; per doz., \$2.25.

RETURN THEM AND GET YOUR MONEY BACK AFTER TRIAL, IF NOT SATISFIED. For sale by dealers.

MENTION THE REVIEW.

Address R. & E. C. PORTER, LEWISTOWN, ILL.

The Bee-Keepers' Review.

A MONTHLY JOURNAL

Devoted to the Interests of Honey Producers.

\$1.00 A YEAR.

W. Z. HUTCHINSON, Editor & Prop.

VOL. VI. FLINT, MICHIGAN, SEP. 10, 1893. NO. 9.

Work at Michigan's Experimental Apiary.

R. L. TAYLOR, APIARIST.
PRATT'S HIVERS.



AS stated in a former article the Pratt Hiver was included in my plan for a series of experiments to be conducted during the white clover honey season. Five of them were used, the first of which was put in place June 16th

on a hive which I shall call No. 1 while a swarm from it was in the air. As the entrance to this hive was not guarded by a queen trap, and no queen being found in front of the hive as was to be expected since I clip my queens, I put a trap to the lower entrance and caused the bees to enter through it that I might find and determine the character of the queen. The result was that I found two or three virgin queens showing that the swarming was probably caused by the rearing of queens to supersede the old one or on account of her death. The young queens were removed and the trap

left in place to enable me to determine the purpose of the next queen that should attempt to try the open air. A few days later a young queen was found in the trap no swarm having issued. She accordingly was returned, the trap removed and the lower entrance left open for the convenience of the queen.

The history of No. 2 up to July 2nd was given in my article in the July number of the REVIEW. Upon the 13th of July it swarmed again, being the fourth time, but this time I discovered the queen was a virgin, showing that the old queen had probably been killed on the return of the swarm July 2nd.

The remaining three hivers were also put in place June 17th.

No. 3 was the only other one of the five from which a swarm issued and from it, first, on the 20 of June. On the next day I found that the queen had been killed by the bees of the returned swarm, so a trap was placed at the lower entrance. After this a swarm issued on each of the following dates: June 30th and July 2nd, 4th and 8th. In the last case the swarm was hived in another hive and given the queen in the trap. In all the previous ones the swarm was returned and the queen removed.

In studying results it should be remembered that these five colonies were of more than average strength and were selected on that account because I was anxious to test the hiver by actual swarming.

If the percentage of loss of queens in these experiments is to be taken in any way as a

criterion of what it would be in general practice, quite a serious difficulty is presented to the practical working of the hive, for it would mean the ruin of all colonies that throw off swarms unless constant watchfulness is exercised, and if there must be such watchfulness there would seem to be little necessity for hivers. Though I should not expect that the percentage of loss would be generally so large, yet I fear it would be sufficiently so as to be still a serious matter.

Of perhaps even greater interest than the loss of queens is the effect of the hive upon the amount and value of the honey produced. At the time the hivers were adjusted all the colonies in question were working in the sections except No. 1 though no great progress had been made except in case of No. 3 which had nearly filled the first super of 28 sections. This was an exceptionally strong colony and was composed of excellent workers. Judging by what other colonies did it should have produced 75 pounds of comb honey had it been managed as the others were. In the same way the other four would have averaged about one-half as much or 225 pounds for the five.

The actual results so far as comb honey was concerned were all contained in three cases, none of which were very well filled, certainly not to exceed 60 pounds all told, and this was all produced by No. 3 and by Nos. 4 and 5 which did not swarm. At once on the close of the clover season the extra hives—those not containing brood—were removed and would yield about 150 pounds of extracted honey. Even the colonies that did not swarm had pretty well filled the hives below the hivers.

Of course I appreciate the unsatisfactory character of the comparative result founded as it is upon an estimate of what the colonies would have done under other circumstances, but with a desire to arrive at the exact truth I have judged as fairly as I am capable of doing.

Until swarming has once begun the hive has apparently a strong tendency to restrain the swarming fever, but when a swarm once issues, if the old queen is killed, the fever will generally persist till all the young queens but one are destroyed or otherwise disposed of.

Before a final determination as to the utility of the hive, further tests must be made, and it is to be hoped that such further im-

provements may be made as may render the circumstances of future trials more favorable.

LAPEER, Mich.,

Aug. 16, 1893.



TIMELY TOPICS.

No. 8.

R. L. TAYLOR.

"Bees can live without love—what is passion but pining?
But where are the bees that can live without dining?"

IF other work of the apiary such as the uniting of colonies and due oversight with regard to queens has been timely attended to there is little to require the attention of the apiarist during the first twenty days of September except the crop of fall honey in places where there is such a crop. For the securing of this the bees must have sufficient room and at the close of the flow all surplus receptacles should be promptly removed and the honey stored in a warm, dry room.

The clearing of the supers of bees will be found a much more difficult undertaking in the fall than it was in July. The bees are sluggish and stubborn and respond very slowly even to a deluge of smoke, so that the apiarist may well try coaxing in place of driving and make use of bee escapes. No doubt they will work more slowly than in the summer but they will still be found a great luxury.

The extracting of the honey from combs destined to that end, if stored in a proper place, should not be very long delayed, else the operation will be found slow and vexatious by reason of the thickening of the honey through evaporation.

When there has been a yield of fall honey but little if any feeding for winter stores will be found necessary even though the brood chambers be quite small, for at that season the brood nest is much contracted thus giving abundant room for stores, but each colony should be examined, for some of the best colonies, if the bees have much brood of the German race and the brood chambers are small, may have put almost all their honey into the supers and when found short of stores the want must be supplied without delay.

This examination does not imply the opening of hives and the handling of combs. This should never be done. It is a course both unpleasant and injurious. Get at the weight of your hive, supposing it to be supplied with empty combs only, by weighing a few of this description, then add to the average weight thus found twenty-five or thirty pounds for honey and bees which will give the weight which each hive must have to be safe for winter so far as the amount of stores is concerned. Now take the scales into the yard and weigh a few colonies marking the weight in each case in a convenient place on the proper hive. When a colony is found whose weight just about reaches the limit, replace the colony and then bend over and "heft" it. Do this repeatedly and study the weight. Now if but few of the colonies need feeding most of them go so much above the limit that it will be perceived at once on hefting them though it may be necessary to return to the "pattern" occasionally for comparison. In this way the great majority may be quickly disposed of as being clearly safe. The doubtful and the light ones must then be weighed and marked.

The syrup to be fed may be prepared by bringing to a boil any given number of pounds of soft water and then adding, by pouring in gently, twice the number of pounds of the best granulated sugar. When this is again brought to a boil it is ready to be fed as soon as it becomes sufficiently cool.

The kind of feeder used is not important. The Heddon feeder is most convenient as enough can always be fed at once and the bees are always safe from drowning, but a tin pan with a piece of cloth, with care, answers very well, or any of the smaller feeders will do if filled so promptly that the bees will get what they need about as quickly as they can take it.

All this should be attended to at once on the cessation of the storing of surplus and where the fall crop is wanting, the 20th of September should see that work begun, and in both cases the work should be finished early in October.

In localities where there is no nectar to gather after basswood fails, the amount of brood reared during August and September is likely to be exceedingly limited and I should greatly fear for the safety of colonies entering the winter with so large a propor-

tion of aged bees as such conditions would entail. Under such circumstances, if I wished to make their wintering well as certain as possible, I should take pains by proper feeding to increase the amount of brood as much as possible during the first half of September.

This work of proper preparation for winter is to the apiarist, if much feeding is to be done, the most trying duty of the year, and happy will he be who can look back on it promptly and properly done.

LAPEER, Mich.

Aug. 23, 1893.



Large Exits and Those Opening Outside the Hive Are No Advantage in Bee Escapes.

R. & E. C. PORTER.

REGARDING the matter of escapes opening outside the hive, mentioned in your last issue, Mr. Shuck and ourselves and no doubt many others have been over this ground very carefully. Mr. Jno. S. Reese, several years ago pointed out in *Gleanings* the disadvantages of such an arrangement as compared with the brood chamber outlet. Admitting light through such devices into the super does not hasten matters in the least and very few will ever care to use such an arrangement. The difficulty in getting or constructing escapes to work rapidly, whether opening into the brood chamber or out side the hive lies in the fact that as the facilities for getting out are increased the inclination of the bees to use them *diminishes*. All that Mr. Shuck and ourselves have said regarding escapes, the most careful experiments will substantially verify. Even Mr. Aikin is getting around into line. Some time ago we sent him a number of forms of escapes of varying exit capacity, to experiment with, one having fifteen exits arranged with double sets of springs so as to completely break the connection between the bees in the super and those in the brood-chamber. In a letter received from him the first of the week, he says: "I can't see that the big one works a bit better than the little ones," *i. e.* our regular form.

LEWISTOWN, Ill.

Aug. 18, 1893.

Experiences and Views at the Forestville
Apiary.—Great Success with the
House Apiary.

E. R. JAKES.

Here's the home where I stay —
And a gown that was Sal's kinder flapped
on a bay —
Not much for a man to be loving, but his
all, as I've hearn people say.

[When Mr. Barnet Taylor, in a private letter, informed me that he had had for a student the past season a gentleman who was making a thorough study of apiculture, I at once wrote him that I should be very glad of that gentleman's views and experience as found at the Forestville apiary. In a few days there came to hand the following, very neatly written.—Ed.]

 LINE of white pine trees, whose tops spread forty-two feet, line the road side. South of these trees, with a fine grass plat in front, stands the modest yet pleasing dwelling of Brother B. Taylor.

comb-leveler, and in fact every thing found in a well appointed apiary ; and the visitor's admiration for the work turned out from this shop will only be excelled by that which he will have for the man when he learns that the machinery itself, unsurpassed in adaptability to work, in finish and quality, has all been made by one and the same hand—brother Taylor's. In the Forestville apiary there are no warped nor leaky covers, nor poor joints.

Fifty feet south [to the right in the cut—Ed.] of the shop on a gently rising slope stands the iron'honey house and the two house apiaries. [The new house apiary is the larger—Ed.] These buildings like all the others on the place are neat and well kept.

To me the house apiary was the center of attraction. In fact a desire to study its



THE APIARY OF BARNET TAYLOR, FORESTVILLE, MINNESOTA.

On its right [at the left in the cut, this view being taken from the rear of the building.—Ed.] and in line with it stands another building having the appearance of a dwelling, it is the *shop*, being one of the attractions at the Forestville Apiary. In it are made the Taylor handy bee-hive, his bee-escapes, honey-boards, swarm-catchers,

workings at brother Taylor's expense led me to pass a few weeks as a student at the Forestville apiary.

The first point scored by the house bees over those in the yard was this,—they built up faster in early spring thus becoming strong in numbers in time for the clover harvest. There were two reasons, I think, for

this: first, the temperature in the house was warmer and much more uniform on cold nights and rough days, thus enabling the bees to rear brood faster. In the second place, hives standing in the yard become heated in sunny yet cold days, the bees being thus induced to fly while they were sure to be lost. Many who removed their colonies from the cellar to the yard early, suffered in

tinguishing features except in color. I am also of the opinion that where one wishes to use the young bees and brood, after a swarm has been thrown off, to build up a weak colony they can do it more conveniently in the yard where they can place the hive by the colony to be helped and remove it at will. The lifting of hives and supers will be found heavier work in than out of the house.



MR. BARNET TAYLOR'S LATEST HOUSE - APIARY.

the same way and were compelled on account of the loss to return them to the cellar.

As to ease in handling I hardly know what to say. Surely here are some of the advantages. It is much more comfortable in the house, out of the hot sun with all your supers, honey-boards, bee-escapes and the like on shelves within easy reach. Then, too, you will not be troubled as much with robbers and will have little use for smoke and veil; for however cross a bee may be out of doors she becomes a lady in the house. The house can be kept clean and there is no necessity for crushing bees. On the other hand I think the house queens will be much more apt to get lost while on their mating trips, there is so much sameness in a long line of entrances closely crowded together on the side of a house with no dis-

tinguishing features except in color. Now for the results as shown in the honey gathered up to date, (July 24th.) Twenty colonies in the house have 100 lbs. each of comb honey in supers, while twenty of the best colonies in the yard have stored but 75 lbs. each. We estimate the white harvest to be one-half over.

I think the house apiary has come to stay, but I do not think it will be a success except in the hands of a skillful apiarist.

In the yard are four colonies of bees working harmoniously together in two of Taylor's non-swarmer hives. They are storing honey well, and I see no reason why this management may not become very useful, especially to those who run out apiaries.

Scattered through the apiary within easy reach may be seen the Taylor swarm-catchers. Most of the swarms are caught in

them and then placed in the cellar to be hived when convenient. Swarming time has no more terrors for Brother Taylor.

I must not pass over the comb leveler. Every super put on this season up to this date (July 24th) has been one-half filled with comb on which the comb leveler has been used, the balance with foundation. The comb has been placed in the corners and on the outside of the supers. Brother Taylor would not use any foundation if he had a sufficient supply of comb. The sections with combs placed in the corners have been completely filled before the foundation ones in the center—and that, too, with nice, clean, straight work.

Bee escapes are in general use. They have an opening so small that only one bee can pass at a time, yet they do good work.

Hives and frames almost numberless make the Forestville apiary a museum in which one may study the progress made in bee-keeping for the past generation. Here every new thing presented has been tried, and cheerfully commended or sorrowfully condemned. Nor is it strange that, in the eager search for the best, the truly good has sometimes for a time at least, been supplanted by the new and untried, as was the case with the little double hive and the wire end frame. These will soon be the only hives and frames used in this apiary except for experimental purposes.

CRYSTAL, Minn.

Aug. 5, 1893.

[After reading the above I saw at once that pictures were needed to make the story complete, and I wrote the same to Mr. Taylor. In due time they came accompanied by the following letter.—ED.]



I SEND you to day
1 photographs of
the Forestville apiary
from two points
of view. One of
them shows to good
advantage the house
apiary, two of the
non - swarmers and
the entrance to the
wintering cellar.
The yard was put in
just the condition

it would be in the active swarming season. The swarm catchers are seen scattered about every where. They are a great thing indeed. The two non-swarmers, one with two, the other with three supers, show plain enough except the entrances, which,

for some reason, do not seem plain. There are but few of the hives in the open yard in this view, yet I think it would be the view that would interest readers most as the house apiary is attracting much thought. Yes, sir, the house apiary grows in favor the longer I use it. The new one is so perfect that I cannot offer an improvement at present. I shall build another on exactly the same model.

The first view was taken from the southwest and gives a more general view, showing the west end of the new house, the iron curing house, the little house apiary, a portion of the shop and wintering cellar (on the left) while a glimpse of the dwelling is seen from more in the back ground. The white stripe behind the shop is the highway. The revolving stand with my new solar wax extractor upon it can be found in front of the new house apiary. There are but few of the out hives visible in this scene and everything seems jostled together a great deal closer than they really are. Your humble servant is seen sitting on the revolving stand near the wax extractor, while his son sits on a daisy wheelbarrow near the iron honey curing house.

FORESTVILLE, Minn.

Aug. 24, 1893.



Perseverance Has at Last Secured an Experimental Apiary for Vermont.

H. W. SCOTT.

FRIEND HUTCHINSON:—Your editorial in the July REVIEW exactly depicts the trials and difficulties to be overcome in securing recognition from the State authorities. Suffice it to say, that we of Vermont have been through nearly the same thing; and I am happy to say have been successful.

On April 13, 1893, Mr. M. F. Crane, representing a committee elected at our last meeting for the purpose of pushing our claims for recognition, O. J. Lowrey, prospective apiarist, F. H. Wheatley, acting apiarist, and myself, appeared before the Board of Control of our Station and presented our case as best we could. The Board heard us very courteously, and the same day voted to add *bee-keeping* as a branch for experimental work at the Burlington experimental farm.

We were allowed a sum sufficient to build a house 16x30 feet, with one side arranged to

hold 24 colonies of bees. The building is finished, and five colonies of bees are now located in it. It is proposed to ask the bee-keepers of Vermont, or others who feel so disposed, to contribute a few colonies of bees, so as to be able to do good work next season. There are seven more colonies in another place that belong to the station, making twelve in all. Next year we hope to have a regular apiarist and to do some good work.

Burlington is as easily reached from many places in New York, as from our own State; and I shall hope that among bee-keepers State lines will be disregarded and that those who can will avail themselves of the welcome offered on behalf of the Vt. B. K. A. to add their names to the membership roll, and assist, or better still, all work together in this experimental work.

Perhaps I shall be able to write more after a visit to the station, but until then, I must extend the congratulations of the Vermont bee-keepers to our brethren of Michigan, on the beginning of experimental work and recognition, by the State authorities, of our industry; and hope that much good may result in the years to come.

BARRE, Vt

Aug. 18, 1893.



Winter Experiments Needed With Heat And Ventilation.

C. W. DAYTON.

"O the long and dreary winter!
O the cold and cruel winter!"



WELL, it appears that the State of Michigan has arranged for another feast and invites the whole United States to share in it. I shall endeavor to remain so far in the rear that those who kicked so hard at certain former experi-

ments, can now step forward and demonstrate their superior (?) judgement, bearing in mind that "a fool can find fault, but it is a wise man who can discern excellence."

The experiment that I would like above all others to have tried just now, is the one with which Mr. B. Taylor has been storming the bee journals of late—ventilation or no ventilation of the hive in winter. To be sure, the foul brood cures are in a most disordered condition at present, mainly because each man strives to hold up his cure as *the* cure. A doubtful appearing phase of Mr. McEvoy's description is in the origination of the disease. Another thing he says that all drugs are "worse than useless." When I was in Colorado, last year, in Boulder county, a big county and a great deal of foul brood existing, I talked with a Mr. Adams, whom I had reason to believe to be an efficient inspector, and he told me that he not only cured the disease with a drug (it may have been salicylic acid but he called it by another name) but by pouring the same in a diluted form on the tops of the top bars occasionally the bees would track it all through the hive, thus preventing or checking the progress of the disease. A prevention is better than cures. He mentioned his own apiaries and the apiaries of several of his neighbors which by this plan had been kept healthy for years while apiaries had died rotten with the disease all about them.

The more I read the more the confusion, and my next move toward certainty would be to buy a few foul broody colonies and try all the remedies.

As the season is so far advanced, experiments on wintering will probably be the more seasonable.

I have not the least doubt but whole apiaries may be wintered safely with or without ward ventilation and whole apiaries die both ways.

I think Mr. Heddon demonstrated that he could winter bees in almost any temperature and with any or no ventilation by taking away their pollen. The principal objection to his plan by the average bee keeper is changing their food and excluding the pollen.

Mr. H. R. Boardman, I believe, uses no upward ventilation and always winters successfully, but it is more than likely he makes the conditions of his repositories such that he himself can not explain or the average bee keeper understand and apply.

Some years ago Mr. Ira Barber created quite a sensation by relating his method of wintering in a very high temperature. Then he became quiet and his method was forgotten.

The next thing that came up, Dr. Miller began to insist that it was foul atmosphere in the cellar that made bees noisy and roar.

When Mr. Barber gave his method we all supposed that with so high a temperature if we should enter the repository with a light the bees would all leave the hives and come for it. By testing Dr. Miller's pure air theory it was found that a high temperature would not cause them to fly out.

In experimenting with upward ventilation I went so far as to remove 115 colonies entirely from their hives and hang them upon racks in the cellar as we hang store-combs on racks in the honey house—no covers, no sides, no bottoms. I visited this repository twice and sometimes three times a day all winter; that was in northern Iowa. I noticed that sometimes the cluster would be disturbed and sometimes not and wondered why this difference, and finally observed that it varied more or less according to the temperature out of the doors. A low temperature outside caused a hasty change of air in the cellar even if it was obliged to make the change through the cracks. When it was warm outside the air remained close and stagnated. On the first day I began to put these clusters of bees in hives and carry them out onto the summer stands, it was required to keep the cellar darkened and even then there was a great commotion. The following night the doors were opened wide in order to cool the cellar. The next morning these bees could be handled easily with doors all open and I thought it was the cool air but when I continued to manipulate their combs until the day got warm and the sun shining right into the cellar, I began to be amazed. Sometimes a person will come to the conclusion that he is becoming magical and can do anything he undertakes. Then again he finds out that all his attempts fail. It may all be caused by some small hidden condition.

I read and weighed Mr. Barber's high temperature method, but Miller's pure air requirement I did not know of. When I came to test Miller's pure air I had forgotten Barber's high temperature.

Now it is quite an undertaking to keep both a high temperature and pure atmosphere through a long cold winter.

You may study the bee journals and you will find that the majority of bees that winter well are kept in a temperature of 45° to 50° with some ventilation. Those who do

this seldom have reason to complain of loss.

If the temperature is higher than this the bees get restless simply because the air is impure.

If the temperature is lower than this, say as low as freezing, the bees remain nice and quiet, but, eventually the combs are covered with sweat which causes them to mould, the honey sours, the bees finally befoul the hive and it turns out a most wretched affair.

Forty-five to fifty degrees then is the zero point between pure atmosphere and temperature, *i. e.* between quiet and moisture.

When my bees used to be so noisy in the cellar and affected by every little light or rise of temperature, I often wondered why they remained so quietly in their hives during the night in summer.

Individual colonies are often known to be set out of the cellar and it takes several hours for them to begin to fly from their hive though the warmth of the day and sun are the most enticing; then when they *do* fly there seems to be little excuse for it beyond a little joyful play spell and many times colonies were so slow to get out that I made examinations to see if they were dead or out of food.

The lower the temperature of the cellar is the earlier in the winter will the combs be covered with moisture and the nearer the moisture will locate to the cluster of the bees. Moisture will accumulate wherever there is a difference of temperature between the cluster and the surrounding atmosphere, and where there is any thing for the moisture to attach itself to. When the temperature is 35° to 40° it shows itself in about a month. Forty-five to fifty degrees, 2½ months, more or less.

Often the bees seem to winter well and come out populous the middle of April, but by the 1st or 10th of May we get very anxious for the little patches of capped brood to hatch out to replenish the swiftly disappearing forces of workers. There seems to be something amiss in such management when at other times the old workers "hang on" until late in June or July, and it is my opinion that there is not so much for the salvation of the bees in the food they eat as in the air they breath.

The requisite probably is *pure food* and *pure air*. Cold air is detrimental only by its effect through the agency of moisture.

A high temperature will dispel the moisture but to maintain a high temperature and

pure atmosphere throughout the winter is laborious and expensive. Forty-eight is not high enough; it only delays the effects a month or two, but our winters are long enough to encompass all such lengths of time. Sixty-five degrees may answer, but I am doubtful. If a sufficiently high temperature is applied until the threatening symptoms disappear the former low temperature may be allowed and it is far easier and cheaper to keep up a temperature of 70° for a month than 45° all winter and the air may be enough purer by ventilation to materially lengthen the lives of the bees. In fact the bees need treatment to the high temperature just as much at 45° as at 32° only a little later on.

When I gave my experience in wintering sometime since, the editor considered it so much trouble to move the bees into such a repository and back again.

Of course it was some labor for me to carry a hive at a time up stairs, but Mr. B. Taylor would soon invent an elevator to move eight or ten at once and it would not cost a fortune to make it.

It is not necessary to be so very careful in handling hives either, as when the bees come out they simply run around and join another colony, when if it is in the colder repository they fall to the floor and die or the bees of the cluster sip up the moisture and become diseased.

The constant and continued watching and fussing with its attendant anxiety is almost as hard to endure as a total loss and it does not begin nor end with the six months of confinement as we are in doubts when the bees are set in and we are not "out of the woods" until late in June, when by the method of which I write each colony may be divided when set out of the cellar and the vitality of the bees will enable each half to build up for the harvest.

There is nearly as much variation in the winter temperature of different cellars as there is in the quality of different soils, and Mr. Barber happened to have a high tempered one where it was easy to keep the temperature high all winter and he may not have taken the trouble to ascertain the real whys and wherefores of his excellent success or whether a less length of duration of high temperature would not have been as well and certainly more practical for and better afforded by the general class of bee-keepers.

PASADENA, Calif.

July 29, 1893.

Practical Breeding.

JAMES HEDDON.

How doth the little lazy drone,
With industry bred in his bone,
Industrious children sire!



WHOEVER has visited many apiaries, or bought bees of farmers to start an apiary, well knows the great difference in the nature and working qualities of different strains of bees of the same race, or races. He also knows of what

great value is this difference. I am sure that all of you have noticed the immense difference in the stinging qualities of different colonies in the same apiary. What causes this difference, it is hard to tell, and certain it is that the difference cannot be detected in any way whatever, except by practical results. Here are two colonies, as nearly alike as can be seen or made; or perhaps No. 2 is, as far as the expert apiarist can judge, the likelier colony of the two. Both are in the same yard, and work in the same fields and on the same blossoms, we are quite sure. But, lo, the results are surprising to the inexperienced: No. 2 stores more than twice as much honey as No. 1, and all the time is no more numerous in workers. Well, it is not at all strange that this great difference in capability should exist in the physiology of the bee, consequently wholly out of sight of the bee-master. But because we cannot detect these valuable qualities in any way other than by actual test, it is no sign we should not foster and propagate them. There is every reason why we should, because of the immense advantage to be gained by so doing, and certain it is that the practical evidences are positive, leaving no mistake as to what qualities we are breeding.

I will now proceed, as briefly as possible, to tell you what experience has taught me to be the best way; in fact it seems to me the only practical way, in a locality like my own, to bring my colonies up to a high standard. In the first place, I have been able to control my field to that extent that in my home apiary of over two hundred colonies, I own nearly all the bees in my field. I have about fifteen hives that purposely contain about

one-third drone comb, and I so manipulate them as to keep my most productive and good natured colonies on those drone combs. All other hives contain almost exclusively worker cells. If I lose bees in winter, in handling over the combs of the dead colonies, I mark the hives containing the drone comb, and into these I put the increase from those best colonies. In other words, I keep the air full of drones from the very best colonies in my area. It goes without saying that when rearing queens, I breed from the best colonies. But if one will follow this simple, easy and practical drone rearing system, it will not be many years before his apiary will be markedly superior, even if the bees are allowed to do all their own queen rearing, wholly unaided by the bee-master.

DOWAGIAC, Mich.

Aug. 23, 1893.

Bee-Keepers' Review.

PUBLISHED MONTHLY.

W. Z. HUTCHINSON, Ed. & Prop.

TERMS:—\$1.00 a year in advance. Two copies \$1.90; three for \$2.70; five for \$4.00; ten or more, 70 cents each. If it is desired to have the REVIEW stopped at the expiration of the time paid for, please say so when subscribing, otherwise it will be continued.

FLINT, MICHIGAN, SEP. 10, 1893.

THE APIOULTURIST occasionally publishes what might be termed an unpleasant truth; but if Bro. Alley could only soften some of his remarks with the "milk of human kindness" they would be much more palatable.

E. KRETCHMER says in *Gleanings* that he thinks the Langdon non-swarmers failed because it was not applied soon enough—that the swarming fever had already been started before the device was applied. Another reason is that not enough ventilation is given.

POSTAGE on queens to Canada was formerly ten cents, and I have only recently learned that it is now the same as our domestic postage. S. F. Trego called my attention to the matter, saying that he had paid only one cent an ounce for a long time. I consulted our postmaster, and find that Mr. Trego is correct. If any of you have been paying ten cents, don't do so any more.

JENNIE ATCHLEY has sent out nearly 5,000 queens this season. She has reared all of them except about 600. I tell you the North has no business with queen rearing, as compared with the South.

SECTIONS that are being scraped clean of propolis must be supported in some manner while the work is being done, and *Gleanings* asks how best to support them. I have always held the section in my left hand and used the knife with the other. I supposed that was the way everybody did. If there is a better way I should be glad to know it. The scrapings go into a box or empty hive placed at my feet.

EXPERIMENT STATIONS in three or four different places in the United States would, in the opinion of some very good people, be a sufficient number. When we have that number in successful operation we can tell better whether more will be desirable. At present there is no occasion to call a halt. The most important point of all is *the men secured to do the work.*

THE CANADIAN BEE JOURNAL under its new management compares favorably with the other journals. It is well printed on good paper, the make up is neat, and there seems to be some *life* in its reading matter. If Bro. Holterman can only keep it up to the high water mark at which it has started, it does not seem as though there need be any question as to its success.

ROBBING in the apiary, that is, the annoyance that comes from the few bees that follow the apiarist about in times of scarcity and become more numerous as the work is continued, may be avoided by having a few combs of honey in hives piled up near the apiary, and allowing so small an entrance that only one or two bees can pass at the same time. Queens and cells are also more readily accepted. In short, it is something the same in its effects as a small honey flow. E. R. Root writes of this in *Gleanings*.

THE "QUERIES AND REPLIES" departments that have had such a "run" in some of the journals, bring information upon the stage too late in the "play;" at least, so thinks the

editor of the *Progressive*. He says that a man seldom inquires until he wants to know, and by the time that the replies are gathered and printed it is too late for that year. There is another objection: to many questions it is impossible to give a correct answer unless it is qualified, and there is not room for much of this. Still, I think these departments have conveyed a large amount of useful information.

THE NORTH AMERICAN BEE-KEEPERS' Association will hold its 24th annual convention in Chicago, on the 11th, 12th and 13th of October. The meeting will be held at the "Louisiana Hotel," corner of 71st street and Seipp avenue. Comfortable accommodations will be afforded at a moderate price. For a small room two persons pay 75 cents each, daily. Larger rooms occupied by two, \$1.00 each. Four persons occupying a room having two beds will pay 50 cents each. Meals can be obtained at the hotel or at the numerous restaurants in the vicinity. The hotel is only a few minutes' walk from the south entrance of the Exposition. An interesting programme is being prepared, and the coming meeting will be one that few beekeepers can afford to miss.

"BEES VERSUS MANIPULATION" is the title that I should give an article contributed to the *Canadian Bee Journal* by that old veteran, G. M. Doolittle. His argument is that a field yields only about so much honey, and that more of it is secured to the bee-keeper if fewer colonies are kept and these so manipulated that they will be in the best condition possible to gather the crop. He assumes that the colony left undisturbed consumes just as much honey as the one stimulated to the greatest brood production. I think these two assumptions are unwarranted, that is, that the yield of nectar is always the same and that the consumption is the same per colony regardless of manipulation. In regard to manipulation or work in the apiary, do nine cents of work whenever it will bring in ten cents of pay, but if this same work can be made to bring in fifteen cents, so much the better, and it is my honest conviction that the majority of beekeepers lose money by not keeping more bees and then adopting such methods as will allow the same amount of work to care for the bees.

WHAT TO DO WITH FOUL BROOD.

A few months ago *Gleanings* printed what, it seems to me, was the best short article I ever saw upon foul brood. It briefly, clearly and concisely gave the symptoms and told how to get rid of it by putting the bees in new hives, giving cautions as to how it should be handled. Very wisely, the *Api.* copied the article, and says it is good advice, except that it is better to burn the hives, bees, combs and all.

If I owned a large apiary, and only a few colonies were affected with foul brood, and I knew that they were the only ones diseased, and that by burning them I should free my apiary of the pest, I should perform the burning act, rather than take the risk of curing the few diseased colonies. If I should find a large proportion of my apiary afflicted with the disease, I should cure the diseased colonies at the risk of infecting the others. I say at the risk of infecting the others, as there is a risk, but an intelligent bee-keeper, who understands the disease and knows how to cope with it, may make the risk a very small one. To destroy a large portion of an apiary, when by perseverance and determination, coupled with knowledge and caution, it can be saved with a very slight loss, is not good generalship.

The most of my readers know that Mr. R. L. Taylor has had a long and wide experience with foul brood: in fact, he has reached that stage where he no longer fears it. If it comes, he feels that he can handle it to such a certainty that it will not get the start of him. When I was over there last summer, I asked him if his apiary was entirely free from it. He said there were two or three colonies in which it was still present. He added that he might have been entirely free from it had it not been that he had had on hand a large lot of empty combs, and some of them, he knew not which, had contained foul brood, and he wished to use these combs. He preferred to use them and keep a close watch, treating the cases of foul brood as they developed rather than destroy the combs or even melt them up into wax. And this from a man who owns a foundation machine.

BEE-DYSENTERY, ITS CAUSE AND PREVENTION.

Homeopath "similibus curantur,"
Allopath big-pillibus banter,
Faith-o-path pietas enchanter—
And get well on the canter.

[The following "leader" is an article that I contributed to the *American Bee Journal*, and

which appeared in its issue of August 31st, 1893, but it occurs to me that, as the wintering season will soon be here, and we have never had a thorough discussion of this subject all in one issue, it may be well to take it up for special discussion in the October REVIEW. It is true that we have discussed food, temperature, ventilation, moisture, etc., but we wish now to consider them collectively in their relations one to the other and to the subject now singled out for special discussion.—Ed.]

"Of all the obstacles with which bee-keepers of the Northern States have to contend, none equal the losses of bees in winter and spring from dysentery. Many are the causes to which it has been attributed. Cold, confinement, improper food, dampness, "pollen," lack of food, or ventilation, etc., etc., have all been blamed for this trouble.

The disease, if such it can be called, is simply the result of an over-loading of the intestines. Cold confines the bees to their hives until they are unable to longer retain their feces, and the result is termed dysentery. Simple enough on the face of it isn't it? Doesn't seem as though there could have been so much discussion about it, does there? Well, it comes about something in this way: One man says it is caused by the cold. Another says "No, it isn't. We have long, cold winters here, yet *my* bees do not suffer from dysentery. If it were the cold they would have it." He doesn't consider that his location may furnish a different class of food. Another says confinement does not cause the trouble as *his* bees were confined in the cellar so many months and suffered little or nothing. This man forgets that in a warm cellar much less food is consumed, and, consequently, the longer it takes to over-load the intestines. Another lays the difficulty to the consumption of pollen. Another says "No, my bees have plenty of pollen in the hives and they never have the dysentery. If pollen causes dysentery, why don't they have it?" This man forgets that pollen in the *hives* does not cause dysentery, it is its *consumption* under such conditions that the bees cannot unload the intestines. We may not know exactly what are the conditions that cause an undue consumption of pollen, but we do know that in almost all cases of bee-dysentery, the fecal mass is almost wholly pollen. We also know that when bees have no pollen in their combs, when their only food is pure cane sugar (honey contains some grains of pollen) they do not have the dysentery under the same conditions when bees with natural stores have perished by the wholesale. I feel quite

certain that bees with only pure cane sugar for stores, placed in a cellar where the temperature is about 45°, will bear a confinement of four or five months with no traces of disease. Some honey is nearly as good as sugar for winter stores. At least, bees have many times passed the winter with it for food and came out in the spring with perfect health. The difficulty is to always know when honey is a healthful food for winter. There are some sections of the country where it never is. Mr. Byron Walker in the eastern part of this State, near large swamps, could not successfully winter bees. He tried almost all known methods for a dozen years or more, and finally moved to another locality where he is more successful. Before he moved away he practiced brushing bees from the combs in the fall, and killing the bees. They were certain to die in the winter, and he reasoned that he might as well save the honey that they would consume, and keep his combs in a clean condition. In the spring he went South and bought bees by the car load and stocked his apiary again. To be able to decide in regard to the suitability of honey as a winter food for bees would be a great step. If a bee-keeper could send a sample of his honey to some chemist and learn if it were safe for his bees to winter upon, it would be a grand thing. If it were not, he could extract it and feed sugar. What is it, aside from the floating pollen, that makes some honey unsuitable for a winter food for bees? This is a hard nut for our Experimental Apiary to crack.

To remove all of the honey from an apiary when we do not *know* that it will prove an unsafe food, and substitute sugar, for the purchase of which we may not have the ready money, with honey of slow sale, is a proceeding that would not be considered business-like. Bee-keepers prefer to take the risk, one year with another, of leaving their bees their natural stores, when these stores are apparently well ripened honey, and then using all other precautions possible to ward off the ill effects of confinement.

If we could only tell in advance what the coming winter would be we would know whether to put the bees in the cellar or to protect them on their summer stands. If bees could have one or two good purifying flights during the winter, I should prefer to winter them in the open air. But of this I cannot be assured, and, as they winter no worse in the cellar in a warm winter than

they do in a severe one, I prefer the latter plan. It is possible that the house apiary may yet furnish the advantages of both methods—warmth and an opportunity for flights when the weather permits. In the cellar we can control the temperature, also the moisture to a certain extent. If we give them sugar stores, we then have everything under our control except the length of the confinement, which will not usually vary sufficiently to undo our plans. It is only by cellar wintering that we can have the same conditions year after year. Just a few more words about stores. Ordinary colonies in a warm cellar consume about two pounds per colony each month. These stores are taken from the center of the hive. By feeding each colony seven or eight pounds of sugar syrup at the end of the season, it will be stored in the center of the hive, and it will be largely this food that the bees will consume during their confinement. This is almost the same as their having all sugar stores. Where a man winters his bees year after year with no trouble from dysentery, all these precautions are unnecessary. They are for the man who *does* have trouble.

To recapitulate: If the honey of any locality was uniformly good I would give but little attention to the food. If it frequently proved unsuitable I would feed sugar late in the season. I would leave the bees in the open air until there was slight prospect of their enjoying another flight; yet I would wish to have them in the cellar before the advent of snow storms and severe cold. I would take in the hives with no bottom boards and stack them up with two-inch blocks between the hives. I would carefully watch the temperature and never allow it to go below 40° nor above 50°. The temperature can be kept up by the use of an oil stove, but I would have a hood over the stove and a pipe to carry off the gases of combustion. If this pipe is connected with a stove pipe in the room above it will also help to ventilate the cellar when there is no fire in the oil stove. I would also have a wet bulb thermometer in the cellar and not allow the degree of temperature marked by the wet bulb instrument to approach nearer than 3° to that of the dry bulb, with a temperature of 45°. Just as soon as it was warm enough in the spring for the bees to fly I would remove them from the cellar. This may be two or three weeks or a month earlier than steady warm weather may be expected, but it will

be seen that an early removal shortens the confinement that much. When a bee has retained its feces three or four months, a further retention of three or four weeks may be all the difference between death and fair health. But I would not leave the bees without protection. I could pack them the same as I would in the fall if they were going to be left out of doors all winter, only I might not do it in so thorough a manner. So thick packing is not needed, and it may be held in place in the most simple and cheap manner. A super filled with sawdust will answer for the over head packing."

Now, friends, I shall be very glad of your views upon this subject for publication in the October REVIEW.

EXTRACTED.

Opportunity.

I do not know that I have ever copied a poem into the REVIEW, but I came across one the other day, entitled "Opportunity," written by Professor Sill, that struck me as so encouraging to those who sometimes lament their *lack* of opportunity, that I must let my readers enjoy it with me. Here it is:

"This I beheld, or dreamed it in a dream;
There spread a cloud of dust along a plain;
And underneath the cloud, or in it, raged
A furious battle, and men yelled, and swords
Shocked upon swords and shields. A prince's
 banner
Wavered, then staggered backward, hemmed by
 foes.
A craven hung along the battle's edge,
And thought, 'Had I a sword of keener steel—
That blue blade that the king's son bears—but
 this
Blunt thing—!' he snapt and flung it from his
 hand
And lowering crept away and left the field.
Then came the king's son, wounded, sore beset
And weaponless, and saw the broken sword,
Hilt-buried in the dry and trodden sand,
And ran and snatched it, and with battle shout
Lifted afresh he hewed his enemy down
And saved a great cause that heroic day!"

What the Experiment Station May Do for Bee-Keepers.

A servant of servants shall he be unto his brethren.

Some of the experiments that are to be undertaken at the Michigan Experimental Apiary have already been mentioned, but in

an article in the *Grange Visitor*, Mr. Taylor brings out the points so clearly that I think best to copy the entire article. He says:—

“Bee-keeping has been carried on for thousands of years but it is only within the recollection of living men that it has passed out of the mediæval, which was probably also the pre-historic stage. It is natural then, that in this, more perhaps than in other rural occupations, there should be questions pressing for solution. It is much that these questions are being propounded, questions for which until recently there was no basis, and this very condition gives promise of certain and valuable results. It is as if the gates were just opened and the apiarists were crowding forward to see what a view of the inside would reveal. The interest thus exhibited will be sure to observe and secure what is of value.

What the station may do for this class is to undertake the solution of these questions that are uppermost, by investigations which the members of the class cannot well undertake separately. For instance, in the matter of diseases of the bee there is much to be learned. It is well known that foul brood, the most dreaded of these diseases, is caused by a bacillus which is liable to convey the disease to any hive which it may enter. It is known that it may be carried from one hive to another in honey. May it be so carried in wax? May it be conveyed by a hive put into use again which had before contained the brood combs and bees of a diseased colony? If so, how may they best be disinfected? Whether the disease may be conveyed in wax made from combs from an infected colony and so carried from one part of the country to another in comb foundation, is a question of especial interest, and demands speedy and careful attention.

Again, it is a mooted question to what extent it is profitable to use comb foundation in the brood chamber. Of course a single experiment would not settle it, but if carefully pursued on a somewhat extended scale, the truth can be made known. At the station this season an attempt in this direction has been begun with twelve colonies. Four swarms were lived on comb, four on comb foundation and four on frames with starters only, and it is quite certain the results will be instructive. Then there is quite a large variety of comb foundations used. These are distinguished by difference in weight as well as by difference in the shape of the septum and of the side walls caused by differences in the machines with which it is made. Now some bee-keepers select the extra-thin, some the thin and some the medium; others choose that with a flat bottom, others again want that of the natural shape, and in almost every case the reasons for the choice are purely fanciful. Which is really the best? Which is least objectionable in the honey, and, by the use of which do the bees secure the most honey? By proper experiments the station should be able to tell the bee-keepers what is the truth in these matters.

It has been assumed that it is more profitable to have very strong colonies rather than

moderate ones during the time when the crop is being gathered. The station ought to be able to say definitely in time whether this is a sound assumption.

Looking in another direction we find from the very expectancy with which new claims and investigations are regarded, and the eagerness with which supposed truth is received, especially in matters where there is a promise held out of a saving of labor or trouble, that it would be desirable that there should be a place where new inventions in the way of apicultural appliances will be promptly and impartially tested, thereby saving individuals large amounts in the aggregate for what proves in the end to be useless traps; as well as introducing to them really useful implements which otherwise would be neglected from a fear that their purchase would prove a useless expense. Already in this line, experiments have been made with the plausible inventions known as the non-swarmers and self-hiver—experiments which should save the bee-keepers of the State much money if they will only read the published reports of their workings.

The foregoing may serve to give an idea of the nature of the work which the station ought to perform, and a hint to those interested of what benefit they ought to derive from it. Of course, other items of work should be undertaken as the favorable season of the year for them comes on, and a watch kept for the rising of new questions which seem to deserve consideration.

LAPPEER, Mich.”

Getting the Bees Ready for Winter.

It is seldom that I come across an article in which I can so fully agree with the writer as in the case with somebody who signed his name A. B. C. and sent the article to *Gleanings*. The only thing in which I do not agree with him is in putting the bees in the cellar as early as October. I cannot help wondering if that is what he really means. Bees often have several flights after that date and I think those late flights are a help to them in bearing the confinement that is to follow. I would leave them out a month later than A. B. C. advises. I quote from the article as follows:—

“I prepared my bees in several different ways for winter—chaff hives, sealed-cover hives, chaff cushions on some, others with folded gunny sacks between the frames and cover, or top-board. All except chaff hives were in the cellar. I also experimented with tight bottoms, Miller's bottom-boards, no bottom-boards, and wire cloth. As to the chaff hives, they seem to answer well for winter, only that they lost too heavily in bees. In the cellar the tight-bottom hives, both with sealed cover and pads, lost greatly in numbers by mold. The sealed covered hives all showed mold from condensed moisture. The Miller bottom-boards showed

considerably less mold, either with or without cushions; in fact, they were about as good as wire cloth, if the latter were left only a bee-space below the frames, thereby holding all the dead bees in contact with the frames.

Two things I am sure at present I do not want; namely, tight bottoms and sealed covers. Taking all things into consideration, I have arrived at the conclusion that the proper method of wintering is about as follows: There should be strong colonies on eight, nine, or ten frames, *without bottoms*, or at least wire cloth held about two or three inches below the frames by a wooden frame the size of the hive-bottom. The hives should be tiered as described in A. I. Root's circular, with a folded gunny sack between the tops of the frames and the top-board of each hive. The lower tier of hives should be two feet from the floor of the cellar, which should be dry and dark. Light, and extremes of temperature, have more to do in rendering bees restless than bushels of fruit and vegetables. They should be put away as described by about the middle of October, and allowed to remain as quiet as possible till the 1st of March, not later than the 15th, if there are some nice days so they can fly. When on the summer stands at this early date they should be protected against sudden changes of temperature."

Self-Hivers.—Another Novel, Non-Swarming Idea.

Perhaps he is right to dissemble his love
But why does he kick us up stairs?

Adrian Getaz contributes the following very interesting article to the *American Bee Journal*:

"Last spring I decided to make 30 self-hivers, and experiment with them. In principle they were similar to the Pratt hivers of 1892; that is, a box placed before the hive and connected with the hive-entrance by a queen-excluding zinc, with a cone permitting the queen to come into the hives, but not to go back. In fact, they were merely queen-traps transformed into hives. Another zinc in the front prevents the queen from going out of the hives.

The first experience was a mishap. My apiaries are both out of town, and other business requires most of my time. So one of the apiaries was a week and a half without attention. When I got there the people living on the place told me that one colony had swarmed every day for several days, and finally the swarm went off. Investigation showed five dead queens in the hives. The theory is, that the old queen was killed by the first virgin hatched, this in turn by the next, and so on. Probably the last one was reared from an old larva, and, as usual in such cases, under sized, and went through the zinc with the swarm.

Well, other swarms came, and were found in the hives, or at least the queens were, with

more or less bees. The thing to do is to move the old hive to a new stand, and leave the supers, about one-third of the brood, and the swarm, in a new hive on the old stand. Thus used, the self-hiver (except perhaps some particularity of construction) is certainly a success.

As a non-swarmmer it is a failure. The Dandants say that if a swarm is returned to the parent hive two days after swarming, the swarming fever being over, the queen will be permitted to destroy the cells, and the colony will not swarm, at least not until new preparations for swarming take place, if the circumstances are favorable to it. Henry Alley says that after a queen has been three days in the trap, she will be permitted to destroy the cells. Acting upon these suggestions, I waited two or three days, and then returned the swarms from the hivers to the old hives. I soon discovered that the majority were swarming again repeatedly, even twice a day. Investigation disclosed the fact that only one queen had destroyed all the cells, the others had only destroyed a part. This was not entirely unexpected. It is obvious that the swarms returned to the hive and left in the hiver are not in the same condition as those coming out with their queens, hived in a new hive, and then returned.

As to Henry Alley's assertion, I have to say that so many conditions influence the swarming of bees, that he may have succeeded under some circumstances, while he might have failed entirely at some other times.

Well, I then proceeded to destroy the queen cells myself. Only three colonies quit swarming; all the others persisted in swarming as long as they had either a queen or some brood from which to rear one. I persisted in returning swarms and cutting cells, and the bees persisted in swarming again and again. Finally, four or five queens 'turned up missing,' probably were killed. Then I acknowledged myself 'licked,' as Mr. Hasty would put it, I divided some colonies, and removed the queens from some others.

Here I have gained an important point. None of the colonies that had been *hopelessly queenless* for some time (from three or four days to nearly two weeks) offered to swarm again. It seems that when they find themselves without queens or brood (except capped brood) they give up all swarming notions and go to work. After new queens were given, they still kept on working regularly.

One or two points in regard to the construction of the swarmer: Excepting the one mentioned at the beginning of this article, no queen, so far as I know, has passed through the zinc. The cone ought to be placed so that the bees are not likely to cluster on the end of it, for when there is a cluster, they cannot go in and out easily through the cluster.

The most serious objection to the self-hiver, as I had it, was that it interferes considerably with the ventilation of the hive. My hives have ample entrances, the zinc be-

tween the hive and hiver was of large size (4x8 inches) with a space behind; and I thought that it would be sufficient. The trouble is, that in hot days some of the workers, and whatever drones are in the hives, cluster on the zinc and cone, and thereby obstruct the holes, and not only interfere with the ventilation, but also with the going and coming of the honey-gatherers. The drones live in the hive several days, being fed there by the workers. This particularity may sometimes be turned to advantage. They can be easily destroyed, except those that may be wanted for fertilization of young queens. When the queens are out, the front zinc of the hiver can be removed, and the select drones permitted to come out. Closing the cone will effectually prevent the loss of a swarm while the front zinc is open.

About June 25th some of the colonies were so large, and the weather so hot, that I had to remove most of the zincs (between the hive and hivers) to insure better ventilation. I left the zincs in front of the hivers. Even thus reduced, the hiver was yet very useful, as no swarm could go off. As a general rule any swarm going out and returning will try again very early the next day, if the weather is favorable. As a returning swarm hangs more or less outside the hiver for an hour or two after returning, by visiting the apiary between 10 a. m. and 12 o'clock, the apiarist can tell which hives have swarmed, and need attention.

After this experience, I doubt very much if the Langdon and Aikin devices to prevent swarming will work satisfactorily. I can only repeat what I said before, that it depends upon the circumstances; as to work always, I doubt it. The change from one hive to another where the bees are equally crowded could not abate the swarming fever. Mine swarmed from the hiver as well as they did from the old hive.

The revolving stand of B. Taylor was also a failure. The destruction of the queen cells by the queens cannot do any more good than when done by the apiarist. It seems very difficult to prevent the swarming fever entirely. We can give plenty empty room, but not plenty empty comb as those who produce extracted honey do. Non-swarming colonies get to be very strong, and therefore more or less crowded.

Summing up, I see three points which conform to the teachings of our leading writers, viz.:

1st. The impossibility of preventing the swarming fever entirely, when producing comb honey. Of course the actual swarming could be prevented.

2nd. As long as the swarming fever lasts, the colony is 'no good,' so far as gathering surplus is concerned.

3rd. The only ways to overcome the swarming fever are these:

a. Allowing swarming, or an equivalent, dividing. That is what Doolittle, Hutchinson, Heddon, etc., are doing. To obtain a surplus, they turn over to the swarm as much of the old force as possible, and whatever surplus is gathered already. This does not work very well here, for reasons that I will explain some other time. The old colony—

well, I don't know, but by their reports, I suppose that most of the time the old colony is so weak that it dies the following winter or spring.

b. Removing the queen and cells, and not returning the queen (or another one) until the colony has been hopelessly queenless for some time. This is practiced by our most extensive and most successful comb honey producers, such as Manum, Hetherington, Elwood, etc.

This will be my next year's experiment—as a help similar to the self-hiver, I want to try the following arrangement:

Have the hive so constructed that the entrance can lead either to the brood-nest or to the supers. Add to the hive, or rather to the brood-nest, a cone giving the necessary ventilation and permitting the bees to come out, but not to go back. At the opening of the honey-flow close the brood-nest, place a solid board between the brood-nest and the supers, so as to cut off entirely the communication between the two, and fix the entrance so as to send the whole force into the supers. Of course, the bees in the supers having neither queen nor brood will be hopelessly queenless and give up (?) any notion to swarm they may have. (Perhaps they will, and perhaps they won't.) The queen in the brood-nest with only young bees will destroy whatever queen cells may be started. Three or four days later the board between the supers and brood-nest can be removed, and the usual brood-nest entrance opened again. The operation can be repeated again during the honey-flow, whenever swarming may occur.

I'll let you know in a year from now whether the above scheme will work or not. At any rate, I think if it fails as a non-swarm-er, it will be splendid to start work in the sections, and could also be used in lieu of contracting the brood-nest, if this is desired at the end of the season.

KNOXVILLE, Tenn., July 10, 1893."

As to what becomes of the old colony when it is robbed of what surplus it may have on hand at the time it swarms, also robbed of its flying bees for the first week after swarming, I will say that it usually proves to be the best possible kind of a colony the next season. It has a young queen and it goes on and raises enough bees for winter, besides this, if it has swarmed early, it sometimes furnishes some surplus besides. If either of the two are likely to succumb, it is the swarm with its old queen and contracted brood nest. It must be given more combs in the brood nest as soon as the white honey harvest is over, and fed a little if there is no honey flow, or else it must be united with some other colony. I have reference to cases where *severe* contraction is practiced—where only four or five Langstroth combs or their equivalent are allowed in the brood nest at the time of hiving.

The idea of throwing the working force into the *supers* instead of into another hive is certainly novel, and just how it would work is difficult to foresee. I honestly believe that one thing will lead on to another until the prevention of swarming will eventually become practical and profitable.

are coming on, and will accept the occasional foot-note in the place of the everlasting one ere long. And for the present we lose the closing chapters of Langstroth's *Reminiscences*—unavoidably of course.

In return for these losses we have several items of gain. The new department of Trade Notes is one. This is designed to give proper recognition to new devices which are offered for sale. Having such a department will keep the editor on the look-out for something to put in it: and so the new hives and "fixins" will not be so much in danger of being overlooked. Good idea. Then we have Jake Smith. Now Jake is a humorist of considerable ability, and I have no desire to blow cold on him; but one thing I can't get reconciled to, and that is the *idea* of having *two* regular humorists appear in each number of a bee magazine. Too open a confession that apiculture is played out, and that horse-laughs must take its place. I don't believe the allegation, and therefore incline to get a little ferocious toward any editor who gives it countenance.

The most important of the recent changes is the appearance of Wallace P. Root as a writer. In this world some workers are greatly overpraised, and some are as greatly underpraised. Wallace is one of the underpraised ones. Probably not one-half of those who read and love *Gleanings* have any idea how much the eminence and stability of that paper is owing to Wallace P. Root—its accurate proof reader, its tasteful make-up man, its translator of languages, its stenographer, its general utility man and factotum. Readers have noted the phrase "our stenographer" perhaps; but whether his name was Adam or Melchizedek they didn't remember. Possibly my impression may be a little astray, but my idea of the man is that he has for many years been "singing the whole gamut"—doing, on occasion, pretty much everything from writing editorials to picking up the peanut shells which careless people throw on the floor. Now that he not only writes articles but signs them, we owe him a "howdy" and shake of the hand. And, friend Wallace, seeing you are still half a stranger to many to whom you ought to be as household words, quit that W. P. R.—get out of bare bones, and sit with your alphabetical flesh on.

Now as to his present series of articles on the old bee books. Of course we must not expect warm blood out of cold turnips, nor

A Condensed View of Current Bee Writings.

E. E. HASTY.

I THINK the first honors this month belong to Willie Atchley, who is not yet seventeen, for an improvement in the queen-rearing process. He changes the Doolittle model on which the queen cups are cast so that his cup represents the base of a queen cell with $\frac{1}{4}$ inch of worker cell in the bottom of it. The latter is flared so that a real worker cell will slip in and wedge tight. Now the inside of a cell in which brood has been reared a few times is not wax, but woven silk; and when the comb is shaved down with a razor as far as it can be without disturbing the little larvae the silken base can be lifted out with fine tweezers, jelly, baby, cradle and all, and put securely into its destined place. Time saved, baby saved from bruises and punches, and the risk of having the bees condemn the job saved to some extent. I may add that it would be a great saving to the operator's nerves, if he were green like me instead of being experienced like Willie. *Gleanings* illustrates his invention on page 600.

GLEANINGS.

This time it is how a great oak has grown and developed, and not the growth of a little and recently sprouted acorn. A bit ago, but longer ago than these papers, Prof. Cook used to be in every number from once to half a dozen times, with his bugs, and bee plants, and bees, and rattlesnakes, and general fund of wisdom. We miss him somewhat; yet *Gleanings* seems well able to endure the loss of any one writer. The oak grows on still, though among its branches one 'possum goeth and another 'possum cometh. We also have half lost the "everlasting foot-note." As this was *Gleanings'* most prominent individuality it takes some time to get used to doing without it; but we

much scientific accuracy in apicultural literature several generations old. And very little practical light as to how we can best produce honey in this year of grace 1893 is to be had from such a source. It is sufficient for the occasion if Wallace makes us pleasantly acquainted with the contents of these queer volumes without the trouble and expense of owning and reading them—and a heavy spanking for the groveling bread and butter man who don't want to know the ancient status of his handycraft. If the ancients knew little of bees they scribbled about them diligently all the same, as we read that about 400 works were compiled for the oldest save one of the volumes reviewed (Samuel Purchas 1657.)

"Probably the English of those days never dreamed that queenhood and utility ever exist in the same body, and hence a queen in the hive was supposed to be as useless as one on the throne."

The oldest of the lot is Butler's *Feminine Monarchy* (1609), which is two years older than our English Bible, and 166 years before the Revolution. But the title is proof that Butler knew more than some log gum chaps of the present generation—didn't call her "the old king." He also gives us the germ of the modern frame in wooden bars at the top to which combs were built. He notices that bees have poor eyesight—the cause and extent of which is to this day unsettled. He knew (what our average population have not yet learned) that it was usually safe to walk quietly around among bees, while in standing still near their entrances one catches it. And (human nature) he was distressed as much as we are by the *ignorance* of those who went before him. And, anon, he tells how bees were made to build a miniature church, with steeple and windows and bells. A Catholic woman slyly brought home the communion wafer in her mouth and gave to them.

Rusden (1679) having got queens to lay in his hand, found in the fact proof exactly opposite to the truth—they were kings! Lots of Rusdens with us still—make up their minds how a thing is first, and then whatever turns up is proof.

"In 1685 Stelluti published a description of the parts of a bee which he had examined through a microscope."

Here the morning dawns at last. Of course dunderheads will continue for a few generations to ignore the morning light and reiterate the midnight traditions, but the end is no longer in doubt.

And how about the other strong men of *Gleanings*? A. I. is still at high pressure gardening and strawberries; and Ernest nicely holds the even tenor of his way at editing. Both with great facility are flashing to and fro upon their wheels, Ernest after bee facts, and his father after garden facts. By the way the latter's wheel gained terribly upon the wheels of Time and Genesis when he got the heathen children, born under the ministrations of John Williams, parading and carrying banners just one year from the good missionary's arrival. Never mind. Somebody's Christian teaching saved the children from being murdered. But what a solemn thing is *impartial* history. The same John Williams who spread the name of Christ spread also the curse of tobacco wherever he went. But those young folks at Medina, especially that little boy who moved his playthings out of sight of the circus when he had made up his own mind not to go, I don't see as any discount comes in there. May some reviewer sometime write "Huber Root, the best editor, take him all in all, that *Gleanings* ever had."

Our Rambler still rambles, and improves as he goes. Our Miller still grinds—grinds straw—but lo, out of the butt end of the straw there spins a stream of good flour. And our Doolittle still contrives to do a little in the interests of apiculture. After so many years of writing, for so many different papers, the way Mr. Doolittle maintains the freshness and interest and practical utility of his writings is certainly very remarkable. Time was when he was showered thick with praises. Of late the fraternity seem to have quit off from praising him—perhaps on the same principle that Homer refrains from praising the beauty of Helen—a man must be a fool not to know without telling that Helen was beautiful. But as some brethren, in whom I fear the wish is the father of the thought, venture to hint, or more than hint, that Doolittle has written himself out, perhaps it would not be a bad plan for us once more to say what we think of our foremost apiculturist. I sample recent utterances as below.

Does rain cause robbing? No.

"During a heavy yield of honey, bees seem almost glad of a rest for at least 24 hours." Page 638.

"In all my experience for the last 25 years, I have never known of a single egg being conveyed from one cell to another; but in scores of cases I have known LARVAE to be transferred." Page 556.

A grand tangle of four prime swarms in one day put 178 little larvae into as many queen cups they had made.

"A hive that has 20 lbs. of honey in it on the first day of April will, as a rule, give double the bees at the commencement of the clover harvest that one will which has only five lbs." Page 514.

"One bee load of nectar from the basswood, in a dry warm time, is equal to three from white clover, or five from the teal." [So little water.] Page 470.

Cutting foundation.

"One day when I was in a great hurry I drew the knife through the foundation as quickly as possible, when, lo and behold! the whole sticking matter was solved," Page 296.

TAKEN TO THE BARN.

I'm sorry to see how editor Alley gives way to his besetting fault in the August *Apiculturist*. Several offenses, of which this is the worst.

"The Canadian Bee Journal has been burned out. Since that paper published a batch of lies concerning the editor of the *Api*, we have no special interest in it."

My boy, Christianity centuries ago shut down on this sort of thing; and that ought to have been sufficient, but somehow it was not. Of late years Civilization has taken up the job which Christianity seemed unable to complete. She actually bears down hard on those who give the word "lie," even if the charge is in a measure true. She ruminates on general principles that black lies of the worst degree are not common; but twisting the truth, and ignoring the truth, is so fearfully common that usually there is lots of it on both sides when two editors quarrel. As a rule you can't get her to look deeper than these general principles; and she feels miserably bored to hear editors call each other liars under such circumstances. And this further offense—dancing an Indian war dance over your adversary the minute a great calamity overtakes him—she loathes that particular offense. And she's safe to wreck the prosperity of any paper or editor who persists any great length of time in keeping that far in the Dark Ages. There, my son, I hope I shall never have to take you to the stable again.

THE GENERAL ROUND UP

Dr. Miller had a young queen pipe while he was holding her cell in his fingers. With the sound he felt a surprisingly strong jar. Of course if the spunky little lady could jar so big a man she could jar the whole hive when in it; and now our best evidence that bees can hear has gone glimmering. What scamps investigators are!

Friend Miller also finds that sheep crowd hives out of place as bad as cows, and worse than horses. Rabbits then? My "animile" is the hoe; but he crowds *me* out of place too much.

Just notice how the workers at the bee escape are drifting in company toward an *intermittent* escape, one that first frightens the bees, and then lets them loose in a flock outside the hive, within smelling distance of the entrance. Don't all say "My invention" at once, boys. Friend Handel honestly reports that his cost-nothing paper escape fails badly when there are crowds of drones and young bees.

The experience of improved agriculture driving out bees has recently been repeated in no less classic a place than Bethlehem, the birth place of the Lord. See Baldensperger's article, *Gleanings* 632.

S. F. Trego in queen breeding helps out the work of his select mother by having the cells started with hybrid larvae, and then picking them out and putting in pure ones. *Gleanings* 528.

Muth says the night temperature must be above 55° else white clover will not yield.

J. D. Fooshe judges the time when, and the quality how good, of his bees destined to raise queens by the plaintive moan they send up when the hive is opened. When they sob out "We've no mother at all, and not a baby in the house," then they can be trusted.

Thousands of pounds of foundation, in which mineral wax is one ingredient are sold in Germany. So says H. Reepen. *A. B. J.* 206. There appears to be no attempt at concealment, and a general what-you-going-to-do-about-it feelin'.

Alberti, a German editor, cut off a branch, thoroughly clearing it of honey dew and insects, and made it exude more honey dew while in his room. I suppose he would say to our doubters, "Vhot kinds mit insect honey ish dot?"

If ants bother you read Dayton (*A. B. J.* 112) and be cheerful again—and thankful you are not in California.

Jennie Atchley has found the best place, and is going there.

And anon Reepen pokes fun at our Doolittle because he has to kill bees to see what they carry. (We do kind o' like to see Damascus blade cross Damascus blade.) As for himself, the tiny drop a bee can be made to disgorge is sufficient not only to taste but to *remember*. Then he catches bees at the

hive and tells what flower they have visited. My, my, my! See *A. B. J.* 109.

Wanted to condense the Langstroth articles in the last *Apiculturist* but, alas, must postpone.

RICHARDS, Lucas Co., Ohio, Aug. 21, '93.

ADVERTISEMENTS

Muth's HONEY EXTRACTOR
PERFECTION
Cold-Blast Smokers,

Square Glass Honey Jars, Etc.

For Circulars, apply to CHAS. F. MUTH & SON,
Cor. Freeman & Central Aves., Cincinnati, O.
Send 10c. for Practical Hints to Bee-Keepers.

1-93-tf.

Please Mention the Review.

—If you are going to—

BUY A BUZZ-SAW,

write to the editor of the REVIEW. He has a new Barnes saw to sell and would be glad to make you happy by telling you the price at which he would sell it.

IMPORTANT TO BEE-KEEPERS!

To make a success of bee-keeping, you want bees that will give the very best results. My *Golden Italians* have gained a good name on their own merits. Those who have tested them with other bees say "they are the best honey gatherers, cap their honey the whitest, as gentle as butterflies, beautiful to look at, are the largest and strongest bee of all the races." Queens bred from mothers that produce uniformly marked

FIVE-BANDED WORKERS

In March, April and May, \$1.25 each, 6 for \$6.00; June, \$1.00 each, 6 for \$5.00; July to Nov., \$1.00 each, 6 for \$4.50. Special prices on large orders. For full particulars send for descriptive circular.

12-92-1f

C. D. DUVALL.

Spencerville, Montg. Co., Maryland.

Illustrated Advertisements Attract Attention.



Cuts Furnished for all illustrating Purposes.

TYPEWRITERS.

Largest like establishment in the world. First-class Second-hand Instruments at half new prices. Unprejudiced advice given on all makes. Machines sold on monthly payments. Any instrument manufactured shipped, privilege to examine. EXCHANGING A SPECIALTY. Wholesale prices to dealers. Illustrated Catalogues Free.

TYPEWRITER } 31 Broadway, New York
HEADQUARTERS, } 186 Monroe St., Chicago.

Bind Your Back Volumes.

The back volumes of the REVIEW are somewhat different from those of some journals; many of them are, to a large extent, little pamphlets devoted to the discussion of special topics. For this reason they will always be particularly valuable for reference. But how provoking it is when desiring to consult some back number, to find that that particular number is missing—has been lost or mislaid. To avoid such annoyance, some have fastened together the issues of each year by tacking them together with wire nails, or something of the sort. This is better than nothing, but there is a lack of flexibility, the book does not open out easily so that it can be read, there is no protection to the outside leaves, besides there is nothing handsome about such an arrangement.

There is a book binder here in Flint that does excellent work at a fair price. He will put the first five volumes of the REVIEW into one handsome volume with morocco back and corners, putting the title on the back in gilt letters, and giving the edges of the leaves a neat, reddish tinge—all for \$1.25.

Send me your back numbers, either by mail or express, and I will get the work done and return the book when bound, making no charge for my services, as the binder allows me a small commission, and should any of your back numbers or volumes be missing, I shall be glad to furnish them as long as the supply lasts, simply charging the regular price for them, which is as follows: Vols. I and II, five cents a copy; Vol. III, four cents a copy; Vols. IV and V, eight cents a copy.

The time will soon come when some of the back numbers will be difficult to obtain, and if you care for the REVIEW complete from the beginning, nicely bound, now is the time to attend to it. W. Z. HUTCHINSON, Flint, Mich.

HONEY ALMANAC AND BEE BOOKS, OF ALL KINDS, A LARGE STOCK.



MY NEW ILLUSTRATED Catalogue and Price List of Supplies for the Apiary will be sent free to all who may apply. Send a postal card for it, writing your name and address plainly. For every Order of \$10.00 and over, I will make you a present. The Catalogue tells you all about it.

T. G. Newman, 147 So. Western Ave., Chicago.

Names of Bee-Keepers.

TYPE WRITTEN.

The names of my customers, and of those asking for sample copies, have been saved and written in a book. There are several thousand all arranged alphabetically (in the largest States) and, although this list has been secured at an expense of hundreds of dollars, I would furnish it to my advertisers at \$2.00 per thousand names. A manufacturer who wishes for a list of the names of bee-keepers in his own state only, or, possibly, in the adjoining states, can be accommodated. Any inquiry in regard to the number of names in a certain state, or states, will be answered cheerfully. The former price was \$2.50 per 1000, but I now have a type writer, and, by using the manifold process, I can furnish them at \$2.00. W. Z. HUTCHINSON, Flint, Mich.

CATCHALL

The orders for untested queens at 75 cts each; six for \$4.00. Tested queens, \$1.50 each, three for \$4.00. Two-frame nucleus with any queen \$1.50 each, extra. Safe arrival guaranteed. 7 93-1t

W. J. ELLISON, Gatchall, S. C.

Great Reduction.

SECTIONS AT GREATLY REDUCED PRICES.

HIVES, SHIPPING CASES, &c., AT BED-ROCK PRICES.

WRITE FOR FREE, ILLUSTRATED CATALOGUE AND PRICE LIST.

G. B. LEWIS CO., Watertown, Wis.

1-93-tf. Please mention the Review.

Second Hand Supplies.

Of the second

hand supplies that I have been advertising in the REVIEW, the following remain unsold:—

100 old-style, Heddon surplus cases at 20 cts. (as a non-separated case, they have no superior); 25 slatted honey boards at 10 cts.; 20 Heddon feeders at 40 cts.; and half a dozen single-comb nuclei for exhibiting bees at fairs. They have glass sides, removable covers and are painted a bright vermilion. They cost \$2.00 each, but will be sold at half-price. All these are practically as good as new.

W. Z. HUTCHINSON, Flint, Michigan.

The Golden Beauties.

Our five-banded Italian queens, warranted purely mated, at 75 cts each; two for \$1.25. Tested, \$1.00 each; two for \$1.50. Safe arrival guaranteed. C. B. BANKSTON
2-93-1f Chriesman, Texas.

Dadant's Comb Foundation.

Wholesale and Retail. Even our competitors acknowledge that our goods are the STANDARD of their kind. **Langstroth on the Honey Bee, Revised.** New edition. Bee Veils; and veil material at wholesale. Bee Supplies, Sections, Smokers, etc Samples of Foundation and veil stuff with circular free. Instructions to beginners Send your address to

CHAS. DADANT & SON, Hamilton, Ills.

4-93-12t

Pl-as mention the Review.

Hastings' Lightning Ventilated Bee Escape.

AGRICULTURAL COLLEGE, Mich. Sept. 17, '92. "I have used the Lightning Bee Escapes you sent and find them certainly the equal of the Porter, and their superior for the reason that they will empty a super more rapidly."

Yours respectfully, J. H. LARRABEE.

"It is our opinion that you have the best Bee Escape ever introduced."

A. I. ROOT, Medina, Ohio.

HONOLULU, Hawaiian Islands, April 25, '92. "Please send me by return mail 5 Lightning Ventilated Bee Escapes. I have the Porter, and the Dibbern and they both clog."

Yours truly, JOHN FARNSWORTH.

Price, by mail, each, 20c. per doz. \$2.25.



"IT LEADS THEM ALL."

Read Testimonials of a few successful Bee-keepers. Send for Sample and after a trial you will use no other. Catalogue sent on application.

CHERRY VALLEY, N. Y., March 20, '93. "I shall take pleasure in recommending them as the best I have ever used."

Truly yours, J. E. HETHERINGTON.

"We believe you have an Escape that 'downs' the Porter."

T. PHILLIP & CO., Orillia, Ont., Canada.

"Your Escape knocks out all competitors."

A. J. LINDLEY, Jordau, Ind.

"They did not clog, and cleared the supers rapidly. In fact it is the best Escape I have yet used. I cannot speak too highly of it, and consider it a great boon to bee-keepers."

W. E. CLARK, Oriskany, N. Y.

M. E. HASTINGS, NEW YORK MILLS, ONEIDA CO., N. Y.

Cut the Price.

This is what Mr. G. E. Dawson of Carlisle, Ark., writes me. You may remember that he is the man who got no orders. He is raising good queens and is bound that they shall be tried, hence he offers them as follows: Untested, 65 cts.; three for \$1.75; six for \$3.00; twelve for \$5.00. Tested, \$1.25. Select tested, yellow to the very tip, \$1.50.

—ED. REVIEW.

Please mention the Review.

If You Wish Neat, Artistic

PRINTING,

Have it Done at the Review.

NOTICE OUR PRICES.

No. 1 Sections \$2.75 per 1,000. Thin, surplus foundation, best quality, 50 cts per pound. A full line of supplies, including Root's Dove-tailed Hives, on hand. Send for circular and free sample of foundation 5 93-tf

J. H. & A. L. BOYDEN,
Saline, Mich.

GO TO HEAD QUARTERS

FOR 4 AND 5 BANDED

QUEENS

Special, breeding queen,	\$5.00
Best, select, tested,	3.00
Tested,	2.50
Untested,	1.00
" per dozen,	9.00

L. L. HEARN,

Oakvale, W. Va.

7-93-tf

Please mention the Review.

GOLDEN ITALIAN QUEENS

Now ready for \$1.00 each. Do not order your supplies until you see our circular for 1893. For the price, we have the best spraying outfit made. Send \$1.50 and get one. Wm. H. BRIGHT, 1-93-12t Mazinga, Minn.

Please mention the Review.

ITALIAN QUEENS AND SUPPLIES FOR 1892.

Before you purchase, look to your interest, and send for catalogue and price list.

J. P. H. BROWN,

Augusta, Georgia.

1-88-tf.

Please mention the Review

For \$1.50 I will send the Review for 1893 and a fine, young, laying, Italian queen.

Queen alone, 75 cts. For \$1.75 I will send the Review, the queen and "Advanced Bee Culture." Tested queens, \$1.00. The Review and

a tested queen \$1.75 A discount on large orders. W. Z. Hutchin-son, Flint, Mich.

REVIEW

QUEENS

The Champion Smoker.

The ORIGINAL curved nozzle, steel lined. Bel lows Smoker. The fire-chamber is $3\frac{1}{2} \times 7$ inches with a corrugated steel lining, which allows a cold current of air to pass between lining and outside shell; keeps the outer shell cool and more than doubles the durability of the Smoker. It has a FORCE draft, and SPARK-ARRESTING CONE connection between bellows and fire-chamber; a base-valve to either keep or extinguish the fire at pleasure; and a removable spark-arresting GRATE in the curved nozzle.

Price, by mail, \$1.90; by express, \$1.65

If your supply dealer cannot supply you, write to the manufacturer,

E. KRETCHMER, Red Oak, Iowa.

See Supply Catalog of 70 Illustrated Pages, free.



HONEY

Superior Quality; Price Low.



About the

NEW HIVE.

Ask for Heddon's Circulars. Address

JAS. HEDDON, Dowagiac, Mich.

HUNT'S

FOUNDATION

FACTORY.

Send for free samples of foundation and sections; warranted good as any made. Dealers, write for special prices and the most favorable conditions ever offered on foundation. Send for new, illustrated, free price-list of a full line of supplies.

1-93-tf

M. H. HUNT,

Bell Branch, Mich.

Bee Hives and Section Boxes.

Simplicity, Langstroth-Simplicity, Standard Langstroth, Dovetailed and Champion Chaff Hives, Supers, One-Piece Sections and Shipping Cases. Foundation, Smokers, etc., etc. Send for 16-page Circular.

1-92-tf PAGE & KEITH, New London, Wis.

Please mention the Review.

New as Well as Valuable IMPROVEMENTS

IN BEE-HIVES, SMOKERS,

FOUNDATION FASTENERS,

SECTION PRESSES AND FEEDERS.

Special prices given to parties who will take hold of and push the sale of these goods. For circulars and particulars, address

LOWRY JOHNSON,

1-93-tf.

Masontown, Pa.

Bee - Keepers' Head - Quarters — The Louisiana Hotel !

EUROPEAN PLAN. — H. L. DAILEY, MGR.

Located at the Corner of 71st St. and Ave. B, Two Blocks from the South Side of World's Fair Grounds, and One Block East of Stony Island Avenue and Parkside Station.

Nearly 300 Large, Light and Well-Ventilated Rooms. All modern Conveniences. Hot and Cold Water on every floor. Free Baths Electric Call Bells. Lighted with Gas and Electricity. Steam and Electric Cars pass near the Door every 15 minutes.

Rates—50c., 75c., and \$1.00 per Day. Meals, 25c. and Upward.

How to Reach the Hotel. Parties arriving on the Baltimore & Ohio R. R., take the World's Fair train at the Rock Island Junction to the Exposition Depot, opposite the Louisiana hotel; or if you arrive on any of these railroads— Big 4, Nickle Plate, Lake Shore, Pennsylvania, Michigan Central, or Illinois Central - Get off at Grand Crossing and take an Electric Car to Parkside Station. If you arrive at the Main Depot of any other R. R., take Illinois Suburban (South Chicago) train to said Parkside Station, and walk one block east.

SHIPPING — AND — WINTER CASES,

— Pasteboard Boxes or Cartons, —

Everything used by Bee-Keepers. Catalogue and Price List free. Ask for a copy of the AMERICAN BEE-KEEPER (50 cts. a year) especially for beginners

The W. T. FALCONER MFG. CO., Jamestown, N. Y.

PATENT. WIRED, COMB FOUNDATION

HAS NO SAG IN BROOD FRAMES.

Thin, Flat - Bottom Foundation

HAS NO FISHBONE IN SURPLUS HONEY.

Being the cleanest, it is usually worked quicker than any fdm. made.

J. VAN DEUSEN & SONS,
(SOLE MANUFACTURERS),

3-90-tf Sprout Brook, Mont. Co., N.Y



Early Queens From Texas,

From my choice golden stock. My bees are very gentle, good workers, and beautiful. Safe arrival and satisfaction guaranteed. One untested queen, April and May, \$1.00; six for \$5.00; later, 75c. Orders booked now; money sent when queens are wanted. Send for price list.

J. D. GIVENS,
Lisbon, Texas.

1-93-9t.

Please mention the Review.

The Bee-Keepers' ENTERPRISE.

A cyclopedia of fresh, bright, original ideas pertaining to Bee-Culture, carefully selected and boiled down for busy people. Published monthly at 50 cts—sent from now until Jan. 95 for 50 cts.

BURTON L. SAGE, New Haven, Conn.

Italian Queens

From imported mother, warranted purely mated, \$1.00 each; six at one time, \$5.00. Untested queens, 65 cts each.

C. A. BUNCH,
Nye, Marshall Co., Ind.

7-93-2t

"Golden" Florida.

My location enables me to rear good queens NOW as cheaply as they can be reared in the North at anytime. Untested queens, 75 cts. each; 6 for \$4.00; one dozen, \$7.50. Last year's tested queen, \$1.25; select, \$1.75; breeder, \$2.50. Safe arrival and satisfaction guaranteed. 41-92-tf

J. B. CASE, Port Orange, Vol. Co., Fla.

IF YOU WANT THE BEE BOOK

That covers the whole apicultural field more completely than any other published, send \$1.00 to Prof. A J. Cook, Agricultural College, Mich., for his

Bee-Keepers' Guide.

Liberal Discounts to the Trade.

Please mention the Review.

BEES QUEENS, SECTIONS, SMOKERS, COMB FOUNDATION

And all Apiarian Supplies. Send for Catalogue.
E. T. FLANAGAN, Belleville, Ill.

Please mention the Review.

Just Splendid

Mr. Alley—The queen I got of you last fall is just splendid! She is the best queen in an apiary 150 colonies. I would not take \$10 for her. John A. Pease, Moravia, Calif.

Price of such queens is \$1.00 each.

HENRY ALLEY,
Wenham, Mass.

THE PROGRESSIVE BEE - KEEPER

Has Changed Hands. It is now Published by the
LEAHY MANUFACTURING CO.,

Higginville, Missouri.

Money, Experience and Enterprise will not be lacking to make it all that its name indicates. Send for Free Samples and Copy of 28-page Catalogue of Apiarian Supplies.

OCT., 1893.



At Flint, Michigan.—One Dollar a Year.

ADVERTISING RATES.

All advertisements will be inserted at the rate of 15 cents per line, Nonpareil space, each insertion: 12 lines of Nonpareil space make 1 inch. Discounts will be given as follows:

On 10 lines and upwards, 3 times, 5 per cent; 6 times, 15 per cent; 9 times, 25 per cent; 12 times, 35 per cent.

On 20 lines and upwards, 3 times, 10 per cent; 6 times, 20 per cent; 9 times, 30 per cent; 15 times, 40 per cent.

On 30 lines and upwards, 3 times, 20 per cent; 6 times, 30 per cent; 9 times, 40 per cent; 12 times, 50 per cent.

Clubbing List.

I will send the REVIEW with—		
Gleanings,.....	(\$1.00).....	\$1.75.
American Bee Journal.....	(1.00).....	1.75.
Canadian Bee Journal.....	(1.00).....	1.75.
American Bee Keeper.....	(.50).....	1.40.
Progressive Bee Keeper.....	(.50).....	1.30.
Bee Keepers' Guide.....	(.50).....	1.40.
Apiculturist.....	(.75).....	1.65.
Bee-Keepers' Enterprise.....	(.50).....	1.40.

Honey Quotations.

The following rules for grading honey were adopted by the North American Bee Keepers' Association, at its last meeting, and, so far as possible, quotations are made according to these rules:

FANCY.—All sections to be well filled; combs straight, of even thickness, and firmly attached to all four sides; both wood and comb unsoiled by travel-stain, or otherwise; all the cells sealed except the row of cells next the wood.

No. 1.—All sections well filled, but combs uneven or crooked, detached at the bottom, or with but few cells unsealed; both wood and comb unsoiled by travel-stain or otherwise.

In addition to this the honey is to be classified according to color, using the terms white, amber and dark. That is, there will be "fancy white," "No. 1 dark," etc.

KANSAS CITY, Mo.—We quote as follows: No. 1 white, 15 to 16; No. 1 amber, 12 to 14; No. 1 dark, 10 to 12; white extracted, 6 ½ to 7; amber extracted, 5 ½ to 6; dark extracted, 5 to 6. Beeswax, 20 to 22.

CLEMONS-MASON CO.,
521 Walnut St., Kansas City Mo.
Sept. 27.

NEW YORK—The new crop of extracted from California and the South is arriving very freely. There is a limited demand and prices have a downward tendency. We quote as follows: White extracted, 6 ½ to 7; Amber, 6 to 6 ½; Dark, 5 ½ to 6. Beeswax, 20 to 27.

HILDRETH BROS. & SEGELKEN,
July 7. 25 & 30 West Broadway New York.

CINCINNATI, Ohio.—Demand from manufacturers for extracted honey is slow, while that for table use is fair. It brings from 5 to 8 cts., according to quality. Choice comb honey is in good demand at from 14 to 16 cts. Arrivals are good for all kinds of honey. Beeswax is in slow demand while arrivals are large. It brings 20 to 23 cts. for good to choice yellow wax.

CHAS. F. MUTH & SON.,
Sept. 26. Cincinnati, Ohio.

CHICAGO, Ill.—Choice white comb honey in one-pound sections brings 15 to 16 cts., per pound. It is selling very well and we have very little surplus—are liable to be cleaned out at any time. The receipts are liberal, but, with the good demand that exists, they are readily sold. Dark comb sells slowly, no matter what the grade. Beeswax is 22 cts.

R. A. BURNETT & CO.,
Sept. 27. 161 So. Water St., Chicago, Ill.

MINNEAPOLIS, Minn.—We are receiving large shipments of honey but they are mostly of poor quality. Fancy white is selling at 15 to 20 cts., but we are cleaning up more No. 1 white at 16 cts. than anything else. We quote as follows: Fancy white, 18 to 30; No. 1, 16; fancy amber, 15; fancy dark, 14; white extracted, 7 ½ to 8; dark extracted, 6 ½ to 6 ¾. Nosale for beeswax.

J. A. SHEA & CO.,
116 First Ave., North, Minneapolis, Minn.
Sept. 27.

CHICAGO, Ill.—**HONEY.**—We want honey, and ask you to ship all you have at once. Quote fancy selling at 16; choice, 15; No. 2, 13 to 14; poor, 12. With prospects of a large crop, we advise early shipments to the market, and can guarantee satisfaction. Extracted selling at 5 ½ to 7, depending on color, flavor style of package, and quantity buyer will take. Beeswax 22 to 24, and we have no stock on hand.

S. T. FISH & Co.,
Sept. 1. 189 So. Water St., Chicago, Ill.

BUFFALO, N. Y.—The demand is improving considerably for honey, and we could now handle quite liberal quantities. We will advance from 10 to 11 cts. on all strictly No. 1, and liberally on lower grades. We quote as follows: Fancy white, 15 to 16; No. 1 white, 4 to 15; fancy amber, 12 to 14; No. 1 amber, 10 to 12; fancy dark, 9 to 11; No. 1 dark, 9 to 10; white extracted, 7 to 8; dark extracted, 5 to 6; beeswax, 22 to 25.

BATERSON & CO.
Sept. 26. 167 & 169 Scott St., Buffalo, N. Y.

CHICAGO, Ill.—We are receiving plenty of honey—four times the amount that we were receiving last year at this time. The weather is cool, and, consequently, business is picking up in the honey line, considering the abundance of fancy stock on the market. With the scarcity of fruits and the high price of other products, we predict a good trade in honey this month. We quote as follows: Fancy white, 15 to 16; No. 1 white, 15; fancy amber, 14; No. 1 amber, 14; fancy dark, 11; white extracted, 7; amber extracted, 6; dark extracted, 5; beeswax, 20 to 22.

J. A. LAMON,
Sept. 27. 44 & 48 So. Water St., Chicago, Ill.

WINTER LOSSES

Are not always the result of the same cause. They may come from starvation; from poor food; from improper preparations; from imperfect protection; from a cold, wet, or possibly a poorly ventilated cellar; etc., etc. Successful wintering comes from a proper combination of different conditions. For clear, concise, comprehensive conclusions upon these all-important points, consult "ADVANCED BEE CULTURE." Five of its thirty-two chapters treat as many different phases of the wintering problem.

Price of the book, 50 cts.; the REVIEW one year and the book for \$1.25. Stamps taken, either U. S. or Canadian.

W. Z. HUTCHINSON, Flint, Mich.

ON HAND NOW.

THE MOST COMPLETE STOCK OF BEE HIVES, SECTIONS AND SUPPLIES IN THE NORTHWEST.

W. H. PUTNAM,

1 93-12t.

RIVER FALLS, WIS.

Barnes' Foot and Hand Power Machinery.



This cut represents our Combined Circular and Scroll Saw, which is the best machine made for Bee Keepers' use in the construction of their hives, sections, boxes, etc.

11-92-16t

MACHINES SENT ON TRIAL.

FOR CATALOGUE, PRICES, ETC.,

Address W. F. & JNO. BARNES CO., 384 Ruby St., Rockford, Ills.

Please mention the Review.



Oh, Mamma!

Have you heard of the **FREE**

200-Page Bee-Book

given to every **NEW** Subscriber to the old

AMERICAN BEE JOURNAL?

Oldest, Largest, Best, Cheapest and the only **Weekly Bee-Paper** in America. 32-pages; \$1 a year. *Sample free*

GEO. W. YORK & CO

56 Fifth Avenue, CHICAGO, ILL.

To New Subscribers: The Journal Alone Sent for Three Months for Twenty Cents.

BEE-KEEPERS'

SUPPLY HOUSE

J. H. M COOK, 78 Barclay St., N. Y. City.

(SUCCESSOR TO A. J. KING.)

4-93-tf

Send for illustrated Catalogue

CLEANINGS IN BEE-CULTURE

For Only 50 Cts.

THIS journal has a big circulation because it is made up of practical ideas, good printing and paper, and first-class original engravings—yes, lots of 'em; in fact, because it has MERIT. But *merit* alone won't boom the circulation; so we propose to offer it TO NEW SUBSCRIBERS from now until January, 1895, for \$1.00. For \$2.50 we will send the journal to new subscribers from now until January, 1895, and one of those new, improved, Crane smokers, postpaid. Crane smoker alone, \$2.00. Send for our free, illustrated, 52-page catalogue of bee-keepers supplies and sample copy of GLEANINGS.

A. I. ROOT, MEDINA, O.

CANADIAN

BEE JOURNAL.

Enlarged. Improved. Monthly. R. F. HOLTERMAN Editor. Sample Copies Free. Address the Publishers, GOOLD SHAPLEY & MUIR CO., Ltd. Brantford, O t, Canada.

Please mention the Review

SHIPPING CASES.

To hold twelve, 1½ sections, or fourteen 7-to-the-foot, at \$6.00 per 100—with glass, \$6.65. They are of fine material, and the workmanship is of the best. Send for free price list of everything needed in the apiary. 9-93 ft

M. H. HUNT, Bell Branch, Mich.

Please mention the Review

FOR ALL KINDS OF BEE-KEEPERS SUPPLIES.
 ADDRESS LEAHY MFG. CO. HIGGINSVILLE Mo.

PORTER BEE ESCAPES

Are used and pronounced the best, and highly recommended as great labor-saving implements by Chas. Dadant & Son, Prof A. J. Cook, Chas. F. Muth, Jno. S. Reese, J. H. Martin, Jno. Andrews, F. A. Gemmill, Wm. McEvoy, A. F. Brown, Thos. Pierce, and many other prominent bee-keepers. Descriptive circular and testimonials mailed free. **PRICES:** each, postpaid, with directions, 20 cts.; per doz., \$2.25.

RETURN THEM AND GET YOUR MONEY BACK AFTER TRIAL, IF NOT SATISFIED. For sale by dealers. MENTION THE REVIEW. Address R. & E. C. PORTER, LEWISTOWN, ILL.

The Bee-Keepers' Review.

A MONTHLY JOURNAL

Devoted to the Interests of Honey Producers.

\$1.00 A YEAR.

W. Z. HUTCHINSON, Editor & Prop.

VOL. VI. FLINT, MICHIGAN, OCT. 10. 1893. NO. 10.

Work at Michigan's Experimental Apiary.

E. L. TAYLOR, APIARIST.

USE OF FOUNDATION IN THE BROOD-CHAMBER.



I desire in this article to set forth briefly the character and results of the experiments made in the apiary to test the comparative value of comb, foundation and starters when used in the brood-chamber for

swarms, and in addition thereto to call attention to what the experiments seem to disclose touching the comparative advantage of swarms of different sizes. In the main all this can be best accomplished by the use of tables which I have prepared and which are presented herewith.

It was not till the 27th of June that I was able to put into operation my plans for making these tests. I prepared twelve hives, four of which were furnished with comb, four with foundation, and four with starters only. The hives prepared with comb were designated by the numbers one to four inclusive with the letter A, those with founda-

tion in like manner with the letter B, and those with starters with the same numbers and the letter C, and each hive was marked with the proper designation and its weight. Then in each case when a swarm issued, which was to be used for making this test, it was secured in a basket and weighed before hiving: the supers also, whether taken from the old hive at the time of swarming or supplied subsequently, were carefully weighed before they were put in place and a record made on the spot of all items. By referring to table A all these will be found in the three columns following the date of hiving except of course the weight of the cases subsequently adjusted which appears further along. I ought also to say that in each case the hive with the bees and cases was re-weighed early on the morning subsequent to the hiving in order to detect and thereby correct any change which might chance to take place before the swarm became settled in its new home. The only change it was found necessary to make was the addition of the fraction of a pound to the weight of the bees which may be supposed to be accounted for by the presence in the morning of bees which at the time of swarming were afield.

Other data for table A were obtained by weighing the several hives, bees, supers and all upon three different dates, viz., the 6th, 12th, and the 19th of July (thus dividing the time of the test into three nearly equal periods) and by weighing the cases of honey separately on July 19th, at the end of the time given to the test. These data with the

Table A.

Start-ers.	Designation.	Hived June.	Wt of Hive.	pounds and ounces.	Weight of (cases.	Weight of Bees.	Total weight at time of hiving.	July 6th.	Total Gain	1st Period.	Gain per lb. of Bees.	Wt of Cases adjusted July 6th.	July 12th.	Total gain.	2nd Period.	Gain per lb. of Bees.	2nd Period.	Total weight July 19th.	July 19th.	Total gain July 19th.	3rd Period.	Gain per lb. of Bees.	3rd Period.	Wt of Cases July 19th.	Total Gain in Comb Honey.	Total Gain in per lb. Bees.	Total gain in Wt of Hives.	Gain in hives per pound of Bees.	Total gain of Bees.			
1 A	Comb.	57	19	11 4	7 12	38	69	30	30	3	3.935	9	39	8	12	1.129	95	47	4	8	1.632	55	13	35	4	516	12	4	1.58	6.06		
2 A		37	16	4 24	7 8	15	80	32	32	4	4.353	9	43	12	8	1.065	108	60	8	15	2.066	62	13	38	8	5.153	22	2,933	2,933	8,066		
3 A		39	19	21	3	43	48	5	5	5	1.853	49	6	8	1	1.818	72	33	4	9	1	1.636	31	10	12	3.045	16	3	3	6.045		
4 A		39	19	14	5	38	53	77	77	4	2.391	14	24	4	31	1	1.818	72	33	4	9	1	1.636	31	10	12	3.045	16	3	3	6.045	
1 B		27	15	5 12	7 8	51	82	30	30	4	4.1	8	12	17	118	1.933	88	50	8	58	14	1.933	88	50	8	6.733	7	8	1	7.733		
2 B		37	15	5 33	7 4	75	105	29	4	4	4.034	7	12	16	8	2.275	131	51	4	5	5	1.58	102	4	13	5.738	9	8	1	3.1	7.068	
3 B		35	17	5 8	7 4	27	12	39	12	2	2.283	49	31	12	1.857	55	27	8	12	8	5	1.095	18	12	8	3.35	15	8	2	5.257		
4 B		39	15	5 6	6 12	4	26	4	4	2	3.375	4	22	8	3.125	56	29	12	12	33	7	1.937	21	14	8	3.625	13	4	3,812	7.437		
1 C		27	16	5 5	7 8	29	46	17	4	3	2.3	8	29	8	1.633	75	38	8	38	8	8	1.133	46	33	4	4	5	5	6,066	5.066		
2 C		37	16	19 8	10 12	57	61	10	10	3	3.98	15	89	12	69	8	2.25	69	22	8	4	4	46	45	25	12	6.45	
3 C		39	16	15 5	8 4	36	47	11	11	2	2.2	8	22	4	3.170	59	12	32	7	32	4	2.41	45	22	8	4	5	9	12	1.95	6.45	
4 C		39	15	5 6	6 12	4	27	4	4	2	2.058	49	22	4	3.170	59	12	32	7	32	4	2.41	45	22	8	4	5	9	12	1.95	6.45	

* 3 A and 2 C are disregarded in subsequent tables.

Table B.

Description of Swarms.	Wt of Bees in pounds and ounces.		Gain per lb. of Bees.		Gain in Wt of Hives.		Gain per lb. of Bees.		Total Gain.				
	1st Period.	2nd Period.	1st Period.	2nd Period.	1st Period.	2nd Period.	1st Period.	2nd Period.	1st Period.	2nd Period.			
Group A	30 12	20 12	4 131	21 4	1.393	23 8	1.541	73 8	4.819	34 4	2.245	107 12	7 065
Group B	24 51	16 12	4 2 591	10 1	1.818	20 8	1.636	16 12	3.045	16 8	3	33 4	6 045
Group C	16 12	16 12	8 2 321	22 4	2.405	13 8	1.459	27	6.254	17	1.52	109	7 406
Group A	7 8	17 4	2 3	12 4	1.638	8 8	1.133	33	4 4	5	.666	38	5 066
Group B	19 12	12 078	24 12	2 6 5	20 4	2.131	36 8	3.812	28 4	2.973	64 12	6.813	
Total of Swarms of more than 7 lbs.	37 8	140 4	3 738	62 12	1.671	52	1.366	198 12	5 3	56 4	1.5	255	6 8
Total of Swarms of less than 7 lbs.	24	55 8	2.312	57	2.375	42 12	1.781	80 4	3.333	75	3.125	153 4	6.468

Table C.

Description of Swarms.	Wt of Bees in pounds and ounces.		Gain per lb. of Bees.		Gain in Wt of Hives.		Gain per lb. of Bees.		Total Gain.				
	1st Period.	2nd Period.	1st Period.	2nd Period.	1st Period.	2nd Period.	1st Period.	2nd Period.	1st Period.	2nd Period.			
Group A	15 4	63	4 131	21 4	1.393	23 8	1.541	73 8	4.819	34 4	2.245	107 12	7 065
Group B	5 8	14	4 2 591	10 1	1.818	20 8	1.636	16 12	3.045	16 8	3	33 4	6 045

Table D.

Description of Swarms.	Wt of Bees in pounds and ounces.		Gain per lb. of Bees.		Gain in Wt of Hives.		Gain per lb. of Bees.		Total Gain.				
	1st Period.	2nd Period.	1st Period.	2nd Period.	1st Period.	2nd Period.	1st Period.	2nd Period.	1st Period.	2nd Period.			
Group A	15 4	63	4 131	21 4	1.393	23 8	1.541	73 8	4.819	34 4	2.245	107 12	7 065
Group B	5 8	14	4 2 591	10 1	1.818	20 8	1.636	16 12	3.045	16 8	3	33 4	6 045

Previous ones enable me to state the exact total gain of each colony for each of the three periods, the gain of each colony in the amount of comb honey together with the gain in the weight of the hive for the entire time. From these I deduce the gain per pound of bees of each colony for each of the three periods as well as for the entire time, and also the gain in the weight of the hive and the gain in the amount of comb honey for the whole time.

It will be noticed by reference to the tables that almost nothing has been made of 3A and 2C. The explanation of this is that the latter persisted in its desire to swarm until it eventually lost a considerable part of its bees by their uniting with another swarm and the former, within a day or two after swarming, in some way lost its queen and dispersed more or less in consequence. The only question with regard to the propriety of this course arises when we consider table C wherein the comparative advantages of large and small swarms are weighed. Perhaps 2C should have been permitted to cut some figure in that for it clearly illustrates one of the disadvantages of very large swarms.

Table B is a summary of table A and puts the tables of each group of colonies employed in the experiment side by side so that the general results are seen at a glance.

Table C is derived from table A and puts in contrast the work of the stronger colonies of each group with that of the weaker ones of the same group, and table D is an epitome of table C.

Now what do the tables teach with regard to the comparative profit of the use of starters, foundation, and comb in the brood chamber as well as with regard to the advantage of larger and smaller swarms? It would be too much to expect that upon either of these points the results shown by the several hives taken separately would invariably point in the same direction. There are so many inscrutable influences at work that we may well look for unexplainable vagaries in the revelations of individual hives. It is largely for this reason that I think the writer who in one of the apicultural journals recently very flatteringly intimated that the results obtained in the experiments at this branch of the Michigan experiment station would be conclusive, was hasty. If several varieties of wheat, for instance, were sown side by side upon precisely the same kind of

soil so far as human skill could determine, and each variety should receive exactly the same treatment in all respects and at the same time, and one certain variety was found to yield twenty per cent. more than any other, yet the farmer who should from the one experiment jump to the conclusion that the result would always be the same would be accounted lacking in judgement. The results must be verified repeatedly before they can be accepted as the rule. Just so it is with the matter in hand. Yet the mutiple character of our experiment with results so nearly uniform give strong assurance that what seems to be disclosed is in the direction of the truth.

From the figures given in the last column of table B, we find that the colonies hived on comb gained in all more than eleven per cent. over those hived on starters and that those hived on foundation gained more than thirteen per cent. over the same. But if we examine with reference to *comb honey* only we find that colonies "A" (those on comb) gain less than five per cent. more than colonies "C" (those on starters) while colonies "B" (those on foundation) gain more than seventeen per cent. over "C." But it may be said that "C" has an undue proportion of the weaker colonies, which is true, still, if we turn to table "C" and consider only the strong swarms in each group we find that "A" gains nine and one-half per cent. more than "C" in comb honey and "B" gains forty-two per cent. more than "C." But strange to say, taking the light swarms in the same table and column the positions are exactly reversed, "A" gains nearly one-half of one per cent. over "B" while "C" gains nearly thirty-two per cent. over "B." If space permitted it would be interesting to inquire why the difference in the weight of the colonies should cause this reversal in their positions in regard to the amount of comb honey produced.

Referring again to table "B" from the figures given in the third column where the gain for the first period is given we deduce that "B" gains during that period more than fifty-three per cent. over "C," while "A" gains more than sixty-eight per cent. over "C," but during the second period the figures show that for that period the positions are exactly reversed, while for the third period the positions as to relative gain are again changed, "A" making a spurt and leaving "B" in the rear. Referring again to table

"C" we find that the strong colonies invariably gain the more in the first period while the light ones take a decided lead both in the second and the third periods; in the amount of comb honey for the entire time in each group the strong colonies have a decided advantage, and so in groups "A" and "B" in the amount of total gain, but in group "C," in this point, the weaker ones are far in the lead. But this sort of comparison might be carried on almost endlessly.

If we examine table "A" we find, as was to be expected, that the results in the cases of some individual colonies do not always accord with the general results, yet sufficiently so, I think, to warrant us in putting some confidence in the general results so far as they go; I say so far as they go, for the test was for three weeks only and *time* appears to be an essential element in the experiment. The colonies that are strong in numbers as compared with the weak, and those aided with comb or foundation as compared with those left unaided, are soonest *out of breath* in the race, or, perhaps, the luxury and wealth of numbers and resources prove destructive to energy and ambition; and, on the other hand, straitened circumstances whether it be from a lack of numbers or of resources, arouse vigor and persistence in a determination to supply the lack. At least, that is what the tables seem to teach, and we can only guess what the result would have been had the tests covered the whole of the honey season instead of the last half. Many and varied experiments must be made in order to arrive at the exact truth in these matters. Let no one fear that apicultural experiment stations may be either too numerous or too well equipped. To one who has entered it the field looks exceedingly large.

For the rest I must be content at this time to close with a summary of the results pretty clearly disclosed by the experiments conducted in the manner and for the time stated but I wish first to invite and urge all who are interested in the matter to make suggestions and criticisms both upon my methods and inferences and let them not, out of a concern for my feelings, so refine their strictures that they lose all their point and with it their effect. That is not the way, as too many bee-keepers seem to think, to get at the truth. At all events, I am not very thin skinned, and I believe that, at least in these experiments, I am willing to look at the naked truth. I know now that in some re-

spects my methods have been faulty and no doubt they have been so in other points than those which I have discovered and what those other points are I am anxious to know.

In this summary as elsewhere when I speak of gain it is not gain per colony for the colonies vary in strength, but per pound of bees, which seems to be the only just way.

If then we may trust our tables, they show for the last half of the summer honey season: 1st, That for profit, foundation in the brood chamber for swarms has a decided advantage in point of surplus comb honey over both drawn comb and frames with starters only; that drawn comb stands second and starters third. 2nd, That in point of total gain in both brood chamber and surplus the same order holds and to nearly the same extent. 3rd, That fairly strong colonies show a very decided advantage over light ones in point of comb honey surplus and also to a small extent in the total gain. 4th, That light colonies sustain their rate of gain in all cases better than fairly strong ones. 5th, That swarms on starters only sustain their rate of gain decidedly better than do those on comb or on foundation. 6th, That of the light colonies those on starters are decidedly more profitable than those on either comb or foundation.

I ought to explain here that each swarm was hived on a brood chamber equal to that required to hold five L combs.

LAPEER, Mich.

Sept., 22, 1893.



Bee Dysentery.

JAMES HEDDON.

Oh fatal pollen, "dust thou art" is still my song!
To dust thou dost return, and take our bees along.



Of course I will be expected to advance the "pollen theory." It does not seem to me, however, that it can any longer properly be called a *theory*. The leader in the last issue has very nearly exhausted my stock in trade for this

article. In fact, Mr. Editor, you have said very concisely, and better than I could have

said it, the very same things which I said and intimated through a series of articles years ago. There is but little left for me to say now, except that I still coincide with you and my former declarations; and I stand corrected and admit my mistake when years ago I contended against your proposition to pack the bees after taking them out of the cellar in the spring. Since then I have demonstrated that you were right.

When I recall to mind how I was ridiculed for the pollen theory, and that even the chemistry of Profs. Cook and Kedzie, could not shelter me, I am exceedingly proud that at this advanced date, the leading editorial in the best and most advanced bee journal the world has ever seen, practically holds to that pollen theory.

I think it wholly unnecessary to dilate upon "prevention," as a correct idea of the cause, which your leader quite clearly gives, in its combination, will readily suggest the correct method of prevention according to the circumstances in each case. As I comprehend the theory it is about like this: The food of the honey bee may be divided into two distinct divisions, oxygenous and nitrogenous, the former being a heat producer, and the latter tissue making. Now it happens that the honey bee lives in two extreme conditions. At one time of year no breeding, no activity, but pressed with cold; at another time of year, extremely active, causing a rapid waste of tissue and undergoing marvelous reproduction, demanding the creation of tissue for the new individuals. During the time of quietude, and accompanying confinement, nitrogenous food is not needed nor could it be safely taken, because, unlike the oxygenous food it cannot be voided by perspiration. It must pass from the body of the bee through the intestines. This the bees will not permit to take place in the hive. Now suppose something should cause the bees to consume this nitrogenous, tissue-making food during confinement. Intestinal inflammation must result. What will do this? A low temperature. Why? In their efforts to keep warm, the bees adopt a second method of consuming oxygen, viz., inhalation by way of exercise. This consumes the tissue to replace which the bees resort to the consumption of bee-bread, and result is the title of this article.

The chemist finds the diarrhetic excreta nearly all pollen. I presume many of your readers remember when I tested the theory,

by giving 73 colonies, clean, dry combs without a cell of pollen, and, after all natural gathering was past, fed them granulated sugar syrup and placed them in the cellar together with 16 colonies containing natural stores. How I let the temperature go below the freezing point for weeks, and how just before removing them, I used to go every day and rattle to wild activity, a certain colony. How all were confined five months, and on a bright, warm day on the 17th of April, I removed them from the cellar and found every colony but one (that was queenless) of the 73 alive, while two-thirds of the 16 were dead with dysentery in its worst form. Not one bee from those 72 hives discharged any matter whatever; not even water. That settled it with me, and it has been settled ever since. During the years that have elapsed since that time I have seen nothing but what went to confirm the correctness of the "pollen theory."

DOWAGIAC, Mich.

Sept 11, 1893.



Why Moisture is Injurious in Wintering Bees.

R. C. AIKIN.

When all flesh did perish in Noah's time of old,
'Twas moisture did it, not pollen or cold.



MY FIRST bee-keeping was in Southwestern Iowa. For over twelve years I remained in the same place, and raised good average crops of honey, but with poor success in wintering. Although near the south line

of the State, the winters were severe, and losses frequently heavy. My worst losses were 93 out of 110, and 70 out of 80; other years 10 to 50 per cent. 'Twas in those times that James Heddon championed the "pollen theory." Now, while I could not believe that pollen was the cause of diarrhoea, I know that diarrhoea was mostly the cause of my losses. Could I have prevented this disease, I believe I could have made big money producing honey.

My pasturage was willow, soft maple, elm, box elder, apple, cherry, plum, gooseberry, currant, motherwort, catnip, white clover, basswood, mustard, locust, hearts ease Spanish needle, cow pea, and much other bloom. The surplus was clover, basswood and mustard in May, June and July, and hearts ease and Spanish needle in autumn.

The late fall bloom kept up brood-rearing so that the last brood hatched in October, hence we had but little spring dwindling; and I never saw a regular siege of it until this season. Go into winter with old bees and spring dwindling will follow if the spring is late.

Since wintering bees in Colorado I believe that I can give some light upon the winter problem.

But few reading apiarists have not read more or less of the discussion in regard to "sealed covers," led by E. R. Root, the past year or so. The "sealed cover" is a snare in cold climates. As this and following articles are intended as somewhat of a review of the question, I shall give not only my own experience and observations, but that of others as given both in and out of print.

Each colony should have its brood nest fully established, and be supplied with sufficient stores, when frost comes. There should also be a good force of young bees that have not done field service, yet have had *cleansing flights* before cold confines them.

Now, what shall be the external arrangements? Shall we put them in the cellar, pack on the summer stands, or leave them unprotected? In either case shall it be "sealed covers," absorbents, or what?

If the winters are close and severe, keeping them in confinement from three to five months, I believe I should recommend the cellar. While in the cellar, they are kept warm enough so that they can *get* after more honey when the supply in the cluster is gone, but a disadvantage is that they must be put out in the spring without protection, just when most needed, or there must be more expense for protection. With open winters and frequent flights, I would recommend out-door wintering. By *out-door*, I mean where they have the liberty of flight when weather permits.

I consider diarrhoea the great enemy in the East and North, or wherever bees are long confined by cold. I do not think that the disease is the result directly of confinement. True, frequent flights prevent, or

cure it, but my opinion is, that the principal cause is *moisture*. If the colony has a sealed cover, the air within the hive will rise to the top and there remain, and soon it is heavily charged with moisture exhaled by the bees. So long as the outside temperature is below that within, this moisture laden air is held there by the law of nature, that heated air rises. This is clearly shown in all mines and in buildings. Now, the hive covers being colder than the air within, that condenses the moisture within until it drops upon the bees and combs. The only way the bee can contend with a liquid, is to take it up and carry it from the hive. So the bees must lick up the water that drips upon them and the combs, in order to keep dry. This added to the natural excrement, with no chance to void, must certainly produce disease.

Does not this show how it is that flights prevent or cure diarrhoea?

If this be true, we may reasonably expect that if we can keep the colony dry, they can be long confined without detriment. When dry, they can endure much cold. It is a fact that in this dry climate bees will fly freely at a lower temperature than where a more moist air exists. Any man knows that cold is more easily borne when the air is dry. A hive with a sealed cover will remain reasonably dry when there be frequent warm spells. If the outside temperature rises above the general temperature inside the hive, the outside air will work into the hive and displace that within, and thus tend to dry the interior.

Last fall we left about ninety stands with the covers just as they had been from the time the supers were removed, from two to three months previous. We had a severe spell of winter in December and when the weather moderated, five colonies were dead. The bees and all the interior were completely wet. Wet killed them. We had another lot packed in sawdust. They were in a hive within a hive with about an inch of sawdust between. A plain board was on top, and sawdust upon this one to three inches deep, with a heavy gable roof over all, making a ten-inch space between covers. Some had diarrhoea, and all suffered with wet. Loss was about two-thirds.

Now, the easiest way to avoid this condensation, is to give upward ventilation. The use of absorbents is *upward ventilation*. Absorbents *may* sometimes become so damp as to be a detriment. At present I am

strongly of the opinion that we do not want absorbents at all; but, instead, direct top ventilation. We want the colony so arranged that the outside heat, when there is any, can easily reach the colony. I have many times seen bees peeping out the hive entrance in a clear, still, but zero cold day, with the sun shining against the hive front and entrance. That is certainly a decided relief, when the weather is intensely cold; but if the colony be hid away beneath a mass of chaff or other material so thick as to exclude the sun's heat entirely, and all the time the interior becoming more and more moist, it certainly must be a disagreeable and unhealthy place in which to live. An absorbing cushion is not what we really want. Packing over head is good so long as it passes off the moisture and absorbs heat. Chaff will allow a slow current to pass through, and if the cover be removed—or partly so—the moisture passes off much better, yet will condense somewhat in a long siege of extreme cold.

In this climate, nearly all bees are wintered out-doors, and unprotected. It is a rare thing to have a week of cloudy weather at one time; so, even with sealed covers, but little condensation takes place before a warm sun shining upon the hive drives it out.

I have been reading over the reports on sealed covers as given in *Gleanings* at the request of editor Root, yet almost invariably the reports are so limited in detail that no correct judgement can be given upon the matter. I believe had the reports told whether the hives were exposed to the sun, or in the shade, or whether there were long sieges of cloudy weather and extreme cold, we might get from these reports something of value. As mentioned elsewhere, we lost some colonies in December because of accumulation of moisture under sealed covers. That siege of cold was also accompanied by some snow, and unusually cloudy weather for about ten days. A part of the time snow lay upon the hive covers.

At our annual State convention in January I advocated top ventilation. Present at the convention were four foul brood inspectors, viz., H. Knight of Littleton, for Arapahoe Co., R. H. Rhodes of Arvada, for Jefferson Co., J. B. Adams and A. M. Preston of Longmont, for Boulder and Weld counties, respectively. These men inspected in the year 1891, over 3,700 colonies of bees. Mr. Adams at our Honey day meeting in

September last, reported nearly 5,000 colonies inspected; while Mr. Rhodes reported 2,000 for the season to date of meeting. Boulder county was reported to have over 18,000 colonies, so these gentlemen have had large opportunities to make observations. After their wide and extended observations upon many thousands of colonies, they unanimously agreed with me in favoring top ventilation. They tell me that those colonies having large cracks or openings about the top of the hive, winter the best, and build up first in spring. However, this does not mean that unlimited ventilation is best in spring, but it does prove that upward ventilation is best in winter. It is reasonable that if the colony winters well, it will also spring well. We will discuss more fully the springing question in the continuation of this discussion.

LOVELAND, Colo.

Aug. 8, 1893.



Warmth, Dryness and Wholesome Food Will Prevent Dysentery.

E. TAYLOR.



I never had serious losses in wintering my bees from the so called disease, dysentery. In my opinion there are three main factors that cause dysentery, viz., cold, dampness and unsuitable food. In regard to food, I believe that any kind

of honey that is gathered from flowers by the bees is healthful food if properly stored and sealed and then the hives are so prepared and housed that the honey shall not become thin and sour from absorbing too much moisture.

One fall my hives were heavy with honey dew, and I was troubled about the result as that kind of stores was declared by high authorities to be unfit for wintering. But it was thick and well sealed, the hives covered with thin porous cushions so all dampness could easily pass off, the hives were raised two inches from the bottom board and placed in a dry, warm cellar where the tem-

perature was constantly from 45 to 50 degrees, and I never had bees winter better. I think every swarm came through alive, there was no dysentery, and I never had bees build up better in the spring. These bees were in hives containing ten frames 6 $\frac{1}{4}$ inches deep and 13 inches long inside the frame, the hive containing but 800 inches of comb space.

I favor a small hive well filled with sealed stores of almost any kind of natural honey for safe wintering. In a large hive there is much space left vacant outside the cluster, here the air stagnates, dampness accumulates, the combs become mouldy and the air of the whole hive is poisoned. The honey absorbs water, becomes thin and unnutritious. The bees have to eat a large quantity of this impure and bulky food. Proper digestion is interfered with and dysentery sets in, the combs are from necessity defiled, rendering the habitation still more unhealthy and the colony finally dies. Human beings would contract disease under the same conditions and die in the same way.

I believe all life is akin and that every thing that breathes needs pure air. I have fitted my winter cellar with a large heating stove. It is surrounded with a brick wall so as to let off the heat slowly. I shall cement the bottom of the cellar and there is a ventilating shaft opening near the floor and connecting with the stove pipe to give good draft. Many times this summer I have made a good fire to keep the cellar from becoming damp and mouldy, and for some days before I put the bees in this fall I shall keep up a fire so the cellar will be perfectly dry and warm when the bees are put in and once in a while through the winter I shall make a little fire and keep the air moving and pure. Every hive will have plenty of upward ventilation, plenty of sealed stores, and with the hive so small that strong colonies will cover nearly every comb. With such preparation I have no fears of dysentery even if the hive contains much pollen. It is natural for the bees to store pollen and I do not believe that nature makes mistakes; we only fail to understand and misfortune follows to help us to learn. I use to talk about good and evil; I believe everything is good when rightly understood and that what we call evil equally with good helps us to learn our lessons. And now, brother bee-keepers, when we lose our bees in wintering we should blame ourselves, and our lack of industry and knowl-

edge, and learn to say less and *intelligently* do more, and if heavy losses lead us to do this they will not be in vain.

I have noticed that bees that die from starvation in the cellar, nearly always defile their hives and combs before they die, regardless of what *kind* of honey it was, and this leads me to think that lack of stores has much to do with the bees dying with dysentery. In such cases it is not pollen or poisonous honey, but the lack of any kind that causes the trouble. Let us be sure that our bees have plenty of sealed stores of their own gathering, put them into such quarters as I have described and in the way mentioned, and I believe you will find the vexed question of dysentery largely settled.

In my house apiary as soon as the weather begins to get freezing cold I will pack the hives on all sides with from three to eight inches of sawdust level with their tops. On top of each hive I will put a slatted honey board with the bee space turned down so there will be three-fourths inch over the frame. There will be one thickness of light sheeting tacked over the top of each honey board and in the center of each a feeder that I have made for this especial use will be placed right over the brood nest so the bees can take feed even in the coldest weather. These feeders are six inches high, and I will at this time cover the hives with sawdust two or three inches thick. This will be early in October, and I will feed each colony five or six pounds of thick sugar syrup. About November 1st the hives will be covered with sawdust entirely over the feeders and the bees will now be left in quiet until about April 1st, when the sawdust will be removed enough to uncover the feeders and in the evening of each day each colony will be fed two or three ounces of sugar syrup, and this will be continued until white clover blooms.

You will say that this is getting away from the question of dysentery, but these bees will have the entrance to their hives left open at all times so they can have a cleansing flight whenever the weather is warm enough outside to invite them to do so. Last winter I treated the colonies in my twelve-colony house in this way and the hives, combs and bottom boards remained as clean and bright as in summer, and I do not expect my bees in the new house to have the dysentery the coming winter or spring.

Bee-Diarrhoea—Is It a Disease?

G. M. DOOLITTLE.

"By time subdued, what will not time subdue?"



HAVING carefully read Bro. Hutchinson's article in the *American Bee Journal*, which is to be the "leader" for the October REVIEW, as I understand, I would like to say a few words thereon, with the editor's permission.

Before touching the real matter up for discussion, I wish to say that I supposed it settled some years ago that when we spoke of our wintering troubles we were to call it "Diarrhoea" instead of "Dysentery," as the word dysentery was not thought to be at all appropriate to the case. If diarrhoea is the word, would it not be well for us to all use that word?

About the first thing we find in the leader is, "The disease, if such it can be called," and from this I gather that there are some who still think that the over-loading of the intestines of the bee is a disease. That diarrhoea only exists under like circumstances has led some to believe that it is the effect of a cause, rather than a disease, myself being one of this latter number. The cause that produces the effect, called "Bee-Diarrhoea," is confinement. This, no one has successfully denied, although many have been the attempts to do so. Bees are natives of a warm climate, where they can fly at their own sweet will nearly every day, as winters are really unknown where all of the environments are suited to bee life, and our bringing them into a land where the environments are not all suited to them, is where the trouble comes in, and that trouble lies largely in the fact that these latter environments keep the bees from flying to void their faeces for from two to six months. "But," says one, "can you tell us why one colony escapes while another suffers, when both are wintered precisely alike, if diarrhoea is not a disease? Unless you can do this, I must differ with you." With all due respect to such, I would ask them to account for this state of affairs along the line of disease. This was the very ground on which I left the

"disease theory." To all the "knowing ones," who answered questions in the bee papers, I propounded the following question: Two colonies sitting side by side and as near alike, as to stores, bees, etc., as two peas, as far as can be seen, are prepared in the same way for winter. One dies before April 1st spotting the combs and soiling the hive, while the other comes through in splendid condition. What caused one to die and the other to live? The reply, without exception, was, "We do not know." Will any reader of the REVIEW answer the question?

Let me explain a little and see if it is not all plain along the line of being caused by confinement. In 1873 I was put on record as saying "that with a long, steady cold winter would come great mortality of bees, while in winters during which warm spells occurred, wherein a chance was given bees to fly, the mortality would be at a minimum, even although the average temperature might be several degrees colder than the former." The twenty years which have elapsed since then have proven this correct.

Many have told us the wintering problem was solved, but a winter like the last always proves that a loss of bees is sure to follow when spring arrives. During one of our hard winters, a few years ago, I had 145 colonies, fifty-five of which were placed in a warm cellar for winter, and ninety left on their summer stands. From the 22nd day of October till the 20th day of March, there was not a day warm enough for the bees to fly, although the average temperature of the winter was above those we frequently have. The result was I lost seventy-five colonies out of the ninety, while of the fifty-five wintered in the cellar fifty-four came out in splendid condition. The question is why did the seventy-five die, and why were the fifteen exempt? Simply because from a little more vitality on their part the fifteen were enabled to hold out a little longer than the seventy-five, while a month more of the same weather would have caused the loss of all that were out door.

There is a period of confinement beyond which a colony possessing the most vitality cannot pass, as all must admit, hence, I ask is it disease which kills the last? If not, and the one possessed with the least vitality succumbs earlier, is it disease which kills the first? Again, if bees having this "disease" have a good fly so as to empty themselves, they are cured at once, thus proving

that I am right, for if a flight cures, the lack of it must be the cause. Once more, with the same food and same surroundings which bring diarrhoea and death here at the north, if down in Texas or Florida give life and health. Is it not plain then, that the prime cause is not in the food, etc., but in the confinement? That food, dampness, poorly protected hives, etc., have much to do with our wintering troubles I am free to admit, but if we had no *winter* we would have no *wintering troubles*. Is not this plain to all? After a careful watching of the matter I find about this in every case. All colonies pass through the November and December confinement in safety, but by the middle of January some of the colonies having older bees or less vitality from any cause, begin to show uneasiness, and as the days wear on the bees begin to eat more to support their wasting tissues, while the abdomen becomes swollen with the accumulating waste matter. From this strain some now begin to die, and instinct teaches the survivors that unless more bees are reared to take the place of those dying they must soon become extinct. Chyme is now prepared with which the queen is fed, so she shall begin egg laying, when the cluster (or quiescent state) is broken, thereby causing the temperature of the hive to rise from its normal degree of about 55° up to that of brood rearing which is about 92°. If a chance to fly occurs at this time or a little before, all the trouble is ended for another six weeks or two months. If not, the mortality gains rapidly, as many times the food is required to keep up this brood rearing temperature, than was required for the other, so that the intestines are soon over-loaded to nearly bursting and the bees have the so called "diarrhoea." A chance to fly now helps a little, but such colony is sure to "spring dwindle" in any event, and if such a state of affairs occurs as early as six weeks before warm weather arrives the colony usually dies of exhausted vitality, during the cool spring weather. Should this chance not come the combs and hive are soiled, the bees die by thousands every day till most of the old bees are dead. Young bees now begin to hatch, but such young fuzzy bees have not vigor enough to stand the rigors of our northern spring and soon all perish together. As week after week of confinement succeed each other, other colonies more vigorous than the first, commence to get uneasy and go through this

same process, this continuing till warm days come, so they can fly often, after which nothing more of the kind occurs. From these careful watchings I am convinced that no colony could endure more than six months confinement on their summer stands and not more than eight when placed in the best repository. To overcome the environments of the North which are unfavorable, I now believe that all we can do is to see that the bees have plenty of good stores or sugar syrup, that they are placed in a good cellar or well protected out door, see that those out have an opportunity to fly when a warm day comes and those in the cellar have an even temperature of from forty-three to forty-five degrees, and to follow Bro. Hutchinson's recapitulation as near as may be. Doing this you will not have yourself to blame should the bees die.

BORODINO, N. Y.

Sept. 14, 1893.



Beware of Poor Food and the Cold, Damp Cellar.

PROF. A. J. COOK.

FRIEND H. :—You have, as usual, covered the ground so fully in your "leader" that it is hardly necessary to say more, but as there is safety in a multitude of counsellors, I will add a word, more in confirmation, than in addition.

Bees are natives of a warm climate, and can in their native home fly forth often. In the long confinement which we often enforce, we do violence to their habits, and unless we provide the best of conditions disaster will often meet us, and very likely snatch away our success.

I believe, with you, that temperature and food, and moisture in the surrounding atmosphere, are the points to look to in order of importance.

If we are to have a very severe and protracted winter bees must be protected either by cellar or packing or disaster is sure. Perhaps, with the best food the danger would be delayed, and, possibly, warded off, but I do not believe that bees can endure our most severe winters in our northern latitude of Michigan, New York, and Wisconsin, without serious, often universal and total loss. This position is proved by several winters' experience in almost all our Northern States. Could we only know that we should not have such winters, then it were better to leave our

bees outside, even with no extra protection, as then we give chance for frequent flight and copy their usual condition.

There are many cases besides the one you give that prove that food is a considerable factor in the matter of safe wintering. It seems positive that honey adulterated with glucose, much fall honey which often has the glucose like honey dew honey in large proportion, and honey dew honey itself, are all fatal to bees as winter food; especially if the bees are long confined. The presence of pollen by stimulating activity may also be harmful, while cane syrup honey is, like our best early honey, a very safe winter food. With other conditions most favorable, probably any food, almost, would be wholesome and safe, but with other conditions awry, then the good food may ward off disaster.

Some years since I doubted if dampness were an obstacle to safe wintering. Our old bee cellar with water always running through it was a great success. The bees always wintered well, and came out bright and strong, even on fall food, and despite the winter, whether very mild, or so cold that the mercury went down among the thirties. Our present cellar is equally unfavorable, yet it preserves as high a temperature. I have known the mercury in the old cellar to be at 38° F for weeks, and yet the bees came through all right. In our present cellar, though the mercury goes no lower, yet the bees never winter well. The old cellar always seemed pleasant in summer or winter. The present one always seems chilly and forbidding. The one was dry and wholesome, the other is dmy and clammy. The one was in sand and well drained, the other is in moist tenacious clay. I feel quite sure that the constant moisture in our present cellar is the explanation of its failure. Both cellars are coated all over with cement, and I supposed and think now that both are well drained. Thus I should like a cellar to be so situated as always to be dry and wholesome, so that when we enter it we do not wish for an overcoat. I am inclined to the opinion that a cellar in sand is better than one in any hard unyielding clay. I should prefer to have my cellar in a protected place rather than on a bleak hill. In such a cellar, with good food, I believe we will suffer no perceptible loss, even in the most serious seasons.

AG'L COL., Mich.

Sept. 16, 1893.

Some Criticisms on the Experiments With the Langdon Non-Swarmer.

FRANK RAOCHFUSS.

Man knows but little here below
Compared with what he longs to know.

FRIEND HUTCHINSON:—In the August number of the REVIEW I find Mr. Taylor's experiments with the Langdon device and as you invite suggestions and criticism of this line of work, I take the liberty in addressing these lines to you,

The report does not mention one important point, *i. e.* whether these colonies which swarmed had queen cells newly started or some which were kept over through the time of depopulation.

In our opinion the devices should be attached very early, before the colonies have any idea of swarming.

The use of only one story of the Heddon hive for brood chambers was hardly fair as almost any colony will swarm thus contracted; how can we expect two colonies thrown together to be satisfied with such cramped quarters? On the contrary we should like to have seen the experiment tried with large hives also, such as 10-frame Langstroth or the Quinby.

During the past season we have used one Langdon device and besides a number of our own get up, which are simpler and allow both colonies to use the same entrance, the alternating of which is regulated by a tongue, this plan avoids confusion in transferring the bees to one colony, this seems to be a point where the Langdon is faulty, as we find that the bees refuse to travel through the passage-way, cluster outside and stop ventilation. The hives used were ten-frame Langstroth and two-story Heddon, and wherever the devices were adjusted early enough swarming was prevented and the yield of those colonies was as large as of any pair, excepting one, in the yard. The next day after alternating, the queen cells would be destroyed and drones killed, still there seemed to be enough bees remaining in the closed hive to take care of most of the brood, although eggs and small larvae were nearly all gone, but the loss sustained in this way seemed to be made up again, in that the bees lived longer as they did not have to take care of so much brood, at least the present strength of the colonies seems to prove this.

Although these devices have worked satisfactorily this season we don't claim them to

be a success yet until they have been tried a few more seasons in different localities and under different conditions. There are several other ways in which such a device could be made useful, for instance, in transferring colonies from box hives into movable frames, by the drumming out of the queen and most of the bees, hiving them in the frame hive and then putting the box hive along side of the frame hive, adjusting the device so that the remainder of the bees will work into the other. After twenty-one days the box hive would be deserted and contents could be thrown into a solar extractor. Probably foul brood colonies could be treated in a similar manner. [I fear it would not answer for treating foul broody colonies, as some of the bees turned into the new hive might carry with them some of the infected honey.—ED.]

Mr. Taylor mentions in one of his reports an experiment he was going to make, which we also had intended to make this season, but circumstances prevented it. The experiment is "what quantity of bees will work to the best advantage." This question seems to us of great importance and has considerable bearing upon the non-swarmer question. Our plan of making the experiment was different from Mr. Taylor's. We were to make artificial swarms, *a la* Doolittle, by taking bees from upper stories, caging them in a box, introducing a queen in a few hours and in the evening hiving them on inch starters. We intended to make two swarms of 3 lbs. each, two of 4 lbs., two of 5 lbs., and two of 6 lbs. and give them young queens all reared from the same mother, by this plan bees and queens would be as nearly uniform in working quality and age as it is possible to get them.

DUFF, Colo.

Sept. 10, 1893.

[I sent the foregoing to Mr. Taylor and he replies as follows:—ED.]

In reply to the criticisms of friend Rauchfuss I desire to say that I write for those who think and who read before they criticize. Time and space would fail me were I to write at such length as to compel acceptance without the exercise of thought. I know my readers have knowledge and I expect them to use it in interpreting me. This is not for friend R. especially, but for certain others also, and, at all events, let the criticism come; it will help to get at the truth which we are all seeking.

As to friend R.'s first point, that I did not report as to the keeping over of queen cells during the time of depopulation, I think I need only say that I stated in substance, as an evidence that the swarming fever was gone from the depopulated colony, that the bees left therein generally began carrying out immature drones; and I supposed that every thinking bee-keeper knew that of the two, queen cells "go" before the drones. Friend R. must know that too, for further along he says, in stating the result of his own experiment, that the "next day" after the "depopulation" "the queen cells were destroyed and the drones killed," so I fear he did not read my entire article.

I am the more inclined to think this for he complains that I did not use a large hive like the ten-frame Langstroth, while if he had read he would have found that I used no less than four two story Heddon hives, each of which is equal in capacity to the ten-frame Langstroth; I used four of the single story Heddon, too, so as to satisfy those who might otherwise have thought that I should have used a smaller hive, nor did I omit, in order to cover the ground well, to use the medium hive also—the eight-frame L.

R. L. TAYLOR.

LAFEE, Mich., Sept. 23, 1893.



TIMELY TOPICS.

No. 9.

R. L. TAYLOR.

All feeding for winter stores should have been finished before the appearance of the October REVIEW, but should there have been a failure it may still be done if the weather continues warm or even if moderately cold if some suitable feeder is used and is kept warmly covered. The feeder should be so adjusted in such a case that the bees can reach the syrup directly over and in close proximity to the cluster. Then the food should be given as warm as the bees can bear it, in quantities of not more than two or three pounds and as rapidly as the bees will take it. If there should be occasion to feed after the weather becomes too cold for this plan it may still be accomplished with a small number of colonies though of course with somewhat greater chances against their wintering well, by giving them the food in a warm room. For this operation each col-

ony must be specially prepared. The feeder may be the Simplicity or some other which, like it, receives the syrup by pouring it from above. Adjust the feeder to the hive, inclose the bees at the top by a rim covered over above with wire cloth and close the entrance of the hive before bringing the colony into the warm room. Thus the bees are all inclosed and may be fed at pleasure by pouring the warm syrup through the wire cloth into the feeder. The syrup should be fed warm and as rapidly as the bees will take it and if they are uneasy on account of their confinement they should be returned to their proper stand as soon as possible on the conclusion of the feeding.

After completing the task of supplying the larders of the colonies against the long period of their enforced retirement, no time should be lost in giving all needed protection against rain, snow, storm and frost. If the bees are to be wintered out of doors each one should follow the course in which he has been successful, but it may not be amiss for me to urge early and thorough preparation. Water-soaked packing cannot conduce to the comfort or safety of the bees. All who have at command a fair cellar and who have not met with satisfactory success in wintering bees out of doors, I would advise to winter them in the cellar. In this latitude I think this both the cheaper and the safer course. This is the method I employ after trying both ways extensively and I would not now winter a single colony out doors except it may be in making experiments. It may be helpful to some to know my method of procedure, so I will state it briefly.

My cellar, though not a particularly dry one, is a very good one. It is under the north half of my shop and honey house and the barn and barn cellar abut it on the west and it is banked up with earth to the sill except where its one door and one window forbid. As a consequence its temperature is very even being not easily affected by the cold of winter or by the warmth of early spring. It contains a cistern which is generally well supplied with water. The chimney of the honey house starts from the bottom of the cellar and in connection with an underground tile drain no doubt does something in the way of ventilation. The door opens directly into the apiary which is reached without ascending any steps. The dimensions are 15x30 feet of which the cis-

tern occupies about one-fourth. It generally contains in the winter upward of two hundred colonies.

When the time arrives for putting the bees in, which is, of late years, from the 8th to the 15th of November, I look out for a day when it is cloudy and the temperature stands at about 45°, because under these conditions the bees are much quieter than they are when the day is clear or when the temperature varies much either way from the above, and, particularly, is a frosty day one to be shunned for the handling of bees. When everything is to my liking, hive after hive can be carried into the cellar without any bottom board with the loss of scarcely a bee. In the cellar each column or pile consisting of the hives of four or five colonies stands completely detached from everything else except its own support which consists of two one inch strips laid across an empty hive thus raising the lowest hive in every case about eleven or twelve inches from the cellar bottom. I first set the empty hive so that it stands firm and level, and then put the two pieces across it. I then bring in a good strong colony without any bottom board and place it firmly on the strips. Then two more strips are placed across the cover of this hive (unless the cover is made so as to preclude the necessity for them as most of mine are) and another colony is placed in like manner on these and so on until the ceiling forbids more. Each additional pile is a repetition of this. I aim to get the lighter colonies at the top and the stronger at the bottom as this is the more trying position. In the case of single story Heddon hives the bottom boards are not removed; in all other cases they are. I do not place any colonies very near either the door or the window, and I so dispose the piles that I can go among them at pleasure so as to see most of their hives and be able to tell how most of the individual colonies are wintering. When the bees are all in I shut the door tightly and do not concern myself much about them except to look occasionally to see that the temperature does not go above, or fall short of, the limits which I have fixed as the best, *i. e.*, 42° to 45°. If the bees show much uneasiness during mild weather I open the door for a night or two during the darkness until they quiet down.

As a rule, all honey should be shipped before cold weather.

LAPEER, Mich.

Sept. 26, 1893.

Bee-Keepers' Review.

PUBLISHED MONTHLY.

W. Z. HUTCHINSON, Ed. & Prop.

TERMS:—\$1.00 a year in advance. Two copies \$1.90; three for \$2.70; five for \$4.00; ten or more, 70 cents each. If it is desired to have the REVIEW stopped at the expiration of the time paid for, please say so when subscribing, otherwise it will be continued.

FLINT, MICHIGAN. OCT. 10, 1893.

LOUISIANA HOTEL—that is where the convention is to be held, and let's all stop there. It is so much more pleasant to have all the family at home.

MY CAMERA will go with me to the Chicago convention. I shall probably try photographing the bee and honey exhibits—possibly a group of the bee-keepers present.

THE ENTERPRISE has been denied second class mail privileges. It will change its name and try again in October at its home post office—Highwood. I presume the authorities have to keep close watch over those who try to palm off as periodicals what are but little more than advertising circulars, but they make greivous mistakes, as they have done in this instance, and that of *Printer's Ink*, which, by the way, has been re-admitted.

STARTERS MAY BE MOST PROFITABLE.

I am proud of the report from the Michigan Experimental Apiary that appears in this issue. At the risk of appearing prejudiced in trying to defend my advocacy of starters only in the brood nest when hiving swarms that are to be employed in comb honey production, I wish to call attention to one or two points brought out by the experiments. Light swarms *did* give the best results when hived on starters, while the heavy swarms on starters *gained on the others from the start*. Had the test been continued through a long honey flow instead of for three weeks only, it is fair to assume that starters only would have proved the most profitable. I have for several years experimented upon a larger scale than Mr. Taylor

did, and continued the experiments from the first swarms to the end of the season, and while I did not take the pains to weigh *every thing* and be so accurate as he has done, I *know* that, so far as the amount of honey gathered is concerned, the use of starters only is the most profitable. I should be glad to have Mr. Taylor tell, in some future report, about the amount of drone comb built, how straight and even the combs were, etc.

THE CAUSE OF BEE-DIARRHOEA.

After reading the articles upon this subject, that appear in this issue of the REVIEW, I see no reason for changing the views that I expressed in the last number.

No one thing alone causes the trouble. (There is no practical benefit in splitting hairs as to whether it is a disease: it certainly is a condition that brings death to the affected colonies.) Cold alone does not cause it. Bees have been very successfully wintered in cold winters, and on their summer stands at that. Confinement alone does not cause it, as bees have been confined three or four months with no trace of the disease. Poor food does not always result in disaster, as bees with what would be called very improper food have wintered most excellently. The same may be said of moisture, as bees have been wintered in a very damp atmosphere.

Of course, there must be confinement, no one disputes that, otherwise there would be no over loading of the intestines. If there were no cold there would be no confinement. The cold causes the confinement, and the confinement causes the over loading of the intestines. There is no dispute over this. When there is a chain of causes and effects we wish to know which is the link that can be most easily broken. Now then, we cannot get rid of the confinement; but we can get rid of the cold by putting the bees in a cellar, but the confinement remains. Having gotten rid of the cold, what are the conditions that will best allow the bees to bear confinement? If the bees must be confined three or four months (and, in our Northern States, this seems safer than to take the risk of not securing one or two flights by leaving the bees out of doors) the question of what their food shall be is one of the greatest importance. Mr. Heddou in his article brings out this point very strongly. If the natural

food of a given locality is such year after year that the bees pass the winter in excellent health, then there is nothing more to be done on that score, but, as I mentioned last month, if it is *not*, if a large percentage of the bees die with the diarrhoea nearly every winter, then there must be a change of food, and I know of no better plan than that of feeding sugar late in the fall as suggested last month. This is a heat forming food, free from nitrogen, and its consumption does not load the intestines. If fed late, it is stored where it will be consumed during the months of confinement.

The warmer the cellar the better, provided it is not so warm that the bees are excited to undue activity. Let it be such that they will remain quietly clustered, but will not be compelled to consume food largely for the sake of the warmth its consumption will generate. A moist atmosphere is detrimental because it is in effect the same as a low temperature. Besides this it prevents, or retards, the perspiration of the bees, which the sooner clogs the system.

Furnish the bees with plenty of wholesome food, put them in a dry, warm, well-ventilated cellar, and take them out as early as possible in spring, protecting them with packing, and all has been done that can be profitably done to prevent diarrhoea.

Dr. Miller says, in his "Stray Straws," that if I lived in Marengo I would not follow the plan of taking the bees from the cellar as soon as it was warm enough in the spring for them to fly. I should not take them out thus early unless I protected them, which I think the Doctor does not do. I think this "Straw" of his is scarcely fair inasmuch as it does not mention that I would protect the bees after taking them out. After bees have been confined sixteen weeks, a still further confinement of three weeks makes more difference than many of us have been aware.

EXTRACTED.

Preventing Bee Dysentery by the Use of Sugar Stores.

Cold cellar did repress their noble rage
And froze the genial current of their soul.

Mr. Heddon, in his article, refers to an experiment that he made in wintering bees on

sugar stores. In his book, "Success in Bee Culture," he goes more into detail, and I quote that part of the chapter on wintering that refers to this particular experiment. He says:—

"In the autumn of 1884, I placed bees in two cellars; one containing 40, and the other 91 colonies. The old cellar containing 40 colonies was at all times very dry, while the new one containing the 91, was very damp. Both cellars were allowed to become quite too cold, to test the endurance of bees with sugar syrup; the temperature in the old cellar was down as low as 10 and 15 degrees above zero, in the new, damp cellar, as low as 25 degrees. The old cellar contained bees with sugar syrup only, and of its 40 colonies, all but five died, with no symptoms of diarrhoea in the hive. The new, damp cellar, containing the 91 colonies, had 73 colonies without pollen or honey—sugar syrup only—10 colonies with little pollen, and stores of part honey and part sugar syrup, and 8 colonies having all natural stores. This cellar was so damp that mold collected on the alighting-boards and between the combs, on the under side of the covers, etc. About one-third of the colonies had upward ventilation by way of nails pushed under the board covers; the other two-thirds had no upward ventilation whatever. In numerous hives, water could be seen running out on the alighting-board. If the covers of those hives which were tight down, were lifted and turned up edgewise, water would run from them. In spring, the health of the 91 colonies stood thus: Of the 8 on natural stores, 6 died with diarrhoea, and the other 2 came out in good condition. All were treated alike with no upward ventilation. Of the 10 with little bee-bread and mixed stores, 8 lived, while 2 died. Of the remaining 73, with nothing in the combs but pure sugar syrup, not one showed any signs of diarrhoea, whatever.

I will now state how matters stood with the out-door colonies of this same home apiary. I had 49 colonies, each on 6 American frames with combs, in tenement hives, that in summer contained 19 combs, all resting horizontally. On either side of the 6 combs and bees, was a 2-inch chaff, cloth-sided division-cushion; over all, in the upper story, was a large chaff cushion, about six inches thick. These hives were painted white, and rested high, so that they were above the most of the snow. Twenty-five of them contained no honey, and only a cell of pollen here and there, and were well supplied with sugar syrup; 24 contained a little honey and bee-bread, and all the rest of the food was sugar syrup. I had no idea of losing any of these colonies, but in this I was in error, for every one died. Among the 25 there was scarcely a sign of disease; the combs were clean and nice. Among the other 24, there were occasional symptoms of diarrhoea, here and there, but not to amount to anything. I have had colonies show many times more symptoms of disease and survive, and come up strong for the June honey harvest. None of these colonies died of diarrhoea. Of what did they die? Cold, too long continued;

and those in the old, cold cellar did the same. But how in the cellar? Cold is a giant in a cellar. Why? Because it continues; there is no ray of sunlight, no immediate raising of temperature, or chance for the bees to change position. What degree can bees stand? That depends upon the duration. Here is the important point that too many of us have overlooked. Forty degrees below, can be endured for a short time, but 10 to 15 degrees above, will kill bees if continued, diarrhœa or no diarrhœa.

It is the temperature within the hive, that effects the bees, and it requires time for the temperature without to effect the temperature within.

In the same yard stood 17 colonies lower down and packed warmer than the 49 just referred to, all being on full natural stores of honey and pollen, and in the regular 8-frame Langstroth hives. All but two died. All of them had diarrhœa badly. Not until we could remove bee-diarrhœa, could we get a clear view of any other causes which might result in the death of our bees.

Just to the left stood 73 colonies packed like the above 17; these had little pollen in their combs, and stores of a mixture of sugar and honey, just the same as the 10 referred to in the new, damp cellar. They, like the 17, were low down, and were pretty well covered with snow during the severe weather. Of these 73 colonies, about one-half survived.

Of my out-apiary of 208 colonies, all packed, and all on natural stores, nearly all died."

Where the Langdon Non-Swarmer Differs From the Taylor.—What Hopes There Are of the Latter.

Little people,
Great big people,
Common size o' men.
If your trying
Ends in crying
Try him once again.

E. R. Root voices my sentiments exactly where he says in a recent issue of *Gleanings* that we should not drop new things too quickly when they are apparent failures. He refers to the Langdon non swarmer as one of the new things that ought to be given a more extended trial. I still have faith in the finding of *some* method for preventing swarming. The Langdon has failed in a way that I did not expect. At first I could see but little difference between it and the method advised by Mr. B. Taylor: in fact, the Langdon seemed the *more* promising of the two. Mr. Taylor, however, has several times told me in private letters that he had no faith in it, but never did he so clearly set

forth the reasons *why* as he has now done in the following article which I copy from *Gleanings*;

"FRIEND ROOT:—The fact that I am and have been experimenting in a non-swarmer hive or system of manipulation to effect that purpose, is generally known to the readers of the bee journals. I see that the Langdon device has failed to come to time, the results and reports of R. L. Taylor and Mr. Secor settling that fact. The editor of the BEE-KEEPERS' REVIEW knows that I have never had any hope of the Langdon plan succeeding, there being more than one reason for expecting failure, to one who had already practically explored the ground occupied by both Langdon and Aikin.

My experiments this year have not darkened the hope of yet perfecting a practical plan whereby swarming can be controlled, even if we could not get quite so much honey. A plan that would enable us to escape that constant watching through the whole working season that is now a necessity, and enable us to keep either a home yard or out-yards by visiting them and giving a little attention once a week, would be a great boon. This much I will assure the bee-keepers: I will not offer any thing, either for sale or even trial, until I have something certain to offer. The plan I am now working on is radically different from the Langdon plan. There is a similarity in some respects; but the radical difference is, that the plan of Mr. L. contemplates two hives and two entirely distinct families, with entirely separate entrances; while my plan is one hive with practically but one family, all the bees using one common alighting-board and entrance, but with two queens, these queens to be kept separated by a wire-cloth partition through the center of the hive. This partition, however, serves other purposes than keeping the queens apart, as it is entirely necessary in order to manipulate the bees as desired. The possibility of working a single colony of worker bees with two queens in a single hive divided by a gauze partition is no longer an experiment. I now state here the fact that I am working such colonies with entire success, the whole colony of workers using either side of the hive, and accepting either queen, without the least disturbance. This is what I claim as my discovery, and I shall keep myself protected legally in its use, so that, if it ever proves successful in serving a useful purpose, there will be no question of priority to dispute about.

The bees I used in the new hives this season were blacks; and to determine whether the bees did fully fraternize I removed one black queen from each of two hives early in the season, and replaced them with pure Italians. Thus there was a black queen in one side of each hive, and an Italian in the other. The point aimed at was to see whether the Italian bees, after they hatched out, would all remain in their own side of the hive with their mother, or would accept the whole hive and both queens as their home. After several examinations I found, to my great joy, that the yellow Italians were

equally distributed in both apartments and were indiscriminately intermixed throughout the hive.

I next tried removing both black queens and substituting Italians, to see whether the bees from the other side would regard them with disfavor; and, after releasing the new queens and waiting several days, I examined the hives and again was overjoyed to find my pet queens peacefully and quietly doing duty.

Now, friends, I have good reason to hope that I shall yet succeed in accomplishing my task of working out a successful non-swarming hive. I have had a higher motive in my nine years' work in this line than the making of money; and if I succeed I will never use it other than to benefit the bee-keeping fraternity.

I see that friend Secor smothered two of his best colonies in trying the Langdon machine. I should have expected this result where a full colony was given no greater means of exit than a passage large enough for only a single bee to pass out. In my own device there is no danger of smothering the bees, as the closed hive may have the entrance at the back opened the whole width of the hive if necessary. I have frequently noticed that, where bees from different hives got mixed together in natural swarming, they are quite prone to swarm out again after being hived. They seem to be in an excited and unnatural condition. Now, when two swarms are thrown together, as in Mr. Langdon's plan, the bees are entire strangers, and I think this accounts for their strong passion for swarming, as reported by R. L. Taylor. In my plan the bees are not strangers that are suddenly thrown together, but members of a common family, and they will be free from that excitement that would naturally follow from the home being suddenly crowded with strangers, and I believe I shall not fail from this cause. In Langdon's hive, every bee that leaves the closed hive has to go into the already overcrowded one. In my hive no bees go to the full hive. After those used to flying have left the closed hive, the young bees that have their first flight will fly from the back entrance and will return there. Friend Langdon tried to criticise this feature; but I regard this as being the strong point in my hive, as these bees are just the needed nurses for the unsealed larvae, and are absolutely needed to maintain healthy condition and enable the queen to continue her work. If I live and have the strength next year, I shall finish my work with non-swarmers; for if this fails I shall "throw up the sponge."

But whatever comes of the non-swarmers, the house-apiary is a complete success with me, and I greatly wish, friend Root, that you could be here and be convinced. I have boomed the house-apiary; I have nursed it as my choice pet; and now, after three seasons' trial, I declare that I made no mistake when I said that the house-apiary had come to stay, and that soon most good bee-keepers would keep their bees in that way.

B. TAYLOR.

FORESTVILLE, MINN., Aug. 19, 1933."

A Condensed View of Current Bee Writings.

E. E. HASTY.

THE Langstroth experiment which I desired to condense from the *Apiculturist* last month was conducted eight years ago. It starts with Bevan's assertion that the drone "hatches" on the 24th or 25th day from the egg; and the experiment is the natural movement of the student who "wants to know you know" not only whether it is correct but also whether it will always be so, under all circumstances, and with all strains of bees. By the way we need a reform of language right here, even if we do have to reform our grandfathers to get it. An egg hatches. A young bee emerges—several weeks after the hatching takes place. Calling both these very diverse occurrences by the same name, "hatching," may in some cases lead to confusion, and is unworthy of cultured people. With words in our language by the hundred thousand we can afford at least one for each distinct thing.

Well in this one experiment (many more are needed before the subject can be properly closed) the first drone emerged in 25 days 8½ hours (probably); and the last one a little scant of 27 days—quite an eye opener. Date and weather were favorable to rapid development; but the honey flow was so scant that other colonies killed drones, and feeding was resorted to in the experimental colony. Possibly they might develop faster when all colonies are breeding drones naturally.

There is also in this article a pretty observation of the *first acts* of newly emerged drones and workers. They are quite characteristic. The worker first takes a walk, stopping occasionally to make a "cat's toilet;" and soon, having no doubt got up an appetite, dips in for a square meal, asking no odds of anybody. The drone, according to the tenor of his nature, very soon touches a worker bee with his antennae and begs to be fed.

Another experiment concerning the emerging of queen and workers was conducted ten years ago. (*Ap.* August, pp. 14-18.) A nucleus was made, and the queen was removed from it at such time that all the eggs must have been laid inside of 24 hours. The

worker progeny from these eggs varied four days, lacking two hours, in their emergency—another eye-opener. The first worker to emerge was only a day and a half behind the *last* queen. The quickest worker time was 19 days 2 hours. The slowest worker time 22 days 3 hours.

CANADIAN BEE JOURNAL.

Except in name the *Canadian* seems to be a new paper. New editor, new dress, new style, new air—and we've got to go to work and get acquainted all over again. That superabundant glee in slinging in the adjectives and things which we used to note will not be found in the new editor; but perhaps his solid, quiet style will serve the purpose as well. He can make a very forcible sentence when he tries. In editing he besprinkles his journal with short items in lighter vein—not a bad plan perhaps—but most of them have no connection with apiculture; and in this he is behind the times, as compared with the best journals. His short editorials come the first thing; and in setting the sub-heads he gets in a pleasant bit of unusual style. One of the proprietors does some of the talking under the head of Strictly Business. We shall have to wait a spell to see whether the intention is to make the journal largely editorial, like the *Apiculturist*, or whether the preponderance of editorials in the first numbers was owing to the empty pigeon-holes with which a new sheet naturally begins life. The beginners department, First Steps in Bee Keeping, is editorial, and seems likely to be one of the strong points of the paper—as per sample—

"With the novice in the past it has too often been the practice to work the 'Stand and Deliver' plan at any time during the honey season, and then the 'Root Hog or Die' system follows." Page 8.

And when you want to try to winter a weak colony short of stores don't feed *that* one. Put a few extra combs into a strong colony that is being fed, feed enough for both, and transfer the combs when they are ready. See page 33. Tip top. Old chaps not Canadians will probably be most interested in Allen Pringle's letters from the World's Fair. In the other journals there seems to be a scarcity of fair letters at present. There is a lengthy continued article of good quality, and illustrated, concerning the bee's work in fertilizing flowers. No name is attached, but it rather seems to be editorial.

Editorial answers to communications are especially good, and show vigor of thought. The contributors to the September number (other than Pringle) are H. Couse, R. W. McDonnell, and G. M. Doolittle. The former well fills a page with the orthodox rules about Marketing Honey—

"Some days I sell 200 pounds or more and often less."

That encourages me. You see if he had said that he sold a ton each day for eight days each week, it would have had a sort of wilting effect upon me. McDonnell seems to be a little "afeerd" of those beginners—almost on the point of petitioning the powers above to "bless us four and no more." And then he has some sensible words on educating people to use honey.

"Honey is too rich for the ordinary appetite to have it served up by the spoonful and apart from some milder food."

Very true of many people. But then some of us have *extra*-ordinary appetites, and like to sail right into a lot of it with spoon, knife, paddle or anything that comes handy. Alas, how many have done so just once? and there was a South American rebellion down below: and after that, "Quoth the raven, Nevermore."

Doolittle fights over the battle of few bees much manipulated versus many bees little manipulated—

"Few seem to consider * * that each of the extra colonies * * costs at least sixty pounds of honey to support."

That's so. A hundred more colonies *might* eat up a surplus of 6,000 pounds slick and clean. Yet a man *can* have too few bees, and spend too much time on them. Undoubtedly he can have too many, and spend good money and valuable time putting supers on a horde that can only provide their own provender. There is a wise medium somewhere. Probably it runs in a different place at different apiaries; and one of the bee man's extra important duties is to locate it. Friend Doolittle fails to get one important element of the decision. Suppose there are flowers enough in the field to keep 150 colonies busy to visit each one properly. The visits are not made, and no honey is gathered, because there is no secretion. Once in a while there comes a time when the flowers *do* secrete. Then if only 40 colonies are in the field much of the honey must be lost—and no colony get a great harvest

either. And it *may* transpire that 100 colonies may get just about as much per stand in one of these runs as 40 will. This state of things seems to be the usual situation in my field.

THE GENERAL ROUND UP

Carlyle named one of his books a queer name which signified, The Tailor Retailored. In like vein Alley in last *Apiculturist* might entitle his sauciest article, The Miller Ground Over. Awful for the miller. And as for the rest of us, we can fairly hear the grim editor humming softly to himself—

"Ye living men come view the ground
Where you must shortly lie."

Our excellent friend Miller will think it pours mostly instead of raining, as the *Progressive* calls for a rest on pulled queens, and "Ellery Krum," who supplies the "Fax" for *Gleanings*, sings:

"When a queen is ready to gnaw from the cell,
And gettin' quite ripe, sometimes it is well
To help her climb out; but then I have seen
A waste in the haste of pullin, too green."

A. B. J. has a new department, "Stray Stings." As is becoming for stings, it is quite sharp. Poetical also; and none but hardened old chaps, and spectators, can see the poetry of getting stung.

Almost equal to Topsy at confessing a fault is the *Enterprise*. Being belated with the August number it comes out floating the following "poem" at mast head:

"He never did a thing on time;
For him all others had to wait,
Promptness he took to be a crime,
And even his drink was choco-LATE."

Books teach that drones from a pure mother are not affected by her mating. To test this, two yellow sister queens of five-banded stock were taken. One was mated to a black drone, and the other was made to lay without mating at all. The virgin mother's drones were all alike, and very yellow, just as drones of five-banded stock should be. Those from the mismated queen were about all styles and colors except black. Now this *might* happen by accident; but it looks suspicious.

Whose experiment is the above? Willie Atchley's—and he is going to conduct a queen-rearing department in the *Enterprise*—the youngest in the world no doubt to have such a charge. But if a boy mows more grass than any man in the world why shouldn't he write about mowing?

"I will try to tell what little I have learned so you may understand it without any grammar."
Page 59.

Bravo, Willie! We won't grumble a bit, so long as you give us facts, and carefully conducted experiments. Good thing if half the writers in the world could be deprived of grammar—and forced to put in some information to fill up the vacancy, else wind up.

Friend Lovesy writes "from the inside" a letter on Mormon social affairs which is very interesting. *A. B. J.*, 369.

If editor York keeps on he'll photograph the whole of us drawn up "300,000 strong." Eight Australians last time.

Prospect for two more babies for Uncle Sam's post office department to strangle.

Mrs. Atchley talks business on the wintering problem. Send her a car load of bees and she will paddle their canoe all winter for 50 cents per colony and send them back in the spring. *A. B. J.*, 304. If the right railroad official could be moved to foster this infant for a few years it would grow to be a big man perhaps.

"In our wanderings among bee-keepers we find that shade boards are rarely used." Ernest Root. *Gleanings* 633.

Dr. Miller caught a laying worker at her nefarious trick. The worker cell she had backed into pushed the wings up about her head in a very uncomfortable looking way. And that seems to be the reason why laying workers almost always choose drone cells. *Gleanings* 627.

And now Ernest finds that the Boardman solar beats the chemical processes of the wax room in getting wax out of dirty refuse. *Gleanings* 687. Not quite level yet. Horse eats cow's "orts," and cow eats horse's "orts." Just so, I suspect, the solar does well on chemical refuse, and the chemicals do well on solar refuse.

And A. I. finds that in this summer's drouth many things won't grow when you do water them. Same way here—have a mind of their own, and are convinced that our watering is a mere sell.

Guess Dr. Miller makes a center shot when he reminds us that unfindable cells are usually the forced work of queenless bees. *Gleanings* 673.

Panic drones from two colonies scatter through the whole apiary at Dr. Miller's. This is a very valuable proof of what has been quite generally assumed. And the occasional crossing of bees at long distances is not caused by queens flying long distances, but by drones going moderate distances to a playground, and going home with new

friends to a different apiary, and doing the same thing next day. There need be no wonder if a drone gets 20 miles from home and fertilizes a queen there.

These two from Dr. Miller, *Gleanings* 699, are good enough to steal.

"A queen has about 5,000 eyes; a worker from that to 6,000, and a drone twice as many as a worker. I'm glad I'm not a bee, for with only two eyes I can see much that ought to be done."

"A queen's brain is not so large as that of a worker, and Cheshire thinks a queen doesn't know as much as a worker. The queen lays eggs, and the workers run all the other business of the hive."

Right in part, no doubt. The queen's world is much more contracted than the worker's world; but she masters it more thoroughly, I think. When she is bold she is bold; but when she is timid it is easy to perceive that her eyesight is better than a worker's, and that she plays squirrel with you when you are seeking her.

RICHARDS, Lucas Co., Ohio, Sept. 23, '93.

ADVERTISEMENTS

IMPORTANT

TO BEE-KEEPERS!

To make a success of bee keeping, you want bees that will give the very best results. My *Golden Italians* have gained a good name on their own merits. Those who have tested them with other bees say "they are the best honey gatherers, cap their honey the whitest, as gentle as butterflies, beautiful to look at, are the largest and strongest bee of all the races." Queens bred from mothers that produce uniformly marked

FIVE-BANDED WORKERS

In March, April and May, \$1.25 each, 6 for \$6.00; June, \$1.00 each, 6 for \$5.00; July to Nov., \$1.00 each, 6 for \$4.50. Special prices on large orders. For full particulars send for descriptive circular.

12-92-tf

C. D. DUVALL.

Spencerville, Montg. Co., Maryland.

Illustrated Advertisements Attract Attention.



Cuts Furnished for all illustrating Purposes.

TYPEWRITERS.

Largest like establishment in the world. First-class Second-hand Instruments at half new prices. Unprejudiced advice given on all makes. Machines sold on monthly payments. Any instrument manufactured shipped, privilege to examine. EXCHANGING A SPECIALTY. Wholesale prices to dealers. Illustrated Catalogues Free.

TYPEWRITER } 31 Broadway, New York
HEADQUARTERS, } 186 Monroe St., Chicago.

Bind Your Back Volumes.

The back volumes of the REVIEW are somewhat different from those of some journals; many of them are, to a large extent, little pamphlets devoted to the discussion of special topics. For this reason they will always be particularly valuable for reference. But how provoking it is when desiring to consult some back number, to find that that particular number is missing—has been lost or mislaid. To avoid such annoyance, some have fastened together the issues of each year by tacking them together with wire nails, or something of the sort. This is better than nothing, but there is a lack of flexibility, the book does not open out easily so that it can be read, there is no protection to the outside leaves, besides there is nothing handsome about such an arrangement.

There is a book binder here in Flint that does excellent work at a fair price. He will put the first five volumes of the REVIEW into one handsome volume with morocco back and corners, putting the title on the back in gilt letters, and giving the edges of the leaves a neat, reddish tinge—all for \$1.25.

Send me your back numbers, either by mail or express, and I will get the work done and return the book when bound, making no charge for my services, as the binder allows me a small commission, and should any of your back numbers or volumes be missing, I shall be glad to furnish them as long as the supply lasts, simply charging the regular price for them, which is as follows: Vols. I and II, five cents a copy; Vol. III, four cents a copy; Vols. IV and V, eight cents a copy.

The time will soon come when some of the back numbers will be difficult to obtain, and if you care for the REVIEW complete from the beginning, nicely bound, now is the time to attend to it. W. Z. HUTCHINSON, Flint, Mich.



Interesting Monthly for
The Family and Fireside

Welcome in every Home.

Large Premiums for Clubs.

Sample Copy sent Free.

THOMAS G. NEWMAN,
147 South Western Ave.,
CHICAGO, ILLS.

Names of Bee - Keepers.

TYPE WRITTEN.

The names of my customers, and of those asking for sample copies, have been saved and written in a book. There are several thousand all arranged alphabetically (in the largest States) and, although this list has been secured at an expense of hundreds of dollars, I would furnish it to my advertisers at \$2.00 per thousand names. A manufacturer who wishes for a list of the names of bee-keepers in his own state only, or, possibly, in the adjoining states, can be accommodated. Any inquiry in regard to the number of names in a certain state, or states, will be answered cheerfully. The former price was \$2.50 per 1000, but I now have a type writer, and, by using the manifold process, I can furnish them at \$2.00. W. Z. HUTCHINSON, Flint, Mich.

CATCHALL

The orders for untested queens at 75 cts each; six for \$4.00. Tested queens, \$1.50 each, three for \$4.00. Two-frame nucleus with any queen \$1.50 each, extra. Safe arrival guaranteed. 7 93-tt

W. J. ELLISON, Catchall, S. C.

Great Reduction.

SECTIONS AT GREATLY REDUCED PRICES.

HIVES, SHIPPING CASES, &c., AT BED-ROCK PRICES.

WRITE FOR FREE, ILLUSTRATED CATALOGUE AND PRICE LIST.

G. B. LEWIS CO., Watertown, Wis.

1 93-tf. Please mention the Review.

Hastings' Lightning Ventilated Bee Escape.

AGRICULTURAL COLLEGE, Mich. Sent. II, '92. "I have used the Lightning Bee Escapes you sent and find them certainly the equal of the Porter, and their superior for the reason that they will empty a super more rapidly."

Yours respectfully, J. H. LARRABEE. "It is our opinion that you have the best Bee Escape ever introduced."

A. I. ROOT, Medina, Ohio.

HONOLULU, Hawaiian Islands, April 25, '92. "Please send me by return mail 5 Lightning Ventilated Bee Escapes. I have the Porter, and the Dibbern and they both clog."

Yours truly, JOHN FARNSWORTH.

Price, by mail, each, 20c. per doz. \$2.25.



"IT LEADS THEM ALL." Read Testimonials of a few successful Bee-keepers. Send for Sample and after a trial you will use no other. Catalogue sent on application.

M. E. HASTINGS, NEW YORK MILLS, ONEIDA CO., N. Y.

Second Hand Supplies.

Of the second hand supplies that I have been advertising in the REVIEW, the following remain unsold:—

100 old-style, Heddon surplus cases at 20 cts. (as a non-separated case, they have no superior); 25 slatted honey boards at 10 cts.; 20 Heddon feeders at 40 cts.; and half a dozen single-comb nuclei for exhibiting bees at fairs. They have glass sides, removable covers and are painted a bright vermilion. They cost \$2.00 each, but will be sold at half-price. All these are practically as good as new.

W. Z. HUTCHINSON, Flint, Michigan.

The Golden Beauties.

Our five-banded Italian queens, warranted purely mated, at 75 cts each; two for \$1.25. Tested, \$1.00 each; two for \$1.50. Safe arrival guaranteed C. B. BANKSTON 2-93-tf Chriesman, Texas.

Dadant's Comb Foundation.

Wholesale and Retail. Even our competitors acknowledge that our goods are the STANDARD of their kind. Langstroth on the Honey Bee, Revised. New edition. Bee Veils; and veil material at wholesale. Bee Supplies, Sections, Smokers, etc. Samples of Foundation and veil stuff with circular free. Instructions to beginners. Send your address to

CHAS. DADANT & SON, Hamilton, Ills.

4-93-12t Please mention the Review.

CHERRY VALLEY, N. Y., March 20, '93. "I shall take pleasure in recommending them as the best I have ever used."

Truly yours, J. E. HETHERINGTON.

"We believe you have an Escape that 'downs' the Porter."

T. PHILLIP & CO., Orillia, Ont., Canada.

"Your Escape knocks out all competitors."

A. J. LINDLEY, Jordan, Ind.

"They did not clog, and cleared the supers rapidly. In fact it is the best Escape I have yet used. I cannot speak too highly of it, and consider it a great boon to bee-keepers."

W. E. CLARK, Oriskany, N. Y.

Cut the Price.

This is what Mr. G. E. Dawson of Carlisle, Ark., writes me. You may remember that he is the man who got no orders. He is raising good queens and is bound that they shall be tried, hence he offers them as follows: Untested, 65 cts.; three for \$1.75; six for \$3.00; twelve for \$5.00. Tested, \$1.25. Select tested, yellow to the very tip, \$1.50.

—ED. REVIEW.

Please mention the Review.

If You Wish Neat, Artistic

PRINTING,

Have it Done at the Review.

Muth's HONEY EXTRACTOR PERFECTION Cold-Blast Smokers,

Square Glass Honey Jars, Etc.

For Circulars, apply to CHAS. F. MUTH & SON, Cor. Freeman & Central Aves., Cincinnati, O. Send **10c.** for Practical Hints to Bee-Keepers.

1-93-tf.

Please Mention the Review.

GO TO HEAD QUARTERS

FOR 4 AND 5 BANDED

QUEENS

Special, breeding queen,	\$5.00
Best, select, tested,	3.00
Tested,	2.50
Untested,	1.00
" per dozen,	9.00

L. L. HEARN,

Oakvale, W. Va.

7-93-tf

Please mention the Review.

GOLDEN ITALIAN QUEENS

Now ready for \$1.00 each. Do not order your supplies until you see our circular for 1893. For the price, we have the best spraying outfit made. Send \$1.50 and get one. Wm. H. BRIGHT, 1-93-12t Mazeppa, Minn.

Please mention the Review.

ITALIAN QUEENS AND SUPPLIES FOR 1892.

Before you purchase, look to your interest, and send for catalogue and price list.

J. P. H. BROWN,

Augusta, Georgia.

1-88-tf.

Please mention the Review

For \$1.50 I will send the Review for 1893 and a fine, young, laying, Italian queen.

Queen alone, 75 cts. For \$1.75 I will send the Review, the queen and "Advanced Bee Culture." Tested queens, \$1.00. The Review and a tested queen \$1.75

A discount on large orders. W. Z. Hutchinson, Flint, Mich.

REVIEW

QUEENS

The Champion Smoker.

The ORIGINAL curved nozzle, steel lined, Bellows Smoker. The fire-chamber is $3\frac{1}{2} \times 7$ inches with a corrugated steel lining, which allows a cold current of air to pass between lining and outside shell; keeps the outer shell cool and more than doubles the durability of the Smoker. It has a FORCE draft, and SPARK-ARRESTING CONE connection between bellows and fire-chamber; a base-valve to either keep or extinguish the fire at pleasure; and a removable spark-arresting GRATE in the curved nozzle.

Price, by mail, \$1.90; by express, \$1.65

If your supply dealer cannot supply you, write to the manufacturer,

E. KRETCHMER, Red Oak, Iowa.

Bee Supply Catalog of 70 Illustrated Pages, free.



HONEY

Superior Quality; Price Low.



About the

NEW HIVE.

Ask for Heddon's Circulars. Address

JAS. HEDDON, Dowagiac, Mich.

HUNT'S

FOUNDATION

FACTORY.

Send for free samples of foundation and sections; warranted good as any made. Dealers, write for special prices and the most favorable conditions ever offered on foundation. Send for new, illustrated, free price-list of a full line of supplies.

M. H. HUNT,

Bell Branch, Mich.

1-93-tf

Bee Hives and Section Boxes.

Simplicity, Langstroth-Simplicity, Standard Langstroth, Dovetailed and Champion Chaff Hives, Supers, One Piece Sections and Shipping Cases. Foundation, Smokers, etc., etc. Send for 16 page Circular.

1-92-tf PAGE & KEITH, New London, Wis.

Please mention the Review.

New as Well as Valuable IMPROVEMENTS

IN BEE-HIVES, SMOKERS,

FOUNDATION FASTENERS,

SECTION PRESSES AND FEEDERS.

Special prices given to parties who will take hold of and push the sale of these goods. For circulars and particulars, address

LOWRY JOHNSON,

Masontown, Pa.

1-93-tf.

Bee - Keepers' Head - Quarters — The Louisiana Hotel !

EUROPEAN PLAN. — H. L. DALEY, MGR.

Located at the Corner of 71st St. and Ave. B, Two Blocks from the South Side of World's Fair Grounds, and One Block East of Stony Island Avenue and Parkside Station.

Nearly 300 Large, Light and Well-Ventilated Rooms. All modern Conveniences. Hot and Cold Water on every floor. Free Baths Electric Call Bells. Lighted with Gas and Electricity. Steam and Electric Cars pass near the Door every 15 minutes.

Rates—50c., 75c., and \$1.00 per Day. Meals, 25c. and Upward.

How to Reach the Hotel. Parties arriving on the Baltimore & Ohio R. R., take the World's Fair train at the Rock Island Junction to the Exposition Depot, opposite the Louisiana hotel; or if you arrive on any of these railroads—Big 4, Nickle Plate, Lake Shore, Pennsylvania, Michigan Central, or Illinois Central—Get off at Grand Crossing and take an Electric Car to Parkside Station. If you arrive at the Main Depot of any other R. R., take Illinois Suburban (South Chicago) train to said Parkside Station, and walk one block east.

SHIPPING — AND — WINTER CASES,

Pasteboard Boxes or Cartons,

Everything used by Bee-Keepers. Catalogue and Price List free. Ask for a copy of the AMERICAN BEE-KEEPER (50 cts. a year) especially for beginners

The W. T. FALCONER MFG. CO., Jamestown, N. Y.

PATENT. WIRED, COMB FOUNDATION

HAS NO SAG IN BROOD FRAMES.

Thin, Flat - Bottom Foundation

HAS NO FISHBONE IN SURPLUS MONEY.

Being the cleanest, it is usually worked quicker than any fdn. made.

J. VAN DEUSEN & SONS,
(SOLE MANUFACTURERS),

3-90-tf Sprout Brook, Mont. Co., N.Y



The Bee-Keepers' ENTERPRISE.

A cyclopedia of fresh, bright, original ideas pertaining to Bee-Culture, carefully selected and boiled down for busy people. Published monthly at 50 cts—sent from now until Jan. 95 for 50 cts.

BURTON L. SAGE, New Haven, Conn.

Italian Queens

From imported mother, warranted purely mated, \$1.00 each; six at one time. \$5.00. Untested queens. 65 cts each.

C. A. BUNCH,

Nye, Marshall Co., Ind.

7-93-2t

"Golden" Florida.



My location enables me to rear good queens NOW as cheaply as they can be reared in the North at anytime. Untested queens, 75 cts. each; 6 for \$4.00; one dozen, \$7.50. Last year's tested queen, \$1.25; select, \$1.75; breeder, \$2.50. Safe arrival and satisfaction guaranteed. 1-92-tf

J. B. CASE, Port Orange, Vol. Co., Fla.

— If you are going to—

BUY A BUZZ-SAW,

write to the editor of the REVIEW. He has a new Barnes saw to sell and would be glad to make you happy by telling you the price at which he would sell it.

IF YOU WANT THE

BEE BOOK

That covers the whole apicultural field more completely than any other published, send \$1.00 to Prof. A J. Cook, Agricultural College, Mich., for his

Bee-Keepers' Guide.

Liberal Discounts to the Trade.

Please mention the Review.

BEES QUEENS,

SECTIONS, SMOKERS,

COMB FOUNDATION

And all Apiarian Supplies. Send for Catalogue.
E. T. FLANAGAN, Belleville, Ill.

Please mention the Review.

Just Splendid

Mr. Alley—The queen I got of you last fall is just splendid! She is the best queen in an apiary 150 colonies. I would not take \$10 for her. John A. Pease, Moravia, Calif.

Price of such queens is \$1.00 each.

HENRY ALLEY,

Wenham, Mass.

Please mention the Review.

THE PROGRESSIVE BEE - KEEPER

Has Changed Hands. It is now Published by the
LEAHY MANUFACTURING CO.,

Higginsville, Missouri.

Money, Experience and Enterprise will not be lacking to make it all that its name indicates. Send for Free Samples and Copy of 28-page Catalogue of Apiarian Supplies.

NOV., 1893.



At Flint, Michigan.—One Dollar a Year.

ADVERTISING RATES.

All advertisements will be inserted at the rate of 15 cents per line, Nonpareil space, each insertion: 12 lines of Nonpareil space make 1 inch. Discounts will be given as follows:

On 10 lines and upwards, 3 times, 5 per cent; 6 times, 15 per cent; 9 times, 25 per cent; 12 times, 35 per cent.

On 20 lines and upwards, 3 times, 10 per cent; 6 times, 20 per cent; 9 times, 30 per cent; 15 times, 40 per cent.

On 30 lines and upwards, 3 times, 20 per cent; 6 times, 30 per cent; 9 times, 40 per cent; 12 times, 50 per cent.

Clubbing List.

I will send the REVIEW with—	
Gleanings,.....	(\$1.00).....\$1.75.
American Bee Journal.....	(1.00).....1.75.
Canadian Bee Journal.....	(1.00).....1.75.
American Bee Keeper.....	(.50).....1.40.
Progressive Bee Keeper.....	(.50).....1.30.
Bee Keepers' Guide.....	(.50).....1.40.
Apiculturist.....	(.75).....1.65.
Bee-Keepers' Enterprise.....	(.50).....1.40.

Honey Quotations.

The following rules for grading honey were adopted by the North American Bee Keepers' Association, at its last meeting, and, so far as possible, quotations are made according to these rules:

FANCY.—All sections to be well filled; combs straight, of even thickness, and firmly attached to all four sides; both wood and comb unsoiled by travel-stain, or otherwise; all the cells sealed except the row of cells next the wood.

No. 1.—All sections well filled, but combs uneven or crooked, detached at the bottom, or with but few cells unsealed; both wood and comb unsoiled by travel-stain or otherwise.

In addition to this the honey is to be classified according to color, using the terms white, amber and dark. That is, there will be "fancy white," "No. 1 dark," etc.

KANSAS CITY, Mo.—We quote as follows: No. 1 white, 15 to 16; No. 1 amber, 13 to 14; No. 1 dark, 10 to 12; white extracted, 6½ to 7; amber extracted, 6; dark extracted, 5. Beeswax, 20 to 22.

CLEMONS-MASON CO.,
Nov. 1. 521 Walnut St., Kansas City Mo.

CHICAGO, Ill.—**HONEY.**—The limited demand for comb honey does not permit our quoting it above 16c, with no sales of white selling below 14 to 14½. The stock that we have received this year is of fine quality, and we advise forwarding to market at once, so as to be received here before the cold weather sets in. Extracted is selling at 6 to 6½. Beeswax, 23.

Oct. 18. **S. T. FISH & Co.,**
189 So. Water St., Chicago, Ill.

BUFFALO, N. Y.—Honey is moving very slowly, but the demand will no doubt soon increase. Stock is light for this time of the year. We have orders for several tons of buckwheat honey which we can place at about 10 cts. We quote as follows: fancy white, 14 to 15; No. 1 white, 12 to 13; fancy dark, 10 to 11; No. 1 dark, 8 to 9; white extracted, 7 to 8; dark, 5 to 6. Beeswax, 25 to 30.

BATTERSON & CO.,
Nov. 1. 167 & 169 Scott St., Buffalo, N. Y.

CHICAGO, Ill.—There is plenty of honey coming in and plenty of buyers for fancy stock. There is good demand for white extracted which is becoming scarce. Some inquiry for beeswax. Honey has sold well this fall. We quote as follows: fancy white, 15; No. 1 white, 14; fancy amber, 14; No. 1 amber, 13; fancy dark 13; No. 1 dark, 12; white extracted, 7; dark, 5½. Beeswax, 20 to 22.

J. A. LAMON,
Nov. 1. 44 & 48 So. Water St., Chicago, Ill.

CINCINNATI, Ohio.—Demand from manufacturers for extracted honey is slow, while that for table use is fair. It brings from 5 to 8 cts., according to quality. Choice comb honey is in good demand at from 14 to 16 cts. Arrivals are good for all kinds of honey. Beeswax is in slow demand while arrivals are large. It brings 20 to 23 cts. for good to choice yellow wax.

CHAS. F. MUTH & SON,
Sept. 26. Cincinnati, Ohio.

MINNEAPOLIS, Minn.—We are receiving large shipments of honey but they are mostly of poor quality. Fancy white is selling at 18 to 20 cts., but we are cleaning up more No. 1 white at 16 cts. than anything else. We quote as follows: Fancy white, 18 to 20; No. 1, 16; fancy amber, 15; fancy dark, 14; white extracted, 7½ to 8; dark extracted, 6½ to 6¾. No sale for beeswax.

J. A. SHEA & CO.,
116 First Ave., North, Minneapolis, Minn.
Sept. 27.

CHICAGO, Ill.—Fancy white comb honey brings 15c per pound. Grades not grading first-class are not selling at over 14c, as there has been quite a quantity of California honey received here that is offered at 14c. The quality is superior to most of that we receive. Dark honey sells slowly at 12 to 13c. Extracted ranges from 5 to 7c per lb., according to color, quality, flavor and style of package. Beeswax 22c per lb. The trade in honey has been large this season.

R. A. BURNETT & CO.,
Nov. 1. 161 So. Water St., Chicago, Ill.

NEW YORK, N. Y.—The market on white comb honey is weak and shows no activity. The supply is plenty and the arrivals large, hence prices have a downward tendency and concessions have to be made in order to effect sales. Fancy dark is scarce and in good demand. Extracted remains quiet with plenty of stock on the market. We quote as follows: fancy white, 13 to 14; No. 1 white, 12 to 13; fancy amber, 12 to 13; fancy dark, 11 to 12; white extracted, 6 to 6½; amber extracted, 5½ to 6. Beeswax, 24 to 25.

HILDRETH BROS. & SEGELKEN,
Nov. 2. 28 & 30 West Broadway New York.

WINTER LOSSES

Are not always the result of the same cause. They may come from starvation; from poor food; from improper preparations; from imperfect protection; from a cold, wet, or possibly a poorly ventilated cellar; etc., etc. Successful wintering comes from a proper combination of different conditions. For clear, concise, comprehensive conclusions upon these all-important points, consult "ADVANCED BEE CULTURE." Five of its thirty-two chapters treat as many different phases of the wintering problem.

Price of the book, 50 cts.; the REVIEW one year and the book for \$1.25. Stamps taken, either U. S. or Canadian.

W. Z. HUTCHINSON, Flint, Mich.

HONEY

Superior Quality; Price Low.

About the

NEW HIVE.

Ask for Heddon's Circulars. Address

JAS. HEDDON, Dowagiac, Mich.

Please mention the Review

New as Well as Valuable IMPROVEMENTS

IN BEE-HIVES, SMOKERS,

FOUNDATION FASTENERS,

SECTION PRESSES AND FEEDERS.

Special prices given to parties who will take hold of and push the sale of these goods. For circulars and particulars, address

LOWRY JOHNSON,
Masontown, Pa.

1-93-tf.

Please mention the Review.

FREE A Whole Year's Subscription

TO THE WEEKLY "AMERICAN BEE JOURNAL."

For the Full Particulars of this Liberal Offer of America's Oldest, Largest and Best Bee-Paper,

SEND AT ONCE FOR A FREE SAMPLE COPY.

Address, **GEORGE W. YORK & CO., 56 Fifth Ave., CHICAGO, ILL.**

To New Subscribers: The Journal Alone Sent for Three Months for Twenty Cents.

CLEANINGS IN BEE-CULTURE

For Only 50 Cts.

THIS journal has a big circulation because it is made up of practical ideas, good printing and paper, and first-class original engravings—yes, lots of 'em; in fact, because it has MERIT. But merit alone won't boom the circulation; so we propose to offer it TO NEW SUBSCRIBERS from now until January, 1895, for \$1.00. For \$2.50 we will send the journal to new subscribers from now until January, 1895, and one of those new, improved, Crane smokers, postpaid. Crane smoker alone, \$2.00. Send for our free, illustrated, 52-page catalogue of bee-keepers supplies and sample copy of GLEANINGS.

A. I. ROOT, MEDINA, O.

Twelve Months

THE CANADIAN BEE JOURNAL, a live bee paper edited by R. F. Holterman, will be sent to any new subscriber for twelve months for 50 cents in stamps or silver. Renewals, \$1.00 per year. Address GOULD, SHAPLEY & MUIR CO., Ltd., Brantford, Canada.

50 Cents.

Please mention the Review.

SHIPPING CASES.

To hold twelve, 1½ sections, or fourteen 7-to-the-foot, at \$6.00 per 100—with glass, \$6.65. They are of fine material, and the workmanship is of the best. Send for free price list of everything needed in the apiary. 9-93-tf

M. H. HUNT, Bell Branch, Mich.

Please mention the Review.

FOR ALL KINDS OF BEE-KEEPERS SUPPLIES.
ADDRESS LEAHY MFG. CO. HIGGINSVILLE-MO.

PORTER BEE ESCAPES

Are used and pronounced the best, and highly recommended as great labor-saving implements by Chas. Dadant & Son, Prof A. J. Cook, Chas. F. Muth, Jno. S. Reese, J. H. Martin, Jno. Andrews, F. A. Gemmill, Wm. McEvoy, A. F. Brown, Thos. Pierce, and many other prominent bee-keepers. Descriptive circular and testimonials mailed free. **PRICES:** each, postpaid, with directions, 20 cts.; per doz., \$2.25.

RETURN THEM AND GET YOUR MONEY BACK AFTER TRIAL, IF NOT SATISFIED. For sale by dealers.
MENTION THE REVIEW. Address R. & E. C. PORTER, LEWISTOWN, ILL.

The Bee-Keepers' Review.

A MONTHLY JOURNAL

Devoted to the Interests of Honey Producers.

\$1.00 A YEAR.

W. Z. HUTCHINSON, Editor & Prop.

VOL. VI. FLINT, MICHIGAN, NOV. 10. 1893 NO. 11.

Work at Michigan's Experimental Apiary.

R. L. TAYLOR, APIARIST.

AN EXPERIMENT IN FEEDING BACK.

Hungry fates!
Where went those other hundred weights?
Suddenly retreating "up the spout?"
Like a bubble when its time is out?



AT the end of the white clover honey season, finding I had a large number of unfinished sections on hand, as well as honey to extract, I planned to make an experiment in feeding back extracted honey to se-

cure the completion of the sections. The experiment was begun about the last week in July and was continued for about four weeks. This was too long a time for the amount of work done. This is to be accounted for partly by the weather during August which was characterized by unusually cool nights and partly by the fact that some of the colonies used were not so strong as they should have been. I also think that the feeders used were partly to blame. They were Heddon feeders brought from the

Agricultural College. It may be they were not properly made, at all events when I came to feed for winter I found I could feed half a dozen with a tin pan to one with one of those feeders.

The only preparation of the colonies to be used was, where they were not already confined to one section of the Heddon hive, to so confine them by removing the extra sections of the hive containing the least brood.

No.	Weight of sections put on.	Amount fed.	Amount removed.	Gain.	Per cent. of gain of am't fed.	Wt of hive at beginning.	Wt of hive at end.	Gain in wt. of hive.	Loss in wt. of hive.
1	115	136.8	202.8	57.8	64.2	39.4	38.4	0.4	0.8
2	78	111	157.8	64.8	50.6	27.6	28	0.6	
3	97.12	116.12	165.4	67.8	57.6	27.8	28.12	0.12	
4	108.4	114	164	60.12	52.3	25.8	28.12	10.12	
5	83.8	85.8	92.8	49	51.3	20.8	41.4	12.4	
6	18.4	80.8	87.12	35.8	41.1	34.8	41.4	6.12	
7	107.12	144.8	205.12	98	61.8	26.12	39	12.4	
8									
9									
10									
11									
12									
13									
14									
15									
16									
17									
18									
19									
20									
21									
22									
23									
24									
25									
26									
27									
28									
29									
30									
31									
32									
33									
34									
35									
36									
37									
38									
39									
40									
41									
42									
43									
44									
45									
46									
47									
48									
49									
50									
51									
52									
53									
54									
55									
56									
57									
58									
59									
60									
61									
62									
63									
64									
65									
66									
67									
68									
69									
70									
71									
72									
73									
74									
75									
76									
77									
78									
79									
80									
81									
82									
83									
84									
85									
86									
87									
88									
89									
90									
91									
92									
93									
94									
95									
96									
97									
98									
99									
100									

It is hardly necessary to say that after this the cases of sections to be furnished were put upon the brood chambers as needed and

the feeder placed above the sections. The feeders were then kept continually supplied with the extracted honey without dilution.

Seven colonies were employed and an accurate account kept of the material in the case of each colony. The results may be most briefly told by the use of a table as shown on the preceding page.

But little need be said in explanation of the table. On the average out of every 100 pounds fed 58 6-10 pounds reappeared in the shape of comb honey. Some colonies did much better than that. In selecting colonies some not very strong were taken to make the fact prominent that for the best results the very strongest should be chosen. This fact of employing some colonies not very strong, with others already mentioned, make the circumstances of this experiment about as unfavorable as they could ordinarily well be, yet there seems to be no difficulty in showing a large percentage of profit.

To show this I think we may properly make the calculation in this way :

Increased value of 588 lbs. 8 oz. of unfinished section honey at 7c.	\$ 41 19
Value of 426 lbs. 12 oz. "gain" at 15c	69 41
Increased weight of brood chambers 59-4 at 5c.....	2 96
Total.....	\$113 56
Deduct value of 788 lbs. 8 oz. fed at 8c	63 08
Profit.....	\$ 50 48

This does not take account of the labor of feeding, but I think the improved condition of the colonies may well offset that item.

There is one drawback with this product—it is liable to candy and so makes it necessary that it be disposed of and consumed without much delay. Perhaps on account of this defect I have estimated the value at too high a figure. If some unobjectionable method of preventing candying could be found it would be a great advantage.

LAPER, Mich.

Oct. 21, 1893.

[I can say to Bro. Taylor that I, too, have tried feeding honey without diluting it, but the bees take it so much more slowly that I abandoned it. To make the best success at feeding back, there should be populous colonies, with the brood nest somewhat contracted, hot weather, and the honey thinned to nearly the consistency of nectar. It should be thinned with hot water and fed while warm.

I can tell you how honey can be treated so that it will not candy when "fed back," but I presume that some of my readers would

consider the plan objectionable. You know that some of us mix a little honey with the sugar that is fed in the fall for winter stores. This is done to prevent crystallization. Well, this rule will work *both ways*. A little sugar mixed with the honey will prevent crystallization.—Ed.]



Apiculture in College and Station.

PROF. A. J. COOK.



YOU ask for an article on the above subject. As I have decided convictions, I am glad to comply with your request, only regretting that lack of time forbids the care in writing it that its importance demands. All should know that our special Agricultural Colleges,

like those of Michigan, Kansas, Massachusetts, Maine, Pennsylvania, Mississippi, etc., and the Agricultural Department of Universities like that of New York at Cornell, of Illinois at Champaign, of Indiana at LaFayette, of Wisconsin at Madison, of Tennessee at Knoxville, etc., were largely endowed by the general government, which fact alone made the existence of many of these colleges possible. The Morrill Bills, one passed in 1862, granting 40,000 acres of public land to each member of congress for each State, and the other passed three years ago granting \$15,000 to each college (which amount should be increased \$1,000 annually till it reached \$25,000 for each college each year), were conditioned on the fact that agriculture in its various departments should be specially taught in each college. In each State this munificent gift from the general government has been supplemented by the State often with very generous liberality.

Thus we see that the money for these colleges has come from a general tax, either State or National, and that agriculture in all its branches is to receive benefit. Thus the bee-keepers have a clear *right* to be remembered: first because they have helped to found and equip colleges and stations, and, secondly, because apiculture is an important

branch of agriculture : important in gathering the vast stores of nectar, and perhaps more important in increasing the fruitage of orchards and gardens through pollenization by the bees.

The bee-keeper, then, has a right to claim recognition in each and every college, where bee-keeping is located ; and in what State or Territory is it not ?

Now that we have proved the right, we next consider the policy. Is it desirable to have bee-keeping taught in the agricultural colleges ? To say no, is to say that the bee-keeper may as well be ignorant of the sciences relating to his business, and ignorant regarding general matters. To be thoroughly taught gives to the bee-keeper the same general advantage that it gives the horticulturist or farmer. If not, why not ? No intelligent bee-keeper would say that a knowledge of botany, entomology, and a general education in science would not be of great benefit to him. Not only in matters of utility, but in adding to life's pleasure.

Again, if bee-keepers are trained, strained honey in fact as well as name will soon be no more, and will cease to injure our markets. If each neighborhood could have a bee-keeper taught to put his honey upon the market only in the finest condition, prices would not be depressed as they must be by ungraded comb honey sent in soiled and broken combs.

Again, if we do not claim and maintain our rights, we shall not only receive less than is our just due, but our business loses in prestige, and instead of assuming its rightful dignity our business will have no standing, and when we appeal for legislation regarding spraying fruit trees, or in regard to foul brood, etc., or ask for appropriations at fairs, or for publications, or to exhibit at great expositions, we must expect the taunt, 'your business is of no account,' and we are denied our just requests.

It seems to me that no bee-keeper who appreciates the importance of his vocation can feel for a minute that he and his business are not entitled to this recognition in our college, just as general agriculture, horticulture, and floriculture are ; and can he hesitate longer, when he knows his rights, to demand them ? He will thus encourage a better market, because of the excellence of the product, and will do much to make the dignity and importance of his business felt in all the community. Thus with the rights

and importance of instruction in apiculture at our agricultural colleges shown, can it be accomplished ? I haven't a doubt of it. Let bee-keepers rise *en masse* and demand this right, and their demand, hedged in on every side by justice, cannot be refused by any College Board. A good committee appointed to urge the matter, sustained by numerous personal letters will succeed every time. If bee-keepers in any State will demand this right, the right will be given. This was done in Michigan when bee-keepers demanded that their Experimental Station recognize bee-keeping ; and though I believe they lost more than they gained, they proved, that energetic action would secure rights. This will always prove true if those who demand their rights are sufficiently in earnest to persist, and urge until success comes.

Like our Agricultural Colleges, so, too, our Experimental Stations are endowed by the general government. Only here the government gives \$15,000 annually to each State and Territory, and entirely equips and mans the stations without expense to the State. As before, the bee-keepers have a right to recognition ; they need the experimentation, unless we now have reached bottom facts, which no intelligent bee-keeper believes. Here, too, insistence will bring recognition, as was proved in Michigan. In Michigan, however, while the experimenter was secured, the station was removed from the college where it should be located as I showed a year ago, and all chance to teach bee-keeping at the college was lost, for to teach apiculture without an apiary is sheer nonsense. I am sure that the Michigan bee-keepers when they realize what was done, will insist that not only shall the station be ably manned as it is at present, but that it shall be re-located at the college, and that apiculture shall again be taught, and the station and college be mutually helpful to each other, as they must needs be when they have so much in common. Would not the farmers protest were the farm to be removed, or the horticulturists kick if the gardens and orchards were moved hence ; and why not then a wave of indignation at this strange move at the Michigan Agricultural College ?

AG'L COL., Mich.

Sept. 16, 1893.

[I fully agree with Prof. Cook that each Agricultural College and Experimental Station ought to have an apiary just as much as

it has a garden or an orchard. If the experiments are all performed at one place they are mutually helpful. If the apiarist wishes to decide some delicate chemical point, an expert chemist with his apparatus is right on hand. If it is a question in microscopy, fine instruments and expert operators are near by. In this sense I agree with the Prof. that it is a mistake to move the apiary away from the College, but we who were working to have bee-keeping recognized at the Station were led to believe that \$1,000 yearly (what it would cost to secure the services of a competent apiarist at the College) could not be spared just at present, while by having the work done at the home of some competent apiarist it could be done for half the money, which could be spared. It was a question of half a loaf or none. I do not understand that it has been definitely decided that the apiary will never be taken back to the College. But so far as bee-keepers are to be benefitted by experimental apiculture, there is one point that overshadows all others, and that is *the man who does the work*. I was well satisfied that Michigan had made a wise choice, but I must confess that Mr. Taylor is doing better work than I expected of even him.—Ed.]



Why Ventilation Plays Such an Important Part in the Wintering of Bees.

E. C. ATKIN.

To the puzzles thick and thin
Look a little deeper in.



IN our last, we left you with the testimony of four of Colorado's foul brood inspectors favoring top ventilation. There was also present, at our annual State convention last January, Mr. W. L. Porter, one of Colorado's leading

apiarists. After hearing the testimony in favor of upward ventilation, he decided to look into the matter. Just at this time the

weather became quite pleasant, and Mr. Porter and a neighbor went out to see about the ventilation question. Mr. Porter's bees were supposed to be under sealed covers in the form of enameled quilts. The bees had, however, made many holes in the quilts. The result of their search was to find every colony with big holes in the quilts *dry and nice*, while those that had *good quilts sealed down*, were damp and in the poorest condition.

This spring we purchased bees from a lady who had a *few* good hives, but most of her bees were in boxes and old traps of hives. Some of the boxes were not over seven inches deep, and ten or twelve wide by sixteen to twenty long. Many of these boxes were so open that the bees had ceased to work from the lower or regular entrance (which was in many cases clogged with bees and dirt, as the hives sat right on the ground in the grass and weeds) and were flying from cracks and crevices about the top. Some had openings from a mere crack to an inch, almost the entire length of the box. Yet the bees had wintered equally as well, if not better, than those beside them in the hives. One thing was in favor of the good hives, most of those in boxes were new, being last year's swarms, and some short of stores, while the good-hives colonies had plenty of stores, and young queens. Now these boxes and all were right out in open ground, except that grass and weeds had grown up all about them.

The situation will be better understood when you remember that this is a dry climate. The ground is bare and often dusty most of the winter, so you will see that these colonies received much heat through direct rays of the sun, and the heat radiating from the ground.

Last winter we had bees out-doors entirely unprotected, and with supposed sealed covers. One lot of seventeen colonies was in a little deep valley in the foot-hills. The first cover over them was a plain thin board cleated, with bee space between it and the top bars of frames: above this was a regular rimmed outer cover, same as illustrated in the K. D. hive in both the *REVIEW* and *Gleanings* some time ago. This gives about one and one-half inches space between the covers. The inner cover become wet to some extent and warped so as to give a little top vent. Right behind the hives on the north and northwest was a big rock and hill. The

rocks piled up almost perpendicularly for fifty feet or more. Thus the sun would beat down upon the hives, and also generate and reflect heat from these rocks, so that almost every clear day those bees were warmed through. There being the two covers on, the outer one slightly telescoped and close, there could not be any decided top ventilation, but where the ventilation lacked, the heat came to the rescue. Not one colony perished although one or two were very weak to start with in the fall.

Another apiary was an open ground. The hives were placed in double rows, back to back, fronting east and west. These were left with the summer quilts on, and a slightly telescoping cover close on these. Most of the quilts were more or less ragged. The most of them had more or less top ventilation, but none having very much. Cases were about the hives, taking ten and twelve hives to a case, half on one side and half on the other. These cases came just about two inches above the brood chamber, and had removable roofs sloping both ways. About two inches of space was between hive and outer case. This and the spaces between hives were packed with chaff, and about two or three inches of chaff on top. Thus the winter case cover lay upon the chaff at the eaves, but rose to about six or eight inches in the center, to give the pitch to the roof.

Here the loss was about five or six out of fifty-seven so far as winter losses were concerned; more, however, were lost by spring dwindling. This dwindling we will discuss farther on.

Another lot previously mentioned in a hive within a hive and sawdust packed, because of much shade and covering, and being so situated that the sun could not penetrate the hives, suffered greatly with moisture and the loss was about two-thirds. This lot was not quite so strong to start with, which had something to do with the difference in loss.

Six colonies we put up-stairs in the honey house. They were left with sealed covers. Three faced east and three south. A four-inch space, vacant, was between the hive-wall and siding. The room was unplastered. Now notice that the location and arrangement would in summer give a more even temperature, and a warmer temperature at night. The sun upon the roof would heat up the room and contents during the day which heat would largely continue during the night. In winter, this same room would become

very cold at night, while the sun's heat by day would never reach the interior of the hives. We put those bees in in the spring, and were highly pleased with the results in honey getting; but, alas, spring again found but one poor "starveling of a thing" to tell the story. Ernest Root reported a similar loss in his home apiary, but omitted particulars.

We also put a lot of bees in the cellar in December, just after a severe spell of intense cold. Most of the covers were sealed on close. There was considerable water in the hives. Nearly all the bees had diarrhoea. Loss about fifteen per cent.

Now, friends, I feel almost like making a positive assertion, that proper ventilation is the main spoke in the wheel of successful wintering. Read again B. Taylor's article on page 129, current volume. Note the account of Mr. Hitt's successful wintering for twenty-five years, by putting his bees in the cellar and *taking off the hive covers*. Also Mr. Taylor's own experience last winter while experimenting with sealed covers versus upward ventilation.

In *Gleanings* for February 1st, page 82, A. E. Manum discusses the wintering question and tells of buying a colony in the spring because it was the strongest in the lot. There was top ventilation. Also how he packed one apiary in shavings so there was ventilation through the cushions. These wintered well. Five colonies that were left with sealed covers *all* died, and were "a dauby mess."

On page 198, Vol. 20, *Gleanings*, C. P. Dadant also gives us conclusive proof that upward ventilation is safest. Holes in the quilts showed him the difference between sealed covers and ventilation.

Although we find some good authorities on both sides of this question, I think we may sum it up about this way: Sealed covers in open winters, and upon all occasions when the conditions do not favor accumulation of moisture, will be O. K. Absorbents when used in such a manner as to allow the moisture to pass out and *not be retained*, will winter O. K. But either one will fail in extreme and long continued cold, when every thing favors the retention of moisture.

I would therefore recommend, in sunny climes, to pack warmly all around the hive, putting on top not over two inches of chaff, and on the sides not to exceed four inches,

while two or three are better. A board or cloth may be used overhead next the bees, but leave a vent somewhere to pass off moisture.

If the climate is such that a damp cold prevails with extreme low temperature and long continued, winter in the cellar with plenty of ventilation, and a temperature not too low, say 45° or over. The more damp the cellar the higher must be the temperature.

In the spring, when brood-rearing is wanted, is the time to economize heat. Last year, brooding stopped early. In January a warm spell set some colonies to brood-rearing. A few matured their brood, and the young had cleansing flights. Such colonies were the easiest to spring. Others that had very old bees, and did no breeding until the last of February and first of March, had hard work to pull through. Some were so much weakened by the death of the old workers that they could not well rear brood, and so just eked out an existence trying to brood but failed.

Right here is where packing shows its value more than anywhere else. If these weak and dwindling colonies are hid away so deep as to exclude the solar heat, they are almost as surely doomed as if exposed to the extreme of heat and cold. But if the packing is only two or three inches thick, and so arranged as to receive the heat of the sun and be warmed through and through, it not only helps the colony during the day time, but also preserves a more even temperature by night. A little close observation will show that of two colonies of equal strength, the one packed, and one not, the former will cover the most brood, the latter being compelled to contract or compactly cluster.

A large apiary in this county has been packed in chaff now for four or five winters. About three to five inches of chaff are above in a hive body, and the cover left partly open to allow moisture to escape. The past two winters have been colder than usual, and when the covers were left too close, moisture accumulated somewhat. However, they have wintered with scarcely any loss. The packing has been too deep all around, but when fairly started in the spring, breeding was rapid.

LOVELAND, Colo.

Aug. 8, 1903.

Bee - Dysentery.—Its Cause and Prevention.

S. CORNEIL.

We shall get there by and by,
Do it right—and know the why.



IN his leader on the above topic the editor says: "We do know that, in almost all cases of bee-dysentery, the fecal mass is almost always wholly pollen." This is a mistake. Dysenteric discharges are distinguished from feces voided in health by the excessive quantity of water they contain. It has been observed that, on the occasion of their first flight in spring, healthy bees often void feces which contain at least twice as much pollen, weight for weight, as is contained in the excrement of dysenteric bees. Prof. Cook examined microscopically some specimens of "dry feces" which I sent to Dr. Miller. His report is that "as they break up they are found to be composed wholly, or almost wholly, of pollen grains." See *Gleanings*, page 391, 1885. Later on Dr. Miller says "I am not mistaken, I think, as to what I saw, for I have often seen the bees in the act of voiding, both in this and other years, and have seen thousands of specimens, such as Mr. Corneil sent, both on the hive and in the vicinity." For a fuller account of Dr. Miller's observations see *Gleanings*, page 703, 1885. Mr. Heddon has said that feces of this description are evidence of disease. If so, I want to have my bees diseased in this way every year.

The editor also says "I feel certain that bees with only pure cane sugar for stores, placed in a cellar where the temperature is about 45°, will bear a confinement of four or five months, with no trace of disease." The editor is mistaken again. Mr. Doolittle tried to winter bees in just this way, and lost them. His experiments and observations show clearly that sugar syrup in place of honey, and the absence of pollen, do not secure immunity from dysentery. See *Gleanings*, pages 231 and 342, 1885.

There is another reason which of itself makes it imperative that pollen must not be excluded from the larder of the bees in winter. It is known that carbohydrates cannot

be digested and assimilated without the addition of nitrogenous food. The highest authorities on dietetics are in accord in regard to this matter. On one occasion Mr. Heddon's bees died, as he tells us, of cold. A post mortem examination by Prof. Cook revealed the fact that their stomachs were full of sugar syrup, without a trace of pollen. The material for heat production was present, but there was lacking the nitrogenous element necessary to start in motion the changes which result in the evolution of heat.

I think the foregoing abundantly proves that, not only is there nothing gained by the exclusion of pollen from winter stores, but its presence is essential for the health of the bees. The editor of the REVIEW is as much opposed to teaching errors through the columns of his paper, as any man can be. May we not now hope to see him boldly recant his opinions, as to the consumption of pollen being the cause of bee dysentery?

The editor recommends a temperature of 45° for the air of the bee cellar, with the wet bulb thermometer 3° lower. This would indicate a relative humidity of 78, or, in other words, 78 per cent. of saturation. If these conditions are kept up continuously the hives being sufficiently ventilated, either upward or downward, and provisioned with buckwheat honey, or other honey equally good, and the stocks moderately strong, there will be no dysentery. Let us consider some of the difficulties to be overcome in maintaining these conditions all winter.

Saturated air at 45° contains 3.61 grs. of the vapor of water per cubic foot, and 78 per cent. of this is 2.81 grs.; therefore the addition of .8 of a grain to each cubic foot of the air approved by the editor will produce complete saturation.

An ounce of honey, on being consumed, produces 328.125 grs of aqueous vapor. 100 colonies, consuming an ounce per day, will give off 32,812.5 grs. which, being added to the air approved by the editor, will saturate 41.015 cubic feet per day, assuming that no ventilation of the repository takes place. This is more than the quantity of air in most repositories, after the hives are put in. In my cellar I have often found that the readings of the wet and dry bulb thermometers were almost identical, indicating saturation, or nearly so. My cellar is too small to enable me to maintain a constant difference of 3°.

In the case of the higher animals, when air is saturated, or nearly so, and is of the same temperature as the body, "it refuses to receive the perspiration which is offered to it from the skin and lungs; the sewerage of the system is dammed up." Such are the atmospheric conditions when cases of sunstroke are most numerous. Supposing the air in the cellar at 45° were fully laden with moisture, the case of the bees is even then not so bad. Saturated air at 45°, when warmed to 65°, will have about 63 per cent. of saturation. Evaporation of the bees will take place under these conditions, but not so effectually as if the air of the cellar were as dry as recommended by the editor.

Air breathed by the bees, when expired, is saturated, and of the same temperature as the cluster. As the vapor laden air escapes from the cluster at 65°, into saturated air at 55°, it deposits 3.2 grs. of water per cubic foot, on the sealed honey, the hive walls and surrounding objects: whereas, if the air of the cellar were dry, and of sufficient quantity, this vapor would be taken up by the air, just as the clouds of condensed steam from a locomotive are absorbed by the atmosphere, and disappear.

Saturated air carries off the heat of the cluster nearly three times as fast as dry air, consequently to keep up the temperature of the cluster, the bees must eat more honey, now thinned by absorbed moisture deposited on the combs. This loads their blood with an increasing quantity of water, which is not completely evaporated. Josh Billings says that when a man begins to go down hill financially, all nature seems to be greased for the occasion. So with the bees, each unfavorable condition brings about others, until their bodies become distended, and as Mr. C. W. Dayton says they must be "evaporated down" or they will die of dysentery.

The only practical way of maintaining the conditions approved by the editor, is to keep the air in the repository constantly changing, and by warming the incoming air by bringing it through a sub-earth pipe, or by artificial heat. I have had bees suffer from dysentery because they were exposed to a current of incoming air. Mr. Boardman records a similar experience. It is not to be wondered at that bees suffer, when exposed to a constant draft for five months. From the experience I have had I consider it essential that the hives should not be exposed to a draft.

It is said that sub-earth pipes are being discarded. They are usually made of wood or porous tile, open at the joints, in either case admitting moisture and foul air from the soil. The only advantage gained by bringing the air through a sub-earth pipe is that, no matter how cold the weather may be, the temperature of the incoming air never varies more than from 37° to 42° in this latitude, and we have had the mercury about as low as it can go. If the sub-earth pipe is impervious to moisture, as it must be if it is used at all, outside air at say 10° above zero, and having 80 per cent. of saturation, will enter the cellar at about 40°, and 38 per cent. of saturation. Of course, the air will be equally dry, no matter how it is brought in, when it is warmed up to this temperature.

My neighbor, Mr. Webster, heats his brick dwelling by means of a furnace in the cellar. A brick partition cuts off the furnace room from the bee cellar. There is a door in this partition, which is opened, from time to time, to let warm dry air into the bee department, and draw the cool damp air out. Mr. Webster has wintered 100 colonies and upwards very successfully, in this cellar, for several years.

If I were building a bee cellar, I should have it wholly under ground, on account of the greater ease in keeping a steady temperature. I should cement the floor because it would then be drier, and more easily cleaned. There is no truth in the statement which we sometimes see, that the uncemented floor absorbs foul gases from the air, making it less foul. If cementing the floor makes any difference at all, in the condition of the air, it is the other way about. Ground air is always rich in carbonic acid. The cement helps to keep the ground air out of the cellar. To draw off the vitiated air, I should have a 7-inch pipe, and if possible more than one, leading from near the cellar floor to a chimney in constant use. I should want to know by an anemometer how many times per hour the air is changed. I should have a small room, cut off from the bee apartment, by a heavy brick or stone partition, and into this room I should bring the outside air, either from above ground, or through a sub-earth pipe. If from above, I should keep a coal stove going when needed, if through a sub-earth pipe a kerosene oil stove, as recommended by the editor, would perhaps do. To admit the warmed air into the bee apart-

ment, I should have registers at the top of the partition, and to draw off cold air from the floor, I should have registers in the partition at the floor. In drawing off cold air from the floor, and sending it back warmed, there is no danger of getting an undue proportion of carbonic acid gas. The carbonic acid gas of breathed air does not separate and fall, by its superior weight, to the floor, as is often stated. The belief that it does so is a popular fallacy.

I have said nothing about the carbonic acid produced by the consumption of honey, *pari passu* with the production of aqueous vapor, the proportion of which can readily be ascertained by means of a Mason hygrometer, because with such ventilation as is recommended above, the one will be removed with the other. Nor have I said anything about the proportion of oxygen necessary in the air for the generation of heat, because in the pure air introduced, as recommended, the quantity of oxygen will be right.

Unless the hives themselves are ventilated, so that the waste products can pass off into the surrounding air, as fast as produced, ventilating and warming the cellar will not save the bees. In the atmosphere recommended by the editor, or perhaps one a little warmer, the covering of the hive may be removed. This will keep the bees dry and healthy.

Dr. Miller and C. W. Dayton are quite correct as to foul air making the bees uneasy. This was, I think, shown very clearly in Mr. Doolittle's case, when, in order to keep the temperature of his cellar up to that advocated by Mr. Ira Barber, he burnt coal oil in his cellar all winter, without any provision for carrying off the products of combustion. By the way, it may be worth while to state that when the supposed high temperature of Mr. Barber's cellar was being discussed, I wrote him, inquiring how he knew that the temperature of his cellar was from 60° to 90°. He replied, saying that when he had finished putting in his bees, he found the temperature was 60°, and that when he returned to set them out the following spring, he found it was 90°. In the mean time he did not see the bees, nor were there any observations made as to the temperature. Most of us have noticed that the disturbance occasioned by placing the bees in the cellar, causes a rise in the temperature, and that as the bees quiet down, the temperature falls. There is

little doubt that such was the case in Mr. Barber's cellar. The high temperature in spring was most likely caused by foul air and warm weather.

LINDSAY, Ont.

Sept. 28, 1893.

Bee-Keepers' Review.

PUBLISHED MONTHLY.

W. Z. HUTCHINSON, Ed. & Prop.

TERMS:—\$1.00 a year in advance. Two copies \$1.90; three for \$2.70; five for \$4.00; ten or more, 70 cents each. If it is desired to have the REVIEW stopped at the expiration of the time paid for, please say so when subscribing, otherwise it will be continued.

FLINT, MICHIGAN, NOV. 10, 1893.

C. B. BANKSTON, of Chriesman, Texas, has, I am sorry to say, lost his home by fire.

GLEANINGS is giving some very excellent pictures and descriptions of English apiculture.

THE CANADIAN BEE JOURNAL was the first to give a large share of the report of the proceedings of the Chicago convention.

DARK QUEENS are the result if the nurses are dark; at least, this is the opinion of some breeders, but my own experience and that of other breeders is different.

R. L. TAYLOR has been sick since his return from Chicago. As a result, his "Timely Topics" were not sufficiently "timely" in their arrival to be given a place in this issue.

THE FIGHTING of bees over a queen when she is being introduced is quite likely to injure her. Better keep her caged until the bees cease to ball the cage. Doolittle gives this good advice in *Gleanings*.

THE NORTH AMERICAN will hold its next meeting at St. Joseph, Missouri. Emerson T. Abbott of that place was elected President; O. L. Hershiser, of Buffalo, Vice President; Secretary Benton was re-elected and so was Bro. York as Treasurer.

C. C. VAN DEUSEN and wife, of Sprout Brook, N. Y., both lost their lives in the terrible railroad accident at Battle Creek, Michigan. Mr. Van Deusen was one of the partners in the firm of J. Van Deusen & Sons, manufacturers of the flat bottomed foundation. All bee-keepers will be most sincere in their sympathy for the father, whose kindly face has often been seen at our fairs and conventions, also for the other friends that are called upon to mourn the loved ones that met such a terrible fate.

E. C. PORTER, the bee escape man was at the Chicago convention and showed me a letter from some one who had tried escapes with an opening at each end and he believed that having two openings was objectionable in that there were bees calling at each end and it was confusing to a bee that had just entered the escape, she turned first in one direction and then in the other—"halting between two opinions." While on this subject of escapes I may say that judging from an examination of the Porter patent, and from a letter received from Mr. Hastings when I asked him for an explanation, I am led to believe that the Hastings escape is an infringement upon the Porter, and the Hastings advertisement will not appear in the REVIEW again until I am satisfied that Mr. Hastings has the right to make the escape that he does.

GRADING HONEY was discussed at the Chicago meeting, but the rules adopted at the Washington meeting were not changed. It was noticeable at Chicago that some of the members had heard the subject discussed until they were sick of it. Mr. Muth made one remark in his paper upon the subject to which I would like to reply. He said he did not see how the word "fancy" could be applied to dark honey. The words "fancy," "No. 1," and "No. 2," apply simply to the condition of the combs and sections, not to the honey itself which is classified into "white," "amber" and "dark." By this arrangement it will be seen that there may be "fancy" dark honey as well as "fancy" white.

HASTY would have us call Mr. B. Taylor's apiary the Minnesota experimental apiary and thinks it would be just as good as though

it had the sanction of the State. I have thought of that same thing myself, but if our Minnesota friend could only have a few hundred dollars from the State it would enable him to devote more time to these experiments, conducting more of them. I know of no better man in Minnesota for this position, and if the bee-keepers of that State would only bestir themselves in that direction they could have the benefit of his best work in that direction—I think.

Hasty is right when he says we must be careful that no mediocrities are appointed as apiarists, or more harm than good will come.

M. H. DEWITT, of Sang Run, Maryland, is an undesirable customer for queen breeders. He buys queens and pays for them mostly with fair promises. He owed Mrs. Atchley more than a year and she finally brought him to time only by threatening to expose him. She says that she gets a great many complaints against him from queen breeders. He made arrangements last spring with J. B. Case, of Port Orange, Florida, to buy queens of him and pay for them in monthly settlements. No remittances have been made since May, but orders have continued to come accompanied by plausible excuses for non-payment. Mr. Case has received numerous complaints against him. He promised to pay me an advertising bill last May. A part of it was paid in July and now he answers no inquiries. The man may not be dishonest, but he is certainly an undesirable customer. So far as I am concerned personally, I would allow the matter to pass unnoticed, but such exposures sometimes become an unpleasant, editorial duty.

VENTILATION AND MOISTURE.

The articles of Messrs. Aikin, Elwood, Dayton and Corneil again bring up the questions of ventilation and moisture. Several times it has been decided that ventilation had a bearing only as it affected temperature. It must be admitted that bees have sometimes wintered well when there was but little ventilation and an abundance of moisture, but in these cases the *food* may have been of the best. I am becoming more and more convinced that we cannot put our finger on any one thing and say "This causes

bee diarrhoea." Or, to be more exact, other favorable circumstances may be such as to overcome the objectionable features of some factor that under other conditions might prove disastrous. For instance, a warm, dry atmosphere may enable the bees to overcome the troubles arising from a poor diet and *vice versa*. Now that Mr. Corneil calls my attention to it I must admit that when I have had bees perish from diarrhoea the *faeces* have *sometimes* been watery as well as composed of pollen; in fact, they might be described as consisting of water and pollen mixed. It is probable that a warm, dry atmosphere would enable the bees to get rid of this excess of water and it is possible that they would then be able to manage the pollen. It is the double load that breaks them down. Too many of us do not know whether the air of our cellars is damp or not. A man reports that the temperature is thus and so. Upon another point equally as vital he is uninformed. He knows nothing in regard to the degree of saturation or moisture. The REVIEW has several times explained how easy it is to ascertain in regard to this point by means of the wet and dry bulb thermometer. This is a matter for our experiment station to take hold of. Bro. Taylor, will you try and produce bee diarrhoea by means of a cold, damp atmosphere? All along we have been trying to *prevent* bee diarrhoea, now let us try solving this problem by working at it from the opposite direction. Let us try and *produce* it at will. If we can succeed in this the results may be helpful.

THE HONEY-SHOW AT THE WORLD'S FAIR.

Considering the amount of money appropriated by the different States for making an aparian show at the Columbian Exposition, and the late day at which some of it was allotted to this purpose, the display was very good. As the show lasted several months, the exhibition of the honey under glass became a necessity. This greatly hampered the exhibitors as it prevented them from getting up large and striking displays. The exhibits were made in large show cases, each case being five feet wide, about ten feet high and perhaps twenty-five or thirty feet in length.

First came New York. This State had two of these large cases, besides two smaller ones about eight feet long that fitted in nicely in filling up a corner. The smaller cases were

filled with comb honey from such men as Hetherington, Elwood and Hoffman. One large case contained mostly extracted honey in bottles and jars. In this case there were also 112 pounds of comb honey and 140 of extracted that had been gathered by six colonies of bees kept in the building, they flying out through the walls *a la* house apiary. This honey was dark. F. H. Cyrenus furnished a box a foot wide by four in length and three inches deep in which were some very fantastically built combs. A little close study showed the initials of his name drawn by the crooks of the combs. He also had on exhibition another box in which were two combs four feet in length at the points of attachment, perhaps six inches in depth, but about three or four inches *thick*. Two large letters, N Y, were built up with pound sections in the front end of the case. There



THE N. Y. EXTRACTED HONEY EXHIBIT.

were also some beautiful mounted specimens of honey producing plants. Yes, and I remember seeing some photographs of the Langdon house apiary—both exterior and interior views. The other large case was filled with comb honey; a long pyramid at each end and a smaller one in the middle.

The New York exhibit was put in place and cared for by our old-time competitor at fairs, O. L. Hershiser, and it showed that he had had experience in that kind of work.

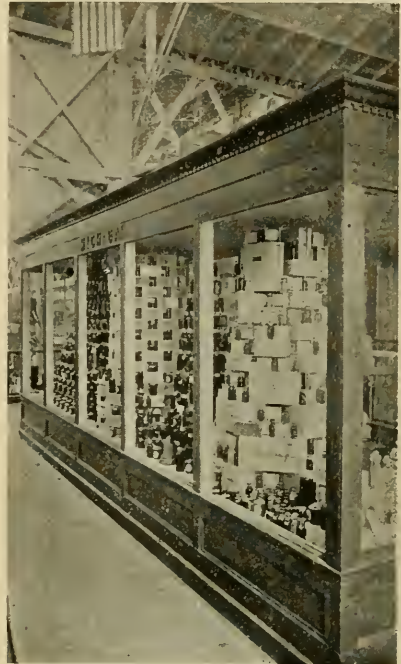

THE MICH. HONEY EXHIBIT.

Michigan's show stood next to that of New York. This is one of the States that gave but little money towards showing up the honey industry, and had it not been for the self-sacrificing labors of Mr. H. D. Cutting, it is doubtful if Michigan would have had any honey on exhibition. Neither should it be forgotten that such men as Taylor, Hilton, Walker and Hunt came forward and loaned honey and wax, and thus saved the honor of the State as a honey-producer. There was one large and one small pyramid of extracted honey from Byron Walker, I believe. In the center was a round pyramid of comb honey from R. L. Taylor, and for a *large lot* of comb honey, I think this was the best comb honey on exhibition. There was a pyramid of honey in cases from Hilton and fine wax from M. H. Hunt.

Next in the row of cases came that of Ohio. It contained three pyramids of comb and extracted honey and small cakes of beautiful wax, the finest I saw, all so combined that one added to the attractiveness of the oth-

ers. The frame work to hold up these pyramids was of metal and the shelves or supports of heavy plate glass. This gave a sort of airiness to the exhibit that was quite attractive. The comb honey was mostly from C. E. Boyer, and was fine. That jolly, "right man in the right place," Dr. A. B. Mason, "set up" the Ohio exhibit, and it showed most conclusively that he was no novice.



CANADA'S HONEY EXHIBIT.

So far as extracted honey was concerned, Canada made the most attractive showing. Especially was this true in regard to the manner and vessels in which it was shown. There was a great variety of kinds of honey, both liquid and in the candied form, and the sizes and varieties of the glass ware were too numerous to mention. Some of the glass jars approached a foot in diameter and two or three feet in height. There was a small lot of comb honey, from Mr. Holterman, I believe, that was unexcelled. Some from Mr. Hall was also very fine. The Canada exhibit was under the management of Mr. Allen Pringle, and it is probable that no better man could have been chosen for the work.

The exhibit from Wisconsin was not so large as that from some of the States, but

its manager, Mr. Franklin Wilcox, had done the best he could with the material on hand by arranging the comb honey in arches as large as the case would allow him to build them, and in this manner he secured a unique display entirely different from that of the others.

I think Mr. Whitcomb arranged the exhibit from Nebraska, but at the time of my visit, Mrs. J. N. Heater had it in charge. It contained a large pyramid of comb and extracted honey, and some figures and flowers in wax, while the top of the case contained the best display of honey producing plants, pressed and mounted, that was to be found in any of the displays.

The next case had a very meager showing of honey from California. It seems strange that such a great honey producing State as this should not have had a better display. I presume if I knew the circumstances it might not appear so strange. There was some comb honey but it was not first class in appearance. Some tall glass bottles filled with extracted honey from J. F. McIntyre were really the most attractive part of the exhibit. In one end of the case were some curiosities in the way of enormous clam shells and the shells of ostrich eggs in which the bees had been induced to store honey.

Iowa had one large pyramid of comb honey and two smaller ones of extracted. In the front end of the case, the words "Iowa Honey" appeared in letters formed by the bees in honey. E. Kretchmer put this exhibit in place, and he, too, showed by his work that he had "been through the mill."

Minnesota made an indifferent showing, but I heard some one say that the honey was so damaged in transit that most of it was unfit for display. A. K. Cooper, who once published the *Magazine*, put this display in position, and probably did as well as he could with what he had to work with.

Illinois probably made as large a display as any State, as it filled *four* cases. The first one was entirely occupied by a castle built of honey-comb; there being doors and windows, the latter being furnished with curtains of foundation. The word ILLINOIS was spelled in the side by using sections of dark honey to form the letters. The second case also contained a comb honey castle, the walls being waved in and out. The next case was entirely filled with a pyramid of liquid extracted honey in bottles. It was unique in that it reached the ceiling of the

case which was lined underneath with a mirror, which reflected the pyramid below and made it appear as though there was an inverted pyramid hung in the air above the one below. Strange to say, it was a puzzle to many visitors. In the last case was the wax exhibit, the most interesting feature of which was a two-story dwelling, with windows, doors and balconies, made from different shades of foundation. This was from the Dadants. Messrs. Hambaugh and Stone showed a great deal to taste and enterprise in getting up the fine display that they did.

Indiana showed a neat hollow castle of comb and extracted honey; the sides being



IOWA HONEY EXHIBIT.

of comb and the ends of extracted. There was also a tall pyramid of bottles very attractively labeled and filled with a kind of drink made from honey, and called "Honey Dew." This was from Mr. Hill of the *Guide*, and he was the man who put the exhibit in shape. It was very tastily done, as he did not make the mistake of trying to do too much, which was the case in a few instances.

A. I. Root made the largest display of implements and supplies. They were in a case of his own construction. It was about

twelve feet long and ten high. E. Kretzmer, A. G. Hill, the Goold, Shapley and Muir Co., W. T. Falconer, J. J. VanDeusen & Sons, Chas. White and M. E. Hastings also had goods on exhibition. On the last day of the convention Mr. Florence Williams of Barnum, Wisconsin, placed on exhibition a six-comb, self-reversing honey extractor. The comb baskets swing around in something the same way as those of the Stanley make, but the peculiar feature is a cog wheel at the top of each comb basket shaft and these cogs fit into cogs upon the inside of a sort of hoop that passes clear around the extractor. This causes all of the baskets to reverse simultaneously; otherwise, being so close together, there would be clashing from one basket getting ahead of another in its reversal. A leaf spring behind each side of each alternate basket causes the baskets to spring out when the stoppage of the machine kills the centrifugal force, and the immediate turning of it in an opposite direction throws the baskets around in the opposite direction.

I left the grounds with the impression that I had seen most of the honey exhibits, but Dr. Miller says in *Gleanings* that there was some very fine honey from England in the British exhibit, and that there were other interesting apiarian exhibits scattered over the grounds. I agree with him in thinking it a pity that everything in the bee-keeping line could not have been in one place.

THE TRIP TO CHICAGO.

As the sons of the prophet do piously try
To see Mecca once ere the hour comes to die.

On the Saturday preceding the convention of bee keepers in Chicago, I packed my telescope grip with a camera and nearly three dozen dry plates. Evening found me enjoying something to which I had been a stranger for several years, and that is the hospitality of Mr. Heddon. I also had the pleasure of meeting a Mr. A. E. Hoshal, of Beamsville, Canada, who has since bought the right of Mr. Heddon's new hive for Canada and the British Possessions. Messrs. Heddon, Hoshal, H. A. Burch, (who has for several years helped Mr. Heddon make the *Dowagiac Times*), and myself held an informal but quite enthusiastic bee-convention of which I may say more sometime in the future. Before leaving, Mr. Heddon and myself drove out to his Glenwood apiary and

took a camera's view of it. On our way back I noticed a deserted dwelling standing among old apple trees and evergreens. Most of the doors and windows had fallen from the casements, but vines made wreaths about the openings and hung in festoons from the cornices. It was romantically picturesque, even for a deserted dwelling, and how I did long to stop and add it to my collection of photographs, but a stiff breeze kept the leaves in constant motion and I knew the result would be a negative not quite good enough to be satisfactory nor bad enough to throw away, hence I reluctantly drove on. Since beginning to use the camera I find myself noticing every little bit of scenery in a way that sometimes surprises me. Before leaving Mr. Heddon's I made "exposures" of his home apiary, the interior of his honey house and of his residence, from some of which I may have cuts made and show them to my readers.

From Dowagiac I went to Buchanan, Michigan, where I visited nothing more nor less than a *skunk farm*, that is, a place where skunks are raised for their fur and oil. About three acres of a hill side that slopes down to a stream are fenced in with a high board fence that extends four feet down into the ground and is surmounted with several strands of barbed wire. Inside this enclosure the animals are kept in what might be termed a half-domesticated state. One place, where the bank is the steepest, is fairly honey-combed with their holes. There is a house in which is a brick arch surrounding a huge caldron kettle in which their food, consisting of scraps of refuse meat and corn meal is cooked. There is an out door cellar in which the food is kept in winter that it may not freeze. There have been as many as 380 skunks inside the enclosure at one time, but at present the exact number is not known. I made several photographs showing the different phases of the business, and, considering that the skunks do not usually come out until dusk, I was fortunate enough to catch three in a group taking their evening meal before it was too dark to use the camera. I may "write up" an account of this visit and send it to some paper for publication.

I reached Chicago early Tuesday evening and was not long in discovering that the "gathering clan" became rapidly greater as the hours went by. The hotel was soon so crowded that it was impossible to make room for one more to sleep. There was a large

transom extending the whole length of my room, or, rather *our* room, as it contained six bee-keepers, and when I awoke in the night I heard voices down in the hall. I listened a few moments and decided that E. R. Root had arrived, as the conversation was none other than he and C. E. Parks of the G. B. Lewis Co., talking sections.

There was the largest gathering of bee-keepers it has ever been my lot to witness. There were 225 in attendance, some 50 of which were ladies. Many were the old familiar faces that greeted and made glad my eyes, and many were the faces with which I at once felt acquainted although I had never seen them before.

While there was a large gathering of the best apiarists of the country, nothing of an unusually valuable character was brought out at the convention. This is not to be wondered at, as all subjects are so thoroughly discussed in the journals that but little of a new character remains to be said at a convention.

As a place for seeing how bee-keepers look conventions are a grand place, but the journals are beginning to rob it of even this feature; but they never can forestall us in the hand clasp, the sound of the voice, and the glance of the eye.

One fact was brought out more clearly to me than it had ever been shown before, and that is in regard to the size of hives and the contraction of the brood nest. We of the North, with our short, early honey flow need small hives and contraction or the season is passed before the colonies are ready for it. Farther south where the seasons are longer, or where there is a bountiful fall flow, large hives give excellent results and there is not so much swarming.

The question of swarming and its prevention also turned largely upon this same point. With a short, early flow swarming is undesirable, while a prolonged flow or one that comes late in the season may make swarming desirable.

The fact that a one-fourth inch bee-space practically prevented the building of brace and burr combs was also given considerable emphasis.

There are also two points in the management that I wish to criticise, that is the lack of a programme properly arranged before the convention was called to order; and the advertising of a three-days meeting and then cutting it down to two. At least one hour of

valuable time was used in discussing this subject of a programme, the appointing of a committee to arrange it and deciding in regard to the hours when it should be carried out. I do not care to discuss as to who was to blame, perhaps the blame does not rest wholly upon one pair of shoulders, but it certainly is a mistake to bring together such a body of men and women without a programme all ready to work from. Another point: some cannot, or do not wish to, be present at all the sessions. If there is a printed programme they can manage to be present when those topics are discussed in which they are particularly interested. The last two meetings of the North American have been advertised as three-day meetings. Each time the programme has been rushed through and adjournment brought about the evening of the second day. I know that the adjournment at Chicago was to meet at noon the next day at the bee and honey exhibits on the fair grounds, and I know that many of the bee-keepers went there at that time, but the gathering was simply a sight-seeing crowd and not a convention as we understand the word. I had business that kept me in the office of the Louisiana Hotel all of the forenoon of what was advertised to be the last day of the convention, and the clerk really lost patience in explaining to belated travellers who came in that the convention was over with and they would find the bee-keepers on the fair grounds. Bee-keepers from a long distance had not counted on trains being belated to the extent they were, but consoled themselves with the thought they would enjoy at least one day of the convention, only to be bitterly disappointed. If we cannot hold a three-days meeting and have it profitable, enjoyable and desirable, then let's not attempt it, but let us live up to what we advertise.

Another thing: there was a motion made to go sight-seeing in the forenoon and have a convention in the afternoon, the plea being made that this arrangement would be less tiresome. Had this plan been adopted it would have been a death-blow to the convention. I have seen a convention practically destroyed by skipping one session that the members might go in a body and visit some institution. At some meetings there seems to be a class of bee-keepers who are more interested in sight-seeing or in going home than they are in convention work, and they are not easy until the convention has been

broken up or the time for holding it has been shortened. If these people care more for something else, why can't they let the convention go on without them, that is, why not go about their sight-seeing or go home, and not try to compel others to join them? Let us have a programme and live up to it, and when the convention is over we can go sight-seeing if we wish. If there will not be time for this after the convention is over then go before. Do as Bro. Root has done. You know a great deal of fun has been poked at him because he visited green houses instead of staying by the meeting; but I believe he has never tried to break up conventions that he might visit green-houses.

What about the fair? Well, imagine a mile square covered with concrete pavement. At appropriate distances large and beautifully constructed buildings of white. These buildings have the appearance of great solidity, but they are simply frame-works of iron covered with "staff," a kind of plaster. In one pillar perhaps three feet in diameter and thirty or forty feet in height, I saw a hole as large as a man's head that had been broken in, and the coating of plaster was not more than an inch in thickness. The buildings are so well proportioned and so well arranged in reference to one another that their great size is not apparent. It was only when I walked toward a building that its size became apparent. It seemed quite near when I started but receded as I approached—after walking three or four minutes it still seemed as far away as when I started. Then there were the lagoons upon which sailed the gondolas, and the electric launches darted hither and thither, and the numerous water fowl made merry. Then there were the immense fountains that foamed and spouted, and the electric fountain with its streams of many hues. Overlooking the main lagoon stood a gilded figure of Columbia sixty feet in height. At twilight is the most witching scene. Sweet chimes are played from the bells in the towers and the daylight and electricity vie with each other, or perhaps it would be more correct to say they combined in filling the grounds with a peculiarly soft, clear, glowing, golden light. There kept running through my mind the expression of a Michigan editor that "if he didn't know better he should think he was in heaven."

The fair is really an epitome of the whole world. What an education it would be to

have spent the whole summer there. But it is so immense that to attempt to see everything in a short time is simply folly. I can appreciate most fully the feelings of the man who felt like taking the train for home at the end of the first day. He was discouraged in even attempting to see the fair. The only thing that I saw thoroughly was the honey exhibition. I spent half a day at the art building and saw pictures that will always remain in my memory; but just think of trying to look at all of the pictures in eighty large rooms in half a day, when there are many pictures before any one of which you would be glad to stand for half a day! I presume I went through half the rooms.

I had my camera with me and was anxious to make photographs of the bee and honey exhibits. Inquiry developed the fact that no camera was allowed on the grounds that took pictures larger than 4x5 inches and mine was twice as large. An official photographer would make one picture for \$3.00. Dr. Mason went with me to the superintendent of the building and stated the case, but he could not help us any. The Doctor said: "I guess the only way will be to smuggle in the camera and use it on the sly. Wont it?" The superintendent said: "That is the way I should do it." And I imagined that I saw the shadow of a wink gather about the corner of one eye. That settled it. I slept on the floor that night in a little room back of the honey exhibits, with a big piece of canvas under and another over me, while for a sheet I used the big piece of cotton cloth that Bro. Root uses to cover up his exhibits so folks cannot see it Sundays. As soon as it was light enough for me to work in the morning I was at it and before the sight-seers were very numerous I had made ten "exposures." Cuts made from some of these appear in this issue.

Monday morning I made Bro. York a short call. I found him in a very cosy office in the very top of one of Chicago's tall buildings. Why did he go there? A printer could easily guess; because he could thereby secure such excellent light.

Eleven o'clock found me on board the train with the best part of the trip before me—the home-going. As I neared home I had no difficulty in recalling the following:—

"Clime above all climes beside
Is where those we love abide,
And that little spot is best
Which the loved one's foot has pressed."

EXTRACTED.

Ventilation of Bee Cellars.

We think the Cosmos quite boiled down—
Canned in a thousand histories—
But what we KNOW is sprinkled round
Among a thousand mysteries.

Although it has several times been decided, apparently, that bees needed no ventilation in winter, I have never been fully satisfied with that decision. When Mr. P. H. Elwood described in *Gleanings*, a few months ago, his wintering cellars and said that his views on the subject of ventilation had been very fully expressed in the *American Bee Journal* for July, of 1878, I at once sent for that issue and read his communication. At this season of the year, and with discussion that is now on hand, probably nothing could be more appropriate than its reproduction.

"Industry, skill, and economy, will secure a competence in almost any legitimate pursuit. Without these three essentials, business becomes a mere lottery, with many more blanks than prizes; and although the prize of success may occasionally be obtained, it adds nothing to the credit of the obtainer.

Formerly, bee-keeping was supposed to be a highly favored pursuit, success depending not upon the amount of labor and skill employed, but upon the possession of a mysterious something, called *luck*. Happily, wiser counsels have prevailed until, at the present time, our leading apiarists are united in the assertion 'That the greatest enemy of the bee is the ignorance of man.' Nowhere do we see the truth of this statement more conspicuously shown than in that much discussed branch of our business, wintering; and were we, to-day, to examine in detail the many theories advanced, and the equally numerous practices founded upon them, we should be compelled to accept the conclusion that luck more often than wit is still to have the credit of success.

As a discussion of the whole subject of wintering would require too much time and space, I will confine my thoughts principally to ventilation while in winter quarters; (a subject upon which no two authorities agree), and in order to be consistent, I shall have to disagree, to a very large extent, with the many that have preceded me. At the outset, we shall have to satisfy all that bees require the accession of fresh air to maintain life and health, a proposition that common sense would answer by an emphatic *yes*, but to which many bee-keepers give an equally emphatic *no*, and bring forward many illustrations to prove the truthfulness of their theory.

Gen. Adair, in an elaborate paper on ventilation, mentions having had a honey box, the air-space of which was half filled with

living bees. After proving to his own satisfaction that it was air-tight, by blowing into it, as a cooper does into a barrel, he covered the entrance with waxed paper and set it away for a couple of days. He then examined it and found that the bees did not seem in the least inconvenienced by their confinement.

Prof. Cook, of the Michigan Agricultural College, reports that one of his most prosperous colonies, in the spring, was one that had the entrance to the hive completely filled with ice for nearly the entire winter. But more important than either of these experiments is the well known fact that bees have been buried for months under ground, with no provision for ventilation, and with the surface of the ground frozen solid during the whole time. Are any more facts needed to prove that ventilation is unnecessary? We might subscribe to this, did we not know that bees require food at all times, and that 1 to 3 lbs. of honey per month is consumed by each colony, while in winter quarters. Chemistry tells us that the consumption of this amount of food requires the introduction of a larger amount of atmospheric air. It also tells us that the combustion of three pounds of honey, within the body of the bee, produces $2\frac{1}{4}$ pounds of watery vapor, and nearly 24 cubic feet of carbonic acid gas. The free atmosphere contains but three or four parts of carbonic acid in ten thousand, and the best European authorities are united in asserting that for the respiration of man, it should never contain more than ten parts in ten thousand. Marker and Schultze, of Germany, in their researches on the natural ventilation of stables, have found that for domestic animals the proportion may safely run three times as high, or 30 parts in 10,000.

On the supposition that bees need an atmosphere no more pure than this, we find the consumption of three pounds of honey requires the passage through the hive of not less than 8,000 cubic feet of air. As the brood department of our hives usually contains less than a cubic foot of free air: this necessitates the complete removal of this air, at least 8,000 times.

These figures, undoubtedly, seem large, but if I should say that 200 colonies of bees require as much air as their owner, you would not be surprised, but think the estimate quite small. Now, Gen. Morin, of Paris, (see Smithsonian reports,) has furnished us the best of proof, (experimental not theoretical), that in close apartments, in order to keep the atmosphere around him sufficiently pure, man requires over 2,100 cubic feet of air per hour, a result subscribed to by the best authorities in Europe. This is largely in excess of the amount required by 200 colonies of bees, supposing each to consume $1\frac{1}{2}$ pounds of honey per month.

But where did the bees in close confinement get their supply of air? There is no proof given that the receptacles were air-tight. Adair's test only proves that the outlet was immeasurably smaller than the inlet: and it is not claimed that Prof. Cook's hive had no crevices through which a limited supply of air might not enter. I have had

the entrances of several hives closed for weeks at a time, without serious inconvenience to the inmates, but I know the connections were not air tight. Even if they had been, the bees would have received a considerable quantity of air through the walls of the hive.

It is a well established fact that atmospheric air freely penetrates the tissues of all plants. Corewinder found that a single colza plant, in twelve hours, decomposed two quarts of carbonic acid gas. Bousingault found that twelve square feet of oleander leaves decomposed about the same quantity. These results prove that a very large quantity of air must have coursed through the plant. Some idea of the size of the 'breathing pores,' or *stomata* may be formed, when it is known that 100,000 of these openings may be counted upon an average sized apple leaf. Although the leaves are much more pervious than the stems, air in various degrees of purity may be found in all parts of the plant. If green wood allows the free passage of air, certainly dry wood will be more pervious. We all know how freely wood imbibes water, and it is safe to say that air will go wherever water can, for it is 770 times lighter. On the supposition that one-half as much air passes through an unpainted inch board as though a lime-stone wall, well laid in mortar, (not an extravagant supposition, I think you will say), I find by computation, that with the size of hive we use, so long as the hive walls remain dry, quite a large percentage of the air required by the bees in winter will enter this way. In proportion as the wood hive becomes saturated with water is the passage of air impeded, a fact of much importance in wintering.

How about the bees buried? Facts are on record, showing that men have been buried for days at a time and were not suffocated. Certainly, when men can live, bees ought to, as they require so much less air. But the men were not buried under the frozen ground you say. Von Rettenkoffer, than whom there is no better authority living, says that he believes frozen soil is to be not much less pervious to air than the same soil unfrozen. I have not space to give his reasons, and will only say that he seems to have the best of the argument. He says, in regard to the free passage of air through the ground, 'I know cases where persons were poisoned and killed by gas, which had to travel twenty feet under the street, and then through the foundations, cellar, vaults and flooring of the ground floor rooms.'

In wintering bees underground, we need not have so much fear that the quantity of air will fall short, as that it will be deficient in quality. A year ago, in reading Prof. Johnson's admirable treatise on 'How Crops Feed,' I learned of the impurity of soil air. It usually contains all the moisture it will hold, and from 10 to 390 times as much carbonic acid gas as the free atmosphere. In sandy soil the air is the purest.

To keep the soil air out of our bee cellars, last fall, we carefully coated the sides and bottom with hydraulic cement, and I find that it makes them much dryer and better.

The material of which your bee house is built will influence the amount of artificial ventilation needed. In order to give you an idea of the extent of natural ventilation through the walls of buildings, I cannot do better than again quote Rettenkoffer:—

'For every square yard of wall surface, at 91½° Fahr. difference of temperature, the spontaneous ventilation, or passage of air through the wall, amounts per hour to

4.7	cubic feet,	with walls of sandstone
6.5	"	" " of quarried limestone.
7.9	"	" " of brick.
11.4	"	" " of mud.'

We prefer to build our wintering houses of earth. You will at first conclude that sandstone walls would be more porous than limestone, but sandstone is a smoother stone and does not require so much mortar. It is the mortar that admits the larger part of the air. There has always been a serious disagreement between theoretical and practical ventilation, until a consideration of the extent of natural ventilation reconciled the difference. Many interesting experiments are on record. With suitable apparatus, candles are extinguished by air blown from the mouth through solid brick walls, a foot in thickness.

Another mistake still current in some of our text books on ventilation is the statement that impure air, being heavier than pure, falls to the bottom of a room and remains there, unless provision is made for its outlet at that point. These authors are ignorant of the law of the diffusion of gases. Gases intermingle perfectly, no matter what the variation in density. Usually there is not much difference in the purity of the atmosphere in the various parts of a room, unless the changes are quite rapid.

A consideration of the moisture of the air, as well as of the practical appliances for ventilation must be deferred for the present.

P. H. ELWOOD.

Starkville, N. Y., Feb. 1, 1878."

After reading over the above it occurred to me that if bees thus secured ventilation in spite of their owners, why need there be any attempt made to secure ventilation for them? I wrote Mr. Elwood saying that it seemed as though a little explanation on this point would make things a little more satisfactory. He replied as follows:—

OCTOBER 18th, 1893.

W. Z. HUTCHINSON, Flint, Mich. :—

DEAR SIR:—Yours of July, also of October 6th, came in due time, but in a busy time. You refer me to an article of mine in the *A. B. J.* for July 1878 and ask why if natural ventilation is so great it ever becomes necessary to resort to the artificial ventilation of a bee cellar? In reply permit me to say we have a pasture lot of about the right size for our old Guernsey. However, if we turn in a pair of horses with her we shortly find that

the pasture is over stocked. So with a bee cellar having enough natural ventilation for fifty swarms of bees. When five or ten times that number are put in it, it is overstocked unless the cellar is artificially ventilated. Again, the feed in the pasture is not a constant quantity, for in a time of drouth the grasses grow very slowly if at all. So in a bee cellar the natural ventilation varies and at times is very little. When the wind is a gale and the temperature below zero, the natural ventilation of our bee cellar is sufficient for a thousand swarms. But let the wind deaden to a calm, the temperature rise outside to that within and the degree of moisture rise to the point of saturation and a million voices would scold you should you depend wholly upon natural ventilation. The most important factor in natural ventilation is the diffusion of gases when brought in direct contact or what is practically the same contact though a porous diaphragm or partition. We inhale air into the passages of the lungs, but diffusion causes it to pass further in while the impure air passes out by this process of intermingling. "The rates of diffusion of gases are inversely proportioned to the square roots of their relative weights." Temperature directly changes the relative weights (besides exerting other influences) and thus becomes an important factor in changing the rates of diffusion. An ordinary room with a capacity of 2,650 cubic feet had its entire contents changed once in an hour by natural ventilation when the difference between the inside and outside temperature was 34° F. (66° inside, 32° outside) the doors and windows of course being shut. When all openings and crevices in doors and windows were pasted up and rendered as thoroughly air-tight as possible, there was still a change amounting to 1,000 cubic feet per hour which was owing to diffusion through the walls. On lessening the difference between the internal and external temperature to 7° F. (71° in 64° out) the change of air was reduced to 780 cubic feet per hour, but on opening a window of eight square feet, the change rose again to 1,000 cubic feet, showing that we may have in winter better ventilation with windows closed than in summer with the same open. Thus it is seen that artificial ventilation is most urgently called for when the temperature outside and inside is nearly the same.

Yours truly,

P. H. ELWOOD.

A Condensed View of Current Bee Writings.

E. E. HASTY.

BROTHER Coleman tells us that downy young bees often die of starvation in the summer time, when there is plenty of honey in the hive—and bee paralysis wrongly gets the discredit of it. This new suggestion well deserves some looking into by all of us. Newly emerged bees feed themselves, as Langstroth has shown. To them, can't find the cupboard, and "cupboard was bare," amount to the same thing; both mean speedy death.

"I found that the honey in the hive was confined to the outside combs, and that the combs from which the bees were hatching contained no honey at all. * * * I shifted a comb containing honey. * * * The young bees quit dying in a few minutes, and have not died any since. A. B. J., 341.

Another idea strikes me. Would not, can't open the cupboard door, mean death also? In scarcity times the honey in a hive is nearly or quite all sealed, and presumably the old bees are not carrying any. Who knows that a little pilgrim, never having broken fast yet, could (or would) uncap a cell?

THE REVIEW.

Once more the REVIEW's turn has come around. Is it the same old sixpence? No, not quite. It is gradually becoming more an illustrated journal than it was. The September number was especially fine in that respect; and the apiary illustrated is one of especial interest to the cause. If we should only call Mr. B Taylor's apiary, The Minnesota Experiment Station, would it not be so to all practical purposes? And is it not worth more to us just as it stands than the average State station would be if State stations became universal? Would not the State station be a "place" for some mediocrity with influence—but not capacity enough to be a valuable leader. Let's go a little slow, brethren. Every wooden-head we get set up in such a place, issuing semi-occasional Pub. Doc., will tend to obscure the excellent private work, and the excellent Michigan station, we already have. Wonder if I'm getting bilious—and is it because I didn't go to Chicago?

Perhaps the most apparent change in the REVIEW is that relief to the tedium of affairs which is afforded by giving each article a heading of proverb or rhyme indicating its

general character—as the Irishman would say, "A fut-note at the head, sure." It would be picking up *Gleanings*' thrown away shoes to put a foot-note at the foot, so on the head it goes. Many of these have a serio-comic turn. If you don't like that, but would rather have everything long faced, just send in a scolding chorus to the editor, and see if things don't come dignified. Some want to eat their spice by the plateful, and some don't want any at all, and some prefer to eat it sprinkled on the food—REVIEW fashion. Is it right, or not?

There is a difference between the treatment an editor may rightly give the head of an article and the same as applied to the foot. On the foot he may put a mustard plaster of reproof or opposition, and sometimes *ought* to do so. Not so on the head. What is put on there must be in line with the writer's thought. Hear him first, before you scold him or twist the reader's ear.

Now let us see about the wintering symposium in the October number. Heddon, Aikin, B. Taylor, Doolittle, Prof. Cook, R. L. Taylor and the editor, take part. No use of trying to deny that there is a certain air of worn-out ness about the lucubrations on wintering. Although we winter our bees on honey we winter our readers mainly on *chestnuts*. (Subdued applause.) But, brethren, when we get it all found out we won't give you anything at all except chestnuts—then what will you do? Better winter on chestnuts and save the bees than on paradise nuts and lose 'em.

What boots it, this beautiful writing,

That sweet on the ear doth melt.

Crisp, novel, fresh and inviting—

☐ And our bees all dead as a smelt?

R. L. Taylor advises feeding in a warm room for neglected colonies that must be fed when the almanac can't be turned back to warm weather again. Seems to me I would rather (as the simpler and less liable to miscarry plan) take out three or four of their lightest combs and replace with combs poured full of warm syrup. Disturbance sooner over, and no possibility of their stopping off and leaving half the syrup in the feeder. Yet the fact that in this way the syrup gets no chemical work put on it *may* put the balance of advantage on the other side—unless one feeds *honey*. And here is the simmer of his excellent putting into the cellar.

15th of Nov.—cloudy—45° —a frosty day one to be shunned—touching nothing else laterally---

foot of open air at cellar bottom—the stronger colonies furthest down, as that is the more trying position.

Notice how most good authorities are gradually getting together on keeping bees away from the cellar *bottom*.

The editor's summing up seems to be mostly very conservative and sound. Matters little whether it is or isn't a *disease* that kills us, so long as we are killed. Usually not any one thing but several things combine in the mischief. And go for those things which we *can* mitigate, seeing that some of them we can not. And where there are heavy losses every winter, under all methods, there must be a change of food. Prof. Cook strikes the same string.

"With other conditions more favorable, probably any food, almost, would be wholesome and safe, but with other conditions awry, then the good food may ward off disaster."

And probably he lights on an important truth where he suggests that somehow or other a cellar dug in sand is better than one dug in clay. In any cellar the air we breathe, much of it, *came out of the ground not long ago*, and soil air differs.

Doolittle describes the symptoms with the ability of a medical almanac—and his prime remedy is "good stores, or sugar syrup."

Heddon's no pollen test, and 72 out of 73 O. K., in the same cellar where two-thirds of those with natural stores died with dysentery looks like knock-down evidence. It probably is conclusive as to such a wickedly cold cellar. It is not quite full *proof* however that in a dry cellar with pure air, and temperature where it should be, the pollen would have done a particle of harm. The bees that lived were compelled to refrain from activity and brooding by lack of pollen; but whether it was the pollen, or the untimely activity and brooding, that killed the others is left entirely unsolved.

Possibly friend Aikin puts too much stress upon moisture; but if inspectors representing more than 7,600 colonies agree that hives having accidental cracks in the top winter the best we had better be looking into the subject a little.

And friend B. Taylor seems to open an inside pocket and give us some nuts that are not altogether chestnuts.

"I favor small hives. * * In a large hive there is much space left vacant outside the cluster; here the air stagnates."

Quite likely (other things being equal) the nearer the cluster comes to filling the cavity the better. Those frequent fires in the cel-

lar are good, and no possible harm before the bees are put in. And the diarrhoea of starvation ought not to be forgotten, until we understand about it.

R. L. Taylor in the station report, tries hard to keep us from driving stakes on the apparent conclusions about starters versus foundation or comb for new swarms. Some will drive 'em all the same; so I will say so some more. Don't do it! This is a scant and inconclusive beginning at an important matter, which will require *piles* of evidence to settle it. And, don't you see the experimenter draws conclusions favorable to foundation and the editor draws conclusions favorable to starters from the same big table? Very likely the man favoring comb could hew out a nice stake for his side also. Quite possibly (probably, I should say) starters only may be good tactics under certain conditions, and wretchedly poor tactics under other conditions. This would be unlikely to come out in one season's experiments.

THE GENERAL ROUND UP

What an unusually meaty number is the *American Bee Journal* for October 12th. How enticingly Dr. Gallup writes of California, and his little out-door Maggie, that was'n't going to live and grow up. Just listen.

"We use Chinese matting—no costly carpets—so we are not afraid to let in the sunshine and air." A. B. J., 469.

O how many thousand lives—yes how many hundred thousand lives—it would save if pretty follies that *fade* in the sun were cast out of our rooms, and God's healing sunshine let in! It would almost amount to bringing California to us; and be money in pocket too. Then we might almost hope (as saying A opens the way for saying B) for another unhopeable reform. Folks might next consent to banish the *mop*, and cease to murder the baby. Just imagine what the angels must think of you as they look at baby, and see him creeping along with his little nose close to the floor, breathing constantly the deadly gases of damp, decaying lumber and crack crumbs; and all for the worship of that Christian Dagon the daily mop! Why the mop is at least fourth cousin to the saloon-keeper in the murder business. The much execrated saloonist at least does'nt feed the essence of death to the baby, and the mop does.

How daring is brother Dayton to say as he does—

"Honey is not at its best until it has remained in the hives long enough to become travel-stained." A. B. J., 470.

I notice that some sections stored early come off looking nice in October. Wish all good bees would learn this tidy art.

Hello! We have here the bee words of two more languages, Algonquin and Iroquois. In the latter tongue if I should feed you some sugar-honey it would be *Otsiketatsinakontakwane-otsiketa*. Think you would survive? A. B. J., 473.

Query 892 wants to know what an inventor shall invent for our craft. Non-swarmers, controlled mating, tool to pull dummies and things, better hive-covers, veils and smokers, and an uncapping machine that will work on crooked comb—seems to be the mind of the crowd. Who knows but some form of the sand blast (using very coarse sand) could be made to fill the latter bill? Cappings broken into bits would release the honey without being removed, and the McIntyre form of strainer would manage the debris without trouble I think. All loose sand in the honey would quickly settle out.

Now hear Muth, the honey dealer, as to the markets.

"A fruit-canner buys a few barrels of honey every fall for making pickels. A few pork-packers and a few brewers buy occasionally 25 to 50 barrels of honey. If barley should ever again bring \$.50 a bushel, brewers would buy the bulk of the honey crop of America and Cuba. Pork men having used honey, acknowledged, in every instance, the superior quality of their meat. But I cannot account for the reason why honey is not in more general use among them." A. B. J., 463.

One tobacco man takes about nine barrels a week, and one baker nearly as much. He lost one good customer for honey dew (printing rollers) by sending him good honey when there was no honey dew on hand. That was adulterated, and no use o' talking.

But after all Jennie Atchley seems to give the most interesting single article. She warns our B. Taylor that she has had his little racket for ten years, and that it won't work, a double swarm with two queens being the result. But curiously it *does* educate queens to tolerate each other, so that she works more or less colonies every year with two laying queens without any partition. The two that survived of the four she sent in one cage to the Roots, went to housekeeping kindly together when they got back. And a quadruple colony, with three perforated partitions is getting to be a favorite queen-rearing wrinkle with Willie. 'Pears like some-

thing profitable would sometime sprout out from all these wonderful things. A woman who could credit Mr. Dadant with suggesting the idea to her (when there was so little to be credited) would hardly wish to rob Mr. Taylor of any part of his due.

According to Doolittle (*Gleanings*, 702) giving a laying queen to a colony that has just swarmed keeps them with swarming and breeding on the brain, so that they store little; when they might have stored 60 pounds if let alone.

Friend Smith, of Lometa, Texas, has had three cases this summer where a young queen had (apparently) a second fertilization. *Gleanings*, 704.

Dr. Miller, while observing, like the rest of us, the usual tendency of virgin queens to fight, *has seen a case* where two virgins touched each other several times without a sign of hostilities. *Gleanings*, 705. The language in which he tells us this is somewhat nervous. Don't think, dear Dr. that the great bee-keeping family is going to doubt your testimony in a plain case, just because you have been harried a bit of late. We have to eat a grain of salt with startling reports when they come from beginners, or unknown persons, but not with yours.

Edwin Erance says he would have been better off had he thrown his twenty queenless colonies away last spring. Even those that had queens had not vim enough to steal, or even to clean up the combs of dead colonies when set invitingly open. Like others, he notices that the pollen from early spring flowers is about the only thing that puts life into dwindling bees. *Gleanings*, 744.

Doolittle's guess at the composition of food for baby bees is, two parts honey, four parts pollen, and one part water. This is not fed raw of course, but well churned first in the laboratory of the nurse bees. *Gleanings*, 772. Seems to me it is not only churned but filtered. And what's the difference between nutriment filtered through live animal tissues and a secretion?

France is sure that on his ground he can get more than twice as much extracted honey as comb. Having gone the rounds of smoker fuels he settles on mixed straw and tobacco stems. *Gleanings*, 775.

Gleanings, 173, begins a beautiful series of camera views of foreign bee manipulation and hives. W. B. Carr, one of the editors of the *British Bee Journal*, appears as operator.

RICHARDS, Lucas Co., Ohio, Oct. 24, '93.

Names of Bee-Keepers.

TYPE WRITTEN.

The names of my customers, and of those asking for sample copies, have been saved and written in a book. There are several thousand all arranged alphabetically (in the largest States) and, although this list has been secured at an expense of hundreds of dollars, I would furnish it to my advertisers at \$2.00 per thousand names. A manufacturer who wishes for a list of the names of bee-keepers in his own state only, or, possibly, in the adjoining states, can be accommodated. Any inquiry in regard to the number of names in a certain state, or states, will be answered cheerfully. The former price was \$2.50 per 1000, but I now have a type writer, and, by using the manifold process, I can furnish them at \$2.00. W. Z. HUTCHINSON. Flint, Mich.

BEE - KEEPERS'

SUPPLY HOUSE

J. H. M COOK, 78 Barclay St., N Y. City.

(SUCCESSOR TO A. J. KING.)

4-93-tf

Send for illustrated Catalogue

Please mention the Review

ON HAND NOW.

THE MOST COMPLETE STOCK
OF BEE HIVES, SECTIONS AND
SUPPLIES IN THE NORTHWEST.

W. H. PUTNAM,

1 93-12t.

RIVER FALLS, WIS.

Please

Send

Muth's HONEY EXTRACTOR
PERFECTION
Cold-Blast Smokers,
Square Glass Honey Jars, Etc.

For Circulars, apply to CHAS. F. MUTH & SON,
Cor. Freeman & Central Aves., Cincinnati, O.
Send **10c.** for Practical Hints to Bee-Keepers.

1-93-tf.

Please mention the Review.

PATENT. WIRED. COMB FOUNDATION
HAS NO SAG IN BROOD FRAMES.
Thin, Flat - Bottom Foundation

HAS NO FISHBONE IN SURPLUS HONEY.

Being the cleanest, it is usually
worked quicker than any fdn. made.

J. VAN DEUSEN & SONS,
(SOLE MANUFACTURERS),

3-90-tf Sprout Brook, Mont. Co., N.Y.



Dadant's Comb Foundation.

Wholesale and Retail. Even our competitors acknowledge that our goods are the STANDARD of their kind. **Langstroth on the Honey Bee, Revised.** New edition. Bee Veils; and veil material at wholesale. Bee Supplies, Sections, Smokers, etc Samples of Foundation and veil stuff with circular free. Instructions to beginners Send your address to

CHAS. DADANT & SON, Hamilton, Ills.

4-93-12t

Please mention the Review.

Nearly 1000 Queens for '93

Is my record. Larger yards, best stock and methods for '94. Golden Italian stock.
11-93-tf J. B. CASE, Port Orange, Fla.

GOLDEN ITALIAN QUEENS

Now ready for \$1.00 each. Do not order your supplies until you see our circular for 1893. For the price, we have the best spraying outfit made. Send \$1.50 and get one. Wm. H. BRIGHT,
1-93-12t Mazeppa, Minn.

ITALIAN QUEENS AND SUPPLIES FOR 1892.

Before you purchase, look to your interest, and send for catalogue and price list.

J. P. H. BROWN,

1-88-tf.

Augusta, Georgia.

If You Wish Neat, Artistic

PRINTING,

Have it Done at the Review.

Notice to Jobbers.

G. B. Lewis Co., Watertown, Wis.,

Invite all Wholesalers and Jobbers of
Bee-Keepers' Supplies to write to them
for contracts for Hives and Sections the
coming season.

11-93-tf

Barnes' Foot and Hand Power Machinery.



This cut represents our Combined Circular and Scroll Saw, which is the best machine made for Bee Keepers' use in the construction of their hives, sections, boxes, etc.

11-92-76t

MACHINES SENT ON TRIAL.

FOR CATALOGUE, PRICES, ETC.,

Address W. F. & JNO. BARNES CO., 384 Ruby St., Rockford, Ills

Please mention the Review.

New Heddon Hive

FOR CANADA.

Having bought the Canadian patent on the above hive I am prepared to supply it in any combination to the bee-keepers of Canada. Circulars of interest to all mailed free. Write for one. A. E. HOSHALL, Beamsville, Ont.

11-93-tf

Please mention this Review.

IMPORTANT TO BEE-KEEPERS!

To make a success of bee keeping, you want bees that will give the very best results. My *Golden Italians* have gained a good name on their own merits. Those who have tested them with other bees say "they are the best honey gatherers, cap their honey the whitest, as gentle as butterflies, beautiful to look at, are the largest and strongest bee of all the races." Queens bred from mothers that produce uniformly marked

FIVE-BANDED WORKERS

In March, April and May, \$1.25 each, 6 for \$6.00; June, \$1.00 each, 6 for \$5.00; July to Nov., \$1.00 each, 6 for \$4.50. Special prices on large orders. For full particulars send for descriptive circular.

12-92-tf

C. D. DUVALL.

Spencerville, Montg. Co., Maryland.

Illustrated Advertisements Attract Attention.



Cuts Furnished for all illustrating Purposes.

HATCH CHICKENS BY STEAM

With the Improved **Excelsior Incubator.**

Circulars free. Send 6c. for Illus. Catalogue.

Simple, Perfect, Self-Regulating. Thousands in successful operation. Guaranteed to hatch a larger percentage of fertile eggs at less cost than any other Hatcher. Lowest priced first-class Hatcher made. **GEO. H. STAHL, Quincy, Ill.**

Bind Your Back Volumes.

The back volumes of the REVIEW are some what different from those of some journals; many of them are, to a large extent, little pamphlets devoted to the discussion of special topics. For this reason they will always be particularly valuable for reference. But how provoking it is when desiring to consult some back number, to find that that particular number is missing—has been lost or mislaid. To avoid such annoyance, some have fastened together the issues of each year by tacking them together with wire nails, or something of the sort. This is better than nothing, but there is a lack of flexibility, the book does not open out easily so that it can be read, there is no protection to the outside leaves, besides there is nothing handsome about such an arrangement.

There is a book binder here in Flint that does excellent work at a fair price. He will put the first five volumes of the REVIEW into one handsome volume with morocco back and corners, putting the title on the back in gilt letters, and giving the edges of the leaves a neat, reddish tinge—all for \$1.25.

Send me your back numbers, either by mail or express, and I will get the work done and return the book when bound, making no charge for my services, as the binder allows me a small commission, and should any of your back numbers or volumes be missing, I shall be glad to furnish them as long as the supply lasts, simply charging the regular price for them, which is as follows: Vols. I and II, five cents a copy; Vol. III, four cents a copy; Vols. IV and V, eight cents a copy.

The time will soon come when some of the back numbers will be difficult to obtain, and if you care for the REVIEW complete from the beginning, nicely bound, now is the time to attend to it. W. Z. HUTCHINSON, Flint, Mich.

HONEY ALMANAC AND BEE BOOKS, OF ALL KINDS, A LARGE STOCK.



MY NEW ILLUSTRATED Catalogue and Price List of Supplies for the Apilary will be sent free to all who may apply. Send a postal card for it, writing your name and address plainly. For every Order of \$10.00 and over, I will make you a present. The Catalogue tells you all about it.

T. G. Newman, 147 So. Western Ave., Chicago.



PER CENT DISCOUNT

From Catalogue Prices, on all Goods Until December 1st.
 (In December, 4 per cent. In January, 3 per cent.)

AMERICAN BEE - KEEPER until January 1895 for 50 cents.

The W. T. Falconer Mfg. Co.,

Manufacturers of Bee-Keepers' Supplies.

ESTABLISHED 13 YEARS.

Jamestown, - - - New York.

Bee Hives and Section Boxes.

Simplicity, Langstroth-Simplicity, Standard Langstroth, Dovetailed and Champion Chaff Hives, Supers, One-Piece Sections and Shipping Cases. Foundation. Smokers, etc., etc. Send for 16-page Circular.

1-92-tf PAGE & KEITH, New London, Wis.

The Bee-Keepers' ENTERPRISE.

A cyclopedia of fresh, bright, original ideas pertaining to Bee-Culture, carefully selected and boiled down for busy people. Published monthly at 50 cts—sent from now until Jan. 95 for 50 cts.

BURTON L. SAGE, New Haven, Conn.

GO TO
HEAD
QUARTERS
 FOR 4 AND 5 BANDED
QUEENS

Special, breeding queen,\$5.00
 Best, select, tested,3.00
 Tested,2.50
 Untested,1.00
 " per dozen,9.00

L. L. HEARN,

7-93-tf Oakvale, W. Va.

-If you are going to-

BUY A BUZZ-SAW,

write to the editor of the REVIEW. He has a new Barnes saw to sell and would be glad to make you happy by telling you the price at which he would sell it.

IF YOU WANT THE BEE BOOK

That covers the whole apicultural field more completely than any other published, send \$1.00 to Prof. A J. Cook, Agricultural College, Mich., for his

Bee-Keepers' Guide.

Liberal Discounts to the Trade.

BEES QUEENS,
 SECTIONS, SMOKERS,
 COMB FOUNDATION
 And all Apiarian Supplies. Send for Catalogue.
E. T. FLANAGAN, Belleville, Ill.

Just Splendid

Mr. Alley—The queen I got of you last fall is just splendid! She is the best queen in an apiary 150 colonies. I would not take \$10 for her. John A. Pease, Moravia, Calif.

Price of such queens is \$1.00 each.

HENRY ALLEY,
 Wenham, Mass.

THE PROGRESSIVE BEE - KEEPER

Has Changed Hands. It is now Published by the
LEAHY MANUFACTURING CO.,

Higginsville, Missouri.

Money, Experience and Enterprise will not be lacking to make it all that its name indicates. Send for Free Samples and Copy of 28-page Catalogue of Apiarian Supplies.

DEC., 1893.



At Flint, Michigan.—One Dollar a Year.

ADVERTISING RATES.

All advertisements will be inserted at the rate of 15 cents per line, Nonpareil space, each insertion: 12 lines of Nonpareil space make 1 inch. Discounts will be given as follows:

On 10 lines and upwards, 3 times, 5 per cent; 6 times, 15 per cent; 9 times, 25 per cent; 12 times, 35 per cent.

On 20 lines and upwards, 3 times, 10 per cent; 6 times, 20 per cent; 9 times, 30 per cent; 15 times, 40 per cent.

On 30 lines and upwards, 3 times, 20 per cent; 6 times, 30 per cent; 9 times, 40 per cent; 12 times, 50 per cent.

Clubbing List.

I will send the REVIEW with—	
Gleanings.....	(\$1.00).....\$1.75.
American Bee Journal....	(1.00)..... 1.75.
Canadian Bee Journal....	(1.00)..... 1.75.
American Bee Keeper.....	(.50)..... 1.40.
Progressive Bee Keeper....	(.50)..... 1.30.
Bee Keepers' Guide.....	(.50)..... 1.40.
Apiculturist.....	(.75)..... 1.65.
Bee-Keepers' Enterprise....	(.50)..... 1.40.

Honey Quotations.

The following rules for grading honey were adopted by the North American Bee Keepers' Association, at its last meeting, and, so far as possible, quotations are made according to these rules:

FANCY.—All sections to be well filled; combs straight, of even thickness, and firmly attached to all four sides; both wood and comb unsoiled by travel-stain, or otherwise; all the cells sealed except the row of cells next the wood.

No. 1.—All sections well filled, but combs uneven or crooked, detached at the bottom, or with but few cells unsealed; both wood and comb unsoiled by travel-stain or otherwise.

In addition to this the honey is to be classified according to color, using the terms white, amber and dark. That is, there will be "fancy white," "No. 1 dark," etc.

KANSAS CITY, Mo.—We quote as follows: No. 1 white, 15 to 16; No. 1 amber, 13 to 14; No. 1 dark, 10 to 12; white extracted, 6½ to 7; amber extracted, 6; dark extracted, 5. Beeswax, 20 to 32.

CLEMONS-MASON CO.,

Nov. 1. 521 Walnut St., Kansas City Mo.

BUFFALO, N. Y.—Sales are very light, but stocks are also moderate, and we have no doubt that liberal shipments to this market will sell to as good advantage as in any market to which honey can be sent. We quote as follows: Fancy white, 14 to 15; No. 1 white, 12 to 13; fancy dark, 10 to 11; No. 1 dark, 9 to 9½. Beeswax, 25 to 30.

BATTERSON & CO.,

Dec. 7. 167 & 169 Scott St., Buffalo, N. Y.

CINCINNATI, Ohio.—Demand is good in a jobbing way for all kinds of honey for family use but from manufacturers the demand is very slow. Extracted brings from 5 to 8 cts.; comb honey, 12 to 16 cts. for best white. Beeswax 16 in fair demand at from 20 to 23 cts. for good to choice yellow.

CHAS. F. MUTH & SON.,

Dec. 8.

Cincinnati, Ohio.

CHICAGO, Ill.—**HONEY.**—The limited demand for comb honey does not permit our quoting it above 15c, with no sales of white selling below 14 to 14½. The stock that we have received this year is of fine quality, and we advise forwarding to market at once, so as to be received here before the cold weather sets in. Extracted is selling at 6 to 6½. Beeswax, 23.

Nov. 18.

S. T. FISH & Co.,

189 So. Water St., Chicago, Ill.

MINNEAPOLIS, Minn.—We are receiving large shipments of honey but they are mostly of poor quality. Fancy white is selling at 18 to 20 cts., but we are cleaning up more No. 1 white at 16 cts. than anything else. We quote as follows: Fancy white, 18 to 20; No. 1, 16; fancy amber, 15; fancy dark, 14; white extracted, 7½ to 8; dark extracted, 6½ to 6¾. No sale for beeswax.

J. A. SHEA & CO.,

116 First Ave., North,

Minneapolis, Minn.

Sept. 27,

CHICAGO, Ill.—Fancy white comb honey brings 15c per pound. Grades not grading first-class are not selling at over 14c, as there has been quite a quantity of California honey received here that is offered at 14c. The quality is superior to most of that we receive. Dark honey sells slowly at 12 to 13c. Extracted ranges from 5 to 7c per lb., according to color, quality, flavor and style of package. Beeswax 22c per lb. The trade in honey has been large this season.

R. A. BURNETT & CO.,

Nov. 1.

161 So. Water St., Chicago, Ill.

NEW YORK, N. Y.—Our market for both comb and extracted honey is unusually dull and inactive. The supply is large and continues to accumulate, and to move round lots, even the above prices must be shaded. Beeswax is firm and advancing in price. We quote as follows: Fancy white, 13; No. 1 white, 12; No. 1 amber, 11; fancy dark, 10; No. 1 dark, 9; white extracted, 6 to 6½; amber, 5½ to 6; dark, 5 to 5½. Beeswax, 26 to 27.

HILDRETH BROS. & SEGELKEN,

Dec. 8.

25 & 30 West Broadway New York.

CHICAGO Ill.—All of the better grades of honey have been worked off and the dark does not sell at any price. If the weather moderates we would advise those having honey of fancy grades to send it at once so as to get it on the market before the holidays. Do not send any dark honey. We quote as follows: Fancy white, 16; No. 1 white, 14 to 15; fancy amber, 13; No. 1 amber, 13; fancy dark, (it don't sell); white extracted, 6½ to 7; amber, 6 to 6½; dark, 5. Beeswax, 22 to 23.

J. A. LAMON.

Dec. 6.

44 & 48 So. Water St., Chicago, Ill.

WINTER LOSSES

Are not always the result of the same cause. They may come from starvation; from poor food; from improper preparations; from imperfect protection; from a cold, wet, or possibly a poorly ventilated cellar; etc., etc. Successful wintering comes from a proper combination of different conditions. For clear, concise, comprehensive conclusions upon these all-important points, consult "ADVANCED BEE CULTURE." Five of its thirty-two chapters treat as many different phases of the wintering problem.

Price of the book, 50 cts.; the REVIEW one year and the book for \$1.25. Stamps taken, either U. S. or Canadian.

W. Z. HUTCHINSON, Flint, Mich.

HONEY

Superior Quality; Price Low.

About the

NEW HIVE.

Ask for Heddon's Circulars. Address

JAS. HEDDON, Dowagiac, Mich.

Please mention the Review

Muth's HONEY EXTRACTOR PERFECTION Cold-Blast Smokers, Square Glass Honey Jars, Etc.

For Circulars, apply to CHAS. F. MUTH & SON,
Cor. Freeman & Central Aves., Cincinnati, O.
Send 10c. for Practical Hints to Bee-Keepers.

7-93-tf.

Please mention the Review.

Nearly 1000 Queens for '93

Is my record. Larger yards, best stock and
methods for '94. Golden Italian stock.
11-93-tf

J. B. CASE, Port Orange, Fla.

Please mention the Review.

Doolittle's Queen-Rearing Free!

We have some of G. M. Doolittle's "Scientific Queen-Rearing" book (170 pages) in paper covers, a copy of which we will mail **FREE** to the New Subscriber who sends us \$1.00 for the **Weekly AMERICAN BEE JOURNAL** for one year. This same book in cloth binding sells for \$1.00, but we give to a New Subscriber one of the paper-bound edition for **nothing**. Order quick, if you want one. They will all soon be gone. A sample copy of the "Bee Journal" is sent free on application to the publishers.

GEO. W. YORK & CO., 56 Fifth Ave., Chicago, Ills.

To new subscribers, the remainder of this year will be sent free.

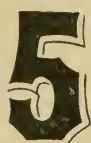

PER CENT DISCOUNT

From Catalogue Prices, on all Goods Until December 1st.
(In December, 4 per cent. In January, 3 per cent.)

AMERICAN BEE - KEEPER until January 1895 for 50 cents.

The W. T. Falconer Mfg. Co.,

Manufacturers of Bee-Keepers' Supplies.

ESTABLISHED 13 YEARS.

Jamestown, - - - New York.

Bee Hives and Section Boxes.

Simplicity, Langstroth-Simplicity, Standard Langstroth, Dovetailed and Champion Chaff Hives, Supers, One Piece Sections and Shipping Cases, Foundation, Smokers, etc., etc. Send for 16 page Circular.

1-92-tf PAGE & KEITH, New London, Wis.

SUCCESS

In Bee-Culture,

A cyclopedia of fresh, bright, original ideas pertaining to Bee-Culture, carefully selected and boiled down for busy people. Published monthly at 50 cts—sent from now until Jan. 95 for 50 cts.

BURTON L. SAGE, Highwood, Conn.

GO TO

HEAD QUARTERS

FOR 4 AND 5 BANDED

QUEENS

Special, breeding queen,	\$5.00
Best, select, tested,	3.00
Tested,	2.50
Untested,	1.00
" per dozen,	9.00

L. L. HEARN,

7-93-tf

Oakvale, W. Va.

-If you are going to-

BUY A BUZZ-SAW,

write to the editor of the REVIEW. He has a new Barnes saw to sell and would be glad to make you happy by telling you the price at which he would sell it.

IF YOU WANT THE

BEE BOOK

That covers the whole apicultural field more completely than any other published, send \$1.00 to Prof. A. J. Cook, Agricultural College, Mich., for his

Bee-Keepers' Guide.

Liberal Discounts to the Trade.

BEES QUEENS,

SECTIONS, SMOKERS,

COMB FOUNDATION

And all Apiarian Supplies. Send for Catalogue
E. T. FLANAGAN, Belleville, Ill.

Just Splendid

Mr. Alley—The queen I got of you last fall is just splendid! She is the best queen in an apiary 150 colonies. I would not take \$10 for her. John A. Pease, Moravia, Calif.

Price of such queens is \$1.00 each.

HENRY ALLEY,

Wenham, Mass.

THE PROGRESSIVE BEE - KEEPER

Has Changed Hands. It is now Published by the
LEAHY MANUFACTURING CO.,

Higginsville, Missouri.

Money, Experience and Enterprise will not be lacking to make it all that its name indicates. Send for Free Samples and Copy of 28-page Catalogue of Apiarian Supplies.

Names of Bee - Keepers.

TYPE WRITTEN.

The names of my customers, and of those asking for sample copies, have been saved and written in a book. There are several thousand all arranged alphabetically (in the largest States) and, although this list has been secured at an expense of hundreds of dollars, I would furnish it to my advertisers at \$2.00 per thousand names. A manufacturer who wishes for a list of the names of bee-keepers in his own state only, or, possibly, in the adjoining states, can be accommodated. Any inquiry in regard to the number of names in a certain state, or states, will be answered cheerfully. The former price was \$2.50 per 1000, but I now have a type writer, and, by using the manifold process, I can furnish them at \$2.00. W. Z. HUTCHINSON, Flint, Mich.

BEE - KEEPERS'

SUPPLY HOUSE

J. H. M. COOK, 78 Barclay St., N. Y. City.

(SUCCESSOR TO A. J. KING.)

4-93-tf

Send for illustrated Catalogue

Please mention the Review

ON HAND NOW.

THE MOST COMPLETE STOCK OF BEE HIVES, SECTIONS AND SUPPLIES IN THE NORTHWEST.

W. H. PUTNAM,

1-93-12t.

RIVER FALLS, WIS.

Pl., ..

GOLDEN ITAL'AN QUEENS

Now ready for \$1.00 each. Do not order your supplies until you see our circular for 1893. For the price, we have the best spraying outfit made. Send \$1.50 and get one. Wm. H. BRIGHT, 1-93-12t Mazeppa, Minn.

Please mention the Review

PATENT. WIRED, COMB FOUNDATION HAS NO SAG IN BROOD FRAMES.

This Flat - Bottom Foundation

HAS NO FISHBONE IN SURPLUS HONEY.

Being the cleanest, it is usually worked quicker than any fdn. made.

J. VAN DEUSEN & SONS, (SOLE MANUFACTURERS),

3-90-tf Sprout Brook, Mont. Co., N.Y.



Dadant's Comb Foundation.

Wholesale and Retail. Even our competitors acknowledge that our goods are the STANDARD of their kind. **Langstroth on the Honey Bee, Revised.** New edition. Bee Vents; and veil material at wholesale. Bee Supplies, Sections, Smokers, etc. Samples of Foundation and veil stuff with circular free. Instructions to beginners. Send your address to

CHAS. DADANT & SON, Hamilton, Ills.

4-93-12t

Please mention the Review.

New as Well as Valuable IMPROVEMENTS

IN BEE-HIVES, SMOKERS,

FOUNDATION FASTENERS,

SECTION PRESSES AND FEEDERS.

Special prices given to parties who will take hold of and push the sale of these goods. For circulars and particulars, address

1-93-tf.

LOWRY JOHNSON,

Masontown, Pa.

ITALIAN QUEENS AND SUPPLIES FOR 1894.

Before you purchase, look to your interest, and send for catalogue and price list.

J. P. H. BROWN,

1-88-tf.

Augusta, Georgia.

If You Wish Neat, Artistic

PRINTING,

Have it Done at the Review.

Notice to Jobbers.

G. B. Lewis Co., Watertown, Wis.,

Invite all Wholesalers and Jobbers of Bee - Keepers' Supplies to write to them for contracts for Hives and Sections the coming season. 11-93-tf

Sections!

We have just completed several new and expensive automatic machines that will turn out sections that *in point of quality cannot be excelled*. They are sanded and polished on both sides, and are of an absolutely uniform thickness from end to end. Samples and prices in quantities on application. Speak quick if you want to lay in a stock of these fine sections, as our stock of lumber is low.

A. I. ROOT, Medina, Ohio.

Sections!

Twelve Months

THE CANADIAN BEE JOURNAL, a live bee paper edited by R. F. Holterman, will be sent to any new subscriber for twelve months for 50 cents in stamps or silver. Renewals, \$1.00 per year. Address GOULD, SHAPLEY & MUIR CO., Ltd., Brantford, Canada.

50 Cents.

Please mention the Review.

SHIPPING CASES.

To hold twelve, 1½ sections, or fourteen 7-to-the-foot, at \$6.00 per 100—with glass, \$6.65. They are of fine material, and the workmanship is of the best. Send for free price list of everything needed in the apiary. 9-33 tf

M. H. HUNT, Bell Branch, Mich.

Please mention the Review.



PORTER BEE ESCAPES

Are used and pronounced the best, and highly recommended as great labor-saving implements by Chas. Dadant & Son, Prof. A. J. Cook, Chas. F. Muth, Jno. S. Reese, J. H. Martin, Jno. Andrews, F. A. Gemmill, Wm. McEvoy, A. F. Brown, Thos. Pierce, and many other prominent bee-keepers. Descriptive circular and testimonials mailed free. **PRICES:** each, postpaid, with directions, 20 cts.; per doz., \$2.25.

RETURN THEM AND GET YOUR MONEY BACK AFTER TRIAL, IF NOT SATISFIED. For sale by dealers.

MENTION THE REVIEW.

Address R. & E. C. PORTER, LEWISTOWN, ILL.

The Bee-Keepers' Review.

A MONTHLY JOURNAL

Devoted to the Interests of Honey Producers.

\$1.00 A YEAR.

W. Z. HUTCHINSON, Editor & Prop.

VOL. VI. FLINT, MICHIGAN, DEC. 10, 1893. NO. 12.

Work at Michigan's Experimental Apiary.

R. L. TAYLOR, APIARIST.

BEST FDN. FOR USE IN SECTIONS.

"He could distinguish and divide
A hair 'twixt south and south-west side"

BUTLER.



EVER since I first began to use it extensively, now fifteen years ago, comb foundation has been to me a matter of much interest and thought. I have often noticed that much interest is taken in the best meth-

ods of extracting the wax from old combs, and in machines that will make the thinnest foundation, but that little care has been exercised with regard to the best methods of manipulating wax to be used in making foundation so as to secure the readiest acceptance and the most thorough manipulation on the part of the bees and that to the interrogatory: Does the thinness of foundation bear any relation to the thinness of the septum of the comb made from it? I have heard hardly an inquiring answer; nevertheless I have all along felt a great in-

terest on these points which experiments conducted in a small way had served greatly to increase, so it was but natural that when I found myself in a position where I could afford to do it somewhat extensively I became interested in the formation of plans calculated to bring out if possible the truth on these and kindred points.

The plan adopted was to procure a conveniently large variety of foundations made for use in sections by procuring from several makers samples of each kind made and comparing them by putting them into cases alternately with no separators and giving them as thus arranged to the bees to work out and fill. It was thought that results might be obtained in two ways: First it seemed reasonable to suppose that those sorts that were most acceptable to the bees would be drawn out first and most rapidly and consequently when capped would contain the most honey and that the preference of the bees could easily be detected by weighing the finished sections: secondly by measuring the thickness of the bases of the cells of the comb produced it seemed clear that if any sort were to any considerable extent better adapted to its purpose than the others that fact would be clearly revealed.

For the purposes of the latter case I have so far been unable to see that the plan pursued could have been improved but in the former case there is some degree of disappointment from the fact that it gradually became evident that the plan pursued was defective so far as the purpose sought was concerned in at least two particulars, viz.,

in attempting to compare too many kinds at once in one and the same case, for it is evident if three sections containing foundation equally good were placed side by side and the trio was flanked on either side by sections with inferior foundation the two exterior ones of the trio would derive an advantage on the side of the inferior ones which the central one containing equally good foundation would be deprived of, and then sections of the usual width, seven to the foot, were employed in the experiment which it became evident in the progress of the experiment were too wide to yield to the full the natural effect of differences in the foundation, for I saw in several cases that the bees worked out some kinds of foundation sooner and more rapidly than others at first but when these reached about the thickness required for brood they were delayed to some extent and more force was put on the kinds that lagged to bring them up, so that in this way the results sought which would perhaps be abundantly revealed by the use of thinner sections were to a large extent concealed.

The remedy which should be applied in further experiments of this character seems to me to be evident; each sort of foundation which it is deemed desirable to compare with others should be compared with each of them separately and the sections should be so thin that the usual thickness of comb desired by the bees would a little more than fill the section's proportionate amount of space.

I have been asked whether in publishing the results of these experiments I should give the names of the manufacturers of the different foundations used. The object of the experiments is to obtain for the use of bee-keepers generally as much new and valuable knowledge with regard to their tools and busness as possible and it is evident that in the particular experiments of which I now write the value of the results depends almost entirely upon a knowledge of the names of the makers of the several varieties of foundation used and I believe I should be doing injustice to any maker of foundation to suppose that he desired his name withheld, for are we not bound to believe that each one desires and is endeavoring to make foundation that shall yield the greatest possible profit to the user and that if he fails in any respect he desires to know it that he may apply the remedy?—So I think I can-

not do otherwise than give all the knowledge I possess in the matter. Not that I think there is anything so far that can very injuriously affect any manufacturer, but I hope there is what may prove an entering wedge to make a way of escape from the domain of theory and an entrance to the domain of fact in this matter of foundation and lead to an effort to make it to please the mandibles of the bee instead of the eye of the purchaser. There may be something to learn yet about the manipulation of wax as well as about the peculiarities of foundation machines.

In the experiments now under consideration eight varieties of foundation were employed of which the sources and other distinguishing peculiarities are sufficiently indicated in the following table:

- A Dadant's Thin, Sheets 12x4 in., 15 to $\frac{1}{2}$ lb.—10 ft. to the lb.
- B Dadant's Extra Thin, Sheets 12x4 in., 18 to $\frac{1}{2}$ lb.—12 ft. to the lb.
- C Van Deusen's Flat-bottom, [procured of A. I. Root] Sheets $16\frac{1}{2}$ x $3\frac{3}{4}$ in., 16 to $\frac{1}{2}$ lb.,—13.75 ft. to the lb.
- D Root's Thin, Sheets $16\frac{1}{2}$ x $3\frac{3}{4}$ in., 12 to $\frac{1}{2}$ lb.—10.31 ft. to the lb.
- E Root's Extra Thin, Sheets $16\frac{1}{2}$ x $3\frac{3}{4}$ in., 14 to $\frac{1}{2}$ lb.—12.03 ft. to the lb.
- F Foundation made on Given Press, Sheets 15x3 13-16 in., $12\frac{3}{4}$ to $\frac{1}{2}$ lb.,—10.09 ft. to the lb.
- G Foundation made on Given Press, Sheets 15x3 13-16 in., 12 to $\frac{1}{2}$ lb.—9.37 ft. to the lb.
- H Fdn. three years old, made on Given Press, about 9 ft. to the lb.

Each variety of the foundation was designated by a letter of the alphabet as indicated and the letters were used for marking the sections to indicate the sort of foundation each contained and also as labels to distinguish the septa of combs made from the foundation when they (the septa) were cut out and sent away for the measurements hereinafter explained.

The foundation was cut to the same size $3\frac{3}{4}$ x $3\frac{3}{4}$ inches and after being fastened in sections were placed in Heddon cases alternately as already stated so that each kind appeared seven times in each pair of cases. In all, eight cases were thus prepared, but misfortune attended them in other ways than indicated in the foregoing; some were not well filled, two contained more bee-bread than I ever found I think in any other two cases and there was only one pair that was filled to my entire satisfaction so that the material that could be fairly used for comparison by weighing was comparatively meagre and consisted of five of each sort from the two cases that were well filled, four of each from two other cases and three

of each from still another pair. The cases were selected with a view to their giving an opportunity of selecting well filled sections of each sort from the same relative positions in the cases and the sections compared were so selected. The following figures give the results in pounds and ounces :

	A	B	C	D	E	F	G	H
5 each sort	4-13.5	4-11.5	4-13.5	5	4-15	4-15.5	4-14.5	4-15
4 " "	3-13.5	3-12.5	3-13.5	3-15	3-15	4	3-15.5	3-15.5
3 " "	2-14	2-14.5	2-14.5	2-15.5	2-15	3-00.5	2-15.5	2-15.5
Total ...	11-9	11-6.5	11-11.5	11-14.5	11-13	12	11-13.5	11-14

This indicates pretty clearly what I have been aiming at as well as the course with the modifications already suggested which I think should be pursued in making further investigations in this line. Of course it would be rash to claim any very definite result from the experiment so far but the totals here given will be found very interesting matter for comparison with the weights and measurements given further on which were procured with the expectation of evolving something that would assist in the solution of the general problem under consideration.

I suppose it would not be denied by any one that so far as the amount of wax contained in comb honey is concerned we must take the amount of wax contained in natural comb when used as the receptacle of honey as the standard of perfection. How near does comb produced from foundation prepared for use in sections approach that standard? And do combs produced from all sorts of such foundation approach equally near to that standard? It was with the purpose of making a beginning if possible at answering these and similar questions that I undertook the experiment with section foundation. It first occurred to me that samples of honey made from different kinds of foundation and from natural comb might be submitted separately to several careful individuals experienced in the production of honey for comparative tests with the hope that the reports of such tests would give the light sought. With further thought that hope gradually grew dimmer, until the committee of the N. A. B. K. convention to whom the septa cut from comb made from the several foundations were submitted for comparison with a view to a report, gave the matter up in despair, when it went out altogether.

My next resource was mechanical instruments for fine work in measuring and weighing. I knew there were such instruments at our agricultural college and in speaking of the matter with Mr. E. R. Root he informed me that his house possessed a micrometer and generously put it at my service. To the

septa of the foundations I added one from natural comb which I designated by the letter "I." I at once gave Mr. Root a set, and measurements of them were taken by C. C. Washburn of his establishment who is skilled in such work. These measurements appear further on.

To procure samples of comb for the purpose of the weighing test I took two sets of sections of the several varieties and extracted the honey as thoroughly as possible then after filling the cells with water I plunged them in a large vessel of water where they remained twenty-four hours when they were further washed and then thoroughly dried. To get pieces of exactly the same size I first shaved off the comb from both sides to bring all to an equal thickness, about one-half inch. To accomplish this I began by cutting away the section box within a little less than a fourth of an inch of the septum making the opposite sides perfectly straight and parallel then using these sides as guides with a long straight sharp knife all portions of the comb jutting out were shaved off leaving a perfectly flat surface of comb. As guides for shaving off the other side two straight pieces of wood of even thickness—about half an inch—were nailed to a smooth, flat board and after cutting away the other edges of the section box sufficiently it was laid on the flat side of the comb between these and fixed firmly with wedges, when the superfluous comb was shaved away as before. After this process was completed a circular piece to be used for the purposes of the experiment was cut from each with a rim of tin a little more than two and a half inches in diameter, used after the manner of a cake-cutter, thus leaving in each case the septum with a portion of the cells upon each side. The first set I thus prepared came short of

perfection to such an extent as to be unsatisfactory so I made use of the other set only. These were taken to the college and after having them weighed I cut each sample in two giving one part to Dr. Beal of the college for measurement reserving the others and afterwards sending them to Mr. E. R.

varying number of measurements of the samples—from once to five times—while in the other cases these measurements were taken in each instance.

The weighing was done by Mr. Frank S. Kedzie, adjunct Professor of Chemistry, with the following results in grams:

	A	B	C	D	E	F	G	H	I
Weight in Grams	1.93	2.2398	2.093	2.2349	1.9664	1.8482	1.8586	2.083	1.6321

If any one has a curiosity to turn the results into grains he can do so by multiplying by 15.432 the number of grains in a gram.

The measurements of the thickness of the bases of the cells now follow in their order in ten thousandths of an inch.

WASHBURN'S MEASUREMENTS.

	A	B	C	D	E	F	G	H	I
	95	86	85	76	86	96	73	66	57
	95	90	83	110	105	70	75	90	57
	125	85	93	96	92	75	75	82	57
Total.....	315	261	261	282	283	241	233	238	171
Average.....	105	87	87	94	94	80	74	79	57

DR. BEAL'S MEASUREMENTS.

	A	B	C	D	E	F	G	H	I
	70	110	65	120	70	60	60	80	50
	100	65	70	100	100	60	60	60	50
	80	100	70	80	90	80	60	60	50
Total.....	250	275	205	300	260	200	180	200	150
Average.....	83	92	68	100	87	67	60	67	50

MR. HUBBELL'S MEASUREMENTS.

	A	B	C	D	E	F	G	H	I
	95	80	62.5	75	70	62.5	50	65	50
		110	67.5				90	75	75
		90							
		95							
		70							
Total.....	445	130	140	140	125
Average.....	95	89	65	75	70	62.5	70	70	62.5

THE GENERAL AVERAGE.

	A	B	C	D	E	F	G	H	I
Washburn's Av.	105	87	87	94	94	80	74	79	57
Beal's Average...	83	92	68	100	87	67	60	67	50
Hubbell's Av....	95	89	65	75	70	62.5	70	70	62.5
Total.....	283	268	220	269	251	209.5	204	216	169.5
Average.....	94	89	73.3	89.6	83.8	69.8	68	72	56.5

Root to secure another set of measurements from Mr. Washburn so as to get them from two capable persons of the same comb as nearly as practicable. As it turned out Mr. Washburn was ill when these reached him and a substitute was found in Mr. Hubbell. As will appear in the summary he took a

All this work it seems to me has been very satisfactory, for while there has not been particular uniformity—a thing which could not be expected—there has been general uniformity.

I must close this article, already too long, by mentioning some of the apparently ten-

able inferences which may be drawn from these tests :

1st. No comb made from foundation quite equals in fineness the natural, though in some cases it approaches it very closely.

2nd. In foundations of the same make the thinner has but very slight advantage over the heavier in point of producing comb of lighter weight.

3rd. That foundation kept for a long time before using has but a slight disadvantage if any as compared with that freshly made. The slightly greater thickness of the septum of comb made from "H," as compared with that made from "G," may well be accounted for by the fact that H was heavier than G.

4th. Granting that different methods ordinarily in use of manipulating wax do not make a difference in the character of foundation made from such wax, that foundation made on the Given press has a pretty decided advantage over that made on the roller machines.

If these investigations lead manufacturers of foundation to strive to learn the best methods of manufacturing wax and to find out what peculiarities characterize the best foundation machines they will not have been made in vain.

LAPER, Mich.

Nov. 29, 1893.



TIMELY TOPICS.

No. 10.

R. L. TAYLOR.

"How can one be warm alone?"—BIBLE.

[Sickness prevented Mr. Taylor from sending the following in time for the November issue, but, as it contains excellent suggestions and is needed to round out the full year of his "Timely Topics," I give it now.—ED.]

The season for the general round up of the year has now arrived. By the time this appears all the work pertaining to the past bee-keeping season in this latitude should either be already done or else it should be attended to at once. I am well satisfied there is nothing gained by leaving bees out of the cellar any longer if they are to be put in at all; and of course if they are to be wintered outside all preparation to be made for the winter if not already done should be completed without any delay. And in this work especially a lookout ought to be kept for improved methods. I am expecting some

genius will yet give us a method of wintering out of doors having all the advantages of both methods with none of the disadvantages of either. The present method is safe in this latitude in exceptional cases only. Besides it is greatly wanting in economy both in the amount of material required and in the conservation of the animal heat of the colony as well as in the amount of labor required. We want the material and labor now required for six colonies to suffice for twenty-five. We want the heat that passes from the colony to pass to the aid of another so that the warmth of the cellar is approximated. To accomplish this a warm, dry compact nest to hold twenty-five or thirty colonies must be devised and each colony must be so encased as to make it as far as warmth and dryness are concerned practically a part of one mammoth colony. It may be that in this direction the next advance may be made. If a few of the thousands of inventive bee-keepers would become interested in the matter something might be done this very winter. Who will take a hand in the work? I think I see a little opening which I am preparing to investigate by experiment as soon as possible.

Late fall and early spring are the hardest times of the year upon woodwork left out in the weather, so it is important if one would have his hives last long, to gather up all parts of hives that are still outside and stack them up in good shape under shelter. This is especially important in the case of the covers. It is more important that they should be well preserved and at the same time they are more liable to injury as well from warping as from decay. I am careful at this time of the year to get together all covers not in use making a point to include all that need any repairs or painting, exchanging for some in use for that purpose, and selecting a place where they will be convenient for painting and not in the way and pile them up making each pile straight and even and weighting it so that each cover is held firmly to its proper shape. With this slight care they are rendered much more satisfactory in service. The covers require painting much oftener than the hives and it pays to keep them well painted. If the shop or honey room can be warmed the painting can be done there excellently well any time in winter. With all this done, the honey crop all disposed of, collections of wax reduced and all combs

safely put away, there is little left but to inquire what are the demands of the coming year.

LAPEER, Mich.

Nov. 7, 1893.



The Orange Blossom.

"RAMBLER."



THE proper time for a person who has always resided in the East to come to this far Western Shore, is during the holidays or in January. The difference in tem-

perature between East and West will be prominently noticed, and if we have had our winter rains the fresh foliage upon the trees and the blooming flowers will attract attention. If the traveler lands in the citrus belt, the orange and the lemon are now getting their color. The lover of symmetrical forms will love the tree and its fruit, and while the tree holds its form well, and attains a height of twelve to fifteen feet, the fruit in the form of those perfect golden globes resting against a background of deep green leaves, or peeping here and there from among the dense foliage presents one of the most beautiful pictures of vegetable growth, that one might with profit travel a long distance to view. The deep green leaves of the center of the tree is livened up by the new growth at the tips of the branches being of a light pale green.

The portion of the orange tree, however, that interests the bee-keeper, is the bloom that puts forth in May. The orange tree is profuse in blossoms and presents a very white appearance during blossom: the blossom is borne in clusters like the apple or cherry, and appears very much like the latter. Its fragrance perfumes the air for quite a distance, and it is not unlike the odor of the lilac. The bees work upon it with as much enthusiasm as they do upon the basswood, and during the honey flow work continues from early morn until dew eve (though the fact is we have but little dew here just at that time.) The orange blossom

can be relied upon for some honey every year, but like all other free bloomers it has its good and its poor seasons. When the secretion of nectar is profuse bees will go a long distance to obtain it and apiaries directly in the orange groves get the surplus receptacles rapidly filled. Many bee-keepers in the citrus belt are now taking advantage of the fact and during the orange bloom locate their apiaries among or near the orchards, and after giving their bees a joyous time upon the bloom, which lasts about three weeks, the hives are then moved out into the foot hills where the bolled sage is coming into blossom and ready to yield its nectar. Whole apiaries are safely moved and the bees are interrupted in their work but a few hours and seem to take quickly to the new class of blossoms that they now find surrounding them. Though migratory bee-keeping might be practiced to a great extent in California, it is not indulged in to much of an extent, but with the growing area of orange groves it may become a settled plan of operations.

Orange honey in color is of a very light amber, and when first extracted and put into a bottle it has a creamy white appearance owing to minute bubbles of air which gradually come to the top but so slowly that it is several days before the honey presents a clear appearance. The taste of orange honey is very pleasant and the person buying it is sure to call for more of the same quality. It is to be regretted that there is not enough of it produced to place it upon the market as a distinct quality. It is also to be regretted that honey from other sources is palmed off upon the public as orange blossom honey. This right of substitution will probably be practiced as long as there are so many qualities and flowers in the honey produced by the bees.

Did you ever think of the amount of adulterated maple sugar there is upon the market? At least we must judge there is a large amount from the fact that there is a way to make good maple syrup without a particle of maple liquid about it. And the foliage of the tree is caused to blush every autumn over deception practiced in its name by dishonest men. We hear but little said by the consumer about this adulteration and the reason lies in the fact that there is but one prominent flavor to maple products, be it sugar or syrup, and when the adulterator catches this he finds a ready market for his compound.

Honey, however, with its many flavors cannot in all cases be so closely imitated and people who eat honey only occasionally are not educated to distinguish the various flavors and never will be for even bee-keepers themselves are often nonplussed over the many flavors of their products. About all the adulterator has to do in the case of honey is to produce a sweet with the body and color of honey and label it orange or clover honey as his fancy may dictate. If the bee blushes at this audacity, it, like the obscure rose, blushes unseen, and while its sweetness is wasted, not on the air, but in a sea of glucose.

The bee-keeper, however, has one heroic remedy that will enable him to get almost if not quite clear of the adulterator, and that remedy lies in the exclusive production of comb honey.

Although I am not ready to change from extracted to comb honey or ready to feed my extracted to produce comb honey, I still recognize the above fact that instead of flavor for a standard quality, as we find in maple products, the honey comb is the standard for our product, and I am aware that upon this point volumes might be written to the profit of the bee-keeper.

BLOOMINGTON, Calif. Nov. 8, 1893.



Bee Spaces, Top Bars, Honey Boards and the Prevention of Brace and Burr Combs.

JAMES HEDDON.



ABOUT sixteen years ago, when I had followed our chosen pursuit eight or nine years, I began making extended experiments based upon the possibility of so constructing a hive that I could manipulate it

about as readily after bees had occupied it several seasons as when it left the shop ready for its first swarm.

At that time I wondered if it were possible to so construct a hive that we could remove and re-adjust the frames and surplus recep-

tacles at will, with nearly the same readiness after having been several years occupied by bees, as when it had been occupied but a single day. To this end I knew it was necessary to do away with propolis and brace-combs. With that end in view, I constructed metal rests, after the style introduced by Mr. Otis, twenty years ago, and introduced grease and all kinds of top-bars, together with several kinds of honey-boards until I discovered two things; first, that I could do away with but a *portion* of the annoyances above referred to, and second, what construction was best to most completely accomplish that end.

The first thing I discovered was that the measurement of a correct "bee-space," had nothing to do with the requirements of the bee regarding room for its passage, but rather was that space in which the worker would be least likely to attach propolis or comb. I also found that this space differed according to where and how it was located. I found that the best space to leave above the top-bars of the frames was 5-16, and between the top-bars, was $\frac{3}{8}$ to $\frac{1}{2}$, according to the depth of the top-bar. I experimented with top-bars of different depths spaced apart from $\frac{1}{4}$ to $\frac{3}{8}$ of an inch, these depths varying from $\frac{1}{4}$ to $\frac{3}{8}$ of an inch. I tried these widths and thicknesses in different combinations, and now have in my apiaries a goodly number of old frames still containing comb and bees with top-bars of the above dimensions, in standard Langstroth hives of my own modification. At that time I used to transfer brood-combs from box hives into my Langstroth hives and when so doing nearly always used a frame containing a top-bar $\frac{3}{8}$ deep and $\frac{3}{8}$ wide, square. I believe in $\frac{3}{8}$ as the best width for top-bars of suspended frames.

Right here I consider it appropriate to digress long enough to say a few words concerning that long abused "Honey-board." I presume your younger readers do not know that among the few of us who used honey-boards, I was left almost alone in their defense and advocacy ten or twelve years ago. Those who considered themselves and were considered by many as "leading lights" in the dark halls of apiculture, at that time, stoutly opposed the now cherished honey-board; but is it not true, Mr. Editor, that all who have adopted and used honey-boards containing a "bee-space," and the "break-joint" principle, which I invented and intro-

duced previous to that time, have carefully adhered to them? I am aware that but a short time ago some leading bee-keepers could find no merit in the "break-joint" principle in the honey-board as a preventive of brace-combs; especially those which annoy us by their attachment to the surplus receptacles. I am also fully aware that any bee-keeper that cannot find this practical and useful feature must be nearly blind when looking in that direction. If our experimental apiarist will use ten hives for this experiment, placing the honey-boards squarely upon five, and pushing them side-ways on five others so that the spaces between the slats of the honey-board and those between the top-bars of the brood-frames, range with each other instead of breaking joints, he will then be able to report to you the marked results, and they will be that the "break-joint" principle prevents the attachment of almost all brace-combs between the top of the honey-board and surplus receptacles and materially lessens the number of brace-combs between the tops of the top-bars and underside of the honey-board, as well as between the edges or sides of the top-bars and each other.

To sum up, a pine top-bar $\frac{3}{8}$ wide and $\frac{5}{8}$ to $\frac{3}{4}$ deep, under a break-joint honey-board, is the best arrangement for prevention of brace-combs. This top-bar will not sag but will cost very much more than the common bar, both for material and labor. How is this, Bro. Taylor?

DOWAGIAC, Mich.

Nov. 28, 1893.

[This matter of the prevention of burr and brace combs and dispensing with the honey board was largely discussed at the Chicago convention. The use of $\frac{1}{4}$ inch spaces between and above the top bars will practically prevent burr and brace combs, if we can believe a large number of most excellent bee-keepers, and I think we can. That this space will *entirely* prevent the building of these combs I believe no one asserted. The honey board will. If you don't want any brace or burr combs, use a honey board. If you can put up with a few, then make your top bars wide and deep and space them very accurately to $\frac{1}{4}$ inch. Although the self-spacing frames and no honey board arrangement is being boomed, I very much doubt if this style of management will ever take with the majority, and I believe that many of those who are now adopting this method

will eventually go back to the ordinary Langstroth frames and a honey board. As for myself, I want no burr combs attached to the bottoms of the sections. I prefer to go the expense of one cent a year for a honey board to that of having any dripping and daubing from broken burr combs, be they ever so few. Below the honey board the bees may build their braces and burrs to their heart's content as I don't take the honey board off once a year on an average. —Ed.]



Medium Colonies, [Stores Well-Placed, Plenty of Protection; and a Generous Entrance Winter Bees in Rhode Island.

ARTHUR C. MILLER.

THEN the REVIEW for October Mr. Hasty calls attention to the careless use of descriptive terms and the confusion caused thereby. In the same number Mr. Aikin calls "sealed covers" a "snare in cold climates." The term "sealed covers" has been used to mean boards, perhaps, and enameled mats and sundry other articles used to cover the top of the hive and allowed to become sealed down by the bees. If Mr. Aikin means board covers not chaff protected, I agree with him, but if he includes mats chaff protected, I do not.

Somewhat over ten years ago I began experimenting on ways of preparing bees for winter, for if properly prepared the bees do the rest. The experiments were on a fairly large scale, the first one embracing over forty colonies and as I was conducting the experiments for my own pleasure I spared no pains or expense. The results were very interesting and in some cases quite surprising.

To be uniformly successful I found it necessary to have a medium colony, an abundance of stores properly placed, an enameled mat sealed down, the whole surrounded with chaff or planer chips and a ten inch entrance wide open.

At first glance this seems like the ordinary "colonies chaff packed," but let me mention a few important features. First a *medium colony*, neither very large nor very small; second, an abundance of stores *properly placed*; third, an enameled or non-porous mat sealed down. It sounds easy and simple, but it took me years to do it every time with my whole apiary.

To get medium colonies that will *stay* medium is quite a task. It requires good judgement and careful selection to have brood and bees equally distributed and particular so to have the same proportion of old and young bees in each colony.

"Abundance of stores properly distributed" is easier of accomplishment. The size of the colony fixed early in the fall, the stores supplied, their proper placing is sure to follow. Take two colonies of equal strength, give one its seven or eight L frames of honey the first of September, the other the same the first of October and notice the difference the following spring. A mat sealed down prevents any draughts except those created by the bees, and together with the chaff packing gives them complete control of the temperature and ventilation of the brood nest. Arranged as my bees are there is never any condensation of moisture on the mat.

I would not have it understood that I have to manipulate all my colonies to prepare them for winter, for by having each colony supplied with a young queen by August very few colonies need any alteration later. I am led to believe that *early* preparation of bees for winter is a *very* important factor in the success of any method, and properly done, it does not interfere with the harvesting of the fall honey crop. Some may say that it is easy to winter bees in Rhode Island, but I assure them it is not, as the temperature is very variable, ranging within twenty-four hours from 50° or 60° to zero and *vice versa*. Intense cold is frequently followed by warm dense fogs that condense on and thoroughly saturate everything.

The system here set forth is a success *every time*, which is more than I can say of any other method I have tried.

PROVIDENCE, R. I.

Oct. 23, 1893.



The Relation of Sugar Syrup to Bees.

C. H. MURRAY.

O life,

Art thou another name for strife?

A daily wonder are thy hidden ways.

Thou goest as thou comest, in a maze.

IF in order I would respectfully correct a statement of Mr. J. Heddon in the Oct. REVIEW in regard to the nature of the food of the bee. He says: "The food of the honey bee may be divided into two distinct divisions,—oxygenous and nitro-

genous; the former being a heat producer and the latter tissue making."

Honey consists of carbon and water. A part of the water is free or hygroscopic; that is, it is not chemically combined with the carbon. The amount of free water varies, but in good honey it is about ten per cent. No where in the animal economy is the oxygen of water, or of any part of the food, employed as a heat producer. The vital force is not sufficiently powerful to decompose water and appropriate either of its elements. It is the combustion of the carbon of honey, sugar, or of any other food, that maintains animal heat, by its combining with the free oxygen of air inhaled or absorbed. The product of such combustion is carbonic acid gas. When the carbon of honey or sugar is appropriated by the bee, the combined water is released and the bee disposes of it by perspiration or otherwise. Honey destitute of free water consists of about forty-seven per cent. of carbon and fifty-three per cent. of combined water, but as honey ordinarily contains from eight to twelve per cent. of free water we have about forty-three per cent. of carbon in each unit of honey. Where there are fifty or more swarms of bees packed closely in a room or cellar the amount of water evaporated by them is very considerable. The vitiating carbonic acid gas should also be taken into account in such cases and means provided for its removal and the substitution of fresh air.

Physiologists maintain that a small proportion of nitrogenous food is essential to aid the assimilation of the carbohydrates, such as honey or sugar. A tablespoonful of boiled flour paste added to each half gallon of sugar syrup and thoroughly mixed might perhaps be sufficient. Undoubtedly a teaspoonful of salt to each gallon of syrup would be of great advantage. Bees long fed on pure sugar syrup alone would undoubtedly die,—not from dysentery, but with stomachs full of material that they were not able to digest. Simple decomposition,—as the separation of carbon in sugar, cannot be effected by vital force. The life forces—like the electric,—require decomposition and re-composition simultaneously in order to maintain their operation. The presence of some catalytic agent, like salt, exerts a most favorable influence in promoting the reactions.

ELKHART, Ind.

Oct. 25, 1893.

Importance of Warm, Dry and Pure Air in
Wintering Bees and How it May
be Secured.

O. SPAETH.

MR. EDITOR:—I have just received the REVIEW which reminds me of the article on house apiaries which I promised to translate for your paper. I am very sorry that I did not find time to do it; translation is for me very slow, tiresome and imperfect work, therefore I am not satisfied with it. I send you the article in German; perhaps you can find somebody that can translate it for you. You can also see in it one of the best bee houses imaginable for wintering bees by all methods.

The wintering trouble and cause of bee diarrhoea is solved by Rev. C. Weygandt, of Flacht, Germany, editor of the *Bee*, a monthly bee paper. He has made the most thorough experiments for years, and has solved a good many riddles, mysteries and problems that still puzzle a good many bee-keepers and papers. I do wish you could read two books which he published three or four years ago on those subjects. The name of those works are: "A Small Contribution to Promote Bee-Keeping."

He kept a good number of bees in his study room, where there was a coal stove burning all winter. The entrances of the hives were left open, the openings being two to three inches wide by one-quarter inch high. He had holes made through the window case or a channel under it. The bees wintered splendidly and came out strong and very healthy.

For years he closely observed bees in winter and tried all kinds of experiments with them. He found out what was the life element that must be taken into account if we want safe wintering. This life element is *pure, dry, warm air*, and good food, which, of course, also includes bee bread.

Some colonies he gave daily their portion of food. He found them scattered all over the combs, the latter, of course, keeping perfectly dry and clean. Their abdomens did not become extended and swollen and there was no need of a cleansing flight. The bees would not try to fly out when the weather would not permit, but they would just peep sometimes out and then go back again.

He found out that dampness and cold combined kill the most bees; causing indiges-

tion, catarrh and inflammation of the bowels or diarrhoea. He cured the worst kind of diarrhoea in a warm, dry, pure air, and with clover honey. Some will say, it is not a disease. They know not what they say. Smell it once, he says! Does it smell like healthy fæces? It nearly knocks one over, it will take your breath away.

Some bees will show much more uneasiness after a few month's confinement than others under the very same conditions, from such bees he would never breed.

After all these experiments he built a bee house which is a model, and not after very many years, all our Northern bee-keepers will have one like it, or similar to it.

He keeps his bees in a chaff hive all the year in the bee house. This is done so that the heat cannot directly strike the hives or bees, it also serves other purposes. If the weather is not too severe he does not have the house heated, or if he has, and it should get too warm, he opens all the doors and windows and has wintering in the open air or on summer stands packed. In a few minutes he can close the outside openings, which he sometimes does, also the doors and windows, and he has cellar wintering, but with much better conditions for the bees. The whole house is then pitch dark. He then opens the entrances on the back part of the channels of the hives.

He has no spring dwindling. As soon as the bees bring in natural pollen, he commences stimulative feeding, and breeding once commenced in good earnest never is checked by cold spells or poor weather. He has giant colonies at the time of fruit bloom and of rape, which is one of his main crops.

Some brag that they winter their bees with success in the old way. But it is one thing to winter bees that just pull through and are kept busy till the latter part of June getting ready for the harvest, giving no spring surplus whatever; and another thing to bring out very strong, rousing swarms which give the least work for the bee-keeper but the most pleasure and profit.

He claims that it pays to have such a house and saves time, money and work. In the first place he can use poor lumber for hives and outer cases, sometimes he used dry-goods boxes. Then they need no paint, and he only needs to pack them once and need not carry them to and fro, and he can do all his work inside. His bees also have shade and are safe from storms and thieves.

It is a pleasure to read his works and follow his experiments. He had a colony in his room gathering pollen and building combs at Christmas. He placed cherry and hazelnut branches in a pail of sand for a few weeks, pouring warm water over the sand every day, and in this way brought them to bloom in a few weeks. He shows how it is done so that not a bee will try to fly at the window to get out. Of course, he only meant to show what could be done with bees. He asserts, too, that his bees voided dry fæces.

He is also a great friend of the German bee and does not get tired to sing their praise. Of course he is not blind toward the good qualities of the other races, but asserts that the German bee has excellent qualities which are entirely overlooked, and if it were bred for years with as much care as the Italian, for instance, then its points of excellence would be brought out still more yet.

You see, in the business part, practical work and in the profits, the Americans take the lead, but in deep thinking and thoroughly performed experimenting the Germans still take the lead. If you will take the two volumes of extracts from the German bee journals to hand, you will find that many questions and problems that we try to solve now, were solved by German naturalists and bee-keepers years ago. I have the work. It is written by Schmid and Klein.

Now I believe fully that the secret of wintering bees cheaply, without loss, and with little labor is solved if the bee-keeper will follow C. Weygandt's advice.

BERNE, Mich.

Nov. 20, 1893.



Shipping and Selling Honey in Cold Weather.

J. C. STEWART.

"If you want your business done, go; if not, send."—FRANKLIN.

HAVE long wanted to write a letter for the REVIEW, and have selected this topic as of most interest to its readers of any thing I could write. My honey is produced with the one-story wide-frame with tin separators so the combs are smooth and no trouble to crate. I took them out of the frames, put them into the shipping cases and placed them in a spare room in my dwelling

where a fire would keep the combs from cracking. I left them there till near the holidays, then scraped, graded, and cased them for market. I stamped them all with a self-inker. As the sections were well filled I paid no attention to the weight except to see about how they averaged. I made the following grades No. 1 white, No. 2 white, No. 1 dark, No. 2 dark, and culls. When I was ready to sell I went to our R. R. agent, told him how easy it was to break comb honey in the cold, and got permission to set a stove in the car, which I did easily in the morning. I took a large bundle of newspapers into the car and tacked them over and upon one door, then closed the other door near to the stove pipe and packed that one and then made a fire. It soon was so warm that I began to sweat. I took into the car a rack of a buggy cart and nailed it fast and upright, the distance from the end of the car that would allow the honey cases and ten inches besides at each end of the inclosure. Hay was spread four inches deep on the car floor and the cases set upon it. Newspapers were placed all over the pile, and hay ten inches deep put at the ends and all sides. I gave the train men a section apiece to not bump the car. They seemed pleased and I think they did as they promised. The car went sixty miles but arrived safe with not a section broken in the 1,400 pounds.

I must state that in the bottom of each case and between the two tiers of sections I had placed a sheet of oiled paper. On this were laid five strips for the sections to rest on; so if any dripped the bottom would not be so much daubed. I shipped no dripping combs.

When I arrived at the city I took a sample section in a small grip and canvassed for orders. I told them they must average thirteen or fourteen ounces and I wanted 18 cents a box for it. A good many grocers said it would never sell for 25 cents each and they must make five cents a box. But I sold out and delivered. If I could not sell for money I traded for goods. All said it was very high, but as it was very nice, all white clover, they bought, and but few stopped to figure on the price per pound. I verily believe a $1\frac{3}{4}$ section full is large enough, and the way to get them full is to use them and no larger. I think they are filled fuller, more even, and quicker, and so are whiter than a $1\frac{7}{8}$ section and two-inch I would not use.

How I wish no one but specialists would raise honey, then we should not have to compete with the broken, stained mussy honey in the market. A commission man offered me 16 cents, but I thought that two cents would pay my expenses and give me a chance to see the city. The R. R. Co, said they had no right to receive it without the cases being crated as per Mr. Ripley, but as nothing else was in the car they did not care. Of course I removed the stove before the car started. I think the car would have gone safely to New York only for the transferring. The Mayor told me I could not sell from house to house without a license, but others said I could sell anything I raised

HOPKINS, Mo.

Jan. 10, 1893.

Bee-Keepers' Review.

PUBLISHED MONTHLY.

W. Z. HUTCHINSON, Ed. & Prop.

TERMS:—\$1.00 a year in advance. Two copies \$1.90; three for \$2.70; five for \$4.00; ten or more 70 cents each. If it is desired to have the REVIEW stopped at the expiration of the time paid for, please say so when subscribing, otherwise it will be continued.

 FLINT, MICHIGAN, DEC. 10, 1893.

ONTARIO, Canada, bee-keepers will hold their annual convention January 9th and 10th, 1894, at Lindsay. The editor of the REVIEW expects to enjoy the pleasure of attending the meeting.

CANADA is to have another bee journal, the first issue being already out. Its name is the *Practical Bee-Keeper* and it is a neatly gotten up quarterly, at forty cents a year, published at Tilbury Center by C. A. Ouellette, with T. N. Leigh as editor. Leading bee-keepers contribute to the first issue.

EIGHT EXTRA PAGES are added this month to make room for the index and to allow plenty of room in which to set forth the prominent excellencies of the REVIEW (see last four pages) in order that the large number to whom this issue will be sent as a sample may more thoroughly understand "What the REVIEW has been, is, and will be."

A CORRECTION.

Mr. Corneil sends the following: "In the second paragraph, second column, page 315, it reads; 'As the vapor laden air escapes from the cluster at 65° into saturated air at 55°, it * * * The figures 55° should be 45°. In Elwood's article you have Rettenkoffer a couple of times where it should be Pettenkoffer. I don't know who made the mistake but I feel sure it was not Elwood."

ORANGE BLOSSOM HONEY must be very delicious, or else Rambler has indulged in picturesque language to such an extent that he can use no other. After reading his article that appears in this issue I did not feel easy until I had written and asked him if it would be possible to send me a can of orange blossom honey. He had none of his own that was pure, but by looking about he finally found one sixty pound can of what appeared to be pure orange blossom honey, "the most delicious honey he ever tasted." and he bought it for me and it is now on its way across the continent. It will probably be here before the Michigan State Bee-Keepers' Association meets, and I will then "stand treat."

E. R. Root calls attention to Hasty's remark that Mr. Taylor drew conclusions favorable to foundation, and that the editor of the REVIEW argued in favor of starters, both using that big table as a basis. Beg pardon Bros., but Mr. Taylor called attention to the fact that those hived on starters "held their rate of gain decidedly better than those hived on comb or foundation." I then called attention to this fact and argued that if the harvest had continued a little longer, or had the test been commenced a little earlier, those on starters *might* have come out ahead. When Mr. Taylor sent in that report he accompanied it by a private note in which he said "There is a big argument in those figures for starters," and I did wonder a little that he did not enlarge a little more on this point in his summing up.

ADVERTISING, *good* advertising, in these times is almost half the battle. I have in mind a queen breeder who keeps his adv. running the whole year. Whenever I write to him for a few queens I always have to wait a long time before he can fill my order—so many orders ahead. But when I send

him a bill for adv. the money always comes back by return mail. I have in mind other men who send in an adv. in June, and stop it in August or September, saying it does not pay them. I am well satisfied that a man can commence *now* and so advertise that he will have a good trade next season in almost anything that bee-keepers need to buy. See what a trade Mr. Trego secured by getting out an attractive line of ads. last year. It's none too soon to begin advertising for next season's trade and the better the advertising the greater will be the trade. I feel perfectly free to talk in this way, if I do have advertising space to sell, because I know that what I say is *true*, besides, I "take my own medicine," as they say, and find that it does me good.

HOW CAN THE REVIEW BE IMPROVED ?

Some editors make just such a paper as suits themselves, foolishly imagining that what pleases them must of course please every one. Others edit their papers with the idea of receiving praise from their contemporaries; or they strive to "scoop" their competitors, to secure some feature that will overwhelm the other journals of that class. This is all right in itself, but such prominent features should be chosen mainly with a view to pleasing the majority of the readers. Some of us edit our journals too much from our own personal point of view, whereas we should try and edit them more from the standpoint of the public. The one question that an editor should put to himself, in deciding as to the availability of an article, is, will this please, interest or instruct the majority of my readers ?

Several times before have I been greatly benefitted by securing the advice and criticism of my readers in regard to the management of the REVIEW, and I should be glad to avail myself of it still farther. This is the time of the year when renewals will be sent in, and it will not be very much trouble to simply say in a few words what you think of the REVIEW, which feature, or writer pleases you best, which is of the least interest, and what new features you would like to have added, or what subjects you would be glad to see discussed. For instance, I am at present interested in photography, and frequent references to it are creeping into the REVIEW. Now, if these references are affording me more pleasure than they are my readers, they can't be dropped too quickly. But how

am I to know unless you tell me ? It's just the same with other things. I am trying most earnestly to edit the REVIEW from the reader's standpoint as well as from my own, and shall be most thankful for a little help. If you like the REVIEW, say so; if you don't, say so; but be sure and give the *why* in either case, as that is the most important point.

MICHIGAN STATE BEE-KEEPERS' CONVENTION.

The Michigan State Bee-Keepers' Association will hold its 28th annual meeting in the Common Council Chambers, at the City Hall, in Flint, on Tuesday and Wednesday, January 2d and 3rd. The room is nicely carpeted, furnished with chairs, desks and tables, well lighted, and away from the racket of the main street. There is a convenient room adjoining in which supplies and implements can be exhibited. The headquarters for bee-keepers will be at the Dayton House, a most excellent, clean, and well furnished, but home-like place, where rates to bee-keepers will be only \$1.00 per day. The time for holding the meeting is placed when in all probability there will be holiday rates on all railroads.

The following programme has been arranged :

FIRST DAY—MORNING SESSION.

10:00 a. m.—"Experimental Work at Experimental Stations," Hon. R. L. Taylor, Lapeer, Mich.

FIRST DAY—AFTERNOON SESSION.

1:30 p. m.—"Advantages of Northern Michigan for Honey Production," Hon. Geo. E. Hilton, Fremont, Mich.

3:00 p. m.—"The Future of the Supply Trade," M. H. Hunt, Bell Branch, Mich.

FIRST DAY—EVENING SESSION.

7:00 p. m.—"Advantages that Bee-Keepers may Expect from Bees and Honey Having been Shown at the World's Fair," H. D. Cutting, Tecumseh, Mich.

SECOND DAY—MORNING SESSION.

9:00 a. m.—"Moisture in the Bee Cellar; What it can do and What we can do," S. Cornell, Lindsay, Ont.

10:30 a. m.—"The Future of Bee-Keeping," James Heddon, Dowagiac, Mich.

SECOND DAY—AFTERNOON SESSION.

1:30 p. m.—"Preparing the Apiary for Winter," R. F. Holterman, Brantford, Ont.

3:00 p. m.—"Selling Honey Without Employing Commission Men," Byron Walker, Ewart, Mich.

It will be noticed that care has been taken not to crowd the programme, as the Secretary believes that a few topics thoroughly discussed are more profitable than a greater number but briefly touched upon. There is also time in which to discuss the little side

issues that are continually springing up.

The Association is invited to hold one session (say in the evening of the first day) at the home of the REVIEW, corner of Wood and Saginaw Streets, where there will be an opportunity to sample that delicious orange blossom honey from California, mentioned in another column.

W. Z. HUTCHINSON, Sec.

—○—
SUPERIOR STRAIN OF GOLDEN ITALIANS.

Mr. Ira Barber of De Kalb Junction, N. Y., has sent me a long letter in which he is very enthusiastic in his praise of some golden Italian stock that came from Mr. Chas. D. Duvall.

Last summer he had thirty colonies of this strain of bees in his yard with 120 other col-

comb to fill, which was not the case with the others. Mr. Barber had 5,000 pounds of comb honey, but says if all had done as well as his light colored bees he would have had three times as much. He has kept a large stock of bees for more than forty years, and he says that these are the first *perfect* bees he has ever had. Very truly he concludes that "The bees that will stick by the sections through hot and cold, through rain and shine, and work for all they are worth, are the bees that will gladden the heart of the honey producer."

Occasionally we see reports telling what miserably poor things are the light colored bees and how the darker bees will out-strip them at honey gathering. The truth probably is that there are both superior and inferior strains of bees in either variety.



THE HOME - APIARY OF JAMES HEDDON, DOWAGIAC, MICH.

onies of all the other different varieties of bees in this country, and the light colored bees outstripped all others. They are gentle, industrious, good comb builders, enter the sections readily and not inclined to swarm. Only one of these thirty colonies offered to swarm, and that was a case of superseding the queen, while from the other colonies came 86 swarms. Wet weather for three or four days did not stop these bright bees from comb building, they kept right on at work and when it cleared up they had

A VISIT TO MR. HEDDON'S.

As mentioned in the last REVIEW, I stopped on my way to Chicago and made Mr. Heddon a visit. We drove out nine miles to take a view of his Glenwood apiary. One of the fascinations of photography is that you are not always *sure* what you have got until you develop the plate. When we reached Glenwood it was about noon, and it was neither bright sunshine, nor exactly cloudy. It was "bright cloudy," but nearer bright sunshine than I judged it was and the result

was an over-exposed plate that produced a weak, "flat" negative unfit for printing a photograph suitable to use in making a half-tone.

We went over to his home apiary about four o'clock and I found it exactly as Rambler said it was when he visited it—very difficult to find a satisfactory point of view. The high board fence surmounted by barbed wire made it necessary to set the camera *inside* the apiary, and in this way only a

necessary. The floor of the house is of hard wood. The windows revolve upon central pivots at the top and bottoms. Outside of each window is a half circle of wire cloth in which the window revolves. By reversing a window all of the bees that may be on the inside are thrown out into the wire cloth addition where they find a hole at the top through which they can escape. I photographed the interior of the honey house, but I had had little experience in photographing



THE HOME OF JAMES HEDDON, DOWAGIAC, MICH.

part of the apiary and hives could be shown, but I selected such a position as would show the honey house and "fired away."

The hives are packed with sawdust in cases. Natural swarming with unclipped queens is allowed as is shown by the ladder leading up into the apple tree top.

The honey house is well-built with an excellent cellar under it. One end of the cellar is partitioned off and a stove is kept in this little ante-room. Around the inside of the stove pass three rings of inch, iron pipe which extends up through the floor and connects with a tank. Water is introduced into the pipe and the heat from the stove heats the water causing it to circulate through the tank above, melting any grannulated honey placed therein. All honey is liquified before shipment. The stove also furnishes heat for warming the cellar when

interiors, and I made the mistake of over-timing.

It was dusk when we reached the family residence, but the family gathered on the lawn and I took a "shot." Here I made the mistake that most photographers do when making exposures near the close of day—I under-timed. The next morning I had to take the train at seven o'clock. I waited as long in the morning as I dared and then made another exposure of the Heddon mansion with Mrs. Heddon sitting on the porch and Mr. Heddon upon his safety with one hand on the apple tree. From this picture I have had a half-tone made. Yes, Mr. Heddon and his two sons and his daughter-in-law (Will's wife) all ride safeties and are enthusiasts like all other bicyclists.

Mr. Heddon is editor of the *Dowagiac Times*, and largely interested in their elec-

tric light plant, hence, bee-keeping does not get the benefit of his undivided attention as it did years ago. In short, almost all of the work is done by his seventeen-year-old son, Charlie. Extracted honey is raised exclusively, and Mr. Heddon told me that he never raised honey more cheaply than he is doing it now. He tries to see with how little labor he can manage the business. In his circumstances he thinks that is the best way for him to do, but he admitted that he longed to be back at the work himself, doing the work in the very best possible manner instead of with a "lick and a brush."

In the evening when Messrs. Heddon, Burch, Hoshal and myself were talking of "feeding back" and feeding bees for winter late in the fall, it was mentioned that bees would take the food more quickly late in the season if it were put *under* the brood nest. Mr. Heddon then suggested the arrangement of his feeder so that it could be used for "feeding back" by being placed under the hive, the reservoir being at the back of the hive with a cover to be removed when the feeder needs filling, a passage way at one side allowing the flying bees to pass up from the regular entrance and gain access to the hive. I believe this idea is worthy of consideration, as the bees do certainly take the food more rapidly from below the hive, especially if the weather is a little cool.

Since the foregoing was written Mr. Heddon has sent in the article that appears in this issue, and in a private note accompanying it he says: "We have sold our electric light plant to the city, and I am going back to apiculture in old fashioned style; I am going into the old work both mentally and physically, heart and hand." I know that all will be rejoiced to know this.

SUPERIORITY OF GIVEN FOUNDATION.

It is very pleasant to know that bright, practical men seem to have a way of getting at the truth of things pretty closely without recourse to such elaborate processes as appear in this month's report from the Michigan Experimental Apiary. Messrs. Heddon, Taylor, E. J. Oatman, Dr. Mason, and some others have declared in favor not only of Given foundation, but of using quite heavy foundation of this make in sections. Their argument was that the press put the wax in the walls of the foundation, leaving it soft, because it was not subjected to pressure,

while the base was left very thin. In these experiments it will be seen that the lightest foundation, 13.75 to the foot gives a septum 73.3 ten thousands of an inch, while Given foundation of 9.37 pounds to the foot shows a septum of only 63 ten thousands of an inch, the thinnest septum of any in the test. Not only this, but foundation from the press gave the best results in the weight of honey produced. Years ago when foundation was discussed at conventions, the Given always came out ahead, and it has always been a puzzle to me why the manufacture of the press was dropped and why manufacturers did not offer Given foundation for sale. The only reason that ever came to my mind was that it seemed to me that it would be more work to make foundation on the press. I think now that if the right man should take up the making of the press, or the making of foundation on the press, success would follow. There are one or two points that I do not understand clearly, and that is why the press can make foundation with a thinner base, or, at least make such a base that the bees leave it thinner, than can be done with rollers, and why the side walls are left softer than with a mill. The columns of the REVIEW are open for the discussion of this foundation question, and contributions on either or any side will be more than welcome.

EXTRACTED.

Riding one Hobby too Long and too Hard.

"Nothing preserves men more in their wits,
Than giving of them leave to play by fits."
BUTLER.

Last June somebody was trying to induce Bro. Root of *Gleanings* to pay him a visit. After mentioning quite a string of allurements, he wound up by saying that he would borrow a swarm of bees. Mr. Root publishes his friend's letter and then replies to it under the head of "Holding too long to one set of Ideas." Here is what he said:—

"Brother G., you need not go to the trouble of borrowing that hive of bees: and perhaps I should say something just here that, in justice to our readers, I ought to have said long ago. An incident of our trip to California brings it to my mind. While traveling somewhere in the vicinity of the Rockies, all at once Prof. Cook remarked:

'Look here, Mr. Root; I want to ask you one question.'

Of course, I told him to ask any question he saw fit. Said he:

'You were once so full of the subject of bees that you could neither think nor talk much about anything else. Of late years, and especially within the last few days, it has seemed to me as if you rather avoided the subject than otherwise. What has brought it about?'

'I am glad to answer you. For many long years, as you say, I never tired of talking about and investigating and studying the honey-bee; and I used to think I should never get weary of that one subject. Finally, however, when my health began to fail, I discovered that I turned almost involuntarily to something else as a relief—a rest, or change; but when business, and a desire to help others who wanted to know, continued to hold me down to that subject, it began at times to be almost painful. I went into other things expecting and rather hoping that a little rest from that one subject would throw off this feeling. It has done so to some extent; but, to tell the truth, I have, at the present time, very little to do with the bees. The bee-keeper of our establishment is, at present, Ernest. Growing potatoes and draining land, riding the wheel, and even looking into the wonderful progress that has been made in your line of business, attracts me much more than bee culture. Sometimes I have felt sad about it; and then I have thought that, perhaps, there was a sort of providence in it; and I do believe that it is God's will that, while we look after our own industry, we should also avoid settling down into one narrow line of work too long at a time.'

After I explained to friend Cook as above, he astonished me by coming over to where I sat, and putting out his hand. When I looked up in surprise for an explanation he said something like this:

'Mr. Root, I rather suspected something of what you have told us; and I want to tell you that my experience is much like yours. I have felt as if I could not stand it unless I had some sort of relief from duties that have been wearing, month after month and year after year, on the same set of nerves, and in the same line of work.'

Perhaps he did not say it just as I have put it, but it was something in that line. It is true, there is such a thing as changing about from one thing to another before one has had time to accomplish anything anywhere; but there is also an opposite extreme to be avoided."

Several times since the foregoing appeared have I been tempted to publish it and comment upon it. Most of you know how strongly I have plead for specialty. Not one word that I have said would I recall. Those old saws about a "Jack at all trades" being "good for nothing at none," and when there are "Too many irons in the fire some are burned," are only too true. A man can never hope to attain the highest success unless he masters one subject, and to attempt the mastery of several means the mastery of

none. But when a man's thoughts flow constantly in one channel they are necessarily narrowed. A man should *sometimes* think of something besides his business. His business and himself will thereby be benefitted. After a dip into something foreign to his regular business, he returns to his post with a sort of enthusiasm for his work. As Dr. Miller remarked after reading the above, "If Mr. Root had not ridden the bee-keeping hobby so long and so hard when he first mounted it he might yet have been editor of *Gleanings*." Perhaps those were not his exact words, but they convey the idea that he meant to advance, viz., that Mr. Root wore out his enthusiasm for bee-keeping by too long continued efforts in that direction: if he had given his mind a rest by taking up something else to a certain extent he might now have had sufficient enthusiasm left for bee-keeping to be able to edit *Gleanings*. I think the Dr. is correct. We all know that Mr. Root has lately taken up gardening and is riding this hobby as furiously as he ever did bee-keeping.

In looking over my own life for the past twenty years I can see that while bee-keeping has been my business most of the time, that is, I have made it a specialty, I have at the same time tried different branches of it, and occasionally indulged in by-plays. When I was about fifteen I began to seriously consider the question of what I should do in life. I wished the question decided that I might be studying and working in the right direction. I had a great love for machinery and the life of a locomotive engineer seemed to me an ideal one. I progressed in this direction until I was able to "fire" and run an engine in a planing mill. Then the beauties of literature took possession of me and I began studying with fresh enthusiasm and teaching school. You may smile if you like, and I will not be offended, but in those days I thought I should like to become a writer. I did not know exactly what I should write about, but I had such an itching for writing that several stories and sketches were sent to different papers only to be returned, as I can now see very clearly they ought to have been. Then music took possession of my soul and I almost decided to make of it a profession. Next came bee-keeping, and twenty-one found me yet undecided. I know that I often felt ashamed of my vacillation; it seemed as though I ought to have sufficient decision to be able to make a choice. I re-

member most perfectly going out to the barn the spring after I was twenty-one and seating myself in a swing with a determination to "have it out." I sat there a long time. Most thoroughly did I go over my past life. I tried to decide which business would best fit my characteristics. I finally arose with the determination that I "would be a bee-keeper, and give my experience to the world." I presume this was a sort of compromise between bee-keeping and authorship, although I did not think so at the time. Had I only known at the time how literally and faithfully I should be able to carry out my decision I should have been much happier. I immediately began studying bee-keeping as I had never done before. Although it was four years later before I actually began the business I think I started in with as thorough a knowledge of my profession as is possessed by most physicians of theirs when they first begin practicing.

During the first year of bee-keeping I decided that I would make a specialty of queen rearing. That fall the twins came. They were very restless and wakeful nights, and you may smile again if you like, but I took a great deal of comfort the following winter when rocking and singing a baby to sleep by the fireside in the "wee sma' hours" of the night and thinking at the same time how I was going to rear queens the following summer. I studied out how I should make a lamp nursery and arrange compartments to prevent the young queens from killing one another when they hatched, how I should arrange my nuclei, how make the cages, yes, even how I should word my advertisements. The work proved fully as enjoyable as I had anticipated. It was such a pleasure to see the plump cells with their rough, corrugated surfaces, to see the bright yellow queens bite their way out to light and liberty, to give them to the bees, and then a few days later to find them plump and laying. Then to make neat cages of the white basswood, catch and cage the bees, put the stamps of different colors upon the cages of different sizes, pack them into a basket and then take a stroll of two miles to the post office going through lanes and woods-roads, stopping on the way home and filling the basket with berries—all this made a happy existence.

Then my brother came to work with me and more bees were bought and the raising of comb honey became the order of the day. Queen rearing was not dropped, but a new

enthusiasm, that of learning how to work to the best advantage in securing tons of honey in those beautiful white sections, had taken possession of me.

In those days my spare moments and the leisure of winter days were employed in writing bee-keeping articles for the bee journals and for the agricultural papers. This proved a pleasant and profitable change from the more arduous labors of the summer.

From such experiences as these sprang the desire to have a journal of my own. Then came the pleasure of anticipation and preparation, lasting two or three years. Next came the realization, and, as I have before stated, no part of my life has been more enjoyable than that spent in publishing the REVIEW. There was one pleasure that I had not counted upon, and that is the mechanical part of making the REVIEW, the studying to make it neat typographically—how I have enjoyed the putting together of types, borders, ornaments, and rules, the selection of the paper and ink and the securing of engravings, etc., etc. But, notwithstanding I love the REVIEW and most thoroughly enjoy the making of it, I must admit that it is not only a relief to sometimes turn my thoughts into other channels, but I actually do better work when my thoughts are again put into their regular harness.

Perhaps some of you may know that photography is my latest hobby. I am now deriving as much pleasure from the perusal of books and journals devoted to photography as I did years ago in my first study of apiculture. This branch of picture making was taken up with no thought of its proving profitable in a money point of view, but it is turning out to be a very profitable investment in a way that I did not expect. For instance, I had often felt that I should enjoy writing a series of articles on trapping mink, muskrat, foxes and the like, showing by illustrations exactly how the traps should be made and set. Lack of skill in drawing had prevented me. As soon as I had learned to use the camera I took a trap, an axe, the camera and a lunch basket, and with one of my daughters for company and to help carry the things, went up the river two miles one morning in August, and in the woods I set some traps, deadfalls, and snares for partridges, exactly as I did when a boy, and then photographed them. I came home in the afternoon awfully tired, but oh, how rested!

What a pleasure it was to me to write the articles. It was upon a new subject and carried me back so completely to my boyhood's days when I tramped the banks of the dear old Buttercut creek with a pack of traps on my back. The articles were sent to the *American Agriculturist* and the first one appeared in the November issue. My next effort in this direction was a bee hunting article, telling how to hunt wild bees and was sent to the *Youths' Companion*. It has been accepted but is not yet published. To illustrate this I made a bee box, and filled it with comb that was nearly white, then with a printer's roller I rolled some printer's ink upon the mouths of the cells, thus blacking them, and you have no idea how clearly the net work of cells showed in the picture. I also put a little honey in the cells and carried some bees with me in a cage to where I was to take the picture and placed them upon the comb, and while they were "filling up" I "pressed the button" as the advertisements say. I spent at least half a day finding exactly the spot that suited me for taking the photograph, and finally found just what I wanted, where there were stumps and brush, and a barn in the distance, with the river to one side in the background, and a tall stump in the foreground upon which to set the bee box. I then hunted up a good looking young man to go with me and lie down on the ground just back of the stump and pretend that he was watching the bees in the box to see them take wing and then "line" them. My visit to the skunk farm as mentioned in the last REVIEW has been written up and sent with the photos to the *Am. Agriculturist*, and been accepted. I have lately been to Saginaw and photographed all of the processes of salt making from getting the brine from the earth, to the finished salt piled up in cords and cords of barrels ready for market. One of my girls lately said: "Papa is just crazy to go somewhere and take a photograph and then write a story around it," and she has expressed it exactly. Now, while this enthusiasm will be at its height, say, next summer, I propose to visit the principle bee-keepers of the Northern States and Canada, taking my camera with me and photographing these bee-keepers, their families, residences, apiaries, and whatever of interest I may come across, have cuts made from the photographs, "write stories around them," and then put all into the REVIEW.

A Condensed View of Current Bee Writings.

E. E. HASTY.

SO inquisitive has modern apiculture become that it is even inquiring after the drones' brains. Of course the querist does not intend to fill vacancies with them, but only to increase the general fund of knowledge. In creatures that have the brain and intelligence mainly limited to the head, cutting the head off leaves the body a helpless lump. On the other hand some creatures of a low down sort have the brain matter so diffused that they may be cut in pieces and the pieces will set up in life for themselves. T. R. Bellamy, *A. B. J.*, 534, reports concerning the drone as follows:

"Once I beheaded a drone, and in 24 hours afterward I saw him standing on his feet. I turned him over on his back, and he would turn right over and stand on his legs again."

Consider once how much this implies—control of nerves and muscles, sense of direction, and so much of thoughtfulness, if that is the proper word, that the slight discomfort of being wrong side up was noticed and acted on. Well, late in the season as it was, I had some drones at one colony, and I went for their heads. Alack! none of mine could stand up after decapitation, much less turn over when put on their backs. After some five hours, being kept warm meanwhile, two out of four could feebly move the legs a little. All were stiff and still next morning. Wonder if friend B.'s guillotine did not bungle its job—cut off, or tear off, most of the *bulk* of the head while leaving most of the brain attached to the trunk. Doubtless he is right as to the great vitality of drone brood. He has often had them survive three days of starvation and cold down cellar, and has reports of survival after six days of it.

I have a vitality yarn to tell also, only it is of a worker bee. On the 15th of October I opened a big can of honey which was closed and brought into the house eight days before. A bee inside, completely plunged in honey, was still struggling, poor fellow.

AMERICAN BEE-KEEPER.

This journal seems not to require any special remark since last time, and we can proceed at once to a "simmer" of the original articles in the November number.

"Wintering Bees." T. W. Wilcox. Chaff in packing box 18x24x21. Boxes stored in a house during summer. His boxes seem to have bottoms to them; and the tip-top idea for tidiness in spring lies in storing the chaff over right in the boxes.

"Wintering Bees." T. B. Darlington. Enamel cloth covering sealed on tight—yet with a two-inch ventilating hole in the middle. Blocks above make a tiny chamber over this hole, and many thicknesses of coarse cloth over the blocks prevent upward ventilation being too lively. Did use some packing cases, but those not cased did fully as well. Small entrance below thought best when there is upward ventilation.

"Progress in Bee-Keeping." C. J. Robinson. This is a running comment on some of the inventions and many of the names of apicultural history. Some of the assertions sprinkled in are noteworthy, and perhaps liable to be contradicted, as—

"Bees have no respect of persons * * are incapable of education and learn nothing."

Considering how quickly they learn to follow the apiarist around to his annoyance while working, the latter assertion seems rather thin.

The copied articles are Doolittle's on little wooden boxes for candied honey, from *A. B. J. Pettit's* on Wintering from the *Canadian*, Wide Entrances and Robbing, from the *British Bee Journal*, and Lovesy's talk about the ants of Utah, from *A. B. J.*

For the coming year more editorial attention is promised.

SUCCESS IN BEE CULTURE.

This takes the place of the *Enterprise* which the postal department stamped out. If it would rile up friend Sage to put as much more improvement on it, we might almost hope that our venerable Uncle S. would stamp it out again. Hereby hangs a story. The teamsters of Maine, my native state, have (or used to have) a peculiar way of driving oxen, not understood in the rest of Yankeedom. For instance I am not going to tell you what they mean when they say "Hoosh!" Ask my grandfather's oxen. Well, a Yankee from some other state saw, and heard, and reported at home how the Maine teamsters hollered, whoa, when they wanted an ox to pull his utmost. It was a mighty whoa; and the verbatim report of it can be dispensed with as a trifle too near the profane. The stranger's ears were truer than his eyes. He failed to see that during

the thunderous whoas the teamster was pricking his oxen with a brad. Make a pin-cushion of an ox, and compel him to stand still the while, and he will pull when you give him permission. It strikes me the untoward happenings have been hollering whoa pretty loud to friend Sage and his publishing *Enterprise*—at any rate he pulls this time like the oxen of the State of Maine.

"Success" commences with one of R. C. Aikin's best articles. The topic is the use of foundation; and he sums it up with—

"First, use foundation to save the honey from going to waste while getting ready to secrete wax. And second, using starters to save the wax while getting secretion stopped."

Next comes the humorist Uncle Cass, who seems to open out fully up front, if not a trifle in advance of all the other apicultural funny men. This is the way he pokes it at Demaree about the corrugations on a queen cell.

"It was done by the "guards," presumably coming to an "order arms" and denting the soft material with the butt of their muskets."

The next article is the first of a series intended to extract and bring forward for the profit of present readers the most valuable things in the bee papers of many years ago. This scheme is a bright idea of friend Sage's. The title is Mousings Among the Early Bee Papers. The authorship is anonymous—or as is quaintly expressed, "by Ann on a mouse." If Ann and her mouse mouse as they "mout" their mousings may rescue from oblivion some valuable things.

Then we have a right-square-from-experience article on the Home Market of Honey by P. H. Hemingway. Over beyond the editorial notes we have a noble page of advice to *Success* by friend Rumford of Los Gatos, California. In the course of this it is suggested that a bit of *cheese* will cure or prevent the colic which so often results from eating honey—Worth keeping before the people if it is a fact. And the copied articles are also very wisely chosen, as we might surmise in advance.

Now "scoot," baby *Success!* And don't come round this shanty again for a third "obituary" on your birth.

THE GENERAL ROUND UP.

"We never could get yellow bees of any race to rear those large, well developed queens so much desired and admired by all bee-keepers." Alley, in *Nov. Api.*, 150.

This from a breeder of such long experience is quite a big concession to the Germans.

As to second swarming he makes this surprising assertion :

"The fact is there is no queen in the hive except those in the cells, till the moment the swarm issues." *Api.*, 153.

This may be sometimes the case ; but it would require considerable proving to convince me that it is always, or even usually the fact. In red hot swarm-fever times it may be ; and that may be the reason why, in such times, so many second swarms go back once before making a go of it—swarm all out before any queen is fairly on deck ; and when one gets out she sees no procession to join, and just stays till next day's effort. But this concession in its very nature rather presupposes that ordinary seconds do have one queen out to start with.

Ernest Root's gentle robbing to stop objectionable robbing gets a counterblast (*Api.* 155) by being put among the Absurdities. My experience this fall, while taking off honey very late, is against it—keeps them forever on the "snoop," during weather so cold that they would be all in their hives if not baited out.

A new chemical 200 times sweeter than sugar is announced. *Api.*, 159. Must be extract of honey-moon. Not much prospect of benefit to our vocation, I think. Mere impression on the nerves of taste is not nutrition—fails to serve the purpose when the internal provision basket "is like a lamb that bleats." May sweeten up the rogue's glucosed honey, but will hardly winter bees. But friend Alley is going to see all about it and report. For this he should have our thanks,—and here's a spank ready for the first one who accuses him of tumbling into that new department of his.

"There is no such thing as a 'contented hum' in the cellar; the very reverse is the matter of fact. * * * Something is wrong. * * * nearly every time foul air." S. T. Pettit in *Canadian*, 60.

I strongly suspect that this is the level truth, and the very wide prevalence of the opposite opinion makes the decision of the thing a matter of great importance.

The *Canadian* is the first to give an extended report of the Chicago convention.

Whoever wishes to be posted on the vital elements of the wintering problem should dip deep into Elwood's articles in last REVIEW. Keep them, and read them more times by and by. And perhaps friend Corneil's article had better be added. And those camera views of the Chicago honey exhibits are

very nice—and make the REVIEW look like a 19th century journal.

Of't we keep a little fib
Painted on our (f)lying jib

But it isn't moral to do so. The fib I am thinking of is the well worn one that candying is proof of the genuineness of honey. Ernest Root (*Gleanings*, 794) gives the results of experiment in the matter which show that it takes *seventy-five per cent.* of glucose to entirely prevent candying. An expert could tell the difference between the granules from impure and those from pure honey ; but that goes for nothing, as retail buyers (to whom the fib is told) are not experts.

Listen to the story T. K. Duke tells about the Florida pinkvine. (*Gleanings*, 785.) Perfect sea of pink blossoms more than six months ; and twenty-seven bees visited *one blossom* in five minutes, the average of several observations being over five bees a minute. But, no, we won't go out nights to sow it round to bother people.

After introducing a laying queen to a fertile worker colony H. C. Quirin, (*Gleanings*, 783) found the following state of things—

"Drone brood was scattered miscellaneously over the combs in the ratio of one-third drone to two-thirds worker."

Other facts also showed that (in this case) fertile workers were on deck all the while. If we are ever to have an effective method of dealing with the fertile worker nuisance we need all the facts ; and this seems to be a new one.

For posts on which groups of hives are to be set to keep down ants, paint a belt around them—three coats tar topped with a coat in which a little lead is rubbed into equal parts tar, axle grease and lard. (Lovesy in *A. B. J.*) Said to be better than legs in cans of crude petroleum ; but needs renewing occasionally.

Several hundred acres of cucumbers in reach of Dr. Miller failed to make him honey happy this fall. (*Gleanings*, 806.) This shows that not only all signs but all plants may fail in a dry time.

Camera pictures are a ceaseless delight to me. To look direct on English workmen in their own native "stamping grounds," as we may in *Gleanings*, 809 and 810, is very interesting ; and the general look of goodness and honest worth on the faces is reassuring in these times of anarchy and labor troubles. I would like it if the skep makers looked a little less like slaves.

It seems the Carniolans paint every front with a rude daub of something holy, emblematic, historic or comic. Very likely that is what we see in the center of fig. 6. *Gleanings*, 775.

Two nuclei were made to test the eating habits of drone and worker bees. The first had 1,000 workers, the second 1,000 workers and 1,000 drones with them. Confined 12 days in Aug. the first ate 2 ozs. and the second 8½. (Translation from Berlepsch, *A. B. J.*, 439.) This seems to bring in our ease loving friend the drone guilty of eating 3½ times as much as a worker. Reasonable doubt, gentlemen of the jury. 'Spects the second nucleus worried at the unnatural state of things, consumed an abnormal amount, and that the workers took their share of it. The others did not worry, both because they were fewer and cooler, and because they were not annoyed by an unnatural ratio of males.

And so the lady of the section-house talked friend Dayton down that the honey was a little sour. (Extracted too soon.) Would that she might talk the rest of the fraternity down to that. See *A. B. J.*, 497.

Whoa, ponies! dear editorial ponies, don't get to kicking about the question of a State experimenter's right to sell reports. That is one of the amazingly few things which

had better not be agitated. Suppose it turns out that he strictly has no right, for either love, money or patriotism, to give out any report at all, except once a year rigidly *pro forma*?

"Extra large and light colored drones—almost a sure test of impurity." E. Gallup in *A. B. J.*, 499.

"If one of my lighter queens mates with a drone having an eighth part of black blood her progeny will no longer be pure; yet I am unable to detect the difference. Chas. Dadant. *A. B. J.*, 500.

"In this progressive day and age thou shalt not rely upon 'the wise men of the East' too much." (Western bee-keeper Rockenbach in the *Progressive*.)

Mrs. Atchley's plan of packing bees for railroading by alternating combs and empty frames and then wedging all tight is very simple and practical; and—

"Whenever they begin to get too hot you can tell it by the odor. To reduce the temperature quickly I throw water all over the ear, hives and all." *A. B. J.*, 527.

Humble pie at last. How we sometimes recount little things and let the big ones slip! I reviewed the *REVIEW*'s growth last time and didn't say a word about the new department of station reports. Looks as if a dunce-block would have to be purchased for me to sit on occasionally.

RICHARDS, Lucas Co., Ohio, Nov, 12, '93.

General Index to Volume VI.

INDEX TO SUBJECTS.

Absorbing Cushions	179	Bees Versus Manipulation	263
Abundant Stores Necessary in the Spring	127	Bee Escape, the Influence by which Bees are Actuated When Passing Through a	107
A Condensed View of Current Bee Writings	17	Bee Escapes no Help in Running Out Apiaries for Extracted Honey	169
47, 71, 110, 146, 184, 214, 241, 269, 327.		Bee Escapes Ought to Have Greater Capacity, Why	92
Adjusting Section Cases and Tying up	164	Bee Paralysis Inherent in the Queen	235
Adulteration of Honey	18	Bee Diarrhoea its Cause and Prevention	263, 314
After-Swarming Prevented by the use of Bee-Escapes	74	Bee Journals and the Supply Business	143
After-Swarming, Prevention of	102	Bee-Keeping for Profit	139
Air Blast in Smokers From Multiple Tubes	9	Bee-keepers' Union	19, 73
Alsike Clover	206	Bee-keepers' Guide	40
American Bee Journal	13, 105	Birds of Michigan	234
Apiculturist	102, 262	Black Bees Enable us to Dispense With Escapes	234
Apiculture in College and Station	310	Brace Combs Prevented by Wide Top Bars	204
Appreciative Words for Gleanings and the Review	230	Breeding, Practical	261
Arrangement of Hives in the Cellar	293	Burr Combs and Hoffman Frames	36
Artificial Watering Place After Nature's Ways, An	141	California, Winter Losses of Bees in	170
Atchley, Jennie	262	California Bee-Keeping, Some Phases of	94
Atchley's Apiary, Mrs.	206	California Bee Keeping in Olden Times	230
Automatic, Reversible Extractor,	105, 136		
Bankston, C. B.	317		

California Bee-Keepers Might Secure a Better Price for their Honey, How 134
 California Need Never be a Failure, With Energy and Right Management Bee-keeping in 227
 California Convention, Prominent Points Caught in 66
 California Bee-Keeping, Some of the Needs and Necessities of 6
 Canada's Foul Brood Inspector 236
 Canadian Bee Journal 234, 262, 317
 Carrying Them Out in the Spring, How to Make Bees Stay in Their Hives when 106
 Cartons, Paper 206
 Cellar, Beware of Poor Food and the Cold Damp 290
 Cellar Wintering 1
 Cheap Queens 40
 Chicago, the Grip to 321
 Civilization Versus Apiculture 21
 Combs, The Most Profitable Use of Empty 183
 Conditions Under which Bees Gather the Most Honey 74, 109
 Combined House Apiary and Self-Hiver and a Combined Hive and Self-Hiver 171
 Contraction of the Brood Nest 163
 Covers on Hives, Successful Wintering of Bees in the Cellar with no 129
 Correspondence, be Prompt in your 237
 Crane and Bingham Smokers 14
 DeWitt, M. H 318
 Diversity of Southern Bee-Keeping 10
 Digested Nectar 11
 Diarrhoea, the Cause of Bee 294
 Diarrhoea a Disease, is 289
 Dibblee Bee Escape 102
 Double Bellows that will Throw a Continuous Stream 37
 Drones and Their Trysting Places, Frolicking 231
 Dysentery, Bee 284
 Dysentery by the Use of Sugar Stores, Preventing Bee 295
 Dysentery, Warmth Dryness and Wholesome Food will Prevent 287
 Early Swarming is Advantageous 128
 Editor of the Progressive 103
 Editorials are Never Paid for 235
 Enterprise, the 139, 180, 233, 294
 Enterprise and its Editor, the Bee-Keepers' Escapes that Turn Bees into the Open Air 180
 Escapes that Turn Bees into the Open Air 228
 Escapes, Large Exits and Those Opening Outside no Advantage in bee 255
 Extractor Really Worth the Effort Being Expended in its Invention, Is an Automatic Reversible 166
 Extractors and Extracting 104
 Extractors, Vital Points in the Construction of 136
 Extracting and Using Bee Escapes 204
 Extracting Pleasant and Agreeable, Conveniences and Arrangements Needed to Make 165
 Experiment Stations 11, 262
 Experiment Stations, why Bee-Keeping is Neglected at the 240
 Experiment Stations may do for Bee-Keepers, what 265
 Experimental Apiary for Vermont 258
 Experimental Apiculture 208, 235
 Experimental Apiary, Congratulations for the 231
 Experimental Apiary, Michigan's 181
 Experiments, Costly 231
 Experiments Needed with Heat and Ventilation 259
 Experiments in Apiculture at the Mich. Ag'l College 239
 Fads and Fancies 232
 Feeder, a Novel and Inexpensive 141
 Feeding Bees in the Spring 91
 Feeding Bees for Winter 292
 Feeding Back, an Experiment in 308
 Forestville Apiary, Experiences and Views at the 256

Foul Brood, What to do with 263
 Foul Brood Generating From Dead Brood 233
 Foul Brood, Dead Brood that is not 234
 Foundation for Comb Honey 211
 Foundation Fastener, Taylor's 64
 Foundation Profitable in the Brood Chamber, is Comb 211, 257, 9
 Golden Italians 233
 Glue for Fastening Foundation 233
 Glucose Barrels for Shipping Honey 233
 Gleanings 179, 317
 Grading Honey 18, 41, 317
 Guide, Bee-Keepers' 206
 Hasty, E. E. 13
 Handling Bees in Winter 11
 Hoffman Frames and Burr Combs 36
 House Apiaries 11, 38
 House Apiary, Great Success with the 256
 House Apiary in the World, the Largest 99
 House Apiary, Barnett Taylor's Latest 21
 Honey Analyses 238
 Honey Consumed by Bees in Winter, Amount of 103
 Introducing Queens by the Hatching Brood Method 182
 Individual Checks—They are Expensive to the Receiver 277
 Incorporation of the North American 20
 "K. D." Hive and Super and its Advantages 7
 "K. D." Hive, More about the 39
 Kretschmer, E. 233
 Langdon Non-Swarmer Differs From the Taylor, Where the 296
 Langdon Non-Swarmer, Some Criticisms on the Experiments with the 291
 Langdon's Non-Swarming Device 145, 206, 212, 225, 233, 262, 291, 296.
 Langdon's House Apiary 99
 Leather for Smokers 233
 Loose Bottom Boards 207, 233
 Michigan's Experimental Apiary, Work at 225, 252, 281, 309.
 Michigan Experimental Apiary, A Visit to the 209
 Modern Bee Farm, A 140
 Moisture is Injurious in Wintering Bees, why Multiple Tubes do not Increase the Blast of a Smoker, Some Experiments and Arguments Showing that 101
 Multiple Tubes Assist in the Ventilation of Rooms, Cellars and Mines, how 71
 Non-Swarming Plans 177
 Non-Swarming Idea, Another Novel 267
 Oil Stoves for Heating Bee Cellars 41
 Old Bee Books 206
 Opportunity for California Bee-Keepers, the Present 94
 Opportunity 265
 Out Apiaries 11
 Pacific Coast, There is a Lack of Queen Breeders on the 203
 Pacific Coast, its Magnitude and Honey Pasturage 35
 Photography, Interested in 236
 Porter Bee Escape, the Superiority of the 47
 Porter Escape Lacks Capacity Experiments Have not Proved it, If the 138
 Porter, the Hastings Bee Escape an Infringement on the 317
 Postage on Queens 262
 Pratt Self-Hiver 67, 212, 253
 Pratt Self-Hiver, A few Words in Defense of the 96
 Pratt Self-Hiver a Success in the Hands of E. R. Root 74
 Protecting Bees in the Spring 92
 Progressive Bee-keeper 13, 103, 139, 133
 Prevention of Swarming 139
 Preventing Swarming, Criticisms on B. Taylor's Method of 135
 Preventing Swarming by Working the Bees of two Queens in one set of Supers 71
 Pulled Queens 233
 Queen Traps Versus Self-Hivers, Some Strong Arguments in Favor of 97

Queen-Trap Versus the Self-Hiver 95
 Queen Excluders, 36
 Queens, Dark 317
 Queens are lost in Queen Rearing, how . . . 143
 Queries and Replies 262
 Residue, or "Slugum," how to get the wax out of 20
 Removing Honey from the Hive 199
 Reversing Combs on their Centers 167
 Reversible Extractors 168
 Rise and Fall of a Bee Hive 94
 Robbers, how Annoyance from them may be Avoided 262
 Robbing Propensity of Bees may be Used to Advantage, how the 212
 Robbing may be Stopped, how 128
 Scraps From Visiting Letters 38
 Selling Glass at the Prie of Honey 41
 Section Leveler 98
 Sections, Scraping 263
 Sections, Advantages of Shallow 23
 Secor, Eugene 233
 Sealed Covers 102
 Self-Hivers 103, 267
 Self-Hivers are too Costly and Cause too Much Labor, Loss and Risk 70
 Self Hivers, a Defense of 95
 Self-Hivers, Latest Improvements in 76
 Self-Hivers Versus Queen-Traps 70
 Self-Hiver, Pratt's 67
 Self-Hiver, the Evolution of the 42
 Self-Hiver Discourages Swarming by Killing off Drones 69
 Simmins System of Introducing Queens not Always Successful 207
 Smoker Construction, Some Novel Hints on . . 36
 Smoker Experiments 174
 Smokers, Experiments to Test the Blast of . . 131
 Smokers, Testing 36
 Smoke from Propolis, Effectiveness of 141
 Somnambulist and the Apiculturist 238
 Southern Bee-Keeping, Diversity of 10
 Solar Wax Extractor and how to use it 20
 Some of the Things I Wouldn't do 182
 Somers, G. T. 13
 Specialty, Bee-Keeping is Drifting into 6
 Stung a Great Number of Times, What to do When 212
 Starters may be the Most Profitable 294
 Sugar-Honey Discussion has Gone far Enough at Present 14
 Swarm, Old Bees do not Locate the Hive When they 206
 Swarms do not Always Return to their own Hives, why 235
 Swarming and its Management 164
 Supers, Removing 234
 Taylor's Foundation Fastener 64
 Tearing Combs, Bees 233
 Three Colonies in one set of Supers and preventing Swarming, Working 201
 "Timely Topics" 33, 63, 91, 126, 163, 199, 226, 254
 Transferring and Getting the Honey out of the Old Combs, an Easy Method of 142
 Uncapping Machines 179
 Uncapping Machines are Needed More than Automatically, Reversible Extractors 166
 Unfinished Sections 73
 Uncertain Behavior of Great Masses of Bees . 228
 Van Deusen, C. C. 317
 Ventilation 259, 318, 324
 Ventilation and its Importance, Top 39
 Ventilation Plays so Important a Part in the Wintering of Bees, why 312
 Ventilation of Bee Cellars 324
 Washington Trip and Something about the Convention 15
 Wax Extractor, a Mammoth Solar and Furnace-Heat 200
 Wax in Comb Honey is not Injurious or Unwholesome 107
 Weak Colonies in the Spring, Strengthening . 106
 Wells System, the 74
 Why Younger Bees Cling to Their Hive Even if it is Moved 45
 What is Honey? 40

Wiring, why Frames need 16
 Winter, Getting the Bees Ready for 206
 Winter, Preparation of Bees for 254
 Wintering Bees Under the Snow a Failure . . 45
 Wooden Queen Excluders that are a Success . 41
 World's Fair, Bees at the 23
 World's Fair, Bees and Honey at the 173
 World's Fair, The Bee and Honey Show at the 318

Index to Correspondents.

Aikin, R. C. 7, 20, 39, 92, 107, 200, 225, 285, 312
 Alley, H. 182
 Atchley, Mrs. Jennie 143
 Barber, C. J. 69
 Benton, Frank 38
 Cornil, S. 9, 131, 311
 Comstock, F. S. 141
 Cook, A. J. 298, 290, 310
 Crane, J. E. 174
 Daggitt, E. A. 37, 136, 167
 Dayton, C. W. 171, 201, 259
 Dibbern, C. H. 95
 Doolittle, G. M. 45, 106, 289
 Elwood, P. H. 324
 France, E. 168
 Frazier, W. C. 6
 Getaz, Adrian 267
 Goldsborough, A. T. 141
 Green, J. A. 11, 183
 Gravenhorst, C. J. H. 75, 106, 109
 Hasbrouck, J. H. 107
 Hawley, H. M. 107
 Hasty, E. E. 21, 47, 77, 110, 146, 184, 215, 241, 269, 297, 327.
 Hewes, W. G. 46, 227
 Heddon, James 231, 261, 284, 295
 Hill A. G. 23, 212
 Jaques, E. R. 256
 Johnson, Lowry 101
 Larrabee, J. H. 239
 Langdon, H. P. 99, 135
 Manum, A. E. 141
 Martin, J. H. 5
 McNay, Frank 165
 Miller, C. C. 36, 166, 182, 212, 240
 Murray, C. H. 71
 Porter, R. & E. C. 138, 255
 Ponder, Walter S. 232
 Pringle, Allen 173
 Pratt, E. L. 67, 76, 96
 Pryal W. A. 231
 Rauehfuss, Frank 291
 " Rambler " 35, 66, 94, 134, 170, 203
 Root, E. R. 74, 105
 Rumford, Isaac 230
 Shuck, S. A. 47
 Sill, Prof. 265
 Taylor, B. 38, 45, 71, 98, 108, 129, 177, 258, 287, 296
 Taylor, R. L. 33, 63, 70, 91, 97, 127, 163, 199, 225, 226, 253, 254, 265, 281, 292, 304.
 Trego, S. F. 9
 Weller, Geo. R. 201

Illustrations.

Apiary of B. Taylor 236
 Canadian Honey Exhibit at the World's Fair . 320
 Comb Leveler, Taylor's 98
 Extractor, Daggitt's Automatic Reversible . . 105
 Foundation Fastener, Taylor's 64
 Heddon's Residence 349
 Heddon's Home Apiary 350
 House Apiary of B. Taylor 257
 House Apiary, Taylor's Latest 108
 Iowa Honey Exhibit at the World's Fair . . . 321
 Mich. Honey Exhibit at the World's Fair . . . 319
 Langdon's Non-Swarmer 144
 Michigan's Experimental Apiary 210
 New York Honey Exhibit at the World's Fair . 319
 Self-Hiver, Pratt 44, 76
 Self-Hiver, Dibbern 43
 Smoker, Daggitt Double-Bellows 37
 Solar Wax Extractor, Aikin's 201



DR. A. B. MASON,
Atburndale, Ohio.



F. A. GENMILL,
Stratford, Ont.



THE EDITOR,
Flint, Mich.



H. P. LANGDON,
East Constable, N. Y.



G. M. DOOLITTLE,
Borodino, N. Y.

Men Who Make the Review.

THE success and usefulness of a periodical are largely dependent upon the men chosen by the editor as correspondents, hence it is worth while to notice who are the REVIEW-correspondents and how they were secured.

During the past sixteen years the editor of the REVIEW has attended nearly every bee-keepers' convention of a national character; has visited scores and scores of bee-keepers in their own homes; and received and answered thousands upon thousands of letters; in short, he has enjoyed, and still enjoys, a personal acquaintance with most of the leading bee-keepers of the country. When he wishes for information upon some special topic he knows *exactly* where to find it. He knows who is posted on this point, who on that—who rides this hobby, who that—and this wide acquaintance has enabled him to choose, as his principal correspondents, successful, practical men, most of whom have numbered their colonies by the hundred and sent honey to market by the ton, and who can write, from experience, articles containing information of real benefit to honey producers.



A. G. HILL,
Kendallville, Ind.



J. A. GOLDEN,
Reinersville, Ohio.



T. F. BINGHAM,
Abronia, Mich.



J. E. CRANE,
Middlebury, Vt.



B. TAYLOR,
Forestville, Minn.



S. CORNEIL,
Lindsay, Ont.



GEO. E. HILTON,
Fremont, Mich.

The Platform on Which the Review was Built.



In order that new subscribers, and those receiving samples, may more thoroughly understand the character of the REVIEW, and the plan upon which it is conducted, the following introduction, which appeared in the first number, is republished :

INTRODUCTORY.

As indicated by its name, one of the distinctive features of the REVIEW will be that of reviewing current, apicultural literature. Errors and fallacious ideas will be faithfully but courteously and kindly pointed out, while nothing valuable will be allowed to pass unnoticed. But few articles will be copied entire, but the ideas will be extracted, given in the fewest words possible, and commented upon when thought advisable.

Another feature will be that of making each issue what might be termed a "special number:" that is, the extracts, correspondence and editorials of any number will nearly all have a bearing upon some special subject. We shall gather together, from every available source, the best that is known upon any given subject: put it into the best shape, and publish it in a single number. In other words, each number will be, to a certain extent, a little pamphlet containing, in the fewest words possible, the best that is known upon some given topic.

Our own apiary will, hereafter, be largely experimental, and of this our readers will have the benefit.

We shall endeavor to advance bee-culture by increasing the prosperity of existing bee-keepers, rather than by adding to their numbers.

Instead of devoting space to "hints to beginners," we shall turn our attention to

the solution of the unsolved problems advanced bee-culture.

While we shall eagerly welcome valuable truths and ideas from any and every source, we shall do our utmost to secure as correspondents practical and successful bee-keepers who will be able to write, from experience, such articles as will help the man who is trying to get his bread and butter by raising honey to spread upon the bread and butter of others.

In short, we shall try to make a journal that will be brimful and overflowing with ideas that are especially valuable to honey producers: and having now introduced the REVIEW, and given a brief outline of its proposed character, we will allow it to speak for itself.

Another short editorial, that appeared in No. 1, may also shed some light upon the character of the REVIEW. It reads as follows :

PRICE OF THE REVIEW.

As the REVIEW will be run independent of supplies, it is evident that the price must be such that there will be a profit in its publication: but we will guarantee that it shall be practical; that its articles shall be the result of bright brains and brown hands: that many of them will "first see light" among the hives—be written, perhaps, upon hive covers, and with fingers to which the pencil sticks—that it will come fresh with the odor of the apiary upon it: and it will always depend for support, not on puffery, "premiums," and a starvation price, but on an intelligent, popular appreciation of a good thing.

The Review for 1894.

Special Topics.

If there is any one thing more than another that has made the REVIEW what it is, it is its discussion of "Special Topics;" the gathering together in one number of the best that is known, of the latest views of the best men upon some special topic. Like a lens, the REVIEW brings together the lines of thought, and so illustrates the subject that it can be clearly seen and understood. While many of the most important subjects have been thus discussed, new ones are continually coming up, and some new discovery often puts an old idea in a new light, hence the REVIEW will always find a fruitful field in the discussion of special topics.

One Journal.

In the main, the contents of our bee-journals are made up of original matter. From the very nature of the case, the value of this matter greatly varies. Many bee-keepers cannot afford to take more than one journal, neither have they the time to read all of the journals, and to be able to find all the most valuable matter of all the journals brought together, condensed, reviewed and criticised, is a blessing to the busy man, and to the one who "can afford only one journal." To thus furnish the cream of the other journals is the province of the REVIEW.

Travels Among Bee-Keepers.

To make the best possible bee journal an editor ought not to sit in his office from one year's end to the other. He ought to have an apiary of his own, to attend conventions, and visit bee-keepers at their homes. Not only will this enable him to keep in touch with his readers, but by visiting apiaries he will run across ideas, implements and methods of which the general mass of bee-keepers is ignorant, their possessors being so accustomed to them that it never occurs to them that everybody does not know of them. In the summer of 1894, in company with his camera, the editor of the REVIEW expects to visit a large number of bee-keepers, making extended trips through Canada, the Eastern, Middle and Western States; and the REVIEW will contain illustrations and descriptions of the bee keepers visited, their homes, families, apiaries, implements, methods, etc

Experimental Apiculture.

Last spring a few bee keepers of Michigan worked hard and spent some money in so forcibly bringing before the State Board of Agriculture the necessity for an experimental apiary, that \$500 were appropriated for that purpose, and the Hon. R. L. Taylor appointed as apiarist. He has proved most emphatically to be "the right man in the right place" All through the year experiments of a practical nature are under way, and the results are given in the REVIEW AT ONCE, months and months before they appear in the official report. Securing these reports and placing them before the public while they are fresh and can be at once utilized is one of the best things that the REVIEW has ever done for bee-keepers

Hasty's Review.

E. E. Hasty needs no introduction. No other apicultural writer approaches him in bright, quaint, original expressions. Coupled with this is a thorough knowledge of practical bee culture, and he is to use these two accomplishments the coming year in helping to make the "Extracted Department" of the REVIEW. He is to read all of the journals, and then criticize their contents in that inimitable way of his. The REVIEW is also to come in for its share of criticism. Probably no feature of the REVIEW for 1894 will be more interesting or profitable than "Hasty's Review."

At the Front.

The REVIEW strives most earnestly to stand in the front rank; to publish advanced ideas before they have become a matter of history; to be interesting, enterprising, wide awake, up with the times, and brimful of ideas that are especially helpful to the honey-producer.



Topics Discussed in Back Nos.

What the

REVIEW

Has Been, is, and

WILL BE.

IT is almost an axiom that what a man *has* been, that he *will* be. Time only strengthens his habits and characteristics. What is true of a man is true of a periodical.

Most of the distinctive features of the REVIEW are mentioned on a preceding page, but in addition to those it might be said that its editor has for seventeen years been a practical bee-keeper, and is thus in a position to choose wisely in selecting matter for his journal, and is also able to write from the standpoint of actual experience upon all subjects pertaining to practical bee-keeping—to criticise, if necessary, the views of correspondents. Another thing: much care is exercised that the REVIEW shall be very neat typographically. Good paper, type, ink and rollers, and a good pressman are employed, and engravings used when necessary. While the neatness with which the REVIEW is gotten up may not add to the value of the information that it contains, it does add to the comfort and enjoyment of those who read it.

Some idea of what the REVIEW has been may be gained by looking over the list (given in the opposite column) of topics that have been discussed. These back numbers are for sale at the following prices: As the supply of Vols. I and II is quite limited, the price is five cents a copy. Of volume III there is a fair supply, and the price is four cents a copy. With Vol. IV the REVIEW was enlarged and the price raised to \$1.00. Copies of Vols. IV, V and VI, are eight cents each.

Anyone sending \$1.00 for the REVIEW for 1894, and ordering back numbers at the *same time*, may have the back numbers at just *one-half* the prices given.

"Advanced Bee Culture" and the REVIEW one year for \$1.25. Stamps taken either U. S. or Canadian.

W. Z. HUTCHINSON, FLINT, MICH.

VOLUME I.—1888.

- Jan. Disturbing Bees in Winter.
- Feb. Temperature in Wintering Bees.
- Mar. Planting for Honey.
- Apr. Spring Management.
- May Hiving Bees.
- June Taking Away the Queen.
- July Feeding Back.
- Aug. Apiarian Exhibits at Fairs.
- Sep. The Food of Bees in Winter.
- Oct. Ventilation of Bee Hives and Cellars.
- Nov. Moisture in Bee Hives and Cellars.
- Dec. Sections and their Adjustment on the Hive.

VOLUME II.—1889.

- Jan. Bee Hives.
- Feb. Mistakes in Bee Keeping.
- Mar. Which are the Best Bees.
- Apr. Contraction of the Brood Nest.
- May Increase, its Management and Control.
- June Shade for Bees.
- July The Influence of Queens upon Success.
- Aug. Migratory Bee Keeping.
- Sep. Out-Door Wintering of Bees.
- Oct. Bee Conventions and Associations.
- Nov. Speciality Versus Mixed Bee Keeping.
- Dec. What Best Combines with Bee Keeping.

VOLUME III.—1890.

- Jan. Brace Combs and their Prevention.
- Feb. Foul Brood.
- Mar. Queen Rearing and Shipping.
- Apr. The Production of Comb Honey.
- May Raising Good Extracted Honey.
- June Apiarian Comforts and Conveniences.
- July From the Hive to the Honey Market.
- Aug. Marketing.
- Sep. Management After a Poor Season.
- Oct. Out-Apiaries.
- Nov. Apicultural Journalism.
- Dec. Use and Abuse of Comb Foundation.

VOLUME IV.—1891.

- Jan. Buildings for the Apiary.
- Feb. Separators.
- Mar. Protection for Single-Wall Hives.
- Apr. Introducing Queens.
- May Adulteration of Honey.
- June " "
- July Bee Escapes.
- Aug. House Apiaries.
- Sep. Handling Hives Instead of Frames.
- Oct. Rendering and Purifying Wax.
- Nov. Moving Bees into the Cellar.
- Dec. Remedies for Poor Seasons.

VOLUME V.—1892.

- Jan. Writing for the Bee Journals.
- Feb. " "
- Mar. The Grading of Honey.
- Apr. Miscellaneous Matter.
- May " "
- June " "
- July Smoke and Smokers.
- Aug. " "
- Sep. Feeding and Feeders.
- Oct. Construction of Bee Cellars.
- Nov. Baising Sugar Honey.
- Dec. "Best Articles" From the Best Men.

VOLUME VI.—1893.

Special Topics did not receive so much attention in this volume. "Self-Hivers" were discussed in the February and March Nos.; "Extractors and Extracting" in the May No.; "Experimental Apiculture" in the August issue; and "Bee Diarrhoea, its Cause and Prevention" in the October No. The Experimental Apiary Reports began in the July issue.



Barnes' Foot and Hand Power Machinery.



This cut represents our combined Circular and Scroll Saw, which is the best machine made for Bee Keepers' use in the construction of their hives, sections, boxes, etc.

11-92-16t

MACHINES SENT ON TRIAL.

FOR CATALOGUE, PRICES, ETC.,

Address W. F. & JNO. BARNES CO., 384 Ruby St., Rockford, Ills.

Please mention the Review.

New Heddon Hive

FOR CANADA.

Having bought the Canadian patent on the above hive I am prepared to supply it in any combination to the bee-keepers of Canada. Circulars of interest to all mailed free. Write for one. A. E. HOSHAL, Beamsville, Ont.

11-93-1f

Please mention the Review.

IMPORTANT TO BEE-KEEPERS!

To make a success of bee keeping, you want bees that will give the very best results. My *Golden Italians* have gained a good name on their own merits. Those who have tested them with other bees say "they are the best honey gatherers, cap their honey the whitest, as gentle as butterflies, beautiful to look at, are the largest and strongest bee of all the races." Queens bred from mothers that produce uniformly marked

FIVE-BANDED WORKERS

In March, April and May, \$1.25 each, 6 for \$6.00; June, \$1.00 each, 6 for \$5.00; July to Nov., \$1.00 each, 6 for \$4.50. Special prices on large orders. For full particulars send for descriptive circular.

12-92-1f

C. D. DUVALL.

Spencerville, Montg. Co., Maryland.

Illustrated Advertisements Attract Attention.



Cuts Furnished for all illustrating Purposes.

HATCH CHICKENS BY STEAM

With the Improved **Excelsior Incubator.**

Chickens free. Send 6c. for Illus. Catalogue.

Simple, Perfect, Self-Regulating. Thousands in successful operation. Guaranteed to hatch a larger percentage of fertile eggs at less cost than any other hatcher. Lowest priced first-class Hatcher made.

Geo. H. STAHL, Quincy, Ill.

Bind Your Back Volumes.

The back volumes of the REVIEW are somewhat different from those of some journals; many of them are, to a large extent, little pamphlets devoted to the discussion of special topics. For this reason they will always be particularly valuable for reference. But how provoking it is when desiring to consult some back number, to find that that particular number is missing—has been lost or mislaid. To avoid such annoyance, some have fastened together the issues of each year by tacking them together with wire nails, or something of the sort. This is better than nothing, but there is a lack of flexibility, the book does not open out easily so that it can be read, there is no protection to the outside leaves, besides there is nothing handsome about such an arrangement.

There is a book binder here in Flint that does excellent work at a fair price. He will put the first five volumes of the REVIEW into one handsome volume with morocco back and corners, putting the title on the back in gilt letters, and giving the edges of the leaves a neat, reddish tinge—all for \$1.25.

Send me your back numbers, either by mail or express, and I will get the work done and return the book when bound, making no charge for my services, as the binder allows me a small commission, and should any of your back numbers or volumes be missing, I shall be glad to furnish them as long as the supply lasts, simply charging the regular price for them, which is as follows: Vols. I and II, five cents a copy; Vol. III, four cents a copy; Vols. IV and V, eight cents a copy.

The time will soon come when some of the back numbers will be difficult to obtain, and if you care for the REVIEW complete from the beginning, nicely bound, now is the time to attend to it. W. Z. HUTCHINSON, Flint, Mich.

HONEY ALMANAC AND BEE BOOKS, OF ALL KINDS, A LARGE STOCK.



MY NEW ILLUSTRATED Catalogue and Price List of Supplies for the Aply will be sent free to all who may apply. Send a postal card for it, writing your name and address plainly. For every Order of \$10.00 and over, I will make you a present. The Catalogue tells you all about it.

T. G. Newman, 147 So. Western Ave., Chicago.

Advanced Bee-Culture



IS a book of nearly 100 pages that begins with The Care of Bees in Winter, and then tells how they ought to be cared for in the spring in order to secure the workers in time for the harvest. Then Hives and Their Characteristics, Honey Boards, Sections, Supers and Separators are discussed. The Best Methods of Arranging Hives and Buildings and Shading the Bees are described. Varieties of Bees, Introducing Queens and Planting for Honey are next given a chapter each. Then the Hiving of Bees, Increase, Its Management and Control, and Contraction of the Brood Nest are duly considered; after which Comb Foundation, Foul Brood, Queen Rearing, the Raising of Good Extracted Honey, and "Feeding Back" are taken up. After the honey is raised, then its Preparation for the Market, and Marketing are discussed. Then Migratory Bee-Keeping, Out-Apiaries, and Apiarian Exhibits at Fairs are each given a chapter. After this comes the question of Wintering, which is discussed in all its phases. The Influence of Food, Ventilation, Moisture, Temperature, Protection, etc., etc., are all touched upon. There are also chapters upon Specialty versus Mixed Bee-Keeping, Comforts and Conveniences of the Apiary. Mistakes in Bee-Keeping, etc., etc.—32 chapters in all.

Price of the Book, 50 cts. ; the REVIEW one year and the book for \$1.25. Stamps taken, either U. S. or Canadian.

W. Z. HUTCHINSON, Flint, Mich. 5



