



774
14
JUL 21 1919

BETTER FRUIT

VOLUME XIV

JULY, 1919

NUMBER 1

U. S. D.
II 634.2
B4-6
12
June 1919 - June 1920

Columbia Univ Libr
30 Dec 19



CLUSTER OF MOORPARK APRICOTS GROWN IN A PACIFIC NORTHWEST ORCHARD

BETTER FRUIT PUBLISHING COMPANY, PUBLISHERS, PORTLAND, OREGON

Subscription \$1.00 per Year in the United States; Canada \$1.25; Foreign, Including Postage, \$1.50.

Single Copy 20 Cents



Better Fruit Gets Better Prices—

A Mathews Gravity Roller Conveyer will enable you to get your fruit to market in better condition and with less trouble.

The portable sections of steel ball bearing rollers can be quickly set up. They speed up loading in the orchard, and at the shipping point. Baskets and crates glide over the steel ball bearing rollers smoothly and save fruit from bruising.

The Mathews System enables a few people to do more work, more quickly than a number of people working by hands. Its first cost is small and its upkeep trifling. Write to us for details.

MATHEWS GRAVITY CARRIER COMPANY

133 Tenth Street, Ellwood City, Penna.

Branch Factories: Port Hope, Ontario—London, England

MATHEWS
SPEED ECONOMY
GRAVITY ROLLER CONVEYER

The Old Reliable
BELL & CO.
Incorporated
WHOLESALE
Fruits and Produce
112-114 Front Street
PORTLAND, OREGON



SULPHUR

It has been proven and so recommended by the University of California that if you sulphur your grape vines and orchards 6 times they will not be affected by MILDEW or RED SPIDERS.

ANCHOR Brand Velvet Flowers of Sulphur, also EAGLE Brand, Fleur de Soufre, packed in double sacks, are the fluffiest and PUREST sulphurs that money can buy; the best for vineyards; the best for bleaching purposes, LEAVING NO ASH.

VENTILATED Sublimed Sulphur—Impalpable Powder, 100% pure, in double sacks, for Dry Dusting and making Paste—(Atomic Sulphur).

For LIME-SULPHUR SOLUTION, use our DIAMOND "S" BRAND REFINED FLOUR SULPHUR. We can furnish you this sulphur at such a low price that it would pay you to mix your own solution and net you a profit equal to the amount paid out for labor in spraying your orchard, even if you pay your men \$4 per day for making the solution and applying same.

To create additional available plant food, drill into the soil 100 to 400 pounds per acre DIAMOND "S" BRAND POWDERED SULPHUR, 100% pure. This has increased various crops up to 500%.

Also PREPARED DRY DUSTING MATERIALS, Tobacco Dust, Dry Bordeaux, Dusting Sulphur Mixtures, etc. And "Anchor" Brand Standard LIME-SULPHUR SOLUTION 33" BE., Sulphur Paste, etc. Fungicides and Insecticides.

Carried in stock and mixed to order.

San Francisco Sulphur Co.
624 California St. San Francisco, Cal.

We are equipped to make immediate shipments. Send for "ILLUSTRATED BOOKLET"; also booklet "NEW USES FOR SULPHUR," Price-list, and Samples.

Please state for what purpose you use the sulphur, quantity needed, and date of shipment preferred. Telephone Kearney 871.

Richey & Gilbert Co.
H. M. GILBERT, President and Manager
Growers and Shippers of
Yakima Valley Fruits and Produce
SPECIALTIES
Apples, Peaches, Pears and Cantaloupes
TOPPENISH, WASHINGTON

THE SELF-OILING WINDMILL
has become so popular in its first four years that thousands have been called for to replace, on their old towers, other makes of mills, and to replace, at small cost, the gearing of the earlier Aermotors, making them self-oiling. Its enclosed motor keeps in the oil and keeps out dust and rain. The Splash Oiling System constantly floods every bearing with oil, preventing wear and enabling the mill to pump in the lightest breeze. The oil supply is renewed once a year. Double Gears are used, each carrying half the load. We make Gasoline Engines, Pumps, Tanks, Water Supply Goods and Steel Frame Saws. Write AERMOTOR CO., 2500 Twelfth St., Chicago

The **CHEMIST** says=
"genuine **GIANT** is always uniform"

At every Giant Powder plant the chemical laboratory controls the processes of manufacture. They make continuous tests that insure the unvarying high quality of Giant Powders. Each pound of Giant Powder is exactly like every other pound of the same grade. Such uniformity means economy, efficiency, safety. Professional users of Giant Powders—miners, quarrymen, contractors—all know that the name "Giant" stands for utmost dependability in explosives. When you have land to clear, trees to plant, subsoil to be broken or ditches to be blasted, tell your dealer to get for you one of the Giant Farm Powders—Eureka Stumping or Giant Stumping. Don't accept any ordinary dynamite, but insist on genuine Giant Powder, bearing the Giant trade mark on every box.

A postal will bring you our book, "Better Farming with Giant Farm Powders." Its 52 pages are full of short-cuts and labor-saving methods.

THE GIANT POWDER CO., CON.
"Everything for Blasting"
202 First National Bank Bldg., San Francisco
Branch Offices: Denver, Portland, Salt Lake City, Seattle, Spokane

GIANT
FARM POWDERS
STUMPING **EUREKA**

Pittsburgh Perfect Cement Coated Nails are of the highest standard

The Heads don't come off. Given Preference by Largest Pacific Coast Packers

MANUFACTURED EXCLUSIVELY BY
PITTSBURGH STEEL COMPANY, Pittsburgh, Pa.

A. C. RULOFSON COMPANY, Pacific Coast Agents
359 Monadnock Building, San Francisco, California

SIMONS, SHUTTLEWORTH & CO.

LIVERPOOL AND MANCHESTER

SIMONS, JACOBS & CO.
GLASGOW

GARCIA, JACOBS & CO.
LONDON

Agencies and Representatives in Every Important European Market

European Receivers of American Fruits

FOR MARKET INFORMATION ADDRESS

SIMONS, SHUTTLEWORTH & FRENCH CO.
204 Franklin Street, New York

SIMONS FRUIT CO.
Toronto and Montreal

SIMONS, SHUTTLEWORTH, WEBLING CO.
Board of Trade Building, Boston.

OUR SPECIALTIES ARE APPLES AND PEARS

Pacific Coast Agents
**United States Steel
Products Co.**

San Francisco
Los Angeles
Portland
Seattle



J.C. Pearson Co., Inc.
Sole Manufacturers

63 Pearl Street
Boston, Mass.

PEARSON
ECONOMY in buying is getting the best value for the money. not always in getting the lowest prices. PEARSON prices are right.
ADHESIVENESS or holding power is the reason for PEARSON nails. For twenty years they have been making boxes strong. Now, more than ever.
RELIABILITY behind the goods is added value. You can rely on our record of fulfillment of every contract and fair adjustment of every claim.
SATISFACTION is assured by our long experience in making nails to suit our customers' needs. We know what you want; we guarantee satisfaction.
ORIGINALITY plus experience always excels imitation. Imitation's highest hope is, to sometime (not now) equal Pearson—meantime you play safe.
NAILS



Your Bank Connection

is very important to the well being of yourself and your family.

When you choose Ladd & Tilton you are sure of financial experience gained through sixty years in the Pacific Northwest.

We welcome savings, checking or commercial accounts.

LADD & TILTON BANK

Washington and Third
PORTLAND, OREGON

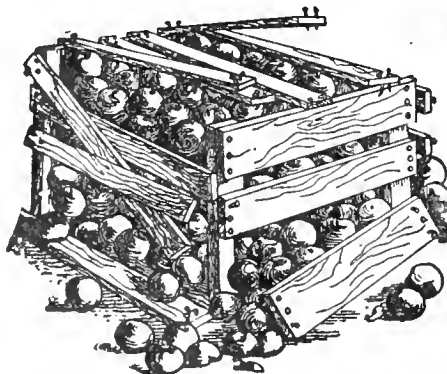

BEFORE using Cement Coated Nails

**Western Cement Coated Nails
for Western Growers**

Our Cement Coated Nails are always of uniform length, gauge, head and count. Especially adapted to the manufacture of fruit boxes and crates. In brief, they are the Best on the Market.

Write for Growers' testimonials.

Colorado Fuel & Iron Co.

DENVER, COLORADO

Pacific Coast Sales Offices
Portland, Spokane, San Francisco
Los Angeles

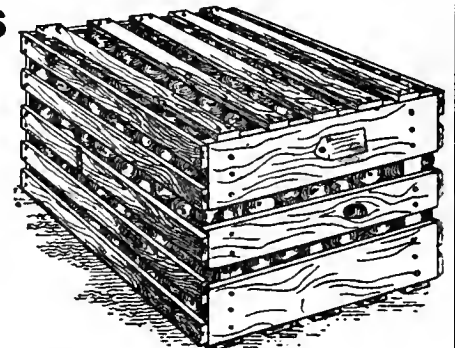

AFTER use of C. F. & I. Co.'s
Cement Coated Nails

BETTER FRUIT

STATE ASSOCIATE EDITORS

OREGON—C. I. Lewis, Horticulturist, Corvallis.
WASHINGTON—Dr. A. L. Melander, Entomologist;
O. M. Morris, Horticulturist; W. S. Thornber, Horticulturist, Pullman.
COLORADO—C. P. Gillette, Director and Entomologist;
E. B. House, Chief of Department of Civil and Irrigation Engineering, State Agricultural College, Fort Collins.
ARIZONA—E. P. Taylor, Horticulturist, Tucson.
WISCONSIN—Dr. E. D. Ball, Director and Entomologist, Madison.
MONTANA—O. B. Whipple, Horticulturist, Bozeman.
CALIFORNIA—C. W. Woodworth, Entomologist, Berkeley; W. H. Volek, Entomologist, Watsonville; Leon D. Batchelor, Horticulturist, Riverside.
INDIANA—H. S. Jackson, Pathologist, Lafayette.

An Illustrated Magazine Devoted to the Interests of Modern, Progressive Fruit Growing and Marketing.

PUBLISHED MONTHLY BY

Better Fruit Publishing Company

703 Oregonian Building
PORTLAND, OREGON

All Communications should be addressed and Remittances made payable to

BETTER FRUIT PUBLISHING COMPANY

SUBSCRIPTION PRICE:

In the United States, \$1.00 per year in advance. Canada \$1.25; Foreign, including postage, \$1.50.

ADVERTISING RATES ON APPLICATION

Entered as second-class matter April 22, 1918, at the Postoffice at Portland, Oregon, under the Act of Congress of March 3, 1879.

VOLUME XIV

PORTLAND, OREGON, JULY 1, 1919

NUMBER 1

California Leads the World in the Apricot Industry

By George P. Weldon, Chief Deputy, State Commission of Horticulture, California

APRICOTS are grown in a number of different states of the Union, but the commercial industry is practically confined to the State of California, where there are at the present time 40,886 acres in bearing and 19,444 acres that have not yet reached the bearing age. The production in 1918 was 135,787 tons, and the valuation of the fruit during the same year was \$8,800,000. Not only is this fruit little grown outside of California in America, but also in other countries of the world.

The Apricot a Popular Fruit.

The apricot is very popular for consumption in the fresh state, also for drying and canning purposes. The industry has suffered somewhat in times past in California because of the desire on the part of the growers of this fruit to get their product into the market as early as possible each season. This has resulted in much fruit being shipped before it was sufficiently matured to be of good quality. When left on the trees until ripe enough for shipment this fruit

is of splendid quality and is generally liked by the consumer.

At the present time the State Commissioner of Horticulture, in the enforcement of a standardization law, is bringing about a decided improvement as to the quality and maturity of fruit that is packed in the fresh state. The future of the industry is therefore very much more promising than it would be were it not for the fact that standardization is being compelled.

Drying and Canning.

There is no fruit that is more popular when dried than the apricot. Most of the drying is done on trays spread in a field, where the sun evaporates the moisture from the fruit. California has a decided advantage over other states in this respect, as nearly always during the fall of the year the weather is warm and dry and there is a scarcity of heavy winds, making it possible to dry the fruit outside.

The canned product is also very fine and thousands of tons of this fruit are

utilized by the canneries during each season. The larger sizes are the most popular for canning purposes.

Tree Characteristics.

In general apricot trees are hardy, making a heavy growth and bearing early. The third season after planting a crop of commercial importance is frequently harvested. Thus, there is not the uneasiness experienced in the case of this fruit as with many other fruits during a number of years while the young trees are making their growth and before any fruit is borne to help pay expenses.

One characteristic of the tree which localizes its planting to a certain extent is the early blooming habit. This fruit comes into bloom shortly after the almond, which is the earliest bloomer of all our common fruits. It is therefore necessary to select localities that are free from spring frosts, in order that the blossoms may not be injured by same.

Bearing Habits.

The fruit of the apricot is borne both on spurs and on one-year-old wood, differing from the peach, which bears entirely on one-year-old wood. Generally this fruit bears heavily, although there are certain varieties that are noted for their shy-bearing characteristics. For example, in California the Royal variety, which is more extensively grown than any other, is a very heavy and constant bearer, while the Moorpark, which is of a much larger size and consequently of greater commercial importance, is inclined to be a light bearer, and is therefore not favored for general planting. Other varieties of commercial importance are Peach, Blenheim, Tilton and Hemskirk.

Pruning.

Some trees bear so heavily that thinning becomes necessary, either by pruning or by the removal of the fruit after it has become set.

The methods of pruning the apricot do not differ widely from those used in pruning other deciduous fruits. On account of its spur-producing characteristics it is not necessary to cut as heavily as is the case with the peach, upon which it is necessary to develop



Photo by California Horticultural Commission.

A round type of apricot tree developed in a heavy producing orchard, Ventura County, California.

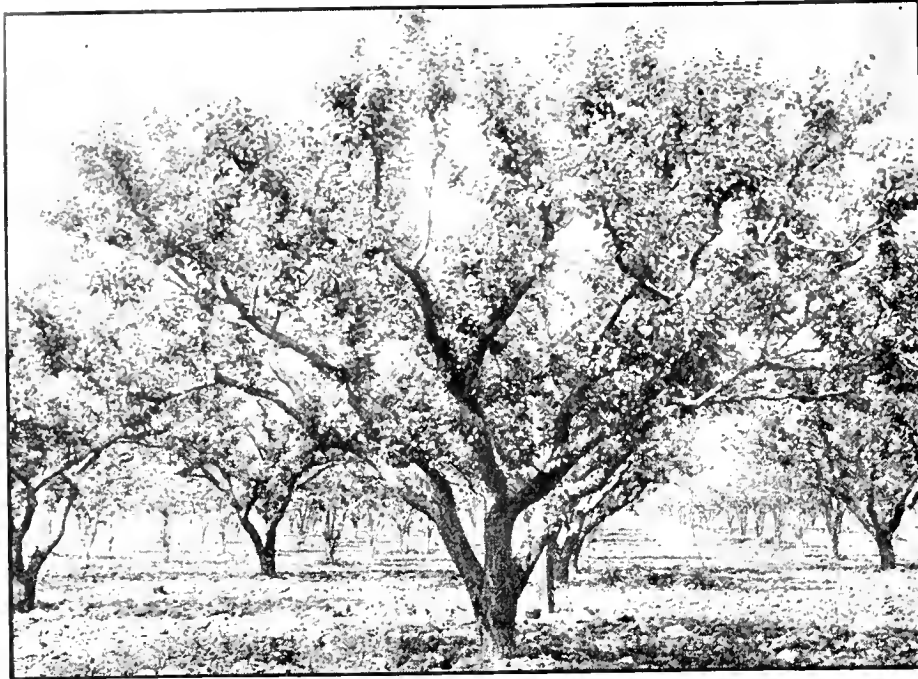

Photo by California Horticultural Commission.

Fine type of apricot tree illustrating very heavy growth and good spread of branches.

an abundance of new wood through heavy cutting each season.

There has been a tendency to prune too heavily in some parts of California and a flat, open type of head has been developed at the expense of productivity. One-year-old trees are pruned back to a height of 18 to 24 inches when set. The second year the framework is developed, with from three to five main branches, which are usually shortened somewhat in the spring of the year. Later pruning consists principally in thinning out the interfering branches and a slight heading in each season to prevent too rank a growth.

Production.

The average production of this fruit in California during 1918 was 3.32 tons per acre. While this average is 'way below the maximum production of the heavier bearing orchards, it takes into consideration those orchards which have just come into bearing and also other orchards which are more or less non-productive. As is the case with all other fruits, there are individuals in the apricot orchards which produce far above the average, indicating a possible production much greater than we have at the present time. Through the selection of buds from heavily bearing individuals and a process of weeding that has not been generally practiced by nurserymen and other propagators of this and other fruits, it would be possible to grow much more per acre than is being grown now.

Insect Pests and Diseases.

There are a number of diseases and insect pests which quite commonly attack the apricot tree. The brown apricot scale is one of the most common of the insects in California. Apricot gummosis, a disease somewhat resembling pear blight, has been found in two different counties of the state, but has not spread generally throughout apricot-

growing areas nor become of any great importance. A fungous disease known locally as shothole fungus causes the formation of red spots on the fruit, thus interfering with its attractiveness and consequently its market value.

There are some more or less obscure troubles of this tree that occur in the main growing sections of California which cause the collar rot, or the death of certain branches. Fungi are probably associated with most of these diseases.

The industry is gaining in popularity in California and if present prices, which are very high, prevail in the future, the returns from this fruit will be great enough to justify a considerable addition to our present acreage.

Why Do Trees Fail to Fruit?

By J. L. Stahl, Experiment Station,
Puyallup, Washington

Why trees fail to fruit is a question that comes more often from the grower of a few trees of different types and varieties of fruit than from growers of large orchards. It is a question, too, that is often hard to answer without knowing the local conditions.

Under normal conditions most fruit trees will begin blooming and setting their fruit at from four to seven years of age. Some types and varieties will often bear in the nursery row, while others will not fruit until ten or more years of age. The Duchess of Oldenburg, Yellow Transparent, Jonathan, Wealthy, Grimes and Wagener apples will usually produce good crops when the trees are young and quite small, while the King, Gravenstein and especially the Northern Spy sometimes fail to fruit or blossom until the trees are quite large.

All varieties of tree fruits are influenced by local conditions. Rich soil is apt to induce an excessive growth of wood and foliage at the expense of fruit-bud formation. This tendency can often be overcome to some extent by summer pruning or by root pruning, and it is sometimes well to try such practices until the habit of fruiting is formed.

Some varieties have the alternate or "off-year" habit of fruiting. A heavy crop may be harvested one year, followed by a light crop. Varieties which would normally bear fruit each year may acquire the alternate-year habit by neglect in pruning, spraying and cultivation. This neglect allows a starved condition of plant growth and fruit-bud development. To rejuvenate such trees careful cultural methods must be practiced.

Some trees will be covered with blossoms, but no fruit is set. This may be



Photo by California Horticultural Commission.

Apricot orchard Winter's section, Yolo County, California, showing the flat open type of head developed by pruning.

due to one of several causes. Bees are essential for pollinizing the blossoms, and if there are none in the vicinity, or if wet, cloudy days during the blooming period prevent their visits from flower to flower, only a poor set of fruit can be expected.

Still other trees set fruit and carry it until about midsummer, when it falls from the tree. This is quite common where trees are growing in sod or in soil that becomes dry during summer. Cultivating the sod or keeping the dry soil moist during midsummer will usually benefit this condition.

Many varieties of pears and plums and some varieties of cherries are quite self-sterile. They need other varieties of the same fruit planted nearby, which bloom during the same period and cross-pollinize their blossoms, to produce a good set of fruit. For instance, the Angouleme pear is often planted near the self-sterile Anjou to pollinize it. Where self-sterile trees are of bearing age it is better to top-graft branches of some of these trees with pollinizers, as several years may be gained in securing blooming wood.



Photo by California Horticultural Commission.

Heavy producing apricot tree, illustrating fruiting wood low down in the branches.

Efficiency of Common Storage Houses for Apples

By F. W. Allen, Assistant Horticulturist Fruit Storage Investigations, Bureau of Markets, U. S. Department of Agriculture

AS prerequisites for success in storing fruit of any kind, whether in cold or common storage, it should be sufficient only to mention the necessity of having good fruit, well grown, picked at the proper stage of maturity, carefully handled and stored as soon after picking as possible. With the importance of these fundamental factors fully appreciated, the efficiency of air-cooled storages depends directly upon three things: The location of the house, its construction, and the way in which it is managed.

The terms "air-cooled" and "common" storage are synonymous, but in using the former we imply the medium by which the fruit is cooled. In this type of house there is no artificial means of refrigeration, only the natural circulation of air. The cooler the air as compared with the temperature of the house the faster the circulation and the more rapid the cooling. In most of the apple sections of the Northwest the nights are generally quite cool, even though the days are warm. Any section having these cool nights is well adapted for successful air-cooled storages. In localities where the days are warm, with little reduction in the night temperature until quite late in the fall, the value of the storage is considerably reduced. In fact, the construction of this type of house in such regions should probably be looked upon with some discouragement.

In planning a common storage we should never lose sight of the fact that the building is to be cooled entirely by air circulation. A few small windows located here and there where they will fit in most conveniently will not accomplish the purpose intended. Air circu-

lation is induced by the difference in weight of air at different temperatures. The weight of a cubic foot of warm air is less than a cubic foot of cold air. Warm air therefore seeks the higher level and cold air the lower. For this reason intake air vents should be placed in the foundation wall, in order that the cold air may enter at the lowest point. After being drawn into the house this cool air expands, its weight becomes lighter, and with the continuous flow of cold air through the intakes it seeks

an outlet through vents or an air shaft in the ceiling. The storage room floor should be not less than eighteen inches above the ground level and of open construction. Two by fours or two by sixes spaced three-fourths of an inch apart are recommended.

With this construction the ventilating system may be compared to a heating stove, where the cold air is taken in under the grate and the heated air passes up and out through the chimney. If we desire more draft, the stove is given more draft, that is, the intake openings are made larger. In order to cool the fruit in an air storage more rapidly, we do the same thing. The same principle applies, only the difference between the temperature of the intake and outlet air in the storage house is much less than that in a stove, consequently the circulation is much slower. For this reason the air vents must be numerous and of proper size. Eighteen by thirty inches is none too large and one such opening should be provided for every ten or fifteen feet on both sides and ends of the house. In extremely large buildings inlet openings should be twenty-four by thirty-six inches. The insulated or refrigerator type of door is much better than those made of only one or two layers of boards.

The flues or outlet ventilators should lead up from the ceiling of the storage room and out through the ridge of the house. By making these from four to six feet square only one or two such outlets should be necessary for the average individual grower's house. As in the case of the inlets, these should be likewise fitted with trap doors in the ceiling of the storage room. By install-

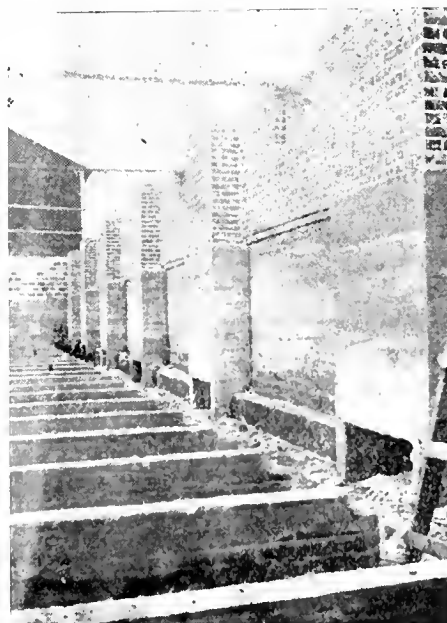

Interior view of air ducts to a basement where the air inlet is built in the wall. With the intake doors on the outside at the level of the ground the cold air is delivered under the false floor.

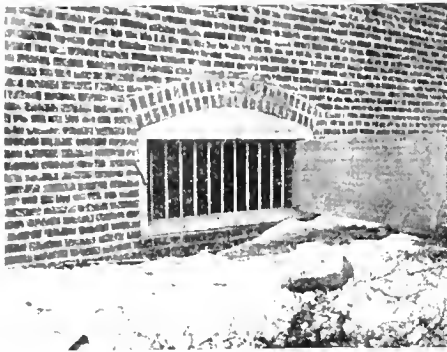

Air intake on an above ground storage. Such an intake, opening directly into a basement, is improperly situated for most efficient cooling.

ing such a system of ventilators the house is equipped with the cooling machinery. The efficiency of this machinery will depend upon the methods of operation, as we shall see subsequently. Most air-cooled houses are too dry for the best results. Tests of methods of adding moisture to the air are now under way, but as yet the easiest and most practical plan is to wet the dirt floor and walls of the house thoroughly each fall before putting in the fruit. This may be repeated to some extent during the storage season.

The general size, arrangement and construction of the walls will depend upon the grower's particular needs and the amount of capital to be invested. Rooms for the combined use of storage and packing are undesirable. The packing room may be adjoining the storage room, or, in basement storages, the packing room is generally on the upper floor. Basements are more difficult to ventilate and cool than above-ground storages, although after once thoroughly cooled they generally maintain a more uniform temperature. In a basement house it is necessary to pipe the cold air down beneath the outside level in order that it may be delivered under the open base floor. The outlet air shafts in this case must also extend down through the room above the basement.

The walls of the house may be constructed of frame, tile, brick or concrete. In some sections storage-house walls are built of adobe brick. In selecting material and in the construction of the wall it should be remembered



Air intake to a basement storage where the air duct is built on the outside. Such openings should be fitted with airtight doors and be located about fifteen feet apart on the sides and ends of the house.

that the wall is not only for the purpose of keeping out low temperatures in winter but it should keep out high temperatures in the early fall and late spring. To protect the stored fruit from injurious temperatures, extremely high and extremely low, the walls should be insulated. Cork, mineral wool and quilting are materials offered for this purpose, although all of them are expensive. For frame constructed houses and buildings with wooden linings, dry mill shavings, where they can be secured, furnish a cheap and very efficient insulation. Doors and windows and the frames surrounding them should so fit as to be practically air tight else a well insulated wall will prove of little value. If storage-room windows are necessary, they should be fitted with double sash and wooden shutters. The doors should be of the refrigerator type. During the early part of the season when it is advisable to have these doors open at night a light slat door to keep out intruders is desirable.

In the above-ground type of house it is well to provide some means of in-

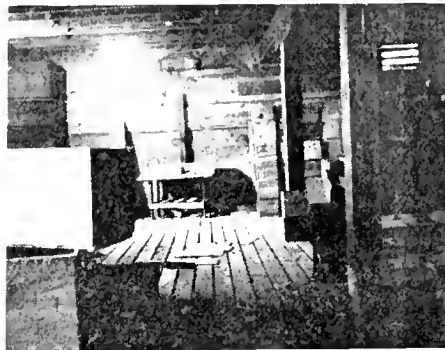

Open false floor made of 2x4 or 2x6 material spaced one-half inch or more apart, enabling the cold air taken in underneath the fruit to cool it more rapidly.

ulating the ceiling. The roof is probably the warmest part of the building, and unless filled with shavings or insulated in some way is a weak part of a good storage. A light-colored roofing material such as white asbestos will be of considerable advantage in reflecting the sun's rays.

With ample means provided for ventilation or cooling the house; with walls, ceiling and other parts constructed to hold a uniform temperature, the final success of the house depends upon its management. A house built of the best materials and constructed along proper lines is of little value unless it is properly operated. Instances in no small number could be cited to prove that this is true. It is believed that it can be stated with perfect safety that less than one house out of ten is properly operated for the most efficient results. In numerous cases houses go through the season with only a pretense of management; a window is occasionally opened for a little fresh air or an oil stove is put in when the temperature reaches the danger point during the winter.

Efficient management of a cold storage for the best keeping quality of apples requires an immediate and uni-



Packing room above, with storage below. The air intakes to the basement (where the shutters are lifted) are sufficiently large. The small outlet flues in the crown of the roof are entirely inadequate.

form temperature of from 30 to 32 degrees. Efficient management of an air-cooled storage requires a consistent and continuous effort to approximate these conditions. The sooner the temperature in the storage room can be brought to 32 degrees, the longer and better the fruit will keep. There is no desire to intimate that air-cooled storages are equal to cold storages for long keeping, for this is not the case. However, with proper management in order to reduce the temperature earlier in the fall and to hold it near the freezing point throughout the winter, quite different results will be obtained than those generally secured. This statement is made after observing fruit and keeping many records in houses of various growers. Good methods and good keeping quality go hand in hand.

One or more accurate thermometers are essential for the successful management of a storage house. They should be tested at 32 degrees in crushed ice to see if they record the proper temperature. Place these thermometers in different parts of the house and consult them once or twice daily—not to see how cold the house is but to see how hot it is. Whenever the temperature of the house becomes warmer than the air outside, turn on all drafts, open the ventilators, both top and bottom, and allow as much air to pass through the house as possible. As soon as these temperature conditions change close all the ventilators and allow no warm air to enter. As a general rule, to follow these instructions means that early in



A three-story packing and storage house. The packing room containing the windows is entirely separate from the storage, a very desirable feature. The air intakes are located under the loading platform. Note the two large outlet flues.

the season all ventilators should be opened in the evening and closed early the following morning. The night air is cool, and within a short time after harvest it drops below the freezing point. This air will cool the storage, and quick cooling means better keeping quality. If, however, the vents are left open both day and night all advantage of the cool night air is lost during the day. This is the basis upon which many houses are operated, but it is not good management.

In answer to the statement sometimes given that it is difficult to keep the storage closed during the day when the fruit is being harvested, it might be suggested that in so far as possible the fruit should be allowed to remain under the trees during the night and should be hauled in early the following morning. This method has the double advantage of getting cool fruit into a cool room. Where it must be brought in during the heat of the day it might be left on the platform over night. Either of these methods is preferable to putting warm fruit directly in the storage room. If

this method cannot be avoided the boxes should be taken in on a conveyor which passes through a small opening in the wall. This will allow much less warm air to enter the storage room than would come through a large door. The thermometers should be watched and the temperature kept on the decline. Each extra degree of heat in the storage early in the season means several days off the life of the apple next spring. The keeping quality of the apple is lost in the fall, not in the spring.

As a further aid in quick cooling enough space should be left between the stacks of fruit in the storage so that the air can have free circulation around at least a part of each box. Main aisle ways in the house should be left directly in front of and above the intake windows. If fruit is stacked directly over these intakes it decreases their efficiency very much. Except in emergency cases boxes should not be stacked more than six or seven high. If stacked to the ceiling the circulating air is again cut off and the cooling of the fruit retarded. Whatever type of house

one may own, or contemplate owning, good, consistent management counts for more than anything else.

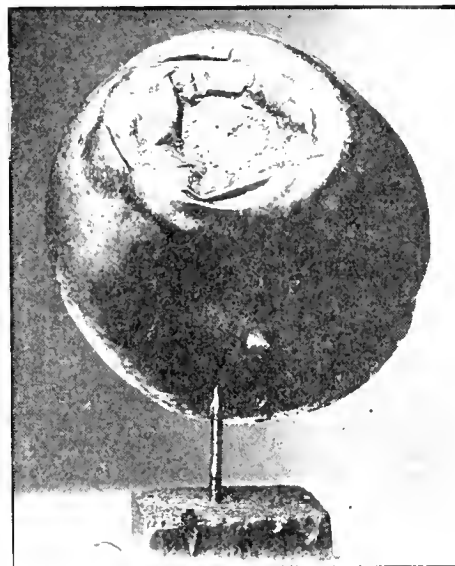

Specimen of fruit rot caused by anthracnose.

Early Fall Spraying for Apple Anthracnose Effective

By Arthur Frank, Plant Pathologist Western Washington Experiment Station, Puyallup, Washington

IN Western Washington it is frequently found that apples rot from the anthracnose quite early in the summer. Cankers of the disease can be found on the limbs of trees with mature spores as early as the middle of July. In a season of abundance of heavy dews

and frequent fogs it is to be expected that under those conditions considerable infection of the fruit will take place.

It was thought desirable to apply an early spray before the apples were picked to see if rotting of the fruit could be prevented. Some trees were secured in the orchard of Mr. C. C. Ireland near Ferndale, Washington, and with the assistance of Mr. H. B. Carroll, Jr., the county agent, the sprays were applied. The application was made the 24th of September, 1918. Burgundy mixture, Bordeaux mixture 3-4-50, and lime sulfur 1 to 40 were used. Boxes of apples from the sprayed trees and also from an unsprayed tree were picked and were stored until March 21, 1919, when the counts were made. The variety was the Salome. The results were as follows:

Treatment	No. of Apples	Sound	Diseased
Lime sulphur.....	171	62%	38%
Burgundy	193	80%	20%
Bordeaux mixture.....	194	84.5%	15.5%
Check (no spray)....	186	54%	46%

The results with the Bordeaux and the Burgundy mixtures were even more marked than the records show, as the spots were much smaller than in the case of those sprayed with the lime sulfur and the unsprayed.

When the apples came from storage no trace of the Bordeaux mixture remained on the fruits. A pound of resin fish-oil soap per 50 gallons of spray was used with the two copper solutions when spraying the trees.

It is thought that if the trees were sprayed earlier that a larger percentage of clean fruit would be secured. The trees, after the apples were picked,

were sprayed again with Bordeaux mixture and the Burgundy sprayed tree with Burgundy. This spring there could be found but one new canker of the trouble in any of the trees. Last season these same trees were thick with girdled twigs and branches and there were many cankers over the entire tree.



Young tree girdled by anthracnose.

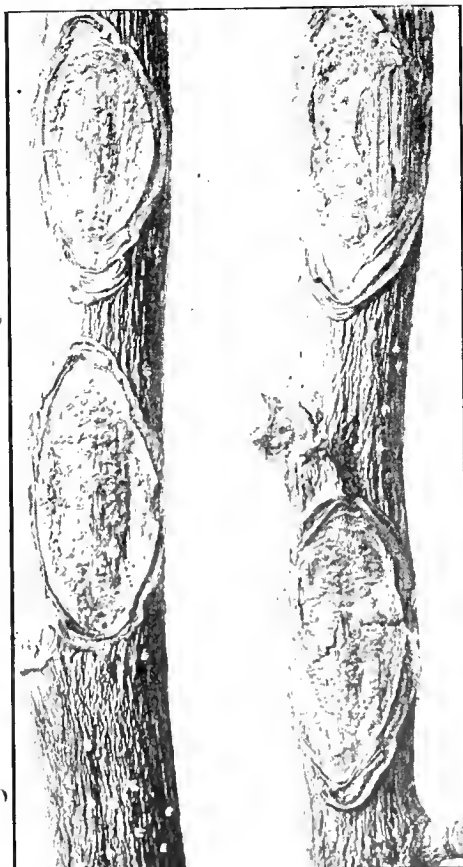

Specimens of anthracnose on apple tree limbs.

The above are the results of but one season's work, but these appear so promising that it is thought that some good may be accomplished by publish-

ing such results as were obtained that growers who are troubled with the disease may try this method in their orchards this season.

Fruit and Vegetable Storage for the Farm

By H. Colin Campbell

THERE is probably no producer of fruit on a large scale who has not at some time wished his place were equipped with proper means for storing either the entire crop or a certain surplus that would permit control of marketing to the extent of being able to take advantage of best or most desirable market conditions. Many millions of dollars of fruits, not to mention vegetables, are probably lost to the consumer, and consequently their money value lost to the producer, merely because fruit growers are, in but few instances, properly equipped to store the produce on the farm. Fruit which, because of the absence of proper storage facilities, must be marketed immediately at the height of harvest, seldom commands the most attractive price. The reason for this is evident. Everyone is disposing of his stock at the same time and the market becomes glutted. A few months after harvest there is usually shortages somewhere that result in attractive prices, and the fruit grower who, favored by having his own storage facilities on the farm, is able to take advantage of this situation, created largely through the neglect or misfortune of others, finds his storage cellar a profitable investment. Usually he finds that the first favorable opportunity thus created pays the bill.

Proper storages save vast amounts of fruit and vegetables that otherwise are

lost due to overstocked markets at harvest. Storage houses using mechanical refrigeration are undoubtedly ideal, but the cost of such is usually beyond the reach of the average fruit grower, so becomes out of the question. The storage house which the average grower can afford must be some type of air-cooled house and, properly built of suitable material, results have been obtained with storage cellars or houses of this type.

The successful storage of fruit, according to cold-storage experts, depends upon the following conditions: (1) Well sprayed, carefully handled fruit; (2) a low temperature; (3) an even temperature; (4) sufficient moisture to prevent shrinkage and keep the fruit crisp and plump. These essentials make it evident that the success of any system of storage becomes largely dependent upon being able to maintain a low and uniform temperature.

The average temperature of the earth is around 50 degrees Fahrenheit, which is much too warm for ideal storage conditions. Often in the latter part of September and early October, there are cold nights when the temperature drops to near the freezing point. Advantage should be taken of these cool spells to lower the temperature in the storage cellar. For that reason a structure of this kind must be provided with good ventilating facilities so there can be as

rapid and frequent change of air as necessary to keep temperature control where desired. Once cooled, it is essential that the storage cellar be kept cool. In order to maintain a low temperature, the walls of the structure must be insulated against possible extreme variations in outside temperature. Air-cooled storages can be used best in latitudes where the winters are fairly cold and constant, as in most northern sections of the United States and throughout Canada. Of course the mountain regions, particularly those of high latitudes, enjoy climate similar to that of the northern states.

Accompanying illustrations suggest details of a storage cellar 20 feet wide and 60 feet long, inside measurements. However, the length can be varied from 10 feet up, according to the capacity desired, by merely omitting as many 10-foot sections or adding as many such sections as necessary to secure the required capacity. Width cannot be changed without a re-design, since the design is based on the present fixed span of 20 feet. The floor, walls and roof of this cellar are of concrete, as this material is best adapted for the purpose.

Concrete makes a storage cellar or cave that is tight—one that keeps out moisture and rats. Concrete has another advantage that nearly everywhere most of the materials are available and construction can be done by ordinary labor under competent supervision. Special provisions for ventilation have been made in this structure. During cold evenings the covers on the cold-air intakes and roof manholes are removed. The cold air rushing down through the cold-air intakes passes under the floor

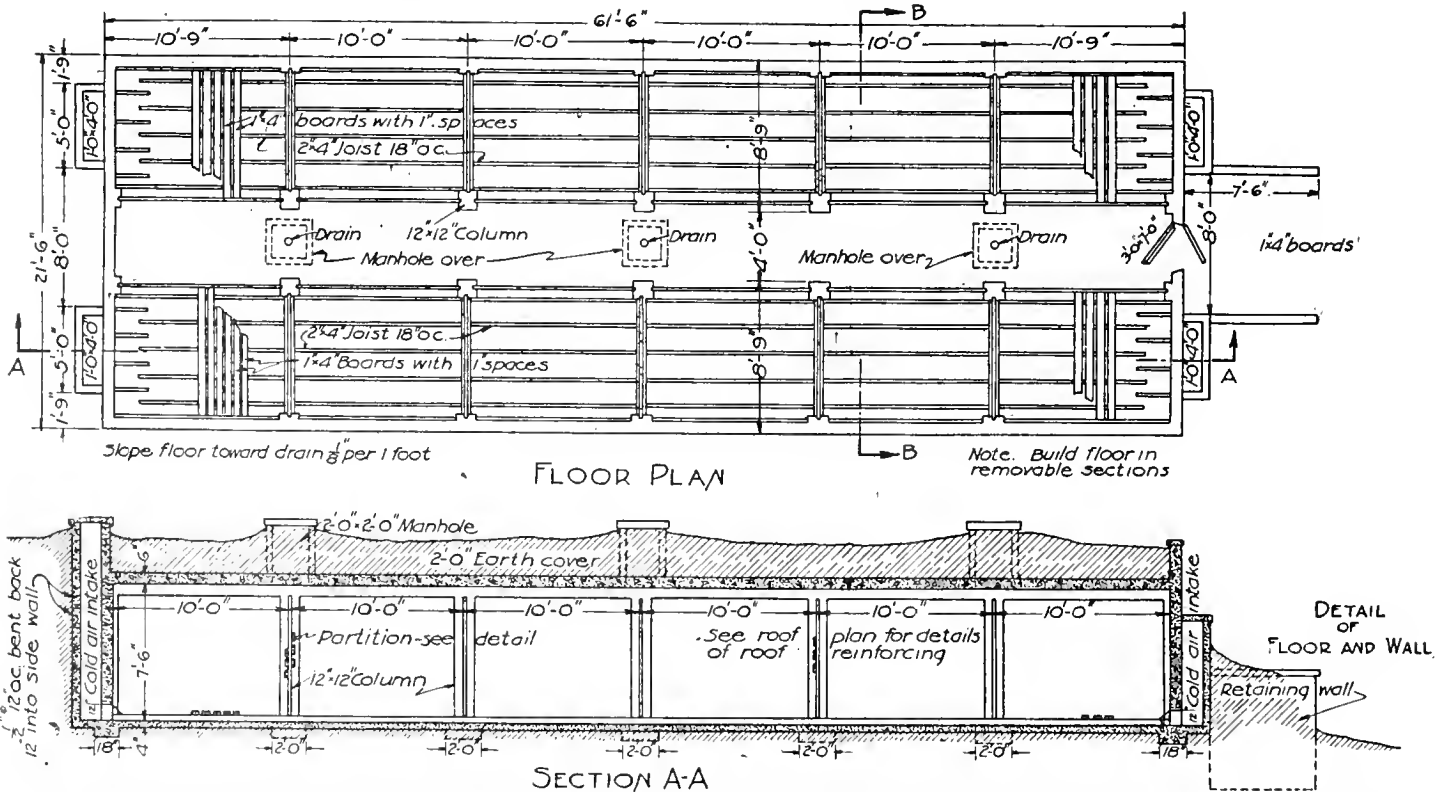

Plan for apple or potato storage cellar suitable for the fruit farm or for commercial purposes. The capacity of this cellar is approximately 5,000 bushels, or about 400 bushels to the bin.

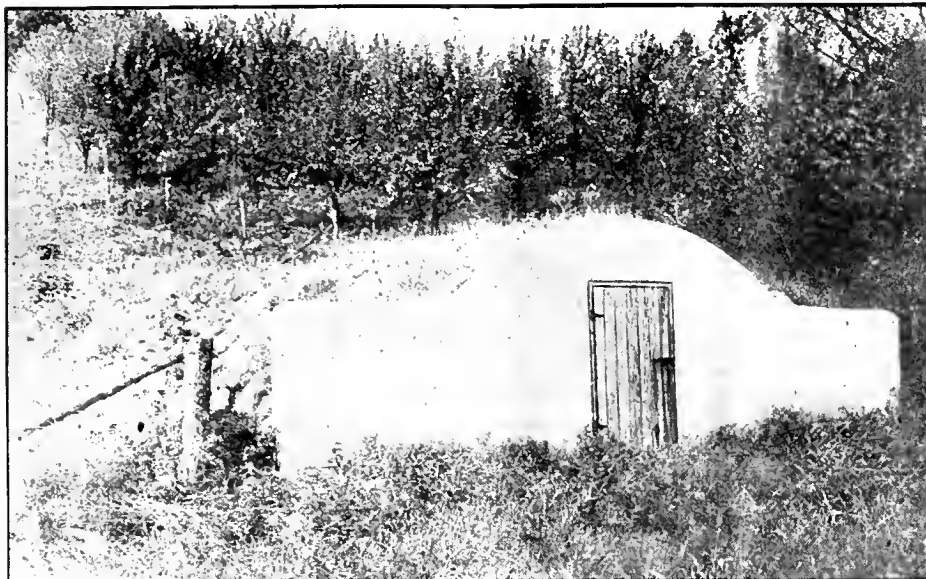

Fruit and vegetable storage cellar (exterior view). This illustration gives view of a storage cellar at Purdue University, Lafayette, Indiana. Its dimensions are 50 feet long by 10 feet 6 inches wide. It is built of concrete and the method of construction is the Van Guilder hollow-wall type. It has three ventilators of six-inch tile and cost \$400 when completed.

of the bins because of a false floor. This floor consists of 2 by 4 joists covered by 1 by 4-inch boards, with 1 inch space between. Joists are so placed that air can pass from one end of the cellar to the other. Openings in the floor allow the air to pass up through the bin, thus cooling contents. Bin walls are also built so that cold air can pass upward around the bins. If the air in this cellar becomes bad because of ripening fruit or because of excess moisture, ventilation can be secured by opening one of the manhole covers slightly. Usually, however, the ventilation obtained incidental to initial cooling of the cellar is sufficient to carry away all vitiated air. Even in the best of storage cellars the air is apt to become too dry at intervals, thus causing fruit to shrink and shrivel.

This tendency should be carefully watched and, as soon as evident, the air in the cave should be moistened by sprinkling water on the floor. Cold, moist conditions are to be sought, but the first consideration should be a low, uniform temperature.

A good location for a storage cellar is on a hillside. Such a location makes it possible to have entrance at grade. A north front is to be desired because such exposure avoids direct rays of sun when the cellar must be opened and also draws in cold air at night.

Georgia Horticultural Meeting.

Horticulturists throughout the country are being invited by the Georgia State Horticultural Society to attend its annual meeting, which will be held this

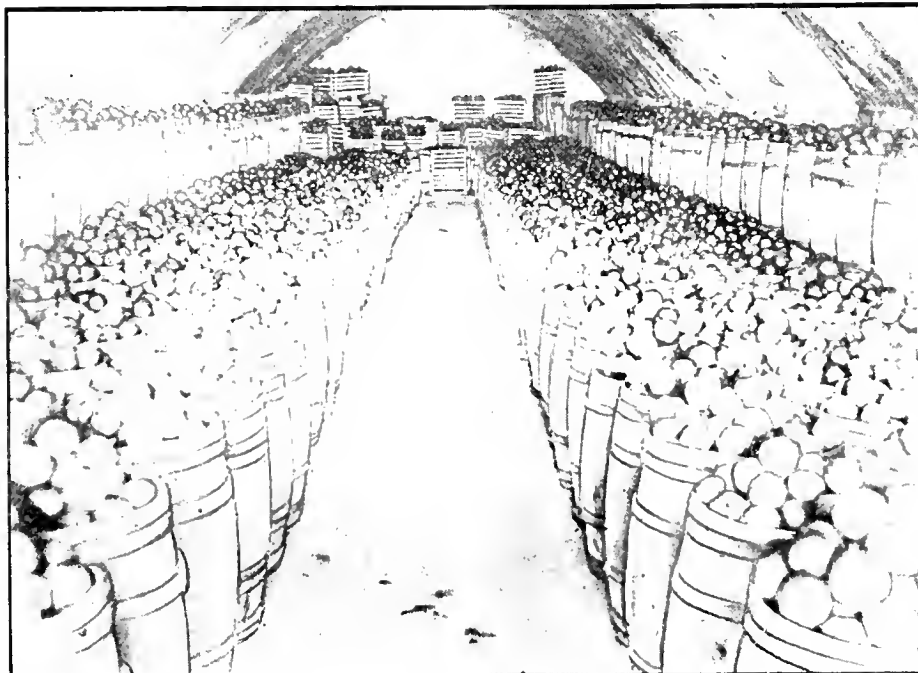

Concrete fruit storage cellar (interior view). This storage cellar, which is located on the grounds of the Great Northern Nursery Company, at Baraboo, Wisconsin, has a capacity of 5,000 barrels of fruit.

year at Cornelia, Georgia, on the 20th and 21st of August. Cornelia is a well-known Southern summer resort, and those who attend the meeting are promised a pleasant and interesting occasion.

Veteran Fruitman Visits United States

After an absence of several years owing to the war, Michael Simons, the veteran English fruitman, made a visit to the United States during the past month. Mr. Simons is a member of the firms of Simons, Shuttleworth & French Co., New York, Simons, Jacobs & Co. of Glasgow, Scotland, and Garcia, Jacobs & Co., London, and although seventy-seven years old, still takes a very active part in the fruit trade.



Michael Simons, veteran fruitman of London, who recently visited United States and predicts prosperous season in export apple trade.

In New York, where he visited the trade, he received a very warm welcome after his long absence. It has been the custom of Mr. Simons when he visits America to come West and visit the Northwest fruit-producing districts, but this year, owing to other matters that took much of his time, he eliminated the Western trip.

Mr. Simons while in New York reported that the prospects for the coming apple season in Great Britain are very encouraging. In speaking of the outlook for 1919 season abroad he said: "We expect a prosperous apple season this year in England and Scotland. By the time the apples are ready for export England should have acquired a considerable number of new ships, and I have no doubt that a liberal provision will be made for apples. What the freight rates will be, however, are uncertain at the present time."

Fruit men are becoming alive to the fact that the pear is a profitable fruit for Western Oregon, and heavier planting is expected in the near future.

Dry Lime and Sulphur as Compared to Liquid

By A. L. Melander, Washington State College, Pullman, Washington

DRY spraying materials are more convenient to transport and keep than liquid or paste sprays, and hence as a matter of trade competition manufacturers have been desirous of placing such materials on the market. In the case of the sulphur-made sprays, two dry forms are being made, one where the sulphur is combined with soda and sold under the trade names of Soluble Sulphur Compound and Spraysulphur, the other a true lime-sulphur manufactured by the Sherwin-Williams Company.

In the early days of lime-sulphur each fruit grower had to make his own spray, cooking it in diluted form because with existing recipes a strong lime-sulphur would crystallize. Then by modifying the formula it became possible to prepare lime-sulphur in concentrated form, and factories took to making strong lime-sulphur solution for shipment. Whenever the attempt was made to increase the concentration further or to cook to dryness the lime-sulphur changed chemically, taking up oxygen and throwing out sulphur, and was so disintegrated as to be nearly valueless. The Sherwin-Williams Company, however, discovered a most ingenious and practical method of preparing lime-sulphur in dry form. A small amount of sugar added to a highly concentrated lime-sulphur solution was discovered to retard the chemical disintegration, so that the liquid could then be evaporated in vacuo and marketed in powder form.

When lime, sulphur and water are boiled together a series of progressive chemical reactions take place, whereby the original ingredients are changed, principally into calcium sulphids, calcium polysulphids, calcium thiosulphate, calcium sulphite and calcium sulphate. When the lime is in chemical excess (i. e., more than half as much lime as sulphur), the relative amount of thiosulphate is increased. When the sulphur is in chemical excess (i. e., more than twice as much sulphur as lime), the relative amount of polysulphid is increased. The best grades of lime-sulphur have the largest amount of polysulphid present, amounting to about 90 per cent. When lime-sulphur is applied as a spray it takes on oxygen; the polysulphid is converted into thiosulphate, the thiosulphate into sulphite and finally the sulphite into sulphate. It is this chemical change that is supposed to give to lime-sulphur its value as an insecticide, for the taking up of oxygen is a sort of chemical suffocation. Obviously, then, the polysulphid is the most valuable ingredient, for it can take on more oxygen than the other chemicals further along in the series.

When Sherwin-Williams dry lime-sulphur is dissolved in cold water a certain amount always remains as sediment. This sediment consists of sulphur and more or less chalk, possibly of value against mildew, but of no worth against scale or aphids. An old sample, or one that has been opened,

will have more insoluble material than a fresh lot. It is claimed that this insoluble material sometimes obstructs strainers and nozzles. If the dry lime-sulphur is boiled in water more or less of the sulphur goes again into chemical solution. A recent analysis by the State Chemist of Washington showed in round numbers the following interesting facts:

	In Cold Water	In Boiling Water
Insoluble	17%	0.4%
Polysulphid sulphur	42%	59.0%
Thiosulphate and other combined sulphur	8%	5.0%
Lime	25%	26.0%
Sugar	2%	2.0%

The Sherwin-Williams Company claims that the sugar stabilizer enhances the value of its product when sprayed on the trees. We know that a solution of dry lime-sulphur will not oxidize as rapidly as the standard liquid lime-sulphur, but this may be regarded as a theoretical disadvantage rather than an advantage, if the insecticidal value of lime-sulphur is due to its ability to absorb oxygen. Until this point is proved it would be unwise to be influenced by this argument.

The printed leaflets distributed by the Sherwin-Williams Company state that "a barrel of liquid lime-sulphur solution weighs approximately 600 pounds, and 80 to 100 pounds of Sherwin-Williams dry lime-sulphur will accomplish the same results." This statement is obviously fallacious, but is made in order that a 100-pound drum of the dry material can compete in selling price with the barrel of liquid. A barrel of standard lime-sulphur concentrate contains approximately 135 pounds of sulphur and 65 pounds of lime in solution in 320 pounds of water. All 200 pounds of the ingredients are soluble and there is the maximum amount of polysulphid sulphur immediately available. In the drum of dry lime-sulphur there are about 65 pounds of actual sulphur and 26 pounds of lime, but of the 100 total pounds about 20 pounds consist of sugar or material insoluble in cold water. Unless there is evidence to the contrary a pound of calcium polysulphid should be regarded as a pound, whether sold in dry form or dissolved in water.

On the basis of actual sulphur content it would take two drums of dry lime-sulphur to be equivalent to a barrel of concentrated liquid, unless the material is boiled into solution two and one-half drums would be a closer equivalent. On the basis of similar strengths of spray solution, therefore, the cost of dry lime-sulphur at present prices is too great to offset the possible advantages of the dry over the liquid.

During 1917 and 1918 the Washington Experiment Station carried on some comparative spraying tests on the San Jose scale, in which the dry lime-sulphur was used. These tests indicate that the Sherwin-Williams product has merit, comparing well with the equivalent strengths of the standard liquid form. The fact that the Sherwin-Williams Company can adduce testi-

monials showing beneficial effects from a weak spray can be paralleled with almost any insecticide. We have repeatedly noticed surprising results from extremely weak solutions, but no one feels ready seriously to recommend ultra-weak sprays for general practice. The fruit grower who depends upon using ten pounds of dry lime-sulphur to fifty gallons is taking a big risk. The weakest lime-sulphur that can be generally recommended for winter spraying tests three degrees, by the Baume hydrometer, and contains about ten pounds of sulphur and five pounds of lime in each fifty gallons. This is equivalent to a dilution of three and one-half gallons of factory-made concentrate in fifty gallons. To produce a similar strength nearly twenty pounds of dry lime-sulphur would be ordinarily required unless the material were boiled into solution, in which case a trifle over fifteen pounds would suffice.

Weighing the pros and cons in comparing liquid and dry lime-sulphur the advantages of the dry form consists in convenience in transportation and avoidance of worries about freezing and leakage. The disadvantages include expense, possibility of deterioration, difficulty of solution and waste of valuable sulphur unless the powder is boiled into solution.

Fruit Growers' Convention

The Fifty-first Fruit Growers' and Farmers' Convention, recently held at Riverside, California, was one of the largest representative gatherings of fruit and vegetable growers, horticultural experts and horticultural inspection officials ever held in the West.

The convention meetings were held in the cloister and gymnasium of the Mission Inn. Programs were carried out by the Fifty-first Fruit Growers' and Farmers' Convention, Interstate Plant Quarantine Conference, California County Horticultural Commission, Convention of California Association of Nurserymen, State Vegetable Growers' Conference and Pacific Coast Economic Entomologists. In addition to the delegates who were present from the Western states, Hawaii, New Zealand, Lower California and British Columbia were represented.

The discussions were of great importance to fruit growers and farmers in the Pacific Northwest. Among the subjects that were taken up were: Marketing methods of fruit and vegetable production; quarantine and methods of control of horticultural and agricultural pests, including boll worm of cotton, cotton boll weevil, alfalfa weevil, citrus canker and other horticultural pests.

One of the results of the conference was the organization of the Association of Western Quarantine Officers, which was formed to further unify and protect the Western states against crop pest invasion. Discussions of uniform grades, packs and packages for horticultural, agricultural and livestock products was one of the most important subjects considered.

Big Shortage Indicated in 1919 Apple Crop

THE Bureau of Crop Estimates, which recently issued its first 1919 apple-crop report, secured through its fruit-crop specialists based on the conditions June 1, states that indications are that the apple output in the United States will be considerably less than last year. The report says only the condition figures are given, as conditions are so changeable at this time that any quantity estimates is certain to be very temporary. The salient features of the report are the prospect of a record crop in the Western States, and a crop for Western New York which will probably not exceed much more than one-half of last year's crop. The indications from Virginia, West Virginia and the heavy production centers in the Middle Atlantic States promise only slightly better than one-half a full crop. Much of the Middle Western crop was severely damaged by frost and conditions throughout the Ohio Valley particularly are very low. Arkansas and Southwest Missouri indicate about three-fourths of a crop, while the same may be said of New Jersey and Delaware. All indications in New England point to a much better crop than last year, while Michigan will have less than two-thirds of a crop.

The condition of the crop for the United States June 1 was indicated at 61.4 per cent as compared with 68.6 per

cent as an average ten-year condition on June 1, and a condition of 69.8 per cent June 1 last year. The final condition figure last year was 55.9 per cent. It should be remembered that the condition figure on June 1 will usually average around 15 points higher than at the end of the season.

The Northwest boxed-apple crop promises to be the largest ever produced, according to conditions the first week in June. Production for Washington, Oregon and Idaho is estimated at about 27,500 cars of 756 boxes each as compared with about 20,000 cars in 1918 and 25,000 cars in 1917.

WASHINGTON.—Approximately 20,500 cars are forecasted for Washington this year as compared with above 17,000 cars last year. Winesaps, which were exceedingly heavy last year, are reported light in places, although all varieties seem well set, and particularly Jonathan, which were light last year. A heavy June drop is reported in progress in the Yakima Valley. Up until this time crop prospects were excellent, and it now seems that the entire Yakima Valley, including Yakima and Benton Counties, may ship approximately 9,000 cars, or about 1,500 cars more than last year. With the exception of limited sections affected by frost the Wenatchee North Central Washington district promises an excellent crop, and there are prospects at this time for about 9,000 cars of 756 boxes as compared with 8,300 cars last year. The Walla Walla district, which last year shipped only 130 cars, has prospects for nearly 1,000 cars in 1919, of which half will be Rome Beauties. Reports from Spokane emphasize the frost damage and June drop, and the crop now promises to be between 600 and 800 cars. Taking Washington state as a whole,

it seems this state may ship its largest apple crop.

OREGON.—The Hood River district will ship from 2,000,000 to 2,250,000 boxes of apples, according to present prospects, as compared with about 1,350,000 boxes last year. Hood River promises by far its largest crop. Other districts in Oregon are equally promising and promise bumper crops. The Rogue River is now estimated at 755 cars, the Mosier and Dufur section at 300 cars, and the Milton-Freewater section at 500 cars, as compared to 250 last year. The state as a whole has prospects for nearly twice as many apples as in 1918.

IDAHO.—Definite estimates are difficult for this state on account of June drop. Various reports give state at from 75 to 100 per cent of the record 3,500-car of 1917. The Lewiston district will have better than 400 cars.

COLORADO.—A heavy freeze reduced prospects in Delta and Montrose Counties on June 1. The Grande Valley escaped, however, and now has prospects for approximately 2,000 cars, or double the 1918 crop. Delta County is estimated at 600 cars, Montrose at 50 cars and Canyon City at 600 cars. The state as a whole may ship 40 per cent more apples than in 1918.

UTAH.—Prospects throughout the state are generally good, showing a 10 per cent increase over last year. The state as a whole will ship approximately 800 cars; Weber and Davis Counties 200 cars each and the Provo district 250 cars.

MONTANA.—Montana is now estimated at 450 cars from the Bitter Root Valley.

CALIFORNIA.—The Watsonville district, which shipped nearly 2,500,000 boxes in 1918, has prospects for a 10 per cent heavier crop than last year. Newtowns, the principal variety, are about the same as last year, while Belleflowers are considerably heavier. The Sebastopol section is now estimated at about 750 cars, of which approximately 500 cars will be Gravensteins. It is too early to forecast dried-apple production, although the Watsonville district is now forecasted at about 5,000 tons of dried apples and Sebastopol at from 3,500 to 4,000 tons, which is almost equal to the very heavy production of 1918.

CANADA.—Reports from Canada promise a

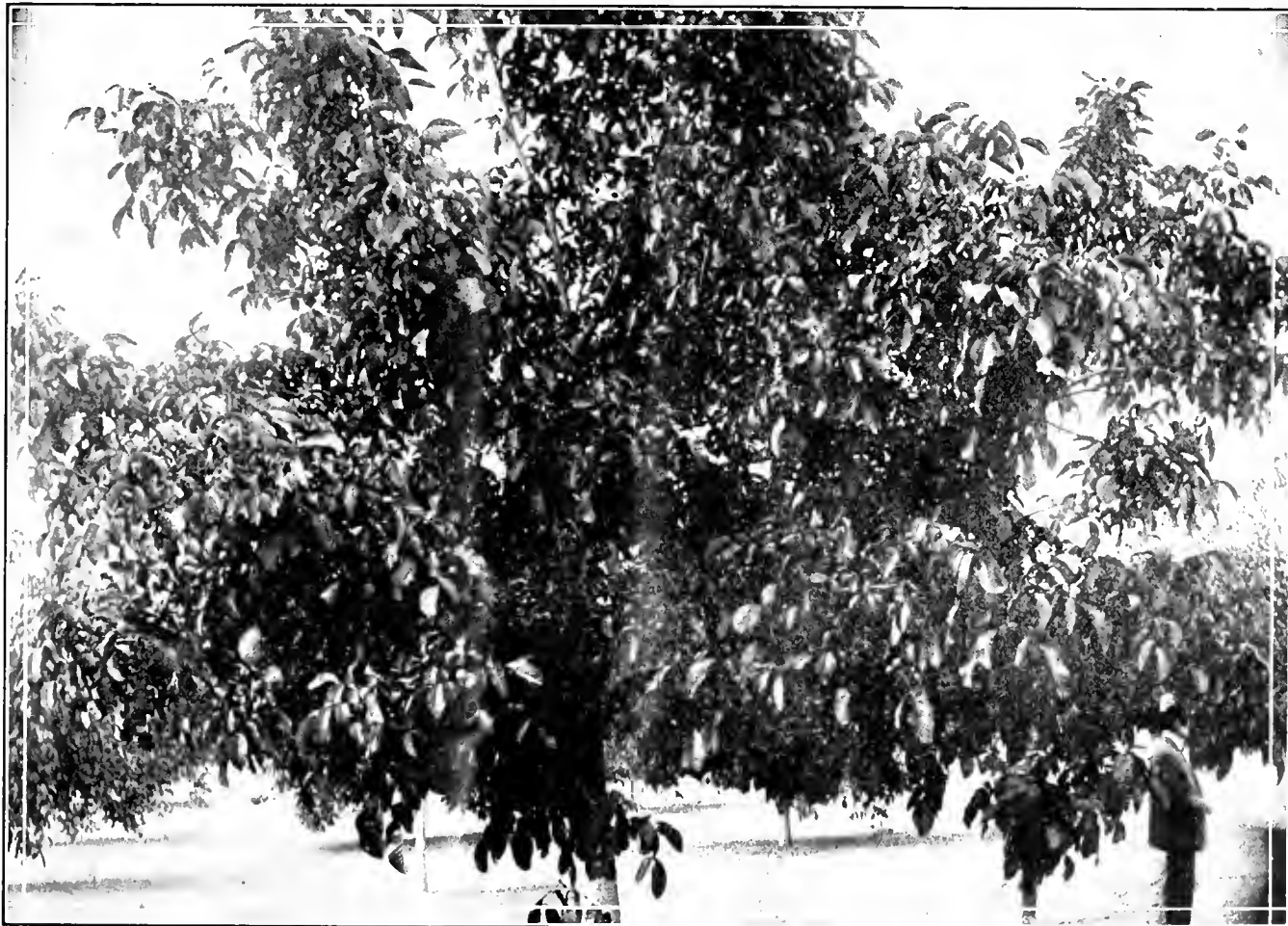

English walnut orchard near Dundee, Oregon. Seven-year-old tree in the foreground. Walnut growing is proving remarkably successful in this section of Oregon, which includes Salem and a large surrounding territory. It is now estimated that there are 8,000 acres set to English walnuts in Oregon.

bumper crop from Nova Scotia, which last year had a fair crop, or about 800,000 barrels. Quebec and Ontario are spotted and indicate rather light crops. The Okanogan Valley in British Columbia indicates a 50 per cent increase in the apple crop over last year.

American Tractors to Farm the World

More than 314,000 motor tractors for farm use will be manufactured in the United States this year, according to the estimate of the Agricultural Department.

Ninety thousand of these tractors, representing about one hundred million dollars, will be sent abroad to foreign countries and will be used to increase the crop production of nearly every country in the world.

Working with a tractor one man can do more work than six men, thirty horses, or a hundred oxen, under the old-fashioned methods formerly in vogue. This will make up, in a large way, in Europe, for the shortage of men caused by the war.

The power of all tractors is derived from internal combustion engines. The fuel used is generally kerosene, though some use gasoline. Practically all have magneto ignition, because of its intense spark, simplicity, and absolute reliability. It would be impossible, in foreign lands, to use any other form of ignition.

The sturdiness of the magneto enables it to withstand rough usage, and, being a self-contained generator of electrical energy which requires no attention or replenishing, it has made the use of American tractors possible everywhere.

Altogether, there will be about half a million American built farm tractors at work in 1920, where there were practically none five years ago. The United States leads the world in this line of manufacture.

Walnut Growers Issue Report

The first annual report of the Western Walnut Association, which was recently issued, contains much valuable information on nut growing and marketing and shows that the organization,

which covers the field both in Oregon and Washington, is in a healthy condition. The object of the Western Walnut Association is educational and to promote a greater development of the walnut and filbert industries of the Pacific Northwest. The association holds an annual winter meeting, at which time a program is given and officers are elected. An annual summer tour in which several days are spent in making observations and gathering information in the nut orchards of Washington and Oregon is also made. Membership in the organization is open to the public and the dues are one dollar per year. The officers of the association are: J. E. Cooper of McMinnville, Oregon, president; Prof. C. I. Lewis of Corvallis, Oregon, vice-president for Oregon; A. A. Quarnberg, Vancouver, Washington, vice-president for Washington; Knight Percy, Salem, Oregon, secretary-treasurer. The executive committee consists of Dr. J. H. Wilkins, McMinnville; Robt. C. Paulus, Salem; Clyde LaFollette, Amity. Nut growers who are not members of the association and desire to join are requested to communicate with the secretary of the organization.

Big Increase in Peach Crop

The Bureau of Crop Estimates has issued its second quantitative forecast of the strictly commercial peach production for the United States based upon the condition of the crop June 1. The condition of the peach crop, according to this report, has undergone considerable change since May 1, notably in the Eastern and Northern States, where the crop will not reach earlier expectations. The most salient feature of the report is the very large crop in the far West, which promises to exceed that of former years.

There is now indicated in the United States a total crop of 30,820,000 bushels as compared with 20,578,000 bushels last year, or 50 per cent increase over the comparatively light crop of 1918. The crop west of the Rockies promises 46,550 cars as compared with 33,905 cars last year. The Southern crop, including Missouri, Arkansas and Oklahoma peaches, promises 15,230 cars as compared with 11,715 cars last year. This increase is due to the large crop in Arkansas and surrounding territory. The crop from the Middle Atlantic States promises 6,725 cars as compared with 4,204 cars last year, while that for the Northern States promises 7,780 cars as compared with 1,685 cars last year.

Virginia Improving Apple Output.

While Virginia is a long way from the Pacific Northwest, it is interesting for Northwest apple growers to know that a good crop is expected in this Southern state, which more nearly competes with the Western boxed apple than any of the other Eastern states. Packing apples in boxes is now quite prevalent in several of the apple-growing sections in Virginia, although the larger part of the crop is still being shipped out in barrels. The Virginia crop this year is expected to exceed

that of 1918 by many thousands of barrels. This increase in the 1919 yield is said to be largely due to a course of education which has been put into effect by men who were formerly engaged in the apple business in the Northwest and who have interested the growers in Virginia in spraying apple and other fruit trees.

Fruit Brings in \$150,000,000.

The income from Northwest fruits is growing by leaps and bounds. Figures recently compiled for the State of Washington show that last year over \$100,000,000 was received by the above-named state for its fruit crop, and that the total figures for Oregon were over \$50,000,000. Of this amount the big increase in the returns in Oregon were due to the immense development taking place in the growing of berries, prunes and other small fruits, and the expansion of the dehydrating, drying, canning and preserving plants. In the Salem district alone the returns from its fruit industry were more than doubled last year. The bank clearances at Salem in 1919 increased from something like a little over \$3,000,000 to over \$6,000,000, the greater part of the increase being from returns on fruit.

Cooking and Canning IS A REAL PLEASURE

Note the picture. You cook everything at once, over one fire. Everything cooked perfectly under steam pressure—no burning, no mixing of flavors, no shrinkage of the food. With it you can everything by the cold pack method—fruit, vegetables, meats, etc. Thousands are using Conservo and say it's worth its weight in gold.

Conservo Cooker

No. 20—Conservo, 21½ inches high, 11½ inches square; 4 removable shelves; 2 pans; cooks for 3 to 15 persons; holds 14 one-quart jars for canning. No. 9—Conservo is 13½ inches high; 2 shelves; 1 pan; cooks for 2 or 3 persons; holds 6 one-quart jars for canning.

Works on any stove—wood, coal or gas

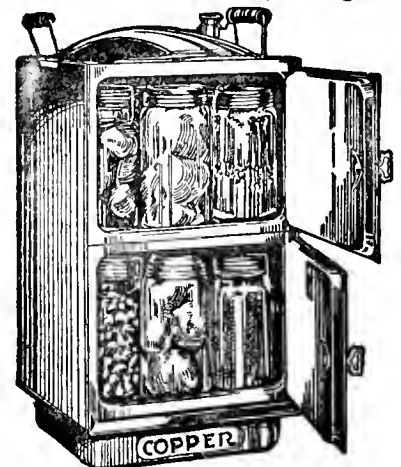

Write for Free Book and Information

"Conservo" is a time and money saver. It is a blessing to the housekeeper. Every home should have one. It will pay for itself in a few months' time by the saving in food and fuel. Foods cooked in it are delicious—they retain all their flavor and natural juices. Canning is done perfectly and with least possible effort.

Write today for booklet and information.

OUTWEST SUPPLY CO.
PORTLAND, OREGON

WANTED!

A high class manager for fruit farm.
Good salary.

Apply **W. E. Schmick,**
Hamburg, Pennsylvania.

Single Man, Good Habits

Nine years experience in orchard work in the Northwest desires connection with orchard ranch where intelligent service would be appreciated. Can get on the job by September 1st.

A. F. PAGE
General Delivery Milwaukee, Wisconsin

POND

"Prop-Hooks" and Screw-Eyes. The best system yet devised for scientifically and economically supporting loaded fruit trees. Free illustrated circulars. **RUSSELL G. POND,** Parkdale (Hood River), Oregon.

Advises Increased Apple Tree Plantings

IN an article recently issued by the Bureau of Information of the United States Department of Agriculture it is advised that increased plantings of apple trees be made to take care of an increased demand which it says is coming and will continue. Commercial apple growers in the United States must meet any such increased demand without increased acreage, and little can be done toward immediately increasing the supply when an unusual demand appears.

Must Increase Plantings

Taking the United States as a whole, there has been very little planting of apple trees since 1910. Comparatively few young trees, therefore, are coming into bearing at this time. This is shown by an investigation of the commercial apple industry recently made by the United States Department of Agriculture. Indeed, the largest single commercial apple-producing section in the United States has reached its maximum production, and unless the planting rate increases a decline is to be expected.

The region is Western New York, which early in the sixties became and has since remained the center of commercial apple production in the United States. Western New York has produced regularly about one-fourth of the normal commercial apple crop of the country. But most of the present bearing trees were planted in the late sixties and early seventies and are now nearly fifty years old. Vigor and productivity continue longer in Western New York than anywhere else in the country, perhaps, yet they cannot be maintained indefinitely, and the center of production may be expected to shift. Similar de-

clines are taking place in what is known as the New England Baldwin belt, including portions of Maine, New Hampshire, Vermont and Massachusetts, but as this has never represented more than five per cent of the total commercial production it is of relatively less importance.

Other Production Centers.

In latter years two comparatively new commercial apple regions have come into large production—the Pacific Northwest and the Shenandoah-Cumberland region of Virginia, West Virginia, Maryland and Pennsylvania. The former is producing now almost as many commercial apples as New York, and the latter is producing about half as many. Roughly speaking, New York, the Pacific Northwest and the Shenandoah-Cumberland produce about five-eighths of all the commercial apples grown in the United States. The Shenandoah-Cumberland region is yet only approaching its maximum production. In the Northwest there was considerable planting of unsuitable lands, but Western production is being stabilized and will continue to be an increasingly important factor in the apple industry.

Other regions of considerable commercial apple production now are the Piedmont district of Virginia, the Hudson Valley, Southern Ohio, Western Michigan, Southern and Western Illinois, the Ozark Mountain region of Arkansas and Missouri, the Missouri River region of Iowa, Missouri, Kansas and Nebraska, the Arkansas Valley region, California and Colorado.

**BEST SERVICE-
QUALITY & PRICES**



FRUIT
LABELS

**THE
SIMPSON & DOELLER CO.**
1423-24 NORTHWESTERN BANK BLDG.
PORTLAND, OREGON.
E. SHELLEY MORGAN
NORTHWESTERN MANAGER
WE CARRY—AND CAN SHIP IN 24
HOURS—STOCK LABELS FOR PEARS,
APPLES, CHERRIES & STRAWBERRIES.

The Furry Fruit and Produce Co., organized a short time ago, is building a \$5,000 warehouse at Yakima. The members of the new company are C. M. Furry, former manager of the Growers' Service Company, and W. D. McNair.

Garden Cutworms

Cutworms are among the most troublesome insects with which the gardener has to deal. They are familiar to most persons, and anyone engaged in gardening for any length of time has to contend with these pests, as they are what are termed "general feeders," attacking plants of almost every description.

Tomatoes, cabbages, sweet potatoes, lettuce and other truck plants, especially those which are started under glass and transplanted, are subject to more or less serious injury by cutworms. These pests appear sometimes in great numbers in the spring and early summer, and frequently do severe injury before they are noticed.

Cutworms are not at all difficult to control, and there are several methods by which this may be accomplished. The best, however, is the poisoned bait or poisoned bran mash. The following formula is for use in a small garden: White arsenic, quarter pound; syrup or molasses, one pint; water, four to six quarts; dry bran, one peck.

Thoroughly mix the arsenic in a peck of dry bran. Stir into four to six quarts of water a pint of cheap syrup or molasses. After this has been made up into a mash let it stand for several

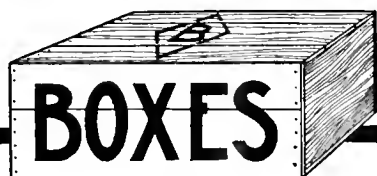

Strong and Tight

Makeshift boxes indicate a makeshift product. First impressions always are the most lasting.

A strong, tight box impresses the buyer first. He wants your product to arrive in good condition.

Bloedel Donovan Boxes
Are expertly sawed and built to fit—
strong and tight. We deliver promptly

BLOEDEL DONOVAN LUMBER MILLS
1018 White Building, Seattle, Wash.

TRUTH WELL ILLUSTRATED

We apply it to your
APPLE LABELS

47TH YEAR OF QUALITY AND SERVICE

Schmidt's
LITHO
CO.

SAN FRANCISCO
PORTLAND
SEATTLE

LOS ANGELES
HONOLULU
FRESNO

hours to allow the bran to take up the arsenic.

Other powdered arsenicals, such as arsenate of lead, may be substituted if double the amount is employed. Dry paris green may be used at the same rate as the arsenic. Arsenic is preferable, however, because cheaper.

Scatter the mash thinly along the

rows or about the bases of the plants to be protected as soon as the cutworms appear. It is better to make the application well toward evening, or at dusk, since the cutworms feed only at night or on dull, cloudy days, and the bait is more attractive when fresh. If the cutworms should reappear, repeat two or three times at short intervals.

Experimenting with Ladybugs

THREE hundred pounds of ladybugs stored at Walla Walla, Washington, during the winter and spring were liberated throughout the fruit-growing districts in that section up to June 5 to rid orchards there of aphids. It is estimated that these little beetles will completely cover 2,000 acres of orchards and grain fields in that section and destroy the aphids.

In liberating the ladybugs they were taken to the west side of the orchards owing to their well-known habit of traveling eastward, and an observation kept on them showed that they had deposited eggs three days after being turned loose. The eggs hatch out in six to twenty days after being laid, depending on the weather conditions. When

the larvæ appears they are said to be even more rapacious enemies of the aphids than the full-grown bugs.

District Horticultural Agent E. C. Wood, who has been conducting the experiments in using ladybugs to prey on aphids, has secured some interesting data concerning them. Investigations made in the mountains this spring satisfy him that the ladybugs can be secured there in the spring for a period of about ten days during the month of April. In the fall, he says, they can be gathered for a much longer period, as they begin to colonize in July and remain in colonies during the winter.

"There are two very important reasons for gathering these beetles rather than letting them come to the valley

by themselves," said Mr. Wood. "When the beetles are gathered we are able to place them where they are most needed, and again they can be set to work several weeks earlier than when left to themselves.

"This beetle is strictly carnivorous and does not feed on any vegetation so there is little danger of it becoming a pest, no matter how rapid the multiplication."

Plans already are being made by local orchardists for a ladybug hunt this fall and it is expected that many hundreds of pounds of the insects will be stored next fall.

Experiments in keeping the ladybugs in storage last winter demonstrated that those kept in ordinary storage showed a loss of about one-third, while those kept in cold storage showed practically no loss at all.

Tour of Nut Growers Arranged

A tentative schedule has been arranged for the annual summer tour of the Western Walnut Association through Oregon and Washington walnut and filbert orchards. The tour as now arranged will start at McMinnville August 5 at 1 p.m. The first afternoon will be spent in Sheridan orchards, where among other places that will be visited will be that of Professor C. I. Lewis. The morning of August 6 the party will leave McMinnville for Portland, going through Washington County, where the groves of Thomas Withycombe and Mr. Malpas at Gaston will be visited and the Forbis place at Dilley. A number of other stops will be made, including one at Orengo to visit the nursery of the Oregon Nursery Company.

The party expects to arrive during the afternoon at Vancouver, Washington, where an inspection will be made of the Quarnberg, Norelius and Shaw orchards. Returning to Portland the party will leave that city at 8 a.m. on August 7 for Oregon City, where plantings will be visited, and continuing south stops will be made at places near Aurora, Canby and Woodburn. At Canby the Dr. Walgamot nursery will be a point of interest. From Woodburn the trip will be routed to Wilsonville, where stops will be made at the orchards of John DeNeui, H. A. Krause and Dr. Jobse. From this point the route is undetermined and will be decided upon when the party reaches Wilsonville. The public is invited to join the walnut men in the tour. Those who decide to do so must provide for their transportation. If they have no car they are advised to arrange with a member of the party who has an extra seat in his car.

The summer tour of the walnut growers last year proved to be highly educational to those who made it, the impromptu discussion that took place in the orchards bringing out many interesting points about nut growing.

The Australian deciduous fruit producers are fast adopting American methods. Their crops do not conflict very extensively with ours, however, and better methods in Australia mean better prices for both.

Cletrac

TANK-TYPE TRACTOR

The logical Tractor for the Orchardist and Fruit Grower

The Cletrac Tank Type Tractor was built for general all around utility on the farm. It was not built alone for orchard work—but if its designers had been trying to construct the best possible orchard tractor they could not have been more successful.

The Cletrac goes under the low branches—it cultivates up close to the trees on side hills or level ground. It pulls the spray machine—in fact it does everything the orchardist could expect of a tractor and does it well.

The Cletrac tank-type tractor is versatile and extremely rugged.

It is small enough to be used economically on light jobs, yet powerful enough to handle the majority of the so-called *heavy* work about the farm.

It plows, harrows, plants, reaps, binds, threshes, hauls, cuts ensilage, fills silos, saws wood and does practically all the work done by animal and stationary engine power.

It is the logical successor to the horse and mule. It is more efficient and does not only *more* but *better* and *cheaper* work.

The tank-type construction of the Cletrac enables it to operate over soft ground where other machines would wallow and “dig themselves in”—an invaluable asset in the preparation of the seed bed.

It will go practically anywhere—and *does not pack down the soil*.

Orders are being filled in the sequence in which they are received. Place your order now—in time for fall work. Write for catalog and name of nearest Cletrac dealer.

The Cleveland Tractor Co.

19145 Euclid Avenue, Cleveland, Ohio

Largest producers of tank-type tractors in the world



BETTER FRUIT

An Illustrated Magazine Devoted to the Interests
of Modern Fruit Growing and Marketing.

Published Monthly
by

Better Fruit Publishing Company

703 Oregonian Building
PORTLAND, OREGON

Organizing the Fruit Industry

The movement for the co-operative organization of the producer is encircling the globe. We are told that co-operation among the tillers of the soil in European countries is not new, but is an old story. And now the movement is being taken up in the deciduous fruit-production sections of South Africa, Australia and Tasmania. The fruit growers of Australia are the latest advocates of a co-operative association which will embrace all phases of the industry in this new group in the fruit-growing world. The activities of this association will embrace everything from fresh fruit to jellies and jams, which are to be put up in a big central canning and preserving factory to be erected at Melbourne. Other deciduous fruit-growing countries in that part of the world are following suit.

The cry for co-operation for the producer from Australia to Oregon and then across the American continent to Europe is a far one, but it is being heard and the fruit growers of the world are apparently determined to standardize and stabilize their products. It seems strange that the comparatively new deciduous fruit-producing countries of Australia, Tasmania and South Africa realized the benefits of co-operation on a big scale before an old established fruit-producing section like Oregon, but such is the case, as the movement toward organization was commenced in the above mentioned far-away countries a long time ago.

However, the fruit growers of Oregon have been awakened. It took a severe jolt to get them out of the rut, but the jar has fully opened their eyes. The rich possibilities for the big, rapidly-growing fruit industry of their state, fostered and completely controlled by a state-wide co-operative organization entirely in the hands of the growers, has at last sunk in. Perhaps the delayed action of Oregon's fruit producers was due to the lack of proper education and the psychological moment to merge, however, as the amalgamation at the meeting held for the latter purpose was apparently complete.

As planned the proposed Oregon Growers' Co-operative Association bids fair to be a success. Organized along even more progressive lines than the most successful co-operative associations of California, its provisions apparently leave nothing to be desired by the grower in the way of a marketing organization and also an organization that should place the former uncertain conditions of the fruit industry on a firm basis. In a word, to make fruit products as nearly as possible a staple rather than a perishable product, by providing a market for them, either

fresh, dried or canned, at the highest market price while not attempting to gouge the consumer. Under the provisions of the organization plan, profits that have heretofore gone to outside concerns should be conserved to the grower, overhead expenses should be minimized and the industry greatly stimulated and developed, provided that the affairs of the proposed organization are administered intelligently and honestly.

It has been suggested that the proposed organization had its inception through channels in California that seek to control the fruit industry in Oregon in order that it will not conflict with the industry in that state. It would seem, however, that Mr. Robert C. Paulus, who has made such a signal success in managing the affairs of the Salem Fruit Union, and is virtually at the head of the new movement as well as the strong personnel of the organization committee should be sufficient assurance that no such underground methods are contemplated. Provision should be made for co-operation with the California associations when deemed expedient, but anything verging on possible control of the Oregon organization should be carefully guarded against.

The Stopping-in-Transit Privilege

The recommendation of the Western Traffic Railroads Committee that the privilege of unloading Northwest fruits in transit be revoked would be a severe blow to the Western fruit grower. If this order is put into effect many sales of fruit which went to points in the Middle West will be stopped owing to the fact that they are unable to purchase in carload lots. It is also expected that the order will do away with the privilege of stopping fruit in transit for the purpose of placing it in storage. The reason assigned by the Traffic Committee for this action is that the privilege is discriminatory in that it only affects the Northwest territory.

Fruit-shipping concerns in the Northwest have taken up the matter and are urging that all interested present a strong protest to the railroads against approving the recommendation of the Traffic Committee.

There is just ground for opposing this recommendation; for while the order may be discriminatory in that it only affects the Northwest it should be remembered that no other deciduous fruit section has such a long haul to its markets and none pays so high a freight rate. The disadvantage, through this high freight rate, that Northwest deciduous fruits are under in competing with the fruit-growing sections of the East are already great enough, without a further handicap.

The railroads which are the greatest beneficiaries of the Pacific Northwest fruit industry should use every means to develop instead of retard it, and this is a case where they can help very materially.

Editorial Comment

Fruit growers will be interested in supporting the proposed establishing of motor-car express routes, a matter which is now before Congress. Nobody will be more benefitted by this rapid method of transportation in districts not reached by the railroads than the fruit raiser.

Congress is being asked by 3,000,000 farmers in the United States for the continuance of the United States Employment Service. The fruit grower should join hands with the farmer in this movement, as his need of labor is even more imperative.

The war between the ladybugs and aphids in Walla Walla County, Washington, will be watched with interest. From present indications the ladybug drive seems to be making great progress. Perhaps it will be wise, however, to await the final report from the front.

The fine results obtained in Washington orchards through early fall spraying for apple anthracnose should encourage orchardists who have trees affected with this disease to apply the remedy which is given in this number of BETTER FRUIT. It means saving your trees and higher quality fruit.

Fruit storage houses and a thorough knowledge of them is a timely topic. The proper kind of a storage house may save your crop. It also makes it possible for you to market your fruit at the most opportune time. The time to build a storage house is well in advance of the harvest.

California leads the world in the apricot industry. In fact in the amount of tonnage produced from the area planted the Golden State exceeds any other spot on the globe. One of the big factors in this achievement is intelligent co-operation.

It is predicted that the time is fast approaching when American tractors will farm the world. They are farming a big slice of it now. Many orchardists are discovering that these machines are 100 per cent efficient. The iron horse has come to stay.

If grasshoppers become as much of a pest in the Northwest as they have in California the orchardist will be compelled to fight them. The United States Agricultural Department advises the use of poisoned bait. The formula is given in this number.

Experiments to improve huckleberry sounds good. There is no reason why the lowly huckleberry should not climb up into the aristocratic society of the cultivated bush berries. The huckleberry is the ne plus ultra of pie berries.

Work for our returned soldiers is a live issue. It would seem, however, that in view of the necessity of employing women in orchard work that the soldier who wants work could help himself a little.

Experimenting to Improve Huckleberries

FOR several years past Mr. F. V. Coville, of the United States Department of Agriculture, and Miss Elizabeth C. White, of New Lisbon, New Jersey, have been cultivating blueberries, also generally known as huckleberries, and have been working to produce new and better varieties. To get new varieties they find the very best wild bushes and then cross-breed these wild plants. The seeds resulting from the cross-breeding grow into all sorts of new varieties, just as seedling apples are seldom like the tree they came from. Many of these new varieties of blueberries are poorer than their parents, but about one in a thousand turns out to be much better than either parent and makes a promising new variety.

About ten years ago the Department of Agriculture published Mr. Coville's first work on blueberry culture. His most surprising discovery was that blueberries cannot live in a well-balanced fertile soil. They require a sour or acid soil and are actually killed by the application of fertilizer, which would be the best possible food for the ordinary plants. Some years ago a wild blueberry plant was found in Massachusetts with berries more than three-quarters of an inch in diameter, but it was killed by people who did not understand its proper care by being fertilized.

Since 1911 Miss White has been associated with Mr. Coville in these investigations, he in the government greenhouses at Washington working out the scientific problems and originating new varieties by cross-breeding, and she at New Lisbon, New Jersey, raising these new varieties and the best wild plants that could be found. Mr. Coville and Miss White are now trying to find a number of wild plants to use for this work. They already have a few plants that have berries three-quarters of an inch through, and hope to produce hybrid berries an inch in diameter. They want more unusually fine wild plants, and will pay fifty dollars for especially fine plants with very large berries.

But it is not only the size of the berry that counts, and they are willing to pay smaller prices for plants that have many berries of slightly smaller size if these berries are of unusually fine flavor. Some bushes bear much more heavily than others. On some bushes the berries stick so tight that when they are picked a piece of the stem pulls off with the berries, or the

berry is torn and the juice leaks out. On other plants the berries come off the stems just right. Berries from some bushes spoil soon after they are picked, while others will keep for a week. Some berries are black and others of a beautiful light blue color. There are doubtless thousands of bushes in the country with berries three-quarters of an inch or more in diameter, and many other bushes with berries just a little smaller but of unusually fine quality, but it is only by having people on the

watch for them that these fine bushes can be discovered.

The fine varieties developed by cross-breeding will be distributed by the Department of Agriculture to persons who have learned enough about cultivating wild blueberries to show they can handle the new varieties with success.

Persons who are interested in finding such plants should write at once to Miss Elizabeth C. White of New Lisbon, New Jersey. Miss White will send full directions, with measuring gauges, and bottles of formaldehyde for mailing large berries that are discovered.

WE ARE BUYING

ROYAL ANNE CHERRIES

10c per Pound

DELIVERED

Portland, Oregon, or Vancouver, Washington

Receiving Station Portland:
East Third and East Main Streets
Phones East 6096--B 2819

WE WILL FURNISH PICKING BOXES

OREGON PACKING CO.

“Listen!” says the Good Judge—

“And remember it, too.”

The better the quality of your
chew, the more you'll enjoy it.

You'll get more out of your tobacco money, too—you'll save part of it for something else. A small chew of this quality tobacco tastes good — and it lasts and lasts.



THE REAL TOBACCO CHEW

put up in two styles

RIGHT CUT is a short-cut tobacco

W-B CUT is a long fine-cut tobacco

NOW is the time to send to
Milton Nursery Company
MILTON, OREGON
FOR THEIR 1919 CATALOG.
FULL LINE OF NURSERY STOCK.
“Genuineness and Quality”

NORTHWEST ORCHARD LADDERS

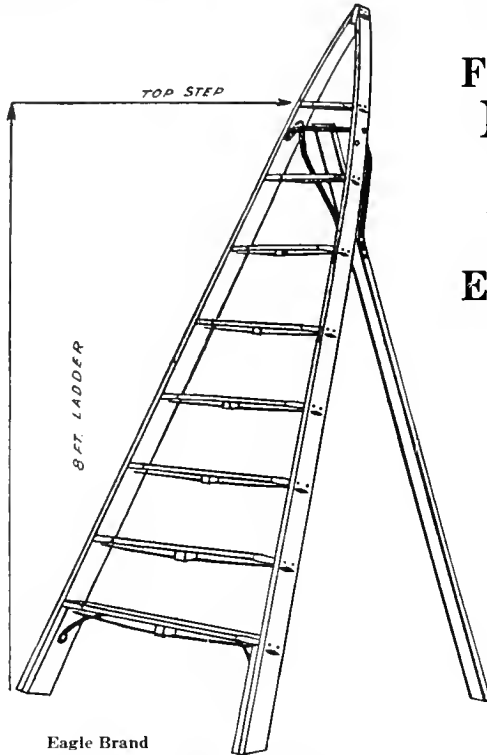

Eagle Brand

Over
Forty Thousand
Northwest
Ladders
in use today.

Every customer
satisfied.

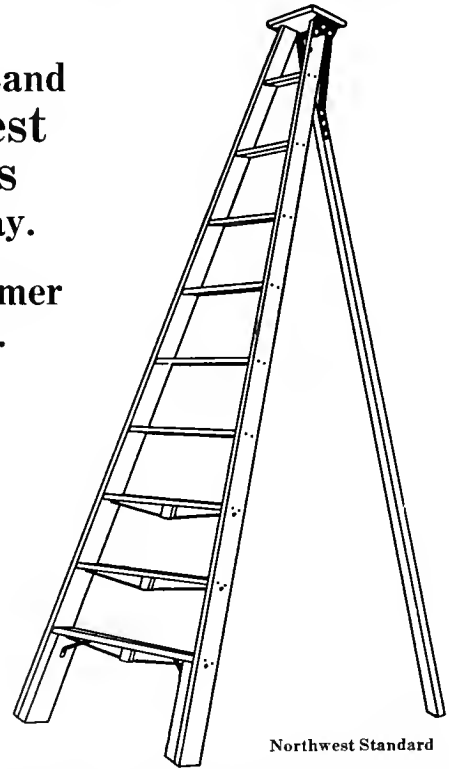

Northwest Standard

52-54 Union Avenue
Corner East Oak Street

Northwest Fence & Wire Works PORTLAND OREGON

THE VERY LATEST IMPROVEMENT IN FRUIT GRADERS

— IS THE —

“New Four” Grade IDEAL Fruit Grader

It is built for the largest growers and packing houses who require a large output each day.

The sizing is by diameter or cheek measurement, the most perfect way fruit should be sized.

We build the Ideal Fruit Grader in four sizes to suit any grower's need, and it will do perfect work on **Apples, Pears, Peaches, Oranges or any other fruit having similar shape.**

We have designed our machine so there is absolutely no bruising of the fruit in any manner. The machine is very simple in construction, with nothing to get out of order or out of adjustment. Does not make the least noise, as there are no metal parts coming in contact with each other to cause a lot of wear and trouble.

The grading is done by elastic bands revolving crosswise of the belt that carries the fruit along the machine until it arrives at the proper bin where it comes in contact with this elastic which rolls it off gently into its proper bin without injury.

This season's crop is such that we have had to double our output to handle our orders, as we are replacing other machines of other makes that have cost much more than what we are asking for ours.

Our prices are very moderate, as we have no agents or brokers to pay a large profit for selling, so by selling direct to the users we can sell very close.

It will pay you big to write us to get more information and prices before you buy, for our machine will prove very satisfactory, as it has to many others for the past few years.

We have one of the most complete shops with the best of machinery to build every part over a pattern to get them exact.

Write us for prices stating your needs then we will gladly quote you prices on any size machine you need.

We also carry in stock the Bryant Clamp Warehouse Truck that will save you the price many times over each season in labor.

WRITE US

IDEAL FRUIT AND NURSERY CO., Hood River, Oregon

How to Grow and Dry Apricots Successfully

A California Growers' Experience

APRICOTS are the first of the larger fruits that we handle. In previous years the buyers would want large fruit some years and in other years the demand was for both the larger and the smaller fruit. For the past two years, however, the demand has been so great for apricots that size mattered little if the fruit was of good quality. The normal demand, however, is for good sized fruit, and one of the problems that the growers have had to solve is to obtain it in a dry year.

Methods of Dry Culture.

There are two methods of obtaining large sized fruit in a dry year—deep plowing in the spring and good cultivation up to the time of thinning. If the trees are young, but of the bearing age,

they will hold the fruit longer and greener on the trees than trees ten to fourteen years old, the young tree ripening the fruit more slowly than the old tree.

If the spring rains do not come before the latter part of March it is time to commence deep plowing and thorough cultivation. At the proper time, usually between May 1 and May 10, the fruit should be thinned. On young trees the fruit should not be allowed to touch each other on the branch. The bunches and clusters in a dry year should be thinned out to half a crop to secure good sized fruit. Old trees should be even more severely thinned, as the fruit on them is inclined to grow in clusters of from four to twenty on a fruit stem. Thin them to one finger apart and to half a crop.

This advice is for the grower who has no system of irrigation. By following the above advice you will be reasonably assured of good sized fruit in a dry year and the sizes come up to the buyer's idea of good, clean fruit.

Irrigation.

If you wish to succeed every year, rain or no rain, you must have irrigation. If you have no water, place in your apricot orchard a good sized pumping plant, suitable to the number of acres of fruit. It has been my experience that it will pay every owner of a five-acre tract in orchard to have water to put on it when needed. Irrigation is the apricot grower's best investment to insure a regular crop.

Other Methods to Be Pursued.

Like other branches of fruit growing, apricot culture is a real science. One should know at sight the condition of the trees, their growth and what they need. Apricots need good heavy pruning every year. If it is a year of no crop there will be plenty of inside growth and lots of wood to cut out.

The year of a good crop there will be but little inside growth of wood. You should watch carefully the condition of your trees for the next year's buds by thinning out all the inside growth and shortening all straggling limbs. The trees should be sprayed in the latter part of November with bluestone and lime or bordeaux mixture. In February or just before the trees come into bloom they should be sprayed with lime, sulphur and salt or given another spraying with bordeaux mixture. The latter is

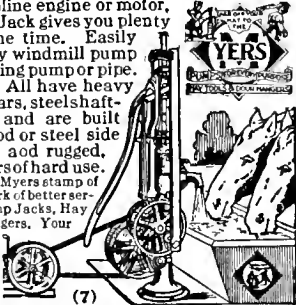

MYERS HONOR-BILT PUMP JACKS

With your gasoline engine or motor, a Myers Pump Jack gives you plenty of water all the time. Easily attached to any windmill pump without disturbing pump or pipe. Several styles. All have heavy machine cut gears, steel shafting and pins, and are built with either wood or steel side arms. Simple and rugged, they stand years of hard use. Each one bears the Myers stamp of quality. It is a mark of better service in Pumps, Pump Jacks, Hay Tools and Door Hangers. Your dealer will show you, or write direct.

F. E. MYERS & BRO.
135 Fourth St.
Ashland, Ohio

PUMPS FOR EVERY PURPOSE

Mitchell Northwest Distributors
LEWIS & STAYERS Co. Portland, Ore.



\$100.00 A WEEK

We want at least one well-acquainted ambitious driver in every locality to demonstrate and sell a wonderful new puncture proof tire. Gives Beadless Tires cost only half as much, yet guaranteed

5000 Miles Puncture-Proof

They're also oversize, better looking and easier riding. We help you establish a substantial floorishing business of your own, the weekly profits from which will amaze you. We show you how and give you every help. If you are ambitious to build a big business of your own, and are now making less than \$100 a week, write or wire at once.

GIVENS CONSOLIDATED RUBBER CO.
237 Second St. San Francisco

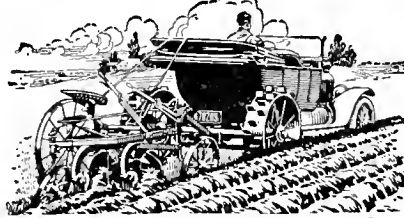

Make a Tractor of Your Car

Use it for farm work. Pullford catalog shows how to make a practical tractor out of Ford and other cars.

Write for Catalog
Pullford Co., Box 346C Quincy, Ill.

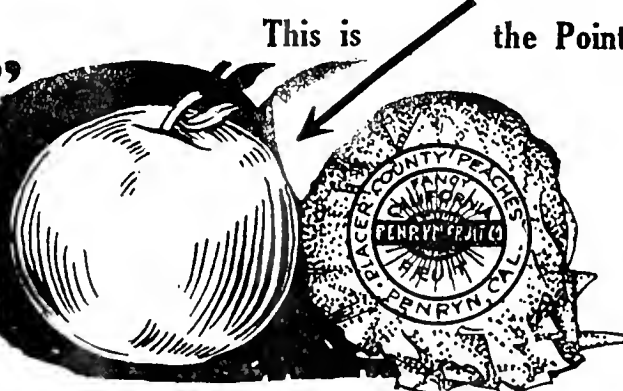

"CARO" FIBRE FRUIT WRAPPERS

This is the Point

Chemically Treated "Caro" Protects "Caro", from DessiCARE (to dry up)

"Caro" Prolongs the Life of Fruit Why?

Fruit decomposition starts from a bruise which opens tiny holes and permits the juice to escape and BACTERIA to enter. "Caro" clings closely and dries up the escaping juice. "Caro" ingredients harden the spot, kill the BACTERIA, arrests the decomposition—and thus **PROLONGS THE LIFE OF FRUIT.** If your fruit is worth shipping it is worth keeping in best condition.

Demand "CARO"—Wrap Your Fruit in "CARO"—The Fruit Buyer Knows "CARO"

Order from Any Fruit Company or American Sales Agencies Co., 112 Market St., San Francisco

more effective against blight and cleans up the bark also.

Like other fruit trees, there are four growths in the apricot tree each year: the bud growth and bloom, the leaf growth, the wood and fruit growth, and the last growth in September to strengthen the buds for the coming year. Then the trees become dormant.

A good time to prepare the land in an apricot orchard for winter is after the fruit is thinned. Run your furrows as the land drops away, plowing three feet from the trees on each side of the row, throwing the furrow toward the tree. When the land has been plowed in furrows one way, then cross plow, if the land is nearly level, every fifty feet; if steeper, every twenty-five feet. These cross checks hold the water from run-

ning faster than you want it. In this way the whole space, including furrows, will be covered with water.

The slower you put on the water, the deeper it sinks. On the first irrigation the land is so thirsty for that long drink you wonder where it is all going, but in a little time it comes along with a strong force until the whole row has been watered.

If your main ditch is large you can irrigate three or four rows at a time. Let the water seep into the ground through every row in the orchard. When you have finished the last row, go right back to the first row and commence all over again. The second watering will be done much faster than the first, and will be very effective.

Some parts of all orchards will dry

out sooner than other parts. Start the cultivation on the part that is ready. You can lose the moisture in a day, if you don't watch it. In three or four days start the cultivation. Do good work; do not skimp any part of the ground that was watered. After the cultivator follow with the disk harrow. Then follow with the clod smasher and smooth the land to prevent evaporation. In that way one will be able to raise good fruit in a dry year, and in no other way.

The Pumping Plant.

My apricots are Royals and Blenheim. The soil is a sandy sediment, twenty-eight feet deep, water gravel twenty-two feet, twelve feet of hard sand pan, where we reached second water. The total depth of wells is sixty-five feet. We have two wells in one pit.

We have a fine 18-horsepower crude oil gas engine. It is started with gasoline and distillate, and afterward run on crude oil. We have a No. 5 centrifugal pump, throwing a powerful stream. It is belted from the engine flywheel horizontally, and has connecting upright belt from the pump, with tightening jacks and levers.

The engine works easily. The pump throws 50,000 gallons an hour, or 500,000 gallons on a ten-hour run. The water is two feet below the pump, and after stopping the engine after a day's run the water is at the same level instantly.

The trees are planted in squares, 25x25 feet apart, and are thirteen years old. I consider a good crop six green tons to the acre, or one ton dried.

I never irrigate less than twice, and three times if needed. My personal judgment and how the trees respond to the water is my guide, but I always err on the side of "more water" for deep sediment soil such as I have. The bottom and top moisture should always meet beneath in any year to insure a full crop.

In ordinary years when the rains are plentiful during or at the time of blooming, only the healthy blooms will stick, which does not insure so large a crop, but larger fruit and not so many on the trees.

The Drying Yard.

During the drying season there are sometimes circular gusts of wind which come up in the afternoon, mostly from the south, and often overturn the trays and despoil the fruit. A cloud of dust rises also, making it very hard for the drying fruit. When this takes place never attempt to place the soft scattered fruit on the trays; if you do you will make a mess of it. Let it dry where it is, as you cannot save it all.

To obviate the trouble from dust we determined to plant alfalfa in the drying yard. After the fruit drying was over we flooded the drying yard space. It was then disked both ways and leveled and harrowed. The land was moist at the time and the seed came up. In April we cut the first crop. Just before we need the space for a drying yard we make another cutting, about June 20, cutting it down close and raking it

J. & H. GOODWIN, LTD.

Apple Exporters

Headquarters in United States
60 State Street
Boston, Massachusetts

*The Largest Handlers of American Apples
in English Markets*

You can send your apples direct from the United States into the industrial centers of England. The same organization (J. & H. Goodwin, Ltd., throughout) which ships your fruit from the U. S. A., sells and distributes in London, Liverpool, Manchester and Hull, and on the European Continent.

This means quick handling, considerable economies and the fruit being sold in the freshest possible condition, which means greater returns.

For Further Particulars Write or Wire Us at Boston
or 97 Warren Street, New York City

clean. Then we are ready to use the yard for trays and fruit. When the drying season is over the yard is cleared and the space then is as clean as a clay floor from being used so much. It is then flooded with water and in three weeks the top of the ground is green all

over and before the rains come we have another cutting crop; three crops a year, a ton at each cutting. So we make something from the space that was before occupied by trees and have also solved the dust problem, which means clean fruit and better prices.

cess, he secured the consent of Aaron Sapiro of San Francisco, attorney for the largest co-operative associations in California, to come to Portland and outline a plan of organization for Oregon growers.

Oregon Growers Form State Wide Association

AS the result of a recent meeting in Portland of seventy-five representative Oregon fruit and nut growers to consider the plan of organizing a state-wide co-operative association, articles of incorporation have been filed and a campaign of education is now being carried on to fully inform the fruit growers of the various sections in regard to the details of the proposed organization. The incorporators of the new association are Isaac D. Hunt, D. W. Johnson, E. L. Klemmer, J. O. Holt, E. W. Matthews, C. I. Lewis, George L. Zimmerman, Seymour Jones and W. E. St. John.

The articles of incorporation cover the formation of two organizations, the Oregon Growers' Co-operative Association and the Oregon Growers' Packing Corporation. Control of both organizations will be vested in the former. The articles of the Oregon Growers' Co-operative Association provide for a non-profit and co-operative organization to promote the production of all varieties of fruits and nuts and to handle and pack these products in the interest of the growers. A contract is provided for between the two organizations whereby the association will deliver its products to the packing corporation, which will handle them on a non-profit basis. The control of selling the packed products is left in the hands of the association. To become a member of the association the applicant must be an actual grower of fruit in Oregon.

The capital stock of the packing corporation is fixed at \$1,000,000. Of this amount \$500,000 worth of common and \$500,000 of preferred stock will be issued, and the plan provides that members shall take stock in the organization on a basis of \$10 for each acre of fruit in bearing. The marketing agreement provides that the grower shall sell his products to the association and that the association shall pay the grower the resale price, less the actual cost of handling and the other necessary charges, which must not exceed two per cent of the gross selling price. The two per cent to be retained by the association will be used to pay advertising costs, dividends, and to create a reserve fund to retire the preferred stock.

While the association will extend its operations to all the fruit-growing sections of the state, its most immediate action will be the absorbing and combining of the interests of the Salem Fruit Union, the Umpqua Valley Fruit Union, the Roseburg cannery, the Douglas County Prune Growers' Association, the Scotts Mills Prune Growers' Association, the Dundee Prune Growers' Association, the Eugene Fruit Cannery's

Association, and the Willamette Valley Fruit Exchange at Corvallis. The large capitalization proposed is for the purpose of providing funds for the purchase of the physical properties of these organizations, such as canneries, packing establishments and equipment, and to construct and maintain additional plants where necessary. Funds to finance the proposition, it is reported, will be forthcoming when the association is ready to commence operations. The new organization will not attempt to handle any of the Oregon fruit crop this year, but expects to have everything complete for taking over this allied fruit industry in 1920.

To give the various districts local representation in the central body it is proposed to appoint a board of directors from each district. It is expected that the new organization will be handling \$5,000,000 worth of fruit products in the near future.

The new organizations had their inception through the efforts of Robert C. Paulus, manager of the Salem Fruit Union. At the suggestion of a number of prominent fruit growers in the Willamette Valley, Mr. Paulus went to California, where he studied the operations of several of the big co-operative associations. Being satisfied of their suc-

The plan received the unanimous approval of the meeting of growers, who appointed an organization committee of the following to take it up: Robert Paulus of Salem, W. W. Silver of Dundee, George Zimmerman of North Yamhill, E. W. Matthews of Amity, K. W. Johnson of Corvallis, E. E. Klemmer of Alvadore, J. O. Holt of Eugene, A. N. Elliot of Dallas and Earl Percy of Roseburg.

The following were also chosen to act in an advisory capacity to the organization committee: J. A. Taylor of Scotts Mills, Seymour Jones of Salem, Stanley Smith of Albany, C. I. Lewis of Corvallis, E. M. Barlow of Eugene, W. C. Jamison of Hillsboro, L. F. Russell of Washougal, R. H. C. Wood of Roseburg, W. C. Harding of Roseburg, W. E. St. John of Sutherlin, John Busenbark of Roseburg, Frank Gibson of Salem, Henry Both of Dallas, E. W. Coulson of Scotts Mills, G. A. Dearborn of Dundee, Ferd Groner of Hillsboro, Kenneth Miller of Sheridan, J. E. Cox of Dallas, H. S. Butts of Dallas, C. C. Hall of Gresham, J. A. Riggs of The Dalles, C. E. Spence of Oregon City, J. E. Ferguson, Stanley Armstrong of Milston, J. J. McDonald of Salem and Professor McPherson of the Oregon Agricultural College.

These two committees worked out the plans of the organizations with the assistance of Mr. Sapiro, which were adopted, resulting in their incorporation as already stated.

Growing Cuthbert Red Raspberries in Oregon

By Oren Stratton, Brownsville, Oregon

IN discussing the subject of growing the Cuthbert red raspberry let it be understood that this article is not written with the intention of encouraging or discouraging the growing of this fruit, but rather of giving some of the experiences we have had in the past few years in connection with berry growing, that the reader may draw his own conclusions.

We first became interested in this business in the year 1907, when we plowed up some river bottom land which had never been cropped, and planted the Cuthbert raspberry in rows seven feet apart and the plants thirty inches apart in the rows. This proved to be a very satisfactory venture, as the plants grew very rapidly and produced some fruit the first year, and the second year the crop yielded about one and one-half tons per acre.

At picking time the young canes had grown to a height of six to eight feet, with a heavy foliage, thus making it very difficult to pick the ripe fruit, and neighbors who saw this splendid prospect were encouraged to set out small tracts to cane fruits. We had planted some loganberries and blackberries also

at this time, which gave equal satisfaction as to yield.

A few years later, when the price for fruit at the canning plants was very low, in fact too low to produce fruit at a living wage, many of the smaller growers plowed up their berries and have since grown other crops on their land. In 1914 we decided to enlarge our berry field, having sixty acres adjoining the tract which we had first planted, all river bottom land and well drained. The sixty-acre field, however, had been farmed to grain for the past fifty years, growing splendid crops, the wheat and oats growing as tall as the horses' backs when harvesting the crops. We found the growth of the canes on this sixty-acre field much smaller than on the first tract planted, which would only be a natural result from the continuous cropping of grain. We have applied land plaster, ashes, etc., to the ground, but thus far have found nothing as satisfactory for a fertilizer as stable manure, though we have only a limited supply of this for use on this berry field.

The second year after planting this tract we had only a light crop of fruit, and in 1917 and 1918 the summer seasons were very dry and as a conse-

quence we cannot give a very glowing report of the yield, as we lost quite a large percentage of the crop in the field, caused by the unusual heat ripening up the fruit much faster than we could pick with the help at hand, though under ordinary conditions we had enough to gather the crop as fast as it would ripen. The yield last season was only a little better than a ton per acre that was saved and delivered to the cannery.

We telephoned the employment agency and bureau at Portland for more pickers, but could not get any relief to help us out of the emergency caused by the unusual ripening conditions.

We now have a small farm tractor of the track-laying type with which we can cultivate between the rows and thus conserve the moisture during the heat of the season, should we have another year as dry as was the last.

I might mention another thing we did last July which I now think was unwise. As we finished picking the raspberries we had a little time to spare for the pickers before the Evergreens were ready to pick, so we had some of the pickers thin apples and others cut out the old fruiting canes from the Cuthberts, thus giving the new canes a better chance to grow during the balance of

the season. We found a surprise in store, for when the rains came on the new canes developed fruit spurs, blossomed and in November we had a splendid crop of berries growing on the wood of last year's growth. We picked as many of these berries as we could, sold some on the local market and shipped many crates to Portland, where they sold at retail for 25 cents per box.

Now the question is, will this impair the growth and yield of the plants to the extent of diminishing the crop for this year? At any rate, we do not plan to repeat the summer pruning this season.

Through the co-operation of the Oregon Agricultural College and under the instruction of Professor C. I. Lewis we applied, as an experiment, 500 pounds of sulphate of ammonia on one plot of ground and 500 pounds of nitrate of soda to another plot, as near alike as we could get, and will note the results in the berries, growth of canes, flavor and color of the ripe fruit, etc.

I cannot give an exact account of the expense per acre of growing the Cuthberts, as we do not keep a check on this field alone, but cultivate and care for the entire tract together, as we grow Cuthberts, Black Caps, Lawtons and Evergreens in the same field. On ordi-

nary soil I do not think raspberry growing is as profitable as the loganberry or Evergreen blackberry, but this, like other propositions, all depends on the price paid for the different kinds of fruits.

To sum up our past experiences I might say, with the prices which prevailed up to 1919, we came out just about even with our expenses, but with the prices that are being paid for all berry fruits at the present time I think where one owns suitable land it could not well yield better returns than in growing berries.

How long these prices will prevail I would not attempt to guess. History tells us that during the boom of 1910-12 about 50,000 acres of fruit was set out in the Medford district. Since that date about 20,000 acres have been dug up and the ground planted to grain and hay crops. It is best that we do not lose our balance of reason when these boom prices are offered. Let one try a small field at first.

I do not favor long-time contracts for fruit deliveries. I have had ten years' experience in the canning business, so I can view it from the standpoint of grower and canner. From my experience I would say that one year at a time is as long as I would advise.

Let the CUTLER

Cut Your Grading Cost 25% to 50%

The Cutler Mechanical Sorting Table will do it.

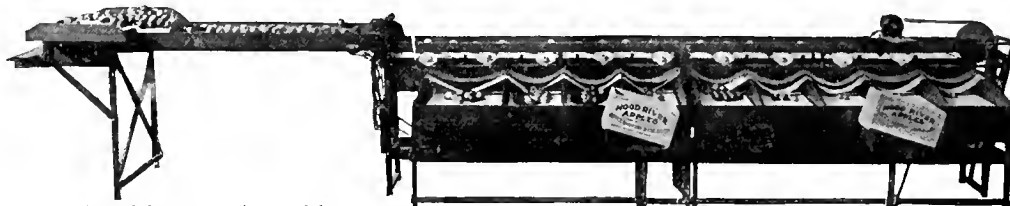

Side view of the two-section model

Read what the users of Cutler Graders have to say:

Chino, Cal., December 3, 1918.
Cutler Manufacturing Company,
Portland, Oregon.

Gentlemen: Your card for suggestions as to the use and care of the Grader was received with thanks. As to the grader which we purchased from you and used this season, we wish to express our perfect satisfaction as to the work it does, and would recommend it to anyone or firm wishing information as to the best grader they could buy.

Respectfully yours,
CHINO VALLEY APPLE GROWERS' ASSOCIATION
(Signed) B. M. Lederer, Secretary.

High Rolls, N. M., January 18, 1919.
Cutler Manufacturing Company,
Portland, Oregon.

Gentlemen: In answer to your letter of January 6th will say as to the Grader, it is just as you recommended. Well worth the price.

Very truly yours,
(Signed) S. KOTOSKY.

Wenatchee, Wash., January 22, 1919.
Cutler Manufacturing Company,
Portland, Oregon.

Dear Sirs: In reply to your of the 3rd instant, will say that I like my two-grade Cutler machine very much. One can take care of a crop much easier, as it saves so very much of the handling of the fruit where there is no grader. I used two packers and two sorters and one of the sorters packed quite a number of boxes each day. We packed out in all 5,200 boxes, averaging 235 a day. One man did the nailing up and stamping, waited on the sorters, besides waiting on one lady

packer, and made himself useful besides. I don't believe I would get along without a Cutler even at twice the price.

Sincerely yours,
(Signed) F. E. GAHRINGER.

Mr. Gahringer purchased a Two-Section Model in 1918. This is a case where our smallest model was run to only part of its capacity.

Wenatchee, Wash., January 29, 1919.
Cutler Manufacturing Company,
Portland, Oregon.

Gentlemen: We are very glad to report to you that we had elegant success with the 1918 grader that we purchased from you last season. We operated the machine thirteen hours per day four days each week, twelve hours two days and ten hours the seventh day. The machine ran continuously without a mechanical break and throughout the season we did not lose more than two or three hours on account of an occasional break with the belts. We put over the grader 67,000 boxes, with an average run of 1,400 boxes a day. Our best run in thirteen hours was 1,742 boxes. We are very enthusiastic over your grading machine and do not hesitate to recommend it very highly to anyone.

Very truly yours,
CLARK-OLIVER APPLE COMPANY.
By (Signed) D. L. Oliver.

The Clark-Oliver Apple Company purchased two Four-Section Cutler Graders in 1917, which were equipped with ordinary belt sorting tables, and in 1918 purchased one of our Four-Section Models equipped with our new mechanical sorting table. Operating both types in 1918 under the same conditions showed a big saving in cost of sorting by the mechanical table.

The output reported above averages 1131 packed boxes based on a ten-hour day. This substantiates our claim that the working capacity of the Four-Section Model is from 800 to 1200 packed boxes in ten hours. This letter also indicates the reliability and staying qualities of the Cutler Grader.

Cashmere, Wash., March 15, 1919.
Cutler Manufacturing Company,
351 East Tenth Street,
Portland, Oregon.

Gentlemen: Replying to your letter asking for statement of our experience with your graders, we wish to say that we have used your graders for several years and have been very much pleased with the results obtained.

During the past season we have operated four of your graders—one four-section and three three-section machines—all of which gave excellent service. However, while we have been satisfied with the work of the smaller machines, we believe in packing houses where the output is considerable, that the larger type of machine is the more desirable, as our experience has been that its capacity is very materially in excess of the three-section type. Trusting that this will give you the information desired, we remain,

Yours very truly,
CASHMERE FRUIT GROWERS' UNION,
(Signed) C. C. Lemmon, Manager.

The Cashmere Fruit Growers' Union is noted for the orderly and systematic movement of fruit through their splendidly equipped packing house at Cashmere, Washington. Their experience concurs with our recommendation that large growers and packers should use our Four-Section or Big Four Models.

THE CUTLER GRADER IS MADE IN THE FOLLOWING SIZES:

<i>For Box Packing:</i>		<i>For Barrel Packing:</i>	
2 section model—Handles 2 grades	18 bins	1 section model—Handles 2 grades	8 bins
3 section model—Handles 2 or 3 grades	26 bins	2 section model—Handles 2 or 3 grades	16 bins
4 section model—Handles 2 or 3 grades	36 bins	2 section model—Handles 3 grades. Combination box and barrel	
Big 4 model—Handles 2 or 3 grades	40 bins		

WRITE TODAY FOR CATALOG AND PRICES

CUTLER MANUFACTURING CO. 351 East 10th Street, Portland, Oregon

List of Northwest Fruit Shippers

IN accordance with its custom from year to year BETTER FRUIT is publishing this month a list of the fruit-shipping organizations, companies and firms throughout the Northwest. The list this year, as far as we have been able to make it complete, is a follows:

NORTHWEST FRUIT EXCHANGE

Baker-Langdon Orchard Co., Walla Walla, Wn.
 Bardwell Fruit Co., Medford, Oregon.
 Bleakley Fruit Co., White Bluffs, Wn.
 H. G. Bohlke, Dryden, Wn.
 Brewster District Unit, Brewster, Wn.
 Jas. H. DeVeney, White Bluffs, Wn.
 J. L. Dumas, Dayton, Wn.
 Entiat Fruit Growers' League, Entiat, Wn.
 Gerrick & Gerrick, Dryden, Wn.
 Clarence Hanford, Hanford, Wn.
 Indian Cache Ranch, Lewiston, Idaho.
 Israel Orchard Co., Dayton, Wn.
 Jones & Day, Dayton, Wn.
 Leavenworth Fruit Growers' Unit, Leavenworth, Wn.
 Methow-Pateros Growers, Inc., Pateros, Wn.
 Milton Fruit Growers' Co-operative Union, Freewater, Oregon.
 Montgomery & Robinson, Dixie, Wn.
 M. C. Moore & Sons, Walla Walla, Wn.
 J. H. Morrow, Walla Walla, Wn.
 Okanogan Growers' Union, Okanogan, Wn.
 Omak Fruit Growers, Inc., Omak, Wn.
 E. S. Phillips, R. F. D. No. 2, Cashmere, Wn.
 Spokane Fruit Growers' Co., Spokane, Wn.
 Stratford Orchards, Stratford, Wn.
 Sunnyslope Fruit Ranch, Prosser, Wn.
 Herbert Charles Taylor, Dryden, Wn.
 Touchet-Gardena Fruit Co., Touchet, Wn.
 United Orchards Co., Dryden, Wn.
 Waitsburg Fruit Growers' Association, Waitsburg, Wn.
 Walla Walla Gardeners' Association, Walla Walla, Wn.

Weiser River Fruit Association, Weiser, Idaho.
 Wells & Wade Orchard Co., Wenatchee, Wn.
 Wenatchee Apple Land Corporation, Quincy, Wn.
 Willamette Valley Fruit Exchange, Monroe, Oregon.

GRANTS PASS, OREGON

Eisman & Hunt.
 U. D. Mihills.

HOOD RIVER, OREGON

Hood River Apple Growers' Association.
 Kelly Bros.
 Hood River Fruit Company.
 Lava Bed Orchard Co.
 Dan Wuille & Co.
 Willis Van Horn.
 L. E. Ireland.
 Davidson Fruit Co.

MEDFORD, OREGON

Stewart Fruit Co.
 Denny & Company.
 George Kaufman.

Rogue River Co-operative Fruit Association.
 Rogue River Fruit & Produce Association.
 Earl Fruit Co.
 Guy Connor.
 J. F. Barkdull.
 Hillcrest Orchard Co.

YAKIMA, WASHINGTON

Roche Fruit & Produce Co.
 Denny & Co.
 R. L. Michaels.
 Yakima County Horticultural Union.
 Washington Fruit & Produce Co.
 Ryan Fruit Co.
 Hays Fruit Co.
 Thompson Fruit Co.
 C. M. Holtzinger.
 Thompson-Duddy Co.
 C. H. Stein.
 Pennington & Co.
 Congdon Orchards.
 Selah Fruit & Cold Storage Co., Selah.
 Thos. R. Robinson Co., Grandview.
 Bichey & Gilbert Co.
 J. MacPhee Ferguson.
 Pacific Fruit & Produce Co.
 Yakima Fruit Growers' Association.
 White Bros. & Crum.
 J. M. Perry & Co.

Fruit Growers of Oregon!

*Stop gambling with your fruit—
 Make your investment safe—
 Broaden and stabilize your markets—
 Get a better price for your fruit.*

The Oregon Growers' Co-operative Association

has organized with the following aims:

1. To nationalize Oregon's horticultural products under an Oregon label.
2. To gain wider distribution and thus prevent an over supply of fruit in limited markets.
3. To eliminate as far as possible the market speculator that stands between grower and consumer.
4. To raise the general standards of fruits so that they may sell for a higher price.
5. To stabilize the value of your investment by stabilizing your markets.
6. To eliminate waste caused by duplication of equipment in new fruit-producing centers.
7. To reduce growing and marketing costs, and to cut out unnecessary expenses of every nature.

This organization will be a business, owned and operated and controlled by and for you — the Oregon fruit producer. It is backed by the most prominent and experienced horticultural men in Oregon. Adequate financial arrangements are being concluded for handling of products.

The present list of incorporators include:

Isac D. Hunt, Vice President Ladd & Tilton Bank; Seymour Jones, Salem, Oregon; J. O. Holt, Manager Eugene Fruit Growers' Association; Prof. C. I. Lewis, Chief Dept. Horticulture; E. L. Klemmer, Fruit Grower, Alvadore, Oregon; B. W. Johnson, Secretary Willamette Valley Fruit Exchange, Monroe; George Zimmerman, Yamhill Fruit Grower; W. E. St. John, Sutherlin, Oregon, Fruit Grower and Douglas County Commissioner; E. W. Matthews, Amity Walnut Grower; Earl Percy, County Fruit Examiner of Douglas County; Robert C. Paulus, Salem, Oregon, Chairman Organization Committee.

INCORPORATION CLOSES JANUARY 1, 1920

For further information address

EARL PERCY, Secretary

Oregon Growers' Co-operative Association
 SALEM, OREGON

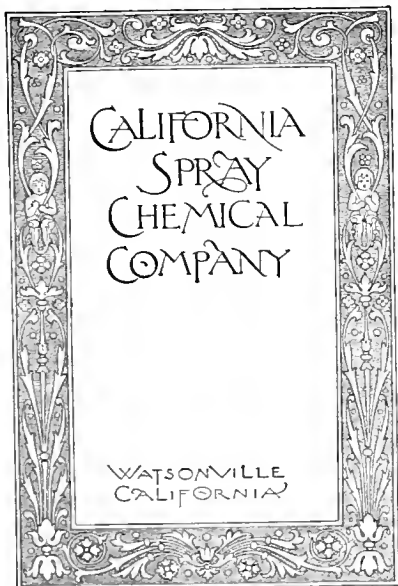

Beautiful 10-Acre Tract

Seven acres in nine-year-old select apples. Located on David's Hill, two miles from Forest Grove, Oregon. Price \$4,000.

Address LOTUS L. LANGLEY,
 Board of Trade Bldg. Portland, Ore.

For Sale or Trade

320 level acres, foothills, Southern California. No alkali or hardpan. Fruit and stock location, gravity water and good well, usual improvements, house and barn, etc. Ideal climate, elevation 3,000 feet. \$30.00 per acre. Write owner.

Box 211, Victorville, California

Dry Your Own Fruits and Vegetables

Imperative necessity demands nation-wide conservation of those portions of our food crops which have heretofore been permitted to go to waste. A considerable portion of this wasted food material is made up of perishable fruits and vegetables produced in home gardens and fruit plots in excess of the immediate needs of the producers, and in the absence of accessible markets for the surplus drying offers a simple, convenient and economical method for preserving food material and permits the carrying over of the surplus into periods in which fresh fruits and vegetables are expensive or unobtainable. Success in drying depends upon the observance of a few fundamental principles, and the quality of the product depends upon the care employed in the selection of the raw material, upon proper preparation for drying and upon careful control of the temperature employed.

In every district, no matter what the climatic conditions may be, drying by artificial heat has proven to be the most economical, quickest and most sanitary method of drying fruits and vegetables. We are therefore introducing our Home Fruit and Vegetable Evaporator. It is recognized by the best authority as being the most practical method of extracting water from fruits and vegetables that has yet been devised, and built especially for use on wood and coal-burning stoves and ranges, with the idea of utilizing their surplus heat.

It can also be used on gasoline, kerosene, gas and electric stoves by the aid of a deflector plate to spread the flame. This may be had at any hardware store by purchasing a piece of 18 or 20 gauge black sheet iron about 16x18 inches, according to the size or style of stove being used. These are not furnished with the evaporator, as there are so many different kinds and sizes of these stoves on the market that it would be impossible to make one deflector plate to fit them all. For instance, stoves having a cooking surface large enough so it would cover the entire bottom of the evaporator, a deflector plate large enough to cover the immediate flame would be sufficient.

Price \$12.50 complete

You could not make a better investment at this season—send your order in direct from this advertisement, or if you want additional information

Write for FREE BOOK "Best Methods of Drying"

This book has been prepared by experts. It tells: "The Possibilities and Limitations of Drying"—"The Fundamental Principles of Drying"—"Preparing Fruits and Vegetables for Drying." It tells how best to dry apples, pears, peaches, apricots, cherries, prunes, figs, berries, potatoes, turnips, pumpkin, tomatoes, sweet corn, beans, etc. Write today for this valuable book.

OUTWEST SUPPLY CO. PORTLAND, OREGON

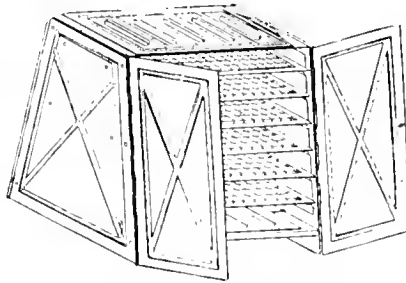

THE HOME Fruit and Vegetable Evaporator

shown above is constructed throughout of Willsville polished blued steel except the six trays, which are made of six-mesh galvanized hardware cloth. It is 18x20 inches at the bottom and 12x20 inches at the top and 24 inches high. Shipping weight, 28 pounds. The six galvanized trays, which are ½ inch deep, comprise a drying surface of approximately 14 square feet. The back is made sloping for two reasons; first, it can be used on the ordinary kitchen range without interference from the high closet; second, it acts as a deflector of warm air as it arises from the stove, deflecting the currents through the trays, as it ascends, giving a perfect circulation and producing even drying.

The large slide drafts at the top and bottom permit the control of the amount of warm air and enable the operator to maintain an even temperature. There is not a bolt or nut in the Home Evaporator, it being held together by five tie rods fitting into pockets on either end; it is hinged on all four corners, and can be folded into a small space in a few seconds by anyone, enabling the housewife to put it away when not in use. By the use of the Home Evaporator a complete process of evaporation can be accomplished in three hours or more, depending upon the article being evaporated.

The E. E. Samson Co.
C. R. Paddock & Co.
Earl Fruit Co. of the Northwest.
Growers' Service Co.
Western Fruit & Produce Co.
Sunset Fruit & Produce Co., Wapato, Wn.

WENATCHEE, WASHINGTON

Cashmere Apple Co.
J. H. Ferryman.
Galletly Fruit Co.
Wenatchee Fruit & Storage Co.
Northern Fruit Co.
Puyallup & Sumner Fruit Growers' Canning Co., Puyallup.
G. M. H. Wagner & Sons.
Settles Commission Co.
United Distributors.
Wenatchee Apple & Warehouse Co.
Wenatchee Northern Warehouse & Marketing Co.
Wilmeroth Co., C. W.
VanHorn & Baker.
Geo. D. Bryan.
Dow Fruit Co.
Clark-Oliver Warehouse Co.
J. H. Garrett.
P. R. Gussman Warehouse Co.
Wenatchee Warehouse Co.
Pacific Fruit & Produce Co.
Rex Spray Co.
Sunny Slope Fruit Exchange.
E. Wagner & Son.
Wells & Wade.
Wenatchee Produce Co.
Earl Fruit Co.
Ryan Fruit Co.
G. B. Tribble.

CASHMERE, WASHINGTON

Cashmere Apple Co.
Cashmere Fruit Growers' Union.
Earl Fruit Co.
Prentiss Warehouse Co.
Wenatchee Valley Fruit Exchange.
Cashmere Fruit Distributors.
Cashmere Warehouse & Storage Co.
East End Warehouse Co.
Sullivan & Gruiter.

MONITOR, WASHINGTON

Clarke-Oliver Co.
Growers' Supply Co.
Monitor Fruit Sales Co.

DRYDEN, WASHINGTON

Dryden Fruit Growers' Union.

PESHASTIN, WASHINGTON

Peshastin Fruit Growers' Association.
J. O. Killian, Entiat, Wn.
J. W. Forsythe, Okanogan, Wn.
O. R. Bond, Orondo, Wn.

Bureau of Markets Chief Resigns.

Charles J. Brand, Chief of the Bureau of Markets, U. S. Department of Agriculture since its inception in 1913, has resigned, his resignation taking effect at the close of business on June 30, 1919. He will become vice-president and general manager of a commercial concern with headquarters at Pittsburg, Pennsylvania. George Livingston, a member of the bureau staff, will be designated to act as chief of the bureau until Mr. Brand's successor is appointed.

Mr. Brand has been with the Department of Agriculture since 1903 and had charge of the forage crop and paper plant investigations and the cotton handling and marketing work of the Bureau of Plant Industry before the creation in 1913 of the Office of Markets, which was afterwards made a bureau. Under his direction, the Bureau of Markets has grown from a dozen employes to a staff of about two thousand, located in Washington and other cities and at country shipping points and it has built up, under Mr. Brand's direction, a nation-wide news service for producers and distributors of farm products and has carried on many investigations for improving marketing practices and methods.

Efficiency and Advertising Bring Success

By P. R. Parks, General Manager Spokane Fruit Growers' Company

THE Spokane Fruit Growers' Company was organized in May, 1913, to fill the need of an orderly control in the handling of the apple crop from the orchards in the Spokane district, which were in the infancy of their production at this time. Large acreages of land had been set to trees and the disastrous results of disorderly marketing in 1912 brought forcibly to the minds of the growers the necessity of combining together and co-operating with each other in the matter of properly grading, packing, shipping and selling of this fruit crop.

A central office was established in

Spokane with various branches at the shipping points. It was believed that an efficient office force and clerical force could be maintained at one central point to transact the business of various small communities at greater economy and more efficiency than could be had through various small forces at shipping points, which were very likely to be untrained, and would be employed for only a comparatively short season each year. The wisdom of this judgment has been demonstrated year after year.

Strict grade and pack rules were adopted and enforced; labels were selected and registered in the patent office, and every endeavor was made to put the apple crop of the Spokane district on the market in such a manner as would create favorable comment and a lasting reputation. Reflections of these endeavors have been apparent, year after year as the company has become older, in the matter of greater demand for fruit packed under the company's brands and a stability of price. It is apparent that no organization, or any individual shipper, can hope to establish a place in the markets of the world without sufficient tonnage to attract attention and without following the policy of delivering quality product.

Notwithstanding the fact that the Spokane Fruit Growers' Company had made an enviable place for itself careful investigation and a survey of five years' operations convinced the Board of Trustees it would be wise to affiliate with other growers' organizations in a general movement to stabilize and unify the grade and pack and to advertise the Northwestern apple. Consequently, in May of 1918 application was made for membership in the Skookum Packers' Association and the entire crop, of those grades and varieties permissible, was packed under this brand in the 1918 season. Evidence at hand, in the nature of favorable comments and increased prices, has convinced the grower members beyond question that the money spent in advertising is returned at least three times.

There is but one solution for the Northwestern apple growers' problem, and that is the placing of a superior product in a superior package in order to enable him to command the higher price which he must have, considering freight charges, to meet the competition in the large Eastern markets offered by Eastern growers. That this can be done is fully demonstrated by increased demand for Northwestern boxed apples.

The grower of poor fruit and the shipper of the same must, and will be, relegated to the discard; his tenure of life is very short. Quality of fruit, honesty of grade and pack and superior services in shipping and selling, coupled with advertising, are the factors which will put the apple industry of the Northwest on a stable, dependable commercial basis.

Universal Bushel Shipping Packages

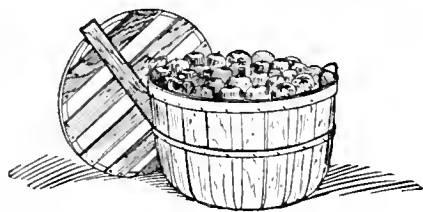

Will Pack One on the Other Without Injury to Contents

You can pack Universal Packages one on the other without the least possible damage to contents or the bottom package. In fact, 450 pounds can be rested upon the bottom package without fear of crushing or bruising fruit or vegetables therein.



Made of tough, strong material, reinforced at all burden bearing points, the Universal is easy to pack, easy to handle, easy to ship. The center post running from bottom to top, assures stability and strength.

Send for a Sample

25c in coin or stamps will bring a Universal Package to your address. Get our Monthly Bulletin of interest to growers and packers. A postal brings it.

Package Sales Corporation

106 East Jefferson St. South Bend, Indiana

Victory Home Food Drier

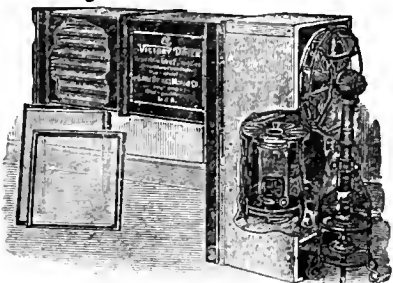

For vegetables, fruit and seed corn. It saves time, labor and money. Foods preserved in **The Victory Drier** "taste just like fresh picked." The process is simple, easy and sure and the foods thus preserved are delicious and wholesome. This is the best and the only dehydrator of the type in the world. Scientific, proved. Run by a Kerosene fan. Ask for catalogue D 2.

The Lake Breeze Motor, 561-B W. Monroe St., Chicago

YES HE WILL GET THEM AND HE WILL NOT FALL!

No More Wobble

—no more getting down to change the position of your ladder every half-minute! Get the

SECURITY LADDER

"A Ladder with the Wobble left out"

Bound and supported at every step by a patented steel cuff bracket. Cuts your picking costs. Saves pickers time by enabling him to reach out farther and feel a greater sense of security, means a better day's work; reduces picking costs!

SECURITY cuff brackets are made of two ounces of sheet steel, attached to each step-end and machine wrapped around stile (side-rail) by a patented process. Makes SECURITY ladders strongest where others are weakest, does away with cutting into and weakening stile to fasten steps in. SECURITY steps easily replaceable without weakening ladder. All wood vertical grain.

Most all big Sun-kist orange growers use SECURITY; used in many orchards of Sacramento and San Joaquin, recognized standard ladder in big apple districts of the Northwest SECURITY is the ladder YOU need NOW!

For sale by SECURITY dealers only. Write me, I will send you name of your dealer and new booklet on the SECURITY ladder. Write NOW!

J. B. PATTERSON
MANUFACTURER
82 Franklin St. Oakland, California

Dealers in the
SECURITY LADDER
Salem, R. L. Farmer Hdw. Co.
The Dalles, Walther-Williams Hdw. Co.
Wenatchee, Wenatchee Produce Co.
Yakima, A. B. Fosseen & Co.

Nice Bright Western Pine

FRUIT BOXES AND CRATES

Good standard grades. Well made. Quick shipments. Carloads or less. Get our prices.

Western Pine Box Sales Co.
SPOKANE, WASH.

SAVE YOUR APPLES

With a Monarch Hydraulic Cider Press you can turn your culls into good selling cider. You can also do custom pressing for your neighbors. Our improved high pressure construction gets all the juice from the apples with minimum power. All sizes of Presses, from 15 to 40 barrels a day. A small investment will start you in a profitable business. Ask for free, 60-page Press Catalogue describing our 1918 models.

WESTERN MONARCH MACHINERY CO.
308 E. Salmon St., Portland, Ore.

WE DEVELOP KODAK FILMS FREE and pay return postage when prints are ordered

Mail us films with Six Cents Stamps for each desired print. We return excess.

NO CHARGE for unprintable films.

Woodard, Clarke & Co.
Photo Supplies
Wood-Lark Bldg. Portland, Oregon
Ask for Catalogue and Special Offer.

Developing Local Market for Oregon-Grown Walnuts

By Knight Percy, Secretary of Western Walnut Association

THERE are no reliable statistics to be had of acreages of nuts planted in Oregon. During the last four years the writer has roamed around among the nut orchards considerably, he has read all items concerning nut orchards that have come to his attention and he has talked nuts with everybody who would talk on the subject with him. In this manner he has learned of the whereabouts of many orchards. The acreage, ownership, age and other data covering the orchards in every case been carefully recorded. No claim is made that these records are complete, but until someone presents a more complete set of statistics I shall consider them the most complete available for the state.

My records show some 6,100 acres of walnuts planted in Oregon. Whatever plantings that are not here covered are probably largely small ones scattered about in districts where walnuts are not widely grown. I am of the opinion that a complete survey of the situation would show close to 8,000 acres in the state.

I have the ages for about 4,400 acres of the above; 927 acres are between one and five years of age; 3,116 between six and ten; 226 between eleven and fifteen, and 160 over fifteen years; 5,300 acres are tabulated according to county. Yamhill leads the state with 3,162 out of the 5,300. Marion is second with a little over a thousand acres. The records in this county are the most complete that I have, as they were largely taken from a survey of the orchard plantings made by Mr. Van Trump, county fruit inspector of that county. Washington has 441 acres; Polk, 402; Lane, 227, and Linn 105.

The tabulation according to age indicates that about 70 per cent of the plantings are between 6 and 10 years of age. In other words, some 70 per cent of the total plantings of the state are at the age where they are coming into bearing and rapidly increasing their yields. Quite a per cent of these are trees grafted from varieties that tend to come into commercial bearing at an earlier age than does the average seedling orchard.

The thought probably comes to many that a large part of these orchards will never come into commercial bearing. I am well enough acquainted with 3,500 acres in the state that I have undertaken to forecast their futures and to tabulate them accordingly. From this tabulation I have reached the conclusion that about 60 per cent of the total plantings of the state will in time average 800 pounds and over per year. About 25 per cent are worthless commercially and the remaining 15 per cent will yield an average of 400 to 500 pounds annually.

Clarke County, Washington, which is tributary to the same local markets as we are, has 7,136 walnut trees, according to a local survey.

Seventy-five thousand pounds covered the walnut production of this state in 1917. In 1918 the production was probably more than 200,000 pounds, and it will continue to double each year for several years to come and to increase annually for many years, as more plantings are going in every year. Those who have had marketing difficulties with walnuts during the last few years can imagine where we will be within a few years in case we continue to re-

main unorganized and to undertake to grade and market our nuts as individuals.

A Portland nut broker, who is in a position to know, informs me that the annual consumption of the territory for which Portland is the jobbing center is as follows: Eight to ten cars Manchurian walnuts; twenty cars unshelled walnuts (other than Manchurians); 24,000 pounds (one car) of chestnuts; 150,000 pounds unshelled almonds;

*Packers and Cannerys
Are You Aware?*

Make This
Season a
REX
SEASON

THOUSANDS ARE ADOPTING

REX DRY PASTE

AND COLD WATER

Smooth as silk — Will not stain or sour — Wonderful sticking qualities
Will not separate water — No acid to rust can

Don't take our word—write today for sample.

PATENT CEREALS COMPANY
325 Thirteenth Street, Oakland, California

The Car Lasts Longer

—because Zerolene meets with scientific accuracy the lubrication needs of the car. It is refined from selected California crude oil. Deposits least carbon. Get a Correct Lubrication Chart for your car.

STANDARD OIL COMPANY
(California)







Corrugated Joint Fasteners

Make Strong 2-Piece End Boxes.

Acme's Patented Divergent Saw Edge Fasteners will not pull out and holds better than cleats or glue.

ACME STEEL BOX STRAPPING

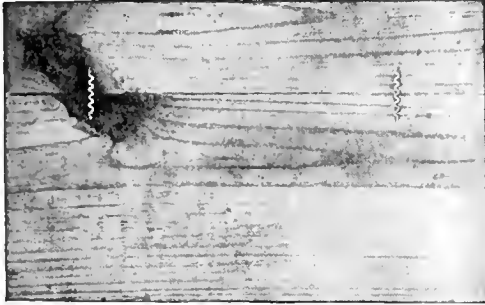

Write nearest office for samples and prices.

ACME Strapping protects goods from damage and pilferage.

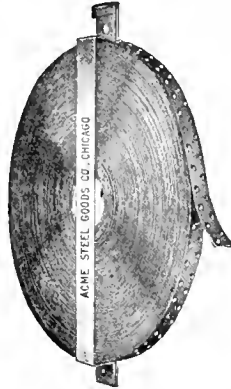

Specify ACME CORRUGATED JOINT FASTENERS.

ACME STEEL GOODS CO., Mfrs.

Works: 2840 Archer Avenue, CHICAGO

Branch and Warehouse: 209 California Street, San Francisco, Cal.

Branch and Warehouse: Foot of Main Street, Seattle, Wash.

Warehouse Only: Holman Transfer Co., Portland, Ore.

30,000 pounds shelled almonds; 40,000 pounds unshelled filberts; 6,000 pounds shelled filberts. If the Portland territory consumes this amount of nuts it is safe to say that the Seattle territory consumes at least an equal amount and that the Spokane district gets away with 30 to 50 per cent of this amount. This territory logically belongs to the Oregon growers.

It is certainly worth our cultivation. It will be our chief market, of necessity, until production increases and the growers pool their products so as to be able to take advantage of carlot freight rates. We cannot compete with California and Europe in the Eastern markets until we can ship in carlots. Even then we should confine our selling to the local markets until they are consuming Oregon nuts to their full capacity. Selling in distant markets means increased freight rates, increased advertising costs and increased selling costs.

However, the fact that this is our logical market will not bring the market to us without effort on our part. The market must be intelligently developed. The jobbers are in the habit of buying from California or from brokers who handle imported stuff. It will take time and effort to break these habits. We cannot do this as individuals unless we are willing to cut considerably under the selling price of California nuts, and price cutting is a poor business.

Oregon walnuts, when they fall off the trees, have no superiors anywhere, but too often by the time they have reached the market their condition justifies their classification as culls or seconds at best. This may be due to ignorance, carelessness or to lack of facilities in harvesting, curing and grading.

Big sales are the cheapest ones. There is more net profit to the grower in selling a carlot at 30 cents than in hawking a crop about in fifty-pound lots at 30 cents. Few of our individual growers are or ever will be able to sell in carlots. The few growers who may be able to ship in carlots and who are turning out a high quality of product will have difficulty in selling to the big jobbers, since these jobbers feel that they have no reliable guarantee as to the grade of the nuts as they have in buying California stuff. There is no

PRINTING

FOR FRUIT GROWERS, CANNERS, MANUFACTURERS AND MERCHANTS

CATALOGS STATIONERY
 BOOKLETS BLANK BOOKS
 POSTERS LABELS
 ADVERTISING MATTER

WRITE FOR PRICES AND SPECIFICATIONS • OUT OF TOWN ORDERS EXECUTED PROMPTLY, ACCURATELY AND ECONOMICALLY
 WE PRINT BETTER FRUIT

F.W. BALTES & COMPANY
 PORTLAND, OREGON

FRUIT GROWERS

Can't Afford the Loss of Bruised Fruit Picked in Ordinary Bags or Buckets when they can

SAVE THIS BIG LOSS BY USING

Palmer Picking Buckets

Which are LABOR and FRUIT SAVERS and Useful for Many Purposes.

Prices { Single Bucket ... \$1.50 } Special Prices on Large Orders
 { In Dozen Lots ... 1.15 }

Send your order with remittance to

HOOD RIVER FRUIT COMPANY

Bucket Filled

HOOD RIVER, OREGON

Bucket Emptied

WHEN WRITING ADVERTISERS MENTION BETTER FRUIT



standard of grading used by any great number of growers over the state.

Necessity will in time force the walnut growers to organize. It has been the history of co-operative organization that growers have refused to organize until necessity, in the form of several years of disastrous returns, has forced the individuals to join hands in the formation of an efficient sales organization. Indications are now that the walnut growers of Oregon will enter the big co-operative fruit growers' association that is being organized and secure the proper marketing facilities for their rapidly-growing output.

Northwest Fruit Notes from Here and There

Yakima Valley Fruit Growers who have made a success of dehydrating apples are now experimenting in drying pears. They have commissioned Ira D. Cardiff of the Washington Evaporated Fruit Company to go to California and investigate the most improved methods of drying pears.

The Hood River Canning Company announces that it will make a departure from the usual custom in handling cherries of the Royal Ann variety. This year a large part of the cherries to be handled by this company will be packed in barrels. Members of the company say that they are satisfied cherries marketed in this way will find a ready demand.

The Wittenberg-King Company of Portland, which has made a marked success in dehydrating fruits and vegetables, has recently invaded the Warren, Oregon, district and contracted for 100 acres of strawberries for four years. Fruit growers in this section are reported to be well pleased with the deal, as it secures for them a stable price for several years.

High prices for fruits are now reported in the Yakima Valley. The going price for cherries during the past month was raised by degrees to 13 cents a pound and a large number of sales in big quantities were made at 12 cents. One grower reported the sale of his Bing cherries at 16 cents. It is said that \$2 per box has been offered in the Yakima district for Jonathans, orchard pack. Prices of peaches will run up to 80 cents per box, while pears are being bought at \$50 per ton, according to these reports.

Lane County, Oregon, owners of Evergreen blackberries until recently had refused to contract their crops. Last year was the first time that a crop in that district was generally harvested. More than \$72,000 was realized from the fruit which had been allowed to grow wild. In 1918 the crop was harvested by University of Oregon students and high school girls, who picked over 900,000 pounds of these berries, which were canned.

Under the direction of the U. S. Department of Agriculture, a survey of farm and orchard conditions is now being made in Jackson County, Oregon. The survey is being made by Miss Anne McCormick, who states that she is meeting with cordial co-operation from the rural residents of the community.

A complete soil survey is now being made in Josephine County, Oregon, by Mr. Kocker of Washington, D. C., and E. F. Torgeson of the Oregon Agricultural College. While the work is said to be progressing as rapidly as possible it will take three months more to complete the task. When finished, the different soils of the county will be classified in the individual sections.

Reports from Grants Pass, Oregon, are to the effect that that district has gone safely through the frost period and that the grape crop, which was at first thought to be damaged, promises to be the largest in several years. In fact, a bumper crop of fruit of all kinds is expected in the Grants Pass district.

Believing that the climate and soil of the Marshfield and Astoria districts of Oregon are well adapted to the growing of fruit, particularly the growing of berries, the Chambers of Commerce in these places have made arrangements with prospective growers to market their crops and they are planting a large acreage to

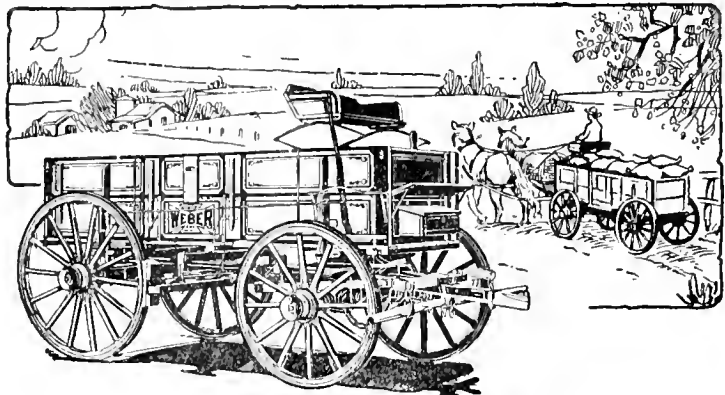

Safety in Wagon Buying

BEAR this point in mind the next time you buy a wagon—**Columbus and Weber wagons are guaranteed to stand up under capacity loads.** You don't have to be a wagon expert to buy a **Columbus or Weber** wagon safely. All you really need to know is the weight of your heaviest loads. Buy a wagon marked to carry that load and we guarantee safety and satisfaction.

Ask any dealer who carries **Columbus or Weber** wagons to show you just what we mean by this statement, or write to us for full information. Our wagons have many good features—the International fifth wheel, the sandboard wear plate, link end rods, folding end gate, superior material—more features than you will find on any other wagon. All these help to give the good service, long life and economy that you get with **Columbus or Weber** wagons. The same high standards of quality and satisfaction apply to all the machines in the list below.

The Full Line of International Harvester Quality Machines

Grain Harvesting Machines	Haying Machines	Corn Machines
Binders Push Binders	Mowers Tedders	Planters Drills
Headers Rice Binders	Side Delivery Rakes	Cultivators
Harvester-Threshers	Loaders (All Types)	Motor Cultivators
Reapers Shockers	Rakes Bunchers	Binders Pickers
Threshers	Combination Side Rakes and Tedders	Manure Cutters
	Sweep Rakes Stackers	Shellers
	Combination Sweep Rakes and Stackers	Huskers & Shredders
	Baling Presses	
		Other Farm Equipment
		Cream Separators
		Feed Grinders
		Manure Spreaders
		Straw Spreader
		Attachments
		Farm Wagons
		Farm Trucks
		Stalk Cutters
		Knife Grinders
		Tractor Hitchers
		Binder Twine

International Harvester Company of America

(Incorporated)

Billings, Mont. Crawford, Neb. Denver, Colo. Helena, Mont.
 Los Angeles, Cal. Portland, Ore. Salt Lake City, Utah
 San Francisco, Cal. Spokane, Wash.

APPLES

PEARS

For European

Distribution

Gerald Da Costa

Long Acre, Covent Garden, London

Cables: "Geracost, London."

Codes: A. B. C. 5th Edition and Private

SHIPPING AGENTS:

Lunham & Moore, Produce Exchange, New York



**TRESPASS
NOTICE**

Anyone found trespassing on
this property will be prosecuted
to the full extent of the law

Owner

**Just Like Having a
Big Policeman to
Guard Your Property!**

Trespassers cost you many dollars each year. They break down fences, steal your fruit, kill your poultry and livestock. Our TRESPASS signs will keep them out. They are printed on oil-treated tough cardboard—absolutely rain and sun-proof. Will last for many years. Each sign is 14x11 inches, and they will keep the trespassers out just as effectively as if you had a big policeman on each side of your farm to guard your property.

Six Big Trespass Signs for \$1
Postpaid—12 for \$1.75

Send today for a supply of these signs and tack them up in conspicuous places along the line fence. Six guaranteed sun-proof and water-proof signs (as illustrated above), size 14x11 inches, mailed, postpaid, for \$1.00, twelve signs, postpaid, for \$1.75.

ADDRESS

Outwest Supply Co.
PORTLAND, OREGON

berries. The Chamber of Commerce at Marshfield has agreed to erect a cannery there if the farmers of that district will plant 250 acres to berries.

While unfavorable weather conditions cut down the estimated tonnage of 115 cars from the Hood River district, over 60 cars of berries had been shipped by the Hood River Apple Growers' Association up to June 20th. Although the yield was cut down considerably by extra cold nights and rain, the fruit produced was of a very large size. The outlook for canning strawberries from the Hood River district, it is stated, is not favorable. This, it is said, is due to the high price at which fresh fruit was selling, the majority of the shipments bringing \$4 per crate.

A dividend of over \$100,000 which was recently made available to members of the Hood River Apple Growers' Association, more than convinced them that co-operative methods of selling apples is successful. The amount which will be paid Hood River growers in dividends is money that has been saved on the estimates made for covering the handling and marketing of their fruit. An interesting statement in connection with the payment of this dividend, contained in Manager Stone's report, is that, notwithstanding the heavy increase in the cost of labor and materials used by orchardists, and all other requirements, the charge to the grower has remained the same during the six years that the association has been organized.

Although Yakima fruit workers lost in the strike which they organized last fall for recognition of their union and a higher wage scale, they have adopted a new schedule for 1919. They are now endeavoring to obtain agreements with fruit growers and warehouse men before the season opens. The 1919 scale, as proposed by the union, is as follows:

Common labor—55c per hour.
Packers—6c where sizers are used and 7c with tables, on apples and pears; 3½c per box for peaches; 7c per box for prunes.

Box making—\$1.25 per 100 boxes for two-piece work and \$1.35 per 100 for three-piece work on apple and pear boxes; 80c per 100 for peach boxes; \$1.25 per 100 for "suit cases."

Lidding—\$1 per 100 for three-strap lids; 5c added for each additional strap—these prices for apple and pear boxes; 70c per 100 for peach boxes.

Transportation to be furnished, or paid for, where the work is out of the city.

The fruit-thinning situation, which promised to be serious in the Medford district, was finally adjusted and orchardists very materially assisted by women and girl workers who volunteered for the work. Orchard and ranch hands, however, are said to be still needed very badly in the Medford district.

Reports from Hood River are to the effect that more pears than apples are being set in the new acreage that is being planted to fruit in that district. The varieties that are being planted are d'Anjous, Bartletts, Bose and Comice. Gordon G. Brown, horticulturist at Hood River Experiment Station, recommends the planting of Winter Nelis for pollenizers. The high price received for pears in the Hood River district is said to be influencing orchardists to plant pears instead of apples.

Grays Harbor County will have a bumper yield of apples this year, according to Mr. O. T. McWhorter, County Agent. The trees are said to have huddled well and to have received no injury from the frost.

The Sunnyside Cannery, which has not been operated for a year or two, it is now reported, will be opened for business this year. The management of the cannery will be under the direction of Edward Hewes, manager of the Sunnyside branch of the Yakima Horticultural Union. The new canning venture is being backed by the Younglove Company, who have become owners of the plant and will have new machinery installed in time to handle the peach crop this season.

On account of lack of pollination, the cherry crop in The Dalles and Mosier districts of Oregon will be short this year, according to reports from that section. Apples in the Mosier district, however, are said to be in fine condition and are expected to surpass anything in former years in the way of quality and tonnage.

Quick action by a determined group of Hood River strawberry growers stopped a recent strike among berry pickers. Organizing themselves into what they called a body of "vigilantes," the growers went to the camps of

No "holes" in it

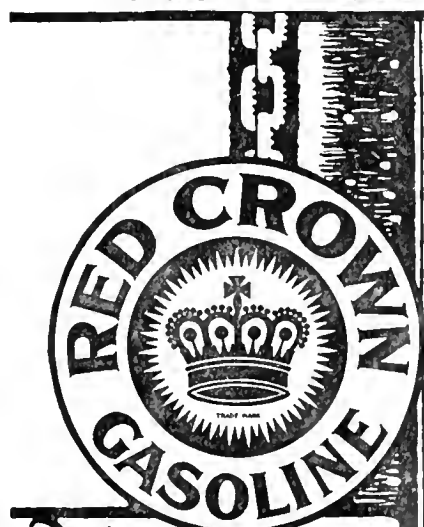

Red Crown's uniform chain of boiling points gives easy starting, quick and smooth acceleration, high power, long mileage. Mixtures have "holes" in the power chain. Look for the Red Crown sign before you fill.

STANDARD OIL COMPANY
(California)

*The Gasoline
of Quality*

a number of pickers who had been visiting ranches in that district and endeavoring to get the pickers to strike and ordered them to leave the valley. The strike agitators were at first defiant, but later, before the determined stand of the growers, consented to go back to Portland. The pickers were receiving 12 and 13 cents per carrier and a good picker could earn as much as \$4 per day. The strikers were demanding 15 cents per carrier.

What They Are Doing in California

The California State Industrial Welfare Commission recently issued an order to the effect that women workers engaged in the preparation of fruit and vegetables in canneries must be paid at the rate of not less than 28 cents per hour. The order is said to affect 20,000 women who are working in the California canneries; it provides that no women or female minors may be employed in the canning industry at a rate of less than \$13.50 per week.

It is reported that the largest almond orchard in California will be planted next season. The orchard will be 750 acres in extent and will be set near the Oakdale district by C. W. Klough of San Jose.

Warnings were recently issued to the orchardists of California by G. H. Hecke, State Commissioner of Horticulture, in regard to an invasion of grasshoppers. These insects, which are reported to be very numerous this year in many sections of the country, have been giving California orchardists a good deal of trouble. They are now endeavoring to get rid of them by a poison mixture that was recommended by the State Horticultural Commission.

The canning season for apricots in California opened June 15th and the output of this fruit from that state this year is expected to be the largest in its history.

It will be interesting for Oregon fruit growers to know that California has what is known as a Housing Act which is designed to regulate housing conditions for help employed by the fruit growers in that state. In order to conform with this act, the Valley Fruit Growers' Association of the San Joaquin Valley recently raised a fund of \$20,000 to improve the conditions of its community labor camp.

Notwithstanding the uncertainty of the wine grape growing industry in California, a 20-acre vineyard in the San Joaquin Valley recently sold for \$1,000 per acre.

One of the most profitable fruits in California during the past season was the grape-fruit. The demand for this semi-tropical fruit is said to be steadily growing and larger acreages of it are being planted in several sections of the state.

Sixty-four thousand dollars was recently paid for a 150-acre peach orchard in Merced and Fresno Counties. Another fruit orchard containing 400 acres of peaches, apricots and prunes sold for \$250,000.

Fruit growers in the Imperial Valley are organizing a movement to prevent alien tenancy of lands in that section. The growers call the movement an Americanization program. It is said that at the present time there are about 25,000 acres in the Imperial Valley that are owned or controlled by Japanese or Hindus. About 50 per cent of the Hindus are reported to have recently moved to the Salt Valley in Arizona, owing to the opposition in California.

A fig tree growing upon Chas. O'Neil's place near Oroville, California, is said to be the largest yet found. The trunk of this tree measures 8 feet in circumference and it has a branch spread of 65 feet. It is estimated that the tree is about 68 years old.

Now that prices for all varieties of fruit in California, as well as elsewhere, are jumping up by leaps and bounds a good deal of dissatisfaction is reported among the growers in the San Joaquin Valley who have long-time contracts with packers and canners. The growers claim that the advance in the price of labor and other items leaves them with little, if any, profit from the year's business. The contract grower is now said to be selling his fruit for \$35 per ton, while the open-market price is around \$70. Many of these contracts, it is reported, were made at \$22.50 to \$25 per ton. Growers are of the opinion that their contracts should be revised upwards.

In a talk on the benefits of co-operation among fruit producers recently made by Col.

"Black Leaf 40"

CHANGE IN PRICES Effective June 1, 1919

We fully realize that a change in the selling prices of a standard commodity like our "Black Leaf 40" causes very considerable inconvenience to all parties in interest. It has long been our custom to "take the general average" of profit over a period of years—rather than to make more frequent changes in price, in direct proportion to varying conditions in the cost of manufacture, etc.

In this connection, you will probably recall that no advance was made in our prices for "Black Leaf 40" during the entire period of the recent War—a circumstance that was happily aided by the fact that we had accumulated some surplus stock of nicotine, thereby the better enabling us to absorb part of the increasing costs which we had hoped would be merely temporary.

However, the heavily increasing demand for "Black Leaf 40" has so reduced this surplus, and the present conditions relative to raw material, labor, supplies, etc., are such that we regret we must announce the following change in our prices, effective June 1st, 1919:

10 lb. tin	\$13.75 each
2 lb. tin	3.25 each
1-2 lb. tin	1.00 each

The Kentucky Tobacco Product Company

INCORPORATED
LOUISVILLE, KENTUCKY



WHAT EVERY HOME CANNER SHOULD HAVE

ONE of our **H. & A. Hand Power Double Sealers**. It is the only hand power seamer built that will seal all sizes of sanitary fruit and vegetable cans. Write for prices and descriptive matter to Department T.

HENNINGER & AYES MFG. CO., Portland, Ore.

Builders of Sealers and Steam Pressure Canning Outfits

A WADE does 10 mens work Saws 25 cords a day!

A money-maker and hard work saver for land clearers and wood-cutting contractors. One man can move it from cut to cut. Simple and reliable. Hundreds in use all over the U. S. When not in use for wood cutting, the 4 H. P. motor will run mills, feed mills, feed cutters, pumps, etc.

"My Wade saw is cutting wood for less than 3 cents a cord."—F. J. Williams, Burns, Ore.

"I have saved through five foot solid oak logs at the rate of one foot a minute."—N. P. Myers, Laton, Calif.

America must burn more wood for fuel. One Wade will do 10 men's work at one-tenth the cost. Write for free Book, "How Dan Ross cuts 40 cords a day," full details and special price.

Quick deliveries from over 100 points throughout the United States.



REWADE & CO.
SINCE 1865

397 Hawthorne Ave., Portland, Ore.

The Big Factor Is Dependability

Any truck will perform more or less satisfactorily under favorable conditions, but dependability, according to the BETHLEHEM standard means consistent performance under any road or load conditions.

1½-ton Chassis **\$1,965** 2½-ton Chassis **\$2,365** 3½-ton Chassis **\$3,465**

F. O. B. ALLENTOWN, PA.

SOME GOOD TERRITORY OPEN TO DEALERS

NORTHWEST AUTO CO., Portland, Oregon

Distributors for Oregon and Washington

Mail the Coupon for Catalogue

BETHLEHEM
Internal Gear Drive
MOTOR TRUCKS
Dependable Delivery
BETHLEHEM MOTORS CORP. ALLENTOWN, PA.

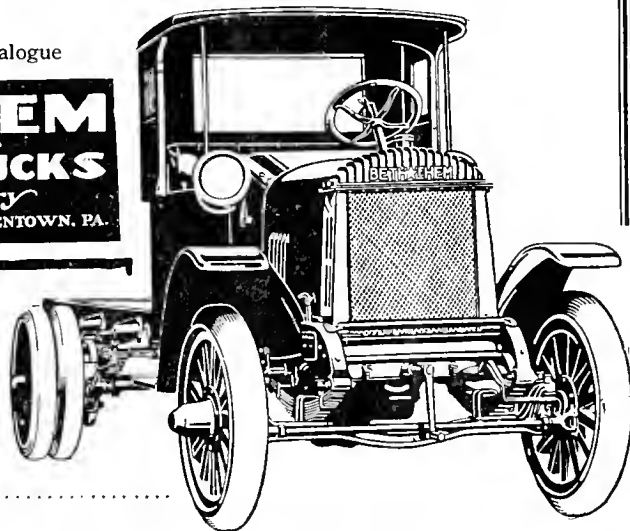

To Northwest Auto Co.
Portland, Oregon

Send catalogue of
Bethlehem Truck to

Name

Address

Ridley, Houlding & Co.

COVENT GARDEN, LONDON

WE ARE

Specialists in Apples and Pears

CABLE ADDRESS: IBOTANIZING, LONDON

Codes: A. B. C. 5th Edition and Modern Economy

Weinstock, State Market Director of California, at a banquet tendered him at the Arlington Club at Portland. Col. Weinstock, who was instrumental in the organization of the big fruit-growers' associations in California, said that before the growers were organized only seven and one-half cents of the consumer's dollar went to the producer. "The organization of the co-operative fruit-growers' associations in California," Col. Weinstock said, "has changed the entire face of the country, whereas in 1914 many horticultural industries were in such a condition that land values had dropped to a point where prices were based upon the value of the raw land less the cost of pulling up the trees and vines, when the producer was receiving less than cost of production and was virtually bankrupting—in 1918 every horticultural industry in the state has been stabilized, the producers are receiving a fair profit for their products and a consumer demand has been created through national advertising far exceeding present or future potential production."

Bits About Fruit, Fruitmen and Fruit Growing

Predicting one of the best export markets for box apples in many years, J. Oliver of London, England, who has been touring the Northwest apple-growing districts in the interests of Dan Wuille & Co., British apple importers, recently left for New York City to said for England. Mr. Oliver expects that there will be a steady demand for export apples from harvest time until the apple-shipping season closes. He stated that he had never known prospects for the apple trade to be better than they are at present. Mr. Oliver said: "Transatlantic freight is now 85 cents a box, with plenty of space offered, and I expect the freight rate to go lower. Before the American apple-shipping season comes on England is expected to repeal the Price Control Act, which will result in fruit of fine quality being sold for a better price."

Mr. A. Moomaw, foreign representative of the Hood River Apple Growers' Association and other similar apple-growing industries in the Northwest, while on a recent visit in this section, stated that the most alarming thing for the exporter at the present time is the proposition that has been advanced in England to license dealers in the large cities, with an idea of limiting them to a certain allotment of export apples at one time. Dealers generally in England are reported by Mr. Moomaw to be organizing to oppose this plan.

In an address recently made before a representative audience of Yakima fruit growers, J. B. Adams, chairman of the Horticultural Committee of the Seattle Chamber of Commerce, stated that there should be a good market this year for Northwest apples in France and Belgium, in addition to the Australian and Philippine markets. The orchards of the two former countries mentioned, according to Mr. Adams, have been destroyed and they must look to America for their deciduous fruits this year. Mr. Adams also stated that he expected the greatest development in the Northwest fresh-fruit industry to come through shipments of fruit to Europe on ships that would sail from the Pacific Coast via the Panama Canal. The saving in freight rates, he said, would be a big help to Northwest apple growers.

Through arrangements that were recently completed the New Phez Company of Salem, Oregon, formerly known as the Northwest Products Company, has entered the Wenatchee field to secure fruit products. Negotiations have just been closed providing for the taking over of the H. E. Farwell plant. It is the intention of the new owners of the plant to use it in the manufacture of cider, jellies and preserves. The company is now contracting for cull apples for the coming season.

The American Fruit Growers, Inc., which has recently been purchasing large acreages of fruit on the Pacific Coast, has entered the Wenatchee, Washington, district and has just purchased a 124-acre orchard in the East Wenatchee section, for which it paid \$100,000 cash. The yield expected on this tract this year is between 40,000 and 50,000 boxes of commercial apples. The purchase included the entire equipment of the place. In addition to their operations in the Northwest, this company has just completed a deal for the purchase of 287 acres of apple orchard in West Virginia, including 200 acres of bearing trees and 87 acres in three-year-old trees. It is also reported to have bought orchards at Florrie Dale, Pennsylvania, and in several sections of Virginia.

Several weeks ago the company bought large citrus groves in Florida and recently also bought extensive deciduous fruit-producing acreages in California. Its total investment in orchard property this year is reported to be over \$1,000,000. The American Fruit Growers, Inc., is also reported to be interested in the recent merger of big deciduous and citrus fruit interests representing a capitalization of \$200,000,000.

Notwithstanding the reports that have been going the rounds that many contracts have been made in Washington by buyers of apples, it seems now that most of these offers have been tentative. In the Wenatchee district, while some offers have been made and a few contracts signed for this year's apple crop, most of the negotiations along this line are still in the preliminary stage. Growers in many sections of Washington are reported to have discussed the situation and formed opinions as to the prices that they will hold out for. It is said that in many cases these prices are beyond what any of the buyers now in the market are willing to pay. Most of the established local apple-buying concerns have thus far declined to make a definite offer for apples upon any basis whatever. They give as their reason that it is too early to anticipate the market and do not care to begin contracting until they are able to form an intelligent idea of the size and character of the apple crop. The schedule of prices that some of the growers are reported to be holding out for in the Wenatchee district is as follows: Winter Banana and Delicious, \$3.50; Spitzenberg, \$3; Winesap and Jonathan, \$2.50 to \$2.75, and Rome Beauty, Stayman and Yellow Newtowns, \$2.25 to \$2.50.

Sgobel & Day, big New York apple dealers, who are well known throughout the Northwest, have recently been granted permission by the Secretary of State to increase their capital stock from \$75,000 to \$200,000. During the past few years Sgobel & Day's business has reached very large proportions. This firm in 1918 did a business of over \$4,000,000. It is interesting to know that during the war-loan campaign Sgobel & Day bought \$110,000 worth of Liberty bonds.

Reports received from reliable sources are to the effect that a heavy freeze which hit the Colorado fruit-producing districts in the early part of June did an immense amount of damage. A cold wave which prevailed for three days forced the temperature down at some points to 20 degrees above zero. In Montrose and Delta Counties the apple crop is estimated to have been damaged fully 50 per cent, while in other districts peaches, small fruits and vegetables also were hit by the heavy frost.

Appreciates Better Fruit

W. E. White & Co.
Newberg, Oregon.
Better Fruit Publishing Co.,
Portland, Oregon.

Gentlemen: Your circular letter this morning's mail reminded me that I had not subscribed for your valuable publication as I told Mrs. White I would do. We thank you for the sample copy and we consider the April number alone worth the price of a year's subscription. I used to be a subscriber when this was published in Hood River, but dropped it for a time intending to renew again. This magazine was good from the start, but I believe it is better now and all fruitmen in the Northwest should be subscribers. Some men ought to be compelled to read this paper and then carry out the conditions laid down.

What has become of the Oregon law compelling orchardists to spray and prune their trees? For a while this was pushed and some old scaly trees were grubbed out, but since then it seems to be a dead letter and we see orchards that to all appearances were never trimmed or sprayed. I am not a large grower at the present time, but I try to care for my trees, and I cleared the land and developed one of the nicest small prune orchards in this country and am putting out more orchard each year. We are making some money out of Valley apples by taking care of the trees and young fruit, but yet hundreds of bushels of nice apples rot on the ground in this country every year. Our juice plant here shipped in ten cars of apples from Hood River last season.

Wishing you success in your future work I am enclosing you my check of \$1.00 for a year's subscription to BETTER FRUIT. I want the next issue, May number, but you may date my year from April 1st, for that number was just what I was wanting to get instructions about caring for my trees.

Yours respectfully,
(Signed) W. E. WHITE.

A Great Bargain Offer

Better Fruit One Full Year
Western Farmer One Full Year
McCall's One Full Year
Good Stories One Full Year

All 4 for \$2.00



For the small sum of \$2.00 you get Better Fruit one full year, Western Farmer one full year, McCall's Magazine one full year and Good Stories one full year.

If you are a subscriber to any of these Magazines your time will be extended one full year from present date.

Better Fruit is one of the two publications of its kind in the United States, and caters to people who are interested in growing fruit for profit. Better Fruit sells for \$1 per year.



Western Farmer is one of the old reliable farm papers of the Pacific Northwest, covers all lines of diversified farming and allied interests, and sells for \$1.00 per year.

The other two Magazines are leading Magazines in their particular line, and can be read with much interest in any family.

This is undoubtedly the greatest combination offer we will ever have and I would advise that you take advantage of it at once, as the price of Magazines is increasing temendously at the present time. This offer may never appear again.

Clip the Coupon now and mail at once to

BETTER FRUIT PUBLISHING COMPANY
Oregonian Building, PORTLAND, OREGON

ENCLOSED FIND \$2.00—SEND ALL FOUR MAGAZINES ONE FULL YEAR

Name
P.O State
R.D. Box Street

Combination includes Better Fruit 1 year, Western Farmer 1 year, McCall's 1 year, Good Stories 1 year



International Motor Trucks In Every Line of Business

INTERNATIONAL Motor Trucks are giving profitable and satisfactory service for the fruit grower, farmer, dairyman, retailer, wholesaler, drayman, manufacturer, oil dealer, in fact, for practically every line of business where there is hauling or delivery work to be done.

Convincing proof of their sturdy construction is found in their steadiness in operation, and the long period of time they continue on the job without lowering their high standard of efficiency.

Neither the condition of the roads nor the harshness of the weather affects the quality of the service given. It is this dependability that is appealing so strongly to farming and fruit growing communities. Prices of farm products depend upon marketing facilities. Internationals carry capacity loads over the roughest roads, saving time and money.

There is an International truck for every

business. Built in $\frac{3}{4}$, 1, 1 $\frac{1}{2}$ and 2-ton sizes, you can equip yourself with the means of improving your hauling and delivery methods. Back of every part entering into its construction is the purpose to build a high-grade hauling unit that will stand years of hard wear. The International engine, of the heavy duty type, provides ample power for all emergencies.

Nearby is a dealer, a branch house or service station where you can get full particulars regarding International Motor Trucks, or an inquiry to the nearest address below will bring a prompt response.

International Harvester Company of America

(INCORPORATED)

Billings, Montana	Crawford, Nebraska	Denver, Colorado	Helena, Montana
Los Angeles, California	Portland, Oregon	Salt Lake City, Utah	
San Francisco, California	Spokane, Washington		

THE WORLD-
OUR ORCHARD

STEINHARDT & KELLY NEW YORK

UNQUESTIONABLY THE
MOST IMPORTANT FACTOR
IN THE DISTRIBUTION OF
THE COUNTRY'S FANCY
APPLES
AND OTHER FRUITS

OUR MARKET-
THE WORLD

BETTER FRUIT

VOLUME XIV

AUGUST, 1919

NUMBER 2



FRENCH PETITE PRUNES.

Grown in large quantities in Oregon and Washington, but not so extensively as the Italian variety.
California is the greatest producer of French Petites.

BETTER FRUIT PUBLISHING COMPANY, PUBLISHERS, PORTLAND, OREGON

Subscription \$1.00 per Year in the United States; Canada \$1.25; Foreign, Including Postage, \$1.50.

Single Copy 20 Cents

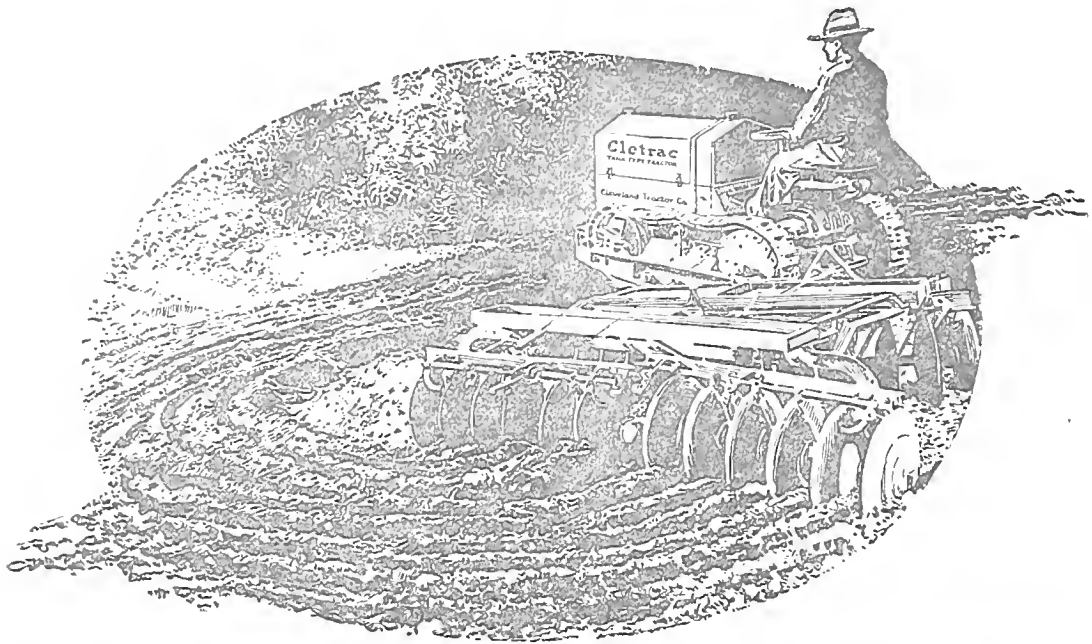

Turns in little more than its own length

The Cletrac is being more extensively used for orchard work than any other tractor because of its small size, short turning radius, sturdy construction and economical operation.

And because of its distinctive tank-type construction it is particularly well adapted for work on hills and over loose, soft soil.

It operates on a surprisingly small amount of kerosene, distillate or gasoline, yet gives you all the power you need. It steers by the power of its own engine.

It will turn completely around, with an implement, *in little more than its own length.*

Its unusually small size, 50 inches wide, 52 inches high and 96 inches long, enables it to drive easily under low hanging branches and between trees making it ideal for practically any kind of orchard work.

Write for our illustrated booklet "Selecting Your Tractor" and the name of the nearest Cleveland dealer.

Cletrac

TANK-TYPE TRACTOR

Formerly known as the "Cleveland" tractor

The Cleveland Tractor Co.

The largest producers of Tank-Type tractors in the world

19145 EUCLID AVENUE

CLEVELAND, OHIO

The Old Reliable
BELL & CO.
 Incorporated
 WHOLESALE
Fruits and Produce
 112-114 Front Street
 PORTLAND, OREGON

Dry Your Own Fruits and Vegetables

Imperative necessity demands nation-wide conservation of those portions of our food crops which have heretofore been permitted to go to waste. A considerable portion of this wasted food material is made up of perishable fruits and vegetables produced in home gardens and fruit plots in excess of the immediate needs of the producers, and in the absence of accessible markets for the surplus drying offers a simple, convenient and economical method for preserving food material and permits the carrying over of the surplus into periods in which fresh fruits and vegetables are expensive or unobtainable. Success in drying depends upon the observance of a few fundamental principles, and the quality of the product depends upon the care employed in the selection of the raw material, upon proper preparation for drying and upon careful control of the temperature employed.

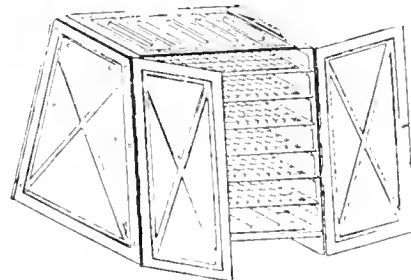

THE HOME Fruit and Vegetable Evaporator

shown above is constructed throughout of Willsville polished blued steel except the six trays, which are made of six-mesh galvanized hardware cloth. It is 18x20 inches at the bottom and 12x20 inches at the top and 24 inches high. Shipping weight, 28 pounds. The six galvanized trays, which are 1/2 inch deep, comprise a drying surface of approximately 14 square feet. The back is made sloping for two reasons; first, it can be used on the ordinary kitchen range without interference from the high closet; second, it acts as a deflector of warm air as it arises from the stove, deflecting the currents through the trays, as it ascends, giving a perfect circulation and producing even drying.

In every district, no matter what the climatic conditions may be, drying by artificial heat has proven to be the most economical, quickest and most sanitary method of drying fruits and vegetables. We are therefore introducing our Home Fruit and Vegetable Evaporator. It is recognized by the best authority as being the most practical method of extracting water from fruits and vegetables that has yet been devised, and built especially for use on wood and coal-burning stoves and ranges, with the idea of utilizing their surplus heat.

It can also be used on gasoline, kerosene, gas and electric stoves by the aid of a deflector plate to spread the flame. This may be had at any hardware store by purchasing a piece of 18 or 20 gauge black sheet iron about 16x18 inches, according to the size or style of stove being used. These are not furnished with the evaporator, as there are so many different kinds and sizes of these stoves on the market that it would be impossible to make one deflector plate to fit them all. For instance, stoves having a cooking surface large enough so it would cover the entire bottom of the evaporator, a deflector plate large enough to cover the immediate flame would be sufficient.

The large slide drafts at the top and bottom permit the control of the amount of warm air and enable the operator to maintain an even temperature. There is not a bolt or nut in the Home Evaporator, it being held together by five tie rods fitting into pockets on either end; it is hinged on all four corners, and can be folded into a small space in a few seconds by anyone, enabling the housewife to put it away when not in use. By the use of the Home Evaporator a complete process of evaporation can be accomplished in three hours or more, depending upon the article being evaporated.

Price \$12.50 complete

You could not make a better investment at this season—send your order in direct from this advertisement, or if you want additional information

Write for FREE BOOK "Best Methods of Drying"

This book has been prepared by experts. It tells: "The Possibilities and Limitations of Drying"—"The Fundamental Principles of Drying"—"Preparing Fruits and Vegetables for Drying." It tells how best to dry apples, pears, peaches, apricots, cherries, prunes, figs, berries, potatoes, turnips, pumpkin, tomatoes, sweet corn, beans, etc. Write today for this valuable book.

OUTWEST SUPPLY CO. PORTLAND, OREGON

WHEN WRITING ADVERTISERS MENTION BETTER FRUIT



SULPHUR

It has been proven and so recommended by the University of California that if you sulphur your grape vines and orchards 6 times they will not be affected by MILDEW or RED SPIDERS.

ANCHOR Brand Velvet Flowers of Sulphur, also EAGLE Brand, Fleur de Soufre, packed in double sacks, are the fluffiest and PUREST sulphurs that money can buy; the best for vineyards; the best for bleaching purposes, LEAVING NO ASH.

VENTILATED Sublimed Sulphur—Impalpable Powder, 100% pure, in double sacks, for Dry Dusting and making Paste—(Atomic Sulphur).

For LIME-SULPHUR SOLUTION, use our DIAMOND "S" BRAND REFINED FLOUR SULPHUR. We can furnish you this sulphur at such a low price that it would pay you to mix your own solution and net you a profit equal to the amount paid out for labor in spraying your orchard, even if you pay your men \$4 per day for making the solution and applying same.

To create additional available plant food, drill into the soil 100 to 400 pounds per acre DIAMOND "S" BRAND POWDERED SULPHUR, 100% pure. This has increased various crops up to 50%. Also PREPARED DRY DUSTING MATERIALS, Tobacco Dust, Dry Bordeaux, Dusting Sulphur Mixtures, etc. And "Anchor" Brand Standard LIME-SULPHUR SOLUTION 33° BE., Sulphur Paste, etc. Fungicides and Insecticides.

Carried in stock and mixed to order.

San Francisco Sulphur Co.
 624 California St. San Francisco, Cal.

We are equipped to make immediate shipments. Send for "ILLUSTRATED BOOKLET"; also booklet "NEW USES FOR SULPHUR," Price-list, and Samples. Please state for what purpose you use the sulphur, quantity needed, and date of shipment preferred. Telephone Kearney 671.

Richey & Gilbert Co.

H. M. GILBERT, President and Manager

Growers and Shippers of

Yakima Valley Fruits and Produce

SPECIALTIES

Apples, Peaches, Pears and Cantaloupes

TOPPENISH, WASHINGTON

THE SELF-OILING WINDMILL

has become so popular in its first four years that thousands have been called for to replace, on their old towers, other makes of mills, and to replace, at small cost, the gearing of the earlier Aermotors, making them self-oiling. Its enclosed motor keeps in the oil and keeps out dust and rain. The Splash Oiling System constantly floods every bearing with oil, preventing wear and enabling the mill to pump in the lightest breeze. The oil supply is renewed once a year. Double Gears are used, each carrying half the load. We make Gasoline Engines, Pumps, Tanks, Water Supply Goods and Steel Frame Saws. Write AERMOTOR CO., 2500 Twelfth St., Chicago

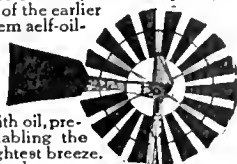

SIMONS, SHUTTLEWORTH & CO.

LIVERPOOL AND MANCHESTER

SIMONS, JACOBS & CO.

GLASGOW

GARCIA, JACOBS & CO.

LONDON

Agencies and Representatives in Every Important European Market

European Receivers of American Fruits

FOR MARKET INFORMATION ADDRESS

SIMONS, SHUTTLEWORTH & FRENCH CO.
204 Franklin Street, New York

SIMONS FRUIT CO.
Toronto and Montreal

SIMONS, SHUTTLEWORTH, WEBLING CO.
Board of Trade Building, Boston.

OUR SPECIALTIES ARE APPLES AND PEARS

Pacific Coast Agents
**United States Steel
Products Co.**

San Francisco
Los Angeles
Portland
Seattle



J.C. Pearson Co., Inc.
Sole Manufacturers

63 Pearl Street
Boston, Mass.

PEARSON

ECONOMY in buying is getting the best value for the money, not always in getting the lowest prices. PEARSON prices are right.

ADHESIVENESS or holding power is the reason for PEARSON nails. For twenty years they have been making boxes strong. Now, more than ever.

RELIABILITY behind the goods is added value. You can rely on our record of fulfillment of every contract and fair adjustment of every claim.

SATISFACTION is assured by our long experience in making nails to suit our customers' needs. We know what you want; we guarantee satisfaction.

ORIGINALITY plus experience always excels imitation. Imitation's highest hope is, to sometime (not now) equal Pearson—meantime you play safe.

NAILS

**A
I
L
S**

LOOK HERE

ARE YOU SATISFIED with your present selling service?

IF NOT try us and learn what an up-to-date selling organization can do for you.

CABLE OR WRITE US NOW for market prospects, terms, etc. Reasonable advances made against shipments of

**APPLES
PEARS
ORANGES**

YOU want the best market in Britain.

WE have it.

McCAIG & WEBB
Fruit Brokers, GLASGOW

Head Office, GLASGOW

Cables—MacWebb, Glasgow
A. B. C. 5th Edition—Marconi International

ALSO RECEIVERS AT
London — Liverpool — Hull

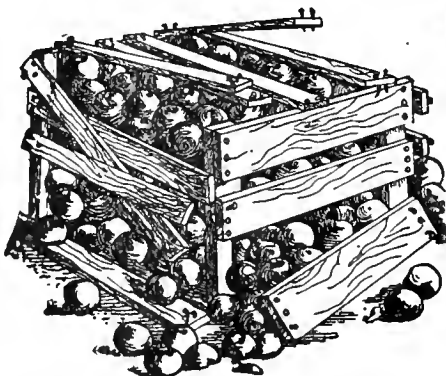

BEFORE using Cement Coated Nails

**Western Cement Coated Nails
for Western Growers**

Our Cement Coated Nails are always of uniform length, gauge, head and count. Especially adapted to the manufacture of fruit boxes and crates. In brief, they are the Best on the Market.

Write for Growers' testimonials.

Colorado Fuel & Iron Co.

DENVER, COLORADO

Pacific Coast Sales Offices
Portland, Spokane, San Francisco
Los Angeles

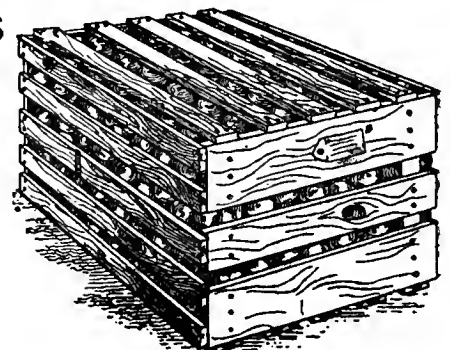

AFTER use of C. F. & I. Co.'s
Cement Coated Nails

BETTER FRUIT

STATE ASSOCIATE EDITORS

OREGON—C. I. Lewis, Horticulturist, Corvallis.
WASHINGTON—Dr. A. L. Melander, Entomologist;
O. M. Morris, Horticulturist; W. S. Thornber, Horticulturist, Pullman.
COLORADO—C. P. Gillette, Director and Entomologist;
E. B. House, Chief of Department of Civil and Irrigation Engineering, State Agricultural College, Fort Collins.
ARIZONA—E. P. Taylor, Horticulturist, Tucson.
WISCONSIN—Dr. E. D. Ball, Director and Entomologist, Madison.
MONTANA—O. B. Whipple, Horticulturist, Bozeman.
CALIFORNIA—C. W. Woodworth, Entomologist, Berkeley; W. H. Volek, Entomologist, Watsonville; Leon D. Batchelor, Horticulturist, Riverside.
INDIANA—H. S. Jackson, Pathologist, Lafayette.

An Illustrated Magazine Devoted to the Interests of Modern, Progressive Fruit Growing and Marketing.

PUBLISHED MONTHLY BY

Better Fruit Publishing Company

703 Oregonian Building

PORTLAND, OREGON

All Communications should be addressed and Remittances made payable to

BETTER FRUIT PUBLISHING COMPANY

SUBSCRIPTION PRICE:

In the United States, \$1.00 per year in advance. Canada \$1.25; Foreign, including postage, \$1.50.

ADVERTISING RATES ON APPLICATION

Entered as second-class matter April 22, 1918, at the Postoffice at Portland, Oregon, under the Act of Congress of March 3, 1879.

VOLUME XIV

PORTLAND, OREGON, AUGUST 1, 1919

NUMBER 2

Harvesting and Preparing Prunes for Evaporation

By C. I. Lewis, F. R. Brown and A. F. Barss, of the Oregon Agricultural College Experiment Station, Division of Horticulture.

DURING the summer of 1911 the Division of Horticulture conducted a prune survey of the state. This survey covered nine counties and involved a study of seven hundred prune orchards. It revealed the fact that there was a great variation in the methods and types of buildings used in the evaporation of prunes.

Since 1911 very little progress has been made in standardizing prunes. The only standard used in the state at the present time for prunes is that of weight, which is based upon the number of prunes to the pound. The California prune growers, wide awake to the needs of the hour, are making efforts to improve the products which they offer the world's markets.

We of the Northwest should do much more than we have done in the past along these lines. What do we mean by standardizing the prune? Simply adopting a degree of excellence which it must attain in order to be marketable. This will mean that the methods employed will in all cases be essentially alike.

Prune growers should study very carefully the cost of producing and evaporating prunes and should conduct their business as economically as is advisable for the production of a high-grade product. Frequently, for over a period of five years, fruit will produce unusually high profits. At such times growers become extravagant, careless in their methods, and are not ready to meet periods of depression or lower prices.

Harvesting.

In order to have a high-grade evaporated product, it is essential that the fresh product also be of a high grade. It is impossible to take inferior prunes and so evaporate them as to make a first-class product. Much of the quality of the product, therefore, will depend upon the time of harvesting and the methods employed. Too many growers have formed the habit of allowing many pickers to shake the trees; or of sending some unusually strong man, no matter how careless he may be, through the orchard to do the shaking. This practice results in the

harvesting of a large amount of unripe fruit.

Shaking.

There seems to be no common practice followed among all growers in harvesting. Some refrain entirely from shaking until the last picking with the idea of harvesting only the ripe fruit. While there is much merit in this system, it has the drawback of allowing a considerable amount of fruit to become overripe. The tendency seems to be to pick the smaller plantings more frequently than the larger ones. This is due to the impossibility at times of getting over large areas frequently.

The most common practice followed is that of three pickings, shaking the trees for the last two. It must be borne in mind, however, that the finest prunes are secured where it is possible to pick the fruit frequently. In this way one is more likely to secure only ripe fruit. Our survey showed us that the average time of maturity for Italian prunes over a period of years in the Willamette Valley was

from September 10 to October 5. In recent years, however, there has been a tendency on the part of a large number of growers to start the harvesting unusually early, generally from the first to the sixth of September, or about ten days in advance of the normal season. This tendency has been brought about by the feeling that the early harvesting might mean less damage from rains later in the season. This early harvesting, however, has necessitated a great deal of shaking. While we do not recommend doing away with shaking entirely, we do advocate delaying the season to the point where a very gentle shake before each picking will supply plenty of fruit. If growers organize their work so as to pick frequently, and there is during the period a moderate amount of wind, practically no shaking will be needed until late in the season.

Picking Too Early.

The season of 1912 should have taught many growers an important lesson. The harvesting that year was started early and at the end of the season after most of the growers had resorted to very vigorous shaking or clubbing, there were still many prunes scattered throughout the trees. A majority of the pickers had finished their work by September 25, which is 10 days in advance of a normal season. A number of orchards were visited on October 2 and the trees examined for fruit. Not a single prune was found still hanging to the trees, although there were many on the ground, indicating that they could not be shaken off at the last picking. Clearly the crop of 1912 was harvested too early and the loss to the growers of Oregon amounted to thousands of dollars.

As fruit matures many chemical changes take place as regards tannin, acids, starches, and sugar. The sugar accumulates very rapidly during the last few days of maturity. Sugar is very desirable in the Italian prune. It means maturity of fruit and heavier fruit, a greater percentage of dried fruit secured from fresh fruit, a shortening of the evaporation period, and the production of a much more desirable product.



Illustration showing 44-year-old prune orchard in the Willamette Valley, Oregon, which is still bearing a good crop. High-headed type of tree.



Low headed type of prune orchard in the Willamette Valley, Oregon, the greatest prune producing section in the state.

While we did not conduct chemical analyses on such a scale that we can regard our results as at all conclusive, nevertheless those we did conduct indicated that the increase in sugar content was very rapid during the last few days of ripening. From the time the prunes are shaken off until they drop naturally, if not shaken, the increase is 1.6% of their total weight. This increase in weight is practically all sugar and would mean that about 11% of the sugar content has accumulated in that short time. Some studies to determine the differences in specific gravity in prunes in these investigations indicated very rapid increase in weight during the last few days before the prunes dropped. The prunes which dropped naturally had a specific gravity of .0283 higher than those which were shaken off. During the season of 1913 we used a brine solution of 1.0905 density. With this solution one could very easily separate the prunes which were shaken from the trees from those which dropped naturally.

Losses from Premature Picking.

Premature harvesting, then, seems to be the greatest cause of loss in the evaporation of prunes. Unfortunately this premature harvesting and great loss has been encouraged by the fact that some packers offer a premium for early delivery. Other growers, fearing rainy weather, practice this early harvesting. Weather records, however, show that rain is as likely to occur early in the month as it is later. Often, if harvesting is delayed, the early rains will cease and good weather will prevail during the remainder of the season. This was true during the seasons of 1911 and 1914. During the season of 1914 the majority of growers were well under way in their harvesting by September 6. In our experimental plots, however, we did not start our picking until Sep-

tember 11 and then obtained only 4.22% of the crop in the picking. Results showed that had we waited five or ten days longer we should have gained more, as that portion of the orchard on which picking was begun September 11 was not completely harvested until September 20.

During the year 1913 we were able to secure some observations in a twenty-acre Italian prune orchard where the owner was harvesting his crop rather early. By harvesting the fruit from a few trees after they dropped naturally, as compared with fruit he was shaking vigorously from the trees, we were able to get a good index of his loss in weight. Using the weight of the dried fruit as a basis, we found that he lost 6% of the total weight of his crop by harvesting too early. In addition to this, the immature prunes dried away more than the ripe ones. This resulted in an additional loss of 6% of his crop, making a total

loss of 12%, or a monetary loss of \$15.00 a ton due to too early harvesting.

Extensive shaking experiments which we carried on during this same season proved that the prunes which dropped naturally in the fruit harvesting, dried 3 2-3% heavier than those shaken off. The gain in weight of the finished product for the season was 6.05%, giving us a total of 9.25%, or \$13.87 a ton.

In obtaining these results we assumed that the cost of harvesting was the same in both cases. It must be remembered, however, that it costs from \$1.00 to \$2.00 a ton to shake green fruit from the trees. This would mean that from \$3.00 to \$6.00 for each ton of dried fruit must be added to the cost of harvesting, where shaking is employed. By watching the fruit carefully one can determine the proper time of harvesting.

The ideal prune for evaporating is one which is mature, (that is, fully ripe), which drops naturally, is plump and has a golden yellow flesh. If the prune is shriveled at the stem, has a fibrous dark-colored flesh, or shows a tendency to become mushy, it will mean that the prune has poor drying qualities. The ideal prune will make a sweet, fine-flavored product, and will give as high as 25 pounds of dried fruit to 60 pounds of fresh. Prunes of the second type will give only about 19 pounds of dried fruit to every 60 pounds of fresh, and are dark colored, sour, and tough. Undoubtedly the question of the production of prunes, so as to have them mature early and have desirable characteristics, is one which needs much study and perhaps extensive experimental observations.

Sorting the Prunes.

A few of the growers sort out all the decayed prunes at the time the fruit is trayed, but a greater number of the growers depend upon the pickers to gather up only good, sound prunes. We have observed both systems, tried out on an extensive scale, from the point of view of economy. For a number of years we have been



Prunes as fillers in a walnut orchard in the Willamette Valley, Oregon.

BETTER FRUIT

August, 1919

convinced that there is a distinct advantage in having the pickers gather everything, the rotten, undesirable fruit being sorted out before it is trayed. With such a system there is very little poor fruit to bother the pickers after the first picking, while if this is not done, the decayed fruit is constantly accumulating, thus making the picking more difficult and disagreeable.

With either system, some sorting will need to be done in the evaporator, and it is well to have some one man in the evaporator responsible for all the sorting, in order that more uniform and satisfactory results may be obtained. This can perhaps be more economically done by emptying the prunes on endless belts, which carry them past the sorter to the dipping machine.

Brown-Rot Infection.

There is one very good argument against mixing decayed fruit with sound fruit and that is the danger of infection from brown rot. Most of the rotten prunes are attacked by a fungous disease known as brown rot (*Sclerotinia fructigena*). This disease will spread very rapidly from decayed fruit to sound fruit whenever conditions are suitable and often the loss from such sources is very great after the prunes have been delivered to the evaporator and have been allowed to stand around in a warm, moist atmosphere for a considerable length of time. It would be well if there was some system whereby these rotten prunes could be removed from the orchard, and thus prevent them serving as a menace to future crops.

Picking Up Prunes.

Prunes are picked from the ground and placed in lug boxes which will hold about 60 pounds. The price paid the pickers ranges from 5 to 10 cents a box, depending on the season, crop, etc. From 30 to 40 boxes is considered a fair amount for ten hours work under normal conditions. There are times when many pickers far exceed this average, due to very favorable conditions. It is desirable after the fruit has been placed in the lug boxes to have it removed to the evaporator as soon as possible.

Yield of Fruit.

The question is often asked as to how many pounds of dried prunes one should expect to the acre. This is an extremely hard question to answer. The condition of the fruit (that is, the degree of its maturity, weather conditions, methods of drying, age and vitality of the orchard, etc.), all exert an influence. At the time we made our survey of 700 orchards we found this kind of information very difficult to secure. The range of yields was wide. One might naturally expect this, owing to the fact that the orchards differed widely; many of them were very old, while others were just coming into bearing. By checking up with packers, as well as with growers, we were able to strike a pretty fair average. The maximum yield reported was 8,000 pounds

of dried fruit to the acre. There were a large number of reports exceeding 4,000 pounds an acre. The minimum yield reported was 500 pounds. The average yield of the bearing orchards was about 2,800 pounds of dried fruit to the acre.

Preparing Fruit for Evaporation.

It is very desirable to evaporate the fruit as soon as possible after harvesting. Unfortunately, fruit is sometimes carried to the evaporator and forced to remain in the boxes for several days before it can be placed on the trays. This always means a serious loss. The brown rot, if present in such boxes, will tend to spread rapidly. There is considerable humidity in the atmosphere around the prune evaporators and the temperature will often range from 90 to 115 degrees. This condition is especially favorable for the spread of fungus, and the loss from this source at times is very high. Again, these conditions encourage the fermentation of sugars in the fruit; our observations revealed a considerable amount of such fermentation. Fermentation always means a loss of sugar and a final loss of weight in the dried fruit, as well as deterioration in quality. The sooner the prunes can be placed in the trays, the less danger there is of loss.

Grading.

From observations we have been able to make and from experiments we have conducted, we are inclined to believe that it would pay to grade the prunes before they are placed on the trays for evaporation. The greater the variation in size and ripeness of prunes the greater will be the percentage of dobies. The percentage of dobies is also increased by premature harvesting. Under normal conditions the percentage of dobies, due to unevenness in size, is about 3%, but may run as high as 8%. In addition to this, the dipping in lye also seems to encourage uneven drying. It would seem wise, therefore, to practice grading, dividing the prunes into at least three sizes. While such grading can be done by hand, and is being done by hand by many growers, we wish to call attention to the fact that it is possible to purchase machines on the market that can be adjusted to peaches,

small and overripe prunes in order to avoid sorting. By spreading the fruits of the same size on a tray, they tend to evaporate in about the same length of time. This would materially reduce the amount of checking and would hasten drying, as it would relieve many of the trays sooner. It would permit, also, at the same time the elimination of worthless fruit, such as decayed fruit, which often takes up too much tray space. By actual observations 6% of the tray space is occupied by fruits which are either partly or entirely rotten. This is where poor sorting and no hand grading is practiced.

Dipping.

There seems to be a great difference of opinion among the growers concerning the question of dipping. We find that some prunes are dipped in hot lye water, some in boiling water, some in cold water, and some are dried without even dipping. Yet all these men are able to market their crop at standard prices.

Where lye is used, the average strength is one pound of lye to from thirty to fifty gallons of water. The cost of dipping in lye will vary tremendously according to whether the work is done by hand or by machinery. During our survey we found that, on the whole, machine dipping could be done at from 70 to 85 cents a ton, the hand dipping costing materially more. With a modern power machine, four men can sort the bad prunes, dip, and tray from 500 to 600 boxes in ten hours. The cost of this entire operation would vary to a certain extent, but would average about one cent a tray. In the smaller evaporators, where a small tonnage is handled, the regular drying crew would be able to do the traying during spare time. In such cases the depreciation for each tray would be greater than if the machine were running to its full capacity. Even then, however, the cost of traying would probably be less than with any other method. In our experimental work, one man did the dipping by hand, two men spread the fruit on the trays, and two did some sorting and stacking the trayed fruit on trucks. The figures in Table

Table I. Cost of Dipping and Traying

Method	Cost per tray	Cost per pound
Machine dipped	\$.011	\$.000314
Hand dipped and spread in water	.023	.000770
Additional cost due to hand dipping	.012	.000156
Additional cost of traying hand-dipped prunes per ton of dried	\$2.73
Cost of Drying Per Ton of Dried Fruit		
Machine dipped	\$21.80	
Hand dipped and spread in water	26.06	
Increase in cost of drying due to hand dipping		\$1.26
Increase in cost of traying due to hand dipping		2.73
Total increase in cost		\$6.99
Received from sale of rotten prunes		2.70
Net loss per ton due to hand dipping		\$4.29

prunes, apricots, and even cherries. These machines, which can be purchased at prices ranging from \$50 to \$100, have a capacity of from 25 to 50 tons.

Where prunes are ungraded, the general tendency is to overdry the

1 are of interest concerning the difference in cost of the two methods.

With hand dipping there seems to be a tendency for more decayed fruit to get on the trays than is true with machine dipping. By the hand method an entire box is handled at a time,

while with the machine and endless belt method the prunes are separately exposed to view both in the feeding trough and as they are carried up into the dipping tank. There is also a tendency not to fill the trays to their entire capacity, the average being only 86 per cent. This would mean that about 20 percent of the trays are

in any way injurious to health. From some chemical tests which were made, however, we found that often the rinsing water was as strong in lye as the dipping solution. To overcome this it would be well to have the prunes pass through a second rinsing vat. The ideal way, however, and the one which every prune evaporator

should be frequently emptied and thoroughly cleaned. We should all aim to maintain the best sanitation possible. Clean, sweet, wholesome fruit is the only kind which will build up a permanent reputation

Boiling Water.

Some growers have tried the boiling water and claim they cannot secure results. We know it is possible, however, to secure splendid results with boiling water, as demonstrated in our own experiments and also by our observations with a number of growers who are turning out a good, first-class product. Investigations have shown that occasionally where men have claimed to use boiling water, they have simply used hot, or even merely warm water. This would not tend to check the fruit as would the boiling water.

To those growers who prefer to use lye, we can say that no serious objection can be raised to the practice, if cleanliness is observed and an abundance of good rinsing water is always supplied.

Table II. Effect of Lye in the Dipping Process

Dipped in lye	Weight fresh lbs.	Weight dry lbs.	No. lbs. dried fruit per bu. lbs.	Drying time hrs.
Prunes grown on upland.....	127	151	21.27	36.
Prunes grown on upland, green.....	138	110	19.17	38.
Prunes grown on lowland.....	190	169	20.36	37.
Prunes from lowland, partly dried on ground.....	111	150	20.27	43.
Total Average.....	1799	698	20.27	38.5
Dipped in boiling water				
Prunes grown on upland.....	491	176	21.16	42.
Prunes grown on upland, green.....	439	113	19.60	45.
Prunes grown on lowland.....	495	151	19.27	45.33
Prunes grown on lowland partly dried on ground.....	266	99	22.33	43.
Total Average.....	1691	569	20.66	43.8

either empty or occupied with worthless fruit.

The chief advantage to be gained from the use of lye is the shortening of the time required for evaporation. General practice, as well as our experiments, would bear out this idea. This difference at times is considerable, as shown in Table II.

As is readily seen it required 5.3 hours more to dry the undyed fruit than it did the dyed. The one mistake made, however, by the strong advocates of lye, is that the shortness of drying time is the main factor considered.

Lye-Checking.

Dipping the prunes in lye generally means a considerable loss in weight. From experiments we have been able to conduct we have found this loss to be about 2%. Another point which calls for careful study is that not all prunes in any single lot will be checked by the same strength of solution. Ripe prunes will check more easily than green prunes. It naturally follows, therefore, that under the present methods of harvesting, some prunes will be checked more than others, and we shall find that either the ripe prunes will be checked too much, or else the green ones will not be checked at all. This, of course, is another argument in favor of grading. It is interesting to note that those prunes which would normally dry more quickly without the checking are the ones always checked. On the other hand, if there were many prunes left unchecked, it would be those that would dry more slowly without checking. Should the lye solution be made strong enough to check the green fruit, the riper fruit would be so badly checked that the same relative difference in drying would obtain. On the other hand, lye-checked prunes tend to dry more unevenly than those dipped for cleansing purposes only.

Sanitary Rinsing.

Another disadvantage connected with dipping is the question of sanitation. It is very doubtful if, under any method of dipping, there is sufficient accumulation of alkali to be

should attempt to adopt, would be to install a water system so that rinsing vats would have a flowing stream of water. Where this cannot be done both the dipping and rinsing vats

Peach Picking and Packing for Fancy Trade

WHEN picking peaches they should be firm, well matured with a good color, but not soft in the least. Peaches should be picked as soon as they will leave the tree without breaking the stem from the tree or tear the meat of the peach when the stem is pulled out. They should come off good and clean. Care should be exercised in selecting picking utensils as the peach is one of the most perishable of fruits. Pails and baskets should be lined with burlap or some other soft material.

The Colorado Pack.

The peach boxes used in Colorado are three sizes, in depth four inches, four and four and one-half inches and five inches; eleven and one-half inches in width and eighteen inches in length, inside measurement. There are three grades of peaches as to size,

extra or 80, fancy or 90, choice or 108, and only one grade as to quality. All peaches should be perfect.

The choice grade is the smallest peach wrapped, and is graded in three sizes. By packing a 3x3 pack, the No. 1 size makes six rows across the box, with nine peaches long, making fifty-four peaches to the layer, or one hundred and eight to the box. Size 2, with six rows across the box, three rows nine long and three rows eight long will make fifty-one to the layer, or one hundred and two to the box. Size 3, with six rows across the box, eight long will make forty-eight to the layer or ninety-six to the box.

The fancy grade is packed the same as the choice, except the rows contain less peaches. This grade is in two sizes. Size 1, with six rows, three rows eight long, and three rows seven long, makes forty-five to the layer, or ninety to the box. Size 2, with six rows seven long, makes forty-two to the layer, or eighty-four to the box.

The extra grade runs from forty to seventy-eight peaches to the box and are packed the same as the choice and fancy, except the very large ones, and these are packed a 3x2 pack, with five rows across the box instead of six. There are nine packs of this grade: One, six rows, three seven long and three rows six long, thirty-nine to the layer, or seventy-eight; two, six rows, three rows six long and three rows six long, thirty-six to the layer, or seventy-two; three, six rows, three rows six long and three rows five long, thirty-three to the layer, or sixty-six; four, six rows, three rows five long and three rows five long, thirty to the layer, or sixty; five, five rows, three rows six long and three rows five long, thirty to the layer, or sixty; six, five rows, two rows six long and three rows five long, twenty-



Some fine Ashland, Oregon, peaches.

Continued on page 27.

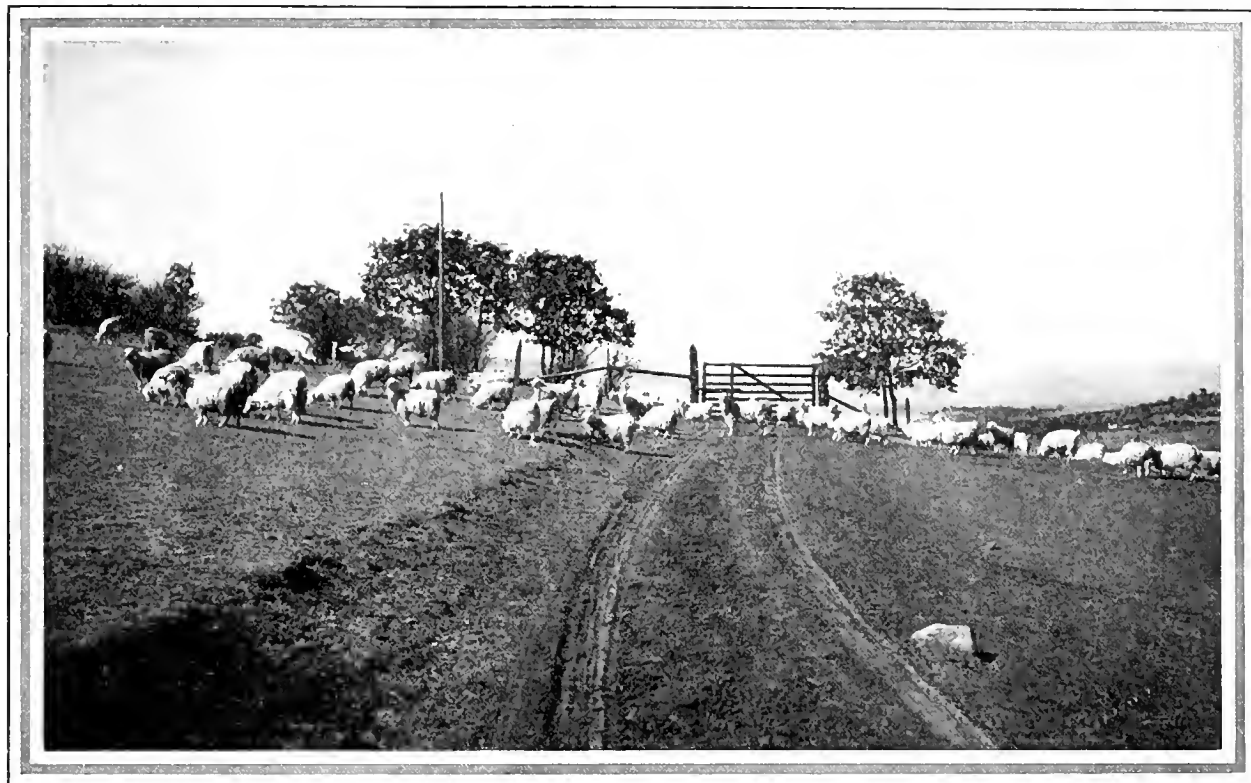

In some sections of the Northwest Angora goats have been found profitable in orchard districts where there is pasture or where cover crops are grown. The above illustration shows a small band of goats in one of these districts.

Increasing Profits by Diversifying and Raising Stock

By R. E. Miller, Director of Agriculture, Idaho Technical Institute

LABOR is to be one of the largest, if not the largest, limiting factor in future successful orcharding. Fruit growers are confronted with the economic utilization of labor as well as the other problems which guarantee profitable production. Practices which conserve the labor outlay should, therefore, merit our closest consideration.

Before the war the questions of orchard culture were largely "settled" but the war, with its food crisis, has upset some of our staid notions and opened up again this "settled" problem. The ideal western orchard before the war was one blanketed with a dust mulch followed usually in the fall by a green cover crop. The purpose of the dust mulch being to conserve moisture and aerate the soil.

Clean cultivation has been called "cruel cultivation" by Professor Paddock, because by this practice the organic matter is readily "burned" out of the soil by the rays of the scorching sun. Unless this organic matter is returned to the soil either by plowing under green cover crops or by direct application of manure, it is not many years until we are unable to secure anything but a clod mulch. In other words, the texture of the soil depends directly upon the amount of organic matter it contains. But important as this fact is, it is not as important as the fact that all plant food in the soil is made available for plant use through the action of soil bacteria. Decaying organic matter is the food of these bacteria and when it is de-

ficient in the soil as a result of being "burned" out by the rot rays of the sun, these bacteria cannot exist in numbers large enough to prepare sufficient plant food to provide for a normal growth of the trees. The result eventually is a decreased fruit yield. In localities of limited rainfall or available moisture, during the growing season, this form of orchard culture will undoubtedly prove not only the best practice but the only feasible practice that could be followed with any degree of success.

Many orchards are located in irrigated sections or localities having an abundant rainfall, and the available moisture during the growing season is not the limiting factor. Orchards so located should consider the problem of decreased labor outlay and increased profits as a result of more diversified orcharding.

The kind of diversification in orcharding to be used is necessarily a local and individual problem, but, generally speaking, there are three ways of accomplishing the desired result.

1. Growing non-leguminous intercrops.
2. Growing various types of fruit harvested at different periods.
3. Raising live stock on legume cover-crops.

While intercrops of various kinds, ranging from vegetables to grains, have proven profitable in young orchards, the question of continued fertility must be considered in mature orchards. In addition to this, the

labor outlay is usually materially increased and the market must be very favorable if the profits are to continue.

The growing of various types of fruit harvested at different periods offers one of the best forms of diversification for the fruit grower; since, by this system, the overhead expense can be distributed over an extended period and cash incomes are received at different periods of the year. Picking and packing may be accomplished by a smaller crew. Diversification by combinations of fruit culture, such as strawberries, bush fruits, cherries, peaches, plums, pears and apples adapted to the locality will do much to eliminate the possibility of lean years. The maintenance of an acreage which guarantees economical production is naturally a problem that enters here.

It has long been recognized that a permanent system of agriculture must rest on livestock and this fact should lend weight to the practicability of raising live stock in connection with orcharding. The pasturing of legume cover crops has proven more profitable than cutting them for hay. The experience of Mr. E. A. Gammon, of Hood, California, is interesting in this connection. Mr. Gammon's 80-acre irrigated pear orchard was planted in the fall to vetch and Japanese clover. In the spring fifteen sows were turned in the orchard to pasture and later a band of Hampshire sheep. The orchard was pastured throughout the

Continued on page 32.

The Use of Powder in Blasting Orchard Tree Holes

BLASTING out tree holes in which to set an orchard is becoming more prevalent. Experiments in planting fruit trees in ground that had been blasted or spade-dug have shown remarkable results in favor of the former way of setting fruit trees, particularly in ground where the soil was very hard. The use of blasting powder in planting an orchard is not new. In 1910 the DuPont Powder Company began to promote the use of explosives in planting new orchards and in rejuvenating old ones. The idea, however, was not original with this company.

Nearly a quarter of a century ago, near LaMesa, Cal., ground was blasted for apple tree planting, because orchardists found the work of planting with a spade in the hard soil in that section too difficult. The experiment proved a success. The trees thrived and bore exceptional crops of apples for many years. Later other orchardists and farmers in different sections of the country used the same method in preparing a home for tree roots and there are records of such plantings, from eleven to twenty years ago before the idea began to spread.

After the idea began to be known extensively throughout the country, many farmers and orchardists tried the new plan on a small scale, and now because of the great success attained in planting orchards in this way, thousands of fruit trees are being planted annually in blasted ground. Many of America's leading orchardists and nurserymen now plant exclusively in this way. In fact, blasting is said by experts in the matter to always produce the best results except in soil that is naturally loose and sandy to a depth of several feet. In such soil, blasting is not advantageous except for the elimination of fungus and nematoid troubles.

What Blasting in Orchards Accomplishes.

1. It mellowes the ground to a depth of five or six feet and throughout a circular area ten to twenty feet in

diameter, making it easy to dig the hole and plant the tree correctly.

2. It creates a porous, water-absorbing condition in the subsoil that makes the tree drouth-proof, stopping the big, first year loss, and invigorates growth.

3. It makes root growth easy and makes tons per acre of new plant food available, hence speeds up the growth of the tree and makes it fruit earlier.

4. It creates drainage and prevents stagnation of water on surface.

5. In old orchards that were planted by the old methods and have ceased to bear well, it is of great value in rejuvenating the old trees, causing them to yield heavily.

6. It destroys fungus, nematode, and other orchard soil diseases, hence makes it possible to plant new orchards where old ones have been removed without waiting several years to rest the land and get rid of the diseases.

In studying comparative costs of planting fruit trees, the investigator is confronted with widely varying figures and methods. There seems to be no machine for planting fruit trees such as a corn drill, but the method of some planters approximates the work of a machine in speed, if not in efficiency. They lay off the site of the proposed orchard in 20-ft. to 40-ft. checks, depending on the kind of trees to be planted. Cross furrows are plowed through the field, marking it off in squares.

One man drives along a furrow with a wagon-load of trees, another lays a tree near each of the furrow intersections, and a third stands the tree in



Six-year-old tree planted in a blasted hole.

can plant it only once, and its health and growth, the age at which it begins to bear, and the quantity and quality of fruit borne, depend chiefly on the care and thoroughness used in planting it."

Up to a few years ago, the method followed by most good orchardists was to dig a hole seldom more than two feet in diameter and 18 inches deep, then plant the tree in top soil or a mixture of top soil and subsoil. Under this system the loss the first year ran from 25 percent to 50 percent, depending on soil and weather conditions. Then tree planting with explosives was taken up by a few orchardists who realized the shortcomings of

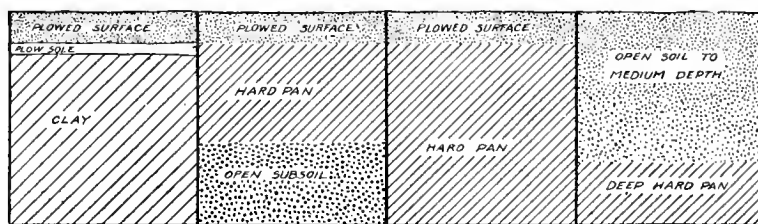

Fig. 1. Different types of hardpan encountered in the orchard.

the intersections, kicks some soil over the roots, tramps it down, and moves on to the next intersection. This method expresses a touching confidence in nature, but results indicate such confidence is misplaced.

A tree that survives such treatment must have as many lives as the proverbial cat, and if it lives, how many years must elapse before it bears any fruit? What grade of fruit can be expected from a tree aged and bent with the fight for existence before it saves strength enough to bear at all?

Going to the other extreme we find a horticulturist advising: "Forget you are about to plant a tree and imagine you are going to bury a horse, and dig a hole accordingly. Remember you

the ordinary methods, and the necessity of cutting down first year losses, and speeding fruition.

The first objections to the new method were largely financial. The cost of explosives, blasting cap, fuse and labor ran from 8c to 15c per hole, whereas trees could be planted with a spade for 3c to 5c per hole. The trouble with this comparison is that the work performed is not the same, hence costs should not be compared.

The question involved is, how soon does the planter want a return from his investment and how large a return? The only way to compare costs is to consider the profit sought and which is the cheaper way to get it.

Continued on page 28.



Six-year-old tree planted in a spade-dug hole.



Fig. 2. Punch for making the bore holes. This is driven in with a heavy hammer.

The Regeneration of the Prune—A Prediction Fulfilled

By H. S. Gile, Salem, Oregon

[EDITOR'S NOTE.—The article printed below was written for BETTER FRUIT by Mr. H. S. Gile of Salem, Ore., and published ten years ago. It is interesting to note that the predictions of Mr. Gile, who has always been a firm supporter of the superiority of the Oregon prune and the future market for it, have come true. The production of Oregon prunes in 1918 reached nearly 60,000,000 pounds and it is believed if it were doubled this year there would be a demand at profitable prices that would absorb it all. While land values in the district mentioned in this article have become higher, there is said to be an opportunity to still purchase good prune land at \$100 an acre and even less than this figure, in the Willamette valley. Prices for bearing orchards are considered conservative considering their income producing power at the present time. In this section as in others the motor truck has lessened the handicap of distance from shipping points. Although there has been a marked improvement in the construction and operation of evaporation plants, the cost of labor and materials have increased. But, comparing income and cost with former years, the grower is receiving a much greater return. Owing to the scarcity and high cost of labor, cheaper methods of packing fresh prunes have been adopted. This eliminates much of the hand work and consists in using a receptacle called a suit case box in place of the hand packed four basket crates. The suit case box is made with one side open into which the fruit is carefully poured and settled solidly into place when the side is nailed on. It is true that the prices of all fruits have appreciated, but considering the low ebb to which the prune had fallen the increase in price and demand for none of them is as great as the prune, with the exception of the loganberry.]

APPLES, pears, cherries and walnuts have been so much to the front during the past few years that the man who would venture to advocate any other variety of fruit, to say the least, would be very much out of fashion, if indeed, he could expect to receive any attention whatsoever. The writer has been from the very inception of the industry, a firm believer in the Oregon prune, and has never forsaken nor been turned aside by the fabulous tales of wealth in growing and marketing six-dollar apples and ten-dollar pears.

That this great Northwest is peculiarly adapted to the production of many varieties of fruit is no longer questioned, and experience has clearly shown that certain localities are especially adapted to certain fruits, and still further that certain varieties of these special fruits do better in specific localities and at different eleva-

tions; hence, there is no occasion of rivalry—certainly not for jealousy—because the Hood River district may grow to perfection a certain type of apple, and the Medford district may produce to just as great perfection Comice and Bartlett pears. And while apples, pears and all of the deciduous fruits, berries, nuts, etc., are produced in a great abundance and to a more or less perfect degree in the Willamette Valley, it also remains for this great valley to win and to hold the reputation of growing, preparing and selling the finest prunes grown anywhere in the wide world. The growing of this fine fruit is still in its infancy; we have only touched the fringe of that which will be done in the future, as the real merit of this fruit becomes more widely and generally known.

Salem is the most important center for both marketing and growing the Oregon prune. Orchards cover many of the elevations surrounding the city, and especially in the Liberty-Rosedale district, from four to eight miles south of the city, where the country is given over almost entirely to prune orcharding. Fine land in this district, splendidly adapted to this particular branch of horticulture, can still be had for \$100 per acre and less, according to location. In fact, full bearing orchards can be bought for less money than they are actually worth, simply because the owners have not yet awakened to the great future which is surely in store for this industry, and have not yet learned to ask the fabulous prices which are being paid for orchards of other varieties of fruit in other districts, and possibly they have scarcely even figured the actual returns upon any fixed acreage valuation for their orchards. Western Washington may be classed with the Willamette Valley in the production of a high grade, cured prune, though not able to produce crops so regularly as the higher elevations in the best valley districts. Eastern Washington, Idaho and certain sections of Eastern

Oregon also grow prunes (Fallenburg plums) which possess less merit for curing, but have fine canning qualities in their fresh state and consequently are shipped green almost entirely. For green shipping the fruit



Average type of small prune dryer in Douglas County, Oregon.

must be very carefully picked from the trees and should be so handled as to retain as much as possible of the natural bloom of the fruit. It is then carefully placed in baskets holding about five pounds each; four of these baskets constitute what is called a crate. The crates are then, as quickly as possible, placed in refrigerated cars, spaced and stripped so that each crate shall have a free circulation of cold air upon all sides of it, and in this condition prunes will carry in perfect condition to almost any market in this or foreign countries. On the other hand, fruit of the same variety grown in Western Washington and in the Willamette Valley will not carry so well, but possesses all of the elements which go to make up a rich cured product, and it is grown exclusively for that purpose.

The ordinary orchard contains from fifteen to forty acres, although there are two or three tracts in the valley much larger. For an ordinary sized family a thirty-five to forty-acre orchard is about the most profitable size. One man and team will do the work of cultivation comfortably and have time for other work. Outside help will be required for a few days during the winter spraying, and possibly some assistance will be needed at pruning time, but very little money will be expended for labor outside of the one man and one team until the time of gathering and curing comes on. The orchardist will then pay from five to six cents per bushel to the men, women

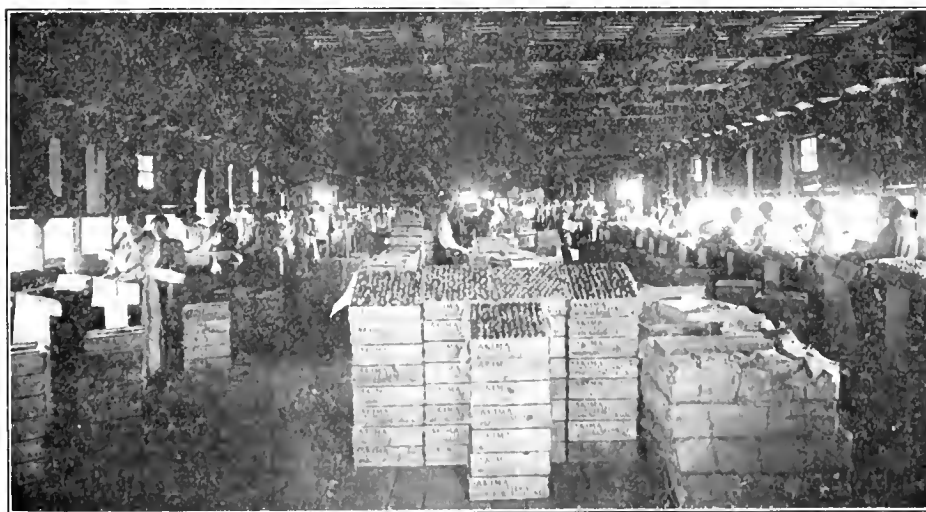

Packing fresh prunes at Toppenish in the Yakima Valley, Washington.

Continued on page 25.

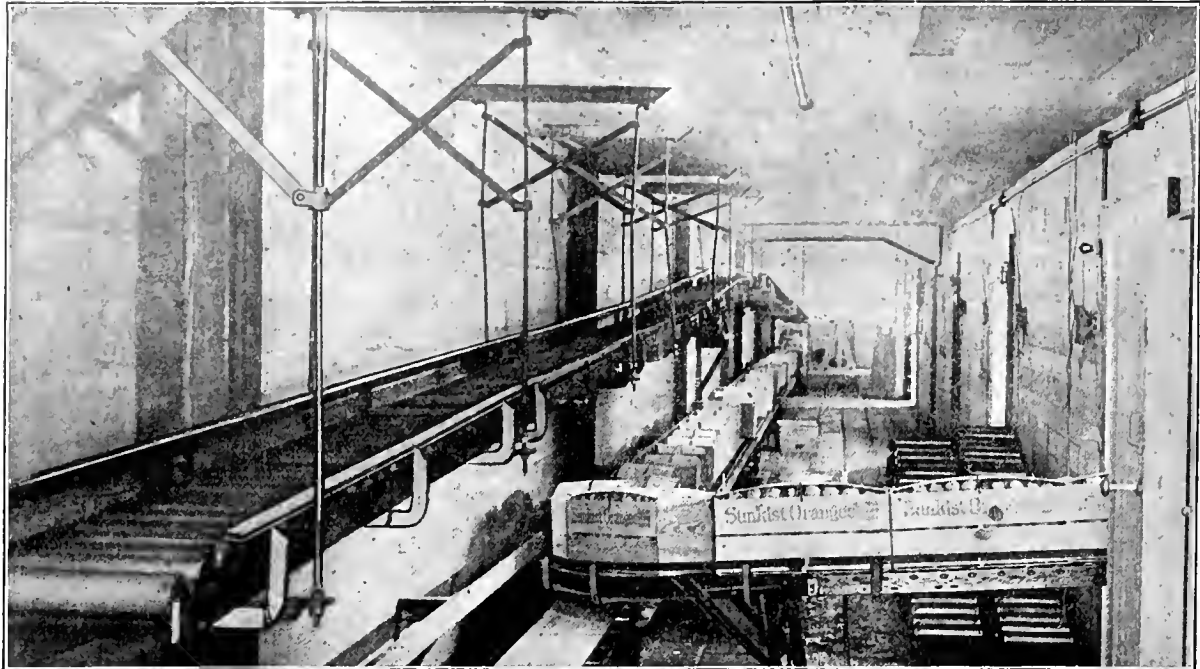

Throw out the Trucks

"Can't afford to at present" is not a legitimate excuse. "At present" you have to pay wages for packing-house trucking, don't you? Why not stop paying trucking wages? Let free gravity do your moving.

A Mathews Gravity Roller Conveyor cuts out the trucks and relieves the truck hands for more productive work. It begins to save your payroll money from the first day it is installed. In many plants a Mathews Gravity Conveyor more than pays for itself the first year.

Just a man or two at each end for loading and unloading. Gravity does the work. Your product gently, safely glides along over shelving, through small openings, from building to building, or floor to floor, over obstacles which trucks and men could not pass. From receiving bins through each department to shipping room anything you wish rolls with no expense for truck labor.

Write us today for complete descriptive literature.

MATHEWS GRAVITY CARRIER COMPANY

133 Tenth Street, Ellwood City, Pa.

Branch Factories: Port Hope, Ontario—London, England

MATHEWS
 SPEED ECONOMY
GRAVITY ROLLER CONVEYER

Well Built Storage House Valuable Investment

THE building of apple storage houses in the Northwest is being engaged in on a larger scale this year than at any other period in the history of the fruit industry in this section. In almost every apple raising

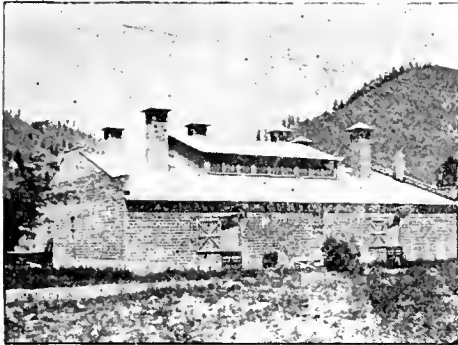

An apple storage house built along good lines. Note the intake doors near the ground level, the slat doors above and the numerous and large outlet flues.

district storage houses are being built, and interest in proper construction to secure the best results from common or air cooled storage is keen. In last

month's issue, BETTER FRUIT published an article written by F. W. Allen, Assistant Horticulturist in Fruit Storage Investigations of the Bureau of Markets of the United States Agricultural Department that attracted widespread attention among western fruitgrowers and fruitmen.

Mr. Allen has taken a deep interest in the matter of securing the kind of construction in apple storage houses that will secure the best results and incidentally save growers many dollars. Many mistakes have been made in the past in the construction of these houses owing to lack of information and the idea that most any kind of a storage house would do. This idea however is becoming a thing of the past as is shown in the accompanying illustration of the latest type of storage house recently completed in a Washington apple growing district. It will be seen at a glance that the construction of this house is complete and substantial, and that it should prove a valuable investment to its owners.

Fertilizing and Topping Strawberry Plants

By Gordon G. Brown, Horticulturist, Hood River Experiment Station

THE strawberry harvesting season is over and the grower must turn his attention once more to problems of fertilization, cultivation, topping, irrigation, etc.

A good deal of data has already been collected regarding the use of commercial fertilizers for this crop as far as spring applications are concerned. Little well established data is yet available bearing upon the subject of applications after the strawberry harvest. However, the information thus far collected seems to support the idea that applications put on after the berry harvest give larger yields and firmer berries than applications in early spring or at blooming time. This applies especially to the use of nitrate of soda and sulfate of ammonia, both of which are high in their readily available nitrogen content.

The aim in this brief article is to help the grower judge this matter for himself. I would recommend, where plants are somewhat lacking in vigor, a condition which may have been brought about by an insufficient amount of soil fertility, lack of irrigation, cultivation or by advanced age, that a small application of nitrate of soda be put on soon and thoroughly hoed in. One hundred and fifty to two hundred pounds per acre would be sufficient if properly applied. In some cases 100 pounds per acre could be considered sufficient.

This may be followed by another application next spring of a similar amount. Whether or not this second application is necessary would depend largely upon the response secured from the first. The great problem that

confronts the berry grower is to get a sufficiently large crop to insure financial success. This means many blossoms maturing into large fruit. On the other hand, unless great care is exercised in fertilization, especially with nitrate there is a danger from soft berries of poor shipping quality. During a short season when extremely hot weather prevails, berries thus grown do not stand up well. However, there are few cases where at least one application of such fertilizer will not pay, and as already suggested the information at hand appears to favor applications after berry harvest. The evidence supporting this is not final however.

Another problem upon which the station is working is that regarding the best time of topping and irrigating. Some growers withhold topping from two weeks to a month after the end of the berry harvest. Others top the plants immediately and continue irrigation. Several growers claim to have checked up this matter pretty closely and prefer the latter plan. In no case allow the plants to dry out.

The Walnut as a Profitable Dooryard Tree

By E. C. Apperson, McMinnville, Oregon

MY first experience with the walnut tree dates back about twenty years, when we purchased two lots in the city having a total area of 100x120 feet. Mrs. Apperson at that time requested that the shade trees be chestnut and black walnut trees in our parking strip, and the agent of the Oregon Nursery Company who called

upon us and entered our order for these trees, insisted that we include in the order one English walnut tree. We accepted his suggestion and purchased a seedling tree, which we planted in our dooryard. It was only a few years, I think not more than four or five, until this English walnut tree began bearing, and it has borne continuously each year since, each succeeding crop being larger than the previous year.

The success of this one tree gave me considerable encouragement in the culture of English walnuts, and some ten or eleven years after the original planting, Mr. Payne, of California, came through the valley and I had him top graft the black walnuts that were in our parking strip into Vrooman Franquettes, since which time our trees have produced nearly enough revenue to pay the taxes on our home property. We have quite a large comfortable home and the taxes on this property at the present time are approximately \$115 per year.

Upon our dooryard lots above referred to we have one seedling tree about twenty years old, and four black walnut trees, top grafted in the Franquette variety of English walnut of the same age, in which the top grafts are now about ten years of age, and we harvested in the year 1918, 454 pounds from these five trees. The seedling tree alone produced 209 pounds, the greater portion of which my daughter sold at 27 cents per pound, while some of the Franquettes she sold at 32 cents per pound, so if we had marketed all the nuts grown on our parking strip and dooryard, we would have realized approximately \$134. This is the largest yield we have ever had, and also the highest price we have ever received for the nuts.

Some few years ago I made a statement before the Walnut Growers' Association of what my trees were then doing, and introduced the slogan, "Let your shade trees pay your taxes," and I am pleased to say that I still believe this is a good slogan to follow, and if every family would place a few English walnut trees around their dooryard, either in the city or country, it would go a long way towards paying their taxes. The walnut business I think is developing rapidly, and the possibilities of it are now being fully realized by the Oregon Agricultural College and the progressive people of our state.

\$1,600 From 1½ Acres of Loganberries.

In showing what loganberries are doing for the growers in the Salem district this year, the return to one grower can be cited. D. L. Hopkins has a patch of these berries about an acre and a half in extent from which he will harvest ten tons of fruit. At the prevailing prices of eight to nine cents a pound which growers are receiving, Mr. Hopkins will get a gross return of \$1,600 for his berries. The patch was planted about five years ago and commenced bearing when it was two years old.

Timely Topics and Advice for Fruitgrowers

FIRE blight, the most fatal of all fruit tree diseases, is reported to be making its appearance in some of the fruitgrowing districts of the Northwest and growers are being warned by horticultural experts to watch the situation closely. Control of this disease can only be obtained by cutting out and destroying the diseased parts of the trees. In cutting for blight, cut below all visible evidence of the disease to prevent its spread and burn the cuttings. Tools used for this purpose should be disinfected with corrosive sublimate 1-1000. Small quantities for disinfesting purposes may be made by dissolving two tablets in a pint of water. The solution should be kept in a wooden or glass receptacle.

Growers should remember that to obtain the best results in ridding orchards of anthracnose they should be sprayed before the fall rains set in. The spraying should be done early in the fall just before the fruit is picked or just after. If the weather remains dry it will be better to spray just after the fruit is packed, but if not spraying should be commenced at the first sign of rain and be continued between showers if necessary. The sprays that are most effective are the Bordeaux and Burgundy mixtures.

Have all your arrangements for the fruit harvesting season made well in advance of the time to commence picking and packing. If you have the proper amount of equipment, see that it is in repair and easily available for immediate use. Engage your pickers and packers. If you are compelled to purchase equipment, do it as early as possible as indications are that the demand for orchard equipment of all kinds will be very heavy and may run short later in the season. By being prepared for the harvesting season early you

may save many dollars, due to weather or other conditions that frequently bring with them uncertainties in getting the fruit crop into the packing house at the right time and in the best condition.

If your orchard needs fertilization from green plant life bear in mind the planting of your cover crop and do not neglect to get it in at the right time. Alfalfa, clover and vetch will answer this purpose in most instances in well watered districts. For unirrigated districts and where the rainfall is light you would do well to communicate with the agricultural experiment station in your state as to what kind of cover crop to use in semi-arid regions.

The late fall during a period of dry weather is the most advantageous time to spray for Jose scale. Effective work with the sprayer in the late fall will control scale just as well as if applied in the spring. Lime-sulphur at a strength of 1-8 should be used and every part of affected trees should receive a thorough coating. On account of the ground being in better condition in the late fall or early winter for spraying operations many orchardists are now applying the spray for scale at that time instead of waiting until spring when the mud and rains interfere seriously with the work.

If you are thinking of doing any fall planting, you will have to get your orders in early. Nursery stock is both scarce and prices are rising. Stocks of some varieties of fruit are almost out of the market and others can be obtained only in limited quantities.

If your orchard is not bearing well, although the bloom was heavy, you should investigate. You may find that while your trees are apparently in a healthy condition, they are lacking in the proper kind of plant life nourishment to form fruit. In many instances this can be remedied by the application of nitrate of soda or some other equally good chemical fertilizer. Pollenization may also be deficient in which case pollenizers should be supplied by top-grafting and the process also assisted by the introduction of bees and other methods. Pollenization is not a matter of guess work any longer. Experimental work carried on by C. I. Lewis, horticulturist at the Oregon Agricultural College, and other leading men engaged in this work, shows conclusively that lack of pollenization and also proper fertilization can be remedied if progressive methods are adopted.

Peach leaf curl may have appeared in your peach orchard and you are wondering what you can do to eradicate it. You can do nothing at the present time as the period has passed for treating it. The control of peach leaf curl is simple. It can be prevented by a single thorough spraying in the later winter or early spring before the leaf and blossom buds begin to open. H. P. Barss, plant pathologist at the Oregon Agricultural College, says that the first favorable opportunity to spray for this disease should be taken advantage of and that Bordeaux mixture is the most effective. This spray should be applied at a strength of 6-6-50 and every bud on the tree should be covered thoroughly. Very good results have also been obtained in controlling peach leaf curl with lime-sulphur, one part of the concentrated solution to eight parts of water. If there is San Jose scale in the orchard as well as peach leaf curl, growers are advised to use the lime-sulphur, as Bordeaux will not control the scale. The best time to do this work is in the latter part of February.

Probably the best wash for apple tree borers is a thick coat of paint made from raw linseed oil and pure white lead. Remove the earth for a distance of three to four inches from the base of the tree, scrape off the dirt and loose bark scales, and, after washing, apply to the exposed trunk a thick, uniform coating of paint to a distance of about a foot above ground.

What They're Doing in California

The California State Horticultural Commission has grown to such an extent that it is necessary to have an expert to look after the various funds and H. W. Levers has been appointed to that position.

New Zealand fruitgrowers have adopted the standard berry pack of California, prompting the horticultural commissioners of that state to remark that our fruitgrowing friends in the Antipodes are not slow to take to a good thing.

**BEST SERVICE-
QUALITY & PRICES**

**PERFECTION IN
FRUIT
LABELS**

THE
SIMPSON & DOELLER Co.
1423-24 NORTHWESTERN BANK BLDG.
PORTLAND, OREGON.
E. SHELLEY MORGAN
NORTHWESTERN MANAGER

**WE CARRY—AND CAN SHIP IN 24-
HOURS—STOCK LABELS FOR PEARS,
APPLES, CHERRIES & STRAWBERRIES.**

Cooking and Canning IS A REAL PLEASURE

Note the picture. You cook everything at once, over one fire. Everything cooked perfectly under steam pressure—no burning, no mixing of flavors, no shrinkage of the food. With it you can everything by the cold pack method—fruit, vegetables, meats, etc. Thousands are using Conservo and say it's worth its weight in gold.

Conservo Cooker

No. 20—Conservo, 21½ inches high, 11¾ inches square; 4 removable shelves; 2 pans; cooks for 3 to 15 persons; holds 14 one-quart jars for canning. No. 9—Conservo is 13½ inches high; 2 shelves; 1 pan; cooks for 2 or 3 persons; holds one-quart jars for canning.

Works on any stove—wood, coal or gas

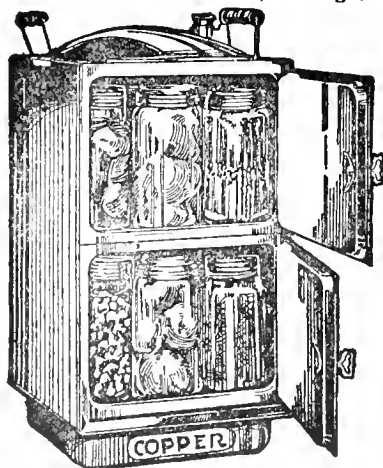

Write for Free Book and Information

"Conservo" is a time and money saver. It is a blessing to the housekeeper. Every home should have one. It will pay for itself in a few months' time by the saving in food and fuel. Foods cooked in it are delicious—they retain all their flavor and natural juices. Canning is done perfectly and with least possible effort.

Write today for booklet and information.

OUTWEST SUPPLY CO.
PORTLAND, OREGON

LABELS WITH A PURPOSE

TO ATTRACT ATTENTION
AND CREATE SALES



47th YEAR of
SERVICE and
QUALITY

Branches:

SEATTLE · PORTLAND
SACRAMENTO · FRESNO
LOS ANGELES · HONOLULU

trees (two acres); fig, 2,460 trees (32 acres); olive, 3,026 trees (41 acres); grape, 14,529 rooted and cuttings; persimmon, 35 trees; walnut, 1,937 trees (17 acres); lemon, 151 trees (two acres); oranges, 901 trees (12 acres); cherry, 21,752 trees (291 acres); pear, 31,088 trees (460 acres); plum, 7,798 trees (105 acres); prune, 26,065 trees (352 acres); peach, 16,561 trees (221 acres); apricot, 12,163 trees (164 acres); almond, 36,676 trees (463 acres); apple, 818 trees (12 acres); pomegranate, 15 trees; chestnut, 156 trees (2 acres).

For the year beginning July 1, 1917, and ended July 1, 1918, the state of California appropriated \$5,000 for the enforcement of the Standard Apple Act. No appropriation was asked or made after July 1, 1918, for the reason that the revenue accruing from the sale of Apple Grade Stamps, at one-half cent each, reached the sum of \$13,543.66, against an expenditure of approximately \$12,500 used in the enforcement of the act during the apple shipping season of 1918.

Wine grape growers are being offered \$25 per ton for their crops and buyers are prom-

ising to take all that are offered, pay cash on delivery and to furnish the lug boxes. The grapes are to be dried and sent out of the United States, where the proper solutions will be added and made into wine. It is claimed none of the nutriment of the grape is lost in the drying process. It has been tried.

Five thousand dollars from a ten-acre Climax plum orchard five years old, near Lindsay, was the return that W. E. Porter received for his crop this year.

A heavy crop of figs is reported in the Sultana district. Figs are selling on the Eastern market from 18 to 30 cents a pound, while cannery prices in the field are 9 cents a pound.

The new process refrigerator cars being used for fruit shipments from California are said to be giving good results, and are likely to supersede the old style cars. The cars are equipped with outside electric thermometers so that the temperatures inside can be read at any time without opening the cars.

Tomato blight is reported generally throughout tomato growing districts and growers are expecting to receive \$18 per ton for their outputs. Climatic conditions this year are said to have been particularly adapted to this disease.

Sixty dollars per ton, said to be the highest figure paid for California Elberta peaches this year in large lots, was recently received by a fruitgrowing company in the Turlock district.

The old story of the fine fruit on the top and the poor quality in the bottom resulted in the condemning of half a car load of plums in the Fresno district recently. The shippers of the fruit were allowed later to repack the shipment according to the fresh fruit standardization law.

Bits About Fruit, Fruitmen and Fruitgrowers

Reports are to the effect that the Fruit Growers' Agency is receiving strong support this year. The Yakima association has undertaken to secure 1,000 members for the agency and other districts are falling in line to secure for this organization a much larger increase in its membership. It is said that with Yakima in line the Northwest will be solid in its support of the agency.

Information from authoritative sources state that there will be no change in car loading specifications for apples this year with the exception of extending the 1x6 middle upright to within two inches of the ceiling. The other requirements proposed by the Railway Administration have been postponed one year. The new apple box specifications adopted by the Railway Administration provide for the minimum sizes of 3/4 inch ends, 5-16 inch sides, and 3-16 inch tops and bottoms with a 1-32 of an inch variation allowed. If the dimensions do not meet with these requirements a higher rate will be charged. These specifications, however, do not go into effect until next year.

A recent cablegram from Consul General Skinner, London, states that the general license for the importation of apples and canned fruits into the United Kingdom has been extended to April, 1920.

Small fruits in Canada with the exception of currants are a very light crop this year. The apple crop is more promising, especially in the Maritime Provinces. The crop in British Columbia indicates a yield estimated at an increase of 50 per cent over last year. In Ontario it is not so good varying from 50 to 80 per cent of a normal crop.

The shipment of new apples commenced early in July. One hundred and fifty-eight cars were put on the market in the United States the first week and 219 the second. Apple exports from April 30 to July 1 this year were 1,546,989 barrels (old stock). The shipments were largely sent to England, Norway and Sweden.

The apple is the king of fruits in value of crop as well as in the estimation of apple lovers, according to information gathered by the United States department of agriculture. For the apple crop of 1918 a value of \$230,000,000 has been estimated, or nearly three-eighths of the value of all fruits.

According to recent reports received from California the prices being paid there for fruits for canning are considerably higher than those paid last year. For apricots last year the average was \$65 the ton; this year it is between \$100 and \$110 the ton; yellow freestone peaches last year, \$37.50; this year, \$15 to \$60; yellow clings last year, \$50; this year \$85 to \$110; Royal Anne cherries last year, \$155, and this year, \$240; pears last year, \$60; this year, \$85; plums last year, \$50; this year, \$75 and \$100.

The opening prices for California prunes announced recently by the California Prune Growers' Association caused widespread interest in the Northwest as many producers in the latter section were waiting for California to set the prices before selling. The California prices are 16 cents a pound on 30-40s, 14 cents on 40-50s, and 12 cents on 50-60s. It is stated that in some sections of Oregon prunes have been sold at 1/2 cent a pound higher for the same sizes.

Much interest is being manifested by fruitgrowers throughout the country in the operations of the American Fruit Growers, Inc., a \$100,000,000 corporation that is acquiring orchard property in both the deciduous and citrus fruit belts of the United States, but about which little was known. According to a recent statement of this company its fundamental object is to organize and finance the fruit and vegetable industry on a stabilized basis. The statement says that the fruit and vegetable industry in the United States represents in gross volume and value the most important item in the food supply of the nation, excepting only cereals and meat, the total annual value of which has been estimated as high as \$3,000,000,000. The large export demand for cereals and meat, this

NOW is the time to send to
Milton Nursery Company
MILTON, OREGON

FOR THEIR 1919 CATALOG.
FULL LINE OF NURSERY STOCK.

"Genuineness and Quality"

statement says, is causing the American public to increase its proportion of fruit and vegetables in the daily diet with the result that during the next five years the public must pay extremely high prices for tree fruits and probably also for vegetables. Fearing that these high prices to the consumer and the excess profits tax will result in a lessening of the production, the company states that it is acquiring ownership to fruit and vegetable properties in those districts in the United States which have proven, over a period of years, most certain in the matter of quantity and quality production. The American Fruit Growers, Inc., has already acquired producing properties aggregating \$3,500,000. It has an authorized capital of \$50,000,000, and had its inception in the hands of Crutchfield & Woolfolk, one of the largest fruit and vegetable handling firms in the East. James S. Crutchfield is president of it, R. B. Woolfolk vice-president, and Charles J. Brand, formerly with the Bureau of Markets, is vice-president

and general manager. The other officers are Chester Tyson, of Pennsylvania, production manager; W. M. Scott of Virginia, assistant production manager; William H. Baggs, of Pennsylvania, chief of distribution, sales and advertising; H. E. Heitman, regional vice-president for Florida; T. H. Peppers, regional vice-president for California; Reginald Parsons, regional vice-president for Washington. The main offices of the company are located in Pittsburgh. The middle western interests of the firm are in charge of W. B. Clore, who is located in Chicago. The company is financing its operation without the issue of bonds or underwriting expense and proposes to list its securities on the Pittsburgh Stock Exchange.

Northwest apple growers have not looked upon the far southern state of Georgia as the successful producer of large quantities of apples, but such is the case. The new apple

producing section is located in Habersham and Rabun counties. One of the orchards in this locality is 300 acres in extent, 200 acres of which are in bearing and last year produced \$80,000 worth of fruit, which paid the stockholders a dividend of 25 per cent. There are 810 acres of apples in this district which are coming into bearing this year and 6,000 acres altogether which it is said are suitable for fruit. The orchard project is owned by a company known as the Appalachian Corporation, which owns a large distributing warehouse in New Orleans and sells its apples direct to the wholesaler or retailer. Louis B. Magid, who is at the head of the company, says that the New Orleans plant and Georgia orchards are the first of a number of projects which will be established to bring about the cheapest and most direct way of distributing fruits and vegetables to the retailer, hence to the consumer. Mr. Magid says that he doesn't consider the middle or commission man necessary in the distribution of foods.

CO-OPERATION

among fruitgrowers has done more than any other one thing to put the fruit industry on a stable basis.

Originated on the Pacific Coast, the movement spread throughout the country, and has given a wonderful impetus to the developing of better varieties of fruits, dropping of undesirable ones, pruning and grafting, packing to display them to the best advantage, and finally marketing them so as to give a reasonable profit to the individual grower.

Ladd & Tilton Bank has always been vitally interested in all industries of whatever sort that tend to develop the Pacific Northwest, and lends its co-operation to the fruitgrowers in every legitimate banking direction.

OFFICERS:

W. M. Ladd, Chairman of Board	Walter M. Cook, Cashier
Edward Cookingham, President	Thomas H. West, Assistant Cashier
Isaac D. Hunt, Vice-President	Cameron Squires, Assistant Cashier
R. S. Howard, Vice-President	G. C. Blohm, Manager Credit Dept.
Samuel L. Eddy, Vice-President	A. W. Brookings, Auditor

DIRECTORS:

W. M. Ladd, Edward Cookingham, Raymond B. Wilcox, Isaac D. Hunt, Fredenc B. Pratt, Harold I. Pratt, Cameron Squires

LADD & TILTON BANK

Oldest in the Northwest
WASHINGTON AND THIRD

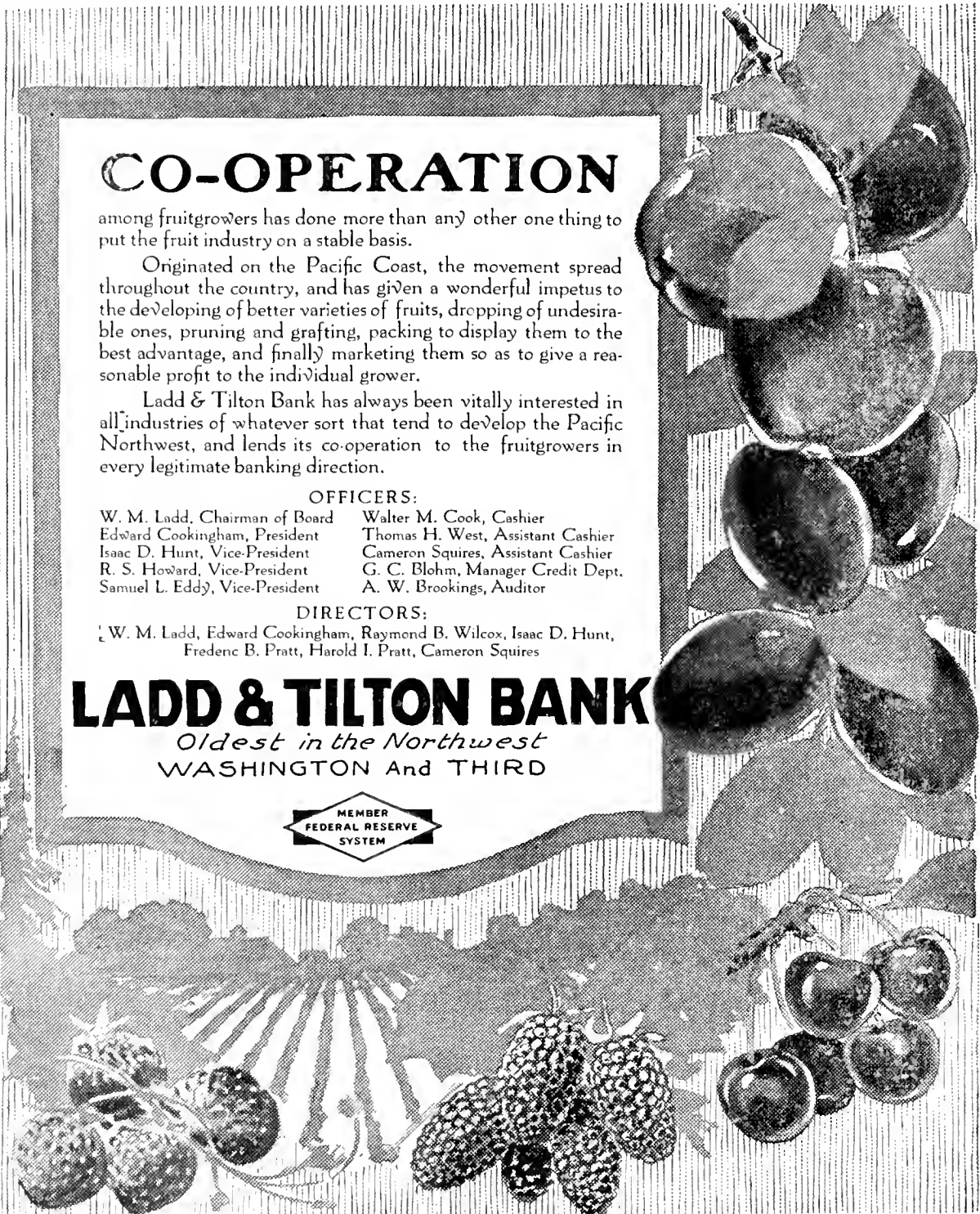

Advices recently received from the Atlantic Conference Lines are that apple freight rates on steamers sailing from New York, Philadelphia, Boston and Baltimore to Liverpool, London, Hull, Manchester and Glasgow during the coming season will be 85 cents per box and \$3 per barrel for ordinary stowage and \$1 per box and \$3.50 per barrel on refrigerator stowage.

The annual convention of the International Apple Shippers' Association will be held at the Hotel Phister in Milwaukee, Wis., August 12-15. Among other important matters to be taken up it is expected that the question of increased freight rates on fruit will be discussed at length at this meeting. W. L. Wagner, of the firm of G. M. H. Wagner & Sons, is chairman of the committee of arrangements. It is expected that the Northwest will be represented by a good sized delegation.

The Vegetable Growers' Association of America will hold its annual meeting at Detroit, Michigan, September 9 to 12. This organization is composed of many of the leading vegetable growers of the United States and Canada. The attendance usually exceeds five hundred and it is expected that this year there will be a larger number than ever before.

Report of Apple, Pear and Peach Crops for July

APPLES.

A sharp decline in the condition of the New York apple crop during June is the principal feature of the special commercial apple report released by the Bureau of Crop Estimates on July 9. The condition of the commercial apple crop for the United States as a whole now indicates 21,454,000 barrels as compared with 24,584,000 barrels in 1918. New York state now promises less than one-third of last year's production. The New England states have very good prospects, while the Middle Atlantic regions, including Pennsylvania, Maryland, the Virginias, New Jersey and Delaware, have on the whole about 20 per cent less than last year. The Middle West, particularly Missouri, shows an increase over 1918.

The very heavy production of boxed apples largely offsets the light crop in New York. Washington will probably lead the states in

commercial production by a large margin. The west as a whole produced its largest crop of 29,000,000 boxes as compared with 21,309,000 boxes in 1918 and 25,689,000 boxes in 1917.

In the Pacific Northwest the state of Washington will lead in the production of apples with a crop that is now estimated at 19,500 cars as compared to 17,000 cars in 1918. The total apple crop in Oregon for 1919 is estimated at 3,936,000 boxes as compared to 2,013,000 boxes in 1918. In Idaho conditions there now indicate that this state will ship 1,000 cars this year or 500 cars in excess of the bumper crop of 1917, giving Idaho the largest apple crop in the history of the state. The crop in Utah is estimated at 175 cars or 80,000 boxes less than the crop of 1918. The estimate for the crop in Montana is about 450 cars, most of which will be shipped from the Bitter Root Valley. The California crop is now expected to be about 3,672,000 boxes as against 3,381,000 boxes in 1918, and the crop in New Mexico is estimated at 600 cars. The Colorado crop is estimated at 3,100 cars.

PEARS.

A heavy pear crop in California and the Pacific West generally, contrasted with poor conditions in such important pear states as New York, Michigan, Illinois, New Jersey and Delaware, is the most important fact brought out in the special commercial pear report. The figures given apply only to that portion of the total crop which moves to market in carload and express shipments or by truck. The total commercial pear production for the United States is now estimated at 7,691,000 bushels as compared with 7,589,000 bushels last year, or 1.3 per cent increase as compared with 1918.

California, which is the greatest pear producing state in the United States, it is estimated will have a crop this year of 4,000,000 bushels as compared to 3,814,000 bushels in 1918. Fifty per cent of this production is usually canned or dried and 50 per cent shipped fresh. The Washington crop of pears promises to be in the neighborhood of 1,560,000 boxes or 260,000 boxes more than last year, while Oregon is estimated to produce 575,000 boxes or 70,000 boxes in excess of 1918. The shipment from Colorado is expected to be 500 cars, while Utah, where the pear

production is limited, will ship, it is estimated, 35 cars.

PEACHES.

A 50 per cent decrease in the commercial peach forecast for New York, Michigan and Ohio during the month of June is the salient feature in the July special peach report for the United States. The heavy drop in the northern peach belt was due to peach leaf curl and Brown rot in New York, peach leaf curl in Michigan, and decreased acreage and peach leaf curl in Ohio. Conditions have been generally unfavorable in all three states.

Brown rot has caused considerable loss among early varieties in the Middle West, particularly in Arkansas, Oklahoma and Texas. The conditions in the Western States continue favorable and almost a full crop is forecasted for the regions west of the Rocky Mountains. California has prospects for a bumper crop.

The July report indicates a total crop of 30,982,000 bushels for the United States as compared with 20,797,000 bushels last year, or 44.6 per cent increase over the light crop of 1918.

A Practical De-Webbing Device.

Drive tacks or small nails into a large spool or block of wood. Mount same on end of long bamboo or other pole—the longer, the better. Thrust into the web and turn slowly. The projecting tacks or nails will engage and "wind up" the web, which may be scorched, burned or plunged into hot water or crude petroleum.

Insect Banquet Costs \$500,000,000.

The American Forestry Association, through its president, Charles Lathrop Paek, estimates the annual loss from insect pests in the United States to orchard and forest trees as approximately \$500,000,000, which does not include losses to foodstuffs from rodents, in field and storage, or from destructive plant diseases.

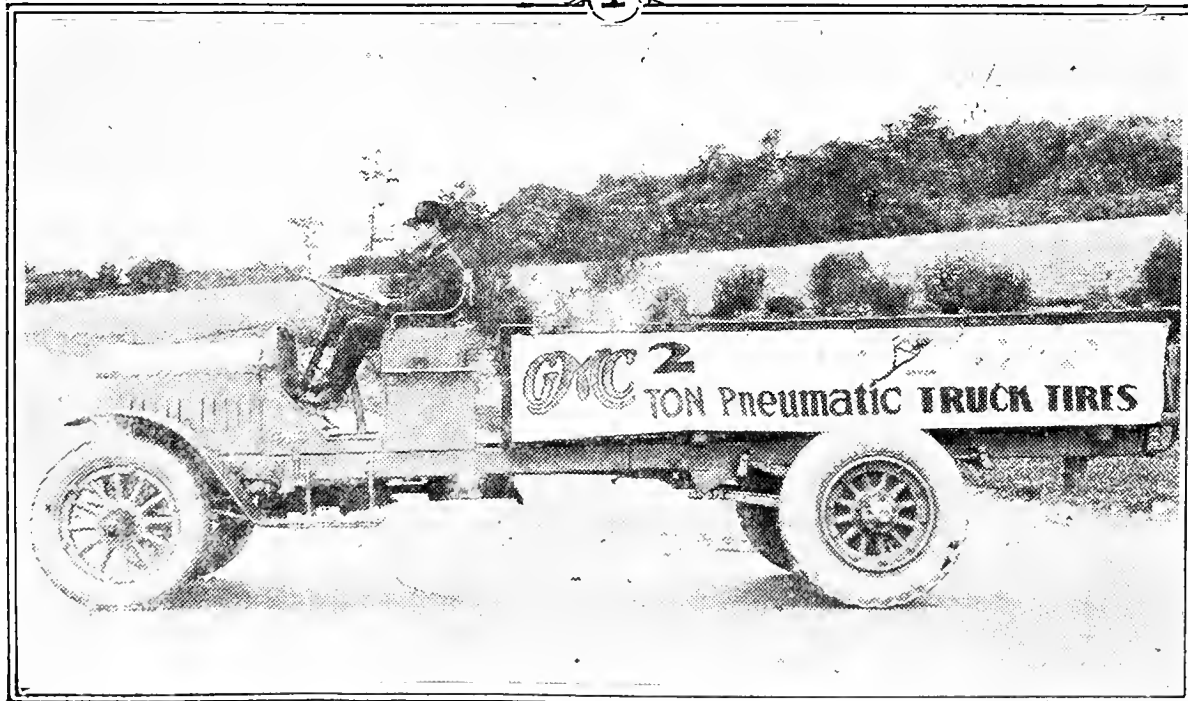

G.M.C. Trucks equipped with pneumatic tires assures you the delivery of your fruit in the best possible condition as well as speeding up your work.

3 1/2 to 5 ton

Seattle
Yakima

Eldridge Buick Company

Spokane
Walla Walla

BETTER FRUIT

An Illustrated Magazine Devoted to the Interests of Modern Fruit Growing and Marketing. Published Monthly by

Better Fruit Publishing Company

703 Oregonian Building
PORTLAND, OREGON

Capitalizing the Fruit Industry

The tendency of several large organizations which have been organized more or less recently to enter the fruit industry seems to be toward capitalization and cutting out the middle, or commission man. The American Fruit Growers' Inc., a \$100,000,000 corporation, which has already acquired \$3,500,000 worth of orchard property and has options on other large holdings, and the Appalachian Corporation, a company owning orchards in Georgia and Missouri and operating a large warehouse in New Orleans, announce that they are adopting a course to reach the consumer in as direct a manner as possible—that is, that they will sell to the wholesaler and the retailer, but not to the commission man.

The big Southern corporation seems to be doing business on a straight-out producing and sales basis, as it makes no announcement of stock for sale or the listing of its securities on the open market. The prospectus of the American Fruit Growers' Inc., which states that its securities will be listed on the stock exchange, smacks slightly of equivocal benevolence toward the consumer and the producer. One of the reasons that it gives for the formation of its organization is that it fears that the consumer will have to pay extremely high prices for fruit products during the next five years, owing to lessened production on account of excess profit taxes, and that it is taking a course that it believes will stabilize the market.

While the course adopted by this organization may have this tendency, this result can only be determined by its future operations. If these result in making a fair price to both producer and consumer the American Fruit Growers' Inc. will, indeed, have served a great purpose in the fruit industry.

Perhaps it would have inspired greater confidence in the minds of the public, however, if this big company had stated that there never was a time in the history of the fruit industry when the opportunity was so great to capitalize it on a big scale and secure so great a reward. New methods and new practices are making fruit a staple, rather than a perishable product, and it is on the boards for it to take its place in the marts of trade along with the meats and cereals.

The organization of the fruit industry by large corporations on a huge scale may benefit the producer and the consumer, but not if it is conducted along the lines employed by many of the big food handling interests which tell the producer what he can get for his products and the consumer what he must pay for them.

The cutting out of the middleman both in theory and practice is correct. But if neither producer or consumer gets the benefit of this cutting-out process "what doth it benefit us?"

As it is apparently the plan of the big companies above mentioned to grow their own products, the producer in this case should not suffer. We will await with interest, therefore, what happens to the consumer.

A Worthy Object

In 1900, and for several years succeeding, the prune industry was at its lowest ebb. A California grower is said to have remarked during this period that the large prunes were more useful than the small ones, as they could be thrown straighter at offending cats and dogs than the small ones.

The history of the prune industry in California is identical with that of Oregon. This condition in the prune industry is ascribed to the manipulation of the prune operators in California and the lack of distribution and creation of demand. The later regeneration of the prune with its attendant prosperity to growers is credited to the organization of the California Prune and Apricot Growers' Association, which controlled the tonnage, advertised, created the market and set the price at what it considered a fair return to the grower.

Next to the citrus fruits the prune industry is now California's greatest asset in the fruit business. In Oregon it is the greatest asset in the state's entire fruit industry.

Oregon growers are now endeavoring to do for Oregon prunes and other fruits what California growers did for California—to stabilize the industry, to ship Oregon fruits under an Oregon brand and to bring prosperity to the growers and the state in general.

This, in brief, is the whole story of the object of the Oregon Growers' Co-operative Association. And its a good story and a worthy object.

Protecting Oregon Investments

The fear that the large amount of capital already invested in Oregon fruit canning and by-products, plants will be jeopardized by the operations of the Oregon Growers' Co-operative Association is groundless. The primary object of the association is to obtain a fair price for the members of the organization for their fruit products in the various districts. If this is accomplished by selling to manufacturing concerns or other fruit handlers that are already in the business, it will probably not be the policy of the association to enter into manufacturing competition where the return to the grower is satisfactory. Where no plants are established it is the intention of the organization to erect them.

The officers and organization committee of the association are Oregon business men as well as fruit growers. The membership of the association is composed of Oregon citizens interested in the development and prosper-

ity of Oregon institutions. It can be safely assumed, therefore, that these institutions will be fairly dealt with.

Editorial Comment

Which would you rather be: John D. Rockefeller or a loganberry grower?

Apple prices are soaring and so are freight rates. Don't take it all, railroad men.

The fruit grower who adopts the latest labor-saving appliances these days will accumulate the biggest bank roll.

Jack Frost must be feeling badly. He, no doubt, tried hard, but he couldn't get the Idaho apple crop this year. It's a bumper.

While the "coming back" of the Oregon prune provides H. S. Gile with the opportunity of saying "I told you so," still we are all glad to hear it.

Elbert Hubbard said that fruit was nature's handmaiden in creating optimism. If this is true, it should be on every table in every household.

The apple growers of Washington are spending \$500,000 to advertise their fruit this year. That's why the Washingtonians are always forging ahead. They are never afraid to spend a dollar to get two back.

The California State Horticultural Commission is a live institution. Nothing is too big or too small for it to tackle, and it makes a success of it. The liberal appropriations it is allowed, however, are a big help.

Cranberry culture is assuming an important place in the fruit industry of the Northwest, and the most salient feature of this fact is that the Pacific Coast berry is a superior product to that grown in other districts.

The expansion of the fruitgrowing industry of the Northwest is now only a matter of securing nursery stock. It is estimated that the United States is short several millions of trees to supply the normal demand for fruit.

The research work of the Experiment Station of the Oregon Agricultural College is bearing good fruit. Information that this institution has obtained on pollenization and fertilization of fruit trees alone is proving of incalculable value to the fruit grower.

The fruit grower, like the farmer in other branches, doesn't take kindly to the daylight saving "bunk." He can't see why the golf and tennis players, the twilight baseball leagues and the fellows that don't have to get up until noon should run the country. Neither do we.

The silver tongued orators are not all in Congress. When it comes to enthraling a group of fruit growers, Prof. C. I. Lewis, organization manager of the Oregon Growers' Co-operative Association, is some Wm. J. Bryan himself—and he gives them something worth listening to.

Pacific Coast Cranberry Industry Growing

At a meeting of the Pacific Cranberry Exchange recently held in Portland it was stated that the Pacific Coast cranberry industry is becoming such an important factor in the fruit industry of the Northwest that it is necessary for the growers to form a more compact organization. To obtain this result it was decided to incorporate and an organization committee consisting of C. E. Griffith, of Portland, Ore.; W. F. Schimpf, of Astoria, Ore., and L. W. Paul, of Ilwaco, Wash., were appointed to take the preliminary steps in the matter. The growers belonging to the Pacific Cranberry Exchange are located in Clatsop County, Oregon, and the southwest counties of Washington. It is estimated that there are now 1000 acres of cranberries under the control of the exchange.

Among the matters discussed at the meeting were a better and more attractive pack, better marketing facilities, wider distribution, and more extensive advertising. The importance of the market for by-products from cranberries was also gone into and it was shown that in some instances there was a greater profit in using the berries for this purpose than in selling them fresh. As an instance it was shown that the juice sold readily at \$1.25 per gallon and that a barrel of berries would produce from 12 to 12½ gallons. Many other profitable uses for the by-products from cranberries were also cited.

An attractive and unique box label with the color scheme worked out in the national colors of red, white and blue, and bearing the slogan "Eat No Better Cranberries, and Know Cranberries Better," was adopted by the exchange to be placed on its shipments.

One of the most interesting points brought out at the meeting was the fact that there was no truth in the

statement that the Pacific Coast berries do not keep as well as the Eastern berries. It was shown conclusively that with proper care that the Pacific Coast fruit could be kept until late in the summer and that an analysis made by an expert proved that the latter required 30 per cent less sugar for canning purposes than the Eastern berry. This fact is looked upon by coast cranberry growers as a big advantage over the Eastern grown fruit and will be used to educate consumers as to the greater value to them of the western berry for canning and jelly purposes.

While no estimates are available for the entire crop from the Oregon-Washington cranberry growing district this year the crop in the Southwest Washington peninsula section in 1917 was 3500 barrels and in 1918 15,000 barrels. One grower from a little less than one acre in this section last year harvested 206 barrels. Two hundred and fifty additional acres were set to cranberries in the Grays Harbor district this year.

A much greater development of this industry is expected in the near future when coast consumers of fruit become alive to the various uses to which the cranberry can be put and when they also become aware of the superiority of the western grown berry.

Cleaning Up the Loganberry Yard

As soon as the crop is picked or shortly afterward the loganberry yard should be cleaned up to insure the best results in fruit the following year. The old canes should be pruned out and a careful search made for anthracnose. This disease affects the canes, leaves and fruit, and if neglected will ruin the patch. The disease can be detected on the stems by

spots having a pale center with irregular brown or black margins and varying in size and color. These spots on the leaves have a pale center with broad reddish or purple borders. If the fruit is attacked it dries up when about half grown. The vines, in the last stages of the disease send out a great many canes that fail to bear fruit.

To control anthracnose the old vines should be pruned out just as soon as the crop is off, for the new growth will be infected if they are left until spring. All diseased vines should be burned. In February the plants should be sprayed with lime-sulphur or Bordeaux, and six weeks later with the same mixture. Care should be exercised in using Bordeaux, as it is inclined to burn the foliage. These sprays should be applied as follows: Dormant, liquid lime-sulphur, two and one-half gallons to 50 gallons of water; soluble sulphur 10 pounds to 50, Bordeaux 4-4-50. Summer, lime-sulphur one and one-half gallons to 50; soluble sulphur, one pound to 50; Bordeaux, 4-4-50.

Well cared for and properly sprayed loganberry plants will last and bear much longer than the unsprayed plants and at present and prospective prices for these berries, growers can well afford to give them the best of care. In cleaning up the yard this year it will be well for the grower to remember that there will be a strong demand at good prices for new plants and that the vines should be pruned with a view to saving all the healthy tips possible.

Shortage of Nursery Stock Serious

Nursery stock for new plantings will be very short this year according to fifty members of the Pacific Coast Nurserymen's Association representing most of the states in the Pacific Northwest, who recently attended the annual meeting of the organization in

**"CARO"
FIBRE
FRUIT
WRAPPERS**

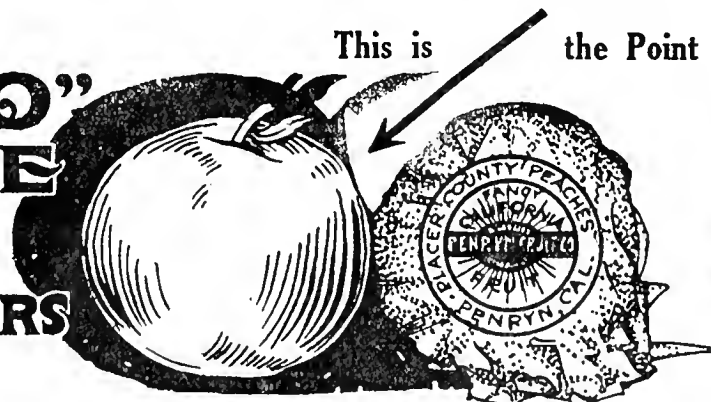

**Chemically Treated
"Caro" Protects
"Caro" from DessiCARE (to dry up)**

**"Caro"
Prolongs the
Life of Fruit
Why?**

Fruit decomposition starts from a bruise which opens tiny holes and permits the juice to escape and BACTERIA to enter. "Caro" clings closely and dries up the escaping juice. "Caro" ingredients harden the spot, kill the BACTERIA, arrests the decomposition—and thus **PROLONGS THE LIFE OF FRUIT**. If your fruit is worth shipping it is worth keeping in best condition.

Demand "CARO"—Wrap Your Fruit in "CARO"—The Fruit Buyer Knows "CARO"

Order from Any Fruit Company or American Sales Agencies Co., 112 Market St., San Francisco

Portland. Some varieties of stock, such as apricots, were declared to be almost impossible to obtain while the demand for apple, pear, prune and berry stock was reported to be far greater than the supply. In order to make a more equitable distribution of

nursery stock it was stated at the meeting that commercial growers planning a large increase in new acreage would be compelled to cut down their plantings.

The program which was an interesting one contained among other top-

ics, "The Elimination of Undesirable Varieties," "Higher Retail Prices," and Stock," "Moulding Public Opinion in Ornamentation," the "Future of the Prune Industry," "Pollination," and "The Labor Problem."

In the discussion on eliminating un-

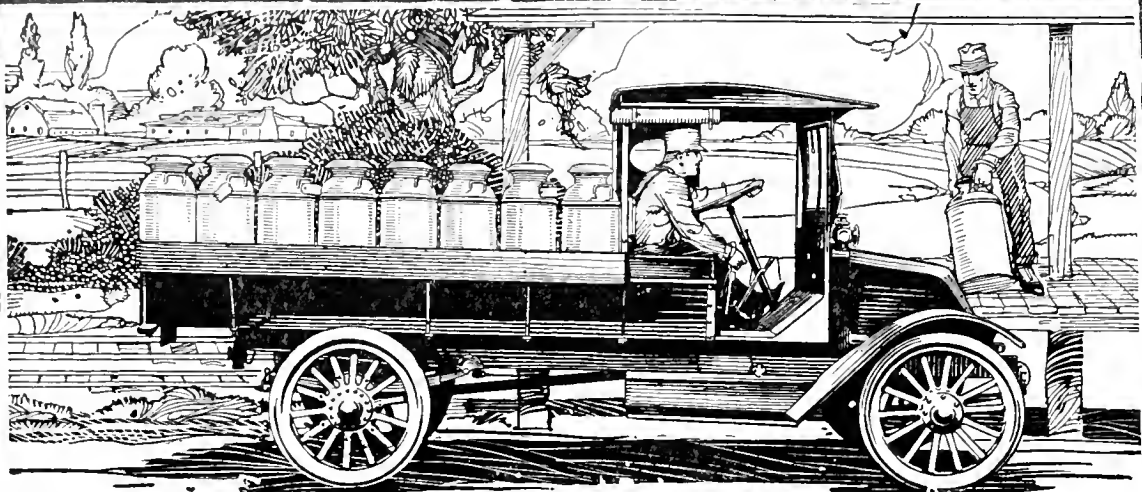

International Motor Trucks For Country Road Hauling

OF ALL the motor trucks offered for farmers' use, the **International** should be, and we believe is, the most satisfactory.

This Company knows the country — roads, farms, and all. Farmers know our standards of quality and service. When we offer a motor truck for farmers' use, it is understood that the truck will do the work expected of it at a cost farmers can afford.

The **International Motor Truck** is built for carrying capacity loads on country roads. It gives satisfactory everyday service, the kind that farmers must have. When an emergency comes — a tough piece of road, a steep hill, a rush trip, a bad day — the **International** has the re-

serve power, speed, and endurance to carry it through.

Mr. L. C. Henry of Utica, Minn., purchased an International Motor Truck to haul his live stock and farm produce to market and to bring return loads from town. He says, "We use the truck for nearly every kind of hauling. It saves more time than any other machine in our farm service." Five of Mr. Henry's neighbors bought International Motor Trucks when they learned, from his experience, what a useful economical farm machine he had.

There are four sizes of **International Motor Trucks** — 1,500, 2,000, 3,000 and 4,000 pounds capacity, with bodies suitable for every kind of hauling. We have a dealer, a branch house, or a service station somewhere near you, where the line can be seen, or we will send full information promptly if you will write us.

The Full Line of International Harvester Quality Machines

Grain Harvesting Machines
Binders Push Binders
Headers Rice Binders
Harvester-Threshers
Reapers Shockers
Threshers

Tillage Implements
Disk Harrows Cultivators
Tractor Harrows
Spring-Tooth Harrows
Peg-Tooth Harrows
Orchard Harrows

Planting & Seeding Machines
Corn Planters Corn Drills
Grain Drills
Broadcast Seeders
Alfalfa & Grass Seed Drills
Fertilizer & Lime Sowers

Haying Machines
Mowers Tedders
Side Delivery Rakes
Loaders (All Types)
Rakes
Combination Side Rakes
and Tedders
Sweep Rakes Stackers
Combination Sweep Rakes
and Stackers
Baling Presses
Bunchers

Belt Machines
Ensilage Cutters
Huskers and Shredders
Corn Shellers Threshers
Hay Presses
Stone Burr Mills

Belt Machines—Cont.
Cream Separators
Feed Grinders

Power Machines
Kerosene Engines
Gasoline Engines
Kerosene Tractors
Motor Trucks
Motor Cultivators

Comb Machines
Planters Drills
Cultivators
Motor Cultivators
Binders Pickers
Ensilage Cutters
Shellers
Huskers and Shredders

Dairy Equipment
Cream Separators
(Hand)
Cream Separators
(Belted)
Kerosene Engines
Gasoline Engines
Motor Trucks

Other Farm Equipment
Manure Spreaders
Straw Spreading Attach.
Farm Wagons
Farm Trucks
Stalk Cutters
Knife Grinders
Tractor Hitches
Binder Twine

International Harvester Company of America

(Incorporated)

Billings, Mont. Crawford, Neb. Denver, Colo. Helena, Mont.
Los Angeles, Cal. Portland, Ore. Salt Lake City, Utah
San Francisco, Cal. Spokane, Wash.



desirable varieties it was decided to leave action on this matter in the hands of the individual nurserymen to cull out the varieties they thought were not suited to their districts. Owing to the higher cost of labor and other rising prices it was the consensus of the convention's opinion that it would be necessary to advance prices for nursery stock and an agreement to this effect was reached. To bring about a plan for educational work to promote the planting of more ornamental trees it was decided to enlist the cooperation of the commercial organizations in the various Northwest states and a committee consisting of F. A. Wiggins of Toppenish, E. F. Stephens of Nampa, Idaho, John A. McGee of Orenco, Richard Layritz of Victoria, B. C., C. I. Lewis of Corvallis and Bert Miller of Milton, was appointed for this purpose.

Valuable information was given the members in attendance on the subject of "Pollination," by Prof. C. I. Lewis, horticulturist at the Oregon Agricultural College and also in regard to plans for beautifying highways and private grounds by the planting of ornamental trees. C. J. Atwood, of Toppenish, Wash., presided at the meeting and C. A. Tonneson, of Burton, Wash., was secretary.

It is unofficially stated that not over one per cent of the projected plantings of fruits in the Northwest will be possible this year owing to the shortage of stock on the Pacific Coast and that prices for stock on this account will rule high.

Offering Higher Prices for Box Apples

Apple buyers in the Yakima Valley, Wash., it is reported, are offering higher prices for boxed apples than 30 days ago. Contracts are being made on the basis of orchard run, in-

BE A LEADER

"A wise and great leader lifts his whole community and may lift an entire nation"—Ely

An immense problem in reconstruction confronts the present generation. Are you doing your utmost to prepare to lead in its solution?



Oregon Agricultural College

Trains for leadership in the industries and professions as follows:

HOME ECONOMICS, AGRICULTURE, COMMERCE, FORESTRY, PHARMACY, MUSIC, VOCATIONAL EDUCATION, CIVIL ENGINEERING, ELECTRICAL ENGINEERING, MECHANICAL ENGINEERING, CHEMICAL ENGINEERING, INDUSTRIAL ARTS, MINING ENGINEERING, LOGGING ENGINEERING, MILITARY SCIENCE.

The College training includes course's in English, Economics, Art, Mathematics, Modern Languages, Physical Education, Industrial Journalism, Natural Sciences, and all essentials of an education.

Three regular terms—Fall term begins September 22, 1919



For College Catalog, Illustrated Booklet and other information address THE REGISTRAR, Oregon Agricultural College, Corvallis



"My WADE Saws Four Cords an Hour"



"The Wade is certainly the farmer's friend. I have cut 1600 cords of yellow fir wood with it, and it's as good as the day I bought it." —Dan Ross, Corbett, Oregon.

Why break your back sawing wood by hand, when the powerful little Wade Portable Gasoline Drag Saw will **outsaw 10 men at one-tenth the cost!** Light, simple, economical. Cuts wood of any size. Averages 8 cords to a gallon of gasoline. Thousands of Wades now in use. When not sawing wood, the 4 h. p. engine will operate other light machinery.

Wade Portable Gasoline Drag Saw

Prompt delivery on WADES from over One Hundred Shipping Points throughout the United States and Canada.

Used and Specified by U. S. Government

RM WADE & CO. SINCE 1865 397 HAWTHORNE AVE., PORTLAND, ORE.

FREE!

Big illustrated Catalog of the Wade—also story of "How Dan Ross cuts 40 cords a day." Write today

MYERS HONOR-BILT PUMPS FOR EVERY PURPOSE

There's one for every home or farm need. Myers Self-Oiling Electric House Pump shown here, and other Myers Hand and Power Pumps for home water systems, give running water in kitchen, bath room, laundry, and in barn or troughs. Myers dealers are everywhere. They handle Myers Hay Tools, Door Hangers and Hand and Power Spray Outfits too. Ask yours today or write for catalog, it's **FREE.**

(2) **F. E. MYERS & BRO.**
135 Fourth St. Ashland, O.

Mitchell Northwest Distributors Portland, Ore.

Agricultural Lime

SHOULD BE APPLIED IN EARLY FALL AND WINTER

ORDER NOW

to avoid delay in shipment. Price \$2.50 per ton, f. o. b. car at Gold Hill. Minimum order 30 tons. Cash with order.

OREGON STATE LIME BOARD, A. B. Cordley, Secretary CORVALLIS, OREGON

cluding all marketable apples produced by the growers. Prices for the different varieties are reported to be as follows: Rome Beauties, Jonathan and Grimes Golden, \$1.75 to \$2; Wine-saps, Spitzenbergs and Yellow Newtowns, \$2 to \$2.25; Delicious and Winter Banana, \$2.50 to \$3. Never before in the history of Yakima Valley have contracts for apples been made earlier than August or September.

M. L. Dean, of the Washington state division of horticulture, is authority

for the statement that apple prices are on an exceptionally satisfactory basis from the producing standpoint. "It is astonishing the prices that apple growers are being offered," says Mr. Dean. "The lowest grades of Winter Banana apples are bringing bids of \$1.60 a box, while extra fancy grades have brought bids of \$2.90 and for some packs Eastern bidders have gone as high as \$3.10. Apples from the Northwest are very much in demand in Eastern markets and Washington farmers are flooded with offers."

According to reports from Toppenish, Wash., Dick Hart of that place sold his entire apple and pear crop last week to the Richey-Gilbert Company of Yakima for \$2 a box straight through the orchard. Mr. Hart says he feels that he received a good price for the fruit of his forty acres.

C. H. Sproat, of Hood River, recently sold his apple crop estimated at 12,000 boxes to Dan Wuille & Co., an English apple exporting firm, for an average of better than \$1.75 per box for all grades and varieties. Later sales there, it is reported, were on a basis of 25 cents a box higher than this price.

New Cannery Rising at Albany.

The Puyallup & Sumner Fruit Growers Canning Company which, early this year, announced that it would commence operations in Oregon now has in the course of construction at Albany the first cannery unit of its contemplated structures. The new building has a floor space of 96x208 feet which is being laid in concrete. It is being constructed of wood in rustic design, two stories high, and the boiler room will be 30x30 feet and will house a 125 horsepower boiler. The site for the new cannery is on a three-acre tract acquired by the company between the Willamette River and Water street in East Albany and was selected on account of its adjacency to shipping sidings. The cannery is expected to be completed in time to handle the large tonnage of wild evergreen blackberries in that district this year.

Large acreages of the cultivated berries have been contracted for future delivery and it is expected that the berry tonnage in this district in the near future will be a large one, as the alluvial soil in the river valleys there is especially adapted to berry growing.

IMPORTANT TO EXPORTERS OF FRUIT

To secure Freight Space and Prompt, Efficient and Reliable
Freight Forwarding Service, Write, Wire or Telephone

Harry K. Barr

THE BARR SHIPPING COMPANY

23-25 Beaver St., NEW YORK

Telephones Broad. 3206-3207-3208

MEMBERS OF

New York Produce Exchange New York Maritime Exchange
S. S. Freight Brokers' Association

BRANCH OFFICES

1042 Drexel Bldg., Philadelphia 260 California St., San Francisco

AGENTS

New Orleans, La. Portland, Me. Boston, Mass.
Baltimore, Md. Montreal, Can.

Apple Exports Our Specialty

INFORMATION BUREAU

On Statistics, Shipping, Etc., at the disposal of all exporters

MEET ME AT THE CONVENTION

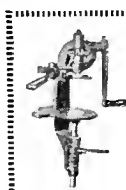

WHAT EVERY HOME CANNER SHOULD HAVE

ONE of our **H. & A. Hand Power Double Seamers**. It is the only hand power seamer built that will seal all sizes of sanitary fruit and vegetable cans. Write for prices and descriptive matter to Department T.

HENNINGER & AYES MFG. CO., Portland, Ore.

Builders of Seamers and Steam Pressure Canning Outfits

Pittsburgh Perfect Cement Coated Nails are of the highest standard

The Heads don't come off. Given Preference by Largest Pacific Coast Packers

MANUFACTURED EXCLUSIVELY BY
PITTSBURGH STEEL COMPANY, Pittsburgh, Pa.

A. C. RULOFSON COMPANY, Pacific Coast Agents
359 Monadnock Building, San Francisco, California

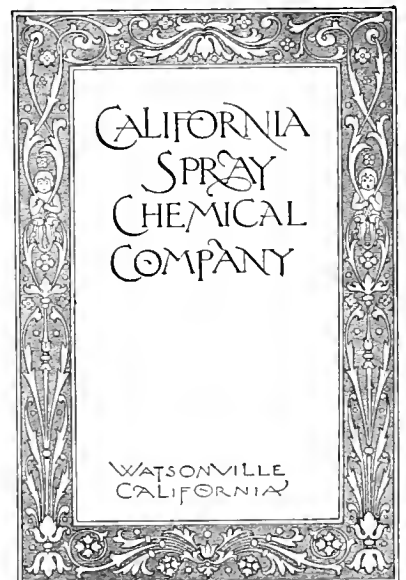

Northwest Fruit Notes from Here and There

OREGON.

MEDFORD will have this year the largest and best quality pear crop in its history and this fact is said by growers there to be due to better facilities for irrigation. The Bartletts and D'Anjous are particularly fine and will ripen early. Fruitmen at Medford are optimistic in regard to the future of that district and say that from now on it is bound to be very prosperous and to develop rapidly. Medford will ship between 700 and 800 cars of pears this year and about the same number of cars of apples according to late estimates.

The National Fruit Company, organized in Oregon with a capitalization of \$50,000, has established its headquarters in Portland. The officers are John F. Sugrue, president; Kenneth McKay, vice-president and general manager, and J. H. Conn, treasurer. Mr. Sugrue was formerly manager of the Cashmere (Wash.) Fruit Growers' Union. Mr. McKay was connected with the Fruit Growers' Exchange at Hood River and Mr. Conn until recently was with the United States Bureau of Markets. The new company will operate in all of the states of the Pacific Northwest, on an f. o. b. basis for eastern dealers.

The Rogue River Valley Canning Company which had been in the hands of a receiver for some time, has changed hands, the new owners being S. S. Bullis and E. T. Skewis, who are now operating it. The price paid for the property which is said to have included 30 acres of tomatoes, was \$5,000. H. W. Hoke, former manager for the old company, is in charge of the plant.

The Hood River Apple Growers' Association recently signed a five year contract with C. W. McCullagh, sales manager of the association, agreeing to pay him a salary of \$8,000 per year. The salary of A. W. Stone, executive manager of the association, was increased from \$3,000 to \$4,000 per year.

P. J. O'Gara, formerly plant pathologist at the Medford Experiment station, was a recent visitor in the Rogue River Valley. Mr. O'Gara is now connected with the American Refining and Smelting Company of Salt Lake, Utah.

The total number of cars of strawberries shipped from the Hood River district this year was 98. Eighty cars of this total was shipped by the Hood River Apple Growers' Association and 18 cars by the W. R. Woolpert Fruit Co. The demand for fresh berries at Hood River this year was so great that canners experienced great difficulty in securing fruit. Prices received ran from \$4.50 per crate for the first car to \$3.94 at the end of the season. An average price of \$1 per crate was maintained and is believed to have set a new national record in strawberry marketing. Hood River expects to market between 1,500,000 and 2,000,000 boxes of apples this year—its largest crop.

The Mosier and Dufur sections are booked for an apple crop of 350 cars this year while the Milton-Freewater district is expected to ship 500 cars or twice the number it shipped last year.

Oregon is expected to harvest a \$40,000,000 prune crop this year, the largest part of which is grown in the Willamette Valley. The apple production of the Willamette Valley for 1919 is placed at 500 cars, or twice as many as last year.

The Bear Creek Orchard, one of the largest commercial orchards in the Rogue River valley, is now in the possession of the Rosenberg Brothers, who recently acquired title to it through the settlement of the estate of their father. The orchard comprises 210 acres, two-thirds of which is in apples and the balance in pears.

Loganberries have now reached a degree of production in the Grants Pass district where the demand for pickers exceeds the local supply of help and growers are forced to import pickers from the outside. Although the acreage in loganberries at Grants Pass is not very extensive as yet as compared to that in the Willamette valley, it is rapidly growing.

The fruit tonnage produced in the Salem district is the greatest in Oregon and one of the largest in the Northwest. While prunes lead in the amount of tonnage, loganberries, cherries, strawberries, raspberries, blackberries, walnuts, apples and pears are also pro-

duced in very large quantities. In fact, Salem may now claim the distinction of being the Queen City in Oregon fruit production in the state.

The Hood River Canning Co. was successful in securing a large quantity of cherries during the season which has just closed. The company made its record day's run, putting up more than 10,000 cans in 21 hours. The price paid for cherries was 8 cents and 101 people were employed during the busy season.

In an injunction suit brought by the Kings Products Company, a fruit drying concern of Salem, Oregon, to force loganberry growers to deliver their fruit at a contract price of 5½ cents instead of selling it in the open market at a higher price, Presiding Judge Bingham rendered a novel decision. He ordered the growers to deliver the fruit at the price mentioned, but directed the drying company to place on deposit with the county clerk the difference between 5½ cents and 9 cents, the amount that the berries were selling for in the open market. At the close of the berry

season the case will be tried and the money awarded to the parties to the suit who win. The case grew out of the fact that a slip is said to have been attached to each grower's contract stating that the company would pay the open market price at the time the berries were delivered.

With headquarters at Roseburg, the Overland Fruit Company has been organized and will grow and market fruit and otherwise engage in the fruit business. The new concern is a stock company.

Recent investigations by the Experiment Station of the Oregon Agricultural College in the big cherry orchards at The Dalles, which have failed to produce, although the trees were found to be in fine condition, are said to show that the shortage of fruit was due to lack of pollenization. Bings, Royal Annes and Lamberts were planted in solid blocks. On the advice of the experiment station experts it is expected that the condition there will be remedied by topgrafting a number of trees in each orchard to the Waterhouse or some of the other varieties of cherries which will act as pollenizers. The Dalles district produces cherries second to none in Oregon.

THE HARDIE MFG. CO.

Orchard and Picking House Supplies

Hardie Fruit Ladders

Best practical design. Made of clear well seasoned spruce. Each step trussed. *A fruit ladder you can depend on.*

Portland Picking Bag

Made of heavy canvass. Cuts cost of picking. Does NOT tire the picker. A safe receptical for your fruit from tree to lug box.

Giard Box Nailing Form and Stand

Enables any one to make accurate boxes with ease and rapidity. A time and labor saver that will interest you.

You can cut your "FROM TREE TO BOX" cost by the use of Hardie goods. Our orchard supply circular describes these devices fully. Write for it.

The Hardie Mfg. Co.

55 North Front Street

Portland, Oregon

WASHINGTON.

In an announcement to the raspberry growers, President W. H. Paulhanus of the Sumner and Puyallup (Wash.) Cooperative Canning Company told them that the management had already booked for sale this year 68,000 cases of jam containing 21 jars each and expects to sell 100,000 cases before the manufacturing season closes. The amount to be received for this output is estimated at \$1,000,000, and the growers have authorized the officers of the canning company to spend \$70,000 in advertising to make its brand of jam known in the markets of the world. The company put into cold storage \$150,000 worth of strawberries which will be manufactured into jam and asked the growers to furnish twice that amount of raspberries.

According to the latest estimates, Wenatchee will be the banner district in the production of apples in the state of Washington this year. The crop at Wenatchee now promises to be 9,400 cars, 2,800 of which will be Winesaps, 1,700 cars of Jonathans, 1,300 cars Baldwins, 900 cars Spitzenbergs, and 800 cars of Rome Beauties. The Yakima district is estimated at 8,000 cars and the Spokane section at 500 cars. One thousand cars it is expected will

be shipped from the Walla Walla district, which last year shipped only 130 cars. Half of the Walla Walla shipment will be Rome Beauties.

Prospects are that Grant County will double up on its apple crop this year according to Horticultural Inspector Darlington, who says that it ought to ship 400 cars as against 200 cars last year.

Wenatchee Valley is said to have suffered many thousands of dollars worth of damage this year owing to the fact that the railroads failed to supply sufficient cars during the cherry shipping season.

Early peaches and apples as well as apricots commenced to move in the Wapato district about the 12th of July and good prices are reported to be ruling. The fruit crop on the Indian reservation in that district this year is reported to be a good one.

The Sumner (Wash.) Index remarks: "The Fruit Growers' Association received a message from Spokane, 15 years ago, saying, 'Send all the raspberries you have.' Spokane couldn't use all of our berries now if the residents ate

em three times a day and got up in the night for an extra meal."

The first raspberries shipped 15 years ago from the Puyallup district averaged \$1.50 per crate. This year the marketing price was \$5.00.

The Shoenberg-Pepper Company, which recently opened a fruit handling establishment at Yakima, is contemplating building a warehouse at Zillah that will be 75x150 feet and is to be finished in 45 days. C. B. Wood, former county horticulturist, is associated with the new firm, which was induced to locate in Zillah by the Zillah Community Club.

The state of Washington ranks sixteenth in the amount of acreage devoted to strawberries for this season. Last year it was the eighteenth state as to amount of acreage. There is now planted in this crop 895 acres as against 870 acres in 1918. Last year the total production amounted to 118 cars, while this year's production was in the neighborhood of 125 cars.

Last year the apple growers of Eastern and Central Washington spent \$75,000 in advertising their apples. This year \$500,000 has been appropriated for this purpose.

The Sampson-Oliver-Gamble Co., which will enter the fruit handling field in the Grandview district, is building a new warehouse which will be ready for the apple shipping season. The new firm is headed by E. E. Sampson, of the E. E. Sampson Company of Yakima. W. W. Gamble will be manager of the Grandview business. The apple crop at Grandview this year is estimated to be between 1,500 and 2,000 cars.

Horticultural Inspector Miller of Yakima county estimates that the entire fruit shipment from that county this year will be about 13,510 cars, divided as follows: Apples, 7,500 cars; pears, 3,000 cars; peaches, 2,500 cars; prunes, 200 cars; cherries, 60 cars, and miscellaneous, 250 cars.

M. L. Dean, chief of the Division of Horticulture of Washington, announces the appointment of Chas. L. Robinson to be horticultural inspector at Yakima in place of H. L. Miller, resigned, and C. A. Noren to be inspector at Prosser in place of Luke Powell, who has also resigned.

J. & H. GOODWIN, LTD.

Apple Exporters

Headquarters in United States
60 State Street
Boston, Massachusetts

*The Largest Handlers of American Apples
in English Markets*

You can send your apples direct from the United States into the industrial centers of England. The same organization (J. & H. Goodwin, Ltd., throughout) which ships your fruit from the U. S. A., sells and distributes in London, Liverpool, Manchester and Hull, and on the European Continent.

This means quick handling, considerable economies and the fruit being sold in the freshest possible condition, which means greater returns.

For Further Particulars Write or Wire Us at Boston
or 97 Warren Street, New York City

WE DEVELOP KODAK FILMS FREE

and pay return postage when prints are ordered
Mail us films with Six Cents Stamps for each desired print. We return excess.

NO CHARGE for unprintable films.

Woodard, Clarke & Co.

Photo Supplies

Wood-Lark Bldg. Portland, Oregon

Ask for Catalogue and Special Offer.

NEW TIRES FOR OLD ONES

You can make new puncture-proof Urea from old worn ones. We give you a written guarantee of 5,000 miles against puncture. You can save half your tire costs.

DO IT YOURSELF IN 30 MINUTES

Over one-quarter million users in America today of this NEW UREA in tire construction. Demonstrator Agents wanted.

GIVENS CONSOLIDATED RUBBER CO.
238 Second St. San Francisco

FREE OFFER DEMONSTRATION

Nice Bright Western Pine
FRUIT BOXES
AND CRATES
Good standard grades. Well made. Quick shipments. Carloads or less. Get our prices.
Western Pine Box Sales Co.
SPOKANE, WASH.

Crops on 700 acres of Yakima Valley land were ruined when vandals blew up the stand-pipe of the irrigating system in that section. To save the trees in one orchard tract belonging to the Union Orchards Company the apples were stripped from the trees. The orchard is estimated to have had a crop of 12,000 boxes on it.

A report from Yakima, Wash., says the Libby, McNeill & Libby cannery interests have announced a boost in contract prices which will mean the payment of about \$60,000 to Yakima orchardists. The increase is over \$20,000 on pears alone. When the cannery was established there long-time contracts were made. The price of cherries was boosted from 4 cents a pound to 7 cents on contracts. Pears, contracted at \$22.50 a ton, are raised

to \$35.00. Cling peaches are to bring \$35, in comparison with the original contract price of \$20. The raise is made voluntarily by the cannery, which said the growers could not pay the present prices for labor and make a profit without greater compensation. The cannery has completed the installation of a maraschino cherry machine, and expects to turn out 500 barrels of this delicacy. At the peak of the season the cannery will employ 500 workers.

Never in its history has there been so much improvement going on at one time as is now the case in the Selah Valley according to the local paper in that section. Hundreds of thousands of dollars are being put into new homes, substantial warehouses, packing sheds and barns and the money to pay for it is all coming from fruit, this authority asserts.

The Spokane Fruit Growers' Company, which was planning to build several apple warehouses in the Spokane Valley, has delayed their erection owing to an unexpected decline in the expected production this year. One of these warehouses will be erected at Greenacres. This company is spending \$450,000 for apple boxes and \$125,000 for wrapping paper this year.

Yakima county lost its second district horticultural inspector within six months when H. L. Miller, who came two months ago from Walla Walla, left for Spokane to become assistant manager of the Skookum Packers' Association. Miller's predecessor, C. B. Wood, left to join the Schoenburg Pepper Company, while H. E. Waterbury and F. H. Desellem, in service before Wood, are also working for private fruit concerns. In addition to Miller, four chief deputies, John A. Webber, J. W. Vaughn, F. A. Kelly and C. E. Flickenger, all have gone with private fruit businesses. Men say that they can not afford to remain in the state's employ at the wages now paid.

Libby, McNeill & Libby are expected to enlarge their operations in the Inland Empire. The firm has had a large cannery at Yakima for some time and has recently acquired a three-acre site at Buena, Wash., in the heart of the orchard section of the lower Yakima valley. The section produces a huge tonnage of fruit, especially peaches and pears. It is reported the Buena cannery will be in opera-

tion this fall and that it will have about half the capacity of the firm's Yakima branch, which cost \$200,000.

H. L. Geary, of Spokane, secretary of the Fruitgrowers' Agency, has completed a tour of the fruit growing sections of the Northwest and expresses the opinion that the fruit yield will be about normal.

The Heights Packing Company, a cooperative company composed of orchardists in the Underwood district, is enlarging its plant, which has been equipped with a power grading machine. This company expects to handle 22,000 boxes of apples this year. The entire apple output from the Underwood district this year is expected to be close to 100 cars.

The Growers' Service Company will erect a new apple warehouse in the Buena district 50x100 feet. The building will be of substantial construction, modernly equipped, and is to be ready for the early fall fruit shipping season.

The yield of cherries in the Inland Empire was below normal this season, but as prices advanced sharply the producers probably received at least the normal returns from orchards. In the Lewiston, Idaho, section the price of packing cherries was around 12 cents and canneries and packing houses operated at extra pressure to handle the fruit. The Tri-State Fruit Concern employed 100 persons and on one day turned out 3,000 boxes of Bings and Lamberts. Pickers received 1½ and 2 cents per pound. Bings brought 30 cents per pound on the Spokane retail market. The Oregon Packing Company employed 200 persons in its Lewiston branch.

The advent of July saw the strawberry season practically finished in the Inland Empire, the cherry crop almost cleaned up and the raspberries and blackberries coming on the market freely, while the apple producers were beginning to shape their plans for the fall season in anticipation of a good normal yield.

The American Fruit Growers, Inc., is apparently preparing to operate on an extensive scale in the Spokane district, Washington. It has obtained two more orchards in the Yakima

CORRESPONDENCE

desired at once with a successful, practical orchardist, having sufficient capital to purchase interest after investigation, and take management of large commercial apple orchard of bearing age. Finest property in East, with great future. Exceptional marketing facilities. A very unusual opportunity for the right man. Correspondence held entirely confidential. Address with particulars,

SEABOARD

Care B. G. Pratt, 50 Church Street
NEW YORK CITY

SAVE YOUR APPLES

With a Mousarch Hydraulic Cider Press you can turn your culls into good selling cider. You can also do custom pressing for your neighbors. Our improved high pressure construction gets all the juice from the apples with minimum power. All sizes of Presses, from 15 to 400 barrels a day. A small investment will start you in a profitable business. Ask for free, 60-page Press Catalogue describing our 145 Outfits.

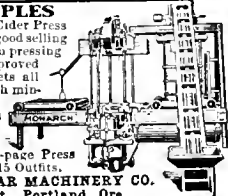

WESTERN PAPER MACHINERY CO.
308 E. Salmon St., Portland, Ore.



KILL THE PESTS

This man is Dusting twenty acres per day at a cost of less than one-half cent per tree, using the

American Beauty Dust Sprayer

- Codling Moth**
- Red Spider**
- Curculio**
- Aphis**
- Catterpillar**
- Mildew, Etc.**

Write us about it.

California Sprayer Co.

6001-29 Pasadena Ave.
Los Angeles, Cal.

Valley by closing deals on the Arthur Eugene Darby place of 20 acres planted to commercial varieties of apples now 11 years old and the E. W. Ross holding of 60 acres adjoining. It is understood that this syndicate also has an option on the C. E. Olson place of 200 acres at \$150,000, and the 212 acres of prunes and apples owned by the Manuel Brothers, near Buena. It is rumored that the price for the latter orchard is close to the \$1,000 per acre mark. If all the options that have been taken by this company on fruit land in the Yakima Valley are closed it will control 1,000 acres of orchard in that valley.

IDAHO.

Stating that Payette Valley Jonathans have been picked too late in former years, causing them to rot in storage, growers in that district are being warned this year to change this practice and to have all the Jonathans off the trees by October 5, if the growing conditions there are the same as they were two years ago. Growers are advised to commence picking September 5 and have all the Jonathans in cold storage by October 5. It is estimated that the Payette Valley will produce 800 cars of Jonathans this year, representing at prevailing prices more than \$1,000,000.

The apple crop in the Weiser district this year is reported to be the largest and apparently of the best quality in the history of the industry in that section. The principal varieties in the Weiser district are the Rome Beauty and Jonathan. Some ravages from aphids is reported from there, but not sufficiently serious to affect the crop very materially.

Dirt storage house for storing apples temporarily are being tried out in the Payette Valley. The movement is said to be meeting with favor in that district and to have attracted considerable attention from fruitmen in Colorado. A model, one twenty-fourth the size of a dirt storage house 36x50 feet is being exhibited at Payette and will be shown also at New Plymouth and Fruitland.

The apple crop in the Payette-Weiser district this year is estimated at 2,500 cars, the Boise Valley district at 500 cars, the Twin Falls district 400 cars and the Lewiston district 350 cars. Midsummer reports show the fruit to be in fine condition.

Funds have been raised in Idaho to employ a special man to recruit fruit labor and an office will be established at Boise to assist growers in securing hands to pick, pack and handle fruit. Growers have been instructed to estimate the number of hands they will need and to send their lists to the Boise office, which will be in charge of H. J. Fleischer.

Although the yield of cherries in all the regions surrounding Lewiston, Idaho, was not more than 65 per cent of normal this season, the total shipments sent out from Lewiston will reach \$270,000, according to the report of D. S. Wallace, of the state department of agriculture. This includes shipments from the big ranches on the Washington side of the Snake river between Lewiston and Riparia, as well as the crops from Lewiston Orchards, Clarkston, and the surrounding country. Eighty carloads of cherries were shipped out of Lewiston, and 350 tons were handled by local canneries. At least 20 tons were shipped by express.

New Growers' Association Grows Rapidly

The Oregon Growers' Cooperative Association has been making rapid progress in organizing the various districts in the Willamette Valley during the past month and recently announced that it had secured a total of 14,000 acres of fruit that will be handled by the association in 1920. The directors of the organization now believe that they will be able to control the tonnage from 25,000 acres by the first of the year.

The executive offices of the association have been established at Salem and Prof. C. I. Lewis is handling the organization campaign which he is conducting out of the time allowed him as a vacation by the Oregon Ag-

ricultural College, where he is chief of the division of horticulture. To inform growers in regard to the benefits of cooperation, the association is issuing a house organ called "The Oregon Grower." A standard brand name for the products handled by the association will be adopted and they will be extensively advertised as Oregon grown and packed.

The association has under consideration the establishing of a number of processing plants which it expects to erect wherever they are needed. A large proportion of the tonnage of the walnut growers of the state, it is expected, will be handled by the association next year. The nuts will be graded and a separate department provided for marketing them to the best advantage.

Oregon Men Make Big Profits.

H. L. Morrell, one of the strawberry growers of Clackamas County, Oregon, is meeting with success in growing this fruit.

Mr. Morrell has seven and one-half acres in strawberry plants at his home at Willamette, two and one-half acres of which are two-year old plants, two acres in one-year-old plants and three and one-half acres in plants that were set out last year.

From these berries Mr. Morrell has made a profit of \$3,300 and he expects to make \$5,000 next year.

THE VERY LATEST IMPROVEMENT IN FRUIT GRADERS — IS THE — "New Four" Grade IDEAL Fruit Grader

It is built for the largest growers and packing houses who require a large output each day.

The sizing is by diameter or cheek measurement, the most perfect way fruit should be sized.

We build the Ideal Fruit Grader in four sizes to suit any grower's need, and it will do perfect work on **Apples, Pears, Peaches, Oranges or any other fruit having similar shape.**

We have designed our machine so there is absolutely no bruising of the fruit in any manner. The machine is very simple in construction, with nothing to get out of order or out of adjustment. Does not make the least noise, as there are no metal parts coming in contact with each other to cause a lot of wear and trouble.

The grading is done by elastic bands revolving crosswise of the belt that carries the fruit along the machine until it arrives at the proper bin where it comes in contact with this elastic which rolls it off gently into its proper bin without injury.

This season's crop is such that we have had to double our output to handle our orders, as we are replacing other machines of other makes that have cost much more than what we are asking for ours.

Our prices are very moderate, as we have no agents or brokers to pay a large profit for selling, so by selling direct to the users we can sell very close.

It will pay you big to write us to get more information and prices before you buy, for our machine will prove very satisfactory, as it has to many others for the past few years.

We have one of the most complete shops with the best of machinery to build every part over a pattern to get them exact.

Write us for prices stating your needs then we will gladly quote you prices on any size machine you need.

We also carry in stock the Bryant Clamp Warehouse Truck that will save you the price many times over each season in labor.

WRITE US

IDEAL FRUIT AND NURSERY CO., Hood River, Oregon

The Regeneration of the Prune

Continued from page 9.

and children of his community, including possibly those of his own family, to have the prunes picked up, having allowed them to remain upon the trees until they have taken on all the sugar possible and have of their own accord dropped, or been lightly shaken down. Man and team will now be kept busy hauling the fruit to the dryer, where it is washed in two or more waters, spread upon the trays, and finds its way into the hot-air chambers of the evaporator. Beginning at a moderately low temperature while the fruit wilts and begins shrinking, it is moved slowly down into the higher temperature until finished in dry heat at about 180 to 200 degrees. It is then removed from trays and such fruit as is not thoroughly cured through to the pit is picked out and given a second drying or finish, and the cured product finds its way at once to the warehouse of the packer.

The cost of an evaporating plant to handle an orchard of thirty-five to forty acres will be according to the type of machine selected and according to the taste of the builder in the manner of construction, anywhere from \$1,500 to \$3,000, and is a part of the fixed investment and cost of the orchard, and should be figured upon at the outset, for no orchard is complete without its own drying plant. With such an orchard, well located in the Willamette Valley, an income from \$3,000 to \$6,000 can be expected with as much or more regularity than the producer of almost any other crop, and at a comparatively light outlay of expense, and with less technical knowledge of horticulture than is required for the raising of almost any other fruit.

Packing and marketing of the Oregon prune is an industry by itself of no small proportions. The grower may belong to a co-operative marketing and packing association; otherwise, he will sell his crop for cash, paid when delivered to the packer's warehouse or f. o. b. the cars at his own station. The value of his product is arrived at by the size which his fruit will average. The packer then puts the fruit through a grading machine which assort it into sizes, 20s to 30s, 30s to 40s, 40s to 50s, 50s to 60s, etc. Twenty to thirty prunes to

Sebastopol Gravensteins

We handle 85 per cent of the famous Sebastopol Gravenstein apples. Community packing houses insure uniform pack.

Season Closes August 30th

See Our Representatives or Wire Us.

Sebastopol Apple Growers' Union

SEBASTOPOL, CALIFORNIA

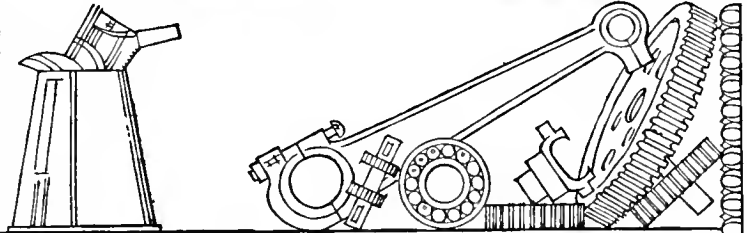

GOOD OIL IS CHEAPER THAN PARTS

Freedom from unnecessary repairs and longer life for your car result from correct lubrication with Zerolene. Scientifically refined from selected California crude oil. Gives maximum lubrication with least carbon deposit. Get a Correct Lubrication Chart for your car.



STANDARD OIL COMPANY
(California)

FRUIT GROWERS

Can't Afford the Loss of Bruised Fruit Picked in Ordinary Bags or Buckets when they can

SAVE THIS BIG LOSS BY USING

Palmer Picking Buckets

Which are LABOR and FRUIT SAVERS and Useful for Many Purposes.

Prices { Single Bucket . . . \$1.50 } Special Prices on Large Orders
 { In Dozen Lots . . . 1.15 }

Send your order with remittance to

HOOD RIVER FRUIT COMPANY

Bucket Filled

HOOD RIVER, OREGON

Bucket Emptied



Peach Picking and Packing, Etc.

Continued from page 6.

seven first layer, two rows five long and three rows six long, twenty-eight second layer, or fifty-five; seven, five rows, two rows five long and three rows six long, twenty-five to the layer, or fifty; eight, five rows, two rows five long and three rows four long, twenty-two first layer, two rows four long and three rows five long, twenty-three second layer, or forty-five; nine, five rows long, twenty to the layer, or forty.

All 3x3 packs vary six peaches to the box, and all 3x2 packs vary five peaches to the box. The fruit is laid on its side lengthwise across the box, or the stem end of the peach to the side of the box.

The Fancy Oregon Pack.

In Oregon peaches are generally packed in boxes which measure 18½x 11½ inches, varying in depth from two and one-half to five inches. These sized boxes take all the various sizes as the fruit is usually packed two layers in depth. The method of packing is the same as employed in Colorado with the exception that the 2x2 pack is employed for the larger sizes running from fifty-six to forty-four to the box. The grading is practically the same as practiced in Colorado; the various grades being designated as extra fancy, fancy and choice. All these grades are carefully wrapped in paper. In the Ashland, Oregon, district where peach culture is carried on to a greater extent than in any other district in the state, the term fancy is generally applied to peaches running 64 or less to the box. The next grade contains from 64 to 80 peaches to the box and the last from 80 to 92 peaches. All this fruit must be free from worms and fungus. All the fruit below these grades is sorted out to be used for canning and pies. One of the most important things in packing peaches is not to allow sufficient space between the lid and the fruit to leave it loose. Peaches packed loosely will not ship well. They should also be kept in a cool place to secure the best results in shipping.

The Grasshopper Pest

Grasshoppers in enormous quantities have invaded the orchards and grain fields of California and are expected to sweep along the entire Pacific Coast. Orchardists and farmers in the Pacific Northwest are being warned to be on the lookout for these pests by the United States Agricultural Department experts, who advise the use of poisoned bait in stopping their devastation. The most effective preparation for destroying grasshoppers is said to be the following: Wheat bran, 15 pounds; paris green or white arsenic, 1 pound; lemons or oranges, 6 finely chopped fruits; low-grade molasses, such as refuse from sugar factories, or cattle molasses, known as "black strap," 2 quarts; water, 2 to 4 gallons. The bran and poison are thoroughly mixed while dry, the fruits are then finely chopped and

added, and, lastly, the molasses and water are poured over the bait and the whole thoroughly kneaded. A coarse-flaked bran is most desirable, although where this cannot be obtained easily ordinary middlings or alfalfa meal may be substituted; a low-grade, strong-smelling syrup or molasses, however, is essential to the entire success of the undertaking. Crushed ripe tomatoes, watermelons or limes may be substituted for the lemons or oranges, if necessary. In semi-arid regions water should be added to the bait at the rate of 4 gallons to 25 pounds of bran, as in these climates the bait dries out very rapidly and the extra moisture is necessary in order to attract the grasshoppers. Five to seven pounds of the mixture should be estimated per acre.

Cherry Leaf-Spot.

The leaf-spot of the cherry seriously injures both sweet and sour varieties of that fruit in many sections of the United States. It is caused by a fungus which lives through the winter on the fallen leaves and infects the new leaves in the spring. The best control of this disease is obtained by spraying with a diluted lime-sulphur solution or with Bordeaux mixture (1) as soon as the petals fall, (2) about three weeks later, and (3) directly after the fruit is picked. Quaintance and Siegler recommend lime-sulphur solution at the rate of one gallon to 40 gallons of water for first treatment, and for control, dilute lime-sulphur as soon as fruit has been picked.

Fruit Growers of Oregon!

*Stop gambling with your fruit—
Make your investment safe—
Broaden and stabilize your markets—
Get a better price for your fruit.*

The Oregon Growers' Co-operative Association

has organized with the following aims:

1. To nationalize Oregon's horticultural products under an Oregon label.
2. To gain wider distribution and thus prevent an over supply of fruit in limited markets.
3. To eliminate as far as possible the market speculator that stands between grower and consumer.
4. To raise the general standards of fruits so that they may command a higher selling price.
5. To stabilize the value of your investment by stabilizing your markets.
6. To eliminate waste caused by duplication of equipment in new fruit-producing centers.
7. To reduce growing and marketing costs, and to cut out unnecessary expenses of every nature.

This organization will be a business, owned and operated and controlled by and for you — the Oregon fruit producer. It is backed by the most prominent and experienced horticultural men in Oregon. Adequate financial arrangements are being concluded for handling of products.

THE BOARD OF DIRECTORS:

ISAAC D. HUNT, President, Vice-President Ladd & Tilton Bank, Portland, Oregon.	E. L. Klemmer, Alvadore.	J. O. Holt, Eugene.
PROF. C. I. LEWIS, First Vice-President, Chief Division of Horticulture, O. A. C., Corvallis, Oregon.	R. A. Busenbark, Roseburg.	S. S. Johns, Myrtle Creek.
W. E. ST. JOHN, Second Vice-President, Douglas County Commissioner, Sutherlin, Oregon.	H. S. Butz, Dallas.	W. M. Elliott, Dallas.
SEYMOUR JONES, Secretary-Treasurer, Salem, Oregon.	Allen Bellinger, Scotts Mills.	W. I. Staley, Salem.
B. W. Johnson, Monroe.	E. W. Matthews, Amity.	Fred Groner, Hillsboro.
G. S. Zimmerman, Yamhill.	Kenneth Miller, Sheridan.	R. C. Paulus, General Manager Salem Fruit Union.
H. M. Harlow, Eugene.		
Fred Ewing, Polk County.		
Frank Gibson, Salem.		
A. E. Reuter, Forest Grove.		
J. O. Holt, General Manager Eugene Fruit Growers' Association.		

YOUR INQUIRY IS INVITED

Address: Earl Percy, Secretary Organization Committee
Oregon Growers' Co-operative Association
Salem, Oregon

Use of Powder in Blasting, Etc.

Continued from page 8.

In the first place, the purpose of blasting is not to supplant the spade. It is possible to dig the hole with explosives, just as a hole may be excavated for a fence post. But the real object of blasting is to mellow the subsoil and make root growth and spade digging easy.

The orchardist must take into account the fact that by loosening the subsoil in a thorough manner, the moisture from the rains can soak in quickly, not only immediately around the spaded out hole, but the fine cracks radiating in all directions from passageways for the further absorption of water. They carry the life-giving moisture to great depths and store it there, to be brought out again by capillarity during the dry seasons for the sustenance of the tree. Our records show that the yearly saving in replacement and replanting costs in young orchards more than balance any expenditure for explosives.

How To Do the Work.

Laying Out the Orchard.—The places to set the trees or other plants are selected and marked by a stake, or better, if the field is large, by furrows plowed to indicate the exact lines for the trees, and crossed at the proper intervals by other furrows to indicate the spacing in the rows. Sometimes a heavy cord or light wire stretched across the field will materially assist in laying out the orchard.

When to Blast.—Blasting for tree planting is best done in the late summer because it is easier to catch the subsoil in a dry condition, but blasting in the spring for spring planting, although the subsoil is apt to be wet or damp, is nevertheless much better than planting in dug holes. It should be done as many days ahead of planting as possible, to get the effect of air and sunlight in the hole.

Examine the Soil.—The exact nature and depth of the subsoil should be known in order that the explosive may be used to the very best advantage.

The only way to know this is to go down and see. Do not stop at the surface, but go down four or more feet. Using a good soil augur is the best and easiest way to test out a subsoil, but if one cannot be had, dig a hole. Another way is to blast out a test hole and examine each layer of the soil. This is not so good as the other methods, as the blast so disturbs the subsoil that it is hard to tell just what the original condition was.

How Deep to Blast.—There are many different kinds of subsoil, but those illustrated by the drawings are the most common. If the arrangement of the soil is like that in illustration "A," Fig. 1, place the explosive well down into the clay and destroy any shallow plow sole with a good plow. The best depth for blasting in such soil is usually from thirty to thirty-six inches.

In soils like the one represented in "B," Fig 1, place the charge toward the bottom of the hardpan so that the



TRESPASS NOTICE

Anyone found trespassing on this property will be prosecuted to the full extent of the law

Owner

Just Like Having a Big Policeman to Guard Your Property!

Trespassers cost you many dollars each year. They break down fences, steal your fruit, kill your poultry and livestock. Our TRESPASS signs will keep them out. They are printed on oil-treated tough cardboard—absolutely rain and sun-proof. Will last for many years. Each sign is 14x11 inches, and they will keep the trespassers out just as effectively as if you had a big policeman on each side of your farm to guard your property.

Six Big Trespass Signs for \$1
Postpaid—12 for \$1.75

Send today for a supply of these signs and tack them up in conspicuous places along the line fence. Six guaranteed sun-proof and water-proof signs (as illustrated above), size 14x11 inches, mailed, postpaid, for **\$1.00**, twelve signs, postpaid, for **\$1.75**.

ADDRESS

Outwest Supply Co.
PORTLAND, OREGON

Ridley, Houlding & Co.

COVENT GARDEN, LONDON

WE ARE

Specialists in Apples and Pears

CABLE ADDRESS: BOTANIZING, LONDON
Codes: A. B. C. 5th Edition and Modern Economy

entire layer may be pulverized, but do not go below the bottom of it, as the force of the blast will tend to raise the hardpan in chunks rather than shatter it. The depth is governed absolutely by the depth of the hardpan.

Illustration "C," Fig. 1, shows one of the most common subsoil troubles. This type of hardpan or tight clay is usually too deep to blast through and relief is obtained by pulverizing several feet of the top, which if well done will be found to be sufficient to store moisture and furnish room for an ample root development. For such a condition the blast should be made not less than three feet deep.

Occasionally a soil is found like that shown in "D," Fig. 1, which will usually be found to require deeper blasting. The explosive should be placed well down in the hardpan—the deeper the better.

When very deep loading is practiced it is best to increase the amount of the charge, sometimes to more than double the amount normally used.

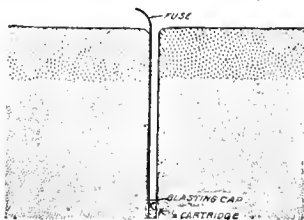

Fig. 3. The charge in place.

Making Bore Holes.—A number of different methods have been devised for making the bore holes for loading, but so far no other tool has given such good results as a heavy subsoil punch Fig. 2. This tool is made of 1½-inch steel and should be not less than three feet long. Smaller drills will not be satisfactory, as the explosive cartridge is itself 1½ inches in diameter and when primed with cap and fuse is difficult to load into a smaller hole. The punch is driven to the desired depth with a sledge, and loosened by pounding on the sides, after which it can easily be withdrawn.

A soil auger is quite satisfactory for making a small number of holes, but is too slow and expensive if there is much work to be done. However, for holes deeper than three feet, one can be used very satisfactorily to deepen the drilled holes. In some cases holes can be made with a heavy crowbar. Some soils are so hard, being in reality soft rock, that a rock drill is required to make the holes.

Preparing the Charge.—The charge is prepared by cutting off a piece of fuse as long as the hole is deep, and crimping a cap on one end by means of a cap crimper. The cap with the

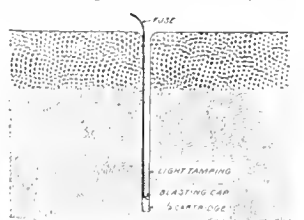
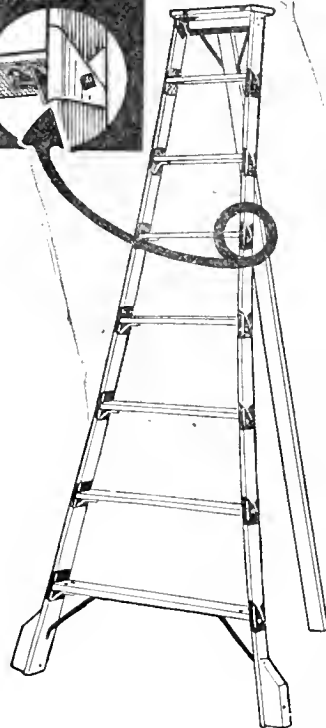

Fig. 4. Light tamping over charge.

Put Me Through the Acid Test!



The supreme test is this: Is the maker willing to ship on approval? Send me your order today for two or more of the

SECURITY KANT-WOBBLE LADDER

—I'll pay the freight and ship subject to approval, C. O. D. The **Security** never comes back! I've sent hundreds on approval—not one was ever returned. Orchardists know when they see the **Security** it is the **one** ladder that actually cuts picking costs and is built **right**.

—The patented steel cuff-bracket grips each step-end, making **Security** strongest where other ladders are weakest. The greatest feature ever put on a ladder, because by saving picker's time it reduces your picking costs, boosts your profits. Picker feels secure on a ladder that **cannot wobble**. Does not spend his time in running up and down so change position of ladder.

—But even without this feature the **Security** would appeal to you because it is built **right** all through. Light, strong, plenty of spread. All wood vertical grain, and the steps are easily replaceable. Swinging back-leg hinged metal-to-metal eliminates side-way.

Prices: 8-ft. \$5; 10-ft. \$6; 12-ft. \$7.20

See any of the following dealers: Salem, Ray L. Farmer Hardware Co.; The Dalles, Walther-Williams Hardware Co.; Wenatchee, Wenatchee Produce Co.; Yakima, A. B. Fosseen & Co.; Hamilton, Mont., Valley Mercantile Co., or write to me direct for shipment on approval, C. O. D. *New booklet now ready.*

J. B. PATTERSON, Mfr.

82 Franklin Street

OAKLAND, CALIFORNIA



Strong and Tight

Makeshift boxes indicate a makeshift product. First impressions always are the most lasting.

A strong, tight box impresses the buyer first. He wants your product to arrive in good condition.

Bloedel Donovan Boxes

Are expertly sawed and built to fit—strong and tight. We deliver promptly

BLOEDEL DONOVAN LUMBER MILLS

1018 White Building, Seattle, Wash.

fuse attached is inserted into the explosive used, and securely tied.

Loading the Hole.—Start the charge into the bore hole and press it gently to the bottom with a wooden tamping stick, Fig. 3. Pour in four or five inches of loose dirt and tamp it gently, Fig. 4, then pour in more dirt, preferably slightly moist, as it packs better, and tamp firmly, Fig. 5. When the explosive is covered with several inches of lightly packed soil the rest of the tamping should be made as hard and tight as is possible, using the stick in one hand. The hole should be tamped full.

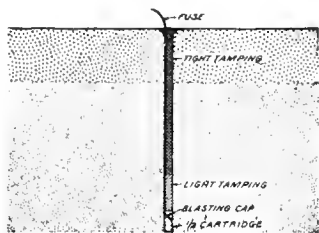

Fig. 5. Top of hole tamped tight.

Firing the Blast.—The next operation is to light the fuse and retire to a sufficient distance to avoid any loose material that may be thrown out. If the loading is properly done and at a sufficient depth there is usually only a thud and a cracking of the surface and no soil is thrown into the air.

How to Treat Blasted Holes.—If the holes are blasted in advance of the time of setting the trees they are left

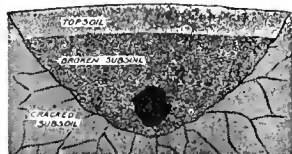

Fig. 6. The blast thoroughly cracks the soil, but leaves a cavity or pothole at the bottom. This must be filled.

without further attention until planting time, unless it is desirable to add some manure or fertilizer to be diffused through the soil. This is a good practice, especially on poor soil. If the soil is sour, sticky clay, a few pounds of lime scattered in the hole will materially assist in loosening the clay and keeping it permanently granulated and sweet.

Setting the Tree.—When the trees are to be planted shovel out the hole and locate the cavity that is usually

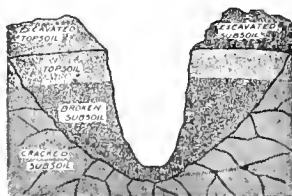

Fig. 7. The best practice is to shovel out the loose soil and expose the pothole. This is easily done in the freshly blasted holes.

sprung at the bottom of the hole, Fig. 7. Fill this with tamped soil to firm the base to prevent subsequent settling of the trees. The filling should

“Maybe nobody has told you,” says the Good Judge—



Why this *good* tobacco costs less to chew. You get real tobacco satisfaction with a *small chew*. It gives you the good tobacco taste. It lasts and lasts. You don't need a fresh chew so often. It *saves* you money.

THE REAL TOBACCO CHEW

put up in two styles

RIGHT CUT is a short-cut tobacco

W-B CUT is a long fine-cut tobacco

Boiling Points

Boiling points are vaporizing points. The full, uniform chain of boiling points is necessary in high quality gasoline. Red Crown has them. Look for the Red Crown sign before you fill.

STANDARD OIL COMPANY
(California)

The Gasoline of Quality

APPLES

PEARS

For European

Distribution

Gerald Da Costa

Long Acre, Covent Garden, London

Cables: "Geracost, London."

Codes: A. B. C. 5th Edition and Private

SHIPPING AGENTS:

Lunham & Moore, Produce Exchange, New York

be up to the level it is desired to set the tree, taking care to keep the soil well tamped. Set the tree with the roots in as near their original position as possible and pack them with the top soil that has been shoveled out of the hole, Fig. 8.

When no attention is paid to settling or firming the soil in the bottom of the hole, trouble often results from the tree settling too deep after the first heavy rains, but this trouble has never been observed when the holes were properly examined and the described precautions observed in setting the tree.

Just before packing the soil around the trees be sure that they are in line with the rest of the row.

When trees are set as much as thirty or more feet apart it is an excellent practice to place blasts midway between the rows after the trees have been growing several years. These will open up the subsoil between the trees that was but slightly disturbed by the original blasts and will induce

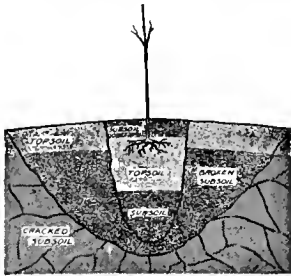

Fig. 8. As much of the hole as possible should be filled with fertile surface soil; the rest can be filled with the subsoil that has been dug out. This should be well packed to prevent settling. The tree is set with the roots spread out in their natural position.

more vigorous root growth, and consequently better trees will be the result.

It should be remembered that this method of setting applies not only to orchard trees such as the apple and peach, but to nut trees, and shade trees as well.

For blasting holes to set large trees additional benefit is derived by placing several blasts close together so that the subsoil is more thoroughly shattered.

Usually one-half cartridge charges are sufficient, except in the heaviest hardpan and where loading deeper than 40 inches is required.

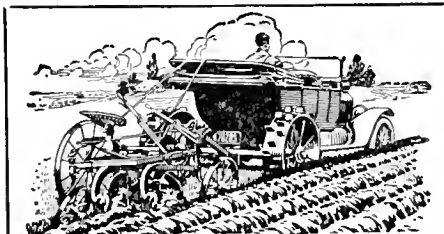

Make a Tractor of Your Car

Use it for farm work. Pullford catalog shows how to make a practical tractor out of Ford and other cars.

Write for Catalog

Pullford Co., Box 346C Quincy, Ill.

A Great Bargain Offer

Better Fruit One Full Year
McCall's One Full Year
Good Stories One Full Year

All Three for \$1.55

Better Fruit's Circulation last month increased 1,000 copies. There's a reason. Fruitgrowers and others interested in the fruit industry want it.

Read What They Say:

Roswell, New Mexico.
I want to congratulate you on *Better Fruit*. It is steadily improving.
BEN AMES,
Fruitgrower.

Albany, Oregon.
Consider *Better Fruit* finest of its kind. Chuck full of meat and should be in the hands of every fruitgrower.
W. R. SCOTT,
Puyallup and Sumner Fruitgrowers' Canning Co.

Nelson, New Zealand.
Have been a reader of your splendid publication for a long time. I want to ask you for some more information.
J. DUDGEON,

Newberg, Oregon.
The April number of *Better Fruit* alone was worth the price of a year's subscription. It told me just what I wanted to know about caring for my trees. Some growers ought to be compelled to read this paper and carry out the instructions in it.
W. E. WHITE,

If you are not a subscriber to *Better Fruit* we will be pleased to send you a sample copy if you are interested in the fruit industry.



For the small sum of \$1.55 you get *Better Fruit* one full year, *McCall's Magazine* one full year and *Good Stories* one full year.

If you are a subscriber to any of these Magazines your time will be extended one full year from present date.

Better Fruit is one of the two publications of its kind in the United States, and caters to people who are interested in growing fruit for profit. *Better Fruit* sells for \$1.00.



The other two Magazines are leading Magazines in their particular line, and can be read with much interest in any family.

This is undoubtedly the greatest combination offer we will ever have and I would advise that you take advantage of it at once, as the price of Magazines is increasing tremendously at the present time. This offer may never appear again.

Clip the Coupon now and mail at once to

BETTER FRUIT PUBLISHING COMPANY
Oregonian Building, PORTLAND, OREGON

ENCLOSED FIND \$1.55—SEND ALL THREE MAGAZINES ONE FULL YEAR

Name

P.O. State

R.D. Box Street

Combination includes *Better Fruit* 1 year, *McCall's* 1 year, *Good Stories* 1 year

Increasing Profits, Etc.

Continued from page 7.

season. The books showed a saving in cultivation that year which amounted to \$987 while approximately \$1,000 was cleared on the hogs. Mr. Gammon figures that the manure from the hogs and sheep offset any loss in fertility due to feeding. In addition the pear trees bore a bumper crop of fruit, some trees yielding from 30 to 40 boxes. Mr. Gammon says he will continue to intercrop with legumes.

Mr. A. B. Humphrey, of Mayhes, California, is as well known among live stock breeders as among fruit growers. His Berkshire boar, Grand Leader II, was grand champion of the Panama-Pacific International Exposition, and later with several of his progeny, sold for \$4,500. Mr. Humphrey also raised Star Leader, sired by Grand Leader II, who headed the

Berkshire herd of the University of California and later sold for \$1,500. Mr. Humphrey has his three orchards of plums and pears on a 300-acre farm sown to alfalfa, not only to save the labor of cultivation but to furnish pasture for his increasing herds.

The Wenatchee irrigated section used to be a staunch adherer to clean cultivation and the dust mulch. One orchard, that of Barney and Williams, however, adopted a permanent alfalfa cover crop. This system has been followed for twenty years. Statistics show that this orchard has one of the largest bearing records of this district. Nineteen boxes represented the average bearing per tree per year from 1907 to 1912 inclusive. The trees are continuing this production. These results have been so definite that today practically seventy-five per cent of the Wenatchee orchards are in alfalfa.

Hogs and sheep offer a good diversification for the average orchard under irrigation, the initial investment in foundation stock being small. Some poultry should be found in every orchard and certain orchards favorably located have found large flocks profitable. Dairying on a large scale makes a rather complicated problem for an orchardist but a few cows will furnish a ready cash product and skim milk forms a valuable part of a ration for either hogs or chickens. Every orchardist regardless of his location should produce as much of the food consumed by his family and by his hired help as is possible.

It is interesting to note that more and more orchardists are finding that it does pay to "fool" with one or more of the side lines. The advantages accrued from the use of legume cover crops in the orchard pastured by live stock such as sheep or hogs may be summarized as follows:

1. The saving of time and labor in cultivation.
2. Organic matter in soil protected from burning sun.
3. Larger numbers of bacteria, which made plant food available for trees, develop in the upper layers of soil because of the presence of organic matter and moisture.
4. Additional crops grown on land not used under "clean cultivation" system.
5. Otherwise non-available nitrogen of the air gathered by bacteria on roots of legumes; used by the legumes; stored in the soil and later used by the fruit trees.
6. The pasturing of intercrops saves time and labor of harvesting.
7. Manure of animals returns fertility used by legumes.
8. Plant food of soil made more available through growth of legumes and manure of animals.
9. Eating cull fruits by animals eliminates many insect and fungus enemies.
10. Increased bearing surface and crop easier to harvest; unnecessary to prune branches high to leave space below the limbs for teams.

\$10.00 FOR YOU

WHAT a lot of pleasure there is tucked away in a \$10 bill. A day at the County Fair, a trip to the seashore, a new hat, or a trip to some friend. No matter what you like, a \$10 bill is full of good times and a chance to earn a \$10 bill is always welcome.

But perhaps you have never been able to find a way of earning extra money that fitted in with your other duties. Still there is a way. *Better Fruit* way of earning extra money will interest you and has become popular in fruit sections. Men and women acting as local representatives.

You Can Earn \$10 or More

Better Fruit Publishing Company will appoint you as a local representative for your vicinity if you have an hour or more each week. You can earn an extra \$10 whenever you want it. The work requires no experience of any kind, nor is there any investment necessary. Read what these people say:

"The subscriptions to *Better Fruit* are so easily obtained it only took a few hours to earn this \$10."
Mrs. J. F. Hindman.

"I am sending ten subscriptions all taken in one day and hardly put in any time at all."
Wm F. Groves.

Write to *Better Fruit Publishing Company* for our \$10 plan. Your letter will be given immediate attention and the \$10 will be yours too, before you realize it.

WRITE TODAY

Better Fruit Publishing Company
603 Oregonian Building
Portland, Oregon

Please send me full particulars of the \$10 plan without obligation or expense.

Name

Address

City and State

FOR SALE 330 ACRES FINEST FRUIT LAND

In the Fruit Belt of Michigan

13,000 select apple trees planted two years ago. Railroad switch on farm. One and one-half miles from town. Price \$100 per acre. Worth double. Address

A. F. BUNTING, 158 Hague Ave., Detroit, Mich.

Universal Bushel Shipping Packages

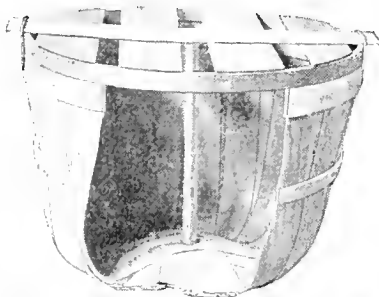

Pay Best Net Profits

- Saves labor in packing, handling and selling.
- Shows off fruits and vegetables to best advantage.
- Most convenient package for handling.
- Centerpost protects pack from crushing and bruising.
- Specifications insure package maximum strength.
- All packages uniform in size—all cover fit snugly.
- Covers attached securely without nailing.
- Handholds always accessible—right for easy handling.
- Economize space—shipped "nested"—by dozens.
- Require no repacking by retailer.
- Serviceable as handy packages when empty.
- Centerpost protects from sides breaking.

Send for Sample

25c in coin or stamps will bring a Universal Bushel Shipping Package to you. Send for one and test its convenience, strength and durability.

Package Sales Corporation

106 East Jefferson St. South Bend, Indiana

does it pay?

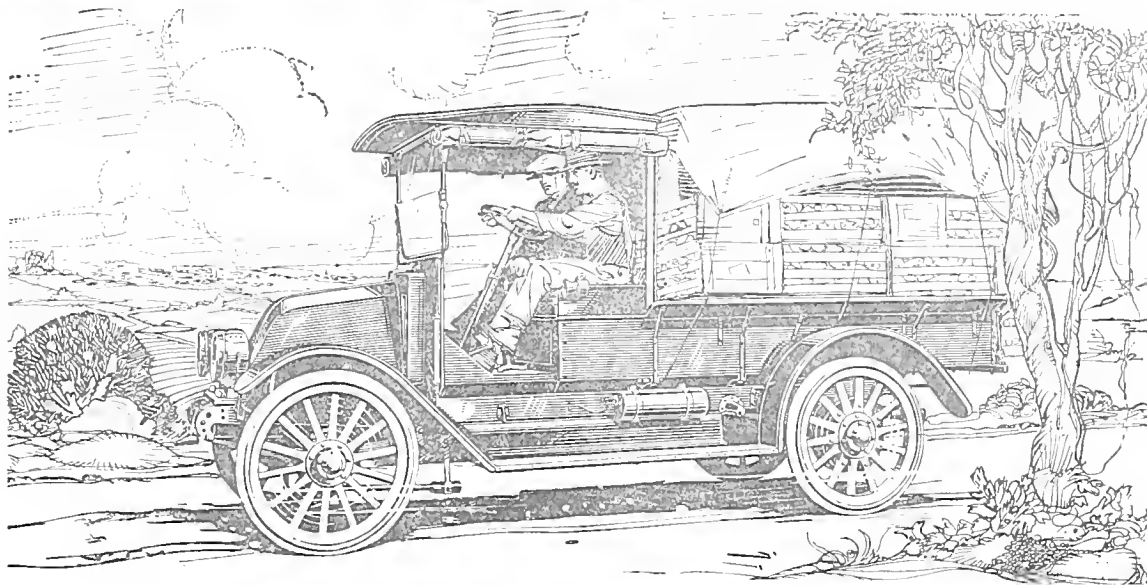

A RANCHER located 45 miles from the railroad used to spend four days on the road with a team going and returning from his shipping point. With his International Motor Truck, he makes the trip in a day and saves three days for productive work.

A farmer living ten miles from town required the greater part of a day to make a round trip haul with horses. With his

International Motor Truck

he makes the trip in about three hours. The rest of the day he has for productive work. To the farmer living closer to market, the saving accomplished with an International Motor Truck is relatively as great.

This truck is built by a Company that knows farm and country road conditions. The engine is a simple, heavy duty type, transmitting ample power to the famous International internal gear rear axle, that converts it into mileage at lowest cost.

When need arises for repairs, or an adjustment, an International owner has

always at ready command a service organization that is thorough and complete. This is an important consideration to the farmer, whose hauling must so often be done at just a certain time.

Figure up the time you and your help spend on the road in the course of a year. Two-thirds of that time is the approximate number of days an International Motor Truck will save you for productive work. There is a style of body and size of truck to meet practically every hauling requirement. Write for full information.

International Harvester Company of America

(INCORPORATED)

Billings, Montana

Crawford, Nebraska

Denver, Colorado

Helena, Montana

Los Angeles, California

Portland, Oregon

Salt Lake City, Utah

San Francisco, California

Spokane, Washington

THE WORLD-
OUR ORCHARD

STEINHARDT
& KELLY
NEW YORK

UNQUESTIONABLY THE
MOST IMPORTANT FACTOR
IN THE DISTRIBUTION OF
THE COUNTRY'S FANCY
APPLES
AND OTHER FRUITS

OUR MARKET-
THE WORLD

BETTER FRUIT

VOLUME XIV

SE1

Columbia PER, 1919
July Libr
30Dec19

NUMBER 3



THE BARTLETT PEAR AS SEEN ON THE TREE

The Bartlett Pear is the most widely grown in the United States of any of the many pear varieties. The pear crop of the Pacific Northwest this year is estimated at over 6,500,000 bushels, the greater proportion of which are Bartletts. Three-fourths of the entire pear crop of the United States was produced this year in the states of California, Washington and Oregon. The view given in the above illustration was taken in an orchard near Sheridan, Oregon.

Features: ("Factors that Influence Diseases of Apples in Storage"
"Specific Results in Pollinating the Bartlett Pear"
"Packing Out the 1919 Apple Crop"
"Dehydration as a Factor in the Fruit World"

BETTER FRUIT PUBLISHING COMPANY, PUBLISHERS, PORTLAND, OREGON

Subscription \$1.00 per Year in the United States; Canada \$1.50; Foreign, Including Postage, \$1.50.

Single Copy 20 Cents

KAOLA MEAL

Cattle—Chickens—Pigs Pay Better

When They Get a Food Like This

Records of 53% increased profits are not uncommon when Kaola Meal is fed to milch cows, calves, pigs, poultry, sheep and horses. The stock and poultry fatten better or produce bigger yields.

The great butter and cheese exporting countries of Europe—Denmark, Holland, Belgium and Switzerland—use enormous quantities of it because they have found that it pays immensely better profits.

Kaola Meal is a wonderful fat food, containing a higher percentage of digestible fat than even linseed oil meal. It is also rich in carbohydrates and the body-building protein.

Remember, though, Kaola Meal is NOT a laxative, so you feed it in the same proportion when you are feeding laxative—from 10% to 25% of the regular grain foods.

We make Kaola Meal from the fine white meat of cocoanuts from which

we extract oil for commercial purposes. But enough oil is left in to make the meal one of the finest fat foods anyone can feed to stock.

We are one of the largest users of cocoanuts in the world, so we can make the best of this type of feed at the lowest price.

Try it and see how it pays YOU. You'll use it continuously once you know.

Order from your dealer now. But be sure it's KAOLA MEAL—the best food of its kind.

Analysis as follows: Protein 16.02%; Carbohydrates 63.50%; Fat 7.18%; Ash 5%.

We have just completed a new book, full of scientific facts on cattle, hog and poultry feeding. It's free. Write us for it. It tells you how the European farmer has gained high yields with this profit food. Clip the coupon now.

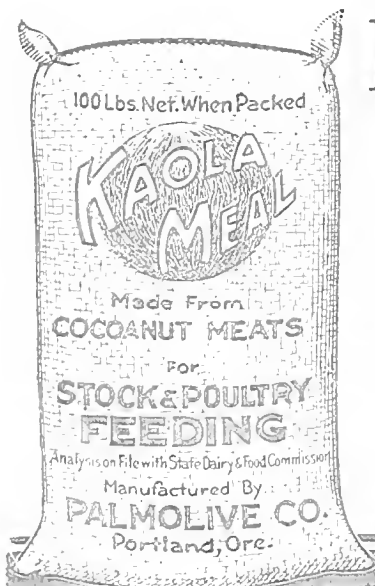

Palmolive Company

Address Department 70
Portland, Oregon

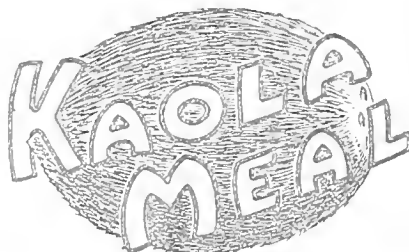

Look for this Mark on the Bag

Cut This Out As A Memo A Reminder:

to write to the Palmolive Company for the booklet about Kaola Meal, and get a trial supply from my retailer.

The Old Reliable
BELL & CO.
 Incorporated
 WHOLESALE
Fruits and Produce
 112-114 Front Street
 PORTLAND, OREGON



SULPHUR

It has been proven and so recommended by the University of California that if you sulphur your grape vines and orchards 6 times they will not be affected by MILDEW or RED SPIDERS.

ANCHOR Brand Velvet Flowers of Sulphur, also EAGLE Brand, Fleur de Soufre, packed in double sacks, are the fluffiest and PUREST sulphurs that money can buy; the best for vineyards; the best for bleaching purposes, LEAVING NO ASH.

VENTILATED Sublimed Sulphur—Impalpable Powder, 100% pure, in double sacks, for Dry Dusting and making Paste—(Atomic Sulphur).

For LIME-SULPHUR SOLUTION, use our DIAMOND "S" BRAND REFINED FLOUR SULPHUR. We can furnish you this sulphur at such a low price that it would pay you to mix your own solution and net you a profit equal to the amount paid out for labor in spraying your orchard, even if you pay your men \$4 per day for making the solution and applying same.

To create additional available plant food, drill into the soil 100 to 400 pounds per acre DIAMOND "S" BRAND POWDERED SULPHUR, 100% pure. This has increased various crops up to 500%.

Also PREPARED DRY DUSTING MATERIALS, Tobacco Dust, Dry Bordeaux, Dusting Sulphur Mixtures, etc. And "Anchor" Brand Standard LIME-SULPHUR SOLUTION 33 BE, Sulphur Paste, etc. Fungicides and Insecticides.

Carried in stock and mixed to order.

San Francisco Sulphur Co.
 624 California St. San Francisco, Cal.

We are equipped to make immediate shipments. Send for "ILLUSTRATED BOOKLET"; also booklet "NEW USES FOR SULPHUR," Price-list, and Samples.

Please state for what purpose you use the sulphur, quantity needed, and date of shipment preferred. Telephone Kearney 871.

Richey & Gilbert Co.
 H. M. GILBERT, President and Manager
 Growers and Shippers of
Yakima Valley Fruits and Produce
 SPECIALTIES
 Apples, Peaches, Pears and Cantaloupes
 TOPPENISH, WASHINGTON

THE SELF-OILING WINDMILL
 has become so popular in its first four years that thousands have been called for to replace, on their old towers, other makes of mills, and to replace, at small cost, the gearing of the earlier Aermotors, making them self-oiling. Its enclosed motor keeps in the oil and keeps out dust and rain. The Splash Oiling System constantly floods every bearing with oil, preventing wear and enabling the mill to pump in the lightest breeze. The oil supply is renewed once a year. Double Gears are used, each carrying half the load. We make Gasoline Engines, Pumps, Tanks, Water Supply Goods and Steel Frame Saws. Write AERMOTOR CO., 2500 Twelfth St., Chicago

The **49er** says=
 "the genuine **GIANT**
 dates back to
 1866"

"I remember well when we used black powder for stump blasting and mining. Just after the Civil War the first Giant Powder ever made in the United States was manufactured in a little laboratory in what is now Golden Gate park.

"Out of that beginning has grown The Giant Powder Co., Con., with its chain of great plants and magazine stocks throughout the entire West. And the Giant Farm Powders are being used for stump blasting, boulder blasting, tree planting, etc., by thousands of Western land owners. Giant Powders have always been so popular that some people have thought any ordinary dynamite was Giant Powder, but that is wrong. The only way to get Giant economy and efficiency is to get the genuine Giant Powders made by the originators of the name.

Just tell us "send me your book," and we will mail you our valuable guide to blasting. "Better Farming with Giant Farm Powders."

THE GIANT POWDER CO., CON.
 "Everything for Blasting"
 202 First National Bank Bldg., San Francisco
 Branch Offices: Denver, Portland, Salt Lake City, Seattle, Spokane

GIANT
FARM POWDERS
 STUMPING **EUREKA**

Pittsburgh Perfect Cement Coated Nails are of the highest standard

The Heads don't come off. Given Preference by Largest Pacific Coast Packers

MANUFACTURED EXCLUSIVELY BY
 PITTSBURGH STEEL COMPANY, Pittsburgh, Pa.

A. C. RULOFSON COMPANY, Pacific Coast Agents
 359 Monadnock Building, San Francisco, California

SIMONS, SHUTTLEWORTH & CO.
LIVERPOOL AND MANCHESTER

SIMONS, JACOBS & CO.
GLASGOW

GARCIA, JACOBS & CO.
LONDON

Agencies and Representatives in Every Important European Market

European Receivers of American Fruits

FOR MARKET INFORMATION ADDRESS

SIMONS, SHUTTLEWORTH & FRENCH CO.
204 Franklin Street, New York

SIMONS FRUIT CO.
Toronto and Montreal

SIMONS, SHUTTLEWORTH, WEBLING CO.
Board of Trade Building, Boston

OUR SPECIALTIES ARE APPLES AND PEARS

Pacific Coast Agents
**United States Steel
Products Co.**

San Francisco
Los Angeles
Portland
Seattle



J.C. Pearson Co., Inc.
Sole Manufacturers

63 Pearl Street
Boston, Mass.

PEARSON
ECONOMY in buying is getting the best value for the money. not always in getting the lowest prices. PEARSON prices are right.
ADHESIVENESS or holding power is the reason for PEARSON nails. For twenty years they have been making boxes strong. Now, more than ever.
RELIABILITY behind the goods is added value. You can rely on our record of fulfillment of every contract and fair adjustment of every claim.
SATISFACTION is assured by our long experience in making nails to suit our customers' needs. We know what you want; we guarantee satisfaction.
ORIGINALITY plus experience always excels imitation. Imitation's highest hope is, to sometime (not now) equal Pearson—meantime *you* play safe.
NAILS

LOOK HERE

ARE YOU SATISFIED with your present selling service?

IF NOT try us and learn what an up-to-date selling organization can do for you.

CABLE OR WRITE US NOW for market prospects, terms, etc. Reasonable advances made against shipments of

**APPLES
PEARS
ORANGES**

YOU want the best market in Britain.

WE have it.

McCAIG & WEBB
Fruit Brokers, **GLASGOW**

Head Office, **GLASGOW**

Cables—MacWebb, Glasgow
A. B. C. 5th Edition—Marconi International

ALSO RECEIVERS AT
London — Liverpool — Hull

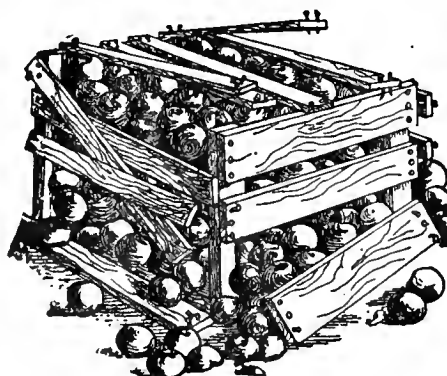

BEFORE using Cement Coated Nails

Western Cement Coated Nails for Western Growers

Our Cement-Coated Nails are always of uniform length, gauge, head and count. Especially adapted to the manufacture of fruit boxes and crates. In brief, they are the Best on the Market.

Write for Growers' testimonials.

Colorado Fuel & Iron Co.

DENVER, COLORADO

Pacific Coast Sales Offices
Portland, Spokane, San Francisco
Los Angeles

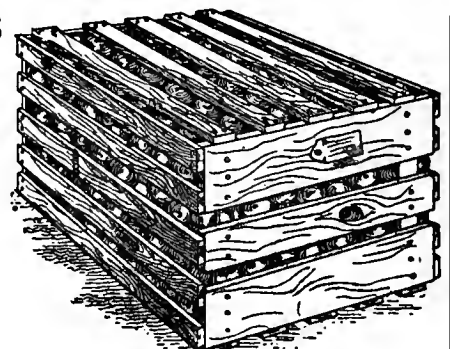

AFTER use of C. F. & I. Co.'s
Cement Coated Nails

BETTER FRUIT

EDITOR: W. H. WALTON

STATE ASSOCIATE EDITORS

OREGON—C. I. Lewis, Horticulturist.
WASHINGTON—Dr. A. J. Melander, Entomologist;
O. M. Morris, Horticulturist, Pullman.
COLORADO—C. P. Gillette, Director and Entomologist;
E. B. House, Irrigation Expert, State Agricultural College,
Fort Collins.
ARIZONA—E. P. Taylor, Horticulturist, Tucson.
WISCONSIN—Dr. E. D. Ball, Madison.
MONTANA—O. B. Whipple, Horticulturist, Bozeman.
CALIFORNIA—C. W. Woodworth, Entomologist, Berkeley;
W. H. Volek, Entomologist, Watsonville; Leon D.
Batchelor, Horticulturist, Riverside.
INDIANA—H. S. Jackson, Pathologist, Lafayette.

An Illustrated Magazine Devoted to the Interests
of Modern, Progressive Fruit Growing
and Marketing.

PUBLISHED MONTHLY BY

Better Fruit Publishing Company

703 Oregonian Building

PORTLAND, OREGON

All Communications should be addressed and
Remittances made payable to

BETTER FRUIT PUBLISHING COMPANY

SUBSCRIPTION PRICE:

In the United States, \$1.00 per year in advance.
Canada \$1.25; Foreign, including postage, \$1.50.

ADVERTISING RATES ON APPLICATION

Entered as second-class matter April 22, 1918,
at the Postoffice at Portland, Oregon, under
the Act of Congress of March 3, 1879.

VOLUME XIV

PORTLAND, OREGON, SEPTEMBER 1, 1919

NUMBER 3

Factors that Influence Diseases of Apples in Storage

By D. F. Fisher, Assistant Pathologist, Fruit Disease Investigations, U. S. Department of Agriculture

[EDITOR'S NOTE.—This article is not a technical discussion of this subject for the professional horticulturist. On the contrary, it is full of valuable practical information for the orchardist, the apple packer, the cold storage man and everyone else who handles apples from orchard to market.]

THE factors that influence diseases of apples in storage are of vital importance to all apple growers, as well as shippers and dealers, but too often the grower feels that his connection with the crop ends with its delivery to the shipper, and especially is this true if he receives cash payment upon delivery. If he sells early, delivering the apples direct from the orchard to the shipper, his connection with the later condition of the fruit is frequently questioned. He feels that thereafter the

risk is all the shipper's or the dealer's, both financial and as to the future condition of the fruit itself. In what manner, then, can the grower be affected if his fruit fails to "hold up" in storage—if his apples develop storage diseases? This question must be satisfactorily answered if the team work is to be secured in the fruit industry which will secure it on that broad basis fundamental to its continued success. To fully answer it the grower must project himself beyond the confines of his own orchard, the dealer must see beyond his own warehouse, each must obtain a concept of the industry as a whole. Each must understand that his own business stands or falls with that of the industry.

Here in the Northwest it has been possible to adopt the motto, "All for one, and one for all"—but, unfortunately, of late there has been a tendency to replace this with one reading, "Each one for himself, and the devil take the rest." There is a growing confusion of "quantity" and "quality," with too much emphasis on the "quantity" which the rapidly growing orchards have yielded and at the expense of the "quality" which it is essential that the Northwestern apple maintain in order to successfully compete in the great consuming markets of the East. Profitable disposition of Northwestern apples in Eastern markets is handicapped; first, by the high cost of production at home; second, by high cost of transportation to reach these markets; and third, by a constantly increasing competition with carefully selected Eastern apples, produced and marketed at less cost. The latter factor may not be a popular subject for discussion in the Northwest, but nevertheless an ostrich attitude does not pay, and the Northwest might as well realize that the East by no manner produces all culls and pie apples. If Northwestern apples must compete with Eastern apples in Eastern markets they can succeed only if they possess a quality upon which the trade will pay a premium. This has been the basis of the success of the Northwestern apple industry in the past, and it must continue to be so, for the other economic factors are inherently of advantage to the East.

Since "quality" necessarily becomes the foundation of the Northwestern apple business, it is the purpose of this paper to discuss certain influences affecting the quality of apples, that is, how quality is affected by storage diseases. The "quality" of an apple is subject to many influences in the realm of botanical science, and a number of technical investigations have been concerned with the subject, the results of which have not been generally disseminated. Some of these investigations have been conducted in the Northwest on Northwestern apples, but the principles deduced are of general application.

The quality of an apple cannot be



Types of soft scald on Delicious apples which were unpacked at Dryden, Washington.

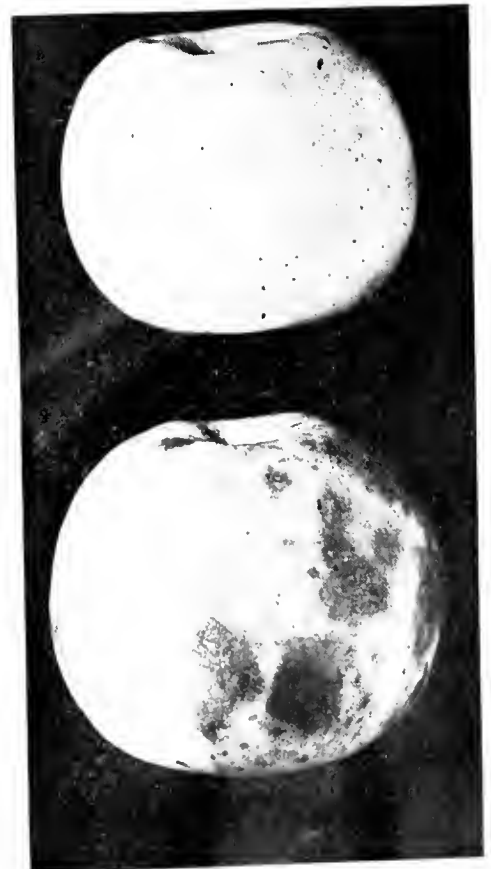

Unscalded Grimes apple at top; scalded at bottom. A disease that is developed by improper storage methods.

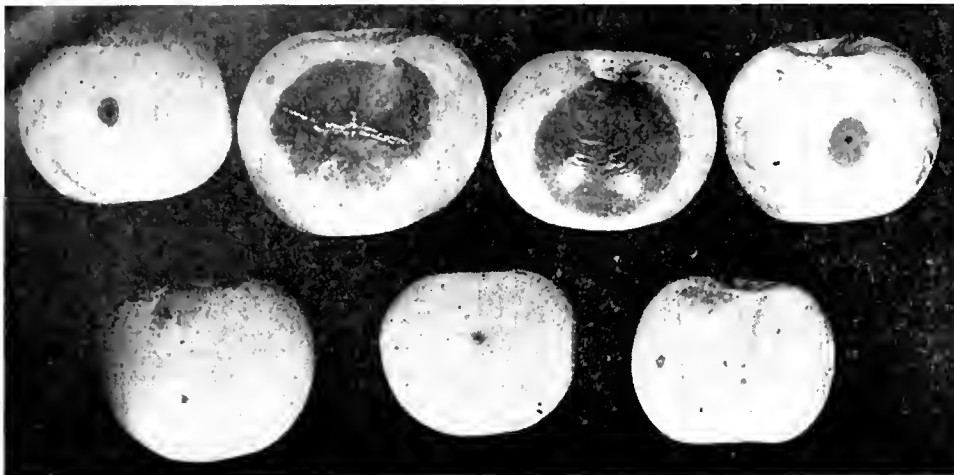

Rots starting from mechanical injuries, such as bruises and slight punctures. This type of damage can be eliminated almost entirely by careful handling.

truly judged until it is eaten—and whether it be fit to eat early or late in its season is dependent upon its “keeping quality.” Consider, then, some of the factors that influence the keeping quality of apples—factors that produce storage diseases. There are two general divisions of storage diseases:

1. Parasitic, or those caused by such organisms as bacteria and fungi, or molds.

2. Non-parasitic, or the so-called “physiological diseases.”

Those in the latter class are frequently not regarded as diseases, but as “conditions,” but call them what you will, they cause pathological abnormalities.

Parasitic Diseases.

The parasitic diseases may be classified into two general groups: (1) Those which may be prevented by spraying and good orchard sanitation, and (2) Those which may be prevented by proper handling of the fruit. As an example of the first class we have the Northwestern anthracnose. This disease is confined to the Pacific Northwest and is most serious west of the Cascades. It is present to some extent in the White Salmon Valley, and it has



Penicillium, known better as “blue mold” rot, a fungous disease that develops in storage. Careful handling is recommended to reduce this trouble to the minimum.

been serious in the Hood River Valley, but it does not exist, so far as known, in any of the major apple districts of the State of Washington. This disease is caused by the fungus *Neofabraea Malicorticis*, which lives over from year to year in cankers on the branches. Its spores are matured in midsummer, but they require moisture for germination, and hence the disease does not spread before the fall rains. These rains usually begin before the apples are picked, and the fruit therefore may be infected before it leaves the tree. The spores may germinate and cause an early rotting of the fruit, but hard, late-season apples are usually not attacked until after they are in storage and have begun to soften. However, if the skin happens to be broken the fungus may secure immediate entrance and rotting proceeds at once. Fruit infection is prevented by spraying with bordeaux mixture before the apples are picked, but to control the limb cankers later applications are necessary.

Apple scab is another fungous disease of importance in some localities of the Northwest, but fortunately is not prevalent in the great apple-producing districts of the State of Washington. The fungus usually produces its scab spots before harvest, but infected apples of course are not sold in the general trade. But late matured spores may lodge on sound fruit and infect the apples after they are picked and stored. Scab injury is superficial and affects the appearance rather than the eating quality of the fruit. But scab is frequently a vital factor in the keeping quality of apples, for various other fungi, in themselves incapable of penetrating the sound skin of the fruit, gain easy access through the scab spots and cause the fruit to rot. From this standpoint alone the exclusion of scabby fruit from the higher

grades is justified. The prevention of scab is accomplished by good orchard sanitation, accompanied by fungicidal spraying at such intervals as to protect the fruit from bud to harvest.

The parasitic diseases of apples in storage that can be prevented by proper handling of the fruit are those due to attacks of organisms which gain entrance through skin punctures. Whenever the skin of a mature apple is broken a fungous rot is almost sure to develop. The fungi which most frequently cause these rots are incapable of penetrating the sound skin, but rots speedily result when they gain access to the flesh and juice of the apple. Skin broken on green apples has a chance to heal, but this power is lost as the fruit matures, hence the great importance of careful handling to prevent mechanical injuries of ripe apples.

Among the fungi of this class which cause storage rots the most common is *Penicillium*, the familiar “blue mold.” Another common fungous rot is caused by *Alternaria*, which is a “black mold.” These two are the most common in the Northwest, but rots due to other “molds,”—pink, white, gray, and various other colors, also occur. Careful handling will reduce these rots to a minimum, and in picking, hauling, putting the apples over the grading machines, and in packing attention should be given this detail. The mechanical graders now in general use are of great utility, but like all conveniences, their benefits may obscure some abuses. The machines are frequently crowded, so that the apples pile up either at the sorting end or in the bins, resulting in numerous stem punctures. Another prolific cause of broken skin is found in finger-nail punctures. Every handler of apples should be required to wear gloves. Greater care in box nailing should be insisted upon also, for protruding nails

Continued on page 23.

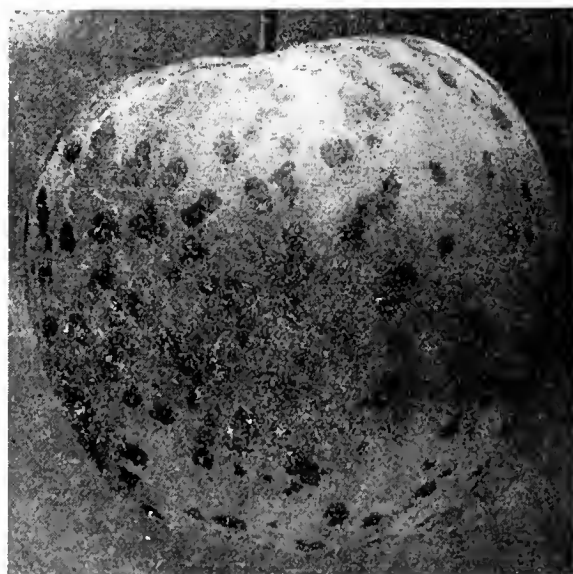

Jonathan apple affected with what is known as Jonathan spot. This disease is not a fungous disease. It usually develops after the apples are placed in storage and is believed to be caused by over-irrigation and allowing the fruit to remain on the tree until it is too ripe. Idaho lost 10,000 boxes of Jonathans in 1917 from this cause after the fruit had all been placed in storage.

Specific Results in Pollinating the Bartlett Pear

By Warren P. Tufts, Professor of Pomology, Agricultural Experiment Station, University of California

THERE is a growing interest on the part of pear growers in California and elsewhere in the Pacific Northwest concerning the question of whether the Bartlett, their chief variety, requires or is benefited by cross-pollination. The fact that Bartlett trees, planted without any regard to cross-pollination, have yielded profitable crops, has led some to believe that the variety is self-fertile. On the other hand, these same growers have noticed when they have a stray tree of some other variety in their orchard that the surrounding Bartletts are more abundantly fruited than the remainder of the orchard. This seems to indicate that the Bartlett, under valley conditions, is greatly benefited by cross-pollination. In the Sierra foothills thoughtful and observant growers have felt sure that the Bartlett, under their conditions, is always self-sterile, to a degree rendering cross-pollination imperative.

Although practically all writers agree in advising the interplanting of other varieties to pollinate the Bartlett, even in the valley locations in California, nevertheless the bulk of the acreage planted to Bartletts in the state contains no other variety. The writer outlined and performed certain experiments dur-

ing the seasons of 1916, 1917 and 1918 designed to test the accuracy of the observations enumerated above.

Organization of the Work.

The methods employed for investigating the various problems were those commonly in use in cross-pollination experiments. Briefly stated, this part of the work consisted in the application by hand of the pollen desired, having first removed the flowers' own pollen-producing organs (the stamens). The introduction of foreign pollen through the agency of wind and insects was prevented by covering the hand-pollinated blossoms with paper sacks. Accurate counts of the flowers were made and recorded. Later in the season the sacks were removed. The fruits resulting from these artificial pollinations were counted and the proper record made after the first and second crops and again at harvest.

The Results.

The results of all the experiments in connection with this work were interesting and showed conclusively the benefits of cross-pollination. Eliminating some of the more technical phases of the work, however, the result of an experiment designed to show from the average yield of two orchards what should be expected from cross-pollination under normal conditions will probably be

of most interest to the Bartlett pear orchardists or those who intend to plant this variety of pears. This result is as follows:

The orchard of Mr. P. M. Beaser, of Chicago Park, Nevada County, consists of one thousand Bartlett pear trees, no provision having been made for cross-pollination. These trees are perhaps twenty-five years old. There is located on the Loma Rica Ranch, some eight miles away, a small block of old Bartlett pear trees of about the same age and vigor as those on the Beaser place. Many of these trees have, however, during the past six or eight years, been top-worked to other varieties. With the exception of the presence of pollinating varieties at Loma Rica the two orchards just described are in all respects comparable. Both orchards bloomed profusely.

COMPARISON OF YIELD ON BARTLETT TREES WITH AND WITHOUT POLLINATING VARIETIES, 1918.

(Loma Rica Ranch, Grass Valley)

<i>With pollinating varieties:</i>	
No. of blossoms counted.....	3007
No. of fruits set May 17.....	419
Per cent set.....	14.9
Average yield per tree in packed boxes.....	2.19
(Beaser Ranch, Chicago Park)	
<i>Without pollinating varieties:</i>	
No. of blossoms counted.....	3170
No. of fruits set May 17.....	192
Per cent set.....	6.0
Average yield per tree in packed boxes.....	.77

The figures show that the trees provided with cross-pollination produced a crop almost three times as great as that produced by the trees which did not receive cross-pollination. It should

Continued on page 21.

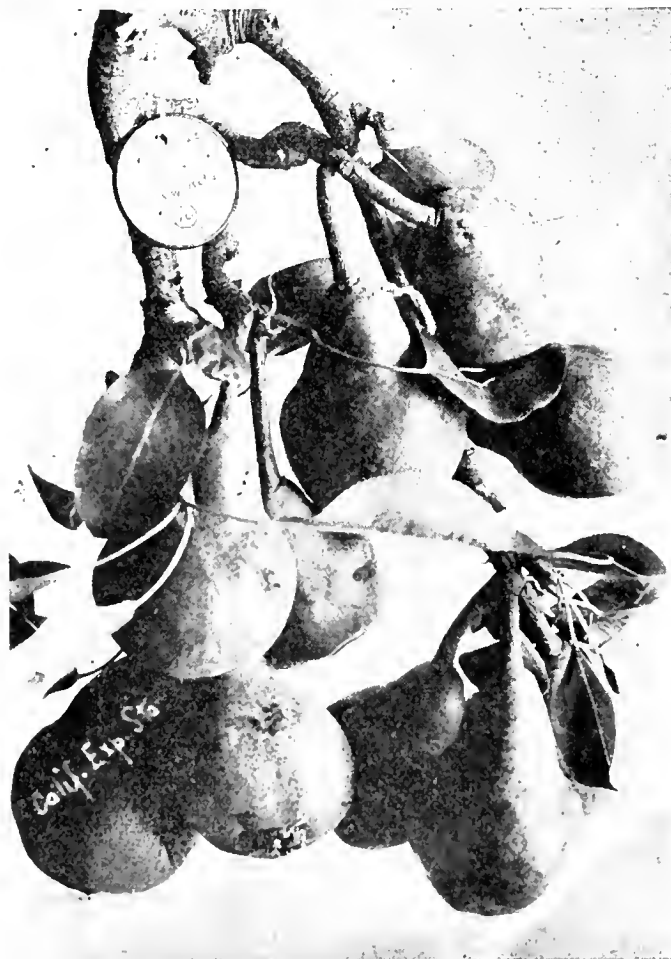

Ten Bartlett pears set from twenty-five blossoms pollinated with Winter Nelis pollen. A typical cluster resulting from crossing Bartlett with Winter Nelis.

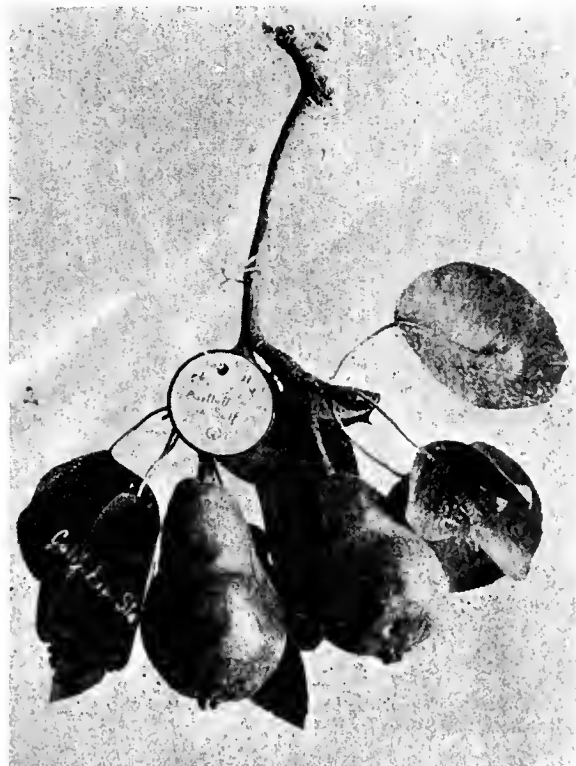

Two Bartlett pears set from eight blossoms pollinated with Bartlett pollen. A typical cluster of this variety when self-pollinated.

Dehydration as a Factor in the Fruit and Food World

By W. H. Walton, Editor Better Fruit



Receiving loganberries for dehydration at the plant of the King's Products Company, Salem, Oregon.

THE preservation of food by drying has been in use for centuries and is probably the oldest known method which the human race has employed in food conservation. The process employed by the ancients and which is still largely employed is to place the fresh food, more particularly cereals and fruits, in the sun and allow the rays of this great heat and light-giving orb to gradually eliminate the moisture. In semi-arid sections where continuous sunlight can be depended upon over a considerable period this method of drying food is a success, with the exception that the food spread on trays out of doors is a prey to the insects and gathers considerable dirt, due to sudden gusts of wind and the dust particles that are in the air at all times during the dry season. These handicaps are no small objection to sun-dried food, in addition to the fact that some fruits and vegetables do not ripen until the rainy season sets in and puts an end to drying food by nature's process.

To meet the growing demands for dried fruits, such as apples, apricots, prunes, pears and some of the other tree fruits, evaporating machines were evolved, and, while they proved a success, failed to be adapted to the needs of the entire fruit, vegetable and other food kingdoms. It was this need that caused the birth of dehydration, which, reduced to its simplest terms, means merely the extraction of water, or the elements of water. "Dehydration," an expert on this subject says, "has come as a term to distinguish a special type of process to preserve fruits, vegetables, meats, fish and eggs for indefinite periods. Properly done, this process entails no loss of the original constituents of the material. The mineral salts, vitamins, acids, proteins, etc., are retained in their original fullness and the cellular structure remains intact.

The first experiments in drying foods according to this principle were not altogether a success, as the method of drying was accomplished by either a horizontal air wave passing over or a vertical wave passing through the material. Circulation was obtained by means of drafts and the natural rising of heated air. The temperatures during this process ran from 140 to 190 degrees and subjected the material to such an intense heat that its entire content was often made valueless. The basic principle of the new process of dehydration is a gradual extraction of the moisture content by means of low temperatures.

The material to be dehydrated is spread on shallow trays, which are slid into steel cars, and the cars then rolled into long, tightly sealed tunnels. The

process that takes place is similar to that of a warm arid wind. The temperatures are kept low, but the volume of air passing through the tunnels is rapid, varying from 25 to 50 feet per minute. Circulation is artificially created by fans, and the air is used but once, preventing the carrying of the odors and moisture from one tray to another. The moisture is removed so gradually that the cell structure of the materials remains intact, the flavor uninjured and the food value unimpaired. The retaining of the cell structure is probably the most important feature of this process, on account of the fact that when the finished product is placed in water it will reabsorb the original amount of moisture it contained, largely regaining in this way its fresh color and flavor and the wholesome, nourishing properties of the freshly gathered produce. In showing how greatly the weight of the fresh material is reduced when dehydrated the following table will be of interest:

NUMBER OF POUNDS OF FRESH MATERIAL REQUIRED TO MAKE ONE POUND OF DEHYDRATED.

Apples	10
Apricots	5
Cherries (pitted).....	5
Loganberries	6
Pears (peeled)	8
Peaches (peeled)	10
Prunes	3
Raspberries	6
Strawberries	8
Cranberries	6½
Beets	9
Stringless Beans.....	10
Cabbage	12
Carrots	10
Celery	20
Onions	10
Parsnips	8
Potatoes	6
Pumpkin	13
Rhubarb	20
Squash	9
Spinach	15
Tomatoes	15
Turnips	15

While the great economic value of artificial dehydration had been realized



Spreading loganberries on trays preparatory to being dehydrated. To the right can be seen the partially loaded steel cars which are used in routing the food materials through the plant.

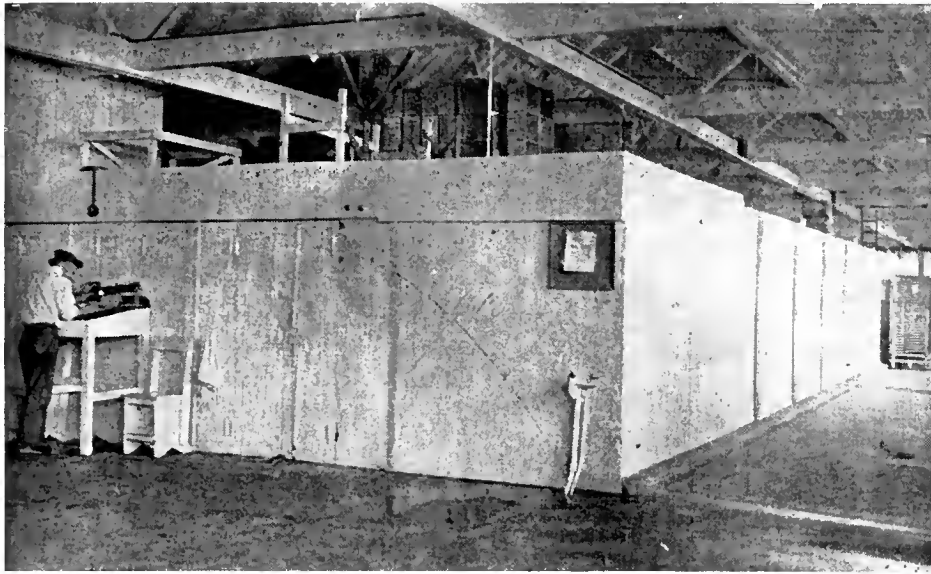

View of room containing dehydrating tunnels. Points of interest are the "drylight construction," combined with the all-white interior finish and absolute cleanliness. The cars containing the fresh food are rolled into these tunnels, where the material has the moisture extracted from it without removing any of its other constituent forces or qualities.

and considerable progress had been made in the process, it remained for the great war to demonstrate its wonderful possibilities and to give it an impetus that now means unqualified success. The small space required to transport and store large quantities of wholesome fruit and vegetable food at a greatly reduced cost opened the eyes of the world to this new factor in food conservation.

It is not the object of this article to go into the comparative merits of dried or canned food. Both of these processes have an important place in the fruit industry and each of them to a large

extent covers a separate field. The outstanding features of successful dehydration are that it permits putting up the maximum amount of wholesome fresh food value in the minimum size package; is a new source of food conservation; a new market for the food producer and a new asset in the industrial welfare of the country. The more forms in which fruit and vegetable foods are made savable and available the greater will be the consumption, bringing with it added stimulation of agriculture and prosperity.

Like other forward strides in the fruit

industry, assured success in artificial dehydration had its birth on the Pacific Coast. In fact, Oregon is the cradle in which it has been nursed along, until now it is spreading out its arms and will no doubt soon be reaching into the other sections of the Northwest. The largest and best known establishments of this kind are those of the Kings Products Company, one of which is located at The Dalles, Oregon, and the other at Salem, Oregon. It is understood that this company is also making arrangements to locate plants in other sections of this state and also in Washington.

The establishments that are being built by this company are models in the way of factory construction, being big and airy and with sanitation as the dominating feature. The products are handled so as to minimize as much as possible exposure to air or human hands and the entire process and system for turning out the finished product is on a basis that is fast making American industrial institutions the finest of their kind.

The great importance of the dehydration process has just been recognized by the government, which has made a large appropriation to be used in conducting experimental work in this industry on the Pacific Coast. Part of this sum will be utilized in installing a large and fully equipped laboratory at the plant of the Kings Products Company at Salem, Oregon, and a laboratory will be located in California also. Both of these establishments will be used to carry on scientific investigations to promote the development of the industry.

Packing the 1919 Northwest Apple and Pear Crops

Written for Better Fruit by an Experienced Fruit Handler

NOTWITHSTANDING the strong demand for apples and pears this year, buyers are announcing that they will not accept fruit that is not correctly packed and strictly up to grade. Buyers are making this announcement owing to the fact that last year a comparatively light crop, coupled with an unexpected demand, resulted in throwing on the market large quantities of inferior fruit, badly packed, which got by as the trade was so great that almost any kind of an apple or pear packed in almost any kind of way could be sold. This, it is pointed out, will not be allowed this year, and a rigid adherence to standard grade and pack will be insisted upon.

Packing Rules Being Enforced.

There are practically no changes in the grade and pack of Northwest apples this year. The Northwest standard box, 10½ x 11½ x 18 inches inside measurement, has now been adopted in all districts, and there is a probability that it will be made the national standard container for box apples by an enactment of Congress. There has been a tendency during the past year to force growers to be more careful in the matter of pack and grade and in some states laws have

been passed to this effect. California now has a law which stipulates the rules for packing and grading fruit in that state and provides for fines for those who fail to comply with the provisions of the measure. The law requires that each box of fruit must be marked with a stamp provided by the state, stating that it has been graded and packed according to the official requirements. It is expected that the other Pacific Northwest states will later adopt such a law.

Labor Saving Devices.

In packing out the 1919 crop of apples labor-saving devices will play a more important part than in former years. There are several reasons for this: shortage of expert labor in the fruit industry; the fact that a better grade and pack can be put up; that crops can be handled more quickly and economically, and that growers made a sufficient profit last year to allow them to invest in up-to-date orchard and packing house equipment. New acreage coming into bearing in the Northwest is also naturally playing its part in stimulating the sale of this apparatus. The main reason, however, for the greater adoption of modern equipment by the

progressive orchardist is its efficiency and economy. The latest and best makes of picking ladders and utensils, wiping and grading machines, packing tables, box presses and conveyors have demonstrated so thoroughly to the grower that greater profits follow their use that few orchardists who have crops large enough to establish a packing house now attempt to market their crops without having most of these appliances.

Undoubtedly the greatest boon that has come to the box apple grower in the last decade is the power grader and sizer, which has reached its greatest degree of efficiency in the Northwest. There are now several types of these graders being manufactured on the Pacific Coast, all of which do efficient work. What the power grader has done in helping the orchardist to pack his fruit better and more economically, the conveyor is now doing in many sections to more cheaply handle it from packing table to car.

Grading Most Important.

Grading for quality is the most important feature of apple packing, for while perfection has been almost attained by machines in sizing the fruit,

no machine is human it cannot see imperfections and judge of color. It takes a quick and experienced eye and hand to detect imperfect fruit, or fruit that should not go into the best grades on account of lack of color. Where possible, experienced hands should be selected to grade apples for quality and they should be fully instructed each year in any changes in the provisions for disqualifying the fruit on account of blemishes or color. Where it is not possible to employ experienced graders, they should be put to work under the supervision of an old hand for instruction and to carefully watch their work. The pack is very important, too, but it should be remembered that a competent packer can make a good appearing pack from fruit of any quality, provided it is properly sized. The packers are expected to keep their eyes open for fruit of inferior quality that gets past the grader and remove it, and while they do this to some extent, they are inclined to pack anything that comes to the table from the sizer and graders. In years when apples are high in price some growers have a habit of winking at this practice and taking a chance on getting by. This idea, however, is a bad one from all points of view. It lessens the morale of the packing house crew, causes the grower's pack to be looked upon with suspicion and ultimately results in a distinct loss in his profits. The apple sorter or grader, therefore, is the most important factor in a packing house, for, if he does his work efficiently and conscientiously, he can force a careless packer or an unscrupulous grower to put up a good quality pack.

Progress in Packing Apples.

While the mechanical grading of apples has simplified apple packing, it is still somewhat of a science, and everybody who tries cannot make a success of it. To be a good apple or pear packer requires a quick eye for gauging size, deft hands, a large amount of nervous energy and a goodly percentage of horse sense and common honesty. In the last few years fruit packing has become more or less of a fixed occupation for hundreds of expert packers, who travel along the Pacific Coast between California and the Northwest states packing out the various fruits during their seasons. As apple and orange packing are more nearly alike, large groups of these professional packers now come from California to the Northwest each year during the apple packing season and return to the citrus belt in time for the first orange crop.

In addition to these professionals are the still larger groups of resident packers who pack out the greater proportion of the Northwest apple crop and on whom the growers of the various dis-

tricts rely to a greater degree than on the migrations of the hobo packers. The yearly influx of these professionals has, however, been of considerable benefit to the apple packing game, as they have brought with them from time to time improved methods, such as better trays for holding apple wrappers, quicker ways of placing the apples in the box and surer systems for a pack true to size.

The fundamental principle for a beginner in learning to pack apples or pears is to become familiar with the various standard packs and learn to put them up correctly before trying to gain speed. The novice in attempting to get too much speed at the start is very likely to lower the excellence of his pack. Having become thoroughly versed in how to pack, rapidity in packing will naturally come to the beginner according to his fitness for the occupation. The cardinal point in packing apples is to have the pack, both in quality and size, as near perfect and as nearly representative of the grade marked on the outside of the box as possible. The correct bulge is also very essential, as it plays an important part in having the fruit ship well and also sell to a better advantage. The bulge is for the purpose of keeping the package tight and also to take care of the shrinkage, so that the buyer will be satisfied that he is getting a full package of fruit.

With the adoption of a standard apple pack for the Northwest a year or two ago, the experienced packer needs little instruction, but for the beginner the illustrations and rules for packing published in this number of BETTER FRUIT will prove valuable. By following these instructions, particularly those relating to starting the pack, the beginner should learn rapidly. The opportunity to attend an apple-packing school in advance of the shipping season, where experienced instructors are provided, will prove of the greatest assistance and should be taken advantage of by all beginners if possible.

Handling the Pear Crop.

The pear crop in the Pacific Northwest this year will be the largest ever shipped from this section and will be sold for the highest prices. More than the usual care, therefore, should be exercised in packing and handling it. Compared to apples, pears are relatively poor keepers. They are easily bruised, decay rapidly, and to get the best marketing results should be handled very rapidly from orchard to cold storage. In fact, where it is possible pears should be placed in cold or cool storage almost as soon as they are picked, and then if to be sold fresh should be packed out from the storage house.

The Time for Picking.

The time for picking pears should be watched very closely, as they ripen more unevenly than any other fruit, and if several pickings are made will keep better and many more of them can be sold fresh instead of being sent to the canneries. Pears should be picked when

**BEST SERVICE-
QUALITY & PRICES**



PERFECTION IN
FRUIT
LABELS

**THE
SIMPSON & DOELLER CO.**
1423-24 NORTHWESTERN BANK BLDG.
PORTLAND, OREGON.
E. SHELLEY MORGAN
NORTHWESTERN MANAGER
WE CARRY—AND CAN SHIP IN 24
HOURS—STOCK LABELS FOR PEARS,
APPLES, CHERRIES & STRAWBERRIES.

they have attained a mature size, although still green. When they have arrived at that stage of ripeness where they can be easily snapped from the spur they are ready to be taken to the packing house.

Packing.

Pears are packed very much the same as apples, although on account of their irregular shape the fruit at each end of the box in the alternate layers is turned with the stem end in. The method employed in packing pears is the 3-3 and 2-2 diagonal pack. The boxes are lined with paper, the same as in a fancy pack of apples, and the fruit carefully placed in wrappers.

In grading pears the best or fancy grade should be as near perfect as possible and be free from worms, bruises, stings, disease marks or defects of any kind. The second or choice grade consists of fruit that is free of diseases of all kinds, but may contain pears that are misshapen to a certain degree. Those which are slightly limb rubbed or have worm stings that have been healed over are also permitted in this grade. Pears are graded by the packer and are now packed from a packing table the same as apples, instead of being packed from the orchard boxes as formerly.

In the Pacific Northwest this year it is estimated that California will produce a crop of over 4,000,000 bushels of pears (its largest crop), Washington 1,600,000 bushels and Oregon 600,000 bushels.

Experienced Orchardist and Nurseryman wants position as foreman or manager.

MOUNT DOME RANCH
Siskiyou Co. Mt. Dome, California



The Tractor with Orchard Traits

A SHORT turning radius—plenty of power—ability to work efficiently on side hills and soft ground—small size—and economy of up-keep—all found in the Cletrac Tank-Type Tractor—all absolutely essential in working the modern, profitable orchard.

The distinctive tank type of construction gives the Cletrac an almost uncanny ability to *stay on top* of soft ground, to stick to side hills, to go over uneven surfaces, and to climb steep grades.

It goes in and out among trees and low-hanging branches quickly and easily—circling closely around small trees if necessary—and doubling back on its own path with no waste of time or space.

The Cletrac operates on a surprisingly small amount of kerosene. Distillate or gasoline may be used if desired.

Early ordering is essential as we cannot promise prompt deliveries much beyond the immediate future. See the Cletrac dealer *today*.

Send for our booklet "*Selecting Your Tractor*." It answers many perplexing questions and shows the way to *better results* and *larger profits*.

The Cleveland Tractor Co.
19145 Euclid Avenue Cleveland, Ohio
Largest producers of tank-type tractors in the world

Cletrac

TANK-TYPE TRACTOR

(Formerly known as the "Cleveland Tractor")

Oregon's Rapid Development in Horticulture

An Appreciation of the Progressive Work Done by Prof. C. I. Lewis and the Oregon Agricultural College for Horticulture by Better Fruit



Prof. C. I. Lewis.

Prof. C. I. Lewis, who for thirteen years has been Chief of the Division of Horticulture at the Oregon Agricultural College, and for the past six years Vice Director of the Experiment Station, has resigned to accept the position of organization and publicity manager of the Oregon Growers' Coöperative Association.

Prof. Lewis came to the Oregon Agricultural College on May 12, 1906. At that time there had not been a professor of pomology at the Oregon Agricultural College for four years. Prof. Lewis began at once to organize and build up the work, and demonstrated early that he recognized the essentials of good organization, by making a careful selection of men and surrounding himself with strong men, giving them every facility and every opportunity for work. The department of horticulture of the Oregon Agricultural College was the first one to establish a strictly research man, to add a fellow to the department, to raise a man to the associate professorship, and to a full professorship. It was this policy which rapidly developed

strong men in the Oregon horticultural field.

It was Prof. Lewis' policy to give these men every facility and encourage them in every way. That the policy was a wise one, the results of the Division of Horticulture themselves testify. During the thirteen years that Prof. Lewis was associated with the Oregon Agricultural College a large number of bulletins were issued by the division of horticulture. Some of the most famous are the pollination series, which had to do with the pollination studies of apples, cherries, and tomatoes; and the pruning series, the nitrate studies in Hood River, Rogue River and the Willamette Valley, with apples, pears, peaches, and prunes. Perhaps the most important bulletin issued was the Loganberry juice bulletin. If it had not been for the work of Prof. Lewis and his associates in 1911, 1912, and 1913, it is doubtful if the Loganberry industry would be what it is today. The first big commercial batch of high grade juice, 3,000 gallons was made by the division of horticulture at the Salem Fruit Union. This demonstration was so successful that it interested manufacturers and the result the following year was that the Phez and Loju firms began to manufacture this juice. It was felt by many that the juice would

not keep. Prof. Lewis demonstrated that it could be made easily, and kept, and that it had a wonderful future. Very helpful bulletins were issued from time to time on the packing and physical handling of fruit, walnuts, and pears, and others too numerous to mention. Prof. Lewis had great faith in the horticultural products work. Six or eight years ago he made a motion at the National Apple Show which was responsible for the formation of a committee to study the possibility of horticultural products work. For six years, Prof. Lewis worked hard to get a horticultural products building at the Oregon Agricultural College, and today the building is erected and completed, the first building of its kind in America, having a complete cannery, evaporation room, equipped for the evaporation of walnuts, vegetables, prunes, and apples, a juice room for the manufacturing of high grade juices of all kinds, and rooms equipped for the investigation of glace and maraschino fruits, jams and jells.

The growth of the division of horticulture at the Oregon Agricultural College was very rapid. In 1906, one room in the old horticultural building, which is now the poultry building, was devoted to the work. The work expanded so rapidly that new space had to be provided, until today the division of horticulture occupies two floors and full basement of the large horticultural wing of the agricultural



KILL THE PESTS

This man is Dusting twenty acres per day at a cost of less than one-half cent per tree, using the

**American Beauty
Dust Sprayer**

**Codling Moth
Red Spider
Curculio
Aphis
Caterpillar
Mildew, Etc.**

Write us about it.

California Sprayer Co.

6001-29 Pasadena Ave.
Los Angeles, Cal.

building, has a horticultural products building, a range of greenhouses, and about sixty acres of land devoted to horticultural work. On this land extensive experiments are being conducted along the lines of pruning, depth of planting of fruit trees, tree stocks, plant breeding, etc.

The teaching phases of the division have not been neglected. In fact, the success of the students has been remarkable. Heads of departments have been furnished to universities in Idaho, Arkansas, and North Dakota. Assistants in either station, college, or extension work have been furnished as follows: Five to Ames, Iowa, four to the University of Virginia, two each to California, Pennsylvania, and Alabama, and one each to the state colleges of Maine, Massachusetts, New York, Indiana, Missouri, Wisconsin, New Jersey, Washington, New Mexico, Kansas. About fifteen men have been furnished to the office of markets. In addition to this, a large number of men are employed as orchard foremen. The famous J. H. Hale orchards at Glastonbury, Conn., and Ft. Valley, Ga., have had Oregon Agricultural College superintendents. In a two-year period 200 men graduated from Oregon Agricultural College, were placed in positions bringing salaries from \$1,000 to \$6,000 a year.

Prof. Lewis was always a strong exponent of the laboratory and field idea in teaching horticulture, and insisted that his men must be taught to do things with their hands as well as being taught in the classroom. In a single year, 10,000 acres in Oregon were given assistance by students. Such work as budding, grafting, pruning, etc., was handled.

During his connection with the Oregon Agricultural College Professor Lewis has developed into one of the most able and best known writers on horticulture in the United States. He is a strong and versatile writer and covers any phase of this subject with equal facility and thoroughness. He has written many valuable articles for BETTER FRUIT and other national horticultural journals, and his work of this character is constantly in demand.

As a public speaker, Prof. Lewis is known in all sections of the Northwest. He has the ability to express clearly and in a way that the farmers can understand what he has to say. Raised on a farm, he understands the farmer's point of view. When it became necessary to seek an organization manager for the new Oregon Growers' Coöperative Association, Prof. Lewis was the one man in the state who was looked upon as especially fitted for this work.

Picking Elberta peaches in the Yakima valley began on a general scale on August 25. Some Elbertas had already been picked in the lower valley, but gathering had not been general in the Buena district, where the largest percentage of the crop is grown. Few growers were willing to pay pickers by the box, as they claim it results in such careless handling of fruit as to cause great loss. This year's crop is estimated at more than double that of a year ago, with fruit of extra high grade.

LABELS

WITH A PURPOSE

TO ATTRACT ATTENTION
AND CREATE SALES



SAN FRANCISCO

47th YEAR of
SERVICE and
QUALITY

Branches:
SEATTLE · PORTLAND
SACRAMENTO · FRESNO
LOS ANGELES · HONOLULU

Oregon State fair

SALEM

SEPTEMBER 22-27

GOVERNMENT's giant war and agricultural exhibit composed of trophies captured on European battlefields by American soldiers, and exhibits from the agricultural, naval and war departments; greatest horseshow ever staged in the Northwest; a colossal array of exhibits representing the state's great industries and resources; a superb racing program and the best of amusements and attractions.

A. H. LEA
Secretary
SALEM

BETTER FRUIT

An Illustrated Magazine Devoted to the Interests
of Modern Fruit Growing and Marketing.

Published Monthly
by

Better Fruit Publishing Company

703 Oregonian Building
PORTLAND, OREGON

Marketing the 1919 Apple Crop.

The 1919 barrel apple crop is now estimated at 12,850,000 barrels, or equivalent to about 38,500,000 boxes. The box apple crop is estimated at 30,675,000 boxes. Of this estimate, Washington, Oregon, and Idaho, in the order named, are expected to produce 23,000,000 boxes. California, Colorado, Utah, Montana, Arizona, and New Mexico will largely produce the remaining 7,675,000 boxes of apples.

Due to light production in the East and heavy and increasing production in the West, boxed apples are the big factor in the apple market for the first time in the history of the industry. The successful moving and marketing of this big crop of Pacific Northwest apples is, therefore, a matter for serious consideration. At the present time the prospects for a wide distribution of apples in the domestic trade, at very attractive prices, are bright. A light crop in the East with high prices for barreled stock should have the effect of creating a greater demand for box apples at more than satisfactory figures. In the export trade, particularly in England, however, there is considerable uncertainty. This is due to food control by the English government, labor troubles abroad, depreciation in foreign exchange and lack of information as to how much space can be obtained on ships for export shipments. The possibility of increased transportation charges and a railroad strike are also factors that must be considered in the export as well as the home trade.

Should the foreign and labor situations be cleared up and the selling agencies which are handling the Western domestic trade make arrangements for a wide distribution, the Pacific Northwest should have the most successful year it has ever experienced in the apple industry. If not, as the season advances, growers or owners of crops who have not sold will do well to watch the marketing situation closely. The situation is not one of too many apples, but with a restricted export trade, a case of properly distributing almost one-half of the apple crop of the United States over a consumption area that is from 2,000 to 3,000 miles away from the production points.

Plant for the Future.

Growers who expect to plant additional acreage to apples, or those who are contemplating planting a new orchard this fall, will act with wisdom if they will look into the matter of selecting varieties that are especially

adapted to the districts in which they are to be grown. In considering this point they should obtain all the information possible as to the varieties that bring the best price, produce the best average yield and for which there is liable to be the largest demand in future. This advice applies to pears as well as apples and the matter of pollination must also be considered in both cases. Before stock is purchased for planting, the number of pollenizers that are necessary for any particular variety should be provided for. The importance of planting under this method is fully set forth elsewhere in this number of BETTER FRUIT. The selection of stock is also very important and should be gone into carefully. Plant for the future.

How You Can Get Better Fruit's Apple Packing Chart

BETTER FRUIT'S apple packing chart as it appears in this number, but printed on cardboard so that it can be hung in the packing house, will be mailed to anyone desiring it on the following terms:

One card FREE with a new subscription to BETTER FRUIT.
One card without subscription . . . 10c
Twelve cards without subscription, \$1.00

For quantity prices write us.

Better Fruit Publishing Co.
703 Oregonian Building
Portland, Oregon

The New Oregon Association.

During the past month the Oregon Growers' Coöperative Association has made rapid strides. It now includes in its membership the majority of the Willamette Valley apple growers as well as a large proportion of the prune and walnut growers, and, as R. C. Paulus, general manager of the new organization, says, "It is winning its place in the sun." The policy that the organization managers of the association have adopted in presenting all the facts to the growers and in announcing that it is not the intention of the association to enter into conflict with the fruit industries already in the field where it is possible to co-operate with them, is winning for the new organization many supporters. It is felt that this is the true spirit of "Oregonization" of the state's fruit products, as proposed by Mr. Paulus, Mr. Hunt, Mr. Holt, Mr. Lewis, Mr. Langner and the others associated in the work of organizing the association.

Saving Labor.

The saving of labor is becoming more and more necessary to the orchardist, and those who have not already done so must look to putting by enough from their profits to secure equipment that will reduce this cost.

With wages, freight rates, box materials, paper and other items that go into the expense column in producing apples at a high level, labor saving devices present themselves as the greatest factor in reducing the cost of production. The using of modern orchard equipment is no longer confined to any particular section of the United States. It is rapidly being adopted in the barrel apple raising districts of the East and South as well as the Northwest, and this year California is taking it up on a wider scale than ever before. California has this year purchased a larger number of apple graders than in any one year in its history. Virginia is going to grade its apples more closely and even New York and Missouri, where apples are almost entirely packed in barrels, are establishing a more uniform and better grade through using apple sizers. All of these districts are adopting other efficient labor saving devices looking to a better grade and lower cost of production. Growers in the Northwest can not, therefore, lag behind. In fact, they should be in advance of the situation and benefit accordingly.

By-Products and Drying Plants.

A healthy condition for the future of the fruit industry is evidenced by the erection in all the sections of the Pacific Northwest of by-product and drying plants. These establishments are creating a big demand for both sound and imperfect fruit, the output of which reaches a wider and an entirely different market than the fresh. This demand, once created, should remain stable and call for an immense tonnage of cull fruit which has heretofore been wasted, or for sound fruit for which there was no market because it was too perishable to be shipped fresh. The psychological time to make this market for the superior fruit products of the Northwest is now, while the demand is on, and it is to be noted with satisfaction that progressive fruitmen are not slow in taking advantage of the opportunity.

Prohibition, bringing with it a national desire for fruit juice drinks, coupled with extensive advertising, is another factor that is building up a demand for Northwest small fruits that are adapted to this purpose, on a big scale.

Editorial Comment.

"By their fruits ye shall know them." With the largest apple crop in its history moving out of the Northwest this year the fruit of this section should be more widely distributed and better known than ever before.

From present indications 1920 will set a record as a mortgage lifter for the fruitgrower.

Don't forget to take measures against that last worm crop. It's not the early worm to look for this year, but the late one.

Speed the day when fruit and produce crooks will be ordered to beat it out of New York on a one-way ticket.—*Fruit Trade Journal*. Yes, and out of every other spot on the globe that fruit is shipped to.

From present advices a jackrabbit drive will be a small affair compared to the hunt for ladybug beetles this fall. The campaign to secure these insects has been mapped out over a wide area and the offensive against aphids will be renewed with vigor next spring.

The fact that Oregonians eat such large quantities of California walnuts when Oregon grows so many fine nuts, stirs the ire of Colonel Dosch of the Oregon State Board of Horticulture. Better to have them eat California walnuts than no walnuts at all, Colonel. The appetite is there, making a good basis to work on.

It is not generally supposed that figs will grow in the Northwest. And yet A. A. Quarnberg has two fig trees on his place near Vancouver, Wash., that are loaded with fruit that will mature. Is Quarnberg a wizard, or is it the climate?

That strip of land at Cape Cod, Mass., is no longer the only habitat of cranberries that are fit to grace the great American dish of roast turkey. Pacific Coast berries are plenty good enough, if not a little better, thank you.

What They Are Doing in California

The 1919 wine grape crop of California is estimated to have a value of \$12,000,000.

In his advice to orchardists on tree planting Commissioner Wren of the California State Department of Agriculture recently said:

"There exists this season a strong demand for, and a big shortage of, nursery stock. Prices are high, and from all indications the nurserymen will be unable to fill all orders. I would therefore urge all who intend to plant next year to place their orders at once. And,

while the prices of stock are high, I believe one should not defer planting on that account. A matter of a few cents per tree does not compare very favorably with the returns of a season when that tree gets into bearing."

California nurserymen are advised that opportunity is knocking at their doors in the way of propagating much of the nursery stock that is needed in the United States. Many nurserymen there are said to have been quick to see the possibilities of the future in this direction and have made large plantings. It is claimed for California that it can grow any kind of crop or fruit that is produced in the United States.

Reports from Tuolumne County indicate the largest crop of apples in the history of the county. In this region especial attention has been directed to the codling moth and spraying operations.

Date specialists and growers at Indio are devising plans for a new packing house to take care of this rapidly increasing industry.

Prof. A. L. Levett, state entomologist for Oregon, stationed at the Oregon Agricultural College, Corvallis, was a visitor in California last month. Prof. Levett was reviewing the pear thrips situation in California, particularly with regard to control methods which may be applicable against the pest in Oregon. He made an extensive survey of the pear orchards in Santa Clara and Contra Costa.

G. A. Nehrhood of Paso Robles has placed orders for 276,000 trees for the coming season for himself and the Associated Almond Growers of Paso Robles. This is the biggest order so far this year for any county. It is made up of almonds, 70 per cent; prunes, 25 per cent, and the remaining 5 per cent are mixed fruits.

The following notice will be interesting to apple growers in other states in showing how California enforces its apple packing regulations. The notice was issued by the State Department of Agriculture and says: Beginning Monday, July 28, only apples bearing the state standard stamp or conforming to the requirements of the 1917 Standard Apple Act can be removed from transportation company terminals by consignee. All others will be returned to the shipper or removed to a cold storage plant and held until shippers conform to the required grade and marking, after which apples will be delivered to original consignee with a statement of storage, transfer and repacking charges, if any, to be deducted from sales account to shipper. The law plainly states that the end of the boxes bear the name and address of packer or shipper, the variety and grade of apples, net weight or number of apples in the box and the date packed. These simple requirements were intended to advertise California apples, facilitate handling in transportation and by the trade, and to protect all parties concerned. Neatly marked boxes lend to appearance and appearance adds to value.

During the 1919 season California will ship to the markets of the world about 25,000 car-

loads of deciduous fresh fruits, and while the cherry shipments probably will not reach more than 275 carloads (fresh), this amount with the canned cherry output makes the cherry crop one of the most successful and remunerative crops of the state.

Reports indicate that the 1919 crop of California peaches will total 10 per cent greater than the record yield of 1917. It is expected that about 12 per cent of the crop will be shipped as fresh fruit and the balance will be dried and canned.

Citrus growers of Riverside are now installing a new type of orchard beater that promises to give better service than was possible with those used in the past.

The first shipments of the California apple crop commenced to move about August 15. The variety shipped was what is known as the Skinner Seedling, Bellefleurs and Yellow Newtowns, which comprise the greater part of the California crop, move considerably later than this earlier variety, but are marketed much earlier than the winter varieties of Northwest apples.

Make More Boxes PER DAY

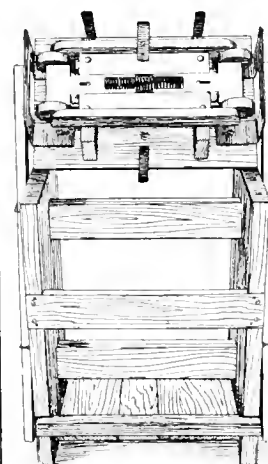

**GIARD
Box
Making
Machine**

Nail 100 to 200 more boxes per day.

**Rapid
Accurate**

\$25.00

Send for a descriptive folder.

**Spokane Seed Co.
DISTRIBUTORS**

Dealers in Fruit Picking and Packing Supplies
SPOKANE, WASH.

"CARO" FIBRE FRUIT WRAPPERS

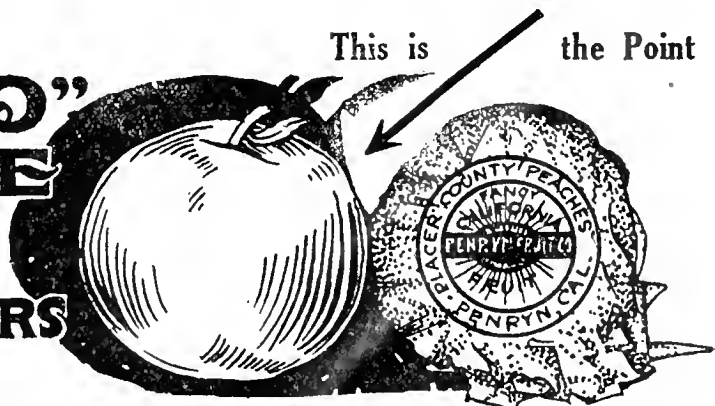

Chemically Treated
"Caro" Protects
"Caro" from DessiCARE (to dry up)

"Caro" Prolongs the Life of Fruit Why?

Fruit decomposition starts from a bruise which opens tiny holes and permits the juice to escape and BACTERIA to enter. "Caro" clings closely and dries up the escaping juice. "Caro" ingredients harden the spot, kill the BACTERIA, arrests the decomposition—and thus **PROLONGS THE LIFE OF FRUIT**. If your fruit is worth shipping it is worth keeping in best condition.

Demand "CARO"—Wrap Your Fruit in "CARO"—The Fruit Buyer Knows "CARO"

Order from Any Fruit Company or American Sales Agencies Co., 112 Market St., San Francisco

Better Fruit's Standard Apple Packing Chart

All packs to go in the Northwest Standard Box— $10\frac{1}{2} \times 11\frac{1}{2} \times 18$ inches inside measurement

THE grading rules and regulations used in connection with these packs are those adopted by the State of Washington for the season of 1919 and are considered standard for the Northwest. All packs are for the standard apple box measuring $10\frac{1}{2} \times 11\frac{1}{2} \times 18$ inside measurement. Description of all packs not illustrated can be found under the caption "Apple Packs."

The method for packing all of the packs not shown, with the exception of

the 200 and 225 packs, is the same as depicted in the illustrations.

The 200 and 225 packs are straight packs, in which the apples are placed straight across the box, with the rows of apples resting on top of each, instead of being arranged to strike the depressions as in the diagonal pack.

The straight pack is now used for only the smallest sizes of box apples that are packed. A good example of a straight pack can be seen in the bottom illustration on the opposite page.

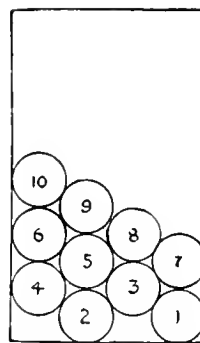

How to start a 2/2 diagonal pack

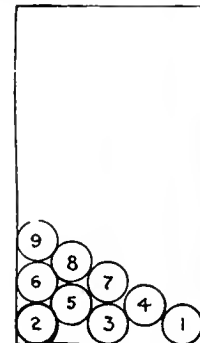

How to start a 3/2 diagonal pack

Diagonal 2/2 pack, 4 layers, 88 apples

Diagonal 2/2 pack, 4 layers, 96 apples

3/2 pack, 1 1/2 tier, 5 layers, 188 apples

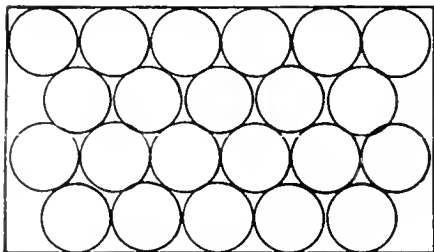

First and third layers

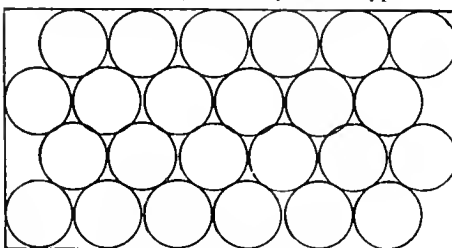

First and third layers

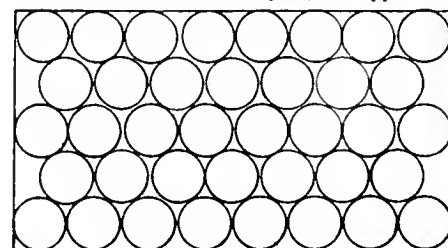

First, third and fifth layers

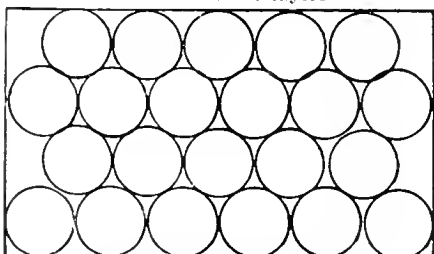

Second and fourth layers

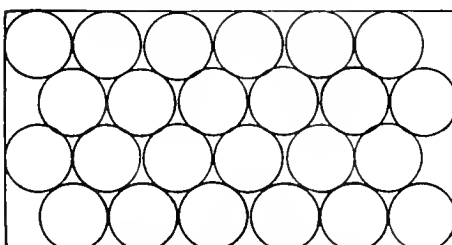

Second and fourth layers

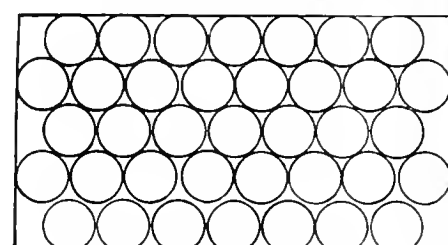

Second and fourth layers

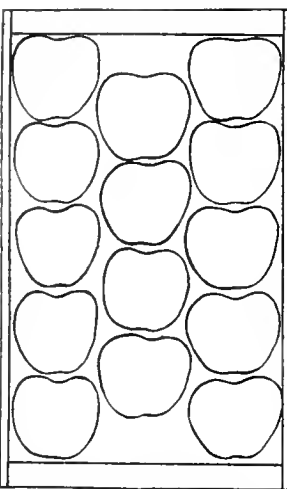

Figure 1—11 apples

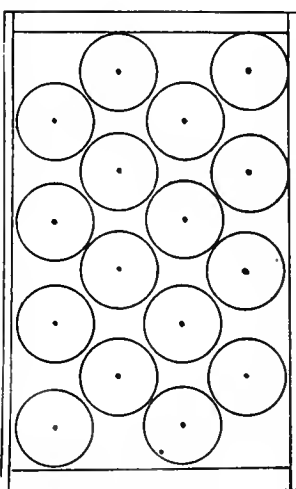

Figure 2—61 apples

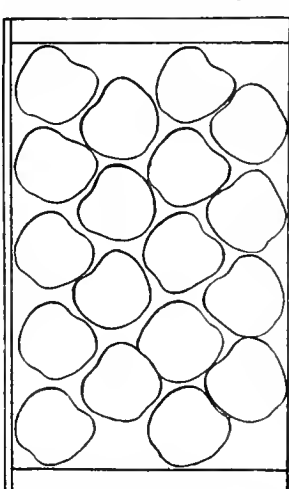

Figure 3—72 apples

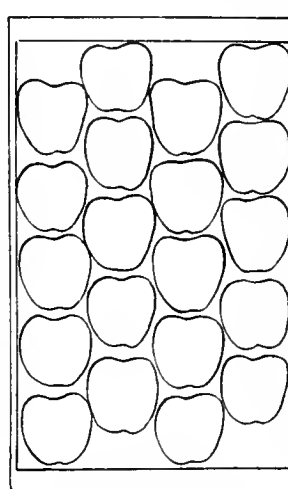

Figure 4—80 apples

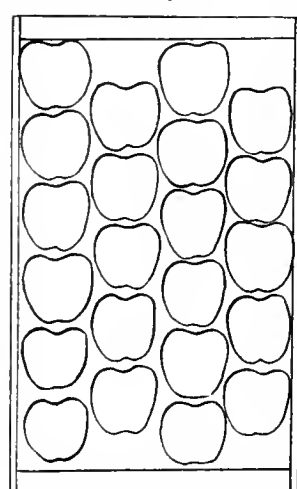

Figure 5—88 apples

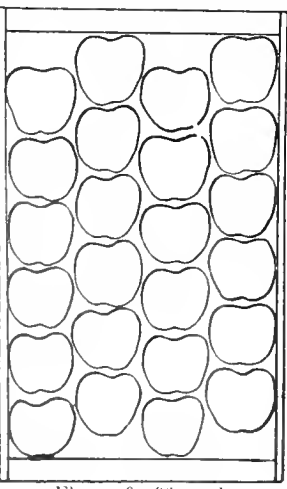

Figure 6—96 apples

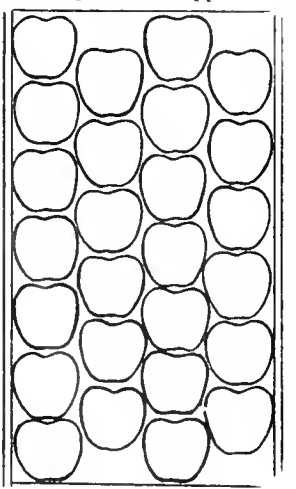

Figure 7—101 apples

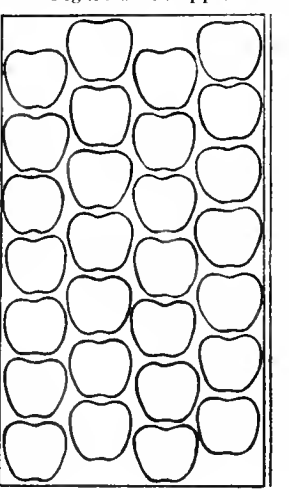

Figure 8—112 apples

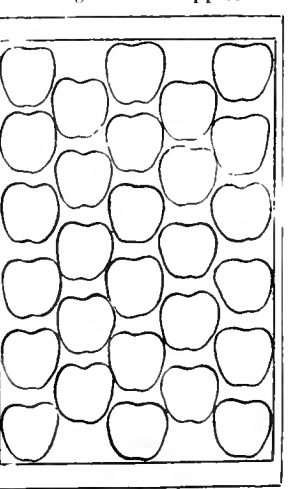

Figure 9—138 apples

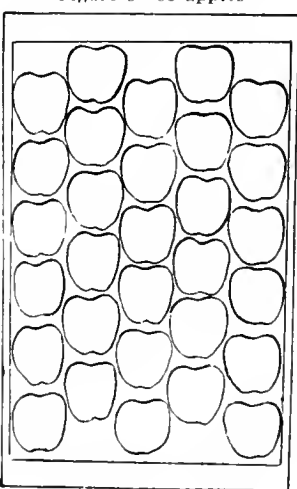

Figure 10—150 apples

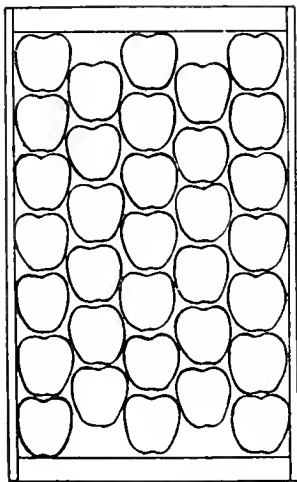

Figure 11—163 apples

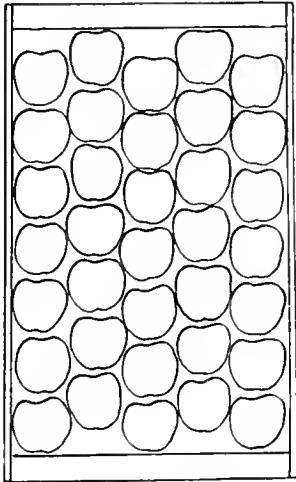

Figure 12—175 apples

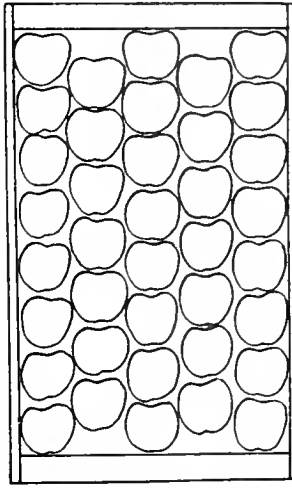

Figure 13—188 apples

Apple Grading Rules, Standard Pack, for 1919

First Grade, Grade No. 1 or Extra Fancy Apples are defined as sound, smooth, mature, clean, hand-picked, well-formed apples only, free from all insect pests, diseases, blemishes, bruises and other physical injuries, scald, scab, scale, dry or bitter rot, worms, worm stings, worm holes, spray burn, limb rub, visible water core, skin puncture or skin broken at stem, but slight russetting within the basin of the stem will be permitted.

Second Grade, Grade No. 2 or Fancy Apples are defined as apples complying with the requirements for first grade apples, except that slight sun scald or other blemishes not more than skin deep shall be permitted up to a total of 10% of the surface of the apple.

Third Grade, Grade No. 3 or C Grade Apples shall include all remaining apples free from infection, excepting that two stings to each apple shall be permitted, and if shipped in closed packages shall be marked "Third Grade or C Grade."

Combination Grade may also include all other apple varieties not provided for in First and Second Grades.

When Second and Third Grade apples are packed together the packages must be marked "Combination Second and Third Grade."

Orchard Run. When First, Second and Third Grade apples are packed together, the package must be marked "Orchard Run," but Orchard Run packages must not contain any apples that would not meet the requirements of Third Grade.

Summer and Early Fall Varieties. Summer varieties such as Astrachan, Railey's Sweet, Beitingheimer, Duchess, Early Harvest, Red June, Strawberry, Twenty-Ounce Pippin, Yellow Transparent and kindred varieties, not otherwise specified in these grading rules, together with Early Fall varieties such as Alexander, Blue Pearmain, Wolf River, Spokane Beauty, Fall Pippin, Waxen, Tolman Sweet, Sweet Rough and other varieties not provided for in these grading rules, as grown in sections of early maturity, shall be packed in accordance with the grading rules covering Fancy Grade as to defects, but regardless of color.

The following varieties shall be admitted to the Extra Fancy and Fancy Grades, subject to the color requirements herewith specified:

SOLID RED VARIETIES

	Extra Fancy	Fancy
Aiken Red	75%	25%
Arkansas Black	75%	25%
Baldwin	75%	25%
Black Ben Davis	75%	25%
Black Twig	50%	15%
Gano	75%	25%
King David	75%	25%
McIntosh Red	50%	15%
Spitzenburg (Esopus)	75%	25%
Vanderpool	75%	25%
Winesap	75%	25%

STRIPED OR PARTIAL RED VARIETIES

	Extra Fancy	Fancy
Ben Davis	50%	10%
Delicious	66 $\frac{2}{3}$ %	15%
Geniton	50%	10%
Gravenstein	25%	10%
Hubbardston	50%	10%
Jefferis	25%	10%
Jonathan	66 $\frac{2}{3}$ %	15%
King of Tompkins County	25%	10%
Missouri Pippin	50%	10%
Northern Spy	50%	10%
Rainier	50%	10%
Rome Beauty	50%	no color
Snow	50%	10%
Stayman	66 $\frac{2}{3}$ %	15%
Wagener	50%	10%
Wealthy	50%	10%
York Imperial	50%	10%

RED CHEEKED OR RUSHED VARIETIES

	Perceptibly blushed cheek; Tinge color.
Hyde's King.	
Maiden Blush.	
Red Cheeked Pippin.	
	Perceptibly blushed cheek; Characteristic color.
Winter Banana.	

YELLOW OR GREEN VARIETIES

	Extra Fancy—Characteristic color.	Fancy—Characteristic color.
Grimes Golden.		
Yellow Newtown.		
Yellow Bellefleur.		
Ortley.		
White Winter Pearmain.		
Cox's Orange Pippin.		
Northwestern Greening.		
Rhode Island Greening.		

APPLE PACKS

Style of Pack:	No. in Box
2x1 diagonal pack 5x5 long, 3 tier deep..	45
2x1 diagonal pack 5x6 long, 3 tier deep..	50
2x2 diagonal pack 3x3 long, 1 tier deep..	48
2x2 diagonal pack 3x4 long, 4 tier deep..	56
2x2 diagonal pack 4x4 long, 4 tier deep..	64
2x2 diagonal pack 4x5 long, 1 tier deep..	72
2x2 diagonal pack 5x5 long, 1 tier deep..	80
2x2 diagonal pack 5x6 long, 1 tier deep..	88
2x2 diagonal pack 6x6 long, 1 tier deep..	96
2x2 diagonal pack 6x7 long, 1 tier deep..	104
2x2 diagonal pack 7x7 long, 1 tier deep..	112
2x2 diagonal pack 7x8 long, 4 tier deep..	120
3x2 diagonal pack 4x5 long, 5 tier deep..	113
3x2 diagonal pack 5x5 long, 5 tier deep..	125
3x2 diagonal pack 5x6 long, 5 tier deep..	138
3x2 diagonal pack 6x6 long, 5 tier deep..	150
3x2 diagonal pack 6x7 long, 5 tier deep..	163
3x2 diagonal pack 7x7 long, 5 tier deep..	175
3x2 diagonal pack 7x8 long, 5 tier deep..	188
3x2 diagonal pack 8x8 long, 5 tier deep..	200
3x2 diagonal pack 8x9 long, 5 tier deep..	213
5 straight pack 8 long, 5 tier deep..	200
5 straight pack 9 long, 5 tier deep..	225

DIMENSIONS OF STANDARD APPLE AND PEAR PACKAGES

The standard size of an apple box shall be 18 inches long, 11 $\frac{1}{2}$ inches wide, 10 $\frac{1}{2}$ inches deep, inside measurement.

Pear—18x11 $\frac{1}{2}$ x8 $\frac{1}{2}$ inches, and outside length 19 $\frac{3}{4}$ inches.

3 $\frac{1}{2}$ -inch suitcase pack Peach-Plum—18x11 $\frac{1}{2}$ x3 $\frac{1}{2}$ inches.

DIMENSIONS OF APPLE BOX MATERIALS

Ends— $\frac{3}{4}$ x10 $\frac{1}{2}$ x11 $\frac{1}{2}$, 2 pieces, 20 to bundle.

Sides— $\frac{3}{4}$ x10 $\frac{1}{2}$ x19 $\frac{3}{4}$, 2 pieces, 40 to bundle.

Top and Bottom— $\frac{3}{4}$ x5 $\frac{1}{2}$ x19 $\frac{3}{4}$, 1 piece, 100 to bundle.

Cleats— $\frac{3}{4}$ x8 $\frac{1}{2}$ x11 $\frac{1}{2}$, 4 pieces, 100 to bundle.

Thirty-two 6d nails commonly used per box.

RULES FOR ESTIMATING PAPER AND CARDBOARD

Apples and Pears.
Wraps for packing 100 boxes, 50 pounds.
Lining for packing 100 boxes, 7 $\frac{1}{2}$ pounds.
Cardboard for packing 100 boxes (apples), 16 pounds.

RULES FOR USE OF PAPER

Apples.
Use 8x8 for 188-200-213-225 Packs.
Use 9x9 for 175-163-150-138-125-113 Packs.
Use 10x10 for 112-104-100-96-88 Packs.
Use 11x11 for 80-72-64-56 Packs.
Use 12x12 for 50-48-44-36-32 Packs.

Pears.
Use 8x8 for 210-228-245 Packs.
Use 9x9 for 193-180-165 Packs.
Use 10x10 for 150-135-120-110-100 Packs.
Use 11x11 for 90-80-70-60 Packs.

CEMENT COATED NAILS

Per keg: 4d, 55,000; 5d, 39,700; 5 $\frac{1}{2}$ d, 31,000; 6d, 23,600.



The above picture shows the proper and improper bulge for a packed box of apples. The box on the left is too low, the one in the center just right, and the one on the right too high. The box in the center is a good example of the straight pack.

in large apple sales to eastern buyers at this time.

The Selah Fruit Growers, Inc., now occupies a commodious new office, recently built adjoining its packing plant.

Lack of pollenization is reported by E. B. Kelly, horticultural inspector with the Washington Department of Agriculture, to be the cause of a big loss in the apple crop in the Inland Empire. Mr. Kelly says that orchardists in this district must pay more attention to the raising of bees, either with or without regard to the value of the honey they make.

An evaporator that will handle 1,000 tons of fresh fruit is to be erected at Grandview. The plant, which will be built by F. M. Martin, will largely handle apples this year but will include peaches and pears in its operations in future seasons.

A \$6,000 frost-proof fruit warehouse was recently opened for business at Dalton. The new structure is built of concrete and will have a capacity of 500 tons of fruit.

Development of eastern Washington orchards and establishment throughout the section of large by-products plants and glass container and box factories under the wing of a \$125,000,000 national corporation is the program which has been outlined for the fruit industry in the Walla Walla district by the commercial club of that place.

The Selah Spray Company has been merged with the Selah Fruit Growers, Inc. Both concerns will be conducted under one management.

A new cannery has been opened at Montesano with a sealing machine that has a capacity of 20 gallons per minute. George Halferty and J. C. Edney, of the Sea Beach Packing Company of Aberdeen and Copalis, are managing the new plant, which will probably do business under the name of the Montesano Canning Company.

Chelan county is elated over the fact that it may have a horticultural experiment station under the direction of the State Agricultural College at Pullman and the United States Agricultural Department. The proposition has the recommendation of State Commissioner of Horticulture M. L. Dean and the authorities of the state college.

Apple growers in the Husum and White Salmon districts have combined to fight fire blight, which is said to have made its appearance in the orchards at Lyle a few miles east of that section.

M. L. Dean, State Horticultural Commissioner of Washington, believes that the production in Wenatchee orchards can be increased 25 to 75 per cent by proper fertilization. Successful experiments with nitrate of soda that have come under Mr. Dean's observation forces him to the opinion that where the soil is lacking in proper nourishment this treatment will accomplish wonders.

A report was telegraphed from Walla Walla during August that the bottom had fallen out of the prune market. The ruling price up to the 18th had been \$100 per ton. It was alleged that after the break the fruit was offered at \$60 and declined. Next day the report of the slump was emphatically denied and growers were urged to stand pat, and refused to be stampeded.

The first carload of winter apples was shipped out of Wenatchee August 23d. It was destined for the Alaska trade and was made up of Winter Bananas, Delicious, Jonathans and Spitzenbergs.

IDAHO.

The harvest of the Idaho prune crop started in full blast about August 23rd, and growers pushed the work of getting the fruit on the market as rapidly as possible. Idaho prunes, most of which are shipped fresh, are reported to have brought good prices. Owing to adverse weather conditions in the spring, the crop was light.

The Fruitland District Fruit Growers' Association recently purchased a whole block in the town of Fruitland. The block adjoins the present packing house of the association and will be used to enlarge its plant.

The Payette Farm Bureau calls growers' attention to the benefits to be derived from providing comfortable quarters for fruit pickers and handlers during the shipping season. Its advice is to "make your help comfortable, pay a bonus at the season's end for good work and

pickers will keep contented. Contented pickers are money makers for the fruit grower."

State Fruit Inspector L. C. Vandenburg recently made a tour of the state in order to properly organize a thorough inspection during the heavy fruit shipping season.

It is reported that 3,000 satisfied Idaho residents went East on the excursion of the National G. A. R. encampment. Many of these took boxes of apples with them to show Easterners the excellence of western fruit.

H. Harland, L. E. Keeler and J. D. Baker have been appointed fruit inspectors for the district comprising Payette, Wood Spur and Crystal. All shipments of fruit in Idaho are to be state inspected as to grade and pack. If a shipper desires a certificate of inspection a charge of \$5 per car will be made. The inspections will be made chiefly at the various packing houses and will be under the direction of the Idaho State Department of Agriculture.

As in other districts there is a strong demand in Idaho for cull apples to be shipped outside of the state. Arrangements for the

shipments will be permitted, provided the shipper procures a license to ship and the state they are to be shipped to will permit them to enter.

The canning plant at Payette was a very busy place during the cherry and apricot season. Fifteen tons of cherries and 30 tons of apricots were put up. Before the season is over the plant expects to handle 100 tons of peaches, 50 tons of pears and the output from 30 acres of sweet corn which was especially grown for the cannery this season. The yield of corn, it is reported, promises to be good.

Idaho orchardists predict the largest crop on record in that state this year. Last year the apple crop in Idaho was a failure, but in 1917 a bumper crop was harvested and 500 carloads were shipped from the central section. This year the crops look better than ever and estimates give the state a total yield of 4,000 carloads.

The Payette Independent in its farm bureau notes calls attention to the serious lack of cold storage in that valley. "The apple crop of the valley," it says, "is estimated at about 2,500 cars, valued at an average price of \$1,800

CITY COMFORTS for Every Farm Home!

Electricity and running water now made possible for every farm at small cost

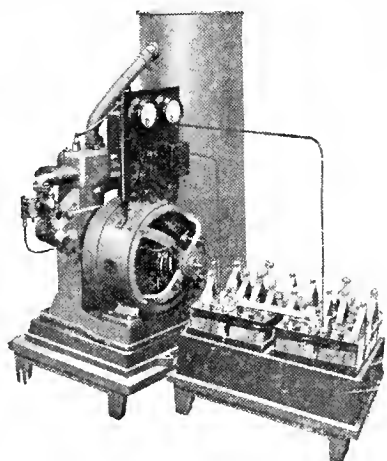

This Universal Lighting Plant

is a simple, practical, thoroughly efficient light and power plant in the most compact form possible.

By pressing a button the gasoline engine is started, electricity is generated and the storage batteries are fully charged—then the engine stops automatically. Power can also be taken directly from the generator, so that with a number of lights burning sufficient power can be used to operate a milking machine, washer or any other machinery without drawing current from the storage batteries. It requires practically no attention.

UNIVERSAL Light Plants range in capacity from a 20-light plant to 1,000-light capacity.

This Paul System of Water Supply

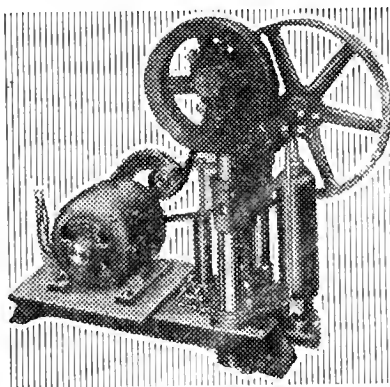

is doing away with hard work on thousands of town and farm homes throughout the country.

The PAUL systems are made in various types and sizes for pumping water from cisterns, wells, springs, lakes or wherever your source of water supply may be.

The type illustrated is a deep-well pump with a capacity of 150-200 gallons per hour for pumping from deep-cased wells two inches or larger in diameter and where the water stands from 22 to 135 feet below the top.

PAUL Shallow-Well Pumps are the only Self-Priming Pumps made. By this feature the system will deliver water always, regardless of slight leakage in piping or foot valves.

There's a PAUL Water System for every size farm.

Write for Catalog and Illustrated Literature, Prices, Etc., to the

Northwest Auto Company

PORTLAND, OREGON

Distributors for Oregon, Washington and Northern Idaho. Representatives are wanted in open territory. We invite correspondence.

per car, or a total of \$1,500,000. Some 1,500 people will need to be imported to help local residents to harvest the crop. We estimate 850,000 will be lost on over-ripe Jonathans because of a lack of cold storages. And \$50,000 would help pay quite a number of mortgages. Two large dirt storage collars that are being built by L. E. Peterson and Henry Reins as an experiment are expected to save many cars of Jonathans.

MONTANA.

Fire blight appeared in many orchards in June and July. As a rule not over six or eight branches per tree were infected. Jonathan, Rome Beauty and Grabs were the varieties which showed the most injury.

One new outbreak of coddling moth was found in the Bitter Root Valley. All orchards in the near vicinity have been carefully inspected and plans are being made to prevent further spreading. All possible precautions will be taken to maintain the past reputation as the home of the "wormless" apple.

On account of the favorable weather conditions, and the spraying program followed by the growers, scab is conspicuous by its absence. Only where wilful neglect is the system followed can traces of scab be found. As will be remembered, there was practically no scab last year.

Despite the late spring frosts there was a good crop of sour cherries which found a ready market at five cents per pound at the canneries. Many crate shipments netted the grower eight cents per pound. The few sweet cherries grown in the valley sold readily at ten and twelve cents per pound on the trees.

The apple crop is much better than reported early in the season. While all varieties will be slightly smaller than usual, they will be very well-colored.

At his own request James M. Hamilton, who has for 15 years successfully administered the affairs of the Montana State Agricultural College as president, has been retired and is succeeded by Alfred Atkinson, who has been connected with the institution for many years. Mr. Hamilton will remain with the institution as dean of men and professor of economics at the same salary he was receiving as president. President Atkinson, the new executive, is said to be specially qualified for his new position and the affairs of the college are expected to go forward successfully and harmoniously under his guidance.

Timely Topics and Advice for Fruitgrowers

To destroy walnut aphid and the walnut worm, dust spraying has been found very beneficial. Results from this treatment in California have been even more gratifying than was expected. In orchards that had an infestation of 50 per cent worms last year and which were dusted, it is reported to be difficult to find even a single infested walnut this year.

Correct open pruning is worth dollars and cents to the orchardist, both from the standpoint of crop production and disease reduction. Pruning for an open condition of the top of the tree so as to admit plenty of air and light to all parts of the tree is also an important means by which losses of fungus infections may be lessened. The most successful fruitmen know this fact and bear it in mind when pruning. The continued presence on fruits or foliage of moisture from rain, dew or fog is exceedingly favorable to the germination of such fungus spores as those of apple or pear scab, anthracnose, brown rot, peach blight, leaf spots, etc., while any condition which tends to bring about a rapid

drying off of the leaves and fruit is decidedly unfavorable to infectious. Sunlight and air movement are nature's great drying agencies. Open pruning by judicious thinning is therefore of great value because it permits air circulation and sunshine within the tree while ordinary heading back without thinning favors the formation of a dense top and thus retards evaporation.

It is generally agreed to be a mistake to consider that the direct application of a concentrated chemical fertilizer, such as nitrate of soda, to the soil is as effective in securing the best growth and vigor of the plants as would be secured by the addition of nitrogen in the form of organic matter. While nitrate of soda will stimulate trees and bring them from a devitalized condition back to a normal condition, in many cases it will not, however, exert much influence on the soil and therefore, in order to improve the physical condition of the soil in many orchards, it is necessary to add organic matter also. One of the best ways of introducing needed organic matter and nitrogen in an orchard is the growing of alfalfa or some other equally good cover crop, a method much to be preferred to the clean cultivation that was so long favored by leading orchardists and that it is still adhered to by many.

Finds Better Fruit 7,000 Miles from Home

H. F. Davidson, of Hood River, Ore., who recently returned from a 14,000-mile trans-continental and trans-Atlantic trip to investigate apple marketing conditions abroad, says that he is now convinced that publicity throws its pitiless glare into the four corners of the globe.

While away Mr. Davidson visited England, Denmark, Norway, and Sweden. Just before he left he wrote an article for BETTER FRUIT on the "Future of the Apple Industry in the Northwest," which was illustrated with his picture. On arriving in Stockholm, 7,000 miles away from Hood River, he secured an interpreter and started to make the rounds of the fruit dealers. He says that on entering the door of the first place he visited, the proprietor took a look at him, didn't say a word, but went to a table, took up a copy of BETTER FRUIT, turned over the leaves and pointed to his picture. Mr. Davidson nodded in assent that the picture was of him, and the Swedish apple man told him that he couldn't read the text but that he could understand the pictures.

The Stockholm apple man told Mr. Davidson that they taught English in the Swedish schools and that his children could read the articles in the magazine to him.

He then went over the magazine with his American visitor, asking about the various illustrations through the interpreter. The things that interested the foreigner most were the pictures of orchard equipment used in the Northwest, among others the Cutler apple grader, the mechanism of which he traced out with his finger and asked where the apples went in and where they came out and other things pertaining to the machine. Mr. Davidson also learned in Norway that one Norwegian orchardist had purchased a Cutler grader and that others were contemplating getting these machines and other up-to-date orchard equipment.

In relating this experience, Mr. Da-



CLAMP TRUCKS
FOR EVERY PURPOSE

THEY ARE
LABOR SAVERS, TIME SAVERS, MATERIAL SAVERS

Write us for information on
PEACH GRADERS APPLE GRADERS
PACKING HOUSE MACHINERY

CALIFORNIA IRON WORKS
RIVERSIDE, CALIFORNIA

NEW CROP —

SEEDS

DIAMOND QUALITY
SELECT RE-CLEANED

Vetches, Alfalfa, Clovers, Grains, Grasses

Selected Recleaned Farm and Field Seed at Lowest Market Prices.
Special Mixtures for Wet Land—Dry Land—Burns—
Permanent Hay Crops and Pastures

Cover Crops for Orchards—Dry Land Pasture Mixtures

OUR SEED LABORATORY is in charge of a skilled analyst and all "DIAMOND QUALITY" Seeds are TESTED for PURITY and GERMINATION

WRITE TODAY FOR SAMPLES NOTE THEIR PURITY and WEIGHT
Or send in your order direct. We guarantee full value for the money sent and will give your inquiries our prompt and careful attention

Ask for Catalog No. 520

PORTLAND SEED CO.
PORTLAND, OREGON

PORTLAND SEED COMPANY
TRADE MARK

Western Agents "CLIPPER" FANNING MILLS

vidson says that at the establishments of five other apple dealers in Sweden and Norway the same thing occurred. That as soon as he entered these places they got a copy of BETTER FRUIT and pointed to his picture. "I'm convinced now," said Mr. Davidson, "that wherever there is anything doing in fruit BETTER FRUIT is in evidence."

As the result of his trip Mr. Davidson believes the export trade for Northwest apples in England is a little uncertain, owing to government control of prices, labor disturbances and the depreciation in foreign exchange, but looks for a very favorable season at home. Germany, he thinks, will not buy many American apples this year on account of unfavorable political, labor and economic conditions, and is likely to buy what she does use from the Scandinavian countries. The latter, he is of the opinion, will not be in the market for a very heavy tonnage from this country. He reports the apple crop in England as about normal and much larger than he expected, and says that the situation there in regard to American apples may be cleared up later.

Horticultural Events of Interest

The thirty-fourth annual meeting of the Oregon State Horticultural Society was held August 14 to 16 at Astoria and Seaside, and while the attendance was not large, a number of valuable papers were read and discussions took

place that were of interest to horticulture generally. Ben S. Worsley, the retiring president of the society, presided at the business sessions of the meeting, and C. D. Minton acted as secretary. Among those who made addresses were the retiring president, J. O. Holt, manager of the Eugene Fruit Growers' Association; W. E. Schimpff, of Astoria, manager of the Pacific Cranberry Association; J. H. Butterfield, of Brown Meade, Ore.; H. G. Lechner, county agent of Clatsop county; Col. Henry E. Doseh, secretary of the Oregon State Board of Horticulture; Robert C. Paulus, manager of the Salem Fruit Union, and A. H. Harris, editor of Better Cooking, of Portland, Ore. The social features of the meeting included visits to the Astoria canneries and other points of interest. The new officers elected are: J. O. Holt, president; R. C. Paulus, vice-president; C. D. Minton, secretary; J. B. Pilkington and J. C. Atwell, trustees.

The combined Multnomah County Fair and Oregon Manufacturers and Land Products Show will be held at Gresham, Ore., September 15 to 20. An extensive premium list has been arranged for exhibits of fruits and other land products and it is expected that the event will be on larger and more successful scale than ever before attempted.

The Oregon State Fair is scheduled this year for September 22 to 27, and everything now points to one of the best fairs that have ever been held by the State Fair Association. Particular attention is being given to securing a fine horticultural exhibit as well as to the other features in connection with the fair.

The Washington State Fair will be held at Yakima, September 15 to 20, and as usual will be of interest to fruit growers and others interested in horticulture throughout the state. For several years the horticultural exhibit during this event has been one of the finest on the coast.

The Idaho State Fair will be held at Boise, September 22 to 27, with a finer exhibit of fruit this year than usual on account of the bumper apple crop in that state. The Montana State Fair was held during the week of September 8 to 12 and contained a number of splendid exhibits of fruit from the Bitter Root Valley.

The Mid-West Horticultural Exposition, which will be held this year at Des Moines, Iowa, November 10 to 15, was given an appropriation by the state of \$8,000 in addition to individual subscriptions, and conditions are said to be more favorable this year for a real horticultural show in the Middle West than ever before. A large and attractive premium list has been arranged and all sections of the country are invited to make exhibits.



**“Opportunities
Seek Those in
Position to
Grasp Them”**

An account with a strong stable bank makes it possible to take advantage of many a chance that otherwise would be passed up.

Ladd & Tilton Bank offers you the business experience of sixty years, and valuable information and assistance on modern problems.





**A READIER
Market for Apples**

APPLES find a readier and quicker market, among present day discriminating dealers, when they come neatly and safely packed in the

**Universal Bushel
Shipping Packages**

Furthermore the dealer need not repack fruits or produce packed in Universal Packages. This is an advantage and saving to him.

Grocers and shippers will realize more money on apple shipments this fall, by considering this dealer preference for Universal Bushel Shipping Packages. Besides they are easier to pack, easier to handle and ship and far more economical.

A Sample Package

will be sent anywhere upon receipt of 25c to cover cost of packing and shipping. Ask for "Bigger Profits" Booklet.

Package Sales Corporation
106 East Jefferson Blvd. South Bend, Indiana

Established 1882

**F. W. Baltes
& Company
Printers**

WE print anything from the smallest to the largest and always welcome orders of any size or quantity, giving prompt, personal and efficient service. Mail or phone inquiries are solicited. We do not specialize — experience and equipment enable us to print everything equally well. We render service in preparing copy and illustrations and furnish plans and estimates for catalogs, booklets, publications, billboard and any other kind of advertising.

First and Oak Streets
Phones: Main 165 and A 1165
Portland, Oregon

PRINCE ALBERT

the national joy smoke



Never was such two-fisted smokejoy

as you puff out of a jimmy pipe or home rolled cigarettes packed with Prince Albert! *That's because P. A. has the quality!*

Your taste apparatus certainly cannot be fooled! So, when you smoke Prince Albert and get a lot of delight *you know* you've got the big first prize on the end of your line!

Prince Albert's quality alone puts it in a class of its own, but when you figure that P. A. is made by our exclusive patented process that cuts out bite and parch—*well*—you realize why P. A. is so unlike other kinds.

No matter what your past luck has been on pipe smokes or makin's cigarettes, you put your confidence in Prince Albert for it certainly makes good every time the clock ticks.

Tappy red bags, tidy red tins, handsome pound and half-pound tin humidors—and—that classy, practical pound crystal glass humidor with sponge moistener top that keeps the tobacco in such perfect condition.

Copyright 1919
by R. J. Reynolds
Tobacco Co.

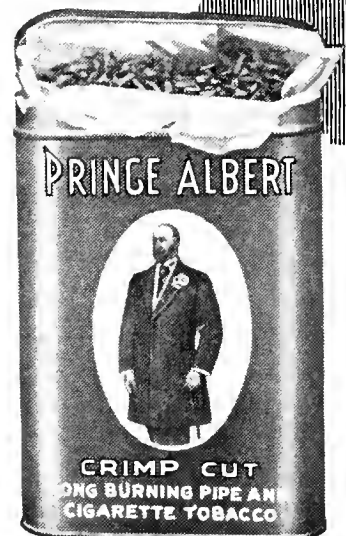

R. J. Reynolds Tobacco Company, Winston-Salem, N. C.

Specific Results in Pollenating

Continued from page 5.

also be noted that the favorable showing for the trees receiving cross-pollination was made in spite of the fact that this orchard lost much of its fruit as a result of the ravages of pear blight.

Recommendations.

From a study of the experimental data secured and also as a result of the observation and experience of many orchardists of the state, the conclusion is inevitable that all Bartlett orchards should be provided with facilities for cross-pollination.

The question at once arises as to what variety shall be selected as a pollinator. For foothill locations where the bulk of the crop is offered for "green" shipment this question is probably not difficult to answer. In these places the Anjou, Bosc, Comice, Howell and Winter Nelis are all excellent pears, bringing prices equal to or better than the Bartlett for Eastern shipment. These varieties may not perhaps give an equal tonnage with the Bartlett, but all are fair producers. The Comice should be avoided in windy locations, due to the fact that its skin is quite delicate and mars most easily.

In valley locations the question of providing cross-pollination for the Bartlett is more difficult. The grower must concede that where the set can be increased 100 per cent or more by the planting of one pollinating tree to every eight Bartletts the returns per acre will still be greatly increased, even though the fruit of the pollinating variety may have little or no commercial value. Although there has been no thorough attempt to test the adaptability of various varieties to different locations, the writer feels that the information in hand indicates that either the Hardy or the Winter Nelis will prove, from all standpoints, to be the most efficient pollinator for the Bartlett when grown under valley conditions.

Where the dried fruit is a primary product and where the fruit of the pollinator for the Bartletts must also be dried, special difficulties are presented. No experiments have as yet been conducted in this state to determine the drying qualities of the various varieties. In order to avoid the use of artificial evaporators, the pollinator must ripen its fruit at about the same time or shortly after the Bartlett. Practically all dried pears in California are sun-dried. Keeping specially in mind the time of ripening, the Howell and Hardy varieties seem to be the best pollinators for the Bartlett where the entire crop is to be dried.

Pollinating Agencies.

After having planted inter-fertile varieties the orchardist should by all means provide an agency for the transfer of the pollen from the trees of one variety to those of another. The common honey bee is by far the best carrier of pollen and it will pay the grower to keep bees, even though he may not care to go into the honey business. Bees, however, are a very profitable side line for the

orchardist, especially if alfalfa fields are available to work on after the blooming season of fruit has passed. About one hive of bees to an acre of bearing orchard should be provided. Preferably the hives should be scattered as widely as possible throughout the orchard during the blooming season. Experiment and experience have shown that little reliance can be placed on the efficacy of wind and of insects other than the honey bee in effecting the transfer of pollen from tree to tree, or in fact from flower to flower.

Eliminating from consideration all conditions which may influence the fruitfulness of an orchard except those occurring at blooming time, it may be said that the set is largely influenced by weather conditions at time of blooming. Cold weather, aside from killing the blossoms or lowering the vitality of the pollen, often prevents bees from working. The same is true if cloudy, wet and windy weather prevails. For their best work bees demand clear, warm and quiet days, and since the weather at the time of bloom is often quite unsettled,

<p>MUSICAL MERCHANDISE</p> <hr/> <p>WRITE US</p>	<p>WE SAVE YOU MONEY!</p> <p>W. Martius Music House Inc.</p> <p>1009 First Avenue, Seattle, Washington</p> <p>Everything Known in Music</p>	<p>SHEET MUSIC</p> <hr/> <p>WRITE US</p>
--	---	--



WHAT EVERY HOME CANNER SHOULD HAVE

ONE of our **H. & A. Hand Power Double Sealers**. It is the only hand power seamer built that will seal all sizes of sanitary fruit and vegetable cans. Write for prices and descriptive matter to Department T.

HENNINGER & AYES MFG. CO., Portland, Ore.

Builders of Sealers and Steam Pressure Canning Outfits

APPLES  **PEARS**

For European **Distribution**

Gerald Da Costa

Long Acre, Covent Garden, London

Cables: "Geracost, London." Codes: A. B. C. 5th Edition and Private

SHIPPING AGENTS:

Lunham & Moore, Produce Exchange, New York

CORRECT LUBRICATION

Zerolene gives a better film of oil between the working parts of your car. It conserves power and saves wear. Scientifically refined from selected California crude oil. Get a Correct Lubrication Chart for your car.

STANDARD OIL COMPANY
(California)





it is readily seen that the blooming period of the various pollinating varieties should overlap perhaps a week, in order that there may be one or two days at least when the weather will be favorable for insect pollination.

Arrangement of the Orchard from a Pollination Standpoint.

In planting an orchard it is desirable to have at least every sixth and preferably every fourth row of a pollinating variety. For convenience in the management of the orchard, it is best to plant two rows of one kind, then two rows of the pollinating variety, and so on; or, if it is desired to have more of one variety than another, four rows of the favorite variety, then two rows of

the pollinator, and repeat. For one reason or another, it is often desirable to reduce the number of pollinating trees to the minimum. Under these circumstances, one tree in twenty-five is perhaps sufficient, although at least one tree in eight is strongly recommended. It is seldom wise to graft over a part of a tree to the pollinating variety, as this tends towards confusion and added expense in harvesting.

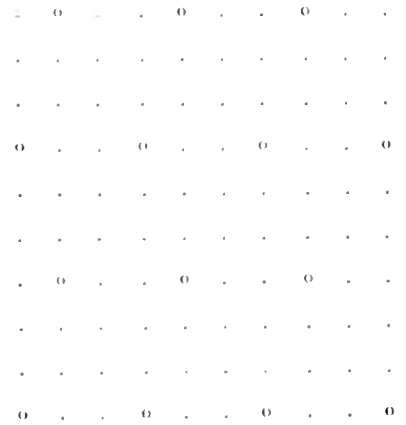
In planting one tree of the pollinator to seven or eight of the main variety, the pollinator should be placed as every third tree in every third row in such a way that the spaces in the pollination rows are broken thus, the "o" in each case representing a pollinator tree.



If by chance a self-sterile variety has been planted in a solid block, the necessary pollinator may be introduced by grafting. Some relief may be obtained during the years while waiting for the trees grafted over to pollinating varieties to come into bearing by cutting off large limbs of pollinating varieties, placing the cut ends in buckets of water and distributing the same throughout the orchard during the blooming period. Such limbs will live for several days and continue to bloom, forming pollen for the bees to transfer to the self-sterile variety.

SUPERINTENDENT

Horticulturist desires position. Orchard experience in Washington, Oregon and Southern California—devised farming, dry land farming, irrigation, engines and pumping plants—married. Good salary required. Would entertain a good practical renting proposition.
Write "T," care of Better Fruit

Wanted---Married Man

to take charge of forty-acre Apple Orchard in Washington. Must be experienced and furnish first-class references. Free rent of six-room house on property and good pay to right party.
Address "A. G." care of Better Fruit

MYERS HONOR-BILT DOOR HANGERS

Known everywhere as the standard in quality. Exclusive patented Adjustable and Stayon features mean better wear, service, and satisfaction. Twelve styles—a type for every need. Give weather-proof doors that *always* push or pull easily. Your dealer who handles the famous Myers line of Pumps and Hay Tools also has Myers Door Hangers. See him today. Let him point out the striking Myers Improvements or write us for catalog.
F. E. MYERS & BRO.
135 Fourth St., Ashland, O.

PUMPS FOR EVERY PURPOSE

Mitchell Northwest Distributors
Portland, Ore.



Call on it when friends call on you

The next time friends call on you—call on Ghirardelli's! You'll find it equal to *any* occasion. And you'll be apt to say—as many another wise hostess has said:

"It's wonderful— isn't it?—how a cup of Ghirardelli's puts people at ease—helps to make them feel 'comfy' and sociable."

Ghirardelli's—the *original* Ground Chocolate—is not sold in bulk but *in cans only*. In ½ lb., 1 lb. and 3 lb. cans—wherever you do your trading. Look for the Ghirardelli label!

Say "Gear-ar-delly"

Since 1852 D. GHIRARDELLI CO. San Francisco

Ghirardelli's Ground Chocolate



Factors that Influence Diseases

Continued from page 4.

and splinters in the boxes are often overlooked.

If, with all care in handling, some apples with incipient rot infection do get into the packed box, there still remains one recourse to reduce danger of rot injury, and that is immediate cold storage. The effect of cold temperatures in slowing up the activities and life processes of plants is well known. It retards the ripening of the fruit and at the same time curtails the activity of the rot fungi. Investigations have shown that at 32 degrees F. most of these fungi are able to make some growth, and that if they have become established they will persist and resume vigorous growth as soon as the fruit is removed to a warmer temperature. However, since their most vigorous growth is made at temperatures of 70 to 80 degrees, the importance of immediately cooling of the fruit is apparent.

Non-Parasitic Diseases.

In the second general class of storage diseases, that is, those due to non-parasitic causes, we recognize two distinct types: (1) Those which are influenced by cultural conditions; and (2) Those which are influenced by storage conditions. Here we get into the realm of plant physiology and deal with the life and growth processes of plants.

In connection with those diseases influenced by cultural conditions we may perhaps give chief consideration to nutrition. Plants live and grow through

processes somewhat different from those prevalent in the animal kingdom, but like all animals they are profoundly affected by their food supply, and many derangements can be traced to conditions of nourishment among plants the same as in the human family. One of such conditions that comes to mind is the overgrown apple, the apple that has been forced to abnormal size by heavy irrigation, heavy fertilization, heavy pruning, heavy thinning, or by growth on young trees. Such apples are not healthy, they are incapable of "holding up" in storage, they quickly reach the end of their life processes and die of "premature old age," or physiological breakdown, as we call it. The flesh becomes dry and mealy, turns brown, and the skin may crack as though burst by internal pressure. Such abnormally large apples are undesirable from any standpoint. They never possess the flavor of normal fruits, they are frequently undercolored, and, as has been pointed out, they do not keep. Avoid excessive stimulation, especially in the case of young trees just coming into bearing.

The other extreme in cultural practice, general neglect and poor cultural conditions, results in many bad effects. One especially concerns us in a consideration of storage troubles. It has been demonstrated that Yellow Newtowns are subject to an internal browning of the flesh when grown under negligent cultural conditions, whereas this variety grown by good methods will go through

the storage season free from this trouble.

The relation of irrigation to bitter pit, or Baldwin spot, another serious storage disease, has been established. This disease is greatly increased by heavy irrigation continued until picking time. It may be almost eliminated by light irrigation which checks the growth during the last month before picking. While bitter pit is generally worse on large apples than on small ones, heavy

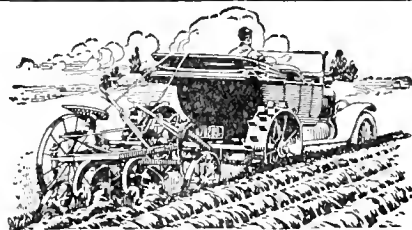

Make a Tractor of Your Car

Use it for farm work. Pullford catalog shows how to make a practical tractor out of Ford and other cars.

Write for Catalog
Pullford Co., Box 346C Quincy, Ill.

SAVE YOUR APPLES

With a Monarch Hydraulic Cider Press you can turn your culls into good selling cider. You can also do custom pressing for your neighbors. Our improved high pressure construction gets all the juice from the apples with minimum power. All sizes of Presses, from 15 to 400 barrels a day. A small investment will start you in a profitable business. Ask for free, 60-page Press Catalogue describing our 1915 Outfits.

WESTERN FARQUHAR MACHINERY CO.
308 E. Salmon St., Portland, Ore.

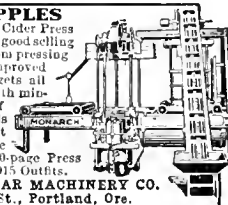

THE VERY LATEST IMPROVEMENT IN FRUIT GRADERS — IS THE — "New Four" Grade IDEAL Fruit Grader

It is built for the largest growers and packing houses who require a large output each day.

The sizing is by diameter or cheek measurement, the most perfect way fruit should be sized.

We build the Ideal Fruit Grader in four sizes to suit any grower's need, and it will do perfect work on **Apples, Pears, Peaches, Oranges or any other fruit having similar shape.**

We have designed our machine so there is absolutely no bruising of the fruit in any manner. The machine is very simple in construction, with nothing to get out of order or out of adjustment. Does not make the least noise, as there are no metal parts coming in contact with each other to cause a lot of wear and trouble.

The grading is done by elastic bands revolving crosswise of the belt that carries the fruit along the machine until it arrives at the proper bin where it comes in contact with this elastic which rolls it off gently into its proper bin without injury.

This season's crop is such that we have had to double our output to handle our orders, as we are replacing other machines of other makes that have cost much more than what we are asking for ours.

Our prices are very moderate, as we have no agents or brokers to pay a large profit for selling, so by selling direct to the users we can sell very close.

It will pay you big to write us to get more information and prices before you buy, for our machine will prove very satisfactory, as it has to many others for the past few years.

We have one of the most complete shops with the best of machinery to build every part over a pattern to get them exact.

Write us for prices stating your needs then we will gladly quote you prices on any size machine you need.

We also carry in stock the Bryant Clamp Warehouse Truck that will save you the price many times over each season in labor.

WRITE US

IDEAL FRUIT AND NURSERY CO., Hood River, Oregon

J. & H. GOODWIN, LTD.

Apple Exporters

Headquarters in United States
60 State Street
Boston, Massachusetts

*The Largest Handlers of American Apples
in English Markets*

You can send your apples direct from the United States into the industrial centers of England. The same organization (J. & H. Goodwin, Ltd., throughout) which ships your fruit from the U. S. A., sells and distributes in London, Liverpool, Manchester and Hull, and on the European Continent.

This means quick handling, considerable economies and the fruit being sold in the freshest possible condition, which means greater returns.

For Further Particulars Write or Wire Us at Boston
or 97 Warren Street, New York City

irrigation, especially heavy late irrigation, will increase the disease on small apples the same as on large ones. That is, the disease is not primarily due to size and overgrowth, but to some conditions which produce overgrowth, whether heavy irrigation, heavy nitrogenous fertilization, or some other condition.

This disease may begin to appear before picking time, but the great proportion of apples are affected after they are picked and packed. However, it is safe to say that most of the apples which will develop the disease do so within a month or six weeks after picking. Therefore, if loss from this disease is to be avoided after storage, it is necessary to modify the culture of susceptible varieties. Under irrigation this is possible and feasible by reducing the soil moisture late in the growing season. But to do this one must know the nature of his soil—how well it retains moisture or how rapidly it dries out, so that he can regulate his irrigation accordingly. The question may well be asked as to what effect this will have both on the size of the individual apples and of the total crop produced, since both factors are concerned in the net returns. The results of some of our experiments at Wenatchee in 1918 may be cited in answer.

RESULTS OF IRRIGATION EXPERIMENTS ON TWO PLOTS OF FOUR TREES EACH, WENATCHEE, WASHINGTON.

	Heavy Irrigation	Light Irrigation
Total apples	1094	1426
Per cent 125s and larger:		
Of total apples	82%	45%
Bitter pit	54%	2%
Per cent smaller than 125s:		
Of total apples	18%	55%
Bitter pit	19%	0.6%
Total % bitter pit for plot...	48%	1%

These results are approximately the same as have been obtained in similar work for several years past, and they have been so consistent that there is no escape from the conclusion that heavy irrigation causes a large amount of bitter pit to appear in storage, whereas light irrigation, especially late in the season, results in a minimum amount of the disease. It is for the grower to decide whether he prefers the 82% large sized apples produced by heavy irrigation, together with 54% of the same apples rendered unmarketable on

ACME BOX STRAPPING

Insures Safe Deliveries—Prevents Pilferage

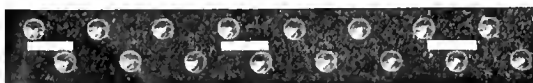

Acme Nailless Strapping

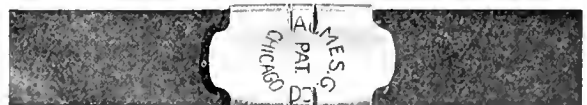

Acme Nailless Strapping, with Seal Applied

Write for the Acme Catalogue of Complete Shipping Room Supplies

ACME STEEL GOODS CO., Chicago, 2840 Archer Avenue, Manufacturers

SAN FRANCISCO, 209 California Street
SEATTLE, Foot of Main Street

PORTLAND, 8 Front Street
ATLANTA, 10 Tift Street

account of bitter pit, or the 45% large apples secured by light irrigation with 2% loss on account of bitter pit,—or, considering the whole crop, whether he prefers the 48% loss occasioned by heavy irrigation or the 1% of disease occurring with light irrigation.

In considering the remaining type of physiological storage diseases, that is, those diseases influenced by storage conditions, we are dealing entirely with the artificial conditions by which we attempt to prolong the life of the fruit and hold it in good condition for later consumption. We store the apples either in a pit or a cellar, in an air-cooled storage house or in a commercial cold storage plant. The general plan upon which we work is, first of all, to hold the fruit as cool as possible in order to retard the ripening process. An apple is a living, breathing organism, and so long as it remains alive it is fit to eat. But when it reaches the end of its life it dies in a process we call physiological breakdown, a process previously mentioned in connection with the troubles of abnormally large apples. But aside from keeping the apples cool and at the same time keeping them from freezing, there are some other factors concerned in the successful storage of apples, factors which have been but imperfectly understood and consequently not given proper attention. Hence we find a number of storage diseases which can be traced to these conditions.

From the nature of the case we naturally expect that the influence of

storage conditions must affect the internal physiology of the apple. Consider the disease we call "soft scald" or "deep scald," which is especially common on Jonathans, Romes and other red varieties. It first exhibits itself in a fading of the skin color, the coloring matter of the skin apparently passes into solution and spreads into the adjacent tissue. When the apples are freely exposed to warm air the spots soon turn dark brown, and the flesh beneath softens and turns dark brown in color as the spots become sunken and definitely outlined. The skin usually remains smooth and tightly drawn. It appears not unlike an apple that has been in contact with a hot iron, and the trouble is sometimes exhibited in such a manner as to suggest that the apple was rolled over a hot stove. Large apples seem especially susceptible to soft scald. It has been demonstrated that this trouble is increased by an increase of carbon dioxide in the storage air (brought about by the "breathing" process of the apples), and by higher temperatures, and that a film of moisture over the apples (also produced in the "breathing") likewise favors the production of this disease. Mechanical injuries and bruises serve as centers from which the disease starts, and it is most common where apples touch each other or the container. Cold temperatures and good ventilation to carry away the respiration products are to be sought for in preventing this disease.

Brooks and Cooley have demonstrated

that Jonathan spot is a form of the ordinary apple scald, or "barrel scald," as it is called in the East. Jonathan spot is a superficial skin disease appearing in the form of brownish or black

Berry Plants Wanted

Loganberry, Burbank Phenomenal, New Oregon Strawberry and Cuthbert Raspberry. Must be True-to-Name Plants.

Write "M. J. M." care Better Fruit, Portland, Oregon

NOW is the time to send to
Milton Nursery Company
MILTON, OREGON
 FOR THEIR 1919 CATALOG.
 FULL LINE OF NURSERY STOCK.
 "Genuineness and Quality"



20 POT BULBS, 20c.

6 New Purity Freesias, 1 Babiana, 1 Bloemeria, 4 Star Bethlehem, 1 Double Rosebud, 3 Buttercup, and 4 Grand Duchess Oxalis, and pkt. of New Winter blooming Spencer Sweet Peas and Carnations (will all bloom this winter)—Catalog and growing instructions.

ALL MAILED FOR 20 CENTS
 Big catalog, free, of Hyacinths, Tulips, Narcissus, Peonies, Lilies, Irises, Phloxes, Hardy Plants, Shrubs, Vines, Berries in great variety. Also splendid window plants for winter. Seeds, etc.

John Lewis Childs, Inc., Floral Park, N. Y.

Nice Bright Western Pine **FRUIT BOXES** AND CRATES

Good standard grades. Well made. Quick shipments. Carloads or less. Get our prices.

Western Pine Box Sales Co.
 SPOKANE, WASH.

Fruit Growers,

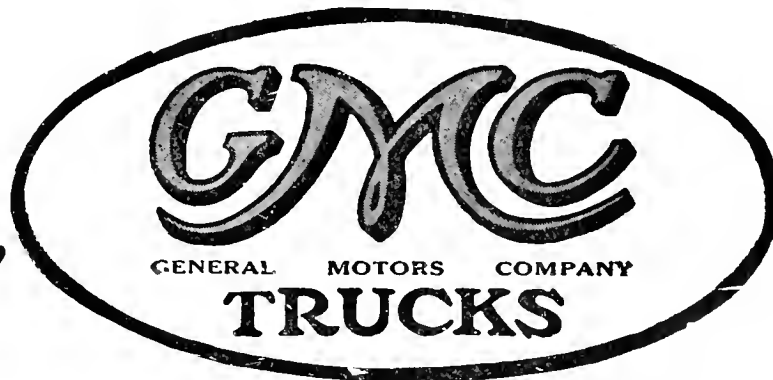

—and isn't this true?

One bump equals one bruise; one bruise equals the difference between Extra Fancy and Fancy Apples. That difference in grade equals the difference in price from 25c to 50c a box.

ELIMINATE

that first bump by hauling your apples in a two-ton pneumatic tired

GMC TRUCK

Investigate GMC's at your local GMC dealer.

Eldridge  **Company**

SEATTLE

SPOKANE



Wagon History Is Being Made These Days

ARE you in any degree familiar with the two greatest of **Weber** and **Columbus** wagon features—the *International fifth-wheel* and the *International swivel-reach coupling*? If you are a wagon user and do not know these improvements, you have a bit of interesting wagon education coming.

You will find the International fifth-wheel is a strong and solid support between bolster and sandboard. It is already famous for reinforcing and saving wear and tear on the entire front gear, preventing breaking and bending of king bolt and circle iron.

You will find the International swivel-reach coupling relieves the reach, hounds, and wheels of all twisting strains under roughest road conditions. Compare it with the racking conduct of the flat hound plates of the old-style wagon.

These are both exclusive International features, each worth twenty dollars to you in wagon-long-life.

Naturally, **Weber** and **Columbus** wagons are now made in the modern 56-inch auto-track width, standardized, improved in many small details, and thoroughly in keeping with International quality standards. When you know the latest **Weber** and **Columbus**, you will see that its price is too low in comparison with the price of others. See the International dealer or write us for information.

The Full Line of International Harvester Quality Machines

Grain Harvesting Machines	Haying Machines	Corn Machines
Binders Push Binders	Mowers Tedders	Planters Listers
Headers Rice Binders	Side Delivery Rakes	Cultivators Drills
Harvester-Threshers	Loaders (All Types)	Lister Cultivators
Reapers Shockers	Rakes Bunchers	Motor Cultivators
Threshers	Combination Side	Binders Pickers
Tillage Implements	Rakes and Tedders	Ensilage Cutters
Tractor Plows	Sweep Rakes Stackers	Shellers
Riding Plows	Combination Sweep	Huskers & Shredders
Walking Plows	Rakes and Stackers	Other Farm Equipment
Disk Harrows	Baling Presses	Cream Separators
Tractor Harrows	Beet Tools	Feed Grinders
Smoothing Harrows	Seeders Cultivators	Manure Spreaders
Orchard Harrows	Pullers	Straw Spreader Att.
Culti-Packers	Planting and Seeding Machines	Wagons & Trucks
Cultivators, one-horse	Cotton Planters	Stalk Cutters
Power Machines	Grain Drills	Cane Mills
Kerosene Engines	Broadcast Seeders	Stone Burr Mills
Gasoline Engines	Alfalfa & Grass Drills	Knife Grinders
Kerosene Tractors	Fertilizer & Lime	Binder Twine
Motor Trucks	Powers	

INTERNATIONAL HARVESTER COMPANY



OF AMERICA, INC.
BILLINGS, MONT. CRAWFORD, NEB. DENVER, COLO. HELENA, MONT.
LOS ANGELES, CAL. PORTLAND, ORE. SALT LAKE CITY, UTAH
SAN FRANCISCO, CAL. SPOKANE, WASH.



flecks or "freckles" on Jonathans, Spitzenburgs and other varieties. It is most important as a storage disease, although it is sometimes found on ripe fruit before picking.

Apple scald has been a puzzling disease. Apples go into storage in prime condition, with sound skin and apparently with every reason to suppose that they will hold in the same condition, and yet it frequently happens that after a period of storage, or shortly after removal to a warm temperature, scald is very prevalent. The disease exhibits itself as a superficial browning of the skin which does not usually affect the flesh or the eating quality of the apple, but it does spoil the appearance and consequently the marketability of the fruit. It may also be important as the forerunner of early physiological breakdown or of fungous rots which gain easy access through the affected skin. *Alternaria*, one of the fungi which cause rotting, is very likely to invade scalded apples.

We now have some investigations partially completed which throw new light on the nature of this disease, but since they are of a very technical character the practical application only need be presented here. We have verified the generally recognized fact that maturity of the fruit at the time of picking is one of the most important factors in the prevention of apple scald, and yet this seems to be less dependable with Eastern fruit than with that produced in the Northwest, possibly because Northwestern apples ripen more evenly. Working with apples alike in all respects except maturity, we obtained from 20% to 100% more scald on the green, immature fruit than on the well colored and mature specimens. The question, "What is the proper maturity?" naturally arises. The best answer we can give is that proper maturity is reached when the green ground color begins to lighten. After this it changes to white or yellow and the apple is well along the road to full ripeness. It is important to pick before the light ground color is well developed, in order to provide as long a storage life as possible. The red or bluish color cannot be depended upon as an indication of ripeness, and neither can the color of the seeds, since both are affected by other conditions.

We find it is frequently the case that apples in air-cooled or ventilated cellar storage do not scald, while those held



FRUIT GROWERS

Can't Afford the Loss of Bruised Fruit Picked in Ordinary Bags or Buckets when they can

SAVE THIS BIG LOSS BY USING

Palmer Picking Buckets

Which are LABOR and FRUIT SAVERS and Useful for Many Purposes.

Prices { Single Bucket . . . \$1.50 } Special Prices on Large Orders.
 { In Dozen Lots . . . 1.15 }

Send your order with remittance to

HOOD RIVER FRUIT COMPANY

Bucket Filled

HOOD RIVER, OREGON

Bucket Emptied



in commercial cold storage are seriously affected, this despite the fact that it has been demonstrated that susceptibility to scald increases with a rise in temperature, and theoretically, therefore, that apples held in cold storage should be less susceptible to scald than those held in the warmer air-cooled storage. The unquestioned benefits of the colder temperature secured in commercial cold storage are largely nullified in many instances by the greater tendency of apples to scald. What is the reason? Some of our experiments give illuminating evidence on this question. We held Grimes, a very susceptible variety, under the following conditions: (1) Constantly in cold storage (direct expansion room) for seventeen weeks; (2) constantly in ventilated cellar storage during the same period; and (3) a lot which was brought out of the cold storage room at the end of five weeks and held for a few hours in the open air, then returned to cold storage and brought out again after ten weeks and held forty-eight hours before returning to cold storage for the balance of the seventeen weeks' period; that is, we simply ventilated this last lot on two occasions in the open air and returned it to conditions identical with those under which the first lot was held. At the end of the seventeen weeks all of the fruit was taken to a warm room to permit the maximum of scald development. After being subjected to the higher temperatures we found that the first lot developed an average of 65% scald, the second lot from 5% to 10%, and the third lot an average of 15%, which indicates clearly the influence of ventilation in the prevention of scald. We found that with the exception of a few tests on immature fruit, scald was prevented on all varieties and at all temperatures at which it occurs by stirring the storage air. A continuous air movement over the fruit of one-eighth to one-quarter mile per hour has been sufficient to hold the disease in check, but a more violent stirring of the air once or twice a week has given as good results as a continuous gentle air movement. From these facts it is natural to infer that apples will scald more seriously in unventilated rooms than where the air is frequently or even occasionally changed. It might be supposed that the direct expansion system of cooling in commercial cold storage plants would be less satisfactory from this standpoint than the bunker system. Theoretically this should be true, but in practice we find that there is frequently very little difference, since the so-called "air circulation" produced by the bunker system changes the air so slowly, if at all, that the air is not changed around the apples. The rooms are usually tightly packed with boxes, leaving no space to provide for air circulation. In a large, compact pile of boxed fruit there is little chance for the apples in the interior to secure any ventilation at all. We find that best results obtain from so stacking the boxes that air circulation between stacks is provided for, and that great benefits are obtained if the rooms

Any Length 6 feet to 20 feet

Pay When Pleased

—you don't send me a cent until you see what you're buying! And I pay the freight! Just send me your order NOW for two or more of the

SECURITY KANT-WOBBLE LADDER

I will ship on approval, freight prepaid; you examine ladders, then send me the money—if you don't like the ladders and their price fire them back and I'll pay the return freight!

But you **will** like the SECURITY. I have sent out hundreds on approval—not one ever came back! When orchardists see that light, steel cuff-bracket that grips stile at each step-end, the device that kills all wobble and takes a big slice out of picking costs, they realize that the SECURITY is the ladder they want—the ladder they **must have** if they are going to make their orchards pay big.

All the following dealers handle the SECURITY:

Hamilton, Montana	Valley Mercantile Co.
Roseburg, Oregon	Churchill Hardware Co.
Salem, Oregon	Ray L. Farmer Hardware Co.
The Dalles, Oregon	Walther-Williams Hardware Co.
Wenatchee, Washington	Wenatchee Produce Co.
Yakima, Washington	A. F. Fosseen & Co.

—or write me direct for prices, booklet or shipment of two or more ladders on approval, prepaid. Write TODAY.

J. B. PATTERSON, Mfr.

80 Franklin Street OAKLAND, CALIFORNIA

Steady power

"Red Crown"—straight-distilled, all-refinery gasoline—gives steady, dependable power. Look for the Red Crown sign before you fill.

STANDARD OIL COMPANY
(California)

The Gasoline of Quality

WE DEVELOP KODAK

FILMS FREE and pay return postage when prints are ordered

Mail us films with Six Cents Stamps for each desired print. We return excess.

NO CHARGE for unprintable films.**Woodard, Clarke & Co.**

Photo Supplies

Wood-Lark Bldg. Portland, Oregon

Ask for Catalogue and Special Offer.

are so constructed that they may be exposed to a sweep of outside air when the outdoor temperature will permit.

The rate of scald development is greatly influenced by temperature. Between 60 and 32 degrees, each drop of 10 degrees results in a delay of from three to six weeks in the time of the appearance of the disease. The optimum temperature for its occurrence is 60 degrees or slightly above. Temperatures of 75 and 85 degrees have prevented the development of the disease, but of course cannot be used as storage

temperatures. High humidities tend to increase scald, but the disease does not occur in saturated air that is kept stirred and does occur in dry stagnant air. The disease is not due to accumulation of carbon dioxide, this gas tending to decrease rather than increase the trouble.

Without going into any involved technical discussion of the manner in which scald develops, it may be said that the disease results from the action of accumulated respiration products, which in the absence of good ventilation are held in close contact with the skin of the apple, preventing normal respiration of the fruit and probably exercising as well a direct toxic effect on the skin. This action is a slowly cumulative one, which explains why apples do not scald until after they have undergone a period of storage and prolonged exposure to the gradually accumulating respiration gases. To provide a long storage life for our apples we must unquestionably hold them at as low a temperature as possible, but to secure their ultimate freedom from scald and their ultimate marketable condition we must at the same time provide good ventilation for the storage rooms. We may summarize scald prevention measures, then, as follows:

(1) Pick When Mature:

Pick when the ground color begins to lighten. Make more than one picking when practicable.

(2) Keep Cool:

In the Orchard—Keep the picked apples as cool as possible. Low temperatures are desirable, but all cooling is valuable. Keep the apples in the shade.

In Storage—Get apples to cold storage or air-cooled storage as soon as possible after picking. Use open crates—they cool more quickly than tight ones.

In Transit—Precool the fruit and ship in ice refrigerator cars if the weather is warm.

(3) Ventilate:

In the Orchard—In case of delay keep the fruit in open crates. Do not hold in large close piles. Give packing sheds and temporary storehouses plenty of air, especially night air.

In Storage—Hold in open crates if practicable, and stack to permit air circulation. Apples scald less in well ventilated cellars and air-cooled storage houses than in unventilated commercial cold storage plants, but the higher temperatures of the former are, of course, undesirable.

In Transit—Give the apples as much air as practicable. If the weather is cool ship "under ventilation." Delay of poorly cooled fruit in tight cars greatly increases scald and causes heavy losses.

The reputation and the sale of the Northwestern apple is based primarily upon its attractive appearance and its keeping quality, points which are vitally affected by storage diseases. There should therefore be intelligent attention devoted to these problems by all concerned with the growing and handling of apples.

Ridley, Houlding & Co.

COVENT GARDEN, LONDON

WE ARE

Specialists in Apples and Pears

CABLE ADDRESS: BOTANIZING, LONDON

Codes: A. B. C. 5th Edition and Modern Economy

"Here's a Friendly Tip" says the Good Judge



Men who know tobacco, chew the best without its costing them any more. They take a little chew and it's amazing how the good taste stays in a rich, high grade chewing tobacco. For lasting tobacco satisfaction, there's nothing like a small chew of that rich-tasting tobacco.

THE REAL TOBACCO CHEW

put up in two styles

RIGHT CUT is a short-cut tobacco

W-B CUT is a long fine-cut tobacco

Weyman-Bruton Company, 1107 Broadway, New York City

Farms and Orchards in Yamhill County and in the Newberg District

We have BARGAINS in Prune Orchards and Berry Tracts and Farms and we also have good buys here in town. We inspect the property we offer for sale and ask you to write us for what you want and prices. Business is GOOD and everybody wants to come to Newberg.

WHITE & COMPANY
703½ First Street Newberg, Oregon

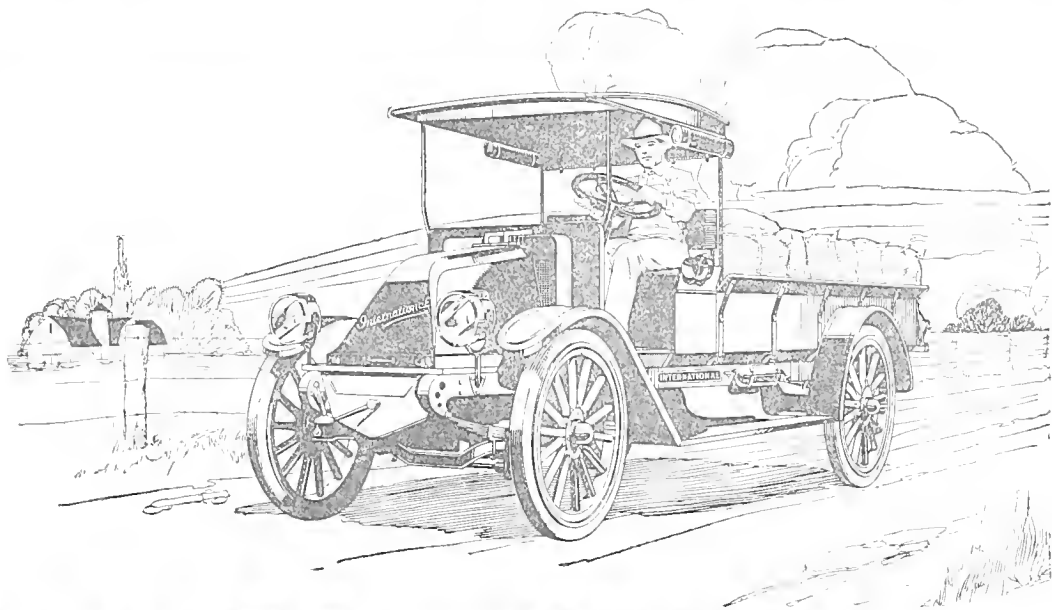

15c or 33c—Which?

HAULING a ton of farm products is costing you either 15c or 33c for every mile, depending on whether you use motor trucks or horses.

The U. S. Department of Agriculture says that it costs 15c per ton mile to haul corn and wheat to market with motor trucks and that it costs 33c to haul corn and 30c to haul wheat with horses. This is the average for the country. In some sections, it costs +9c to haul corn and +2c to haul wheat with horses.

There is One Best Way

to haul farm products by motor truck and that is to use the dependable International Motor Truck with service and quality built into it to the last part. Our many years of experience in developing and selling power equipment for farm use—engines, tractors and all kinds of farm machines—and all the knowledge of farm conditions that experience has given us, are built into the International Motor Truck. It will prove as useful, as convenient and as profitable as your engine, tractor or automobile—perhaps

more so.—Every part—engine, transmission, internal gear drive rear axle—is made to work efficiently with every other part under country road and load conditions. It is a truck you can afford to buy and afford to use. There is a style of body and size of truck to meet practically every hauling requirement.

Give us your annual tonnage to and from town, and we will tell you whether or not an International will prove a profitable investment. Write now so you will have complete information to use when you need it.

International Harvester Company of America

(INCORPORATED)

Billings, Montana	Crawford, Nebraska	Denver, Colorado	Helena, Montana
Los Angeles, California	Portland, Oregon	Salt Lake City, Utah	
San Francisco, California	Spokane, Washington		

THE WORLD-
OUR ORCHARD

STEINHARDT & KELLY NEW YORK

UNQUESTIONABLY THE
MOST IMPORTANT FACTOR
IN THE DISTRIBUTION OF
THE COUNTRY'S FANCY
APPLES
AND OTHER FRUITS

OUR MARKET-
THE WORLD

Columbia Univ. Libr
30 Dec 19

FEATURES:

- Advice for the Orchard Planter
- Harvesting and Marketing Apples
- Quarantine Laws as Applied to Fruit
- Assisting Barren Orchards to Bear



BRANCH OF HOOD RIVER SPITZENERGERS
 A Best of Show Symbol of Apple Harvest
 From the Northwest

KAOLA MEAL

The Profit-Food

That All Stock and Poultry Should Have

We call Kaola Meal "The Profit-Food" because it has increased profits from butter fats and skim milk and other produce by 53%.

Its records with milch cows, calves, pigs, poultry, sheep and horses are too numerous to quote in this announcement. But you can find them out by talking with men who have fed this food.

It's a well-balanced food, rich in protein, carbohydrates and fat. It has a higher percentage of digestible fat than even linseed oil meal.

Yet it isn't a laxative. You feed it in the same proportions when you are feeding laxative—from 10% to 25% of the other bulk foods.

It is made from the fine white meat of coconuts after extracting the commercial oil, but with sufficient oil remaining to make it one of the best fat foods for stock and poultry known.

The great butter and cheese exporting countries of Europe, Denmark,

Holland, Belgium and Switzerland, have been its largest consumers up to now because it was easily procured and the butter producers abroad have known its efficiency for twenty years.

A large company here now use hundreds of thousands of coconuts annually to produce commercial oil. So now you can have the highest grade of this type of feed and can profit as the European nations have done.

Try it and note the results. You'll always use this feed once you see what it produces.

Order from your retailer. But get **Kaola Meal**.

We have just completed a new book, full of scientific facts on cattle, hog and poultry feeding. It's free. Write us for it. It tells you how the European farmer has gained high yields with this profit food. Clip the coupon now.

Analysis as follows: Protein 16.02%; Carbohydrates 63.50%; Fat 7.18%; Ash 5%.

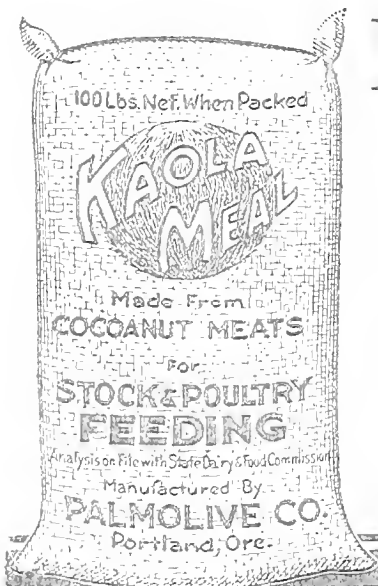

Palmolive Company

Address Department 71
Portland, Oregon

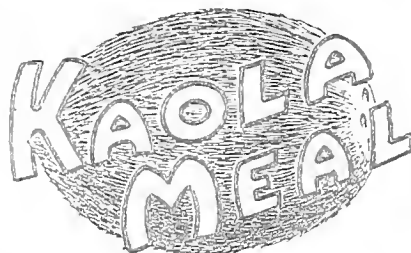

Look for this Mark on the Bag

Cut This Out As A Memo
A Reminder:

to write to the Palmolive Company for the booklet about Kaola Meal, and get a trial supply from my retailer.

Subscription Rates Advance December 1st

New or Renewal Subscriptions Received Until December 1st at Old Rates

Better Fruit Readers Getting More for Their Money

Each issue of Better Fruit published this year has contained from 30% to 50% more reading matter than the corresponding issues of recent years. It has also contained a higher class of material from the highest authorities.

The paper has been improved editorially and mechanically — in fact many letters from highest authorities assure us that the value and usefulness of Better Fruit has increased many fold. These improvements cost tremendously and yet, until now, the subscription price has not been raised.

Postage and Publishing Costs Have Increased

Paper, Ink, Postage, Wages — everything which enters into the production of a magazine has increased — is still increasing, and there seems no prospects of lower costs. Take the item of postage for example, it is costing us from **two to three times as much for postage now as it did in 1918** and almost every other cost has increased in like proportion. We have still further plans for the improvement of Better Fruit which make it absolutely necessary that we advance the subscription price.

We Have Confidence in Our Readers' Fairness

You have been getting an **extra** value in Better Fruit—an improved and enlarged Better Fruit at the same old rate. At the same time our cost of producing the magazine has doubled. You know yourself how prices have increased. The United States Bureau of Statistics shows that prices on the average have doubled since 1915. We believe that our readers are fair minded—that they appreciate the situation and will gladly pay the increased subscription price.

This is Your Chance to Save Half

But here is an agreeable surprise for you. In spite of the increased postage charges, higher prices of paper and printing, labor, etc., and notwithstanding the fact that we are giving you a bigger and better magazine we are going to give everyone who acts promptly the opportunity to subscribe, renew or extend a subscription at old rates providing they act before December 1st, 1919. Beginning December 1st the subscription price will be \$2.00 per year in the United States and its possessions and \$3.00 in Canada and Foreign Countries.

USE THIS SPECIAL ORDER BLANK



Do It Now

before you forget and if you have a friend who should be taking Better Fruit tell them. Use the blank below.

Better Fruit Publishing Co. Oregonian Building
Portland, Oregon

SPECIAL ORDER BLANK (Good only if used before December 1, 1919)

The Use of This

Order entitles the user to a new, renewal or extension subscription to Better Fruit at following old rates:

In United States and Possessions—	1 year	\$1.00
	3 years	2.00
In Canada	1 year	1.50
In Foreign Countries	1 year	1.50

Better Fruit Publishing Co., Oregonian Building, Portland, Oregon:

Gentlemen:—Enclosed find \$ for a { new
renewal } subscription to
extension }

Better Fruit for a period of years in accordance with your special offer.

Name

Address

SIMONS, SHUTTLEWORTH & CO.

LIVERPOOL AND MANCHESTER

SIMONS, JACOBS & CO.

GLASGOW

GARCIA, JACOBS & CO.

LONDON

Agencies and Representatives in Every Important European Market

European Receivers of American Fruits

FOR MARKET INFORMATION ADDRESS

SIMONS, SHUTTLEWORTH & FRENCH CO.
204 Franklin Street, New York

SIMONS FRUIT CO.
Toronto and Montreal

SIMONS, SHUTTLEWORTH, WEBLING CO.
Board of Trade Building, Boston

OUR SPECIALTIES ARE APPLES AND PEARS

Pacific Coast Agents
**United States Steel
Products Co.**

San Francisco
Los Angeles
Portland
Seattle



J.C. Pearson Co., Inc.
Sole Manufacturers

63 Pearl Street
Boston, Mass.

PEARSON

ECONOMY in buying is getting the best value for the money, not always in getting the lowest prices. PEARSON prices are right.

ADHESIVENESS or holding power is the reason for PEARSON nails. For twenty years they have been making boxes strong. Now, more than ever.

RELIABILITY behind the goods is added value. You can rely on our record of fulfillment of every contract and fair adjustment of every claim.

SATISFACTION is assured by our long experience in making nails to suit our customers' needs. We know what you want; we guarantee satisfaction.

ORIGINALITY plus experience all ways excels imitation. Imitation's highest hope is, to sometime (not now) equal Pearson—meantime you play safe.

NAILS

LOOK HERE

ARE YOU SATISFIED with your present selling service?

IF NOT try us and learn what an up-to-date selling organization can do for you.

CABLE OR WRITE US NOW for market prospects, terms, etc. Reasonable advances made against shipments of

APPLES PEARS ORANGES

YOU want the best market in Britain.

WE have it.

McCAIG & WEBB
Fruit Brokers, **GLASGOW**

Head Office, **GLASGOW**

Cables—MacWebb, Glasgow
A. B. C. 5th Edition—Marconi International

ALSO RECEIVERS AT
London — Liverpool — Hull

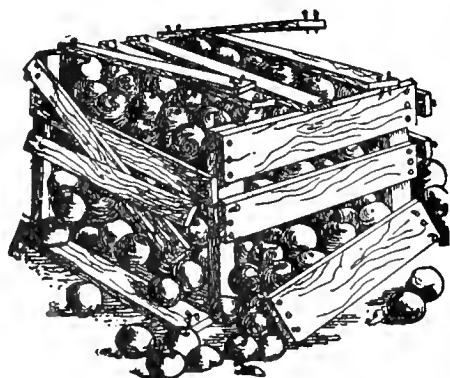

BEFORE using Cement Coated Nails

Western Cement Coated Nails for Western Growers

Our Cement Coated Nails are always of uniform length, gauge, head and count. Especially adapted to the manufacture of fruit boxes and crates. In brief, they are the Best on the Market.

Write for Growers' testimonials.

Colorado Fuel & Iron Co.

DENVER, COLORADO

Pacific Coast Sales Offices
Portland, Spokane, San Francisco
Los Angeles

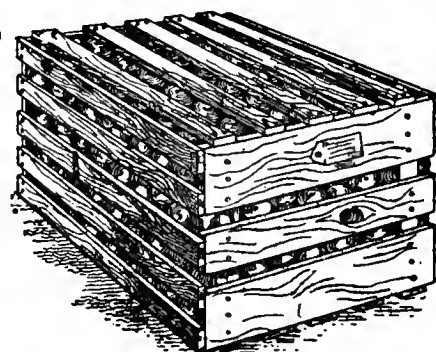

AFTER use of C. F. & I. Co.'s
Cement Coated Nails

BETTER FRUIT

EDITOR: W. H. WALTON

STATE ASSOCIATE EDITORS

OREGON—C. J. Lewis, Horticulturist.
 WASHINGTON—Dr. A. L. Melander, Entomologist;
 O. M. Morris, Horticulturist, Pullman.
 COLORADO—C. F. Gillette, Director and Entomologist;
 E. B. House, Irrigation Expert, State Agricultural College,
 Fort Collins.
 ARIZONA—E. P. Taylor, Horticulturist, Tucson.
 WISCONSIN—Dr. E. D. Ball, Madison.
 MONTANA—O. B. Whipple, Horticulturist, Bozeman.
 CALIFORNIA—C. W. Woodworth, Entomologist, Berkeley;
 W. H. Volek, Entomologist, Watsonville; Leon D.
 Batchelor, Horticulturist, Riverside.
 INDIANA—H. S. Jackson, Pathologist, Lafayette.

An Illustrated Magazine Devoted to the Interests
 of Modern, Progressive Fruit Growing
 and Marketing.

PUBLISHED MONTHLY BY

Better Fruit Publishing Company

703 Oregonian Building

PORTLAND, OREGON

All Communications should be addressed and
 Remittances made payable to

BETTER FRUIT PUBLISHING COMPANY

SUBSCRIPTION PRICE:

In the United States, \$1.00 per year in advance.
 Canada \$1.50; Foreign, including postage, \$1.50.

ADVERTISING RATES ON APPLICATION

Entered as second-class matter April 22, 1918,
 at the Postoffice at Portland, Oregon, under
 the Act of Congress of March 3, 1879.

VOLUME XIV

PORTLAND, OREGON, OCTOBER 1, 1919

NUMBER 4

Timely Advice for the Prospective Orchard Planter

By Gordon G. Brown, Horticulturist, Hood River Experiment Station

WHEN the Editor of BETTER FRUIT suggested that I write an article on this subject it seemed as though we were being carried back to the old days of 1909 and 1910 when advice upon the subject of planting was most plentiful. Then, we were advised to plant according to a multitude of ideas. Those who have gone through the ups and downs of the past ten years now have some pretty definite ideas of their own as to whether this advice was good or bad and also whether it was prompted by the get-rich promoter or the horticulturist of actual experience whose purposes were above reproach. Surely we have all learned.

The subject upon which I have been asked to write is a broad one and I prefer to view it in that light. It goes much beyond the mere laying off of an orchard and planting trees. What are the problems involved? To me the matter unfolds somewhat according to the following definite questions, arranged

with some idea of sequence. Considering the enormous plantings of apples a few years ago and the experiences in securing a market, is there any need of further planting? Assuming that there is such a need, shall it be on a large or small scale? Then follows another series of questions of a different character but equally, if not more, important. What variety or varieties shall I plant? Upon what kind of soil shall I set my trees? What are the details to be observed in dealing with the nursery man and finally, planting? Upon the correct answer to these depends success.

Let us go back to the first question suggested: that regarding the need of additional planting. Let us consider apple statistics recently compiled by the United States Department of Agriculture. These data point out clearly that there is no actual need for wholesale planting according to the proportions of ten years ago. On the other hand, there is an actual need for further planting upon a conservative scale for two definite reasons. Taking the United States as a whole there are comparatively few trees coming into bearing since there has been little planting since 1910. Furthermore, market demands are expanding and the productivity of certain apple districts which have furnished the bulk of the tonnage in the past is declining. This is true of Western New York which has furnished approximately one-fourth of the normal commercial apple crop of the United States. This is due largely to the fact that the trees are old. Many were planted in the late sixties. This is also true of the New England Baldwin Belt including Maine, New Hampshire, Vermont and Massachusetts. Commercially, the states of the Pacific Northwest have superceded, or at least equalled, the output of Western New York.

What of pears? Due to the ravages of fire-blight in most states the industry has declined almost to the vanishing point. This fact is now greatly reflected in gross tonnage for the United States and also in prices which are especially remunerative for all standard sorts. Canneries have paid as much as \$80.00 per ton for Bartletts and are calling for more. The industry is now largely centered in California and Ore-

gon. In the former state in 1917 there were 19,233 acres in bearing and 28,069 non-bearing. When viewed in the light of the country as a whole, the total acreage is comparatively small. There is room for additional planting of pears but on a conservative scale.

In Oregon during the past few years prices for Italian prunes have been very high. Many prune growers have made large fortunes from one or two good crops. The result has been that thousands of acres of new plantings have been set. The demand for prune trees is so great that the nurserymen are charging from fifty to seventy-five cents per tree and in some instances more. Obviously a greater market for the vast tonnage of prunes that will be borne in a few years must be found. It can scarcely be said that present high prices of prunes should be taken as a safe index of what prices may be expected when yields are doubled and trebled. There is no need for hysterical planting along this line.

What about nursery stock? The need of securing first-class trees has been emphasized so often as to be almost axiomatic. It should be vigorous, free of insects or disease, true to name, and preferably one year old from the bud. Incidentally, it is urged that the largest nursery stock is not necessarily the best. Trees four feet or higher that caliper about five-eighths of an inch just

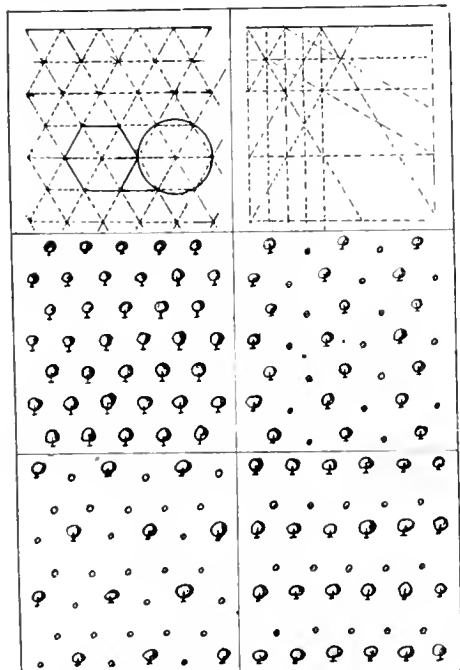

HEXAGONAL SYSTEM OF PLANTING

1, Field staked by use of triangle. 2, Field set. 3, Field properly thinned. 4, Field properly rowed off by running lines. 5 and 6, Illustrations of improper thinning.

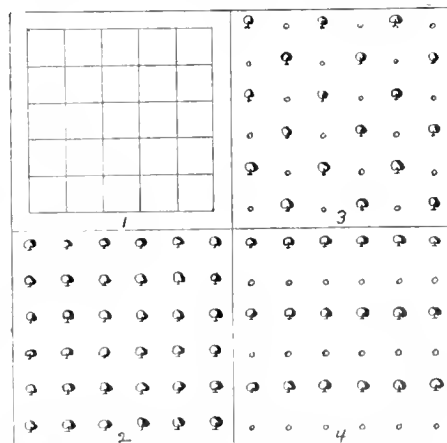

THE RECTANGULAR SYSTEM OF PLANTING

1, Field lined. 2, Field set. 3, Proper thinning. 4, Improper thinning.

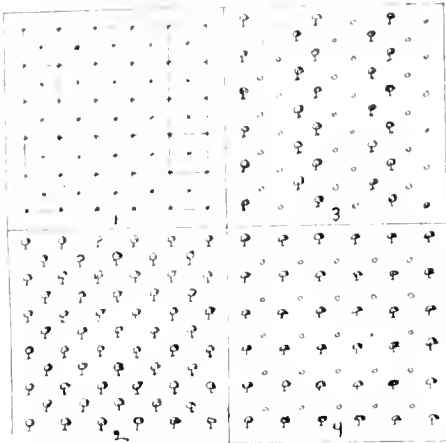

THE QUINCUNX SYSTEM OF PLANTING
1, Field staked, 2, Field set, 3, Improper thinning, 4, Proper thinning.

above the point at which the bud can be inserted can be considered, roughly speaking, first-class trees. As a rule they have large vigorous roots and when well planted make a greater percentage increase in trunk diameter during the first season's growth in the orchard than larger trees. One year old trees are preferred to older stock, not only because trees can be headed to better advantage but also because a two-year-old tree does not have a much greater root system after digging than does the one-year-old tree. Again, the medium sized tree is preferred to the abnormally large tree because the lower buds are stronger and more capable of developing well spaced branches than those similarly located on the large tree.

I do not know of a point in connection with nursery stock that is more worthy of emphasis than "Order Early." The planter who waits until next spring before looking after this matter is pretty likely to face an unprecedented shortage and be forced to accept cull

stock for which he will undoubtedly be charged a fancy price or go without, which is by far the lesser of the two evils. Another point of importance: Don't go bargain hunting in nursery stock if price alone is the deciding factor unless you know your business pretty well and can judge nursery stock. Better pay the full price asked by the nurseryman of established reputation, even though it may seem exorbitant, than deal with the fly-by-night agent connected with a distant firm about which you know nothing. Viewing the matter from the standpoint of the nurseryman, it is fair to say that he has had a pretty up-hill game the past few years and that in many cases present prices are justified on account of the greatly increased cost of growing trees.

The variety question is one which is easier of solution than a few years ago. All of the important ones have been tested out and the planter has an opportunity to know what to plant instead of making a guess. He will by now have appreciated that all varieties are not equally well adapted to all soils and climates. This is a lesson which has been learned at a big cost in many of our districts. The record of acreages platted out amply testifies to this fact. It is assumed that the planter will set his trees in an established district where the variety question has been worked out. If he does not expect to do so he will be facing a very definite handicap. He will have to take his chances on variety adaptability and face many other inconveniences in growing and marketing which are found in districts with sufficient tonnage to justify cooperative effort.

Let the beginner take council with those successful in his district. Find out which varieties yield the largest tonnage year in and year out, what the

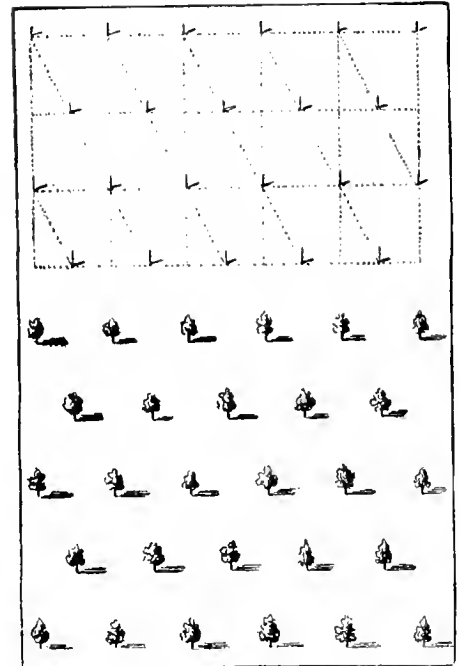

TRIANGULAR OR ALTERNATE SYSTEM OF PLANTING.

net sales price per box has been and from these data determine which varieties return the highest net profit per acre. In Hood River the Yellow Newtown and Spitzenberg are standards, both being splendidly adapted. Delicious and Winter Banana are found in limited plantings and both sell at higher prices than the two just mentioned. In Wenatchee the Winesap and Jonathan are favorites and show very high returns per acre. In British Columbia, the McIntosh, Jonathan and Wagener are most prominent.

There is probably no variety which enjoys greater popularity where known than the Delicious. It well merits this

Continued on page 26.

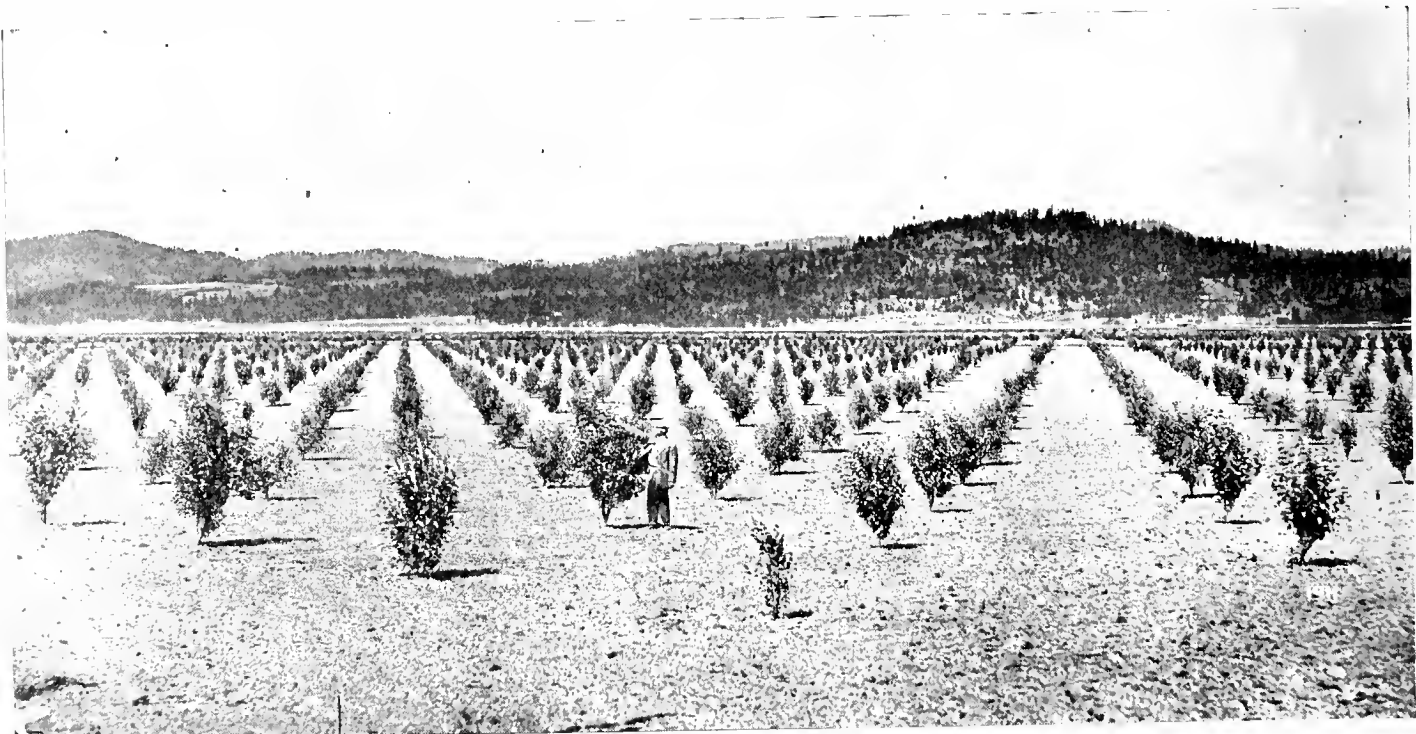

Illustration of a well set orchard. This view is of a young orchard in the Spokane Valley, Washington.

Harvesting and Marketing Walnuts the California Way

By J. B. Neff, Anaheim, California

WHEN the walnut hulls have opened so they will clean from the nuts readily it is best to take advantage of all dry weather by shaking the trees lightly so as to get the ripe nuts. This method adds slightly to the cost of harvesting, but is much more satisfactory than waiting for the nuts to fall if continued wet weather comes during the harvesting period. The shaking may be done with a light pole having a steel hook bolted on the end. The pole may be of spruce, or other straight grained lumber, one by one and three-quarters inches at the bottom and one by one and one-quarter inches at the top, and of any desired length.

The hook can be made of a piece of light carriage spring bent so as to make the opening three and a half to four inches and rounded on the inside to keep from cutting the bark of the branches. A short quick jar will loosen the nuts, but care must be taken to loosen only those nuts which will hull clean since any part of a hull which does not come off will adhere so closely when dry that the nut will be passed as a cull. It is best to go over the orchard about once a week in dry weather, but the nuts should be gathered from the ground oftener if the weather is rainy.

After the nuts are gathered and taken to the drying ground they should be cleaned of lint and particles of dirt by running through a cylindrical screen having a pipe above with small perforations, one-eighth inch or less, about six inches apart to allow water to spray on the nuts while the screen is turning. It is better, however, to clean the nuts without water unless particles of dirt should adhere to the nuts.

A convenient screen for small orchards can be made by using wooden heads doubled, with six-inch pipe flanges bolted outside in which to screw one-inch pipe and fittings for a bearing and crank at each end. The screen for hand work should not be more than 30 inches in diameter and four feet long, covered with any strong netting of one-half-inch mesh.

A door twelve inches wide and full length of the screen should be arranged for filling and emptying the screen. If more than ten tons of walnuts are to be handled it will pay to have a larger and more permanent cylinder and to use power of some kind, in which case the screen can be made to fill at one end and empty at the other. The nuts can be made to run from the screen to the drying trays by having a sloping floor under the screen. The nuts may be sorted when they come from the screen to remove the damaged and unsalable nuts but the final culling should be done when the nuts are dry.

The drying trays should be made of light lumber. The most convenient size is made of the following pieces: Sides 1x6x6 feet long, ends, 1x6x2 feet 10 inches long nailed together so as to have the body of the tray 3 feet by 5

feet outside and leaving 6 inches at each end of the side pieces for handles which should be cut down to 3 inches in width. For the bottom use ½-inch laths 6 feet long cut in two and nailed ½ inch apart. Also nail an extra lath on each side of the bottom to keep the short laths from coming off. They will also be strengthened if a lath is run full length in the center and nailed to each cross-lath as well as to the ends. Corner braces about 12 inches long of 1x½-inch soft pine nailed on top of each corner adds to the strength and allows additional ventilation when the trays are piled.

Do not put more than 60 pounds of walnuts in a tray when drying and stir often, particularly if the weather should be damp. Sun drying is best when the weather will permit. The trays should be piled and covered at night or taken indoors. Light covers 3 feet by 6 feet made of shakes are very convenient as a temporary roof can be made hurriedly.

A hopper six feet long and large enough to hold 1000 pounds of walnuts placed at the proper height for filling sacks is very convenient.

When the nuts are dry, properly culled and sacked, the grower's work is done and the nuts ready for the association.

In marketing walnuts in California the method now pursued by the walnut growers of California is to form associations for walnuts exclusively. The association outputs varying from 150 tons to more than 1000 tons.

These associations take the nuts from the growers, grade, bleach and sack them, then turn them over to the California Walnut Growers' Association which sells them. The local associations equip a warehouse to handle their crop, either by selling stock, or by assessing each member according to the amount of nuts put through the house, payments being made to run over a number of years. Samples of nuts are taken from each load as brought to the packing house and if it shows the required percentage of perfect nuts, usually 85% to 87%, the load is weighed and a receipt given the owner. The nuts are kept separate until graded, bleached and culled. The amount of number one and number two nuts are then credited to the grower's account and the culls are either thrown into a common pool or a charge is made for the work of culling and the culls returned to the grower. Payment of about 75% of the selling price is made to the grower within a week and final payment when the season is over. Several methods of bleaching walnuts have been used but that in use now is known as the chlorine in which chloride of lime, sal soda and a small quantity of sulphuric acid is used. The nuts are either dipped in the solution or have it sprayed on them as they pass over shaking tables. A later and apparently more convenient plan is to buy the

chlorine solution in carboys. This solution is made by electrically decomposing salt under a high voltage and has the merit of cheapness as well as avoiding the unpleasant odors of chloride of lime.

The selling is done exclusively by the California Walnut Growers' Association which acts as the broker for the local associations. This is a non-profit, co-operative association under the laws of the State of California, composed of one member from each local association. Its purpose is to sell the walnuts of its members at the lowest possible cost and to secure the widest possible distribution of the walnuts. In this way it is hoped prices can be kept down to the consumer, a large demand developed and a reasonable profit secured for the grower.

The business of this association is carried on by a manager who is under the direct supervision of an executive committee of the board of directors.

Selling agents are appointed throughout the United States and may be either brokers or salaried agents, all of whom are under surety bonds.

The contracts with the member associations are for five years but provide that any member association may withdraw by giving notice thirty days before any annual meeting. The walnuts are pooled according to quality and time of gathering.

The California Walnut Growers' Association in order to secure uniformity of the walnuts, determines the size of screens for grading; the manner of handling and bleaching and establishes a cracking test. It also appoints inspectors to examine each lot of walnuts before shipment.

Any walnuts which will not meet the requirements as to quality of first-grade nuts are sold as off-grade, or near-grade walnuts at the best price obtainable for the account of the grower. A plant has also been established for cracking the cull walnuts of its members and the result has been that instead of selling cull walnuts for much less per pound they are now bringing the grower a good return without raising the price of walnut meats to the consumer. The association also buys all walnut bags and other materials used by the member associations, thereby making large savings.

“Pinching Back” Conserves Tree Energy.

Pinching or stopping the growth of suckers or branches that are not wanted and must eventually be removed at an earlier date seems to be a reasonable and effective manner of conserving energy and diverting it to the permanent branches of the trees. Pruning demonstrations have been very useful if for no other reason than that they have jarred many growers loose from old methods and compelled them to think deeply and reasonably upon the “whys and wherefores” of cutting the branches of trees.

Weevil Quarantines in Relation to Marketing Fruit

By W. H. Wicks, Director Idaho Bureau of Plant Industry

THE alfalfa weevil (*Pythonomus posticus*) has caused the states of Arizona, California, Nevada, Oregon, Washington, Montana and Colorado to place a quarantine against alfalfa infested counties of Idaho in common with the entire state of Utah, and certain counties in Colorado and Wyoming. Since the beginning of the spread of alfalfa weevil, it has been found in newer sections from year to year, and quarantine laws are being passed by other states, which laws are more and more rigid in regard to the movement of various products from infested sections. Alfalfa hay is the most valuable crop in the state of Idaho. The 1917 report of the State Bureau of Markets gives the following figures:

Alfalfa hay, 1,241,328 tons.....	\$18,664,920
Wheat, 9,638,537 bushels.....	13,557,805
Oats, 4,548,672 bushels.....	3,093,097
Potatoes, 2,636,229 bushels.....	2,636,229
Apples, 1,995,000 bushels.....	1,895,250
Prunes, 600 cars.....	360,000
Pears, 70,000 bushels.....	105,000
Peaches, 165,000 bushels.....	198,000

These figures show that the apple crop ranks first of all fruits in the state and the total value of the fruit output of the state, at average pre-war prices, amounts to \$2,558,250. In the movement and handling of horticultural products, including potatoes and vegetables, the alfalfa weevil quarantines play an important part.

Extent of Quarantine Regulations of Neighboring States.

Arizona quarantines entire state.

California quarantines Cassia, Bingham, Bear Lake, Oneida, Bannock, Franklin, Power, Payette and Madison.

Nevada quarantines Cassia, Bingham, Bear Lake, Oneida, Bannock, Franklin, Power, Payette and Madison.

Oregon quarantines that portion of the state of Idaho bounded on the north by the 43d parallel north latitude, on the east by the State of Wyoming, on the south by the State of Utah, on the west by 113th meridian west longi-

tude, and on the northwest by the Snake River.

Washington quarantines all counties in Idaho south of Idaho county.

Montana includes in their quarantine Cassia, Bingham, Bear Lake, Oneida, Bannock, Franklin, Power and Payette.

Colorado quarantines Cassia, Bingham, Bear Lake, Oneida, Bannock, Franklin, Madison, Power and Payette.

Upon recent investigation by the United States Department of Agriculture Bureau of Entomology, Salt Lake City, represented by Mr. George I. Reeves, being assisted by county agents, evidence has been produced resulting in the repealing of county quarantines in Idaho. This action has been officially recorded as follows:

REPEALING QUARANTINE ORDER NO. 11 Pertaining to Alfalfa Weevil

July 22, 1919.

WHEREAS, The alfalfa fields of the following counties of the State of Idaho are infested with alfalfa weevil (*Pythonomus posticus*): Bear Lake, Franklin, Oneida, Cassia, Bannock, Bingham, Madison, Power and Payette; and,

WHEREAS, Said quarantine declares and proclaims a quarantine prohibiting the shipment of alfalfa hay and cereal straw as stock food, stock bedding or packing for potatoes, fruit and nursery stock, or for any other purpose from or which has been grown in any of the above named counties to the following alfalfa-producing counties of the State, to-wit: Minidoka, Twin Falls, Lincoln, Blaine, Gooding, Camas, Elmore, Ada, Owyhee, Canyon, Gem, Boise, Washington, Adams, and Nez Perce; and,

WHEREAS, Recent investigation by the Bureau of Entomology, U. S. Department of Agriculture, has made it appear that in order to make county quarantines effective against the counties of Washington, Canyon and Ada where alfalfa weevil has recently been found, it would be necessary to quarantine also, Owyhee, Gooding, Lincoln, Blaine, Elmore, Boise, Custer, Lemhi, Idaho and Adams; and,

WHEREAS, It appears that the weevil probably always occurs from 50 to 100 miles beyond the point where it is possible to find it; and, furthermore, it has been demonstrated by careful investigation and carefully enforced quarantine regulations in Colorado and Utah that the operations of quarantine orders have proved valueless in preventing the spread of the weevil;

THEREFORE, It is hereby ordered that said quarantine No. 11, issued August 1st, 1918, be repealed and all state quarantine guardians

and deputy horticultural inspectors are hereby notified that no further quarantine regulations shall be enforced in the movement of Idaho alfalfa hay to any part of the state. This order shall take effect and be in force on and after the 22nd day of July, 1919.

MILES CANNON,
Commissioner of Agriculture.

C. C. MOORE,

Acting Governor of the State of Idaho.

Attest: ROBERT O. JONES,
Secretary of State.

It appears that it is only a matter of time when the alfalfa fields of Idaho will contain the weevil and quarantines will necessarily become state-wide, the same as those affecting the state of Utah. States which now have quarantines for the above named counties will no doubt revise their laws to include the entire state of Idaho. The marketing of alfalfa hay and products becomes more difficult as states pass more rigid quarantine laws. The outlet for alfalfa will then be either feeding it to livestock in the state, or shipping it out into states without quarantine, or in the form of alfalfa meal or similar products.

State Requirements in Moving Products from Weevil-Infested Territories.

The recent quarantine order from the State of Washington is here given as typical of the intent and purpose of other states which now have quarantine laws on this matter, which show the requirements that must be fulfilled in the movement of Idaho products into such states:

Alfalfa Weevil Quarantine.

1. Alfalfa hay and other hays of all kinds and cereal straws, excepting the material known locally in Utah as salt grass packing hay, which shall be admitted into Washington, provided that such material be cut only between the dates of October 1 and April 1, and that the raking, shocking, stacking, baling or shipping of this material as a commercial product be allowed only after the maximum daily temperature of the season has fallen below sixty degrees Fahrenheit.

Provided further, that a certificate be required from the Crop Pest Inspector of the State of Utah showing that these requirements have been met, which certificate shall accompany each shipment. Provided further, that no salt grass packing hay shall be held over in the field from one season to another. The use of salt grass hay as a packing material in shipments of fruit, crockery and other materials is permitted, provided said salt grass hay has been cut and removed from the field between October 1 and April 1 as above specified and stored in warehouses removed from alfalfa fields, alfalfa hay or other suspected materials.

2. Fresh fruits and vegetables, exclusive of potatoes, excepting under the following regulations:

a. Shipments for Washington to be made only from points designated by the recognized State Pest Inspection Officers of the State shipping into Washington, said officers to notify the De-

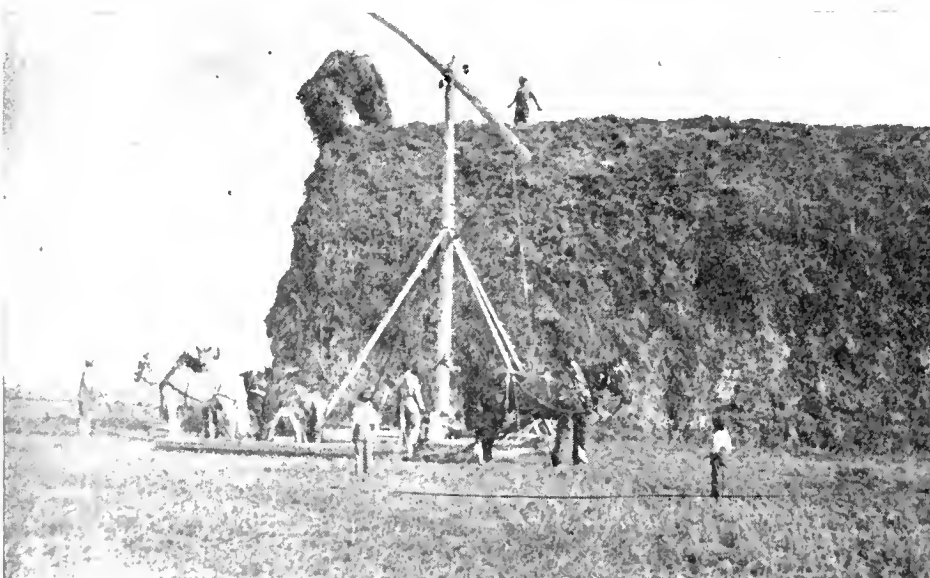

Alfalfa hay harvest in Southern Idaho. Alfalfa hay is the most valuable crop in the state.



Horticulturists, Entomologists and Fruit Inspectors attending second annual meeting of Western Horticulturists and Entomologists at Pullman, Wash., U. of L. Moscow and Lewiston, August 11-12-13, 1919. Workers for the development and protection of Agriculture and Horticulture.

partment of Agriculture of Washington, at Olympia, by registered mail or by telegraph of the designation of all shipping points in the aforesaid State of Utah, or all portions of the State of Idaho lying south of Idaho county; or counties of Oneida and Lincoln in Wyoming; and the county of Delta in Colorado; and the counties of Malheur and Baker in the State of Oregon; said notification to be sent and its receipt to be acknowledged before any shipments are made to the State of Washington from said designated points.

b. Shipments to be repacked from orchard or field boxes into new, clean boxes, or other fresh containers.

c. All wagons or other conveyances used in hauling to the place where repacking is conducted to be kept free from alfalfa hay or other hays, straw, and other means of contamination.

d. All packing houses to be at all times free of alfalfa hay, other hays, straw, and other means of contamination.

e. Each lot shipment shall bear an official certificate of the state from which the shipment originates stating that it has been inspected and passed in compliance with these regulations and stating where it was repacked and inspected.

3. Potatoes unless accompanied by an official certificate signed by the recognized State Pest Inspection Officer of the state from which such shipments of potatoes originate, setting forth that the potatoes have been passed over a screen, placed in fresh, clean sacks and packed in cars that are free of alfalfa hay or other means of contamination.

4. All nursery stock, unless accompanied by special certificate setting forth that such nursery stock has been fumigated for the alfalfa weevil in an airtight enclosure subsequent to being boxed, baled or packed for shipment, with cyanide of potassium or cyanide of sodium at the rate of one ounce to each one hundred cubic feet of enclosed space.

5. That no shipment of household or emigrants' movables originating in any

state or county designated as infested with the alfalfa weevil, shall be brought into the State of Washington by any common carrier, person or persons, unless such shipments be accompanied by a copy of a sworn statement made in duplicate by the owner or shipper after the following forms on blanks which will be furnished to applicants by the Department of Agriculture at Olympia, Washington. Copy No. 1 to be mailed to the State Department of Agriculture at Olympia, Washington, and Copy No. 2 to be delivered to the common carrier agent, with a special certificate appended, to attach to waybill.

Idaho Inspection Service.

In order to comply with the quarantine regulations of other states, which quarantine laws affect the marketing of Idaho products from weevil-infested territory, the Department of Agriculture through its Bureau of Markets is placing in each car of potatoes the following certificate as such car is officially inspected:

STATE OF IDAHO
 Department of Agriculture
 Bureau of Plant Industry
 Idaho, 19.
TO WHOM IT MAY CONCERN:
 This is to certify that car shipped from 00 19. to by contains potatoes which have passed over screen and have been placed in fresh, clean sacks. The car is free from alfalfa hay, other hay, and cereal straw, and is free from alfalfa weevil.
 Inspected by
 Deputy Inspector, District No.

It is the policy of the department to have an inspection certificate accompany each car. This procedure will aid materially in marketing Idaho products, as it sometimes happens that a car is rebilled, owing to market conditions, from its original destination and finds its way back into a state requiring such inspection and certificate.

In addition to inspection of horticultural products for quality and condition, freedom from insect pests and diseases, inspection is being given to meet the quarantine requirements of other states. The new official grades for Idaho on apples, Italian prunes, potatoes, hay, grains and leguminous seeds has brought about a state system of inspection which will give more thorough and adequate supervision of the marketing of all these commodities.

**How You Can Get
 Better Fruit's
 Apple Packing Chart**

BETTER FRUIT'S apple packing chart as it appears in this number, but printed on cardboard so that it can be hung in the packing house, will be mailed to anyone desiring it on the following terms:

One card FREE with a new subscription to BETTER FRUIT.
 One card without subscription . 10c
 Twelve cards without subscription, \$1.00

For quantity prices write us.

Better Fruit Publishing Co.
 703 Oregonian Building
 Portland, Oregon

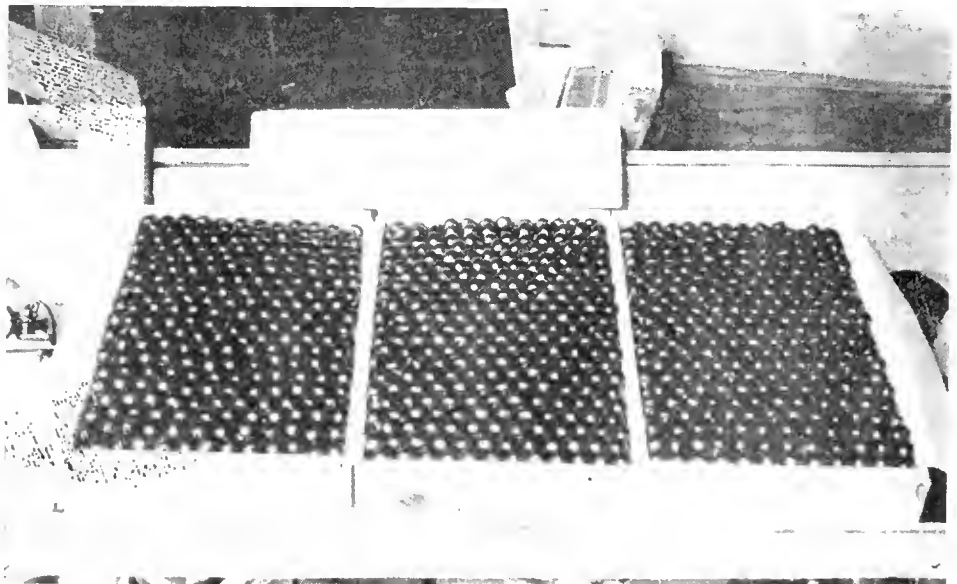

Idaho cherries commercially packed. Alfalfa quarantine laws make it more difficult to move various products from infested sections.

Science Aids Nature in Causing Barren Trees to Bear

By Harry L. Pearcy, Horticulturist, Amity, Oregon

THE pollenization of the sweet cherry previous to the days of large plantings was of an unknown quantity; but with the advent of the large plantings with solitary varieties or one or two varieties at most, pollenization has turned out to be the most vital of all the problems confronting the cherry grower. His trees were coming into the bearing age but there were no cherries to harvest. What caused this apparently phenomenal condition as contrasted to the heavy bearing condition of the cherry trees of the family orchard?

For years fine cherries have been raised in the Willamette Valley and at The Dalles, Oregon; the trees usually setting good crops. Being a popular fruit both in the fresh and dried state and as a canned product, it found a ready sale and proved to be a profitable crop for the orchardist to raise. Hence the large plantings of cherries of the last 12 or 13 years. When many of these plantings reached the age when they should have begun to bear large and profitable crops, it was found that they were producing little or nothing.

The above serious condition led to an investigation by the Oregon Experiment Station eight years ago. This work was carried on under the direction of Prof. V. R. Gardner. Too much credit cannot be given Prof. Gardner for the service he performed for the cherry grower in this investigation. Many theories were advanced to explain these crop failures. Frost, wind and soil conditions were all advanced as reasons for the trees not to set their fruit. Careful investigation failed to substantiate these and other theories. Much of the work of this investigation was carried on at The Dalles. The Professor set to work with a view of evolving a cherry which would bear prolifically in the Northwest. To this end he pollenated or rather cross-pollenated several varieties. The idea was to take the seed of the resulting crosses and plant them, hoping to get a seedling of the desired characteristics. This led to the important discovery that most sweet cherries were sterile and nearly inter-sterile. These discoveries led to further investigation resulting in the discovery that the leading varieties of sweet cherries, Bing, Lambert and Napoleon (Royal Anne), were self-sterile as well as inter-sterile. This explained, in a minute, why the large plantings were not bearing, for, as a rule, they consisted of no other varieties than the Bing, Lambert and Royal Anne. But, since many small plantings and "back yard or home orchard trees" were producing large crops, there must have been some variety or varieties that were furnishing fertile pollen that was causing the self-sterile and inter-sterile varieties to set large

crops. Such proved to be the case. The Black Republican was one of the first to be found to be a good pollenizer and was recommended as such. Other varieties, including the Tartarian, Coe, Elton, Wood, and many seedlings, etc., were found to be of pollenizing value.

Further work was carried on in the hope that a variety valuable as a pollenizer and at the same time a marketable cherry that would bring as high a price as the Royal Anne would be brought to light. A variety fulfilling these conditions has been found, as the wide awake cherry grower knows. This variety is known as the "Long Stemmed" Waterhouse. Whence came this "life saver" of the cherry industry?

In the early '70s a seedling of the Royal Anne bore fruit on the grounds of Judge Waterhouse at Monmouth, Oregon. As it had the characteristics of a desirable variety, it was propagated and named Waterhouse. Some of our best authorities and cherry growers claim that this is not the Waterhouse that is known for its pollenization value. It has no value as a pollenizer and is mentioned here only as a matter of information. The Waterhouse that is of particular interest to the cherry grower is designated as the "Long Stemmed Waterhouse." The name Waterhouse was most likely attached to it because of its similarity to the Waterhouse growing on the grounds of Judge Waterhouse. The Long Stemmed Waterhouse besides having a long stem has a larger pit than the Royal Anne, is softer of flesh, and is somewhat pointed; otherwise, is similar to the Royal Anne, being impossible to identify when they are in the canned state except that the Waterhouse has a larger pit. (Future reference to the Waterhouse applies to the Long Stem Waterhouse.)

The Waterhouse probably originated in the vicinity of Salem, Oregon. At any rate, it was grown in a cherry orchard at that place unknown to the cherry grower himself. While this grower was aware that there was a difference in the cherries in his orchard, he did not know at that time that his large crops were due to the pollenizing effects of the Waterhouse, which it proved to be. This variety is a more vigorous grower than its probable parent, the Royal Anne. Scions from this orchard were used in budding and grafting nursery trees and were naturally sold as Royal Annes. Since the scions were taken from both Royal Annes and Waterhouse, most of the trees sold were Waterhouse, due to the fact that more scion wood was available from the Waterhouse than Royal Annes because of their more vigorous growth, the two varieties being about equal in number in this orchard. The interesting fact in this

connection, is that all orchards set out with trees from this nursery have been heavy bearers, and we now know that the Waterhouse was responsible. Thus, the reason for the heavy crops of many of the small orchards and "back yard trees" was determined. In all cases, pollenizers, either seedlings of pollenizing value, or of certain named varieties, some of commercial importance and some not, were responsible. Some of these seedling trees and named varieties have been found to be of more value than others; this being determined by the set of fruit on the near-by self sterile varieties. There are certain seedlings that are excellent pollenizers. There are numerous edible varieties such as Black Republican, that are good pollenizers. In fact, great numbers of Black Republicans were grafted into non-productive orchards a few years back. Under certain conditions these grafts have given good results. The Black Republican, however, is not uniformly a good pollenizer because of the fact that nearly all sweet, black, small cherries are generally called Black Republicans, these different strains of blacks not having the same value as pollenizers.

With the Black Republican, as well as with the seedling, we have a tree which bears a heavy crop, but one which in the case of the seedling is worthless and in the case of the Black Republican is a second class cherry and, therefore, not a profitable one to raise except for its pollenizing value. The pollenizer is the most valuable tree in the orchard, so even if the pollenizer does not produce commercial fruit, the space taken up by it is well occupied. Fortunately, we have a cherry that is both an excellent pollenizer and a profitable market variety. This variety, which is the Waterhouse, before mentioned, and should be the only one planted or top worked as a pollenizer, at least under Oregon conditions.

In 1918, Black Republicans sold for 4c to 5c a pound. Waterhouse sold from 6½c to 8c, the same price as Royal Annes. There is no reason why the Waterhouse should sell for less than the Royal Anne, according to one prominent canneryman. Another point in favor of the Waterhouse is that it makes a larger tree and produces a heavier crop than the Royal Anne.

The Waterhouse is uniformly the best pollenizer for the sweet cherry. There is a mistaken impression among some cherry growers and nurserymen that black cherries should have a black cherry as a pollenizer. This is not so. There is no better pollenizer than the Waterhouse. It is not unusual for a 9 to 11 year old Royal Anne or Lambert tree growing along side of a Waterhouse to produce 300 pounds of fruit and the Waterhouse

tree itself producing over 300 pounds. If a tree of that age is not producing over 100 pounds there is something wrong, either a lack of a pollinizer or a lack of a pollen carrying agent, namely, bees.

What method of procedure must we follow to introduce the pollinizer into the orchard, and how far apart should the pollinizer be? In orchards already established the trees must either be budded or grafted. If the trees are under six years they may be budded. The cherry tree buds very readily. It may also be grafted at that age, grafting into one year old wood, using a whip graft. If the trees are eight years or older a cleft graft would be preferable, not cutting into larger than three-inch wood, as it will take longer for the graft union to heal over. If the tree is an old one a few small limbs should be left to take up the surplus sap, which might otherwise drown the grafts. It might be well to paint a band of tanglefoot around the trunk to prevent ants from crawling up the tree. The ants herd aphids in the tree like they were a bunch of goats and usually select tender grafts for their pasture. Should the grafts become infested with aphids they will make very little growth that season. Vigorous trees only should be grafted; grafts will not grow on a

gummosis infested tree. In three years' time the tree will have formed a new top, that is, a top which will produce an abundance of blossoms. As to the distance apart that the pollinizers should be, it would not be safe to have any self-sterile tree further than 75 feet from a pollinizer, as the yield rapidly falls off where the trees are at a greater distance. Some growers have made it a practice to graft but one limb in a tree. It is a mistake not to graft over the whole tree, with the exception of a few small limbs, because if only one or two limbs are grafted, the resulting growth will be very disappointing. A single graft of this nature stands no chance of getting its share of sap so does not make a growth of over a foot or so when it should grow three to five feet. If the varieties are mixed in the picking box the fruit stands a chance of being rejected by the canneryman. If the whole tree is Waterhouse there will be no chance of mixing the varieties.

Needless to say, bees in abundance should be a part of every orchard. Enough bees should be provided to be able to pollinize the whole orchard in a few hours, if necessary, for during rainy springs there may not be more than a few hours of sunny weather in which the bees can carry on their important work.

ceptible than Jonathan was borne out by infections. Soil on which the experiment had been carried on had had infected trees in before, so that the bacteria which spread the disease were present in the soil. Some trees of each variety, free from infection, were planted, and investigation showed that 62 per cent of the wealthy became infected while only 12 per cent of the Jonathan succumbed.

Trees can recover from crown gall, but of course are stunted from being held back by the disease. From those trees that were infected when planted, it was found that 81 per cent of the Wealthy had thrown off the disease in five years, while 31 per cent of the Jonathan had recovered. This goes further to prove the greater hardiness of the latter variety.

Effects of Galls.

Galls were found to be of two varieties, the hard gall and the soft gall. The hard gall is woody, and seems more like a dead body, as if the gall were dead or lying dormant, while the soft gall or hairy root, is a more lively body and seems to be more actively growing. Perhaps the fact that of the infected Jonathans that recovered, 36 per cent of the Jonathans were of the hard galls and only 29 per cent of the soft, may indicate a more active growth in case of the soft galls.

This hairy root, a form of soft gall, is peculiar. When a tree is planted out, it seems to make a good growth, due to the large number of sap roots which are put out from the gall. However, if the gall is located in a position as to directly interfere with the flow of sap, it will later stunt the tree.

Galls act on trees by interfering with sap flow. In this manner, a gall on the main root is more serious and more of a detriment than one on some side roots or secondary feeders. When the sap flow is cut off, the tree is stunted as was shown in the experiment by reduction in twig growth and growth of trunk diameter.

Our grandfathers used to girdle or partially cut off the sap flow of the trees to throw them into fruitfulness. Crown gall does the same in a modified way, thus throwing the infected trees into fruitfulness early. This was shown by the fact that in five years, those trees which were known to have been infested, showed blossoms and fruit spurs while normal trees were still making their younger growth.

Galls that were formed on stock and union seemed to be equally harmful, being both on main feeding portions of the tree. Galls on secondary roots naturally seemed to be less harmful than those on main roots.

The experiment as carried on at Shenandoah, of course, has not had time to run to trees of bearing age, but does cover that kind of stock which would be planted out by the orchardist or grown by the nurseryman. Crown gall is dangerous. It is quarantined from interstate shipment in

Continued on page 24.

The Fatality of Crown Gall in Apple Orchards

By J. M. Van Houten, Iowa State College of Agriculture

IF you were building a house to live in for forty years, would you build it of plaster or bricks? Would you situate it in the valley near the floods or on the proverbial rock, high and dry?

In a similar way, if you were planting out an orchard, would you plant one comparable to the plaster, that would stand up only a few years, or would you make one like the brick, to last for a long time?

Crown gall has been known for a long time but its injury to apple trees has not been known for long and what is known now is still more or less vague. Back in 1910, at the convention of the National Nurserymen's Association held in Denver, members of that body became agitated in regard to the amount of damage caused by this growth and appointed a committee for investigational purposes. Mr. E. S. Welch, president of the Mount Arbor Nurseries of Shenandoah, Iowa, happened to be a member of this committee.

By securing co-operation of authorities at the Iowa Experiment Station at Ames, he has carried on experiments at his place which when finished, will no doubt be of great value to orchardists as well as nurserymen.

In the spring of 1912, the first planting, consisting of 310 trees affected with crown gall and 246 normal trees, was made. There were two varieties, Jonathan and Wealthy, there finally

being 200 of the latter infested and 210 of the former, their totals being 326 and 330, respectively.

It seems strange that crown gall infested apple trees showed more life than those that were supposed to be healthy, but such was true, for at the end of five years, more of the infested trees were alive than the normal ones. However, conclusions cannot satisfactorily be drawn from this, for in the severe winter of 1916-1917, the stand of infested trees was reduced to 91 per cent while 95 per cent of those trees in the healthy block were still standing. Perhaps the more satisfactory conclusion might be drawn from the latter fact.

Different varieties of apples have been known to vary in susceptibility to disease. The same is true of crown gall. While the experiment itself established conclusively the fact that Wealthy is more susceptible than Jonathan, it has been generally recognized that hardier varieties are more seriously affected with crown gall. Take such varieties as the Patten Greening, Brilliant, Okabena, Eastman, Anisin, Wolf River, Tolman, Sops of Wine, the Ben Davis group, Winesap and Jonathan and Wealthy as well, are known to be particularly susceptible to crown gall. Other varieties as Duchess of Oldenberg or Hibernial are seldom infested with the disease. The various varieties of crab are heavily struck.

The fact that Wealthy is more sus-

LABELS

WITH A PURPOSE

TO ATTRACT ATTENTION
AND CREATE SALES



Schmidt
LITHO.
CO.

SAN FRANCISCO

47th YEAR of
SERVICE and
QUALITY

Branches:
 ▼ ▼ SEATTLE · PORTLAND
 ▼ SACRAMENTO · FRESNO
 LOS ANGELES · HONOLULU

allow the bud to slip into place. The bud stick should then be taken and one of the buds removed carefully with a knife. This is done by starting the cut from one-third to a half inch above the bud and cutting carefully underneath the bud, including some of the wood, and coming out about one-half inch below the bud. With the stem as a handle, the bud can be taken and pushed gently down into the T cut made on the branch. When the bud is solidly in place, the upper portion of the bud wood should be cut off transversely so that the wood will fit down tightly upon the stock. The stock is then wrapped carefully with rattia, beginning below the bud at the bottom of the T cut and working upward, taking care not to cover the bud itself, but wrapping securely about the top of the T. A good square knot, drawn tight, should be used. As soon as the bud has "stuck," which will usually be in about two weeks, the rattia should be cut in order that it may not girdle the branch and kill the bud.

Spring budding is often done soon after the sap has begun to flow by using buds from sticks cut and kept in a dormant condition until time of setting.

When it is desired to work over apple or pear wood two or three years of age, whip grafting is frequently used. Whip grafting is performed by making a smooth and straight diagonal cut across the branch to be grafted. Then a split of about an inch down through the center of the limb completes the cutting. The scion to be grafted upon this branch should be of last year's wood, cut when the buds are entirely dormant and prepared for grafting by making a diagonal cut similar to the cut made on the stock. The stock and scion should be carefully fitted together, so that the cambium layers of the stock and scion may coincide at least upon one side. Unless the cambium layers touch at some point the graft will not be successful. Two or three buds are left upon the scion. Finally the scion is either waxed carefully or is wrapped with waxed muslin or waxed string. This grafting may be done in the early spring from a time shortly before the sap begins to flow until the buds have begun to open.

Large Trees.

Often it becomes necessary to work over an old tree in order to change the variety or to fill in the top after some accident. A sleet or snow storm may have taken a valuable limb out of the top. Grafting is the only way by which this condition can be remedied.

On the large trees budding is very seldom used. Here and there on a one-year-old sucker or limb, budding may be used to try out a new variety or for purposes of cross-pollination.

Cleft and bark grafting are the methods used for top working pome and stone fruits. The cleft graft is more popular for the apple and pear, while the bark graft is used more frequently for the stone fruits, except peaches. The apple and pear lend themselves best to cleft grafting because the wood is so

Continued on page 21.

Points On the Art of Top Working Fruit Trees

By W. S. Brown, Professor of Pomology, Oregon Agricultural College

REASONS for top working: Fruit trees are top worked usually for one or more of the following reasons: To change from unsuitable to desirable varieties. To place weak-growing wood of certain varieties upon strong stock. To work over seedlings or varieties that are immune to certain diseases. To shape over an old tree top or to fill in after accident. To provide for cross-pollination in an orchard.

Description of Top Working.

Trees may be budded in the summer as soon as mature wood and good plump buds are available. The peach may be worked over in this way about midsummer, the cherry a little later, the apple and pear in the latter part of August or the first part of September. The equipment for budding consists of a knife with a sharp blade rounded at the point and sometimes fitted with a horn scapel at the other end of the handle

for lifting the lid of the cut, before the bud is inserted. Besides the knife, one needs strands of rattia cut in proper lengths for tying and thoroughly moistened. Limbs or "bud sticks" from trees of the variety desired are taken to the field in wet gunny sacks and kept thoroughly moistened. All bud sticks should have their leaves cut off, leaving the leaf stems in place.

The act of budding, when understood, is a simple one. It consists first in choosing a point on the branch where the new bud when set will have a good opportunity for growth and will grow in the right direction to shape the tree properly, etc. Then a T cut is made in this branch. The downward cut or stem of the T is made first. Then the transverse cut is made by holding the knife blade at a slight angle in order to lift the bark when this cut goes across the stem of the T. Next, if it is necessary, the bark is lifted somewhat to



Stop Feeding Away Your Profits

There's only one way—*spray and spray right.*

Spray at the right time and spray with the right kind. You probably know the enemy's habits and when the most timely spraying or dusting can be done. If you're in doubt ask for Glidden spraying literature.

And spray with the right kind. That's just as important as spraying at the right time. Users of Glidden sprays know this from experience. They know how the Glidden kinds spread the poison evenly over all the foliage and keep it there until it does effective execution.

They know, too, that the big factor in this result lies in the Glidden organization and the complete equipment in the big Glidden plants. Having used Glidden products over and over again they have had evidence of uniformity as well as quality.

The Glidden line includes: Glidden Dry Powdered Arsenate of Lead, Glidden Dry Powdered Arsenate of Calcium, Glidden Dry Powdered Bordeaux Mixture and Glidden Dry Powdered Bordo-Arsenate, Glidden Dry Lime Sulphur, Glidden Paris Green.

Everywhere on Everything

Glidden Products cover such a wide range of usefulness that "Everywhere on Everything" is now a true expression of Glidden service. On farm buildings, on the farm implements, in the farm home, everywhere on everything. Glidden Paints, Varnishes, Stains and Enamels are providing the necessary protection and where needed, attractive decorations as well. There are Glidden Dealers in every locality.

THE GLIDDEN COMPANY, Cleveland, Ohio

Factories: Cleveland Chicago San Francisco Reading Toronto

Branches: New York Chicago Kansas City Detroit St. Louis Boston Pittsburgh Atlanta New Orleans Dallas London

Stoaks in principal cities.

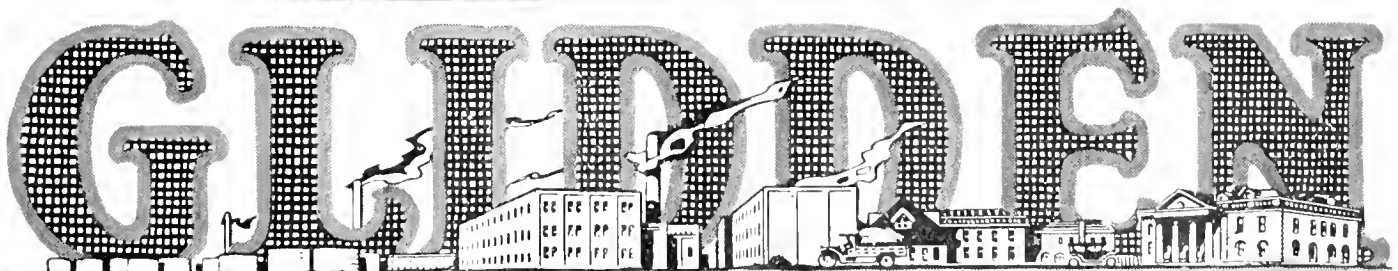

PAINTS - VARNISHES - COLORS - INSECTICIDES

Comparative Efficiency of the Spray Gun

By Prof. R. B. Cruickshank, Experiment Station, Ohio State University.

PERHAPS the one outstanding saving effected during the past season was by the use of the spray gun. The spray gun happened in the nick of time and proved to be a godsend to the hard-pressed grower who had sufficient pioneering spirit to buy one even in the face of what seemed to be a big price. The spray gun has definitely proven its value, to the fruit grower with a power sprayer, in three fundamental ways—in the saving of time, in the saving of labor, and in the saving of spray material.

People are usually slow to adopt new practices, especially when those practices are opposed to current conception, but the spray gun has been taken up by growers all over the country in a brief time. It came, it was seen, it conquered.

Of course, doubts and objections were advanced. In the first place, some said that it could not do the amount and quantity of the work claimed for it. It sounded too good.

One objection raised was that it would not force the spray into the calyx at the time of the first coddling moth application. We had been using angle nozzles and laboring under the supposition that the material must be sprayed into the blossom cup with considerable force. Probably that is correct with the ordinary nozzle, but the spray gun seems able to diffuse such a fog of spray throughout the tree that plenty of poison is lodged in the place where it will be most unhealthy for the apple-worm. Answers to a questionnaire which I addressed to a large number of growers recently were practically unanimous in that they had fewer worms than usual.

Another point of practicability raised was the possible injury to the fruit and leaves, due to very high pressure used. There have been but few instances of any such injury, and in all cases this has been traced to the fact that the gun was held close up and the spray dashed into the foliage on "high." If the operator is working rapidly and does not care to shut off the gun too much, he should endeavor to spray the lower side of the tree at some distance, gradually going higher as he approaches the tree.

The matter of the amount of spray has also been answered in a way complimentary to the spray gun. Except in the early work before a man becomes accustomed to it, the usual answer is that the gun uses less material than the nozzles. Some growers have experienced an economy in spraying even fairly small trees.

I believe that where lack of control of orchard pests has been experienced, the cause may be assigned to application at a time just aside from the critical one, to the use of too low a pressure or to lack of thoroughness on the part of the operator. All these

apply equally to the rod and nozzle. The great danger in the use of the spray gun verily appears in its great capacity. It may lead men to an undue elation and an unconscious carelessness, resulting in the trees getting the proverbial "lick and a promise." I have found but two men in Ohio who, after a fair trial of the gun, are willing to go back to the rod and nozzle. The first man's reason was that "he couldn't work fast enough to keep up with the gun"; and the second one's was that "the spray men could not keep from getting themselves drenched and so preferred the long rods." In opposition to this objection most men have found that it was easier to keep out of the mist.

The spray gun is efficient only as an accessory to a power outfit that is capable of maintaining about 200 pounds pressure. Some men use them with less, most men prefer more.

This immediately brings up the question of the power sprayer to the man who does not possess one. We believe in Ohio that a man who has as few as five acres of orchard can afford to buy a power outfit. I have known men to make them pay and pay well on three acres. The introduction of the spray gun has added another argument for the power sprayer. In comparison with a barrel outfit, the power sprayer is more rapid, more efficient, a saver of time, temper, labor, and material. The man who is still handicapping himself with a barrel sprayer has no cause to complain about the scarcity or high price of labor. For him the power sprayer offers a definite economy.

The tendency even in the hilliest of orchard sections is toward the larger and more powerful machines. If there is a question as to the advisability of buying a duplex or a triplex machine, it should be well considered before choosing the lighter one.

Cherries by Parcel Post

During the season, says the Payette Independent, it was learned that at a town up the road a grocery store was selling sweet cherries at retail at 20 cents per pound. The dealer was asked if he could use some cherries of the same varieties at 10 cents per pound, and he said he could not. Developments: H. Harland inserted a small ad. in the local paper of the town offering to deliver, by parcel post, cherries in 20-pound crates at \$2.00 and \$2.50 each per crate. Mr. Harland has been busy filling the orders that have come in. A decent profit on fruit raised in Payette Valley, a fair rate of transportation and the distribution would be such that all the fruit would find a welcome in homes of people wanting it, but who are prohibited too often from having it because of the middle man's large percentage of profit and big transportation charges.

**BEST SERVICE-
QUALITY & PRICES**



**PERFECTION IN
FRUIT
LABELS**

**THE
SIMPSON & DOELLER CO.**
1423-24 NORTHWESTERN BANK BLDG.
PORTLAND, OREGON.
E. SHELLEY MORGAN
NORTHWESTERN MANAGER
WE CARRY—AND CAN SHIP IN 24
HOURS—STOCK LABELS FOR PEARS,
APPLES, CHERRIES & STRAWBERRIES.

No Orchard or Farm is Complete
Without Our Latest Model

COMMERCIAL SIZE All Purpose Evaporator

Write for Folder D.

HOME EVAPORATOR CO.
ST. LOUIS, MISSOURI

Willamette Valley Apple Orchard OREGON

For sale, 18 acres, of which 10 acres are in apples, 10 years old; ¼ Yellow Newtowns, balance Grimes Golden, Winter Banana and Yellow Transparent; some pears, peaches, cherries and small fruits. Four-room bungalow, good barn, 4 chicken houses, good well. Four miles from Corvallis on Philomath (hard) road; ½ mile to school. Price \$9,000, half cash. Address

Box 782, Roundup, Montana

THE SELF-OILING WINDMILL

has become so popular in its first four years that thousands have been called for to replace, on their old towers, other makes of mills, and to replace, at small cost, the gearing of the earlier Aermotors, making them self-oiling. Its enclosed motor keeps in the oil and keeps out dust and rain. The Splash Oiling System constantly floods every bearing with oil, preventing wear and enabling the mill to pump in the lightest breeze. The oil supply is renewed once a year. Double Gears are used, each carrying half the load. We make Gasoline Engines, Pumps, Tanks, Water Supply Goods and Steel Frame Saws. Write **AERMOTOR CO., 2500 Twelfth St., Chicago**



Plans Shipping Export Apples Through Canal

CHARLES M. SIMONS of London, connected with the firm of Simons, Shuttleworth & Co., British apple and pear exporters, who have places of business in London, Liverpool, Glasgow and also in New York and Boston, who was in Portland recently and talked to a representative of BETTER FRUIT, says that the time has arrived when Pacific Northwest apples and pears should be shipped under refrigeration in ships direct from Pacific coast ports to England.

Simons, who is making a tour of all the Pacific Northwest fruitgrowing districts, including California, says that

other English firms that are handling fruits from this section of the country are joining with his firm in this opinion and that a movement has been started to bring the matter to a successful issue.

The plan as announced by Simons is to secure from the American government, if possible, the use of a dozen ships that are now under the control of the shipping board and that have refrigerating plants and have them make regular runs via the Panama Canal from Portland, Seattle and San Francisco to English ports.

The apple tonnage for export in the Northwest, Simons says, will be so large in a year or two that it should provide a highly remunerative business for refrigerator ships, in addition to the fact that this method of transportation will be much quicker than the present one of shipping across the continent by railroad and reloading on the Atlantic coast. The fruit, he says, will arrive in England in much better condition and at a lessened transportation charge.

To secure a concerted movement, Simons is taking it up with shippers in each of the apple raising districts of the Northwest, as well as with the business organizations in the cities of Portland, San Francisco and Seattle, and on his return to New York is to have a conference with several large shipowners as well as officials, who will ask the shipping board to provide vessels.



CHARLES M. SIMONS
OF LONDON, ENGLAND

Mr. Simons, who is connected with several of the largest apple importing firms in the British Isles, has recently been making a tour of the Northwest apple growing districts advocating the shipping of boxed apples direct to England through the Panama Canal.

Saving Injured Fruit Trees by Bridge Grafting

VALUABLE fruit trees are often so seriously injured by spilling or being gnawed by mice and rabbits who eat the bark and sapwood at the surface of the ground that they die unless aided by tree surgery. The remedy to be supplied in this case is bridge graft-

ing. In order to apply this remedy you should first trim off the gnawed parts of the bark or the bark on the edges of the split with a sharp knife leaving the edges smooth. Then take a twig or scion of last summer's growth about as thick as a lead pencil and long enough to extend an inch and one-half above and below the gnawed part. Both above and below the part to be grafted, cut out a strip of bark an inch and a half long and as wide as the twig or graft is thick. Trim both ends of the graft on the same side by paring it down to about half its thickness for a length of about two inches and then fit the prepared ends into the bark cuts above and below the injury. Fasten each end of the graft to the tree by driving in a very fine tack or brad not much thicker than a pin. Cover the ends of the graft and all cut surfaces with grafting wax.

A union between the graft and the tree will then take place and the injured part will be bridged over. In very bad cases of injury it may be necessary to fasten the lower end of the graft into one of the tree roots. Place a graft every two inches across the injured part.

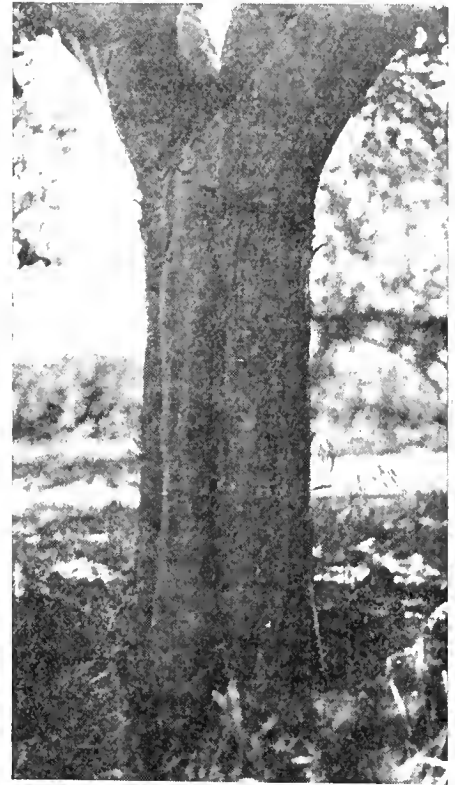

A FINE EXAMPLE OF BRIDGE GRAFTING

The apple tree shown in this illustration was frozen four years ago and the trunk split open. A scion was cut and grafted in from bark to bark along the break, with the result that the tree is today in fine condition. By splitting the bark on this graft at the sides it will eventually seal up with the trunk and in a few years it will be difficult to perceive that a graft has been set in.

\$200 from One Fig Tree

A single tree of Capri figs, situated in an orange orchard at Portersville, California, purchased recently by the Rev. A. H. Zahl, retired pastor of the Emmanuel Evangelical church, netted the owner \$200 in one season, it became known recently. Rev. Zahl discovered the tree situated in a corner of the orchard and covered with the Capri wasp, necessary for the pollination of the fig. He later secured a crop of 2000 pounds from the tree, which he sold for ten cents a pound.

WE DEVELOP KODAK FILMS FREE and pay return postage when prints are ordered

Mail us films with Six Cents Stamps for each desired print. We return excess.

NO CHARGE for unprintable films.

Woodard, Clarke & Co.
Photo Supplies
Wood-Lark Bldg. Portland, Oregon
Ask for Catalogue and Special Offer.

The Old Reliable
BELL & CO.
Incorporated
WHOLESALE
Fruits and Produce
112-114 Front Street
PORTLAND, OREGON

Richey & Gilbert Co.
H. M. GILBERT, President and Manager
Growers and Shippers of
Yakima Valley Fruits and Produce
SPECIALTIES
Apples, Peaches, Pears and Cantaloupes
YAKIMA, WASHINGTON

BETTER FRUIT

An Illustrated Magazine Devoted to the Interests
of Modern Fruit Growing and Marketing.
Published Monthly
by

Better Fruit Publishing Company

703 Oregonian Building
PORTLAND, OREGON

Restrictions on Storing Apples.

The restrictions that the Department of Justice is reported to be contemplating on the storing of apples are not only unwarranted, but unjust in view of the fact that apples are distinctly a perishable product. Even in the best of storage they will not keep only for a short period compared to other food products.

The statement attributed to the Department of Justice is to the effect that it "will permit the storage of apples where it is shown that the same is in line with normal business, or according to the practice of previous years," but that "it will be considered as unfair practice if it is shown that apples are stored with the idea in mind of holding for higher prices."

This ruling has called forth a protest from Eastern growers who say that if it means that apples cannot be sold out of storage at prices higher than the average out-of-orchard prices great injustice will be done the growers as well as the storage plants. With the latter interpretation of the ruling in effect it is feared that a glut in the market would ensue early in the season which would be disastrous to both grower and buyer.

With so many flagrant instances of the hoarding of foods that are not of the perishable nature of fruits, it would seem that the Department of Justice could utilize its authority and energies to better advantage than in attempting to hurt an industry that largely depends for its success on proper storage methods. In fact, fruit is one of the products in which there has been little juggling to obtain high prices through cold storage methods. With a much larger tonnage arriving at the distributing points than the demand called for it has been imperative to place apples and other fruits in storage until such time as the market was ready for them.

Therefore, if the regulations in regard to storing apples are so designed so as to interfere with this practice they should be modified.

Shipping Export Apples Direct.

Now that shipping is resuming to some extent its normal tone the question of shipping Northwest apples for the export trade direct via the Panama Canal is again coming to the fore. The matter at the present time is being taken up by English apple importers who look upon this method as being the ideal way to ship fruit from the Pacific Coast to Europe; and it is the ideal way. With sufficient tonnage to keep a number of refrigerator ships engaged in this trade during the shipping season the fruit should be transported more quickly, more cheaply and arrive at its European destination in better condition.

To secure this result, however, it will

be necessary for the entire Northwest apple growing sections to combine in a concerted movement. One or several districts do not furnish enough export apples to make the venture pay. All of the districts do furnish or will furnish enough tonnage in a year or two and the time to commence the movement and bring it to a successful conclusion is now.

Maintaining Soil Fertility.

The time is fast approaching when America will adopt the methods of maintaining soil fertility that have been practiced by agriculturists in Europe for many years—that is putting back into the soil as much substance as is yearly drawn from it. Quite a long step in this direction is already being made in this country, but a still longer and faster one must be made to catch up with impending conditions. For many years the rich virgin soils in many parts of the United States have withstood annual or semi-annual cropping. This condition, however, is waning and from all sections of the country where crops are grown come reports of the need of re-fertilization.

The encouraging fact in this situation is that this need is being realized by intelligent farmers and orchardists and that they are taking up systematic methods to take care of a possible soil exhaustion. As has been well said, the latter day agriculturist is now farming with his head as well as his hands and is getting better and more stable results. The soil is like anything else, if you keep taking from it and giving nothing back you will eventually have nothing left. Give to your soil and give willingly and it will, with proper care, yield rich returns.

The Increasing Consumption of Fruit

It is said by authorities on the matter that the consumption of fruits and nuts in the United States is greatly on the increase. The reason assigned for this is that the American housewife no longer regard fruits and nuts as a luxury, but as a necessity to be used in the daily diet if possible, on account of their health-making qualities. The truth of the latter statement is borne out by the advice of the medical fraternity who have long and diligently urged an American diet that would include more fruit and vegetables and less meat and pastry.

There are other things, however, that have had their influence in increasing the demand for fruit, two of which were the canning campaign waged by the government during the war and which taught thousands of housewives who had never canned before how to can and the educational campaigns that have been carried on by the large fruit-growing and fruit handling concerns showing the healthfulness of fruit and how to cook and serve it. Due to these facts the fruit tree in the back yard that was formerly looked upon as an incident is now regarded as a distinct asset to be carefully taken care of, and the city matron is as active during the canning season as her country-bred sister.

To Patrons of Better Fruit:

Owing to increased cost of production and the continued high postal rates the management of Better Fruit finds it necessary to raise the subscription price of this magazine to \$2.00 after December 1, 1919. Until then subscriptions will be taken at the old rates, viz:

In United States and possessions—	
1 year	\$1.00
3 years	2.00
In Canada—	
1 year	\$1.50
In Foreign Countries—	
1 year	\$1.50

By renewing your subscription now or becoming a new subscriber you will get the benefit of the present rate.

A return blank allowing you to take advantage of this special offer will be found on page 1 this issue.

Better Fruit Publishing Co.

Editorial Comment.

From all indications an automobile, a motor truck and a tractor is the program soon to be adopted by the successful orchardist.

Cull apples are really worth while this year. Both the "drys" and the "wets" want them. The former for drying and the latter for cider.

Orchards in Berkeley county, West Virginia, recently sold at values of \$1000 to \$400 per acre. West Virginia is evidently getting into the Northwest class when it comes to raising apples on a commercial basis.

The September apple crop report of the Bureau of Crop Estimates shows a slight improvement in apple crop conditions in some of the Eastern states, while conditions in the Northwest are shown to be fully up to early forecasts—the largest of any one section in the United States.

As an illustration of the need for advertising as a factor in the exploitation of a given food product, Mr. Dunlap of the California Prune and Apricot Growers, Inc., cited the following humorous story at the Riverside Convention: A grower sent his wife's sister in Texas a 25-pound box of prunes and received the following acknowledgment: "The prunes arrived in fine shape and are mighty nice to eat, but they don't fry very well." This recalls the sailor laddie in the old wooden-ship days, who sent his mother in Bedford a chest of tea from a China port. She cooked the tea with bacon and, calling in her friends, served it as "greens." All of which causes the remark that judicious advertising is the red blood of industry.

Salem is to be made the dehydration center of the United States and an advertising appropriation of \$250,000 has been made to tell the world about it. It is already the great and only loganberry juice center, and its fruit cannery output is not exceeded on the Coast, while the organization of fruit growers, recently perfected, will make it the greatest prune market in this country. All of which indicates that the Capital City of Oregon is getting ready to go some in the near future.—*Daily Capital Journal.*

Timely Topice and Advice for the Fruit Grower

Notwithstanding the oft repeated advice in regard to spraying, many orchardists fail to provide correct spraying outfits and give attention to the proper methods of spraying their orchards. A neglected or poorly sprayed orchard becomes an incubator for insect pests and plant diseases; a menace to the orchard of a careful neighbor, and loses money for its owner. If nothing else is done to an orchard, it ought to be thoroughly sprayed.

Any system of tenantry on an orchard which results in the depreciation of the soil will eventually have to be abandoned, and it is safe to say that any form of tenure will not be permitted in the future which does not insure the highest possible production permanently. It is well said, that of all forms of conservation, conservation of the soil is the most important.

Cranberries are usually grown on reclaimed salt marshes but will not be a success in such locations until dykes are constructed which prevent the flooding with salt water. In order to put the bog in condition for planting sufficient time must elapse to wash out the salt, as the plants will stand only a limited amount of saline matter. Salt marshes treated with fresh water flooding develop into fine cranberry land, provided the soil matter is of the correct nature.

Quack tree doctors are said to be working on the Coast and a warning is issued to orchardists to be beware of their operations. Federal inspectors have recently seized several shipments of concoctions which were being sold on the Pacific Coast as cures for all the ills of trees; therefore, fight shy of the tramp tree physician.

According to Prof. T. J. Headlee, experiments show that the most practical method of controlling appleaphids consists of the application of winter strength lime-sulphur, to which 40 per cent nicotine has been added at the rate of 1:500, during the green bud stage. At this time the maximum number of lice will be hatched and will be killed by the nicotine, and the unhatched eggs will be in their most sensitive state and will be destroyed by the mixture.

Fads and fallacies, says the California Agricultural Bulletin, are sometimes exploited in the columns of rural publications, and they frequently deceive those who are inexperienced in horticulture or farming. It is well to look askance upon some of the theories and alleged experiences which are related by people whose fanciful and romantic conception fit them better for fiction than farming. When we read of the staggering crops of Phenomenal Phodder Plants, Spineless Gooseberries or Miraele

Melons, it is well to turn to the advertising pages and see who has offered these promising introductions for sale. This is not written to decry or discourage new productions or condemn everything new, but as a warning to go slow in accepting as gospel truth everything written by the amateur plant wizard who may sign himself Horticola, Agricola or Cococola. It is best to try new introductions furnished by reliable and well known seed houses or nurseries which have carefully tested what they recommend, and then to consider if it is actually adapted to the situation where it is to be tried.

What They Are Doing in California

An experimental drier for the purpose of effecting a method of saving the California wine grape crop was installed recently at Davis by the State Department of Agriculture. Experiments in drying wine grapes in the sun are also being gone into for the purpose of turning them into raisins as well as a method that will allow them to be cured and shipped out of the United States for the making of wine.

It is reported that the majority of growers, packers and fruit handlers in California see in the new state standardization law a means of bringing the fruit industry of that state to a much higher level. While some resentment is being shown by a small percentage of those interested, the great majority of the growers are loyally cooperating with the state department of agriculture in enforcing and observing the law.

Dr. S. I. Kuwana, entomologist for Japan, arrived in Sacramento recently. Dr. Kowana brought with him a number of beneficial parasites of the Japanese mealybug.

A better article of dried peaches is the aim of the California Peach Growers' Association. The peach growers' association will adopt the plan of the apricot growers in improving their output and advertising it to the consumer.

California is adopting the plan of turning over to the charitable institutions of the state fruit that has been condemned as unfit for the public markets.

During the height of the grape shipping season nearly 200 carloads a day were shipped from Lodi.

A Clovis woman who started putting up a fancy pack of figs and nuts four years ago is now operating a big brick warehouse in which 25 people are employed to handle the output, which this year will total about 25 tons. The first year she shipped only 250 pounds.

R. L. Nougaret was recently appointed by Director Hecke to take charge of the Viticultural office of the new Department of Agriculture. Mr. Nougaret has had a wide experience in this line and is looked upon as a very valuable addition to the staff of the department.

The experiment of shipping ladybugs to Modesto from Tuolumne county will be tried for commercial purposes the latter part of this week. When four sacks will arrive for distribution to bean growers at \$2.75 per sack. If the bugs are in good condition, arrangements will be made for shipments in larger lots. Assistant Farm Adviser Roy D. McCallum returned from the strawberry section last week, after having arranged with George Conlin to ship ladybugs to Stanislaus farmers. He also brought back 32 sacks of bugs, which will be distributed in the bean fields where the black aphids are numerous. McCallum inspected a number of fields where the bugs were used and found the aphids completely destroyed. About a sack and a half to five acres are required to combat the pests.

California is rapidly becoming the "greatest home in the world for peaches," according to a statement made at Riverside by Homer B. Fairchild, promological expert with the Department of Agriculture, at Washington, D. C. "The peach crop of America this year will not be more than 20,000,000 bushels," said Mr. Fairchild, "and of that amount California will produce 16,000,000 bushels. What with peach yellows and curly leaf, Delaware, Michigan, Ohio and parts of Indiana and New Jersey will not have a quarter of the crops they used to have, while California has an immense field and the demand is proportionately large. Every dollar California has spent vanquishing horticultural diseases and insect pests will return ten-fold, and then some. In ten years the crop of Georgia has fallen from 1,200,000 to 2,700,000 bushels, all because of the yellows which have slowly sapped the life out of the trees. It is almost the same in Virginia. California is more nearly free of peach tree diseases than any other state in the Union."

The American Fruit Growers, Inc., recently absorbed the American Fruit Distributors, a \$50,000,000 corporation doing business in Southern California. It is expected that Brawley will be the headquarters of this new branch of the organization.

Nursery stock in California is reported to be almost as short as it is elsewhere and peach trees are quoted at 40 cents apiece for 1 or 1,000. Grape cuttings have risen in price from \$10 to \$30 and \$35 per thousand.

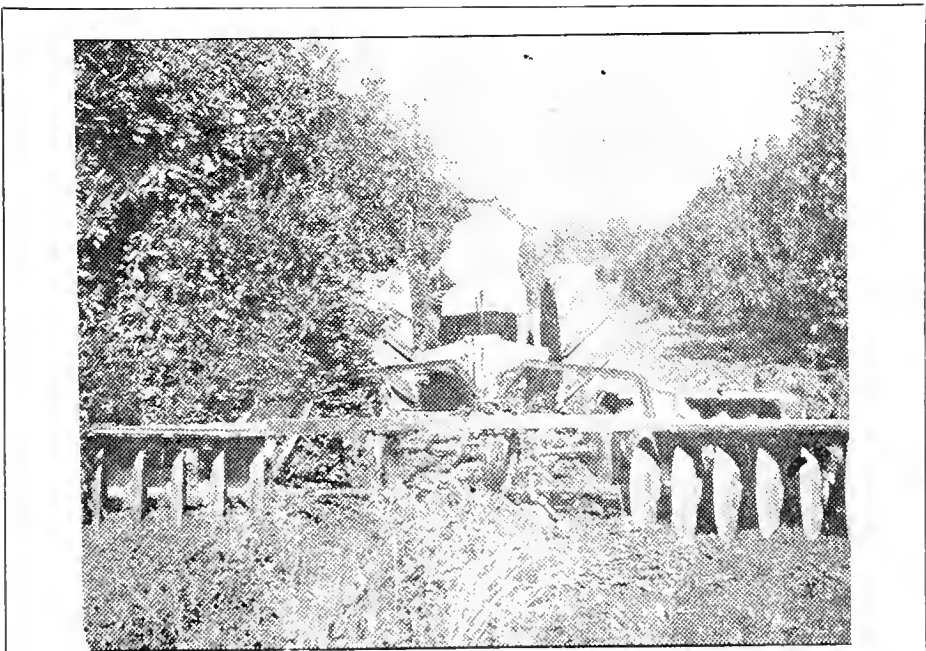

The Roderick Lean Automatic Orchard Disc, which is attracting a good deal of attention in California where it is being tried out extensively. In this illustration the disc is being pulled by the Fordson tractor, for which it was designed.

SAVE YOUR APPLES
 With a Monarch Hydraulic Cider Press you can turn your culls into good selling cider. You can also custom pressing for your neighbors. Our improved high pressure construction gets all the juice from the apples with minimum power. All sizes of Presses, from 15 to 400 barrels a day. A small investment will start you in a profitable business. Ask for free, 60-page Press Catalogue describing our 1915 Outfits.
WESTERN FARQUHAR MACHINERY CO.
 308 E. Salmon St., Portland, Ore.

Diamond Quality Strawberry Plants
 FOR IMMEDIATE DELIVERY
SPECIAL!
"PROGRESSIVE" EVERBEARING
Planted Now—
 Will fruit heavily in the early spring.
 We offer a fine lot for Prompt Shipment
 Price, doz. 60c, 100 \$3, 1000 \$20
PORTLAND SEED CO.
 PORTLAND, OREGON

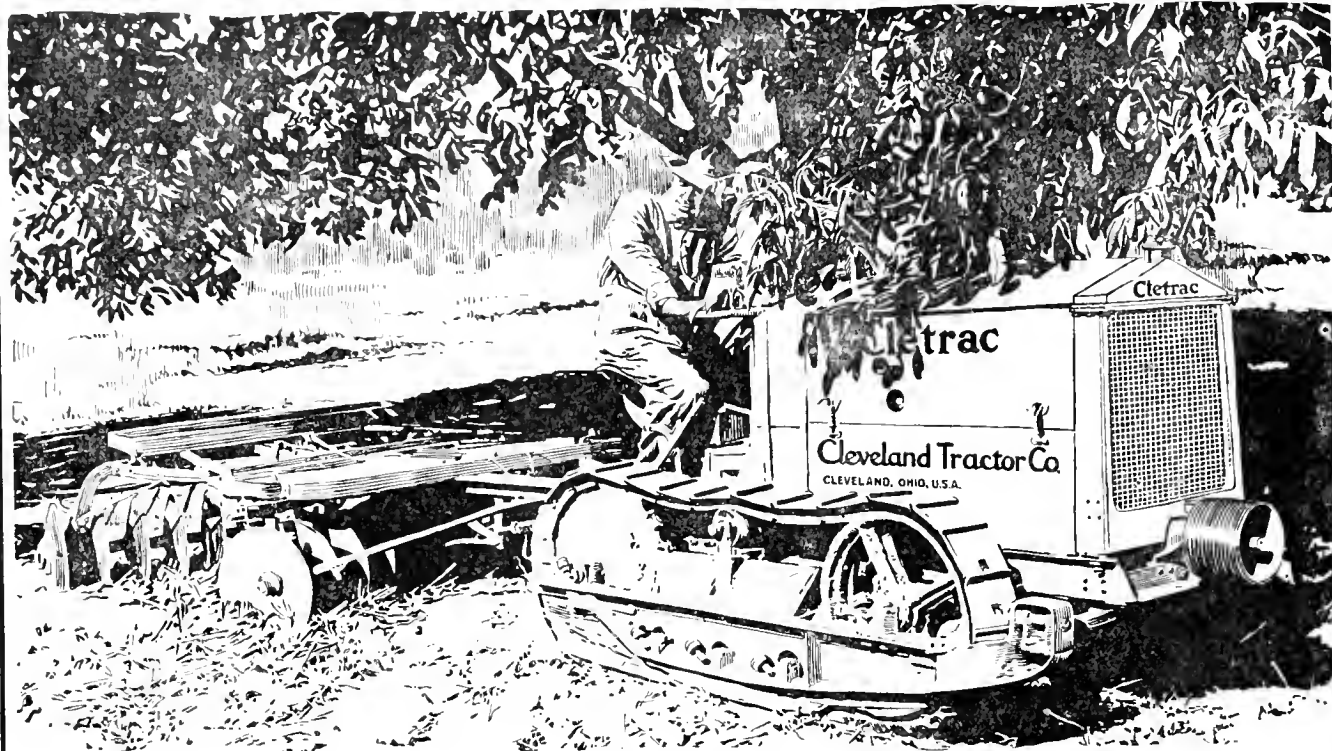

Powerful and Compact

Ideal for Orchard Work

A tractor to be profitable in orchard work must have plenty of power—but it must be a *small* machine, capable of working up close to trees, capable of getting under low hanging branches, capable of turning sharply, capable of good hillside work.

The Cletrac Tank-Type Tractor meets *all* of these requirements—and more.

It is the embodiment of compact power. It is small. It is easy to handle among fruit trees. It turns in little more than its own length. It is ideal for hillside work because of its tank type of construction, which enables it to go practically

anywhere without slipping, sliding or packing down the soil.

The Cletrac burns kerosene—and is very miserly in the quantity it consumes. Distillate or gasoline can be used equally as well if desired.

“Selecting Your Tractor” is the name of an attractive booklet that every orchard owner should have. It gives a rich fund of information about tractors and their uses. Your copy is ready. Send for it today—or ask the Cletrac dealer for one.

The Cleveland Tractor Co.
 19145 Euclid Avenue Cleveland, Ohio
Largest producers of tank-type tractors in the world

Cletrac

TANK-TYPE TRACTOR

(Formerly known as the "Cleveland Tractor")

If you had been on the Arizona

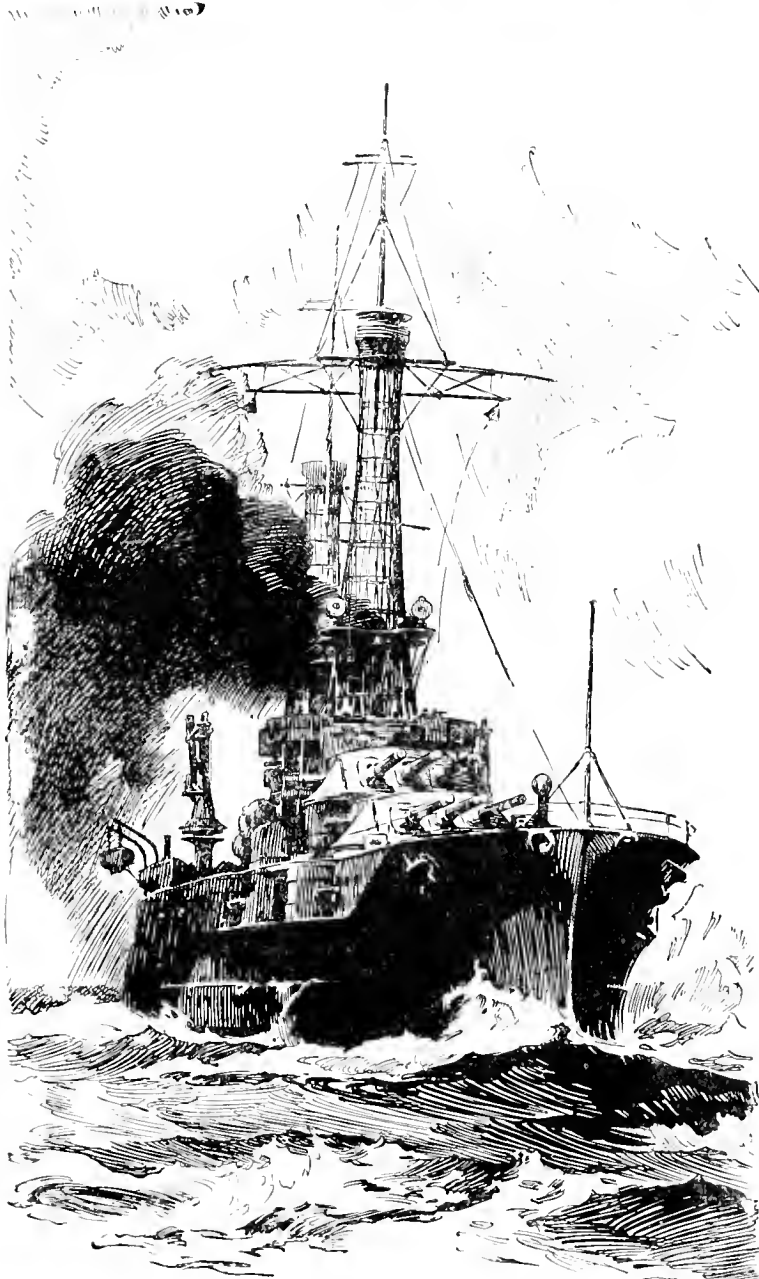

HERE she comes, homeward bound, with "a bone in her teeth," and a record for looking into many strange ports in six short months.

If you had been one of her proud sailors you would have left New York City in January, been at Guantanamo, Cuba, in February, gone ashore at Port of Spain, Trinidad, in March and stopped at Brest, France, in April to bring the President home. In May the Arizona swung at her anchor in the harbor of Smyrna, Turkey. In June she rested under the shadow of Gibraltar and in July she was back in New York harbor.

Her crew boasts that no millionaire tourist ever globe-trotted like this. There was one period of four weeks in which the crew saw the coasts of North America, South America, Europe, Asia and Africa.

An enlistment in the navy

gives you a chance at the education of travel. Your mind is quickened by contact with new people, new places, new ways of doing things.

Pay begins the day you join. On board ship a man is always learning. There is work to be done and he is taught to do it well. Trade schools develop skill, industry and business ability. Work and play are planned by experts. Thirty days furlough each year with full pay. The food is fine. A full outfit of clothing is provided free. Promotion is unlimited for men of brains. You can enlist for two years and come out broader, stronger, abler. "The Navy made a man of me" is an expression often heard.

Apply at any recruiting station if you are over 17. There you will get full information. If you can't find the recruiting station, ask your Postmaster. He knows.

Shove off! - Join the U. S. Navy

Northwest Fruit Notes from Here and There

OREGON.

Claiming the record for Bartlett pear prices in Oregon, Medford during the month of September reported the sale of a car of Bartletts at \$5.20 per box. Another car from that district sold for \$5.00 per box.

Although the early rains caused some loss to prune growers in the Willamette Valley, the damage was not heavy, and the Oregon prune crop is expected to be very good. Growers have been warned by the prune handling concerns to separate the damaged prunes from the perfect fruit, in order to keep up the grades. The damaged prunes will be marketed separately.

With an addition to their plant costing \$60,000, the Hood River Apple Vinegar Company now has what is said to be the largest and best equipped cider and vinegar making plant on the Pacific Coast.

Ten cars of fresh prunes shipped from the Mosier district, it is reported, will return to prune growers of that section an amount that will give them an average of \$1,000 per acre for their crops. The prunes were sold for \$100 per ton, f. o. b. shipping point. One grower figures his returns from two acres at \$1,100 per acre.

During the month the prices for Oregon apples was generally well maintained, but buying was somewhat less than during the month of August. Sales were reported running from \$2.40 to \$3.75 per box, the latter price being for Delicious.

Prune picking commenced September 15 near Dallas, where the fruit was said to have been practically unhurt by the early rains. The prices for picking were about the same as those paid last year.

Low temperatures prevailed in the Medford district during the early part of September where the pear picking was on in full blast. Later the weather warmed up and the pear harvest went on briskly.

During the past year the King's Products Company distributed \$125,000 in salaries in the Salem district and paid out for products \$525,000.

The annual packing school conducted at Hood River by the Hood River Apple Growers' Association had an initial attendance of 70, the largest number that has ever attended the school on the opening day. A feature of the course were lectures every day on grading and packing apples by experts.

George Sykes, who has spent considerable time studying fruit packs, is this year introducing a new system of packing apples. The apples are laid on cardboard patterns in which slits are cut. The system, it is said, makes a tight pack. It has proven popular with the

trade, in that the apples are immediately on display when the top of the box is removed.

Gervais claims the champion berry picker of that section. Her name is Miss Esther Gleason, and in one day Miss Gleason picked 157 pounds of Evergreen blackberries at 4 cents a pound, netting her \$6.28 for her day's work.

According to Earl Percy, secretary of the Oregon Growers' Cooperative Association, the demand for fruit and nut products is increasing rapidly and the average housewife no longer considers these foods as luxuries. This is said to be particularly true of walnuts which formerly were in demand largely at Christmas time. This is no longer the case and walnuts are now being used very generally throughout the year.

The Himalaya berry is being put forward as a fine berry to grow in Oregon. It is a berry somewhat like the Evergreen blackberry, ripens about the first of August, continues bearing until October, and is a very heavy bearer.

Reports are to the effect that the Flame Tokay grape crop at Grants Pass matured in good shape and that the output will be of fine quality. The first car of Winter Banana apples from the Grants Pass district this year sold for \$3.81 per box on the New York market.

The Multnomah County Fair and Land Products Show, held at Gresham, September 15 to 20, resulted in a good collection of exhibitors of stock, land products and farm implements. The fruit exhibit was somewhat limited owing to the fact that only early apples were available. The racing events were unusually good but the attendance throughout the week was not as large as it should have been.

Hood River held its county and fruit fair September 19 and 20, and many fine exhibits of fruit were on display. In fact, the fruit display was one of the best ever made in the Hood River Valley.

Salem during the past two months is reported by the Daily Capital Journal of that city to have been the reddest, juiciest spot in Oregon. This comment was called forth by the fact that the Phez Company and other plants there were putting up thousands of gallons of loganberry juice and thousands of cases of jams, jellies and cans of small fruits. The Rupert Company also had a very successful season and reports a large output at its various plants.

The Oregon Growers' Association reports a greatly added membership to its ranks during the past month. Wherever meetings have been held many growers have voluntarily joined the association while the propaganda conducted by the association's managers is bringing in others who are not able to attend the meetings.

WASHINGTON.

The Harry Shotwell ranch, near Monitor, has a good example of what can be done in taking care of orchard help during the fruit harvesting season. Mr. Shotwell has erected six small houses, each containing a kitchen and sleeping room, furnished with a bed, stove and other conveniences. These are to be occupied by families who will have charge of the picking and packing of the apples on his twenty-acre orchard.

A Wapato rancher, who recently paid \$19,000 for a fruit ranch, expects to harvest enough fruit from it this year to more than pay the purchase price.

The Puyallup and Sumner Fruit Growers' Association has disposed of 95,000 cases of canned berries this year. The association now has plants at Albany, Oregon, Wenatchee and Chehalis, Washington, in addition to the one at Puyallup.

After being located at Toppenish for 22 years, Richey & Gilbert, the well-known Washington fruitmen, recently moved their headquarters at Yakima, where they have just completed a large and modern warehouse.

According to figures recently published by the government, Grandview will this year produce an apple crop as large as that of several of the New England states combined. The whole state of Ohio this year, it is said, will not produce as many apples as the Grandview section.

A peach measuring 11½ inches in circumference and weighing 1½ pounds was on exhibition recently at Wapato. The peach was sent to Kansas City to be exhibited there.

The harvesting of Selah's Jonathan crop commenced about September 22 and the picking of other varieties was commenced in the early part of October.

The last Bartlett pears to be accepted by shippers under the contracts entered into with the growers were loaded out at Yakima on August 16. A special train of 50 cars was made up and shipped east. This time limit does not apply to Bartletts raised on the hills, which are from ten days to two weeks later than those in the valley proper. About 500 cars of pears will be shipped from the Yakima district this season, totalling in value \$750,000.

Work on the season's run of Bartlett pears began on August 19 at the Libby, McNeill & Libby cannery, when a crew of 300 started. The cannery expects to handle a minimum of 500 boxes daily, and will use 150 tons of pears weekly during the season. Manager R. C. Turvin says the pears were in better condition than he has ever seen them in the Yakima valley, and anticipates no difficulty in having them keep until the end of the run.

An utter collapse of the market for summer fruits was threatened during August because of the shortage of sugar existing throughout the country, according to reports received at Yakima. As a result the price of pears dropped from \$2 to \$1.75, though practically all the crop has been sold. Peaches that were contracted for at \$1 a box early in the season dropped to 50 to 60 cents and buyers were not eager to buy at those prices.

Washington's commercial apple crop this season will total 21,300 cars, an increase of 5,050 cars over the 1918 crop, according to estimates issued recently by the federal bureau of crop estimates. The combined apple tonnage of Idaho, Oregon and Washington is estimated at 30,328 cars, an increase of 11,296 cars over the 1918 yield.

Topping the market for this or any other season, as far as known in the Yakima district, is the price of \$3.25 a box, in the orchard, for 2,500 boxes of Delicious apples reported to be paid to Sanderson Brothers for the fruit in their orchard this season. They sold the entire crop of 25 acres at a price which will bring them \$10,000, the amount they paid for the place when they acquired the ranch five years ago.

Nice Bright Western Pine
FRUIT BOXES
AND CRATES
Good standard grades. Well made. Quick shipments.
Carloads or less. Get our prices.
Western Pine Box Sales Co.
SPOKANE, WASH.

Send for This
Wonderful One-Man Puller
and pull your stumps 30 days FREE. One man alone handles and operates. No horses needed—no extra help required—wonderful leverage principle gives a man giant's power to pull big, little, rotten, low-cut tap-rooted stumps and brush. Patented quick take-up for slack cable. Several speeds—when stump loosens increase the speed and save time. Works in any position. Easily moved around field.

Thousands of Kirstins Now in Use.

One Man Alone Handles Biggest Stumps!

Write for Special Agent's Proposition!

Pull Stumps Free

Single! Double! Triple Power!

Kirstin One-Man Stump-Puller

Shipment From nearest of following distributing points as a very time and freight:

Escanaba, Mich.
Atlanta, Ga.
Portland, Ore.
Soo, Canada

Factory and General Office, Escanaba, Mich.

Send No Money Not even a penny! After 30 days FREE trial you are to be the judge. Your word is final.

Half Year to Pay Buy on easy payments if you wish. This way the Kirstin pays for itself from the fine profits it makes you.

The Kirstin will clear an acre from one anchor. All-steel construction—unbreakable. Sent anywhere on promise to give puller a fair trial. If satisfied, keep puller. If not pleased, return at our expense. You don't risk a penny. Four easy ways to pay. Priced as low as \$49.50. One-man style or HORSEPOWER—all sizes. 3-year guarantee, flaw or no flaw.

Big Free Book! Send for most valuable stump puller book—pictures—prices—terms—letters from Kirstin users—also full details of Special Agent's Proposition. Don't miss it! ALL FREE. Write today.

A. J. KIRSTIN CO., 228 E. Morrison St., Portland, Ore.

Make More Boxes PER DAY

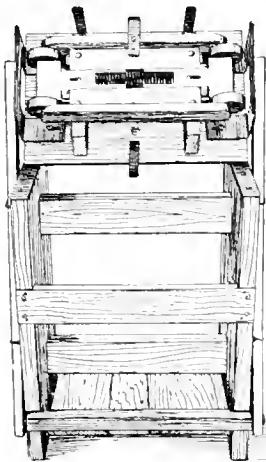

**GIARD
Box
Making
Machine**

Nail 100 to 200
more boxes
per day.

**Rapid
Accurate**

\$25.00

Send for a
descriptive
folder.

Spokane Seed Co.
DISTRIBUTORS

Dealers in Fruit Picking and Packing Supplies
SPOKANE, WASH.

Berry Plants Wanted

Loganberry, Burbank Phenomenal, New Oregon Strawberry and Cuthbert Raspberry. Must be True-to-Name Plants.

Write "M. J. M." care Better Fruit, Portland, Oregon

Established 1882

F. W. Baltes & Company Printers

WE print anything from the smallest to the largest and always welcome orders of any size or quantity, giving prompt, personal and efficient service.

Mail or phone inquiries are solicited. We do not specialize — experience and equipment enable us to print everything equally well. We render service in preparing copy and illustrations and furnish plans and estimates for catalogs, booklets, publications, billboard and any other kind of advertising.

First and Oak Streets
Phones: Main 165 and A 1165
Portland, Oregon

Conservative estimators are now placing the apple crop to be shipped out of Omak, Wash., this fall and winter at 600,000 packed boxes. This is the basis taken for ordering boxes by the two large shipping organizations.

A market for between 4,000 and 5,000 tons of cull apples will be provided this season by the California Packing Corporation of Yakima, involving a payment of at least \$10,000 to Yakima farmers, according to an announcement made by T. L. Tennant, superintendent.

Alleging that recent advances in wholesale lumber prices have necessitated the move, fruit box manufacturers have advanced prices four cents per box, making the ruling quotation 21 cents each. This is double the figure charged three years ago and ten cents over last year's prices.

At Yakima when the rush of the fruit harvest is under way, a thousand men, women and young people are at work on Produce Row, handling the flood of fruits. Fully 100 cars of pears, soft fruits and mixed produce are rolled out daily during the season and the weekly payrolls total \$30,000. The row is a mile long and a paved highway, bordered on either side by warehouses, packing plants, evaporators, canneries and cold storage plants.

More than 25 firms have entered the Wenatchee field to handle the 1919 apple crop. The following average prices have been offered for extra fancy grades and are about 50 per cent higher than last year's early quotations: Winesap, \$2; Spitzenberg, \$2.50; Delicious and Winter Banana, \$3 to \$3.25; Jonathan and Rome Beauty, \$2.25; Black Ben, \$2; Ben Davis, \$1.85, and summer apples, \$1.75 a box. Some contracts have been made at \$2.50 for the entire production of the grower on the orchard run basis.

J. C. Lilly, president of the Farmers and Merchants' Bank of Cashmere, reports that a big apple crop in that district is assured and that prices, from present indications will break all records.

Luke Powell, former district horticultural inspector, is reported to have sold his crop of Winter Bananas at \$3 a box, orchard run. The crop is estimated at 4,000 boxes. From his home ranch near Prosser, J. A. Anthon of Grandview is said to have sold his crop of Winter Bananas from 10 acres at the same price.

Ten years ago the Spokane Valley section immediately adjacent to the city of Spokane was a barren waste. Irrigation was introduced and this season the apple production of Spokane Valley is estimated at 600 to 900 cars. Spokane Valley Fruitgrowers' Union, with 225 growers and a fine modern packing plant at Opportunity, employing 125 persons, will ship more than 200,000 boxes. Two-thirds of the crop, 110 cars, has already been sold and in many instances partly paid for. On September 15 the union commenced picking winter Bananas of which 5,000 boxes will be shipped. Pickers started on Wageners on the 22nd inst.

Apples ripened a week to ten days earlier than usual in the Wenatchee district. Winter Bananas and Jonathans have been picked and by September 22 the apple harvest on late varieties was in full swing. The district will ship a solid trainload of fifty refrigerator cars daily if cars are forthcoming. By October 1 this output was doubled. It is estimated that 5,000 persons will be employed in the Wenatchee apple orchards.

At the apple exhibit of the International Shippers' Association at Milwaukee, the Boston-Okanogan Apple Company was awarded a silver cup for the sweepstakes prize for plate exhibits.

Spokane Valley apple growers and shippers seem convinced that they should sell no cull apples this year under \$20 a ton. It is expected that the market will open here at about that figure.

One of the largest land deals ever consummated in the Okanogan Valley was closed when Charles Simpson, an apple grower of Cashmere, purchased for \$60,000 from George H. Ellis and James E. Forde of Spokane 180 acres under the irrigation system. Eighty acres are in six-year-old apple trees and 100 acres in alfalfa and corn. The orchard is one of the finest in the county. It will yield nearly 10,000 boxes of apples this year, and with anything like a favorable season will produce from 18,000 to 20,000 boxes next year.



Are You Satisfied

with your present banking connection? Is it adequate, strong, well-established in the community?

If not, we wish to call to your attention the facilities and resources of this sixty-year old bank, the pioneer of the Pacific Northwest.

Correspondence or calls invited.

LADD & TILTON BANK
Portland, Oregon



Apple Profits Are Increased

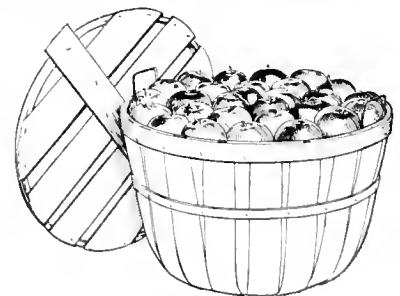

BY USING

Universal Bushel Shipping Packages

Fruits and vegetables can be handled at a greater profit by shipping in UNIVERSAL BUSHEL SHIPPING PACKAGES.

- They can be stored better.
- They can be shipped better.
- They show off to better advantage.
- They can be handled easier.

Get that interesting and helpful booklet—"Shipping Profits." It is sent FREE.

For 25c in coin or stamps sample of the UNIVERSAL BUSHEL SHIPPING PACKAGE with centerpost and cover, will be sent.

Package Sales Corporation

106 East Jefferson Street South Bend, Indiana

MYERS HONOR-BILT

Pumps that give most modern water supply for home and farm. Myers Cog Gear Pumps operate one-third easier and have Glass Valve Seats that cannot wear or corrode. Myers Self-Oiling Power Pumps, Working Heads and Pumping Jacks run by any gasoline engine or motor. Myers Hydro Pneumatic Pumps and Self-Oiling Electric House Pumps furnish running water systems for all buildings. Myers Spray Pumps protect fruit and vegetables. Also World famous Myers Hay Unloading Tools and Door Hangers. Dealers everywhere. Ask yours. Attractive booklets on request.



F. E. MYERS & BRO.
135 Fourth St. Ashland, Ohio

PUMPS FOR EVERY PURPOSE

Mitchell Northwest Distributors
Portland, Ore.

NOW is the time to send to
Milton Nursery Company
MILTON, OREGON
FOR THEIR 1919 CATALOG.
FULL LINE OF NURSERY STOCK.
"Genuineness and Quality"

9 CORDS IN 10 HOURS



RUNS EASY No Backache
SAWS DOWN TREES weighs only 45 lbs.
EASILY CARRIED

BY ONE MAN. IT'S KING OF THE WOODS. Saves money and backache. Send for FREE catalog No. B 140 showing low price and latest improvements. First order gets agency.
Folding Sawing Machine Co., 161 West Harrison St., Chicago, Ill.



"That's Relief for My Rheumatic Aches"

SLOAN'S LINIMENT is an effective counter-irritant that penetrates to the affected part, without rubbing, scatters the congestion, and promotes a warm, comfortable relief. Try it when your "bones ache" and you feel you "can hardly stand up any longer."

For more than 38 years Sloan's Liniment has been used by the families of the nation in quickly relieving rheumatic aches, lumbago, neuralgia, sciatica, lame, sore, strained muscles, bruises and other pains and sprains. Put up in convenient bottles in three sizes—the larger the bottle the greater the economy. 35c., 70c., \$1 40.

Sloan's Liniment

Keep it handy

IDAHO.

Concord grapes appeared on the market at Lewiston, Idaho, on August 22. The crop in the district is considered fair, and it is expected the demand locally will outstrip the supply. The prices are high, and the minimum for standard Concord, Muscatel and Flamme Tokays is expected to range about six cents a pound. Some white Sweetwater grapes have also been placed on the market.

Fruit growers and packers in convention at Lewiston, Idaho, went on record as favoring the adoption of the Washington pack for the marketing of Idaho fruit. The Washington pack was favored because it is so well established in Eastern markets, and is looked upon as a standard for Western apples. It is felt that the adoption of a new system, which would be unknown to consumers at the market centers, would benefit Idaho growers far less than the adherence to the Washington pack.

The Indian Cache Ranch in the Lewiston district is estimated to have produced about 75 tons of grapes this year. The Indian Cache Ranch is the largest vineyard in the Lewiston country, with an area of about 23 acres and an average production of three tons of the fruit to the acre. The entire crop is sold directly to the retailer, most of the crop going to the Western and Middle Western states. Little of the choice fruit is offered on the local market.

MONTANA.

The apple harvest in Montana is in full progress. All but the very late varieties, of which there are few, were ready to pick by the 20th of September. By October 5th practically all fruit was off the tree. Varieties were ready to pick two weeks earlier than last year and some even three weeks ahead of 1917.

Despite the earliness of the State Fair, an attractive apple exhibit was staged. Every important apple district in the state was well represented. While the majority of the prizes went to the Bitter Root apples, other districts had very commendable exhibits.

The county exhibits at the State Fair were a surprise to everybody. Even the "drouth stricken" sections so much talked about during the summer could not be distinguished by their exhibits.

During the early part of the season considerable fear was expressed that the late spring frosts had greatly reduced the fruit crop, but the harvest results showed that early estimates were short.

The color, size and general condition of all varieties, except Wealthy, are very satisfactory. The Wealthies, due to continued smoky conditions during August, were decidedly of color.

The labor supply is more plentiful than in past years. While unskilled labor receives from \$3.00 to \$5.00 per day, and skilled from \$5.00 to \$7.00, the growers feel justified in paying it as there is a brisk demand for all produce, and at the same time they realize that the laboring man must pay good prices for his needs.

While fruit prices vary in different districts there is a decided increase over those of last and previous years. Already growers are preparing to give their orchards better attention in the future on the strength of the upward tendency of the fruit market.

UTAH.

The annual "peach day" at Brigham, Utah, has developed into both a tradition and an institution. This year it was held on September 3rd. Great things from various parts of Utah and Idaho filled the peach center to overflowing. In the shady grove of the public park stands were erected where vast quantities of peaches and melons were dispensed free of charge to feed the hungry thousands. An excellent exhibit of fruit filled the show cases in another part of the park. In those cases Brigham displayed both her pride and her resources.

The peach shipping season at Brigham was on full blast at that time. In spite of both frost and drouth this year, the peach crop is the heaviest in the history of that section, and that is saying a good deal. Furthermore, prices are good, the growers getting from \$1.50 to \$1.80 a bushel for their crop. An air of smiling prosperity therefore pervades the place.



SULPHUR

It has been proven and so recommended by the University of California that if you sulphur your grape vines and orchards 6 times they will not be affected by MILDEW or RED SPIDERS.

ANCHOR Brand Velvet Flowers of Sulphur, also EAGLE Brand, Fleur de Soufre, packed in double sacks, are the fluffiest and PUREST sulphurs that money can buy; the best for vineyards; the best for bleaching purposes, LEAVING NO ASH.

VENTILATED Sublimed Sulphur—Impalpable Powder, 100% pure, in double sacks, for Dry Dusting and making Paste—Sulphur.

For LIME-SULPHUR SOLUTION, use our DIAMOND "S" BRAND REFINED FLOUR SULPHUR.

To create additional available plant food, drill into the soil 100 to 400 pounds per acre "DIAMOND" "S" BRAND POWDERED SULPHUR, 100% pure. This has increased various crops up to 500%. The sulphur may be applied broadcast by hand or with a duster, but usually an ordinary land plaster sower or lime spreader is used.

Also PREPARED DRY DUSTING MATERIALS, Tobacco Dust, Dry Bordeaux, Dusting Sulphur Mixtures, etc. And Standard LIME-SULPHUR SOLUTION 33° BE., Fungicid. and Insecticidal.

Carried in stock and mixed to order.

San Francisco Sulphur Co.
624 California St. San Francisco, Cal.

We are equipped to make immediate shipments. Send for "ILLUSTRATED BOOKLET"; also booklet "NEW USES FOR SULPHUR," Price-list, and Samples.

Please state for what purpose you use the sulphur, quantity needed, and date of shipment preferred.

Make Money All Winter

Pull out stumps and get all the virgin land at work making money for you. It's the best land you have. Work can be done in Winter and early Spring. Stumps pulled at 8c to 5c each. An acre or more a day.



Hercules Triple Power Stump Puller

Find out all about it by sending for the big book at once. See the proof we offer. Get the special low price proposition we are making. Address **Hercules Mfg. Co.** 969 28th St., Centerville, Ia.



Get him with a Stephens Trap

—and ship his hide to DENVER. Stephens will pay you the highest prices for all Western Furs — Coyotes, Skunks, Muskrats, Wild Cats and all others. DENVER is the Closest and Best Market on Earth for Western Trappers and Fur Shippers. Stephens of Denver is the largest exclusive buyer of Western Raw Furs in the world. Stephens charges you no commission—saves you 6c to \$10 on express or parcel post and you get your money back 2 to 10 days quicker—because Denver is closer to your town than any other important Fur Center. Every shipment personally graded and priced by a member of the firm.

WRITE TODAY For Big Illustrated Trappers Guide FREE

TRAPS AT FACTORY PRICES

Stephens sells Traps, Animal Bait and all Trappers' Supplies at rock bottom prices. Write today for Big, Illustrated Trap Catalog, Trappers' Guide, Fur Price List and Shipping Tags—ALL FREE.

E. A. Stephens & Co.
132 Stephens Bldg.
Denver, Colo., U.S.A.

Trappers' Guide and Trap Catalog free

Points on Art of Top Working

Continued from page 10.

tough that it springs back upon the scion and holds it firmly in place. The cherry and prune are sometimes cleft grafted with fair success, but the wood is more easily split and does not hold the scion as well as does apple and pear wood. Consequently, the bark graft is more popular for the stone fruits. The bark graft is best for healing over large cuts on both stone and pome fruits.

Cleft Grafting.

The equipment needed for cleft grafting consists of a fine-tooth hand saw, a grafting tool made of steel and equipped with a blade for making the split cut and a wedge for holding open this cut, a wooden mallet or a hammer, a small sack to hold the scions, and some grafting wax. If the weather is cold, the grafting wax should be kept hot in what is called a grafting pot. The essential features of these grafting pots are an alcohol lamp set in the bottom of a small bucket with holes made for draft and above a basin placed in the top of the pail to hold the melted grafting wax. Melted wax should be put on with a brush. In making the cleft graft, limbs of from one-half to two and one-half inches in diameter are chosen. These limbs are cut squarely across with a saw and the edges smoothed with a knife. The splitting tool is next brought into play and driven down into the center of the limb by blows from the mallet. A cut from an inch and a half to two inches long is made in this way. The splitting tool is then removed and the wedge of the tool is inserted near the center of the limb if it is a large one or at the side if it is small. The wedge is driven deep enough so that the scions may be placed at the edges of the cleft. Scions for grafting are chosen from the central portion of the one-year-old wood where the wood is mature and the buds are plump. Two or three buds are left on each scion. The scion is shaped by cutting a thin long wedge, starting on each side of the lowest bud, so that the buds will face outward when the scion is set. The outside of the scion should be cut a little thicker than the inside, in order that the cambium layer of the scion may be held firmly against the cambium layer of the stock. When the scion is set it should be slanted slightly toward the outside in order that the cambium layer may cross. If the limb is an inch and a half or more in diameter, two scions are usually set. If it is smaller, one only can be set. As soon as the scions have been set and the wedge removed, the graft is waxed very thoroughly along the sides and over the top and the tips of the scion are also touched with wax to prevent evaporation.

Bark Grafting.

In bark grafting the limb is cut at right angles with a saw as in cleft grafting. But, while in cleft grafting there are only two scions set, in bark grafting there may be several, usually about a couple of inches apart, around the edge of the cut. The scion for bark grafting

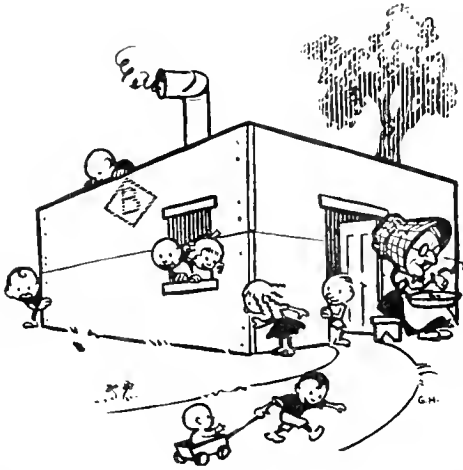

There was an old woman
Who lived in a shoe;
She had so many children
She didn't know what to do.
She had them boxed by
Bloedel Donovan
And now her troubles are
through.

Your troubles will be
through too when you
place your order for
Bloedel Donovan Boxes
Expertly sawed, carefully
inspected and promptly
delivered.



BLOEDEL DONOVAN LUMBER MILLS
1018 WHITE BUILDING
SEATTLE, U. S. A.

run-STOP-Start

The trials of driving in the traffic prove the quality of Red Crown gasoline. Look for the Red Crown sign before you fill.

STANDARD OIL COMPANY
(California)

The Gasoline of Quality

CLAMP TRUCKS
FOR EVERY PURPOSE

THEY ARE
LABOR SAVERS, TIME SAVERS, MATERIAL SAVERS

Write us for information on
PEACH GRADERS APPLE GRADERS
PACKING HOUSE MACHINERY

CALIFORNIA IRON WORKS
RIVERSIDE, CALIFORNIA

is shaped by cutting a shoulder on both sides of the scion and leaving a thin wedge to be inserted between the bark and the wood of the stock. The bark of the stock is lifted slightly or is cut vertically at the points where the scions are to be placed. Then the scions are inserted. After all have been set they are waxed thoroughly and the tops of the scions are covered with wax. The scions are allowed to grow until they have covered, or nearly covered, the top of the wound and until they become rather crowded. Then they are gradually removed until two usually are left for permanent limbs.

For whip grafts old muslin torn in half-inch strips and soaked in the grafting wax when it is hot, or soft twine string soaked in wax, are often used in place of grafting wax.

New Data Secured on Northwest Nut Culture

THE annual tour of the Western Walnut Association this year, which included many field meetings and covered an area extending from McMinnville, Oregon, to Clarke County in Western Washington, proved a valuable trip to many of the growers now engaged in nut culture in Oregon and Washington. About 20 cars containing 70 members of the organization and others interested in this rapidly growing industry, which is estimated to cover at present 8,000 acres in Oregon alone, made the tour. The trip was made under the direction of J. C. Cooper, of McMinnville, president of the organization; Prof. C. I. Lewis, vice-president, and Dr. J. H. Wilkins, of McMinnville, of the executive committee, acting for Knight Pearey, secretary-treasurer, who was unable to be present.

The tour, which covered only a small part of the acreage represented in the two states, demonstrated thoroughly the growing importance of the nut industry to the Northwest and that both the soil and climate of this region is especially adapted to the grow-

SUPERINTENDENT

Horticulturist now open for position. Wide experience in the fruit growing industry, and has both practical and scientific training. Understands diversified farming, irrigation, dry farming, pumps, motors, etc. Good salary expected. Address A. M., care Better Fruit.

For Sale, 30-Acre Apple Orchard

ten years old in the famous Willamette Valley, Oregon, 2½ miles from State Agricultural College, Corvallis; on gravel road. Eight-room bungalow, electric lights, beam ceiling, built-in buffet, mantel and fire place, bath room and toilet; good well, garage, barns and packing sheds, 3 chicken houses. House alone could not be duplicated for \$7,500. Team good work horses, harness, wagons, fresh Jersey cow. Fully equipped with orchard tools, including power sprayer. Apples mainly Yellow Newtowns and Spitzenbergs. Estimated crop 4,000 to 5,000 boxes this year. This magnificent home must be seen to be appreciated. For sale on account owners illness. Address Mrs. Emma Lundeen, Corvallis, Ore., Route 2

ing of both the English walnut and the filbert to perfection. It also demonstrated that large yields of these nuts are soon to be put on the market from this section and that steps must be taken to handle and market them.

Walnut orchards both of the seedling and grafted types were found in all the districts visited in fine condition and with heavy yields. The discussions that took place developed the fact that there are strong adherents for both these types of walnut trees among Northwest nut growers and that at the present time it is so difficult to determine which has the advantage,

although scientific investigators are inclined to the opinion that the English walnut tree grafted onto the carefully selected black walnut stock, makes a better all round tree than the seedling. This is a point, however, on which Oregon walnut men are ready to debate at any time with considerable heat and bids fair to become as celebrated a contention as to who wrote the famous poetry and dramas accredited to William Shakespeare—Shakespeare or Bacon. An older and more extensive development of the walnut orchards in this section will probably solve this problem.

<p>MUSICAL MERCHANDISE</p> <hr/> <p>WRITE US</p>	<p>WE SAVE YOU MONEY!</p> <p>W. Martius Music House Inc.</p> <p>1009 First Avenue, Seattle, Washington</p> <p>Everything Known in Music</p>	<p>SHEET MUSIC</p> <hr/> <p>WRITE US</p>
--	---	--

food

is mightier than pen and sword

It is the foundation of health and human energy. It produces the stamina and the strength to do things. On the field of battle—as well as on the tables where peace and plenty reign—chocolate has proved itself a 100% food.

To insure supreme quality chocolate you must *insist* upon Ghirardelli's. It comes *only* in cans —for your protection.

At the store where you do your trading—in ½ lb., 1 lb. and 3 lb. cans.

"Say Gear-ar-delly"

D. GHIRARDELLI CO.

Since 1852

San Francisco

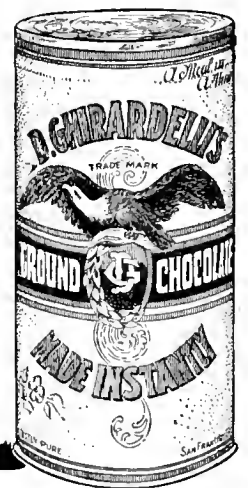
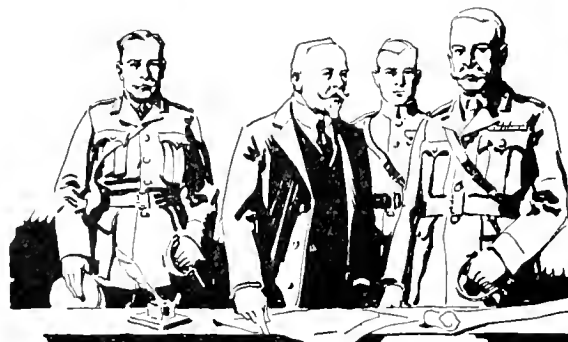

Ghirardelli's Ground Chocolate

One of the important features demonstrated was that blight, which is the bane of the walnut grower, was present only to a very limited extent in Oregon and Washington orchards. The filbert acreage visited was uniformly found to be in fine condition, with good yields where the trees were old enough to bear and comparatively free of pests and diseases of any kind.

The facts of greatest value learned on the trip are:

First, that while walnut blight may attack certain trees more than others, it is aggravated by poor soil or poor care.

Second, that one should be very careful in choosing the stock. If it is planned to top-work trees, only rapid growing stocks are desirable.

Third, the reuter leader tree, which has never been headed, has a great deal of merit. These trees have a good distribution of branches, are exceedingly strong, and undoubtedly more and more of this type will be grown.

Fourth, that the fundamentals of good walnut culture are: (1) Proper selection of site; (2) Very intensive tillage.

Fifth, that the filbert is bound to become a great horticultural asset. The Barcelona undoubtedly will be the leading variety, but that the Du Chilly is needed to pollinize the Barcelona, and that a third variety is needed to pollinize the Du Chilly. In some cases it is thought this may be the Daviana; in other cases, Clackamas or Turk, or possibly other varieties.

Among the interesting places that were visited on the first and second days were the orchards of Prof. Lewis and others at McMinnville, the Curfman orchard at Carlton, Withycombe and Malpas orchards at Gaston, the Forbis and Schoolcraft orchards at Dilley, the large establishment and nursery with many acres of stock of the Oregon Nursery Company at Orenco where dinner was served and a new cherry that bears several weeks after other cherries are off the market was eaten and discussed, and the Quarnberg, Shaw, Norelius, Root, Sturgess and Spurgeon orchards at Vancouver, Wash. In the latter district it was found that plant life of all descriptions was considerably earlier, and fruits and nuts more mature, than in the Oregon districts visited. On the third day visits were made to the places of the Frandquette Nursery Co. and the Walgamot orchards at Canby, Ore., and the plantings of Dr. Jobse, H. A. Kruse, J. R. De Nui and Mr. Stein near Wilsonville.

J. & H. GOODWIN, LTD.

Apple Exporters

Headquarters in United States
60 State Street
Boston, Massachusetts

*The Largest Handlers of American Apples
in English Markets*

You can send your apples direct from the United States into the industrial centers of England. The same organization (J. & H. Goodwin, Ltd., throughout) which ships your fruit from the U. S. A., sells and distributes in London, Liverpool, Manchester and Hull, and on the European Continent.

This means quick handling, considerable economies and the fruit being sold in the freshest possible condition, which means greater returns.

For Further Particulars Write or Wire Us at Boston
or 97 Warren Street, New York City

ACME BOX STRAPPING

Insures Safe Deliveries—Prevents Pilferage



Acme Nailless Embossed Strapping

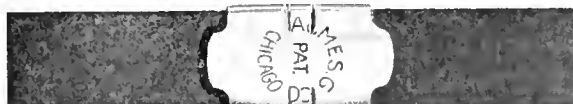

Acme Nailless Strapping, with Seal Applied

Write for the Acme Catalogue of Complete Shipping Room Supplies

ACME STEEL GOODS CO., Chicago, 2840 Archer Avenue, Manufacturers

SAN FRANCISCO, 209 California Street
SEATTLE, Foot of Main Street

PORTLAND, 8 Front Street
ATLANTA, 10 Tift Street

The Fatality of Crown Gall, Etc.

Continued from page 9.

many of our states. In the vicinity of Shenandoah alone, where there are two nurseries, the loss in a bad year is often as high as \$40,000 or \$50,000. The annual loss in nurseries in the middle west is 20 per cent to 50 per cent of the total production, as all galled trees are a total loss.

Work is now being done on methods of control. Such means as selection of roots, various grafting methods, and disinfection of roots before planting have been tried. So far no satisfactory means of prevention has been found, although results have been encouraging.

There seem to be about four points that if borne in mind will reduce the losses due to this disease materially:

1. Secure healthy trees.
2. Plant in clean soil if possible.
3. Use resistant varieties.
4. Watch out for preventive methods.

A complete summary of this experiment to date can be obtained by sending for Research Bulletin No. 50, Iowa State College, Bulletin Section, Ames, Iowa. The bulletin was written by Laurence Greene and I. E. Melhus.

Orchardists Clash

An interesting clash of interests appears to have developed in the fruit producing district of which Spokane is the commercial center as between fruit growers and apairists.

One side of the subject is set forth in a statement by E. B. Kelly, state agricultural inspector, who says: "Never before has the Inland Empire apple crop showed up the need of bees in this district as it has this year. Many apples will be lost this year because of lack of proper pollenization and although the loss does not compare with the frost damage, it is very noticeable. There are a few bees in the Inland Empire, but the majority of fruit growers depend too much upon

APPLES



PEARS

For European

Distribution

Gerald Da Costa

Long Acre, Covent Garden, London

Cables: "Geracost, London."

Codes: A. B. C. 5th Edition and Private

SHIPPING AGENTS:

Lunham & Moore, Produce Exchange, New York

SEEDS

for FALL SOWING

Vetches—Clovers—Alfalfa

GRASSES AND GRAINS

Selected Re-cleaned Farm and Field Seed at Lowest Market Prices. Special Mixtures for Wet Land—Dry Land—Burns—Permanent Hay Crops and Pastures.

Cover Crops for Orchards.

OUR FALL CATALOG OF FRUIT AND SHADE TREES

Berry Bushes and Plants, Bulbs, Roses and Shrubs Mailed on Request.

You Gain a Whole Year by Fall Planting.

Write for prices or SEND in your ORDER. We guarantee full value for the money sent.

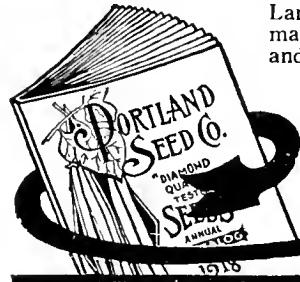

Ask for Catalog No 520



"CARO" FIBRE FRUIT WRAPPERS

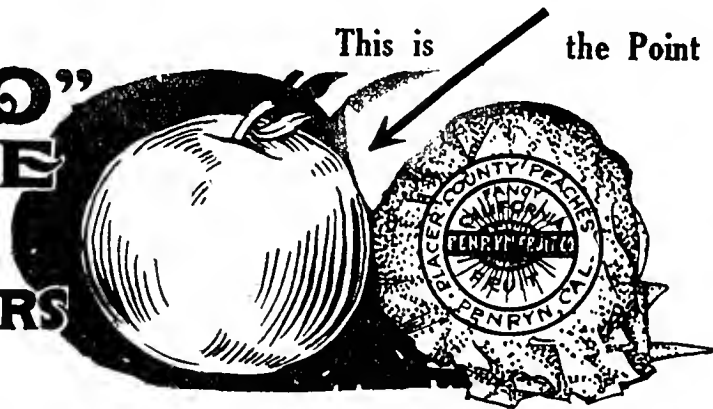

Chemically Treated "Caro" Protects "Caro" from DessiCARE (to dry up)

"Caro" Prolongs the Life of Fruit Why?

Fruit decomposition starts from a bruise which opens tiny holes and permits the juice to escape and BACTERIA to enter. "Caro" clings closely and dries up the escaping juice. "Caro" ingredients harden the spot, kill the BACTERIA, arrests the decomposition—and thus **PROLONGS THE LIFE OF FRUIT**. If your fruit is worth shipping it is worth keeping in best condition.

Demand "CARO"—Wrap Your Fruit in "CARO"—The Fruit Buyer Knows "CARO"

Order from Any Fruit Company or American Sales Agencies Co., 112 Market St., San Francisco

their neighbor's bees for charity work and sooner or later the live producer will see the need of having a good stock of bees on his own farm.

"If bees are introduced into the Inland Empire on a large scale, the farmers will first have to provide better means of feeding. Food secured by the bees during the first season will not be enough for their winter supply and every corner and nook will have to be sown in clover."

Quite another aspect is presented in a dispatch from Prosser, Wash, which said that a startling mortality among bees indicates an unusual shortage of honey in the Yakima Valley for the present season. Tons of honey were shipped from this locality last year and brought fancy prices. W. H. Tucker, who had over 200 stands of bees, which yielded him an income from \$25 to \$54 a stand last year, reports that he will have no honey for sale this year. Mr. Tucker reports his loss to be between \$10,000 and \$12,000.

He stated that the unusual value of the apple crop has caused orchardists to continue spraying much later than heretofore and in much heavier quantity. The chemicals in the spray fluids, he said, is killing the bees by the million. Mr. Tucker started this season with 250 stands, 50 of which have been entirely wiped out and no more than 10 to 20 per cent of the inmates of the remaining stands still survive. Other bee keepers in the Prosser district report similar damage.

The subject will be debated at fruit growers' conventions this fall. There seems to be a strong conflict of opinions as to whether the spray used to combat the coddling moth is fatal for bees.

Dedicate Memorial to Rome Beauty.

At its summer meeting on July 23, the Ohio State Horticultural Society dedicated near the site of the original tree a boulder memorial to the Rome Beauty apple, the most important variety produced in the state. The original tree, a sprout from below the graft was planted near Proctorville, Ohio, in 1817, by a small boy whose father thought the tree a worthless seedling.

This apple has since been planted well over the country. It was carried to California in the gold rush of '49 via Cape Horn. Statistics for 1918 show that in the state of Washington it is exceeded in numbers only by Jonathan and Winesap. It has been planted largely, too, in Oregon and Idaho.

Its characters of late blooming, annual bearing, comparative resistance to fireblight and its late keeping coupled with its size and attractiveness, have made it a valuable apple, Ohio's most important contribution to the fruitgrowing industry.

R. B. CRUICKSHANK, Secretary.

The output of orchards in the Wenatchee district can be doubled by creating the proper soil conditions, the *Wenatchee Advance* announces, and advocates the planting of alfalfa in them as one means of helping.

Ridley, Houlding & Co.

COVENT GARDEN, LONDON

WE ARE

Specialists in Apples and Pears

CABLE ADDRESS: BOTANIZING, LONDON

Codes: A. B. C. 5th Edition and Modern Economy



FROM CALIFORNIA CRUDE

Zerolene is correctly refined from selected California crude oil. It meets with scientific accuracy the lubrication needs of all types of automobile engines. Get a Correct Lubrication Chart for your car.

STANDARD OIL COMPANY
(California)

Pittsburgh Perfect Cement Coated Nails

are of the highest standard

The Heads don't come off. Given Preference by Largest Pacific Coast Packers

MANUFACTURED EXCLUSIVELY BY
PITTSBURGH STEEL COMPANY, Pittsburgh, Pa.

A. C. RULOFSON COMPANY, Pacific Coast Agents
359 Monadnock Building, San Francisco, California

Timely Advice, Etc.

Continued from page 4.

distinction. It sells on all markets for a greater price than any other variety. It has often sold for \$5.00 per box. However, the Delicious has its faults. It is not adapted to all regions, and often does not come into bearing young, although there are many exceptions, especially on certain soils in the Hood River Valley.

The Jonathan has many points to commend it. It is a rapid growing tree which comes into bearing early. It gives a high average yield per acre because it bears a good crop every year. It is a beautiful red apple of high quality. Its greatest fault lies in its tendency to develop fruit spot. These are small black spots which spread over the entire surface. Very often Jonathans which show no symptoms of the trouble when packed will very quickly break down or become spotted in the package. In many districts it is impracticable to store the fruit on this account. The remedy often lies in early picking and prompt marketing.

The Stayman and Winesap are two varieties which have found much favor in the markets. The former is a seedling of the latter and is a distinct improvement. The fault of the Winesap especially on poor soils is that it tends to run small as the tree becomes older. The Stayman is larger and of better quality and is reported as being more vigorous and more or less disease resistant. It comes into bearing early but is somewhat given to alternate bearing.

The Baldwin continues to be a favorite in the large markets. It does not compare in quality with the varieties mentioned or others which could be cited, nor does it come into bearing as young, but it has produced a profit to the grower in the districts where adapted. Its natural habitat lies north of the Ohio river and east of the Great Lakes.

Among the other varieties of note are the Rome Beauty and Grimes. The former is a beautiful fruit, of good size, symmetrical, easily packed, a good shipper and keeper. It readily sells well at good prices, principally because of its culinary value. It is not desired as a dessert variety, but is relished as a baking apple. The chief handicap of the Grimes is that it is yellow. Its chief market is in the Central States, but in other markets does not compete well with red varieties. It is reported as being short lived, due principally to a form of collar rot. This tendency is now being largely overcome by nurserymen who are double working with some other variety so that the Grimes will not come into contact with the ground.

The Ben Davis at Hood River is grown only in limited quantity from old trees whose owner still hesitates to grub them out or work them over to some more desirable sort. There have been no late plantings in this district. Its six year net average to the grower per box has been less than that of nineteen other varieties grown there. The day of the Ben Davis is past. As an

More Than a Yard Every Second



When You Use This Handy

MERRY GARDEN AUTO CULTIVATOR

THINK what it means to cultivate your crops at the speed of from 120 to 200 feet per minute—more than a yard every second! And not merely scratch up the surface, but really work down deep—five or six inches and within one-half inch of the plants—without the push, pull or bearing down that wears you out. That is the kind of service you get from the MERRY GARDEN AUTO CULTIVATOR.

Saves the Work of Three Men

Actual tests prove one man with a MERRY GARDEN does more work and does it easier and better than four men do with hand cultivators. It works uniformly without slighting a single row. Goes between wide rows and astride narrow rows.

Simple to Operate

The power is furnished by a reliable 2 h. p. gasoline motor controlled from the handles. Requires no pushing or pulling. Simply guide it along the rows. "It leads the way." When not used as a cultivator, the addition of a pulley frame furnishes power for small machine, such as the separator, churn, lawn mower, saw or grinder. Price of frame, \$10 extra.

Sold on a Money-Back Guarantee

We allow a 5-day trial, backed by a rigid money-back guarantee. Order direct from this advertisement, as you are fully protected by this guarantee. If for any reason the MERRY GARDEN fails to do the work, purchaser in accepting same agrees to notify us within 5 days from receipt thereof. We reserve the right to send a demonstrator, and if machine fails, purchase money will be refunded. Price \$185.00, f. o. b. Cleveland, Ohio. Terms 10 per cent, or \$18.50, with order. Balance on delivery, with privilege of examination subject to five-day trial and guarantee. Shipping weight 250 pounds. For further information and particulars, address

The Atlantic Machine & Mfg. Co.
468 W. Prospect Ave., Cleveland, O.
Gentlemen: Find enclosed \$18.50 for which ship the Merry Garden Auto Cultivator, balance to be paid on delivery. This order is placed subject to the terms of your money back offer.

Name.....
Address.....
Town..... State.....

THE ATLANTIC MACHINE & MFG. COMPANY
468 W. Prospect Avenue
Cleveland, Ohio
Wanted: Live Wire Representatives in all localities



WHAT EVERY HOME CANNER SHOULD HAVE

ONE of our **H. & A. Hand Power Double Seamers.** It is the only hand power seamer built that will seal all sizes of sanitary fruit and vegetable cans. Write for prices and descriptive matter to Department T.

HENNINGER & AYES MFG. CO., Portland, Ore.
Builders of Seamers and Steam Pressure Canning Outfits

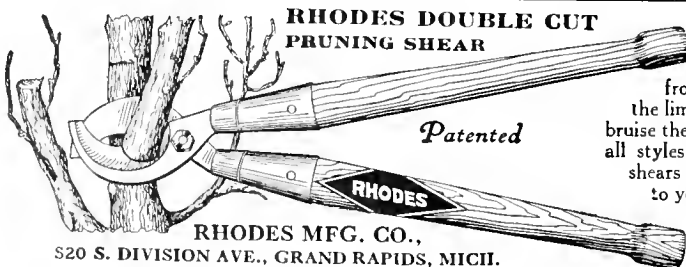

RHODES DOUBLE CUT PRUNING SHEAR

Patented

RHODES MFG. CO.,
520 S. DIVISION AVE., GRAND RAPIDS, MICH.

THE only pruner made that cuts from both sides of the limb and does not bruise the bark. Made in all styles and sizes. All shears delivered free to your door.

Write for circular and prices.

export apple it still has some possibilities on account of its shipping qualities.

Of summer and early fall varieties the following are favorites: Yellow Transparent, Red June, Duchess and King.

There are four varieties of pears which are at present very popular with the planter. The Bartlett stands first from the standpoint of acreage. It is estimated that from eighty to ninety per cent of all pear trees in California are Bartletts. It is a rapid grower and comes into bearing young. It bears large crops regularly and has wide adaptability to soils and climates. It matures its fruit early and is eagerly sought by canners and dryers at high prices and meets with a strong demand for dessert purposes. It is quite susceptible to fire-blight. The Anjou is another popular pear. Trees become very large and bear in early Fall. When young, trees have an irregular bearing habit. Very often they produce a heavy bloom but the fruit does not set well. It is thought by prominent horticulturists that this non-bearing habit while young is a natural characteristic since the trees when older bear heavily, although often irregularly. Others feel that it is largely a problem of pollination. The trees are subject to blight but less so than the Bartlett. The fruit is of high quality, a good keeper and sells well as a winter pear. The Bosc is an excellent variety which is increasing in popularity very rapidly because of its splendid quality as a dessert pear. It is a good keeper and sells for a high price. The trees come into bearing about the seventh to eighth year. It is a very regular bearer and averages high yields per acre. The trees do not become as large as the Anjou and probably will not give as high yields. The fruit has a very distinct shape, being large, acute pyriform, very long and narrow. The skin is yellow, somewhat rough and covered almost entirely with a heavy brown or cinnamon russet. The Winter Nelis is also an excellent pear but scarcely in a class with the varieties mentioned. The fruit is small, but the quality is excellent. When the trees become old they require considerable thinning in order to insure good size. The variety ranks high as a winter pear and often sells high. The Comice is an excellent pear but growers hesitate to plant this variety because it blights badly, comes into bearing quite late and in many places is a very shy bearer.

Fire-blight has been the principal drawback in pear growing, but much is being done to overcome this in growing resistant stocks upon which standard varieties may be budded or grafted. Professor F. C. Reimer of the Southern Oregon Experiment Station has taken the lead in this work and has disseminated to the trade a middle western variety known as Surprise. This tree is remarkably resistant to blight and is a vigorous grower with a slightly spreading habit. It makes a splendid tree to top-work after the second season's growth. He is also experimenting with a Chinese species of pear



You Wouldn't Haul Crops

to town on your back and yet you unnecessarily break your back doing a lot of odd chores around the farm such as sawing wood, turning the grindstone, pumping water for the livestock, etc., and let your wife and girls wear themselves out over the wash-tub, churn, and separator. Drudgery of this sort was absolutely necessary on the farm once upon a time—but times have changed.

There is no need to let these little jobs take the joy out of life, because an **International Kerosene Engine** will perform all of these tasks—and a lot more, besides—doing the work much faster and more cheaply, to say nothing of doing it better than it could be done by hand. These engines deliver steady, uniform power—they **never lag**—so any machine that they operate works to the best possible advantage. There are three sizes—1½, 3, and 6-h. p. engines.

The 1½ and 3-h. p. engines are the all-around "chore boys" while the 6-h. p. engine is the dependable "man about the farm". It does work that a dozen hired men couldn't do, such as shelling corn at the rate of from 1,000 to 1,500 bushels a day, baling 15 to 20 tons of hay in a day, grinding feed at the rate of from 5 to 25 bushels an hour, and threshing 20 to 40 bushels of wheat an hour (operating a Sterling thresher).

Shall we mail you a catalogue and tell you where you can see an **International Engine**?

INTERNATIONAL HARVESTER COMPANY

OF AMERICA INC.

BILLINGS, MONT. CRAWFORD, NEB. DENVER, COLO. HELENA, MONT.
LOS ANGELES, CAL. PORTLAND, ORE. SALT LAKE CITY, UTAH
SAN FRANCISCO, CAL. SPOKANE, WASH.

DEPENDABLE TREES

Planters, it is time to order your Fruit, Shade and Nut Trees, Berry Plants, Shrubbery, Roses, etc., for fall or spring planting. Send for our large illustrated catalogue from which to select your list; it only costs you 5 cents in stamps for postage. Our trees are mighty fine, but we haven't enough. If you WANT trees, don't delay ordering.

OREGON NURSERY COMPANY
ORENCO, OREGON

"Ever Occur to You?"

says the Good Judge



That it's foolish to put up with an ordinary chew, when it doesn't cost any more to get real tobacco satisfaction.

Every day more men discover that a little chew of real good tobacco lasts longer and gives them real contentment.

There's nothing like it.

THE REAL TOBACCO CHEW

put up in two styles

RIGHT CUT is a short-cut tobacco

W-B CUT is a long fine-cut tobacco

Weyman-Bruton Company, 1107 Broadway, New York City



*Comfortable
warmth*

Filled with Pearl Oil, a good oil heater gives comfort without dust or dirt. Oil consumed only when needed; portable, economical.

Pearl Oil is the ever obtainable fuel, refined and re-refined to be pure and clean burning. Order by name—Pearl Oil.

We recommend Perfection Oil Heaters.



STANDARD OIL COMPANY
(CALIFORNIA)

known as *Pyrus usuriensis* which is absolutely blight resistant. Should it prove adapted in other ways to our conditions here it will prove a very valuable addition to the list of blight resistant varieties. Growers will do well to watch these varieties and note the outcome of these investigations.

In closing, the writer would urge the need of a thorough preparation of the soil preparatory to planting. A field which has been in alfalfa for a number of years if properly worked up provides an excellent place in which to plant trees. Lastly, he would emphasize the need of interplanting varieties for pollination purposes and to equalize the labor at harvest time. Plant the trees far enough apart to insure full development. See that soil and air drainage is ample, and where rainfall is insufficient that irrigation can be had. If the experience of successful growers is taken advantage of and a few simple rules followed success should follow.

Orchardists Buy Many Warehouse Sites

Orchardists in the Omak section, upper Wenatchee Valley, are solving loading problems along modern lines. At a recent government lot sale the bulk of the 200 lots offered adjacent to the right of way and industrial sites of the Omak Railway Company were purchased by orchardists for warehouse sites. The main line of the railway is less than a mile long but the sidings to take care of the fruit warehouses will be considerably greater in length.

An estimate of the outlay for storage facilities in the Wenatchee district is half a million dollars. At Monitor, for instance, the warehouses extend for 1000 feet along the track. The effect is odd in view of the fact that Monitor itself is a tiny hamlet. On the fruit farms a large number of sorting and packing houses are being installed to handle this year's output.

An interesting sidelight on the apple industry is the statement that in an effort to procure legislation whereby the standard box for apples as adopted by the state legislatures of Washington, Oregon and Idaho, will be adopted for the box apple zone of the West. Congressman J. Stanley Webster, of Washington, recently secured an appointment to appear before the committee on coinage and weights to discuss this subject.

Washington Strawberries Pay Well.

W. Munson and E. Mattin this year planted an acre and a quarter to strawberries near Wapato, Wash. The berries made an excellent yield. The first crop has been marketed and the gentlemen report a total of \$910.66 from the berries sold. Pickers were permitted to have several crates and a certain amount was kept for use of Messrs. Munson and Mattin. The vines will bear another crop this fall, which is expected to be larger than the one just marketed.

PRINCE ALBERT

the national joy smoke

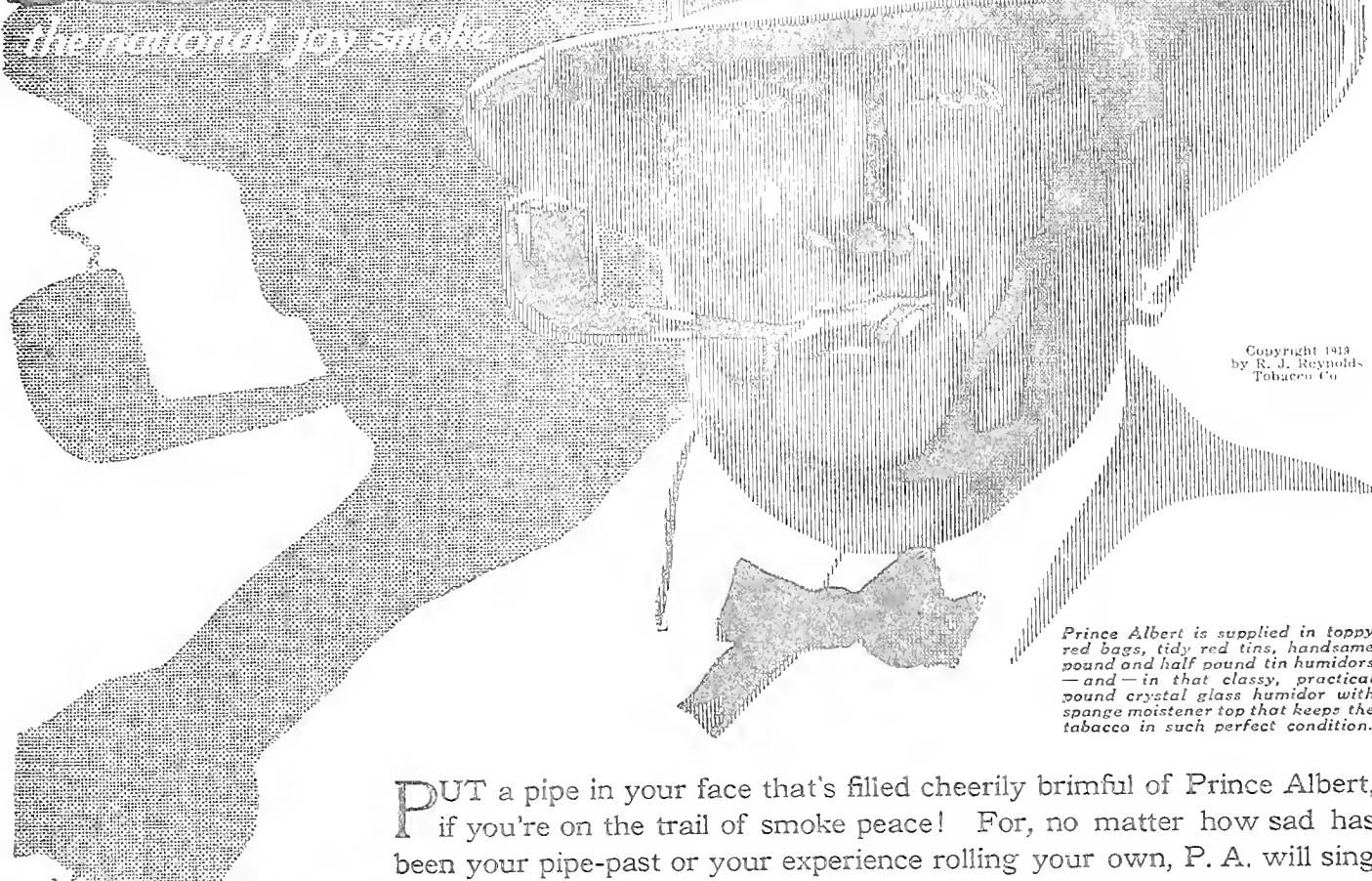

Copyright 1913
by R. J. Reynolds
Tobacco Co.

Prince Albert is supplied in tippy red bags, tidy red tins, handsome pound and half pound tin humidors — and — in that classy, practical pound crystal glass humidor with sponge moistener top that keeps the tobacco in such perfect condition.

PUT a pipe in your face that's filled cheerily brimful of Prince Albert, if you're on the trail of smoke peace! For, no matter how sad has been your pipe-past or your experience rolling your own, P. A. will sing you a song of tobacco joy that will make you wish your life job was to see how much P. A. you could get away with!

You can "carry on" with Prince Albert through thick and thin and no matter how hard you test it out you'll find it true to your taste and tongue. You'll be after laying down a smoke barrage that'll make the boys think of the days in France!

P. A. never tires your taste *because it has the quality!* And, let it slip into your think-tank that P. A. is made by our exclusive patented process that cuts out bite and parch—assurance that you can hit smoke-record-high-spots without any comeback but real smoke joy! And, no matter how tender your tongue may be!

R. J. Reynolds Tobacco Company, Winston-Salem, N. C.

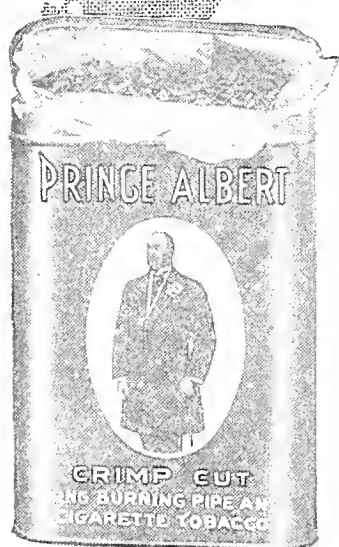

THE WORLD-
OUR ORCHARD

STEINHARDT & KELLY NEW YORK

UNQUESTIONABLY THE
MOST IMPORTANT FACTOR
IN THE DISTRIBUTION OF
THE COUNTRY'S FANCY
APPLES
AND OTHER FRUITS

OUR MARKET-
THE WORLD

BETTER FRUIT

VOLUME XIV

NOVEMBER, 1919

NUMBER 5

Univ. Libr
30 Dec 19

FEATURES IN THIS ISSUE:

Selecting an Orchard Tractor
The Why of Co-operation
The Value of Predatory Insects
Growing the Loganberry



VIEW OF AN APPLE TREE TAKEN IN THE PRODUCTIVE
WENATCHEE VALLEY, WASHINGTON

BETTER FRUIT PUBLISHING COMPANY, PUBLISHERS, PORTLAND, OREGON

Subscription \$1.00 per Year in the United States; Canada \$1.50; Foreign, Including Postage, \$1.50.

Single Copy 20 Cents

Every grower must be used

to yield
top grade fruit

Sap is a tree's life

The Sap-Wood may be called its Arterial System. This is the vital part of a tree. It must be protected, to yield vigorous growth. That demands thorough spraying before foliage appears. Sap-Wood pests must be prevented from draining a tree's vitality. The full flow of sap should be saved for bud and foliage points. Nothing known to growers equals Lime Sulphur for this work. Sherwin-Williams now make lime sulphur in dry powdered form.

S-W Dry Powdered Lime Sulfur

Is the regular standard 33° Baume, but sold to you *dry*, without the water. It does absolutely everything the liquid formerly did. It is not an experiment. For four years leading growers have used it. Millions of pounds have been sold, and users steadily re-order in greater quantities. It is well known in every U. S. and State Test Station. It embodies every progressive advance in chemical science and agricultural research, invariably shows maximum results in actual orchard use.

For Scale and Fungus Diseases

S-W Dry Lime Sulfur is very effective against San Jose Scale, Oyster Shell Scale, etc., and is an equally efficient preventive against Rot, Scab, and various fungus diseases attacking apples, peaches, pears, grapes, etc. It is also of great value to citrus growers.

Combination Summer Spray

S-W Dry Lime Sulfur and Dry Arsenate of Lead combine with the greatest effectiveness as a mixed spray, for spring and summer use against leaf-curl, rot, scab, and against chewing insects.

Arsenate of Lead,

Arsenate of Calcium, Paris Green, Tuber-Tonic, Fungi-Bordo and Pestroy,—and a complete line of germicides, vermicides, dips and Wood Preservatives. For 53 years we have been selling Paints and Varnishes on their covering and protective powers. We are now the largest makers of insecticides in this country and sell them the same way, on their covering qualities, killing action and permanence.

A free copy of book,

"Sprayer's Manual" will be mailed on request. Address, The Sherwin-Williams Co., 602 Canal Road N. W., Cleveland, O.

SHERWIN-WILLIAMS

PRODUCTS

PAINTS AND VARNISHES, DYES AND
PIGMENTS, CHEMICALS



INSECTICIDES, COLORS, DISINFECTANTS
AND WOOD PRESERVATIVES

Subscription Rates Advance December 1st

New or Renewal Subscriptions Received Until December 1st at Old Rates

Better Fruit Readers Getting More for Their Money

Each issue of Better Fruit published this year has contained from 30% to 50% more reading matter than the corresponding issues of recent years. It has also contained a higher class of material from the highest authorities.

The paper has been improved editorially and mechanically — in fact many letters from highest authorities assure us that the value and usefulness of Better Fruit has increased many fold. These improvements cost tremendously and yet, until now, the subscription price has not been raised.

Postage and Publishing Costs Have Increased

Paper, Ink, Postage, Wages—everything which enters into the production of a magazine has increased—is still increasing, and there seems no prospects of lower costs. Take the item of postage for example, it is costing us from **two to three times as much for postage now as it did in 1918** and almost every other cost has increased in like proportion. We have still further plans for the improvement of Better Fruit which make it absolutely necessary that we advance the subscription price.

We Have Confidence in Our Readers' Fairness

You have been getting an **extra** value in Better Fruit—an improved and enlarged Better Fruit at the same old rate. At the same time our cost of producing the magazine has doubled. You know yourself how prices have increased. The United States Bureau of Statistics shows that prices on the average have doubled since 1915. We believe that our readers are fair minded—that they appreciate the situation and will gladly pay the increased subscription price.

This is Your Chance to Save Half

But here is an agreeable surprise for you. In spite of the increased postage charges, higher prices of paper and printing, labor, etc., and notwithstanding the fact that we are giving you a bigger and better magazine we are going to give everyone who acts promptly the opportunity to subscribe, renew or extend a subscription at old rates providing they act before December 1st, 1919. Beginning December 1st the subscription price will be \$2.00 per year in the United States and its possessions and \$3.00 in Canada and Foreign Countries.

USE THIS SPECIAL ORDER BLANK



Do It Now

before you forget and if you have a friend who should be taking Better Fruit tell them. Use the blank below.

Better Fruit Publishing Co. Oregonian Building Portland, Oregon

SPECIAL ORDER BLANK (Good only if used before December 1, 1919)

The Use of This

Order entitles the user to a new, renewal or extension subscription to Better Fruit at following (old) rates:

In United States and Possessions—	
1 year	\$1.00
3 years	2.00
In Canada	1 year 1.50
In Foreign Countries	1 year 1.50

Better Fruit Publishing Co., Oregonian Building, Portland, Oregon:

Gentlemen:—Enclosed find \$ for a

}	new
	renewal

 subscription to

Better Fruit for a period of years in accordance with your special offer.

Name

Address

SIMONS, SHUTTLEWORTH & CO.
LIVERPOOL AND MANCHESTER

SIMONS, JACOBS & CO.
GLASGOW

GARCIA, JACOBS & CO.
LONDON

Agencies and Representatives in Every Important European Market

European Receivers of American Fruits

FOR MARKET INFORMATION ADDRESS

SIMONS, SHUTTLEWORTH & FRENCH CO.
204 Franklin Street, New York

SIMONS FRUIT CO.
Toronto and Montreal

SIMONS, SHUTTLEWORTH, WEBLING CO.
Board of Trade Building, Boston

OUR SPECIALTIES ARE APPLES AND PEARS

Pacific Coast Agents
**United States Steel
Products Co.**

San Francisco
Los Angeles
Portland
Seattle



J.C. Pearson Co., Inc.
Sole Manufacturers

63 Pearl Street
Boston, Mass.

PEARSON

ECONOMY in buying is getting the best value for the money, not always in getting the lowest prices. PEARSON prices are right.

ADHESIVENESS or holding power is the reason for PEARSON nails. For twenty years they have been making boxes strong. Now, more than ever.

RELIABILITY behind the goods is added value. You can rely on our record of fulfillment of every contract and fair adjustment of every claim.

SATISFACTION is assured by our long experience in making nails to suit our customers' needs. We know what you want; we guarantee satisfaction.

ORIGINALITY plus experience always excels imitation. Imitation's highest hope is, to sometime (not now) equal Pearson—meantime you play safe.

NAILS

A
I
L
S

LOOK HERE

ARE YOU SATISFIED with your present selling service?

IF NOT try us and learn what an up-to-date selling organization can do for you.

CABLE OR WRITE US NOW for market prospects, terms, etc. Reasonable advances made against shipments of

APPLES PEARS ORANGES

YOU want the best market in Britain.

WE have it.

McCAIG & WEBB
Fruit Brokers, **GLASGOW**

Head Office, **GLASGOW**

Cables—MacWebb, Glasgow
A. B. C. 5th Edition—Marconi International

ALSO RECEIVERS AT
London — Liverpool — Hull

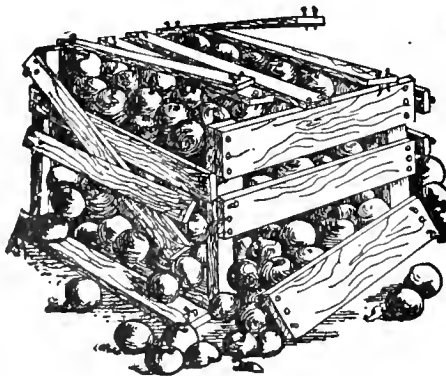

BEFORE using Cement Coated Nails

Western Cement Coated Nails for Western Growers

Our Cement Coated Nails are always of uniform length, gauge, head and count. Especially adapted to the manufacture of fruit boxes and crates. In brief, they are the Best on the Market.

Write for Growers' testimonials.

Colorado Fuel & Iron Co.

DENVER, COLORADO

Pacific Coast Sales Offices
Portland, Spokane, San Francisco
Los Angeles

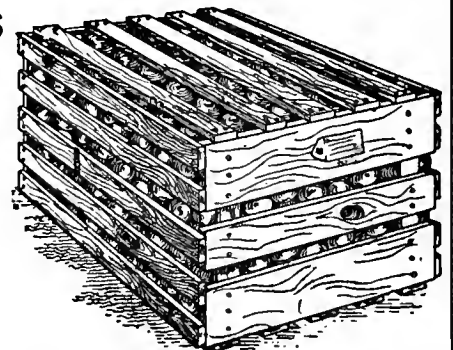

AFTER use of C. F. & I. Co.'s
Cement Coated Nails

BETTER FRUIT

EDITOR: W. H. WALTON

STATE ASSOCIATE EDITORS

OREGON—C. I. Lewis, Horticulturist.
WASHINGTON—Dr. A. L. Melander, Entomologist;
O. M. Morris, Horticulturist, Pullman.
COLORADO—C. P. Gillette, Director and Entomologist;
E. E. House, Irrigation Expert, State Agricultural College,
Fort Collins.
ARIZONA—E. P. Taylor, Horticulturist, Tucson.
WISCONSIN—Dr. E. D. Ball, Madison.
MONTANA—O. B. Whipple, Horticulturist, Bozeman.
CALIFORNIA—C. W. Woodworth, Entomologist, Berkeley;
W. H. Volck, Entomologist, Watsonville; Leon D.
Batchelor, Horticulturist, Riverside.
INDIANA—H. S. Jackson, Pathologist, Lafayette.

An Illustrated Magazine Devoted to the Interests
of Modern, Progressive Fruit Growing
and Marketing.

PUBLISHED MONTHLY BY
Better Fruit Publishing Company

703 Oregonian Building
PORTLAND, OREGON

All Communications should be addressed and
Remittances made payable to

BETTER FRUIT PUBLISHING COMPANY

SUBSCRIPTION PRICE:

In the United States, \$1.00 per year in advance.
Canada \$1.50; Foreign, including postage, \$1.50.

ADVERTISING RATES ON APPLICATION

Entered as second-class matter April 22, 1918,
at the Postoffice at Portland, Oregon, under
the Act of Congress of March 3, 1879.

VOLUME XIV

PORTLAND, OREGON, NOVEMBER 1, 1919

NUMBER 5

The Tractor in the Orchard—Its Selection Important

By W. H. Walton

WITH prospects of the most successful year for orchard products in the history of the industry this year, 1920 looms up as the period in which many tractors will be bought by fruit growers. The tractor is particularly alluring to the orchardist, as in most cases he grows no other crop and has to buy horse feed the year around. By using a tractor he can dispense with horsepower entirely, as the advent of the motor truck is rapidly taking care of most of the hauling from orchard to railroad.

With ninety per cent of the orchardists of the Northwest in possession of automobiles, their fond hope now is to secure a tractor. This fact is shown by the large number of inquiries that are being made in sections of the country where tractors are being used in orchards and also by the quest for information from the engineering departments of agricultural colleges.

From investigations made by the agricultural colleges it is found that over seventy-five per cent of the orchardists who are using tractors are satisfied with the results they are getting and state that the only question as to the efficiency of a tractor in an orchard is in the right selection.

So many inquiries of this character have been directed to the engineering department of the Agricultural College of California that J. B. Davidson, connected with the state college experimental farm at Davis, recently published a short bulletin on the subject, entitled "Selecting a Tractor for the Orchard or Vineyard." In handling the question Mr. Davidson says that the largest number of inquiries that are now being received on tractors refer to what kind of a tractor to select. "This," he continues, "perhaps indicates that the selection of a tractor is not only a problem with a large number of ranchers, but also is a very perplexing one. Three or four years ago the inquiries were concerning the relative economy of tractor and horsepower, but now this question is not so prominent, and the outstanding question is, what kind of a tractor to buy. It is not always possible to answer this question. However, when the conditions under which the

tractor must work are known, it is easier to offer definite suggestions.

"In buying a tractor the dealer is almost as important to the purchaser as the machine itself. This conclusion is inevitable after coming in contact with an occasional example of bad faith on the part of the dealer or manufacturer

toward the purchaser. The sale of a tractor should carry with it a guarantee and assurance based upon the responsibility of the house making the sale, that the tractor sold is adapted to the work for which it is purchased, and that the seller intends to help make the tractor a good investment. The view held by a



A Cletrac Plowing in a Large Orchard.



A Best "25" Tracklayer Turning Over the Soil in a Cherry Orchard in California.

few dealers that their responsibility ceases as soon as the order is closed is not good modern merchandising. If the taking of a commission is to represent a 'square deal,' the seller is under an obligation to furnish the necessary repairs as long as the tractor may be used.

"It is fully realized that most successful machines had a small beginning, and good tractors manufactured in a small way should not be discriminated against, but fly-by-night concerns with undeveloped machines should be carefully avoided.

"Much is made today in present day tractor sales of the service rendered, and no doubt this is a very perplexing problem for the conscientious dealer as well as the purchaser. Service is usually referred to as the assistance given the tractor owner in the care, repair and adjustment of the tractor after it has been put to work. It is undesirable from the purchaser's standpoint to have too much of such service rendered promiscuously without charge, because the operator will call upon the dealer for more service than is necessary, and inasmuch as the cost of the service must in this case be added to the purchase price, it makes the first costs of the tractor too high. It would seem that only enough free service should be rendered to guarantee good faith and confidence upon the part of the seller and all other assistance not charged to a faulty construction should be paid for. It would seem that the best service arranges for providing quickly the tractor's future needs in the way of mechanical skill and repair parts, rather than to furnish an unlimited amount of gratuitous service. In selecting a tractor, it would be well to determine accurately the dealer's service policy.

"A tractor that is too large does not give good economy either in investment or fuel economy. For most operations, in orchard cultivation, a large unit is of little use because it is not needed for the implements to be used. On the other hand, too small a tractor does not economize in the use of labor, one of the principal items in the cost of opera-

tion. Practice seems to indicate that a tractor ought to have capacity to draw the same load as six work animals, or, in other words, a capacity of twenty-five to thirty inches of plows and a six-foot double-disk harrow or larger. Some orchard and vineyard men use a rather large tractor with equipment to cultivate the entire middle between the rows at once over. Such a plan saves much labor. At least fifteen drawbar horsepower will be needed where such practice is followed.

"The type of tractor will be determined largely by the character of the soil and operating conditions. If irrigation is practiced or the soil especially light, with little supporting power, the track-laying tractor has the advantage; while under other conditions, with little need of operating over soft soil, the wheel type of tractor has the advantage in simplicity and cost. The practice followed in pruning the trees will determine whether the tractor must be low or not.

"One of the most important factors in the selection of an orchard tractor is the matter of control. It is quite

necessary to be able to drive the tractor accurately and easily. Any purchaser would do well to test out these characteristics thoroughly before purchasing, observing whether the tractor can be manipulated among the trees with safety and without undue exertion on the part of the driver. A tractor that can be driven at any desirable and reasonable speed has a still further advantage. It is only by driving a number of tractors in the orchard that the importance of control can be fully appreciated. It perhaps will be well to mention that convenience and safety should be mentioned in this connection. Recently a rancher complained that it often required an hour or so each day to start his tractor. It is possible that the owner was much at fault, but it is obvious that a good tractor must provide facilities for sure and easy starting.

"There are three principal factors involved in the ultimate success of the tractor, i.e., the tractor, the work and the operator. Of these, no doubt the latter plays the most important part. To have success with a tractor, the operator must understand and feel for the machine—he must have faith in it and like to work with it. A man not in sympathy with the tractor is not apt to succeed with it.

"To care for a tractor, an operator must be able to inspect the tractor and detect trouble as it arises and before it becomes serious. Most of the troubles with tractors that are serious in character appear gradually. Furthermore, certain parts of a tractor are subject to wear, and the capable, efficient operator, as distinguished from the one that is not, is the one with the necessary skill to make the adjustments needed to compensate for wear. The principal item in the care of a tractor is lubrication. It is claimed by those making a study of the matter that nearly ninety per cent of the repair bills on tractors can be traced to faulty and inadequate lubrication. This may not have a direct bearing upon selection other than to point out that the lubrication system



A Five-Ton Holt Pulling a Double Disk and Drag Harrow.



An International at Work Disking in a Young Orchard.

should be carefully studied in making a selection.

"Finally, no tractor can do its best work unless used with suitable implements. These should be of such a size as to give the tractor a good load, not too heavy nor too light—not too heavy because overloading is the father of

much tractor trouble, and not too light because of the poor economy. Like the tractor, these tools must be easily managed. The modern power-lift plow has many advantages. The tractor implements with lever within easy reach are distinctly more convenient than those in use for horsepower."

A number of tractors are now being used successfully in orchard work, among the most prominent and efficient being the Fordson, Moline, Avery, Huber, Case, Wallis, Cletrac, International, and Holt caterpillar, the latter, however, being best adapted to large acreages.

The Oregon Growers' Co-operative Association

By Prof. C. I. Lewis, Organization Manager

THE Oregon Growers' Co-operative Association was formed because there was a distinct and imperative need for such an organization. We can perhaps state that our ideals and aims are bound up in three words, "Stabilize," "Advertise," "Oregonize." Our aim is, to first stabilize the prices received for our horticultural products. Succeeding in this, we will certainly stabilize our land values. This will of course stabilize credits. Stabilizing all these three will stabilize our prosperity.

The present prune situation on the Pacific Coast is one which needs careful study. We have in Western Oregon and Clarke County, Washington, at the present time about 33,000 acres in prunes, about half of which are not bearing. California has from 80,000 to 100,000 acres in bearing, with a similar amount just coming into bearing. The Pacific Coast crop of prunes this year, which is a big one, is about 250,000,000 pounds. Within two to four years our yield of prunes on the Pacific Coast will range from 600,000,000 to 800,000,000 pounds. The normal consumption of prunes in the United States is 100,000,000 pounds and normally we can export 100,000,000 pounds. The question is, what is to become of the additional tonnage which we will soon have to handle? We are told that we need not worry, that prunes are a staple food, that people will eat them all right. There is no

doubt in my mind but that people should eat them, and I sometimes seriously doubt whether an overproduction in food ever occurs, but this I do know, that underconsumption is just as bad for the producer as overproduction, and underconsumption is staring us in the face.

At the present time, prunes in the Pacific Northwest are largely handled by independent buyers, each selling to rather limited markets. Seemingly, no attempt has been made to establish an Oregon brand and to advertise it to the consumers as such, and to take steps to develop adequate market for the new tonnage. Suppose we should suddenly have a very large production of prunes. What is the grower going to do about it? There are several things that can be done. One thing would be to put prunes on the market so cheap that the housewives could buy more prunes for their money than anything else. That will undoubtedly move the prunes, but it will also move the orchards out by the roots. Another method is to organize and advertise, and attempt to develop new markets as rapidly as the new tonnage comes in. Also we must eliminate speculation from prune marketing. While perhaps relatively little speculation was done by local buyers, they do, however, turn the prunes over to speculators in the East, and in some cases \$2,000 to \$3,000 has been made out

of a single car of prunes by brokers who never see the crop, and \$5,000 could be realized on a few carloads of prunes which were sold early in the season. There is something wrong with this system whereby a man can go out and buy prunes the same day for half a dozen different prices and perhaps buy them on a different drop. Such a condition is not good for the producer, the consumer, nor the legitimate middleman. Prunes were being handled this year in such a way that in a little while they would be put on the grocers' shelves at a price that would keep them there. This would be fatal to the industry. We must not only get a good price to the grower, insure the middleman a fair profit, and the retailer his profit, but it must be handled in such a way that the commodity will move, will be offered to the consumer at an attractive price. Prunes which growers received 9 to 11 cents for in this state last year are now retailing at local grocery stores at from 25 to 36 cents. Certainly there is something wrong in that condition. The prune is following the history of the apple quite rapidly. It will be interesting to review that history for just a few moments. We all remember the prosperous condition of apples from 1906 to 1912; prices were very satisfactory; Chicago and New York were taking about all of our tonnage. In 1912,

Continued on page 25.

Does Experimenting with Native Predatory Insects Pay

By Elwin G. Wood, District Horticultural Inspector, Washington State Department of Agriculture

[**Editor's Note.**—The experiment of collecting ladybird beetles in the fall and liberating them in the spring to prey on apple tree and other species of aphids has attracted a great deal of attention in the Pacific Northwest, not only from professional entomologists and plant pathologists, but also from practical fruit growers. Through its state department of agriculture Washington this year conducted quite an extensive experiment along this line, and California started this fall to collect these beetles to conduct a widespread experiment next spring. The professional entomologist in most instances is inclined to view these experiments with a skeptical eye and to voice the opinion that the more efficient way of eradicating aphids is by spraying, although a number of them admit that beneficial results have apparently been obtained where ladybird beetles have been used. The most definite data on this question that has been obtained was secured this year in the district adjacent to Walla Walla, Washington, by Mr. Elwin G. Wood, horticultural inspector in that district, which is published in the accompanying article. In this article Mr. Wood arrives at the conclusion that it does pay to collect and liberate these insects to prey on aphids.]

THE experiment of collecting ladybird beetles to prey on aphids has been the cause of many inquiries being made as to the actual results obtained and the method used in collecting and liberating the beetles.

In Walla Walla County the ladybird beetles begin colonizing as early as the first of July. This year on the fifth of July they had not begun to colonize in the creek canyons near Walla Walla, but on the eighth of July we found large colonies in the canyon of the east fork of the Walla Walla River in Oregon above Milton. By the middle of July very few ladybugs could be found in the orchards near Walla Walla. They continue to collect in the mountain canyons and by September large colonies may be found in the damp places in the canyons of any of the creeks flowing into the valley. They collect in great masses, crawling over damp rocks and logs, and may be collected any time in September and October. As winter comes on they crawl down into the pine needles at the base of the trees and under rotten logs and stumps. In April of the following spring they emerge from their hiding places and for a few days crawl over the damp rocks and stumps in swarms and then disperse in search of feeding and breeding grounds. Very few dead beetles can be found in the places where they have spent the winter.

This spring in upper Mill Creek Canyon colonies of beetles began to emerge from their hiding places and appeared in swarms crawling over rocks and logs on about the 10th of April. They were thickest about April 15, and by the 20th they had all disappeared and no more colonies were observed after that date. This suggests that there are about ten days in the spring of the year that the beetles may be gathered and taken to the orchards where most needed. This, too, would be as early as we liberated the ones we had in storage.

Collecting and Storing.

Last fall sixty-eight boxes of beetles were collected and stored by Frank George and H. L. Miller. Of these, fifty boxes were made of apple box lumber

sawed in two lengthwise, giving a box when made up 10x10x11 inches and screened on two sides. These were filled about one-third full of dry excelsior and three pounds of ladybugs or 90,000 beetles were put in each. The rest were beehives screened on the top and bottom. Excelsior and four pounds of beetles were put in thirteen of them and six pounds of beetles put in the other five. This made a total of 232 pounds of beetles. This spring the county agent gave us 72 pounds of the beetles he had stored, making a total of 304 pounds or 9,120,000 beetles liberated by us this spring. In addition to this the county agent liberated 36 pounds or 1,080,000 beetles in alfalfa fields in Walla Walla County.

The beetles were placed in three kinds of storage and accurate data kept on forty-nine of the cages. Twenty-six of the three-pound cages were put in cold storage at 40 degrees on October 26, six cages were put in a basement cellar or common storage on November 8 and the rest were stored above ground out of doors and protected from the snow and rain.

From a study of the data obtained we discovered that almost 95 per cent of the beetles in cold storage were alive at the time liberated, and if we count out two cages on which water dripped, causing a high mortality, practically 98 per cent of the beetles lived, and the cages taken out on May 2 were in as good condition as those taken out on

Name of Owner	Date liberated	Date eggs and larvae were counted	Total eggs	Total larva	Total No. of eggs & larvae on single tree
Frank George	April 24	May 22	315		
Devine	April 25	May 26	419	415	864
Julius Levy	April 25	May 26	200	150	350
Obenholtzer	April 25	May 26	157	152	309

April 17. Of the beetles in common storage only 76 per cent were alive on April 17. Of the ones stored above ground out of doors an average of half of them were dead when liberated. However, of those liberated on April 17

71 per cent were alive, while of those liberated after April 24 only 40 per cent were alive. Up until the first of April the beetles in the cages stored out of doors appeared to be nearly all alive and in good condition. These observations indicate that outdoor storage would be satisfactory if the beetles were liberated by the first of April.

The beetles given us by the county agent had been stored in the same cold storage room with ours and were put up in apple boxes, six pounds in a box. They were liberated about the fourth of May and about 70 per cent of them were alive.

Ladybird eggs were found on April 8 at Blalock. They were undoubtedly laid by beetles that had hibernated under rubbish in the orchard.

As soon as the beetles were liberated they began to hunt for food and within three days were laying eggs on aphid-infested trees. The first larvæ from these eggs was observed on May 21 and most of them were hatched by the first of June. Data on observations made on May 22 and 26 is given in the following table. These counts were made in four prune orchards in different parts of the Blalock tracts. The eggs were counted on each of five trees in each of the orchards and the figures given are the average of the five. Only the eggs that could be seen from the ground were counted and the number would undoubtedly have been larger if the tops of the trees had also been searched.

The trees in these orchards were quite badly infested with aphid. Devine's were so bad that he had sprayed with Black Leaf 40 a few days before. The other men put off spraying until we could see what the ladybugs would do.

So far as I know, Devine was the only man who sprayed for aphid in Walla Walla County this year. On June 18 no live aphid could be found on the trees at Levy's that had been quite bad three weeks before, and no ladybugs or larvæ were present. On an apple tree in the same orchard that had some woolly aphid on, three adult beetles and five egg patches were found. Three larvæ were found in the curled leaves of another apple tree that had a few rosy aphid.

Nowhere in the county did the aphid get bad. At Blalock on July 8 there were aphid on the water sprouts in a good many trees and very few ladybugs were present. We brought down twenty pounds from East Walla Walla Canyon and liberated



Ladybird Beetles Colonizing on the Trunk of a Tree.



Another View of the Beetles Colonizing. They can be seen on the trunk of the tree and also at its foot.

them in the Blalock orchards. These ladybugs quickly scattered and some of them were found eating aphids the next day. On the second day a few fresh egg patches were found, which were evidently laid by the ladybugs liberated two days before. During the next few days a considerable number of ladybugs were observed on woolly aphids. However, large numbers were found on potatoes and weeds. They seem to prefer the naked aphid to the woolly ones.

Reports from Other Sections.

Twenty-two three-pound cages were sent to other parts of the state. Four were liberated by Mr. Andrus in Clarkston. Regarding them Mr. Andrus writes that according to Fred Ranson and Mr. Steininger the aphid did little damage

this season, and credit for this was given the ladybird beetles. Four cages were sent to Mr. Wills at Wawawai. Mr. Wills states that he thinks they were a great help in controlling the aphids, as he found them at work in all the trees that had aphids. Two cages were sent to Mr. Darlington in Wenatchee. Mr. Darlington writes that he cannot give anything of any particular value on the ladybird beetles because there was very little trouble from aphids in any part of the

Wenatchee district this year. It was quite noticeable, however, that where aphids did appear ladybugs were there in plenty to keep them in control. On the other cages that were sent out we have no data to indicate whether they were a help in controlling the aphids or not.

Conclusions.

As a result of our experiments with the ladybird beetles during the past year we conclude that:

1. September or October is the best time to collect them. However, it might be possible to collect them during a period of about ten days in April.

2. The best method of storing is in small boxes with dry excelsior and about three pounds in each box, the boxes being screened on two sides and kept in cold storage at 40 degrees. By



Box of Ladybird Beetles Ready to Be Transported to Cold Storage.

this method 98 per cent can be brought through the winter in good condition.

3. Common storage or outdoor storage is fairly satisfactory if the beetles are liberated about the first of April.

4. They should be liberated about the first of April or early enough in the spring so that the eggs will be hatching before the aphids begin multiplying rapidly.

5. Although there may be several other important reasons why there were so few aphids this year, the ladybugs were undoubtedly a large factor in keeping them in control.

6. The practice of storing ladybird beetles and liberating them in the spring should be continued and more data collected to prove that they control the aphids.

Planting and Growing the Loganberry and Its Future

By C. M. Lafollette

IN the past few years and particularly during the last two years the loganberry has come to be recognized as one of the most valuable bush fruits that can be raised, and, like the Holstein cow in the dairy world, is probably the best all-purpose berry that is now grown. The demand for it is becoming very great and it is now being extensively planted.

The loganberry will grow almost anywhere in Western Oregon, Western Washington and California, but is especially adapted to the Willamette Valley. As you go farther south in Oregon the climate is a little too warm and dry to obtain the best results with it, although it will grow on almost any soil as do other berries. It thrives best, however, on a heavy clay loam or rich river bottom sandy soil. I do not recommend light sandy soil for the best results. A great deal of our prairie soil where it has good water drainage is well adapted to the loganberry and some of the best patches we have are to be found in these locations. Also we

have some very good fields in the foothills, but as you get higher up the berries are inclined to dry out in the hot months.

The loganberry will not thrive in cold climates. When the mercury drops below 10 degrees above zero the vines will perish. The best time to plant loganberries is in the spring, usually during the month of April, or as soon as you can get good, strong plants and the soil is in the proper condition. They may also be set in May with good results. The plants should be from four to six inches high before planting. It requires 608 plants, set eight feet each way, or 775 plants set seven by eight feet apart, to plant an acre. They should be set about eight feet in the rows, with the rows from seven to eight feet apart. I believe, however, that setting the rows seven feet apart is equally as good, as it makes more shade for the ground and also has the advantage of giving one-seventh more rows on the same space of ground.

After being set, the following fall or

winter the vines should be trained up. For this we use from three to four wires No. 12 size. Three wires will do very well, but four are much better. The bottom wire should be placed about eighteen inches from the ground and the top wire from four to five feet above the ground, the latter distance being preferable for heavy soil. The rows should always be planted to run north and south if it is practicable, as it divides the sunlight on both sides of the row. In training the vines they should be distributed equally over the wire and trained as tightly as possible, so as not to allow them to be baggy or in bunches. A well trained patch has a great advantage in being cultivated, or at picking time. Picking usually commences about the 20th of June when the season is normal. Most of the berries are gathered by women and children, and as the loganberry season comes between the other fruit harvesting seasons pickers are usually plentiful and make good wages.

When the berries are harvested,



A Properly Set Out Loganberry Yard.

which is about the last of July, the old vines should be cut out and the new canes trained up. The prunings from the old vines are usually cut up with a small disk harrow with enough weight put on it to accomplish this purpose. The old vines, when they are disposed of in this way, make good fertilizer for the soil, as well as being an economical way in getting rid of them.

With the demand for loganberries for so many different purposes and the world as a market for them, they are destined to become one of the most profitable of fruits if they are properly planted and given the right kind of care, which, it may be added, is far less than is required to grow many of the other fruits that do not produce as much revenue.

New Containers Save Michigan Grape Crop

By a Michigan Grape Grower

THE grape growers of the State of Michigan, especially the section of St. Joseph, Michigan, and Benton Harbor, rejoiced over the bumper grape crop of this season. This year's crop is looked upon as the best crop since 1911, all of the grapes being fully ripened and fully flavored. The greatest problem which the grape growers had to solve was the matter of getting a sufficient number of grape packages for the shipping of their big grape crop. The package situation was a very serious one and for a while it threatened many a grape grower, the package manufacturers making only sufficient grape

packages for a 70 per cent crop, as forecasted.

However, the old adage that every cloud has its silver lining was truly applicable in this instance. A progressive and far-sighted grape grower, Mr. Walter Donaldson, thought it a good idea to press into use the universal bushel shipping package, using the centerpost reinforcement. Most of the growers at first scoffed at the idea and suggestion. However, Mr. Donaldson felt that it would pay to try it.

A carload of grapes was loaded with this new container with the centerpost attachment, and the growers were star-

ttled at the returns this car of grapes brought them—\$85 a ton as against \$70 a ton for the same grapes when shipped in jumbos.

The growers were quick to see that it was to their best interest to ship their grapes in universal bushel packages, using the centerpost to reinforce the package, so as to bring the grapes in perfect condition to destination. Every available bushel basket that could be found was filled with grapes. Several cars of grapes were loaded with the universal basket.

In putting into service the universal packages as grape packages, the entire grape crop of Michigan was saved, and many a grower is mighty thankful for being able to get a supply of universal packages.

Again the fact demonstrates itself that it pays to do things slightly different, as the big returns received by Michigan grape growers who tried the experiment of shipping in the new basket proved conclusively.

The Gravity Conveyor

If Isaac Newton could, without too greatly inconveniencing himself, return to old Mother Earth and visit the famous fruit packing district in Hood River, Yakima and Bitter Root Valley during a busy packing season and observe the wonderful amount of work being performed by his revelation, gravity, he would be justified in remarking, "Well, I'll be jiggered," or some other more forceful exclamation of surprise. His mind would revert back to the brief space of two hundred years or more and he would again visualize himself under the old apple tree and see again the apple descending and fall true to the center of gravity.

It is the same old gravity, not an ounce greater, not an ounce diminished, that is now performing such wonderful work and bringing about such gratifying results in the indoor transportation and handling of this delicious fruit.

Gravity, securely harnessed, and under the control of a gravity ball-bearing roller conveyor, is now performing all of the hard, laborious work in the packing, warehousing and shipping of thousands of cases of apples that are raised and handled annually in this favored district.

Gravity literally takes most of the Man-ual out of packing and warehousing, conserving and releasing the available local labor supply for the many other demands made on it during the comparatively short harvesting season. The filled open baskets or boxes are placed on receiving portable sections of the gravity conveyor and friction-free are rapidly transported into the packing room.

Resting on sections of a gravity conveyor, the fruit is transferred and packed into the empty cases. The filled cases are then allowed to proceed on the gravity conveyor, usually leading to an automatic inclined elevator, released to a gravity conveyor line on the upper floor, and conveyed direct to the storage pile. Portable sections are again used to excellent advantage for transporting either to wagons or directly into cars.

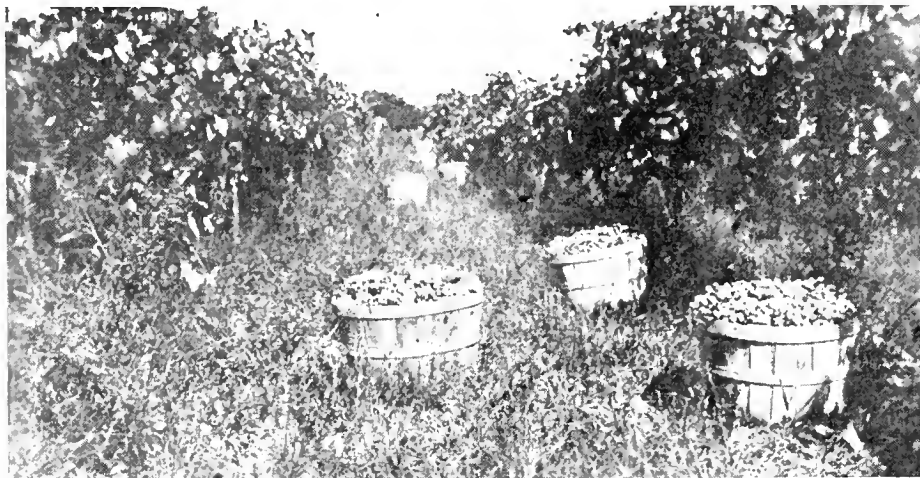

Grapes in a Michigan Vineyard Packed in a New Way

Bees An Invaluable Aid to the Orchardist

By George W. York, Spokane, Washington

IT was with considerable interest that I read the following paragraphic note in the September BETTER FRUIT:

"Lack of pollenization is reported by E. B. Kelly, horticultural inspector with the Washington department of agriculture, to be the cause of a big loss in the apple crop in the Inland Empire. Mr. Kelly says that orchardists in this district must pay more attention to the raising of bees, either with or without regard to the value of the honey they make."

It was my whole business for over a quarter of a century to advance the interests of beekeepers, as editor and publisher of the *American Bee Journal*, a publication devoted exclusively to beekeeping. During all those years it frequently came to my attention, through reports from beekeepers who also were fruit growers, that bees were exceedingly valuable as pollinators in the orchards. While most people seem to regard the little busy bee's work as a honey-producer as being the most important object of its existence, it may yet be shown that its value as a pollinizer of fruit is far and away more valuable to mankind than is its sweet product—honey.

So when I read the suggestion by Horticultural Inspector Kelly it came to me with great force. I was reminded that just recently a wise orchardist in the Yakima Valley has already arranged with a local beekeeper to place his hives of bees in his (the fruit grower's) orchard next spring, for the sole purpose of aiding in a more thorough pollenization of the fruit blossoms, and for this work he has agreed to pay the beekeeper five dollars per hive, regardless of the amount of honey the bees may produce while thus located.

But one unfortunate thing about the keeping of bees in or near the orchards in the Yakima Valley, and doubtless elsewhere as well, is the poisoning of bees through the spray material that drips off the trees on the alfalfa blossoms found under the fruit trees.

While recently in Yakima, and talking with some of the beekeepers there, they thought it would be possible to mix something in the spray material that would be offensive to the bees, so they would not visit the blossoms that had caught the spray. But another beekeeper and orchardist from the same

valley, who is exceedingly well informed, felt that mixing the offensive material in with the sprays would not accomplish the desired object, as the bees work on such sprayed blossoms only when there is a dearth of nectar elsewhere, and so he thought nothing could be used to prevent them working on such blossoms when they were forced to visit them in the absence of other bloom or feed. He was of the opinion that it would be necessary to enact a law compelling the orchardists to cut the blooming alfalfa from beneath the trees for hay, just before spraying, and thus remove the attraction that drew the bees to their death.

Surely the orchardists will be glad to do anything within their power to preserve the work of the bees, for they are rapidly realizing that without the full aid of the bees they could not possibly hope to harvest the large fruit crops that they would otherwise secure.

It is surprising, and also exceedingly interesting, to note how closely allied are the efforts of both the human and the animal in this instance. Through the work of the orchardist and the bees not only is a better and larger crop of fruit produced, but also an increased return in the way of a honey harvest. The results of harmonious coöperation are almost perfect in this case. Hence it behooves the fruit growers everywhere to encourage the keeping of bees within easy flight of their orchards. There should be the utmost sympathy and coöperation between the fruit growers and the beekeepers, when their interests are so clearly and exceptionally one.

I believe a thorough discussion of this subject would be of value to all concerned. There must be ample evidence scattered around in very many localities which if assembled would help to bring into closer relation the interests of both beekeepers and orchardists. More and more we are all coming to appreciate the truth of the utterance that "no man liveth unto himself." Our interests and our hopes are mutual. Only by the heartiest coöperation of all the allied lines of endeavor can we hope to make the progress that all concerned so enthusiastically desire.

High Road to Appleland as Seen by New Yorker

By Sylvanus Van Aken

THE phenomenal growth of the fruit industry in the country during the past few years has not alone been due to improved business methods of packing and marketing. Nor has it been due to cool nights, the warm days and the amount and intensity of the sunshine. Other factors have been instrumental in promoting this rapid advancement. The growers have, first, exercised care in selecting varieties best adapted to their localities; secondly, they have paid particular attention to the types of soil best adapted to these varieties; thirdly, they used judgment when selecting the

proper location as regards site, slope, irrigation, transportation, etc., and lastly, they were careful in planting. When it comes to planting a commercial orchard the prospective grower should thus make haste slowly. Mistakes made in fruit growing are often irreparable. It is my purpose to give such advice as the progressive growers in this section have, by common experience, demonstrated to be practical and useful.

Locate Right—Orchards Can't Move.

The proper selection of a site is vital to successful orcharding. Faulty selections have not infrequently been made

**BEST SERVICE-
QUALITY & PRICES**



**PERFECTION IN
FRUIT
LABELS**

**THE
SIMPSON & DOELLER CO.**
1423-24 NORTHWESTERN BANK BLDG.
PORTLAND, OREGON.
E. SHELLEY MORGAN
NORTHWESTERN MANAGER
WE CARRY—AND CAN SHIP IN 24
HOURS—STOCK LABELS FOR PEARS,
APPLES, CHERRIES & STRAWBERRIES.

by growers or speculators, and the result has been failure. When choice is permitted, the orchard should be on a more elevated spot than the surrounding country. This insures good air drainage, as well as good soil drainage. As cold air settles to the lower levels, low places are more subject to frost; hence, low-lying basins or pockets or practically level places should be avoided.

Careful attention should also be given to the selection of suitable slope. In the Hudson River Valley, owing to the high slope on both sides of the river, such sites have proven ideal fruit sections, for the following reasons: First, the soils do not become warm until late in the spring and this retards the blossoming period; second, a better protection from the prevailing winds can be had; third, the soils are usually deeper and richer. These conditions apply more specifically to sections having a long growing season. Where the growing season is short, a southern exposure may be preferred, as the larger amount of sunshine brings about an earlier ripening of the fruit. Higher color is sometimes obtained from southern slopes.

Soil and Water.

As regards soils, light loamy soils with deep and porous sub-soils are, generally speaking, best adapted to the growing of the apple. As the character of the soil influences to a certain extent the character and quantity of the product, the grower should keep in mind this fact when locating the fruit planta-

LABELS

WITH A PURPOSE

TO ATTRACT ATTENTION
 AND CREATE SALES



SAN FRANCISCO

47th YEAR of
**SERVICE and
 QUALITY**

Branches:
 SEATTLE · PORTLAND
 SACRAMENTO · FRESNO
 LOS ANGELES · HONOLULU

will be well to deal through a reliable, well-established firm in his locality and also consult men you know are reliable and up in those matters. It is then generally safe to rely upon the nurseryman's judgment, for his business reputation rests upon the service rendered.

As regards the age of trees to plant, this section has been, and is now to a certain extent, advising the selection of two and three-year-old trees, though some growers are now taking to younger trees. Some prefer one-year-old trees for the following reasons: First, young trees make a more vigorous growth than older ones. Second, in removing from the nursery less of the root system is left. Third, with the root and stem system intact, the transplanted tree does not receive such a severe shock. Fourth, the head can be formed at any height to suit the convenience of the grower. Fifth, a better yield is obtained.

New Spraying Materials

By Prof. R. B. Cruickshank, Ohio State University

New materials and methods for the control of insects and diseases are constantly appearing, and if any of these offer the fruit grower a saving in money or time they become a matter of immediate interest.

Arsenate of calcium, as a substitute for arsenate of lead, is beginning to attract attention. Manufacturers have been gradually improving it for the past few years and it promises perhaps to be a spray material which will do the work of arsenate of lead at less cost. Calcium arsenate runs 10 to 12 per cent higher in arsenic oxide than lead arsenate powder, and at least 50 per cent cheaper. Using the calcium arsenate at the rate of one pound to fifty gallons, this would mean a saving of about 15 cents per 50 gallons of spray. Calcium arsenate has been found to be effective against codling moth, perhaps does not stick as long as lead arsenate, does not injure foliage when used with either liquid or dry lime-sulphur, bordeaux mixture or lime. In Maine, for the past two seasons, the percentage of merchantable apples has been decidedly in favor of the arsenate of calcium as compared with arsenate of lead. A general and universal recommendation of this material would be dangerous, but it is certainly worthy of trial by growers, as it holds the possibility of a considerable saving.

Study Northwest Apple Growing Methods

A most interesting visitor at the office of BETTER FRUIT during the past month was David H. Rundle, of the Australian, Tasmanian and New Zealand fruit growing world, who was on the Pacific Coast studying fruit growing and packing methods. Mr. Rundle is also interested in coöperative fruit growing organizations as conducted in the Northwest, with a view to organizing the growers in the South Seas countries along co-

tion. He should select a soil suitable to the varieties he wishes to grow.

Proximity to water is important. Orchards located near lakes or large rivers are less liable to injury from radical climatic changes than those farther away. Near large bodies of water the development of vegetation in the spring is retarded and the season is extended in the fall. Immunity from late spring frosts is practically insured.

An Outlet for Your Product.

Nearness to a shipping station is a point to consider in selecting a location for an orchard. As fruit is usually grown in a commercial way for a distant market, it is well to locate where there are competing lines of transportation, which usually enables one to secure cheaper rates.

One of the first and greatest problems confronting the prospective grower is the selecting of the proper varieties for commercial planting. Several factors, such as soil, climate, etc., must be taken into consideration. A variety that does well in one section probably will not do equally as well in another, and the

grower should confine his attention to the varieties that flourish in his locality. Nothing is gained by lamenting over the fact that a certain variety can not be grown that is bringing such handsome returns in another section.

The market demand is another factor in the choice of varieties. The apples that find readiest sales are those that are fairly large and highly colored. The American people prefer a highly colored apple. Many of the yellow sorts, however, are selling remarkably well, especially in the English markets.

In starting the commercial orchard, the grower should insist on having nothing but first-class trees, no matter if the initial cost is a little greater. It is seldom economy to buy cheap trees. The following points constitute a first-class tree:

First, a well-grown, medium-sized specimen. Second, a tree having characteristics of the variety. Third, a tree that is healthy and free from injurious diseases and insects.

If the growers are not familiar with the variety he wishes to purchase, it

öperative lines. In fact, he has already done considerable work of this kind in Tasmania, which grows the largest crop of apples in that section of the world. Mr. Rundle left Seattle for Nelson, New Zealand, early in October, where he will continue his work of organization in that country.

While here he stated that orchardists in the Australian group of countries were not realizing the returns they should from their fruit owing to improper methods of marketing and packing. The custom is largely in vogue there, he said, of letting the buyer set the price, which resulted in the grower having to take what was offered him, or taking the alternative of sending it to the auction room, where it sold for whatever the large buyers wanted to pay. These conditions it is hoped will be changed if a sufficient number of growers can be secured to form organizations that will market their own fruit. While there has been much done and said on paper in regard to coöperative organization in Australia, Mr. Rundle reports the situation far from satisfactory. "One of the things we are especially interested in," he said, "is your method of sizing apples. Our growers have not yet learned how to standardize their packs. They have been putting apples of all sizes in the same box. We hope by studying the packing methods here to eliminate this condition. While here I have arranged for the purchase of fourteen power apple sizing machines manufactured by the Ideal Fruit Grader Company at Hood River."

In company with J. A. Campbell, assistant director of the horticultural division of the department of agriculture of New Zealand, Mr. Rundle had spent several weeks in the Pacific Northwest investigating fruit growing conditions before his return home.

Nut Growers to Meet in November

In answer to many inquiries being made to him about walnut growing, J. C. Cooper, president of the Western Walnut Association, through BETTER FRUIT says that nearly all the nurseries in the Pacific Northwest sell walnut and filbert trees. Mr. Cooper states that at present there is a shortage of grafted walnut trees and that growers are planting black walnuts and grafting them to English varieties. Very valuable literature on walnut and filbert culture may be secured by those interested by securing the published proceedings of the Western Walnut Association for 1918, which can be had for a one dollar membership fee sent to Knight Percy, secretary, at Salem, Oregon.

The fifth annual meeting of the association will be held at the Multnomah Hotel in Portland, November 12 and 13 next. There will be a fine nut exhibit in connection with the meeting and the public as well as walnut growers is invited to attend the meetings.



TOP DRESSING TALKS

WHEN you get ready to buy nitrogenous fertilizers for orchards, truck crops, top dressing grass, grain, corn, cotton or tobacco, let us tell you about

Arcadian Sulphate of Ammonia

ARCADIAN Sulphate of Ammonia is the well-known standard article that has done you good service in your mixed fertilizers for years past, now especially kiln-dried and screened to make it fine and dry. Ammonia 25¼%, guaranteed. Made in U. S. A.

The Great American Ammoniate

Arcadian Sulphate of Ammonia is For Sale By:

CALIFORNIA—*San Francisco*: Hawaiian Fertilizer Co., Pacific Bone Coal & Fertilizing Co., Pacific Guano & Fertilizer Co., Western Meat Co., California Fertilizer Works. *Los Angeles*: Pacific Guano & Fertilizer Co., Pacific Bone Coal & Fertilizing Co., Agricultural Chemical Works, Hauser Packing Co. OREGON—*Portland*: Union Meat Co.

For Information
as to Application
write

The *Barrett* Company Agricultural
Department

510 FIRST NATIONAL BANK BUILDING
BERKELEY, CALIFORNIA

Growth and Value of the Canning Industry

By J. O. Holt, Manager of the Eugene Fruit Growers' Association

ABOUT the year 1795 the French government offered a prize of 12,000 francs for the best method of preserving fruits and vegetables aside from pickling or dyeing. This prize was awarded to Nicholas Appert in 1810, thus canning was not an accidental discovery but the result of the hard and intelligently directed labor of a French scientist.

Although a French invention, its development has been largely due to American enterprise. At the present time it is only in the United States that canned goods are packed in water or syrup. Other countries pack largely jams, preserves and fruit and vegetable pastes. For instance, in Italy tomatoes are canned by being peeled, pulped, part of the moisture removed and then canned as a thick paste.

On the continent peaches and apricots are canned the same way. Thousands of cases of this paste are being exported from this country.

I will not take the space to follow the development of the canning industry from the time of its beginning in France, interesting as it is. Its growth was slow until the Civil war. Since that time it has grown with increasing momentum until it is not only one of the big industries but one of the vital industries of our country.

It is the canner who takes the surplus perishable products which would otherwise be lost, and preserves them for consumption through the balance of the year. If it was not for the canner perishable fruit would be in our supply at picking time, the price would become so low the producer would lose money and production would be cut to a half or a third of the needs of the public.

The industry has developed in rather well defined belts. The best corn is packed in Maine, Northern New York, Wisconsin and Michigan.

Tomatoes take a more southern belt country—in Maryland, Virginia, Southern Ohio, Indiana, Illinois and Utah, while peas are packed in a belt between and overlapping the other two. By far the larger part of the fruits are packed on the Pacific Coast.

The total pack of salmon in 1918 was eight million cases, peas ten million cases, corn eleven million cases, tomatoes fifteen million cases, and a total pack of all sorts of vegetables of 48 million cases, while the total pack of all kinds of fruits for the same year was 11 million cases. There were packed in Oregon last year about 750,000 cases of fruits and vegetables, including jams, jellies, etc. Of this amount only about 25 per cent was vegetables.

I expect to see our most rapid development in the future to be in the canning of vegetables. Not necessarily tomatoes and peas, but string beans, beets, brocoli, carrots, parsnips, turnips, etc. Our climate is especially adapted to produce these with a flavor and texture which cannot be excelled elsewhere. We are now selling these vegetables in car lots to restaurants and

hotels. These people find it cheaper to buy the canned article than to buy in the local market, and pay the cost of peeling and cooking them. The canner takes the vegetable fresh and crisp from the fields, prepares them by machinery and cans them before they have time to wilt. Fruit is sometimes improved by standing awhile after picking but a vegetable immediately begins to deteriorate.

Just as the Civil war made canning a commercial industry the present great war has proven it to be a national necessity. An industry is going forward faster than this. Machinery which is the best obtainable in one year goes to the junk pile the next season to make room for improvements.

Canning factories today are being made more sanitary than most of the kitchens in our homes. People are learning that canned foods are the purest, cleanest and most sanitary foods obtainable.

One of the hardest lies about canned goods to down is the old bugaboo "Ptomaine Poisoning." Even now in this enlightened age occasionally some ignorant editor will publish a story of ptomaine poisoning from eating canned goods. Officials of the National Canners' Association have for years been running down these stories and trying to find an authentic case of ptomaine poisoning traceable to canned goods, but without success. Two years ago a committee headed by Dr. Roseneau of Harvard University was appointed to try to settle this matter. After studying

51 cases involving 1,500 persons, they have been unable to verify one case of ptomaine poisoning traceable to canned goods. Their verdict is summed up as follows:

"It is becoming convincingly clear to us that there is no such thing as 'ptomaine' poisoning, and that canned goods have a clean bill of health. They are, in fact, the safest foods that come to our tables." Ptomaine poisoning has often been used as a cloak for professional ignorance.

The canning industry is prosperous and expanding rapidly in a great many directions, but the future is not altogether clear of difficulties. Complication in many locations is becoming so keen that it is impossible to run the plant in the most economical way and get the most out of the product for the man who grows it, and in order to do so the plant must run at capacity for the greater part of the season. But when the canner must not only take into consideration the hazard of the elements but compete with other canneries and the fresh market for his supplies he cannot pay as much or sell as cheap as he should. I predict that it will not be many years before the canners will have to grow their own supplies or the growers will have to own their own canneries. The canneryman is a criminal if he adds one cent more than absolutely necessary to the products as they pass through his hands from the producer to the consumer. The big meat packers are reaching out their tentacles to take in the canning industry and are making some headway. I see no better way to solve these problems than by supporting the Growers' Coöperative Association.

Adding to the Life of Orchard Implements

By G. W. Jaap

"LOCKING the barn door after the horse is stolen" is an adage so old and so commonly used that it has lost considerable of its truth and meaning with the passing years. Nevertheless it is undoubtedly true that in the care of farm implements this same practice of not locking the door is very commonly and generally used.

Farm and orchard implements represent a considerable investment and because of high replacement values are worth more today, generally speaking, than they were at the time of purchase. Farm implements should be given the greatest care and protection from the weather. They are subjected to all sorts of hard wear under different conditions, they are used in the hot sunshine, in the rains, they are allowed to stand in the open exposed to the action of wind and weather, making them victims of decay and rust, and leaving them with years of usefulness gone, worn out before their time and a big cash loss to their owner.

It costs very little to insure your house compared with the cost of replacing the building. It costs only a trifle to protect farm implements against

the ravages of weather compared with the cost of replacing them. A few dollars worth of paint will add years of life and service to these implements and more than repay the owner for the investment and time he spends in protecting his implements by painting.

It is unnecessary to go into detail concerning the action of water on wood or metal. Every farmer knows that water will rot wood and rust metal. He knows that when decay sets in it does not take very long before the wood parts of his machinery are thoroughly rotted away, and that when rust attacks the metal parts it is practically impossible to stop its action—it eats deeper and deeper into the metal until the part is so weakened as to be useless.

Paint is the best protection you can give to farm implements. All decay begins at the surface and generally eats its way deeper. It follows then, that by protecting the surface with a coat of good paint it is impossible for decay to attack the surface, and since it cannot reach the surface because of the protecting film of paint, it is impossible for parts to rot or rust.

It is not good policy to satisfy your-

self with just any old kind of paint. The best paint is the only kind you should buy for use on farm implements, because this paint is made with a lead and zinc base with pure linseed oil, which when properly applied offers genuine protection against wear and weather, the lead and zinc forming as it were an armorplate which successfully prevents decay from attacking the surface of the implement. The surface to be painted must be clean and free from grease or oil and perfectly dry. It is essential that the implements be free from grease and thoroughly clean and dry before a coat of paint is applied because the paint will not adhere to a greasy surface and the best results cannot be obtained.

Touch up the bare and worn spots with a thin coat of paint and allow to stand until perfectly dry, then apply a smooth, even coat over the entire surface, using a good bristle brush.

The best implement paints dry with a rich oil gloss and give durability and beauty of finish which at once increases the value of the implements, adds years of service to its life, and stamps the farmer as being progressive and possessed of good business judgment.

Wagons on which the color finish is not worn, but which have lost their luster, can be greatly improved not only in appearance but in actual wear and weather-resisting qualities by a coat of wagon coach varnish, a clear finishing varnish which gives a hard, tough, durable and elastic finish which is sun-proof, windproof, waterproof and frost-proof.

Take an inventory of your farm implements. Set down the cost price and then figure the replacement value. You will find that your farm implements are worth considerable more today than they were when you bought them. Then figure how much these implements are worth to you each year and how much it would cost if you were obliged to be without them during your busy season. Figure how much they actually produce for you on your investment and then ask yourself if your farm implements are not deserving of the greatest care and attention; if it isn't worth while for you to give them maximum protection against wear and tear and the action of the elements. Your answer will be "yes."

The best time to paint implements is in the fall, before they are put away for the winter months. Throughout the country you will see hundreds of thousands of dollars' worth of farm implements standing in the open all winter long, subject to all the attacks of winter. By painting the implements before they are put up for the winter they are secure from weather and you are protecting them from loss through rot and rust. They should be given another coat of paint in the spring, before they are put into actual use, for there is very little opportunity to apply paint to implements during the busy farming months.

Paints frequently and properly applied to farm implements is one of the

best investments any farmer can make. Compared with the advantages of painting and the results obtained, you will find that the best paint you can buy for

your implements is, in dollars and cents, the cheapest form of protection you can obtain for your farm equipment.

Fruit Should Be Carefully Graded for Export

By Edward A. Foley, American Agricultural Trade Commissioner at London

TOO much stress cannot be laid on the fact that those who expect to sell apples in the markets of Great Britain must carefully grade their produce.

Last year, because of extraordinary conditions, it happened that ungraded produce from the United States brought a fair price here, but the conditions which made this possible no longer exist. The British public at that time, having been deprived of foreign apples since the beginning of the war, was apple-hungry and eagerly purchased apples regardless of quality. This hunger has been appeased by large shipments from America, Tasmania and other places, and the normal market conditions now prevail.

It is well to note that the Tasmanian Parliament, appreciating the importance of apple grading, has issued regulations regarding the export of fruit. Stress is laid on the fact that it is believed that the standardization of fruit will result in more satisfactory returns and enable Tasmania the better to meet competition.

The chief points in the regulations are as follows: Cases must be legibly and indelibly marked with one or other of the following brands or marks: "Extra Fancy," "Fancy," "C Grade," "Ungraded"; the size of the fruit; the

varieties (if not known to be so marked); the name and business address of the person or firm who packed the fruit, or if repacked, of the person or firm who repacked it.

Apples branded "Extra Fancy" or "Fancy" must be not less in size than 2¼ inches; apples less than 2¼ inches but not less than 2 inches must be shipped in cases branded "C Grade." No case shall contain any apple below the size branded on such case, but may contain apples one-quarter inch larger in size. "Extra Fancy" apples must consist of sound, clean, well-formed fruit, free from all insect, fungus and other blemishes. Full-colored varieties of this brand shall have each apple colored to the extent of not less than two-thirds of its skin with good red coloring. Striped varieties must have not less than half their surfaces colored with distinct red stripes or streaks. Yellow and green varieties shall be even in color, but may show flushes of another color where such is natural to their respective kinds.

This action of the Tasmanian Parliament is a forcible reminder of the constant advice of the Department of Agriculture to those who would successfully handle and market fruit, to wit: "Grade your fruit."

MUSICAL
MERCHANDISE

WRITE
US

WE SAVE YOU MONEY!

W. Martius Music House Inc.

1009 First Avenue, Seattle, Washington
Everything Known in Music

SHEET
MUSIC

WRITE
US



Little Miss Knox sat on a Box,
Her weight was too great—
She went down with a roar.
"Next time I'll be wise
"And get the right size
"Of a Diamond B Box
"And avoid all hard knock.

Diamond B Boxes are
built to withstand hard
knocks and rough usage.
They stand the pressure.

BLOEDEL DONOVAN LUMBER MILLS

1018 WHITE BUILDING
SEATTLE, U. S. A.

BETTER FRUIT

An Illustrated Magazine Devoted to the Interests
of Modern Fruit Growing and Marketing.
Published Monthly
by

Better Fruit Publishing Company
703 Oregonian Building
PORTLAND, OREGON

The Tractor for Orchard Work.

The efficiency of the tractor in the orchard is no longer a mooted question. Its adaptability and economical operation for orchard work have been fully demonstrated, and the main question with the average orchardist who is contemplating the purchase of one of these machines now is, what kind of a tractor to select.

A tractor for an orchard should, like a well pruned tree, be "low headed," in order that it will not injure the branches of the trees and can be driven close enough to them to allow the implement it is pulling to cover the surface nearest the trees. It should be built so that it can be turned in a small space. It should also be quick acting and have plenty of reserve power for emergency pulls on hilly ground without being unwieldy and expensive to operate.

While there are other features that will suggest themselves to the intending purchaser, these are the most important requirements for a tractor for the orchard. The tractor with the right requirements is undoubtedly the ideal power for the orchardist whose mode of production is intensive, whose acreage in most instances is limited, and who, on this account, grows little if any forage crops with which to feed horses. The horse must be fed whether idle or active. The tractor only eats when it works, and, given proper care, is always ready for work. In addition it will perform many duties that cannot be done by horses.

Fortunately there are now a number of tractors on the market that fill the needs of the orchardist. To the intending purchaser, therefore, the paramount thing is in making the right selection—that is, make the selection with the idea always in mind that the tractor is for the orchard first and for other things afterward.

Better Fruit Packages.

The fine grade and pack of apples put up in the Northwest has been one of the most important contributing causes in securing for the fruit of this section better prices. Other things have helped, of course, such as good quality, superior color and long keeping characteristics.

But all the apples containing these desirable qualities are not grown in the Northwest, and the apple growing districts of the Middle West and the East have not been asleep during the past few years. They are now carefully grading and packing their apples, whether packed in boxes, baskets or barrels. Grading and sizing machines adapted to the style of pack they put out have been adopted and their competition with Northwest fruit is becoming keener each year.

To some extent this is a procedure that can be welcomed by the Western box apple grower, as it is resulting in eliminating a large quantity of inferior fruit. At the same time the Northwest grower must bring himself to the realization that perfection in grading is one of his greatest trump cards and that it must be looked to with constant care.

This improvement in fruit packages is marching around the globe. It is being taken up in Australia and South Africa, Canada and Nova Scotia, and it remains for America and particularly the Pacific Northwest to remain in the lead.

"More Bees, More Fruit."

Without an exception experts on orchard fruits are recommending the keeping of bees in or near an orchard to assist in pollination. This course is recommended in addition to the planting of a certain number of trees of other varieties that are known to be pollinators in large orchard blocks of one particular variety. It has come to be recognized that bees are one of the most valuable assets that the orchardist can have and that the beekeeping industry should be stimulated and protected in orchard districts in every way possible. In fact, it will pay the orchardist to make a study of the beekeeping industry and to place as many hives as he believes will secure the necessary food in or near his orchard, regardless of the income he may secure from the honey.

This course has been advised by many prominent fruit growers in the Northwest. In Washington a campaign is being conducted to raise more bees and to protect them. In California the same action is being urged, while the matter is also receiving the endorsement and approval of a large number of growers in Oregon.

A good slogan in waging this campaign for increasing the number of these valuable insects would be "More Bees, More Fruit," and every orchardist should bear this in mind.

The Penalty for Neglect.

In an article recently published in a Hood River paper Mr. Leroy Childs, entomologist at the local experiment station, sounds a serious note of warning to growers in that section to not neglect to spray for anthracnose. This same warning has been sounded to growers by experts in Washington and other sections of the Northwest.

It is pointed out by these experts that once this tree disease becomes deep-seated in an orchard it is more to be feared than swarms of codling moth or insect pests, which can be controlled if the proper spraying methods are pursued. Anthracnose can also be controlled in its early stages if the trees are sprayed when it is developing, viz., in the fall just before the heavy rains set in. With a profitable fruit crop being taken from the trees, many growers seem to forget that another year of harvest is coming. Why not remember that it takes a healthy tree to continue to bring this harvest and take the

necessary precautions to eliminate this most serious tree disease?

This is an instance where the old adage, "A bird in the hand is worth two in the bush," doesn't work out, for if you kill the bush you will have no birds.

RECLAIMED.

(An Ode to the Yakima Valley.)

By ALICE CROCKER.

I belong to the land of the golden west,
The land of the bright sunshine,
Where myriads of songbirds build their nests,
Winging their way from every clime,
Back to the glad springtime.

The land of the rosy-cheeked apples rare,
Where the orchards bloom and flowers fair,
And far beyond them the desert stretches
Are lost in those misty, magic spaces—
In the purple haze of the air.

If you travel the highway, the Scenic Highway,
If you list you can hear any time, any day,
In notes sweet and clear, in coats of gray,
The meadow larks singing their roundelay.

Nature's granaries are full unto bursting.
Years past and present yield profits untold.
The reason? you question; the answer, I give it:
'Tis soil—irrigation—reclamation—and grit.

Atop of the hills beyond the fair city,
Away to the top of the hills,
What is it? A serpent, a monster crawling?
What is it afar, away up on the hill,
Encircling the crest of the hill?

'Tis the siphon, the flume up yonder
That causes the water to flow
In and out, across the valley beyond,
'Til it blossoms like the golden glow,
Like the shining golden glow.

'Tis the wonderful way the West has
Of reclaiming the desert sands;
Changing the face of the landscape
Into the fairest of lands.

It's not merely a question of luck,
Neither is it a question of pull;
The acres and sunshine and climate
Are for fellows with plenty of pluck.

So, if you are coming to Washington, stop
Where the people "go over the top";
For a cause that is right
They will boost main and might
'Til what they're after's in sight.

There is room for you, countless millions,
Join the ranks that are passing by
To the land of the western horizon;—
You shall flourish and live for aye.

Peace and plenty shall crown your endeavors;
Though you may not be acquainted with fame,
You may add to your laurels and ours;
All you need is to get into the game.

What Newspapers Interested in Fruit Are Saying

Portland's fruit paper, *BETTER FRUIT*, is widely read.—*Portland Telegram*.

Maybe you have a hard row to hoe because you don't like to hoe.—*Toppentish* (Wash.) *Review*.

Cull apples have their choice this year of being dried or going to the cider mill.—*Medford* (Ore.) *Mail*.

Apple buyers are not so numerous as they were before the meeting of the International Apple Shippers.—*Yakima Valley Optimist*.

Our notion of a waste of effort is the plan of Congress to prevent a farmer from storing a barrel of cider in his cellar.—*Fruit Trade Journal*.

While it is probably not advisable to encourage growers in allowing their hopes to soar too high, in view of the phenomenal prices realized for soft fruits this season, orchardists have every reason to be optimistic.—*Hood River Glacier*.

Crown galls on peach trees, where they are not too large, should be cut out with a chisel until a smooth surface is reached in the healthy wood. The cut should then be painted over with bordeaux paste.

Roadside Planting of the English Walnut

By A. L. Peck, Professor Landscape Gardening, Oregon Agricultural College

I PRESUME that I have been called to write on roadside planting because of the fact that the English walnut is considered a good roadside tree. I am willing to agree that this species can be used to good advantage in a good many instances. We cannot, however, plant or advocate planting any one species without making a great many reservations and expecting, in the development of plantations, to modify and to change materially as we encounter various conditions. It is in order, therefore, to look into the history of the development of roadside planting in order that we may properly understand the movement.

Many years ago, in Europe, it became evident to the rulers and to those dependent upon wood for fuel that means of increasing plantations of trees must be found. In the desire to use every available foot of ground for this purpose, the land lying along the roadways was naturally planted. In flat countries the farms were all divided into rectangular areas and the roads were naturally long and straight, and we have that famous picture in our minds of lengthy rows of trees of the same size and of the same form, and these plantings pleased us.

This idea of planting a single or double row of trees along the roadway was in vogue when the colonies were developing on the Atlantic seaboard. Naturally they planted as the Europeans had planted years before them, and then many of the towns took up the same ideas.

They planted trees in rows along the side of the road. People persisted in planting in this way until such a method became almost a strict law or custom, and today we feel that if we are going to plant in an organized way along the country road, that we must have a magnificent row of trees on either side.

This method is good, and can be used in a great many places. We must not feel, however, that this is the only way to plant roadsides. Many of our roadsides are located through hilly country; much of the land on either side is likely never to be improved; the wild woody

ideas are brought right to the edge of the road. Tourists and people motoring for pleasure want to see these woods. The scenery along the way makes the drive interesting because of its variety and because of the beautiful views in the distance. It would appear to any one then that the formal planting of rows of trees would not fit into surroundings such as have just been described.

It is the idea then that considerable damage may be done by the over-enthusiastic planter unless some means are taken to make him understand the fitness of things and the reasonableness of planting.

Take the English walnut, which all of you admire so much, and imagine it planted along the roadside in a hilly country where you will find large rock outcrops along this road, and tangles of underbrush, large masses of Douglas fir, the Oregon maple creeping in, unusually dry, shallow soil in places; wet, spring land in others, and in the distance of a few miles to find a very wide range of conditions.

You who have cultivated the English walnut know its requirements. You know that if you are going to make a satisfactory planting you must have the soil and other conditions conducive to its growth. From a practical standpoint, then, it will appear to you that the indiscriminate use of your favorite tree would be a failure along a road running through a variety of soils and conditions. The same, of course, is true with all other materials, and it is because of this variation that I believe that someone who understands the nature of all our different plant material must be placed in a position where he can influence to a large extent the choice of materials and their location in order to make this move a success.

A landscape architect is so trained that he should know what materials ought to be used under certain conditions. He can choose from a wide field of experience in solving planting problems and in introducing the necessary variety that makes the entire composition a pleasing one. The plant material must be of a kind that fits into its surroundings.

Adaptability of the plant to its surroundings, then, is of very great importance. Merely the idea of succeeding in planting hangs upon this adaptability. There is, however, a greater question, that of aesthetic value; a plant must fit into its place and harmonize with its surroundings or it is a failure. Landscape architects recognizing this factor would carefully design a roadside planting, varying its material as the topography and general environment of the road changed. Definite plans, after careful study of a roadside district, so that those who are going to work out the planting plan would be able to follow this development even through the course of a number of years before the planting is completed. The idea of a

To Patrons of Better Fruit:

Owing to increased cost of production and the continued high postal rates the management of Better Fruit finds it necessary to raise the subscription price of this magazine to \$2.00 after December 1, 1919. Until then subscriptions will be taken at the old rates, viz:

In United States and possessions—	
1 year	\$1.00
3 years	2.00
In Canada—	
1 year	\$1.50
In Foreign Countries—	
1 year	\$1.50

By renewing your subscription now or becoming a new subscriber you will get the benefit of the present rate.

A return blank allowing you to take advantage of this special offer will be found on page 1 this issue.

Better Fruit Publishing Co.

definite plan on paper specifying and outlining this work is very important, and insures the ideas of some one man, studying the proposition at one time, will hold through to the end. A unity in the planting may thus be attained, whereas otherwise such a thing is entirely lacking.

This planting plan should not only call for the location of planting, but it should also specify where openings or vistas are to be made or preserved. People drive through a country and call it beautiful and interesting, or otherwise, because of the scenery which may be viewed from the road. If these views, then, are all masked by planting we lose the most valuable asset to the road.

Judicious cutting and preserving of open spaces would therefore be as necessary as good planting.

It is evident, then, that many problems, large or small, bear upon this question of roadside planting. We know that tastes of people differ. Some tastes being good and others otherwise. If we allow enthusiastic planters of various tastes to leave their marks along the highway we are going to have a sadly mixed up condition of affairs in the course of a few years. Many of you would want to plant English walnuts, but there are other people who like equally well the cut-leaf weeping birch, or the blue spruce, or the weeping willow, or the so-called monkey puzzles. Such mixed up array of material would, of course, prove a failure when we consider its value from an aesthetic standpoint. The sporadic efforts of school districts or communities must be definitely controlled or advised, or this same result will develop.

I am convinced that there is only one way to control this planting, and that is through a well defined, definite head,

WANTED

Position by experienced horticulturist as a manager of fruit farm, preferably apples. Married. Good salary required.

Write "A. P.," Better Fruit

How You Can Get Better Fruit's Apple Packing Chart

BETTER FRUIT'S apple packing chart as it appears in this number, but printed on cardboard so that it can be hung in the packing house, will be mailed to anyone desiring it on the following terms:

- One card FREE with a new subscription to BETTER FRUIT.
- One card without subscription ... 10c
- Twelve cards without subscription, \$1.00

For quantity prices write us.

Better Fruit Publishing Co.
703 Oregonian Building
Portland, Oregon

which might or should be associated with or under the direction of the State Road Commission.

Here in this office the general problem and its relation to the state at large can be definitely started and solved. Here the man in charge of the planting can keep his hand on the various problems and through his means of obtain-

ing information can become acquainted with all the topographic features along the road. In this way, then, and in this way only, I feel that a definite development along satisfactory lines may be made, and thus the roads which are to be developed in the next decade can be made attractive from the standpoint of beauty as well as of good engineering.

Strawberry Culture From All Viewpoints

Written for "Better Fruit" by a Grower

TO break right in at the start, in setting strawberry plants you should always get the very best plants obtainable. Don't think that you can economize by getting plants from a run-out fruiting bed for nothing and then expect to grow a good fruit crop. A few years ago I was talking with several of my neighbors at Twin Falls. One man remarked that he wanted to buy some strawberry plants. His neighbor spoke up and said, "You don't need to buy plants. Come on over and I will give you all you want. They're so thick they will not fruit anyway, and I intend plowing them up in the spring." Now this fellow meant well, but he evidently had never had any experience in growing fancy strawberries. The neighbor did not take his advice, however, but bought his plants elsewhere.

One should get plants adapted to the locality. If inexperienced in this line, most any reliable plant grower or nurseryman can advise you about what to get, or possibly you can get the information from successful growers in your locality.

For a family garden one ought to have two or three early variety and two or three medium or late varieties and at least one ever-bearing variety. This assures us of strawberries during the season. For commercial purposes we want to grow whatever the market

demands. We might get a much higher price by shipping to a distant city. Such being the case, we want strawberries that will be good shippers. However, whether for domestic use or for commercial purposes, we should grow at least two or three varieties to insure pollenization. There are male and female in strawberry plants. The female will not fruit unless set with a male; however, it is not necessary to set a male with a female to insure success, as the male variety has both male and female organs and is self-pollenizing.

I always advise setting plants in the spring. At that season transplanting does not set them back. For transplanting we use a tool something like a trowel, which we call a steel dibble. Sticking it in the soil five or six inches deep makes a good sized hole. It is easily handled with one hand, and while making the hole, holding the dibble in one hand, you can pick up the plant with the other hand, and thus set the plant. The roots should be well down and all spread out. Care should be taken that the crown is not covered, as plants should have air the same as human beings.

Preparing the Soil.

I prefer clover sod plowed in in the fall, and then covered two or three inches deep with well rotted manure. There is nothing equal to manure. After the manure has been put on, get on it with a good sharp disk harrow, which mixes it with the soil. The rains and snows will dissolve the manure and put it in good shape. In the spring it should all be dissolved, and then should be disked and rolled. This makes an ideal bed and gives the weeds such a backset that they are not likely to give any trouble until the plants are well started.

I would advise growing strawberries in the hill system. There is no question but that this system is the easiest, simplest and the most profitable way to grow strawberries. Make the rows about thirty inches apart, and set the plants about fifteen inches part in the rows. The rows are close together, and where irrigation is necessary one corrugation between each two rows is all that is necessary. I am referring now to irrigating after the plants are started. When first set, corrugation should be as close to the plants as possible. With the hill system you will have less trouble to keep out the weeds, the berries are much easier to pick, and will produce more fancy fruit.

There are other systems which may be followed with satisfactory results. The single hedge, and the double or

triple hedge-row systems have proven successful.

If you desire to follow the single hedge row system the rows should be at least three feet apart, and the plants should be set two feet apart in the row. Each plant should be allowed to make two runner plants, which should be layered in line with the original row, one on each side of the mother plant. This gives continuous rows with plants about twelve inches apart in the row. After the rows have been thus formed, the rest of the runners should be pruned off. This leaves room between the rows for cultivating, and pickers can get through without disturbing the vines and fruit.

In using the double hedge row system you make the rows three and one-half feet apart and set the plants two feet apart in the rows. Each of these plants should be allowed to make six runner plants. The first two runners of each plant should be layered directly in line with the original row, one on each side of the mother plant, and the remainder should be layered on each side of the row. When runners are layered in this manner the rows will be about one foot wide, and each plant will have plenty of room to develop into a heavy fruiter. After the rows have been thus formed, all other runners should be pruned off the same as in the single hedge row system.

I do not recommend the wide matted row system, which is formed by making rows from three and one-half to four feet apart and setting plants two feet apart in the rows, allowing each

HIGHEST QUALITY

SEEDS
BULBS ROSES
TREES

NEW FALL CATALOG

Our new 48-page fall catalog of FLOWERING BULBS, ROSES, FRUIT, SHADE and ORNAMENTAL TREES and SHRUBS is free on request.

We offer you "HIGHEST QUALITY" stocks of real merit and varieties especially adapted to this coast. Twenty years' practical experience here enables us to serve you intelligently.

No Agents

We employ no agents, sell direct only. This saves you agent's commission, insures satisfaction, etc. Read about our NEW MARVEL STRAWBERRY, BANWINE RHUBARB, etc.—money makers for you.

When you want

SEEDS of any kind, POULTRY, BIRDS or PET STOCK SUPPLIES, FOOD OR REMEDIES, FERTILIZERS, INCUBATORS and BROODERS, etc., write us.

Special Catalogs on request.

Routledge
SEED & FLORAL Co.
145 147 2nd St. PORTLAND ORE



TRAP FURS

for
Stephens

**Your Chance Now to
MAKE BIG MONEY**

Stephens' New Trappers' Book tells you how. Coyotes, Muskrats, Skunks, Wild Cats and all other Western Furs are selling in Denver this year at the highest prices ever paid.

DENVER, COLORADO is the Closest and Best Market on earth for Western Trappers and Fur Shippers. Stephens of Denver is the largest exclusive buyer of Western Raw Furs in the world.

STEPHENS charges you no commission—saves you 50c to \$10 on express or parcel post and you get your money 2 to 10 days quicker—because Denver is closer to your town than any other Important Fur Center.

TRAPS AT FACTORY PRICES. Stephens sells Traps, Animal Baits and all trappers' supplies at rock bottom prices. Write today for Big, Illustrated Trap Catalog, Trappers' Guide, Fur Price List and Shipping Tags—**ALL FREE AND POSTPAID.**

E. A. Stephens & Co.
161 Stephens Bldg.
DENVER, COLORADO, U. S. A.

Trappers Guide Free.

plant to make all the runners it will. This makes a thickly matted row which produces small, inferior berries.

We have found two very successful ways for setting plants. In both cases corrugation should be made first. In one way we turn a small stream of water in each corrugation and when the ground is thoroughly soaked we set the plants. This should be done when the water is running. You should never attempt to set plants in soil after it has begun to dry, as it gets soggy. It cements on either side, and you can notice that throughout the season, and it is very hard to get the plants to take root.

In the other way we set the plants two inches from the corrugation in the dry soil before any water is turned on, and the water should then be turned on immediately after setting. The plants should be watered two or three times, or until they start growing, before cultivating. Of course, if you have a very small garden, just a few hundred plants, they could be cultivated after watering, where you can make cultivation with a hoe, but growing on a large scale it is impossible to get the ditch as close to the plants as it ought to be. I have found by experience that if you let the plants get dry, after they have started to grow, they often die in a few hours.

Cultivating.

Strawberries should be cultivated about the same as most garden crops. The roots should not be disturbed by deep cultivating too near the plants, and they should not be cultivated during fruiting season. There should be thorough cultivation before the strawberries come on, and then continuous cultivation or cultivating every week or two, when the weather permits, after the crop has been gathered. If you are growing ever-bearing varieties, they fruit throughout the growing season

and it is necessary to cultivate occasionally.

The blossoms should be removed the first year set. With the ever-bearing varieties the blossoms should be picked two or three times until about July 1, and from then on they can be allowed to fruit without injuring the plant in any way. They will bear a fine crop the first year, averaging about one quart per plant.

Mulching.

I am sure it pays to protect plants during severe winter weather in high altitudes, especially when first set. Straw, stable manure or most anything of the sort is suitable. It should be put on at the beginning of the freezing weather and should not be put on too deep. In the spring after the frosts are past you should remove the mulching. There should be plenty of moisture in the ground at the beginning of freezing weather. Dry freezing is very hard on plants.

At the beginning of the picking season one should have crates on hand and pickers engaged. When the berries are ripe they should be picked immediately, or there is a loss. They should be picked with short stems and not stripped off the vines. The berries should not be overripe and no ill-shaped or small berries should be put in, and the boxes should be well filled.

Strawberries are very profitable when handled in a business way. There is no other small fruit that will return the profits of strawberries. They are very easily grown. Anyone can make a success of growing the berries if they work. And in closing let me say, remember to get good plants adapted to your locality, have the soil fertile and well prepared, cultivate and water thoroughly, protect during the severe freezing weather, pick every day, giving good measure, pack in neat crates, putting in only good fruit, and the selling will be a very easy matter.

shortage, which threatens to keep much of the fruit from market.

The barreled apple crop is now estimated at 13,332,000 barrels, or 76 per cent of last year, while the box apple crop is estimated at 29,535,000 boxes, or 139 per cent of last year.

STATEMENT OF THE OWNERSHIP, MANAGEMENT, CIRCULATION, ETC., REQUIRED BY THE ACT OF CONGRESS OF AUGUST 24, 1912,

of the Better Fruit, published monthly at Portland, Oregon, for October 1st, 1919.

State of Oregon, County of Multnomah—Before me, a notary public in and for the state and county aforesaid, personally appeared D. L. Carpenter, who, having been duly sworn according to law, deposes and says that he is the business manager of Better Fruit, and that the following is, to the best of his knowledge and belief, a true statement of the ownership, management (and if a daily paper, the circulation), etc., of the aforesaid publication for the date shown in the above caption, required by the act of August 24, 1912, embodied in section 443, postal laws and regulations, printed on the reverse of this form, to-wit:

1. That the names and addresses of the publisher, editor, managing editor and business managers are:
 Publisher, Better Fruit Publishing Co., Inc., 800 Oregonian Building, Portland, Oregon.
 Editor, E. E. Faville, 800 Oregonian Building, Portland, Oregon.

Managing editor, none.
 Business manager, D. L. Carpenter, 800 Oregonian Building, Portland, Oregon.

2. That the owners are: (Give names and addresses of individual owners, or, if a corporation, give its name and the names and addresses of stockholders owning or holding 1 per cent or more of the total amount of stock.)
 Owner, Better Fruit Publishing Co., Inc., Portland, Oregon.
 Stockholders, D. L. Carpenter, 800 Oregonian Building, Portland, Oregon.

E. E. Faville, 800 Oregonian Building, Portland, Oregon.
 A. W. Stripes, 800 Oregonian Building, Portland, Oregon.

3. That the known bondholders, mortgagees and other security holders owning or holding 1 per cent or more of total amount of bonds, mortgages or other securities are: (If there are none, so state.) None.

4. That the two paragraphs next above, giving the names of the owners, stockholders and security holders, if any, contain not only the list of stockholders and security holders as they appear upon the books of the company, but also, in cases where the stockholder or security holder appears upon the books of the company as trustee or in any other fiduciary relation, the name of the person or corporation for whom such trustee is acting is given; also that the said two paragraphs contain statements of contractor, affiant's full knowledge and belief as to the circumstances and conditions under which stockholders and security holders who do not appear upon the books of the company as trustees, hold stock and securities in a capacity other than that of a bona fide owner, and this affiant has no reason to believe that any other person, association or corporation has any interest, direct or indirect, in the said stock, bonds or other securities than as so stated by him.

5. That the average number of copies of each issue of this publication sold or distributed, through the mails or otherwise, to paid subscribers during the six months preceding the date shown above is: (The information is required from daily publications only.)

D. L. CARPENTER,
 Business Manager.
 Sworn to and subscribed before me this 24th day of September, 1919.
 H. R. SHAW,
 Notary Public for Oregon.
 (My commission expires September 21, 1921.)



SULPHUR

It has been proven and so recommended by the University of California that if you sulphur your grape vines and orchards 6 times they will not be affected by MILDEW or RED SPIDERS.

ANCHOR Brand Velvet Flowers of Sulphur, also EAGLE Brand, Fleur de Soufre, packed in double sacks, are the fluffiest and PUREST sulphurs that money can buy; the best for vineyards; the best for bleaching purposes, LEAVING NO ASH.

VENTILATED Sublimed Sulphur—Impalpable Powder, 100% pure, in double sacks, for Dry Dusting and making Pests—Sulphur.

For LIME-SULPHUR SOLUTION, use our DIAMOND "S" BRAND REFINED FLOUR SULPHUR.

To create additional available plant food, drill into the soil 100 to 400 pounds per acre DIAMOND "S" BRAND POWDERED SULPHUR, 100% pure. This has increased various crops up to 500%. The sulphur may be applied broadcast by hand or with a duster, but usually an ordinary land plaster sower or lime spreader is used.

Also PREPARED DRY DUSTING MATERIALS, Tobacco Dust, Dry Bordeaux, Dusting Sulphur Mixtures, etc. And Standard LIME-SULPHUR SOLUTION 33° BE., Fungicides and Insecticides.

Carried in stock and mixed to order.

San Francisco Sulphur Co.

624 California St. San Francisco, Cal.

We are equipped to make immediate shipments. Send for "ILLUSTRATED BOOKLET"; also booklet "NEW USES FOR SULPHUR." Price-list, and Samples.

Please state for what purpose you use the sulphur, quantity needed, and date of shipment preferred.

WHEN WRITING ADVERTISERS MENTION BETTER FRUIT

Decrease in Estimate of Northwest Apple Crop

The commercial apple crop for the United States for October was estimated at 23,177,000 barrels, or 105,000 barrels increase over the September estimate and compared with a production of 24,724,000 barrels in 1918, according to the report issued by the Bureau of Crop Estimates through its fruit crop specialists. Changes have occurred in the Yakima Valley, which has decreased about 1,500 cars from the September estimate, and in Southern Idaho, which has decreased about 500 cars, due in both cases principally to late infestation of codling moth. Colorado has also decreased about 10 per cent and quality is extremely poor, particularly in the Grand Valley. On the other hand, California and Oregon have increased over the earlier estimate.

There has been an increase in the barreled apple crop in the Hudson Valley and parts of New England. Arkansas is harvesting a bumper crop of fine fruit under extremely unfavorable conditions, there being a very serious ear

Pull the Stumps

Clear land slick, clean and fast at low cost. Big money clearing land for others. The Hercules big Free Book contains boiled down experience of 25 years of land clearing. Turn low cost stump land into high priced crop land.

Hercules Portable

Solid steel bed plate, broad steel wheels. The marvel of the age. Get our special low introductory offer. 30 days' free trial—3 year guarantee. Write today for book of photographs and letters from owners.

Hercules Mfg. Company
 169 28th St., Centerville, Ia.

Catalog FREE

All-Steel Triple Power With or Without Wheels

Get Hercules Big Book FREE

WHEN WRITING ADVERTISERS MENTION BETTER FRUIT

Timely Topics and Advice to the Fruitgrower

Remember that an annual light pruning is much better than a heavy pruning every few years.

Grapes are one of the few fruit crops that require little preparation of the soil.

Did you ever stop to think that practically all the work that is done in an orchard is practically lost if the trees are not sprayed. A high pressure and hard and thorough work are essential in spraying an orchard properly. Almost as important is getting the spray on at the right time. In the enthusiasm of high prices apple growers should not forget that this is the time to spray for anthracnose and that its inroads result in one of the most serious conditions in an orchard.

The time to secure humus for your intended raspberry patch is before the plants are set. Humus in a raspberry patch is more important during the early growth of the plants than later. A cover crop of clover in the previous season to planting makes a fine soil condition for the new berry patch, either raspberries or strawberries.

Do not leave rotten peaches, pears or apples hanging on your trees after the harvest. Rotten fruit left on the trees causes disease. This is especially true of peaches, where what is known as "mummies" develops, which even spraying does not kill. This disease causes the peach to shrivel up and hang onto the trees throughout the year, scattering the disease spores and ruining a great many peaches of next year's crop. These "mummies" should be picked off and burned.

Apples that fall off the tree or are imperfect may not keep well or find a ready sale, but they can be used satisfactorily to make apple products. These products are available for home consumption throughout the entire year, which is an advantage worthy of the consideration of apple growers. The following recipes recommended by the United States Department of Agriculture will utilize the windfalls and culls. Do not can any decayed part nor allow apples to become overripe before canning. Wash the apples, which must be reasonably firm. Remove core and blemishes (pare if desirable when for immediate use). Place whole apples in blanching tray or blanching cloth

and blanch in boiling water for two minutes. Remove and plunge quickly into cold water. Pack in large, empty glass jars or gallon tin cans. Pour over the product a hot, thin syrup of about 18 degrees density. This is made in the proportion of 2¼ pounds of sugar to 5¼ quarts of water. Place rubber and top in position. Seal partially, not tight. If using tin cans, cap and tip completely. Process half-gallon or gallon containers 20 minutes in boiling water, in home-made or hot-water bath outfit; 15 minutes in water-seal; 10 minutes in steam pressure outfit, with five pounds of steam pressure. Remove jars, tighten covers, invert to cool, and test joints. Wrap in paper and store. The time of heating will have to be varied according to ripeness and condition of the fruit. Use just enough time to sterilize perfectly, and yet not enough to change the color or reduce the pulp to sauce.

Ordinarily spraying solutions are considered in quantities of 50 or 100 gallons and the proportion for small doses is neglected. Large trees may take up to 20 or 30 gallons of spray and demand a sprayer of large capacity. An apple tree 25 years old would need about 8 gallons of spray solution. The usual formula, therefore, is given as so many pounds or gallons to 50 or 100 gallons. The formulas can, of course, be reduced but it is sometimes puzzling to know just how much of the spray material to use for one gallon of water, especially so when scales or a small measure are not handy. To inform those who need but a small quantity of spray, the California State Department of Horticulture has just issued a valuable little schedule for this purpose which says:

The most widely used spraying materials for orchard and vineyard work are arsenate of lead, lime-sulphur, blackleaf 40 and Bordeaux mixture. For shrubs and plants, soap, kerosene emulsion, hellebore, Paris green and tobacco water are often used in addition to those mentioned for trees.

Arsenate of Lead.—Arsenate of lead, either paste or powder, is the most used insecticide for chewing insects. Two teaspoonfuls of the paste mixed with a little water and added to one gallon of water will be strong enough for caterpillars and other leaf eaters. Three and a half teaspoonfuls of the powder should be used.

Paris Green.—Paris green was one of the first arsenical poisons, but is being replaced by arsenate of lead. It may be used as a dust with lime or in water, one teaspoonful to two and a half gallons.

White Hellebore.—White hellebore is a brown powder made from the roots of the hellebore plant. It is poisonous to insects but only slightly so to man and quickly loses its toxic value. For this reason it is usually used on mature fruits or vegetables. It may be used dry with twice its bulk of flour or ten teaspoonfuls to a gallon of water.

Tobacco Derivatives.—Blackleaf 40 is probably used more than any other nicotine product for aphids. It should be used at the rate of two teaspoonfuls to a gallon of soapy water. Tobacco water may be made by soaking a pound of stems in two gallons of water. This should never be boiled or the active agent will be lost.

Emulsions.—Kerosene emulsion may be made in small quantities by using a generous half cake of Ivory soap, or other neutral soap, a pint of water and one quart of kerosene. Dissolve the soap in hot water and thoroughly mix in the kerosene. For summer spraying, use one part of the stock solution in ten parts of water. Very often the desired results can be obtained by washing or spraying a plant with soap alone, using a little less than half a cake of Ivory soap to a gallon of water.

Lime-Sulphur.—Lime-sulphur is not often used in very small quantities. For a small apple tree, from four to five years old, from one to two gallons of spray solution would be needed. This would require about a pint of concentrated material.

Note.—These recommendations call for a teaspoon level full.

NOW is the time to send to
Milton Nursery Company
 MILTON, OREGON
 FOR THEIR 1919 CATALOG.
 FULL LINE OF NURSERY STOCK.
 "Genuineness and Quality"



SHE has a good time at *her own party*—does the hostess who serves Ghirardelli's Ground Chocolate. Whether it's an "afternoon at home"—an informal evening—or some guests who "drop in" unexpectedly—Ghirardelli's offers the happiest solution to the refreshment problem. So delicious, so economical, so easily made!

Never sold in bulk—but in cans only.
 In ½ lb., 1 lb., and 3 lb. sealed cans—
 at the store where you do your trading.

Say "Gear-ar-delly"

D. GHIRARDELLI CO.

Since 1852

San Francisco

(F1)

GHIRARDELLI'S Ground Chocolate

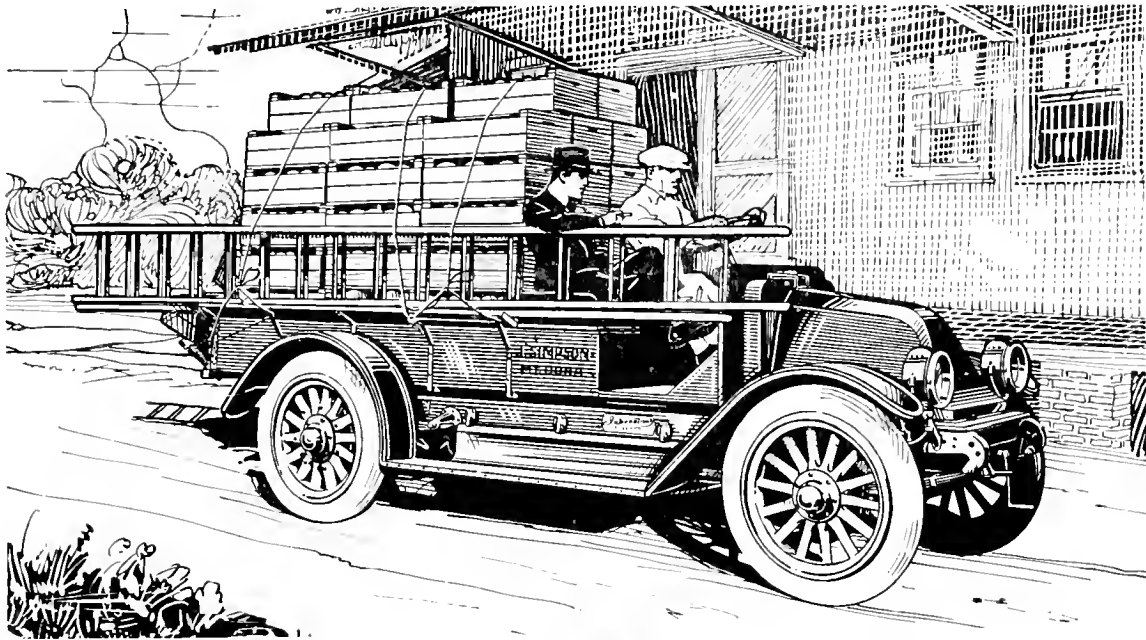

International Motor Trucks

For Low-Cost Farm Hauling

There comes a time in the life of every motor truck, no matter how good it is, when some part requires replacement or adjustment. That must be expected, just as with the best machine you own and use. When that time comes, the right part and the man to make the adjustment must be available immediately.

Several million dollars of repair parts, distributed among our 92 branch houses and thousands of dealers, is evidence that the **International Motor Truck** organization is unrivaled in its "after-sale" service. Road engineers traveling out of each branch house always keep in touch with International truck owners. All this so that we may give our customers the "after-sale" service that we feel they are entitled to.

The International Motor Truck has a record for performance which we invite you to investigate. It requires "after-sale" service to a surprisingly small degree, but it is a source of satisfaction to an owner to know that the service is available in case of necessity.

International is preeminently the motor truck for farm use. It holds a position in the good opinion of the farmer which is the result of nearly a century of building machines for use in agriculture. The knowledge and skill which built good binders and tractors has also put strength, sturdiness and efficiency into International Motor Trucks for use in country and in town. For time-and-money-saving economy in your hauling, make an International Motor Truck investment. Your letter to the Chicago address will bring you full information and the name of your nearest dealer.

INTERNATIONAL HARVESTER COMPANY

OF AMERICA INC.

CHICAGO

U S A

Distributors and Dealers Everywhere

Northwest Fruit Notes from Here and There

OREGON.

The announcement was made at Salem recently that the Steward Products Company, which will manufacture flavoring extracts, pie filling, egg substitutes, apple butter, baking powders and many other articles, adds another institution which will be a help to the fruit industry in that city. The new firm will employ about twenty-five people at the start and expects to commence operations as soon as the equipment can be installed.

The Minto prune orchard, one of the largest in the Willamette Valley and located five miles from Salem, was sold recently for \$30,000. The new owner is George W. Shand of the Salem Iron Works.

The using of a large tonnage of grapes by the Phez Company at Salem this year for jams and jellies will, it is believed, result in greatly stimulating the grape industry in that section. The fact that this company is utilizing 110 tons of grapes this year is causing the planting of a number of additional vineyards in that section.

A labor shortage in many of the apple growing districts in Oregon was reported during the month. In some of these districts a large number of pickers arrived in the various towns with the expectation that they could make from \$6 to \$8 per day. When they found that they were unable to do this many of the pickers refused to work.

Mosier orchards, it is reported, will be greatly enlarged if growers there can obtain the stock. The largest planting will be made in prunes if orchardists in that section can get the nursery stock.

A large acreage, it is reported, will be planted in berries in Clatsop County next spring. The varieties to be set out will include loganberries, blackcaps, strawberries and Cuthbert raspberries.

The record shipment of fruit from the Rogue River Valley is predicted for this year. It is stated that 1,000 cars of fruit will be shipped from this section before the 1919 season closes. Buyers of fruit for dryers and cider plants are active there and have bought many tons for these purposes.

The prune harvest in the Willamette Valley was completed about October 5 and the crop is reported to have averaged about 85 per cent of normal. In some sections the crop averaged only 50 per cent, while in others it is reported to have been above normal.

Horacio Parada and George Silva, two Chilean citizens, recently spent a month in the Hood River district studying the methods used there in growing and packing apples. Mr. Parada recently took a two years' course in horticulture at Stanford University and Mr. Silva entered the Agricultural College at Pullman, Washington, this year for the same purpose. According to these visitors, Chile is going into the orchard industry on an extensive scale.

The Hood River Apple Growers' Association has just secured 200 feet of additional frontage on the railroad and it is stated that the association plans a large development in fruit by-product manufacture next spring.

The packing plant recently opened at Roseburg by the California Packing Company corporation is said to be the largest of its kind in the Northwest and is modern in every detail. It is equipped with a restroom and other comforts and conveniences for its employees. Roseburg now has three fruit packing plants, the other two being those of the Drager Company and the H. S. Gile Company.

The Eugene Fruit Growers' Association has been successful in exporting apples so far this year. Several carloads have been forwarded to England at top prices and others it is expected will soon be sent across. According to J. O. Holt the prune crop in the Eugene district this year was about 50 per cent of normal.

Indications now point to at least 20,000 acres of Western Oregon orchards being enrolled in the new Oregon Growers' Cooperative Association. Many large orchards are reported to have been signed up recently and many new members were secured during the State Fair at Salem. The output from the orchards already secured is expected to run between 500 and 800 cars. Arrangements are being made by the association to equip the community packing houses that it will control next year with the most modern appliances and equipment.

The adjustment of the British railroad strike was welcome news to Northwest apple growers who had sold their crops to British importers. The settlement of the strike is reported to have resulted in a much better tone in the foreign market already.

T. B. Evans & Son are reported to have taken a crop of 5,000 boxes of tomatoes from five acres of land near Dillard this year. The fruit brought a price of more than 40 cents per box.

WASHINGTON.

Through the initiative of the Northwestern Fruit Exchange many of the leading apple shippers and organizations in Wenatchee, Yakima, Hood River and the Spokane districts have raised a fund of \$50,000 which will be used in advertising Jonathans to Eastern and Middle Western consumers. The campaign is already under way in the leading magazines and newspapers of the country.

The new apple evaporator recently opened at Selah has a capacity of thirty to forty tons of green fruit per day and employs about seventy-five people. The plant represents an investment of \$65,000.

A shortage of cider presses is reported from Clarke County, Washington. The last one in that district was sold on October 9 and no new stock was in sight.

Lyle, which hasn't figured very strongly in the apple growing game heretofore, will ship fifty cars of apples this year.

Universal Bushel Shipping Packages

- Costs Less to Fill,
- Easier to Handle,
- No Nails Required for fastening covers,
- Preferred by Dealers,
- Give Better Display.

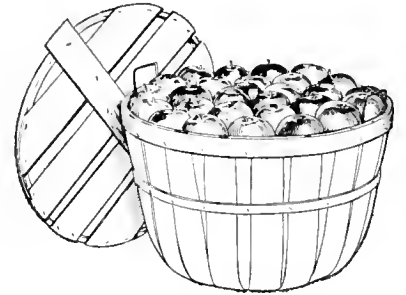

Write for "BIGGER PROFITS." Gives interesting and helpful information about UNIVERSAL PACKAGES with centerposts. List of satisfied users will be sent.

Package Sales Corporation

106 East Jefferson Street South Bend, Indiana

Established 1882

F. W. Baltes & Company Printers

WE print anything from the smallest to the largest and always welcome orders of any size or quantity, giving prompt, personal and efficient service.

Mail or phone inquiries are solicited. We do not specialize - experience and equipment enable us to print everything equally well. We render service in preparing copy and illustrations and furnish plans and estimates for catalogs, booklets, publications, billboard and any other kind of advertising.

First and Oak Streets
Phones: Main 165 and A 1165
Portland, Oregon

Dutch Bulbs

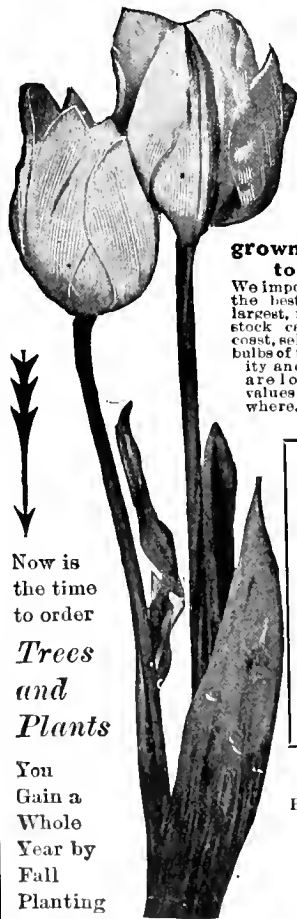

for Winter Blooming and Earliest Spring Flowers

Hardy, Easily grown and sure to bloom

We import direct from the best growers the largest, most complete stock carried on this coast, select "top-root" bulbs of the finest quality and our prices are low. The best values offered anywhere.

SPECIAL

Now Ready "Progressive" and "Everbearing" Strawberries
Doz.....\$.75
100..... 3.50

Postpaid

Big Healthy Plants

AUTUMN CATALOG
Bulbs, Roses, Tees and Plants
Mailed Upon Request
Ask for Catalog No. 521



Charles R. Crewdson, a leading Wenatchee orchardist, makes the statement that fruit growers of the Wenatchee district have lost \$20,000,000 by not advertising their apples during the past seven years. Mr. Crewdson says that every grower in the Wenatchee district could well afford to give 3 per cent of his gross returns to an advertising fund to be used throughout the year, instead of spending a small amount in this way about Christmas time.

The 1919 blackberry pack of the Puyallup and Sumner Fruit Growers' Association totaled 96,000 cases and was sold before the canning season was closed. The payroll for the plant for August was \$628,000.

White Salmon reports an unusually heavy apple crop this year. It is stated that practically all the trees in the orchards there had to be propped to carry their big load of fruit, which is of fine quality.

In honor of the prune, which is the greatest crop in Clarke County, it is proposed to name one of the leading streets there Prune Boulevard and to plant prunes and walnuts alternately along the thoroughfare.

Eighty-one Japanese farm 6,800 acres, or approximately one-tenth of the irrigated area of the Yakima Indian reservation, according to figures from the records of the United States Indian Irrigation Office. These Japanese practically control the reservation melon output.

By giving a bond that cull apples will not be used for any other purpose than for by-products, the Interstate Commerce Commission will allow Washington shippers to dispose of their defective fruit outside of the state. It is said that this action will allow growers to get from \$8 to \$10 more per ton for their culls than they would receive if they sold them locally. In some sections of Washington \$15 per ton is being paid for packing house culls and \$12 for windfalls.

The Washington Dehydrated Food Company of Yakima is erecting a new plant and expects to handle 2,000 tons of cull apples this season. It is reported also that this company plans to erect a dryer at Grandview.

The apple tonnage from Underwood is expected to be about 100 cars and will be handled by the Underwood Fruit Growers' Association.

Five thousand, seven hundred and eighty-one cars of fruits of all kinds had been shipped from Yakima up to October 1.

Cashmere growers are congratulating themselves on the fact that they now have a drying plant which is taking their cull fruit, in addition to providing a substantial payroll for a number of local people.

Fearing the operations of the I. W. W. in endeavoring to influence the harvesting forces in many of the Northwest apple growing districts, residents at Grandview considered the matter of reorganizing the Home Guard to guard against such a contingency during the past month. At Hood River, Oregon, prompt action by the authorities nipped a proposed I. W. W. campaign in that section in the bud.

While a shortage of boxes was feared early in the season in Washington and other Northwest states, later reports were to the effect that the supply was equal to the demand. Growers who waited until late to order their supplies are the only one who are now said to be experiencing any difficulty in getting boxes.

According to Fred Eberle, manager of the Yakima Horticultural Union, apples in that section are showing a loss in culls of from 15 to 50 per cent, due to scale and worms. High winds just before the apples were picked shook hundreds of tons of fruit from the trees, Mr. Eberle states, rendering them only fit for the cider mill.

Washington shipped 282 carloads of apples to eighteen different cities October 14. Idaho shipped 101 carloads to eight cities. The total for the Inland Empire was 1,110 carloads. Between 1,000 and 1,200 persons are now engaged on the 1919 apple crop in Spokane Valley. Varieties now moving are Jonathans, Wageners, Delicious and Grimes Golden for the most part. No serious car shortage has occurred as yet.

The Allen Evaporating Company's plant at Elberton, Washington, has commenced operations. This year's prune crop is the best the growers have had for years and the price is higher. Growers are getting \$50 a ton deliv-

"Wood-Lark" Gets Them

Before They Get Your Trees



"Wood-Lark" Sings the "Swan Song" for All Rodents

THRU the winter months the gopher is active and hungry; feeding on fruit tree roots, root crops in pits, etc. How often in the spring have you found young trees left rootless by these pests. You can protect your trees and crops by planting "WOOD-LARK" well down in adjacent gopher runs and in pits where it is somewhat protected from the rain.

Gophers Prefer "WOOD-LARK" to Roots

If your dealer hasn't any, write us

CLARKE-WOODWARD DRUG CO.

Portland, Oregon



PEERLESS

Automobile Specialties

Make Old Cars Look Like New

They are made from highest quality raw materials. They add to the appearance of your car and the greater durability of these products, more than pays for any possible extra cost over ordinary paints and varnishes.

SOLD BY

Leading jobbers and dealers of automobile supplies all over the country, also Garages and Hardware stores, who handle automobile supplies.

PEERLESS QUALITY PRODUCTS ARE:

Mohair Top Dressing	Touch-Up Black
Jet Black Fender Japan	Lining Dye
Extra Fine Black Japan	Mirroroid
Leather Top Dressing	Tire Paint
Ford Top Dressing	Liquid Wax
Cushion Dressing	Rim Paint
Cylinder Enamel	Gasket Shellac
Auto Body Polish	Lamp Enamel

Dealers Notice

Order Peerless Automobile Specialties through your jobber. If his stock has not arrived write us and we will see that you are supplied. Also write for our Selling Helps to Dealers

Also eight color finishings in following colors:

BLUE, RED, BLACK, WHITE, YELLOW, GREEN, GRAY, STRAW COLOR

It does not take an expert to apply PEERLESS AUTOMOBILE SPECIALTIES. Anyone can do it by following simple directions on each can and first class results are invariably obtained where PEERLESS SPECIALTIES are used. There is a Peerless Product for each part of your car that needs toning up—body, wheels, fenders, and tops. And when refinished your car will have an appearance that anyone will be proud of.

MADE ONLY BY

THE COLUMBUS VARNISH COMPANY

Columbus, Ohio

U. S. A.

Ridley, Houlding & Co.

COVENT GARDEN, LONDON

WE ARE

Specialists in Apples and Pears

CABLE ADDRESS: BOTANIZING, LONDON

Codes: A. B. C. 5th Edition and Modern Economy

SCIENTIFICALLY CORRECT

Zerolene, scientifically refined from selected California crude oil, gives better lubrication with least carbon deposit. Get a Correct Lubrication Chart for your car.

STANDARD OIL
COMPANY
(California)



CLAMP TRUCKS

FOR EVERY PURPOSE

THEY ARE
LABOR SAVERS, TIME SAVERS, MATERIAL SAVERS

Write us for information on
PEACH GRADERS APPLE GRADERS
PACKING HOUSE MACHINERY

CALIFORNIA IRON WORKS
RIVERSIDE, CALIFORNIA

ered at the dryer. They are realizing from \$200 to \$500 an acre from this year's crop. Several young orchards have been set out and others will come to bearing next year.

The Libby, McNeill & Libby cannery at Yakima in its seasonal report says this year it handled 565 carloads of fruit, for which it paid the growers \$205,000, prices ranging from \$2,330 for a carload of cherries to \$50 for a like amount of pumpkins. There was an appreciable increase in the amount and variety of produce used. The cannery is taking 100 carloads of pumpkins. In every case the growers were paid more for their products than required in the original contract.

Apple shippers of Yakima consider the Boston health authorities' attitude against apples showing spray entirely unreasonable, and are unwilling to concede that there is any possibility that the spray used could be deleterious. Formerly all fruit was wiped, but it was discovered the fruit kept better if this was not done, and hence the custom was dropped. Yakima shippers will take the case up direct with the Boston authorities, who are reported to have rejected and forbidden the sale of a carload of apples shipped by the E. E. Samson Company. On account of the extra severe battle waged against insect pests this year a larger percentage of fruit was rolled out marked by spray.

IDAHO.

Payette County had the banner apple exhibit at the Idaho State Fair and carried off 50 per cent of the prizes. This county won the first prize for its collective exhibit and secured individual prizes that totaled \$300.

Those Idaho growers who were enterprising enough to provide apple storage houses this year are now said to be richly repaid, owing to a car shortage. It is said that as a result of this condition fully twenty-five more storages will be built before another fruit harvesting season rolls around.

In the Southern Idaho district many defective apples are reported as the result of failure to spray. Frosts in May are also said to have cut down the Southern Idaho crop.

S. J. Klepfer, inspector for the Bureau of Markets, Department of Agriculture, announces that permission has been obtained from the authorities of the States of Wisconsin and New York to ship worm and scab infected apples from Idaho to those states for manufacturing purposes only.

A Boise fruit broker has announced that he will take unlimited offerings of infected apples, barring decayed only, at \$25 a ton f.o.b. shipping station for shipment to Wisconsin.

The Idaho Horticultural Department is waging an unusually vigorous campaign against infected, poorly graded and poorly packed fruit. Twenty-five inspectors are at work in the fruit growing communities watching the marketing of this year's crop, with the intention of raising the standard of Idaho fruit to the highest possible level.

Inspector S. C. Vanderburg states that the South Idaho orchards in the Boise and Payette Valleys, Canyon County and the Twin Falls district will have between 3,000 and 3,500 carloads of apples.

MONTANA.

The Bitter Root Cannery at Stevensville, Montana, had a very successful year. Peas were the main crop canned. A total of 35,500 cases of peas were canned off about 375 acres, and enough seed is on hand to plant the same acreage next year. The pea acreage is contracted for by the cannery, which furnishes the seed for the growers and pays them for the return of the seed in the fall at the rate of three cents a pound green or five cents a pound dry. In addition to the peas 1,000 dozen gallons of sour cherries and 500 cases of string beans were canned. Sour cherries are a success in the Bitter Root Valley, and between the regular market and the cannery all of the sour cherries raised can be sold at a good price.

Potatoes have proven to be a very profitable crop in Montana this year. While some areas, especially in Western Montana, yielded a total of ten or twelve tons per acre, and even more under the most favorable conditions, the average would not fall below five or six tons. The price early in October was around \$1.50 per sack, but jumped to \$1.80 the middle of the month.

The shortage of apple boxes has been a great handicap to the harvesting and marketing of Montana's apple crop. The shortage was due to underestimating the number needed by the growers, and poor transportation. To assist the growers several local saw mills have installed machinery and are turning out a limited number of boxes per day. Early in the season the price was 19 cents, but none can be had now for less than 25 cents. A large quantity of C Grade apples were shipped loose in cars, with only enough boxes to form bulkheads at the doors of the cars.

State Horticulturist A. L. Strausz reports that the McIntosh Red crop being harvested is the largest ever gathered in Montana. The apples are of excellent color and prices to the growers range from \$2.25 for the Fancy grade to \$1.50 for other grades, according to variety and condition. All fruit is free from scab and only from the old orchards is fruit found with oyster shell scale or other serious defects.

The freeze of October 8 and 9 has not proven as serious as was expected. The temperature fell to 22 degrees both nights, but the fact that there was no sun either day following allowed the frost to escape from the apples gradually. With the exception of a few of the more tender varieties no discoloration has developed and only a slight difference can be noticed in the flavor. Most early varieties were picked, leaving only the Rome Beauty, Gano, etc., out when the freeze came.

The Ravalli County Fair was a success from every point. The display of fruit and vegetables was excellent, despite the fact that the fair came during the busy season. The display from the dry land farms was good, and the many types of produce shown again demonstrated the wide adaptability of the valley for agricultural purposes.

The sugar beet harvest is in full swing. Growers are receiving \$10 per ton and the yield is estimated at ten to twelve tons per acre.

Eleven varieties of grapes, including the Concord, which is not a high-altitude variety, ripened this year on the Robert Snow ranch, five miles northeast of Corvallis, Montana. One variety, a red grape, ripened several weeks ago; others are hanging now, in purple clusters, waiting to be picked, while the later varieties require more frost to sweeten and color them. The grapes are grown on trellises and some of the vines have attained a height of six feet.

An excellent crop of big walnuts will be harvested this year on trees planted twenty years ago on the John Woods ranch, five miles north of Corvallis, Montana. The nuts are not yet all ripe, but Mr. Woods stated Sunday that he believed they would mature better this season than any year previous. They are fully as large as the old Missouri variety. Mr. Woods has lived on the same ranch for forty-two years and has a fine collection of trees and shrubs.

What They're Doing in California

According to the weekly bulletin of the California State Department of Agriculture efforts of various American interests to have set aside the embargo against apples from this country placed by the Australian government have been futile, and latest advices from there are to the effect that the embargo will be continued because it will be an aid to the Australian producer. At the same time Australia is asking the United States to purchase and consume liberal supplies of apples from that country during the period when American apples are high and the growers here are getting the benefit of the lessened supply.

An unprecedented demand for information regarding California farm lands is flooding the office of Director G. H. Hecke of the State Department of Agriculture with letters from prospective buyers in all parts of the United States. It is estimated that several hundred of these inquiries have been received during the past few weeks, and not a few of them are from men who have been or who still are in the military forces of the United States. The inquiries usually concern these classes of land: Developed farm property, and undeveloped property represented in government and state lands. One of the letters, more or less typical of others received, is from a commander of the United States Navy stationed at Norfolk, Virginia, who states that he has \$50,000 to spend as an initial investment providing he can find the sort of proposition he is looking for. An interesting feature brought out in the letter is that the erroneous idea has pervaded the East that, due to the labor situation, it may be un-

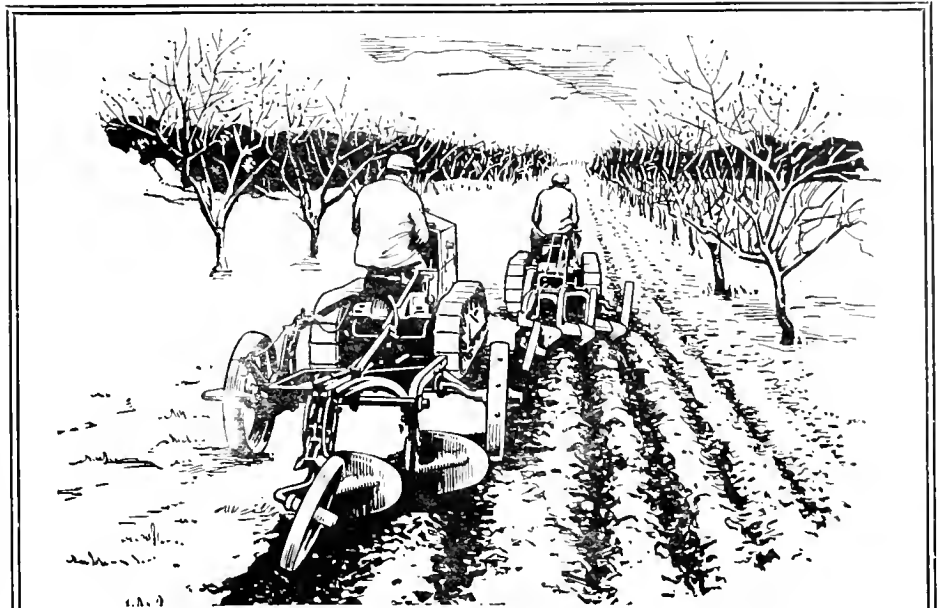

Wherever there are Orchards there are Cletracs

FRUIT growers everywhere recognize the Cletrac as the standard orchard tractor. It gets in close to the tree trunks without injuring crop or branches. It turns so short and so easily that you can readily work around trees, bushes and fence corners.

tractors would be in danger of turning over. It runs on top of the ground on its own tracks like a locomotive. None of its power is wasted.

The Cletrac plows and cultivates faster, better and cheaper than animal power—and does it more days in the year.

Because of its tank-type of construction you can safely drive it on side hills—where ordinary

Send today for booklet "Selecting Your Tractor".

The Cleveland Tractor Co.

19145 Euclid Avenue

Cleveland, Ohio

Largest producers of tank-type tractors in the world

Cletrac
TANK-TYPE TRACTOR

(Formerly known as the "Cleveland Tractor")



WHAT EVERY HOME CANNER SHOULD HAVE

ONE of our **H. & A. Hand Power Double Seamers.** It is the only hand power seamer built that will seal all sizes of sanitary fruit and vegetable cans. Write for prices and descriptive matter to Department T.

HENNINGER & AYES MFG. CO., Portland, Ore.

Builders of Seamers and Steam Pressure Canning Outfits

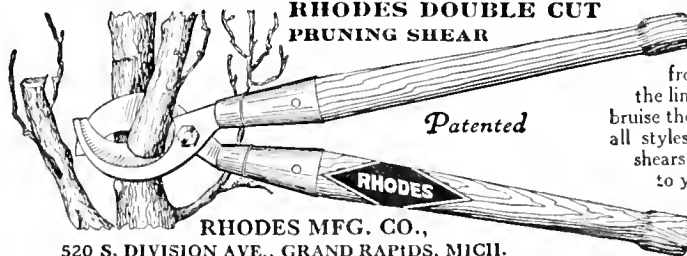

RHODES DOUBLE CUT PRUNING SHEAR

Patented

RHODES MFG. CO.,

520 S. DIVISION AVE., GRAND RAPIDS, MICH.

THE only pruner made that cuts from both sides of the limb and does not bruise the bark. Made in all styles and sizes. All shears delivered free to your door.

Write for circular and prices.



The **BLASTER** says=
 "I use **GIANT**
 It gets them out
 cleaner"

Professional blasters know explosives. They have tried all the different makes. Many of them say "Giant gets the stumps out cleaner." John Zurr of Santa Rosa, Cal., writes:

"From the beginning of the time I have been using powder for stump blasting and other agricultural work, I have found the powder made by The Giant Powder Co. to be the most satisfactory. Each certain percentage of Giant Powder is exactly what it is represented to be."

Tell your dealer you want the genuine Giant Farm Powders—Giant Stumping or Eureka Stumping. The Giant trademark on every box is your sure protection against imitations.

It will pay you to write today for our book, "Better Farming with Giant Farm Powders." It tells scores of money-saving ways of doing farm jobs—land clearing, ditching, tree planting, etc.

THE GIANT POWDER CO., CON.
 "Everything for Blasting"

202 First National Bank Bldg., San Francisco
 Branch Offices: Denver, Portland, Salt Lake City, Seattle, Spokane



STUMPING

EUREKA

DEPENDABLE TREES

Planters, it is time to order your Fruit, Shade and Nut Trees, Berry Plants, Shrubbery, Roses, etc., for fall or spring planting. Send for our large illustrated catalogue from which to select your list; it only costs you 5 cents in stamps for postage. Our trees are mighty fine, but we haven't enough. If you WANT trees, don't delay ordering.

OREGON NURSERY COMPANY
 ORENCO, OREGON

profitable in California to engage in the growing of perishable fruits.

A new building will probably be erected in Sacramento in the near future to house the government insectary, which it is planned to move there from Berkeley. The insectary will be an experimental station, officials devoting their time to propagation of insects that destroy fruit and vegetable pests.

Fruit shipments from California this year handled through the California Fruit Distributors of Sacramento passed the 18,000 carload record some time ago, with 10,000 cars, principally grapes, still to be sent East. Early indications were that the shipments would total as high as 35,000 carloads, but this mark cannot be reached, due to shortage of cars.

Among the fruit shipments from the Sacramento Valley recently was a carload of Tokay grapes from the Humphrey vineyards in Sacramento County to Havana, Cuba. This was the first time a grape shipment of such size was sent to Havana.

That wine grapes in California are far from being unprofitable as yet is shown from the fact that Emerzian Brothers, who own a vineyard near Porterville, took \$25,000 worth of fruit from an eighty-acre vineyard, averaging \$312 per acre.

The California almond crop, which was picked early this season, is reported to be showing satisfactory results, and a big tonnage is now expected.

Bush fruits are now engaging the attention of fruit growers in the Turlock Valley and a large number of acres of small fruits, it is reported, will be put out in this section during the coming planting season.

Up to October 10 cantaloupes were still being shipped out of the Turlock district and the season's crop totaled around 4,500 cars.

A bunch of Thompson Seedling grapes weighing five pounds and measuring twenty-one inches in length was recently exhibited at Turlock.

Organized citrus fruit growers in Tulare County recently met and agreed to assume all the expenses of a series of fertilizer and irrigation experiments to be conducted by experts in that county. The experiments are to extend over a period of five years.

The first of the new crop of dates in the Imperial Valley appeared on the market about October 1. They retailed for 75 cents a pound.

Weather conditions for the raisin crop in California are said to have been ideal during this year and a large part of the crop is already in the stack for drying.

More than a dozen new small prune orchards will be planted in Tulare County this fall.

The apple crop in Tuolumne county is way above normal and owing to close grading and standardizing the pack is selling at \$2.40 to \$2.50 per box.

Practically all the Lake County pears will be dried this year. A big loss that has heretofore prevailed in that district was prevented this year by "strawing" the orchards which stopped the bruising of windfalls.

Nice Bright Western Pine FRUIT BOXES AND CRATES

Good standard grades. Well made. Quick shipments. Carloads or less. Get our prices.

Western Pine Box Sales Co.
 SPOKANE, WASH.

9 CORDS IN 10 HOURS



BY ONE MAN, 10% KING OF THE WOODS. Saves money and backache. Send for FREE catalog No. B 140 showing low price and latest improvements. First order gets agency.

*Solving Sawing Machine Co., 161 West Harrison St., Chicago, Ill.

Oregon Growers' Association

Continued from page 5.

however, we produced such a large tonnage that our buyers could not handle the product. Apples were dumped on markets under all sorts of conditions; throat-cutting and speculation was rife for three or four years. Finally, in 1915, when the Fruit Agency, Inc., was formed, growers and buyers were brought together, consignment was largely eliminated, new markets were developed. Advertising campaigns were launched, and today, instead of sending our apples to two or three markets, we are sending them to over one thousand markets. Producing this year approximately 30,000 cars of apples, which show every evidence of selling for a very satisfactory figure. Someone says the war did this. Well, the war helped, but it did one or two other things for the apple game: it shut off our splendid export business, and also dumped large quantities of Canadian apples into our local markets.

Oregon is the victim of speculation. I have already quoted the fluctuation of prices of prunes from 10 to 20 cents; cherries have fluctuated from 6 to 10½ cents; walnuts last year were very hard to sell indeed, despite the fact that California sold its entire crop, which went out of markets like Portland and Seattle, for 36 cents wholesale. Few Oregon growers realized such a price. Some got 30 cents, some 28, some 25, and some did not sell at all. With a superior product, a larger, better flavored product, our growers were unable to handle the situation. Simply because California was organized, was advertised and was prepared to do business. The coöperative bodies in Oregon during the past four or five years have been the balance wheel. Such organizations as the Salem Fruit Union, the Eugene Fruit Growers' Association and the Hood River Fruit Growers' Association have been the factors which have enabled growers to obtain better prices. Had they been stronger they could have done much more. The Salem Fruit Union price of 10¼ cents for cherries, including a 10% tolerance allowance, that is 10% of the cherries could be defective; an average price on large sales of prunes of from 3 to 5 cents a pound more than most independent growers received; its sale of Bartlett pears at \$85 a ton, and its sale of dried loganberries for 72 cents a pound, which will bring about 12 cents a pound to the grower for fresh fruit, are all testimonies of what marketing knowledge, coupled with good business and control of tonnage, will do.

Years ago one could speculate with bananas. As a small boy I can remember one incident which happened in New Bedford, Massachusetts, when three steamers came into the harbor within a few days loaded with bananas. There were no refrigerator cars in those days, no good marketing machinery for handling bananas. Those bananas finally sold for 5 cents a bunch, and I have commonly bought six dozen for 25 cents on a Saturday afternoon. Certainly the men who grew those bananas didn't make very much. Today bananas are

"Take it from Me"

says the Good Judge



Wise tobacco chewers long since got over the big-chew idea. A little chew of this real quality tobacco gives them better satisfaction and they find their chewing costs even less.

With this class of tobacco, you don't need a fresh chew so often and you find you're saving part of your tobacco money.

THE REAL TOBACCO CHEW

put up in two styles

RIGHT CUT is a short-cut tobacco

W-B CUT is a long fine-cut tobacco

Weyman-Bruton Company, 1107 Broadway, New York City

The power chain

The
Gasoline
of
Quality

"Red Crown" has a continuous, uniform chain of boiling points which gives easy starting, power and mileage. Mixtures have "holes" in the chain. Look for the Red Crown sign before you fill.

STANDARD OIL COMPANY
(California)



APPLES

PEARS

For European

Distribution

Gerald Da Costa

Long Acre, Covent Garden, London

Cables: "Geracost, London."

Codes: A. B. C. 5th Edition and Private

SHIPPING AGENTS:

Lunham & Moore, Produce Exchange, New York

sold at a fixed price, and furnished in constant supply, a splendid testimony to good organization.

It is becoming more and more difficult to speculate with California products, such as oranges, raisins, walnuts, owing to the fact that these industries are organized along state-wide lines, are properly financed, are well advertised, and control more than 50 per cent of the tonnage. The pear price in the past in the Pacific Northwest is a fine testimony of the need of the growers to

arouse themselves and become thoroughly organized. When purchased as they were this year at prices ranging from \$22 to \$85 a ton, there is something wrong with our business methods, especially when California firms received from \$75 to \$85, and buyers claim our pears are superior.

When we first started this organization there was some opposition from cannerymen, or at least some concern on their part. Now they are coming to our office, are coming in personally, and saying that this movement is the best thing that has happened in the state. There are forty-six canneries in the state already. Some of these canneries will have a hard time when business begins to readjust itself and prices begin to come down. If, however, we can establish a good, fair price, and stabilize the price paid for products which go to the canner, we will eliminate throat-cutting in the cannery game and keep this splendid industry permanently in this state.

When a fruit grower comes to town and goes into a store he doesn't walk up to the owner and say, "I'll give you so much for that sewing machine, that pair of shoes, that piano," or whatever the commodity may be, but he asks the owner what he will take for the commodity. On the other hand, when the fruit grower or farmer comes to sell anything, he always asks, "What will you give me?" There certainly is something wrong in this combination. An individual grower cannot fix a price. He hasn't the money or time in which to find what a good, fair price would be. Large groups of growers can find what a fair price is, can establish this price, thus enabling the grower to name his price for his commodity. A staple commodity like prunes, canned goods, and even apples, should have a true value. And this value can be established if one cares to take the means to get the proper sources of information.

Some of our critics are taking us to task because we are going to sell apples, pears, prunes, canned goods, dried fruits

and berries all in one organization. They say this cannot be done. Well, the California state-wide coöperative organizations would give a great deal if they could combine. It is too late for them to do it, however. When a man says he cannot combine these lines call his attention to the fact that the California Packing Corporation handles many varied goods. They control the salmon packing of Alaska, do a huge business in canned and bottled goods in



A Feeling of Prosperity

comes to one with the possession of a bank account; it brings also a sense of protection against unexpected emergencies.

Your banking connection, too, if it be with a bank like Ladd & Tilton that has had sixty years of experience, will be of great assistance to you in business matters.

LADD & TILTON BANK
Portland, Oregon



Berry Plants Wanted

Loganberry, Burbank Phenomenal, New Oregon Strawberry and Cuthbert Raspberry. Must be True-to-Name Plants.

Write "M. J. M." care Better Fruit, Portland, Oregon



"My, what a relief!"

THAT *rheumatic twinge* doesn't bother you long after you've had the aching part bathed with the old standby—Sloan's Liniment. You just put a little on—it doesn't stain the skin—gently pat it, and it penetrates, sending a *warm, soothing glow* through the tortured part.

It stands alone in promoting quick relief from *after-effects of exposure, lumbago, sciatica, muscle and joint strains, pain strains and stiffness, neuralgia, bruises*. There's a successful record of 38 years back of Sloan's Liniment.

Keep a big bottle ready for use—it may be any minute. The big bottle holds six times as much as the small one. 35c., 70c., \$1.40.



"CARO" FIBRE FRUIT WRAPPERS

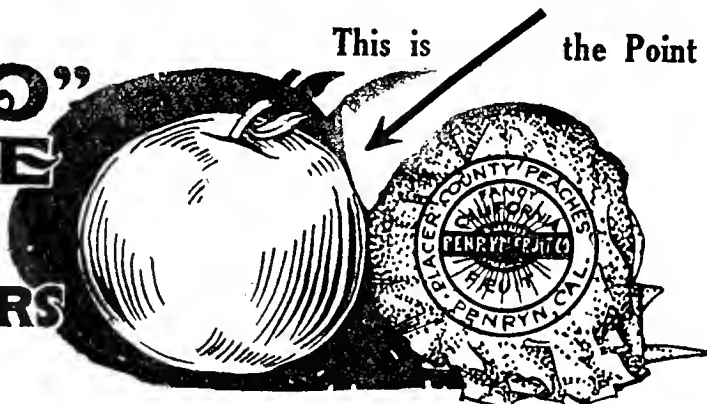

Chemically Treated
"Caro" Protects
"Caro" from DessiCARE (to dry up)

"Caro" Prolongs the Life of Fruit Why?

Fruit decomposition starts from a bruise which opens tiny holes and permits the juice to escape and BACTERIA to enter. "Caro" clings closely and dries up the escaping juice. "Caro" ingredients harden the spot, kill the BACTERIA, arrests the decomposition—and thus **PROLONGS THE LIFE OF FRUIT**. If your fruit is worth shipping it is worth keeping in best condition.

Demand "CARO"—Wrap Your Fruit in "CARO"—The Fruit Buyer Knows "CARO"

Order from Any Fruit Company or American Sales Agencies Co., 112 Market St., San Francisco

MYERS

HONOR-BILT
POWER PUMPS

No more hand pumping and carrying water in pails. Myers Self-Oiling Bulldozer Power Pumps give running water—all you need and wherever you need it. Extra strong and of simple, high grade construction. Moderate in cost, requires minimum attention and is easy to install. Is self-oiling, has covered working parts, large valves, liberal water-ways. Operated by gasoline engine or electric motor. Sizes for every need, 200 to 3000 gal. per hour capacity. You know it is better because it's a Myers. For the Myers Line of Pumps, Door Hangers and Hay Tools is acknowledged the standard in quality. Ask your dealer or write us. Booklet on request.

PUMPS

FOR EVERY PURPOSE

Mitchell Northwest Distributors
Portland, Ore.

California, handle pineapples in the Hawaiian Islands, and handle huge quantities of dried fruits and even dried beans, all through one organization, all advertised by one brand. Armour & Co., the well-known meat packers, not only handle all classes of meat and meat products, but do a huge business in dairy products, poultry products, grape juice and canned goods, handling 300 products with one brand. Montgomery, Ward & Co. and Sears, Roebuck & Co. and similar organizations are paying huge dividends, millions of dollars annually, and they handle everything you need in the home or on your farm. The large department store of the city does likewise, the wholesale grocer handles various products. It is the trend of the times. It is the tendency in the United States, in England and Germany, in every big industrial nation. By combining these products overhead is reduced, the volume of business is increased, the force of advertising is enormous. Each product handled advertises the remainder. It is good sound business, and just as sound for a bunch of fruit growers as for a private corporation.

Our prunes will make a wonderful pie. They are large, tender and sufficiently tart for such purposes. Advertising will bring to us the same results that it has to California. Two organizations in California last year received 20,000 letters of inquiry from people in the East who had read the advertisements and were interested in making California their home.

We are going to adopt one brand, this one brand to advertise all the products which we now handle, and that one brand will be advertised freely in such

BEES PAY. Easy, interesting work, with honey for home use. Send 50c today for 24-page Bee Primer and six months' subscription to the American Bee Journal. Catalogs of supplies sent free.

American Bee Journal
Box 36 HAMILTON, ILLINOIS

No Orchard or Farm is Complete Without Our Latest Model

COMMERCIAL SIZE All Purpose Evaporator

Write for Folder D.
HOME EVAPORATOR CO.
ST. LOUIS, MISSOURI

G. L. Davenport

Grower and Shipper

MOSIER, OREGON

MAIN OFFICE
147 Front Street, PORTLAND, OREGON

BELL & CO.

Incorporated

WHOLESALE
Fruits and Produce

110-112-114 Front Street
PORTLAND, OREGON

Write us what you have to offer—Car lots or less

Turn over the pages of the popular magazines; you won't find Oregon advertisements outside of some splendid "Phez" advertisements, some of Hood River apples, or some Skookum apples, little is known concerning Oregon. Yet the word California is found in all these magazines, and has become so well advertised that it is probably the best-known section of the world today, a household word in every home. Who has not heard of Sunkist oranges; when you say Sunkist you mean oranges, and when you see an orange you think of California. The Sunmaid raisin development has been marvelous. I have been told that they increased the use of raisins in bakeshops alone from 700 tons to 30,000 tons in four years, and they have made their growers prosperous and have stabilized their industry. The California prune growers are going to spend \$200,000 this next year advertising Sunsweet prunes. How long will it be before the word "Sunsweet" will be the standard for prunes and the one brand that the housewife all over the United States will ask for?

5 DAY FREE OFFER

"It Leads the Way"

Try the MERRY GARDEN Auto Cultivator on your own farm. We will allow a thorough trial of 5 full days without placing you under obligation to keep it. This is the most wonderful farm help devised in years.

MERRY GARDEN AUTO CULTIVATOR

No more pushing, pulling, twisting or straining. The 2 h. p. motor furnishes the power, which is controlled from the adjustable handles. Simply guide it.

Does the work of 4 men
quicker—better—cheaper.

Guaranteed Sold on a Money-Back Guarantee. Write today for folder and full particulars.

Atlantic Machine & Mfg. Co.
468 W. Prospect Avenue
Cleveland, Ohio

It is time for us to arouse ourselves; to advertise Oregon's superior products.

ACME BOX STRAPPING

Insures Safe Deliveries—Prevents Pilferage



Acme Nailless Embossed Strapping



Acme Nailless Strapping, with Seal Applied

Write for the Acme Catalogue of Complete Shipping Room Supplies

ACME STEEL GOODS CO., Chicago, 2840 Archer Avenue, Manufacturers

SAN FRANCISCO, 209 California Street
SEATTLE, Foot of Main Street

PORTLAND, 8 Front Street
ATLANTA, 10 Tift Street

Try This One-Man Stump Puller 30 Days FREE

SEND NO MONEY!



If you have useless stump land, I want to PROVE to you on your own stumps—30 days before you pay me a penny—that ONE MAN with my famous Kirstin Stump Puller can pull big, little, green, rotten, low-cut, tap-rooted stumps, hedged trees or brush. I want to convince you that this is the easiest, quickest and cheapest way to pull stumps.

One Man Alone Handles Biggest Stumps! Thousands of Kirstins now in use!



Read These Letters!

I pulled one pine stump 3 ft. across top. My One-Man Kirstin pulls bigger stumps than I ever expected.

Mr. J. Erkila, Calumet, Mich.

My Kirstin pulls stumps up to 2 ft. blind maple 8 to 16 inches. Pulled tree 150 ft high and 22 inches at base, in 15 minutes.

A. H. Jeffery, Goble, Oregon.

My Kirstin pulled stumps we thought it could not pull.

Mr. G. A. Buckler, Bay Springs, Miss.

Quick Shipment From

Escanaba, Mich.
Atlanta, Ga.
Portland, Ore.
Soo Canada

After 30 days trial—if satisfied, keep puller. If not pleased, send it back at my expense. You don't risk a penny. Four easy ways to pay.

Kirstin One-Man Stump Puller Single, Double, Triple Power!

Weights less—costs less—yet has greater speed, strength, power and lasts longer! Clears one acre from one anchor! Easily moved around field. A few pounds pull or push on handle exerts tons on stump—due to wonderful leverage principle. 3-year guarantee against breakage!

Get My Big New Book NOW!

Tells how one man pulls stubborn stumps in few minutes at low cost. Explains all about different speeds. Also patented quick "take up" for slack cable. Describes Kirstin one man Clutch Model; Kirstin One Man Drum Model; and Kirstin Horse Power Model. Get the book and Special Agents' Offer. Shipment from nearest distributing point saves time and freight. Write today.

A. J. KIRSTIN, Gen. Mgr., A. J. KIRSTIN CO.
257 E. MORRISON ST., PORTLAND, ORE



Factory and General Office Escanaba, Mich



Portable heat - convenient - economical

At the light of a match—instant heat. No smoke, no odor. Comfort without dust or dirt. Oil consumed only as needed.

Pearl Oil is refined and re-refined; pure and clean burning. Sold in bulk and in five-gallon cans. Order by name—Pearl Oil.

We recommend Perfection Oil Heaters.



STANDARD OIL COMPANY
(CALIFORNIA)

a way that the consumers will become familiar with Oregon. Whatever our sales word may be, we will have written on all our advertisements the word "Oregon" in a very conspicuous manner. There is no state in the Union that can surpass Oregon in the quality of its horticultural products. One of our functions will be to educate the consumer so that they will recognize this fact.

In closing I wish to say a few words on the financial end of our organization. This is the end that especially appealed to me when I first heard of the proposed plan. It has attracted the attention and support of our leading bankers. We have, first, the Oregon Growers' Coöperative Association, which is the selling organization. We have the Oregon Growers' Packing Corporation, which packs our fruit, both organizations operating at cost. The need of the two organizations is, namely, that we cannot issue to ourselves warehouse receipts, but that the association can turn over the fruit to the corporation to be packed, can immediately secure from the corporation a warehouse receipt which can be cashed, and this money can be used to finance the growers. Thus the grower will receive up to 90 per cent of the value of his fruit at delivery. The same officers and the same directors hold forth in both organizations, are fruit growers, and are elected by the stockholders. To build our buildings we have both common and preferred stock. The common stock is issued to growers on the basis of ten dollars an acre, which is paid in two five-dollar notes, one due December, 1920, and the other December, 1921. The payment for these notes is taken out of the sale of the crops. In exchange for these notes the grower is given a ten-dollar share of common stock. In addition to the common stock we can issue preferred stock up to the same amount as the common stock. This can be held by anybody, but will be retired one-fifth annually. The money from the common and preferred stock will be used to finance our buildings, put up our community packing plants and so forth. The preferred stock can easily be retired from packing profits. For example, the Salem Fruit Union last year handled 4,000,000 pounds of prunes, making \$26,000 in packing profits. This organization did over a million dollars worth of business last year at a cost of \$16,000, or 1 1/10%.

That the organization was needed is shown by the way growers are responding. Despite the fact that we started in July, during the cherry and berry harvests, that we have had to encounter the grain harvest and vacation period, we have nevertheless signed up over 10,000 acres and have 20,000 in sight. It now looks as though the association would do over \$5,000,000 worth of business during the first year, will control over 70% of the fresh fruit tonnage of Western Oregon, more than half of the prunes, nearly all the walnuts and a large percentage of the products for canning, such as cherries, berries and pears. Truly a remarkable record to attain in so short a time.

THE WORLD-
OUR ORCHARD

STEINHARDT & KELLY NEW YORK

UNQUESTIONABLY THE
MOST IMPORTANT FACTOR
IN THE DISTRIBUTION OF
THE COUNTRY'S FANCY
APPLES
AND OTHER FRUITS

OUR MARKET-
THE WORLD

DEC 23 1919

BETTER FRUIT

VOLUME XIV

DECEMBER, 1919

NUMBER 6

FEATURES IN THIS ISSUE:

- Pruning the Apple and Pear
- Restoring the Orchards of France
- Measuring Irrigation Water
- Topworking Inferior Orchards
- Greater Small Fruit Production

*Columbia Univ Libr
30 Dec 19*



SOME OF THE FINE FRUITS OF FRANCE

Before the war the orchards of Northern France produced large quantities of the finest of deciduous fruits. During the great conflict an immense orchard area was devastated by German troops. It is estimated that the destroyed territory devoted to agriculture covers 6,000 square miles, 250,000 acres of which was rendered absolutely useless for cultivation. The loss to soil and crops is estimated to be \$2,000,000,000.

Better Fruit Wishes
You
A Merry Christmas

BETTER FRUIT PUBLISHING COMPANY, PUBLISHERS, PORTLAND, OREGON

Subscription \$2.00 per Year in the United States; Canada and Foreign, Including Postage, \$3.00.

Single Copy 20 Cents

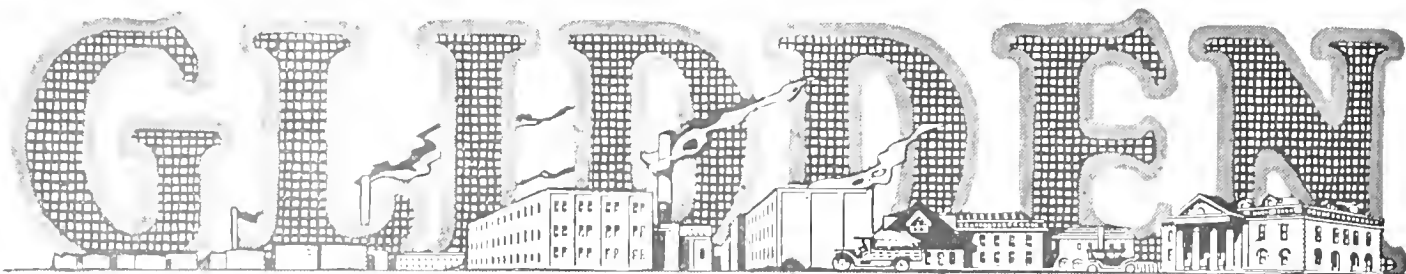

Know the Enemy as Well as the Glidden Remedy

Then you can combat the many pests that destroy crops and eat up the profit.

Know pest habits. Anticipate their coming. Get ready ahead of time, and end them forever with a timely Glidden spraying or dusting.

Glidden Spray Books will help in your study of bug life. Glidden experimental workmen will advise you and the Glidden spraying materials will provide the means of ending your greatest crop loss.

The Glidden line includes: Glidden Dry Powdered Arsenate of Lead, Glidden Dry Powdered Arsenate of Calcium, Glidden Dry Powdered Bordeaux Mixture, Glidden Dry Powdered Bordo-Arsenate, Glidden Dry Powdered Lime Sulphur and Glidden Paris Green.

Everywhere on Everything

Glidden is the word for protection whether it be farm buildings, implements that need paint or trees and shrubs that need spraying.

Whenever you need anything in paints, varnishes, stains, or enamels, let Glidden be your buying name.

THE GLIDDEN COMPANY Cleveland, Ohio

Is. Agency: Cleveland, Chicago, San Francisco, Reading, New Orleans, Toronto.

Branches: New York, Chicago, Kansas City, St. Louis, Detroit, Boston, Pittsburgh, Atlanta, Dallas, Montreal, London.

Stocks in principal cities.

America's Foremost Spraying Apparatus

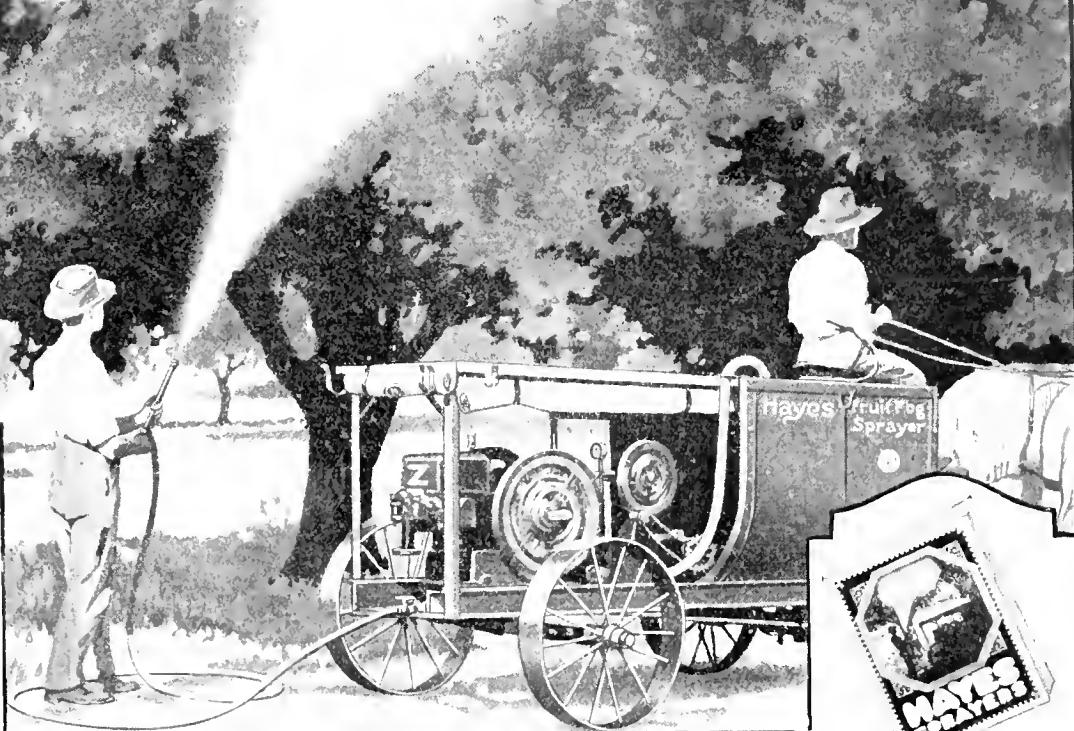

HAYES Fruit-Fog Gun

Send coupon for FREE BOOK and see why this is the World's fastest spraying apparatus. The only gun which combines great speed with the thoroughness of Fruit-Fog. One man handles capacity of big power sprayer. Does four days' work in one. Simple twist shoots long spray to top of tallest trees, or gives wide spray for close-up work, or shuts off tight and prevents waste of solution between trees. Mechanically perfect and fully guaranteed. Get the book for full details.

Hayes Hand Barrel Spray Pump



Hayes Platform Duplex Hand Sprayer



Hayes High Pressure Triplex Power Sprayer

Send for the Startling Story of Fruit-Fog Spraying!

Fruit Growers and Farmers should beware of life-sucking, profit-stealing pests this year. Reports say their ravages are more terrible than ever before in some sections. Send the coupon for Big New FREE Book and Valuable Spraying Guide now. Get all the new facts on spraying before it is too late. Learn, for example, why Fruit-Fog—the vaporous super-spray—is the ONLY spray fine enough to penetrate into the microscopic niches in bark, buds and foliage—where millions of UNSEEN deadly pests hide—and where no coarse, heavy, low-pressure spray can reach. This explains why ordinary spraying often fails. Also why Fruit-Fog Spraying has been pronounced a phenomenal success by Experts, Experiment Stations and Fruit Growers everywhere. Fruit-Fog positive thoroughness is the direct reason for the big crops and big profits that have made Fruit-Fog Spraying famous. Send the coupon now.

HAYES FRUIT-FOG SPRAYERS

The Hayes scientifically atomized, fog-like spray is produced by Hayes guaranteed 300 lb. pressure and the scientific Hayes nozzle. Its vapory fineness gives Fruit-Fog remarkable adhering powers. No drops form—no solution wasted—no buds or leaves knocked off—as with coarse, heavy, low-pressure sprays.

Hayes Fruit-Fog sprayers are positively standardized in every part. They are skillfully made in a way that insures enduring service and greatest efficiency under high pressure.

To assure Hayes Fruit-Fog users the best possible engine service, we have selected the famous Fair-

banks-Morse "Z" Engine as standard equipment.

Sprayers for Every Purpose

There are Hayes Sprayers for Orchards, Gardens, Field Crops, Vineyard, Nurseries, Cemeteries, Greenhouses, Shade Trees, Potatoes, Cotton, Flowers, Alfalfa, Sugar-beets, Poultry and Hog Disinfecting, Whitewashing, Cold Water Painting and every other known use.

No matter what your sprayer needs, from our great Triplex Fruit-Fog Power Sprayer to the smallest Garden Atomizer, we make it.

Send the Coupon Today!

Tell us how many trees you want to spray and how old they are on the average. Also what other uses you have for your sprayer. We'll tell you where and how you can get the style of Hayes Sprayer best suited to your needs, and its price. We'll also send our Big New Book of Hayes Sprayers and Valuable Spraying Guide FREE. Send the coupon today.

HAYES PUMP & PLANTER COMPANY
Dept. K, GALVA, ILLINOIS (44)



Send for Big Spraying Book FREE!

The book pictures and describes the Fifty Styles of Hayes Sprayers. Tells why the deadly pests that infest your Fruit, Potatoes, Hogs, Poultry, etc., cost you more each season than several Hayes Spraying outfits. Proves that these destructive pests are costing American Farmers and Fruit Growers an appalling toll. Shows how thousands of owners of Hayes Sprayers have stopped these losses—and turned them into big profits. Send the coupon now and get the FREE BOOK.

Valuable Spraying Guide Also Sent FREE!

This Spraying Guide tells you, in simple, handy form, how to recognize and kill every known pest that infests every fruit and other crop, also every animal on your place. Tells what solution to use—how to mix it—how and when to apply it. Worth hundreds of dollars to any Farmer or Fruit Grower. Send the coupon and get your copy FREE.

Nation-Wide Service

Users of Hayes Power Sprayers are within only 24 hours of a service station at all times. In case of accident at a critical time this quick service may save your fruit crops. Hayes Power Sprayers, Engines & Repairs are distributed by

Fairbanks, Morse & Co.
Atlanta, Los Angeles, San Francisco
Denver, Jacksonville, Salt Lake City
Spokane, Portland, Seattle

We Also Maintain Stocks at
Flora Dale, Pa. Philadelphia
Kansas City, Little Rock
Grand Rapids, Albion, N. Y.
Hayes Hand Sprayers are distributed by Hardware, Implement and Seed Jobbers.

Hayes Pump & Planter Co.
Dept. K, Galva, Ill.

Gentlemen:

Please send FREE and without obligation, your Big New Sprayer Book and your Valuable Spraying Guide.

No. of trees _____ Average age _____

Other uses _____

Name _____

P. O. _____

State _____ R F D _____

SIMONS, SHUTTLEWORTH & CO.

LIVERPOOL AND MANCHESTER

SIMONS, JACOBS & CO.

GLASGOW

GARCIA, JACOBS & CO.

LONDON

Agencies and Representatives in Every Important European Market

European Receivers of American Fruits

FOR MARKET INFORMATION ADDRESS

SIMONS, SHUTTLEWORTH & FRENCH CO.
204 Franklin Street, New York

SIMONS FRUIT CO.
Toronto and Montreal

SIMONS, SHUTTLEWORTH, WEBLING CO.
Board of Trade Building, Boston

OUR SPECIALTIES ARE APPLES AND PEARS

LOOK HERE

ARE YOU SATISFIED with your present selling service?

IF NOT try us and learn what an up-to-date selling organization can do for you.

CABLE OR WRITE US NOW for market prospects, terms, etc. Reasonable advances made against shipments of

**APPLES
PEARS
ORANGES**

YOU want the best market in Britain.

WE have it.

McCAIG & WEBB
Fruit Brokers, GLASGOW

Head Office, GLASGOW

Cables—MacWebb, Glasgow
A. B. C. 5th Edition—Marconi International

ALSO RECEIVERS AT
London — Liverpool — Hull

“Wood-Lark” Is Indispensable

In the Orchard



Feed the Gophers “Wood-Lark” and Save Your Fruit Trees

Place some in gopher runs adjacent to pitted spuds or other root crops and save much of your loss from these rapacious little beasts thru the winter. A sprinkling also occasionally on the rafter plates in the barn will soon rid you of squirrels, rats, etc., and save you many a bushel of feed, and will protect that pile of empty sacks in which, each spring, you find so many have been gnawed.

They All Like “Wood-Lark”

If Your Dealer Hasn't Any, Write Us

Clarke-Woodward Drug Co.

PORTLAND, OREGON

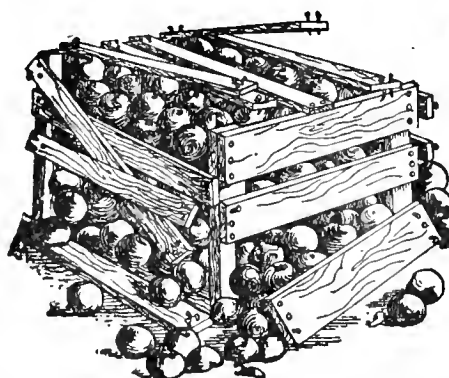

BEFORE using Cement Coated Nails

Western Cement Coated Nails for Western Growers

Our Cement Coated Nails are always of uniform length, gauge, head and count. Especially adapted to the manufacture of fruit boxes and crates. In brief, they are the Best on the Market.

Write for Growers' testimonials.

Colorado Fuel & Iron Co.

DENVER, COLORADO

Pacific Coast Sales Offices
Portland, Spokane, San Francisco
Los Angeles

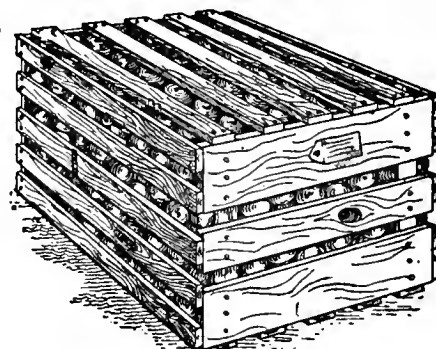

AFTER use of C. F. & I. Co.'s Cement Coated Nails

BETTER FRUIT

EDITOR: W. H. WALTON

STATE ASSOCIATE EDITORS

OREGON—C. I. Lewis, Horticulturist.
WASHINGTON—Dr. A. L. Melander, Entomologist;
O. M. Morris, Horticulturist, Pullman.
COLORADO—C. P. Gillette, Director and Entomologist;
E. B. House, Irrigation Expert, State Agricultural College,
Fort Collins.
ARIZONA—E. P. Taylor, Horticulturist, Tucson.
WISCONSIN—Dr. E. D. Ball, Madison.
MONTANA—O. B. Whipple, Horticulturist, Bozeman.
CALIFORNIA—C. W. Woodworth, Entomologist, Berkeley;
W. H. Volz, Entomologist, Watsonville; Leon D.
Batchelor, Horticulturist, Riverside.
INDIANA—H. S. Jackson, Pathologist, Lafayette.

An Illustrated Magazine Devoted to the Interests
of Modern, Progressive Fruit Growing
and Marketing.

PUBLISHED MONTHLY BY

Better Fruit Publishing Company

703 Oregonian Building

PORTLAND, OREGON

All Communications should be addressed and
Remittances made payable to

BETTER FRUIT PUBLISHING COMPANY

SUBSCRIPTION PRICE:

In the United States, \$2.00 per year in advance.
Canada and Foreign, including postage, \$3.00.

ADVERTISING RATES ON APPLICATION

Entered as second-class matter April 22, 1918,
at the Postoffice at Portland, Oregon, under
the Act of Congress of March 3, 1879.

VOLUME XIV

PORTLAND, OREGON, DECEMBER 1, 1919

NUMBER 6

Practical Pruning as Applied to Apple and Pear Trees

By O. M. Morris, Horticulturist, Washington State College of Agriculture

(PART ONE)

THE best place to study pruning is in the most productive orchards in the community. Study there the system of pruning that has been practiced on the best and most satisfactory producing trees. Become acquainted with the habits of growth of the different varieties and the form of the tree at different ages. Adopt a system of tree development that has given satisfactory results in your community in the quantity and quality of fruit produced. Systems of pruning recommended by fruit growers from different sections than yours may not be at all satisfactory in your district. A system once adopted and established should not be changed except for very good reasons.

Apple Trees.

The one-year-old tree just set in the orchard should be cut back to a straight stock about three feet in height. This cutting back should determine the height of the trunk. The upper buds left will usually be the ones to produce the branches that will form the framework of the head. These branches which are to form the permanent framework of the tree should be distributed through a space of 12 inches, extending downward from the top of the young whip. The branches that are only three or four inches apart on the young tree will be too close together by the time they are four or six inches in diameter. Trees with a clean trunk 20 to 24 inches high are easier to cultivate and work around than trees with a shorter trunk, and a few inches difference in the height of the trunk of the tree does not modify greatly the convenience of the work of pruning, spraying and harvesting the fruit crop. The extremely short trunk is not as popular after the trees are in full bearing as it is while the trees are two or three years of age.

Trees that are growing very rapidly and producing long slender shoots can be made more stocky by clipping off the growing tip of the branches during the summer. Branches on the

windward side of trees exposed to strong prevailing winds can sometimes be kept growing in almost normal position by careful attention to summer tipping back. Trees that are vigorous and strong will grow in better form with little or no care, than weak trees

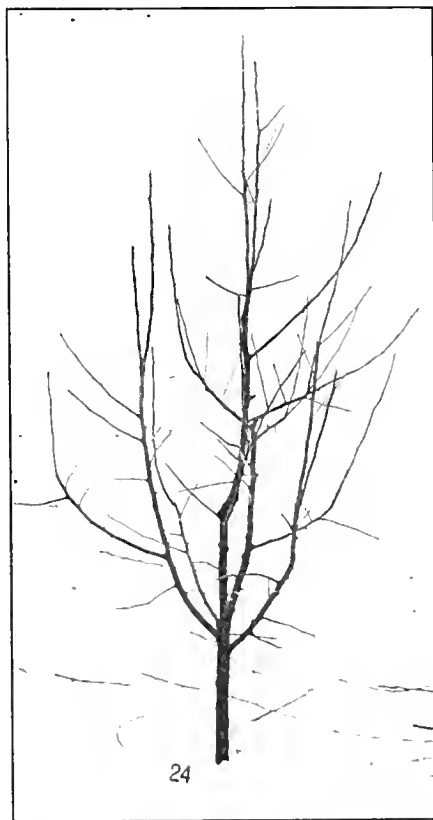

Figure 1. A young Jonathan tree pruned to a central leader form. This is a good type of tree and is well pruned, altho not quite ideal, because of the low trunk.

can be developed with all the pruning and training that may be given them.

The two-year-old nursery tree is seldom used in Washington for planting commercial orchards. It can sometimes be used to advantage for home orchards and in replanting, but must be severely cut back at the time of transplanting. The three to five branches selected to form the frame-

work are cut back to about one-third of their length and all others removed. In varieties like Jonathan, Winesap and Ben Davis, the center or leading branch should be left several inches above the highest side branch. Cutting all branches back to three or four buds may be advisable if the trees have been exposed to drying conditions after digging, or if they are to be planted in a district of light rainfall without irrigation. When good trees are planted in a section where moisture is abundant, as in most districts of Western Washington, they will make a good growth if given only enough pruning to secure a well balanced top.

The tree that has made one year's growth in the orchard should be carefully pruned, although this pruning should not necessarily be extremely heavy. A few years ago, when so many commercial orchards in the Northwest were young, the practice of very severe pruning of young trees was common. It was carried to a destructive extreme in many cases. Winter pruning that cuts away three-fourths or four-fifths of the previous summer's growth of wood does not assure a stocky growth of trunk and permanent branches, but causes the production of another crop of long, whip-like branches. It is not necessary at the first winter pruning to select the branches that are to form the permanent frame of the tree and remove all others; but if they can be selected, the pruning should be so done as to give them the advantage. A little thinning out of the top to let sunlight in and tipping back of the longest shoots is usually all that is necessary at this time. It may not ruin the tree to do more, but usually, light pruning will accomplish about all that can be accomplished by a more severe pruning.

The old controversy as to the advantages of a tree with a central leader or one that has been developed in vase form is not discussed so much as the orchards grow older. Neither ex-

treme form is desirable and both forms are foreign to the natural development of the tree, and if the tree is given reasonable opportunity to develop this extreme soon disappears. The natural and best form is about midway between these extremes. The center of the tree must be open to light without regard to the particular way in which the scaffold limbs are distributed. Trees that are prone to develop low drooping side branches, as the Jonathan, can often be developed in a form of central leader type for a few years to advantage. Other varieties, as the Esopus and Rome Beauty, do not lend themselves well to this type of young tree. The vase form is purely an artificial type conceived in the mind of the grower. The trees can be trained to this type, but it is seldom a profitable form.

The Second Winter Pruning

Thin out the top of the tree where the number of branches growing is so great as to cause the limbs that are more or less permanent to be very slender. Small side shoots should not be removed because of their value in helping to develop and make more stocky the main branches to which they are attached. The top should be opened by removing large limbs as far as possible without destroying the frame of the tree. The large limbs

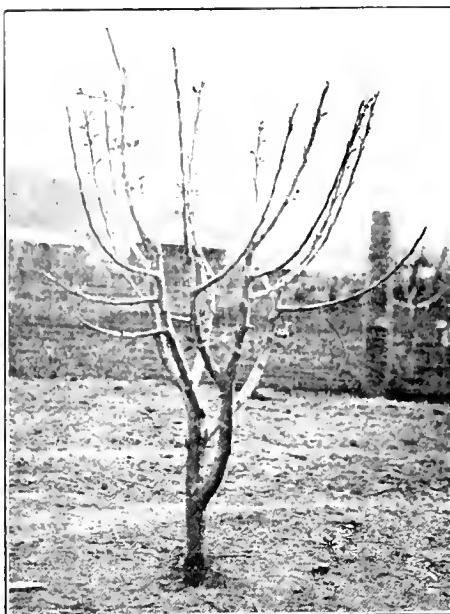

Figure 2. A Delicious tree that has been excessively pruned. It is now carved out to the vase form.

wood that is where none is wanted and correct faulty distribution of branches. The main business of the tree during the period of development before heavy fruit production begins is to produce wood, or to grow, and for this purpose an abundance of foli-

From the time of the second winter pruning until fruit production is established, pruning should be done with the idea of training to the adopted system more than modifying growth. Most of the work should be done in the winter, but constant attention throughout the year is necessary to have the trees make the most rapid permanent progress. The top should be open enough to let a little of the direct rays of the sun reach the ground beneath. The change from a nursery tree to a tree in full fruit production is gradual without definite dates or sudden changes from one stage to another. Pruning is only one of the several cultural practices necessary to secure the maximum fruit production and it cannot be used successfully as a substitute for soil fertility or good tillage. If the trees are well grown in the nursery and well planted on good soil and if thereafter they receive plenty of moisture and soil tillage, they will develop into good fruit producers.

In pruning young trees, a great deal has been said and practiced relative to the point at which one-year-old branches should be cut. A great deal of emphasis has been placed by some pruners upon cutting the branch diagonally so that the base of the cut would be opposite a bud. If they de-



Figure 3. A Jonathan tree excessively pruned by constant cutting back and removal of small twigs, resulting in an over abundance of large branches about the same size. A tree of this type requires the removal of a large number of these large branches with a minimum cutting of small ones.



Figure 4. Trunk and framework of a young Jonathan tree after bearing its second crop of fruit. A form thought to be almost ideal by many growers. The trunk is too short and the branches too nearly horizontal in their direction. Such trees usually require heroic treatment later, with the resulting loss of production.

and trunk require protection from extreme heat of the summer sun and the development of a reasonable quantity of laterals tends also to bring the tree into early fruit production.

Beginning with the second winter pruning the work should be mostly corrective in its character. Prune out

age and small twigs are necessary. It is a wise plan to leave plenty of wood in a tree to be taken out later, but all branches that interfere with the framework should be removed. Wood once taken out cannot be easily replaced by new growth, but excessive growth can be cut away at any time.

sire to have the trees spread more they cut back to a bud pointing toward the outside of the tree. The careful cutting close to the bud avoids the dead stub that develops if a twig is cut one-half inch or more above the bud. The tip bud left on the branch usually assumes almost the original

direction of the branch and the lower branches from side buds because of their position and exposure to light assume lateral directions. It is often

shapely, and in a good, vigorous growing condition without reducing its fruit production. No definite rules can be given, but the skill of the grower

growing trees, are extreme measures and are not to be advised under ordinary conditions. If trees will not bear good crops of fruit without these



Figure 5. A Jonathan tree of the same age as Figure 1 but of better form.



Figure 6. A common type of trunk and base of the framework of a nature fruiting Jonathan tree.

advisable to develop lateral spreading branches by first pruning to an inside bud and the following year cutting back to the second or third branch which has assumed a distinctly lateral direction. This is especially true with Rome Beauty and Wagener.

In pruning trees four years old, or older, the extra care required to "cut to a bud" is not worth while. Side branches, however, that are removed should be cut close to the parent branch; and terminal branches, when cut back to side branches, should be cut close so that no stubs are left.

Fruiting Trees

Green skin varieties may be permitted to develop a more dense top than red skin varieties; but a thick top tends to shade and kill the interior branches and twigs, and to cause the production of fruit to be carried by the branches further from the trunk. This reduces the load of fruit that can be carried by the tree and is not desirable. Red skinned varieties should have the tops of the trees kept sufficiently open so that good strong sunlight can reach past the center of the tree top. This will maintain strong, even development of the fruit spurs and lateral fruiting branches, and secure the maximum coloring of the fruit.

As the trees attain age, the amount of pruning done on each tree should be increased and the amount that should be done will depend upon the growth and development of each individual tree. Enough of the top should be removed to keep it open and

will be measured by the degree of accuracy of balance between his pruning and other cultural operations that cause the tree to yield its maximum quantity and quality of fruit annually.

Special practices in pruning, such as girdling, stripping of the bark, and other mechanical injuries intended to induce fruit production on vigorously

special treatments, they are not adapted to their location and should be removed.

(EDITOR'S NOTE—This concludes the part one of Professor Morris' article on "Practical Pruning as Applied to Apples and Pears." The second part which will include the Season of Pruning, Pruning the Different Varieties of Apples, Repairing Injured Trees and Pruning Pear Trees will be published in the January number.)

Increasing the Production of Bush Fruits

By W. H. Paulhamus, President of the Puyallup and Sumner Fruit Growers' Association

Toward a big development of the bush fruit industry. The present demand for jellies, jams, juice products and preserves has given a new stimulus to the growing of bush fruits, consisting of blackberries, red raspberries, black raspberries, gooseberries, red and black currants, loganberries and phenomenal berries, and in fact every other kind of berries that do so well in our North Pacific Coast climate.

A few years ago red raspberries were a drug on the market at four to five cents per pound, today the canner is paying the grower eight cents per pound for the same product, and is unable to secure a sufficient quantity to take care of his requirements. The old evergreen blackberry that has been so much of a pest to the average farmer has certainly come into its own, with a result that every canner is anxious to secure all of the evergreen blackberries that are obtainable, and is willing to pay a price ranging from five to five and one-half cents per pound. In

fact, every cross-roads merchant can create a market for these blackberries by arranging to put them in barrels for some responsible canner, and ship them daily to a cold storage plant, in other words, the present prices of all brush fruits should stimulate very materially an increased production.

The question that naturally arises in the mind of the man who has a few surplus acres of land is the advisability of planting; what variety to plant; how they should be planted, and the best method of handling after the planting is completed.

In red raspberries the desirable variety is the Cuthbert, for the reason that it can be used in jam making or in canning in syrups. There is no other red raspberry grown that has sufficient texture to withstand the necessary processing required in putting up in cans. Of course, in jam making it doesn't make any difference how much the berry is crushed up, the jam is equally good, but this is not

How the Ruined Orchards of France Are Being Restored

Written for Better Fruit by an Invalid Soldier

ANATION'S progress, credit, the health of her populace, the success of her industries and manufactures, largely depend upon the condition of her agriculture. Four years of war, during which the enemy invaded the land, spreading desolation and devastation, not to mention the depletion of man-power, has woven the agricultural problems of northern France into a tangle which defies the learned. The solution of her agricultural problems is not charity; it is merely the simple exercise of the spirit of compassion toward a helpless people in the hour of their need. Moved by this spirit of compassion, of fraternal duty, and of patriotism, the American Red Cross has pledged itself to serve the agricultural interests of the impoverished country.

Through generous contributions of the American people, the American Red Cross was enabled to send practical and theoretical men to France to determine conditions; how they would be met by the government and the people; and what foreign aid was needed and might be enlisted. George B. Ford, deputy commissioner of the American Red Cross in Paris, was placed in charge of the research work. He had formerly been a consulting specialist on town planning in New York City.

In many sections of France the devastation of its fine orchards by the German troops was of the most wanton nature recorded during the entire war. Hundreds of acres of orchards that were not in the pathway of troop operations and gun fire were deliberately cut down and burned, and the once blooming hillsides and other land adaptable to orchards left scarred and desolate. Like other phases of

agriculture in France before the war, horticulture and fruit growing were carried on by the most careful and intensive methods. No matter how small the acreage in fruit or how few the trees under cultivation, they were given the most tender care. In fact such care as the American fruitgrower with his greater resources of undeveloped land and larger acreages has never attempted. Every fruit bud was to the Frenchman an undeveloped form of life to be cared for with the solicitude of the unborn child. This was due to the fact that it not only meant an addition to his income so thriftily looked after, but to the fact also that the French are lovers of nature—of flowers of the green forests—of all the growing things of life that are produced from the earth.

Before the war many fine fruits were grown in the part of France that was overrun and largely destroyed by German troops. These fruits were given the greatest care in growing and marketing, not only in the open, but growing them under glass was also practiced. In fact Americans who visited France and were interested in fruit often marveled at the perfection of the fruits served at the high-class cafes in Paris. Not a flaw in the shape, coloring or the quality could be found. And these fruits, such as pears, peaches, plums and grapes, brought extremely high prices—prices that caused the American visitors to marvel likewise until they were informed as to the care taken of them in the growing.

It is little wonder, then that the great destruction of the orchards of France caused grief and hardship to the French. But with that heroism and patience for which they are noted,

they are going to work to restore them and the American Red Cross is helping them.

The belt of agricultural devastation in France stretches for 150 miles and is from five to ten miles wide. The total invaded area includes about 15,000 square miles, five per cent of the acreage of France, including about 35,000 communes with a population of 4,000,000. The devastated area, about the size of Connecticut and Rhode Island, comprises 6,000 square miles, or about two per cent of France, and in which 2,000,000 people lived. According to the report of the Minister of the Liberated Regions, this was fifteen per cent of the tillable area of the country having an agricultural population of about 807,000 persons. About 250,000 acres have been rendered beyond cultivation by the war.

In this neighborhood there were 250,000 farms, of this number 110,000 were less than two and a half acres each, 100,000 were upwards of twenty-five acres, 26,000 were from twenty-five to 100 acres each, and about 5,500 were over 100 acres, many of them belonging to factory workers. The original capital investment was about \$4,000,000, or \$1,600 per farm, but the value of farms in France has now doubled.

A government engineer, detailed to inspect the loss of agricultural implements, placed the total number at 666,000, which included the various kinds of plows, mowing machines, farm wagons, hoes, fertilizers, reapers, binders, root-cutters, et cetera.

There were 607,000 horses in the country in 1914, prior to the war; there were in 1915, 242,000, sixty per cent having been lost. In addition, 380,000 of the 850,000 stock were gone, or about fifty-five per cent.

After a thorough investigation, conservative judgment being exercised, the total loss to soil and crops was estimated by the French government at two billion dollars.

It was not only this initial loss, but the agencies for commencing the tilling of the soil, the re-establishment of farms, were gone. It would be impossible for the poverty stricken farmer to purchase implements because of the condition of the mines and factories. The work must be done by the government, which then appropriated \$60,000,000, with a revolving fund of \$20,000,000. To further assist the work of reconstruction, a tractor service was organized with 15,000 machines.

The part played by the American Red Cross was an important one. A Reconstruction Research Bureau was opened and a Red Cross delegate placed in every invaded department. The work was especially concentrated



A mute, with both hands gone, wielding his spade at the school established for French mutes by the American Red Cross at Rannes, France.

upon the after-war reconstruction of the small farmer and with this in view, the Red Cross brought together the leading French and many American specialists to consider the problems and to decide upon the most wise solution.

The wondrous old orchards in Northern France had been laid to the ground, and, for replanting them, the Red Cross contributed 40,000 fruit trees. 50,000 francs were also appropriated for the cultivation of small fruits.

Southern France is a great fruit country, and here the vineyards are suffering from the unavoidable shortage of labor. Many men from this part of the country are attending the Red Cross Agricultural School at Rannes. Here the "Mules" are fitted with artificial appliances which will permit them to wield the farmers' tools. They return, when well, to their communities to earn their livelihood and to cultivate their neglected fruit-lands.

While solving the housing problem of refugees, the Red Cross has simultaneously solved one in agriculture. There were hundreds of homeless families wandering over France, forced from their homes by the invasion. These were collected and replaced in communes. The Red Cross communes consisted of thirty or forty buildings which accommodated about seventy-four persons each. Five of these villages were constructed near the Somme. The people were given the necessary farming equipments and not only did they supply their own needs, but soon began to help surrounding communities.

Lands were rented from the government by the Red Cross and given to the refugees and repatriates to cultivate. Agricultural centers were established, an especially flourishing one being at Bourges-Montefaut.

In the military hospitals were hundreds of men, unable to be removed from medical supervision, yet capable of engaging in the farming occupations and eager for employment. So it was, that gardening and horticulture became a part of the cure of the army hospitals, the Red Cross supplying the necessary materials. The work proved beneficial to the men, especially to the shell-shocked and the tubercular. Many were experienced fruit-growers and welcomed the chance to get back to "the simple life." Both French and American soldiers look part in this work and many prosperous farms are now in operation. In fact, the experiment was so successful that it has been introduced in hospital work over here.

The raising of vegetables was especially favored by the men, because their labors were so soon rewarded. At Base Hospital No. 6, the soldiers' gardens produced two tons of vegetables in a season. They served to sup-



A happy group of harvesters at an American Red Cross hospital farm in France run solely by convalescent soldiers. These men are being taught agriculture that they may return to their homes and help in the restoration of the fruit and other soil products of their native land.

ply the mess officer with foodstuffs and gave the boys dishes which would have cost a fortune had their contents been purchased by the quartermaster.

The response of the French people to the efforts of the government and the Red Cross to assist them to regain their lost fortunes has been most gratifying. Fighting against great odds, suffering from ill health, from sorrow for lost ones who fell in the war, the people, with a valiant spirit worthy of those who died for their protection,

are taking up the task of rebuilding the orchards of France.

The Red Cross has established schools for the children, where modern agricultural methods are taught. This, coupled with the natural intuition and the knowledge gained from associates, promises to make an intelligent group of agriculturists, through whose efforts, the ruined orchards of France will be restored in a far shorter time than would have been otherwise possible.

Improving the Seedling Walnut—Important

By J. C. Cooper, President of the Western Walnut Association

The request for information concerning the best seedling walnut grown in the Northwest has been an issue ever since the Western Walnut Association has been in existence. Some years ago I published a blank for giving the history of seedling trees and nuts, but of the thousands distributed in this and other states, not more than three blank cards were returned filled out. Committees have been appointed year after year, and furnished with blanks with orders to comb the country for the best seedling walnut trees. All of this has been productive of no material results.

Finally, two years ago, Mr. M. McDonald, of Orenco, offered in the name of the Walnut Association prizes aggregating \$100 for the best seedling walnut. Owing to the disturbed condition of the country last year, nothing was done. A few weeks ago Mr. McDonald called my attention to the matter and I appointed a committee which I think will make a start toward the object of our search.

A seedling walnut adapted to our soil and climate is of paramount importance to the industry of the Northwest, and the search therefor takes

first rank in the duties of our association. To be of material value this seedling must be a better nut with all other conditions of vigor, timely growth and productivity than any we have. But to use a slang phrase, the proposed seedling will have to "go some" to beat the Meylan, Wiltz, Franquette and possibly some others.

There are seedlings already growing that equal these standard varieties in many respects, but it may take some years of orchard tryout to establish their claims of being the super nut of commerce. In the meantime the standard varieties will be reaching out and occupying much of the lands suited to the walnut. The demand now for grafted trees is beyond the combined powers of all the nurseries in the Northwest to fill in the next four or five years.

This need not stop the search or discourage the experimenter who loves his work and his country with its coming millions of nut eaters, who will demand the best, and we must stick to the trail of the seedling, even if we did not have the inspiring and patriotic offer of prize money. A seed-

Continued on page 36.

Information on the Measurement of Irrigation Water

By O. W. Israelsen of the Utah Agricultural Experiment Station

THE economical use of water in irrigation depends primarily on water measurement. That significant advantages, public and private, attend the measurement of water delivered to individual irrigators has long been recognized in older irrigated countries. The rapidly increasing utilization of Utah's available water supply, the consequent increase in its value, and the tendency on the newer canal systems to base the annual irrigation charges on the amount of water used make an understanding of the methods of water measurement an absolute necessity. Furthermore, many irrigators now realize that the vast store of information concerning the relations of water, soils and plants that has been accumulated in years past cannot be utilized in practice without the measurement of water.

As a result of the growing appreciation of the value of water measurement, there is frequent inquiry as to materials and methods used in measuring water under different conditions. To facilitate the answering of such inquiries, and otherwise to spread information concerning water measurement, this circular is prepared.*

*No attempt is made to present an exhaustive discussion of the subject. The material is simply a compilation from State and Government publications on water measurement. An attempt is made to meet the needs of practical irrigators and canal company officers and hence technical language is avoided where possible.

Units of Water Measurement.

The units of water measurement naturally fall into two classes: first, those expressing a specific volume of water at rest, and second, those expressing a rate of flow.

Water at Rest.—The commonly-used units of volume of water at rest are the gallon, the cubic foot, the acre-inch and the acre-foot.

Flowing Water.—The commonly-used units of rate of flow are gallons per minute, miner's inches, cubic feet per second and acre-inches per hour.

Convenient Relations.

Some convenient relations between the units of flow above given follow:

First: One cubic foot per second (c. f. s.) or (sec.-ft.)=450 gal. per min. (g. p. m.) (approximately) because there are nearly 7.5 gal. in one cu. ft. and 60 sec. in one min. and therefore $7.5 \times 60 = 450$ g. p. m.

Second: One cubic foot per second (c. f. s.)=one acre-inch per hour, (approximately). Since there are $60 \times 60 = 3600$ sec. in 1 hr., one c. f. s. will give 3600 cu. ft. in 1 hr. and there are 1-12 of 43560 cu. ft.=3630 cu. ft. in one acre-inch. One c. f. s. therefore equals one acre-inch per hour (approximately).*

*It will be noted that saying that 1 c. f. s. is equal to 450 g.p.m. is true within $\frac{1}{4}$ of 1 per cent and that 1 c. f. s.=1 acre-inch per hour is true within $\frac{5}{6}$ of 1 per cent, both of which are amply accurate for practical purposes.)

Third: One cubic foot per second (c. f. s.)=50 Utah miner's inches.

Use of Convenient Relations.—Examples of how to use the above relations are given below:

1. An irrigator is entitled to 3 c. f. s. to irrigate a 10-acre alfalfa tract. How long will it take him to apply 5 acre-inches per acre? Note that the quantity of flow, the area to be irrigated and the average depth of water to be

applied are given. The necessary time is to be found.

To do this proceed as follows: 3 c.f.s.=3 acre-inches per hour. The total number of acre-inches needed is 50, that is, 5 on each of 10 acres. Since each hour brings 3, the time necessary is $50 \div 3 = 16 \frac{2}{3}$ hours. *Ans.*

2. Smith has a pump which discharges 900 g.p.m. If he spends 30 hrs. in irrigating a 10-acre orchard, what average depth in inches does he apply?

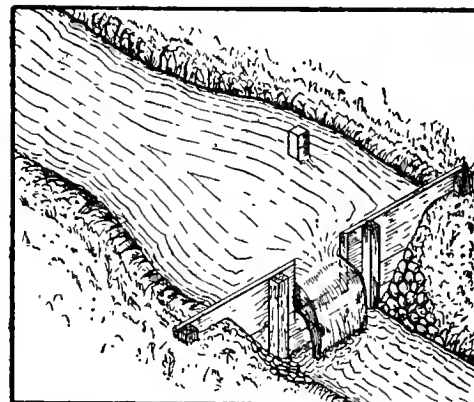

Fig. 2. Weir notch and bulkhead in weir pond.

Note that the quantity of flow, the lime run and the area of land covered are given, and that the depth of water applied may be found as follows: 900 g.p.m.=2 c.f.s.=2 acre-inches per hour. Therefore, in 30 hrs., 60 ac.-in. will be supplied, and this amount spread uniformly over 10 acres will cover it to a depth of 6 inches. *Ans.*

Weirs Having End Contractions. †

Descriptions of the rectangular, the trapezoidal§ and the 90-degree triangular notch weirs, with "complete contractions," free fall and sharp crests are accompanied by tables for each weir. The quantity of water passing over either weir can be determined by use of the proper table. The depth of

†A weir having end contractions is one in which the length of the weir crest is so much less than the width of the water channel that the water filaments are completely deflected in flowing from the sides of the channel past the sides of the weir.

§This weir is also called the Cipolletti weir after the engineer who designed it.

water flowing over the weir must be determined and if the rectangular or trapezoidal weir is used the length of weir crest must be known. For example, if the length of trapezoidal weir crest is 2 feet, that is the bottom width of the notch, and the head or depth of water over the weir crest is $\frac{1}{2}$ foot or six inches, the discharge will be 2.37 cubic feet per second.

The following definitions taken from Farmers' Bulletin 813, U. S. Department of Agriculture, by V. M. Cone, will make clear the above and other terms used in connection with weirs.

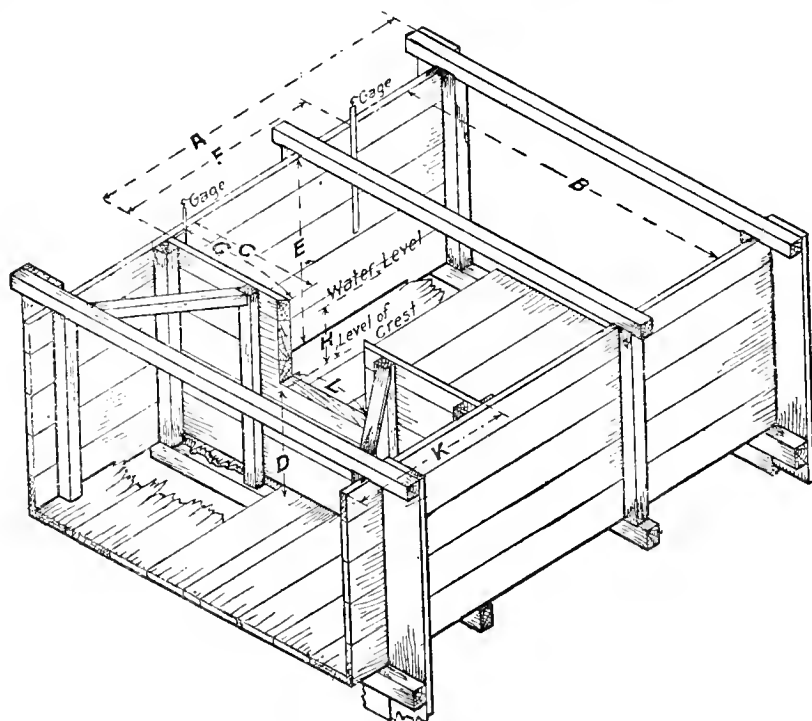

Fig. 1. Plan of weir box.

Definitions.—"A bulkhead or wall built across a ditch or stream, with an opening cut in the top of the wall through which the water is allowed to pass, is called a 'weir' and the opening is called the 'weir notch.' The bottom portion of the ditch immediately upstream from the bulkhead is the 'weir box' or 'weir pond.' The height of the water surface in the weir pond above the weir crest is the 'head.' When the water flows over the crest into the air before it strikes the surface of the water in the ditch downstream from the bulkhead, it is said to have 'free fall,' and when this overpouring stream of water touches only the sharp upstream edge of the crest, the weir is said to be 'sharp crested.' The weir notch must have a definite shape and size. The horizontal distance from the end of the weir crest to the side of the weir box is called 'end contraction,' and the vertical distance from the crest to the floor of the weir box is called 'bottom contraction.' When these contraction distances are great enough to cause a pondlike condition, which permits the water to approach the weir notch without any appreciable velocity, the weir is said to have 'complete contractions.'"

Advantages and Disadvantages of Weirs.—The advantages of weirs for water measurement are: (1) accuracy, (2) simplicity and ease of construction, (3) non-obstruction of moss or floating material, and (4) durability. The disadvantages are: (1) the requirement of considerable fall of the water surface, or loss in head, which makes their use in sections having level land impractical, and (2) the collecting of sand and silt above the weir which prevents accuracy of measurement.

Weir Box and Pond.—In the use of either of the weirs above described, the ditch or canal must be made wider and deeper than the average section of the canal for some distance upstream from the weir. This is to make the water approach the weir very slowly by flowing through a relatively large channel. The enlarged section of the ditch should be gradually tapered to the natural size about 40 to 50 feet above the weir. Cross currents just upstream from the weir must be prevented.

The weir may be placed in a weir box built of lumber or concrete, as shown in Fig. 1, or it may simply be placed in an enlargement of the ditch.

Less room is required when a box is used but cleaning is made more difficult. For temporary use the placing of a weir in the open ditch as in Fig. 2 is the more economical method.

Cleaning is also less expensive in the open ditch as a scraper may be used. The ditch downstream must be protected with loose rock or other material to prevent washing by the falling water.

Table I, taken from Farmers' Bul. 813 by V. M. Cone, Irrigation Engineer for the U. S. Department of Agriculture, gives the sizes of weirs best adapted to measuring streams of water varying from 1/2 to 22 cubic feet per second, and also the proper dimensions for each size of rectangular, trapezoidal and 90-degree triangular notch weirs.

Table I.—Weir-box dimensions for rectangular Cipolletti, and 90-degree triangular notch weirs.

(All dimensions are in feet. The letters at the heads of the columns in this table refer to Fig. 1.)

Flow (second-feet)	H Maximum head	L Length of weir crest	A Length of box above weir notch	K Length of box below weir notch	B Total width of box	E Total depth of box	C End of Crest to side	D Crest to Bottom	F† Hook gage distance	G‡ Hook gage distance
1/2 to 3	1.0	1	6	2	5 1/2	3 1/2	2 3/4	2	4 1/2	2
2 to 5	1.1	1 1/2	7	3	7	4	2 3/4	2 1/2	4 1/2	2 1/2
4 to 8	1.2	2	8	4	8 1/2	4 1/2	3 1/4	2 3/4	5 1/2	3
6 to 11	1.3	3	9	5	12	5	4 1/2	3 1/4	6	3
10 to 22	1.5	4	10	6	11	5 1/2	5	3 1/2	6	3
90-degree triangular notch weir.										
1/2 to 2 1/2	1.00	..	6	2	5	3	2 1/2	1 1/2	4	2
2 to 4 1/3	1.25	..	6 1/2	2 1/2	6 1/2	3 1/4	3 1/4	1 1/2	5	2 1/2

*This distance allows for about 1/2 foot freeboard above highest water level in weir box.
†Equals distance from crest upstream to gage.
‡Equals distance from end of crest over to gage.

*Cone, V. M. "Construction and Use of Farm Weirs," Farmers' Bulletin 813, U. S. Department of Agriculture, p. 9.

The weir dimensions in Table I, illustrated in Fig. 1, as given by Cone are a little smaller than what would be necessary to obtain rigid accuracy, but boxes of these sizes will give results within 1 per cent of the correct values. Cone outlines the conditions necessary for weir crests and sides as given below.

Weir Crests and Sides.—"Weir crests and sides should be true, straight and rigid. The crest must be level, the sides must be set to the proper angle with the crest, and carefully spaced to give the correct length of crest, as indicated by 'L' in Fig. 1 and Table I. The 90-degree triangular notch has no length of crest because the sides meet at a point.

"It is not necessary that the sides and crest be sharpened to a knife edge, but the edge of the crest on the upstream side must be sharp in the sense that it is not rounded. If a depth of water not less than 3 inches is to be run over the weir, the crest thickness on the edge may be as great as one-fourth inch without the water adhering to the crest, provided the inner edge is sharp. However, if the crest is beveled, this bevel must be placed on the downstream side, for the upstream face of the crest and of the bulkhead which holds the crest must be even and in a vertical position. The downstream face of the opening in the bulkhead must be beveled outward and downward about 45 degrees to insure free passage of air under the sheet of water as it flows over the weir.

"Instead of cutting the notch in the bulkhead to just the size desired and

leaving this rather rough edge to serve as the crest and sides of the weir notch, it is better to make the opening in the bulkhead at least one inch deeper and two inches wider than the desired size of weir opening. This will permit attachment of crest and side strips to the bulkhead so as to project about an inch all around, making more perfect edges, and the overpouring sheet of water will not touch the bulkhead."

On permanent installations it is de-

sirable to make the crests of metal heavy enough to avoid warping. On small weirs the crest may be cut out of a single sheet but on large ones separate strips are necessary. Angle iron is now frequently used, one face of which is bolted into the bulkhead opening in such a position that the other face is flush with the upstream face of the bulkhead.

For temporary wooden weirs, the wood of which the weir is constructed may well form also the weir crest and sides. Since wood warps easily and the sharp edges become worn and splintered, its use for crests and sides is seldom desirable.

Measurement of Head or Depth on Weir Crest.—The measurement of the head or depth of water on the weir crest is obtained with a specially constructed scale or a carpenter's rule. The special scale called the weir gage must be set upon upstream above the bulkhead a distance no less than four times the depth of the water "H" flowing over the crest. This is made necessary by the downward curvature of the water surface near the crest. A scale marked off into feet, tenths and hundredths of a foot on hard wood is satisfactory. The zero point on the scale must be set level with the

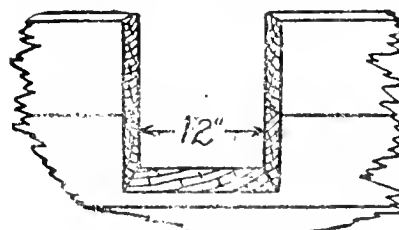

Fig. 3. Rectangular weir.

crest of the rectangular or trapezoidal weir, or with the vertex of the triangular weir. If an open weir pond of sufficient width is used the scale, or a lug upon which to place a rule, may

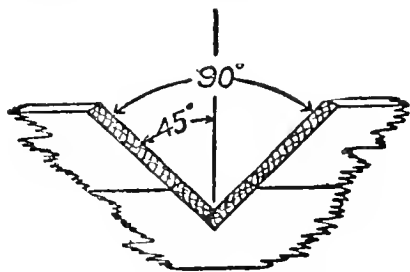

Fig. 4. Triangular notch weir.

be fastened to the bulkhead at a lateral distance from the end of the notch of not less than twice the greatest depth of water "H" over the crest. To get the zero point of the scale or the lug level with the crest, a carpenter's level and straight edge or a surveyor's level must be used. Allowing the water to flow into the pond and slowly rise till it flows over the weir crest is inaccurate, since the water surface will rise appreciably above the crest before flow over the crest begins. Small errors in reading "H" causes relatively large errors in the discharge determination.

Rectangular Weir.—The rectangular weir, named from the shape of its notch, is the oldest weir in use. Its simplicity of form, ease of construction and accuracy make it a desirable device for measuring water.

Because of the vertical ends and the complete end contractions the middle part of the weir discharges more water than the same length of weir near either end, whereas the trapezoidal weir with sloping ends is commonly believed to discharge the same amount of water near either end as it does in the middle. However, extensive experiments conducted by the United States Department of Agriculture indicate that four times the discharge over a 1-foot trapezoidal weir is greater than the discharge under the same head over a 4-foot trapezoidal weir.

Ninety-Degree (90°) Triangular Notch Weirs.—The triangular notch weir is especially adapted to the measurement of small quantities of water, varying from a very small fraction of a second-foot to 2 or 3 second-feet.

Cone has demonstrated that very small crest lengths in the rectangular and trapezoidal weir, e. g. 1/2 foot, do not follow the laws of discharge for lengths of 1 foot and above. Therefore for the measurement of streams of 1-3 of 1 c.f.s. or less, which are too small for the 1-foot rectangular weir, the triangular-notch weir is especially valuable. The 90-degree weir should be so placed that each side will make an angle of 45 degrees or half pitch with the vertical.

Trapezoidal or Cipolletti Weirs.—The trapezoidal weir, called also the Cipolletti weir after the Italian engi-

neer who designed it, is equally accurate but more difficult to construct than the rectangular weir. Its sides are made on a slope of one inch horizontal to four inches vertical.

The conditions of installation outlined above apply to this weir.

Submerged Orifices.

Submerged orifices as used in the measurement of irrigation water may be divided into two general types. A description of the type of orifices most commonly used—that with fixed dimensions—is here given. The other type is that in which the opening may be varied.

Definition.—A submerged rectangular orifice having four sides which are covered with thin edged plates, and which are so far removed from the top, the sides and the bottom of the water channel, as to cause complete deflection of the water filaments as they pass through the orifice, is

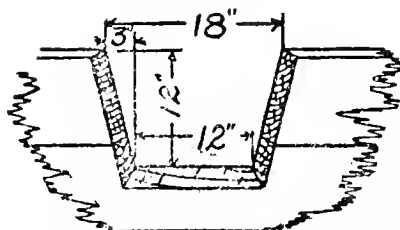

Fig. 5. Trapezoidal or Cipoletti weir.

classed as standard submerged orifice. The sides of the orifice may be made of properly sharpened planks, but it is best to use a thin metal plate.

Conditions for Accuracy. The U. S. Reclamation Service has outlined the following conditions as necessary for obtaining accurate measurements:

"(a) The upstream edges of the orifice should be sharp and smooth and the distance of each from the bounding surfaces of the channel both on the upstream and on the downstream side should preferably be not less than twice the least dimension of the orifice.

"(b) The upstream face of the orifice wall should be vertical.

"(c) The top and bottom edges should be level from end to end.

"(d) The sides should be truly vertical.

"(e) The head on the orifice that should be measured is the actual difference in elevation between the water surface on the upstream side of the orifice and the water surface on the downstream side thereof.

"(f) The cross-sectional area of the water prism for 20 to 30 feet from the orifice, on the upstream and on the downstream side thereof, should be at least six times the cross-sectional area of the orifice."

Advantages and Disadvantages.—The greatest advantage in the use of submerged orifices is found in relatively level sections where it is difficult to obtain fall enough for weir measurements. They have in addition to the above, the advantages already enumerated for weirs.

The more important disadvantages are (1) occasional collecting of floating debris, and (2) collecting of sand and sediment above the orifice, thus preventing accurate measurement.

As in the use of weirs, the ditch or canal immediately above the orifice must be wider and deeper than the

Continued on page 34.

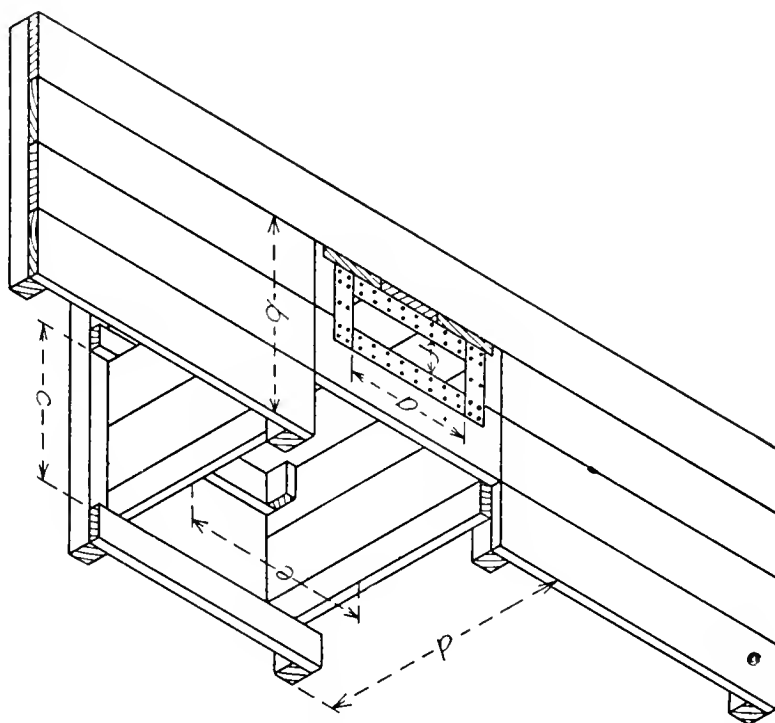
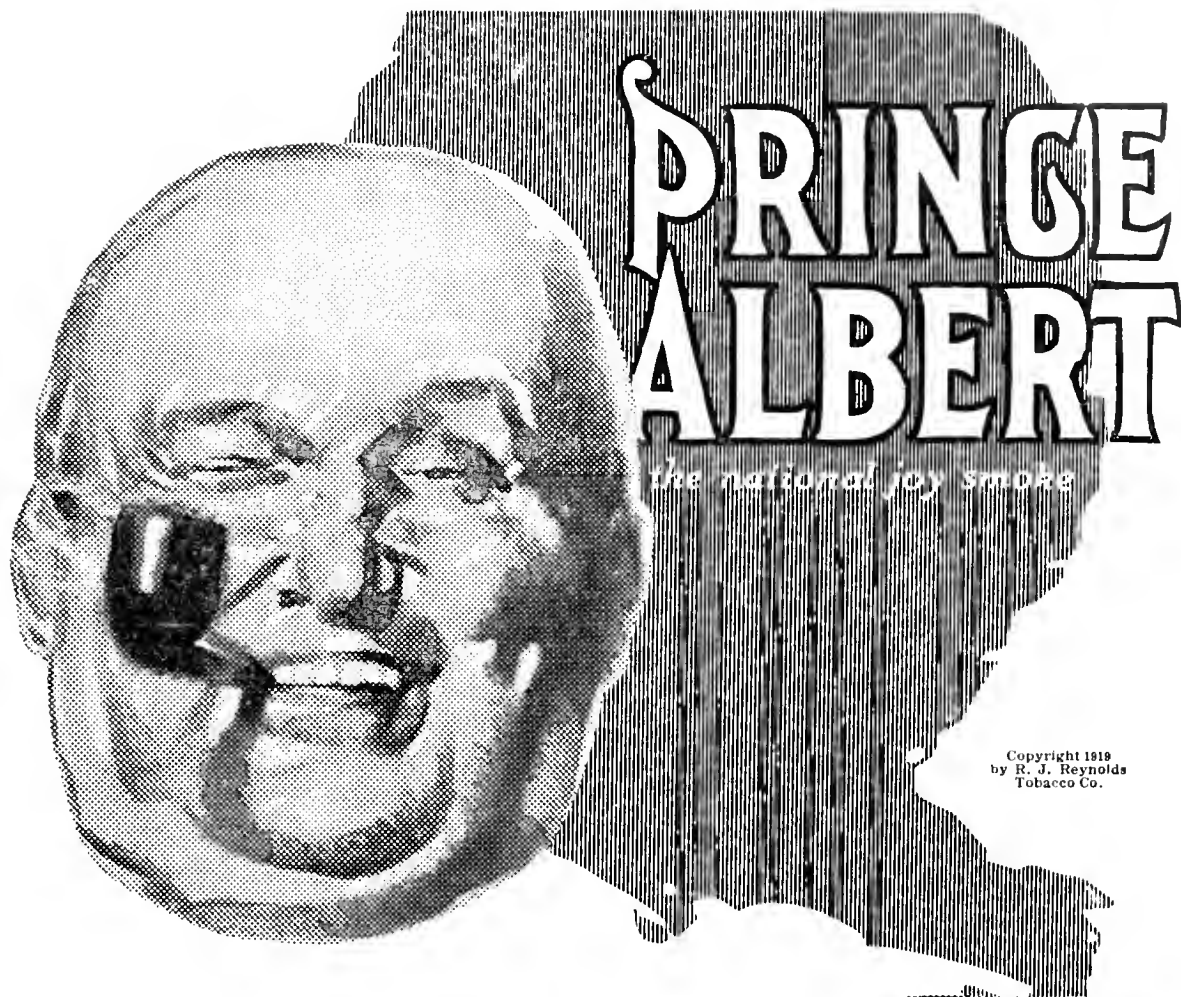

Fig. 6. Submerged orifice used by the U. S. Reclamation Service.



IF you haven't rung-in on the joys of a jimmy pipe with Prince Albert for packing you certainly want to get introduced inside the next hour! Talk about a pal-party! Why, it's like having a pass on a park merry-go-round early in June!

For, Prince Albert has brought pipes into their own—led *three men* to the utmost tobacco happiness where *one man* smoked a pipe before! P. A. has blazed the trail for thousands who figured they would have to do "Kitchen Police" on pipe smokes the rest of their lives! Thousands more have taken the tip to roll their own with Prince Albert!

So, climb into the P. A. pipe or makin's cigarette pastures and have a session! You'll soon get wise, all right, that Prince Albert never did bite the touchiest tongue in your township—and, it's a brace of aces against a two-spot that it never will fuss yours! Read on the reverse side of every Prince Albert package that P. A. is made by our exclusive patented process that *cuts out bite and parch!*

Give Prince Albert the speed-o taste-test and tongue-test *if you want to sing-smoke-songs-at-sunrise!*



Tippy red bags, tidy red tins, handsome pound and half-pound tin humidors—and—that classy, practical pound crystal glass humidor with sponge moistener tap that keeps the tobacco in such perfect condition.

R. J. REYNOLDS TOBACCO COMPANY

Winston-Salem, N. C.

Topworking An Inferior Orchard To Better Varieties

By O. T. Wyckoff

THE search for better fruit. What an interesting story might be written on this subject! And how far-reaching it would be in extent of time and space. Let me furnish a very brief chapter with special reference to top-working poor varieties to better ones.

Several years ago I bought a 40-acre tract in Benton County, Ark., just on the borders of Missouri and Oklahoma, in the famous Ozark region. According to Professor Waugh, Benton County has more apple trees than any other county in the United States. The tract just mentioned had only 13 acres in apples, with five acres in corn, and the balance in hardwood timber or scrubby pasture. The trees are now ten years old, though many of the original planting doubtless succumbed to neglect or hard usage and were reset at a later date. At the time of purchase, some were stunted in growth, but healthy; others sickly and in need of removal; but the majority were in fairly good condition. There were 150 Jonathan and 25 Maiden Blush. The remainder were Ben Davis and Gano. The trees were 28 feet apart each way. The first winter the trees were thoroughly pruned. In some cases nearly half the top was removed to correct a bad head formation. Trees that did not promise well were taken out and Stayman, Winesap, Jonathan and Delicious reset. Then the plow and harrow were put to work and at the proper season cowpeas were drilled in, followed by rye as a cover crop. Meanwhile all the land was cleared and put in corn except eight acres of the best timber located a deep "draw," where there is a good spring. Four acres in a choice location were planted to peaches.

During the next winter we prepared to set an additional five acres, which had been in corn, to apples, and also to top-graft most of the Ben Davis and Gano to Jonathan and Grimes Golden. I made various attempts to find an expert grafter, but without success. The nurserymen to whom I appealed and also the experiment stations were of course all busy at that season. At last, Professor Ernest Walker of the Fayetteville (Ark.) Station suggested that I should send Mr. Shird Robertson, who was caring for my place, in addition to his own adjoining, to Fayetteville to receive instruction in top-grafting. Mr. Robertson was thoroughly qualified in orchard work, but had never had experience in grafting. He proved an apt pupil, for after two or three days' instruction and practice, he gained a remarkable success, as shown by the table below:

Variety of Tree Grafted.	Variety of Scion.	No. of Trees Grafted.	No. of Grafts.	No. of Grafts Failing to Grow.
Ben Davis and Gano.	Jonathan	85	468	none
	Grimes	44	216	8
	King David	11	58	9
	Delicious	12	69	5
Totals	4	152	811	22

The Jonathan scions he cut himself from selected trees in my orchard and that of Mr. E. M. Dunn of the same region. The Grimes scions were from a local nursery, and the King David and Delicious were kindly furnished by Stark Bros. Mr. Robertson began grafting March 19th and ended his work on April 3rd. He attributes his success in part to the fact that he worked only when weather conditions were favorable. He had an assistant to do the waxing. In some cases only part of the tree was grafted this season, but a majority were completely worked over, a few subordinate

branches being left with the grafts till next season. Experiments were made with stunted trees. In some cases the entire top was removed and the grafts were inserted in the stub. In others they were inserted in the branches close to the stub. In both, the work proved highly successful. The stub grafts grew vigorously, throwing out branches and making a fine head. As an instance, the entire top was removed from one tree, the scions being inserted in the branches near the stub or trunk. This tree was grafted on April 3rd to Grimes Golden. When the photograph was taken on July 16th, the grafts had made a growth of 30 inches. Others exceeded this growth, but none made a better head.

The trees reset made a fine growth and promise well. In setting this year we used dynamite. The young apple orchard will be in corn for a couple

of years, but in general we practice clean cultivation, followed by cowpeas and a cover crop of rye or a similar treatment.

We are giving special attention to all wounds or signs of disease, going over the entire orchard at regular intervals with this sole point in mind and with the proper materials for doing good work. We plan to put the cultivated land into grass or alfalfa, or whatever will give the largest return with the least outlay of time and money, so as to be free as far as possible for or-

Continued on page 30.

"CARO" FIBRE FRUIT WRAPPERS

This is the Point

Chemically Treated
"Caro" Protects
"Caro" from DessiCARE (to dry up)

"Caro" Prolongs the Life of Fruit Why?

Fruit decomposition starts from a bruise which opens tiny holes and permits the juice to escape and BACTERIA to enter. "Caro" clings closely and dries up the escaping juice. "Caro" ingredients harden the spot, kill the BACTERIA, arrests the decomposition—and thus **PROLONGS THE LIFE OF FRUIT**. If your fruit is worth shipping it is worth keeping in best condition.

Demand "CARO"—Wrap Your Fruit in "CARO"—The Fruit Buyer Knows "CARO"

Order from Any Fruit Company or American Sales Agencies Co., 112 Market St., San Francisco

Obtaining New Fruit Stocks is Big Problem

THE matter of obtaining or propagating fruit stocks for the greatly increased orchard plantings which will undoubtedly be made in the near future in this country, is an important one and is now engaging the attention of horticulturists, nurserymen and fruitgrowers. In referring to this situation at present, the Fruitman and Gardener says:

"The above-ground portion of your fruit trees may be pure American, but the underground portion is very likely to be foreign. With the exception of the apple and peach, most of the seedling plants on which grafting or budding is done are imported, and even with the apple, many nurserymen have heretofore preferred to import apple seedlings from France and to pay more for them. However, attention has been turned toward a solution of the problem of fruit stock production in this country, and all of the peach stocks are now grown from seeds produced in America."

The devastation of large areas in France where fruit stocks were grown, and the fact that it will take considerable time to start propagating and grow stocks in Europe to an age where they can be used is causing writers on the subject to advocate that immediate steps be taken toward propagating home-grown stocks.

"We are beginning to appreciate more and more," says one of the plant pathologists of the United States Department of Agriculture, "that our future successful fruit culture is intimately associated with the problem of stocks. With the exception of the grape, no far-reaching studies have been made on stocks in this or any other country. We have followed certain empirical practices in the past, but as competition becomes greater and the demand for the highest grades of fruit and plant products increases, we must know more of the actual re-

lation of stocks to quality of product, to the length of life of the tree or plant, to adaptability to soil and climate, to resistance to disease and insect attacks."

One of the questions to be solved, according to the Department of Agriculture, is the practicability of producing in this country the millions of ordinary apple, pear, plum, and cherry stocks which hitherto have been secured largely abroad. Another need is the systematic study of stocks with a view to their improvement and better adaptability to the wide variety of conditions and needs that exist here and that are likely to develop as the fruit industry becomes more complex. If fruit industries are to be maintained, the department thinks it is imperative that there be available full supplies of the ordinary stocks, and it is desirable to find or develop stocks that may prevent some of the losses from insects and diseases.

"If stocks are to be produced in this country to take the place of those hitherto secured abroad," the statement continues, "it would seem proper that efforts should be made by the Government to aid those who are anxious to know where the work can best be done and how it may be done to the best advantage. The problems involved are so complex that the private interests can not well handle them. The chief problems are to find regions and soils in this country where stocks may be commercially grown and to demonstrate on a commercial scale that such stocks are equal to or better than those grown abroad. Correlated with the problem of commercial stock production is that of securing seeds for stocks. There is need for developing our home supplies. This is a long-time proposition, as there are few recognized sources of supply here, such as exist in Europe."

The Effort to Economize in Spraying Materials

IT is stated by the United States Department of Agriculture that on account of the present high price of copper sulphate, the principal active ingredient in bordeaux mixture, that many who are compelled to use this material in spraying are seeking a substitute. The specialists of the department, who have taken this matter up, state that there is no substitute for bordeaux for the purposes it is used in the orchard, and further say that it is the only reliable preventive for certain plant diseases which are so well known that it is not necessary to enumerate them.

One of the most important things in using commercial bordeaux is to know its value. Methods of calculating the value of commercial bordeaux mixtures have, therefore, been published in Farmers' Bulletin 994, a copy

of which can be obtained from the department at Washington.

Every package of commercial bordeaux mixture carries a label on which is given its content of copper. This is usually given in percentage, and by multiplying this percentage by 3.93 the result gives the amount of crystallized copper sulphate, the bulletin explains. If the percentage is given in terms of copper oxid, multiply by 3.14; if in copper hydroxid, multiply by 2.56. In order to calculate the copper sulphate when diluted ready for application, multiply the number of pounds of the concentrated bordeaux mixture to be added to 50 gallons of water by the percentage of copper sulphate.

Physical properties, such as adhesiveness, texture, spreading quality and rate of settling, also are impor-

**BEST SERVICE -
QUALITY & PRICES**

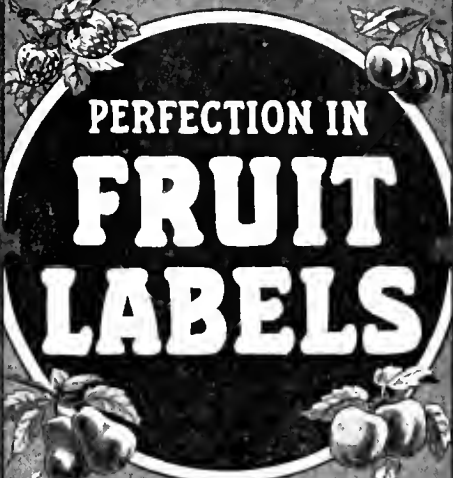

**PERFECTION IN
FRUIT
LABELS**

**THE
SIMPSON & DOELLER CO.**
1423-24 NORTHWESTERN BANK BLDG.
PORTLAND, OREGON.
E. SHELLEY MORGAN
NORTHWESTERN MANAGER

WE CARRY - AND CAN SHIP IN 24
HOURS - STOCK LABELS FOR PEARS,
APPLES, CHERRIES & STRAWBERRIES.

tant factors in determining the efficiency of bordeaux mixtures. A preparation containing a large amount of copper, but coarse and granular in texture, with poor spreading and sticking qualities, cannot be expected to give good results in cases where a good fungicide is required. To test the physical properties, dilute the mixture and place a small quantity in a glass tube, and watch the speed with which the solids settle to the bottom. If the copper is held in suspension for a great length of time the physical properties of the mixture may be regarded as good.

In order to reduce the cost of spray material some growers are using a weaker mixture than is commonly advised for the various diseases which require bordeaux treatment. When the disease attacks are mild a bordeaux mixture containing considerably less copper sulphate than is commonly advised may give very good control, provided its physical properties are good and it is thoroughly applied, the bulletin states. When infection is severe, weak mixtures should be avoided, for the resultant loss when they are used may much more than offset the amount saved by using the proper strength.

The department advises that the use of inferior spraying material or so-called substitutes is a dangerous practice and an economy that growers will do well to avoid.

LABELS
WITH A PURPOSE
TO ATTRACT ATTENTION
AND CREATE SALES

Schmidt
LITHO.
CO.

SAN FRANCISCO

47th YEAR of
SERVICE and
QUALITY

Branches:
 SEATTLE · PORTLAND
 SACRAMENTO · FRESNO
 LOS ANGELES · HONOLULU

The Origin of the Ettersburg Strawberry

By Albert F. Etter

BECAUSE ordinary strawberries would not grow to amount to anything at Ettersburg, I decided to try to grow some that would. I took the native plants and some other wild species, considered worthless, and out of these and certain varieties of our cultivated strawberries I have made a wonderful collection of strawberries of hybrid origin. One can not conceive just what I mean unless he be a visitor to Ettersburg in strawberry season.

There is no question but that I get all that is in the variety generally, but the astonishing thing to all visitors is that these hybrids are so vigorous and prolific when the regular varieties amount to little under exactly the same conditions growing along side.

One thing that should be constantly remembered is this: that while Ettersburg strawberries are capable of flour-

ishing where other varieties are a failure, does not imply that if other varieties are a success, they should do still better. They may do better and they may not do at all well. Their requirements are different and conditions may suit them or they may not, it all depends. They have excessive vigor and robustness and like their wild ancestors are capable of growing in poor land with little cultivation, far better than ordinary varieties, while if planted in rich moist land they run all to foliage and runners, the fruit will be small and poorly flavored, and the foliage susceptible to attack by leaf-spot fungus. There is so many ways that a strawberry plant is affected by soil and climate that it would take a whole book to go over it all. One general remark might be made on Ettersburg strawberries, and that is this: the poorer the soil the more moisture the

plants will tolerate and still produce fine fruit, and the richer the soil the more the moisture in the soil must be regulated if one be successful. I meet with the best success by giving perfect care the first season and after that let them shift pretty much for themselves. I never plant closer than 30 inches each way, and on a richer soil 36 inches would be preferable.

My first attempts to grow strawberries from seed was about 30 years ago. I crossed the old Sharpless with a variety known as the Parry. I grew second and third generation seedlings of this type. At about this time I got in a roundabout way a few plants of a peculiar fuzzy leaved strawberry. Captain Cousins, of Eureka, Calif., had picked up and brought it to Eureka on one of his trips on a lumber schooner to Calao, Peru. It was years afterwards that I accidentally discovered the identity and history of this Peruvian Beach strawberry. It was not only an odd plant, but it was an exceedingly shy bearer. The second attempt it made to fruit, I emasculated the primary blossom on the truss and pollinated it with a blossom of one of my third generation Sharpless-Parry plants. Eleven seedlings were grown from this seed and among these was the Rose Ettersburg, one of the most peculiar strawberries ever produced. Mind you, this variety was produced in the cool foggy climate of Eel River valley, yet it will endure the excessively high temperatures on the desert in Southern California at Thermal and Wagner where it goes up to 120 degrees in the shade, and resists the alkali where the ground is white with it.

Why Orchards Must Be Sprayed.

"What's all this new fangled talk about spraying?" says the oldest inhabitant. "When I was a boy——." That is the difference. Grandfather did not have to contend with the swarms of pestiferous insects, that make orcharding so difficult for his grandson. Spraying was not necessary in those days because apple orchards were more widely scattered and as a result insects were not so numerous. With the increase of orchards, insects became more numerous not only from multiplication but by importation from infested territory and from foreign lands. For many years insects were permitted to multiply unhampered and as a result they made orcharding unprofitable. They are so numerous and destructive now that spraying, pruning, and the best cultural methods must be practiced to make the orchard pay.

The University of Missouri College of Agriculture is now engaged in a campaign to show that small orchards such as are usually found on every farm can be sprayed with profit. If you have only one or two fruit trees the small cost in spraying them will be repaid many times over in a more abundant yield of higher quality fruit.

Prof. O. B. Whipple Resigns

The announcement has just been made that Professor O. B. Whipple, for ten years horticulturist at the State College of Montana, has resigned to take up work in a new field. Professor Whipple was one of the best-known men in his profession in the Northwest. He graduated from the Kansas Agricultural College in 1904; was a graduate student of Massachusetts Agricultural College, 1904-5; was instructor in horticulture at Colorado Agricultural College, 1905-6; and field horticulturist for the Colorado Experiment Station, 1906 to 1909; and since July 1909 has been horticulturist at the Montana State College.

While field horticulturist in Colorado, Professor Whipple was the joint author with Professor Paddock of the book entitled, "Fruit Growing in Arid Regions," and since then has favored the public with several valuable bulletins and other publications on fruit and vegetable work in Montana. During recent years he has specialized on



Prof. O. B. Whipple, who has resigned as head of the department of horticulture at Montana State University, to take a position with a private enterprise.

potatoes. His recent publications on potato breeding, selection and culture, which are the results of the work carried on at Bozeman, contain many new and interesting, as well as valuable ideas.

It is with regret that we announce the decision of Professor Whipple to leave Montana. During his stay of over ten years he has gained the confidence and respect of the fruit growers in Montana, as well as the neighboring states, and through his untiring efforts has done much to further the industry.

Professor Whipple is leaving Montana to assume the management of a five-hundred acre general farming proposition under irrigation near Grand Junction, Colorado, and will take up his new duties the first of the year.



TOP DRESSING TALKS, No. 2

Fertilizer Bulletins Free—

We would like to tell you about ARCADIAN Sulphate of Ammonia; why it is the great American ammoniate; why it is the best top dressing for any crop that needs nitrogen; and how to use it most profitably.

Write for these instructive and interesting free bulletins and we will send them. Order by number. Address The Barrett Company, Agricultural Department.

- | | |
|---|--|
| No. 1—"Important Facts About Arcadian Sulphate of Ammonia." | No. 89—"Sulphate of Ammonia for Vegetables." |
| No. 27—"How to Increase the Yield of Timothy." | No. 90—"Which Source of Nitrogen Is Best?" |
| No. 59—"Sulphate of Ammonia by Those Who Know." | No. 91—"Sweet Potatoes and Yams." |
| No. 61—"Oats and Their Fertilization in the South." | No. 93—"Sulphate of Ammonia as a Nitrogenous Fertilizer." |
| No. 68—"Sulphate of Ammonia vs. the Boll Weevil." | No. 94—"Sulphate of Ammonia for Sugar Cane." |
| No. 69—"More Cotton." | No. 95—"Reference List on Sulphate of Ammonia." |
| No. 71—Fertilizer Note Book. | No. 96—"Some Experiences in Orchard Fertilization." |
| No. 81—Arcadian Sulphate of Ammonia—Directions for Use | No. 97—"Field Experiences on Availability of Nitrogenous Fertilizers." |
| No. 84—"Sulphate of Ammonia: Its Source, Production and Use." | No. 98—"Fertilizers for the Orchard." |
| No. 85—"Fertilizing the Apple Orchard." | No. 99—"Fertilizing with Sulphate of Ammonia." |
| No. 86—"More Wheat." | |
| No. 88—"Successful Potato Growing." | |

ARCADIAN

Sulphate of Ammonia

Sulphate of Ammonia is the well-known standard article that has done you good service in your mixed fertilizers for years past.

Arcadian is the kiln-dried and screened grade, made fine and dry for top dressing purposes. Ammonia 25¼% guaranteed. Made in U. S. A.

FOR SALE BY

CALIFORNIA: San Francisco, Hawaiian Fertilizer Co., Pacific Bone Coal & Fertilizing Co., Pacific Guano & Fertilizer Co., Western Meat Co., California Fertilizer Works; Los Angeles, Pacific Guano & Fertilizer Co., Pacific Bone Coal & Fertilizer Co., Agricultural Chemical Works, Hauser Packing Co., Hawaiian Fertilizer Co., Ltd., Southern California Fertilizer Co.; OREGON: North Portland, Swift & Co.

FOR INFORMATION
AS TO APPLICATION,
WRITE

The *Barrett* Company

AGRICULTURAL
DEPARTMENT

510 FIRST NATIONAL BANK BUILDING, BERKELEY, CAL.

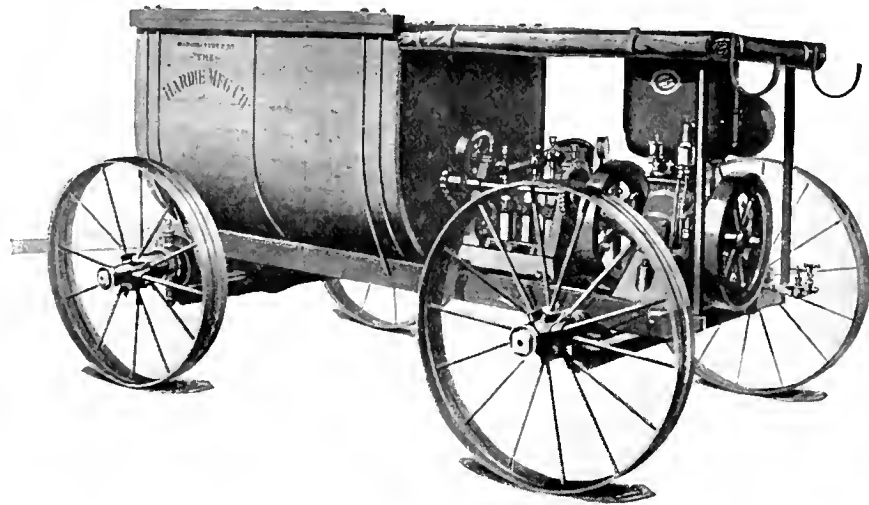

The HARDIE

Has the pump capacity to give you rapid spraying without any sacrifice of thoroughness.

Has the ample engine power to produce constantly the high pressure needful for the effective killing application of your spray liquid.

Has the truck which has never been equalled for the power sprayer. You can operate with ease and safety under the adverse conditions of bad soils, steep hillsides or rocky ground. The low-hung load saves fruit and limb injury in closely set orchards.

Has everything needful in proven time and labor saving devices.

Has the sound mechanical design and sturdy construction for constant, consistent performance, giving you years of service at low upkeep cost.

Equip yourself with this powerful machine and our famous time-saving Hardie Orchard Guns.
Gain more effective spraying at a lessened cost.

Let our catalog tell its story by sending for it today

THE HARDIE MFG. CO.

55 North Front Street

Portland, Oregon

Timely Topics and Advice for the Fruitgrower

Individuals who engage in the work of spraying and fumigating plants as a business for hire in California will be required to register with the horticultural commissioner's office and file regular reports with the State Department of Agriculture according to plans now being made by the department. The purpose of this ruling is to give more effective control over plant pests and diseases, through close cooperation with the men who do the spraying and at the same time to gain better results in spraying for growers. Registration of this kind has been required for some time in one county in California and its results have been so beneficial that it will be made the basis for further extension.

It's a good time now to look for the scale insects which attack fruit trees, says C. L. Fiske, entomologist at the Wisconsin Experiment Station. San Jose is the most destructive of all the scale insects. It spreads very quickly and kills trees outright unless soon checked. The scales are about the size of a pinhead, usually circular in outline and dark gray in color. The distinguishing feature is a central raised portion which is surrounded by a sunken ring, which is again surrounded by a yellowish raised ring. The insects pass the Winter as partly grown scales on the bark of branches or limbs of trees. Young scales, thin and flattened, may be found on the under side of small branches during the Winter. The eggs are laid in a white cottony mass of waxen threads secreted by the body of the mother scale.

Formulas that have proved very efficient in poisoning gophers and digger squirrels are as follows:

For Gophers: Mix dry $\frac{1}{8}$ ounce of strychnine alkaloid and 1-10 ounce of saccharine and sprinkle over a quart of chopped carrots. Place the poison bait in main runways, using care to close the burrow against any light.

Digger Squirrels. Part 1—Mix dry one ounce of strychnine alkaloid, one ounce of baking soda, four tablespoonfuls of table salt and $\frac{1}{8}$ ounce of saccharine.

Part 2—Make $1\frac{1}{2}$ pints gloss or laundry starch paste and add one pint of Karo or other heavy corn syrup and one ounce of glycerine. Mix No. 1 and No. 2, stirring thoroughly to prevent lumps. This mixture is sufficient to poison 16 quarts of rolled barley. Do not put bait in burrows but scatter just outside.

R. H. Robinson, associate chemist of the Oregon Agricultural College school of agriculture and experiment station, who has completed examination of apples from Oregon orchards, which bear heavy deposits of spray material, is quoted as saying, "that it would be impossible to eat a sufficient number to cause fatal arsenic poisoning." Mr. Robinson's laboratory tests of the fruit followed a recent alarm raised by Boston health authorities who ordered the condemnation of California Bartlett pears and Yakima Jonathan apples, declaring the fruit dangerous for food purposes. The action of the authorities resulted from the illness of a woman in a Boston suburb. She had eaten California pears, and analysis of her stomach contents, it is said, showed traces of arsenic poisoning.

"I endeavored to obtain samples with exceptionally large quantities of spray sediment left on the apple and consequently picked apples from trees that had received five applications during the season," says Mr. Robinson. "Also the strength of these applications was double that ordinarily used by horticulturists generally.

"Chemical analysis of these apples showed that the average amount was only .0007 grams of arsenic. Compared with an average fatal dose, it would be necessary for a person to eat 300 apples."

The question has been much discussed as to the possible life of an apple tree, grown in the Wenatchee district and nurtured by irrigation, says the Wenatchee Advocate. This much only has been established—no apple tree in this part of the state has yet lived long enough to show signs of dissolution or decay from old age. On Pogue Flat there are trees approaching 40 years of age, still thrifty, flourishing and producing fine apples. In the Wenatchee valley proper, trees more than 30 years old are still in a vigorous condition yielding increasingly large crops of apples. Recently the little town of Procterville, Ohio, held a celebration to commemorate the history of the oldest living apple tree in the United States according to the local chroniclers. This tree is said to be 102 years old and is claimed to be the first Rome Beauty tree propagated. While dying at the top, the tree is said to annually produce several bushels of apples.

Probably there is no way of preventing the formation of scum which is universally found on cranberry vines in the spring, according to the Wisconsin Horticulturist. It is a growth or accumulation that comes from long submersion in the more or less stagnant water of the Winter flooding. The longer the vines are kept under, the greater the amount of scum, and the more difficult to remove. Instead of holding the Winter flood till late in May as was the general custom years ago, many successful Wisconsin growers now let the water down, exposing the vines in March or early April. The vines then have the benefit of Spring rains which wash off and remove this scum before it has become so thick and tenacious, leaving the vines in a clean and healthy condition, and before there is any start of new life or growth. Early in May bogs are reflooded and kept under a week or ten days, from the ponds or reservoirs which have also been freshened and improved by the rains of early Spring.

Why Hens Won't Lay When Eggs Are High Priced

They miss the green of a summer diet, they become lazy laggards, have not the vitality to molt quickly, or digest properly the usual feed. They lack the ability to exercise, and eat and drink what you give them without relish. Laymore, the greatest Egg Tonic, persists in making layers out of winter laggards. It adds to their vitality, sharpens their appetite, and tones up the laying organs without force or injury.

Two full packages is sufficient for 100 hens three months, and cost but \$1.00 (delivery charges and war tax paid.) Guaranteed to give results or money refunded. Write today to Mayer's Hatchery, 213 First Ave. N., Route 60, Minneapolis, Minn., for these two packages, and it is not necessary to send any money with the order. Simply say, "I'll pay when the packages arrive," and delivery charges will be paid.

Cletrac

TANK-TYPE TRACTOR

(Formerly known as the Cleveland Tractor)



Pushing a wheelbarrow through soft soil is almost an impossible job. The wheel sinks in and gets stuck.



Lay a track of boards over the ground and you can roll along easily enough.



It runs on tracks as a wheelbarrow runs on a plank

TRY to push a loaded wheelbarrow through soft plowed ground. You have to exert every ounce of your strength. The wheel sinks in deeper and deeper and you finally get "stuck" altogether and have to take off your load.

But lay a plank over the same soft ground and you can roll the same wheelbarrow over it with the same load—but with only a fraction of the effort. It was the plank that made the difference. Its broad flat surface distributed the weight of the load so that there was very little pressure at any one point.

And right there you have the principle back of the Cletrac Tank-Type Tractor. It runs on broad flat tracks in much the same way as the wheelbarrow runs on the plank. No power is wasted. You can pull a bigger

load. Fuel and oil go further. And more work can be done in less time—at less cost.

Ideal for orchard work

The Cletrac is compact, powerful, easy to operate, can be turned in a 12-foot circle, and performs practically all kinds of work formerly done with horses or mules, and does it faster and better and cheaper. On account of its compactness and short turning radius it's ideal for orchard work.

Order your Cletrac now. We have an interesting 32-page book entitled "Selecting Your Tractor" that will be sent free upon request. It discusses tractor farming problems on a "brass tacks" basis. Write for your copy today.

The Cleveland Tractor Co.

19145 Euclid Avenue, Cleveland, Ohio

The largest producers of tank-type tractors in the world

BETTER FRUIT

An Illustrated Magazine Devoted to the Interests
of Modern Fruit Growing and Marketing,
Published Monthly
by

Better Fruit Publishing Company

703 Oregonian Building
PORTLAND, OREGON

Motor Truck Transportation.

To no occupation has the introduction of the motor truck been of greater value than to the fruitgrower. To emphasize this statement we are publishing the following item taken from the Hood River Glacier:

Gasoline motors have revolutionized the methods of transporting apples in the valley. Of the 2,000,000 boxes of commercially packed fruit that will be harvested this season, it is likely that not more than 100,000 boxes will be hauled from packing houses to shipping stations by horse drawn vehicles. Motor trucks are making short work of apple hauling. It is rare that a grower owning large acreage is found without a motor truck. Truck sales the past year are approaching close to the century mark. Scores of orchardists, buying new passenger vehicles, have turned their old cars into serviceable trucks. In a single line at the receiving stations of the Apple Growers Association last week 19 different makes of trucks, ranging from a huge Mack to a Ford, were seen.

The motor truck has been of great benefit in enlarging the scope of rapid urban transportation in all lines of endeavor, but to none of them is it so valuable as to the fruit industry, which of necessity requires the quickest possible handling of perishable products. This is particularly true of the small fruits which must be marketed daily with the utmost dispatch. More time can be taken with the larger fruits such as apples and pears but there are limes also with these fruits when it is advisable to get them to the storage house or to the shipping point as quickly as possible. This the motor truck is accomplishing with an efficiency never before known, in addition to the fact that it is making it possible for a far greater development in fruit production than could be attempted heretofore.

In sections that are isolated from railroad transportation thousands of acres adapted to fruit raising that have lain idle because the owners could not get their products to market are now being planted. In fact this method of transportation has increased the area suitable to fruit-growing beyond estimation, in addition to doubling the value of the land.

While motor truck transportation has done much toward a greater development of the fruit industry in the past year or two in the Pacific Northwest, it is safe to say that only a start has been made in this direction and that in the next few years it will have reached that point where only the most inaccessible districts will be

without this means of getting their products to market.

Like the automobile and the tractor, and other mechanical inventions, the motor truck is reducing the drudgery of country life as well as bringing to it an economy and an efficiency of service of untold value.

Cheap Spraying Solutions.

There are undoubtedly ways in which the fruitgrower can economize in managing his orchard, but we do not believe he can afford to do so by experimenting with cheap and untried spraying materials. The advanced prices of these materials it is reported, is causing some growers to seek cheaper so-called substitutes. It should be remembered that the standard spraying solutions now in use are the result of years of study and experiments made by experts employed to determine their value and that until they evolve or discover something that is better than the sprays now in use, that the safest and wisest plan is to use the standard brands—the brands that have secured results.

The Benefits of Advertising.

The successful sale of the entire crop of the California Walnut Association in a few hours after the price was announced, and the success in marketing Northwest Jonathan apples through advertising campaigns, should be sufficient evidence to fruit growers that money spent in this way is not a contribution, but should be regarded as one of the most important fixed charges of the industry. The Jonathan advertising campaign which was inaugurated in the Northwest by Messrs. Clark, Gwin, Rose, McCullagh and others interested in box apple distribution with the coöperation of John Denny and Wagner & Sons of Chicago, Steinhardt & Kelly and Sgoebel & Day of New York, John Canelmo of Philadelphia and other prominent apple men in the east was a big stroke in behalf of a greater consumption of all varieties of Northwest apples. Attractive copy prepared by Arthur Rule of the Northwest Fruit Exchange and H. J. Woodruff, New York representative of the Hood River Apple Growers Association, played an important part in moving the Jonathan crop at a critical period. This creation of a consumption demand when it is most needed is one of the most valuable features of advertising apart from the organized publicity campaign which should precede the shipping of the crop to points of distribution.

When the returns are in for the Northwest apple crop this year, it should not take much more hammering to induce the apple grower to freely open his pocketbook for advertising funds in the future. When the dealers feel that they can afford to spend large sums to increase apple

sales, the grower ought to be convinced that it is sound policy to coöperate and secure still greater results by appropriating funds to be used in a nation wide consumer-demand publicity campaign.

The Hen Fruit Union.

The Hen

I shall not lay as often as of yore,
Our Rooster orders us to organize;
Like everybody else, we're getting wise!
Now for your eggs you will be paying more,
I've scratched until my toes are sick and sore,
But now I take but little exercise—
Our Union has compelled these rural guys
To serve our pickings on a marble floor.
And at our next convention we'll decree
How many eggs each one of us shall lay,
How many shall be hatched, how many
stored.
We have demanded better rooms and
board,
A holiday on every other day,
And no wire fences, Chickens shall be free!
—Cleveland Plain Dealer.

What the Newspapers Interested in Fruit Are Saying.

Apple growing is a fine occupation to go into for a change and a rest. The commission merchants take all the change and the wholesalers get the rest.—Canadian Horticulturist.

A record price for a citrus orchard is claimed to have been established at Whittier last week with the sale of ten acres of 11-year-old Valencia oranges and lemons for \$60,000.—Pacific Rural Press.

There is developing a marked increase in demand for apples in the local markets, but people would like to buy cheaper apples. They are willing to accept poorer grades in order to keep within their means.—Pacific Homestead.

More than 314,000 motor tractors for farm use will be manufactured in the United States this year. Ninety thousand of these tractors are intended for export. We wonder how many are likely to find their way to South Africa.—South African Fruitgrower.

Ripe olives, the last of California's fruits to "fall" for advertising, will soon be advertised nationally out of a fund contributed by growers and packers in equal amounts. The list of advertised or immediately-to-be advertised California products now includes oranges, lemons, raisins, prunes, apricots, olives, walnuts and almonds—all sponsored by associations of growers. Add to these the preserved fruits and vegetables in cans and it is plain to see that California has found itself.—Western Advertising.

Western New York, which last year marketed nearly six million barrels of apples, will this season have only two and one-third million barrels, not including apples used for drying or cider, or sold in bulk on local markets. The forty per cent increase in the western states which pack their apples in boxes will make up in bushels for the short crop in New York state, but will not help much to reduce the price. Buyers in western New York are now paying an average of about \$6.25 a barrel.—The Evaporator.

The news that Australia is not going to raise the embargo on importations of apples has not affected the market at all. Now if it were the grain market—those fellows always are looking for some "factor" to put 'er up or down.—The Packer.

It was in the spirit of enterprise and progress that a resolution, agreeing to a small acreage tax to organize the fruit industry, was carried at the annual convention of the Victorian Fruitgrowers' Central Association.

So far as the fruit industry of Victoria can speak with a united voice the Victorian Fruitgrowers' Central Association is the chosen and effective means of such expression.

The affiliated societies represented at the convention have had the proposal for organizing the industry by means of an orchard tax in front of them for many months; the proposal has been discussed from every standpoint, consequently delegates came prepared to vote. Delegates from Northern and Southern Victoria were emphatic in supporting the proposal, and with only four dissentients, the resolution was carried.—The Fruit World, Sydney, Australia.

Motion Pictures to Teach Apple Growing

By a Special Correspondent

ONE of the most interesting features of the meeting of the Maryland State Horticultural Society held recently at Hagerstown, Md., was the showing of a motion picture visualising in a limited way the various operations relating to the production of apples.

The story, based upon actual facts as they have occurred in Maryland, was that of a grower who was confronted with the problem of how to produce salable fruit. He noticed the demand for his neighbor's fruit, and upon inquiry learned of the assistance which could be obtained from the State College through the county agent. Taking advantage of the opportunity thus afforded, he was soon able to sell his fruit more profitably and in addition was encouraged to increase his orchard planting. In the course of several years he became so proficient that there was a constant demand for his fruit. Today finds him successfully competing on the market with growers from all parts of the United States.

The scenario of this picture was prepared by S. B. Shaw, extension horticulturist of the Maryland State College of Agriculture, and the direction was under the personal supervision of D. C. Ellis, in charge of motion picture activities of the U. S. Department of Agriculture. The taking of this picture was made possible through the coöperative effort of the extension service of the Maryland State College and the U. S. Department of Agriculture. It is the first of its kind to be distributed and the initial showing was made at Hagerstown, Md.

The possibilities of visual education are believed unlimited, and this is but the initial step in what the extension service of the State College hopes to do along this line.

One of the most interesting speakers at the meeting was Prof. S. A. Beach, of Ames, Iowa, who presented the "Future of the Fruit Industry." Among other things he pointed out that the

fruit growers are not asking for five hours a day, or for time and a half overtime and double time on Sundays. They are not stopping production to scrap and quarrel over conditions, but are working steadily along from morning until night and doing their duty at this time in the history of our country. Prof. Beach then pointed out that the future of the fruit industry was brighter than ever before, and showed by careful analysis the possibilities of the industry.

An important result of the meeting, and one which will interest Northwest apple growers, was the passing of a resolution by the society approving the proposed legislation providing for the standardization of basket hampers, round stave baskets, splint baskets and the establishment of a standard box for apples.

In an endeavor to popularize the more extensive use of Maryland apples, an apple banquet was held at the conclusion of the meeting, and the following menu shows some of the many ways in which apples can be used:

Apple Cocktail	
Oysters en Apple	
Baked Maryland Ham	
Scalloped Apples and Sweet Potatoes	
Spinach en Surprise	Green Peas
Maryland Biscuits	
Apple Chutney	Apple Jelly
Gingerale Apple Salad	
Apples a la Creole	
Applebutter Cookies	Sweet Cider
Cafe Noir	
Cigars and Cigarettes	

Washington Horticulturists Meet

The annual meeting of the Washington State Horticultural Association and conference of the Northwest Fruit-growers, which was held at Spokane, December 1 to 5, proved to be an interesting session and was largely attended. A good program had been prepared and live topics were taken up for discussion. Among those on the program to address the meeting on matters relating to horticulture were:

E. E. Williams, president of the Washington State Horticultural Association; Prof. A. L. Lovett, entomologist, Oregon Agricultural College, Corvallis, Oregon; P. S. Darlington, district horticultural inspector, Wenatchee, Wash.; Leroy Childs, Hood River Experiment Station, Hood River, Oregon; Dr. A. L. Melander, State Agricultural College, Washington; D. F. Fisher, plant pathologist, U. S. Department of Agriculture, Wenatchee, Wash.; Lee N. Hutchinson, plant disease investigations, U. S. Department of Agriculture; W. S. Peachy, vice-president, Seattle National Bank; J. J. Rouss, cashier, Fidelity National Bank, Spokane, Wash.; L. C. Gilman, district director of U. S. Railway Administration, Portland, Oregon; Prof.

O. M. Morris, head of department of horticulture, State College of Washington; Prof. C. C. Vincent, head of department of horticulture, University of Idaho, Moscow; Prof. H. J. Eustace, San Francisco, Calif., western publicity manager Curtis Publishing Company; G. Harold Powell, general manager, California Fruitgrowers' Exchange, Los Angeles, Calif.; Prof. C. I. Lewis, organization manager, Oregon Growers' Coöperative Association; H. W. Sampson, bureau of markets, U. S. Department of Agriculture.

Mayor C. M. Fassett, of Spokane; J. Howard Wright, Yakima; C. J. Newcomer, Federal Bureau of Entomology; Lee N. Hutchins, Plant Disease Investigations, U. S. Department of Agriculture; F. W. Graham, of the Great Northern Railway, Seattle, Wash.; Ralph Sandquist, Selah, Wash.; J. G. Carlisle, Kettle Falls, Wash.; W. T. Clarke, Wenatchee, Wash.; J. R. Everett, Okanogan, Wash.; L. E. Longley, Department of Horticulture, University of Idaho; W. H. Wicks, Director State Department of Horticulture, Boise, Idaho; S. M. McKee, Selah, Wash.; E. F. Benson, State Commissioner of Agriculture, Olympia, Wash.; W. H. Lyne, Vancouver, B. C.; Avery S. Hoyt, Sacramento, Calif.; Prof. E. P. Sandsten, Ft. Collins, Col.; S. O. Vanderburg, Boise; A. L. Strausz, Missoula, Mont.; J. H. McCullagh, Manager Hood River Apple Growers' Association, Hood River, Oregon.

Nitrate of Soda

Many apple growers who had complained of light yields have been using nitrate of soda for several years, with wonderful results. In cases where the supply of nitrate had become deficient many orchards bloomed but failed to set a crop. Orchards in some instances blossomed well for several seasons but failed to set a crop. Nitrate of soda was applied at the proper time, about March, and in the same year produced a crop of about 500 boxes to the acre. Nitrate was used again the next year and a crop of more than 500 boxes to the acre was produced. It is generally conceded by the fruit growers that where apples have failed to set, due to the deficiency of nitrate contained in the soil, that by judicious application of nitrate, where the other necessary soil qualities are present, a good set and increasing yield results.

SURPRISE PEAR on JAPAN ROOT

This is the blight resistant stock recommended by Prof. Reimer of the Southern Oregon Experiment Station and so much in use by large planters.

Plant the Surprise, topwork it to Bartlett, Anjou or whatever variety you wish and you have a trunk that has proven itself immune from blight.

We have had a big demand for this stock, but fortunately still have a few left. Scions were secured direct from Prof. Reimer.

*For other dependable nursery stock, as well, write

WASHINGTON NURSERY COMPANY

TOPPENISH, WASH.

Salesmen Everywhere

More Wanted

How You Can Get Better Fruit's Apple Packing Chart

BETTER FRUIT's apple packing chart as it appears in this number, but printed on cardboard so that it can be hung in the packing house, will be mailed to anyone desiring it on the following terms:

One card FREE with a new subscription to BETTER FRUIT.

One card without subscription ... 10c

Twelve cards without subscription, \$1.00

For quantity prices write us.

Better Fruit Publishing Co.
703 Oregonian Building
Portland, Oregon

Peerless Automobile Specialties



MAKE OLD CARS LOOK LIKE NEW

With these specialties you can keep your car in first-class condition with little effort and minimum expense.

Peerless Quality Products Are:

- Mohair Top Dressing
- Leather Top Dressing
- Cushion Dressing
- Lining Dye
- Jet Black Fender Japan
- Liquid Wax
- Touch-Up Black
- Mirroroid
- Carbon Remover
- Auto Body Polish
- Extra Fine Black Japan
- Rim Paint
- Tire Paint
- Gasket Shellac
- Lamp Enamel Gloss and Dull
- Cylinder Enamel Gray and Black
- Ford Top Dressing

Also eight color finishings in following colors: Red, White, Black, Gray, Blue, Green, Straw Color and Yellow.

Peerless products are put up in convenient sized lithographed cans and will give complete satisfaction to the most exacting purchaser.

Sold by leading Jobbers and Dealers of Auto Supplies also Garages and Hardware Stores.

DEALERS:—Order from your jobber today. If his stock has not arrived, write us and we will see that you are supplied.

MADE ONLY BY

The Columbus Varnish Co.
COLUMBUS, OHIO
U. S. A.

Northwest Notes from Here and There

OREGON

The Newberg High School has organized an agricultural department and in future will make it part of the regular course to those desiring to take it. Plant husbandry is being taught the first year. Oliver F. Killham, director, states that the department will appreciate the coöperation of advertisers in **BETTER FRUIT** in placing the Newberg High School on their mailing lists for literature of any kind that will be of interest to the school.

A very interesting and valuable bulletin on pear harvesting and storage was recently issued by the division of horticulture of the Oregon Agricultural College. The bulletin was compiled by Prof. C. I. Lewis, A. E. Murneck and C. C. Cate. It can be obtained by applying to the college.

The most interesting and largely attended horticultural show which has been given by the Oregon Agricultural College took place at the college during the early part of November. In addition to the fruits of Oregon, there were shown horticultural exhibits from many other states, and the exhibits which were divided into four sections, included the products of pomology, floriculture and olericulture, as well as horticulture.

A large membership in the Oregon Growers' Coöperative Association is expected to result from a mass meeting held at Medford recently. Several hundred Rogue River valley fruit-growers were present and gave evidence of their interest and approval of the plan to form a local association which will be affiliated with the statewide organization.

The Umpqua Valley Fruit Union, at Roseburg, will become a part of the Oregon Growers' Coöperative Association, January 1. The matter was decided at a recent meeting of the Roseburg concern when its members voted to sell its plant to the Oregon Growers' Association.

A recent census of the farm acreage of Marion county shows that section of Oregon to have a much larger acreage of fruit than was generally supposed. The figures are as follows: Apple trees bearing, 2124; apples non-bearing, 507; cherry trees bearing, 512; cherry trees non-bearing, 456; peach trees bearing, 319; peach trees non-bearing, 44; pear trees bearing, 433; pear trees non-bearing, 191; prune trees bearing, 6611; prune trees non-bearing, 1695; walnut trees bearing, 257; walnut trees non-bearing, 421; loganberries, 1922; blackberries and raspberries, 324; strawberries, 386; other fruits and nuts bearing, 97; other fruits and nuts non-bearing, 61.

Altogether there are 188,850 acres in Marion county producing agricultural and horticultural products.

The announcement is made that Grants Pass orchardists will have a much larger supply of water next year than was possible this season. This is being made possible by the construction of many more miles of main and lateral ditches by the Grants Pass Irrigation District. Much of the new territory to be irrigated is set to apple trees, the owners of which have heretofore been handicapped in the development of their orchards by lack of moisture.

The first shipment of Oregon apples to the Philippine Islands in any quantity was made recently when 4,000 boxes of Hood River fruit was loaded out of Portland for Manila.

Robert C. Paulus, manager of the Salem Fruit Union, who is this year marketing over 300 cars of Willamette valley apples in addition to handling the tonnage of the Salem institution, has again proven his ability in marketing fruit to the best advantage. Mr. Paulus sold the Bartlett pears of the union for \$85 per ton, and obtained from 72 to 75 cents per pound for dried loganberries. The pears which he is handling it is stated will average the growers better than 18 cents per pound.

The activities of the Phez company, which has its headquarters at Salem, Oregon, but also operates plants in Washington, and produces loganberry and apple juice drinks, as well as large quantities of jellies and jams will greatly extend its activities next year. This company is one of the heaviest advertisers of Northwest fruit products on the coast. Up to the present time its demand for small fruits has been far greater than the supply, and it is now conducting a campaign to induce greater plantings of bush fruits in both Oregon and Washington.

With a huge banner on each car an English apple exporting firm recently shipped 25 cars of apples from Hood River in box cars, owing

to the fact that it was impossible to obtain refrigerator cars. Each car was supplied with a heater and fuel, and several men were sent with the train to see that the fruit was properly ventilated or heated as the temperatures enroute required. The fruit was shipped to London.

It is now estimated that 5 per cent of the apple crop in the Hood River valley was hit by the severe frost which visited that valley during the latter part of October. Part of this 5 per cent was only slightly frosted, but the Hood River Apple Growers' Association, to be on the safe side, issued a bulletin to the growers instructing them not to pack out the frosted apples with those which were picked before the frost occurred. Many of the Hood River growers instead of packing the frosted fruit sent it to the cider and vinegar manufacturers.

WASHINGTON

A rapid development of loganberry planting in Western Washington counties is noted by M. L. Dean, chief of the division of horticulture of Washington. During the past season the canning factory at Chehalis paid growers \$75,000 for small fruits, Olympia concerns paid out over \$300,000. In the Puyallup valley the yield of blackberries was 7,000,000 pounds, 90 per cent of which were put up by the canneries at Puyallup and Sumner. The yields of other berries in this section were loganberries, 240,000 pounds; raspberries, 7,200,000 pounds; strawberries, 3,800,000 pounds.

A carload of melons that were shipped out of the Yakima district this year was a record breaker for size. None of the melons weighed less than 30 pounds, and a majority of them weighed 50 pounds, according to the horticultural inspector in that district.

A Rome Beauty apple that weighed 1¼ pounds was recently exhibited at Prosser, Wash. It was grown by H. E. Robinson.

Growers of Winesap apples, in some sections of Washington, had the unusual experience this year of having the fruit drop from the trees in large quantities before it could be picked. Several reasons were advanced for this, one of them being that irrigation was stopped too early, causing the fruit to ripen too fast.



Sixty Years

of devotion to the financial problems of the Pacific Northwest has given the Ladd and Tilton Bank a varied and comprehensive experience in business matters and trade development.

This is at the service of depositors who are puzzled over questions arising in the conduct of their business affairs, or the trend of the market in general.

The advice of this bank may be invaluable at a crisis in your affairs. Make use of it.

LADD & TILTON BANK
Portland, Oregon



What's back of—

Traung

Label & Lithograph Co.

LABELS and CARTONS



No. 3



No. 2

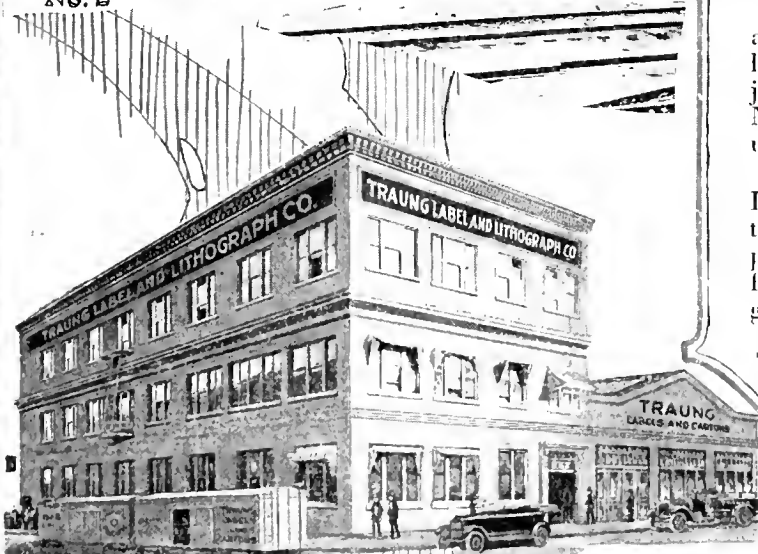

No. 1

BACK of every Traung label or carton is "an institution that sticks to its last"—that is content to make labels and cartons and make them as good as can be made.

All the resources of three factories, several sales offices and 300 employes are devoted to the exclusive making of labels and cartons.

Plant No. 1 in San Francisco, and Plant No. 3 in Seattle, thoroughly modern in their extensive equipment, manufacture labels exclusively.

Plant No. 2 at Stockton is the carton and folding box plant—the finest and largest in the West. Operated in conjunction with the Board Mills of the National Paper Products Company, it has unexcelled manufacturing facilities.

Inspired by those master craftsmen, Louis and Charles Traung, founders of the firm, the men who head every department and the artisans under them find satisfaction in the production of good work well done.

Traung Label and Lithograph Co.

SAN FRANCISCO SEATTLE STOCKTON

Sales Offices:

PORTLAND FRESNO
SACRAMENTO

"An Institution that Sticks to it's Last"

The Centerpost

in



Universal Bushel Shipping Packages

—With the centerpost—the Universal Bushel Shipping Package is stronger, more rigid and durable.

—With the centerpost—fruits and vegetables are protected against bruising or crushing.

—With the centerpost—your product reaches the market in a condition commanding a better price.

Learn more about Universal Bushel Shipping Package. Send for free booklet "Efficient Loading." Send 25c for a sample.

Package Sales Corporation

106 East Jefferson Street South Bend, Indiana

Established 1882

F. W. Baltes & Company Printers

WE print anything from the smallest to the largest and always welcome orders of any size or quantity, giving prompt, personal and efficient service.

Mail or phone inquiries are solicited. We do not specialize—experience and equipment enable us to print everything equally well. We render service in preparing copy and illustrations and furnish plans and estimates for catalogs, booklets, publications, billboard and any other kind of advertising.

First and Oak Streets
Phones: Main 165 and A 1165
Portland, Oregon

Apple growers, in the vicinity of Selah, are considering the erection of a common storage plant that will hold 500 to 800 cars of fruit. The lack of storage facilities this year is said to have emphasized the need of greatly increased storage.

Washington's apple crop, November 1, amounted to 19,135,890 bushels, based upon a total production which is 89 per cent of that normally produced in a favorable season, according to the report issued by G. S. Ray of the Federal Bureau of Crop Estimates. Last year's production was 16,459,000 bushels. Quality of the crop is 87 per cent, as compared with 88 per cent one year ago.

As the season progresses the magnitude of Eastern Washington's apple crop and fruit yield generally is emphasized. Final estimates of the apple crop of the Wenatchee district, including Chelan, Okanogan and Grant counties, indicate a total yield of more than 11,000 carloads, an increase of 30 per cent over 1918. The newer apple districts on the Columbia river show the largest increases. Thus Entiat is credited with 700 cars, Lake Chelan vicinity 625 cars, Pateros 475, Brewster 410, Malott 150, Okanogan 300 and Omak 800.

A total of 10,325 cars of fruit are reported shipped up to November 1 from the Yakima section, of which 5200 have been soft fruit. There is a shortage of cars, but the railroads are credited with accomplishing substantially more this year than ever before in respect to moving the crop promptly.

Spokane county has shipped 714 cars of apples this season up to November 1, while Stevens county has sent out 145 cars and Lincoln county 91.

The palm for intensive production in Yakima valley has been awarded to John G. Hartman, who took \$11,861 from an 11-acre ranch. The returns were as follows: Pears, \$6800; peaches, \$3600; prunes, \$1295, and small amounts from grapes, plums and cherries. A few years ago this place was in such a run-down condition that it was hardly regarded as worthy of development.

Recently C. L. Robinson, district horticultural inspector, announced a ruling that no frozen apples would be shipped unless marked frozen, and sent direct to by-products plants. The edict destroys the hope of many growers and shippers, that it would be possible to thaw frozen fruit and send it as fancy stuff. Robinson, one of the most conservative estimators of frost damage, says the order affects at least 300 cars, estimated at a value of \$450,000. While inspecting produce from warehouses, Robinson found a crew behind closed doors engaged in packing frozen fruit for shipment. The stuff was confiscated and the proprietor warned that any repetition of the offense would result in court action. All dealers are warned they must pack in the open.

The apple crop of the Spokane valley is practically completed and the bulk of the fruit is on rail. The estimate of 900 cars seems in a fair way to be realized. Earl Fruit company with packing plants at Otis Orchards and various other points, states that its business is double that of 1918, and that it will pay northwest growers more than \$4,000,000.

The Palouse corporation operating a dry land orchard at Fairfield, Spokane county, is reported to have shipped this season 75,000 boxes from its 1000-acre tract. The same company operates 300 acres of orchard at Waverly and 500 acres at Meadow Lake in the same county. The packing plant at Waverly is filled and the overflow is being stored in a church.

During one week 1152 cars of fruit, practically all apples, rolled to market from Yakima, Wash. Estimated value of the week's shipments is \$2,000,000. Wenatchee and Yakima apple shippers have cornered the cold storage space in Spokane. It is stated at the offices of the Spokane Fruit Growers company that space for another box of apples could not be purchased in the city.

The Wenatchee valley apple crop this year will bring the growers \$20,000,000, according to W. T. Triplett, secretary of the Spokane and Eastern Trust company, after a motor trip through Central Washington. "It is estimated that the valley will have 9000 to 10,000 cars of apples this season," said Mr. Triplett. "The valley is so prosperous and there is so much surplus money available that the successful growers are looking to the Okanogan country, north of them, as their logical field for expansion. The new irrigation projects under way in that section are opening up a vast new apple territory and Wenatchee growers are buying land there."

IDAHO

During the apple harvest in the little village of Fruitland, the orchards were filled with the tents of the pickers, and even the public school buildings were used to house apple pickers. The first week of harvesting, 37 cars of apples were shipped from Fruitland.

Payette has started a campaign to destroy gophers. The plan suggested is to make one day in each week gopher day, and have everybody devote the day to poisoning these little animals. The poison being used is alkaloid strychnine and saccharine, which is put into slices of apples and carrots. Enough of this material to cover 40 to 60 acres can be obtained for \$2.40, according to the Payette county farm bureau.

The canning factory, at Payette, had a very successful season, it is reported. There was a good demand, and high prices, for the entire output of the factory. About 100 people were employed during the canning season and \$15,000 was paid out for fruit.

Idaho, like other sections of the Northwest, was seriously hit by the car shortage. At one time one district had 600 boxes of fruit that was exposed to the weather on account of lack of cars for transportation. The situation is said now to have been materially relieved.

What They're Doing in California

A recent article in the Monthly Bulletin, of California State Department of Agriculture, tells of an ingenious way of attempting to smuggle into that state Florida grapefruit, which is barred from California by quarantine laws to stop the importation of citrus pests. The grape fruit was sent by express to Riverside from Chicago, and owing to the way the boxes were wrapped attracted the attention of the quarantine officer. When the boxes were inspected they were found to contain Florida grape fruit, but were labelled Oregon apples. The grape fruit was found to be infected with purple scale.

The California Prune and Apricot Growers' Association will erect two packing plants in the San Joaquin valley in order to handle next year's fruit crop. One of these plants, which will cost \$100,000, and will be constructed of reinforced concrete, will be built at Visalia, and work on it will be commenced the first of the year.

The apple shipping season in Northern California this year was the most profitable in its history. Owing to the heavy demand for apples last year, old orchards that had been neglected for a long time were pruned, sprayed and cultivated this summer with the result that several districts that had stopped shipping apples, this year marketed many carloads.

The University of California, which experimented this year with drying peaches with the pits left in them, is reported to have achieved remarkable success, and opened the way to saving an immense quantity of small clingstone peaches that heretofore had been wasted. The process as described by H. Sevier, foreman of the University Farm at Davis, California, is as follows: Cut several circles around the peach at right angles to each other and allow the pit to remain within. The peaches are then laid on trays, sprinkled with water, put in the sulphur house and sulphured very thoroughly. They are then put in the sun to dry and will dry down from three pounds fresh to one dry. In preparing the peaches for eating they are soaked until they attain normal size and the slits close up.

The State Department of Agriculture of California, which is being kept busy enforcing the new California fresh fruit standardization law, gives three reasons for the absolute enforcement of the law that are well worth remembering. They are:

1. Protection to the grower, who has properly cared for his orchard, and therefore has a first grade fruit to market.
2. Protection to the grower or dealer who is establishing a reputation for handling a clean product honestly packed.
3. Assurance to the consumer of receiving a standard product.

The Pomona Valley Dehydrating company, which is now in full operation, is said to bear the distinction of having the first commercial dehydrating plant for wine grapes in the United States, or in the world, according to S. A. Burrows, its inventor. At the end of the first day's run the plant had handled 10 tons of wine grapes, half of which would have been absolutely useless for any other purpose because of their overripe and broken condition, due to rainy weather.

Bean Spray Pumps

have always been

dependable

—always efficient

—always durable

—always economical

They represent today more than ever before the grower's surest means to a better crop and resultant better profits. Our catalog recites many reasons why "The Bean is the Best."

Learn about these and other Bean features:

- Bean Pressure Regulator**
- Bean Threadless Ball Valves**
- Bean Porcelain Lined Cylinders**

Our new Simplicity Sprayers are now ready. Ask about them! Mail the coupon today!

Bean Spray Pump Co.

118 West Julian Street, San Jose, California
19 Hosmer Street, Lansing, Michigan

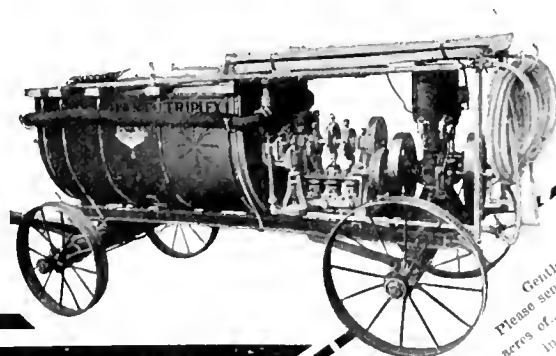

CLIP AND MAIL

Gentlemen: **BEAN SPRAY PUMP CO.**
 Please send me a copy of your catalog. I have
 118 W. Julian St., San Jose, Cal.
 in Hand Pumps. I am especially interested
 Accessories. Power Sprayers.

NAME.....
 ADDRESS.....

Near Portersville there is a 4-acre Lisbon lemon orchard, which was set out in 1907, with trees all grown from buds from one productive parent tree, according to the Weekly Bulletin, of the State Department of Agriculture. Mr. A. D. Shamel, who recently examined this orchard says that not one off-strain tree was found, whereas in neighboring Lisbon lemon orchards, where no bud selection based on performance records and intimate tree knowledge had been practiced in propagation, it was found that from 10 to 70 per cent of the trees were of variable or off-type strains.

D. B. Mackie, field entomologist, office of pest control of the State Department of Agriculture has successfully solved the problem of destroying date storage pests which caused a big loss to date growers. The treatment consists in fumigating the dates under vacuum with carbon bisulphide. This is a new method of fumigation which was originally worked out by him for controlling tobacco pests in the Philippine Islands. By this method all eggs, larvae, pupae and adults are killed by one to two hours fumigation utilizing a twenty-six inch vacuum. Two fumigators, each with a daily capacity of over two tons of dates, are already installed and operating successfully in the Coachella valley. The California Date Association and Mr. A. W. Risher are the growers who will thus protect their pack. Not only are these two machines the first ever used for fumigating dates under this method, but this is perhaps the first commercial use of carbon bisulphide under vacuum in the United States.

European buyers have contracted for practically the entire output of California fruit canneries this year, say fruit dealers and canners of this section. The canneries are having a record year, giving higher prices, employing more help and paying better wages than ever before.

The California State Department of Agriculture gives this explanation of the motive power of jumping oak galls: Many inquiries have been received concerning the cause of the "jumping gall" of the oak tree. By opening the galls, they will be found to contain a worm or larva of a fly (*Cynips saltatrix*), one of the "gall flies." It is of interest that these same "jumping galls" are humorously described in "The Comic Almanack," illustrated by the famous Cruikshank, and published in London in 1835. The "jumping gall" is an illustration of the motive power that produces the "jump" in the "Mexican jumping bean."

Advocates a Natural Brace for Orchard Trees

Written for Better Fruit by a Washington Orchardist

(EDITOR'S NOTE—The following article is presented to the readers of BETTER FRUIT on account of the novelty of the idea, and also because it presents an interesting phase of tree grafting. The use of this natural brace is said to have been employed quite extensively in the Pajaro Valley, California, where it worked out successfully. The writer of this article, in a letter to the editor, says that he has employed it on all trees in his own orchard, and that his neighbor has done likewise. The process may not appeal very strongly to the average practical orchardist, but we believe that he will be interested in knowing of the experiment.)

THERE is scarcely any incident so provoking to the owner of an orchard as the breaking or splitting down of some favorite tree and yet this is a fairly common occurrence in a great many orchards. One reason for it, is the abandonment of the central leader tree in modern pruning, and some fruitgrowers have, in disgust, gone back to the central leader type to insure themselves from loss of limbs, crop and temper. However, the advantages of the open center type of tree are so evident that strenuous efforts have been made by the large majority to keep the open center tree and avoid the loss from breakage by more careful pruning, when the trees are young, and in the formative stage, and by judicious thinning of the crop after they have begun to bear heavily. These efforts have helped wonderfully, but, in spite of all that can be done, we find trees propped up with joist and scantling to save them from the utter ruin which even then occasionally overtakes them.

In the Pajaro Valley of California, peopled largely by immigrants from Southern Europe, a system of bracing trees is used which is, at the same time, simple, inexpensive and effective. Occasionally it may be found in

orchards in Oregon and Washington, though seldom, if ever, on a large scale. Why it is not used more extensively is hard to understand. For want of a better name this brace, or support, might be called the natural brace.

When the tree is young there are many shoots and tender branches growing from the scaffold limbs to-



1. A brace just made on a young Jonathan tree.

ward the center of the tree. Instead of immediately pruning out all of these shoots, they can be made the future life preserver by thrusting tightly together two which grow parallel to each other, from opposite main limbs, repeating the process with other limbs, where it may seem necessary or desirable. Two branches kept in close contact, will after a time, grow together, and when the union is finally secure, the opposite scaffold limbs are held together by a live wood coupling which will last as long as the tree lasts—providing no young George Washington is allowed to try his new hatchet on it—and cannot pull apart, as the strain is not across the grain, but wholly longitudinal. Each main limb supports the weight of its opposite fellow and splitting at the points where each joins the trunk is impossible.

While the natural brace can be easily formed at almost any time from the second to the fifth year, the sooner it is done, the better, so that the young branches may have plenty of time to knit firmly together. Because of the lack of material to work with, it cannot be done before the end of the second year's growth and sometimes not until the end of the third summer. If possible to avoid doing so, it should not be left later than this. The young shoots should have time to knit and grow strong before any considerable strain is placed on them which would, in most cases, be when they are five years old. One year should be sufficient to start the knitting, or growing together process, if the shoots are twisted tightly, so that there are several points of close contact, and

Illustrated With
Color Photographs

LILLY'S
Established 1885

Our 1920 Seed Catalog

Is the Finest Western American Seed Book

- BECAUSE it tells of the seeds—specially selected and grown—to suit the climatic and soil conditions of the Northwest.
- ITS PAGES are living tributes to the years of unceasing labor spent in the selection of the "Best Seeds for the West."
- IT CONTAINS over 300 photo engravings (including four beautiful color illustrations) showing actual results from LILLY'S Seeds.

LILLY'S
Established 1885

Get Your
Copy Today

The Chas. H. Lilly Co.
Seattle

each succeeding year will strengthen the union considerably.

The late fall seems to be, as a rule, the best time of year for the work, as the leaves have fallen, enabling the operator to see his work plainly and twist the branches more tightly than would be possible in the summer time without stripping the leaves. While early spring might also, for many reasons prove convenient, the shoots are more pliable in the fall and therefore easier to handle. Moreover, after the middle of November there is usually less to do than in the spring with its pruning, early spraying, and possibly, ploughing.

It is very easy to make the natural brace on some varieties and much harder, though seldom, if ever impossible on others. The Jonathan apple, for example, nearly always provides a multiplicity of suitable raw material, growing almost at right angles from the main limbs and in just the right direction. They are usually of good length and very pliable. Yellow Belleflower, Spitzenburg, Black Twig and White Winter Pearmain offer few difficulties, but the Rome Beauty is frequently inclined to be obstinate. Each variety will present certain peculiarities, which must be dealt with as they are encountered. Sometimes, when the twigs are short, it becomes necessary to tie the twists in place with soft twine, but, when this is done, the strings should be removed within the year, or before they begin to cut into the bark. In most cases it will be found that the twists, if properly made, will hold themselves without tying.

Cost is a very important item to the orchardist, particularly in these days of heavy initial investments and for

largely on the varieties. This gives an average cost in labor, which is also the total cost, of about a cent per tree and that it will save many a dollar and considerable disregard of the third commandment, no intelligent orchardist will doubt. Like fire insurance, it

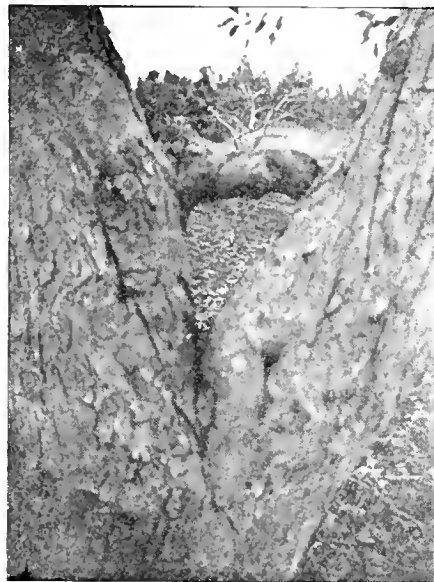

3. The natural brace on a mature apple tree.

not only provides safety from loss, but it makes the owner feel safe, which every fruit grower will appreciate, codling moth, scab and blight bringing enough gray hairs to his head.

The brace cannot be broken by any strain that it will be called upon to bear; it will grow stronger each year and as long as the tree lasts, the natural brace will be on hand doing its work without additional expense for upkeep or renewal. It is well worth a trial.



2. Brace a year old on a four-year-old Jonathan tree.

that reason the natural brace will appeal to most growers. Whereas methods sometimes used of wiring the scaffold limbs together, need tools, wire, screweyes and considerable labor; making the natural brace calls only for labor and very little of that. Any man with a little practice should be able to handle two hundred trees in a ten-hour day and a fast worker three hundred or more, depending

With the Beekeepers

Bees are a profitable crop, according to a report by Roy Gilbert, a Tieton, Wash., farmer. Gilbert says that in 1910 he obtained a hive of bees which was swarming while engaged in cutting wood in Tieton. From this he developed 150 stands, which this year yielded honey worth \$2600. They are altogether a side issue on his place.

An organization of Inland Empire apiarists to be known as the Inland Empire Beekeepers' Association, and to hold its first meeting in Spokane the early part of next February, is recommended in the report of the executive committee of the Northern Idaho Beekeepers' Association.

National Apple Day

November 6 was observed in Washington as national apple day and every one of 500 sick and wounded soldiers in the hospitals of that state of Washington received a gift of a couple of dozen of the finest Delicious, Jonathan, Grimes Golden and Spitzenburg apples, with the best wishes of the apple growers and shippers of the Wenatchee and Yakima valleys. The idea of remembering the soldiers on apple day originated two years ago, when the International Apple Shippers' Association sent several carloads overseas, enough to give every man in the service there two or three apples.

The recent freeze in the Northwest has taught apple growers a much needed lesson, namely the necessity of erecting additional packing plants and warehouses. This precaution against future frost damage ought to be speeded up the coming winter and next summer to a maximum of unbroken and continuous work.—Fruit Trade Journal.

G. L. Davenport
Grower and Shipper
MOSIER, OREGON
—
MAIN OFFICE
147 Front Street, PORTLAND, OREGON

DAHLIAS
World's Best Prize-winning
Latest of the new kinds and the best of the old
Catalogue Free
H. G. NEY
E. 614-31st St. - Spokane, Wash.

WANTED
to rent or lease farm with improvements in Western Washington or Willamette Valley by party having both practical experience and technical training. Best of references furnished.
Address REM, Care of Better Fruit

BELL & CO.
Incorporated
WHOLESALE
Fruits and Produce
110-112-114 Front Street
PORTLAND, OREGON
Write us what you have to offer — Car lots or less

APPLES - PEARS
Whole root stock that will give results
Send for Price-list No. 10
Trees - Shrubs - Vines - Plants
J. B. PILKINGTON
NURSERYMAN
Portland Oregon

The Use of Fillers in An Apple Orchard

By N. D. Peacock, Horticultural Instructor, University of Georgia

THE average man is impatient. He wants to see the results from his work at once, or he is not satisfied. It is exactly this that has prevented many men from starting an apple orchard. In all probability that has been a good thing for the industry because it has kept the kind of men who would have become discouraged and given up at the first disappointment from starting at all.

To set an orchard and care for it for seven or eight years, or perhaps even longer, without any financial return requires considerable patience and perseverance, as well as a large amount of capital. In order to reduce this long wait as long as possible two systems have been developed. One of these is a system of intercrops, that is, some cash crop is grown between the trees while they are young. The other is a system of fillers. By fillers we mean trees which are planted temporarily between the permanent ones in the orchard. These trees are varieties, such as Yellow Transparent or Wealthy, which come into bearing early and are rather short-lived, the intention being to cut them out when they begin to crowd the permanent trees. Very frequently a combination of these two systems is worked out successfully, and the orchard made to

pay for itself during its period of growth.

The planting of fillers in an orchard has given very satisfactory results in some cases, while in others it has proved to be very harmful. The cases where unsatisfactory results were obtained should not be held entirely against the system itself, because they have usually followed failure to remove the temporary trees, when the proper time came, as was recommended. It is very easy to talk about allowing the fillers to remain in the orchard just a certain number of years, but it is quite a different thing actually to cut them out when the time comes. In all probability at that time the temporary trees will be bearing very profitable crops while the permanent ones will only just be coming into bearing. Therefore, removing the fillers will be cutting off the source of income, necessitating another wait of a year or two. Such a practice is decidedly against human nature and requires considerable self-control. Thus we may say that the question, whether or not you should plant fillers resolves itself into the question: How much have you? If you are very sure that you will give the permanent trees first place in your consideration, and cut out the fillers when they begin to crowd, then the

plan can be made profitable and can be recommended to you personally.

Under most conditions it is best to use the same kind of trees for fillers as are used for the permanent ones. That is, use apple fillers for an apple orchard, and peach fillers for a peach orchard. The reason for this is that if a different kind of temporary tree is used, times will occur when methods of care needed by the fillers will be worthless, or perhaps harmful to the permanent trees. At such times it is a great temptation to care for the fillers and neglect the others because the fillers are producing your income. For example, if peach trees are used as fillers in an apple orchard, they may suffer from winter injury at some time and be weakened in vitality while the apple trees are uninjured. In that case the peach trees would require a heavy application of fertilizer in order to enable them to mature the crop properly. The apples, on the other hand, perhaps were just coming into bearing; and, should the fertilizer be applied, they would at once stop bearing and begin an extravagant production of wood, which would delay fruiting several years. Evidently the fertilizer should not be applied in such case, even though the peach crop suffered.

I have said that generally the apple fillers should be used in an apple orchard, but there are many exceptions to every rule, and in this case there are many men who have made marked success with peach fillers in an apple orchard. Their success with that system is due to the fact that they held the welfare of their permanent trees uppermost in their minds and arranged their cultural practices accordingly.

Very probably a person who has nerve enough to cut out the fillers when they begin to interfere with the permanent trees will also have foresight enough not to injure his future prospects for the sake of a little present gain. For such a man the system may be highly recommended as a means to reduce the cost of growing an orchard; but for any other person it is a very dangerous system.

Apple Packing Record Broken

Mid-Columbia apple packing records were broken recently by Miss Pearl Saltzman. In four hours and 40 minutes she packed 140 boxes of fruit, more than the average packer will prepare in a day.

Churches Were Full of Apples

Hood River churches were recently bulging with apples. All edifices in which regular services were not being held were secured for storing Newtowns. In other churches the basements are filled with fruit. All available space in local business houses has been requisitioned for apple storage.

Are You the Man?

*If so, BETTER FRUIT offers you
a chance to make good money*

We want a representative in every fruit-growing community. In every such community there is some individual with a little time each month to spare, who, by representing BETTER FRUIT, can make a good income.

Perhaps it will be an elderly man?

A young fruit-grower just getting started?

A wife who wants to help out?

An ambitious boy or girl who wants to make extra money?

We want someone in *your* community to become our *permanent* representative—to secure new subscriptions for us and renew old ones.

We want two or three representatives in the Hood River Valley. Several in Yakima and Wenatchee—in the Willamette Valley, Rogue River, etc. In fact we want *permanent* representatives in every fruit district of the West.

Our proposition is a good one. Are you the man or woman for the job?

Write today, stating your qualifications.

BETTER FRUIT PUBLISHING COMPANY

OREGONIAN BUILDING, PORTLAND, OREGON

Harvesting Shows Increase in Apple Crop

The commercial apple crop of the United States is now estimated at 24,416,000 barrels, by the Bureau of Crop Estimates through its fruit crop specialists. This estimate is based on conditions as of November 1, and shows an increase of 1,239,000 barrels as compared to the October estimate of 23,177,000 barrels, or a decrease of 308,000 barrels from the 1918 crop.

The salient feature of this report is the large increase in the crop throughout the West, notwithstanding a severe freeze the latter part of October in Washington and Oregon, which reduced the total tonnage by approximately 1,000 cars. The production for all the Western states, with the exception of Utah, is far exceeding all former estimates. It is now estimated that these states will produce 32,478,000 boxes, or an increase of 2,943,000 boxes over the October estimate.

The barrel apple states show an increase of 258,000 barrels over the October report, and are now estimated at 13,590,000 barrels. Slight increases are noted in New England States, New

York, Virginia, Missouri, and a decided increase in Arkansas. The Arkansas crop being the largest in the history of commercial apple growing in that state.

PER CENT OF CROP IN GROWERS' HANDS.
(See note below.)

State.	Per cent.
Main	28
New Hampshire	32
Vermont	30
Massachusetts	36
Rhode Island	57
Connecticut	53
New York	27
New Jersey	38
Pennsylvania	27
Delaware	10
Maryland	23
Virginia	28
West Virginia	21
North Carolina	13
Georgia	27
Ohio	26
Indiana	12
Illinois	12
Michigan	13
Wisconsin	18
Minnesota	14
Iowa	21
Missouri	21
Nebraska	12
Kansas	15
Kentucky	14
Tennessee	15
Oklahoma	19
Arkansas	19
Montana	25
Colorado	20
New Mexico	12
Arizona	39
Utah	28
Idaho	31
Washington	23
Oregon	52
California	28

These estimates are based on answers to the following question asked the growers the last week of October: "What per cent of the crop is still in the hands of the grower?"

Berry Plants Wanted

Loganberry, Burbank Phenomenal, New Oregon Strawberry and Cuthbert Raspberry. Must be True-to-Name Plants.

Write "M. J. M." care Better Fruit, Portland, Oregon



SULPHUR

It has been proven and so recommended by the University of California that if you sulphur your grape vines and orchards 6 times they will not be affected by MILDEW or RED SPIDERS.

ANCHOR Brand Velvet Flowers of Sulphur, also EAGLE Brand, Fleur de Soufre, packed in double sacks, are the fluffiest and PUREST sulphurs that money can buy; the best for vineyards; the best for bleaching purposes, LEAVING NO ASH.

VENTILATED Sublimed Sulphur—Impalpable Powder, 100% pure, in double sacks, for Dry Dusting and making Paste—Sulphur.

For LIME-SULPHUR SOLUTION, use our DIAMOND "S" BRAND REFINED FLOUR SULPHUR.

To create additional available plant food, drill into the soil 100 to 400 pounds per acre DIAMOND "S" BRAND POWDERED SULPHUR, 100% pure. This has increased various crops up to 500%. The sulphur may be applied broadcast by hand or with a duster, but usually an ordinary land plaster sower or lime spreader is used.

Also PREPARED DRY DUSTING MATERIALS, Tobacco Dust, Dry Bordeaux, Dusting Sulphur Mixtures, etc.

And Standard LIME-SULPHUR SOLUTION 33° BE. Fungicid. and Insecticid.

Carried in stock and mixed to order.

San Francisco Sulphur Co.
624 California St. San Francisco, Cal.

We are equipped to make immediate shipments. Send for "ILLUSTRATED BOOKLET"; also booklet "NEW USES FOR SULPHUR," Price-list, and Samples.

Please state for what purpose you use the sulphur, quantity needed, and date of shipment preferred.

ORCHARD MAN

and all around farmer soon open for engagement. Can take full charge. Thoroughly experienced. Used to best places.

Address W. care of Better Fruit

FARM MANURE

Stock manure is valuable for the organic matter and the Nitrogen, Phosphoric Acid and Potash it carries. It is valuable and in all crops absolutely necessary in some form for their continuous production at a profit.

"MARPROCO" Brands of FERTILIZER, including

"Puyallup Brand" Berry Fertilizer "Clarkes Wenatchee" Orchard Dressing

represent a natural animal manure multiplied MANY TIMES as to the constituent elements of plant food.

MANURE is good in England, in Maine, in Washington and Oregon—this accounts for the success in Dollars and Cents Profits to the grower from the use of PUYALLUP BRAND BERRY FERTILIZER amongst members of Puyallup and Summer Fruit Associations in Puyallup Valley and the corresponding success of W. H. STRONG, at Gresham, Oregon, who writes: "Mr. Hall, the County Agent, agrees with me that my yield was increased one ton to the acre, or a profit of \$300 per acre on fertilizing of berries."

We offer NITRATE OF SODA which we import, February deliveries, but care must be taken in the use of this fertilizer. NITRATE OF SODA unduly influences unnaturally early blossoming, makes some of the Willamette Valley soils gummy and non-porous and delays the ripening. It is not a complete fruit developer and should be used only to stimulate old, run-down orchards where legumes and manure are to be added.

COMPLETE ORGANIC FERTILIZERS

on the other hand, build humus and promote development of micro-organic life in a natural way, and are potentially rich in plant food.

Marine Products Company, Incorporated

TACOMA, WN., U. S. A.

Principal Importers and Exporters of Aquatic and Animal By-Products
Manufacturers of Commercial Manures

FARMERS' NOTE: See principal dealer, all Northwestern cities, or write or wire for our experts. Now booking car lots in Oregon, Washington and Canada. A representative is undoubtedly close to your farm now. See the picture story of actual results. On request of commercial clubs, farmers' organizations, agricultural agents, or colleges, Major E. P. Newsom will deliver his own and National Soil Improvement Committee's lectures on soil fertility. He is a brilliant speaker, nationally known, who has a thorough mastery of his subject.

DEALERS, WIRE FOR TERRITORY

PRIZE APPLES PACKED ON BURRO

Forty miles on a burro's back is the record of the prize-winning plate of Gano apples from Greenlee County at the recent State Fair at Phoenix. Thomas McCulloch grew these apples on his snug little ranch on Eagle Creek,

40 miles from Clifton. The only way he could get them to the fair was to load them onto a pack saddle on a burro's back and move them over the mountain trail to Clifton. From there they went by rail to the County Fair at Duncan, where the horticultural

judge, Prof. A. F. Kinnison, decorated their rosy cheeks with a prize ribbon of blue. From here they journeyed by rail several hundred miles further to the State Fair at Phoenix, where Prof. Sanster, the horticultural judge from Colorado, placed again upon them the blue ribbon of first merit.

Things to Look For—

WHEN you buy a tractor, use just as much care in making your selection as you would in buying a good horse. Don't take anyone's word for its being good—find out for yourself. Be sure that the tractor you buy has all the features essential to all-around service, efficiency, and economy of operation. For instance, look for—

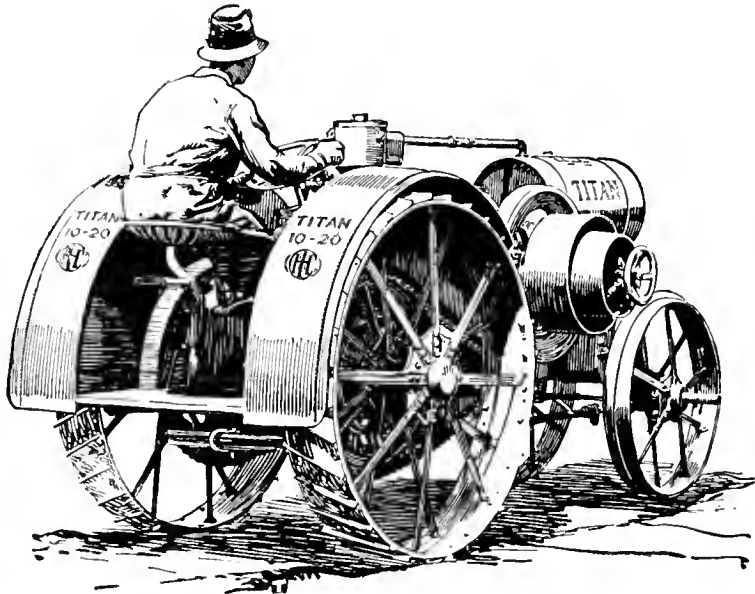

A **kerosene engine** so that you can use cheap fuel, thereby doing your power work at the lowest possible cost;

A **throttle governor** to regulate the fuel to the load variations, insuring uniform speed and fuel economy and saving one man's time when engaged in belt work;

A **drawbar** with a wide range of adjustment both ways so that the tractor will pull any machine or implement on the farm with equal advantage;

A **friction clutch pulley** with a wide face and broad diameter to insure full power-delivery to the driven machine—a pulley so placed that the belt doesn't rub or drag;

Wide, full-length fenders over the drive wheels to protect the operator and engine from dirt and mud. Also a "safety first" feature;

A **rear platform** so that the operator can rest himself occasionally by standing up without losing time from his work.

You will find these and a number of other excellent features on the **Titan 10-20** tractor.



Dependable Plowing Power



Efficient Belt Power

If you need a larger tractor just bear in mind the International 15-30—50% more power than the 10-20—and it's a kerosene burner. Write for pamphlet descriptive of the tractor best suited to your needs.

International Harvester Company of America

(Incorporated)

Billings, Mont. Crawford, Neb. Denver, Colo. Helena, Mont.
 Los Angeles, Cal. Portland, Ore. Salt Lake City, Utah
 San Francisco, Cal. Spokane, Wash.



KAOLA MEAL

The Great Food For Stock and Poultry

That Has Increased Profits 53%

Here is a wonderful fat food for milch cows, calves, pigs, poultry, sheep and horses that expert stockmen have used for 20 years.

The great butter and cheese exporting countries of Europe, Denmark, Holland and Switzerland, have been its largest consumers because it was easily procured and largely increased there production and resulting profits.

Now you can get it in the form of Kaola Meal to help you make more money.

Increased net profits from butter fat and skim milk amounting to 53 per cent have been recorded in tests made by unprejudiced dairymen.

Its great value lies in its comparatively high fat content. Kaola Meal containing a higher percentage of digestible fat than even linseed oil meal.

But remember, Kaola Meal is not a laxative. It is simply a well-balanced food rich in carbohydrates and protein as well as fat. Feed it in the proportion of 10 to 25 per cent of your other grain foods.

Kaola Meal is made from the pure white meat of cocoanuts after the commercial oil has been extracted. The remaining oil and the coconut meal, as we offer them to you, makes one of the finest foods for stock and poultry that any breeder knows.

Try it and see. Ask your dealer for it.

We have just completed a new book full of scientific facts on cattle, hog and poultry feeding. It's free. Write us for it. It tells you how the European farmer has gained high yields with this profit food. Clip the coupon now.

Analysis as follows: Protein 16.02%; fat 7.18%; carbohydrates 63.50%; ash 5%.



Palmolive Company

Address Department 72
Portland, Oregon

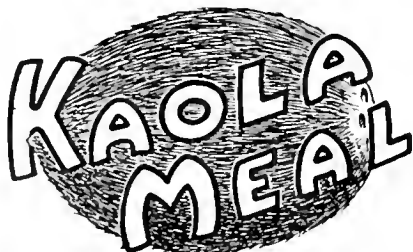

Look for this Mark on the Bag

Cut This Out As A Memo
A Reminder:

to write to the Palmolive Company for the booklet about Kaola Meal, and get a trial supply from my retailer.

Topworking Inferior Orchards

Continued from page 12.

chard work. The timber and spring adjoining the cultivated land make an attractive pasture proposition.

As to varieties, we have Liveland Raspberry for early, Maiden Blush and Wilson Red June or Mammoth June for mid-summer, Jonathan and Grimes for late summer, and Stayman, Wine-sap, Delicious and a few King David

for fall. Only about 75 Ben Davis and Gano remain.

The grafting has rejuvenated the stunted trees and will shortly bring them to bearing high quality fruit. The young trees are coming on rapidly and in a few years we hope to have an orchard fairly even in appearance and bearing profitable crops of fruit. The acreage is small, but we hope to offset this by having time to make every tree

do its duty. Already the orchard is responding to good treatment and some trees have needed a few props to help them bear their load.

Nice Bright Western Pine
FRUIT BOXES

AND CRATES

Good standard grades. Well made. Quick shipments.
Carloads or less. Get our prices.

Western Pine Box Sales Co.
SPOKANE, WASH.

6% loans to farmers!

Do you want money on a *non-maturing mortgage* for a term of 5 to 40 years? Do you want to re-finance your present mortgage? increase your land holdings? buy additional equipment or live stock?

The farmers, horticulturists and stock-owners of California and Oregon may now obtain 6% loans ranging in amounts up to \$37,500. This has been made possible thru the recent organization of the California Joint Stock Land Bank of San Francisco.

Loans made by this bank may be paid off any time after five years—and the borrower may enjoy the unusual privilege of taking 40 years to repay his loan in installments.

The loans are made under the supervision of the United States Government.

Important Features

1. No limitations or special conditions as to how money borrowed shall be used.
2. The mortgage never becomes due. You pay no renewal expenses.
3. Payments may be extended over a period of 40 years.
4. The land may be sold subject to the mortgage.
5. The borrower pays no commission. We loan *direct* to farmers. Loan made up to 50% of appraised value of the land, and 20% of the insurable improvements.
6. Positively no red tape of any kind.
7. The best and broadest type of service ever extended to farmers.

Officers

A. P. Giannini, President (President, Bank of Italy)
P. C. Hale, Vice-President (Pres. Hale Bros. Inc., San Francisco, Oakland and Sacramento)

A. W. Hendrick, Cashier (Formerly Sec'y Federal Land Bank, Berkeley, Calif.)
E. C. Aldwell, Sec'y Treasurer.

Write for further information. Address all letters to



California Joint Stock Land Bank

• CAPITAL \$ 250,000 •
OFFICES IN BANK OF ITALY BUILDING
• SAN FRANCISCO •

Bits About Fruit, Fruitmen and Fruit Growing

Gerald Da Costa, of London, who has been receiving Hood River apples for sale in England for the past nine years writes BETTER FRUIT that the market for Pacific Northwest fruits is ruling high at the present time. Mr. Da Costa says that two cars of California Comice pears in half boxes recently sold in London for 20 to 21 shillings a box, and that a car of D'Anjou pears from the Rogue River valley sold for 32 to 36 shillings per box. Oregon Newtowns, according to Mr. Da Costa are expected to bring around 20 shillings a box.

J. A. Campbell, assistant director of the horticultural division, Department of Horticulture, of Wellington, New Zealand, was an interesting visitor at the office of BETTER FRUIT recently. Mr. Campbell was in the Northwest studying the methods in use by fruitgrowers, and frankly stated that the Australian states expected to become keen competitors of the Pacific Northwest in the European fruit markets, and also to make an attempt to establish markets for fruit in the United States.

Tasmania recently shipped 40,000 cases of jam to this country, and it is reported that other shipments will follow.

Two large bears were recently killed in a Hood River orchard. The animals had been feeding on the fruit for some time, causing considerable destruction to the trees.

Of the 2,000,000 boxes of apples shipped out of the Hood River valley this year, it is estimated that 1,900,000 of them were hauled to the valley shipping points in motor trucks.

The California Walnut Growers' Association sold 23,000 tons of walnuts within 36 hours after the opening prices were announced, and within three days had to decline orders aggregating 93 carloads more, despite heavy importations of nuts from abroad. The association put on a nationwide advertising campaign through the national journals to reach the consumer.

According to historical data which is said to have recently come to light, the first apple harvest in the United States took place on Governor's Island in Boston Bay. The document states that on October 10, 1639, ten fair pippins were picked and brought to Boston. If latter day slang has been prevalent in those days there would be some doubt as to whether this statement referred to apples or damsons. In view of the straight-laced methods of both conduct and speech at that period however, we will have to conclude that it was apples that were picked.



THE refreshment tray can always thank Ghirardelli's Ground Chocolate for its magic aid. Creamy hot chocolate to drink; cakes with possibly a chocolate filling and frosting; waxy squares of chocolate fudge—not to mention countless other "goodies"—appear in a twinkling when the hostess summons the ever-ready can of Ghirardelli's.

Never sold in bulk—but in cans only.
In ½ lb., 1 lb. and 3 lb. sealed cans—
at the store where you do your trading.

Say "Gear-ar-delly"
D. GHIRARDELLI CO. San Francisco
Since 1852 (F2)

GHIRARDELLI'S Ground Chocolate



TRAP FURS for Stephens

Your Chance Now to MAKE BIG MONEY

Stephens' New Trappers' Book tells you how. Coyotes, Muskrats, Skunks, Wild Cats and all other Western Furs are selling in Denver this year at the highest prices ever paid.

DENVER COLORADO is the Closest and Best Market on earth for Western Trappers and Fur Shippers. Stephens of Denver is the largest exclusive buyer of Western Raw Furs in the world.

STEPHENS charges you no commission—saves you 50c to \$10 on express or parcel post and you get your money 2 to 10 days quicker—because Denver is closer to your town than any other Important Fur Center.

TRAPS AT FACTORY PRICES. Stephens sells Traps, Animal Baits and all trappers' supplies at rock bottom prices. Write today for Big, Illustrated Trap Catalog, Trappers' Guide, Fur Price List and Shipping Tags—ALL FREE AND POSTPAID.

E. A. Stephens & Co.
161 Stephens Bldg.
DENVER, COLORADO, U. S. A.

Trappers Guide free.

Orchard Cultivation
Is simple and easy with an
O. K. CHAMPION TILLER

It reaches in under the low branches and stirs all of the soil Right Up To The Tree Trunks without damaging the boughs or fruit.

Further Information Cheerfully Given.
CHAMPION POTATO MACHINERY CO., Dept. 14 Hammond, Ind.



<p>MUSICAL MERCHANDISE</p> <p>WRITE US</p>	<p>WE SAVE YOU MONEY!</p> <p>W. Martius Music House Inc.</p> <p>1009 First Avenue, Seattle, Washington</p> <p>Everything Known in Music</p>	<p>SHEET MUSIC</p> <p>WRITE US</p>
--	---	------------------------------------



Tom, Tom the piper's son,
Stole a box and away he run;
The box was strong--of B. D. make--
Tom fell down and broke his pate,
Not a creak nor a groan,
Not a sigh nor a moan,
Came from that box
With all those Knox.

Strong boxes, carefully inspected, promptly delivered.

That's the kind from the

BLOEDEL DONOVAN LUMBER MILLS
1018 WHITE BUILDING
SEATTLE, U. S. A.



FOR THE HOME GARAGE

A 15-gallon black steel barrel of Zerolene affords the greatest economy and convenience in the use of correct lubrication. Takes up little room. Consult your dealer or our nearest agency today. Get a Correct Lubrication Chart for your car.

STANDARD OIL COMPANY
(California)

DEPENDABLE TREES

Planters, it is time to order your Fruit, Shade and Nut Trees, Berry Plants, Shrubbery, Roses, etc., for fall or spring planting. Send for our large illustrated catalogue from which to select your list; it only costs you 5 cents in stamps for postage. Our trees are mighty fine, but we haven't enough. If you WANT trees, don't delay ordering.

OREGON NURSERY COMPANY
ORENCO, OREGON

Cannery Notes

The new fruit dryer and processing plant at Selah, Wash., has been handling a heavy tonnage. During the season from 40 to 50 tons of green fruit passed through it daily. The supply of fruit was so great, however, that storage had to be provided until it could be processed.

In three weeks after the work of building the new plant of the Washington Dehydrated Food company, at Grandview, was started at Grandview, Wash., the plant was completed and commenced to receive fruit. The capacity of the plant, which was sufficient at the start to turn out 15 tons of raw material daily is being increased.

The Libby, McNeil & Libby canning plant at Yakima, Wash., recently started canning apples and pumpkins, having completed the run on pears. Over 1800 tons of pears were canned, and the plant will put up 1000 tons of pumpkin and 4000 tons of apples.

The Rupert Canning company, which has two plants in Oregon, had a successful season. The Rupert company makes a specialty of putting out its product under an Oregon brand.

The cooperative cannery of the Eugene Fruit Growers' Association, which recently completed an addition to its plant, is now doing \$1,000,000 worth of business a year. J. O. Holt, manager of the association, who also handles the canning plant is one of the most successful cannery men in the Northwest. Besides operating the cannery the association conducts a processing plant, vinegar works, prune dryer and spray-making establishment.

Canned fruits of the temperate zones, such as peaches, pears, cherries, and plums, will find a ready sale throughout Brazil, according to a report of the American Consul in Charge at Rio de Janeiro. Tropical and subtropical fruits—bananas, oranges, pineapples, and guavas—furnish suitable material in unlimited quantities for jams and jellies, so that no large market in Brazil for American jams and jellies can be established. Either tin or glass containers may be used. The goods should be packed in strong wooden cases, which should be strapped with wire. If glass containers are used, they should be well packed in straw or sawdust in order to reduce to a minimum the breakage caused by rough handling. Pilfering during transit should be guarded against by strapping the cases.

BEES

PAY. Easy, interesting work, with honey for home use. Send 50c today for 24-page Bee Primer and six months subscription to the American Bee Journal. Catalogs of supplies sent free.

American Bee Journal

Box 36

HAMILTON, ILLINOIS

MYERS HONOR-BILL SPRAY PUMPS

Get a Myers Pump--- Hand or Power---and begin spraying Myers Way now

The many patented Myers features make spraying, painting or disinfecting easier, quicker and more thorough Hand Pumps with easy operating Cog Gear heads and Power Pumps with automatic control give powerful and penetrating sprays, which reach every part of leaves and blossoms Spray Guns for any power pump. Nozzles, Hose and Accessories. A Myers Outfit means better fruit and truck or field crops See your dealer or write for 64-page free catalog today

F. E. MYERS & BRO. (5)
135 Fourth St. Ashland, Ohio

PUMPS FOR EVERY PURPOSE

PACIFIC NORTHWEST DISTRIBUTORS

PORTLAND, ORE.



SPOKANE, WASH.

BUY FROM THE LOCAL MITCHELL DEALER

Checking Apple Leaf Hoppers

The apple leaf hopper, a destructive insect that occurs in nearly every state of the Union, may be materially checked by a single spraying with 40 per cent nicotine sulphate in the proportion of one to 1,500, combined with soap, according to the bureau of entomology of the United States Department of Agriculture. The solution should be applied against the first-brood nymphs. The same treatment made three or four weeks earlier is effective against the rose leaf hopper, though this species is seldom injurious enough to justify a special application.

The apple leaf hopper causes serious injury to apple nursery stock by extracting the plant juices from the terminal leaves. As a consequence the leaves gradually become undersized and fail to function normally, thereby retarding the growth of the trees. The rose leaf hopper feeds on the lower leaves and produces white or yellow spots on them.

Embargo on American Apples

The American consul general at Sydney, Australia, is in receipt of a communication from the Department of Trade and Customs of Australia, stating that the question of lifting the embargo on the importation of apples into Australia has been carefully considered, but that in view of the large stocks held at present in Australia, it has been decided not to permit importations of apples this year. Inasmuch as the market for imported apples in Australia is favorable only during the months of October, November, and December, the question of lifting the embargo in January is not of importance. Early fruit from Queensland and New South Wales is on the Australian market at that time and the prices fall rapidly. According to the Canadian Weekly Bulletin, it is the opinion of some dealers that hereafter Australian growers who have stored fruits for late markets and high prices will strongly oppose importations even in the month of October, which would leave two months only for importation from abroad.

**“Don't Cheat Yourself”
says the Good Judge**



There's nothing saved by chewing ordinary tobacco. A little chew of that good rich-tasting tobacco goes a lot farther, and its good taste lasts all the way through.

Little chew — lasting — satisfying. That's why it's a real saving to buy this class of tobacco.

THE REAL TOBACCO CHEW

put up in two styles

RIGHT CUT is a short-cut tobacco

W-B CUT is a long fine-cut tobacco

Weyman-Bruton Company, 1107 Broadway, New York City

Apples and Pears

For European Distribution



Gerald Da Costa

Long Acre, Covent Garden, London

Cables: "Geracost, London." Codes: A. B. C. 5th Edition and Private

Ridley, Houlding & Co.

COVENT GARDEN, LONDON

WE ARE

**Specialists in
Apples and Pears**

CABLE ADDRESS: BOTANIZING, LONDON

Codes: A. B. C. 5th Edition and Modern Economy

SAVES MONEY AND BACKACHE



FOLDS LIKE A POCKET KNIFE. ONE MAN with the **FOLDING SAWING MACHINE** saws down trees—saws any kind of timber on any kind of ground. One man cuts **more** timber with it than two men in any other way, and **it does it easier**. Send for free illustrated catalog No. 110 showing **Low Price** and latest improvements. In use 30 years. First order gets agency. Folding Sawing Machine Co., 161 West Harrison St., Chicago, Ill.

NOW is the time to send to
Milton Nursery Company
MILTON, OREGON
FOR THEIR 1919 CATALOG.
FULL LINE OF NURSERY STOCK.
"Genuineness and Quality"

Measurement of Irrigation Water

Continued from page 10.

average section of canal, in order to cause the water to approach the orifice very slowly.

The depth of water or head may be measured by means of carpenters' rules or by specially constructed scales like those already suggested for weirs. One scale should be placed on the upstream side of the orifice and one on the downstream side with the zero end of each scale at the same level near the top of the structure.

A complete bulletin by Mr. Israelen on this subject can be obtained from the Agricultural Experiment Station at Logan, Utah.

Nut Growers Have Good Meeting

The annual meeting of the Western Walnut Association, held in Portland, November 12 and 13, was attended by a large number of nut growers from Oregon and Washington. There was a very attractive exhibit of filberts and walnuts, and the program was an interesting one. For the fifth time J. C. Cooper, of McMinnville, was elected president of the association. The other officers for the ensuing year are: A. H. Henneman, of Portland, vice-president for Oregon; A. A. Quarnberg, of Vancouver, vice-president for Washington, and A. J. Harris, of Portland, secretary-treasurer. Mr. Harris succeeds Knight Pearcey, who has been secretary of the organization for several years, and declined to again serve in this capacity.

The winners of the \$100 cash prizes offered by M. McDonald, president of the Oregon Nursery company, for the best nuts from seedling trees for two years were John Spurgeon, Vancouver, Wash.; Henry Sexton, The Dalles, Oregon; T. H. Brooks, Silverton, Oregon; E. J. Stewart, McMinnville, Oregon, and R. E. Brown, Vancouver, Wash.

Among those who delivered addresses on nut culture were: Chas. Trunk, who spoke on "Planting the Nuts in the Orchard;" J. C. Herren, "Nursery Grafting Filberts;" J. R. De Neui, "Walnut Growing Experiences;" J. F. Langner, "The California Walnut Growers' Association;" Frank V. Brown, "Nuts in Confectionery Use;" John Norelius, "Filbert Growing;" Robert C. Paulua, "The Oregon Nut Grower;" Geo. Dorris, "Filbert Growing in the Northwest;" C. A. Reed, chief of the division of nut culture, United States Agricultural Department, "Nut Growing in the United States;" H. A. Kruse, "Pruning the Filbert;" N. F. Britt, "Growing Walnuts on Logged Off Land;" Knight Pearcey, "A Tree Agriculture for Logged Off Lands;" Fred Groner, "Drying Walnuts;" Geo. Hall, "Increasing the Consumption of Oregon Nuts;" Prof. C. I. Lewis, "Maintaining the Vigor of Nut Tree;" R. Graves, "Filbert Varieties;" J. C. Cooper, "Promising Seedlings."

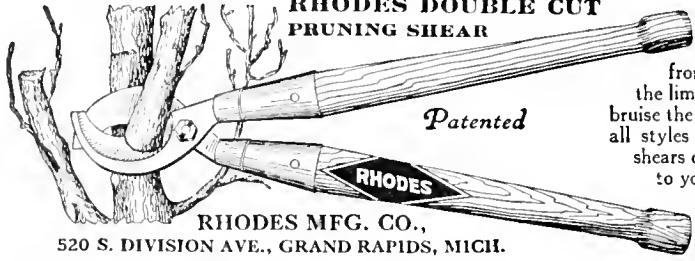

RHODES DOUBLE CUT PRUNING SHEAR

THE only pruner made that cuts from both sides of the limb and does not bruise the bark. Made in all styles and sizes. All shears delivered free to your door.

Patented

RHODES MFG. CO.,
520 S. DIVISION AVE., GRAND RAPIDS, MICH.

Write for circular and prices.



WHAT EVERY HOME CANNER SHOULD HAVE

ONE of our **H. & A. Hand Power Double Seamers**. It is the only hand power seamer built that will seal all sizes of sanitary fruit and vegetable cans. Write for prices and descriptive matter to Department T.

HENNINGER & AYES MFG. CO., Portland, Ore.
Builders of Seamers and Steam Pressure Canning Outfits

Last Big Block of the Canadian Pacific Reserved Farm Lands

THIS announces the offering of the last big block of the Canadian Pacific Reserved Farm Lands. Until this block is disposed of you can secure at low cost a farm home in Western Canada that will make you rich and independent. The country is ideal for mixed farming as well as grain growing. Later, the same lands can be bought only from private owners—and naturally, prices will be higher. Never again on the North American Continent will farm lands be offered at prices so low.

Your Last Big Opportunity

This block contains both fertile open prairie and rich park lands in the Lloydminster and Battleford Districts of Central Alberta and Saskatchewan. You can buy farm lands on the rich prairies of Manitoba, Saskatchewan and Alberta for \$11 to \$30 an acre. Or land in Southern Alberta under an irrigation system of un-failing water from \$50 an acre and up.



No Taxes on Improvements

There is a small tax on the land—seldom more than 20¢ an acre for all purposes but there are no taxes on your livestock, buildings, improvements, implements or personal effects. Good markets, modern schools, roads, churches, amusements, make farm life desirable and attractive. Here you can achieve independence.

No Sale Without Investigation

The Canadian Pacific will not sell you a farm until you have inspected it. You must be satisfied—and every question answered before taking up your home. Investigation is invited and made easy. Don't delay your investigation. This announcement calls attention to the last great block of Canadian Pacific Reserved Farm Lands.

Special Rates for Homeseekers and Full Information

Special railway rates for homeseekers make inspection easy. Send now for free illustrated pamphlets answering all questions and setting forth figures about land values, acreage yields, climate, opportunities, etc. Do not delay. Send coupon below for information.

Lands Under Irrigation

In Southern Alberta, the Canadian Pacific Railway has developed the largest individual irrigation undertaking on the American Continent. This district contains some of the best lands in Canada. An un-failing supply of water is administered under the Canadian Government. Prices range from \$50 an acre up on the same easy payment terms.

M. E. THORNTON
Supt. of Colonization
Canadian Pacific Railway
960 First Street, E., Calgary, Alberta

M. E. THORNTON, Supt. of Colonization
CANADIAN PACIFIC RY.,
960 First St., E., Calgary, Alberta
I would be interested in learning more about:

- Irrigation farming in Sunny Alberta.
- Farm opportunities in Alberta, Saskatchewan and Manitoba.
- Special railway rates for homeseekers
- Business and industrial opportunities in Western Canada.
- Two lots in growing Western towns.

My name

Address

Town

State

For full information about Canada, ask the C.P.R.

Increasing Bush Fruits

Continued from page 5.

true in canning and is equally not true in the whole-fruit preserves in glass.

In the black raspberry the Munger variety appears to do the best in the canneries of the Pacific Northwest, therefore, the grower should produce the black raspberry that the canner desires to purchase.

In the loganberries, it doesn't make any difference to the manufacturer of loganberry juice whether it is the loganberry or the phenomenal berry, but from a canning standpoint the larger the berry the more satisfied the consumer. Inasmuch as the phenomenal berry is very much larger than the loganberry and of equally good quality, it would be advisable to set out a portion of the new plantings of phenomenals and a portion of loganberries, in fact, the variety to plant depends entirely upon the adaptability of the berry to the particular soil that

you are using. The phenomenal berry is a little more tender in some places than in others, but it is not advisable to undertake to plant too great an acreage of phenomenals without having some experience as to the adaptability of this berry to your particular community.

In strawberries, of course, we all appreciate that there is no strawberry equal to the Clark Seedling, either for fresh consumption, or for canning purposes; but the Clark Seedling is generally considered a shy bearer, therefore, if you could produce a crop of one hundred per cent more berries of some other variety, the chances are that the crop producing the big yield will be the greatest price-getter for you. Next to the Clark Seedling, from a canning standpoint, is the Wilson, which is an excellent canner and a very fine berry for every purpose. In the Puget Sound country the Marshall comes third, as it is a good cropper and an excellent cannery berry. The Magoon berry appears to grow the greatest yield per acre, but if berries are plentiful it would be impossible for the grower to sell any Magoons to a canner just as long as he is able to procure any other variety for his requirements.

Gooseberries are becoming a great factor in the manufacturing of jams. The old-fashioned Oregon Champion appears to be the most desirable that can be grown. Gooseberries should be planted not closer than five feet apart and should be sprayed very thoroughly at least twice every year, so as to produce the best results.

Victoria red currants are good, heavy croppers. The berry is of good size, good texture, and of excellent quality. The black currant is very desirable for jam-making purposes and can be marketed at a very satisfactory price.

Damson plums are in great demand for jam-making purposes, as are also quinces. Quinces and Damson plums do about as well in this part of the world as any other tree fruit that is available; they are hard to secure for the reason that there are so few places that they can be used to advantage, but the increased demand for jam makes them a very desirable product.

The apple grower needs a reasonable amount of bush fruits on his farm so as to give him early money. The gooseberry is the first berry to ripen, then comes the strawberry, red raspberry, loganberry, currants, and finally the blackberry. All of these crops are matured and out of the way before the apple crop is ready to harvest, and there is no grower who should not enter into all of these lines to a reasonable extent.

Growing Blackberries.

To get the best results from cultivated blackberries they should be trellised, and when pruned the bearing wood of the past year should be cut entirely away, leaving the new growth to bear the coming season's crop. If the new shoots are too close together they should be pruned out so as not to leave too many vines. The same rule applies to all other berries that bear their fruit on canes.



Don't Miss the Big Money

THE virgin soil that the stumps keep out of cultivation in the best soil you have. You can pull out an acre or more of stumps in a day with a Hercules Stump Puller. No matter how big or tough the stump, it walks right out when the Hercules gets hold of it. With the stump come all the long tap roots that spread out in all directions. The land is left ready for cultivation.

HERCULES Triple Power Stump Puller

Let us send you proof. Thousands of farmers have made big money turning stump land into crops.

HERCULES MFG. CO.
16928th Street
Center-ville Iowa

Ask About Hand-Power Pullers. Low Price. 129.00 Pounds Pull.

The Real Pruner *Saves Time, Money and Trees*

Makes a smooth perfect cut. The working principal is simple and powerful, a child can cut the largest limb. Both hands on the pruner at all times gives perfect control. Nothing to get out of order, and no limbs too hard or tough for THE REAL PRUNER to cut.

Ask your dealer or write

THE REAL PRUNER CO., Box 123, Salem, Oregon

ACME BOX STRAPPING

Insures Safe Deliveries—Prevents Pilferage



Acme Nailless Embossed Strapping

Acme Nailless Strapping, with Seal Applied

Write for the Acme Catalogue of Complete Shipping Room Supplies

ACME STEEL GOODS CO., Chicago, 2840 Archer Avenue, Manufacturers

SAN FRANCISCO, 209 California Street
SEATTLE, 114 Railroad Avenue, South

PORTLAND, 8 Front Street
ATLANTA, 10 Tift Street

Improving the Seedling Walnut

Continued from page 7.

ling walnut that will win its way over the grafted varieties that we have will be a greater prize in itself than any man or association of men can offer in money.

I herewith submit a score card for a seedling tree and nut. It may not be scientifically, according to the ideas of some. I give it for what it is worth. Experience and investigation may suggest changes.

SEEDLING WALNUT SCORE CARD FOR WESTERN OREGON AND WASHINGTON.

Tree Quality—	Perfect Score.
Vigor	15
Productivity	8
No blight	7
Proximity of blooms.....	5
Budding out April 20 to May 20.	5
Maturing before October 10.....	5
Uprightness	5
Tree score total.....	50
Nut Quality—	
Taste	25
Kernel, light color.....	5
Form, round, size No. 1.....	5
Shell and kernel, weight equal....	4
Cracking out readily.....	5
Sealing quality.....	4
Shell color and smoothness.....	2
Nut, total score.....	50
Total tree and nut score.....	100

There are many fine seedling walnut trees in the Dundee orchards of Trunk, Dearborn and Prince. Also in the extensive orchards of the Matthews Planting company in Yamhill county. Mr. McDonald reports a very fine seedling at Oregon City, Mrs. Chas. T. Kamm has a very fine Mayette seedling; Senator McNary has a very fine prolific seedling at his home in Salem. One of the best is reported from W. B. Andrews at Eugene. I have two seedlings of promise, but have not had sufficient time to recommend them. The best one is a seedling from the Prince. It misses the frost, both in the Spring and Fall, and is of high quality, but does not produce as well as the other, which is wonderfully prolific, but the kernel is dark at the point. There are many other seedlings of promise, but it will take time to determine their worth.

MANAGER

Horticulturist and agriculturist of practical and scientific training and experience requires position. Have been manager of large orchard for 10 years; understands all phases of farming. Good salary expected.

Address E., care Better Fruit.

FRUIT AND STOCK FARM

900-acre farm in famous peach belt of Alabama; 130 acres already bearing in Mayflower, Hiley Bell, Georgia Bell and Elbertas; crop sold for \$35,000 last season. 700 acres cleared and stumped, on which there is fine crop of cotton, corn and various food crops. All 900 acres of finest dark sandy loam, best all-purpose land in the South. Peach crop from this section reaches market 10 days ahead Georgia crop and highest prices obtained. Fine land for strawberries, melons, cotton, oranges, figs, cane, rice, oats, hogs, dairy and all kinds stock. A wonderful investment for one with capital to handle it. For detailed description and price, write J. W. Beeson, Meridian, Miss.

Try This Stump Puller FREE 30 Days



Read These Letters

My old stump land now pays me \$125 per acre in cotton—and my corn is great, many ears 11 inches around. My One Man Kirstin Outfit pulled 38 inch red pine stumps. Also a 30 x 40 ft. store house to the astonishment of all present.—*H. J. Thompson, Appleton, Ark.*

Have tried the One Man Kirstin Stump Puller and it works fine. My little boy 10 years old can pull a good size tree with it. *F. G. Pyle, Aberdeen, Md.*

My pine stumps are sold in the ground, and average about one and a half to four feet across the top, but the LITTLE KIRSTIN takes them all out fine.—*Mr. F. J. Stoltz, Washburn, Wis.*

Quick Shipments from Escanaba, Mich. Atlanta, Ga. Portland, Ore. Soo, Canada

World's Largest Makers of Stump Pullers!



One Man Alone Handles Biggest Stumps! Thousands of Kirstins Now in Use!

Single Double! Triple Power!

Kirstin STUMP PULLER

Weights less—costs less. Has greater speed, strength and power. Lasts longer! With scientific Kirstin leverage principle a few pounds pull or push can handle exerts tons on stump!

My Big New Book on Stump Pullers FREE!

Tells how to pull stubborn stumps in a few minutes at low cost. Shows how the Kirstin clears acre from one anchor! Low speed to start stump—high to rip it out quick! Patented quick "take up" for black cable. Read the book—the 3-year GUARANTEE AGAINST BREAKAGE—Four Easy Ways to Pay—and Special Agent's Proposition. Shipment from nearest distributing point saves time and freight.

A. J. KIRSTIN COMPANY 277 E. MORRISON ST., PORTLAND, OREGON.

Factory and General Office, Escanaba, Mich.

Try It 30 Days FREE!

No horses or extra help required. No digging, chopping or other expense. One average size man alone handles biggest stumps—quick! easy! cheap! Saves labor, time, money! Pulls big, little, green, rotten, low-cut, tap-rooted stumps trees or brush.

any kind! I send puller without a single penny of money in advance to prove it! If not pleased return at my expense. You don't risk a penny. Four easy ways to pay.



Drives the chills from the morning shave

Portable comfort—instant heat at the touch of a match. No dust or dirt. No smoke or odor. Oil consumed only when needed.

Pearl Oil is refined and re-refined; pure and clean burning. Sold in bulk and in five-gallon cans. Order by name—Pearl Oil.

We recommend Perfection Oil Heaters.

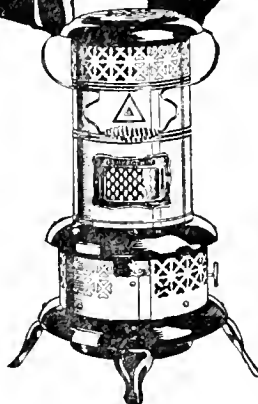

STANDARD OIL COMPANY (CALIFORNIA)

THE WORLD-
OUR ORCHARD

STEINHARDT & KELLY NEW YORK

UNQUESTIONABLY THE
MOST IMPORTANT FACTOR
IN THE DISTRIBUTION OF
THE COUNTRY'S FANCY
APPLES
AND OTHER FRUITS

OUR MARKET-
THE WORLD

Golden Delicious Apple



Photo of life size Stark's Golden Delicious-apples shown in natural coloring and actual size—50% larger than Grimes Golden. Only part of a big crop of an 18-months-old top graft of Golden Delicious—a World's Record for young and heavy bearing. Has borne every year since—three big crops within 4½ years.

The \$5,000 Golden Apple America's Keenest Growers Are Planting

Stark's Golden Delicious—the most deliciously flavored yellow apple in the world.

Superior to Grimes Golden in quality and size and flavor. Keeps four months longer. Fills the Grimes Golden demand long after Grimes Golden is gone from the markets.

We discovered the original Golden Delicious tree several years ago, growing, bearing abundant crops of prize-size fruit, on a barren West Virginia mountainside. We bought this remarkable tree for \$5,000.00—the record price for all time for a single apple tree.

We propagated young Golden Delicious trees from the "wood" of this original tree—and Stark's offered these trees to fruit growers.

Every year since we have quickly sold out every Golden Delicious tree we could grow.

Silas Wilson, the noted Iowa and Idaho 750-acre orchardist (photo at left) declares:

"All the big apple buyers say it is the handsomest, showiest apple they have ever seen!"

"The best apple I have ever tasted since you introduced Stark Delicious. Tree is hardy as Stark Delicious and Wealthy. Sets an apple for every blossom!"

Our advice to you is to plant Golden Delicious this year. But—order quick—demand is twice as great as the supply. Better write today.



Silas Wilson

Use the
Coupon
Today

STARK'S

Golden Delicious

Endorsed by Over 25,000 Growers

"At last! A yellow apple that beats Grimes Golden, with all the Grimes' good points and none of its weaknesses!" Orchardists in Iowa, Illinois, Arkansas, Kansas, Ohio, New York, Missouri, Pennsylvania, Virginia, West Virginia, Idaho, everywhere—are praising and planting Stark's Golden Delicious in generous quantities. J. L. Webster, Wenatchee, Wash., sent us part of his great 1919 crop of Golden Delicious—all splendid apples, which, though "orchard run," averaged 64 to a box. He wrote:

"Golden Delicious strong grower, heavy bearer, does not drop. Keeping quality equal to old Winesap. Eating quality equal to Stark's Delicious. Will surely excel in world's apple markets."

FREE! 1920 Year Book "Prize Fruits"

Get all the interesting facts about this fruit—and all Stark Bro's Apples, Peaches, Pears, Plums, Grapes, Cherries and Berries. Act quick.

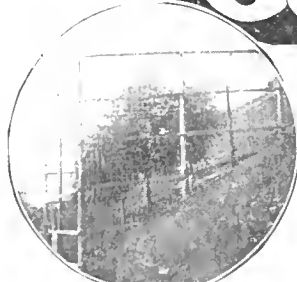

The \$5,000 Tree in a Cage
The original Stark's Golden Delicious in cage protected by burglar proof alarm system.

Stark Bro's Nurseries

104 Years of Nursery and Orchardng Experience

The Only Stark Nursery in Existence—at LOUISIANA, MO. SINCE 1816

Address Box 6

Stark Bro's Nurseries, Box 6, Louisiana, Mo.
Send me your 1920 Free Year Book—"Prize Fruits"—at once.
 If you also want our Free Book, "Secrets of Ornamental Planting," and information about Landscape Plans—check in square to left.
I may want..... trees this spring.
Name.....
Street or R. R. No.....
Post Office.....
State.....

BETTER FRUIT

VOLUME XIV

JANUARY, 1920

NUMBER 7

FEATURES IN THIS ISSUE:

Filberts in the Northwest
Fruit Growing and Coöperation
Northwest Fruitmen Confer
Financing Horticulture
Codling Moth Extermination
American Fruits in England



*Columbia Univ. Libr.
30dec20*

THE WALDRON BEAUTY APPLE

A new autumn variety propagated in Oregon that matures between the early fall apples and the early winter varieties. The Waldron Beauty belongs to the same family of apple as the Fameuse and McIntosh Red. The specimen illustrated above is somewhat reduced from the average size.

BETTER FRUIT PUBLISHING COMPANY, PUBLISHERS, PORTLAND, OREGON

Subscription \$2.00 per Year in the United States; Canada and Foreign, Including Postage, \$3.00.

Single Copy 20 Cents

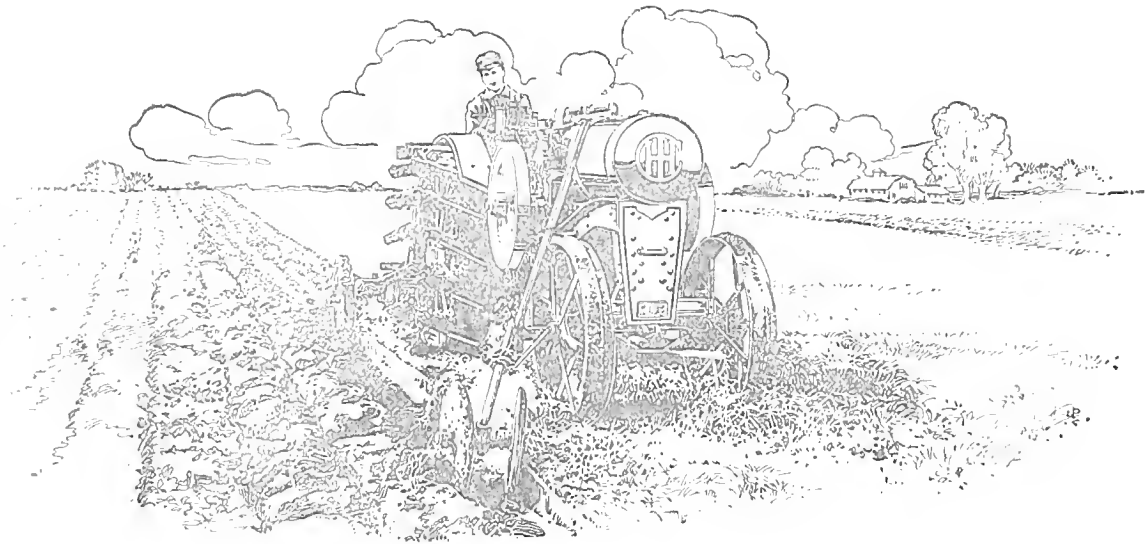

The Sensible Leader of the 1920 Tractor Field

NOWADAYS the chug-chug of the farm tractor is heard in every corner of the land. Tractors are at work in the fields of many thousands of farms and if you look them over you will find them a mixed lot.

Tractor farming is still in its youth. Novelty is still in the surge toward power farming.

The impractical theorists are still in the ring, limping but not out of the running. Adventurers who swarmed into what they termed the "game" are still "playing." The hazards facing the farmer in search of reliable power are many.

In all this turmoil, one tractor like a steady star has lighted the way. That tractor bears the trusted name—**Titan 10-20**. It has led because it is the product of practical builders of good farm machines; because it is backed by many years of experience and unquestioned reputation.

Today **Titan 10-20** is the standard-setter among all tractors. During the past year it has been the topic of conversation on the tongues of farmers and tractor makers the nation over.

Selling at the popular low price—**\$1000 cash f. o. b. factory**—**Titan 10-20** faced a sensational demand. A few months ago this desire for Titan ownership had flooded the factory with thousands of orders which could not be filled at once, though a new Titan was being turned out every few minutes.

Every effort is being directed to greater production and to continued Titan 10-20 pre-eminence during 1920. In view of manufacturing difficulties however, this is earnest advice to the intending purchaser:

Orders for Titan 10-20—and also for International 15-30 and International 8-16—must be placed far in advance. No other course will assure delivery.

International Harvester Company of America
(Incorporated)

Billings, Mont.	Crawford, Neb.	Denver, Colo.	Helena, Mont.
Los Angeles, Cal.	Portland, Ore.	Salt Lake City, Utah	
	San Francisco, Cal.	Spokane, Wash.	



Sell Those Horses Now!

Sell them and save their feed—save chores—save the exercising they need to harden them up for Spring work.

Get a Cletrac instead. Get it now—be sure of delivery—get used to it and work it in on odd jobs. You and your Cletrac will both be keener for weeks of steady, fast work once you're well acquainted. Put in waste chore-time learning to get 100% out of your tractor and add that to the profit you'll make from the feed you save.

The Cletrac will keep on saving you money all year. It isn't a tractor that shirks the unhandy jobs and makes you keep a lot of horses, too.

In all the corners and sticky places, as well as on big work in the open, it's *there* with plenty of pull. Its long wide tracks and its economical weight get over the grades with power to spare. Burns kerosene or distillate.

There's a book, "Selecting Your Tractor," that you ought to have. Send for it today, *or ask the Cletrac dealer.*

The Cleveland Tractor Co.

19145 Euclid Avenue, CLEVELAND, OHIO

Largest Producers of Tank-Type Tractors in the World

SIMONS, SHUTTLEWORTH & CO.

LIVERPOOL AND MANCHESTER

SIMONS, JACOBS & CO.

GLASGOW

GARCIA, JACOBS & CO.

LONDON

Agencies and Representatives in Every Important European Market

European Receivers of American Fruits

FOR MARKET INFORMATION ADDRESS

SIMONS, SHUTTLEWORTH & FRENCH CO.
204 Franklin Street, New York

SIMONS FRUIT CO.
Toronto and Montreal

SIMONS, SHUTTLEWORTH, WEBLING CO.
Board of Trade Building, Boston

OUR SPECIALTIES ARE APPLES AND PEARS

LOOK HERE

ARE YOU SATISFIED with your present selling service?

IF NOT try us and learn what an up-to-date selling organization can do for you.

CABLE OR WRITE US NOW for market prospects, terms, etc. Reasonable advances made against shipments of

**APPLES
PEARS
ORANGES**

YOU want the best market in Britain.

WE have it.

McCAIG & WEBB
Fruit Brokers, GLASGOW

Head Office, GLASGOW

Cables—MacWebb, Glasgow
A. B. C. 5th Edition—Marconi International

ALSO RECEIVERS AT
London — Liverpool — Hull

“Wood-Lark” Saves

Your Trees From This!



*All Farmers Need “Wood-Lark”
All Rodents Like*

The gopher does not hibernate. He is active all winter, and with less green feed is more apt to attack your trees and stored crops. Protect your harness and grain in the barn from squirrels and rats—Use “Wood-Lark”

If Your Dealer Hasn't Any, Write Us

Clarke-Woodward Drug Co.

PORTLAND, OREGON

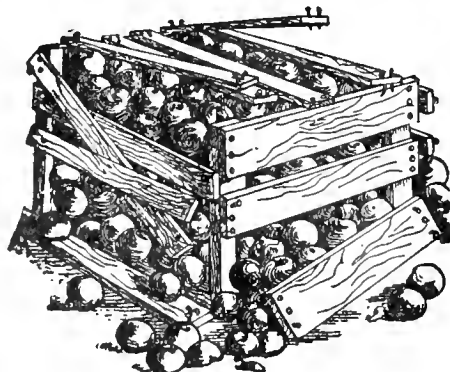

BEFORE using Cement Coated Nails

Western Cement Coated Nails for Western Growers

Our Cement Coated Nails are always of uniform length, gauge, head and count. Especially adapted to the manufacture of fruit boxes and crates. In brief, they are the Best on the Market.

Write for Growers' testimonials.

Colorado Fuel & Iron Co.

DENVER, COLORADO

Pacific Coast Sales Offices
Portland, Spokane, San Francisco
Los Angeles

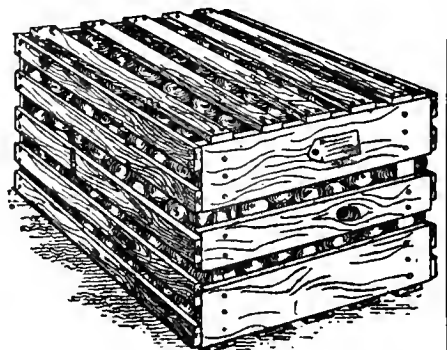

AFTER use of C. F. & I. Co.'s Cement Coated Nails

BETTER FRUIT

EDITOR: W. H. WALTON

STATE ASSOCIATE EDITORS

OREGON—C. I. Lewis, Horticulturist.
WASHINGTON—Dr. A. L. Alexander, Entomologist;
O. M. Morris, Horticulturist, Pullman.
COLORADO—C. P. Gillette, Director and Entomologist;
E. B. House, Irrigation Expert, State Agricultural College,
Fort Collins.
ARIZONA—E. P. Taylor, Horticulturist, Tucson.
WISCONSIN—Dr. E. D. Ball, Madison.
MONTANA—O. B. Whipple, Horticulturist, Bozeman.
CALIFORNIA—C. W. Woodworth, Entomologist, Berkeley;
W. H. Volk, Entomologist, Watsonville; Leon D.
Batchelor, Horticulturist, Riverside.
INDIANA—H. S. Jackson, Pathologist, Lafayette.

An Illustrated Magazine Devoted to the Interests
of Modern, Progressive Fruit Growing
and Marketing.

PUBLISHED MONTHLY BY

Better Fruit Publishing Company

703 Oregonian Building

PORTLAND, OREGON

All Communications should be addressed and
Remittances made payable to

BETTER FRUIT PUBLISHING COMPANY

SUBSCRIPTION PRICE:

In the United States, \$2.00 per year in advance.
Canada and Foreign, including postage, \$3.00.

ADVERTISING RATES ON APPLICATION

Entered as second-class matter April 22, 1918,
at the Postoffice at Portland, Oregon, under
the Act of Congress of March 3, 1879.

VOLUME XIV

PORTLAND, OREGON, JANUARY 1, 1920

NUMBER 7

The Cultivation of the Filbert in the Northwest

By Knight Percy, Salem, Oregon

THE names of Gillette, Quarnberg and Dorris stand out head and shoulders among those who have contributed towards the development of the filbert industry in the West. Felix Gillette, of Nevada City, California, introduced and tried out many varieties of filberts, as well as walnuts, from France, his native country. He propagated them and disseminated the most promising of the varieties, and today

had sufficient faith in the filbert to make a real planting. While he started with filberts a number of years after Quarnberg did, he is nevertheless as much of a pioneer as is the Vancouver man, in that he knew nothing of the results of the latter when he made his planting. His results have been such that he has increased his acreage from year to year until he is probably the largest commercial grower in America, and he has

this fungus. The cultivated filbert of commerce, which is a European cousin to our American hazels, however, has never had the opportunity to build up strains immune to this American fungus, and shows little resistance to it. The wild hazel growing in Western America is of a different species than that of Eastern America and is not a host to the filbert blight, hence the cultivated filbert is grown here without danger of



View in Oregon filbert orchard, showing filbert bush in foreground being trained to tree form. The young limbs around the trunk of the tree are being left to provide material for new plantings.



Filberts in the same orchard showing the bush form. Both of these illustrations show that, while the trees are young, they are making a good growth and are in fine condition.

most of the plantings of the Northwest trace their origin to these early importations of this nut-loving Frenchman.

A. A. Quarnberg, of Vancouver, Washington, is a tree lover with an experimental turn of mind, with an especial leaning towards nuts. He early got in touch with Gillette and carried on an extensive correspondence with him, in addition to buying many varieties of nut trees, which he set out in his experimental grounds at Vancouver. In 1894 Quarnberg planted the first DuChilly filberts in the Northwest, and since that time has tried out perhaps thirty varieties of this nut. While he made no extensive plantings he has made an extensive study of varieties and his writings and talks on the subject have been the inspiration of many plantings.

George Dorris, of Springfield, Oregon, was the first grower in the West who

what would be considered a small grove at that, when compared with other nut plantings.

For over a hundred years attempts have been made to establish filbert growing in the Eastern states of this country, but no planting has ever been able to make a permanent stand. Many growers there have been able to get trees to live for a number of years and have often got into print with the announcement that they have solved the problem of growing the filbert under their conditions, but sooner or later the deadly filbert blight has killed them off. This blight is a fungous disease that is present on the wild hazel of Eastern America, on which, however, it does little damage, due to the fact that through centuries of "natural selection" a strain of hazels has developed that is more or less immune to the ravages of

extinction from that blight. Growers in the West, however, should take care that this fungus is not introduced here, as it may be by introducing filbert bushes grown in Eastern nurseries. There should be an embargo against shipping Eastern hazel and filbert bushes into the Northwest.

The United States imported annually between 11,000,000 and 15,000,000 pounds of filberts in the pre-war period from 1900 to 1914. Turkey, Spain and Italy are the principal producing countries, although both France and Great Britain grow the nut.

Compared with other tree crops in the Northwest, the filbert acreage is very insignificant, but a study of yields and costs of production show this nut to be a very promising one for this favored region. While there are no official statistics for Oregon, the writer,

being familiar with most of the plantings in the state, ventures to estimate the acreage of filberts over six years of age at thirty-five to forty-five acres, and the total number of trees planted in orchard form in the state at from ten to twelve thousand. Production will increase rapidly during the next few years and the home grown nut will soon become known in the channels of trade.

The filbert trees are planted much closer together than most other nut trees and their yields are greater per acre, and usually they get into commercial bearing at an earlier age than do the other nuts. Among the records of yields that have come into the writer's hand the following are interesting: H. A. Kruse of Wilsonville obtained 1,400 pounds from 100 trees 9 years old; in 1918 from one and one-third acres of 13-year-old trees he reported a yield of 2,165 pounds. Fifty Barcelonas averaged 30 pounds per tree, while some of his individual trees produced as high as 50 pounds. The trees are growing on a fine silt-loam soil and are given splendid care.

A Gresham grower, whose trees are much crowded, 215 being planted on about an acre of ground, reports that in his seventh year his yield was 900 pounds and in the following two years 700 pounds.

A Vancouver grower, who planted 380 trees to the acre, spacing them 10x14 feet apart, reports a peak yield of 2,000 pounds and an average yield of about 1,000 pounds per acre.

A Salem grower with two acres of trees 6 or 7 years old that had been considerably neglected and which were allowed to grow suckers obtained 1,200 pounds in 1917 and netted \$125 per acre in 1918.

Joseph Nibler, of Woodburn, with two and one-half acres 9 years old, harvested 3,100 pounds of nuts in 1918. One thousand pounds of these came from 400 Aveline bushes. One hundred and twelve Barcelonas produced 2,000 pounds. Nibler had one 8-year-old Barcelona that yielded 35 pounds and two others 25 pounds each. His soil is the ordinary Willamette Valley loam, of which there are thousands of acres as good as his.

George Dorris, at Springfield, reports a 3-year-old tree that bore 384 nuts; a 5-year-old that produced 16 pounds; a 6-year-old, 21 pounds; a 10-year-old tree 46 pounds, and 13-year-old trees with 50 to 60 pounds. Dorris has an ideal filbert location. His soil is a rich, moist river bottom. He stated at a meeting of the Western Walnut Association that one acre of No. 1 Barcelonas, given every advantage of soil, care and pollination, should produce the following yields:

At 5 years.....	500 to 1,000 pounds
At 6 years.....	1,000 to 1,500 "
At 8 years.....	2,000 to 3,000 "
At 10 years.....	3,000 to 4,000 "
At 12 years.....	4,000 to 5,000 "

The better growers, such as Dorris, are now advising that the filbert, especially varieties such as Barcelona, be planted about 20 feet apart, which gives 108 to 125 trees per acre, depending

upon the system of planting. Small growing varieties, such as the Avelines, can be planted at 14 to 16 feet apart. However, as the different varieties are usually planted together for pollination purposes, the larger spacing should be used.

The filbert is usually propagated from suckers that grow from the root or from the underground part of the stem of the tree. Those suckers that have a few fibrous rootlets on them are transplanted to the nursery row for a year or two, when they are ready for the orchard. Layering is also practiced. This form of propagation prevents intensive cultivation of the trees and hence tells on the resulting crop of nuts. To obtain trees by this method, bend over a low-growing limb and partly cover it with dirt, leaving the tip exposed. Some growers tie this tip to a stake to insure a straight growing tree. Layering is done in the spring. One grower reports an average of sixteen salable plants or trees, using this method of propagation. Some of the more progressive nurserymen are planting seed and grafting the two-year-old roots, which gives a much more desirable form of tree. This practice will permit a more rapid expansion of the filbert acreage, which has been retarded because of scarcity of nursery stock.

There is little reliable information on the subject of filbert pollenization. No carefully controlled experiments have ever been reported. Such information as we are able to present is based on field observations of growers, where the liability of error is always present. Barcelona, which is the most widely planted variety in the West, is at least partially self-fertile. It will bear crops when isolated, but some growers are of the opinion that the yield is increased by cross pollination with certain other varieties. Dorris reports that both DuChilly and White Aveline have a beneficial effect on it. Nibler, at Woodburn, thinks that his Barcelonas among his Kentish Cob seedlings yield better than do those that are isolated. Many of the pistillate blossoms of this variety are out when the catkins are, and these are probably fertilized by their own pollen, but later, after the Barcelona catkins are all gone, still other pistillate flowers appear. It is probably the pollenization of these late blossoms by the pollen of varieties that shed their pollen later than does the Barcelona that causes the increased crop noted when this variety is planted among certain other varieties.

White Aveline is self-sterile. Dorris finds that when planted with Red Aveline and Davidiana, both red and white Avelines produce well, but whether it is the Avelines pollenizing each other or the Davidiana pollenizing them he cannot tell. For this reason he recommends that these three be planted together.

DuChilly is one of the finest nuts grown and as soon as a sure pollenizer is found for it it will be more largely planted. Several growers think they have varieties that will fertilize it, but more definite proof will have to be given before one can plunge on the

variety. With Dorris the Davidiana seems to do the work, but this combination is not the best, since no variety has yet been found to pollenize the latter variety. With him, too, the Avelines pollenize the DuChilly only to a very limited extent.

Barcelona is the safest variety to plant in the light of present knowledge. One cannot go wrong with it. As a matter of safety DuChilly should be planted with it in at least limited quantities. Barcelona is a strong grower and heavy bearer of large nuts with medium thick shells. The nuts are of good quality. The variety is quite a heavy producer of suckers when young, which is probably one of the reasons why it is so widely planted. The nut itself is large, short, compressed, thick, shell hard; husk shorter than the nut, which makes it a self-husker, a very desirable feature.

If a perfect pollenizer were to be found for DuChilly, it would probably become the most popular variety grown. It produces the largest and one of the best quality nuts of the varieties commonly grown in the Northwest. The nut is elongated, oval, broad, over an inch long and three-quarters of an inch wide. The nut is often confused with Davidiana, but is longer, flatter and more angular. The bush is less rank in growth than Barcelona, being of medium size. It is a rather shy producer of suckers.

Davidiana—This variety is not widely distributed in this section and it is doubtful whether any of the nurserymen can supply it in any quantities. Those who wish to have Davidianas in their plantings for pollenizers will do well to plant the strong growing Barcelona and later top-work Davidiana into them. Grafting wood is much more plentiful than are Davidiana suckers and the filbert is not as hard to graft as is the walnut. Scions should be cut in January and grafting done in February. A softer wax than the common walnut wax should be used in the grafting. This variety resembles to quite an extent the DuChilly in character of nut produced. The husk is nearly smooth or slightly downy, as long or longer than the nut and deeply cut; the nut is large, roundish ovate; shell pale brown and beautifully striated with dark brown lines; kernel is full and of excellent flavor. While according to Dorris' observations Davidiana has great value as a pollenizer to DuChilly and possibly to Barcelona and the Avelines, no variety is yet known in our country that will pollenize it. The bush is a strong, vigorous grower. Dorris says of it: "The Davidiana to my mind is the finest variety grown, if only a pollenizer can be found for it."

White Aveline—This variety produces a medium sized nut with very thin shell, and with kernel full and sweet and of the highest quality. It is the choicest home nut, and when the public once learns of its quality it will be in great demand in spite of its smaller size. It has a commercial disadvantage in that the husks are longer than the nuts, preventing the nuts from falling from the

shell when ripe, as do the self-husking varieties. However, greater disadvantages than this have been overcome in the fruit world and someone will undoubtedly develop a mechanical husker which will do the work. The White Aveline is a better yielder than Red Aveline and husks better. It is a very regular bearer when properly pollenized. The tree is medium to below medium in size. Dorris thinks the small size of the tree is due to the tendency towards overbearing. His trees seem to be growing more rapidly as they reach the age of 9 to 12 years. Nibler thinks that this variety does best as a bush, as it is a weak grower at best, and he thinks the training to tree form stunts it.

The Red Aveline is very similar to the White Aveline in its various characteristics. The skin around the kernel is wine colored in this variety and the nut itself is a little smaller than in the White.

Until more definite information is available on the subject, the planter had best plant a mixture of varieties. The bulk of the planting will probably be Barcelona. About 10 per cent Du-Chillys at least should be planted with the Barcelonas and about 5 per cent Davidianas. If the latter cannot be purchased, Barcelonas should be planted and later top-worked to Davidiana. These varieties are all fairly strong growers and should be planted at 20 feet apart as a minimum. The Avelines can be planted separately from the larger growing trees, as they will do well at 14 or 15 feet apart. The latter spacing will require 195 trees per acre, while the 20-foot spacing of the Barcelona will require 108 trees. Dorris found that the White and Red Avelines, when growing near Davidiana, produced well. On the strength of his observations, we would plant 195 trees per acre, about 20 per cent Red Avelines and the balance White Avelines. While the initial cost of such a planting would be more than

with the larger varieties, one would be certain of a heavy yielding grove of a variety of nuts that will, in discriminating markets, command a premium.

We know of successful plantings on river bottom soils, on the silt loam valley soils and on the red hill type of soil. Our personal opinion is that the desirability of these soil types is about in the order that they are above mentioned. Frost need cause no worry to the planter, as it does not seem to affect these early blooming nuts. While it is not desirable to plant any tree in extremely wet soils, the filbert does not seem to be as particular in this respect as are many other trees.

The filbert is with us to stay. While many phases of its culture are still in an experimental stage, the question as to whether it will make a paying investment is past that stage. Within a few years the filbert industry will be mentioned along with the apple, pear, berry and walnut industries of the Northwest.

Solving the Fruit Growers' Problems by Cooperation

From the Viewpoint of G. Harold Powell, General Manager California Fruit Growers' Exchange

WILL the coöperative organization solve the production and marketing problems of the producer without disturbing the functions of the jobber and the retailer and at the same time maintain a fair price to the consumer for fruit and other perishable products of the soil? G. Harold Powell, general manager of the California Fruit Growers' Exchange, answers this question in the affirmative and adduces incontrovertible evidence as to what the organization he represents has done to support his statements. Furthermore, Mr. Powell, who, in addition to his long experience with the California Fruit Growers' Exchange, was identified with Herbert Hoover in the Food Administration during the war, is emphatic in his statements that the producer must work out these important problems for himself. In addressing the Northwest Fruit Growers' Conference at Spokane recently on this subject he said:

"The citrus industry of California represents an investment of \$225,000,000. For a period of twenty-five years the growers have coöperated in the distribution and marketing of their crops; in the last ten years in many phases of production, in fruit handling, in the purchase of orchard and packing house supplies, in the protection of their groves against diseases, insects or frost, in the ownership of timber lands and the manufacture of boxes, and in the conversion of low grades of fruit into by-products. The growers of the California Fruit Growers' Exchange own the trade-mark under which their better fruit is sold and they have invested more than \$250,000,000 in national advertising in twelve years to increase the consumption of citrus fruits. They have coöperated with the wholesale and retail trade in the development of better methods of fruit merchandising; with the state and national governments in

the establishment of better methods of production and of fruit handling; and with the railroads in securing a better service and a better type of refrigerator car.



G. HAROLD POWELL
General Manager of the California Fruit Growers' Exchange, the largest and most successful coöperative association in the world.

The Producer and His Problems.

"The questions which affect the stability and permanently successful development of the fruit industry can only be worked out by the producers coöperatively. They will not be solved by anyone else, because no one but the producer has a primary, vital interest in production. They cannot be solved by an individual producer. The progress that has been made in every question affecting the production of citrus

fruits, such as the cheaper purchase of supplies, the community protection against insect pests or community frost protection, the economical harvesting and handling of the fruit, the establishment of a citrus fruit experiment station by the State University, has resulted exclusively from the initiation and the coöperation of producers. Those who handle the growers' product for them sometimes follow: they cannot lead in the progress of an industry. Their interest in the problems of production is secondary.

"The problem of distribution and marketing a rapidly increasing crop, such as equitable national distribution, the development of new markets, and effective national advertising, can be handled by producers coöperatively, and by them alone. Twenty years ago, when the rapidly increasing citrus fruit crop was left in the hands of individual buyers, either local or distant, to handle, the marketing collapsed because the buyers could not take a risk when the crop was large and the distribution was not coöordinated. The industry problem was met only when the producers systematized the distribution of their own fruit, eliminated speculation from its purchase and distribution, established their own agents, and sold it to the wholesale trade in the markets where the fruit was to be consumed. The delivered system of selling replaced the speculative f.o.b. method of sale, which had brought the industry to a state of bankruptcy, and with the speculative element at the point of production eliminated the growers have been able to keep the markets of the country evenly supplied, thereby making it possible for the jobber and retailer who bridge the gap between the producer and consumer to sell on an even merchandising, rather than an erratic speculative basis. The average jobber's margin on oranges, for

example, is now less than 10 per cent on the selling price, while the retailer's margin is about 25 per cent. These trade margins, which are the lowest on any of the fruit crops, have been gradually reduced because the growers have furnished an even, dependable supply of standard grades of advertised fruit to the markets where they are to be sold.

Principles of Organization.

"A coöperative organization, to be successful permanently, must be founded on economic necessity. It must be composed of growers exclusively, and it must be financed exclusively by the growers. None has succeeded in which the growers and the buyer and speculator are joined together, because the interests of the two are not the same. The grower's primary interest is in the permanent prosperity of his investment; the buyer or speculator primarily in the success of his immediate business transactions. Only the man who owns the land and whose investment runs into the future is willing or is in a financial position to make investments that safeguard the future of an industry.

"A coöperative organization is one in which the members form an agency through which they work out their common problems at cost without profit to the agency—the benefits going to the members in proportion to the business transacted by each, but the cost being the same per unit for each, irrespective of the volume contributed. To be permanently successful the organization must be formed by the growers, organized by them, and the benefits returned to them. Any other type of organization is not coöperative, and if used, the term misleads the public as to its purposes.

Capital in a Coöperative Organization.

"The California Fruit Growers' Exchange has no capital stock. It estimates the cost per box of transacting business annually, then levies an arbitrary assessment for the year. At the end of each month it renders a bill to each District Exchange for the number of boxes shipped during the month. It does not take the marketing cost out of the proceeds before returning them to the District Exchanges. At the end of the year a surplus, if one has been accumulated, is prorated to the District Exchanges on the basis of the shipments of each. The Exchange makes no profit, receives no dividends, accumulates no surplus.

"Where a producers' organization requires capital for the purchase of supplies or for other purposes, the Exchange has worked out a plan by which the capital contribution of the stockholder is kept permanently proportional to their shipments by a revolving fund into which the stockholders agree to pay a specified amount per box annually, based upon their respective shipments. With the money so contributed an equivalent amount of the oldest issued stock is purchased and is transferred to the stockholder making the last contribution. The capital stock is revolved out every five or more years,

depending on the cycle adopted. The grower contributes annually on the basis of his previous shipments, and receives a return of capital based on his shipments of five or more years previously. The capital contributed is paid 6 per cent interest, but no dividends are paid to the capital except the interest rate. The corporation is not formed for money-making purposes. The capital is necessary to provide the facilities through which the members transact their business, and both the benefits and capital contribution of the members are always kept proportional to the use which the member makes of his own facilities. American agriculture is full of the wrecks of farmers' organizations that were formed as stock corporations, with disproportional capital contributions of the members, with no way to retain the capital within the organization or to keep it always proportional to the shipments of the members. The revolving fund plan overcomes the objections to a capital stock corporation and provides a strictly democratic form of organization.

The Open Door to Square Deal.

"A coöperative organization should have an open-door policy, i.e., one by which every grower who will conform to the policies of the organization, who will abide by its rules and regulations, and who will assume his share of its responsibilities may be admitted to membership. It is equally important that a member be permitted to withdraw from the organization should he become dissatisfied, provided his withdrawal is in accordance with the by-laws or contract provisions governing withdrawals. No grower should be held permanently in a coöperative organization against his judgment. A contract or membership agreement between the association and the grower is fundamental for purposes of business stability. The association must know definitely what it is expected to do, the volume of business to be transacted, the approximate overhead cost and the preparation necessary to transact the business in an orderly, economical manner. But in the long run the benefits of a coöperative organization are the only things which hold the members together.

Coöperation and Standard Grades.

"No community can become known in the markets of the country, and especially to the consumers, unless the fruit is handled, graded and packed under standard rules and regulations and sold under an association trademark brand, each local unit retaining its own local brand in addition to the trademark to identify the quality of the fruit of the community. The wholesale and retail dealer buys on the quality of the local brand to supply the quality required by their customers. The consumer buys on the advertised trademark of the general association. The trademark is the guarantee of the association to the consumer and the public. It represents a minimum standard grade, with various grades above the minimum representing the quality of fruit of each community.

An unadvertised local or buyer's brand may have been sold for twenty years in a community and not be known to 2 per cent of the consumers who have actually used the fruit, while a nationally advertised brand will be known to more than half the consumers in the same community. Such has been the actual experience of the association of citrus fruit growers selling under local brands alone as compared with the growers selling under the Sunkist brand with the local brand added.

The Need of National Advertising.

"Advertising to the consumer is fundamental in increasing the consumption of a rapidly increasing production of fruit. It increases the per capita consumption and develops new consumers. It widens the growers' markets and produces a consumers' demand which helps the jobber and the retailer, who are primarily order takers, sell the fruit. It strengthens the relations between the grower, the trade and the consumer. It makes it possible for the jobber and retailer to sell quicker at lower margins per turn over, and to give the consumer a product uniformly distributed at a lower cost of distribution.

Coöperation Between the Producer and the Trade.

"There should be the closest coöperation between a producers' organization and the wholesale and retail trade. The latter are the distributing agents which bring the producer and consumer together, and the span can be efficiently and economically bridged only when there is a mutual understanding of each others' problems. The producer cannot deliver his fruit to the retailer without the jobber, nor to the consumer without the retailer. There are 3,500 fruit jobbers in America, with 10,000 or more traveling salesmen to develop a country business, and 350,000 retail merchants who sell the fruit to the consumer. The producer cannot take the place of either. The risk and the cost are both prohibitive.

The Future of Coöperation.

"The future of coöperation will depend not alone on how well the growers handle the business in hand, whether it be in production, in distribution and marketing, or in development of a larger consumer demand, but largely on how well they meet the vital questions of the day which are leading to world-wide social and economic unrest. A coöperative organization has a public interest relationship which it must scrupulously fulfill, as well as the relationship to its members. It cannot live for itself alone.

"A coöperative organization of fruit growers by illustration should be an important factor in reducing the cost of living as well as insuring the grower a fair price for his fruit if it is to play a vital part in future social and economic life. The producer is entitled to a fair return on the cost of production, if the law of supply and demand warrants it. The coöperative organization, however, should make a larger production possible by reducing the cost of production

Practical Pruning as Applied to Apple and Pear Trees

By O. M. Morris, Horticulturist, Washington State College of Agriculture

(PART TWO)

Varieties.

The commercial varieties grown in Washington differ greatly in their general shape and characters of growth, and each requires more or less different lines of treatment to prune them best.

Jonathan—This tree is typical of those that are inclined to start with a strong central leader and very quickly develop strong lateral branches. The central leader usually subdivides by developing in lateral directions and the strong side

knowledge that heavy fruit production will cause the top to spread, and as the trees grow older more severe training and more thorough fertilizing of the soil is necessary to maintain vigor in this variety. This variety has a good habit of bearing fruit on small side branches and with proper training the fruit will be well distributed from center to circumference of the top.

Rome Beauty—Rome Beauty produces a tree that, until fruit production begins, has a strong tendency to grow upward and the branches assume a lateral direction only when trained by the grower or held in that position by a load of fruit. This variety has a strong tendency to produce its fruit on long fruit spurs which are often more like terminal branches than fruit spurs of other varieties. A rather thick, bushy top is required by this variety for the production of a crop of fruit distributed throughout its top. The most common experience of the unskillful grower is to have the Rome

Beauty produce a large amount of fruit in the outer part of its top. This causes a drooping of the branches and often a canopy form of top in late summer and early fall, with the result that a very large proportion of the crop is not well exposed to the sun and colors poorly. A rather severe thinning out of the large branches and careful tipping back of the young shoots is necessary to secure an even distribution of fruiting wood throughout the top of this variety. It does not develop its fruit well on short side spurs, as does the Jonathan; and growers expect it normally to produce a larger proportion of its fruit in the outer part of the top.

Ben Davis—The Ben Davis, Gano, Black Ben Davis, Arkansas, Winesap, Stayman Winesap, and Delicious, as young trees have a strong tendency to grow in height, with a development of well distributed lateral branches capable of making a good well-balanced top. All of these varieties can be well developed by starting the young trees with a central leader and maintaining it for three or four years. The maintenance, however, of the central leader with these varieties is not as important as with the Jonathan and, as with that variety, it will usually cease to be noticeable in trees seven or eight years of age. All these varieties are vigorous growers as young trees and can be easily trained to open tops with well-balanced heads. The Ben Davis, Gano, Black Ben Davis, Arkansas, Stayman Winesap, and Delicious are vigorous trees even while in heavy fruit production. These varieties are moderately heavy, annual fruiters. The Arkansas Black is often a light producer and should be pruned so as to open the top as much as possible with the removal of a minimum amount of wood. This process will usually bring the trees

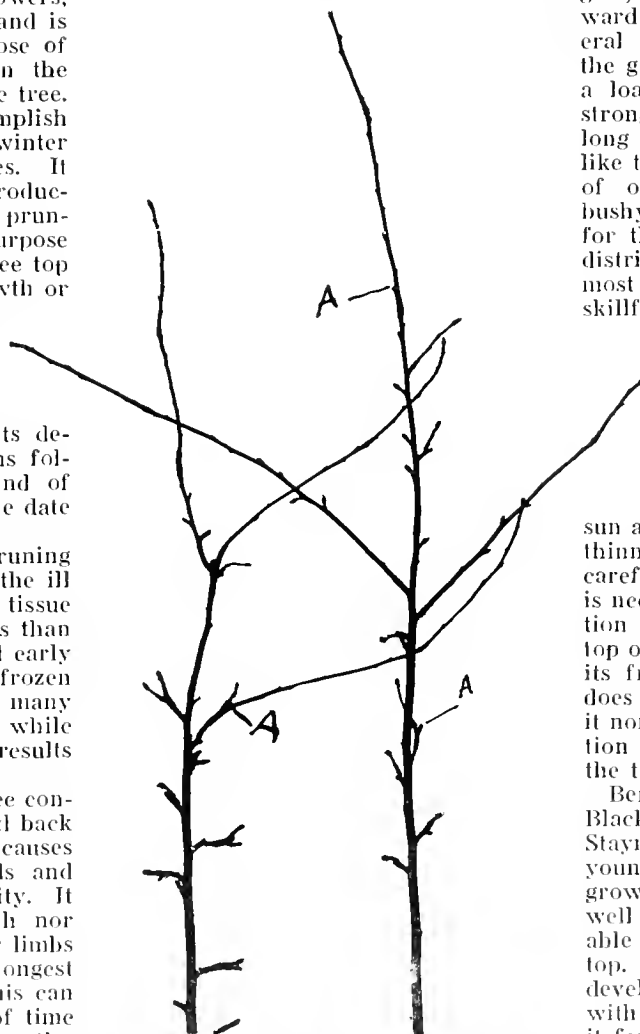

FIGURE 7. The fruiting branches of a Jonathan tree. Note that all of the larger terminal buds both on the twigs and the spurs are blossom buds for next year's crop. At the point A the fruit spur has developed into a twig. Such forms are common in this variety.

THE general practice in pruning is to do the larger part of the work during the winter. This has two things to justify it. The workman can get a better view of what he is accomplishing and there is then more time for the work. As a rule, trees pruned in winter have a stronger tendency to respond to producing new growth in the form of water sprouts or new twig growth at the points where the cuts were made. Summer pruning, as usually practiced by careful growers, is as much training as pruning, and is practiced as much for the purpose of modifying the form rather than the growth or fruit production of the tree. Heavy summer pruning may accomplish the same results that heavy winter pruning ordinarily accomplishes. It may increase or decrease wood production or fruit production. Summer pruning can be practiced for the purpose of modifying the shape of the tree top without altering its habit of growth or fruiting. The exact dates at which summer pruning may be done for the purpose of increasing fruit production cannot be indicated by the calendar with any degree of exactness. Results depend upon the growth conditions following the pruning and the kind of pruning done, more than upon the date of pruning.

Late winter and early spring pruning is less liable to be followed by the ill results of the killing back of tissue around the edge of large wounds than the pruning done in late fall and early winter. The wood should not be frozen when the pruning is done, but in many of the irrigated sections pruning while the wood is frozen frequently results in no harm to the tree.

The young, rapidly growing tree constantly tempts the pruner to head back severely each year. Heading back causes the development of lateral buds and branches in the immediate vicinity. It does not greatly modify growth nor strengthen the main branches or limbs of the tree. Shortening of the longest branches is often necessary. This can be done with a minimum loss of time and energy to the tree by frequent tipping back in summer. Persistent annual heading back delays as often as it hastens fruit production. It commonly results in the formation of a tree with an excess of large branches and an undersupply of fruiting wood in the center of the tree top. The thinning out of the top should consist of the removal of crossing and interfering twigs and small branches and of such larger branches as will prevent the best development of the remaining limbs. A great deal of small side wood should be left. It increases the diameter of the main limbs and causes the tree to come into fruit production at an earlier age. Thinning out by the removal of large branches is not so frequently overdone as is heading back.

branches have a tendency to assume a horizontal position and, with a heavy crop of fruit, to become pendant and drooping. The extremely short trunked trees of this type are disappointing because the fruit is produced so low that it hinders the ordinary cultural processes and the fruit produced on such branches is of poor color and quality. A constant effort is necessary to keep the tree growing in an upward direction sufficiently vigorous to develop and color its fruit well. Young trees should be trained to grow upward with the



FIGURE 8. A common type of trunk and lower framework of a Rome Beauty tree.

into their heaviest fruit production. The Winesap is a vigorous growing tree while young; but, when heavy fruit production begins, the tendency of the tree is to over-bear and lose vigor. This must be corrected by sufficient pruning to prevent an excessive development of fruit wood and the maintenance of a good supply of young growing shoots. Pruning alone can not secure the best results with this variety; but thinning of the fruit and improvement of soil fertility and tillage must be depended upon to secure the annual production of extra fancy fruit. The Stayman Winesap is less inclined to over-bear, but in other respects is very much like the Winesap tree.

Esopus—The Esopus (Spitzenburg) is difficult to prune to the best form. The tendency of the tree is to produce long branches and to produce the fruit on short spurs distributed along these larger branches. Young, vigorous growing shoots that are headed back frequently fail to produce three or four side branches as desired, but produce one and sometimes two branches which assume the direction of the original branch. Every effort possible is usually necessary to cause this variety to produce sufficient side branches to carry a good crop of fruit. The variety also has a strong tendency to biennial crop production. Thinning the fruit and careful, regular annual pruning with good cultural care will do the most possible to overcome this unsatisfactory tendency.

Wagener—The Wagener tree must be treated very much the same as the Spitzenburg in as much as it fundamentally develops in the same way. Careful thinning of the fruit of this variety is necessary to avoid biennial

fruiting. Another peculiar characteristic often manifest is the tendency of the tree to produce a heavy crop of fruit on two or three large branches while the remaining part of the tree will have very little, if any fruit. Careful thinning and regular annual pruning will do the most possible to correct this habit.

Yellow Newtown—This variety often puzzles the grower with its tendency to produce many long slender branches with a strong upward tendency of

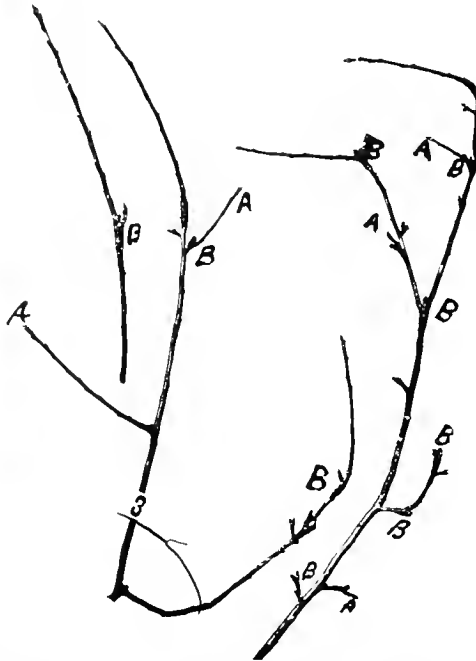

FIGURE 9. The fruiting branches of a Rome Beauty tree. The enlargements of the branches marked by B are the points at which the fruit was produced last summer. The buds marked A are blossom buds for the next spring's crop. Note the long twig growth beneath each of last season's fruit spurs.

growth. Careful thinning of the largest branches with light heading back and encouragement of small side branches will produce the best results.

Wounds.

Wounds heal by the growth of the adjacent cambium layer and bark, which gradually spreads over the exposed area. The more rapid the growth of the plant in that area, the more rapid the healing. Stubs of branches left by pruning heal slowly because they are usually removed from the line of travel of the sap which feeds the new developing tissue. Not only the fresh cut wound that is exposed must be healed, but the entire stub should usually be considered as the area to be healed in the growing process. This makes it doubly important to prune carefully in removing large branches and to make the cut as close as possible and almost parallel to the main branch or trunk.

Wounds made in the process of cutting away diseased parts of trees should always be disinfected, and for this purpose there is nothing

better than a 1 to 1000 solution of corrosive sublimate (mercuric chloride). It is now prepared in tablets, one of which dissolved in a pint of warm water, gives the desired solution. Grafting wax and similar preparations are often used on stubs left by removing branches but this material is of doubtful value. The use of common white lead paint is growing more in favor and seems under the greatest range of conditions to produce most uniformly satisfactory results. The practical value of any dressing for wounds lies in the extent to which it disinfects the wound without injury to the tissue, and prevents excessive drying.

Broken Trees.

Branches broken by an overload of fruit or by a storm can seldom be repaired with good results. Small branches that do not leave large enough open spaces in the trees to be a serious loss should be cut back to side branches or to a parent branch. The neighboring branches will, if permitted, soon fill such spaces. Large branches, when broken should be cut off smooth with a saw and the following winter top grafted. If the work is well done the open space left will be filled in two or three years by the new wood. This form of renewal can very often be quite satisfactorily used and reduces the loss from such breakage to the minimum.

Large branches that are split from the trunk of mature trees can often be lifted back to their original position and fastened there with a bolt through the base. Guy wires should then be attached to the branches higher up to help hold the load. The bolt used should have no larger head than is positively necessary to hold the weight and should be sunk into the wood. This will enable the wood to heal over



FIGURE 10. Base and framework of a Gano tree. This shows a type of framework that is common, but the individual tree has too short a trunk to be satisfactory.

quickly. Large wood screws that will not reach quite through the base of the tree can often be used with better results than bolts. This work must be done very soon after the damage has occurred. If a top is permitted to retain this broken position long the wound will dry badly and worse breakage will occur when the repair is attempted. If this repair work cannot be done very soon, it is usually better to remove entirely the broken parts. Young trees badly split or broken can best be renewed by trimming away the broken parts and permitting the trunk to develop a new top. In extreme cases it is best to remove the tree entirely and replant with a young tree.

There are many forms of supports used in trees to prevent breakage. The best system is to prune and train the tree so that the large limbs will be evenly distributed and sufficiently strong to support a large crop when the fruit is properly thinned. The special propping of individual limbs will be required occasionally in heavily bearing orchards that have received the best pruning and training possible to give, but proper thinning of the



FIGURE 12. A Wagener tree that has been in fruit production three or more years. Note the distribution of the fruit spurs alongside of the pole-like large limbs.

the limbs is sometimes used to good advantage. Usually, however, such ties are too rigid and do not completely avoid breakage.

The center prop system with guy wires running from the top of a pole standing in the center of the tree to each individual branch is used by many with very satisfactory results. The

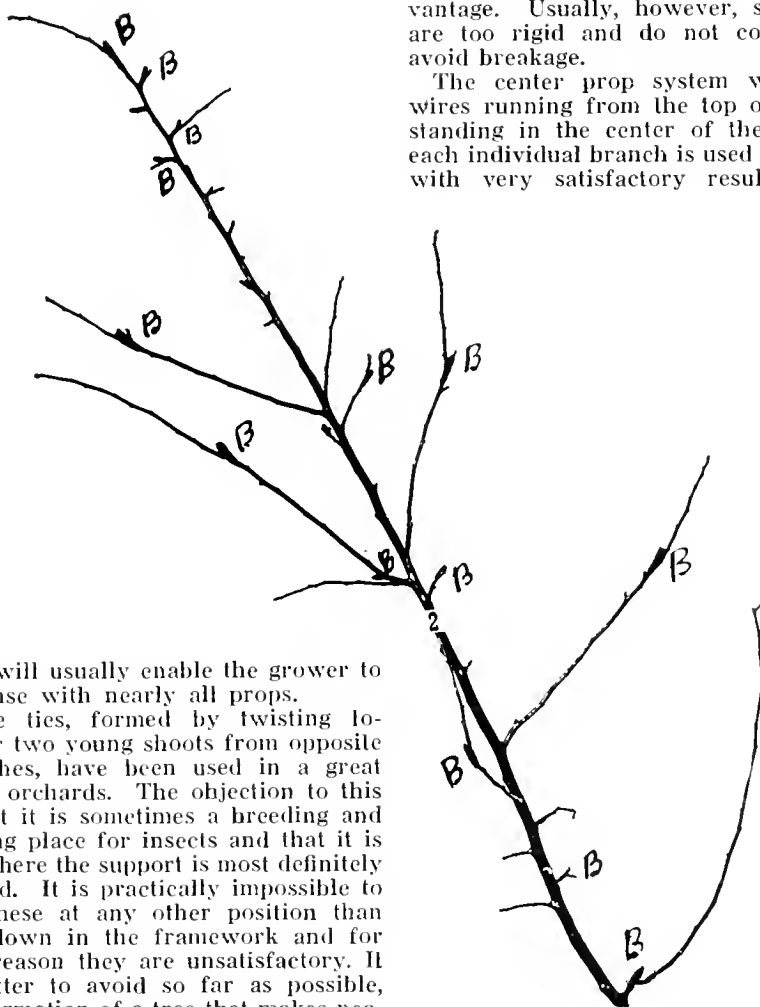

FIGURE 11. The fruiting branch of a Gano tree. Note the distribution both on long and short spurs or twigs of last year's fruit crop produced at points B.

fruit will usually enable the grower to dispense with nearly all props.

Live ties, formed by twisting together two young shoots from opposite branches, have been used in a great many orchards. The objection to this is that it is sometimes a breeding and lodging place for insects and that it is not where the support is most definitely needed. It is practically impossible to use these at any other position than low down in the framework and for that reason they are unsatisfactory. It is better to avoid so far as possible, the formation of a tree that makes necessary the use of such ties.

Cross tying opposite limbs with wire that is fastened to screw eyes placed in

damage that is liable to occur with this form of prop is that the point of support is placed under the limb too near the trunk, with the result that the limb breaks near the point of support. In order that this system may be used to its best advantage, it is necessary that the pole should extend well above the highest branches of the tree.

The individual pole prop has the advantage of being susceptible of adjustment in any way that the situation may demand, and can be removed easily as soon as its need has ceased to exist. All forms of props should be considered as a temporary relief from the unsatisfactory situation that has developed and no form can be devised that will be of any more than temporary value. The growth of the tree and its development from year to year will change the position and amount of assistance needed to carry the load of fruit.

Pears.

Young pear trees are pruned very much the same as young apple trees. A greater effort is usually made to cause the young trees to assume a

spreading form. A little summer pruning may be of much help in accomplishing this. The top branches, if cut back to an inside bud, will throw out several branches and the following year the two-year-old branch can be cut back to the one-year-old outside branch. This process will usually secure a greater spread of framework than cutting to an outside bud. Heavy cutting back is often carried to excess in an endeavor to cause the young tree to develop more side branches and to cease its strong upward tendency. Better results will often be attained if the trees are brought to bearing age with no more pruning than is necessary to secure a good, well balanced framework. After the habit of fruit bearing is well established heavy pruning is most successful. The trees, while bearing heavy crops of fruit, develop more lateral wood and assume a more spreading form.

The fruit may be thinned by pruning, but hand work in removing the fruits is much more successful. The most important work in pruning is to head back the few longest and strongest growing branches



FIGURE 13. The fruiting branch of a Wagener tree, showing the short fruit spurs and the tendency of the variety to produce extensional branches when headed back.

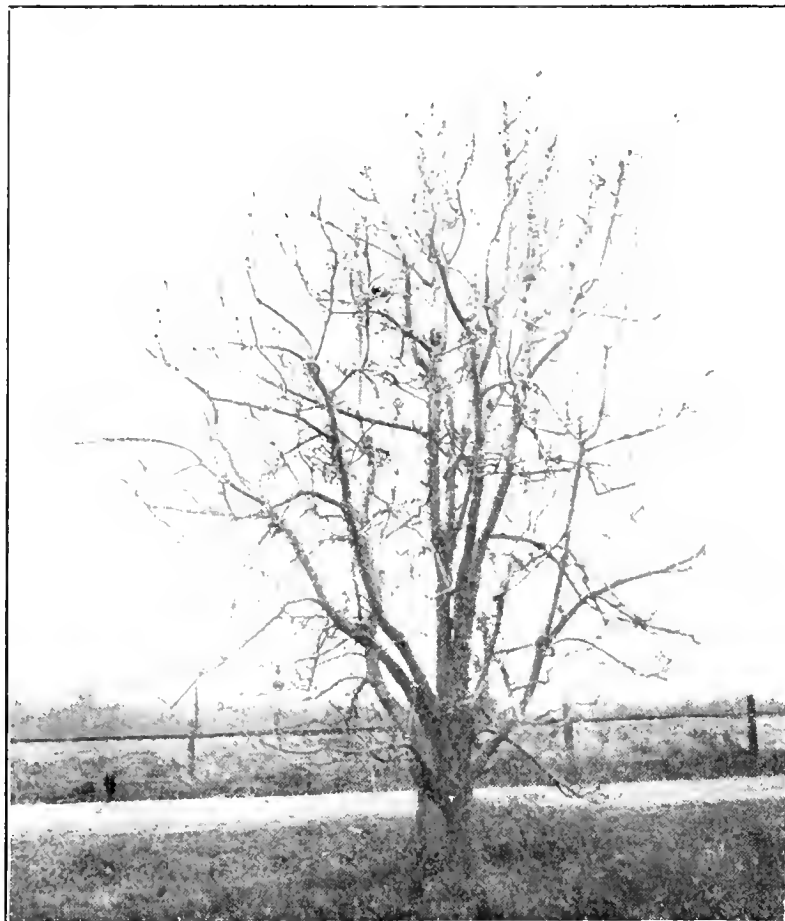

FIGURE 14. An ideal form of Bartlett pear tree in full fruit production. Of special interest is the upright form of the main branches or framework of the tree and the crooked stub form of the smaller wood.

and remove enough wood to maintain the vigor of the tree. Mature trees in heavy bearing require heavy annual pruning. The top should be kept sufficiently open to let some of the direct rays of the sun reach well into the center.

The pear bears its fruit from blossoms borne in winter terminal buds on spurs, and the heavy fruiting tree tends to fill the top with short crooked spur wood. This must be greatly thinned each year at the same time the strong terminal branches are cut back. By carefully maintaining a balance, these spurs will continue a vigorous growth at the same time the outer branches are making strong wood growth.

The varieties of pears differ greatly in their habits of growth and the system of pruning followed must be especially adapted to each variety. The Bartlett and the Kieffer are very vigorous growers as young trees and all the branches grow nearly straight up. Heavy winter pruning seems to accentuate this characteristic. The older trees develop a more rounded top. The Winter Nelis produces such crooked branches that all that can be done for it is to thin out the top to admit light and cut back some of the longest and strongest growing shoots. In pears, as in apples, heavy pruning of young trees tends to delay fruit production and if not well done will do more harm than if pruning had been neglected.

The presence of diseases sometimes makes it necessary to cut away most of the fruiting spurs developing on the large branches. This, however, should be practiced only as an expedient under abnormal conditions.

Northwest Fruitmen Discuss Production Problems

By W. H. Walton

THE joint meeting of the Washington State Horticultural Association and the Northwest Fruit Growers' Conference held in Spokane in the early part of December resulted in assembling one of the most notable gatherings of fruitmen and others interested in horticulture that has taken place in recent years. All of the Northwest states were represented and keen and intelligent interest was taken in all of the subjects discussed—the kind of interest that forced the conclusion that the 200 or more representative Northwest fruitmen who were in attendance were in the fruit business as an industry and not from the speculative point of view. In fact the "boom" element was noticeably absent. It was evident also, that the fruit growers from the regions represented are not being led astray by the high prices that have obtained for the past two years and that although they look forward to the future with confidence that they are taking the necessary steps, through lower costs of production, more practical and scientific cultural methods, better packing and grading and improved marketing facilities, to meet contingencies that may arise under normal conditions.

Sectional Rivalries Dropped.

The dropping of sectional rivalries was also another feature that was obvious. This was particularly shown in the desire of the representatives from the various states to establish a standard Northwest grade and pack, although this was not accomplished owing to the fact that Oregon and Montana have no state grading laws. The three-grade pack was retained and it is hoped at some future time it may be possible to establish uniform grades and pack for the entire Pacific Northwest. If the two-grade pack had been adopted by Washington, which was proposed, it would have undoubtedly delayed united action on this much desired result for a long time and might have killed it. The spirit of cooperation was also manifested along other lines. In fact it was referred to by almost every speaker who addressed the meetings and was the common theme in nearly every conversation of growers. The revelations of G. Harold Powell, General Manager of the California Fruit Growers' Exchange as to the success of that organization in handling the marketing and other problems of the citrus fruit producers were undoubtedly an eye-

Continued on page 36.

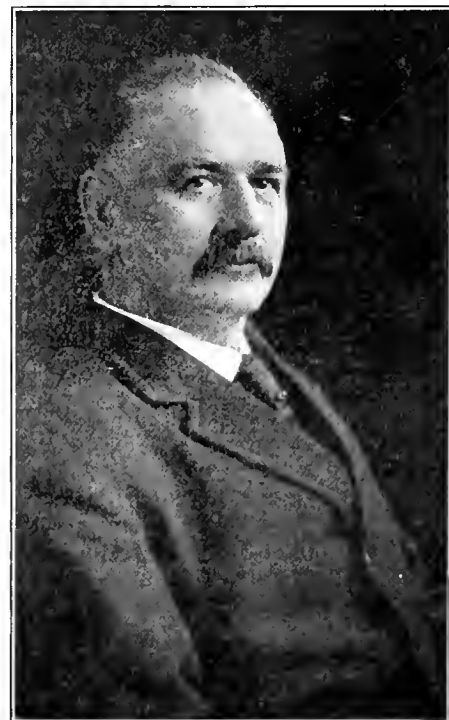

E. F. BENSON
Washington State Commissioner of Agriculture who urges the abolishment of sectional lines in handling the problems of Northwest fruit growers.

Some Observations on Financing Horticulture

By W. S. Peachy, Vice President of the Seattle National Bank

THE caption assigned to me indicates an unlimited field in which to roam. A pardon must be granted me if I go too far afield or cover any part of my subject too thinly.

I have been becoming acquainted with the subject of financing fruit to market for three or four years, but will not attempt to present the last word in fruit financing. I want to be as definite however, as I can, and I shall commence with the one definite statement that financing the fruit crop of the Pacific Northwest is now one of the clearly recognized functions of the banks in this field. In fact, I have seen evidence of competition for the preferred class of this business, where previously there had been reluctance. The bankers have changed their attitude only because the fruit growers have done so; because organization and science have in many instances succeeded haphazard operation and speculation.

Financing horticulture, like financing any other crop, goes from the ground up. Undoubtedly the banking fraternity got some of its worst experiences on the ground floor when it was assisting in speculation in orchard lands. Sad though it may be, it seems to have been a necessary experience—only on the theory, however, that all things are for the best. Presumably, the lesson had to be learned and let us profoundly hope that the losses of that unhappy time have in many cases at least been offset by those who turned their speculative swords into ploughshares and by untiring and continuous industry have brought conditions up to the solid state they are in today when the fondest dreams of horticulturists are being realized so far as price is concerned.

When I was asked to cover this subject my first impulse was to get among other things—statistical facts and figures that would show clearly the results to banks of financing horticulture, but I abandoned this idea because of insufficient time, and for the further reason that I was disinclined to open old sores, as I undoubtedly would have done by a state-wide search for financial results to banks; and also because of disagreeable subjects like this one does not always bring forth true revelations. The next best way in which I can do justice to the subject is to tell in detail why the bankers are now warming up to the financing of horticulture and how they will be glad to go further under certain conditions.

In the first place, the banks are pretty well satisfied that the speculative era has departed, so far as land is concerned, and that so far as the products are concerned, the tendency to speculate at present is waning. This is a good place to warn against a revival of land speculation and against any tendency toward fruit speculation. Perhaps the prime basis of this disinclination of bankers in this respect, is the perishable nature of fruit. To add speculation to this objectionable feature

would and should prove fatal to those desiring banking coöperation in the industry.

The technicalities of handling financial transactions to facilitate the fruit growing movement are many and varied, each with its weakness and merits. I shall attempt to discuss a few of the most familiar types. Possibly the oldest and the best known is the ordinary rancher crop moving loan, which comes to the bank like any other crop loan and is liquidated as the crop is liquidated. If the borrower is good in the usual respects and a good fruit man besides, with proper equipment for packing and storage this type of loan may well be acceptable to the banker. If the statement of the maker is satisfactory his notes can be rediscounted at the Federal Reserve Bank. Next comes the unit, the strength of which makes all the difference to the banker and his judgment of the paper and also to the Federal Reserve Bank. It means everything to the banks to know that the unit is strong, well organized and equipped.

The unit must be well organized from every angle. Generous allowances should be made for unit purposes, warehouses, machinery, advertising and lean years. Of these perhaps the most pressing requirement is warehousing, for stabilizing the market and to provide against car shortage. This unit paper is likewise acceptable at the Federal Reserve Bank, if the unit statement is satisfactory. Next comes the central selling organization, really a collection of units and on the strength of that organization depends more completely its credit standing with the bank than in the first two named cases. The Federal Reserve Bank of this district has adopted a liberal policy toward fruit crop movement paper, no matter how it originates, and provided it is received from strong initial sources through member banks.

The paper most desired by the bank is the draft payable at thirty days or so, after date, with documents attached covering the fruit in transit. These drafts can be handled on an interest basis for outstanding time. Some local bankers, depending on the standing of the drawer make advances on these drafts as high as face value, with interest adjustment as mentioned above. It is quite essential in some cases to require a margin of the value of the draft to protect against fatalities, which the banker may consider not properly protected by the general credit of the drawer. This practice is particularly in vogue between dealers or factors and the banks. Many of these dealers are highly responsible firms whose ratings are such as to require but ordinary banking precautions. Others are able to do business only under a guarantee or letter of credit from buying sources. Others handle on consignment, a practice mostly in lean years. I am re-

liably informed that there are firms, often with high sounding names, who establish themselves with an office, make arrangements for space in a warehouse, then attempt to do business without any capital to speak of, trusting entirely to their resourcefulness in establishing credit and in holding off settlement until they get returns. The career of this type of dealer or agent is usually short with the bank.

I mention these numerous means of financing for the stress I wish to put upon the preferred type of customer the bank likes to coöperate with, and that is the organized unit. The organized unit is the thing, in my opinion, and organization should be the main cry of the fruitgrowers of the Pacific Northwest.

Too little emphasis is placed upon this vitally important subject by a majority of the growers. There is a far too large proportion of the growers totally unorganized; too much of a tendency to play a lone hand—to "go it alone." There is a true saying that "Coöperation is born of adversity and dies of prosperity." Since 1915 prosperity has come to the fruit growers of the Northwest in steady increasing measure and many of them have forgotten the lessons of 1912 and 1914, becoming blinded to the inexorable laws of cause and effect—of action and reaction.

Yet many of these so-called independents will concede, under pressure, that a large share of their success is due to the unremitting toil, sustained through the years gone by, of a faithful minority of earnest growers who have steadfastly supported local and general associations. These organizations have borne practically the entire burden of the constructive development of the industry. They have supported their vision with their credit and used this credit to finance the construction of a majority of the best buildings now serving the industry, lacking which, this very season appalling losses would have been sustained. They, and they alone, are responsible for the amazing growth of market development and distribution, which is the most important single economic factor in the entire industrial equation.

Consider the figures descriptive of this accomplishment. Prior to 1910, it is estimated that boxed apples were distributed direct from the Northwest in carload lots to less than twenty-five cities in the entire United States and Canada. The great majority were bought up by a few large speculators and shipped to Chicago, New York, Philadelphia, Pittsburg, and Boston, and from these centers the surplus reshipped in small lots to other markets. This indirect method of distribution was not conducive to free consumption because the expense of so many handlings and combinations of freight charges made the fruit a luxury unavailable to the man in the street.

Now note what has been accomplished in the intervening years: The United States Bureau of Markets in a circular issued on May 1st, 1919, reports that there were shipped out of the states of Washington, Oregon, Idaho and Montana, of the 1918 crop, 18,849 earloads of apples, and that these 18,849 earloads were directly distributed to 743 different primary destinations scattered over every state of the Union and every province of Canada.

Now this impressive distribution has not, like Topsy, "just grown"—it is the clearly demonstratable result of intelligent, sustained, constructive salesmanship and advertising conducted and financed by the organized minority. But for this tremendous expansion of the market for boxed apples, nothing could have prevented a series of market disasters ending in the bankruptcy of the industry. Non-organization growers are too prone to attribute their period of prosperity to superficial causes, or to give undue weight to certain contributing causes, such as shortage of competitive crops, superiority of their product, etc. These factors are all important, but fundamental to the whole problem—the one indispensable controlling factor—is distribution and it cannot be too strongly reiterated that distribution is not a spontaneous growth, but a definite result, flowing from intelligently directed effort.

I think this is especially interesting as I hear so much talk of "cash buyers" which are well enough I think when recognized in their true proportion as a fractional part of the whole market, but a very dangerous factor when, as too often happens, the grower puts his whole dependence on the "cash buyer" and neglects to provide selling machinery which is reliable in years of market adversity when sales are difficult and require genuine salesmanship to effect, as well as in years like the past four or five in which a sales organization has, to the shortsighted ones among the growers, seemed only a burden.

Now I am not forgetting that my subject is a financial one, but these questions of organization, distribution, and marketing are fundamental to practical financing. The banker wants to know that the security behind his loan is ample and this assurance is strengthened when numbers of growers are joined together in guaranteeing an undertaking. But, the independent says: "The fruit is good security of itself." The banker answers: "Perhaps. It is good security if in strong, competent hands, but very doubtful security in weak hands." The banker wants to know that the industry he is financing has a sales policy and commands a dependable year-in-and-year-out, rain-or-shine marketing machinery that is able to cope with an adverse market situation as well as merely to ride the tide of prosperity. And it must never be forgotten that the law of equal and opposite reaction has never yet failed to operate—that the pendulum has never failed to swing backward as far as it swung forward. There are signs that commodity prices have reached if not passed their crest. A reaction is

coming sooner or later and while this need not spell disaster or even loss it does mean a declining market, when the real test of the strength or weakness, the soundness or rottenness of industrial organization will come.

"In time of peace prepare for war" was the immortal advice of the illustrious patriot for whom our great state was named, the banker's paraphrase of this is "In time of prosperity prepare for adversity."

The question of by-products and the many important interests tied in with the general fruit business belongs importantly to the general subject I am endeavoring to treat. For lack of time, however, I would briefly state that the question of financial strength of the borrower is the all important one, be the industry a cannery, a dehydrating plant, or any other. Any of these enterprises desiring bank help must observe great care to satisfy the banker that the organization is a well-rounded one, that it knows its business, that it has good marketing connections, and that its brands are backed up with every showing of intelligence and sincerity.

Northwest Apple Grade Schedule Submitted

AT the recent conference of the Northwest fruitgrowers held in Spokane a tentative apple grading schedule was submitted for Washington, Oregon, Idaho and Montana. This plan has been in prospect for several years and it is hoped that it will now be realized. The advantages claimed for the new schedule are that it is more simple than the ones now in use in the various states and that a uniform grading for boxed apples is very much needed. In making out the new schedule it was necessary for Washington to raise the color requirements on the fancy grade and for Idaho to lower them. Some of the size requirements were dropped and other changes made. The new schedule which has the en-

dorsement of the conference is as follows:

Extra Fancy.

Extra fancy apples are defined as sound, mature, clean hand picked, well formed apples only, free from all insect pests, diseases, blemishes, bruises and other physical injuries, scald, scab, scale, dry or bitter rot, worm stings, worm holes, spray burns, limb rub, visible water core, skin punctures or skin broken at stem, but slight russeting within the basin of the stem shall be permitted.

Fancy Grade.

Fancy apples are defined as apples complying with the standard of Extra Fancy grade, except that slight leaf

**"CARO"
FIBRE
FRUIT
WRAPPERS**

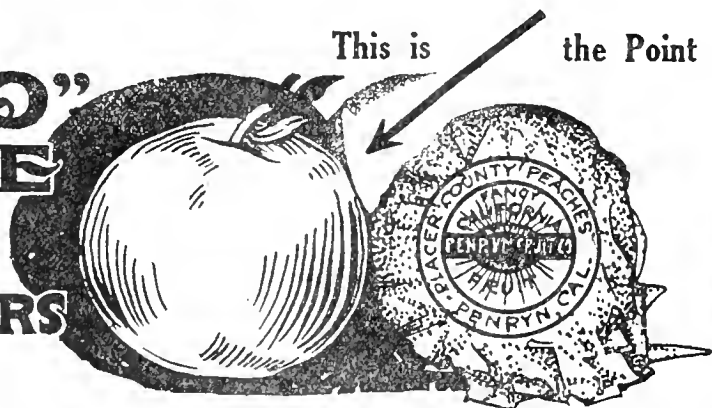

**Chemically Treated
"Caro" Protects
"Caro" from DessiCARE (to dry up)**

**"Caro"
Prolongs the
Life of Fruit
Why?**

Fruit decomposition starts from a bruise which opens tiny holes and permits the juice to escape and BACTERIA to enter. "Caro" clings closely and dries up the escaping juice. "Caro" ingredients harden the spot, kill the BACTERIA, arrests the decomposition—and thus **PROLONGS THE LIFE OF FRUIT**. If your fruit is worth shipping it is worth keeping in best condition.

Demand "CARO"—Wrap Your Fruit in "CARO"—The Fruit Buyer Knows "CARO"

Order from Any Fruit Company or American Sales Agencies Co., 112 Market St., San Francisco

rubs, scratches, or russeting shall be permitted up to a total of ten per cent of the surface, and provided that scab spots not larger than one-quarter inch in diameter in the aggregate shall be permitted in this grade.

"C" Grade.

"C" grade apples shall consist of sound mature apples which are free from infection, bruising or broken skin and which are not badly mis-shapen, provided that two healed worm stings, slight sun scald, and scab up to a total of one-half inch in diameter shall be permitted in this grade.

Combination Grade.

When Extra Fancy and Fancy apples are packed together the boxes must be marked "Combination Extra Fancy and Fancy." When Fancy and "C" grade apples are packed together the box must be marked "Combination Fancy and 'C' grades."

Orchard Run.

When Extra Fancy, Fancy and "C" grade apples are packed together the boxes must be marked "Orchard Run," but Orchard Run apples must not contain any fruit that will not meet the requirements of "C" grade. Note: It is unlawful to remove any apples from Orchard Run grade and thereafter mark grade Orchard Run.

Tolerance.

In order to provide for the variations incident to commercial grading and handling a tolerance of 5% from standard will be permitted in all grades.

Change in Color Requirements.

	<i>Color Per Cent</i>
McIntosh Red, Extra Fancy.....	66 $\frac{2}{3}$
Aiken Red, Fancy.....	25
Arkansas Black.....	25
Baldwin.....	25
Black Ben Davis.....	25
Gano.....	25
King David.....	25
McIntosh Red.....	25
Spitzenberg (Esepus).....	25
Vanderpool.....	25
Winesap.....	25
Jonathan.....	25
Black Twig.....	25
Missouri Pippin.....	15
Delicious.....	25
Staymen.....	15
Ben Davis.....	15
Hubbardston Nonesuch.....	15
Jenison.....	15
Kaighn Spitzenberg.....	15
Northern Spy.....	15
Rainier.....	15
Snow.....	15
Wagener.....	15
Wealthy.....	15
York Imperial.....	10
Gravenstein.....	10
Jeffrey.....	10
King of Tompkins County.....	10
Rome Beauty.....	15

*No color requirement on Fancy Rome Beauty 96 and larger.

Propagating the Apricot

In propagating the apricot it will succeed on the apricot root only where the soil is deep and with no indications of a clay subsoil or hardpan. The apricot may be planted on the peach root in a shallow soil or in a soil moderately heavy and retentive of moisture. The Myroholan root is the only stock to use if the soil is wet or subject to seepage in the spring.



TOP DRESSING TALKS, No. 3

Does Nitrogen make Fruit Buds?

" It is very evident that the application of nitrogen has been a very decisive factor in both the formation of the fruiting parts and the development of bloom buds. It is only where the nitrogen is added that any effect is noted."

The above are the conclusions of Prof. C. C. Wiggans, (Research Horticulturist, Delaware Agr. Experiment Station) as a result of experimental work done at Missouri Agricultural Experiment Station.

The following results were obtained by Prof. Wiggans. Trees were Rome Beauty budded on Paradise Stock.

FERTILIZER	No. of Trees	BLOSSOM BUDS IN		
		1916	1917	1918
Check, No Fertilizer	8	0	0	8
P & K, No Nitrogen	6	0	0	0
P & K, with Nitrogen	8	39	175	413

If you want fruit every year you must develop fruit buds by supplying an abundance of nitrogen.

ARCADIAN
Sulphate of Ammonia

Regardless of the kind of fruit you grow, *Arcadian* will develop the fruit buds and will feed a big crop to maturity.

Top dress with from 100 to 200 pounds *Arcadian* per acre in the zone of the feeding roots just before blossoming and increase your profits.

Write for free bulletin "Fertilizing the Apple Orchard."

Sulphate of Ammonia is the well-known standard article that has done you good service in your mixed fertilizers for years past.

Arcadian is the kiln-dried and screened grade, made fine and dry for top dressing purposes. Ammonia 25 $\frac{1}{4}$ % guaranteed. Made in U. S. A.

FOR SALE BY

CALIFORNIA: *San Francisco*, Hawaiian Fertilizer Co., Pacific Bone Coal & Fertilizing Co., Pacific Guano & Fertilizer Co., Western Meat Co., California Fertilizer Works; *Los Angeles*, Pacific Guano & Fertilizer Co., Pacific Bone Coal & Fertilizer Co., Agricultural Chemical Works, Hauser Packing Co., Hawaiian Fertilizer Co., Ltd., Southern California Fertilizer Co. OREGON: *Portland*, Swift and Co.

For information as to application, write

The *Barrett* Company

Agricultural Department

510 First National Bank Building, Berkeley, Cal.



FLOOR SPACE 200,000 SQ. FT.

SERVICE
 PLUS
QUALITY

IS THE REAL
BASIS OF VALUE

SCHMIDT PRODUCTS

LABELS
CARTONS
POSTERS
ADVERTISING
DISPLAYS

OUR NEW FACTORY
 WILL EMBRACE
 THE MOST MODERN IDEAS
 OF EFFICIENCY
 AND THE INSTALLATION
 OF NEW MACHINERY
 IS AN
 ASSURANCE TO OUR CUSTOMERS
 AND
 PROSPECTIVE CUSTOMERS
 THAT EVERY EFFORT
 WILL BE MADE
 TO RENDER
SERVICE and QUALITY
 EVEN SUPERIOR
 TO THAT GIVEN IN THE PAST

BRANCH OFFICES
 LOS ANGELES - FRESNO
 PORTLAND - SEATTLE
 SACRAMENTO - HONOLULU

47TH



YEAR

SAN FRANCISCO

Apple Industry, Theme of Transportation Men

INFLUENCE in promotion of Northwest industry by the transportation interests was manifested in Seattle Dec. 15 in the inauguration of a Transportation Apple Day, the Transportation Club of Seattle formally celebrating the first of what promises to be an annual apple event. The affair was held at the headquarters of the Transportation Club and was presided over by J. Curtis Robinson, traffic manager of the Northwestern Fruit Exchange. Mr. Robinson explained that Transportation Apple Day was the creation of Fred W. Graham, president of the Transportation Club, and he reminded the audience that a few years ago this same body had with great success inaugurated an annual Salmon Day. He pointed out that the transportation interests today represented the greatest industry in the United States—transportation, and it was to be expected that taking the initiative in a movement like this, stimulating the entire transportation to a "thought for apples," really meant something. It was creative work. He then outlined some important features of the apple industry, pointing out its tremendous volume, showing that today in the state of Washington alone six-and-a-half millions of apple trees were planted and 91,500 acres devoted to apple culture, the actual number of trees bearing fruit being 6,000,000. He also referred to Oregon and Idaho, and their heavy share in the industry, Oregon today devoting over 39,000 acres to apples.

W. F. Gwin, general manager of the Northwestern Fruit Exchange followed Mr. Robinson with a pointed talk on the apple industry in general. He complimented the Transportation Club on their Apple Day idea, declaring that the industry is served potently by all

efforts of this nature and that the industry had reached such vast proportions that service in it or to it now amounted to more than mere personal interest—its importance touched every department of our Northwest life. He said it was perhaps not generally known that today the Northwest apple crop was over twice the volume of the California orange crop, that the apple crop of the United States ranked ninth in importance as an agricultural product.

The event was made interesting by the presentation of motion pictures showing the development of the apple industry from the days of the Indian, the first series of pictures showing the development of irrigation projects, the planting, cultivating, spraying, irrigating, picking and packing of the apples, and also loading, icing and transportation. A second and third series of pictures displayed the marketing and advertising of the Northwest apple, and included views of the offices of the Northwestern Fruit Exchange, the exhibit being explained by Fitzherbert Leather, advertising manager. Decorations were supplied by the advertising department of "Skookum" apples, and the guests enjoyed an apple feast, "Skookum" apples being served to all.

Referring to the idea of Transportation Apple Day, F. W. Graham, president of the Transportation Club, stated that the apple industry was now the third industry of the State of Washington, and rapidly assuming large comparative importance in Oregon and Idaho. The movement over the rails of the enormous apple crop was of first importance however, since apples require refrigeration and prompt handling, while lumber and grain involve no such difficulties.

"The transportation interests are as much interested as the growers in this industry," said Mr. Graham. "We want them to feel that we know our responsibility, and indeed during the season of transportation of apples I think I make no mistake in saying that where the growers are anxious for the safe and fast transportation of the crop we are anxious and straining every nerve to allay their fears—to do the mortal best possible. Our Transportation Apple Day is a slight token to the industry of our appreciation, and also a conveyance of our determination to foster it and conserve it, so far as we are able, with our utmost endeavor."

Among the guests of the club present was Reginald H. Parsons, president of the Seattle Chamber of Commerce and Commercial Club and president of the Northwestern Fruit Exchange. Mr. Parsons is also the owner of large orchard acreage.

On December 22 W. H. Paulhamus, president of the Puyallup and Sumner Fruit Growers' Association spoke before the club on "How transportation employes can best serve the public." As usual Mr. Paulhamus handled his subject in a vein that was both entertaining and instructive.



W. F. GWIN

General Manager of the Northwestern Fruit Exchange, who says that the Northwest apple crop is now twice the volume of the California orange crop and has become so important that it touches every phase of industrial life in this section.

**BEST SERVICE -
QUALITY & PRICES**

FRUIT
LABELS

**THE
SIMPSON & DOELLER CO.**
1423-24 NORTHWESTERN BANK BLDG.
PORTLAND, OREGON.

E. SHELLEY MORGAN
NORTHWESTERN MANAGER

WE CARRY—AND CAN SHIP IN 24
HOURS—STOCK LABELS FOR PEARS,
APPLES, CHERRIES & STRAWBERRIES.

The Waldron Beauty Apple

The Waldron Beauty apple, an illustration of which appears on the cover page of BETTER FRUIT this month was propagated by G. W. Waldron of Oregon City, Oregon, and is the result of one of those accidents that some times occur in horticulture. In telling how he came to grow this apple Mr. Waldron says that several years ago he grafted some seedling trees and there was one that failed to grow, so he left it as a seedling. When it bore fruit the apples were of exceedingly fine quality and color.

The flesh of the Waldron Beauty is extremely white and of fine flavor and the tree of vigorous growth. In the Willamette Valley where it originated the fruit matures the latter part of September at a time when the early fall apples have been shipped and the early winter varieties are not yet ready for the market.

On this account it is believed that the Waldron Beauty is a very valuable new variety and will take a place among the standard apples of the Northwest.

Alfalfa and Walnut Orchards

Alfalfa can be grown in a walnut orchard with good results, provided there is sufficient water to keep the soil moist. Where water has to be lifted to the surface long distances it will be better not to plant alfalfa in a walnut orchard. Instead, during the summer the soil should be cultivated frequently to conserve the moisture.

BETTER FRUIT

An Illustrated Magazine Devoted to the Interests of Modern Fruit Growing and Marketing. Published Monthly

Better Fruit Publishing Company
703 Oregonian Building
PORTLAND, OREGON

Worm Extermination.

To the fruit grower the possibility of exterminating the worms should be a fascinating subject. From time immemorial worms have been the bane of the grower of fruit either in a small or a large way and in later years when the orchard industry has reached such huge proportions the loss from these insects which particularly infest the apple has run into many millions.

At first glance a plan to entirely rid large orchard districts of these pests seems impossible. Yet we find that in British Columbia, which now has an immense orchard development, that the extermination plan has been to a large extent a success—not through watchful waiting but through aggressive preventative measures. It is true that the codling moth is not as active in this more Northern district as it is in the districts in the United States farther south owing to the cooler temperatures at night when this moth, which is a nocturnal insect, does most of its work. But from time to time the codling moth has appeared in the orchards of British Columbia. When this has happened strict quarantine measures have been adopted in the sections affected and we have good authority for the statement that it has been exterminated in these districts.

Other evidence is to the effect that in a district in Washington which was badly affected but where the spraying operations were carried on under the direction of experts and thoroughness of application made the watchword that the proportion of wormy apples was decreased to a very small percentage. In view of these results the suggestion comes of itself that more drastic measures in spraying and inspection methods should reduce the losses from worms to an almost negligible amount. In any event a widespread operation of this character is well worth a trial.

Home Grown Fruit Stocks.

The ravages of the war to European horticulture is affecting this country more closely than was at first thought.

We find that although the lessened production of deciduous fruits in France, which has heretofore been a light buyer of American fresh fruits, should create a greater market for fruit products from this country, that the propagation of fruit stocks on which to grow fruit of which France has been a large shipper to America, has practically ceased. Of the two situations the latter is considered the most important by American fruitgrowing specialists in view of the demand for a greatly increased production of all fruits in this country.

The growing of disease free and vigorous fruit stock is one of the most important phases of horticulture. With the exception of peach stock and a few varieties of apples very little fruit tree stock has been propagated in America. One of the first sections of the country to realize the importance of taking up the matter of home grown fruit stock was California and experiments will be made there next year to determine its possibilities in that state.

It is also proposed by the United States Agricultural Department to make a survey of the United States for the purpose of selecting those sections of the country where this industry can be tried out most successfully. With the variety of soil and climate that can be found in America it would seem that should be no bar to growing large quantities of these stocks successfully. The United States as the greatest all around fruit producing country in the world ought to produce its own stocks.

Growing Fruit for the Home.

A statement recently sent out by the United States Department of Agriculture should find its way into every home where there is an opportunity to grow fruit. The statement says:

Well-ripened, sound fruit is healthful. It is also a valuable food. It should form a part of every meal, fresh when possible, or dried, canned or otherwise preserved.

Home-grown fruit is desirable—

Because it reaches the family fresh and in the best possible condition.

Because the family has fruit of which it would often be deprived if it had to be purchased.

Because, if the proper varieties be selected, a continuous supply of fruit of superior quality may be secured, regardless of market prices.

Because any surplus may be sold without difficulty, or may be canned, evaporated, or otherwise conserved for use when fresh fruit is not available.

Because the care of the home fruit garden provides for spare time congenial and profitable occupation which is in reality recreation for those who enjoy seeing things grow.

Thousands of persons who have the opportunity grow fruit for home consumption either neglect to set out the trees or plants or if they have them fail to give them the care that brings success. Formerly one of the cheapest commodities used in the household, fruit has now taken its place in the list of high priced foods and its production for home use means a large saving in the family living expense. Even the grower of fruit in small quantities can now dispose of any surplus at a profitable figure. Home grown fruit should no longer be regarded as an incident in family life but as a distinct asset.

Grape Fruit Sells High

A record high price for California grape fruit was recently paid for a car of 535 boxes shipped from Woodlake. It brought the growers, Thomas Edmiston, Henry Hein and Capt. Lancashire \$6.00 for fancy and \$5.00 for standards f. o. b. shipping station.

Failed to Spray.

Sez Farmer Bill, it's one darn thing, or it's three or four,
There's worms and flies and bugs galore,
And smut and blight and anthracnose,
And take-all, scab and other foes,
Some of them fly, and some just crawl,
And some don't even move at all,
But whatever the shape or name may be,
They manage to ruin our crops, by Gee!
—Marion County (Mo.) Farm Bureau News.

What the Newspapers Interested in Fruit Are Saying.

"Nil desperandum" is the spirit that prompted many of our growers to forego sleep rather than permit the fires in their apple houses to die down during the cold spell.—*Hood River News.*

Apple holdings in cold storage are considerably in excess of last year, according to government reports. Barreled stocks are only slightly larger than a year ago, but there is a big increase in boxed apple holdings. The big Northwestern crop of apples is responsible for the heavier stocks of boxed fruit, there being two and three-quarters millions of boxes more held in storage now than a year ago.—*The Packer.*

Want to live to a ripe old age? Well, follow the example of Dan B. Day of Lincoln, Kansas, who passed his eightieth birthday recently and is more vigorous and active than most men of fifty. Mr. Day declares that his vigorous health is due to his eating from three to five apples every evening before going to bed. He enjoys his apples and lots of them, Mr. Day declares, just as much as he did seventy years ago, when he began the practice.—*Oregon Journal.*

Five thousand dollars per acre is the amount William Hanks of the Naches figures on making from a new variety of strawberry he has developed. With the average yield of this fruit 250 crates, he claims his variety will produce 1,000 in a single season. He has never, he says, received less than \$5 a crate. He has fifteen acres set to the plants between young apple trees. This season he preserved 1,000 gallons of the fruit.—*Yakima Valley Progress.*

The shipping of immature fruit in the end defeats its own object, which is presumably to get ahead of the legitimate market and reap the benefit of extra high prices. While the public may be taken in by such fruit for a very limited period, the result is to demoralize the market, and all fruit growers suffer for the sharp practice of a few who cannot be content to let their product stand on its merit.—*American Fruit Grower.*

As we have traveled over the South these many years, we have often wondered as we saw the weatherbeaten, paintless houses whether or not the owners of those houses were mad at the paint dealer and manufacturer. Weatherbeaten, paintless houses are not pleasant to the eye, and what's far worse, unpainted buildings exposed to the weather will decay and bring a repair and lumber bill in about half the time that a house kept well painted does. Most of us look on the cost of good paint as an unnecessary expense, something to spend money for when everything else imaginable has been bought and paid for.—*Southern Ruralist.*

These are days of commercialization. Everything is commercialized. It is a bad omen, but we must be optimistic enough to know that it cannot go on forever. Germany's ruin was simply due to her placing commercialism and prosperity before God. High prices of the necessities of life have made us almost as selfish as beasts. The result is natural. It is a poor tribute to a human being to say only of him when he has left this world that he was a good provider for his own family. Such a tribute may be said of every bird that flies and every beast that stalks the earth. Beasts have just as great family ties as the human family. A human being rises above the beast when his unselfishness extends beyond his own family, and causes him to recognize the brotherhood of man.—*Southern Fruit Grower.*

Extends Operations of Small Fruit Industry

W. H. Paulhamus, pioneer in launching propaganda as to the opportunities in the Northwest for the small fruit-grower and president of the Puyallup and Sumner Fruit Growers' Canning Company of Puyallup, Wash., is still a firm believer in future prospects for a greatly increased production of berries. Having brought the Washington branch of the organization he represents to a high state of efficiency and success Mr.



W. H. PAULHAMUS

President Puyallup and Sumner Fruit Growers' Canning Company, which is extending its operations in small fruit industry.

Paulhamus entered the Oregon field early last spring and established a large and modern canning and berry handling plant at Albany. This field was selected on account of the large acreage of soil in the vicinity of Albany adapted to berry growing and also due to the fact that a large number of fruit growers there were willing to insure sufficient tonnage to make the plant a success.

The Puyallup company now plans to widen its operations in Oregon by establishing another cannery to be located at Salem. In connection with this movement growers of 300 acres of loganberries recently held a meeting at Salem and formed a tentative organization. W. R. Scott, Oregon manager for the Puyallup company addressed the

meeting. Mr. Scott said his company had great faith in the future of the Salem district, and it was the purpose of the corporation to erect a cannery there in the event sufficient acreage was available. He declared that there was no danger of low prices for at least another year, for the reason that the demand for berries was fast increasing, both in the local and eastern markets.

During the past season the Puyallup and Sumner Fruit Growers' Canning Company handled in the neighborhood of 20,000,000 pounds of berries at its Washington plants, the larger part of which were sold before the product was ready for shipment. This tonnage is expected to be greatly increased this year at the Puyallup and Sumner plants while a large output is looked for by the company from its Oregon enterprises.

Another Montana Man Resigns

Montana is again called upon to regret the retirement of one of its prominent men in horticulture owing to the decision of Mr. A. L. Strausz to sever his connection with the Montana State Board of Horticulture.

Mr. Strausz has served as State Horticulturist since June, 1917, and during that time has done much to assist and encourage the fruit growers in Montana, and has won the respect and confidence of every one who has had the good fortune to meet him. Previous to his appointment as State Horticulturist, Mr. Strausz was for three years instructor in horticulture at the State College of Washington. He graduated there in 1913 and in 1917 was given the degree of master of science.

As proof of the faith which Mr. Strausz has in the fruit industry he has purchased a tract of bearing orchard in the Yakima Valley near Yakima, and will in the future direct his efforts to the production of apples and pears.

Montana Fruit Men to Meet

The Montana Horticultural Society will hold its annual meeting at Missoula on January 21, 22, 23, 1920.

One of the most important subjects up for discussion at this time will be the "Standardization of Grades for the Northwest." The Department of Agriculture has worked on this problem for several years and the grade rules which they have formulated were adopted at the Grade and Pack Conference held lately at Spokane and will be in force in the State of Washington for the coming year.

Jam Shortage Predicted

A report from the Canadian Trade Commissioner, stationed at Manchester, England, bears out the statement recently made by the American trade representative in London, regarding a shortage of jam in the United Kingdom.

The Canadian commissioner says that "though there may be fair quantities on the market during the next three months, it is anticipated that a serious shortage will be experienced from January next until May. The high prices of fruit ruling this Summer made it impossible for jam makers to lay down large stocks. For example, raspberries, which were at the high price of \$225 a ton in 1918, rose to \$425 this year; black currants advanced from \$300 to \$525; red currants rose from \$160 to \$250; gooseberries advanced from \$135 to \$230; and strawberries rose from \$200 to \$480. To these enhanced values of the raw material had to be added the increased cost of labor, coal, jars, bottles, etc."

Bees and Fruit

Fruit growing and beekeeping belong together, and fruit growing absolutely requires bees for best results. The bees do the indispensable work of pollinating the blossoms of most all fruits, insuring larger yields and better quality. Every up-to-date fruit grower knows this. Beekeeping is easy to learn, small expense to start. Out of our 50 years' experience in beekeeping we can tell you how. Better fruit and a crop of honey will be your profit. Write us today, asking for our two handsome booklets, "Bees and Fruit" and "Beekeeping for Pleasure and Profit." Tell us if you have ever kept bees.



THE A. I. ROOT COMPANY
512 Main Street Medina, Ohio

26

1920 LILLY'S Seed Catalog

Established 1885

ILLUSTRATED IN COLORS

—A dependable book telling about the "Best Seeds for the West" which are specially selected and grown to suit our climatic conditions.

—Entirely different from any other, the Lilly Seed Annual is said to be the leading Western Seed Catalog.

—It contains over 300 photo engravings showing actual results produced from Lilly's Seeds.

WRITE FOR YOUR COPY TODAY



The Chas. H. Lilly Co.
Seattle Yakima Portland
The Northwest's Greatest Seed House

HAYES



How to Kill the Pests and Stop Your Losses

SEND THE COUPON on opposite page. Read these *new* facts on spraying now. You can't expect your apples, peaches, pears, plums, grapes and other fruit to live and produce profitable crops if infested with San Jose Scale, Codling Moth, Scab, Blotch, Bitter Rot and other deadly, life-sapping diseases and pests. You can't expect your potatoes to develop and grow — your Hogs to put on money-making weight — or your Hens to lay — if eaten up and tormented by bugs, mites and lice! Authorities say that the deadly ravages wrought by these ruinous, destructive pests cost farmers untold millions each year.

Spraying Will Stop Your Losses

Learn how spraying will enable you to drive these pests from your farm. How spraying will save your part of this tremendous loss and add hundreds—even thousands—of dollars to your profits each year. Send the coupon for all the facts now.

* * * *

There is a type of Hayes Sprayer for Orchards, Gardens, Field Crops, Vineyards, Nurseries, Trees, Potatoes, Cotton, Flowers, Alfalfa, Sugar Beets, Disinfecting Hogs and Poultry, Whitewashing and Cold Water Painting. Whether you need the great Triplex Fruit-Fog Power Sprayer or the smallest Garden Atomizer, you'll find it in the Hayes Line.

Send the Coupon

Fill out and mail the coupon on opposite page now. Tell us how many trees you want to spray and how old on the average. Also other uses you have for your sprayer. We'll tell you where and how you can get the style of Hayes Sprayer best suited to your needs, and its price. We'll also send our Big New Book of Hayes Sprayers and our Valuable New Spraying Guide FREE. Send the coupon today.

50 Styles of Sprayers for All Purposes



The Hayes Compressed Air Outfit sprays Garden quick, easy and cheap



The Hayes Wheelbarrow Sprayer is ideal for spraying Hogs



The Hayes Atomizer is worth its weight in gold for spraying Flowers

**"America's Foremost Spraying Apparatus"
Sprayers for All Purposes**

FRUIT-FOG SPRAYERS

Send Coupon for Secret of "Fruit-Fog" Spraying

LEARN why Fruit-Fog is the greatest boon to Fruit Growers ever discovered. How mighty yields that are almost unbelievable are being produced in Fruit-Fogged orchards. This is because Fruit-Fog—the vaporous super-spray—is the only spray *fine enough* to seek out and kill the *hidden* pests.

These *hidden* pests are the millions of insects that infest the microscopical niches and crevices in bark, buds and foliage, where no heavy, coarse low-pressure spray can reach. These hidden pests cost fruit growers untold millions each year. They sweep away fine fruit worth fortunes in a single season. Yet Fruit-Fog will entirely *exterminate* them. Fruit-Fog will add 100% to 5,000% to your yield and your profits this year. Send the coupon and learn *all* the facts.



Hayes Fruit-Fog Gun

World's fastest spraying apparatus. The only gun which combines great speed with the thoroughness of Fruit-Fog. One man handles capacity of big Power Sprayer. Simple twist shoots long spray to top of tallest trees, or wide spray for close-up work, or shuts off tight—preventing waste of solution between trees. Guaranteed. Write for details.

Hayes Hand Barrel Spray Pump

Hayes Platform Duplex Hand Sprayer

Hayes High Pressure Triplex Power Sprayer with truck

"Fruit-Fog" Sprayers With Famous Engine

Fruit-Fog is produced by Hayes **guaranteed** 300-lb. high pressure and the Hayes Scientific Nozzle. Because of its **vapory fineness**, Fruit-Fog has wonderful **adhering power**. No drops form—no solution wasted—no buds or leaves knocked off—as with heavy, coarse, low-pressure sprays.

Hayes Fruit-Fog Sprayers are skillfully designed and finished. Every part is positively standardized. They give enduring service and greatest efficiency under high pressure. To insure the best possible engine service, we have selected the famous Fairbanks-Morse "Z" Engine after countless comparative tests.

Valuable Spraying Guide Sent FREE

Send the coupon for Big Book FREE, which pictures and describes the Fifty Styles of Hayes Sprayers. Also for our valuable FREE Spraying Guide. See why the deadly pests that infest your farm **cost you more** each season than several Hayes Spraying Outfits. Learn how to **stop these losses**. How to recognize and kill **every pest!** What solution to use—how to mix it—how and when to apply it. The Book and Guide are worth hundreds of dollars to any Farmer or Fruit Grower. In sending coupon, please tell us how many trees you have and how old on the average. Also other uses for your sprayer. Send coupon today.

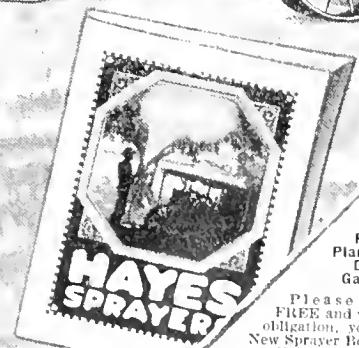

Hayes Pump & Planter Co. Dept. K. Galva, Ill.

Please send FREE and without obligation, your Big New Sprayer Book and your Valuable Spraying Guide.

Number of trees

Average age

Other uses

Name

P. O.

State

R F D

Hayes Pump & Planter Company

Department K

Galva, Illinois

(37)

Nation-Wide Service

Users of Hayes Power Sprayers are within only 24 hours of a service station at all times. In case of accident at a critical time this quick service may save your fruit crops. Hayes Power Sprayers, Engines and Repairs are distributed by **FAIRBANKS-MORSE & CO.** Hayes Hand Sprayers are distributed by Hardware, Implement and Seed Jobbers



SULPHUR

It has been proven and so recommended by the University of California that if you sulphur your grape vines and orchards 6 times they will not be affected by MILDEW or RED SPIDERS.

ANCHOR Brand Velvet Flowers of Sulphur, also EAGLE Brand, Fleur de Soufre, packed in double sacks, are the fluffiest and PUREST sulphurs that money can buy; the best for vineyards; the best for bleaching purposes. LEAVING NO ASH.

VENTILATED Sublimed Sulphur—Impalpable Powder, 100% pure, in double sacks, for Dry Dusting and making Paste—Sulphur.

For LIME-SULPHUR SOLUTION, use our DIAMOND "S" BRAND REFINED FLOUR SULPHUR.

To create additional available plant food, drill into the soil 100 to 400 pounds per acre DIAMOND "S" BRAND POWDERED SULPHUR, 100% pure. This has increased various crops up to 500%. The sulphur may be applied broadcast by hand or with a duster, but usually an ordinary land plaster sower or lime spreader is used.

Also PREPARED DRY DUSTING MATERIALS, Tobacco Dust, Dry Bordeaux, Dusting Sulphur Mixtures, etc.

And Standard LIME-SULPHUR SOLUTION 33' BE. Fungicides and Insecticides.

Carried in stock and mixed to order.

San Francisco Sulphur Co.

624 California St. San Francisco, Cal.

We are equipped to make immediate shipments. Send for "ILLUSTRATED BOOKLET"; also booklet "NEW USES FOR SULPHUR." Price-list, and Samples.

Please state for what purpose you use the sulphur, quantity needed, and date of shipment preferred.



**Winds and Rains;
Aches and Pains**

EXPOSURE to bad weather means *rheumatic twinges* and other handicapping after-effects. We can't be too careful in relieving *pains and aches, stiff joints, sore muscles, lumbago, sciatica.*

"We keep a large bottle of Sloan's Liniment in the house all the time to use when an attack comes on. You know Sloan's is one of the old timers. Doctor Earl S. Sloan put it on sale 38 years ago.

"We get the biggest bottle because it's more economical. A little applied to the spot *penetrates without rubbing* and promptly eases up the pain and ache."



BELL & CO.

Incorporated

WHOLESALE

Fruits and Produce

110-112-114 Front Street
PORTLAND, OREGON

Write us what you have to offer - Car lots or less

Timely Topics and Advice for the Fruitgrower

Good cultural methods and correct soil management will do more than anything else to prevent many of the diseases of fruit trees. This should be remembered by orchardists who are inclined to resort too much to artificial means which take the form of remedies rather than preventive methods.

Tile drainage has been found to correct many of the areas of grayish-white damp soil quite common throughout Ohio on which farm crops have never been profitable, according to soil specialists of the Ohio Experiment Station and Ohio State University. According to specialists there is no important cause for lack of crop production, except that the soil has a low content of organic matter. Fertilizers do not bring response in these soils. When tile-drained thoroughly the increased yield is at once noticed. Under drainage acts as an aerating agent and thus allows the roots to penetrate more easily into the subsoil, and after systematic crop rotation and fertilization is carried out, these areas become darker in color and quite as productive as the alluvial soils.

Heart rot is bound to get in wherever sun-scald cankers are not taken care of or good-sized branches are cut off without disinfecting the wood, according to Dr. S. M. Zeller, assistant pathologist at the Oregon Agricultural College. Once started heart rot is difficult if not impossible to control. The only safe way is to prevent the start of the trouble by disinfecting every wound made on the body or main branches of the tree, according to Dr. Zeller, who recommends a coating of Bordeaux paste, and in case of large wounds treating with the Volck method of driving copper nails into the exposed wood.

A dust spray formula recommended by a successful orchardist is 100 pounds of dehydrated lime, 20 pounds of flowers of sulphur, 5 pounds of powdered bluestone and 5 pounds of Paris green or 4 pounds of powdered arsenate of lead. The cost of applying the dust spray is considerably less than that of the liquid although the expense of the dry material itself is greater.

Damage to young fruit trees during the winter by rabbits and mice may be best prevented where these pests cannot be gotten rid of entirely by the use of tree protectors. The best of these protectors are made of galvanized iron wire, which lasts for several years, and can be purchased at a reasonable figure.

Studies in comparison of spring and fall-plowed land made by soil specialists in Ohio show that early spring-plowed land contains practically as much moisture for crop production as fall-plowed soil. Fall plowing is regarded as essential where labor conditions do not permit of spring plowing, or where it is necessary to destroy insects in infested lands. With spring plowing specialists point out it is possible to use a cover crop on land after other crops are harvested.

The time to remove peach tree borers is in the fall. At this time the borers feed under the gum for a few weeks before entering the bark. If the gum is scraped away the borers are removed. The holes of those who have entered the bark can be easily seen and they can be removed by hand with a sharp knife. Except when there is a freezing temperature the borers remain alive during the winter and once beneath the bark are much more difficult to remove in the spring.

**G. L. Davenport
Grower and
Shipper**

MOSIER, OREGON

MAIN OFFICE

147 Front Street, PORTLAND, OREGON

APPLES - PEARS

Whole root stock that
will give results

Send for Price-list No. 10

Trees - Shrubs - Vines - Plants

J. B. PILKINGTON

NURSERYMAN

Portland

Oregon

Ridley, Houlding & Co.

COVENT GARDEN, LONDON

WE ARE

**Specialists in
Apples and Pears**

CABLE ADDRESS: BOTANIZING, LONDON

Codes: A. B. C. 5th Edition and Modern Economy

Northwest Notes from Here and There

OREGON.

Figures obtained from the packing houses at Roseburg, Oregon, indicate that the prune crop of Douglas county this year will total 7,000,000 pounds. The prices received by the prune growers of this section this year were the highest on record although the crop was not as large as in some former years.

Learning that frozen apples were being shipped from some points in Oregon during the past month the railway administration took steps to protect the roads against claims for damages for the transportation of this class of fruit. To secure information in regard to these shipments inspectors were placed at the shipping points by the railroads.

A tractor demonstration that caused a good deal of interest was held in Hood River during the month. Demonstrations of plowing and orchard cultivation were made by small models. Many apple growers who are contemplating the purchase of these machines in the spring were in attendance.

While the extreme cold weather which hit Portland about the middle of December, lasted the apple trade was almost entirely suspended. Shippers were warned that they would make shipments at their own risk. The situation during the cold spell in the Pacific Northwest was similar to that in the Portland district and apple shipments in this territory were pretty generally tied up.

Under the direction of Prof. R. V. Wright, Hood River is this winter having a short course in agriculture. Prominent fruitgrowers and representatives of the Hood River Experiment station are assisting Professor Wright in the work.

Newberg made its entry as an apple shipping center this year by marketing 100 cars of apples, a part of which were sold for export to England and the Scandinavian countries. To handle the rapidly growing crop in this section a large cement block apple warehouse and packing plant is now in use. The packing plant contains all the latest apparatus including power graders and gravity conveyors which facilitates moving the crop rapidly. On this account Newberg growers were able to market their apples early and experienced very little difficulty from the crop shortage. The varieties grown in this district are the Spitzenberg, Newtown, Jonathan and Wagener.

Medford about wound up its shipment of an 800 car apple crop December 15. While this section has experienced some damage from the cold spell it is stated that not over 20 cars of fruit were frozen and these were in the storage houses of the owners on their orchard properties. Prices for apples in the Medford district this year have been more than satisfactory.

A box of apples of the Red Cheek variety found in a cellar in Portland which was recently being cleaned had been there since the winter of 1917. The apples were in a good state of preservation and are causing Oregon growers to again call attention to the long keeping qualities of Oregon apples. The fruit was grown at Mosier.

Investigations at Hood River where the temperature dropped to 27 below zero led to the belief that little damage was done by the December freeze to apple orchards although it is feared that the peach trees in that section were injured.

Stanfield marketed a crop of apples this year that is expected to return growers \$75,000. The varieties produced in this district are Rome Beauty, Jonathan and Winesap and 50 per cent of the crop was packed out as extra fancy. The Stanfield Growers' Association shipped 45 cars of the crop.

Besides the large shipment of apples marketed by the Dufur Orchard Company which owns one of the largest single orchard tracts in the world, other growers in that district are reported to have shipped nearly 20 cars of apples each this year. The Dufur Orchard Company's holdings which came into bearing for the first time on a commercial basis this year yielded 300 cars of fine fruit.

A report from Salem is to the effect that a cannery at Albany has offered the loganberry growers of Marion county 8 cents a pound for

their next year's crop of fruit. The offer is said to carry with it the guarantee that the purchasers will meet any advance in the market price above the 8 cent quotation.

The membership in the Oregon Growers Co-operative Association which has been growing rapidly is reaching into all parts of the state. Contracts with the organization now include a fruit acreage of over 15,000 acres. Salem growers alone have come into the association to the extent of over 3,200 acres while over 1,000 acres of prunes in the northern part of Yamhill County will be controlled by the organization.

At the recent rate hearing held in Portland to consider the increase in freight rates on apples it was stated that the new rate means an increase to apple shippers of \$96.37 a car on fruit shipped to Chicago. The testimony submitted by the representatives of the fruit-growing industry in the Northwest was to the effect that the new rate is discriminatory and should therefore be reduced.

WASHINGTON.

Fifteen million dollars is the estimated return to growers of the Yakima Valley for their 1919 apple crop. The total income in this valley this year from all agricultural products is estimated at \$40,000,000. The return from fruit and other products of the soil in the Wenatchee district is estimated at \$20,000,000.

The Skookum Packers' Association is understood to be contemplating the construction of a warehouse at Spokane to carry several hundred cars.

At a recent luncheon of the Spokane Chamber of Commerce a feature was the introduction of Rainier apples for all present. The

Pull Stumps

Clear Land the Easy Way—
Get This Book

Hercules Triple Power Stump Puller
More Hercules Stump Pullers in use than all others combined. Reason—they make big money for owners. No stump too big. No land clearing job too tough. Man and horse clear an acre a day. Pull stumps and turn loading acres into crops.

Hercules Portable
All-Steel Triple Power Stump Puller

GET FREE BOOK—Filled with photographs. Special low price to first buyers. 30 days' free trial. Unlimited Guarantee. Get the story. Mail postal today.

HERCULES MFG. CO.
169 28th Street, Centerville, Iowa
Both Horse and Hand Pullers

All-Steel Triple Power
With or Without Wheels

DEPENDABLE TREES

Planters, it is time to order your Fruit, Shade and Nut Trees, Berry Plants, Shrubbery, Roses, etc., for fall or spring planting. Send for our large illustrated catalogue from which to select your list; it only costs you 5 cents in stamps for postage. Our trees are mighty fine, but we haven't enough. If you WANT trees, don't delay ordering.

OREGON NURSERY COMPANY

ORENCO, OREGON

*Humpty Dumpty sat on a wall;
Humpty Dumpty had a great fall;
But every joint
Was true and strong;
So Humpty Dumpty couldn't go wrong.*

Like Humpty Dumpty, every **Bloedel Donovan Box** is constructed so true and strong that it will withstand the roughest handling. The contents of these boxes are safe. Selected spruce and careful workmanship insure satisfaction when these boxes are used.

BLOEDEL DONOVAN LUMBER MILLS
1018 White Building
Seattle, U. S. A.

Prospects for American Fruit in the United Kingdom

By Edward A. Foley, American Agricultural Trade Commissioner at London

BEFORE discussing the fruit situation in the United Kingdom and its relation to the prospects for American fruits, I wish to call attention to the decision of the British Food Controller to limit the retailers' profit on fruits. This regulation is not yet in effect in all parts of the country. Just what the margin of profit will be was left to the Food Control of the various sections of the country. At the time of writing this report (October 24) the profit allowed the retailer in the Birmingham section had been set at 33 1/3 per cent—that is, fruit must be sold to the consumer at not more than 33 1/3 per cent above the maximum price allowed the wholesaler.

This margin of profit would be probably more than fair if it were not for the fact that perishable products deteriorate and rot, and such a profit may be insufficient to cover the losses from such sources.

If the other districts follow the lead of Birmingham, and I have reason to believe that they will, a radical change will be made in the retailing of American and other fruits. The retailer will buy a week's supply of apples and a smaller supply of the more perishable fruits; he probably will not take any chance of loss through deterioration. This will throw the stocks back on the wholesaler, who has in most cases no storage facilities and who is also bound by the maximum price fixed when the value of the pound sterling in New York was around \$4.60. It may also disturb the equilibrium of the markets. Under the old system the re-

tailer fell back on his accumulation in the cellar when there was a shortage in the wholesale market. As he probably can not afford to carry a reserve supply under the new system he must go without supplies during the shortage. This regulation will also tend to reduce further the price to the producer, as the wholesaler must carry the loss by deterioration and will recoup this loss from the sale of the fruit, which he must sell at the fixed maximum price, or lower. This condition is one that should be watched very closely, as the margin between profit and loss has been very close this year. It might be well to notice that the era of high war-time wages is over and that there is considerable unemployment. These two factors were absent in last year's market conditions.

Apples—It is difficult to get a very accurate estimate of the 1919 apple crop of Great Britain. However, 230 odd inquiries showed that 100 placed the crop at normal, 80 over the average, and 50 under the average. The supplies are pouring into the London and other markets in large quantities at lower prices; hence, it is safe to say the crop is larger than has been produced for some years. The prices of English cooking apples range from \$1.50 to \$2.10 per bushel; dessert varieties, \$2.10 to \$4.20 per bushel. Many of the most careful importers are dubious of the success of the importations of apples into Great Britain this year. At the time this report was written American apples could be bought for 60 cents per box less in Liverpool than in Boston.

American barrelled varieties have been ranging from \$8.35 to \$14.10 per barrel, but in many cases the fruit has been out of condition, and the prices, therefore, have been unsatisfactory. However, fruit arriving in sound condition and well graded brings the maximum price. A few consignments of American boxed apples have arrived and have sold for an average of \$3.75 per box.

Considerable quantities of apples from Nova Scotia have been arriving, the prices ranging from \$5.20 to \$13.55 per barrel. A great many of these apples also have arrived out of condition and have brought unsatisfactory prices. With a reported Nova Scotia crop of from 1,000,000 to 1,500,000 barrels, the majority of which find their way to the English markets, and a large domestic crop, careful attention must be paid by American exporters to this market, especially until the absorption of the home crop.

I am not at all pessimistic about the outlook for American apples in this market, but I do want at this time to urge shippers to be careful of conditions here, especially as the margin of profit is so close. And, above all, must Americans be careful of their pack. High class, well graded apples will bring the maximum price, but ungraded stock falls into competition with the ungraded home stock and is slaughtered.

And there is a lot of this ungraded home stock. Every huckster's cart around London is filled with it.

Pears—British pears range from \$2.10 to \$6.67 per bushel; American pears from \$6.25 to \$7.30 per box. The condition of many California Bartlett pears left much to be desired. Those on the London market really were not fit for sale. Some pears, however, arrived in excellent condition and brought a good price.

Grapes—Large quantities of Almeria grapes are usually absorbed in the British markets. Late heavy frosts, however, have affected the shipping and carrying qualities of these grapes and their importation has about finished. It is quite possible that the American grape could be successfully introduced at this time. A small shipment of Malagas from California has recently arrived in good condition. They have only the competition of the hot-house muscatel at \$0.62 to \$2.50 per pound; therefore, if the American grape can be landed here successfully, there is

MYERS POWER SPRAY GUN

**CAN BE USED
SUCCESSFULLY
WITH ANY
POWER
SPRAY
PUMP**

**"BROAD OR LONG
DISTANCE SPRAY"**

**AS SIMPLE AS
A-B-C TO ADJUST**

You will appreciate the remarkable simplicity of the Myers Power Spray Gun — You will like its common-sense features that have made it so successful — You will be more than pleased with its easy adjustment (long distance or broad fanlike spray by one third turn of handle) — You will marvel at the uniform manner in which it discharges the spraying liquid and will appreciate its capacity range, (4, 6, 8 or 10 gallons) **adapting it for use with any power spray pump** — and, above all you will profit by the time, labor and material it saves during spraying operations.

Help is scarce — time is money. Here is the opportunity for relief — equip your Power Spray Outfit with a MYERS SPRAY GUN — the simplified one man spraying device. Your dealer will supply you or write us.
1920 Spray Catalog on request.



F.E. MYERS & BRO. NO. 135 ORANGE ST.
ASHLAND, OHIO.

ASHLAND PUMP AND HAY TOOL WORKS

PACIFIC NORTHWEST DISTRIBUTORS

PORTLAND, OREGON



SPokane, WASH.

BUY FROM THE LOCAL MITCHELL DEALER

TREES AND SHRUBS



Fruit trees budded from bearing orchards. Apple, Pear, Cherry, Peach, Plum, Prune, Apricot, Quince, Grape Vines, Shrubbery, Plants, Raspberries, Blackberries, Logans, Dewberries, Asparagus, Rhubarb, Flowering Shrubs, Roses, Vines, Hedge, Nut and Shade Trees. Carriage paid. Satisfaction guaranteed.

WASHINGTON NURSERY CO.
Toppenish, Washington.
Salesmen everywhere. More wanted.

every reason to believe that a successful import trade can be established.

Oranges—The orange situation is also interesting and encouraging. It is reported on good authority and it is in fact generally conceded that the Spanish crop in Valencia is only a moderate or a light to moderate one. The crop in the adjoining districts, Murcia, Denia, Gandia, etc., is reported to be good. The Spanish growers insisted on high prices during the war and are maintaining them now. These conditions should allow American, especially California, oranges considerable scope at remunerative prices. The arrivals of Murcias so far have realized \$5.00 to \$7.30 per half box; Valencias \$7.90 to \$9.00 per half box.

The Jaffa crop is only a moderate one, estimated at 500,000 to 750,000 boxes. This is said to be about one-eighth of the 1914 crop. The shippers are here trying to obtain advances on this crop, as the cost of material and labor there is very high. The freight is expected to be about \$1.70. It is anticipated that one-half of this crop will be used for the demands of Turkey and Egypt.

As in apples and other fruit so in oranges the study of market conditions is a prerequisite of success. A high price in a market indicates a shortage on the market on the auction day but is absolutely no indication of the number of boxes of produce in transit to that market. Uninformed American shippers frequently noticing these prices ship large consignments to the market only to find that a good many others equally uninformed have done the same thing. The inevitable result has been a glut, and the fruit has been sacrificed to the hucksters to get whatever was possible out of the consignment.

Northwest Beekeepers to Meet

The Inland Empire Beekeepers' Association will hold its first regular annual meeting at the Davenport Hotel in Spokane, Wash., Jan. 26 and 27, 1920. Preparations are being made for the best and largest meeting of beekeepers ever held in the great Northwest.

It is expected that there will be present leading beekeepers from the East and South, including representatives of the older bee-papers and bee-supply dealers.

Beekeeping in the Northwest is going forward with wonderful strides, and this section of the country is destined to surprise the older portions with its annual honey crops. Come to the convention, Jan. 26 and 27, 1920, and help make it a most profitable meeting of beekeepers.

EDGAR L. LUDWICK, Secretary,
Sandpoint, Idaho.

NOW is the time to send to
Milton Nursery Company
MILTON, OREGON
FOR THEIR 1919 CATALOG.
FULL LINE OF NURSERY STOCK.
"Genuineness and Quality"

WHEN WRITING ADVERTISERS MENTION BETTER FRUIT



The **FARMER** says=
"for stumping
genuine **GIANT**
has no equal"

From recent letters of ten farmers who have used Giant Powders for Stumping we make these extracts:

"1. Your Giant Farm Powders shoot the roots. 2. They have wide breaking power and less bad gases than others. 3. I get the same excellent results from them every time. 4. They are always uniform. 5. I used eleven tons and wouldn't have any other make. 6. I want to sell a lot of other powder that I have because Giant does the work much better. 7. Genuine Giant can't be equalled. 8. I don't have to use so much powder when I blast with Giant. 9. You know what we need for stumping. 10. I save money by using Giant Powders."

Write today for our free book, "Better Farming With Giant Farm Powders." It tells how to save money and get better results in stumping, ditching, tree-planting, etc.

THE GIANT POWDER CO., CON.

"Everything for Blasting"

202 First National Bank Bldg., San Francisco

Branch Offices: Denver, Portland, Salt Lake City, Seattle, Spokane



STUMPING

EUREKA

Apples and Pears
For European Distribution



Gerald Da Costa

Long Acre, Covent Garden, London

Cables: "Geracost, London." Codes: A. B. C. 5th Edition and Private

WHEN WRITING ADVERTISERS MENTION BETTER FRUIT

fruit is a new variety produced by W. W. Scott at his Fruitvale ranch. Some persons profess to believe the Rainier is a sport from the Delicious and the Hubbertson Nonsuch. It has the spiciness and juicer of the former and resembles it in shape while in appearance it favors the latter. As a keeper, however, the Rainier is claimed to far exceed either variety. The Yakima County Horticultural Union says the Rainier has been sold for consumption in July and August and that it is an extraordinarily long keeper.

Canada is buying virtually no American apples this year, according to P. R. Parks, general manager of the Spokane Fruit Growers Company. In the past the northwestern provinces have been large consumers of Washington boxed apples, particularly the "C" grade. The Okanogan districts of British Co-

lumbia have big orchards in bearing this year for the first time and are supplying the northwestern Canadian trade. The policy of "Buy-in-Canada" is being vigorously pressed since the war. American apples pay a duty of about 10 cents a box when they cross the line. "Prices are not quite as high as they were earlier in the season because of indiscriminate shipping, but they are higher than they were a year ago, barring the fancy figures received for a little stuff at the end of the season. The growers will realize handsome returns this year again, although the crop is slightly under that of a year ago," according to Mr. Parks.

A pile of 35,000 boxes of apples was one of the sights of the warehouse district at Grandview, Wash., the pile being owned by the Washington Dehydrated Food Company, to be

used in its local plant. The company's big warehouse was also full of apples and the plant was operating night and day.

All previous estimates, as late as November 1, upon the apple yield of the state of Washington are exceeded by a more authentic approximation issued by the Bureau of Crop Estimates on December 16. The Spokane district yield is estimated at 1500 cars, of which 190 cars are yet to move. Estimates are placed on other districts as follows: Wenatchee district, 11,500 cars; Yakima Valley, 10,700 cars; Walla Walla district, 1100 cars; White Salmon district, 400 cars; and scattered points in western Washington, 500 cars. The Wenatchee and Yakima districts are estimated to have 2500 and 2600 cars, respectively, yet to move.

With orchard holdings of 1760 acres the Palouse corporation, apple growers with headquarters at Spokane, has reaped a harvest of more than 100,000 boxes of apples this season. The market has returned from \$1.75 to \$2.50 a box for fancy apples, according to J. R. Wilson, manager and treasurer. The company has packing plants at Medical Lake, Fairfield and Waverly. All products are grown on non-irrigated land. The Palouse corporation markets its fruit through the Northwestern Fruit Exchange at Seattle. During the picking and packing season an average of 325 men were employed by the company, with a daily payroll running from \$1200 to \$1500. Enlargement of the packing plant and housing facilities at Fairfield is being considered.

IDAHO.

Many Washington county, Idaho, fruitgrowers are reported by the Farm Bureau to be preparing to build "semi-underground" storage cellars for the 1920 crop. The success of these storage cellars in the Payette Valley this year where a number of them were constructed was so noticeable and productive of such good results in preventing shipments of overripe fruit; it is expected that many others will be built next year throughout the state.

The total apple crop in Idaho is now placed at 1762 cars, an increase of 1293 cars over the state's largest crop in 1917.

According to the Payette Independent Boise and Payette Valley apple orchards show no further signs of infection, and conditions indicate that the rotting and dying of trees, which were noticed in 1917, resulted from an epidemic of blight that prevailed in the season of 1915 or of 1916, says a report by E. R. Bennett, field horticulturist, of the University of Idaho extension division. Mr. Bennett based this report on investigations made in company with Lee M. Hutchins of the United States Department of Agriculture. The orchards inspected in the recent investigation were on the Boise bench and in the Emmett, Payette, New Plymouth, Fruitland, Parma districts. This work was a continuation of the investigations of the orchard work that was made in 1917.

A survey of the Lewiston, Idaho, apple season, which has just closed, by H. H. S. Rowell, prominent grower of the district, estimates the apple pack to be in excess of 250 carloads. A conservative estimate of the receipts for this year's apple crop in the Lewiston-Clarkston Valley is \$600,000. This is far in excess of previous records. This year seven packing houses were kept busy. The chief varieties raised are Jonathans and Bome Beauties, although many carloads of Delicious, Yellow Newtowns, Spitzenburgs and Winter Bananas were shipped.

Last Big Block of the Canadian Pacific Reserved Farm Lands

THIS announces the offering of the last big block of the Canadian Pacific Reserved Farm Lands. Until this block is disposed of you can secure at low cost a farm home in Western Canada that will make you rich and independent. The country is ideal for mixed farming as well as grain growing. Later, the same lands can be bought only from private owners—and naturally, prices will be higher. Never again on the North American Continent will farm lands be offered at prices so low.

Your Last Big Opportunity

This block contains both fertile open prairie and rich park lands in the Lloydminster and Battleford Districts of Central Alberta and Saskatchewan. You can buy farm lands on the rich prairies of Manitoba, Saskatchewan and Alberta for \$11 to \$30 an acre. Or land in Southern Alberta under an irrigation system of un-failing water from \$50 an acre and up.

Twenty Years to Earn and to Pay

The Canadian Pacific offers you this land under a plan of long term, easy payments that is remarkable in the history of farm investments. You pay down 10%. Then you have no payment on the principal until the end of the fourth year, then fifteen annual payments. Interest is 6%. In central Saskatchewan, Seagar Wheeler grew the world's prize wheat. World's prize oats were grown at Lloydminster.

Lands Under Irrigation

In Southern Alberta, the Canadian Pacific Railway has developed the largest individual irrigation undertaking on the American Continent. This district contains some of the best lands in Canada. An un-failing supply of water is administered under the Canadian Government. Prices range from \$50 an acre up on the same easy payment terms. \$2000 loan in improvements; twenty years to pay back.

M. E. THORNTON
Supt. of Colonization

Canadian Pacific Railway
960 First Street, E., Calgary, Alberta

For full information about Canada, ask the C.P.R.



No Taxes on Improvements

There is a small tax on the land—seldom more than 20c an acre for all purposes but there are no taxes on your livestock, buildings, improvements, implements or personal effects. Good markets, modern schools, roads, churches, amusements, make farm life desirable and attractive. Here you can achieve independence.

No Sale Without Investigation

The Canadian Pacific will not sell you a farm until you have inspected it. You must be satisfied—and every question answered before taking up your home. Investigation is invited and made easy. Don't delay your investigation. This announcement calls attention to the last great block of Canadian Pacific Reserved Farm Lands.

Special Rates for Homeseekers and Full Information

Special railway rates for homeseekers make inspection easy. Send now for free illustrated pamphlets answering all questions and setting forth figures about land values, acreage yields, climate, opportunities, etc. Do not delay. Send coupon below for information.

M. E. THORNTON, Supt. of Colonization
CANADIAN PACIFIC RY.,
960 First St., E., Calgary, Alberta
I would be interested in learning more about:

- Irrigation farming in Sunny Alberta.
- Farm opportunities in Alberta, Saskatchewan and Manitoba.
- Special railway rates for homeseekers
- Business and industrial opportunities in Western Canada.
- Town lots in growing Western towns.

My name

Address

Town State

FREE! **Kirstin Stump Puller Book**

WRITE TODAY!
Get this big new Stump Puller Book now. Read how strong, powerful, speedy is the Kirstin. How quick, cheap, easy **One Man Alone** pulls most stubborn stumps. No horses, digging or chopping required. Lowest in first cost—lowest in operating cost.

Kirstin ONE MAN Stump Puller

Wonderful all-steel, guaranteed unbreakable design. Few pounds on handle exerts tons on stump. Sold on "No-Money-in-Advance," "30-Day-Free-Trial" offer. Six months to pay. Write for **FREE** Book and Special Agent's Proposition today.

Send for Agent's Offer

A. J. KIRSTIN CO.
290 E. Morrison St., Portland, Or.

<p>MUSICAL MERCHANDISE</p> <p>WRITE US</p>	<p>WE SAVE YOU MONEY!</p> <p>W. Martius Music House Inc.</p> <p>1009 First Avenue, Seattle, Washington</p> <p>Everything Known in Music</p>	<p>SHEET MUSIC</p> <p>WRITE US</p>
--	--	--

Spray in Winter to Harvest in Summer

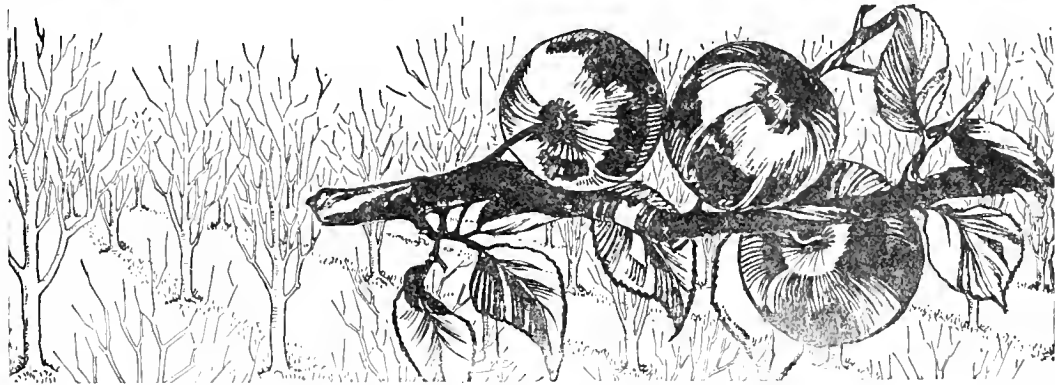

Dormant Spray with Lime Sulfur is the surest guarantee of abundant yield and prime fruit

A thorough spraying with Lime Sulfur while trees are dormant is one of the most important, if not the most important, spray in your entire spraying schedule, as it not only controls San Jose Scale, Oyster Shell Scale, etc., but greatly assists in combating numerous other insects and fungus diseases.

S-W Dry Powdered Lime Sulfur Saves Buying Tons of Water

You buy a ton of water in every six barrels of liquid lime sulphur you use. Sherwin-Williams Dry Powdered Lime Sulfur saves your paying for 80% water in your spray. It saves freight costs on tons of water, and the difficulties of road haul just when going is heaviest from thaws and rains. It saves leak-loss from rough handling of weighty barrels, and saves troublesome leakage adjustments. It saves loss of power from freezing, and the great loss of fruit due to using spray which had already lost killing power.

S-W Dry Lime Sulfur

is the old standard 33 degree Baume Liquid Lime Sulfur, the same as you have always used, reduced to powdered form by a patented process. It will do everything that Liquid Lime Sulfur has done in the past but eliminates all of the inconveniences experienced with the use of Liquid Lime Sulfur.

S-W Dry Lime Sulfur

mixes readily in cold water and will not clog the nozzles. In using Dry Lime Sulfur, spray tanks should be about two-thirds full. Then add the Dry Lime Sulfur and the balance of the water, agitate for a minute or

two and you are ready to go to work. No heavy barrels to haul to your orchard and no slopping around with Liquid Lime Sulfur. Mixes perfectly with Arsenate of Lead for summer spraying.

Sherwin-Williams Also Make

Dry Powdered Arsenate of Lead, Arsenate of Calcium, Paris Green, Tuber-Tonic, Fungi-Bordo and Pestroy,—and a complete line of germicides, vermicides, dips and Wood Preservatives.

Sprayers' Manual Free

Address The Sherwin-Williams Company, 602 Canal Road N.W., Cleveland, Ohio

SHERWIN-WILLIAMS PRODUCTS

PAINTS AND VARNISHES. DYESTUFFS
PIGMENTS, CHEMICALS

INSECTICIDES, COLORS, DISINFECTANTS
AND WOOD PRESERVATIVES



What They're Doing in California

Oroville, Cal., lays claim to the distinction of shipping the first olives from California to eastern markets this season.

Fruit shipments from the Vaca Valley, Solano county, totalled 1,015 carloads this year.

Nearly 100 students—orchardists, horticulturists and farm advisers—were enrolled in the short course in horticulture which is being held at the State University Farm at Davis, California.

One thousand dollars a day was expended in the campaign for the eradication of ground squirrels in California during the past year, says G. H. Heoke, head of the State Department of Agriculture.

According to reports received from Chico, the value of the three principal orchard crops in that vicinity this year was \$3,000,000. The crops are peaches, prunes and almonds.

With the fruit shipping season practically over, the California Fruit Distributors, of Sacramento, announce that 30,000 cars of fruit were shipped east this year, an increase of 5,000 cars over last year. The total number

of cars and contents leaving Sacramento were: cherries, 335 cars; apricots, 125 cars; peaches, 2,800 cars; plums, 2,900 cars; pears, 4,300 cars; grapes, 19,000 cars.

The California Almond Growers Exchange, with headquarters at Sacramento, recently completed filling orders for 70 cars of almonds the purchase price of which totalled \$1,700,000. The California almond production this year broke all records, totalling 7,000 tons compared with 5,000 tons last year. The growers also secured the highest figure ever paid for almonds, the total return being more than \$3,000,000. The Sacramento plant is the clearing house for twelve other plants and 22 local stations throughout the state. It has a storage capacity of 300 tons and is equipped with bleaching machines, steam apparatus which kills pests on the shells, and other modern machinery, all automatic. Special machinery has been installed for handling "Sticktight" almonds, formerly used for hog feed, so that the growers now get from six to ten cents a pound for this kind of almonds—as much as was paid formerly for first class varieties. More than 100 persons are employed at the Sacramento main plant. The valuation of the plant is \$250,000. The eastern market for California almonds was stimulated by an extensive advertising and promotion plan conducted by the Almond Growers' Exchange.

Cannery Notes

A census of the by-product plants in Yakima county, Wash., show a total of 13, with a total consumption of 37,122 tons of fruit during the season. Of the total tonnages used 24,790 tons were apples, 2225 pears, 500 prunes, 350 cherries, 9257 peaches. The total value to growers is figured to be \$525,505. Total tonnage of fruit dried was given as 11,700; canned, 6250; vinegar and cider, 5900; jelly and apple butter, 500. Cull apples from this county used in by-products plants totaled 2212 cars, 1562 of which were used in the county and 650 elsewhere.

Libby, McNeill & Libby are to locate another large cannery in the Sacramento Valley. It will be a \$325,000 structure on a 13-acre site in Gridley.

C. G. Horner, representing Libby, McNeill & Libby, recently visited Prosser, Benton county, Washington, with a view of establishing a branch cannery, if local growers will contract enough Blenheim or Tilton apricots, Tuscan cling peaches and Royal Anne cherries to keep the cannery in operation from July 1 to August 15, annually.

The cannery at Juliaetta, Idaho, has closed with the biggest tonnage of any season since it was installed. The plant opened July 1. The output was approximately 400 tons, of which 65 tons were apples, 40 tons cherries, 55 tons prunes, 150 tons tomatoes, 30 tons pears and about 50 tons beans and other vegetables and fruits.

Bits About Fruit, Fruitmen and Fruit Growing

A recent report is to the effect that ocean freight rates on apples have been reduced. The reduction on box apples is from 85 cents to 70 cents per box and from \$3 to \$2.50 on barrels.

Winchester, Va., apple growers who had been expecting to export large shipments of apples to England in January and February are withholding them due to the advice that the English market is not promising.

According to the South African Fruitgrower there have been planted in that country 100,000 acres of oranges only a small portion of which are yet in bearing. As oranges from that part of the world are marketed in March and April they do not come into competition with the American crop. There has also been planted on the upland sections of South Africa a large acreage to apples. Both the citrus and deciduous fruitgrowers of Africa are making a close study of the methods employed in growing fruit in the United States.

Southern fruitgrowers are making a protest to the federal government against the prices of fertilizers. The Alabama Department of Agriculture recently sent a representative to Washington to take up the matter with government officials of the United States Agricultural Department.

The cooperative organization of fruitgrowers is taking hold in the east. The Frederick County Growers' Association was recently formed at Winchester, Va., with an initial membership of 100. The association as one of its first actions went on record as against a national grading and packing law, and in favor of a state law.

The Tennessee State Horticultural Society, State Nurserymen's Association and State Beekeeper's Association recently held a joint meeting at Nashville that was attended by 600 delegates. The program which contained many valuable subjects for discussion was carried out successfully. Of interest in connection with the meetings was a fine exhibit of the fruit and vegetable products of the state. Many new members were added to the horticultural association during the session and it is expected that a strong organization will be built up in Tennessee which is rapidly coming to the front in many horticultural lines.

With the apple crop of the country harvested, it is apparent that control of the codling moth has been more effective this year than for many seasons past, according to deciduous fruit specialists of the Bureau of Entomology, United States Department of Agriculture. Because of the unusually high value of the apple crop, the specialists expect that the results obtained will stimulate similar thorough work another year.

ORCHARD SUPERINTENDENT WANTED

Man to act as resident manager for a prune ranch. Must have experience, executive ability, be able to keep books and be willing to do manual work on place as far as his other duties permit. Give salary, references and state when you can come.

Box N, care Better Fruit.

SAWS ANY WOOD IN ANY POSITION ON ANY GROUND 4 in. to 5 ft. Through

1 Man With a Folding Sawing Machine Beats 2 Cross-cut Saw MEN With a

5 to 9 cords daily is the usual average for one man

RUNS EASY No Backache weighs only 45 lbs. EASILY CARRIED

SAWS DOWN TREES

Our 1920 Model Machine saws faster, runs easier and will last longer than ever. Adjusted in a minute to suit a 12-year-old boy or strongest man. Ask for catalog No. M140 and low price. First order gets agency. Folding Sawing Mach. Co., 161 W. Harrison St., Chicago, Ill.



WHAT EVERY HOME CANNER SHOULD HAVE

ONE of our H. & A. Hand Power Double Seamers. It is the only hand power seamer built that will seal all sizes of sanitary fruit and vegetable cans. Write for prices and descriptive matter to Department T.

HENNINGER & AYES MFG. CO., Portland, Ore. Builders of Seamers and Steam Pressure Canning Outfits

"Now Is the Time to Do It" says the Good Judge

Go to real tobacco—the small chew with the rich tobacco taste that lasts a long time. It will cost you less to chew than ordinary tobacco. Any man who uses the Real Tobacco Chew will tell you that.



Put Up In Two Styles

RIGHT CUT is a short-cut tobacco

W-B CUT is a long fine-cut tobacco

Weyman-Bruton Company, 1107 Broadway, New York City

Codling Moth Control vs. Extermination

By P. S. Dartington, District Horticultural Inspector, Wenatchee, Washington

THE codling moth was introduced into the State of Washington many years ago and has pretty thoroughly disseminated itself over the older apple growing sections of the state.

Had it been possible during the early development of the apple industry in this state to prevent the introduction of this pest or to stamp out at the beginning any slight infestation, it would have been worth many millions of dollars to the state. In 1918 the Wenatchee district alone spent about \$500,000 in an attempt to control this pest and then took a direct loss from its ravages of about \$1,000,000. It is estimated that the State of Washington in the same year spent about \$1,500,000 in an attempt to control the pest and then took a direct loss of \$4,000,000.

In contrast to this, the Province of British Columbia had no direct loss from codling worms in 1918. In British Columbia, it has not been a matter of codling moth control, it has been a matter of codling moth extermination. Codling moth has been introduced into British Columbia. In fact, there have been some fifteen outbreaks of codling moth in the different fruit growing sections of the Province, but in each case a quarantine has been thrown around the infested area and rigid measures taken to stamp out the pest before it became widespread. Today British Columbia has 40,000 acres of

orchard, mostly apples. In 1918 these orchards produced about 3000 carloads of apples and production is rapidly on the increase and still British Columbia is a codling worm free Province with the exception of two or three small areas now under quarantine and in process of moth extermination.

The commercial apple industry in Washington is older than the commercial apple industry in British Columbia. Perhaps at the beginning of the apple industry in this state and at the time of codling moth introduction, life history and combative measures were not sufficiently well known to make a campaign of extermination practicable. Consequently, we have developed control measures rather than a process of extermination, but if it had been practicable in the beginning, I think all will agree that a process of extermination would have been much better.

If a process of extermination would have been better in the beginning, the question now arises to what extent if any can it be applied now? Let us consider this point. There are in this state certain apple growing localities of more or less limited area to which the codling moth has not yet migrated, or in which there may be as yet only a very slight infestation. I can mention a number of such localities in the Wenatchee district, which includes all of Chelan, Douglas, Okanogan and Grant

counties. Portions of the Okanogan Valley are, I believe, free from codling worms. A large portion of the Okanogan Valley is only very slightly infested. I believe the Methow Valley is practically free from worms except for a few small orchards at the mouth. The Manson district is only very slightly infested. The Entiat Valley is almost free. The upper end of the Wenatchee Valley is only slightly infested. I am not so familiar with other parts of the State, but I feel sure that there are similar areas in the Yakima district and in other portions of the state.

Are the growers in these uninfested, or slightly infested areas, going to play a game of watchful waiting while the worms slowly encroach upon them year by year until their orchards finally become just as badly infested as those in the older districts? That has been the history of all the older orchard sections in the state, and is the inevitable outcome of the sections that are now uninfested, unless some radical steps be taken to check the migration and to stamp out the present slight infestation.

Now, the question is can this migration be checked? Can the slight infestations be stamped out? That is just what British Columbia is doing successfully. Are we going to admit that we cannot do it? With proper organization and methods it can be done. Present control measures have not been successful.

I am even led to believe that it is possible to completely exterminate the

FARM MANURE

Stock manure is valuable for the organic matter and the Nitrogen, Phosphoric Acid and Potash it carries. It is valuable and in all crops absolutely necessary in some form for their continuous production at a profit.
"MARPROCO" Brands of FERTILIZER, including

"Puyallup Brand" Berry Fertilizer
"Clarkes Wenatchee" Orchard Dressing

represent a natural animal manure multiplied MANY TIMES as to the constituent elements of plant food.
MANURE is good in England, in Maine, in Washington and Oregon—this accounts for the success in Dollars and Cents Profits to the grower from the use of PUYALLUP BRAND BERRY FERTILIZER amongst members of Puyallup and Sumner Fruit Associations in Puyallup Valley and the corresponding success of W. H. STRONG, at Gresham, Oregon, who writes: "Mr. Hall, the County Agent, agrees with me that my yield was increased one ton to the acre, or a profit of \$300 per acre on fertilizing of berries."

We offer NITRATE OF SODA which we import, February deliveries, but care must be taken in the use of this fertilizer. NITRATE OF SODA unduly influences unnaturally early blossoming, makes some of the Willamette Valley soils gummy and non-porous and delays the ripening. It is not a complete fruit developer and should be used only to stimulate old, run-down orchards where legumes and manure are to be added.

COMPLETE ORGANIC FERTILIZERS

on the other hand, build humus and promote development of micro-organic life in a natural way, and are potentially rich in plant food.

Marine Products Company, Incorporated

TACOMA, WN., U. S. A.

Principal Importers and Exporters of Aquatic and Animal By-Products
Manufacturers of Commercial Manures

FARMERS' NOTE: See principal dealer, all Northwestern cities, or write or wire for our experts. Now booking car lots in Oregon, Washington and Canada. A representative is undoubtedly close to your farm now. See the picture story of actual results. On request of commercial clubs, farmers' organizations, agricultural agents, or colleges, Major E. P. Newsom will deliver his own and National Soil Improvement Committee's lectures on soil fertility. He is a brilliant speaker, nationally known, who has a thorough mastery of his subject.

DEALERS, WIRE FOR TERRITORY

codling moth in a given area even in the old, badly infested districts. Certain observations and experiences lead me to this belief.

As early as 1907, Dr. Melander carried on codling moth work at Wenatchee. He took for his work there that year, an orchard that had been about fifty per cent wormy in 1906, and by thorough combative methods reduced the infestation in that orchard that year to one-tenth of one per cent. It is only a short step from one-tenth of one per cent infestation to extermination, and British Columbia has shown us that that step can be accomplished. If this can be accomplished, on a single orchard, it can be accomplished in a whole community, if the whole community can be handled in the same way. We are now working on this community idea on Sunnyslope. A community of about 1400 acres close to Wenatchee.

In 1918, Sunnyslope was the wormiest orchard area in the whole Wenatchee district. This community shipped that year about 400 cars of apples. The damage done by worms was estimated at 20 per cent of the entire crop, which amounted to a loss of about 80 carloads of apples, or a loss in money of about \$100,000 dollars. Such a loss as this

has an effect on the growers similar to the effect of the loss of a great battle on an army. It hurts morale. It has a tendency to make the grower skeptical and to lose confidence in himself and tried methods of codling moth control. Fortunately, however, we had one good example in Sunnyslope in 1918. During the winter of 1917-18 a certain grower in Sunnyslope asked me if there was anything he could do to get rid of the worms. He felt that he had done everything that he possibly could do, but still had suffered a loss from worms of 35 per cent for three years straight running. He was becoming discouraged. I promised to give him some special attention during the season of 1918 and to see if we could not help him get rid of his worms. His orchard lay on three different slopes. We made it a point to determine spray dates for these different slopes and made it a point to be present each time he sprayed to see that his equipment was right and that the spraying was properly done. The consequence was that in 1918 when all of Sunnyslope averaged 20 per cent worm infestation, this man had just 1½ worm infestation.

In the spring of 1919 I called a meeting of growers in Sunnyslope for the

purpose of discussing the codling moth situation. I emphasized to these growers the fact that the codling moth could be controlled and cited the example of this one particular grower who was present at the meeting to substantiate my statements. I explained to these growers that if, by giving one grower special attention straight through the season, we could help him reduce his worm infestation from 35 per cent to 1½ per cent in a year like 1918, I could see no reason why, if we gave each individual in the community the same special attention and could get them all to give us the same coöperation why we could not materially reduce the worm infestation of the whole community. However, there were not sufficient funds available for that kind of service, and if the growers wanted that kind of service it would be necessary to raise the funds in the community. It seemed to me that if we could put a man in that community to give each grower in the community special attention and would be able to reduce the infestation even from 20 per cent down to 19 per cent that it would pay the salary and expenses of the man several times over, and I felt confident that a very much greater reduction than that could be made. At this meeting, the Sunnyslope growers voted to assess themselves \$1.00 per acre for the purpose of putting on this extra man, and appointed a committee to collect the fund. The funds were collected and the special man was put on.

Better Fruit Trees

We offer direct from nursery to planter, subject to stock being unsold, the varieties listed below. Our trees are guaranteed to pass government inspection and to arrive in prime condition, subject to penalty of replacement without charge.

APPLE—	Baldwin	Delicious	Rome Beauty	King David
PEACH—	Arp Beauty	Champion	Early Rose	Elberta
	J. H. Hale	Krummel	Late Crawford	Heath Cling, Etc.
PLUM—	Abundance	America	Burbank	Italian Prune
	Shropshire Damson		Endicott (Mammoth Gold)	

APRICOT—Superb

Other varieties of peach and limited quantities of other varieties of apple.

Lowest net prices f.o.b. Neosho, cash with order and subject to change without notice.

APPLE—	Caliper	Each Rate	5 Rate	25 Rate	50 Rate	100 Rate
1-yr.	Under 5/16	.45	.35	.30	.25	.20
	5/16 to 7/16	.55	.45	.40	.35	.30
	7/16 to 9/16	.65	.55	.50	.45	.40
	9/16 up	.75	.65	.60	.55	.50
2-yr.	1/2 to 5/8	.65	.55	.50	.45	.40
	5/8 to 11/16	.75	.65	.60	.55	.50
	11/16	.85	.75	.70	.65	.60
	* 3/4 up	.95	.85	.80	.75	.70
* (This size in Baldwin only.)						
PEACH—	Under 5/16	.65	.55	.50	.45	.40
	5/16 to 7/16	.70	.60	.55	.50	.45
	7/16 to 9/16	.75	.65	.60	.55	.50
	9/16 to 11/16	.80	.70	.65	.60	.55
	11/16 up	.85	.75	.70	.65	.60
PLUM—	Under 5/16	.70	.60	.55	.50	.45
	5/16 to 7/16	.75	.65	.60	.55	.50
	7/16 to 9/16	.80	.70	.65	.60	.55
	9/16 to 11/16	.90	.80	.75	.70	.65
	11/16 up	1.00	.90	.85	.80	.75
APRICOT—	Under 5/16	.70	.60	.55	.50	.45
	5/16 to 7/16	.75	.65	.60	.55	.50
	7/16 to 9/16	.80	.70	.65	.60	.55
	9/16 up	.85	.75	.70	.65	.60



Our catalog, "Better Fruit Trees," mailed free on request. Every customer also receives free of charge our 80-page illustrated book, "Inside Facts of Profitable Fruit Growing," which experts and beginners too say is "A Wonderful Help to Fruit Growers." (Price 10 cents to others.)

NEOSHO NURSERIES CO.
1 Lake Street
Neosho, Missouri

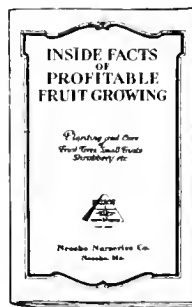

Start the New Year Right

If you did not walk in the Thrift path this last year, set your feet in it for 1920.

The Thrift path may be a hard one, and a bit steep, but it leads to comfort, success, and strong moral character.

This bank will gladly help you get started.

LADD & TILTON BANK
Oldest in the Northwest
Portland, Oregon



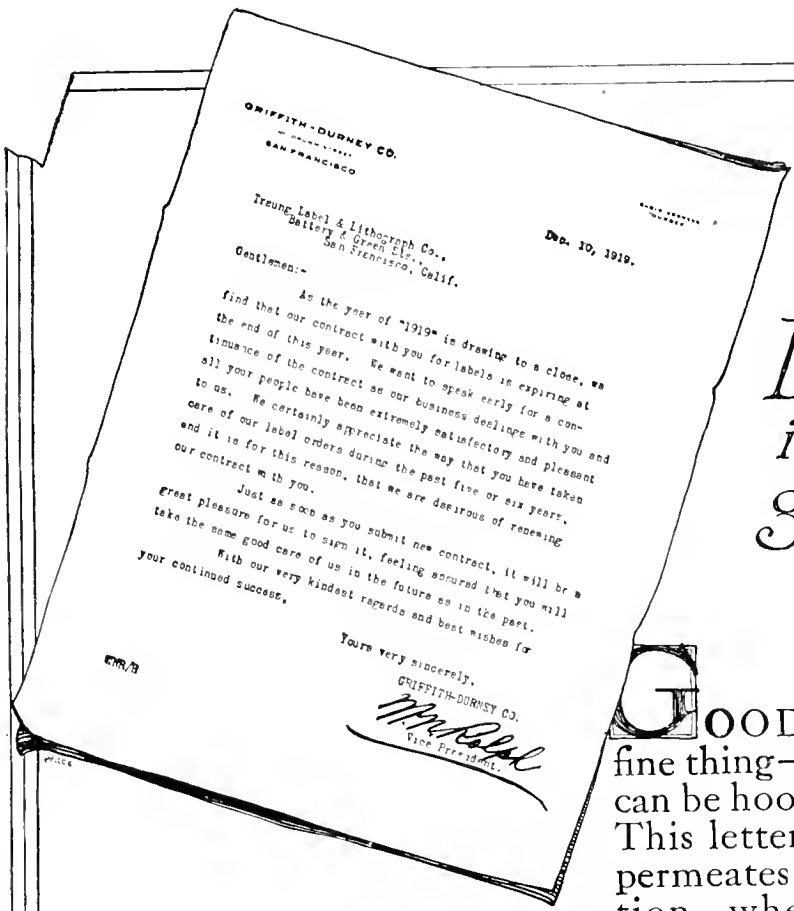

Do you suppose it's because we're good fellows?

GOOD fellowship is a mighty fine thing—but it's a finer thing if it can be hooked up to good business. This letter typifies the spirit that permeates every Traung transaction—whether it's an order for 25,000 labels or for 5,000,000.

Traung service is more than a service of filling orders—it is that larger service which seeks and senses what is best and obtains it for you.

In the light of such a thorough, broad-gauged service, can you afford not to put your label-and-carton problems up to us?

Manufacturing Divisions
 SAN FRANCISCO
 SEATTLE STOCKTON
Sales Offices
 Portland Fresno
 Sacramento

Traung

Label & Lithograph Co.

LABELS and CARTONS

"An institution that sticks to its last"



My but it's cozy here!

Pearl Oil gives instant heat when and where needed. No smoke, no odor; without dust or dirt. Oil consumed only when heat is needed.

Pearl Oil is refined and re-refined; pure and clean burning. Sold in bulk or five-gallon cans. Order by name—Pearl Oil.

We recommend Perfection Oil Heaters.



STANDARD OIL COMPANY
(CALIFORNIA)

Each grower was checked up as to the amount of acreage to cover and equipment with which to do it. If the equipment, was not right, or was insufficient, he was advised to get the necessary equipment and in most cases followed the advice. Spray dates were determined and each grower was checked up on his methods of application. Special attention was given to each individual straight through the season. Attention was also given to thinning and picking off what first brood worms got by the early sprays.

The consequence is that Sunnyslope in 1919, instead of being the wormiest section in the district, is the cleanest of all the old infested areas. Worm infestation in Sunnyslope will not exceed 2 per cent for the whole community. There are a number of orchards in this section that will have scarcely a perceptible portion of 1 per cent infestation this year, and I do not know of a single orchard in the community that will exceed 5 per cent.

These growers are well pleased with the result, and while I have not made a careful canvass of the situation, a number of the growers have voluntarily told me that they want the service again next year.

Now, my idea is this. If we can reduce a whole community, of 1400 acres, from 20 per cent to less than 2 per cent infestation the first year, I am confident enough to believe that if we can carry the work on next year under the same conditions, we can reduce the worm infestation in Sunnyslope to a very small point and perhaps in the course of two or three years, practically exterminate the moth in this area. Such a thing is possible. British Columbia has proven and is proving that it can be done. Is it worth trying? I'll say it is, even if we should never reach the goal.

Let us see if this work as far as we have gone, has been profitable to Sunnyslope. As stated above, Sunnyslope took a loss of 20 per cent on a four hundred carload crop, which amounted to a loss in money to about \$100,000. In 1919, the loss was reduced to 2 per cent or a gain of 18 per cent over 1918. Sunnyslope produced this year seven hundred and fifty carloads of apples and 18 per cent gain on 750 cars of apples will amount to about \$200,000.

Codling moth control or extermination? Which?

If it be possible to exterminate the worms in a community of 1400 acres, the edges of that community can be continually pushed back, so that that area can be made continually larger. Other areas can be treated in the same way. There are no limits to the possibilities. It is possible to exterminate the worms from a whole country or even from a whole state if we become properly organized to do it.

MYERS POWER SPRAY PUMPS

JUST THE PUMP FOR SPRAY GUN SPRAYING

ECONOMICAL-EFFICIENT-SAFE-SPEEDY

The truly satisfactory power spray pump most efficiently sprays the greatest number of trees in the shortest period with a minimum of material and labor. Myers Automatic Power Spray Pump — Duplex or Triplex Cylinders — Separate or Complete with Spray Rig — measures up to the highest standards of spraying requirements. Automatic Control, Uniform Pressure, Powerful Spray, Fast Service, No Waste of Mixtures, produce satisfied owners. Not a fad — not an untried theory — a remarkable success. Ask your dealer or write us.

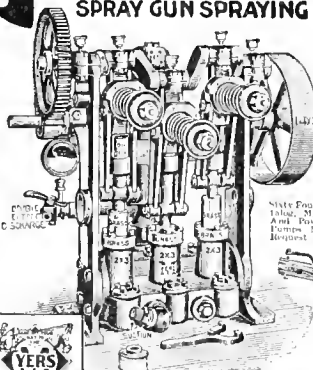
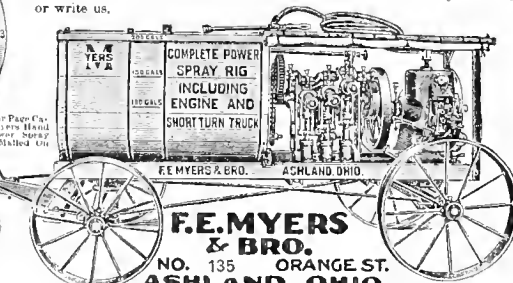
F.E. MYERS & BRO.
NO. 135 ORANGE ST.
ASHLAND, OHIO.
ASHLAND PUMP AND HAY TOOL WORKS

PACIFIC NORTHWEST DISTRIBUTORS

PORTLAND, OREGON



SPOKANE, WASH.

BUY FROM THE LOCAL MITCHELL DEALER

WHEN WRITING ADVERTISERS MENTION BETTER FRUIT

Nice Bright Western Pine
FRUIT BOXES
AND CRATES

Good standard grades. Well made. Quick shipments.
Carloads or less. Get our prices.

Western Pine Box Sales Co.
SPOKANE, WASH.

WHEN WRITING ADVERTISERS MENTION BETTER FRUIT

The HARDIE

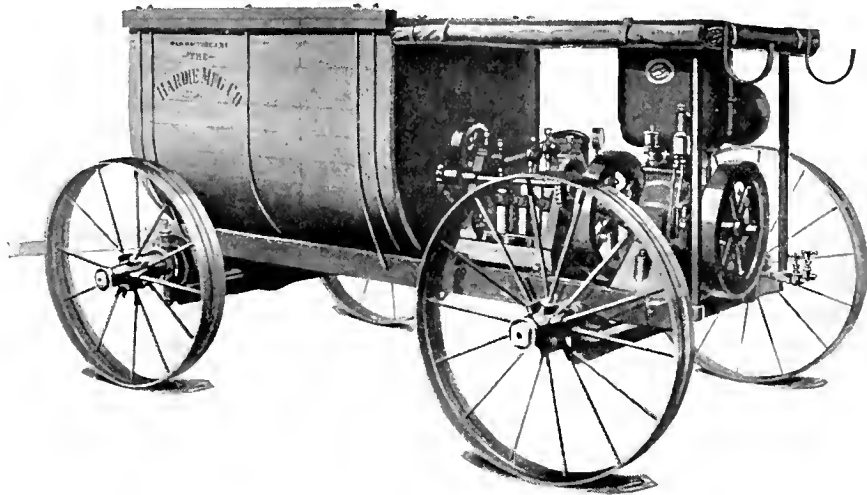

Depending not on one feature alone, nor adaptable to only one class of growers, this machine will fit any orchard condition and meet any spraying problem.

Combined in this one machine is the ample capacity for rapid work, the uniform high-pressure which insures effectiveness, the under-slung truck enabling operation under adverse orchard conditions; plus a sturdiness that enables it to stand the strain of hard service for years.

*It is first, last, and all the time your most powerful weapon
in your fight against insect pests.*

If you desire low operating costs, high speed work, and
above all, the satisfaction of a clean, high-quality
fruit crop

Get a Hardie

THE HARDIE MFG. CO.

55 North Front Street

Portland, Oregon

Florida Establishing Blueberry Industry

From a Florida Correspondent

CULTIVATED blueberries as a crop for sections where the soil is extremely sour is the hope of exports of the United States Department of Agriculture, who have been working on the development of the blueberry plant for 10 years. It was found that blueberries cannot live in a well-balanced fertile soil, and that they are actually killed by the application of fertilizer which would be the best possible food for ordinary plants. In sections of the light soil regions where large quantities of lime are necessary to put the soil in condition for general farming, it is thought that this peculiar characteristic of the blueberry plants may make them a profitable cultivated crop.

Further work on the blueberry plant

includes breeding plants which bear fruit unusually large or of especially fine flavor.

The most extensive operation in cultivating the blueberry by private enterprise that has been made is taking place at Oldsmar, Florida.

In addition to becoming the Florida headquarters for the grape business, Oldsmar has already taken steps to become headquarters for cultivated and adapted native Florida huckleberries. Some of the specimens attain a height of fifteen feet and bear the most luscious berries, which can be shipped to Northern states without refrigeration.

The Carmen Grape Company has closed a contract which enables it to make this important announcement. It

has been preparing for this step for twelve years, and meanwhile the huckleberry stock has been cultivated to produce larger berries with improved flavor. The bushes produce one year after planting, without any sweetening of the soil being necessary; in fact, the berries do better in the natural soil. Fertilizer is not required at the start and if it is desired to renew the soil later on, this can be done by spreading decayed vegetable matter or muck on the land. Three acres planted 14x14 feet, produced \$605.85 last summer. The bushes can be planted 4x8, but the most profitable method is to plant the bushes in solid rows eight feet apart, and under such arrangement mature plants in good condition could produce as high as \$2,000 per acre.

Zimmerman Brothers of the Carmen Grape Company, Oldsmar, have bought up all the available plants and have the only nursery selling cultivated huckleberries and blueberries. They will plant a number of acres at Oldsmar, and expect this business to develop to be as big a proposition as the grape business. It has been thoroughly tried and tested, and is now a proven proposition. Agricultural experts from Washington have taken a deep interest in this work at Oldsmar and have expressed surprise and great satisfaction over the important progress made with this fruit. The leading varieties, which ripen from May to August, are the Florida highbush, Texas highbush, Rabbit eye and Oldsmar special. The sparkleberry ripens late in November.

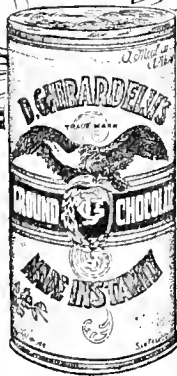

LOTS of chores about the farm—up late and early—out in all sorts of weather. Farm folks need a food-drink like Ghirardelli's Ground Chocolate—delicious, rich, strengthening! A steaming cup of Ghirardelli's has saved many an exposure from developing into a serious illness. Made in a jiffy, too!

Never sold in bulk—but in cans only.
In ½ lb., 1 lb. and 3 lb. sealed cans—
at the store where you do your trading.

Say "Gear-ar-delly"

D. GHIRARDELLI CO.

Since 1852

San Francisco

(F3)

GHIRARDELLI'S Ground Chocolate

Established 1882

F. W. Baltes & Company Printers

WE print anything from the smallest to the largest and always welcome orders of any size or quantity, giving prompt, personal and efficient service.

Mail or phone inquiries are solicited. We do not specialize — experience and equipment enable us to print everything equally well. We render service in preparing copy and illustrations and furnish plans and estimates for catalogs, booklets, publications, billboard and any other kind of advertising.

First and Oak Streets
Phones: Main 165 and A 1165
Portland, Oregon

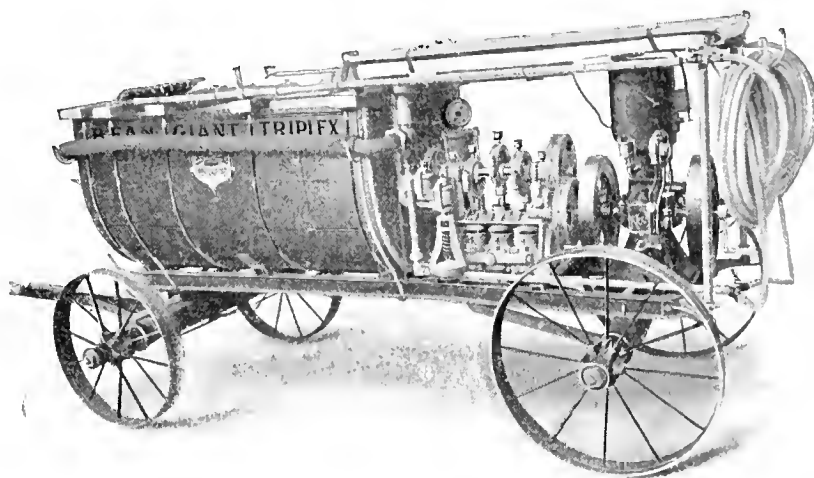

Spray with the **BEAN** and finish the job

There are literally hundreds of men who have had Bean Sprayers on their places for years. Some of them have tried others and have finally settled on the Bean. Some of them have already used a Bean and always will. They all get complete satisfaction.

These and others are features that place the Bean in a class by itself.

- Valves removed in two minutes while engine is running.
- Large capacity, slow running pump—saving wear and tear.
- All three plungers out and replaced quickly.
- Valve seats easily reversed, making two valves in one.
- Porcelain-lined cylinders—they eliminate grit troubles.
- No trouble-making stuffing boxes.

SPRAY WITH A BEAN AND FINISH THE WORK

Send for our Sprayer book. Use the coupon.

Bean Spray Pump Co.

218 West Julian Street, San Jose, California
29 Hosmer Street, Lansing, Michigan

CLIP AND MAIL

BEAN SPRAY PUMP CO.,
218 W. Julian St., San Jose, Cal.

Gentlemen: _____ acres of _____
Without obligation to me, please send me a copy of your catalog. I have _____
in Hand Pumps _____ I am especially interested
Power Sprayers _____
Name _____
Address _____

Bigger Profits

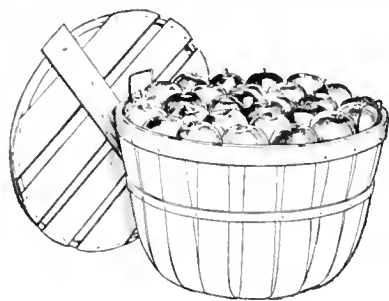

In buying fruits and vegetables folks are guided largely by the eye. Fruits and vegetables are displayed to best advantage in

Universal Bushel Shipping Packages

This means quicker and easier sales. Further, it means your fruits and vegetables can be handled better, shipped better, stored better. All this means *bigger profits* for you.

Shall we send you *free* our helpful booklet "How to Load Cars?" Send only 25c in coin or stamps for sample of the UNIVERSAL PACKAGE.

Package Sales Corporation

106 East Jefferson Street South Bend, Indiana

Final Estimate Apple Crop 26,174,000 Barrels

THE commercial apple crop for the United States is now estimated at 26,174,000 barrels by the Bureau of Crop Estimates, through its fruit crop specialists. This estimate is the final one of the season and indicates that the crop has overrun even the most liberal estimates, particularly in the far west. There has been an increase of 1,758,000 barrels over the November 1 estimate and this increase has occurred principally in the box apple district, although there has been a very considerable increase throughout some of the barreled apple sections, particularly Michigan and Arkansas. Arkansas, Washington, Oregon, Idaho and California have the largest crop in their history. The commercial crop of the United States as now estimated, ex-

ceeds last year's crop by 1,431,000 barrels.

It is now estimated that the far western or box apple states will produce 35,463,000 boxes, or an increase of 2,985,000 boxes over the November estimate, and 14,154,000 boxes over the crop of 1918.

The barrel apple states indicate a crop of 14,353,000 barrels, an increase of 763,000 barrels over the November estimate, or 3,287,000 barrels less than last year. The shipments from nearly all important sections with the exception of New York, have run heavier than last year. In addition, much more of the fruit is in storage at this time than at the same date last year.

Special Regional Report.

SPECIAL REGIONAL REPORT.

Region	Condition		Commercial Crop		% of last year
	Final 1919	Final 1918	Final 1919	Final 1918	
	%	%	Barrels	Barrels	
Western New York	27	75	1,728,000	4,800,000	36
Hudson Valley	60	37	1,050,000	647,000	162
Southern Ohio	23	72	184,000	558,000	33
Shenandoah-Cumberland District	45	65	1,980,000	2,600,000	76
Piedmont District	58	48	551,000	465,000	118
New England Baldwin Belt	72	43	1,120,000	645,000	174
Western Michigan	56	59	912,000	760,000	120
Western Illinois	30	50	300,000	500,000	60
Southern Illinois	27	20	405,000	300,000	135
Ozark Region (Southern Missouri and North-western Arkansas)	75	32	1,395,000	404,000	345
Missouri River Region	45	30	990,000	630,000	157
Arkansas River Region	45	42	135,000	123,000	110
Pacific Northwest	90	65	9,128,000*	5,037,000*	181
Colorado	64	43	828,000*	527,000*	157
California	98	79	1,511,000*	1,127,000*	134

*To reduce to boxes multiply by 3.

All the above figures both for states and regions, it should be understood apply to what is known as the commercial crop. That is, that part of the crop which is put up in barrels, boxes, or some other form of container, or that sold in bulk where some attempt is made at grading before the apples are put on the market for sale in the fresh state. It may be mentioned in this connection that while the commercial apple crop of the United States is 26,174,000 barrels as indicated, the total apple crop, that is to say, the total production, which includes all waste apples and those from home and farm orchards is estimated at 147,457,000 bushels or 49,152,000 barrels. Of this total apple crop about 15% or 7,373,000 barrels, goes to waste or is used on the farm; about 20% or 9,830,000 barrels, or approximately 713,000 tons, is made into by-products, the greatest per cent of which is cider. California, Western New York and a few other heavy producing centers, dry enormous quantities of apples. Canneries, vinegar factories, jelly factories, etc., also consume very large amounts. The remaining 65% of the total crop, or 31,949,000 barrels, is used for consumption as fresh fruit. Of these 31,949,000 barrels, however, it is estimated that but 26,174,000 barrels make up part of the crop which is not commercial, and which finds its way into local consumption from farm orchards, the fruit from which is of inferior quality and ungraded. Smaller towns in many of the eastern and middle western states consume a large portion of this grade of fruit.

Are You the Man?

If so, BETTER FRUIT offers you a chance to make good money

We want a representative in every fruit-growing community. In every such community there is some individual with a little time each month to spare, who, by representing BETTER FRUIT, can make a good income.

Perhaps it will be an elderly man?

A young fruit-grower just getting started?

A wife who wants to help out?

An ambitious boy or girl who wants to make extra money?

We want someone in *your* community to become our *permanent* representative—to secure new subscriptions for us and renew old ones.

We want two or three representatives in the Hood River Valley. Several in Yakima and Wenatchee—in the Willamette Valley, Rogue River, etc. In fact we want *permanent* representatives in every fruit district of the West.

Our proposition is a good one. Are you the man or woman for the job?

Write today, stating your qualifications.

BETTER FRUIT PUBLISHING COMPANY

OREGONIAN BUILDING, PORTLAND, OREGON

Solving Fruit Growers' Problems

Continued from page 6.

through the purchase of orchard supplies and in production activities of various kinds, such as the use of tractors, in pruning, fumigation and harvesting. It should reduce the cost of packing by the purchase of packing house supplies and by cooperative packing; it should reduce the cost of distribution to the wholesale trade, and by even distribution and national advertising it should help place the wholesale and retail distribution of fruit on a merchandising rather than a speculative basis, thereby reducing the distributing costs of the trade to the consumer. These are public relationships that should be inherent in the legal right of producers to organize. They are responsibilities which no cooperative organization can safely avoid."

Details of the Organization.

The California Fruit Growers' Exchange is a non-capital, non-profit association of 11,000 growers of citrus fruits who provide the facilities through which their fruit may be sold at cost to the wholesale trade. There are 196 associations of growers in the Exchange, representing three-fourths of the citrus fruit of the state. An association builds a packing house, harvests the fruit of its members, assembles it in the packing house and there grades and packs it in accordance with the rules of the Exchange. These associations are financed by the growers and are operated exclusively for them. They are managed by a board of directors through a salaried manager. The cost of the packing houses varies from \$20,000 to \$250,000 or more.

The associations of a community federate into a non-profit district exchange, with a director from each. The district exchange acts as a clearing house between the associations and the California Fruit Growers' Exchange in handling the marketing problems of the associations. There are twenty of these district exchanges. Its business is handled through a manager. The California Fruit Growers' Exchange is formed by the district exchanges, with a director representing each district exchange.

The Exchange furnishes the facilities through which the fruit of the growers is sold on a delivered basis except in a few pocket markets.

In 1919 the Exchange growers sold \$75,000,000 worth of citrus fruits to the wholesale trade, which returned \$55,000,000 to California. The cost of the Exchange, including the district exchange sales service, was 5.2 cents per box, or 1.04 per cent of the delivered value. In addition, there was invested in national advertising and trade promotion \$500,000, making a total sales and advertising expense of 1.62 per cent of the delivered value of the fruit. Due to the increased volume of business handled, the Exchange selling cost, including advertising, was lower in 1919 than ten years ago.

During the last sixteen years there has been returned to California through the Exchange \$317,000,00. The losses from all causes during this time in dealing with 3,000 or more wholesale merchants have been approximately \$8,000, or $\frac{1}{400}$ of 1 per cent of the f.o.b. returns.

The Fruit Growers' Supply Company.

The Fruit Growers' Supply Company, which handles the purchases of orchard and packing house supplies for the Exchange growers, owns 65,000 acres of timber lands and operates mills and factories for lumber and box making. It has an authorized capital stock of \$1,500,000, which it is increasing to \$4,000,000, owned and contributed exclusively by the members. In 1919 the Fruit Growers' Supply Company transacted a business of \$6,200,000 in packing house and orchard supplies at an operating cost of \$1.10 per \$100.00 of value on purchases, and after paying 6 per cent on the capital invested, refunded \$525,000 to its members, in proportion to the purchases of each.

WANTED

to rent or lease, an improved orchard farm by party having both practical experience and technical training. Best of references furnished.

Address REM, Care of Better Fruit

CORRECT LUBRICATION

FOR - MOTOR CARS - MOTOR TRUCKS

CONSULT THE CHART

Zerolene is made in various consistencies to meet with scientific accuracy the lubrication needs of each type of automobile engine. You have the benefit of experts' advice when you consult our Correct Lubrication Charts. Get a chart for your car.

STANDARD OIL COMPANY
(California)

ACME BOX STRAPPING

Insures Safe Deliveries—Prevents Pilferage



Acme Nallezy Embossed Strapping

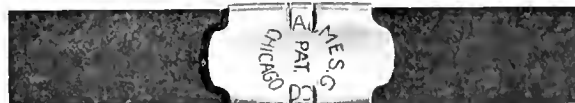

Acme Nailless Strapping, with Seal Applied.

Write for the Acme Catalogue of Complete Shipping Room Supplies

ACME STEEL GOODS CO., Chicago, 2840 Archer Avenue, Manufacturers

SAN FRANCISCO, 209 California Street
SEATTLE, 114 Railroad Avenue, South

PORTLAND, 8 Front Street
ATLANTA, 10 Tift Street

Orchard Brand Dry Powdered Arsenate of Lead

CODLING moth and other insects obtain their food by eating the fruit. To prevent that loss we have manufactured Orchard Brand Dry Powdered Arsenate of Lead. It also prevents injury to foliage by chewing insects.

The superior mechanical process by which it is made, and its chemical purity, gives the maximum concentration. It is so finely divided that it mixes readily with water, and remains in good suspension in the spray tank. When properly applied it spreads evenly and uniformly over the surface of fruit and foliage. It does not collect in splotches, but gives the greatest protection.

After years of experience in the orchards of the Pacific Coast, constant research and laboratory tests Orchard Brand Dry Powdered Arsenate of Lead is recommended as the most effective poison obtainable.

Complete chemical investigations, and trained workers in many actual field tests have proved its efficacy.

Practical fruit growers and experienced entomologists alike commend Orchard Brand Dry Powdered Arsenate of Lead for its uniformity, high concentration, spreading ability, adhesive and lasting qualities. It has proved satisfactorily effective under all conditions.

It is packed in 200-lb. and 100-lb. drums, 50-lb. and 25-lb. packages, 4-lb. and 1-lb. cartons, all net weight.

Other tree sprays we make are: Orchard Brand Arsenate of Lead Paste; Atomic Sulphur; Bordeaux Mixture, Paste; Bordeaux Mixture, Powdered; Lime Sulphur Solution; B T S Dry Sulphur Compound; Weed Killer; Universal Brand Dormant Soluble Oil; Crude Oil Emulsion; Miscible Oil No. 1; Miscible Oil No. 2; Distillate Oil Emulsion; Liquid Whale Oil Soap, and Black Leaf "40."

Write us about your tree troubles. The best available information will be sent in reply.



General Chemical Company

710 Royal Insurance Building
San Francisco, California

Fruitmen Discuss Production

Continued from page 10.

opener to the deciduous fruit growers of the Northwest, while the statements of Professor C. I. Lewis, Organization Manager of the Oregon Growers Coöperative Association telling what the Oregon growers were doing in the way of forming a state wide organization to pack, market and process fruits and their by-products proved an added stimulus to the coöperative spirit.

Sidelights On Cultural Methods.

Among the subjects that deeply interested the conference was that of the extermination of the codling moth as advocated by P. S. Darlington, district horticultural inspector at Wenatchee, which is published elsewhere in this issue. New experiments that promise to give more effective worm control as explained by Prof. A. L. Lovett of the Oregon Agricultural College were also of much interest.

In the matter of applying sprays the spray gun had many friends among those at the meeting. Apart from being championed by a number of growers, Leroy Childs, horticulturist at the experiment station at Hood River, showed that experiments there had demonstrated a high degree of efficiency for the gun.

The more general use of oil sprays was advocated by Prof. A. L. Melander who believes that they are capable of a high degree of control of the various pests. Lee N. Hutchins of the bureau of plant disease investigations of the United States Agricultural Department in discussing collar rot which has appeared in some of the Northwest orchard districts said the only remedy given for this trouble was to cut out the diseased spots and paint them with coal tar diluted with creosote.

The advocacy of keeping livestock in an orchard did not meet with a warm welcome by the conference except from J. R. Everett, manager of the Boston-Okanogan Orchards Company, which has a large acreage in trees and other crops, making it possible for this company to pasture the stock in other fields during the period when the fruit is making its greatest growth. The experiences of other orchardists was to the effect that the stock injured the trees and were an expense rather than a profit.

To secure better pollination Prof. C. C. Vincent, horticulturist at the University of Idaho, advised the keeping of bees in an orchard at a ratio of one hive to the acre.

Banking and Transportation.

W. S. Peachy, Vice President of the Seattle National Bank and J. J. Rouse, Cashier of the Fidelity National Bank of Spokane, handled the topics of financial interest, the former stating that organized coöperation was a big asset to the fruit grower in getting help from the banker, and the latter advising the fruit grower not to forget the rainy day and to place his present profits in investments that will be of help to him in future. F. W. Graham of the Great

Northern Railway, in discussing transportation problems wanted the growers to build more warehouses in order to relieve car shortages, and the growers were of the opinion that the railroads should build more cars. The advice of S. M. McKee of Selah, Wash., was to the effect that a by-product plant is the necessary adjunct to every fruit raising community. With every part of cull apples from the core to the peeling being used and paid for at \$15 per ton, Mr. McKee said that the by-product plant was a big source of income to the grower. Results of apple breeding work at the University of Idaho discussed by L. E. Longley; enlarging the markets for western fruit through national advertising as set forth by Prof. H. J. Eustace, western publicity manager for the Curtis Publishing Company, and orchard tillage discussed by Ralph Sandquist of Selah, Wash., all proved interesting.

Patriotism Rules at Banquet.

The arrangements for the four day's sessions which were largely in the hands of M. L. Dean, horticulturist of the Washington State Department of Agriculture and W. P. Romans of the Spokane Chamber of Commerce were admirably conducted. During their visit the fruitmen were the guests of the Chamber of Commerce and Ad Club at luncheons and on the last evening of the conference were entertained with a banquet.

On this occasion, at which E. B. Benson, Washington State Commissioner of Horticulture acted as toastmaster, 100 per cent Americanism was the dominating theme of the speakers. In the opening talk made by Commissioner Benson he urged the fruit growers of the Northwest to get together on all their problems and to abolish sectional lines for their common welfare. The principal addresses were made by E. H. Lindley, President of the University of Idaho and Dr. E. O. Holland, President of Washington State College. The other speakers were H. A. Lyon of the Idaho Bureau of Markets, representing the governor of Idaho; President E. T. Corman of the Exchange National Bank; L. C. Taylor of Kelowna, B. C.; John A. Gellatly of Wenatchee, and F. A. Wiggins of Toppenish.

Spokane was again selected as the place for the next annual meeting of the State Horticultural Association with the provision for a summer meeting to be held at Wenatchee. The new officers of the association are: President, H. D. Bohlke, Dryden; Secretary, M. L. Dean, Olympia; First Vice-President, F. A. Wiggin, Toppenish; Second Vice-President, S. H. Kipp, Quincy; Trustees for two-year term, Dr. Geary, Underwood and J. R. Schwartz, Yakima; Trustees for three-year term, A. G. Craig, Spokane, and M. L. Dean, Olympia.

SUPERINTENDENT WANTED

To take full charge of an 80-acre bearing orchard near Hood River, Oregon, on share basis. Applicants must state their experience in apple raising, irrigation and gasoline engines, also mention their age and number in family.

Address **E. M. RIETZ**, care Better Fruit

THE WORLD-
OUR ORCHARD

STEINHARDT
& KELLY
NEW YORK

UNQUESTIONABLY THE
MOST IMPORTANT FACTOR
IN THE DISTRIBUTION OF
THE COUNTRY'S FANCY
APPLES
AND OTHER FRUITS

OUR MARKET-
THE WORLD

BETTER FRUIT

VOLUME XIV

FEBRUARY, 1920

NUMBER 8

FEATURES IN THIS ISSUE:

Insecticides and Spraying
Oregon Cranberry Industry
The Use of Orchard Heaters
Winter-Injured Fruit Trees
Apple Pollination Studies

Columbia Univ. Libr. 30dec20



THE WINESAP—THE MOST EXTENSIVELY PRODUCED APPLE IN THE NORTHWEST
(The Winesap is considered one of the best keepers of any of the red varieties of apples grown in the Northwest as well as being of very fine quality). The districts where it is grown in the largest quantities are in Washington and Southern Idaho

BETTER FRUIT PUBLISHING COMPANY, PUBLISHERS, PORTLAND, OREGON

Subscription \$2.00 per Year in the United States; Canada and Foreign, Including Postage, \$3.00.

Single Copy 20 Cents

Stop Feeding Away Your Profits

There's only one way—*spray and spray right.*

Spray at the right time and spray with the right kind. You probably know the enemy's habits and when the most timely spraying or dusting can be done. If you're in doubt ask for Glidden spraying literature.

And spray with the right kind. That's just as important as spraying at the right time. Users of Glidden sprays know this from experience. They know how the Glidden kinds spread the poison evenly over all the foliage and keep it there until it does effective execution.

They know, too, that the big factor in this result lies in the Glidden organization and the complete equipment in the big Glidden plants. Having used Glidden products over and over again they have had evidence of uniformity as well as quality.

The Glidden line includes: Glidden Dry Powdered Arsenate of Lead, Glidden Dry Powdered Arsenate of Calcium, Glidden Dry Powdered Bordeaux Mixture and Glidden Dry Powdered Bordo-Arsenate, Glidden Dry Lime Sulphur, Glidden Paris Green.

Everywhere on Everything

Glidden Products cover such a wide range of usefulness that "Everywhere on Everything" is now a true expression of Glidden service. On farm buildings, on the farm implements, in the farm home, everywhere on everything, Glidden Paints, Varnishes, Stains and Enamels are providing the necessary protection and where needed, attractive decorations as well. There are Glidden Dealers in every locality.

THE GLIDDEN COMPANY

National Headquarters, Cleveland, Ohio. Stocks in principal cities

Factories: Cleveland, Chicago, San Francisco, Reading, New Orleans, St. Louis, St. Paul, Toronto

Branches: New York, Chicago, Kansas City, Detroit, Boston, Scranton, Evansville, Birmingham, Baltimore, Pittsburgh, Atlanta, Dallas, Des Moines, Montreal, Winnipeg

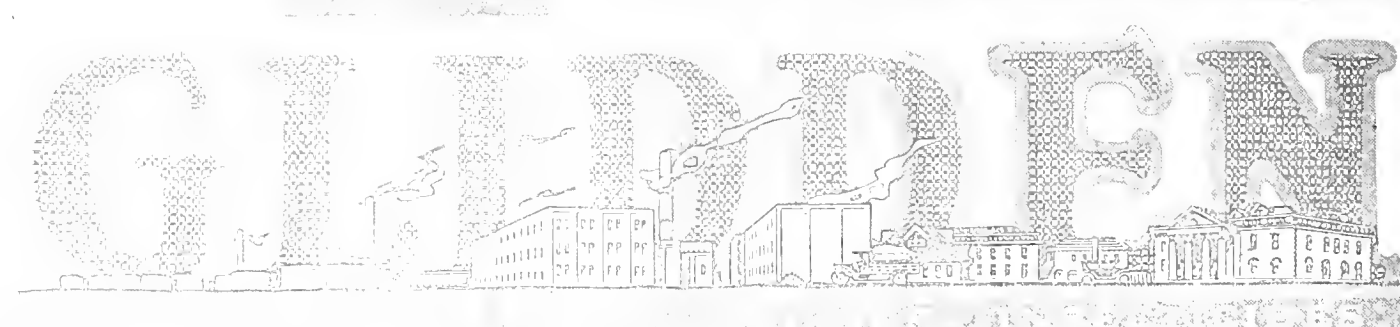



Users of Hayes Power Sprayers are within only 24 hours of a service station at all times. In case of accident at a critical time this quick service may save your fruit crop. Hayes Power Sprayers, Engines and Repairs are distributed by:

- Fairbanks, Morse & Co.**
 Atlanta Portland Denver
 Los Angeles Salt Lake City Seattle
 Jacksonville San Francisco Spokane
We Also Maintain Stocks at
 Muskogee, Pa. Philadelphia
 Kansas City Little Rock
 Grand Rapids Auburn, N. Y.
 Hayes Hand Sprayers are distributed by Hardware, Implement and Seed Jobbers

Get These Amazing Facts on "Fruit-Fog" Spraying

SEND the coupon today. Read the story of "Fruit-Fog" Spraying now. Learn why Fruit Fog, after the severest tests by experts, Experiment Stations, Fruit Growers and Farmers, is today publicly pronounced a wonderful success. That is because this vaporous, fog-like super-spray is the ONLY spray fine enough to reach the millions of tiny, UNSEEN hidden pests that infest microscopic niches in bark, buds and foliage—where no coarse, heavy, low-pressure spray can reach. These hidden pests wipe out millions of dollars' worth of fine fruit each year. They cost Fruit Growers an appalling toll. Yet Fruit-Fog positive thoroughness will exterminate every one of them. This explains the fact that thousands of Fruit Growers and Farmers now credit their clean orchards, mighty yields and record-breaking profits to Fruit-Fog Spraying. Send the coupon and get the complete story today.

HAYES FRUIT-FOG SPRAYERS

Fruit-Fog Spray is produced by the Hayes 300 lbs. guaranteed high pressure and the scientific Hayes nozzle. Fruit-Fog, because of its vaporous fineness, has wonderful adhering power. No drops form—no solution wasted—no buds or leaves knocked off as with a heavy, coarse, low-pressure spray.

Hayes Sprayers are famous for combining speed with utmost thoroughness and lowest consumption of solution. They are skillfully made and every part is positively standardized to the closest limits of

accuracy. This is obtained enduring service and greatest efficiency under high pressure. The famous Fairbanks-Morse "Z" Engine assures Hayes users the best possible service.

SPRAYERS FOR EVERY PURPOSE

Hayes Sprayers are made to meet every orchard, field, garden, park, disinfecting, white-washing and cold water painting need. No matter what your sprayer requirement, from our great Triplex Fruit-Fog Power Sprayer to the smallest Garden Atomizer, we make it.

Send for New Book and Spraying Guide FREE

Tell us how many trees you want to spray and how old they are on the average. Also what other uses you have for your sprayer. We'll tell you where and how you can get the style of Hayes Sprayer best suited to your needs, and its price. We'll also send our Big New Book of Hayes Sprayers and our Valuable Sprayer Guide FREE. Send the coupon today.

HAYES PUMP & PLANTER COMPANY

Department K, GALVA, ILLINOIS (45)

HAYES Fruit-Fog Gun
 Send coupon for FREE BOOK and see why this is the world's fastest spraying apparatus. A simple twist gives long spray for tall trees, or wide spray for close-up work, or shuts off light. Prevents waste of solution between trees. The only gun which combines great speed with the thoroughness of Fruit-Fog. Enables one man to handle the capacity of big power sprayer. Get the book for full details.

Hayes Hand Barrel Spray Pump

Hayes Platform Duplex Hand Sprayer

Hayes High Pressure Triplex Power Sprayer

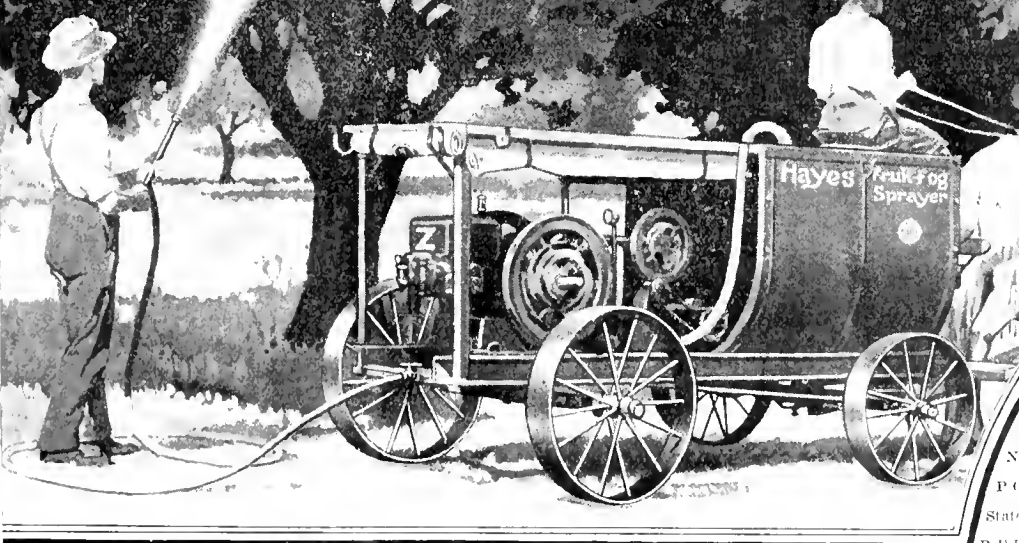

HAYES PUMP & PLANTER CO.
 Dept. K, Galva, Ill.
 Gentlemen: Please send FREE and without obligation, your Big New Spraying Book and your Valuable Spraying Guide.

No. of trees _____
 Average age _____
 Other uses _____
 Name _____
 P. O. _____
 State _____
 R. F. D. _____

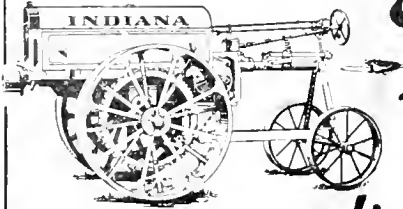
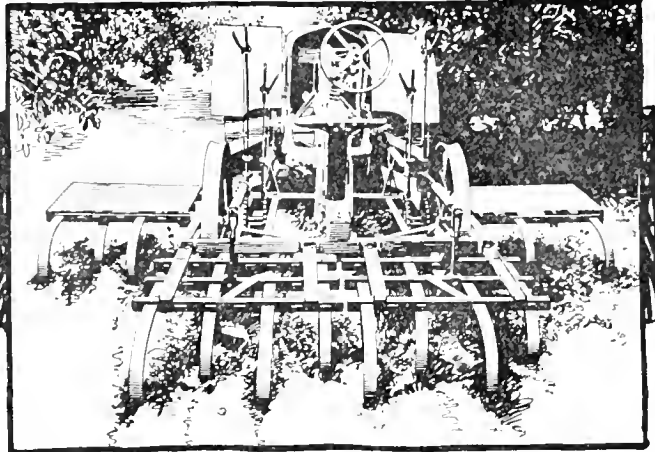
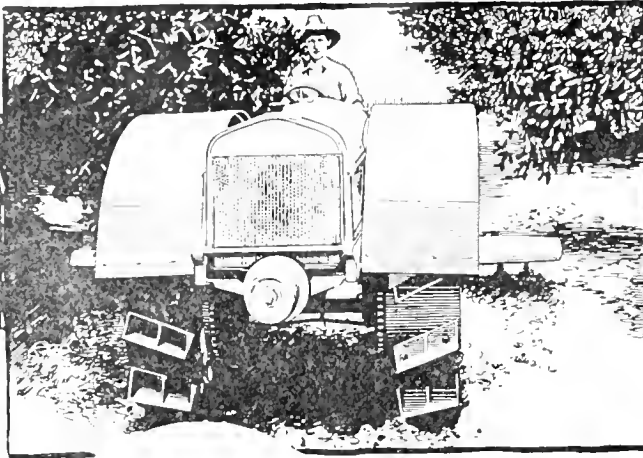

The One-Man Tractor You Can Use Every Day

It really replaces Horses and Mules

HERE is a one-man, single-unit Tractor you can use not just twenty-five or thirty days a year—but as many days as you now use your horses for orchard and farm work. It will save its cost over and over again for you whether your orchard is large or small. It costs about the same to buy as four horses and does more work than they can do.

It does as much work with orchard tools as two good horse teams. A special adjustment of the axle enables the hood to be lowered about six inches so that the tractor will pass under the low branches. Where necessary it may be equipped with lower wheels and special lugs provided for work in deep sand. Because of light weight it can be used in sandy soil.

And it cultivates, pulls harrows, discs, drills, rollers, mowers, binders, potato diggers, as well as the orchard tools—every implement you now have and no expensive hitches are required. It uses the horse-tools and implements you have now, except plow—no need to spend hundreds of dollars for new tools and implements to use with the Indiana Tractor. The driver rides the implements—you don't need an extra man to ride the Tractor. It turns shorter than other types of tractors—backs up easy—handles nicely in close quarters.

The Indiana Tractor weighs no more than a farm team. That's why it really replaces horses and really saves money for every farmer. There is no waste of fuel and power.

The Indiana Tractor was designed and perfected by the most skilled engineers and mechanics to do the work of horses without wasting power and fuel. It does a year's work of four horses at a gasoline and oil cost of about one-third the cost of feeding your four horses or mules for a year. Saves the cost of one man. It does light belt work economically.

Farmers who have had big four-wheeled Tractors are now buying the Indiana to cultivate and work their row crops, for they can use it to harrow, disc and drill on ground too soft for a heavy tractor.

The Indiana Tractor is "The World's Tractor." It has a dependable Motor made to stand up and last. Every part is made the very best, no unnecessary parts, it's simple in construction, anyone can operate it and few repairs are ever necessary. Indiana Tractors are built by the old reliable company that makes the Indiana Silo—America's most successful silo. Farmers everywhere know this company and its products, and that they are made to give satisfaction. Investigate the Indiana Tractor now.

INDIANA ALL-ROUND TRACTOR

"The World's Tractor"

Write us for book of pictures, made from photographs showing the Indiana Tractor actually doing all the work that horses and mules do on a farm. It's the biggest tractor proposition ever offered a dealer. Dealers should write us quickly.

Indiana Silo & Tractor Co.
Anderson, Indiana
Gentlemen: After having investigated at least a dozen leading makes of tractors I have purchased an Indiana tractor from you. The reason that I bought big to investigate before purchasing for full purpose that has so far been made for me. I have the finest of good behavior that has marked feature. One does not have to have a degree from a school of mechanics to understand it. As a farmer and a bit of knowledge of machinery tractor going without help. I wish to state further that I have owned and operated other tractors before purchasing this one so that the tractor is not a new thing with me.
Yours truly,
BOYD HAWKINS
Gladehurst Ranch, Tr. Lauderdale, Fla.

Hundreds of Indiana Owners Talk Like This!

Buy an

INDIANA SILO NOW!

IT WILL more than pay for itself the first year, and buy another also for you with the money saved the next year, and keep on saving more than its cost for you, every year. More than sixty thousand farmers say that it makes better silage, allows less waste, stays in better condition, lasts longer and that they would have no other make.

The higher the price of feed, the more it saves for you.

Write for our catalogue, easy payment plan and early buyers' proposition.



The Indiana Silo & Tractor Company

LARGEST Silo Manufacturers in the World

42 Union Building.....Anderson, Indiana
42 Indiana Building.....Des Moines, Iowa

222 Silo Building.....Kansas City, Mo.
222 Live Stock Ex. Bldg... Fort Worth, Texas

BETTER FRUIT

EDITOR: W. H. WALTON

STATE ASSOCIATE EDITORS

OREGON—C. I. Lewis, Horticulturist.
WASHINGTON—Dr. A. L. Melander, Entomologist;
O. M. Morris, Horticulturist, Pullman.
COLORADO—C. P. Gillette, Director and Entomologist;
E. B. House, Irrigation Expert, State Agricultural College,
Fort Collins.
ARIZONA—E. P. Taylor, Horticulturist, Tucson.
WISCONSIN—Dr. E. D. Ball, Madison.
MONTANA—O. B. Whipple, Horticulturist, Bozeman.
CALIFORNIA—C. W. Woodworth, Entomologist, Berkeley;
W. H. Volck, Entomologist, Watsonville; Leon D.
Batchelor, Horticulturist, Riverside.
INDIANA—H. S. Jackson, Pathologist, Lafayette.

An Illustrated Magazine Devoted to the Interests
of Modern, Progressive Fruit Growing
and Marketing.

PUBLISHED MONTHLY BY

Better Fruit Publishing Company

703 Oregonian Building

PORTLAND, OREGON

All Communications should be addressed and
Remittances made payable to

BETTER FRUIT PUBLISHING COMPANY

SUBSCRIPTION PRICE:

In the United States, \$2.00 per year in advance.
Canada and Foreign, including postage, \$3.00.

ADVERTISING RATES ON APPLICATION

Entered as second-class matter April 22, 1918,
at the Postoffice at Portland, Oregon, under
the Act of Congress of March 3, 1879.

VOLUME XIV

PORTLAND, OREGON, FEBRUARY 1, 1920

NUMBER 8

Insecticides, Spraying and Fruit Insect Control

By A. L. Quaintance, Entomologist in Charge of Deciduous Fruit Investigations
and E. H. Siegler, Entomological Assistant U. S. Department of Agriculture

ORCHARDS and vineyards are usually troubled with different classes of pests, as biting insects, sucking insects and fungous diseases, each of which usually require for their control a different kind of spray material.

Combined Sprays.

Fortunately it is possible to combine the necessary materials for the simultaneous control of the pests, thus avoiding separate applications. In figure 1 are given the standard spray materials for chewing insects, sucking insects and the fungous diseases and the way in which they may be combined. It will be noted that there are three main divisions separated according to the principle stomach poisons in use: (1) Arsenate of lead; (2) Arsenate of lime; (3) Paris green. Each of these divisions is divided in accordance with the kind of fruit: Pome fruits, grape and stone fruits. These in turn are subdivided into sections: (1) Chewing insects; (2) chewing and sucking insects, (3) sucking insects, sucking insects and fungous diseases. These are further divided when a choice of spray material could be given. To make use of the diagram, the first consideration is the kind of fruit to be sprayed; next, the pests to be combatted; and finally the choice of the spray materials. In selecting the spray materials the specific recommendations as given elsewhere should be consulted.

If pome fruits, for example are to be treated for chewing insects, arsenate of lead, arsenate of lime, or Paris green may be used, but as will be seen in the latter diagram milk of lime should be added to the latter two. If stone fruits are to be sprayed for chewing insects, it will be noted that nothing but arsenate of lead combined with milk of lime should be employed. Again, suppose apple trees are infested with chewing and sucking insects and that arsenate of lead is selected for the former, it will be observed that this arsenical may be combined with soap, or nicotine, or nicotine and soap, or kerosene emulsion. If apples are to be sprayed for both chewing and sucking insects and also fungous diseases and arsenate of

lime is to be used for the chewing insects, nicotine should be added to it and also lime-sulphur or Bordeaux mixture.

Spray Distributions.

Table I shows the amount of spray material required for a number of different quantities of sprays. The rate at which the materials have been computed will be found in the first column.

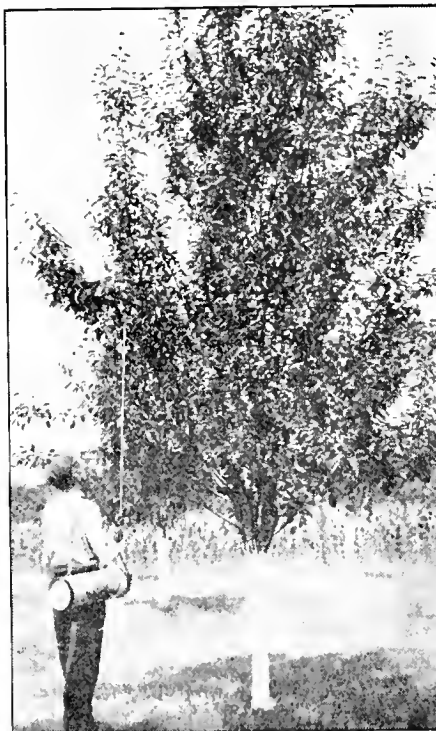

Small pressure tank type of sprayer.

The figures at the top of the table represent the total number of gallons of diluted spray desired, and the figures in the vertical columns give the amount of spray material required. Thus, if 150 gallons of arsenate of lead, paste at the rate of 2 pounds to the gallon, 50 gallons is to be used, it will be noted in the table that 6 pounds is required. If 25 gallons of self-boiled lime and sulphur mixture is needed, the table shows that 4 pounds of stone lime and

4 pounds of sulphur should be used. Again if 100 gallons of kerosene emulsion, 10 per cent strength, is wanted and the stock solution contains 66 per cent of kerosene, it will be found, by referring to the table, that 15 gallons of the stock emulsion should be used.

SOME IMPORTANT INSECTS AND THEIR TREATMENT.

APPLE INSECTS.

CONTROLLED BY WINTER OR DORMANT TREE SPRAYING.

San Jose scale—The San Jose scale infests the trunk, limbs, and branches of most fruit trees—apples, pears, peaches, plums, etc. The mature scale is about the size of a pinhead, circular in outline, grayish in color, with a nipple-like prominence in the center. The bark of badly infested trees is ash gray, and when cut into shows a reddish discoloration. In the absence of treatment young trees are usually killed in two or three seasons, and the vitality of older trees is quickly impaired and eventually they are destroyed by its attack. It is usually controlled by one thorough spraying of the trees each year, preferably with lime-sulphur solution. Petroleum oil sprays also are used, but these sometimes cause injury to the trees and fruit buds. Fish-oil soap washes may be employed and these are convenient where only a few trees are to be treated. Badly infested trees should be sprayed in the fall as soon as the leaves are down, and again the following spring before the buds open. Ordinarily one treatment each year, preferably in the spring, will be sufficient, although thorough work is necessary to destroy the insect so that there will be no spotting of the fruit.

Oyster-shell scale—The oyster-shell scale is readily recognized from the resemblance of its scale, or covering, to a long narrow oyster shell. The female scale is about one-eighth of an inch long, in color brown to dark brown, though sometimes grayish in appearance. While less susceptible to winter treatments than the San Jose scale, the oyster-shell scale will be sufficiently controlled in orchards by the lime-sulphur solution employed for the former species. When infesting apple, pear, etc., it may also be treated with kerosene emulsion or lime-sulphur spray at summer strength when the young are hatching in the spring, which for any locality will usually occur during the period of one to three weeks following the blooming of the apple, or, in the case of the peach, with self-boiled lime-sulphur mixture in from two to four weeks following the blooming of the peach.

Scurfy scale—Although not often very injurious to orchard trees the scurfy scale is the subject of frequent inquiry from fruit growers and others. The treatment recommended for the San Jose scale will aid much in keeping this species in check, and it may be treated with dilute scale washes as the young are hatching in the spring, as just described for the oyster-shell scale.

Pear-leaf blister mite—The very minute creature known as the pear-leaf blister mite in recent years has become an important apple

patches or winding burrows here and there in the flesh of the apple, and several larvae in a fruit usually will reduce the pulp to a slimy brownish mass. The insect is more or less prevalent throughout the northeastern states. It prefers sweet and subacid varieties. Some experimenters have found that if the foliage and fruit are kept covered with a poison, such as arsenate of lead, during early July, the flies are destroyed before egg laying begins to any extent. Experience with this insect in Canada is to the effect that sprays regularly applied for the control of the codling moth and other insects will also control the apple maggot. In the home orchard and elsewhere care should be taken to gather up promptly and destroy wormy, fallen fruit.

Apple red bugs—The sucking insects known as apple red bugs came into prominence recently in New York state, Pennsylvania, and elsewhere. They puncture the little fruits early in the season, causing them to fall or become pitted and deformed. Best control comes from the use of 40 per cent nicotine sulphate, 1 pint to 100 gallons of spray, added to the first scab treatment before the blossoms open. It may also be necessary to add the nicotine sulphate to the first codling-moth treatment after the falling of the petals.

Bud moth—The caterpillars of the bud moth attack the opening buds of the apple in the spring, and it is particularly destructive throughout the northern United States, extending west to the Pacific coast. The dark brown caterpillars hibernate about half grown in little cases around the buds, and as the little leaves expand in the spring these are folded together by threads of silk and the caterpillars feed within the folded leaves. Injured leaves often turn brown, and if the caterpillars are abundant their work is quite conspicuous. During late summer the young larvae of the new brood eat small holes in the apples, causing important blemishes. In seriously infested orchards a spray of arsenate of lead, 2 pounds of the powder (or 4 pounds of the paste) to 50 gallons of water or lime-sulphur solution, should be applied when the flower clusters are first in evidence. The arsenical in the first scab treatment just before the flowers are opened will effect further control. After the pest is well reduced the usual spraying schedule should keep it in check.

Cankerworms—The cankerworms are slender measuring worms, about 1 inch long when full grown, that feed upon the foliage of various fruit and other trees, but especially the apple and elm. The leaves are attacked shortly after they put out in the spring and may be quickly devoured, leaving the trees brown as if swept by fire. Orchards well sprayed as for the codling moth suffer little. Injury to young orchards can be stopped by spraying with arsenate of lead promptly upon first signs of injury. Cultivation of orchards during early summer destroys many pupae in the ground. Large apple and shade trees may be protected by using bands of sticky substances, cotton batting, etc., around the trunk. For the fall cankerworm these bands should be in place in late fall (October), and for the spring form some four or five weeks before the buds are due to open.

Apple-tree tent caterpillar—In the spring the apple-tree tent caterpillars make their unsightly nests, or tents, in trees along the roadside, streams, neglected orchards, etc. The wild cherry is their favorite food, though numerous other plants are attacked when the caterpillars are abundant. They are rarely of much importance in well-sprayed orchards. The egg masses on the twigs should be searched for when the trees are leafless, and destroyed, and in the spring the nests should be torn out and the caterpillars killed. Bags saturated with kerosene on the end of a pole may be used to destroy caterpillars in their nests in the higher parts of the trees.

Apple aphids—Plant-lice, or aphids, often become abundant on the apple trees during spring and summer. They are best treated as the buds are breaking but if the insects continue abundant when the first scab treatment is due, 40 per cent nicotine sulphate at the rate of three-fourths pint to 100 gallons of spray should be added to the dilute lime-sulphur solution. It may be advisable to use the nicotine in the first codling-moth treatment also, if the aphids continue destructive, though it will serve merely to check them. The green aphid is sometimes so abundant during summer, especially on young trees, as to warrant treatment, but satisfactory control is difficult on account of the curled condition of the leaves.

Roundheaded apple-tree borer—The round-headed apple-tree borer infests the apple, quince, pear, and numerous wild plants, especially the service-berry, mountain ash, and crab. Trees are attacked at or near the base,

the larvae feeding the first season under the bark and during the second and third years entering the wood. A few borers in a young tree may kill it, and older trees are always greatly injured by them. Fruit trees subject to attack should be wormed each year, care being taken not to injure the bark and wood more than necessary. The beetles are laying eggs during May and June and less actively until September. They may be largely deterred from egg laying by coating the trunk of the trees, from 3 to 4 inches below the ground to about 1 foot above, with paint. It will often be practicable to remove from the neighborhood of orchards wild host plants, such as service-berry trees and the mountain ash.

Woolly apple aphid—The woolly apple aphid occurs on the limbs and twigs of apple as bluish-white colonies, or patches, but is more injurious to the roots, which become knotty and deformed, thereby stunting the trees and at times resulting in their death, especially during periods of drought. Trees found to be suffering from the woolly aphid at the roots should be given especial care as to fertilization and cultivation, to enable them to grow in spite of the presence of the insect. Lack of growth due to unfavorable soil conditions is often attributed to this insect. Colonies of aphids on limbs and branches may be controlled with contact sprays, such as petroleum oils.

APPLE SPRAYING SCHEDULE. DORMANT TREE SPRAYING.

During the dormant period of trees sprays may be used much stronger than at other times and for this reason dormant tree spraying is especially advisable for the treatment of scale insects, the blister mite, etc. Applications may be made after the leaves have fallen in the fall, during warm days in the winter, or in the spring before the new growth begins to appear. Where aphids are troublesome it is often practicable to delay the San Jose scale treatment until just as the buds are breaking, and, by adding nicotine to the strong lime-sulphur solution, effect a combination treatment for both the scale and aphids.

SUMMER SPRAYING.

First application—Use concentrated lime-sulphur solution (33° Baumé) at the rate of 1½ gallons to 50 gallons of water plus 2 pounds of arsenate of lead paste (or 1 pound of powdered arsenate of lead) just before the blossoms open. This is for apple scab, the plum curculio, cankerworms, the bud moth, case-bearers, and the tent caterpillar. Add about one-half pint of 40 per cent nicotine sulphate if apple red bugs are troublesome and if apple aphids are much in evidence.

Second application—Use same spray as in first application as soon as the blossoms have fallen. This is for the above mentioned troubles as well as for the codling moth and leaf-spot. It is the most important application for both apple scab and the codling moth. In spraying for the codling moth at this time the aim is to drive into the calyx end of each little apple a quantity of the poison, and, to accomplish this, painstaking work is necessary. Failure to do thorough spraying at this time for the codling moth can not be remedied by subsequent applications.

Third application—Use the same spray indicated above, three to four weeks after the blossoms have fallen. This is the second treatment for the codling moth and leaf-spot, and gives further protection against apple scab and certain insects. In orchards in which blotch has been prevalent this application should be made not less than three weeks after the blossoms have fallen. Where this disease has been severe, Bordeaux mixture (4-4-50) should be substituted for the lime-sulphur solution.

Fourth application—Use Bordeaux mixture (4-4-50) and an arsenical eight to nine weeks after the petals have fallen. This is the first application for the second brood of the codling moth and for bitter-rot. In orchards in which bitter-rot has been a serious disease this application should be advanced about one week.

Fifth application—Use Bordeaux mixture from two to three weeks after the fourth application. This is the second application for bitter-rot, and since it is very little extra expense to add an arsenical, this may be profitably done as a further protection against late-appearing larvae of the codling moth.

Sixth application—Use Bordeaux mixture again two or three weeks after the fifth treatment has been applied. This is the third application for bitter-rot and is ordinarily sufficient to carry the fruit through, but on specially susceptible varieties in bitter-rot sections a treatment to be made two weeks later may be found necessary.



Small hand pump type of sprayer.

Seventh application—In severe cases of bitter-rot a seventh application may be necessary, and in severe cases of blotch an extra treatment midway between the third and fourth applications is sometimes required.

Note—In the more northern apple-growing sections the first four applications, during ordinary seasons, will be sufficient to protect the fruit from various insects and diseases mentioned. In the more central states, where bitter-rot and blotch are prevalent, the fifth and sixth applications will be necessary. In the case of summer apples only the first three applications are needed.

PEAR INSECTS.

CONTROLLED BY WINTER OR DORMANT TREE SPRAYING.

San Jose scale—The San Jose scale infests pears (except Kieffer and LeConte varieties), and should be treated as described for the San Jose scale on apple.

Pear-leaf blister mite—The leaf blister mite is usually present wherever pears are grown and frequently requires treatment on pears as well as on apples. The mites winter behind the bud scales and attack the unfolding leaves and young fruit in the spring, causing reddish or greenish blisterlike spots which, later in the season, become brown and dead. If the attack is severe, the foliage may fall, stunting the fruit and in extreme cases causing it to shed. The lime-sulphur and oil sprays used for the San Jose scale keep the blister mite in check.

CONTROLLED BY SUMMER SPRAYING AND OTHER MEASURES.

Codling moth—The apple worm also attacks the pear, in some localities quite seriously. It should be treated as recommended for the apple; the second, third, and fourth applications of the apple spraying schedule being sufficient.

Pear slug—The pear slug skeletonizes the leaves of the pear, cherry, and to some extent the plum. The slimy snail-like larvae appear on the trees in May or June, according to latitude. A second brood may be in evidence about midsummer. The pest is easily controlled by arsenicals sprayed or dusted on the foliage, or by the use of contact sprays.

Pear-tree psylla—The pear-tree psylla is very troublesome in some regions and careful and persistent work is required to keep it under control. The insects suck out the sap from the foliage and leaf stalks, causing the leaves to turn yellow, and later brown, and many of these fall prematurely, with consequent injury to the fruit. Infested trees are usually sooty in appearance, resulting from the growth of a black fungus on the sticky excrement or honeydew voided by the insects. Adults hibernate in cracks in the bark of the trunk and limbs, under bark scales, or under trash on the

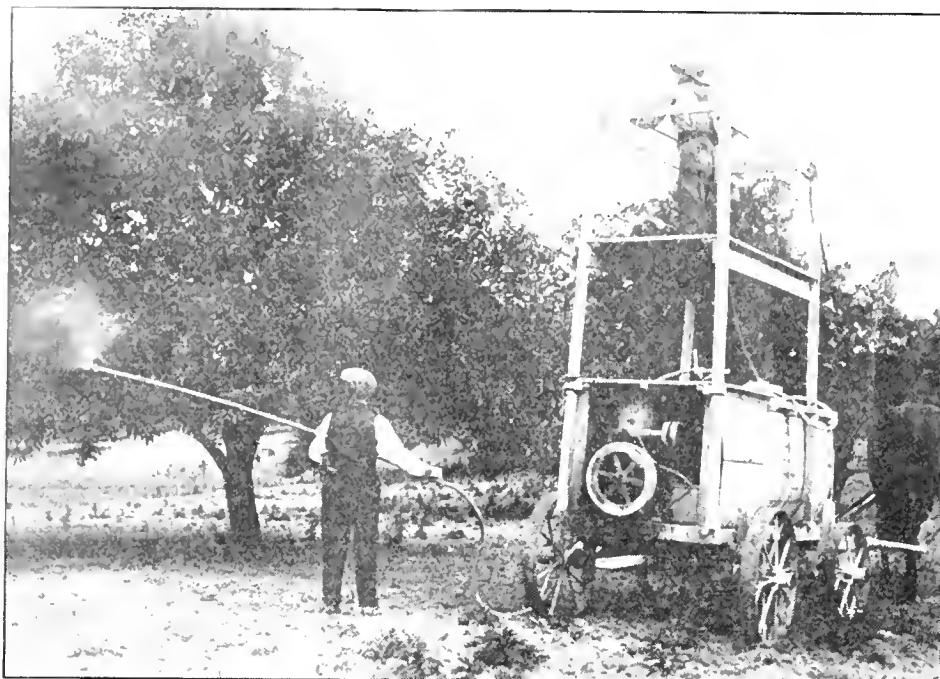

Power sprayer arranged to reach both the upper and lower parts of the tree.

ground. Special attention should be given to the destruction of the hibernating insects by scraping off the rough bark of the trunk and limbs, and spraying the trees thoroughly before the adults go into hibernation in the fall, or before they emerge from hibernation in the spring. Days should be selected when the sprays will not freeze on the trees. An effective winter-spray is made up as follows: Forty per cent nicotine sulphate, three-fourths of a pint; fish-oil soap, 3 to 5 pounds; water, 100 gallons. Psylla eggs about to hatch, and young nymphs, may be successfully treated in early spring as the blossoms in the cluster buds are spreading, using winter-strength lime-sulphur solution. It usually will be practicable to defer the application for the San Jose scale until this time. Nymphs of the first brood mostly congregate in the axils of the young leaves and fruit, and may again be treated with the nicotine-soap spray, above mentioned, applied just after the blossoms have fallen, arsenate of lead being added for the codling moth.

Pear thrips—The adult pear thrips come from the ground in the spring as the bud scales are spreading, and owing to their minute size are able to work their way within, where they feed upon the tender tissues of leaf and flower buds. Fruits like the pear and prune, which bear the blossoms in clusters, suffer worst, and when the insects are abundant the crop literally may be destroyed in the bud. Fruit blossoms attacked, but which escaped destruction, is likely to be deformed and scabby and of lessened market value. The pear thrips has caused large losses on the Pacific coast, and more recently has become established in the Hudson valley, in Maryland, and elsewhere in the east. It is controlled by spraying with nicotine and soap, or nicotine-distillate spray when the buds first begin to open, and again after falling of blossoms. A second "bud application" is desirable when the insects are very abundant. Best results follow the use of a coarse spray under high pressure and directed from above into the opening buds.

PEACH INSECTS.

CONTROLLED BY WINTER OR DORMANT TREE SPRAYING.

San Jose scale—The San Jose scale requires treatment on peach, and the winter strength lime-sulphur solution should be used on stone fruits in preference to oil sprays.

Terrapin scale—In some regions the terrapin scale is very troublesome on the peach and plum. The honeydew or excrement voided by the scales furnishes a medium for the growth of a black mold which covers the foliage and fruit, lessening the market value of the latter. Lime-sulphur sprays are not effective against this pest, and a miscible oil should be applied in the spring just as the buds begin to swell.

Peach twig-borer—The peach twig-borer tunnels into the tender shoots of the peach in the spring and later attacks the fruit. Fruit in-

jury is especially common in California and other western states. The insect winters as a very small larva in burrows in the bark, in the crotches of the limbs, where it may be destroyed by spraying the trees during the dormant period with winter-strength kerosene emulsion. Lime-sulphur solution, as used for the San Jose scale, is effective if applied as the buds begin to swell in the spring.

CONTROLLED BY SUMMER SPRAYING AND OTHER MEASURES.

Plum curculio—The little snout-beetle known as the plum curculio punctures the fruit for egg-laying and feeding purposes, causing it to fall or become knotty or distorted. It is best controlled by the use of arsenate of lead. Peach growers should follow the peach spraying schedule given later, thus controlling also the peach scab and brown-rot. These three troubles are much the most important ones of the fruit and may be largely prevented.

Peach borer—The peach borer attacks the tree at or below the ground, eating out patches or burrows in the inner bark, and its presence is usually indicated by the exudation from the crown of a mass of gum more or less mixed with dirt and grass. It is a most serious enemy of the peach and to a less extent of other stone fruits, and in most regions must be controlled to prevent destruction of the trees. There is no known method of control more satisfactory than carefully worming the trees in the spring and fall of each year. A related species occurs on the Pacific coast, for which the same control measures are recommended.

Lesser peach borer—The lesser peach borer affects principally the trunk and branches of the peach, plum, and cherry. It follows injury to the bark, as from the effects of freezing, barking during cultivation, etc. Its attacks are best prevented by avoiding mechanical injury to the trunks and limbs. Injured bark should be cut out and the exposed parts of the tree thoroughly coated with suitable paint. Thorough worming is desirable in fall and spring while worming for the peach borer.

Fruit-tree barkbeetle—The fruit-tree barkbeetle, also called the shot-hole borer, attacks most fruit trees as well as related wild plants. Small holes are eaten in the bark, and in stone fruits its injury is usually indicated by the exudation of gum, often copiously. The beetles prefer sickly or diseased trees, or those in a weakened condition from any cause. Such trees when once attacked may be quickly destroyed, and the beetles, on account of their abundance, are thus often thought to be the real cause of the trouble. Injury is best avoided by maintaining trees in a vigorous growing condition, by cultivation, fertilization, pruning, etc. Trees recently attacked may often be saved by severe pruning and fertilization with a nitrogenous fertilizer. Thorough coating of the trunk or branches with heavy whitewash is desirable, as this interferes with the activities of the beetles.

PEACH SPRAYING SCHEDULE.

DORMANT TREE SPRAYING.

Use lime-sulphur concentrate at the rate of about 7 gallons for each 50 gallons of water. This is for the San Jose scale, and if applied just before the buds are due to swell in the spring it will also control peach leaf-curl and the peach twig-borer.

SUMMER SPRAYING.

In the eastern half of the United States most of the peach orchards should be given the combined treatment of arsenate of lead and self-boiled lime-sulphur mixture for curculio, scab, and brown-rot. The latter disease is more especially troublesome in the south, whereas peach scab is worst in the Allegheny mountain region and in the northern states. Peach spraying is now largely practiced by commercial orchardists with excellent results.

Midseason varieties—The midseason varieties of peaches, such as Reeves, Belle, Early Crawford, and Elberta, should be sprayed as follows:

(1). With 2 pounds of arsenate of lead paste (or 1 pound of arsenate of lead powder) per 50 gallons of water, to which has been added the milk of lime made from slaking 3 or 4 pounds of stone lime, about 10 days after the petals have fallen, or at the time the calyxes are shedding.

(2). With self-boiled lime-sulphur mixture and arsenate of lead, two weeks later, or four to five weeks after the petals have been shed.

(3). With self-boiled lime-sulphur mixture (omitting the arsenical) four or five weeks before the fruit is due to ripen.

Late varieties—The Salway, Heath, Bilyeu, and other varieties with a similar ripening period should receive the same treatment prescribed above, with an additional application of self-boiled lime-sulphur mixture alone, to be applied three or four weeks after the second application.

Early varieties—The Greensboro, Carman, Hiley, Mountain Rose, etc., and varieties of the same ripening period should receive the first and second applications only, as prescribed for mid-season varieties.

PLUM AND CHERRY SPRAYING.

Japanese plums should receive the same treatment as peaches having the same ripening season. Soap should be added in the third application to enable the spray to stick to the smooth plum fruits.

Plums other than the Japanese varieties should receive the treatment outlined in the peach-spraying schedule, except that lime-sulphur solution diluted at the rate of 1 gallon to 40 gallons of water is to be preferred to the self-boiled lime-sulphur mixture.

Cherries should receive the same treatment as early varieties of peaches, except that lime-sulphur diluted at the rate of 1 gallon to 40 gallons of water should be used in place of the self-boiled lime-sulphur mixture. Where leaf-spot has been severe this solution should also be used in the first treatment. For the control of leaf-spot an application of the diluted lime-sulphur solution should also be made as soon as the fruit has been picked.

CHERRY INSECTS.

CONTROLLED BY WINTER OR DORMANT TREE SPRAYING.

Cherry scale—The cherry scale resembles closely the San Jose scale and sometimes requires treatment on cherry. Lime-sulphur solution is used as for the San Jose scale. See peach spraying schedule.

Cherry aphid—The cherry aphid is a black, shiny aphid which curls the tender foliage of the cherry in the spring and summer, often severely checking the growth of the trees. It winters on the trees in the egg state, and the young aphids upon hatching congregate on the opening buds. Thorough spraying as the buds are breaking with a nicotine-soap spray or with nicotine in winter strength lime-sulphur spray as for apple aphids will be effective. Summer spraying is of comparatively little value, the insects being protected from the spray by the curled-up leaves.

CONTROLLED BY SUMMER SPRAYING AND OTHER MEASURES.

Plum curculio—The plum curculio seriously injures the cherry and with brown-rot is controlled by the schedule of spray applications given for the peach. The first and second treatments only are necessary.

Cherry fruit flies—In some parts of the northern United States cherries are often more or less infested by the maggots of two species of fruit flies. There is often little external evidence of infestation, though well ripened cherries may become more or less shrunken. Wormy cherries thus are often gathered for

Continued on page 40.

Development of the Cranberry Industry in Oregon

By Wm. E. Schimpff, Secretary of the Oregon Cranberry Growers' Association

THE English language is recognized as the most complete language in use. It is especially rich in words to convey various shades of meaning. In spite of this wealth of words, as applied to the cranberry industry the language is singularly incomplete. It does not contain a single distinctive word that can be used to designate a modern improved cranberry planting. The term bog is used by some to so designate a cultivated cranberry planting, others speak of the same thing as a marsh. Neither of these words does the planting justice, for from these words in their common acceptance we would infer, did we not know better, that either a swamp, or a quagmire, or some other kind of a wilderness was referred to. Such however is not at all the case, as a modern cranberry bog is more like the well kept lawn in a beautiful park. It is the direct opposite of a quagmire.

Were we to look for the reason, we would find that cranberry growing as a commercial proposition is comparatively new, and was started a long time after the promiscuous coining of words for the language was in vogue. Inasmuch as the industry had its beginnings in the United States, an English speaking country, it was not possible to borrow the proper word from a foreign language, because none existed, there being no cranberry industry in any country other than our own.

Then again, the history of agriculture and horticulture of the world is connected solely with alkaline soils. The cranberry being the first cultivated product of an acid soil to make its bow to the world commercially. Hence there was no opportunity for the cranberry industry to borrow any terms from allied industries. It is the pioneer of all horticultural efforts with acid soils. It is unique among the agricultural pursuits of man.

The cranberry is distinctively an American fruit. While varieties of cranberries are found both in Europe and Asia, these are of the small species, and are not readily adaptable to commercial uses. These berries are always popular in the particular district in which they grow. The fruit is gathered from the wild marshes by the people who live in the vicinity of them, but there is no real commercial activity in the wild cranberries of these countries. Here in this country alone is found the large species, which today has become a most important commercial product. No patriotic American family would consider a Thanksgiving or a Christmas dinner complete without having cranberries served on that festive occasion.

The Pilgrim fathers recognized the merits of the cranberry and made use of them immediately upon their reaching this country. It was from the Massachusetts Indians that the Pilgrims learned the art of making sugar from the sap

of the native maple, and with this as a sweetener cranberries promptly found a place on the table of these hardy pioneers. The Pilgrims found their Thanksgiving dinner in the country in which they had selected as their home, for not only did cranberries abound there, but wild turkeys as well. This ideal combination has persisted to this day, and it is doubtful whether a combination can be found that is so fittingly appropriate and so typically American as well.

From the limited use to which cranberries were put by the residents of the Massachusetts colony, an industry in a small way sprang up. Shipments of cranberries were made to nearby cities and were readily consumed. It was not until the beginning of the last century that the industry began its real march of progress. Massachusetts was the pioneer state. Other states of the union took up the challenge, and the cranberry was taken seriously. Today Cape Cod is the ranking cranberry growing district of the United States, New Jersey comes next, following New Jersey comes Wisconsin, and now comes the Pacific Coast modestly claiming fourth place.

Contrary to the general belief, the cranberry industry is not any new undertaking here. Some thirty-five years ago H. D. McFarlin, a Cape Cod cranberry grower, and the originator of the variety which bears his name, came to the Pacific Coast and located in Coos County, where he set out a five-acre tract of cranberries, and from the crops raised on this tract he made his living. McFarlin lived to a ripe old age. His marsh is still one of the best producing cranberry bogs on the Coast. About this time A. Chabot undertook the setting out of a tract of about fifty acres in Pacific County, Washington. This location is just north of the Columbia River at its mouth. Unfortunately Chabot died before the tract was completely set out,

and while today the marsh still bears fruit, it is in a poor condition as compared with the well kept McFarlin bog at Coos Bay.

Cranberry culture was next undertaken in a small way on the Ilwaco Peninsula, and almost invariably the efforts of the growers met with wonderful success. Crops of 100 barrels to the acre were common. The wonderful climate of this section seemed to particularly favor the harvesting of bumper crops year after year. The greatest factor in this regularity of big crops being without question immunity from frost during the growing and harvesting season. The first large undertaking in this district was the setting out of eighty acres at Seaview, Washington, in 1910. This is still the largest tract of improved cranberry land on the Pacific Coast. About this same time H. M. Williams was attracted to the Pacific Coast by reason of the wonderful yields made in this section. Williams being an old time Cape Cod cranberry grower at once selected the mouth of the Columbia as his field for operation. His experience in the industry convinced him of the wonderful possibilities of the industry in this section.

Williams undertook the setting out of a tract of some two hundred acres, and while this tract was coming into bearing, he made a very careful and thorough study of cranberry by-products. Today in addition to owning one of the finest cranberry bogs on the coast, Williams is also engaged in the manufacture of cranberry juice, cranberry syrup, cranberry jam, and other similar products at his plant, the Cranmoor Manufacturing Company in Portland. The fame of Cranmoor products has already been well established.

For a long time after this development had begun in her sister state of Washington, Oregon, with characteristic deliberateness, made no effort at the development of its similar land in Clat-



Cranberry bog at Allendale, Oregon, being put in condition for planting. This view shows how the turf is scalped down to the peat, which is then sanded.



An illustration showing in the foreground a newly planted cranberry bog.

sop County. The climatic conditions were identical, and in addition to the natural advantages of the district immediately to its north, the Cullaby Lake district in Clatsop County was favored with a bountiful water supply, as well as having the further advantage of splendid rail transportation. At length the Oregon spirit became aroused, and cranberry planting began in Clatsop County in real earnest. To C. N. Bennett, a civil engineer, properly belongs the credit of being its chief sponsor. Bennett had been engaged in making a complete survey of the industrial, agricultural and horticultural possibilities of Clatsop County and his trained mind immediately recognized the latent possibilities of a cranberry industry in Oregon. Associating himself with some of the business men in Astoria, cranberry development was begun in the Cullaby Lake district of Clatsop County.

The wild marsh selected by Bennett was the tract lying directly east of the right of way of the main line of the S. P. & S. Ry., and bounded on the east side by the waters of Cullaby Lake, Cullaby Creek and Cullaby Canal. The tract is just one mile from the Pacific Ocean and lies but eleven miles from Astoria by railroad. No cranberries had ever been commercially grown in this district. Wild cranberries abounded in this region. They were of excellent flavor and grew profusely. These wild cranberries were much esteemed by the natives. Lewis and Clark in their Memoirs mention cranberries as one of the articles of food which they traded for with the Indians of this section. The site of their camp when they wintered here in 1805-06 is but a short distance from one of the bogs of Clatsop County. The dinner bell calling the pickers from their labors on this bog, can be heard at the site of the winter camp of these intrepid explorers.

A few years previous to Bennett's discovery of this section as a cranberry district, a drainage canal had been dug connecting the waters of Cullaby Lake with Skipanon Creek, a tributary of the Columbia River. The purpose of this canal being to bring logs from the Cullaby Lake district to the mills of the

Columbia River. The drainage of the lands of the district was incidental. To a prospective cranberry grower, the district was at once made available for development. The presence of Cullaby Lake makes the district especially attractive from the viewpoint of cranberry development. Today the lake level is about eight feet lower than the level of the marsh, thus providing sufficient drainage at all times when needed. Cullaby Lake is a body of fresh water about two miles in length and varying in width from one-fourth to one-half mile.

It is the intention of the growers to use the waters of this lake by pumping the same directly on their lands. After the land has been flooded, the water will run back into the lake through the ditches which are used in flooding the marsh. The water is thereby conserved and can be used over and over again. It is questionable whether there is such a favorable location for a cranberry marsh anywhere else in the United States.

The first planting of cranberries in the Cullaby Lake district of Clatsop County, was made in May, 1911. That year a total of three acres were set out to vines. Today there is a total of 129 acres in vines in this locality. The setting out of an acre of cranberries is a much more complicated matter than the setting out of an acre of fruit trees. It is first necessary to drain the wild marsh. This in Clatsop County is quite inexpensive as ditches need only be cut to Cullaby Lake. Next the marsh must be cleared of all trees and brush, then the turf must be scalped and removed, leaving only the bare peat, which is covered with a coating of sand to a depth of about three or four inches. Planting is the next proceeding, and for this purpose vine cuttings are used which are pressed into the peat through the sand with a planting tool or dibble. The usual distance between hills being ten inches in this section. This makes over sixty thousand hills to the acre. The cost of this improvement varies. Including the land it should cost in Clatsop County about \$1000 per acre.

Since the conclusion of the war a larger development has been undertaken in spite of the increased cost of labor. The noteworthy point in connection with this great development is that it is being undertaken almost exclusively by those who already have large holdings in the industry.

Fortunately all of those who are engaged in the industry in the Cullaby Lake region reside at the bogs or at best a few miles away at Astoria. This insures the bogs receiving the very best attention. Cranberry culture is a strictly horticultural venture and requires close application. During the period when the vines are coming into bearing, the bogs must be kept free from weeds, so that the plant can make its best growth. The cranberry vine has so far only been improved by selection, and therefore retains all of the vigor it had in its wild state, but naturally thrives best when carefully nurtured and kept free from weeds.

The first real commercial pack of cranberries from this district was harvested in 1918. In that year the total yield was over 3000 barrels. At that time, counting every acre set out to vines there was an even 100 acres in Clatsop County. This included many acres too young to bear any fruit. Yet taking them all into consideration the average in consequence of this computation was in excess of 30 barrels to the acre. This exceeds or at least equals the average yield for Cape Cod, where the average yield is placed at 30 barrels to the acre. Records of 100 barrels to the acre on the Pacific Coast are common and have run as high as 250 barrels to the acre.

Several different varieties of fruit have been planted by Oregon growers. All of these varieties having originally been imported from eastern bogs. The native berries being universally of the smaller, uncommercial species. During the early days of this country, these small berries were picked by the residents of the district and shipped to various coast markets. The industry was



How the cranberries are picked.

in no wise an important one. With the development of the cranberry industry in eastern states, and the improvement of the pack of those sections, the demand for the native berries fell off rapidly and the industry died before it really had much of a beginning.

Today the growers of Clatsop County are organized into a live association, which they designate the Oregon Cranberry Growers' Association. This association has greatly helped in standardizing the pack of its members. It markets its fruit through the medium of the Pacific Cranberry Exchange, an organization which also handles the Washington product. Nearly every berry grown on the coast finds its way to the market through this agency. It is a 100 per cent growers' affair. Henry S. Gane, a Long Beach, Washington, grower, is the sales manager for the exchange, and has handled its business in a very successful manner. The returns to the grower have been very satisfactory during the entire period of the organization of the exchange.

The Pacific Coast growers have paid particular attention to the selection of such varieties as will be of good marketable size and excellent keeping quality. One of the varieties which has been imported originally from eastern sources has done so well that it has been appropriated by the growers of Oregon and is now known as the Oregon Jumbo. This berry is of large size and is in great demand by the trade. It is a splendid keeper. Some of the fruit of this variety being placed on the markets of Portland just preceding last Easter. With this variety the growers feel satisfied that they can meet the demands of the most particular trade.

Unlike other small fruit cranberries are not generally placed on the market immediately after harvesting, but are stored in warehouses until such times as they are needed in the markets. Just before being put on the markets they are run through a mill which takes out

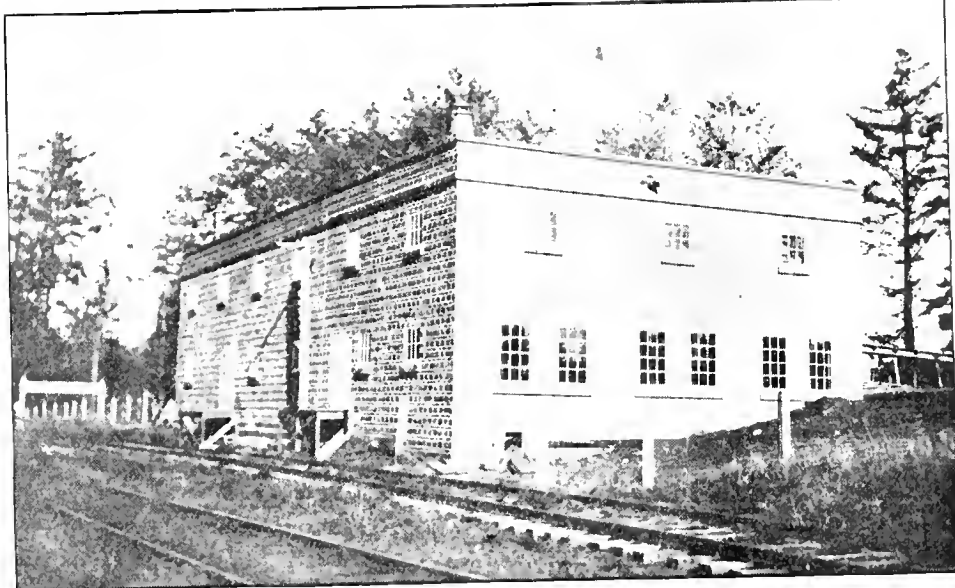

Warehouse of the Oregon Cranberry Growers' Association at Allendale, Oregon, located along the main line railroad. At the extreme right can be seen the railroad that runs from the second floor of the warehouse to the bogs.

the chaff, and removes the small and soft berries. It is the usual practice to run the fruit over sorting tables in addition to the milling process, in order to remove such imperfect fruit as may have escaped the mill. At Allendale, where one of the largest cranberry projects is located, and a modern warehouse built, hand sorting was not resorted to this year. The work of the mill being satisfactory. The berries being marketed early in the season, there was but little shrinkage and the extra cost of hand sorting was saved to the growers. In the preceding season, 1918, the last run of berries was made on December 17th. During the afternoon of this day two women hand sorters packed 90 boxes of one-third barrel each. The cost of this sorting being

but 23c per box. A most gratifying record. The advantage of a good keeping variety to the grower can readily be seen. It not only saves him from running up excessive packing house costs, but the saving in fruit alone is in itself a very considerable item. The fruit which is graded out by the machine or by the hand pickers costs just as much to harvest as that which goes in the boxes to the trade.

While there is a salvage obtainable from soft fruit, which can be used for juice making, still it is much more satisfactory to the grower to have the fruit hold out sound until actually ready to be put on the market. A further advantage in having fruit of this variety is in the fact that the fruit is uniformly large, and the percentage of undersized, or so-called pie berries is negligible.

Combined Bordeaux Oil Emulsion Spray

By Dr. C. A. Macrum

THIS emulsion spray was evolved by Dr. C. A. Macrum, commissioner for the Fourth District of the Oregon State Board of Horticulture.

If applied as the buds are opening, before the blossoms appear, will control scab, San Jose scale, aphid, leaf roller, red spider, curl leaf of the peach and the copper will be present to prevent the ravage of anthracnose spore when the rains come in the fall of the year, and control the disease in prunes due to the *cyllindros porum*.

The method of preparation is as follows: Prepare the copper sulphate solution in the usual proportions of one pound to the gallon of water, dissolve one and one-half pounds of common glue in one and one-half gallons of water, slack twelve pounds of lime, or stir twelve pounds of hydrated lime in water at time of using. Fill a 200 gallon spray tank three-fourths full of water. Pour twenty-four gallons of bluestone solution into the tank, start the agitator

and add the lime milk slowly until a neutral solution is had. Test with litmus paper to tell when the solution is neutral. Add the one and one-half gallons of glue solution. Measure out twelve gallons of the General Chemical Company's No. 1 oil emulsion, or a corresponding oil emulsion, add a little water and stir until emulsion is started as shown by the mixture turning milky. Pour into the spray tank and add water to make 200 gallons. The agitator must be kept running during the whole procedure. The spray should be applied as soon as prepared.

The above are the proportions for a 200 gallon tank. In making stock solutions for a day's spraying the quantities given can be multiplied by the number of tanks required.

The strength of the Bordeaux can be varied as deemed necessary. The amount of copper sulphate in the above formula is the same as the ordinary

Continued on page 39.

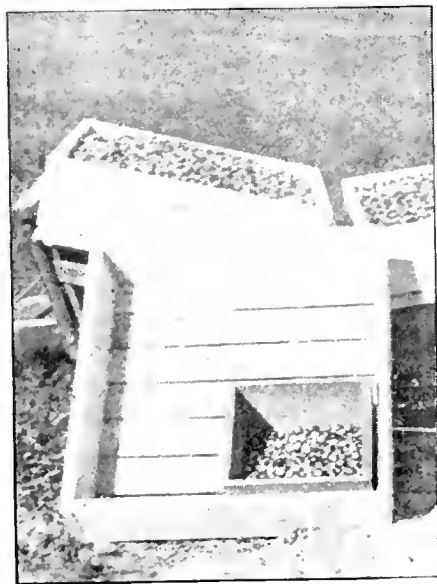

Cranberries in the field ready to be taken to the warehouse. The large box shows the style of crate used for storage and the small one the picking box.

Practical Methods in the Use of Orchard Heaters

By George Calvert

ORCHARD heating, like spraying or any other of the special departments involved in fruit raising, must be conducted on absolute rules prescribed by the work if the grower hopes to obtain a high degree of success. In spraying there are many men who condemn the practice, but this condemnation comes from the man who has made a failure of it and not from that large class of up-to-date hardworking body of fruit growers who by following scientific methods are today realizing handsome returns from their orchards.

There are many growers who do not believe in orchard heating, but these are the very same men who never believe in anything which is an innovation in past history and methods. It is right here that I desire to point out an analogous case of business judgment which compares favorably with the orchard heating subject. Where, for instance, can the intelligent man be found who will refuse to protect a twenty thousand dollar building against fire through the agency of an insurance policy due to the cost of the annual premium. Yet, there are thousands of fruit growers with ten to twenty acres of modern orchard capable of producing an annual crop valued at a gross of from \$500 to \$1200 per acre who refuse to safeguard the same against the ravages of frost. Suppose that the frost cuts the crop down to 25 per cent of its normal production, or in other words a frost loss of 75 per cent. If the normal crop was valued at \$500 per acre, the loss in dollars and cents is \$325 per acre, leaving a gross return from the orchard of only \$125. Just think in figures for a minute in order to argue this subject with yourself. Say the orchard heating work costs \$25 per acre, (which is almost the maximum) and a normal crop was secured through orchard heating. Is not the frost insurance premium a mighty small item of cost?

In this discussion of the rules to be followed for practical orchard heating work the writer does not aim to challenge a dispute with so-called scientists who have experimented with orchard heaters in a laboratory, and who could not make a living in a real orchard if someone else put up the money and did the heavy work. Scientific knowledge coupled with practical work are the components which has made and is making the fruit industry of today and the future.

The sole aim of this story is to outline a series of practical suggestions on orchard heating which may be used to advantage by the practical grower—the grower who is in the fruit raising business for the profits which it affords.

First comes the question of fuel for operating orchard heaters, which comprises crude oil and coal. The former is more convenient in every way though in certain localities the price of oil is high due to the distance from the source of supply, and the price of coal is low.

In this case coal heaters are to be considered. When it comes to a question of selecting an orchard heating equipment this is an important subject for the success of orchard heating depends upon the ability of the heaters to do the work desired. First of all the heaters must be able to make sufficient heat to offset the frost forming temperature within the orchard area. The heat pro-



Orchard heaters in operation.

ducing capacities of the heaters must therefore be able to cope with varying degrees of temperature which visit each fruit district at a time when the crop native to the locality is at the critical period of growth. Almost all fruit belts of the United States are subject to a frost and a low temperature reaching 15 degrees above zero, and it is this cold temperature which the fruit grower has to combat, although in most fruit belts the extreme low temperature mentioned above is rarely reached at times when frost is a factor. One may have ideas to the contrary but it is a fact nevertheless. As an illustration the conditions existing on the extreme Southern Peninsula of Florida may be pointed out to advantage. This semi-tropical latitude

is subject to frost from December 20 to March 20, although of course that section does not have injurious frosts every succeeding year, yet the danger is there all the same and the growers cannot afford to take a chance with their valuable produce without the protection of orchard heaters. There are many fruit belts in the far west where growers have been placed in financial straights due to the almost entire loss of crops in succeeding years. So it is well to illustrate the safeguards which orchard heaters afford.

The month of April is usually the mischief maker among growers of all deciduous fruits and the conditions apply in all sections both east and west.

Much confusion has existed among growers in the practical utilization of orchard heaters, so well defined rules will be helpful to obtain the greatest success. An abundance of fuel for refilling the heaters should be provided in order to combat thoroughly every time frost appears, for unless the job is done completely the growers had better save the expense, because the work will produce far greater results than the man who makes no attempt to protect his crop.

The heater should be placed in the orchard at least ten days or two weeks prior to the blossoming, but when frost is impending it is well to arrange two rows on the north and west-ward sides of the orchard as from these directions usually come the accompanying winds which bring the low degrees of temperature. Many growers have had excellent results from arranging the heaters in the form as shown in diagram No. 1. Others prefer to arrange them as illustrated in figure 2. As frost formation moves in streaks over a given surface of land, it has been proved that the arrangements indicated in figure 1 has been equally as successful as the arrangement shown in figure 2. The double row affords an abundance of heat which will drift toward the inner area of the orchard provided wind accompanies the low temperature and the distribution of the heated air in the orchard area is kept in circulation to better advantage and prevents the formation of frost.

There are many different types of oil heaters on the market and a good plan for every practical fruit grower to adopt is, to get a sample of each make and try them out under his own tests. For a few dollars he could secure before purchasing an entire equipment, a sample of all the different styles and by this measure he can soon determine upon the device which meets all the demands of the work. It is well to warn growers not to purchase an equipment of orchard heaters which make an excessive amount of smoke when burning, for a fruit tree is in its most tender condition of growth at the blossoming point and the delicate little blossoms are often injured by an excessive amount of smoke and soot, which not

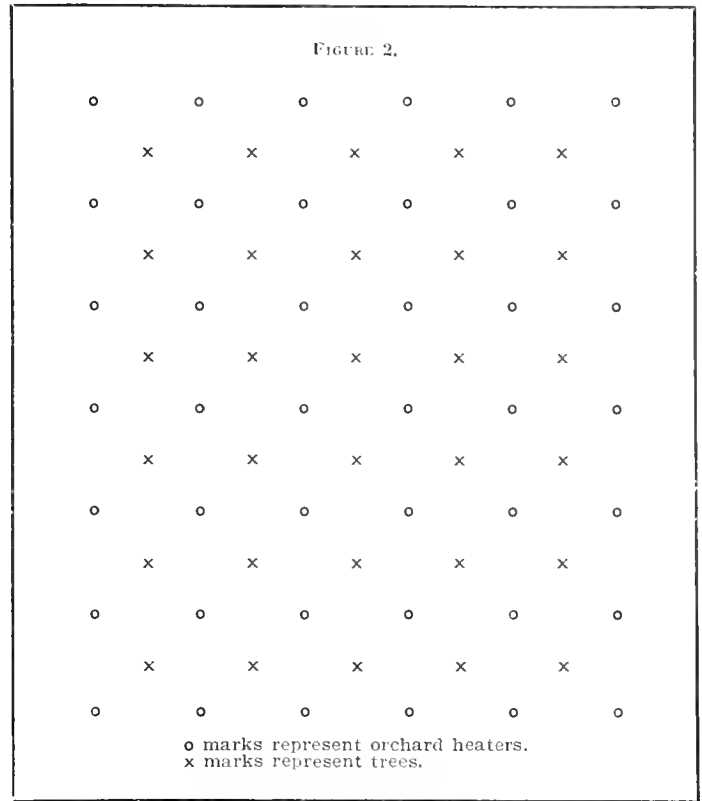
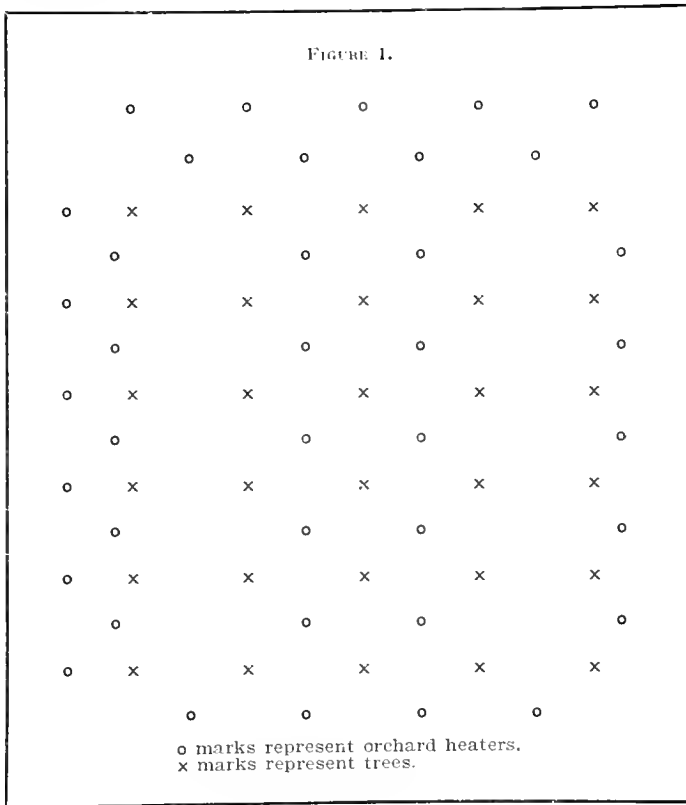

only reduces the size of the crop but may permanently injure the future health of the trees themselves. A fruit tree at this stage of development cannot stand being smoked like a ham, so it is important that the heaters burn the fuel with a good degree of combustion.

The latest and much approved types of orchard heaters are constructed with dampers. This improvement permits of regulating the amount of heat necessary to combat the temperature upon a particular night and thus works a big economy in the saving of fuel oil as it is both useless and impractical to burn

the heaters at full blast when the temperature has only reached twenty-five degrees. In case the succeeding night the temperature falls to 20 degrees it would be necessary to apply a greater amount of heat and the dampers could be adjusted very quickly to offset the

Continued on page 38.

Results of Pollination Studies at Idaho University

By C. C. Vincent, Horticulturist, University of Idaho, Moscow, Idaho

THE subject which has been assigned for me to discuss, "Orchard Pollination," is one which has received considerable attention at the Idaho Experiment Station for the past ten years. The original problem, Apple Breeding, has had to do with the improvement of orchard fruits and in the investigating of this phase of the work, certain problems have been encountered, which it is hoped will prove of interest and value to all investigators in a similar field as well as to practical orchardists of the Pacific Northwest.

Self-Sterility an Orchard Problem.

One of the first problems in orchard pollination is the discovery of varieties which are inclined to be unfruitful when planted alone. There are several reasons for this failure to produce fruit: too vigorous wood growth; defective stamens, which do not produce normal pollen; location; climatic conditions such as frost injury and rain during the blooming period. Probably the principal cause of self sterility is the inability of the pollen of a variety to fertilize its pistils.

The writer first became interested in pollination studies in 1907, while connected with the Oregon Agricultural



The bagging methods used in making sterility and fertility tests.

College. The results of this work were reported in Bulletin No. 104 of that station. The data showed that out of 87 varieties of apples, 59 varieties were found to be self-sterile; 15 varieties self-fertile; and 13 varieties partially self-fertile.

Various reports seem to indicate that a variety may be self-fertile in one locality and self-sterile in another. W. S. Fletcher in his bulletin entitled "Pollination in Orchards," concludes that "self-sterility is not a constant character with any variety." The same variety may be self-sterile in any place, and nearly self-fertile in another. Darwin writes of a plant that was self-sterile in Brazil, but when grown in England became self-fertile in one or two generations.

That self-sterility is not a constant character is shown by the following examples: The Yellow Newtown is listed as self-sterile in Farmers' Bulletin No. 65, and self-fertile in Oregon Bulletin No. 104. In our experiments at the Idaho Experiment Station we have found this variety to be partially self-fertile. The Rhode Island Greening is listed as self-fertile in Farmers' Bulletin No. 65 and in Bailey's "Principles of Fruit

Growing." Fletcher in his book, "How to Make a Fruit Garden," Oregon Agricultural Experiment Station Bulletin No. 104, and in Idaho this variety is listed as self-sterile. The same variations are also noticed with the Grimes Golden. Fletcher classifies the Grimes as self-sterile, Oregon bulletin as self-fertile, and Idaho reports it as partially self-fertile. This peculiar phenomena existing among different varieties makes it almost necessary to test out commercial varieties in each locality. The results secured are shown in the following table:

to be true with such varieties as the Bismarck, Cox Orange, Hydes King, Haas, Jefferies, King David, Mother, Rome Beauty, Twenty-Ounce Pippin and White Winter Pearmain. Kraus of Oregon, states that "some varieties of apples have been found to be self-sterile three years out of five and self-fertile the other two."

Hendrickson, of California, in his work with the common honey bee as an agent in prune pollination has found that the Imperial prune, though usually self-sterile, in occasional years, at least, is partially self-fertile. The Winter

King, Haas, Jefferies, Jonathan, King David, Mann, Mother, Missouri Pippin, Palouse, Rome Beauty, Spitzenburg, Stayman Winesap, Twenty-Ounce Pippin, Wealthy, White Winter Pearmain, Whitney Crab No. 20, Westfield, Yellow Newtown.

Setting of Fruit Under Natural Conditions

The percentage of fruit that set when the blossoms were confined to their own pollen, as shown in Table 1, varies from .17 per cent to 38.8 per cent. What then would constitute a normal set of fruit among varieties of apples when the blossoms are exposed to insect visitation, as it is a well known fact that all the flowers that are produced in the spring will not mature fruit. To determine the percentage of fruit that ordinarily sets under natural conditions, counts were made on certain branches at blooming time and final counts made later in the season. The final counts of the "fruits set," were taken on June 15. The results secured were as follows:

TABLE No. 2.—No. OF FRUITS SET UNDER NATURAL CONDITIONS.—1912.—UNIVERSITY OF IDAHO.

Variety	Number blossoms counted	Number fruits set	Per cent of fruit set
Wagener	1140	664	58.2
Grimes	1077	819	76.0
Bome	1092	510	46.7
Jonathan	1106	814	73.5

The average for the four varieties is 63.6 per cent. Unfortunately counts were not made when the fruits were harvested in the fall. If they had been made, it is evident that this average would have been reduced at least 50 per cent. A normal set of fruit among apples then would be approximately 31.8 per cent. Fletcher states that under eastern conditions "Scarcely one fruit blossom in ten sets fruit, even in the most favorable seasons and with the most productive varieties." From personal observations I am under the impression that his estimate would be entirely too low for our dry conditions here in the Northwest.

TABLE 1.—SELF-STERILE AND SELF-FERTILE VARIETIES—UNIVERSITY OF IDAHO.

Variety	Blossoms bagged			No. fruits set			Total Fruit Set	% Fruit Set
	1911	1912	1914	1911	1912	1914		
Arkansas Beauty	216	81	81	38.8
Arkansas Black	418	0	0
Ben Davis	708	9	9	1.2
Bailey's Sweet	515	0	0	0
Bismarck	515	...	195	8	...	0	8	1.1
Ben Hur	93	0	0	0
Blue Winter Pearmain	1191	...	228	0	...	0	0	0
Cox Orange	1102	...	175	0	...	2	2	1.3
Early Harvest	152	0	0
Elk Horn	178	4	217	2.2
Grimes Golden	683	9717	365	16	227	...	21	3.6
Gano	310	...	358	0	...	17	31	3.5
Gravenstein	230	...	596	16	8	1.6
Hyde's King	289	...	207	0	10	5.3
Hill	189	10	4	.79
Haas	227	...	280	0	5	1.1
Jefferies	258	...	200	0	...	15	566	2.9
Jonathan	388	17376	1317	5	547	...	3	.49
King David	357	...	248	0	...	3	5	2.1
Mann	235	5	2	.41
Mother	317	...	170	2	...	6	33	5.8
Maiden's Blush	564	33	0	0
Minkler	323	...	191	0	...	0	6	1.4
Missouri Pippin	155	...	250	2	...	1	17	7.1
Montreal Beauty	239	17	0	0
McIntosh Red	228	0	0	0
Northwestern Greening	293	...	306	0	0	0
Northern Spy	43	0	...	75	75	19.9
Oldenburg	381	0	0
Primate	131	...	118	0	4	4.4
Palouse	90	4	60	33.3
Red June	180	60	0	0
R. I. Greening	415	...	136	0	...	0	170	4.6
Rome Beauty	263	9288	535	0	470	0	1	.4
Spitzenburg	250	1	...	1	1	.17
Twenty Oz. Pippin	110	...	152	0	...	1	0	0
Transcendent Crab	573	...	263	0	...	0	0	0
Tetofsky	150	...	192	0	...	0	0	0
Winesap	215	...	150	0	...	0	13	3.7
Wealthy	135	...	216	3	...	10	1014	13.2
Wagener	1309	6115	214	57	953	4	4	.74
W. W. Pearmain	400	...	110	0	2	.37
Whitney Crab No. 20	535	2	...	0	0	0
Winter Banana	351	...	187	0	...	0	1	.71
Westfield	140	1	36	33.6
Yellow Transparent	107	36	0	0
Yellow Bellflower	372	0	2	1.5
Yellow Newtown	133	2

SELF-STERILE AND SELF-FERTILE VARIETIES—1914.—LEWISTON, IDAHO.

Variety	Number blossoms bagged	Number fruits set	Per cent of fruit set
Arkansas Black	63	0	0
Black Twig	27	0	0
Delicious	231	0	0
Jonathan	486	13	2.8
Rome Beauty	240	2	.83
R. I. Greening	45	0	0
Stayman Winesap	225	1	.45
Spitzenburg	379	3	.79
Winter Banana	222	5	2.2
Yellow Newtown	417	20	4.4

The above results would indicate that the majority of the varieties were practically self-sterile. In a number of instances it will be noticed that only one or two fruits would set out of the 300 or 400 blossoms enclosed, and while these have been classed as partially self-fertile, they would from a practical standpoint be considered as self-sterile. Another surprising feature of the work as shown in the table is the fact that certain varieties when confined to their own pollen may set a few fruits one year and none the next. This was found

Banana at Moscow was found to be self-sterile, while at Lewiston, it was partially self-fertile.

Out of the fifty varieties of apples tested for their sterility and fertility, eighteen were found to be self-sterile; seven self-fertile and twenty-five partially self fertile. They have been classified as follows:

Self-sterile Varieties: Arkansas Black, Bailey's Sweet, Blacktwig, Ben Hur, Blue Winter Pearmain, Delicious, Elkhorn, Minkler, McIntosh Red, Northwestern Greening, Northern Spy, Primate, Rhode Island Greening, Transcendent Crab, Tetofsky, Winesap, Winter Banana, Yellow Bellflower.

Self-fertile Varieties: Arkansas Beauty, Hill, Maiden's Blush, Montreal Beauty, Red June, Wagener, Yellow Transparent.

Partially Self-fertile: Ben Davis, Bismarck, Cox Orange, Early Harvest, Grimes Golden, Gano, Gravenstein, Hyde



General view of the cages in the college orchard at the University of Idaho.

If then, under the most favorable conditions 31.8 per cent constitutes a normal set of fruit when two or more varieties are planted together, we can readily see that the majority of the varieties listed in Table I would not produce a crop if planted in large blocks by themselves.

Methods of Determining Self-Sterility.

Fletcher states that "merely enclosing the unopened blossoms of a variety in paper sacks is not a fair test of the ability of the variety to set fruit with its own pollen." This method, however, is one followed largely by investigators at the present time. If the bagging method is not a conclusive test for self-sterility, what method then should be followed? In 1912, two methods were tested out: First, enclosing unopened blossoms in paper sacks; second, erecting tents of cheese cloth over individual trees. The results secured by the two methods are given in Table III.

TABLE 3.—BEHAVIOR OF DIFFERENT VARIETIES TO SET FRUIT UNDER THE TWO METHODS—1912—UNIVERSITY OF IDAHO.

Blossoms Bagged	Number blossoms bagged	Number fruits set	Per cent of fruit set
Grimes	1485	78	5.2
Jonathan	1788	86	4.8
Rome	2418	72	3.0
Wagener	2456	302	12.3

Blossoms Caged	Number blossoms in cages	Number fruits set	Per cent of fruit set
Grimes	8232	149	1.7
Jonathan	15888	461	2.9
Rome	6870	398	5.7
Wagener	3659	651	17.7

It is evident from the results secured that there is very little difference between the two methods used.

To determine if there was any difference in the temperature within the cages and the temperature on the outside, thermometers were placed in different positions among the branches. The readings show that the differences under the two conditions were very slight.

TABLE 4.—TEMPERATURE WITHIN THE CAGES.

Position of Thermometer	Grimes Golden. Temperature in cage	Temperature in open
Under branches....	21½°c	21°c
Exposed to sun....	22½°c	23°c
Center of tree.....	22°c	19½°c
Side of tree.....	21½°c	20½°c
Upper branches....	21°c	22½°c

Seed Development.

In view of the fact that seed production is supposed to be the exciting cause of the growth of the flesh of the fruit, a study was made of the self-fertilized and cross-fertilized fruits. In Bulletin No. 104 of the Oregon Experiment Station, it was found that the majority of the fertile and partially fertile fruits were seedless fruits or fruits with only a few seeds. Fletcher in his work with pears found that the fruits produced from Bartlett pollen had shrunken seeds and failed to germinate. Our results confirms those already recorded as shown in the following table:

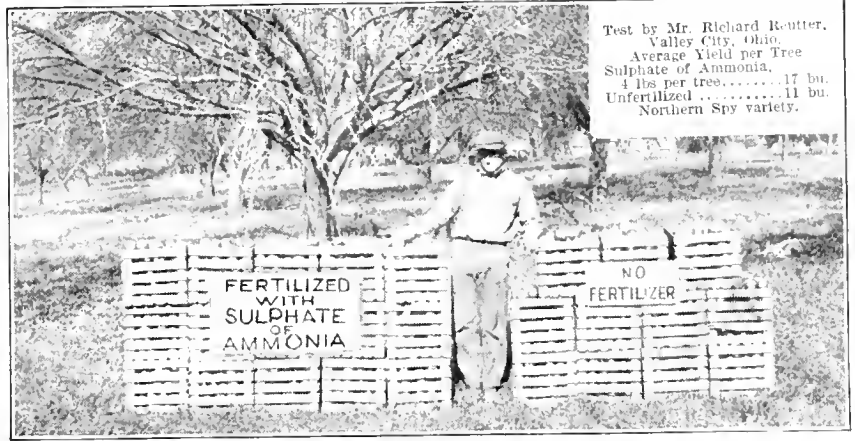

TOP DRESSING TALKS, No. 4

Nitrogen Pays in the Orchard

"Orchards in a somewhat run-down or devitalized condition are greatly benefited by the use of nitrogen.

"Nitrogen added in March causes a larger percentage of set of fruit in April, an immediate change in the character of the foliage, and a stimulation of the wood growth." (From Oregon Agricultural Experiment Station Report 1914-1915.)

This station also reports that in an apple orchard test in Hood Valley, Oregon, "\$30.57 worth of fertilizer for each acre increased the yield from 68 to 756 boxes, approximately 11.1 times in two years."

ARCADIAN
Sulphate of Ammonia

Arcadian Sulphate of Ammonia is the best form of nitrogen for orchard fertilization. The following are its advantages:

Arcadian contains 1/3 more nitrogen than any other top dressing fertilizer. The nitrogen is all soluble, quickly available and non-leaching.

Its crop-producing power per unit nitrogen is equal to or greater than any other nitrogenous fertilizer.

In addition to its high nitrogen content it is rich in sulphur, an important plant food often lacking in Western soils.

It comes in fine mechanical condition and can be applied by hand or fertilizer distributor without previous grinding or screening.

It is low priced per unit ammonia.

Top dress the orchard with from 100 to 200 lbs. per acre in the zone of the feeding roots, just before blossoming time.

FOR SALE BY

CALIFORNIA: San Francisco, Hawaiian Fertilizer Co., Pacific Bone Coal & Fertilizing Co., Pacific Guano & Fertilizer Co., Western Meat Co., California Fertilizer Works; Los Angeles, Pacific Guano & Fertilizer Co., Pacific Bone Coal & Fertilizer Co., Agricultural Chemical Works, Hauser Packing Co., Hawaiian Fertilizer Co., Southern California Fertilizer Co. OREGON: North Portland, Swift and Co.

For information as to application, write

The *Barrett* Company

Agricultural Department

510 First National Bank Building, Berkeley, Cal.



FLOOR SPACE 200,000 SQ. FT.

SERVICE
PLUS
QUALITY

**IS THE REAL
 BASIS OF VALUE**

SCHMIDT PRODUCTS

**LABELS
 CARTONS
 POSTERS
 ADVERTISING
 DISPLAYS**

OUR NEW FACTORY
 WILL EMBRACE
 THE MOST MODERN IDEAS
 OF EFFICIENCY
 AND THE INSTALLATION
 OF NEW MACHINERY
 IS AN
 ASSURANCE TO OUR CUSTOMERS
 AND
 PROSPECTIVE CUSTOMERS
 THAT EVERY EFFORT
 WILL BE MADE
 TO RENDER
SERVICE and QUALITY
 EVEN SUPERIOR
 TO THAT GIVEN IN THE PAST

47TH

YEAR



SAN FRANCISCO

BRANCH OFFICES
 LOS ANGELES - FRESNO
 PORTLAND - SEATTLE
 SACRAMENTO - HONOLULU

TABLE 5.—No. OF SEEDS PRODUCED BY VARIETIES IN DIFFERENT CROSSES.

Cross	No. fruits	No. seeds	No. seeds per fruit
Gravenstein x Gravenstein	47	5	.10
Maiden's Blush x Maiden's Blush	2	7	3.5
Rome Beauty x Rome Beauty	2	6	3.0
Spitzenburg x Spitzenburg	3	7	2.3
Winter Banana x Winter Banana	4	3	.76
Wagener x Wagener	27	11	.51
Yellow Newtown x Yellow Newtown	10	0	0
Spitzenburg x Jonathan	12	81	6.7
Jonathan x Wagener	31	205	6.6
Wagener x Jonathan	131	769	5.8
Jonathan x Spitzenburg	11	76	5.4
Jonathan x Ben Davis	207	1216	5.1

Apple Cross-Pollination.

From the data presented it is evident that a large number of our commercial varieties of apples are self-sterile and furthermore those that are apparently fertile or partially so, are inferior in size to the fruits that set under natural conditions.

Cross-pollination experiments are therefore necessary in order to arrive at definite conclusions, concerning the best pollinizers for any commercial variety. Naturally then the question arises as to what constitutes a good pollinizer. In the first place there must be a mutual affinity between the varieties planted together. At the present time very little is known about the sexual affinities of our cultivated fruits. To throw some light upon this important question at the Idaho station a number of crosses were made during the season of 1915. A study of the following table may be found of interest in this connection:

TABLE 6.—CROSS-POLLINATION OF APPLES 1915—STATE OF IDAHO.

Cross	Number blossoms pollinated	Number fruits set	Per cent of fruit set
Rome x Newtown	100	10	10.0
Newtown x Rome	200	30	15.00
Rome x Gravenstein	120	1	.83
Jonathan x Newtown	260	71	27.3
Newtown x Jonathan	200	69	34.5
Jonathan x Rome	140	36	25.7
Grimes x Wagener	300	4	1.33
Wagener x Grimes	180	19	10.5
Grimes x McIntosh	16	2	12.5
McIntosh x Grimes	100	8	8.0
Grimes x Gravenstein	30	0	0
Spitzenburg x Grimes	20	7	35.0
Wagener x McIntosh	120	9	7.5
McIntosh x Wagener	80	4	5.0
Wagener x Gravenstein	100	0	0
Gravenstein x Wagener	160	36	22.5

These results show that certain crosses give better results than others. For instance, Jonathan X Newtown gave a 27.3 per cent of fruit, which would be considered a normal set, if 31.8 per cent represents approximately a normal set under natural conditions. A combination of Jonathans and Romes would be good economy in view of the fact that approximately 26 per cent of a set of fruit was obtained. On the other hand, one would hesitate in planting Romes and Gravensteins together, as only .83 per cent of fruit set. Likewise the same is true of Grimes and Gravenstein. Before definite conclusions can be drawn further, experimentation is necessary, but on the face of the evidence presented, it is apparent that all varieties will not cross with each other.

Therefore, in the selection of a pollinizer, the following points should receive due consideration: First, there must be a mutual affinity between the varieties planted together; second, the two varieties must bloom at approximately the same time; and third, the varieties should be good pollen producers.

Those who have orchards just coming into bearing, or old orchards for that matter, planted with one or two varieties which are shy pollen producers, should graft over one tree at least out of every ten with some other variety that is an abundant pollen producer, and blooms at the same time as the others.

BEST SERVICE - QUALITY & PRICES

PERFECTION IN FRUIT LABELS

THE SIMPSON & DOELLER CO.
1423-24 NORTHWESTERN BANK BLDG.
PORTLAND, OREGON.
E. SHELLEY MORGAN
NORTHWESTERN MANAGER

WE CARRY—AND CAN SHIP IN 24 HOURS—STOCK LABELS FOR PEARS, APPLES, CHERRIES & STRAWBERRIES.

Bees and Pollination.

In a discussion of the subject of orchard pollination, the question of bees should not be overlooked, for cross-pollination will not be effective unless insects are present to carry pollen from tree to tree. The wind is a very poor conveyor of pollen, hence the orchardist depending entirely upon this agency in fertilizing his trees will meet with disappointment. Mr. E. B. Kelly, Horticultural Inspector for the Spokane Valley, is confident that lack of pollination in his district is due largely to the absence of pollen-carrying insects. This is apparently true in practically all commercial fruit districts of the Northwest.

The experiments conducted by the University of California with prune trees confirm these points. Their results seem to warrant the following conclusions:

- (1). Both the French and Imperial prunes may be aided in setting fruit by the use of bees in the orchard during the blooming period, provided the trees are in a normal, healthy condition.
- (2). The absence of bees in the orchard may mean a low percentage of set with both these varieties.
- (3). The French prune does not absolutely require interplanting with the Imperial, even though this arrangement may prove beneficial to both varieties.

In conclusion therefore I wish to say that the introduction of a number of hives of bees in the orchard, one hive to the acre, especially during the blooming period would unquestionably increase the normal set of fruit.

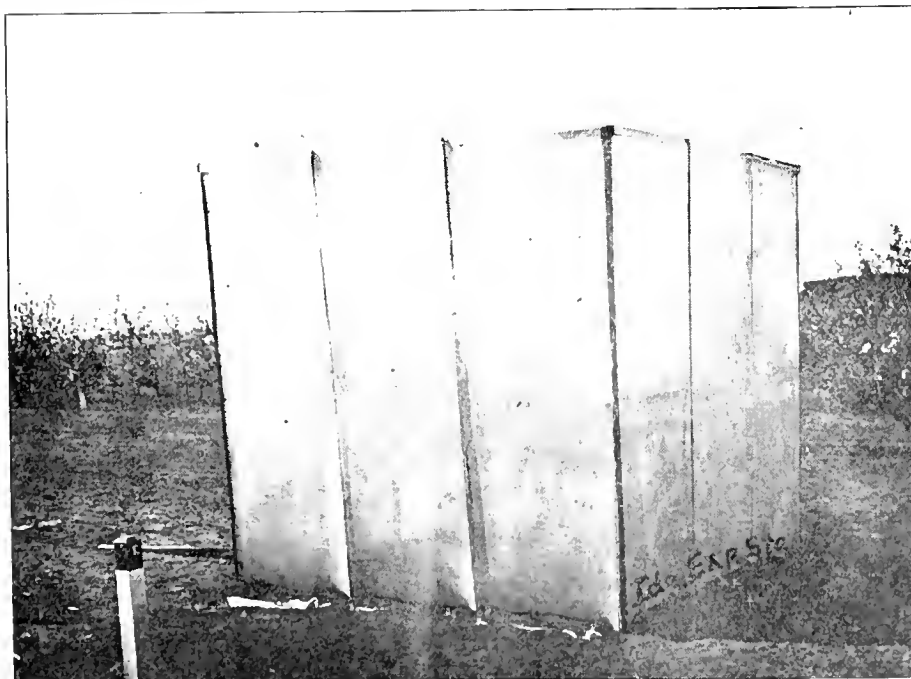

Showing one of the cages used in making the tests.

Observations on Treatment of Winter-Injured Trees

By W. H. Walton

EXPERTS in horticulture both in the Pacific Northwest and elsewhere who have had experience with fruit trees that have been injured by low temperatures are advising orchardists to proceed with caution in their treatment. It is pointed out by these authorities that the winter is not yet over and until such time as it is and the extent of the injury more definitely known, it will be the part of wisdom not to take action hastily.

Growers Should Be Cautious

Reports from the various sections of the Northwest are to the effect that stone fruits, particularly peaches, have been more severely hurt than apples and pears, and that the latter are apparently injured to a greater extent than apples. In the Willamette valley district of Oregon, where almost record low temperatures for this district were recorded it is not believed by Prof. C. I. Lewis, former chief of the division of horticulture of the Oregon Agricultural College, who investigated this section, that the injury is as great as at first reported and he is advising growers not to act on hastily made conclusions which would subject their orchards to too heavy pruning.

In the Hood River district which was subjected to still lower temperatures than the Willamette valley, Gordon G. Brown, horticulturist at the Hood River

Experiment station is advising the same plan of operation. In writing of the injury and the treatment for it Mr. Brown says:

Apple and Pear Injuries.

"Now that the trees have thawed out, many of the older orchards are showing serious injury as a result of the recent freeze. In most instances the injury is definitely located in the trunk and main body of branches where the cambium is prominently discolored. The injury appears for some distance above and below the level to which the snow had settled. As a rule the greatest destruction took place between the two and four-foot levels. An examination of the cambium tissue at greater heights above the ground showed that the trouble lessened and gradually disappeared altogether. Hence, an examination of the smaller, younger growths, which in many cases show no injury whatever, does not offer any clue as to what may be found in the main body of the tree. This injury is found both in apples and pears and the peculiar fact is found that the injury apparently bears no definite relation between trees on different soils, sites or under different orchard management. Apples appear to show considerable difference in resistance to injury. Baldwin and Arkansas Blacks appear to be highly resistant, while Jonathans, Ortleys and Spitzen-

bergs to be less so, and the Newtowns give indications of being the least resistant of any of the varieties examined.

Pruning Recommendations.

"Despite the fact that the injury is quite severe, the situation has a very hopeful aspect. It is found most prominently on the south or southwestern portions of the tree. However, the opposite side of the tree or limb is much less affected and should be able to function when the growth starts. Therein lies the hope for trees so injured.

"Should the most severely injured portions fail to resume growth normally there is considerable danger from sunscald next summer against which the grower should guard. Applications of Bordeaux whitewash to such parts next summer should prove effective in such cases where the body of the tree is exposed directly to the sun. Otherwise heart-rot fungus may gain entrance to the tree.

"Where trees are severely injured I believe heavy pruning next spring will be effective in strengthening the tree. This in case the tree has an excessive amount of top. In cases where the trees have made normal growth and the top is already thinned out I do not believe the case calls for special treatment. Whether applications of nitrate of soda will help is very problematical since it

Continued on page 34.

"FRIEND" SPRAYERS

FASTEST AND BEST MADE

"Time once lost can never be replaced"

SOME OF THE SPECIAL FEATURES

Large Wheels - Light Draft - Short Turn - Hillside Design - Tank Low Hung - Cannot Overturn - Extreme Flexibility - "Friend" Pressure Controller - Quick Accessible and Detachable Valves and Pump Parts - Adjustable Packing - Direct Propeller Agitator Auto Type Engine - Large Reserve Power.

SIZES FOR ALL ORCHARDS

CAPACITIES 5 TO 20 GALLONS PER MINUTE

"Friend" Users are "Friend" Boosters.

MANUFACTURED BY

"FRIEND" MFG. CO.
GASPORT, N. Y.

FOR SALE BY

HOOD RIVER SPRAY COMPANY

Distributors for Oregon
HOOD RIVER, OREGON

MANUFACTURERS OF SPRAY CHEMICALS

Lime - Sulphur - Miscible Oils - Bordeaux Paste - Distillate Oil Emulsion - Lead Arsenate



Introducing New Styles

Combined With an Improved Chassis

FIRST to make radical improvements in Light Six cars, Mitchell again departs from old-time standards. New and original designs now replace former types.

They are built complete in the Mitchell factories. Quantity production and efficiency methods effect vast savings. Thus Mitchell offers bodies comparable only with the most expensive cars or custom-built for the individual.

The mechanical excellence of the Victory Model Mitchell has established a confidence so far-reaching that one need only view the new models to know that these are truly the cars of today — and the future.

When you see the Mitchell, be sure to make a thorough investigation and comparison of the scores of improvements found throughout the chassis.

Note how this car has been built for long life and economical operation. See how we have made many improvements by adding strength, better materials and greater accuracy.

See also, how roominess and riding comfort have been provided. Cantilever rear springs give matchless riding ease.

Mitchell dealers are now showing these new cars. You are urged to see them and judge what Mitchell improvements can mean to you.

MITCHELL MOTORS COMPANY, INC.,
RACINE, WIS.

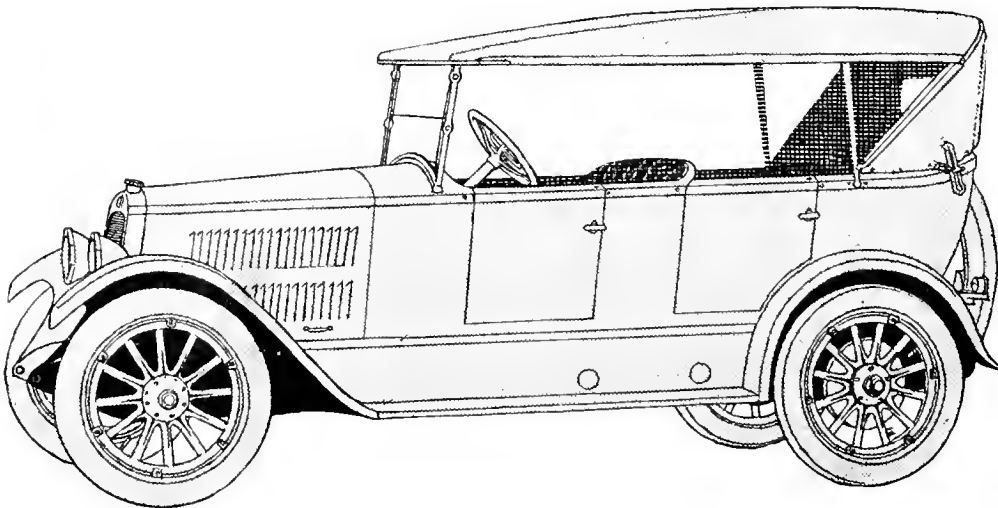

5-Passenger Touring Car
3-Passenger Roadster

5-Passenger Sedan
4-Passenger Coupe

PACIFIC NORTHWEST DISTRIBUTORS



PORTLAND, ORE.. SPOKANE, WASH.

BUY FROM THE LOCAL MITCHELL DEALER

WHEN WRITING ADVERTISERS MENTION BETTER FRUIT

Managing Bees from a Production Standpoint

By Geo. S. Demuth, Agricultural Assistant, Bee Culture Investigations,
United States Department of Agriculture

It is important to note that four essential factors enter into the securing of a crop of honey: (1) A sufficient amount of bloom of healthy and well-nourished nectar-secreting plants growing in soil to which they are adapted and within range of the apiary. (2) Weather conditions favorable to nectar secretion and bee flight. (3) A large number of workers in excess of those needed for the routine work of the colony. (4) Conditions of the colony making the storing instinct dominant. If any one of these factors is absent, the effect of the other three is immediately nullified, and the amount of honey secured will vary as these factors are present at the same time in greater or

less degree or as the time during which they are all present is longer or shorter. It is therefore possible to have each of these factors present at some time during the season without securing a crop of honey. The period during which they are all present at the same time is usually quite short.

Grouping the first and second factors, we have a combination usually spoken of as the locality and season. These factors are largely beyond the control of the beekeeper except that (1) he may choose a location in which both are usually present at some time or times during the season, (2) he may take advantage of the plants of several locations by practicing migratory bee-

keeping, or (3) he may improve a given locality by directly or indirectly increasing the amount of nectar-secreting plants, such as buckwheat, alsike clover, sweet clover, or alfalfa.

In the third and fourth factors we have conditions capable of being brought about by management and for which the beekeeper is more directly responsible. The beekeeper's skill therefore lies in supplying and maintaining these factors throughout the short period during which the bees may store more than they consume. In order to do this he should know which plants may be expected to furnish the nectar for his crop of honey, that his various operations may be properly timed. It should be noted that the shorter the duration of the honey-flow, the greater becomes the necessity of having the colonies in proper condition at its beginning and keeping them so until its close.

Nectar may be available in abundance and the weather may be ideal for gathering and storing, yet no honey can be produced if there is not a large force of workers in each colony, in excess of those needed for colony maintenance, to gather and store the honey crop. Furthermore, nectar may be abundant, weather conditions ideal, and the colonies strong, with the results in honey secured meager or none at all because the beekeeper has failed to keep the forces of each colony together and the storing instinct dominant. It is a common occurrence among inexperienced beekeepers to have the colonies become strong enough to work in the supers only after the flowers have ceased blooming or to see strong colonies during a good honey flow doing nothing in the supers simply because conditions are not such as to make the storing instinct dominant.

So far as the skill of the beekeeper is concerned in the production of the crop of honey in a given location, every manipulation of the season should be directed (1) toward securing the greatest possible number of vigorous workers at the proper time, and (2) keeping the entire working force of each colony together and contentedly at work throughout the given honey-flow.

Securing Workers for the Honey-Flow.

The management directed toward securing workers for the honey-flow begins during the previous late summer and early autumn. It includes (1) providing favorable conditions for the production of the bees that constitute the winter colony; (2) conserving the energy of these bees during the broodless period of winter, when they can not well be replaced by further brood-rearing; and (3) building up the population of the colony after the adversities of winter so that the maximum strength is reached at about the beginning of the main honey-flow.

The function of the beekeeper is first to see that each colony is in normal condition and headed by a good queen in time to produce the bees that form the winter colony and then to supply any deficiency in food, protection, and room for both brood-rearing and stores that may exist at any time during the three periods mentioned above.

SINCE the discovery of the science of spraying no experimental nor half-tested spray-material has ever been put on the market under a Grasselli label. To play absolutely safe, use these Grasselli products.

ARSENATE OF LEAD, PASTE AND POWDER
CALCIUM ARSENATE
LIME SULPHUR SOLUTION
BORDEAUX MIXTURE PASTE
SULPHATE OF NICOTINE FREE NICOTINE

The Grasselli Chemical Company
Founded 1839 Cleveland

If you don't know your nearest agent, write us



GRASSELLI GRADE
Insecticides
and Fungicides

The Complete Line of Sherwin-Williams Insecticides and Fungicides is Now Sold in Dry Powdered Form

This saves buying tons of water; paying heavy water freight; saves loss by leakage and freeze, and deterioration of strength. S-W Dry Powdered Insecticides haul light, mix right on the spraying ground, and work fresh, at full killing strength. They give maximum solubility, great bulk, longer suspension, uniformity of strength, fluffiness, unusual fineness of cover and extreme adhesiveness.

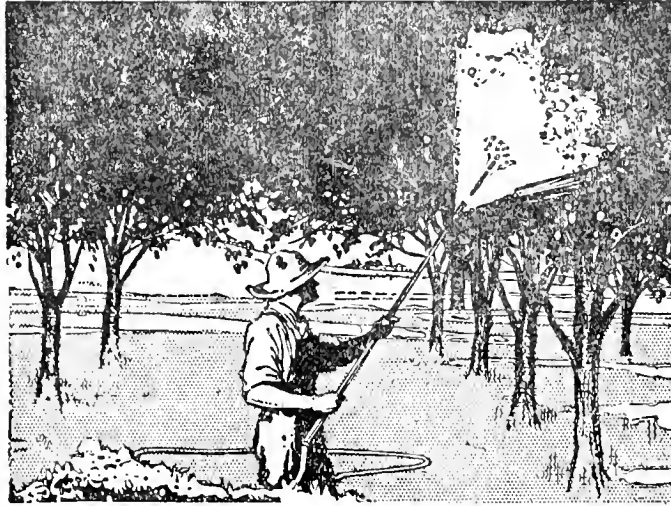

S-W Dry Powdered Arsenate of Lead

is a remarkably high-profit spray which insures whole leaf, worm-free fruit and sound vegetables. It attains the highest perfection in arsenical poisoning for fruit trees. Its high percentage of arsenic oxide (30 to 33%) in combination with lead, insures maximum poisoning strength and quick killing power. Its extremely low content of water soluble arsenic (1-2 of 1%)

insures against burning the foliage.

In competitive tests S-W Dry Arsenate of Lead has shown 30% greater bulk and 6 times better suspension than average paste forms. This gives the finest, most thorough and most inescapable cover. Its great adhesion assures longer efficiency to each spraying and makes fewer sprayings necessary per season.

Combines Perfectly with Lime Sulfur

S-W Dry Powdered Arsenate of Lead and Lime Sulfur mix with the greatest effectiveness as a combined summer spray for use on apples, plums, cherries, etc.

Sprayers' Manual Free

This book is a complete encyclopedia of the newest methods of increasing yield, bettering grade and commanding highest market prices for fruits and vegetables. It gives valuable charts, schedules and information telling what, when and how to use the most efficient poison for every variety of pest or disease, on all garden and orchard growths.

Address The Sherwin-Williams Co., 602 Canal Road, N. W., Cleveland, O.

SHERWIN-WILLIAMS PRODUCTS

PAINTS AND VARNISHES, DYESTUFFS
PIGMENTS, CHEMICALS

INSECTICIDES, COLORS, DISINFECTANTS
AND WOOD PRESERVATIVES



Food, protection, and room are the three requirements for colony existence and prosperity. Most failures to have colonies profitably strong at the beginning of the honey-flow are due to negligence on the part of the beekeeper in supplying, in advance of the needs of the colony, any deficiency that may occur in one or more of these requirements.

Production of Bees for the Winter Colony.

Fall Stores and Room.—During late summer and early autumn, when the bees are reared that make up the winter colony, a deficiency in either stores or room for brood-rearing may so restrict the production of young bees that their number may be too low for successful wintering. Colonies that are abundantly supplied with stores and have sufficient brood-rearing space at this time usually continue to rear sufficient young bees even in the absence of a fall honey-flow or any stimulative feeding. This is especially true if the queens are young.

Winter Stores—Before the beginning of cold weather each colony should have available at least a sufficient quantity of stores to supply the needs of the bees until late spring. In the northern states, where bees wintering out of doors do not have frequent flights or where bees are wintered in the cellar, it is exceedingly important that the winter stores be of the best quality, such as honey which contains the min-

imum amount of gums or a sirup made of granulated sugar. If inferior honey is present in the brood-chamber when brood-rearing ceases in the fall, the defect may be remedied by feeding at this time about 10 pounds of heavy sugar sirup to each colony. This will be stored where it will be immediately available for winter consumption, thus leaving the inferior stores for spring consumption when they do no harm. Any deficiency in either quantity or quality of winter stores should be supplied immediately after brood-rearing ceases or earlier.

Conservation of Energy of Winter Colony.

Winter Protection—During the broodless period of winter the life of the worker bees must be greatly prolonged in order that the colony may survive. The energy of the bees must be so conserved that they will live six months or more instead of six or eight weeks, as in the active season. Bees live most slowly when they are broodless, undisturbed, and have a temperature within the hive of 57° F. to about 65° F. When the temperature within the hive goes below 57° F. the bees become more active in order to maintain the minimum of 57° F. within the cluster. When the temperature within the hive goes above about 65° F. the bees begin some of the activities similar to those of the summer season. For best results in wintering, it is necessary therefore for the beekeeper to provide

abundant protection against cold and wind either by wintering the bees in the cellar or by protecting them out of doors. (See Farmers' Bulletin 695.)

Increase in Population.

During spring, while still anxious that bee-energy shall not be wasted, the beekeeper desires that it be spent judiciously in brood-rearing. For best results the maximum of colony strength should be reached about the time the honey-flow begins.

In most localities suitable for the production of comb-honey there is during the season but one honey-flow that furnishes any considerable surplus suitable for comb-honey, with perhaps minor honey-flows either meager in quantity or furnishing honey unsuitable in color. Furthermore, in these localities the main honey-flow usually occurs so early in the season that only those colonies provided with the best environment are able to build up to profitable strength to take advantage of it. In other localities the main honey-flow may occur later in the season or the season may furnish a series of important honey-flows with sometimes long intervals between them. Each type of location furnishes its own modification of the problem.

Spring Stores—When brood-rearing is resumed in the spring the consumption of stores is greatly increased over that of winter and as spring brood-rearing approaches its maximum the daily consumption of stores increases until an enormous quantity of honey is used for this purpose. At this time there is great danger of the colonies running short of stores, especially if no nectar is being brought in from the fields. Colonies that run short of stores during the spring rear brood sparingly and are so severely retarded in development that they usually attain profitable strength too late for the honey-flow. All colonies should be so abundantly supplied with stores for winter that there will be plenty left for early spring brood-rearing. If this was not done an early spring examination of all colonies is necessary to find which need more stores. Any deficiency in stores should be supplied immediately by inserting frames of sealed honey saved from the previous year or by feeding sugar sirup. Each colony should have at this time at least 10 to 15 pounds of honey in excess of their daily needs. Some beekeepers practice feeding each colony a small amount of sugar sirup daily to stimulate brood rearing. This should not be done during early spring, but under some conditions may be profitable during the few weeks just previous to the beginning of the honey-flow. Extensive producers, however, usually prefer to give 10 or 15 pounds of sealed honey or to feed an equal amount of sugar sirup at one time to colonies that are short of stores in the spring.

Spring Protection—A good hive that conserves the heat of the colony is a great help in early brood-rearing. Some beekeepers who winter their colonies in the cellar in single-walled hives find it

"Wood-Lark" Is Good Orchard Insurance

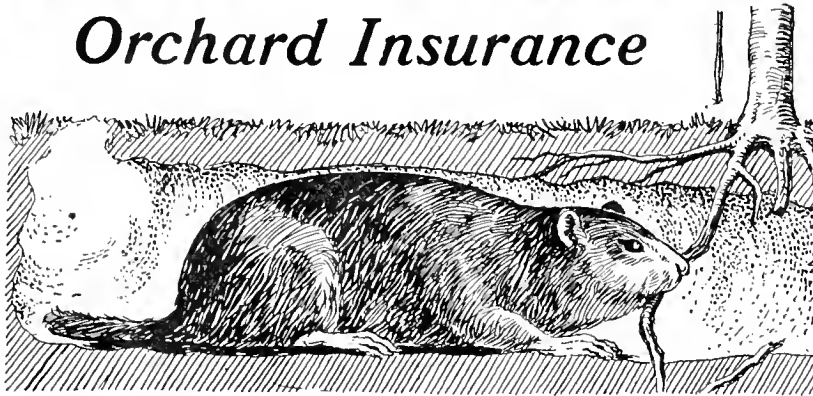

You must guard the roots of your trees, else there will be no tops to care for.

"Wood-Lark" gives you this protection. Sprinkle some in gopher runs, and stop the Spring multiplying of these pests.

"Wood-Lark" IS SURE DEATH TO GOPHERS.

If Your Dealer Hasn't Any, Write Us

Clarke-Woodward Drug Co.
PORTLAND, OREGON

profitable to put them into winter packing cases after they have been removed from the cellar. When colonies are wintered out of doors in winter packing cases, it is well to leave them packed until late spring. In the northern states double-walled hives are especially advantageous during the spring if bees are wintered in cellars. A location for the apiary that is well protected against cold winds is also of great importance in spring brood-rearing.

Room for Spring Brood-Rearing—There should be no restriction whatever in the room for brood-rearing up to the time of putting on the supers, just previous to the honey-flow, for a crowded brood-nest at this time tends to diminish the number of workers available for the honey-flow as well as to encourage swarming.

If the space for brood-rearing should be restricted by too much early honey in the brood-chamber, some of the heaviest combs should be removed and empty ones given instead, or an extra brood-chamber containing empty combs may be given. In localities where considerable early honey is gathered the brood-chamber may be kept almost free of honey by placing an extracting super over each colony at the beginning of such a honey-flow. This super should not be removed until the comb-honey supers are given, for the honey they contain may be needed later in brood-rearing.

Should the brood-nest be restricted by a small brood-chamber, more room may be given either by removing some frames of brood from the stronger colonies, exchanging them for empty combs taken from colonies less strong, or adding another brood-chamber filled with empty combs. The former method has the following advantages: (1) After being built up to approximately the same strength, most of the colonies will be ready for a given manipulation at the same time, thus facilitating the work of the beekeeper. (2) It requires a smaller stock of extra brood-chambers and combs, at least previous to the honey-flow. (3) The brood is in a more compact form, which is a very desirable condition in comb-honey production. (4) When properly done, the total number of young bees reared in a given time is probably considerably greater, owing to the fact that none of the colonies is strong beyond the capacity of the queen, the workers of the entire apiary being so distributed that all the queens are utilized to the best possible advantage. (5) When the honey-flow begins the colonies are ready for the supers without additional labor, such as removing extra brood-chambers, sorting combs of brood, etc. In equalizing colonies combs of emerging brood with the adhering workers, without the queen, are usually drawn from the strongest colonies and given to colonies less strong, but never to very weak colonies. The weakest colonies are left until the last, then built up quickly provided there is time enough to have all the hives well filled with brood. If this is not possible the very

weak colonies can more profitably be used for purposes other than comb-honey production. Another plan of equalizing is that of shaking bees from combs taken from strong colonies at the entrance of colonies less strong. The older bees at once take wing and return to their hives, while the younger bees enter the weaker colony. The operator must, of course, be sure the queen is not on the comb thus shaken.

Some of the advantages of using a second brood-chamber, thus building up the colonies as individuals, are: (1) The labor required is considerably less, fewer visits being required, so that this method is particularly adapted to out-apiary conditions. (2) It is possible to determine with much greater accuracy which colonies show the most desirable traits for breeding purposes. (3) It can be more safely practiced if brood diseases are imminent.

The Critical Period in Spring Brood-Rearing.

With the single short major honey-flow, which is characteristic of most localities that are suitable for comb-honey production, the entire honey-crop may be gathered and stored by the workers that are reared within a period of six or eight weeks. Except when the honey-flow is of considerable duration, the eggs that produce the workers that gather the crop are laid before the honey-flow begins, since those that develop from eggs laid later are not ready for work until after the close of the honey-flow. On the other hand, the workers that emerge six weeks or more previous to the beginning of the honey-flow will have died of old age or are too old to be of much value during the honey-flow.

This limits the time of the production of the bees that actually gather and store the honey-crop to a certain definite period, which puts an importance upon brood-rearing during this time far above that of any other period during the year. All the other bees that are reared during the entire year may be considered by the beekeeper as useful only inasmuch as their labors contribute to the rearing of an enormous quantity of brood within this critical period of brood-rearing and to the maintenance of the normal strength and the existence of the colony during the remainder of the year.

Colonies that are not strong enough to care for a large amount of brood during this, the most important period of brood-rearing must utilize the honey-flow to build up to maximum strength and are therefore unproductive this season.

Colonies that are strong enough for heavy brood-rearing at the beginning of this critical period are frequently rendered unproductive for the season by a cessation or restriction of brood-rearing during this period caused by insufficient stores or insufficient room. Such colonies begin the harvest with old, worn-out workers, and usually give poor results. This may explain to some extent the belief among beekeepers that colonies may become strong too early. It is therefore highly important (1) that

each colony be in a normal condition at a period six or eight weeks previous to the honey-flow, and (2) that brood-rearing be at its maximum for the entire period of six or eight weeks during which the brood is reared to produce workers that will be available for the honey-flow.

To have colonies sufficiently strong in time for the critical period of brood-rearing involves the management of the previous late summer, autumn, winter, and early spring. To keep brood-rearing at its maximum during this period requires only the presence of favorable conditions which if not already present are easily supplied by the beekeeper during the short period when the workers that gather the honey-crop are reared.

An abundance of stores in excess of the immediate needs of the colony sufficient room in the form of empty worker-combs for the heaviest possible brood-rearing, and a good queen are the most important factors to insure unrestricted brood-rearing during this, the most important period in the year's cycle of brood-rearing. It is not sufficient to have only enough stores to maintain the colony at this time, since, long before there is actual danger of starvation, brood-rearing is greatly reduced or even suspended, and some of the immature young are carried out of the hive. Any possible deficiency in either stores or room should be supplied promptly by the beekeeper in advance of the immediate needs of the colonies.

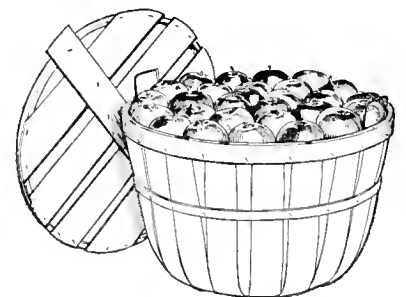

Universal Bushel Shipping Packages

—offer many advantages to all fruit and vegetable growers and shippers. They afford a neater and more attractive pack. They positively protect fruit and produce from being crushed while in transit.

Furthermore, retailers and commission merchants pay bigger prices for fruits and vegetables packed in Universal Bushel Shipping Packages.

Write today for interesting booklet "How to Load Cars."—It is FREE.

Package Sales Corporation

106 East Jefferson Street

South Bend, Indiana

BETTER FRUIT

An Illustrated Magazine Devoted to the Interests
of Modern Fruit Growing and Marketing.

Published Monthly
by

Better Fruit Publishing Company

703 Oregonian Building
PORTLAND, OREGON

Fruit Crop Prospects.

Unprecedented cold weather has undoubtedly injured almost all fruit plant life in the northwest although the definite extent of the injury will not be known until the season is sufficiently advanced for new growth to commence. Stone fruits are believed to have been more seriously injured than apples and pears while cane fruits in many districts were nipped quite severely above the snow line.

With apples, which constitute the most important crop grown in the northwest it is natural to conclude that the injury was sufficient to cause a considerable reduction in the 1920 crop although this may not prove as serious as was at first thought. According to all precedents the 1920 apple crop, even if there had been no winter-injury, could not be expected to be as large as that of last year as orchards in this territory where soil and other growing conditions and proper cultural methods were pursued, invariably bore heavily. In other words 1919 was the heavy bearing year and the coming season should therefore be expected to produce only a moderate crop. The pear production in 1919 was also very heavy but the tendency of this fruit is to produce more evenly than apples. Reports now seem to indicate that pear trees were seriously damaged.

The fruiting tips of cane fruits undoubtedly suffered some damage which will result in a more limited crop on the older plantings. New acreage which was largely covered by the snow will not be much affected and no harm is expected to have resulted to strawberries. It is believed therefore that the berry crop will be little less this year than the 1919 output and that it may be considerably larger.

The outlook for prunes, peaches and cherries is problematical, although if prune trees were only slightly injured there should be a larger crop in the northwest this year than last when the crop was far below normal.

Reports received to the present time indicate that the situation is serious but far from discouraging and that while the coming season will not see the large production of 1919 it should result in the harvesting of a tonnage that will be fairly normal, considering all contingencies.

Spraying.

The spraying program which should be commenced soon by the progressive fruit grower is the most important as a marketable crop producer of any of the operations in an orchard. No grower who wants to make it possible to obtain the maximum income from his orchard can afford to take any chances

in omitting sprays. In the past two years with the big advance in the price of fruit this fact has been driven home to the orchardist more emphatically than ever before. As a result spraying has been done more scientifically, more thoroughly and more generally and reports are to the effect that the largest as well as the cleanest crop of apples ever produced in the northwest was harvested in 1919.

Spraying is an operation that must be done intelligently. It is not sufficient to throw the spray on the trees in any old way trusting to luck that it will "take." The utmost care should be taken in the selection of the materials to accomplish the purpose for which the spray is being used. It should be applied at the right time and the application so directed that it will accomplish the maximum results. Those who are not getting these results should make a study of the methods of those who are and also consult authorities on the subject. In many instances this means not only better results but economy in material and labor as well.

In this particular, efficient equipment plays a very important part. In the rapid progress which is being made in the use of sprays and in applying them a grower who fails to keep himself informed will discover later that he has lost both time and money by not adopting the improved methods and equipment.

Of late spraying, has to some extent been made much simpler by the use of combination sprays where they will serve a double purpose. For this reason it will be well for growers to consult the diagram and table published in another part of this issue. In applying these combination sprays the fruitgrower should remember that they must be selected with caution and used for the purposes designated. Map out your spraying program in advance; know what it is necessary for you to do in this regard; the time that it should be done; apply the spray correctly and the results will show for themselves.

Prunes a la Eastern Prices.

A Roseburg, Oregon, lady who was visiting in the east, 3,000 miles away from home, was served four Oregon prunes in a high-class hotel for which she was charged 50 cents, according to a report from the turkey metropolis. Not so bad, after all, when you consider that two Oregon hen fruit served in Portland, Oregon, the hub of the state cost anywhere from 35 to 65 cents.

Geographically Speaking.

Billie Strandborg, publicity man for the Portland Railway, Light & Power Company, who recently returned from a trip east tells us that New Yorkers think Hood River apples are grown in Washington and that Cleveland people opine that Wenatchee apples are produced in Oregon. If he had inquired in Chicago he might have discovered that the residents of the Windy City think that Tillamook cheese is made in the Hawaiian Islands. It seems that

the geography of easterners is still very much mixed notwithstanding the magnificent eloquence of Frank Branch Riley. However, geographically speaking Libby, McNeil & Libby recently discovered through the operation of the government food act that pears grown and canned in the state of Washington are not grown and canned in California and will so announce next season.

Pruneizing the United States.

Robert C. Paulus, manager and C. J. Lewis, organization manager, respectively of the Oregon Growers' association, have figured out that in order to profitably market the rapidly increasing U. S. prune crop, that each inhabitant must, in the near future consume 3 and one-half pounds of prunes per annum. Up to the present time it hasn't been decided just how this per capita dose of prunes is to be taken—that is whether the allotment must be gormandized at one fell swoop or be consumed in homeopathic quantities each morning for breakfast. But, the fact remains that Messrs. Paulus and Lewis and other authorities on prune crop production have decided that the American people, with what foreign assistance they can get, must take these prunes.

The campaign to accomplish this result will not be one of coercion, but of persuasion through the channels of national advertising and a much wider distribution. With the plantings already on the Pacific coast the prune crop in the next few years is expected to reach more than 300,000,000 pounds.

For the Idle Moment.

Bees accomplish nothing save as they work together, neither do men.—Hubbard.

Cultivators of the earth are the most valuable citizens. They are the most vigorous, the most independent, the most virtuous; and they are tied to their country and wedded to its liberty and interests by the most lasting bonds.—Thomas Jefferson.

Sour soils and sour dispositions are both bad for the farm. Men think that a little sweetening of the soil with lime would produce such good results that the farmer's disposition might also be sweetened.—Exchange.

The belief is crystallizing that faith isn't dead in the world yet. Farmers are still shipping fruits and vegetables to fly-by-night commission merchants, with offices in their hats and fountain pens and typewriters as capital.—Fruit Trade Journal.

The Oregon Growers' Cooperative Association believes that the fruit growers are entitled to a fair profit on their investment, to a fair return for their labor, to an allowance for depreciation. We believe the middle man and the retailer are entitled to fair profits. The speculator, however, has no place in the marketing of food products.—The Oregon Grower.

That the price of fruit, particularly apples, in the future will only justify the conservative planting of orchards is the opinion of W. J. Green, horticulturist at the Ohio Experiment Station. Mr. Green points out that the enormous crop of apples a few years ago really resulted in a loss as the over-production reduced the price to such an extent that orchard owners could not even pay for the expense of handling the apples. This year with Ohio producing approximately not more than 30 per cent of an average crop, the price has risen to \$7 and \$8 per barrel for apples shipped out of orchards and from 8 to 12 cents a pound for apples retailed in grocery stores. It would not be safe to start extensive planting expecting to receive the present high prices. Mr. Green believes, however, that the price of apples in the future will adjust itself profitably to the grower who sets out orchards containing varieties of general commercial importance.—Ohio Experiment Station Bulletin.

Appointed Horticultural Chief at O. A. C.

Prof. W. S. Brown, who has been acting chief of horticulture at the Oregon Agricultural College since the resignation of Prof. C. I. Lewis, has been regularly appointed to that position by the college board of regents. Mr. Brown graduated from Cornell University in 1904, specializing in horticulture and was a student under such noted men in the field of horticulture as John Craig



PROF. W. S. BROWN
The new Chief of the Department of Horticulture Oregon Agricultural College

and L. H. Bailey. Before entering Cornell he had taken a degree at Alfred University in 1899 and had engaged in the profession of civil engineering.

On graduating from Cornell he became connected with the University of Wisconsin as instructor in horticulture. While there he pursued a post graduate course in horticulture and received his

degree in H. S. in 1906. Later he took charge of the horticultural department at the University of Agriculture at Winoona, Indiana. On coming to Oregon in 1908 he organized a company to engage in the commercial orchard business and was manager of this concern for several years. At the end of this time he accepted an appointment as extension specialist at the Oregon Agricultural College and in this capacity visited all parts of the state and became familiar with its needs in successful fruit production.

In the spring of 1919 he was appointed professor of pomology and has been acting chief of the department of horticulture up to the time of accepting the regular appointment. Owing to the rapidly increasing growth of the fruit industry in Oregon this department is now regarded as one of the most important under the direction of the college. It includes the departments of pomology, vegetable gardening and landscape gardening as well as all horticultural products. There are now engaged in this work at the college a staff of 14 members which is covering all phases of the work. In fact these branches of agriculture have been taken up so thoroughly at the Oregon Agricultural College that it is said there is but one other college in the country that offers a greater variety of instruction in horticulture. To carry out the work with the greatest degree of efficiency a horticultural products laboratory was recently placed in use at the college that for completeness is said to be the only one of its kind in the United States and has already contributed to the solution of some of the most important problems in the field of horticulture. As the head of this important work, Prof. Brown, with his staff of competent assistants, is expected to render valuable service to the horticulture of the state and nation on account of his special fitness for the position.

SUPERINTENDENT WANTED
To take full charge of an 80-acre bearing orchard near Hood River, Oregon, on share basis. Applicants must state their experience in apple raising, irrigation and gasoline engines, also mention their age and number in family.
Address E. M. RIETZ, care Better Fruit

UNQUESTIONABLY—

Modern methods applied to fruit growing have made the Northwest a great fruit growing center, with possibilities of extensive development.

Modern methods applied to banking have made the **FIRST NATIONAL BANK** pre-eminently the ally of the horticulturist. Its facilities, service and the personal interest of its officers are at your disposal.

THE FIRST NATIONAL BANK
OF PORTLAND OREGON
THE FIRST NATIONAL BANK WEST OF THE ROCKY MOUNTAINS

WHY PAY FROM ONE TO TWO THOUSAND DOLLARS PER ACRE FOR APPLE ORCHARDS WHEN YOU CAN BUY A BEARING ORCHARD IN THE FAMOUS BITTERROOT VALLEY FOR LESS?

I will sell my entire ranch of 70 acres, 43 acres of which consists of from 19 to 12-year-old well taken care of trees and 27 acres of improved farm land, well supplied with irrigation water, 4 miles from railroad station, good roads in all directions. The trees are mainly McIntosh Reds, with a few Delicious and other good varieties. 1919 crop was 4,000 packed boxes. On it there is a 4-room dwelling, barns, chicken sheds and other outbuildings, a 28x40-foot packing house with cement basement. Will take \$500 per acre. This is a bargain and will bear investigation. Reason for selling, other business. CHAS. PENTTILA, 509 Jackson Street, Eveleth, Minn.

FOR SALE

Ten-Acre Orchard — Spitzenbergs and Yellow Newtowns — ten years old, in the Willamette Valley, Oregon — Price \$5,000. Half cash — terms on balance.
Box 5, care Better Fruit

BEARING PEAR ORCHARD FOR SALE

Twenty acres of 10-year-old pears; about 12 acres planted to Boses and the balance to Bartletts and Howells. Tract half a mile from station at Sutherlin, Oregon, on a paved road. Land under irrigation. The trees have always had fine care and are large and thrifty. Sutherlin is located in the heart of the Umpqua Valley, where climatic conditions cannot be excelled. The town is alive and progressive. A large new cannery and packing house was established there last year.
Price for this orchard is \$16,000; \$6,000 cash, balance on time at 6% interest. Address the owner, Maude B. Luse, 820 Spalding Building, Portland, Oregon.

*Jack and Jill went up a hill
To fetch an empty box
Jack fell down and broke his crown
But Jill climbed in the box.*

Needless to say Jill showed discretion because it was a **Bloedel Donovan** box — strong and tight — built to withstand hard knocks.

If it's worth sending—pack it right. If it's worth packing make it strong and safe. Use a **Bloedel Donovan** box and be sure.

BLOEDEL DONOVAN LUMBER MILLS
1018 White Building, Seattle, U. S. A.
Manufacturers of Douglas fir, cedar, spruce, hamlock and red cedar shingles

The Natural Tree Brace—Home Grown Fruit Stocks

By G. F. Richards, Fishkill, New York

BETTER FRUIT, Portland, Ore.:—The December issue of BETTER FRUIT proving especially meaty reading to me I should like to add a word or two concerning some of the topics discussed.

The article on natural bracing young trees meets my hearty endorsement. I have followed the practice for the past ten years, for a majority of that time on an orchard containing about two hundred acres of apples, and find it to be a good investment of time.

In fact I have been able to make a sweeping refutation of the charges brought against the practice by some of the wisacres who declared the scheme impractical on the following counts:

First—The braces would never knit. Second—They would never get large

enough. Third—Pickers would break them off by standing on them when picking the center of the tree. Fourth—The interstices between the branches would prove a lodging place for every kind of insect, scale and fungus. Fifth—The braces would grow a lot of water-sprouts and make a lot of extra pruning; and sixth, that it was a darn fool idea anyway.

I have found it of especial benefit where trees have been pruned to an extreme vase form, and in strengthening the tops of topworked trees which are making excessive growth.

My practice differs from your Washington correspondent in that I have worked with trees five years old and over. I make the braces while pruning in the spring, and find that it works

well. The stimulation due to pruning seems to give the braces a big advantage over those put in without pruning.

The only care needed after making the braces is to cut off any lateral branches which may spring from them, and after the brace has made a perfect union, which generally is in three or four years, to cut off the ends of the limbs forming the brace, which are generally stunted by that time, as the sap flows through the brace from trunk to trunk, giving less to the tip of the branch each year.

I have had splendid results with it in every variety (nearly thirty) I have tried it on, with the exception of the Wealthy. The reason for failure with that I think is that the trees had begun to bear, and in consequence had less strength to put into wood.

Taking it by and large I call it good orchard practice, especially in a district liable to high winds or heavy ice storms.

Now in regard to producing fruit stocks in this country. It has been done and I see no reason why it should not be done again.

I am intimately acquainted with an orchard which was started back in the late forties in the hill country of Massachusetts.

The owner started to grow a few trees as a hobby, washing out seeds from pomace, rejecting the inferior stocks and budding or root-grafting the stronger ones. He finally gave up his farming in favor of fruit production, and grew all his own trees for over forty years.

The last planting was made in 1890, making an orchard of over fifty acres.

NOTHING SO SATISFACTORY

as having water under pressure, wherever desired, about the home and farm. Nothing makes for so much happiness in the home and eliminates so much drudgery. A dependable supply of water under any desired pressure is best and most economically furnished by a

Mitchell Farm Water System

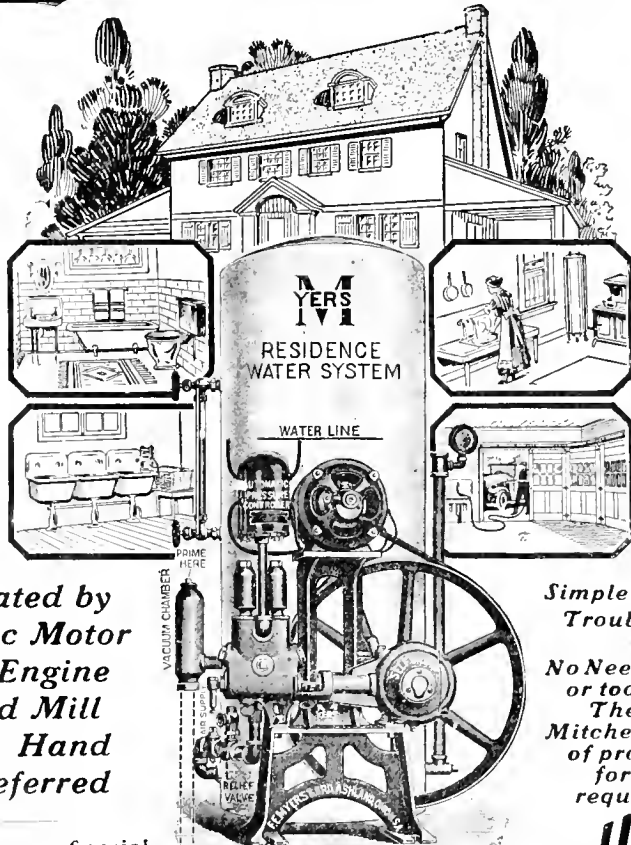

Operated by
Electric Motor
Gas Engine
Wind Mill
or by Hand
if preferred

Write for our Special
Water System Catalog

MYER'S PUMPS
POWER SPRAYERS
ORCHARD HARROWS
and TILLAGE TOOLS of ALL KINDS

Simple Durable
Trouble-Proof

No Need too large
or too small—
There are
Mitchell Systems
of proper size
for every
requirement

Mitchell
LEWIS & STAYER CO.

PORTLAND
SPOKANE

Pull the Stumps



Clear land
slick, clean
and fast at low
cost. Big money
clearing land for others.
The Hercules big Free
Book contains boiled
down experience of 25
years of land clearing.
Turn low cost stump land
into high priced crop land.

Hercules Portable

Solid steel bed plate, broad
steel wheels. The marvel of the
age. Get our special low intro-
ductory offer. 30 days' free trial—3 year
guarantee. Write today for book of
photographs and letters from owners.

Hercules Mfg. Company
169 28th St., Centerville, Ia.

Catalog
FREE

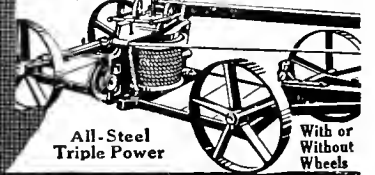

All-Steel
Triple Power

With or
Without
Wheels

Get Hercules Big Book FREE

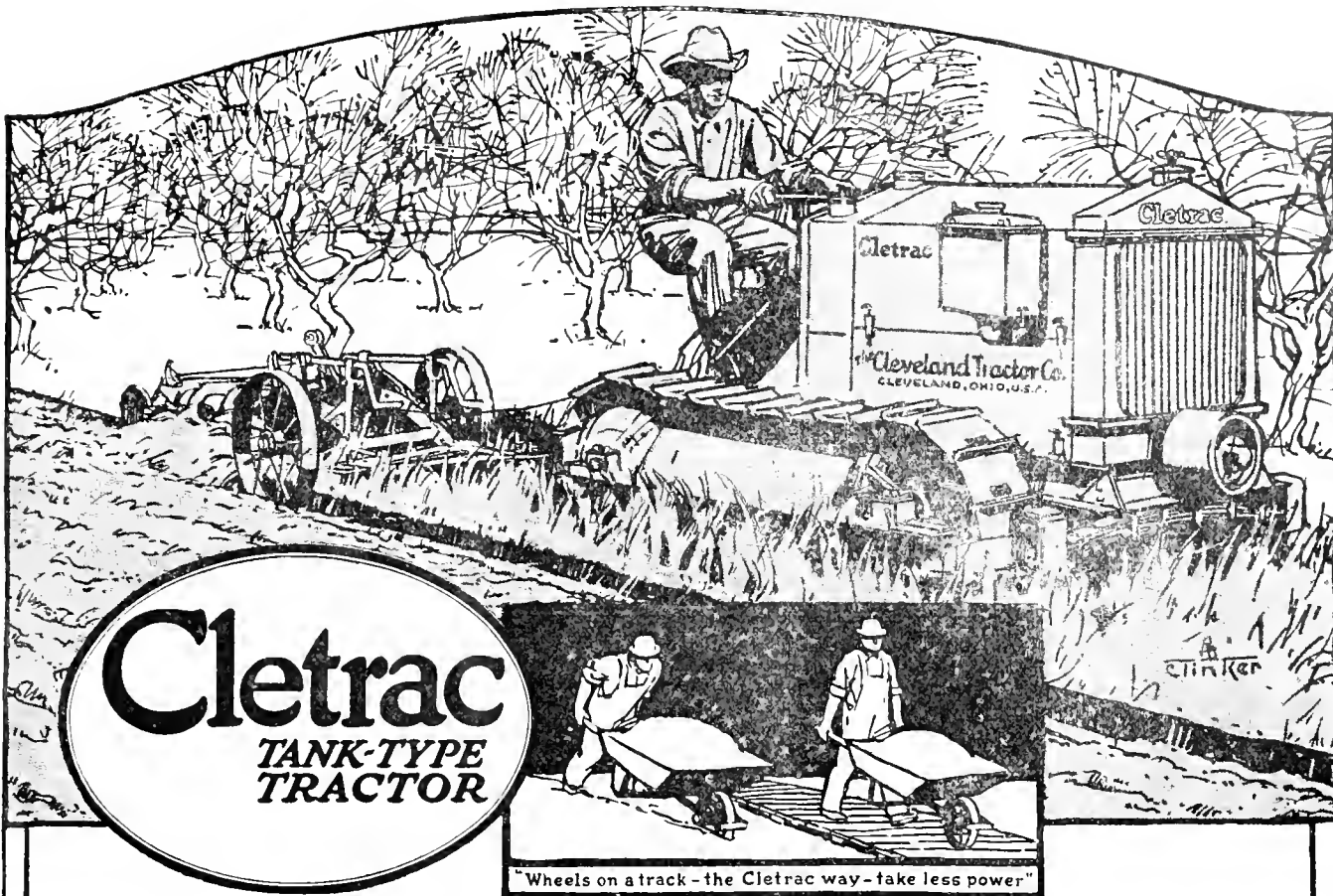

Cletrac
TANK-TYPE
TRACTOR

"Wheels on a track - the Cletrac way - take less power"

In the Orchard—with a Cletrac

Plow your orchard better this year—put a Cletrac on the job.

Small, powerful, easy to run—working every day, 24 hours a day if necessary—the Cletrac plows closer to trees, quicker and at lower cost.

Laying its own endless tracks, the Cletrac travels the orchard floor with a light, sure foot and a strong, steady pull.

Long-hung, with no projections—it weaves in and out and around trees without injuring bark or branches. Turns short—gets the corners, works in the sticky places—goes everywhere, with power to spare.

The Cletrac rides on top of the soil—doesn't pack it. That's why it's so good for discing and other mellowing jobs.

Spraying, ditching, fertilizing, road building, operating cooper shops and cider mills—these are but a few regular Cletrac jobs. All the year around—any time, anywhere—it does all your haulage and belt work. Operates perfectly on distillate or kerosene.

The Cletrac costs less to operate than any similar power unit or the six or eight horses it replaces—works more hours a day and more days a year, too.

Be ready when the rush comes—get your Cletrac now.

Write today for that interesting booklet
"Selecting Your Tractor"—it's free

The Cleveland Tractor Co.

LARGEST PRODUCERS OF TANK-TYPE TRACTORS IN THE WORLD

19145 Euclid Avenue

Cleveland, Ohio

You Are Welcome To This Ten-Day Test

All Statements Approved by High Dental Authorities

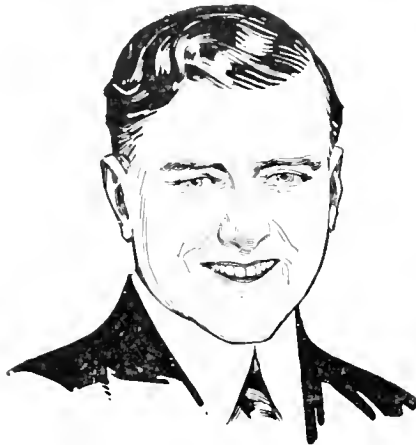

See What it Does for Your Teeth

This is to urge a ten-day test of a new, scientific tooth cleaner.

You have found, no doubt, that brushed teeth still discolor and decay. The methods you use are inadequate. There is now a better way.

The cause of most tooth troubles is a film. It is ever-present, ever-forming. You can feel it with your tongue.

That film is what discolors—not the teeth. It is the basis of tartar. It holds food substance which ferments and forms acid. It holds the acid in contact with the teeth to cause decay.

Millions of germs breed in it. They, with tartar, are the chief cause of pyorrhea.

That film is clinging. It gets into crevices and stays.

So, despite your brushing, it may do a ceaseless damage. Teeth are safer, whiter and cleaner if that film is absent.

Science Now Combats It

Dental science, after years of searching, has found a way to combat film. Years of careful tests under able authorities have amply proved its efficiency. Now leading dentists all over America are urging its adoption. It is now used daily on millions of teeth.

This film combatant is embodied in a dentifrice called Pepsodent. And a 10-Day Tube is offered to every home for testing.

Pepsodent is based on pepsin, the digestant of albumin. The film is albuminous matter. The object of Pepsodent is to dissolve it, then to day by day combat it.

For long this method seemed impossible. Pepsin must be activated, and the usual agent is an acid harmful to the teeth. But science has discovered a harmless activating method. And that discovery opens a new teeth-cleaning era.

The results are quickly apparent. A ten-day test is convincing. We urge you to make it at our cost and learn what clean teeth mean. Lest you forget, cut out the coupon now.

Pepsodent PAT. OFF.
REG. U.S.
The New-Day Dentifrice

Now advised by leading dentists. Druggists everywhere are supplied with large tubes.

Look in Ten Days

Make this ten-day test. Note how clean teeth feel after using. Mark the absence of the slimy film. See how teeth whiten as the fixed film disappears. In ten days let your own teeth tell you what is best.

Ten-Day Tube Free

THE PEPSODENT COMPANY,
Dept. 179, 1104 S. Wabash Ave., Chicago, Ill.
Mail 10-Day Tube of Pepsodent to

Name

Address

WHEN WRITING ADVERTISERS MENTION BETTER FRUIT

The trees are still vigorous and producing crops of quality fruit. In fact buyers bid higher for the fruit from this orchard on account of its bright color and good size, as compared with other fruit in the district.

Fruit from this orchard won prizes at the Paris exposition in 1900 as well as at innumerable local exhibits.

In thirty years which I can vouch for, the only trees lost from the orchard were: Two struck by lightning; about two acres of fall apples which succumbed to San Jose scale before it was well understood, the trees being about thirty-five years old at the time; five acres of Northern Spy planted on uncongenial soil, and some of the older plantings which outgrew their allotted forty feet of space were thinned out to stand eighty feet each way. The orchard still bears well, in 1916 bearing 3000 barrels of apples, the average crop being 1000 to 1500 barrels.

In my estimation that orchard is living proof of long-lived, disease resistant, crop producing native stock, and I hope to see the day when imported stocks will be the exception rather than the rule. Certainly it is here to be developed. All we need is a few years time and a few hard headed men to develop it.

NOW is the time to send to
Milton Nursery Company
MILTON, OREGON
FOR THEIR 1919 CATALOG.
FULL LINE OF NURSERY STOCK.
"Genuineness and Quality"



National Thrift Week

to be celebrated January 17 to 24, shows the importance that Uncle Sam ascribes to the good old-fashioned virtue of thrift.

The schedule for the week embraces several things that every good citizen should put into his regular scheme of life. It is a good time to take account of your own personal finances, and see whither you are tending.

LADD & TILTON BANK
Oldest in the Northwest
Portland, Oregon



WHEN WRITING ADVERTISERS MENTION BETTER FRUIT

Northwest Fruit Notes from Here and There

OREGON.

The Ashland section has had the most prosperous year in fruit in its history according to A. C. Briggs, manager of the Ashland Fruit and Produce association, a cooperative marketing concern. The association did a business of \$150,000 during the past year and recently has bought a property adjoining the present warehouse in order to extend its operations. The new directors recently elected are J. H. Dill, A. S. A. Peters, J. M. Wagner, J. H. Sander and S. J. Evans.

One hundred and twelve cars of apples sold by the Umpqua Fruit Union netted the growers of that district an average price of \$1.65 per box, the selling committee of the union recently reported.

High grade Oregon apples were recently selling for more in Portland than they were in San Francisco, according to a statement made by Walter R. Woolpert, manager for a large apple handling concern in the northwest, who says that Spitzenburgs were selling in Frisco for \$3.50 per box when they were bringing \$4.50 in Portland.

At the request of Senator McNary, D. F. Fisher, government plant pathologist at Wenatchee, it is reported will be sent to the Willamette valley, Oregon, to investigate damage reported in that section to walnut and prune trees. Senator McNary has an extensive walnut orchard in that district.

The Ideal Grading Machine Co., with headquarters at Hood River, is busy completing 15 apple graders which are to be shipped to New Zealand, Tasmania, and Australia. It is expected to ship the graders in time to reach their destinations for the coming apple harvesting seasons in these foreign countries, which comes on in April and May.

The strawberry acreage in the Hood River district will be largely increased this spring. Ten logged-off tracts that were recently purchased there from the Oregon Lumber company will be set to pears, with berries between the trees. On the west side of the valley, F. B. Mercer will set out 200,000 strawberry plants of the Clark seedling variety.

Clatsop county is going in for strawberries on an extensive scale this year for that section. Over 50,000 plants have been set and many more have been ordered for planting.

Loganberry patches in the Eugene district it is now reported were not injured as badly as was first thought and this is said to apply also to the other sections of the Willamette valley. Recent investigations show that the vines are developing buds under the influence of warmer weather.

At the annual meeting of the Oregon Growers' Cooperative association, which was recently held, the following were chosen as officers of the association: President, W. E. St. Johns of Sutherlin; vice-president, H. M. Harlow, Eugene; secretary-treasurer, Seymour Jones, Salem. St. Johns, Harlow and Jones, together with E. W. Matthews of Amity and B. W. Johnson of Monroe, constitute the executive committee of the association. M. O. Evans, formerly with Swift & Co., was selected as field manager of the association in place of Earl Percy, who resigned to become manager of a large orchard property in the Willamette valley. Isaac D. Hunt, who had been president of the temporary organization declined the office of president for the coming year on account of his health which will necessitate his being out of the state considerably during the coming year. Plans were discussed at the

meeting for the erection of six large packing plants to be located at various heavy fruit producing points in western and southern Oregon.

County Agricultural Agent Fluharty of Wasco county, reports serious injury to peach, apricot and cherry trees in that district from the freeze, although the heavy snows proved a great saving to many trees.

Returns from the apple crop in the Hood River valley for 1919 are expected to reach \$1,500,000 and pear returns will reach \$175,000. Cull apples were sold to the value of \$225,000 although 70 per cent of the crop is reported to have graded out extra fancy. It is estimated that \$500,000 was paid out for labor in harvesting and packing the Hood River apple crop. The Hood River Apple Growers' association handled 1,500,000 boxes of the total crop.

The Earl Fruit company, which bought the box factory of the Klamath Manufacturing company some time ago, for which it paid \$700,000, has assumed charge of the plant. The output of the factory will be used by the company to supply its various packing plants throughout the northwest with fruit boxes.

Although it is estimated that there are now 800 power sprayers in the Hood River valley, growers in that district are reported to be making extensive purchases of this kind of orchard apparatus for the coming year. The demand there for automobiles and tractors is also said to be heavy.

The Kings Products company, which was the pioneer institution in establishing dehydration of fruit and vegetables in the northwest, and has plants at The Dalles and Salem, has shipped an immense tonnage of their products for eastern consumption during the past two months. The wholesale trade is reported as being favorable to handling these products owing to the great saving in freight charges over canned goods.

The Oregon Growers' Cooperative association, which controls 16,000 acres of fruit in Oregon, has opened a national campaign for a name. A hundred dollars is offered for the first prize, and fifty dollars for the second prize, for the best suggestion for a brand name. The Oregon Growers' Cooperative association will sell all kinds of fruits, such as apples, prunes, pears, cherries, berries, walnuts, and dried and canned fruits. The name must be one which can be applied to all. Since the association is a statewide organization, the name must not be localized, but must be appropriate to the entire state. The contest will close April 1. All names should be sent in to C. I. Lewis, organization manager, Masonic Building, Salem, Oregon. A short, catchy name is preferable to a long one. Such names as Sunkist, used by the orange growers of California, Sunsweet, used by the prune growers, and Skookum, used by the apple growers of the northwest, are good. Later an additional prize will be offered for the best design to go with the name. The contest is open to all, regardless of age, sex, or locality.

WASHINGTON.

What is claimed to be the first full ship load of apples ever shipped from the Pacific coast to an Atlantic port was scheduled to leave Seattle about the middle of January. Fifty cars of the cargo were secured in the Wenatchee district, 150 cars from the Northwestern Fruit Exchange, and the rest from other shippers, and is being sent through the Panama canal. It is stated that if the experiment is a success that the United States Ship-

ping Board promises to establish regular sailings of fruit steamers from the Pacific coast next year, sufficient to handle from 1,000 to 2,000 cars of apples. The initiatory work in starting this movement was taken up by Arthur M. Geary of Portland, at the request of English apple importing firms. In order to get cooperation Mr. Geary recently spent a month in the east conferring with shipping board officials and others who could aid in the matter. It will cost 70 cents per box to land the fruit at New York or about the same as the railroad charge.

At a recent meeting of the board of directors of the Washington Growers' Packing corporation, a cooperative organization of fruit growers organized along the lines of the Oregon Growers' association, L. F. Russell was elected president; Fred Brooker vice-president and Henry Crass, secretary. M. J. Newhouse, who was formerly county agent of Clarke county, and a member of the Washington State College staff has been selected as business manager. It is expected that the new organization will handle a large share of the fruit crop of Clarke county and nearby territory this year.

E. S. Robertson, horticulturist of the extension service of the Washington State College,

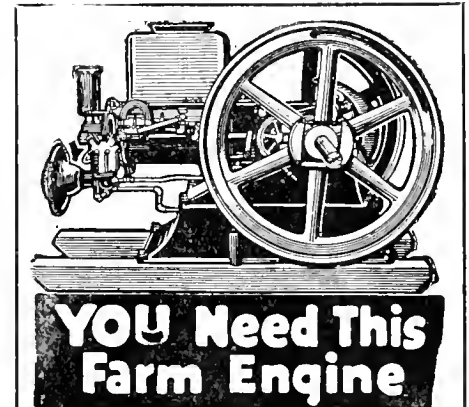

YOU Need This Farm Engine

**Abundant Power
Mechanical Perfection
Low Fuel Cost**

This dependable, sturdy low cost power servant gives a measure of power economy and faithful service that makes thousands upon thousands of power users choose Stover Good Engines in preference to all others.

1-2 to 60 H. P.

**GASOLINE, KEROSENE,
DISTILLATE, CRUDE OIL**

Stover Good Engines are particularly designed for the work you are going to do. Dimension for dimension, rating for rating, gallon for gallon of fuel a Stover Good Engine affords cheaper power and more of it than any engine you can buy. They come to you all ready to begin work. Their construction, material, workmanship and features afford every user of the Stover Good Engine many years of satisfactory service. Easy to operate—nothing to get out of order or make trouble. A size and type for all practical needs.

**Apples and Pears
For European Distribution**

Gerald Da Costa

Long Acre, Covent Garden, London
Cables: "Geracost, London." Codes: A. B. C. 5th Edition and Private



Mitchell's
LEWIS & STOVER CO.

Northwest Distributors
PORTLAND - SPOKANE

**STOVER
GOOD ENGINES**

who recently made an investigation of the damage done by the cold weather in the Yakima valley, is quoted as saying that peach buds were killed in most of the orchards in the valley, many of the trees probably injured and some of them killed. The apricot crop he believes will be cut short, but says that the trees were less injured than peaches. Cherry trees give evidence, according to his investigations of having been severely hit while

pears are only slightly injured. Prunes are said to have been hurt but little and apple trees not much injured except in orchards where the trees lacked vigor due to poor soil or other causes.

C. L. Robinson, district horticultural inspector in the Yakima district, recently issued a warning to growers there not to pull up peach trees that they thought had been killed by the freeze. Mr. Robinson says that it will

not be possible to tell the extent of the injury until spring sets in.

A report from Wenatchee is to the effect that claims amounting to \$600,000 to \$1,000,000 for 2,000 to 3,000 carloads of apples said to have been frozen in transit have been presented to the railroad administration from that district alone. The opinion prevails at Wenatchee that these claims will have to be paid if the fruit was shipped under heat in refrigerator cars, but that no damages can be collected for fruit shipped in ordinary box cars.

The aggregate yield of farm and orchard products of the Sunnyside project for 1919, amounted to \$12,678,217, according to the annual report by J. G. Heinz, project manager. In the preceding year the crop return was but \$7,218,392. The project totals 90,000 acres. Prunes gave an average net return of \$613 an acre. The second highest acreage yield is hops, with \$528 per acre. For the first time in the history of the project alfalfa was displaced as the most valuable crop grown. Increased production and high prices placed apples in the lead with a total value of \$4,771,750 for 59,646 tons produced. Hay was second with a value of \$3,955,050.

At the annual meeting of the Peshastin Fruit Growers' association it was decided to build a new cold storage warehouse at Peshastin with a capacity of 300,000 boxes of apples. A hotel and boarding house will also be built to take care of 200 persons whom the association employs each year. The improvements will cost \$100,000.

The lumber required to make boxes for Washington's 1919 apple crop was sufficient to build 9,660 average country homes, each housing a family of five, according to estimates given by the U. S. Reclamation Service in the January issue of the Reclamation Record. The basis for the computation is that five board feet of lumber is required for an average apple box. The reclamation service estimates that the average country home, large enough for a family of five requires 10,000 board feet of lumber. The Bureau of Crop Estimates, U. S. Department of Agriculture, gives the commercial 1919 apple crop of Washington as 19,320,000 boxes.

IDAHO.

Two hundred delegates attended the convention of the Idaho State Horticultural Society recently held at Payette, which proved to be one of the most interesting and valuable meetings ever held by the organization. The program included speakers of note in the fruit growing industry in the northwest as well as from the Idaho State University. The new officers of the society are: President, D. L. Ingard of Payette; vice-president, J. P. Gray of Nampa; treasurer, A. E. Gipson of Caldwell; secretary, I. Lee Truax of Meridian; directors, first district, Professor C. C. Vincent, Moscow; second district, Guy Graham, Fruitland; third district, L. G. Dunn, Bliss; fourth district, J. A. Waters, Twin Falls. Resolutions were adopted by the association commending the action of the state department of agriculture in carrying on such an extensive orchard inspection program.

Experienced Orchardist Wanted

To care for ten-acre apple orchard, ten years old, located near Newberg, Oregon. Would prefer share basis. Good opportunity for the right man.

G. E. S., care of Better Fruit

Keep Bees Too

Every up-to-date fruit grower knows that bees are indispensable to the best fruit growing. There is no argument about it. Why not begin with the bees this year? We will tell you how. Not hard to learn. Easy to do—but get started right. Small expense to start. You profit doubly in better fruit and a crop of honey. Drop us a card today, asking for our two handsome and valuable booklets entitled "Bees and Fruit" and "Bees for Pleasure and Profit." They are full of every sort of information about bees and beekeeping. Tell us whether you have ever kept bees before.

THE A. I. ROOT COMPANY
(Fifty Years In the Beekeeping Business) 3G
513 Main Street Medina, Ohio

DON'T Throw away your Dollars
buy a **MYERS "HONOR-BILT" SPRAY PUMP**

MYERS HANDY SPRAY OUTFIT
PANAMA
PNEUMATIC
MYERS O.K. BARREL SPRAY PUMP
MYERS AUTOMATIC POWER PUMP
MYERS COMPLETE POWER SPRAY RIG

This is the year of years to prevent loss through carelessness, use of poor materials, or cheap equipment. In spraying your orchards, trees and gardens, don't fool with experiments, untried theories or impractical construction. Failure and disappointment often result and your pocket book suffers.

Buy MYERS "Honor-Bilt" SPRAY PUMPS and ACCESSORIES—standard for fifty years—and place your spraying operations on a scientific basis. Economy, ease of operation, uniform application of mixtures, fast service, better fittings, are known qualities of MYERS SPRAY PUMPS—They have made the name MYERS synonymous with better spraying and have made MYERS SPRAY PUMPS favorites with the largest producers of fruits and vegetables in the world.

MYERS SPRAY PUMPS and ACCESSORIES—for Hand or Power—come in so many styles and sizes that it requires a 64 page Catalog to illustrate and describe them, and—the 1920 Edition is now ready for distribution. Write for your copy today and spray MYERS WAY for bigger and better crops and accompanying profits.

ASK YOUR DEALER—He can supply you with the MYERS.

F. E. MYERS & BRO.
NO. 135 ORANGE ST. ASHLAND, OHIO.

Hand and Power Pumps for Every Purpose. Hay Unloading Tools, Door Hangers, Etc.

MYERS
PUMPS FOR EVERY PURPOSE
HAY TOOLS & DOOR HANGERS

PACIFIC NORTHWEST DISTRIBUTORS

PORTLAND, OREGON



SPOKANE, WASH.

BUY FROM THE LOCAL MITCHELL DEALER

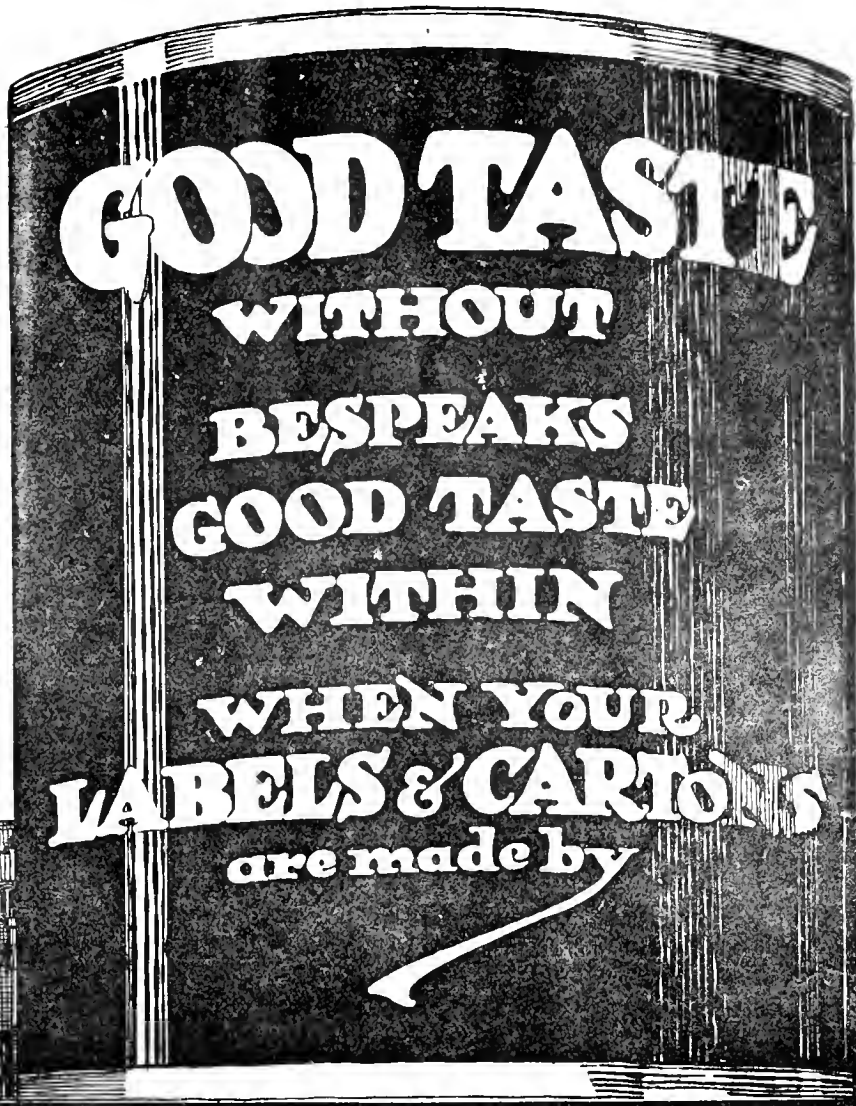

Traung
Label & Lithograph Co.

LABELS and CARTONS

"An institution that sticks to its last"

SAN FRANCISCO-STOCKTON-SEATTLE
Sales Offices Portland-Fresno
Sacramento

R. F. Taussig in the Payette district has built an underground cold storage room that will accommodate 9,000 boxes of apples. The storage apartment is built into the hillside and although filled to capacity during the severe cold weather, Mr. Taussig reports that not an apple was injured and that he estimates that the value of the fruit saved this year will more than pay the cost of construction.

Fruit tonnage from the Lewiston and Clarkston districts in 1920 will be materially less than normal owing to frost damage it is reported. Cherry and peach trees in the Lower Snake River valley are said to have suffered very heavily, while a very light cherry crop is expected in the Lewiston district proper.

The plant of the Oregon Packing company at Lewiston has closed after a record breaking summer and fall. In spite of the fact that last summer was very unfavorable for the growing of tomatoes, the packing plant had a run of 20,000 cases.

What They're Doing in California

It is now predicted that Imperial Valley cantaloupes will go on the market the earliest in history of the melon business and that the crop will be the largest from that section ever known. It is said that one-third of the

cantaloupes consumed in the United States will come from this district this year. The Japanese, who are the heaviest growers in the Imperial Valley are using forcing methods in order to ship the first fruit and avoid a glutted market during the mid-season.

The California Prune and Apricot Growers, Inc., with headquarters at San Jose, is making a strenuous campaign to secure sufficient additional acreage to maintain its control of 75 per cent of the production. The organization announces that failure to get the requisite quota of acreage will compel it to permit its options on members of crops of 1920 and 1921 to lapse. It is believed, however, that this serious situation will be fully met and overcome. The campaign has been endorsed by the San Jose Chamber of Commerce and the Merchants' association.

The northern California orange crop season which has just ended was 15 per cent heavier in production than ever before. Notwithstanding this fact the prices received are reported to have been highly satisfactory. Northern California lemon growers are now making heavy shipments of the fruit which is reported of finer quality than usual.

According to experts, successful culture of pecans on a commercial scale in Fresno county is not problematical. A Riverside firm has also issued a bulletin calling attention to that

section as a natural home of pecan orchards. The market for pecans is good and if there is an abundance of water, there seems to be no reason why they cannot be grown successfully.

Stating that they desire to propagate better fruit trees the nurserymen of California have organized a state-wide organization to carry out this plan. One of the leaders in the movement is George C. Roeding, president of the California Agricultural Society. In setting forth the objects of the organization which has been incorporated the incorporation document says: "The purposes for which this corporation is formed are to improve the grade and character of fruit trees grown in the state, and to increase the production of fruit therein by a selection of bud wood from trees producing record crops and fruit of a superior type, and by the distribution of nursery stock grown from such selected bud wood, and to, as far as possible, cause such superior type of trees to be used by the fruit-growing interests of the state; and for such purposes to experiment in or to produce such superior types; to accomplish the foregoing with the cooperation, as far as possible, of experts connected with the United States Department of Agriculture and the University of California, and any and all other experts whose experience and advice will be of such character as to accomplish the best results."

SERVICE

WATSONVILLE, CALIFORNIA



BULLETIN

SEATTLE

NEW YORK

SUBJECT.

The Time to Winter-Spray Pear, Prune, Apricot, and Apple Trees with Grade "A"

In Spraying with Ortho Crude Oil Emulsion Grade "A," it should be remembered that for the best results, the emulsion should be applied at the proper time. From the experimentation which I have conducted, the best time was determined as being while the trees were dormant, from January 1st to the time of visible bud swelling. We are glad to note that practically all of the purchasers of our emulsions are following, with very pleasing results, our recommendations:

First—Use the emulsion at the proper strength, usually 36 gallons to the 200-gallon tank.

Second—Apply at the proper time: i. e., while the trees are dormant, from January 1st to time of visible bud swelling.

Third—Apply with great thoroughness so as to cover all the twigs and branches perfectly.

The highest possible success for the control of orchard pests, by winter-spraying, will follow the use of our Ortho Crude Oil Emulsion, Grade "A," well applied.

When referring to this bulletin, please give date and subject.

Watsonville, California

Date: January 10, 1920

W. H. VOLCK,

Director of Research.

Cannery Notes

The Umpqua Fruit Growers' association, with headquarters at Roseburg, Oregon, has decided to build and equip a modern cannery in time to take care of the 1920 fruit crop. This action was taken as the result of the successful year the association has had in the marketing of canned goods from their old plant. The new plant will be located in the center of the city of Roseburg along the Southern Pacific railroad tracks. Seventy per cent of the stock of the concern is now owned by farmers near Roseburg and last year it did a business in the neighborhood of \$200,000.

According to an item in Western Advertising Libby-McNeil & Libby has purchased the Hinckley-Beach cannery at Burbank, Calif. This cannery was the first institution of its kind to locate in the San Fernando valley town.

The Hood River Glacier says that the Hood River Canning Co., one of the most unique concerns in the country, in that it aims to pack a product of super-excellent quality, has doubled its capacity. The season's run on strawberries, cherries and pears resulted in a total pack of 192,000 cans. A total of 280,000 cans of the valley's best grade of apples will be packed. The cannery company's payroll for the year's run will approach \$10,000.

An extensive national campaign has been started by the National Cannery Association to increase the consumption of canned fruits and foods and to show that the generally accepted idea that canned goods cause ptomaine poisoning is erroneous. National weeklies, women's magazines, agricultural journals, trade papers and medical and hospital magazines will be used in addition to the newspapers. A four year campaign is planned according to a statement in Judicious Advertising and the association will spend \$500,000.

The Puyallup and Sumner Fruit Growers' Canning company of Puyallup, Wash., is to spend \$100,000 during 1920 to advertise "Paul's Jams," named after W. H. Paulhamus, president of the company, who has been so successful in building up the business of this cooperative association. The leading national weeklies and magazines of the country will be used. The business of this concern in 1919 amounted to nearly \$1,000,000 and it is expected that it will be greatly extended this year.

Canning companies operating in the state of Washington are reported to be making contracts for fruit for the coming season.

Owing to the competition of cider making plants and the short apple crop in New York the evaporating plants in that state had one of the shortest seasons in their history. The prices paid for stock for evaporators ran from \$1.75 to \$2.00 per hundred and chops and other waste used in by-products ruled high.

Two million gallons of wine grape juice was put up during the past season by a company in San Joaquin county, Calif. The juice was put into 50 gallon barrels and the barrels were varnished to keep them air tight. The product was shipped east.

The Buhl Canning company, an Idaho concern, announces that it will furnish hot beds for the germination of tomato plants this spring. This step is expected to greatly expedite transplanting and insure an early crop of tomatoes for canning.

Work has commenced on the cannery to be constructed at Gridley, Calif. Because of the lack of housing accommodations, a large dining room and dormitory will first be built. The first unit of the cannery will be complete about June first. A survey has been made of the prune orchards and it has been decided to erect a packing house at Gridley.

The United States has built up an increasingly large trade in dried fruits with Australasia, especially with New Zealand, where the

exports from the United States have increased from 3,325,211 pounds in 1911 to 9,205,028 in 1918, or 177 per cent. A table in a recent report on foreign markets made by the Bureau of Markets of the U. S. Department of Agriculture shows that raisins are the largest item in this total, prunes second and apricots third.

Canneries are contracting for next year's asparagus crop in the Sacramento river delta section at from six to eight cents a pound. Last season the price ranged from three to six cents. The asparagus-growing acreage has increased in a phenomenal manner during the past few years in this section, and now totals over 12,000 acres.

Bits About Fruit, Fruitmen and Fruit Growing

Under a bill recently introduced at the special session of the Oregon legislature, all persons and companies engaged in the packing or canning of fruits in Oregon would be made liable to a fine of \$25 to \$100 unless all containers holding fruits or vegetables grown in the state are labelled designating them as Oregon products.

Leroy Childs of the Hood River Agricultural Experiment station recently made an address before the annual meeting of the American Entomological Society held at St. Louis. The subject selected by Mr. Childs was "The Control of Codling Moth, With the Spray Gun, the Spray Rod and Dusting."

The horticultural department of the Oregon Agricultural Department will experiment with a freak apple shaped like a banana that has been produced at Oregon City. The tree which grew the fruit was purchased several years ago as a Gravenstein. This year three bushels of apples were harvested from it, few of which had seeds.

Ciders and fruit juices which are allowed to have more than one-half of one per cent of alcohol will come under the ban of the constitutional prohibition act according to a recent announcement of Prohibition Commissioner Kraemer.

Frosted box apples on the eastern market which have been selling for \$1.25 to \$2.00 per box according to their condition have very materially hurt the sale of sound fruit according to reports from New York. Up to the middle of January over 8,000 more cars of northwest apples had been shipped to the Atlantic coast than at the same time last year. It is estimated that there are more than 5,000 more cars of apples in storage on the Pacific coast at this time than there were last year.

Of a total of 58,651 cars of apples shipped in the United States up to December 1, the northwest had shipped 20,759 cars.

A large delegation of fruitmen from the east were in attendance at the recent meeting of the Western Fruit Jobbers' association which met in San Francisco.

The possibility of using logged-off lands for the planting of berries is receiving a great

Mitchell

FRUIT GROWER'S MACHINERY

Clark's Cutaway Harrows

Roderick Lean Tractor and Horse Drawn-Disc-Spring and Spike Tooth Harrows

Vulcan and J. I. Case Orchard Plows

Light Draft Harrows

Cyclone Orchard Weeders

Planet Jr. Cultivators

J. I. Case Orchard Cultivators

Myers Spray Pumps and Sprayers

Stover Spray Engines

Mitchell Irrigating Outfits

Steel Wheel Orchard Trucks

Spray Hose-Nozzles Fittings Etc.

Drop us a Card for Catalogs on any of the above Special Lines

Mitchell
LEWIS & STAYER CO.

PORTLAND — SPOKANE

"STRAWBERRY PLANTS and PEACH TREES"

We have one of the largest stocks of pure Aroma and Klondike strawberry plants in the country. Also nice lot of Excelsior, Gandy and Early Ozark. Also leading commercial varieties of peach in June Bude trees.

We have more orders booked than we ever had before at this time. Write for prices, we would like to book you before our supply is exhausted.

CHATTANOOGA NURSERIES
CHATTANOOGA, TENN.



Try It 30 Days Free
Send No Money

One Man Alone
Handles Biggest Stumps!

To prove the Kirstin is the most powerful, speedy and efficient Stump Puller, we will ship you any size or style on 30 Days' Free Trial. Send no money. When Puller comes, try it on your own stumps—give it every severe test. Let it prove that it will do the hardest work easier and quicker, return at our expense, you don't risk a penny. Four easy ways to pay.

Write for Big New Free Book of Kirstin Stump Pullers!

Kirstin ONE-MAN Stump Puller

Thousands of Kirstins Now in Use!



operates. Just a few pounds on the handle means tons on the stump. When stump starts throw machine into high speed and out comes the stump, roots and all. Positively no other machine like it. Send for most valuable Stump Puller Book ever published—pictures, prices, terms—and our Special Agent's Proposition—all FREE. Write today. One-man style or HORSE POWER, all sizes. 3-year guarantee with each machine. Shipment from nearest distributing point saves time and freight. Low prices now. Write for FREE BOOK, etc., TODAY! A. J. KIRSTIN CO., 306 E. Morrison St., Portland, Oregon.

Quick Shipment From:
Escaaba, Mich.
Atlanta, Ga.
Portland, Ore.
Sao, Canada

9 CORDS IN 10 HOURS



BY ONE MAN. IT'S KING OF THE WOODS. Saves money and backache. Send for FREE catalog No. B 14 showing low price and latest improvements. First order gets agency. Folding Sawing Machine Co., 161 West Harrison St., Chicago, Ill.

deal of attention from those who contemplate going into this industry on a big scale. The fact that the land can be utilized for this purpose in many instances without removing the stumps until such time as an income is provided is making this kind of fruit raising attractive. It is believed that thousands of acres of logged-off lands in Oregon and Washington will be utilized in this way in the near future.

The rumor that the English government's price control of apples had been removed recently was very emphatically denied by Dwight Woodruff, New York representative of the Hood River Apple Growers' association. To substantiate his statement Mr. Woodruff published a cable message from London which said that the price control act was still in effect. Inasmuch as there is a large quantity of Canadian and Nova Scotia barreled apples yet to be marketed abroad and they can be sold at a profit for less money than American box apples it is doubtful if the English government, which is apparently favoring the

sale of fruit from the home country and its provinces will allow any raise in apple prices this year. In April and May the apple crop from the Australia and New Zealand sections will be ready for shipment so that the British market for apples from the United States this year is liable to continue weak and uncertain.

California's fruit crop in 1919 totalled approximately \$50,000,000 in value, according to an estimate made by Charles E. Virden, president of the California Fruit Distributors.

FOR SALE

Thirty-acre 8-year-old irrigated apple orchard, well taken care of, plenty of water and in fine condition. Located in Southern Idaho in one of the best apple growing districts in the country. Good climate, beautiful country, big crops, high prices and a fine opportunity for anyone interested in securing a bearing orchard of the best varieties of apples. Address Dept. L, Better Fruit.

Northwest Fruit Industry Loses Able Friend



ARTHUR RUPERT
President of the A. Rupert Company, Inc.,
who recently died.

Although the fruit industry of the Northwest lost one of its foremost advocates in the death of Arthur Rupert, president of A. Rupert Company, Inc., still the big work he had undertaken for the development of the industry and the expansion of his canning activities will continue.

This was assured by the action of the directors at a meeting immediately after his death in January when they unanimously voted to follow his policies of coöperation with the growers and also authorized the expenditure of \$150,000 for betterments of the plants and extensions this year.

The company owns fruit canning plants at Newberg, Falls, City, Springbrook and Lebanon, Oregon, and he has just taken over another big plant at North Puyallup, Washington. It is also building a new one at McMinnville, Oregon. The capacity of the plants this year was 625,000 cases of canned fruit.

The company has distributing branches in the principal cities of America and also sells heavily in Europe through its London and Paris branches.

Mr. Rupert was one of the West's most successful canners and was considered an authority on the industry. He believed that growers and canners had, in the development of the industry, a mutual interest and that the prosperity of one depended on the other. For this reason he gave much of his time to the creation of a service for growers, with the object of assisting them in the selection of suitable lands, and plants for the production of the best fruits. He also made the canneries the meeting place for growers and provided lecturers for such gatherings. He was 44 years of age and is survived by his widow and three children.

EARLY MATURITY plus GREATER YIELD equals GREATER PROFIT

Never in the history of commercial fertilizers has
NITRATE OF SODA

been so universally accepted as a revenue producing investment as this year. From the Peanut producing sections of the Southwest to the Fruit sections of the Northwest, farmers are not asking "What Fertilizer?" but "How Much Nitrate?" with the result its use in the United States this year will be nearer to the volumes imported by Japan and European countries where intensive farming is a necessity.

Address

NITRATE AGENCIES CO.
Eighth Floor Hoge Building SEATTLE

DEPENDABLE TREES

Planters, it is time to order your Fruit, Shade and Nut Trees, Berry Plants, Shrubbery, Roses, etc., for fall or spring planting. Send for our large illustrated catalogue from which to select your list; it only costs you 5 cents in stamps for postage. Our trees are mighty fine, but we haven't enough. If you WANT trees, don't delay ordering.

OREGON NURSERY COMPANY
ORENCO, OREGON

THE ELECTRIC HOME

EQUIPPED WITH A

DAYTON COUNTRY HOME LIGHTING SYSTEM

\$150

AND UP

AND A ROBERTS WATER SYSTEM
MAKES FOR GOOD CHEER AND A
HAPPY, HOME LOVING FAMILY

Our I. K. W. Plant Does
All of the Electric Chores

Belt and Direct Connected—Write for Prices

CHAS. W. RAYMOND

521 OREGON BUILDING

PORTLAND, OREGON

Some territory still open for live dealers

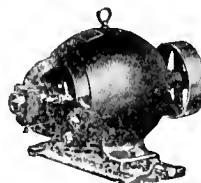

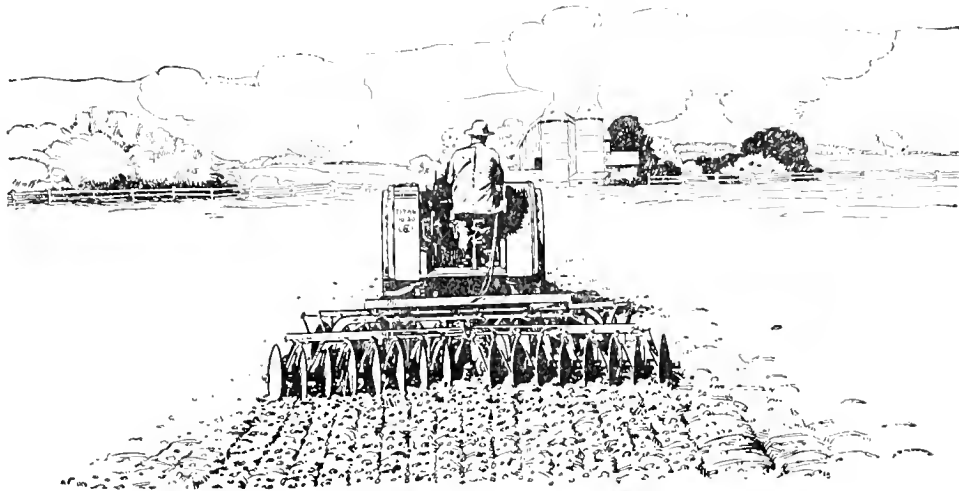

Help Mother Nature

NATURE does her share in seed bed building by providing fertile soil, moisture, and healthy seed. There Nature's obligation ends. The rest is up to you.

And the preparation of a mellow, thoroughly pulverized seed bed is almost as important as fertile soil and moisture. Upon it depends the healthy germination of the seed and a sturdy growth of the plant.

A seed bed prepared with **International Tillage Tools** — disk harrows, spring and peg-tooth harrows, combination harrows

and **culti-packers** — will form a solid foundation for a bumper crop because these implements are thorough in their work. And they are not only efficient but also very durable, being made of high-grade material throughout. The name "International" is a guarantee of unquestioned worth.

Let us mail you descriptive folders of these tillage implements so that you will know just a bit more about the preparing of Spring seed beds. With every implement goes an alert, responsive and intelligent service. The International dealer will serve you direct.

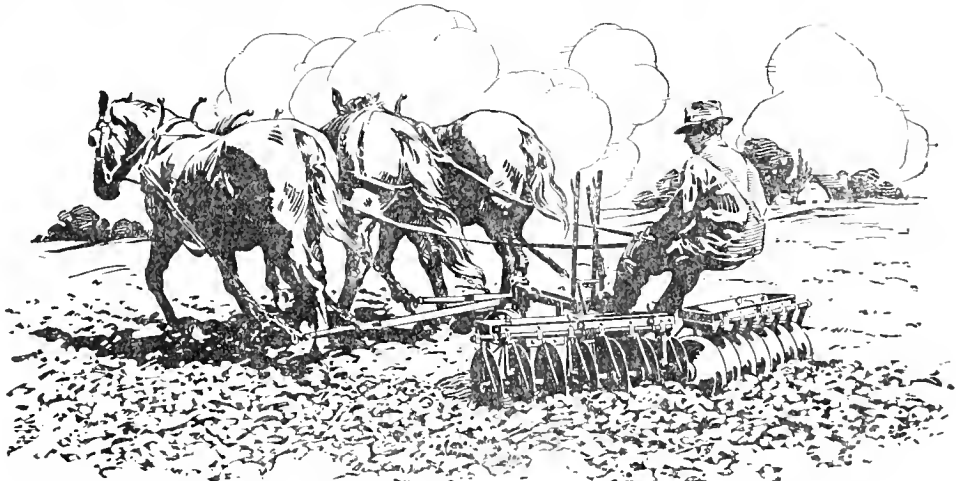

International Harvester Company of America

(Incorporated)

Billings, Mont. Crawford, Neb. Denver, Colo. Helena, Mont.
 Los Angeles, Cal. Portland, Ore. Salt Lake City, Utah
 San Francisco, Cal. Spokane, Wash.



Observations on Treatment of Winter-Injured Trees

Continued from page 16.

is not so much a problem of available plant food in the soil so much as it is a question of the tree's ability to make use of it.

"I believe it best for the grower not to prune young trees until winter is definitely over and no further danger of hard freezes is probable. Considerable evaporation takes place from the cut surfaces, which can, to a large extent, be curtailed by leaving the tree alone. The grower will readily recognize that the cut surfaces of the injured wood will more readily dry out and die back than is true of healthy tissue because of the former's inability to supply the moisture as fast as it is carried away. In some cases I believe it well for the grower to wait a few days after the

growing season starts before pruning, as then one will have a more definite idea whether the injured wood is going to grow or not. However, if growth does not start promptly within a week or ten days after the normal season, pruning should be done promptly.

"Trees which have been injured quite badly should be pruned heavily, the idea being to concentrate the sap to a smaller area and thus strengthen those parts. This will apply equally to trees in bearing or not in bearing."

Injury to Peach Trees.

In the pruning treatment of winter-injured peach trees we find that experiments made by A. J. Gunderson, Associate in Horticulture of the University of Illinois Agricultural Experiment Station, apparently demonstrated that moderately heavy pruning was the most beneficial. These experiments were made in the summer of 1918 as the result of prolonged periods of very cold weather in peach orchards in Southern Illinois, in the winter of 1917-18, when the temperatures reached as low as 20 to 25 degrees below zero.

In recording the results of these experiments Mr. Gunderson in his bulletin remarks:

"During the periods of low temperature strong winds prevailed. Fortunately, however, there was a good covering of snow in most peach orchards, and therefore the injury was confined to the trunks and the branches of the trees. Peach growers were at a loss to know how their trees should be treated, especially with reference to pruning. Some were pruning their trees severely, while others were pruning moderately. The writer recommended moderate pruning for both old and young peach trees, as experimental evidence had indicated that for winter-injured peach trees more than one year old moderate pruning was better than severe pruning. In the case of June-budded or small yearling trees planted during the fall of 1917, however, it was recommended that the usual cutting back to whips be practiced.

"Winter injury to peach trees in Illinois during the winter of 1917-18 including the killing of the fruit buds and injury to wood of different ages, varying from a slight injury to the tissues to severe injury and subsequent death of the trees. In most cases trees which had been planted but one year showed less injury than older trees. The internal symptoms of winter injury appeared in the form of discoloration of the heartwood and sapwood, varying in color from light to dark brown. The cambium layer turned a pale, watery green. The odor of the cell sap was sour, suggesting fermentation. These conditions were present in the trunk and the branches. The roots of the trees in every peach orchard examined remained normal, owing to the protection afforded by the heavy covering of snow.

"The first external symptoms of winter-injury appeared in the form of shrunken bark on which the lenticles stood out prominently, giving the bark a slightly roughened appearance; and

also in some cracking or splitting of the tree trunks. A later symptom was noted in which the leaf buds expanded, owing to the local supply of stored food, but finally wilted on account of the inability of the injured tissues to conduct sap from the roots. This type of injury appeared both on single branches and on entire trees.

"The amount of winter-injury to peach orchards in southern Illinois varied not so much with latitude, for the low temperatures were quite uniform, as with differences in vigor and healthiness of the trees, elevation of the orchard, and age of the trees. Trees devitalized as the result of previous injury from borers, gummosis, and lack of proper feeding and cultivation were most severely injured and in many cases died. Those located on well elevated and properly drained soil showed less serious injury than those situated on level land or in 'pockets.' In some cases a difference of a few feet in elevation within the same orchard caused a marked difference in the severity of the injury. Trees which had been planted one year appeared to be injured less than older ones.

"Little opportunity was afforded to study winter injury on any variety of peach trees other than Elberta and Hale. The former variety is the most important one grown commercially in southern Illinois, while the latter is being planted to some extent. It has been thought by certain peach growers of other states that Hale is more resistant to low temperatures in the bud than is Elberta, but in southern Illinois during the winter of 1917-18, both varieties proved failures in this particular. Hale is a less thrifty grower than is Elberta in this section of the state and following the winter of 1917-18 showed as much, and in certain cases more, serious wood injury.

"As serious winter-injury to the wood of peach trees rarely occurs in south-

Last Big Block OF THE CANADIAN PACIFIC RESERVED FARM LANDS

THIS announces the offering of the last big block of the Canadian Pacific Reserved Farm Lands. Until this block is disposed of you can secure at low cost a farm home in Western Canada that will make you rich and independent. Never again on the American Continent will farm lands be offered at prices so low.

Last Big Opportunity

This block contains both fertile, open prairie and rich park lands in Lloydminster and Battleford Districts of Central Alberta and Saskatchewan. Farm Lands on the rich prairies of Manitoba, Saskatchewan and Alberta acreage about \$18.00 an acre. Lands in Southern Alberta under an irrigation system of unfailling water from \$50 an acre up.

Twenty Years to Pay

The Canadian Pacific offers you this land under a plan of long term, easy payments that is remarkable in the history of farm investments. You pay down 10%. Then you have no payment on the principal until the end of the fourth year, then fifteen annual payments. Interest is 6%. In Central Saskatchewan, Seagar Wheeler grew the world's prize wheat. World's prize oats were grown at Lloydminster.

Lands Under Irrigation

In Southern Alberta, the C. P. R. has developed the largest individual irrigation undertaking on the American Continent. This district contains some of the best lands in Canada. An unfailling supply of water is administered under the Canadian Government. Prices range from \$50 an acre up on the same easy payment terms. \$2000 Loan in improvements. 20 years to pay back.

Special Rates for Home-seekers and Full Information

The Canadian Pacific will not sell you a farm until you have inspected it. To make this easy, special railway rates have been arranged. Do not delay your investigation. This is the last great block of Canadian Pacific Reserved Farm Homes. Send today for complete information — without obligation.

M. E. THORNTON
Supt. of Colonization
Canadian Pacific Railway
960 First St., E., Calgary, Alberta
For all information about Canada, ask the C. P. R.

Every Stroke Counts—
WITH THE GILSON WEEDER



Backward and forward, every stroke counts with the double-edged blade of the Gilson Weeder. It cuts both ways under the soil surface, destroying weeds and forming a perfect mulch. A marvel in the garden, children can do as much work as grown-ups. You work away from the cultivated soil instead of tramping over it. The side arms act as fenders protecting plants and under shrubbery. Six-foot handle makes operation easy and eliminates backache. Made in four sizes—3½, 5, 6 and 8 inch.

GILSON GARDEN TOOLS
(Hand or Wheel Outfits)

A complete variety for intimate garden cultivation. Send \$1.15 for 6-in. Gilson Weeder (under money-back guarantee), or have your dealer order for you. Free — Booklet describing complete line of labor savers.



J. E. GILSON COMPANY
102 Western Avenue
FORT WASHINGTON, WIS.

Free Booklet for Asking

The HARDIE

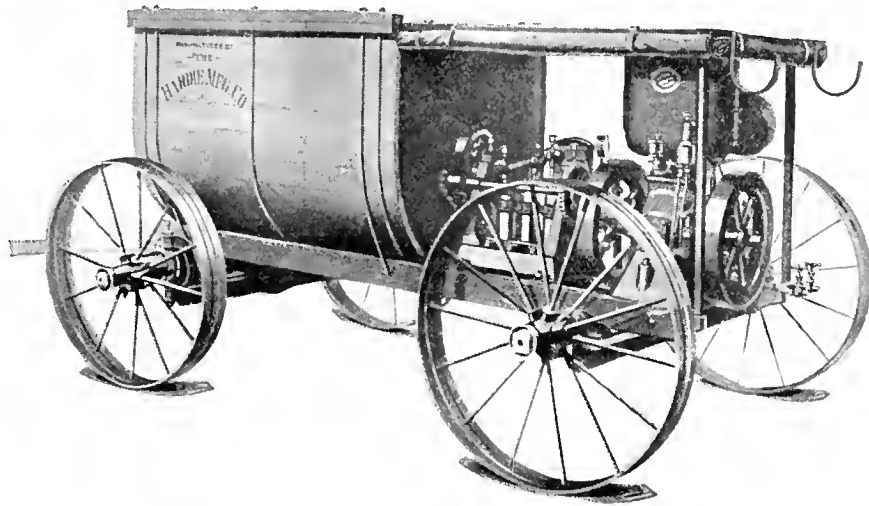

Depending not on one feature alone, nor adaptable to only one class of growers, this machine will fit any orchard condition and meet any spraying problem.

Combined in this one machine is the ample capacity for rapid work, the uniform high-pressure which insures effectiveness, the under-slung truck enabling operation under adverse orchard conditions; plus a sturdiness that enables it to stand the strain of hard service for years.

*It is first, last, and all the time your most powerful weapon
in your fight against insect pests.*

If you desire low operating costs, high speed work, and above all, the satisfaction of a clean, high-quality fruit crop

Get a Hardie

THE HARDIE MFG. CO.

55 North Front Street

Portland, Oregon

ern Illinois, advantage was taken of the opportunity offered at this time to conduct investigations with the view of determining a satisfactory way of handling such trees. Experimental work was confined to the Elberta variety."

Results of Experiments.

In the spring of 1918 three sets of pruning experiments were started on different plots of the injured trees, the pruning being done from March 26th to March 28th, when the leaf buds had started. The methods of pruning were as follows:

- Row 1. Pruned moderately; previous year's growth clipped approximately one-half.
- Row 2. Dehorned, the one and two-year-old wood removed.
- Row 3. One-year-old wood removed.
- Row 4. Check. Unpruned.

On April 1, Mr. Gunderson notes that one pound of nitrate of soda was applied broadcast to three of the trees in each row for the purpose of studying

the effects of fertilizer on the recovery of fruit trees from winter-injury. The trees were examined frequently during the spring and summer and the fact is noted that the foliage of the trees which had received the nitrate of soda was heavier and of a darker green color than that of the untreated trees. "This difference," the writer says, "was much more apparent however in the check and the moderately pruned trees than in those dehorned. This was probably due to the fact that the heavy pruning of peach trees usually results of itself in the stimulation of heavy wood growth and foliage, especially when the trees are in vigorous condition."

On October 30, Mr. Gunderson made an examination in regard to these experiments which he records as follows: "Observations were made October 30 on the relative amount of fruit-bud formation on the trees in the different rows. The trees in Row 1, whose one-year-old wood had been clipped, carried the largest number of well distributed, vigorous fruit buds and on wood of desirable size. The unpruned trees carried a large number of less plump but well distributed fruit buds on small-sized branches. The trees in Row 3, from which the one-year-old wood had been removed entirely, had a good many poorly distributed fruit buds carried on wood that was a little too heavy to be desirable. The tops of the trees in this row were so dense as to require considerable thinning of the branches and consequent removal of many fruit buds.

"Very few fruit buds were present on the dehorned trees in Rows 2 and 4. This was due to the fact that, as usual on severely pruned trees, long and heavy primary growth of branches developed, on which relatively few fruit buds ever appear.

"Examination of the internal tissues of the wood of both branches and trunks was made in the experimental orchards during November after the growing season had ended. It was observed that a new layer of sapwood had been formed of greater thickness in the trunks of the trees than in the branches. The heartwood and pith had assumed a 'punky' condition, suggesting decomposition. Whether such a condition will eventually prove detrimental to the productiveness and vigor of the trees remains to be seen."

Vigilance Necessary.

In view of the fact that extensive winter injury to fruit trees in the Pacific Northwest has heretofore been limited the experiments of the Illinois Experiment Station are both interesting and valuable and lead, as Mr. Brown says in summing up his conclusions to the belief that the situation is hopeful.

The proper method for growers in the Northwest who have injured trees is to investigate their orchards carefully from now on, keep in touch with the agricultural experiment stations and adopt those methods which will result in the minimum loss in both fruit and trees.

G. L. Davenport

Grower and Shipper

MOSIER, OREGON

MAIN OFFICE
147 Front Street, PORTLAND, OREGON



15 Acres per Day

Is the Average for One Man with the

American Beauty Dust Sprayer

This Man is dusting 20 Acres
per day, on Peaches

CODLING MOTH
RED SPIDER
CURCULIO
APHIS
CATERPILLAR
MILDEW, Etc.

WRITE TO-DAY

THE CALIFORNIA SPRAYER CO.

6001-11 Pasadena Avenue

Los Angeles

DOW

DEPENDABLE INSECTICIDES

PAY

Dow Powdered Lead Arsenate
 Dow Paste Lead Arsenate
 Dow Powdered Magnesium Arsenate

Dow Lime Sulphur Powder
 Dow Powdered Magnesium Bordo
 Dow Powdered Magnesium Bordo-Arsenate

GOOD PROFITS

Every successful grower of fruit realizes that it is impossible to produce good fruit without spraying. Satisfactory results cannot be obtained from inferior materials, and superior materials cannot produce the proper results if they are carelessly applied. Obviously it is not possible for the manufacturer of Insecticides to superintend the application of his products. This must be done by the grower. But, the manufacturer is responsible for the integrity of his materials. He should establish the highest possible standard for his goods and should maintain that standard always. To this latter phase—the manufacturer's responsibility, as applied to The Dow Chemical Company's line of Insecticides—we invite your attention.

OUR COMPANY

Was a large producer of war materials.
 Is the largest producer of Chloroform, Chlorine and Bromine products.
 Is the country's greatest producer of Indigo Blue.
 Owns one of the best chemical libraries in the country.
 Has made dependable Insecticides for many years.
 Has the confidence of America's largest fruit growers.

OUR PLANT

Covers over one hundred acres of ground.
 Includes over ten miles of railroad track within the property.
 Employs over 100 graduate chemists.
 Keeps busy over 1,500 loyal employees.
 Is run on the Profit Sharing plan.
 Has been built by honest service in the manufacture of essential chemicals.

DOW
 INSECTICIDES ARE DISTRIBUTED AT IMPORTANT
 WESTERN FRUIT CENTRES

Get your copies of our new spraying leaflets. A postal will bring them.
 Ask for the name of the DOW DISTRIBUTOR near you.

THE DOW CHEMICAL CO.

INSECTICIDE DEPARTMENT

MIDLAND,



MICHIGAN

Ridley, Houlding & Co.

COVENT GARDEN, LONDON

WE ARE

Specialists in Apples and Pears

CABLE ADDRESS: BOTANIZING, LONDON

Codes: A. B. C. 5th Edition and Modern Economy

Better Fruit Trees

We offer direct from nursery to planter, subject to stock being unsold, the varieties listed below. Our trees are guaranteed to pass government inspection and to arrive in prime condition, subject to penalty of replacement without charge.

APPLE—	Baldwin	Delicious	Rome Beauty	King David
PEACH—	Arp Beauty	Champion	Early Rose	Elberta
	J. H. Hale	Krummel	Late Crawford	Heath Cling, Etc.
PLUM—	Abundance	America	Burbank	Italian Prune
	Shropshire Damson		Endicott (Mammoth Gold)	

APRICOT—Superb

Other varieties of peach and limited quantities of other varieties of apple.

Lowest net prices f.o.b. Neosho, cash with order and subject to change without notice.

APPLE—	Caliper	Each Rate	5 Rate	25 Rate	50 Rate	100 Rate
1-yr.	Under 5/16	.45	.35	.30	.25	.20
	5/16 to 7/16	.55	.45	.40	.35	.30
	7/16 to 9/16	.65	.55	.50	.45	.40
	9/16 up	.75	.65	.60	.55	.50
2-yr.	1/2 to 5/8	.65	.55	.50	.45	.40
	5/8 to 11/16	.75	.65	.60	.55	.50
	11/16	.85	.75	.70	.65	.60
	* 3/4 up	.95	.85	.80	.75	.70
	*(This size in Baldwin only.)					
PEACH—	Under 5/16	.65	.55	.50	.45	.40
	5/16 to 7/16	.70	.60	.55	.50	.45
	7/16 to 9/16	.75	.65	.60	.55	.50
	9/16 to 11/16	.80	.70	.65	.60	.55
	11/16 up	.85	.75	.70	.65	.60
PLUM—	Under 5/16	.70	.60	.55	.50	.45
	5/16 to 7/16	.75	.65	.60	.55	.50
	7/16 to 9/16	.80	.70	.65	.60	.55
	9/16 to 11/16	.90	.80	.75	.70	.65
	11/16 up	1.00	.90	.85	.80	.75
APRICOT—	Under 5/16	.70	.60	.55	.50	.45
	5/16 to 7/16	.75	.65	.60	.55	.50
	7/16 to 9/16	.80	.70	.65	.60	.55
	9/16 up	.85	.75	.70	.65	.60



Our catalog, "Better Fruit Trees," mailed free on request. Every customer also receives free of charge our 80-page illustrated book, "Inside Facts of Profitable Fruit Growing," which experts and beginners too say is "A Wonderful Help to Fruit Growers." (Price 10 cents to others.)

NEOSHO NURSERIES CO.
2 Lake Street
Neosho, Missouri

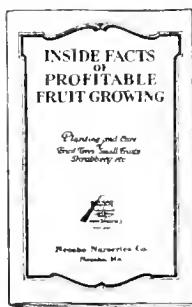

Methods of Orchard Heaters

Continued from page 11.

changed condition. The regulated type of heater thus provides many advantages over the crude styles of smudge pots which were formerly on the market.

It is of much importance to carry on the heating work if frosts appear any time during the swelling of the buds up until the time the fruit has reached the size of marbles, for unless the crop is protected at this later period of growth, the tender little stems will freeze and large quantities of fruit will fall to the ground. It must not be lost sight of that unless a heater of at least three or four gallons capacity is used, the work involved of refilling is large and in commercial orchards the growers demand the larger sizes.

In concluding these remarks to the commercial fruitgrower—to safeguard his crop it may be mentioned that man has devised irrigation to offset drouth, insurance to offset fire and orchard heaters to eliminate frost. The protection is at every grower's command, but the work must be prosecuted intelligently and thoroughly if he expects to secure a high degree of success and a bumper crop each succeeding year.

The white arsenic produced in the United States in 1918 amounted to 6,323 short tons, valued at \$1,213,000. By far the greater part of the domestic white arsenic consumed in the United States in 1918 was used in preparing insecticides and weed killers, the total quantity so used in 1918 being about 2,000,000 pounds, according to the United States Geological Survey.

Established 1882

F. W. Baltes & Company Printers

WE print anything from the smallest to the largest and always welcome orders of any size or quantity, giving prompt, personal and efficient service. Mail or phone inquiries are solicited. We do not specialize — experience and equipment enable us to print everything equally well. We render service in preparing copy and illustrations and furnish plans and estimates for catalogs, booklets, publications, billboard and any other kind of advertising.

First and Oak Streets
Phones: Main 165; 511-65
Portland, Oregon

Combined Bordeaux Oil Spray

Continued from page 9.

6-6-50. It is necessary that the Bordeaux solution be neutral and not alkaline as Bordeaux is ordinarily made. This is determined by adding the lime milk slowly allowing the lime milk and copper solution to be well mixed and testing with blue or red litmus paper to determine when the neutral point is reached.

If no rain follows the application of Bordeaux oil emulsion spray for 24 hours, the spray dries thoroughly and stays on the bark of the trees throughout the season, and is effective against anthracnose development after the fall rains begin.

Prof. W. S. Thornber to Enter New Field

The announcement is made that Prof. W. S. Thornber, who, for many years was director of the agricultural extension service at Washington State College, will take up the work of consulting horticulturist in the northwest as a profession. It is Prof. Thornber's intention to cover the entire northwest territory in this capacity, going to any section where there is a demand for his services although his headquarters will be established at Lewiston, Idaho.

A study of the situation has convinced Prof. Thornber and others who are in touch with the fruit industry of the northwest that there is a wide field for this character of work notwithstanding the excellent service being rendered by the government and state institutions. It is not necessary to say a great deal in regard to Prof. Thornber's special fitness for the work he is about to take up. He has grown up with the great agricultural development that has taken place in the northwest and has had an experience and an opportunity to become informed on the various branches of agriculture and horticulture such as is presented to few men in the profession, in addition to his thorough technical training. Added to this is the fact that he has a natural liking for the work which leads him to an investigation of the most unimportant problems connected with it as well as those of a more serious and important nature. Along with all this he is practical in the application of his ideas which forms the basis of all real help to the fruit grower.

In entering this new field Prof. Thornber will undoubtedly find a demand for his aid and will render a service that will be of great help to the fruit growing industry of the northwest.

WANTED

to rent or lease, an improved orchard farm by party having both practical experience and technical training. Best of references furnished.

Address REM, Care of Better Fruit

Peach Nursery Stock Short.

Mr. Frederick Maskew, chief deputy quarantine officer of California, advises that all indications at the present time point to a shortage of peach nursery stock for planting during the coming season. In view of this fact, it will be good policy for all state quarantine guardians to secure an approximate

knowledge of the area expected to be planted to peaches in their respective counties this winter, and interview the prospective planters as to the source from which they intend to obtain the nursery stock, at the same time explaining to all concerned the insidious nature of the disease known as "peach yellows."



Wellington's Marvel

A NEW STRAWBERRY OF MERIT

We have tried out this wonderful variety for the last five years, and claim it has *no equal in flavor, perfection of fruit, and productiveness.* For table, canning or fruit juices it will command the highest price. It is strong, vigorous, hardy and immune from all lop-sided, scrubby, defective specimens. Don't wait—get a start this year. Prices: 75c per doz., \$4.00 per 100, postpaid.

OUR CATALOG FOR 1920

tells all about it and our other Fruits and Berries, Garden, Farm and Field Seeds, Poultry Supplies, Sprays and Sprayers, Tools, etc.

Mention "Better Fruit" when you write, and receive our 1920 calendar as well as our new catalog.

W. S. Butler, Originator, and a Box of Marvels

Routledge Seed & Floral Co.

145 Second Street

PORTLAND, OREGON

Are You the Man?

If so, BETTER FRUIT offers you a chance to make good money

We want a representative in every fruit-growing community. In every such community there is some individual with a little time each month to spare, who, by representing BETTER FRUIT, can make a good income.

Perhaps it will be an elderly man?

A young fruit-grower just getting started?

A wife who wants to help out?

An ambitious boy or girl who wants to make extra money?

We want someone in *your* community to become our *permanent* representative—to secure new subscriptions for us and renew old ones.

We want two or three representatives in the Hood River Valley. Several in Yakima and Wenatchee—in the Willamette Valley, Rogue River, etc. In fact we want *permanent* representatives in every fruit district of the West.

Our proposition is a good one. Are you the man or woman for the job?

Write today, stating your qualifications.

BETTER FRUIT PUBLISHING COMPANY

OREGONIAN BUILDING, PORTLAND, OREGON

Fruit Insect Control
Continued from page 6.

market or cooking purposes, the infestation being discovered first when the maggots which have deserted the fruit are found on the bottom of the container. The adult flies feed more or less before egg laying and, it is stated, can be killed if the foliage is kept covered with a poison spray. A good spray for this purpose is arsenate of lead paste 2½ pounds (or 1½ pounds of the powder), cheap molasses 1½ gallons, and water to make 50 gallons. The first application should be given in early June and occasionally repeated during the succeeding three or four weeks, depending upon the rains. Some cherry growers report that it is unnecessary to sweeten the spray.

Cherry leaf-beetle—The cherry leaf-beetle occurs sometimes in enormous numbers in the northern and more eastern states, attacking the foliage and fruit of the cherry, and to a less extent the foliage of the peach. A careful lookout should be kept for the beetles, and upon their first appearance trees should be sprayed with arsenate of lead at the rate of 5 pounds of the paste (or 2½ pounds of the powder) to 50 gallons of water. The addition of 1½ gallons of molasses to the spray is said to increase its effectiveness.

PLUM INSECTS.

Several of the insects injurious to the peach, already considered, attack also the plum, as the San Jose scale, the terrapin and other lecanium scales, the plum curculio, the peach borer, etc. See "spraying schedule" for control of plum curculio and brown-rot.

Plum aphids—Three species of plant-lice are common on plums and often require treatment. These winter on the trees in the egg stage, the aphids hatching in the spring about the time the buds are breaking, and later may become very numerous. In localities where injury is

usual each year trees should be sprayed as the buds are breaking, as described for apple aphids. Otherwise it will be sufficient to spray when the aphids are actually troublesome, using 40 per cent nicotine sulphate, three-fourths of a pint to 100 gallons of soapy water, or in the self-boiled lime-sulphur mixture and arsenate of lead spray described in the spraying schedule.

GRAPE INSECTS.

CONTROLLED BY SUMMER SPRAYING.

Grape-berry moth—In late summer grape berries are often found infested by an active, greenish caterpillar about three-eighths of an inch long, the larva of the grape-berry moth. It is at present destructive in northern Ohio and to a less extent in portions of the Chautauqua and Erie grape belts. First-brood larvae feed on the blossom or young fruit clusters, and those of the second brood injure the green and ripening berries, often so soiling the bunches that they must be carefully picked over by hand before marketing. The insect is well controlled by an arsenate of lead spray of 3 pounds of paste (or 1½ pounds of powder) to 50 gallons of Bordeaux mixture, applied by the "trailer" method just after the blossoms have fallen, and again two weeks later.

Grape rootworm—The presence of the grape rootworm in vineyards is shown by chain-like feeding marks of the adult beetles on the foliage. The larvae consume the fibrous roots of the grape and eat out furrows in the larger roots, stunting the growth of the vine, so that the foliage becomes yellowish, and the fruit may shrivel and fall. It is a serious pest in the Erie-Chautauqua and northern Ohio grape districts and requires annual treatments to keep it reduced below injurious numbers. Since the beetles feed on the leaves during early summer and before egg laying to any extent, they may be controlled by the use of arsenical sprays applied in Bordeaux mixture, as for the berry moth, as described in the spraying schedule.

Grape leafhopper—The grape leafhopper is a small, agile, whitish insect, with red and yellow markings, often noted as abundant during summer on the lower surface of grape leaves. It feeds by sucking juices from the leaves, and its punctures cause the foliage to become blotched with white and later to turn brown, and many of the leaves fall from the vines. This injury interferes with the proper ripening of the fruit and prevents normal vine growth. The insect is a pest of much importance on American varieties of grapes throughout the country, generally, and especially in the Great Lakes district, and also on vinifera varieties in some regions of the west. It is controlled by the use of one-fourth pint of 40 per cent nicotine sulphate to 50 gallons of soapy water or Bordeaux mixture. The first application should be made when the wingless hoppers or nymphs of the first brood are present in large numbers (in the north this will be in late June or early July), as can be determined by examination. The nicotine should be used in the arsenate of lead and Bordeaux mixture spray, described in the spraying schedule, and the "trailer" method of application followed. Much care is necessary in spraying to hit the insects on the lower surface of the leaves.

Rose-chaffer—In some sections of the country the long-legged, yellowish-brown beetles, about one-half inch long, known as rose-chaffers, often put in appearance in large numbers about the time of blossoming of the grape, roses, and many other garden flowers, stripping the plants of blossoms and foliage. They feed upon a large variety of plants, and when very abundant do much damage in spite of treatment. Thorough spraying upon first appearance of the beetles is recommended, using arsenate of lead, 5 pounds of the paste (or 2½ pounds of the powder) for each 50 gallons of water, repeating the application as necessary to keep the plants coated with poison. Hand picking of beetles in the early morning may be practiced on a small scale, and bagging choice plants with mosquito netting also may be resorted to.

Grape leaf-folder—Grape leaves are often rolled or folded over by an active, grass-green caterpillar about three-fourths of an inch long, the so-called grape leaf-folder. Within the folded leaf the larva eat out the soft leaf substance, and when numerous may cause more or less defoliation of the vines. The larva of the first brood appear on the vines in early summer. Well-sprayed vineyards are not seriously troubled by the leaf-folder, and its injuries are usually confined to the home vineyard. Spraying the vines with arsenate of lead when the larva are first in evidence will keep them in check. Hand picking of infested leaves or crushing the larva in the folded leaves is practicable where only a few vines are involved.

Eight-spotted forester—The caterpillar of the moth known as the eight-spotted forester feeds on grape foliage and is sometimes much complained of locally. The full grown caterpillar is about 1½ inches long with transverse black and orange stripes or bands, and there is a distinct hump near the hind end. Larvæ are present on the vines from early June until about August. They may be controlled by the use of arsenate of lead, as described for the grape leaf-folder.

Grapevine flea-beetle—A small, steely blue beetle often attacks the swelling buds of the grape in the spring. The larvæ of the beetles later feed upon the foliage. Where injury by this pest, known as the grapevine flea-beetle, has been prevalent or is to be expected, vines should be sprayed, as the buds are swelling, with arsenate of lead—3 pounds of paste or 1½ pounds of powder to 50 gallons of water or fungicide. This insect usually is kept in check by the arsenate of lead used in the first and second applications. This destroys the larvæ.

GRAPE SPRAYING SCHEDULE.

First application—About a week before the blossoms have opened, or when the shoots have become 12 to 18 inches long, spray with Bordeaux mixture 4-4-50 for fungous diseases, adding 2 to 3 pounds of arsenate of lead paste, or one-half that quantity of the powdered form, for the flea-beetle, the rose-chaffer, etc.

Second application—Just after the blossoms have fallen spray with the same materials as in the first application for the same fungous diseases and insects and for the grape-berry moth, grape leaf-folder, and adults of the grape rootworm, by the "trailer" method.

Third application—About two weeks later use Bordeaux mixture 4-4-50, arsenate of lead paste 2 to 3 pounds, 40 per cent nicotine sulphate ½ pint, to 50 gallons of spray mixture, for fungous diseases, berry moth, eight-spotted forester, grape leaf-folder, grapevine aphid, grape rootworm, and grape leafhopper. To destroy the leafhopper, direct the spray against the lower surface of the leaves. To control the berry moth, thoroughly coat the grape bunches with the spray by the "trailer" method.

Fourth application—About ten days later, or when the fruit is nearly grown, if black-rot or mildew are still appearing, spray with neutral copper sulphate or verdigris (acetate of copper) at the rate of 1 pound to 50 gallons of water.

CURRANT AND GOOSEBERRY INSECTS.

CONTROLLED BY WINTER OR DORMANT SPRAYING.

The San Jose and certain related scales are frequently present in injurious numbers on currant and gooseberry plants, the first mentioned especially often requiring treatment. Winter strength lime-sulphur solution is effective and should be used as directed for the control of this insect on fruit trees as already given.

CONTROLLED BY SUMMER SPRAYING.

Imported currant worm—The imported currant worm when full grown is about three-fourths of an inch long, uniformly green, but yellowish at the ends. Young larvæ are covered with black spots and the head is black. They attack both currants and gooseberries, appearing on the plants shortly after the leaves are out in the spring, feeding at first in colonies but later scattering over the plants. Currant worms are voracious feeders and quickly strip the plants of foliage, hence treatment should be given promptly upon their discovery. Another brood of larvæ appears in early summer, and some seasons there may be a partial third brood. These insects are destroyed readily with an arsenical, sprayed or dusted over the plants. Effort should be made to destroy the first brood and prevent later injury. In treating the second brood when the fruit is ripening, powdered hellebore should be used, diluted 5 to 10 times with flour or air-slaked lime, or as a spray, 1 ounce to 1 gallon of water.

Currant aphid—The currant aphid curls the terminal leaves of the currant and gooseberry, especially the red currant, its presence resulting in little pits or pockets on the lower leaf surface. A reddish color usually develops on the upper surface of injured leaves, which is visible some distance away. This aphid is easily controlled by spraying the plants as the leaf-buds are opening in the spring, thus destroying the young stem-mothers. The 40 per cent nicotine sulphate-soap spray should be used, or kerosene emulsion or fish-oil soap wash. In spraying later in the season the liquid should be directed against the insects on the lower surface of the leaves.



Exposure's After-Effects

RHEUMATIC Twinges, Sore Muscles, Stiff Joints, and all other external aches and pains—are quickly relieved by an easily-made application of Sloan's Liniment. Put in on, *don't rub*, for it penetrates and scatters the congestion, and soon a soothing, comforting, warm relief comes to the afflicted part.

Three sizes—the larger the bottle the greater the economy—35c., 70c., \$1.40.

Sloan's
Liniment
Keep it handy

ARE YOU ALERT?

Why love half your Tomatoes by frost when the Best Tomato in the World is also the earliest?

The Burbank Tomato is the crowning result of 13 years of careful, painstaking labor on the part of Luther Burbank

BURBANK TOMATO

In earliness, productiveness, size, shape, color, flavor, solidity and all desirable qualities it is par excellence. Will stand ahead of all in popularity when better known for both home and market use.

Order early as stock is very limited and sold in packets only. Packet of 100 seeds, 20 cents; 3 for 50 cents; 7 for \$1.00.

Catalogue of other sterling seed varieties and specialties, free.

ISAAC F. TILLINGHAST
Seed and Plant Grower SANTA ROSA, CALIF.

Returns with Valuable Data About Pear Blight

THE seriousness of fire blight which threatens the pear industry of Oregon and which has already wiped it out in certain sections of the country and how the Southern Oregon branch experiment station hopes to be of service through the propagation of blight resistant varieties, was told by Prof. F. C. Reimer, superintendent of the stations during Farmer's week at the Oregon Agricultural College. Prof. Reimer has just returned from his second trip to China for the purpose of obtaining pears which are blight immune. He brought home between 40 and 50 new varieties, and these will be tested at the station next spring and summer.

Prof. Reimer told of oriental customs which were not altogether to his liking. "Chinese hotels," he said, "should be called Chinese hovels. Donkeys, goats, pigs, chickens, and all the vermin God ever made are there. There is no bed, no bedding and no stove. It is a real experience to spend a few nights in one of these places.

"Fifteen to 30 Chinese all sleep in the same room. The Chinese are kicking each other all night long and they snore like a rhinoceros. The noise of the donkeys in another part of the inn is terrific, but when I was given the choice

of sleeping next to the Chinese or the donkeys, I chose the donkeys.

"It is a common experience to find a hog in your room rooting in your baggage. One must carry his own cot, bedding and food. The Chinese inn is beyond description."

Prof. Reimer returns with what is undoubtedly the most complete collection of oriental pears in the world. He has also found several species which are practically immune from blight, and by using this type for the root and branch structure, and grafting with the more edible Bartlett, Bosc, or Anjou, it is believed that a pear will be evolved which will not be affected by blight. Professor Reimer is also interested in creating a new species of pear tree entirely by a process of cross fertilization, using the Chinese and American varieties, which would produce a commercial pear, suitable for the table and free from blight infection.

Prof. Reimer's experiments and discoveries are of far reaching importance, pear growers in all parts of the country being intensely interested in them. In the near future Prof. Reimer will give a lecture on his experiences in China and the result of his research work to date.



WHAT EVERY HOME CANNER SHOULD HAVE

ONE of our H. & A. Hand Power Double Sealers. It is the only hand power seamer built that will seal all sizes of sanitary fruit and vegetable cans. Write for prices and descriptive matter to Department T.

HENNINGER & AYES MFG. CO., Portland, Ore.

Builders of Sealers and Steam Pressure Canning Outfits

"Some Men Don't Know It Yet" says the Good Judge

This class of tobacco gives a man a lot more satisfaction than he ever gets out of ordinary tobacco.

Smaller chew—the good taste lasts and lasts.

You don't need a fresh chew so often. Any man who uses the Real Tobacco Chew will tell you that.



Put Up In Two Styles

RIGHT CUT is a short-cut tobacco

W-B CUT is a long fine-cut tobacco

Weyman-Bruton Company, 1107 Broadway, New York City

Knowledge Experience Demonstration

THOSE three words sum up the whole story of Orchard Brand Dry Powdered Arsenate of Lead. What it will do to protect your fruit trees has been proved by discerning growers in the most productive orchard districts.

It prevents injury by codling moth and other insects that obtain their food by eating the fruit.

It also is used to prevent injury to foliage of fruit trees and other plants by chewing insects.

Orchard Brand Dry Powdered Arsenate of Lead is very finely divided. It mixes readily with water. In the spray tank it remains in good suspension. When properly applied by spreading evenly over the surface of the fruit and foliage, it does not collect in splotches. It gives the greatest possible protection.

After years of work and research by experienced chemists and investigators, and carefully executed field tests, Orchard Brand Dry Powdered Arsenate of Lead is recommended as the nearest perfect tree spray material.

Practical fruit growers and experienced entomologists have demonstrated its qualities as reliable and effective. It is in convenient form to handle; uniform mechanically; of high concentration; good spreading ability; adhesive and lasting; and produces satisfactory results under all conditions.

Made in California. Ready for immediate shipment in 200-lb. and 100-lb. drums, 50-lb. and 25-lb. packages, 4-lb. and 1-lb. cartons. Every package net weight.

Write us fully about your tree troubles and ask for new Bulletin 3 on Dormant Spraying of Deciduous Fruit Trees.



General Chemical Company

770 Royal Insurance Building
Department A

San Francisco, California

CONSULTING HORTICULTURIST

PROFESSOR W. S. THORNBUR

Formerly

HEAD OF THE DEPARTMENT OF HORTICULTURE
AND LANDSCAPE GARDENING

Later

DIRECTOR OF THE EXTENSION SERVICE
OF THE
STATE COLLEGE OF WASHINGTON

WILL ADVISE with fruit-growers upon all horticultural problems, including selection and preparation of orchard lands; propagation and care of nursery stock; planting and care of young orchards and small fruit plantations; the control of codling moth, San Jose scale, blight and other orchard pests; the preparation of lime-sulphur at home and the mixing of other sprays; economical orchard management; the irrigation and fertilization of orchard lands; the use of cover-crops and grass mulches; the pruning of fruit trees, shade trees, shrubs, bushes and vines; the renovation of old or neglected orchards, top-working or replacing of poor or unprofitable trees, and the examining and the working out of practical management plans for large orchards and orchard companies.

If your orchard has not been a financial success, and you wish to determine its possibilities or you wish to improve your orchard, reduce your losses and increase your returns I will assist you in working out your problem.

WRITE FOR TERMS

W. S. THORNBUR
LEWISTON, IDAHO

The British Fruit Market

By Edward A. Foley
American Trade Commissioner at London

London—During the past week there has been but little change in the apple situation. British fruit is being absorbed gradually, and American fruit has begun to appear in quantities in the better class of shops.

Liverpool—There is considerable complaint about the bad condition of Virginia fruit.

Bristol—Apples of the best quality are in good demand.

Manchester—The Manchester market was quite bare of American fruit this week, though an arrival on Friday promised a big market for the coming week. There were, however, fair stocks in the hands of retailers selling at the maximum price.

Glasgow—There were fair supplies of American apples on hand, but the delay in unloading, owing to the port congestion, often was responsible for the marketing of apples in bad condition. American and Canadian apples in first-class condition brought maximum prices, but those out of condition resulted in heavy losses. There is a glut of English apples, bringing from 10 to 18s, per cwt. of 112 lbs. (\$2.02 to \$3.64.)

Walnut Production in North China

By Consul General P. S. Heintzleman
Tientsin, October 1, 1919

According to reports received at Tientsin, the market in America for North China walnuts is declining. This trade is conducted between Shanghai and the United States and the prices for shelled walnuts are 16½, 17 to 17½ cents gold per pound, c.i.f. San Francisco. The last offer of 16 cents was refused by firms in the United States, and merchants in Shanghai are warned that the American market is declining.

The many large orders which have been placed in the local market have affected prices in the interior by causing an average increase of about \$2 per picul of 133½ pounds. Walnuts, to be acceptable to the American market, must be white and between 1½ and 1¾ inches in diameter.

The crop for 1919 is good, but the sizes are rather smaller than those of

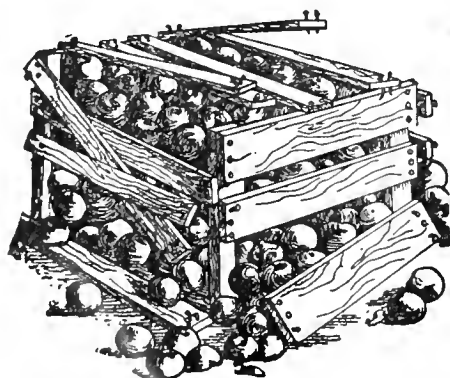

BEFORE using Cement Coated Nails

Western Cement Coated Nails for Western Growers

Our Cement Coated Nails are always of uniform length, gauge, head and count. Especially adapted to the manufacture of fruit boxes and crates. In brief, they are the Best on the Market.

Write for Growers' testimonials.

Colorado Fuel & Iron Co.

DENVER, COLORADO

Pacific Coast Sales Offices
Portland, Spokane, San Francisco
Los Angeles

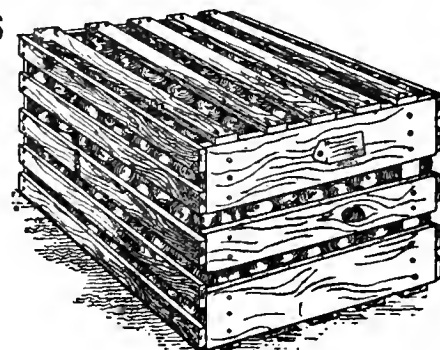

AFTER use of C. F. & I. Co.'s
Cement Coated Nails

last year. The harvesting season opens in the latter part of September.

The price for shelled walnuts, not picked and not graded, was about \$2150 Mexican per picul (\$1 Mexican=\$0.90 gold, and 1 picul=133½ pounds) for the 1918 season. The price for walnuts in shell, average quality, but not graded, was approximately \$11 Mexican per picul.

Walnuts are, as a rule, grown on small farms, owned by individual families. Harvesting is usually done by members of the family, so that it is impossible to calculate the cost of such labor. It may be stated, however, that labor of this class costs about 20 cents a day.

There has been no recent development in the walnut industry; but owing to the greater demand for export there may be increased efforts to greater output. The trees take nearly 15 years to bear. Walnuts are grown over a very large area in North China and come mostly from Shantung, Shansi, and Chihli provinces. The groves in most cases are located on the mountain slopes and hill side, on land not particularly adapted to the growing of other crops.

According to the returns of the Maritime Customs, the export abroad of walnut kernels from Tientsin in 1918 amounted to 2,475,867 pounds, valued at \$263,437, as compared with 968,800 pounds, valued at \$97,252 in 1917; the exports of walnuts in shell amounted in 1918 to 3,178,933 pounds valued at \$160,377, as against 4,863,333 pounds, valued at \$184,154 in 1917. According to the annual declared export returns of this consulate general shipments of walnuts, shelled and unshelled, to the United States amounted to 1,183,640 pounds valued at \$339,718 in 1918, compared with 2,830,646 pounds valued at \$493,239 in 1917.

A Distinctive Book

It is decidedly refreshing to turn the well printed pages of the new 1920 seed catalog just issued by the Chas. H. Lilly Co. Without doubt it is one of the most attractive books of its kind that has come before us, and we do not remember ever having seen better printing in any of the seed catalogs either for this or any previous year.

The cover is at once original and unique in its simplicity of design. It is an imposing, dignified, yet attractive volume externally, it gives all the information and explanatory notes which should be given in relation to seeds for garden and field; poultry and bee supplies, fertilizers, etc., while its excellent illustrations adorn and make clearer its arguments. It also contains four beautifully colored photo plates which are more truthful to type than anything we have seen hitherto.

Altogether the Lilly seed annual for 1920 is worthy of a place on the gardeners' bookshelf. A postal request addressed to Seattle or Portland will bring a copy free.

Protect Your Tools From Rust.

Nearly every man owns at least a few tools such as chisels, hammers, augers, saws, wrenches, files, etc.

These tools as a rule are infrequently used. They are often kept in places where they are exposed to moisture and consequently rust. Almost all tools with the possible exception of hammers are rendered less efficient by rust.

Probably the best tool protector and carrying case for a small kit may be made in the shape of a roll from a piece of pyroxylin coated fabric having a napped or fleecy back. This material is thoroughly waterproof and if care is taken in wrapping the tools in it after use, it will prevent moisture from reaching them and no damage from rust can occur.

Nice Bright Western Pine

FRUIT BOXES AND CRATES

Good standard grades. Well made. Quick shipments. Carloads or less. Get our prices.

Western Pine Box Sales Co.
SPOKANE, WASH.

TREES AND SHRUBS



Fruit trees budded from bearing orchards. Apple, Pear, Cherry, Peach, Plum, Apricot, Quince, Grape Vines, Shrubbery, Plants, Raspberries, Blackberries, Logans, Dewberries, Asparagus, Rhubarb, Flowering Shrubs, Roses, Vines, Hedge, Nut and Shade Trees. Carriage paid. Satisfaction guaranteed.

WASHINGTON NURSERY CO.
Toppenish, Washington.
Salesmen everywhere. More wanted.

Chemistry Entomology and Botany

are the three sciences back of

ZENO

It is the result of ten years of study, Comparison, test and proof—not only In this country but abroad—under many And varied conditions, for the control of sucking insects such as scale, aphid, mealy bug, red spider, thrips, and the stimulation and renovation of trees in general.

It will remove black fungus, moss and lichens, and produce clean, smooth bark and vigorous bearing trees.

ZENO is an internationally used spray and these are some of the reasons why it has proved the best by years of test.

MANUFACTURED ONLY BY

Eastbay Chemical Co.

Formerly Standard Chemical Co., Inc.

of Emeryville [Oakland] California

T. O. McCLURE, Director of Research

[Zeno may be had of your local Distributor, Fruit Company, Exchange, or by writing to us direct]

SPOHN & WING

NORTHWEST AGENTS

223 Sherlock Building Portland, Oregon

Some Wet Spots Drained by Dynamite

By A. H. Harris

A neighbor had an old low pond place of about one-quarter acre in his upland field, which, owing to the nature of the land could not be drained by an open ditch. Therefore the only way of draining it was by an underground outlet. He drilled several holes in this piece of ground about twelve feet deep and exploded from 2 to 3 pounds of 40 per cent dynamite in them. These explosions thoroughly broke up and shattered the hard pan so that the water could escape downward. The next year a much larger yield was harvested from this piece of ground on account of better drainage.

Another man had a very low piece of land. This was drained by using one-half pound of 20 per cent dynamite ex-

ploded at a depth of 3 feet. A few of the latter charges in the lower places were planted a little deeper and charges were made a little heavier. The tough, underlying subsoil was thoroughly broken up, allowing the surplus surface water to escape downward. He too, has harvested considerably better yields every year.

Last spring I subsoiled a piece of ground which was of a very cold, wet nature. The soil was so wet that the ground could not be put in good condition for an early crop. The past year three crops were grown on this piece of ground and all good ones. The soil has worked much better since being drained by the blasting.

For this work I used farm powder. These holes I put down about three feet apart and used one-quarter pound of the farm powder per hole.

A few large, deep basins have been successfully drained by driving a well until a sandy or gravelly stratum or a stratum of rock with cracks in it is reached. Dynamiting to drain wet spots and basins with no outlets can only be successful in a type of soil where a well would also be successful. As it is much cheaper it is preferable where the sandy, gravelly or rock stratum with cracks in it is near enough the surface that the explosion would open up pass-ways to this stratum. Where clay subsoil extends down as far as the blast would affect the soil no permanent good can be expected from dynamiting and the blast must go below this clay to an easily pervious stratum to get the desired drainage. Then such holes should be filled with long poles, stump wood or other rubbish to keep the soil from running back together afterwards, making absolutely sure of a permanent drainage system.

New Mexico Fruit Shipments

The fruit season for the Pecos Valley, Roswell district of New Mexico, was on the whole a very successful one. About 150 cars of peaches were shipped out, chiefly to middle west and northern markets. Eight hundred and forty-one cars of apples were shipped and about thirty remain in local cold storage.

Jonathans started to move about August 20th and the entire crop was harvested by November 10th.

As usual the bulk of the crop was marketed in Texas, although some of the early Jonathans went to New York, and the middle west and Great Lakes territory took a larger percentage than in former years. Prices were good and orchardists will use greater care in packing and grading next year.

Peach Leaf Curl Tests.

The first of a series of leaf curl control tests has been made on the Oregon Agricultural college station farm by W. A. Smart, crop pest assistant. The purpose of the tests is to determine the best materials to use, and the best time of year to make the spray applications. November sprays are not recommended by the college at present, but applications in December, January and early February are safe. Former tests have shown that March is too late and that Bordeaux is superior to lime-sulphur for this disease.

GOOD SEEDS

**GOOD AS CAN BE GROWN
Prices Below All Others**

I will give a lot of new sorts free with every order I fill. Buy and test. Return if not O. K.—money refunded.

Big Catalog FREE

Over 700 illustrations of vegetables and flowers. Send yours and your neighbors' addresses.

R. H. SHUMWAY, Rockford, Ill.



YOUR party, dance, social or club session calls for refreshments—and there's one unfailingly successful beverage—Ghirardelli's. Creamy, delicious, fragrant—it's an instant favorite with or without cakes or sandwiches. Better than all, Ghirardelli's is made in a jiffy!

Never sold in bulk—but in cans only.
In ½ lb., 1 lb. and 3 lb. sealed cans—
at the store where you do your trading.

Say "Gear-ar-delly"

D. GHIRARDELLI CO. San Francisco

Since 1852 (F4)

GHIRARDELLI'S Ground Chocolate

We Supply Every SPRAYING DEMAND

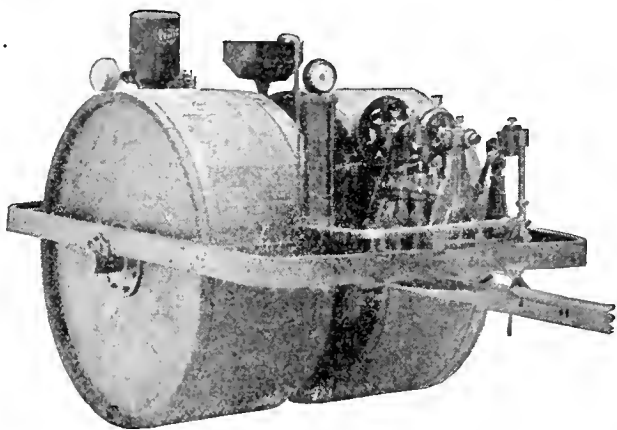

Bean Roller Power Sprayer

Manufactured by Bean Spray Pump Co. in their Lansing, Michigan factory for service in the sand dunes of Florida.

North, east, south, west—in this country or across the seas—

BEAN Power Sprayers are, each season, adding to an already favorable International reputation.

To build sprayers as good as they can be built and in construction and principle adapted to the specific needs of growers in certain sections is our aim, and in practice our accomplishment.

We have a sprayer for every need and in these days no grower can afford to grow fruit without Bean Equipping his orchard.

Write for our catalog today, describing the Bean line. It includes our new Simplicity outfit. If you have five acres or fifty you need a Bean sprayer. If your orchard is in South Africa or California there is a Bean fitted to your particular needs.

BEAN SPRAY PUMP CO.

318 West Julian St., San Jose, Cal. 39 Hosmer St., Lansing, Mich.

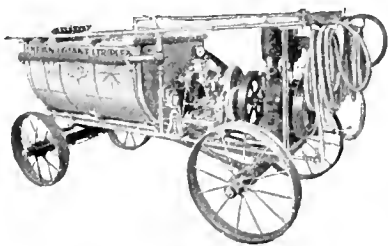

Bean Giant Triplex Sprayer



Bean Magic Spray Pump



Bean Little Giant Spray Pump

CLIP AND MAIL

Bean Spray Pump Co. 318 W. Julian St., San Jose, Cal.
Gentlemen: Without obligation to me send me
your catalog No. 33.
I have _____ acres of _____
Name _____
R.F.D. _____
Box _____



SULPHUR

It has been proven and so recommended by the University of California that if you sulphur your grape vines and orchards 6 times they will not be affected by MILDEW or RED SPIDERS.

ANCHOR Brand Velvet Flowers of Sulphur, also EAGLE Brand, Fleur de Soufre, packed in double sacks, are the fluffiest and PUREST sulphurs that money can buy; the best for vineyards; the best for bleaching purposes, LEAVING NO ASH.

VENTILATED Sublimed Sulphur—Impalpable Powder, 100% pure, in double sacks, for Dry Dusting and making Paste—Sulphur.

For LIME-SULPHUR SOLUTION use our DIAMOND "S" BRAND REFINED FLOUR SULPHUR.

To create additional available plant food, drill into the soil 100 to 400 pounds, per acre DIAMOND "S" BRAND POWDERED SULPHUR, 100% pure. This has increased various crops up to 500%. The sulphur may be applied broadcast by hand or with a duster, but usually an ordinary lead piester sower or lime spreader is used.

Also PREPARED DRY DUSTING MATERIALS, Tobacco Dust, Dry Bordeaux, Dusting Sulphur Mixtures, etc.

And Standard LIME-SULPHUR SOLUTION 33° BE, Fungicides and Insecticides.

Carried in stock and mixed to order.

San Francisco Sulphur Co.

624 California St.

San Francisco, Cal.

We are equipped to make immediate shipments. Send for "ILLUSTRATED BOOKLET"; also booklet "NEW USES FOR SULPHUR." Price-List, and Samples.

Please state for what purpose you use the sulphur, quantity needed, and date of shipment preferred.

The Orchard Business in Southern Indiana

From a Special Correspondent

THE possibilities of the orchard business in Southern Indiana are realized by only a few of our farmers, therefore it will be interesting to western fruit growers to know what can be accomplished in this industry here.

We have the available land, which will produce fruit, with the color and flavor, if given attention, as is shown by the number of premiums, our apple growers in Knox and Daviess County take each year at the Indiana State Apple Show.

We have in this section one of the best paying apple orchards in the State of Indiana, and perhaps in the United States. It belongs to Allen Harbin, and is located 7 miles from Washington, Ind. Mr. Harbin was not an experienced orchard man when he took this orchard over, some six years ago, but he observed from careful study the possibilities of this orchard, if given good care and attention. Part of this orchard was 40 years old, and part of it 22 years old, there being 8 acres of it, set with the Old Fashioned Winesaps and Mammoth Black Twig. The orchard had never been cared for, but was just allowed to grow. It had never been pruned or sprayed; so Mr. Harbin started by first cleaning it up, then pruning and spraying it. He cared for it according to the instructions of the Purdue University Bulletins, together with the hints and advice he could get from practical orchard men. Today he has a well cared for orchard, and one that is perhaps making him more clear money, than any other orchard of its size in the State of Indiana. This year he sold his apple crop for \$8,000 and his cost of pruning, spraying, spray materials, plowing, discing and the harvesting of the crop was \$2,400, leaving him a net profit of \$5,600 on 8 acres or \$700 per acre. What other crop will bring a net profit of anything like this?

Three years ago Mr. Harbin had a good crop of apples, but the price was not quite so high, yet his net profits per acre were \$450. Last year the crop was small, but he had a nice profit left, after all his expenses were paid.

Mr. Harbin is an apple grower that does not believe in doing things by halves; so three years ago he decided that in order to get the best results from spraying it would be necessary for him to get a power sprayer. He purchased one and has sprayed his orchard six or seven times each year since getting this spray pump, and his apples certainly show the effects of good spraying for they are 90% free from worms or disease. First, Mr. Harbin sprays in the fall for the scale after the leaves have dropped off and the trees are in the dormant stage, with a very strong solution of lime-sulphur. The next spray is for the scab and green aphid, applied just as the buds begin to turn pink, for this spray he uses lime-sulphur, arsenate of lead and Black Leaf 40, next he sprays after the petals fall with the lime-sulphur and arsenate of lead, to control the codling moth, late scab and curculio. In years favorable for scab infection, he puts on a follow-up spray ten days later, using lime-sulphur, arsenate of lead. The fourth summer spray is three weeks after the petals fall to control the blotch. This spray is repeated five weeks after the petals fall. The last spray is usually ten weeks after the petals fall for the second brood of codling moth.

In the fall of the year, before the weather gets too bad, Mr. Harbin plows his orchard to the depth of 4 to 6 inches and in the spring double discs it both ways, and harrows it twice, then he sows it in Red Clover, thus keeping as much moisture in the ground as possible. The appearance of his orchard

5 GREAT NOVELTIES
20 cts. The glorious crimson Woolflower recently introduced by us has succeeded everywhere and proved to be the most showy garden annual. Nothing can surpass the mass of bloom which it shows all Summer and Fall. We now have three new colors—pink, yellow and scarlet, as well as crimson. All these colors mixed. 20 cts. per pkt. With each order we send 1 trial pkt. each of Giant Kochia, most decorative foliage annual. *Salvia Hybrids*, white, pink, striped, scarlet, plumed, etc., mixed. *Japan Iris*, new hybrids, all colors. Magnificent. *Giant Centaurea*, superb for garden or vases. And our Big Catalog, all for 20 cts. Big Catalog, free. All flower and vegetable seeds, bulbs, plants and new berries. We grow the finest Gladioli, Dahlias, Cannas, Irises, Peonies, Perennials, Shrubs, Vines, Ferns, Peas, Asters, Fancies, etc. All special prize strains, and many sterling novelties. JOHN LEWIS CHILDS, Inc. Floral Park, N.Y.

"CARO" FIBRE FRUIT WRAPPERS

This is the Point

Chemically Treated "Caro" Protects "Caro" from DessiCARE (to dry up)

"Caro" Prolongs the Life of Fruit Why?

Fruit decomposition starts from a bruise which opens tiny holes and permits the juice to escape and BACTERIA to enter. "Caro" clings closely and dries up the escaping juice. "Caro" ingredients harden the spot, kill the BACTERIA, arrests the decomposition—and thus **PROLONGS THE LIFE OF FRUIT.** If your fruit is worth shipping it is worth keeping in best condition.

Demand "CARO"—Wrap Your Fruit in "CARO"—The Fruit Buyer Knows "CARO"

Order from Any Fruit Company or American Sales Agencies Co., 112 Market St., San Francisco

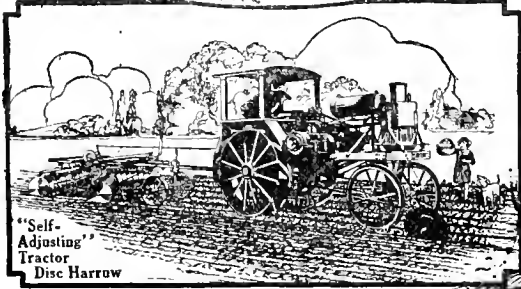
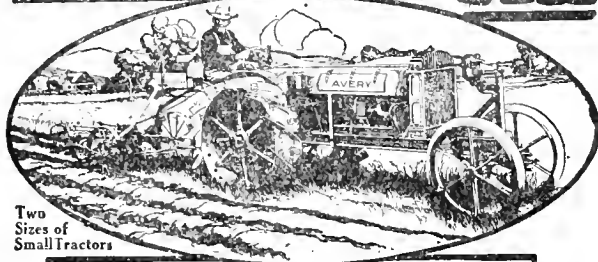
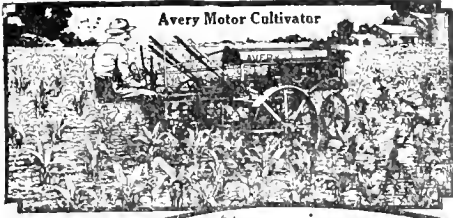

'Averyize' All Your Farm Work

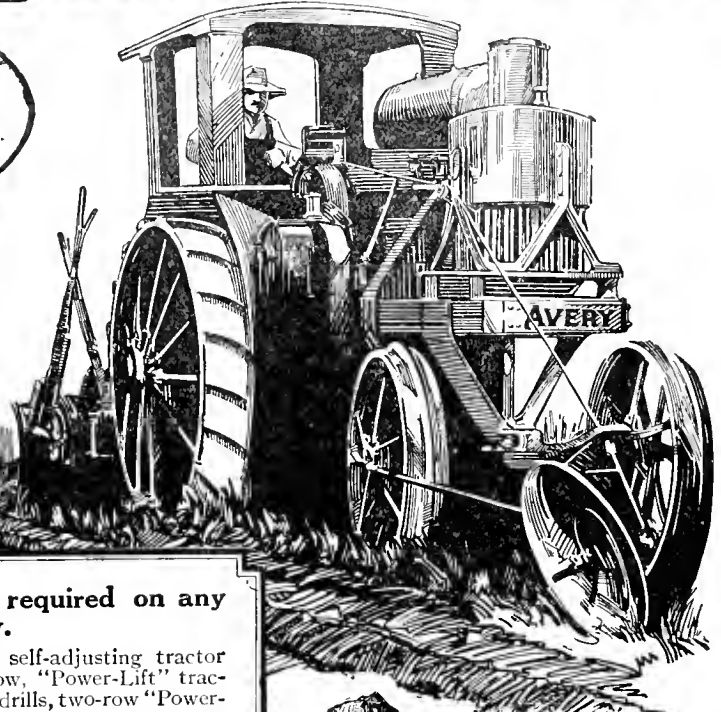

YOU can do all the power work required on any size farm with Avery Machinery.

The Avery Line for 1920 includes a four-cylinder 14-28 H. P. tractor in addition to the previous 8-16, 12-25, 18-36, 25-50 and 40-80 H. P. sizes.

—A new six-cylinder small tractor.

—A six-cylinder two-row motor cultivator, a new four-cylinder one-row motor cultivator.

—A new self-adjusting tractor disc harrow, "Power-Lift" tractor, grain drills, two-row "Power-Lift" listers.

—Light and heavy "Power-Lift" moldboard and disc plows for any size tractor.

—A complete line of roller bearing threshers, and

—A roller bearing silo filler.

It Pays to "AVERYIZE"

Avery machines are built simple—can be operated without previous experience. Avery prices are based upon large quantity production and the low selling cost of a complete line.

When you get an Avery you are assured of prompt and permanent service—backed by an organization with three large factories, many branches and satisfied customers in every State in the Union and 63 Foreign Countries.

Write for the Avery Catalog

and interesting Tractor "Hitch Book." Contains many valuable suggestions for the satisfactory operation of trac-

tors, tractor drawn tools and tractor driven machinery. Two books mailed free.

AVERY COMPANY, 10702 Iowa Street, Peoria, Illinois

FEENAUGHTY MACHINERY CO.

DISTRIBUTORS
PORTLAND, OREGON

AVERY

Motor Farming, Threshing and Road Building Machinery

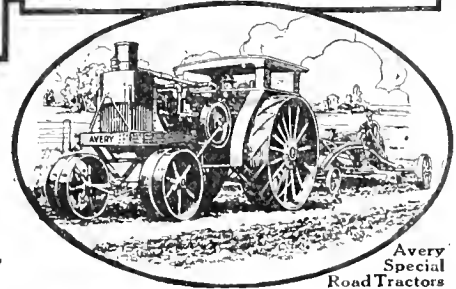
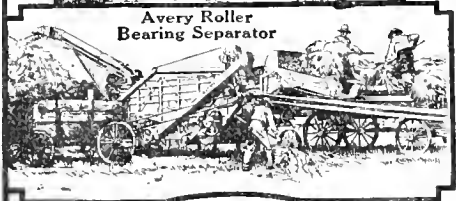

in the spring reminds one of a well-prepared garden.

Two years ago Mr. Harbin put three

tons of limestone per acre on this orchard, and last year he used 300 pounds of nitrate of soda per acre. This,

together with what barnyard manure is produced on the place is the fertilizer used. His trees have very heavy foliage this year and great vitality due to the fact that much fertilizer had been used. The frost last spring had very little effect on this orchard, while some of his neighbors, who do not spray, cultivate or take care of their orchards have not enough apples for their own use.

Had it rained in the early part of July this year Mr. Harbin's orchard would have produced possibly 300 barrels of apples more, on account of the increased size of the apples.

Mr. Harbin is not a young man, but is nearing 70 years of age, yet he looks after the general work of the orchard and directs his men what to do and when to do it. Mr. Harbin says that his only regret is that he is not 20 years younger, for he sees the possibilities of the orchard business.

DIAMOND QUALITY
SEEDS



For 1920 Plant Only The Best-

The increased cost of farming makes necessary the careful selection of seeds—improved varieties that produce profitable crops.

A Safe Guide to Quality and Fair Price

Our Seed Catalog and Planter's Guide is the standard reference for growers of the Northwest, listing our complete lines of Seeds, Trees and Plants, Fertilizers, Poultry and Bee Supplies, Sprays and Sprayers, Dairy Supplies and Equipment.

Agents

**"CORONA" Arsenate of Lead—
GOULDS SPRAY PUMPS—
SCALECIDE, Miscible Oil Spray—**
Spray Materials, Pruners and Orchard Supplies for every requirement.

Your Name should be on our Mailing List
ASK FOR CATALOG No 200

Offices and Salesroom
S.E. Cor.
Front and Yamhill
Sts.

PORTLAND SEED CO.
PORTLAND, OREGON TRADE MARK

Warehouse
East First
Alder
and
Second
Sts.

BELL & CO.

Incorporated

WHOLESALE

Fruits and Produce

110-112-114 Front Street
PORTLAND, OREGON

Write us what you have to offer—Car lots or less

APPLES - PEARS

Whole root stock that will give results

Send for Price-list No. 10

Trees - Shrubs - Vines - Plants

J. B. PILKINGTON

NURSERMAN

Portland Oregon

MUSICAL
MERCHANDISE
—
WRITE
US

WE SAVE YOU MONEY!
W. Martius Music House Inc.
1009 First Avenue, Seattle, Washington
Everything Known in Music

SHEET
MUSIC
—
WRITE
US

SIMONS, SHUTTLEWORTH & CO.
LIVERPOOL AND MANCHESTER

SIMONS, JACOBS & CO.
GLASGOW

GARCIA, JACOBS & CO.
LONDON

Agencies and Representatives in Every Important European Market

European Receivers of American Fruits

FOR MARKET INFORMATION ADDRESS

SIMONS, SHUTTLEWORTH & FRENCH CO.
204 Franklin Street, New York

SIMONS FRUIT CO.
Toronto and Montreal

SIMONS, SHUTTLEWORTH, WEBLING CO.
Board of Trade Building, Boston

OUR SPECIALTIES ARE APPLES AND PEARS

THE WORLD-
OUR ORCHARD

STEINHARDT & KELLY NEW YORK

UNQUESTIONABLY THE
MOST IMPORTANT FACTOR
IN THE DISTRIBUTION OF
THE COUNTRY'S FANCY
APPLES
AND OTHER FRUITS

OUR MARKET-
THE WORLD

The "Supreme Court

of Fruit World" Awards Wilder Medal to this Apple!

What the U. S. Supreme Court is to American law, the American Pomological Society is to American fruit.

This society (composed of the foremost fruit authorities of the entire United States), at its 1920 meeting gave to the Golden Delicious apple the highest award ever given by it to any fruit variety in its 75 years' history—the *only* Wilder Medal (see cut of medal below), with one exception, ever given to an apple during the last 25 years.

The Wilder Medal (provided for by a Trust Fund left by the late Marshall P. Wilder, who for 38 years was President of the American Pomological Society) is awarded only after exhaustive investigation and only after absolute proof of a fruit's supreme merit has been produced. It is the "Nobel Prize" of the fruit world—the

American Pomological Society's Highest Honor

And when this authoritative body has thus placed its stamp of approval on this apple, it means that this Golden Delicious apple is a truly great fruit achievement. To all who have been waiting to see the Golden Delicious "prove itself," here is indisputable proof. Here is the evidence of the esteem in which this Queen of all Golden Apples is held by the leading pomological experts, horticulturists and orchardists in all sections of America. It is assurance to you that you will profit by planting this great, glowing golden fruit.

Stark's Golden Delicious

Golden Delicious apples, actual size and natural coloring—bearing 18 months after top-grafting.

Highest
Award
—1920

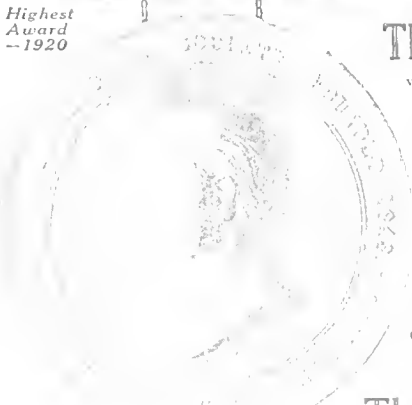

The Famous \$5,000 Golden Apple

which we discovered years ago flourishing and bearing bumper crops of finest apples, on a barren West Virginia mountainside. We immediately bought this remarkable tree for \$5,000—the highest price ever paid for a single tree and have for years propagated young Stark's Golden Delicious trees from "the wood" of this original tree.

The apples they bear are easily the finest yellow apple we have ever seen or eaten in all our 101 years of nursery and orcharding history. Superior to even Grimes' Golden in appearance, size, flavor and quality. Vastly superior in keeping quality—keep four months longer. All the Grimes' Golden demand long after that apple is rotted and gone from the markets. One of the leading members of the American Pomological Society, Prof. J. C. Whitten (for 25 years, Dean of Horticulture, Missouri Agricultural College, now Prof. of Horticulture and Forestry, University of California) writes:

"I have never eaten an apple coming out of storage this late (July 15th) which retained so fully its normal crisp, juicy condition as these Golden Delicious."

Orchardists and owners of home orchards everywhere are planting Stark's Golden Delicious this year.

We're Planting It by the Thousands in Our Own Orchards

Wilder
Medal

Members of our firm have carefully watched the Stark's Golden Delicious tree and its superb fruit in test orchard all across America. During this and last season we have made especially big plantings of this tree in our own personal orchards. In fact, it is the "backbone" of our own

commercial fruit-raising farms. That shows what we think of it! We are doing this because, like J. L. Webster, the well known Washington, Wash. grower, we know that "the Golden is not cheap. Keeping quality equal to old Winesap. Eating quality equal to Stark Delicious. It will surely excel in world's apple markets."

Learn All the Facts—Get Free Copy of "Prize Fruits"—Send Coupon TODAY

Whether you plan to plant only a few trees in a home orchard or a big commercial orchard, it's your duty to your pocket to get posted on Stark's Golden Delicious and all Stark Prize Fruits—Pears, Plums, Grapes, Cherries, Berries, Garden Fruits, etc.

Send your name and address on the coupon for a free copy of this year's big 75-page Catalog showing our Prize Fruit in Nature's own colorings. Do this today.

ADDRESS BOX 520

STARK BPO'S NURSERIES

104 Years of Nursery and Orcharding Experience

The Only Stark Nursery in Existence—at LOUISIANA, MO., Since 1816

Use the Coupon Today

Stark Bros. Prize Fruits Catalog

Stark Bros. Nurseries, Box 520, Louisiana, Mo.

If you take want our Free Tree Catalog, please check the appropriate box.

I have not yet ordered by forming you about Free Landscape Plants

I may want _____ trees this spring.

Name _____

Address _____

R. R. No. _____

Post Office _____

State _____

MAR 23 1920

BETTER FRUIT

VOLUME XIV

MARCH, 1920

NUMBER 9

FEATURES IN THIS ISSUE:

- Controlling Pear Scab
- Commercial Fertilizers
- The Currant and Gooseberry
- Pruning the Prune Tree
- Fruit Box Supply Serious

*Columbia Univ. Libr.
304-220*



PRODUCTS OF THE GARDEN AND BERRY PATCH

A reminder of the season soon to start for the cultivation of horticultural and other soil crops

20 Cents
The Single Copy

BETTER FRUIT PUBLISHING COMPANY, PUBLISHERS, PORTLAND, OREGON

Subscription \$2.00 per Year in the United States; Canada and Foreign, Including Postage, \$3.00, Payable in American Exchange

Practical Tractor Facts

THE 1920 "Ten-Twenty" that is going to outdistance all other tractors not only in the matter of nation-wide popular demand, but also in general satisfaction to the farmer, is the **Titan 10-20**.

In five years' time a great many thousands of Titan tractors have been manufactured at the great Milwaukee Works, the home of the Titan. Practically every one of these tractors is in use today. They are serving not only the farmers of America, but also thousands in Europe, rebuilding the dormant war-torn acres that are hungry for crops.

With so great a number of Titan 10-20's in active use — setting so many good examples to farmers in need of right power — it has been necessary to enlarge the manufacturing facilities to meet the rapidly developing demand for this most

Titan 10-20 Features

1. Wide friction-clutch pulley
2. Economy throttle governor
3. Adjustable drawbar
4. Safety fenders
5. Comfort platform
6. Sixteen-tool set
7. Free starting-instruction service

popular of popular tractors. The scene at the tractor plants is one of night-and-day activity, with 5,000 men on the job. It is probable that, by the time this notice appears, producing volume will have been increased sufficiently to enable you to get a **Titan 10-20** for early spring delivery *if your order is placed at once*.

There has been no increase in price. **Titan 10-20** is available for you at the 1920 price fixed last July — **\$1,000 cash, f. o. b. factory**. See your International dealer.

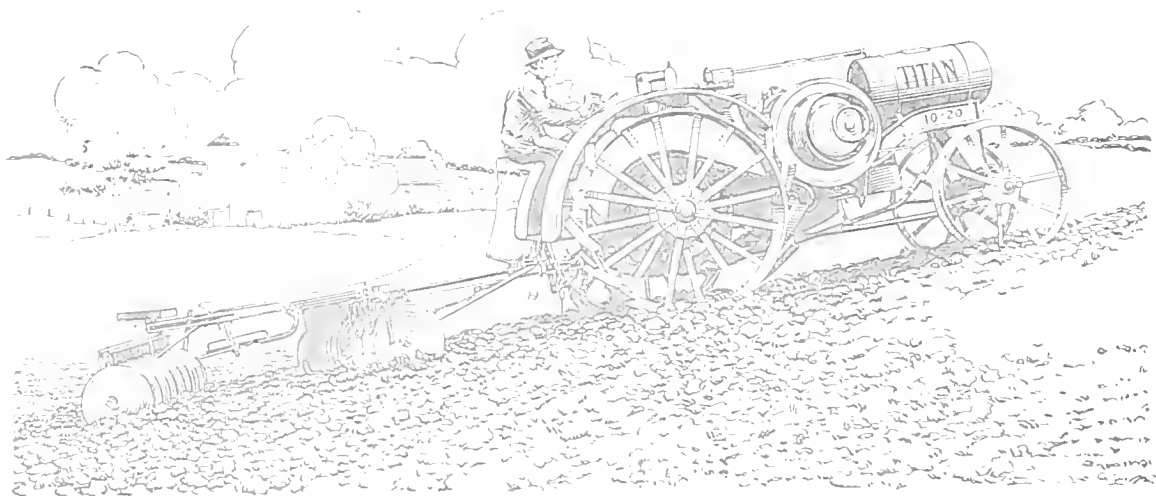

INTERNATIONAL HARVESTER COMPANY
OF AMERICA
(INCORPORATED)

Billings, Mont. Cheyenne, Wyo. Denver, Colo. Helena, Mon.
Los Angeles, Cal. Portland, Ore. Salt Lake City, Utah
San Francisco, Cal. Spokane, Wash.

America's Foremost Spraying Apparatus

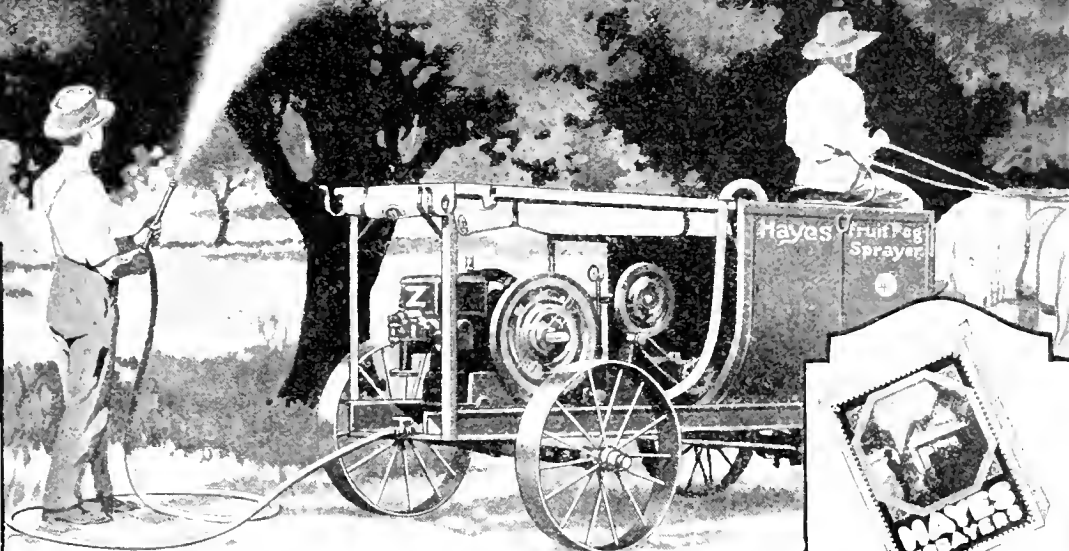

HAYES Fruit-Fog Gun

Send coupon for FREE BOOK and see why this is the World's fastest spraying apparatus. The only gun which combines great speed with the thoroughness of Fruit-Fog. One man handles capacity of big power sprayer. Does four days' work in one. Simple twist shoots long spray to top of tallest trees, or gives wide spray for close-up work, or shuts off tight and prevents waste of solution between trees. Mechanically perfect and fully guaranteed. Get the book for full details.

Hayes Hand Barrel Spray Pump



Hayes Platform Duplex Hand Sprayer

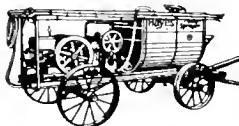

Hayes High Pressure Triplex Power Sprayer

Nation-Wide Service

Users of Hayes Power Sprayers are within only 24 hours of a service station at all times. In case of accident at a critical time this quick service may save your fruit crops. Hayes Power Sprayers, Engines & Repairs are distributed by

Fairbanks, Morse & Co.
Atlanta, Los Angeles, San Francisco
Denver, Jacksonville, Salt Lake City
Spokane, Portland, Seattle

We Also Maintain Stocks at
Flora Dale, Pa. Philadelphia
Kansas City Little Rock
Grand Rapids, Mich. Albany, N. Y.

Hayes Hand Sprayers are distributed by Hardware, Implement and Seed Jobbers.

Send for the Startling Story of Fruit-Fog Spraying!

FRUIT Growers and Farmers should beware of life-sucking, profit-stealing pests this year. Reports say their ravages are more terrible than ever before in some sections. Send the coupon for Big New FREE Book and Valuable Spraying Guide now. Get all the new facts on spraying before it is too late. Learn, for example, why Fruit-Fog—the vaporous super-spray—is the ONLY spray fine enough to penetrate into the microscopic niches in bark, buds and foliage—where millions of UNSEEN deadly pests hide—and where no coarse, heavy, low-pressure spray can reach. This explains why ordinary spraying often fails. Also why Fruit-Fog Spraying has been pronounced a phenomenal success by Experts, Experiment Stations and Fruit Growers everywhere. Fruit-Fog positive thoroughness is the direct reason for the big crops and big profits that have made Fruit-Fog Spraying famous. Send the coupon now.

HAYES FRUIT-FOG SPRAYERS

The Hayes scientifically atomized, fog-like spray is produced by Hayes guaranteed 300 lb. pressure and the scientific Hayes nozzle. Its vapory fineness gives Fruit-Fog remarkable adhering powers. No drops form—no solution wasted—no buds or leaves knocked off—as with coarse, heavy, low-pressure sprays.

Hayes Fruit-Fog sprayers are positively standardized in every part. They are skillfully made in a way that insures enduring service and greatest efficiency under high pressure.

To assure Hayes Fruit-Fog users the best possible engine service, we have selected the famous Fair-

banks-Morse "Z" Engine as standard equipment.

Sprayers for Every Purpose

There are Hayes Sprayers for Orchards, Gardens, Field Crops, Vineyard, Nurseries, Cemeteries, Greenhouses, Shade Trees, Potatoes, Cotton, Flowers, Alfalfa, Sugar-beets, Poultry and Hog Disinfecting, Whitewashing, Cold Water Painting and every other known use.

No matter what your sprayer needs, from our great Triplex Fruit-Fog Power Sprayer to the smallest Garden Atomizer, we make it.

Send the Coupon Today!

Tell us how many trees you want to spray and how old they are on the average. Also what other uses you have for your sprayer. We'll tell you where and how you can get the style of Hayes Sprayer best suited to your needs, and its price. We'll also send our Big New Book of Hayes Sprayers and Valuable Spraying Guide FREE. Send the coupon today.

HAYES PUMP & PLANTER COMPANY
Dept. K, GALVA, ILLINOIS

Send for Big Spraying Book FREE!

The book pictures and describes the Fifty Styles of Hayes Sprayers. Tells why the deadly pests that infest your Fruit, Potatoes, Hogs, Poultry, etc., cost you more each season than several Hayes Spraying Outfits. Proves that these destructive pests are costing American Farmers and Fruit Growers an appalling toll. Shows how thousands of owners of Hayes Sprayers have stopped these losses—and turned them into big profits. Send the coupon now and get the FREE BOOK.

Valuable Spraying Guide Also Sent FREE!

This Spraying Guide tells you, in simple, handy form, how to recognize and kill every known pest that infests every fruit and other crop, also every animal on your place. Tells what solution to use—how to mix it—how and when to apply it. Worth hundreds of dollars to any Farmer or Fruit Grower. Send the coupon and get your copy FREE.

Hayes Pump & Planter Co.
Dept. K, Galva, Ill.

Gentlemen:

Please send FREE and without obligation, your Big New Spraying Book and your Valuable Spraying Guide.

No. of trees _____ Average age _____

other uses _____

Name _____

P O _____

State _____

R. F. D. _____

SIMONS, SHUTTLEWORTH & CO.

LIVERPOOL AND MANCHESTER

SIMONS, JACOBS & CO.
GLASGOWGARCIA, JACOBS & CO.
LONDON

Agencies and Representatives in Every Important European Market

European Receivers of American Fruits

FOR MARKET INFORMATION ADDRESS

SIMONS, SHUTTLEWORTH & FRENCH CO.
204 Franklin Street, New YorkSIMONS FRUIT CO.
Toronto and MontrealSIMONS, SHUTTLEWORTH, WEBLING CO.
12 South Market Street, Boston

OUR SPECIALTIES ARE APPLES AND PEARS

Be On Guard with

"BLACK LEAF 40" for Aphis

Aphis is a serious menace to your orchard profits.

Don't forget that the best time to spray is when the Bud shows the Green Tip.

"BLACK LEAF 40" is a spraying solution that can be used as recommended in "combination sprays" — with Lime-Sulphur, Arsenate of Lead, Bordeaux Mixture.

"BLACK LEAF 40" is endorsed by Experiment Stations and Agricultural Colleges throughout the United States and Canada.

Universally conceded by growers to be the most effective and practical material for the control of Aphis, Thrips, Pear Psylla, Leaf Hopper, Woolly Aphis and other soft-bodied, sucking insects.

Write us today for our complete spray chart leaflet and bulletins.

Order your supply early from your dealer.

Manufactured by

Tobacco By-Products & Chemical Corporation

Incorporated

Successors to The Kentucky Tobacco Product Company

Louisville, Kentucky

Sulphur

It has been proven and so recommended by the University of California that if you sulphur your grape vines and orchards 6 times they will not be affected by MILDEW or RED SPIDERS.

ANCHOR Brand Velvet Flowers of Sulphur, also EAGLE Brand, Fleur de Soufre, packed in double sacks, are the fluffiest and PUREST sulphurs that money can buy; the best for

vineyards; the best for bleaching purposes, LEAVING NO ASH.

VENTILATED Sublimed Sulphur — Impalpable Powder, 100% pure, in double sacks, for Dry Dusting and making Paste Sulphur.

For LIME-SULPHUR SOLUTION, use our DIAMOND "S" BRAND REFINED FLOUR SULPHUR. We can furnish you this sulphur at such a low price that it would pay you to mix your own solution.

To create additional available plant food, drill into the soil 110 to 220 pounds per acre DIAMOND "S" BRAND POWDERED SULPHUR, 100% pure. This has increased various crops up to 500%.

Also PREPARED DRY DUSTING MATERIALS, Tobacco Dust, Dusting Sulphur Mixtures, etc., Fungicides and Insecticides, carried in stock and mixed to order.

SAN FRANCISCO SULPHUR COMPANY
624 California Street, San Francisco, Cal.

We are equipped to make immediate shipments. Send for "ILLUSTRATED BOOKLET"; also booklet "NEW USES FOR SULPHUR." Price-list and Samples.

Please state for what purpose you use the sulphur, quantity needed and date of shipment preferred.

Bing, Lambert, Royal Ann cherries, Bartlett pears, Italian prunes, Delicious, Winesap, Winter Banana apples, roses, dahlias, gladioli. Ask for bargain list.

Home Nursery Co.

Richland, Washington

Bees for Profit

Make big money with little work. Small expense to start. Bees find own food. Honey brings good prices. We buy all you can spare. Bees are easily kept and cared for

The Root Way

Our special hives give winter and summer protection. We've made complete line of Beekeepers' supplies for 50 years. Tell us your occupation and whether you keep bees now. This helps us help you. Handsome free booklet, "Bees for Pleasure and Profit," packed with beekeeping information. Write for it today.



THE A. I. ROOT COMPANY
515 Main Street Medina, Ohio

BETTER FRUIT

EDITOR: W. H. WALTON

STATE ASSOCIATE EDITORS

OREGON—C. I. Lewis, Horticulturist.
WASHINGTON—Dr. A. L. Melander, Entomologist,
O. M. Morris, Horticulturist, Pullman.
COLORADO—C. P. Gillette, Director and Entomologist;
E. B. House, Irrigation Expert, State Agricultural College,
Fort Collins.

ARIZONA—E. P. Taylor, Horticulturist, Tucson.
WISCONSIN—Dr. E. D. Ball, Madison.

MONTANA—H. Thornber, Victor.

CALIFORNIA—C. W. Woodworth, Entomologist, Berkeley;
W. H. Volek, Entomologist, Watsonville; Leon D.
Batchelor, Horticulturist, Riverside.

INDIANA—H. S. Jackson, Pathologist, Lafayette.

An Illustrated Magazine Devoted to the Interests
of Modern, Progressive Fruit Growing
and Marketing.

PUBLISHED MONTHLY BY

Better Fruit Publishing Company

703 Oregonian Building

PORTLAND, OREGON

All Communications should be addressed and
Remittances made payable to

BETTER FRUIT PUBLISHING COMPANY

SUBSCRIPTION PRICE:

In the United States, \$2.00 per year in advance,
Canada and Foreign, including postage, \$3.00,
payable in American exchange.

ADVERTISING RATES ON APPLICATION

Entered as second-class matter April 22, 1918,
at the Postoffice at Portland, Oregon, under
the Act of Congress of March 3, 1879.

VOLUME XIV

PORTLAND, OREGON, MARCH 1, 1920

NUMBER 9

Controlling Pear Scab in the Pacific Northwest

By D. F. Fisher, Assistant Pathologist, Fruit Disease Investigations
and E. J. Newcomer, Scientific Assistant, Deciduous Fruit Investigations, United States Department of Agriculture

[This article applies particularly to that part of the state of Washington west of the Cascade Mountains and to the Willamette Valley and the northwestern part of Oregon.]

THE culture of pears in that section of the Pacific Northwest located west of the Cascade Mountains has become an industry of rapidly increasing importance. In the Willamette Valley, Oregon, there is a large acreage of established commercial orchards, while a considerable planting of young orchards has been made both in this section and in the Puget Sound region of Western Washington, where older orchards are not so numerous. Pears thrive unusually well in these districts and have thus far not suffered from the pear blight scourge that has handicapped the culture of this fruit in other sections of the Pacific Northwest. Pear growing in these districts has also been greatly stimulated by the development of canning factories, which provide a ready outlet for a considerable portion of the crop.

The industry has, however, suffered severe loss and its development has been greatly handicapped by various insect pests, as well as by the prevalence of pear scab, a fungous disease. While spring and summer spraying of pears for the control of scab has been quite generally practiced, the results have often been disappointing, especially when spraying has not included an insecticide for the control of insects which cause a disfigurement that appears very much like scab spots when the pears are mature. It is the aim of this article to present to the orchardist information which will enable him to recognize and distinguish these troubles and to take the necessary measures for their control.

Pear Scab

Scab is the only fungous disease of importance occurring on pears in the region covered by this article.

Next to pear blight, scab is the most serious disease to which the pear is subject. While it is readily controlled by sprays it annually causes a heavy loss because of inattention to spraying, inefficient spraying materials, careless methods of application, or failure to spray

at the right time. The crop yield is frequently cut from 50 to 75 per cent, and unsprayed fruit is usually so unsightly that it is practically worthless for marketing. If greatly deformed it can not be disposed of even through the canneries.

Influence of Climatic Conditions—The economic importance of the disease varies greatly with the climatic condi-



FIGURE 1—Scab on a mature Bartlett pear from infection occurring early in the season.

tions. Where the climate is strictly arid and where pear growing is entirely dependent upon irrigation, scab is not found; but where humid conditions prevail and natural rainfall is depended upon for soil moisture, scab must be contended with. Thus, in the Pacific Northwest scab is entirely absent from the hot interior irrigated districts east of the Cascades, such as the Yakima and Wenatchee Valleys, where pear culture has been developed into an extensive industry, while west of the

Cascades every pear tree is subject to the attack. The natural limitation of the disease is due to moisture conditions.

Scab infection requires moisture on the surface of the susceptible parts, such as leaves, blossoms and fruit. Moreover, it requires the surface to be wet for about two days; mere dews or fogs followed by drying weather will not suffice, for although the spores may germinate, the subsequent drying kills the fungus before it has an opportunity to establish itself in the plant tissues. Frequent rains followed by muggy weather which does not permit the trees to dry create the most favorable condition for scab growth. This being true, it is to be expected that the severity of the disease will vary from year to year in accordance with the precipitation and that it will become more serious in seasons of prolonged rainfall, but be restricted during periods of drought.

The climate of Western Washington and Northwestern Oregon is peculiar in that the winters are very mild, with little snowfall but considerable rain. The spring is usually rainy, with some precipitation or fog during part of nearly every day. The summer, however, is prevailingly without rainy periods, with bright clear weather most of the time. With the coming of fall, however, rains begin again. Under such climatic conditions the greatest injury from pear scab occurs early in the spring, but late attacks of the fungus often occur on fruit that does not mature before the fall rains. The early infection of the fruit results in the greatest disfigurement (Figure 1), as well as often preventing a crop from setting; consequently, it causes more loss than later attacks. During the summer season scab infection is less likely to occur and is entirely dependent on chance periods of rainy weather.

Character of the Injury—Pear scab is a fungous disease that attacks the fruit, foliage, and twigs. The greatest damage is done to the fruit, on which it produces the sooty appearing spots so familiar to most orchardists. These spots are generally somewhat irregularly circular in outline, with a velvety-like ap-



FIGURE 2—Late infection of scab on a Bartlett pear and injury caused by the syneta leaf beetle. The elongated spots were produced by the beetle.

pearance, black or olive green in color. In size the spots range from mere specks to areas that may cover the entire side of a young pear, while two or more spots may coalesce and increase the extent of the affected area. When very young pears are affected they may drop before they become one-half inch in diameter. The fungus causing the disease grows just beneath the cuticle, which becomes ruptured, exposing the epidermis, which is rendered corky on exposure, thus forming a roughened spot. Its effect is strictly local at first and causes no discoloration or hardening of the flesh beneath; but as the pear grows the scab injury restricts the expansion of the fruit and causes it to become distorted in shape, a most objectionable feature. If the normal growth of the fruit is greatly distorted, cracks may be formed which extend halfway around the pear and almost to the core.

The infection of buds and blossoms on unsprayed trees is frequently severe and often results in a great reduction of the crop. Scab on the buds and blossoms is exhibited as dark, velvety, and sooty-appearing spots, much the same as on the young fruits, and infection may occur on any of the more exposed flower parts. Infection of the flower stalk is almost certain to prevent the fruit from setting.

Foliage infection frequently is not recognized by the orchardist, but it is one of the most serious manifestations of the disease. Infection occurs chiefly on the under side of the leaves and is exhibited as a dark olivaceous colored spot, similar to scab on the fruit. When many infections occur on a leaf it may become somewhat curled and deformed, and frequently it drops prematurely. If the defoliation is severe the tree is unable to function normally and can not store up the food requisite for the production of fruit buds and the maintenance of its own vitality; hence, the succeeding crop may be greatly affected. Foliage infection is also important as a means of carrying over the disease from year to year.

On tender twig growth scab first appears in the characteristic sooty spots, but persists over winter and eventually causes the bark to become ruptured, so that after a year or two the younger branches seem to be covered with small irregularly circular shaped and blister-like cankers. As the branch grows older these roughened areas slough off and healthy bark is formed over the injury. Twig infection is not as prevalent as the other types, but is likely to be found in neglected orchards. It is important chiefly as a source of infection for fruit and foliage.

The Fungus Causing the Disease—The fungus causing the disease is closely related to the well known apple scab fungus, but it is a different species. It persists over winter not only on the

able. These "summer spores" thus rapidly reproduced serve as a constant source of infection throughout the season, and the fungus becomes established. Spores matured on the twig cankers cause infection in the same manner or may be washed on to the fruit and foliage during rains.

The period of greatest infection is from the time the first buds appear until about a month after blossoming, or until summer weather is encountered. The cool, wet weather which usually prevails during this period constitutes the most favorable climatic condition for the growth and dissemination of the fungus, while the new pear growth is very tender, permitting scab infection to be easily established. Hot, dry weather is very unfavorable to scab and it does not thrive after the period of spring rains, but if a period of wet weather is encountered later in the season new infections will be formed. If infection occurs when the fruit is about mature, small scab spots are produced, but no distortion occurs. (Figure 2.) Frequently at this time the fungous growth occurs around the margins of earlier scab spots, so that these roughened areas are often seen surrounded by a fresh ring of dark velvety scab growth.

Treatment—In the treatment of pear scab it is important to dispose of all possible sources of infection, and to this end twig cankers, if present, should be removed in pruning and the infected wood burned. Some disposition should also be made of fallen leaves, which harbor the fungus over winter and which are the most important source of early spring infection. It is impracticable to rake and burn them, and



FIGURE 3—Power dusting machine in operation showing how the trees should be covered with dust.

twigs but also on the fallen leaves. Infected leaves remaining on the ground over winter permit the fungus to complete a stage in its life history. In the spring, at about the time the buds on the pear trees are breaking, "winter spores" are matured from the old scab spots on the fallen leaves. These spores are wafted about by the wind and lodge on the tender buds and foliage, and if the moisture which is necessary for their germination is present infection proceeds and a new scab spot is formed. This new scab spot produces "summer spores" with great rapidity, mature spores being formed within two weeks if weather conditions are favor-



FIGURE 4—A Bartlett pear twig, showing the condition of the buds at the time when the first scab spray or "delayed dormant" spray should be applied.

because of their fertilizing value it is not desirable, but early plowing should be practiced and the leaves all turned under before the buds break and expose the flower parts. Such sanitary measures are valuable in connection with subsequent spraying during the summer season, but in themselves are incapable of controlling the disease.

In spraying for pear scab as well as for other fungous diseases the fundamental point to be considered is that spraying is preventive and not curative in nature; that is, after infection has taken place and the fungus has established its growth in the host, it can not usually be eliminated by spraying. To be most effective the fungicides must be applied before infection takes place; the spray coating must be present before the spores reach the parts that may be infected. The action of such sprays is to inhibit the germination of the spores or to destroy the fungus before it can penetrate the cuticle.

To combat pear scab successfully requires, first of all, efficient fungicides as spray materials; second, thorough spraying, so as to cover all growing parts; and, third, properly timed applications to cover the requirements of the locality and the season. Bearing in mind the fact that scab infection must be anticipated and that the period of greatest infection is from the time the buds appear until about four weeks after blossoming, it is apparent that during this period the trees should be covered at all times with a protective spray coating. But since scab development

is dependent upon moisture conditions it is evident that the number of sprayings must vary with the season.

Among the most efficient fungicides against pear scab are two materials quite universally used, lime-sulphur solution and bordeaux mixture. Both may be purchased in convenient form on the market, but often may be more economically prepared at home. The former sometimes causes foliage injury, but at a dilution of 1 to 40 it is quite safe to use on pears. Bordeaux mixture is a somewhat stronger fungicide, but it frequently causes an objectionable russetting when applied to tender young fruits and is in less favor on this account. It is, however, very efficient in controlling pear scab. Sulphur, very finely divided, in the form of an impalpable powder and applied with a dusting machine (Figure 3), is also an efficient fungicide against pear scab, being much more satisfactory in this respect than the commercial bordeaux dusts that are now on the market.

These general statements concerning spray materials, as well as those which follow in regard to their application, are based upon a series of experimental tests carried out by the Office of Fruit Disease Investigations of the Bureau of Plant Industry during the seasons of 1915 to 1918, inclusive, at Vancouver, Clarke County, Washington, and at Salem, Marion County, Oregon. The results agree, however, rather closely with those previously obtained, and with well-established usage, in the humid Northeastern United States, especially in the Great Lakes region, where pear scab is very severe.

When to Spray for Pear Scab—Make the first application for pear scab before the cluster buds begin to separate (Figure 4), and about the time that the first white is seen in the flower buds, using a strong bordeaux mixture (4-4-50 is satisfactory) or lime-sulphur solution (testing 32° Baumé) diluted 1 to 20. This application is important in those orchards whose immediate past history reveals serious scab infection, especially if early plowing has not been resorted to to dispose of infected leaves on the ground or if twig cankers remain plentiful on the trees. This application is frequently very valuable when the weather continues rainy and when the fungus may obtain a foothold on the exposed leaves before the time for the next spraying. As the disease is brought under control and the orchard is maintained free from infection, it probably will be found that this application may be eliminated. A practice that has met with favor with some orchardists is to delay the application of dormant strength lime-sulphur solution (1 to 8) until this time, making what is known as a "delayed dormant" application. However, this procedure involves considerable danger of injury to advanced fruit buds, and can not be considered a safe practice, especially if the buds are pushing out rapidly. If the blister mite is present the "delayed dormant" spray is too late for the best results against this pest, and the strong lime-sulphur should be applied at the



FIGURE 5—A Bartlett pear twig showing the condition of the buds at the time when the second scab spray or the "pink" spray should be applied.



FIGURE 6—Bartlett pears, showing the condition of the fruit at the time when the third spray or calyx spray should be applied.

time it will be most beneficial against the blister mite, a separate fungicidal application being made for scab.

The second application (corresponding to the "pink" spray in the case of apples) should be made as soon as the buds are separated and showing white, which will be just before blossoming (Figure 5). Either bordeaux mixture (4-4-50) or lime-sulphur solution diluted 1½ to 50 should be used. At this time all of the outer flower parts are exposed and may be protected by spraying. The period for most effective spraying does not usually exceed three or four days. This is probably the most important single application, especially in a wet season, and should not under any circumstances be neglected, since infection of the flower stalks at this time is almost certain to cause the fruit to drop.

The third application, known as the "calyx spray," is also highly important and should be made as soon as the petals fall (Figure 6), using lime-sulphur diluted 1 to 40 instead of 1½ to 50. In practice it is best to begin spraying before the petals are all off, if a large acreage is to be covered, since the period for most efficient spraying sometimes does not exceed two or three days after the blossoms fall, depending on the weather conditions. By this time the young pears are fully exposed and must be protected. Infection at this time causes a serious stunting and distortion in the growth of the fruit. For the control of the syneta leaf beetle lead arsenate should be added to the fungi-

cide. Lead arsenate is valuable not only as an insecticide but in increasing the effectiveness of the fungicide.

A fourth application, in which the same fungicide is used and at the same strength as in the preceding application, should usually follow the "calyx spray" within ten days or two weeks, in order that the protection of the rapidly growing fruit may be continued. In a dry spring, however, this application is less important and may be omitted. Lead arsenate should again be added to the fungicide, to control chewing insects.

The last spray which is generally required should be applied about a month after the "calyx spray." Either lime-sulphur solution, diluted 1 to 40, or bordeaux mixture (3-3-50) may be used, but the latter is recommended for this application because of the tendency of sulphur sprays to cause injury to fruit and foliage when used during hot weather and intense sunlight. For summer pears, such as the Bartlett, no later spraying ordinarily is necessary in this region, but in the case of varieties that are not picked until after the fall rains begin it is essential to spray again before the rainy period is expected.

By systematically following the spraying schedule here described and concisely outlined in the table it has been possible to reduce the loss from pear scab to an amount almost negligible from a commercial standpoint as seen in Figure 7.

Insect Pests

There are several insects which cause a great deal of damage to pears in Western Washington and Oregon. The methods of controlling these insects vary, and it is therefore essential that the orchardist know what insect is damaging his trees or fruit before attempting to remedy the trouble. Otherwise he may be spending his time and trouble for nothing.

The table given with this article summarizes the control measures recom-

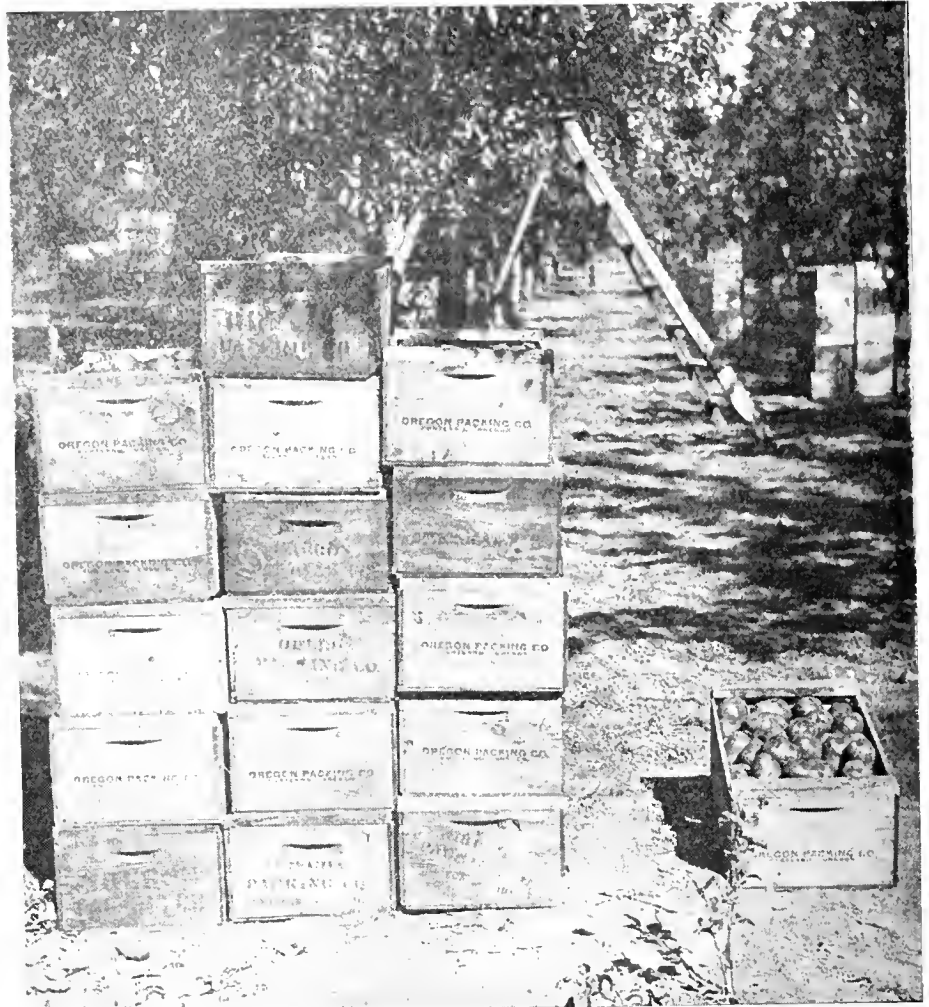

FIGURE 7—Sixteen boxes of clean pears and one box of scabby and injured pears from three sprayed trees. The injuries from scab and the syneta leaf beetle in the box shown were almost negligible from a commercial standpoint, the fruit suffering no discount at the cannery. In contrast to this, three unsprayed trees yielded nine boxes of clean pears and six boxes of scabby and injured pears. The injured fruit on the unsprayed trees was so bad that it was discounted one-third at the cannery.

mended for pear scab and insects for the coast regions of Washington and Oregon and shows when and with what materials to spray.

Since it is not always necessary to apply all of the five scab sprays or to

spray for all the insect pests mentioned, a distinction has been made in the table between the more important and the less important applications. The more important applications are printed in heavy type, namely, the dormant spray, the second scab spray, the third scab spray, and the fifth scab spray. The materials to be used and the pests controlled by these sprays are also indicated by heavy type. Under most conditions these four sprays should be applied to insure maximum returns from the trees, and it is believed that a consistent spraying program involving the use of these four applications will suffice in most cases. In orchards that have been neglected or carelessly sprayed it will be necessary to include the first scab spray until the disease is brought under better control, and in a wet season the fourth scab spray should also be included. The various insects whose names appear in light type are more numerous in some seasons than in others or occur more commonly in some localities than others. Hence local and seasonal conditions will have to determine whether or not they should be sprayed for.

SPRAYING SCHEDULE FOR PEARS IN WESTERN WASHINGTON AND OREGON.

<i>Application and Time</i>	<i>Materials</i>	<i>Pest Controlled</i>
Dormant spray. Apply when tree is dormant, preferably in spring.	Lime-sulphur, 32° Baumé, 1 to 8.....	San Jose scale and pear leaf blister mite.
First scab spray (delayed dormant). Apply when buds are bursting (Figure 5).	Lime-sulphur, 32° Baumé, 1 to 20, or Bordeaux mixture, 1-1-50. Lead arsenate, powder, 1 pound, or paste, 2 pounds, to 50 gallons of spray.	Pear scab. Bud moth.
Second scab spray (pink spray). Apply when blossom buds are well separated (Figure 6).	Lime-sulphur, 32° Baumé, 13 or 2 to 50, or Bordeaux mixture, 1-4-50. Lead arsenate, powder, 1 pound, or paste, 2 pounds, to 50 gallons of spray.	Pear scab. Bud moth.
Third scab spray (calyx spray). Apply as soon as most petals have fallen (Figure 7).	Lime-sulphur, 32° Baumé, 1 to 40... Lead arsenate, powder, 1 pound, or paste, 2 pounds, to 50 gallons of spray.	Pear scab. Syneta leaf beetle and pear leaf worm.
Fourth scab spray (10-day spray). Apply 10 days or two weeks after calyx spray.	Lime-sulphur, 32° Baumé, 1 to 40... Lead arsenate, powder, 1 pound, or paste, 2 pounds, to 50 gallons of spray.	Pear scab. Syneta leaf beetle and pear slug.
Fifth scab spray (30-day spray). Apply 30 days after calyx spray.	Bordeaux mixture, 3-3-5, or Lime-sulphur, 32° Baumé, 1 to 10. Lead arsenate, powder, 1 pound, or paste, 2 pounds, to 50 gallons of spray.	Pear scab. Pear slug.

Commercial Fertilizers for the Orchard and Garden

W. S. Thornber, Consulting Horticulturist

THE increased cost of orchard and garden operations during the past four years and the world-wide demand for increased production of food compels fruit men and gardeners to avail themselves of every possible opportunity to increase crop production to the maximum without seriously increasing the amount of labor necessary to produce additional crops, and at the same time not materially increase the cost of production.

Orchard and garden operations that will require an unusual increase in labor cannot be favorably looked upon by farmer folk this year. Increased production by other means than by increasing the number of laborers for the small farm must be the solution of the problem.

One or both of the following methods can be used to advantage in solving the problem. One is the use of power machinery or larger teams and the other is the use of commercial fertilizers.

The use of tractors or larger teams in orchard work will reduce the man labor to the minimum and in some cases one man will be able to do the work ordinarily done by several men and thus will increase production be possible by means of better and more thorough soil tillage and more timely operations. This can be worked to advantage in many gardens and orchards in the Pacific Northwest and especially in some of the larger orchards where cultivation has never been brought up to the highest possible practical degree. However, the greatest opportunity for increasing production at a minimum increase in cost and labor for the gardener and fruit grower lies in the use of commercial fertilizers.

The fruit growers and farmers of the West have long depended upon the plant food nature so abundantly gave them and entirely too many have failed to recognize the unmistakable signs of depleting soils and unprofitable crops.

Clean cultivation and dust mulches while excellent for the conservation of moisture plays havoc with humus and plant foods.

An average sized crop of fruit is more injurious to the soil than an average crop of wheat, in that while it does not necessarily take out more plant food, it leaves the soil exposed to the burning action of the sun during a long period of the season.

A few years ago our college specialists told us that there was enough plant food of certain kinds to produce bumper crops for the next century or two but that certain other plant foods must be fostered and conserved in every possible way or it would be impossible for us to maintain our present high standard of yields. Fortunately or otherwise this condition has already appeared in a large number of the older orchards of the Northwest and the problem is now how can it best be met at the present time without serious loss of crops or large financial expenditures.

The results of successful fruit growers in different parts of the Northwest point to one of three methods for at least temporary if not permanent solution.

Where large quantities of barnyard manure can be secured at a reasonable cost it can be used to advantage, in the long run; however, very few growers will be able to secure manure in sufficient quantities to replace the losses



View of raspberry patch at North Puyallup, Washington, on which was applied a commercial fertilizer containing nitrogen, phosphoric acid and potash in a concentrated form. The canes in this patch reached a height of eleven feet and the yield of berries was correspondingly heavy.

that have already taken place and furthermore the action of the manure will be too slow to be of immediate use for the coming crop. Eventually, if not at the present time, many fruit growers will find it economically advantageous to combine dairying or livestock projects with their fruit work.

In districts where there is an abundance of water for irrigation purposes nitrogen gathering crops can be used as cover and mulch crops in the orchard and the fertility of the soil be maintained at a small expense per acre. The action of these crops are very slow and not infrequently it is impossible to see results from their use before the

third or fourth year; nevertheless it is a good business proposition to make every possible use of these crops, even though it is necessary to supplement their actions with other more concentrated plant foods.

The use of commercial fertilizers is a new story to the Western fruit man. Nevertheless he will eventually adapt himself to their use just as he has to the spraying, pruning, cultivating, irrigating and thinning of fruit and in a comparatively short time the use of commercial fertilizers will be as common here as in other intensive agricultural sections. The fruit growers and gardeners long ago demonstrated their ability to adapt themselves to new and local conditions and chose methods, sprays, improved machinery and new varieties of fruit best fitted to their various localities, plans of management and marketing organizations, and when they realize the importance of keeping the chief elements of plant food in a balanced proportion in their soils in order to make it possible for the trees to produce profitable crops annually, large quantities of commercial fertilizers will be used.

Recent experiments and demonstrations prove beyond a doubt that it is just as important to provide a so-called balanced ration for the bearing fruit tree as it is for the dairy cow or the laying hen.

Undoubtedly many a fruit grower has seen his trees produce an abundance of water sprouts and wood growth for two or three years following a very heavy application of a rich nitrogenous coat of manure and possibly during the fourth and fifth years harvested good crops of fruit but failed to realize that his orchard so to speak has been out of balance. In other words the food provided had resulted in wood growth at the expense of fruit production and the trees had done the most natural thing in plant life and that is to produce wood when wood producing plant food was in excess of the food for a reasonable wood production and a crop of fruit. On the other hand, had these trees been supplied with a so-called balanced ration, profitable annual crops would have been the outcome, unless affected by late spring frosts or other unfavorable weather conditions.

It is also interesting to note that the fruit buds and blossoms on trees fed on a properly balanced ration will withstand injury from several degrees more of frost than trees either overfed or underfed under similar conditions. The writer had the opportunity last year to carefully observe during the spring frost the behavior of several varieties under test and it was especially evident in all varieties that the properly fed trees came through with very little if any loss while other trees lost all or nearly all of their fruit.

Just what fertilizer to use and how to apply it is a problem that must be

Continued on page 39.

The Currant and Gooseberry and How to Grow Them

By George M. Darrow, Office of Horticultural and Pomological Investigations, United States Department of Agriculture
(With acknowledgment to others)

BOTH currants and gooseberries are natives of cool, moist northern climates and in the United States succeed best in the northern half of the country and east of the one hundredth meridian. They are injured by the long hot summers of the Southern States, except in the higher altitudes of the Appalachian Mountains. Even in Missouri and Kansas they do not succeed very well. They are not adapted to the hot interior valleys of California, but are grown in the northern coast counties of that state.

Gooseberries are grown slightly farther south than currants and seem to endure the summer heat somewhat bet-

danger of that disease being spread to valuable forest areas.

The fruit worms, especially the currant maggot, are very serious pests on currants and gooseberries in the mountain and Pacific Coast states and have made the production of these fruits difficult in many sections there. The currant maggot, for which there is no known means of control, occurs also in some localities in the Eastern states.

Soil and Site for a Plantation.

The soil selected for the currant and the gooseberry should be cool, well drained, and fertile. The heavy types, such as silt or clay loams, are usually

rowing. Recently plowed sod land should not be used as a rule, because the sod will interfere with the setting of the plants and the management of the plantation until it becomes completely rotted. Sod land plowed early in the autumn and reseeded and harrowed the following spring will usually be in good condition for planting, as will land in a good state of fertility following a crop of potatoes, tomatoes, or some other hoed crop.

Propagation of the Plants

Plants of the varieties desired generally can be secured from reliable nurserymen at small cost, and this is a satisfactory way to obtain them either for the home fruit garden or for commercial plantings. They may be propagated in the home garden, however, by means of layers or cuttings.

Gooseberries ordinarily are propagated by mound layers. The plant from which layers are to be procured should be cut back heavily before it begins to grow in the spring. By July it will have sent out numerous vigorous shoots. It should then be mounded with earth half way to the tips of the shoots. By autumn the shoots will have rooted. Those with strong roots may then be cut off and set in the nursery, to be grown for one or two years before planting in the field. If the roots are not well developed, it will be better to leave the shoots attached to the parent plant for a second year. They will make strong root systems meanwhile, and then, if grown for a year in the nursery, after being cut from the parent plant they will be satisfactory for planting. The latter method is more common in the case of European varieties, which do not root so readily as American sorts.

A few varieties of gooseberries are propagated more easily by cuttings than by layers. Those varieties which are of European parentage are generally the most difficult to propagate by cuttings. American sorts vary greatly in this respect, however. Thus, cuttings of the Houghton variety root readily, while those of the Downing do not. Two new and as yet little known varieties, the Poorman and the Van Fleet, are easily propagated by cuttings. If cuttings are used, they should be of the current season's growth and about eight inches long, and they should be handled in accordance with the directions given below for currant cuttings.

Currants are propagated almost entirely by means of cuttings made from vigorous shoots of the current season's growth. In the Eastern states cuttings are made about eight inches long and in the Pacific Coast regions from ten to twelve inches long. They are usually cut in the autumn after the leaves have dropped and may be set in the nursery row immediately, or buried in sand with the bottom end up, or stored until spring in a cellar cool enough to keep them dormant and moist enough to pre-



Branch of the Golden Prolific variety of currant, which is a native of Western Kansas and Oklahoma and Eastern Colorado. The fruit of this currant is golden in color, and like some of the black varieties, must be picked singly, as they do not ripen at the same time. Varieties of this species are very productive under proper soil and climatic conditions.

ter. More spraying, however, is necessary to keep the foliage of currants and gooseberries in a healthy condition in the southern part of their range than in the northern part.

Currants and gooseberries are very hardy and withstand extremely low temperatures; in fact, if windbreaks are provided, most varieties are able to withstand the severe conditions in most parts of the upper Mississippi Valley and the northern Great Plains area.

In the region west of the one hundredth meridian limited rainfall restricts their culture materially, except in irrigated sections and in comparatively small areas in Northern California, the Willamette Valley, and the Puget Sound region.

Four factors limit the growing of currants and gooseberries in the United States: The white-pine blister rust, the currant maggot, the lack of moisture, and the heat of summer.

The blister rust makes it necessary to eradicate currant and gooseberry plants already growing and to prevent new plantings wherever the white pine is an important forest tree and there is

better in these respects than sandy soils. Neither fruit will do well on land where water stands during any part of the year.

In regions toward the southern limit of their culture it is best to select a northern or northeastern slope, in order to give some protection from the sun. The north side of a building may be selected when only a few plants are to be grown for home use.

A place with good air drainage is preferred for gooseberries. In low, damp places mildew attacks both fruit and foliage more severely than on higher sites where the air circulation is better. Currants, however, are seldom severely attacked by mildew. Therefore, when the site is a sloping one, currants may be planted on the lower parts and gooseberries above. As both fruits blossom very early in the spring, neither should be planted in low pockets where late spring frosts may kill the flowers.

Preparation of the Soil

Before planting the soil should be prepared as for garden crops. This includes deep plowing and thorough har-

vent drying, but not so moist as to cause mold to develop on them. The cuttings may also be made during the winter or in early spring. In the latter case they are put in the nursery at once. The cuttings should be set from three to six inches apart in the nursery row, with the soil firmly packed about them. This is done as early in the spring as the soil can be worked, whether the cuttings are made in the autumn or later. Not more than two buds should be left above the ground. At the end of one or two seasons they should make plants satisfactory for setting in the field. All the new wood is removed each year to make cuttings.

Time to Plant

In most sections plants may be set either in the autumn or spring, but in Northern Iowa and Nebraska and the states north of them only spring planting should be practiced. Both currants and gooseberries start growth very early in the spring, and if nursery stock can be secured in the autumn that season is preferred for planting except in the section just mentioned. In order that the roots may be thoroughly established in the soil before winter, the plants should be set as early as it is possible to obtain them in a dormant condition. Currants may be planted as early as the middle of September in the Northern states, except as noted above, and gooseberries as early as October 1. It is often difficult, however, to purchase plants for autumn setting.

Distance to Plant

The distance between the rows depends on the method of tillage. If a one-horse cultivator is to be used, the rows should be set six feet apart, while for a two-horse cultivator the rows should be eight feet apart.

The distance between the plants in the rows depends to a considerable extent on the variety. If the bushes are of a variety that does not grow large, they may be set as close as four feet, while if the bushes are naturally large when fully grown or the ground is very rich five or six feet apart is preferred. The bushes of the Wilder, London, and some other red currants and of all black currants grow larger than those of the Perfection, Fay, and Red Cross varieties and should be set farther apart in the row. Therefore, if in any section Red Cross bushes are commonly set five feet apart in the row the Wilder bushes should be at least six feet apart.

The Downing, Houghton, Oregon, and Poorman gooseberries have larger bushes than most others. They may be set four or five feet apart in soil of ordinary fertility, but in very fertile soil they will need to be six or seven feet apart. Gooseberry bushes of European parentage usually do not grow as large as those mentioned, which are believed to be at least partly of American ancestry, and it is rarely necessary to set them more than five feet apart.

Directions for Planting

Before planting, all broken roots should be cut off and the top cut back to stand about six inches above the

ground. If the plants have especially strong root systems the tops may be left ten to twelve inches high. The plants should be set somewhat deeper than they stood in the nursery. If they do not branch naturally near the surface of the ground, they should be set so deep that the lowest branch starts just below the surface of the soil. This will cause them to take the form of a bush instead of a small tree.

The soil must be packed firmly about the roots with the foot as the plants are set. Without such packing the roots may dry out and the plants die.

In friable soils, such as fine sandy loams, the hole for planting may be made by forcing a spade straight down and then pressing it forward. The roots are thrust into this hole, the spade withdrawn, and the soil firmed about them. Plants can be set very rapidly in this manner. In heavy soils holes may have to be dug with a spade before planting.

be used, and very little hand hoeing will be necessary. If they are set so that the cultivator can be run in one direction only and the rows are seven or eight feet apart, a horse hoe may be used. This is easily guided, and if used in connection with the cultivator will reduce the amount of hand labor very considerably.

A mulch of straw or wild hay is sometimes advised for currants and gooseberries. It conserves moisture, keeps down weeds, and takes the place of tillage. Mice are likely to multiply in mulched fields, however, and girdle the plants; in fact, the injury from this source is so often serious that growers rarely use a mulch.

Interplanting and Intercropping

Gooseberries and currants frequently are interplanted in orchards or vineyards.



A plant of the May Duke gooseberry grown in New York. This gooseberry, which has large dark red fruit, is recommended by the New York Agricultural Experiment Station as the best early gooseberry of European parentage.

The cost is then much greater than by the former method, but unless the holes are dug the clay may harden about the roots so that the plants will never grow well.

Tillage and Mulching

Tillage should begin soon after the plants have been set and should be continued at frequent intervals throughout the growing season or until a green-manure crop is planted. The tillage should be deeper the first year than later.

Both currants and gooseberries usually are shallow rooted, and care must be taken not to injure the roots in tillage. If a cultivator is run rather deep the first year the roots may be made to grow somewhat deeper than they otherwise would. The first spring cultivation should be deeper than later ones. Growers sometimes use a plow at this time.

If plants are set five or more feet apart each way a horse cultivator may

When interplanted in cherry orchards gooseberries and currants may be left for several years, according to the growth of the orchard and the size of the bushes; and in apple and pear orchards they may be left somewhat longer, though the ground occupied should be restricted to one or two rows of bushes through the center of the space between the tree rows. Otherwise, the bushes will be likely to interfere with the proper care of the trees. In vineyards the currants and gooseberries are often made a part of the permanent plantation, but while they are commonly productive when so grown, the grapes are likely to be rather unproductive.

In gardens where the available land is limited in extent, currants and gooseberries may well be planted among the tree fruits and left there permanently. The shade of the trees protects the fruits from sun scald, and the foliage is usually healthier in such locations

than when grown where it is freely exposed to the sun. The shade afforded by the fruit trees will be especially beneficial in southern sections, and the currants and gooseberries should be even more productive than if planted by themselves.

When currants and gooseberries are not grown in orchards they may be intercropped for the first two years; that is, vegetables may be grown between the plants in the rows and between the rows. Lettuce, early potatoes, early cabbage, and other early crops requiring intensive cultivation are especially desirable for this purpose. The thorough tillage required by the vegetables is also needed by the berry plants, and the intercrop will often pay for all expenses connected with the care of the plantation.

Maintenance of Fertility

Both the currant and the gooseberry respond well to the use of fertilizers, even when planted on fertile soils.



A 32-quart crate of Perfection currants ready for market as packed in the East. A large, bright crimson, slightly subacid berry, with compact clusters, long stems easy to pick. This variety is considered the best for many parts of the Northwest.

Their use, however, is governed by the same principles that apply to other crops. The kinds and quantities of the different plant foods that can profitably be used depend on the physical condition of the soil and the plant foods already available in it. The needs in any particular case can be determined only by applying the different plant foods separately and in different combinations to different parts of the plantation and noting the results. Thus, while stable manure and wood ashes can be used in liberal quantities and will generally prove profitable, each grower must determine for himself the amounts that will give the best results on his soil. In like manner the kind and quantities of commercial fertilizer to be used must be determined.

In places where a supply is available, 10 to 20 tons of stable manure per acre each year may be found profitable, and some successful growers use even larger quantities. Many use hen manure. Larger quantities of this may

be applied safely to gooseberry plantations than to currants.

In many sections green manure or cover crops may be used to keep up the humus supply. The seed is sown or drilled in between the rows early enough to allow good growth before winter, and the crop is plowed under early the following spring. If this practice is followed, less stable manure or commercial fertilizer will be needed. The green manure crops should be those best adapted to local conditions. Preferably, however, they should consist of legumes or a combination of legumes and non-leguminous plants.

Pruning the Bushes

Currants and gooseberries naturally form bushes with many branches which start out near the surface of the ground. Too many branches are usually formed. Pruning in a new plantation consists in removing the superfluous ones. It is only rarely that the branches are headed back. The prun-

ing just enough one-year-old shoots to take their places. Pruning, therefore, in effect is a process of renewal.

In pruning varieties of spreading growth the outer and lower shoots generally should be removed, as these branches are likely to droop to the ground and the fruit borne on them be covered with dirt. Varieties of very erect growth, on the other hand, should be thinned by the removal of the central shoots.

Black currants bear well on one-year-old wood. In pruning them wood that has borne two years should be removed and new wood left to replace it. Most, if not all, black varieties have an erect habit of growth, and the bushes should be thinned by removing some of the central canes. From six to eight branches are usually left on each plant. Within certain limits the heavier the pruning the larger and better the fruit, yet care is necessary not to go to extremes.

The general principles of currant pruning apply also to gooseberries. The fruit is produced on one-year-old wood and one-year-old spurs of older wood. Pruning consists in removing branches after they have borne fruit for two years and allowing new shoots to replace them. On the Pacific Coast, however, the practice is to allow a branch to fruit for three years before removing it. It is said in that region that the canes are most productive the third year, after which they should be removed. If the side shoots become too numerous, enough of them should be cul out to form a fairly open head. Branches which have borne heavily tend to droop, and these, as well as all other drooping branches, should be removed.

Plantations of gooseberries trained to the tree form, where all the branches start from a main stem at a height of one or two feet above the ground, have been comparatively unproductive in the United States. As the bush form, where all the branches start from the root at or just below the surface of the ground, is more productive, and as the gooseberry naturally grows in that form, it is the only one discussed here.

Yields of Fruit

The currant as a rule bears abundant annual crops. Good plantations in full bearing should yield not less than 100 bushels per acre, annually. Yields of 300 bushels per acre are exceptional, but have been recorded. Good plantations of gooseberries of European parentage should yield at least 100 bushels per acre. Those of American or partly American parentage are generally more productive and yields of 300 bushels per acre are not unknown. European varieties, however, usually sell for much higher prices than American varieties.

Bushes in gardens usually receive more intensive cultivation than those in large plantations and therefore yield more as a rule. Currant bushes under garden conditions often yield from five to ten quarts each and gooseberries even more.

Continued on page 38.

Bean Spray Pumps

have always been

dependable

—always efficient

—always durable

—always economical

They represent today more than ever before the grower's surest means to a better crop and resultant better profits. Our catalog recites many reasons why "The Bean is the Best."

Learn about these and other Bean features:

- Bean Pressure Regulator**
- Bean Threadless Ball Valves**
- Bean Porcelain Lined Cylinders**

Our new Simplicity Sprayers are now ready. Ask about them! Mail the coupon today!

Bean Spray Pump Co.

418 West Julian Street, San Jose, California
49 Hosmer Street, Lansing, Michigan

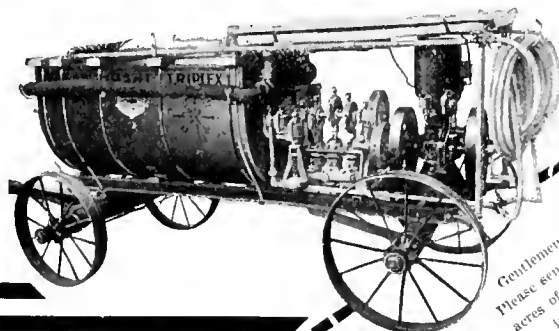

CLIP AND MAIL.
 BEAN SPRAY PUMP CO.
 418 W. Julian St., San Jose, Cal.

Gentlemen:
 Please send me a copy of your catalog. I have
 acres of _____ I am especially interested
 in Hand Pumps _____
 Accessories _____
 NAME _____
 ADDRESS _____

Setting, Pruning and Cultivating the Prune Tree

A Brief Summary On the Subject from Expert Sources

IN setting prune trees, severe pruning of the roots should be avoided and except where the roots have been mangled in removal from the nursery or in shipment it is not good practice to do much root trimming. As mangled roots are liable to engender the growth of fungus they should be removed. Great care, however, should be exercised in preserving the tap root from severe cutting.

In a recent bulletin on the subject of pruning young prune trees as well as apples, cherries, pears and European plums, Prof. Warren P. Tuffis, of the Agricultural Experiment Station of the

University of California at Berkeley, summarizes as follows:

1. The nursery tree should be cut at planting at a height of 20 to 24 inches above the ground.
2. The young trees should receive a coat of whitewash soon after planting to prevent sunburn on the trunk.
3. During April the orchard should be carefully pruned, the three main scaffold branches being selected and all undesirable growths pinched back.
4. At the first dormant pruning the trees should be thinned to the three main branches, properly placed, and

these limbs cut back so that they will be from 15 to 30 inches or more long.

5. During May of the second summer the trees are in the orchard, all unnecessary growth should be "thinned out." If the trees are making a vigorous growth, a "heading back" of the secondary scaffold branches, in addition to the thinning process may be given. Under favorable conditions, this practice will result in the securing of the usual second and third year's shaping during the second season.

6. With the exception of all varieties of the sweet cherry and of certain varieties of the other fruits of this group, the pruning out given during the second dormant season will consist of a thinning out only. "Heading back" one-year branches, under most conditions and in many varieties of apples, pears, European plums and prunes, will have a decided tendency towards forcing all new shoot growth to arise from near the pruning cuts. On the other hand, if these same branches are not cut back, the new shoots, except in certain varieties, will be well distributed up and down the previous year's growth. Notable exceptions to this rule are the Spitzenburg apple, Lincoln pear and the Pond plum, which follow the habit of the sweet cherry, in that new shoot growth arises from the tip of one-year wood whether this has or has not been headed.

7. The same pruning that is outlined for the end of the second growing season should be given during the third dormant season and until the trees come into bearing. Prunes and European plums may be expected to come into bearing somewhat sooner than apples and pears. The latter fruits in general, bearing sooner than cherries. The question of variety plays a most important role in determining the age at which a certain fruit may be expected to bear profitably. For example, the Wagener apple is noted for its precocious fruiting while the Northern Spy is notoriously slow in reaching productivity.

8. Trees in this group, as above designated, may be expected to reach a profitable bearing age during the fourth to eighth season and should thereafter be handled as full bearing trees.

9. All the above discussion presupposes good solid conditions and careful cultural treatment.

In writing on successful cultural methods for bearing prune trees Professor C. I. Lewis says:

"The man who is getting the best results, practices thorough tillage, tills early, keeps up the fertility of the ground and above all prunes annually. Unless a prune tree receives annual pruning, consistent, regular bearing cannot be expected. Unpruned trees will have many off years. Strong buds, blossoms which set well, and large

Continued on page 37.

CONSULTING HORTICULTURIST

PROFESSOR W. S. THORNBUR

Formerly

HEAD OF THE DEPARTMENT OF HORTICULTURE
AND LANDSCAPE GARDENING

Later

DIRECTOR OF THE EXTENSION SERVICE
OF THE
STATE COLLEGE OF WASHINGTON

WILL ADVISE with fruit-growers upon all horticultural problems, including selection and preparation of orchard lands; propagation and care of nursery stock; planting and care of young orchards and small fruit plantations; the control of codling moth, San Jose scale, blight and other orchard pests; the preparation of lime-sulphur at home and the mixing of other sprays; economical orchard management; the irrigation and fertilization of orchard lands; the use of cover-crops and grass mulches; the pruning of fruit trees, shade trees, shrubs, bushes and vines; the renovation of old or neglected orchards, top-working or replacing of poor or unprofitable trees, and the examining and the working out of practical management plans for large orchards and orchard companies.

If your orchard has not been a financial success, and you wish to determine its possibilities or you wish to improve your orchard, reduce your losses and increase your returns I will assist you in working out your problem.

WRITE FOR TERMS

W. S. THORNBUR
LEWISTON, IDAHO

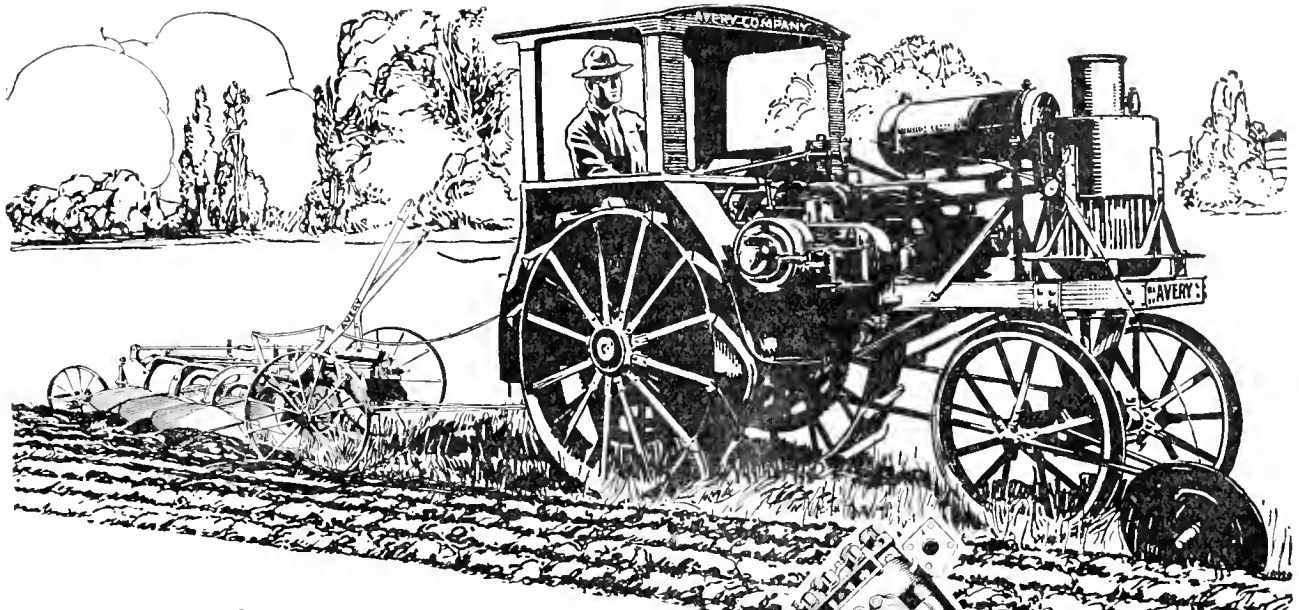

Averys Are the Tractors with the "Draft-Horse" Motor and "Direct-Drive" Transmission

WHEN you get an Avery, you get a tractor with a motor especially built for tractor work, and exclusively for Avery Tractors. It is built like a draft-horse for the kind of work a tractor must do. *Powerful, heavy duty, low speed*—does not race under light loads or stall under heavy pulls.

It is a horizontal opposed motor improved and perfected with many exclusive Avery features. Its length distributes the weight properly between the front and rear wheels. Its narrow width makes possible a narrower tractor with less side draft. Also a short heavy, practically unbreakable crankshaft—requires only two main bearings—always in perfect alignment—quickly adjustable with an ordinary socket wrench.

It is built with five-ring pistons, thermo-siphon cooling system, valves-in-the-head, renewable inner cylinder walls, and gasifiers that turn the kerosene or distillate into gas and burn it all.

Because of its low speed the power of the Avery "Draft-Horse" Motor is delivered through

The Avery Patented Sliding Frame Transmission

giving "Direct-Drive" in high, low, reverse, or in the belt. The belt pulley is mounted right on the motor crankshaft. You get a larger percentage of the power developed by the Avery "Draft-Horse" Motor at the drawbar, and *all* the power in the belt.

These and other big features make Avery Tractors run steady, economically and last a long time. These are some of the reasons why Avery owners are buying their second, third, fourth and even sixth Avery Tractors. They are easy to operate, even by the inexperienced. Avery prices are based upon the big output of three large Avery factories and the low selling cost of the complete Avery Line.

The Avery Line

includes tractors for every size farm. Six sizes, 8-16 to 40-80 H. P., with "Draft-Horse" Motors and "Direct-Drive" Transmissions. Two small tractors, Six-Cylinder Model "C" and 5-10 H. P. Model "B." One and two row Motor Cultivators, "Self-Lift" Moldboard and Disc Plows, Listers and Grain Drills, "Self-Adjusting" Tractor Disc Harrows. Also roller bearing Threshers, Silo Fillers, etc.

Write for the Avery Catalog and interesting Tractor "Hitch Book." Both books *free*.

AVERY COMPANY, 10703 Iowa St., Peoria, Illinois
FEENAUGHTY MACHINERY CO., Distributors, Portland, Oregon

AVERY

Motor Farming, Threshing
and Road Building Machinery

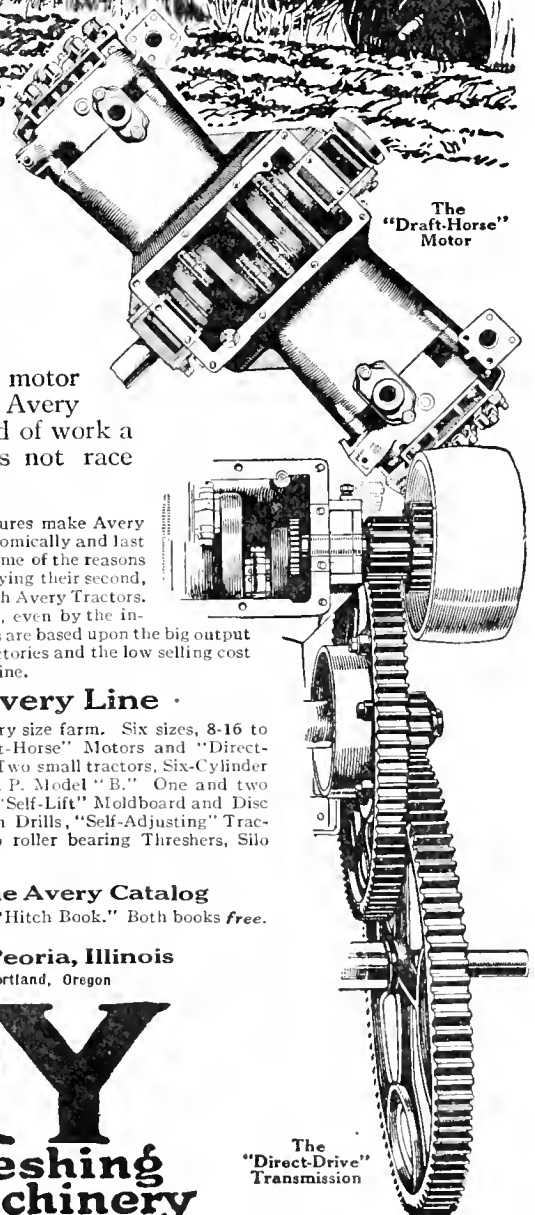

The "Draft-Horse" Motor

The "Direct-Drive" Transmission

Fruit Box Supply for 1920 Reported Serious

By Shad O. Krantz

ON account of the comparatively better prices for lumber, material that ordinarily goes into box shooks will be cut into other stock this year unless the fruit packers of the Northwest awaken to the situation that is confronting them and order their boxes early, was the statement made at the recent meeting of the West Coast Lumbermen's Association held in Portland.

Market conditions as influenced by demands of the fruit industry furnished the principal topic of discussion at the meeting. The proposal to change specifications on certain standard boxes so as to permit the use of two-piece ends was presented and while the meeting went on record as favoring the manufacture of cannery cases and fruit boxes with one or two piece ends and sides and two or three piece tops and bottoms, it did not make any definite agreement as to the exact style of box that would be manufactured. It is expected that this question will be brought before the association at some future date for final determination.

As temporary chairman George M. Cornwall, editor of the *Timberman*, pointed out to the box manufacturers their responsibility in helping to maintain the growth of the fruit industry on the Pacific Coast by providing sufficient box material, while E. E. Young, of the California Peach Growers' Supply Company, who was elected permanent chairman declared that owing to the lumber shortage and apparently permanent car shortage it will be necessary for the box manufacturers to exert early efforts to meet the requirements of the box-using trade.

At the suggestion of the chairman, G. M. Calef, of the Liberty Box Company of Tacoma, discussed the competition of the fibre container. Mr. Calef advised the meeting that the Carnation Milk Products Company now is using fibre packages extensively in its

domestic trade, but that in his own experience he had learned that buyers almost invariably prefer the wood box; substitution of the fibre container is due to difference in price, only, he added.

W. C. Geddes of the Oregon Lumber Company reported the recent establishment of a fibre box plant at Ogden, Utah—the center of the canning industry in that state. This industry, he said, formerly used 7,000,000 feet of box shooks annually. In 1919 at least 10 per cent of these requirements were furnished in fibre and he anticipated that even a greater proportion of fibre will be used this year.

In 1919, he explained, the two-pound fibre case sold at \$11.90 per 100, delivered in Utah, which was substantially lower than wood boxes could be sold for. He enumerated the objections raised by the trade against the fibre container and reported on the new fibre box made of waterproof material.

C. M. Crego of the Western Pine Manufacturing Company of Spokane, declared that fibre will not materially affect the large volume of shook business available. He suggested that ultimately waste from the box factories may be used in producing fibre containers.

George E. Chaffee of the Lumber Products, Ltd., Vancouver, B. C., outlined the conditions under which the British Columbia box manufacturers operate, advising the volume of their local market and how they have urged upon growers to take delivery of fruit boxes beginning in December, 1919, and continuing at the manufacturer's option until June and later. This practice has been established satisfactorily by British Columbia operators and will forestall the possibility of a very large shortage of containers for handling the fruit crop of that district. Apple boxes there are now selling at 26c delivered, or 24c F. O. B. mill.

G. A. Parkins of the Brooks-Scanlon Lumber Co., of Bend, Oregon, said his plant, which cut 15,000,000 feet into box shooks in 1919 was operating very light on account of low and greatly broken lumber stocks. He said that the average cost of converting lumber into shooks ranges from \$11.35 to \$13.00 per 1,000 shook footage. With Mr. Parkins leading the discussion and various members participating, it was found that the waste of conversion ranges from 10% to 20% of the lumber utilized, which with the manufacturing costs and value of lumber, brought the cost of shook production from \$50 to \$60, depending on the grade of lumber utilized.

J. L. Reeder of the California Peach Growers, Fresno, California, spoke of the large and growing demand for all classes of fresh and dried fruit packages and vegetable crates in the California markets. He stated that the present consumption of box shook in the state of California approximates 550,000,000 feet per annum, while the increased acreage now set and rapidly coming into bearing would increase this consumption to approximately 800,000,000 feet within five years; he stated in the Fresno district there are 50,000 acres of peach orchards, with 10,000 to 15,000 added acres coming into bearing within the next few years. There are 200,000 acres of raisins and shipments in 1919, approximated 35,000 tons of peaches and 200,000 tons of raisins. The fig crop in the Fresno district is rapidly increasing and will be ten times as large as at present within a comparative short time. The approximate acreage of figs at present is from five to ten thousand and there is now being planted 14,000 additional acres. In four years the fig acreage will be from 20,000 to 25,000. The raisin and peach crops in the Fresno district consumed 30,000,000 feet of box shooks during 1919. This district requires 3,000,000 drying trays and approximately 1,000,000 sweat-boxes per annum.

Continued on page 36.

**"CARO"
FIBRE
FRUIT
WRAPPERS**

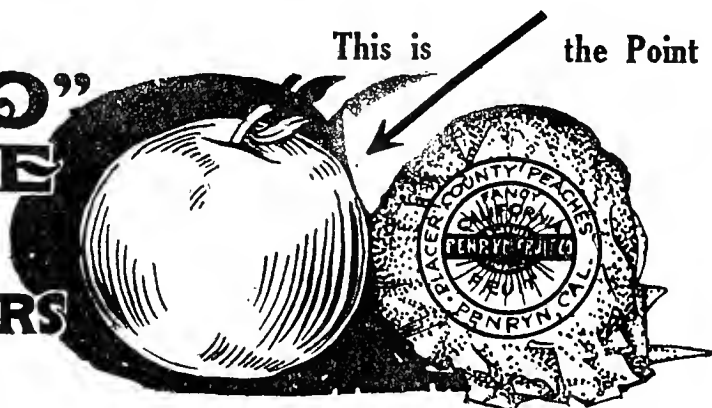

**Chemically Treated
"Caro" Protects
"Caro" from DessiCARE (to dry up)**

**"Caro"
Prolongs the
Life of Fruit
Why?**

Fruit decomposition starts from a bruise which opens tiny holes and permits the juice to escape and BACTERIA to enter. "Caro" clings closely and dries up the escaping juice. "Caro" ingredients harden the spot, kill the BACTERIA, arrests the decomposition—and thus **PROLONGS THE LIFE OF FRUIT**. If your fruit is worth shipping it is worth keeping in best condition.

Demand "CARO"—Wrap Your Fruit in "CARO"—The Fruit Buyer Knows "CARO"

Order from Any Fruit Company or American Sales Agencies Co., 112 Market St., San Francisco

"Sixty Cents a Can for Bartlett Pears"

By Frank T. Swett of the California Pear Growers' Association

"Sixty cents for a can of Bartlett pears. Good night!" So said Jones to the grocery clerk. "What's the idea? I used to buy the same brand for thirty."

Jones is a successful business man of San Francisco. Mrs. Jones has 'phoned his office that afternoon, "Company for supper; we haven't a bit of fruit in the apartment; it's too late to order; now, Dearie, call in at Goldberg? Bowen grocery and bring home a can of nice Bartlett pears."

Jones is a man who wants to be shown. He asked the clerk "What's the reason of this raise?"

"Why, Mr. Jones, don't you read the papers?" Senator Browne of Los Angeles, Mrs. Cleverdon of Berkeley, Secretary Connelly of the Grocers' Association, and a whole bunch of mayors are agreed that the farmers are profiteering on us city guys; and wicked Weinstock has organized them into terrible trusts to sting the consumer!"

"Believe me," said Jones, "I'm going to investigate," as he jumped into his Pierce-Arrow and sped home to the apartment.

The next day he talked with a banker on that painfully popular theme, High Cost of Living.

"Inflated currency, diminishing dollar, excessive demand for all foods, restricted production of commodities due to the strike habit—the customary aftermath of all big wars," said the banker. "Mark Sullivan said it in *Colliers Weekly* in his remark that the 'dollar should be renamed and designated a 'dollarlette.'" We're all trading in fifty-cent dollars. Now, Jones, your sixty-cent can of pears is really a merely old-fashioned thirty cents.

"This is too abstract for me," said Jones. So he asked a prominent canner who recently announced in a financial letter to the press that canners had all made phenomenal profits this season; but now that it had all been sold the price was really too high and that the remedy next year would be to pay the fruit growers less for their fruit. "Growers must not expect such exorbitant prices next season." The canner told Jones all about higher cannery labor costs, etc., but said nothing about higher costs on the farm.

But Jones was thorough. He had been told at second hand, about farmers' combinations. He wanted to beard one in its den. He bravely ventured into the office of the Pear Growers' Association.

The retailer had passed the buck to the "farmers' combine"; the canner had followed suit. The mayor and supervisors of the city that presents gold plates to the Irish president had emphatically berated the far-off farmer. Was this solution correct?

Secretary Hamilton was at his desk. Said Jones, "I'm going to ask some important questions. While I'm making double the money I used to, it takes it about all to live comfortably. Shoes,

clothes, nurses, housemaids, rent, theater tickets, all have gone up; and it's most aggravating to have to pay more for food."

"Why did the grocer charge me sixty cents for those pears? Why don't your association sell the fruit cheaper to the canner? I'm afraid the growers are profiteering. Defend yourself if you can!"

"All right," said the secretary. "Let's analyze your sixty cents." "When you paid, you laid on the counter a four-bit piece and a dime. What did the grower get from the four-bit piece? Not one penny! The grower got the dime. Out of that dime he paid for a whole year's work in the orchard, taxes, irrigation, spraying, plowing, tractors, compensation insurance, spray materials, distillate, housing for employees.

"The owner and his family lived and worked on only four pennies of your dime. Six cents he paid out for employees and orchard expense.

"If the philanthropic grower could afford to work for nothing and board himself, then pears might sell four cents cheaper, or fifty-six cents. Now Mr. Jones, if you are looking for profiteering, will you seek it in the grower's four cents, or in the other fifty-six cents? Without your dime, production would stop short."

"You surprise me," responded Jones. "I can hardly credit your data."

"Here are the facts," said Hamilton. "The Association sold 14,000 tons to canners at \$85 a ton. A ton will make from 37 to 40 cases of canned pears, or considerably more than 850 cans. At 10 cents a can this is \$85."

"The deuce you say," said Jones. "I don't begrudge the dime, for I realize the production must continue. But where did my four-bits go?"

"That went for canners' boxes, freight, stevedores, deck hands, coal miners, oil men, draymen, cold storage in cannery, wages that are three times as high as formerly, in high freight rates on sugar, perhaps hauled in the ships that made Mayor Rolph a millionaire, for tin and labels and cannery cases, higher wages in lumber camps, rent, clerk hire and delivery for the retailer.

"The canner sold the case of 24 cans for \$8.50. When retailed the same case cost consumers \$14.40. Each can carried a burden of 25 cents in its trip from the canner's warehouse to the consumer, or a total of \$6. When the grocer took your can from the shelf and handed it over the counter, his 20 per cent earned in two minutes, cost you twelve cents, more than the original grower's price on the pears."

"Robbers," said Jones. "Wait," said Hamilton, "doesn't Mrs. Jones usually telephone the store and have goods delivered at your apartment and charged? The grocer's price is set according to customary expense and not by the exceptional occasions when patrons pay cash and carry home. The grocer is

**BEST SERVICE-
QUALITY & PRICES**



PERFECTION IN
FRUIT
LABELS

THE
SIMPSON & DOELLER CO.

1423-24 NORTHWESTERN BANK BLDG.
PORTLAND, OREGON.

E. SHELLEY MORGAN
NORTHWESTERN MANAGER

WE CARRY—AND CAN SHIP IN 24
HOURS—STOCK LABELS FOR PEARS,
APPLES, CHERRIES & STRAWBERRIES.

lucky if he nets 4 per cent after all expenses are paid."

"Just one more question," said Jones. "How about the expense of this Association; isn't it just one more expense between producer and consumer? What does this cost, and who pays it?"

"It came out of your dime," said Hamilton. "In 1919 the business of 450 growers, producing about half the pears of California, was handled at an average cost, not of 20 per cent, not of 10 per cent, nor of 5 per cent; but the almost microscopic and infinitesimally small charge of two-thirds of one per cent on the growers' whole output.

"Canners used to have scores of buyers in the field at an expense of \$1.50 to \$2.50 a ton for the fruit purchased. This needless expense is practically eliminated. One man, the manager of the Association, does all the selling, at minimum expense.

"And furthermore, out of the Association charge to growers of ninety cents a ton on the canned pears, there is provision for inspection, shipment, billing, collection, and remitting the grower, and included also adequate financial insurance. This is credit indemnity insurance. Should a cannery fail to pay the Association, the American Credit Indemnity Company pays, just like fire insurance."

"You astonish me," said Jones. How do you get by so cheap?"

"Because this is modern, scientific, cooperative marketing. We have had the assistance in organizing of a man who is one of California's most success-

ful merchants, a man who has studied marketing the world over, a man who has done more to encourage food production and to stimulate California agriculture than all others put together—State Market Commissioner, Colonel Weinstock.”

UNQUESTIONABLY—

Modern methods applied to fruit growing have made the Northwest a great fruit growing center, with possibilities of extensive development.

Modern methods applied to banking have made the FIRST NATIONAL BANK pre-eminently the ally of the horticulturist. Its facilities, service and the personal interest of its officers are at your disposal.

THE FIRST NATIONAL BANK
OF PORTLAND OREGON
THE FIRST NATIONAL BANK WEST
OF THE ROCKY MOUNTAINS

STRAWBERRY PLANTS

Everbearing, bear this year. Superb and Americus, \$2.50 per 100, \$5.00 per 250, postpaid. Catalog free.

CANYON HOME NURSERY
F. I. Moffet Ellensburg, Wash.

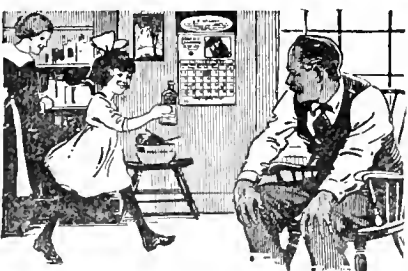

“That’s Relief for My Rheumatic Aches”

SLOAN’S LINIMENT is an effective counter-irritant that penetrates to the affected part, without rubbing, scatters the congestion, and promotes a warm, comfortable relief. Try it when your “bones ache” and you feel you “can hardly stand up any longer.”

For more than 38 years Sloan’s Liniment has been used by the families of the nation in quickly relieving rheumatic aches, lumbago, neuralgia, sciatica, lame, sore, strained muscles, bruises and other pains and sprains.

Put up in convenient bottles in three sizes—the larger the bottle the greater the economy. 35c., 70c., \$1.40.

Sloan’s
Liniment
Keep it handy

“But don’t associations stifle competition?”

“On the contrary, they encourage competition of a new kind—constructive, not destructive. Speculation is lessened or eliminated. The grower encouraged, bends every energy in competing with his neighbors for better quality and increased production. New fields and orchard lands are cleared and planted. You consumers want more to eat. Better methods mean better crops. Better spraying and cultivating means better quality. Maximum production means reasonable prices.”

“This Association has directors’ meetings monthly. In winter and spring these meetings are held in the different fruit districts. Growers attend; last week 69 growers of Santa Rosa met our directors from other sections and a day was spent in planning, with the assistance of scientific experts, better cultivations and spraying methods. This means increased production of better fruit for you, Mr. Consumer.”

“In a few years, California, instead of 100,000 tons of pears, will produce 300,000 tons. Does that sound good to you?”

“Have we hampered canning and drying by Association prices? No. This season the greatest pack of pears on record, over 30,000 tons, was canned. Twice the usual tonnage was dried. Practically none went to waste.”

“The smallest canner can buy his

little supply, perhaps only 40 tons, at the same price and of the same quality as the buyer who buys 5000 tons. Does this encourage him to put up a full pack? I guess yes.

“One canner, who had ordered 400 tons before we named a price, upon being notified of the price on June 2, came to the office the next day. ‘Increase my order to 900 tons—your price is reasonable, and we are going to strain every effort to put up a larger pack than ever before.’”

“We marketed this year \$1,100,000 of pears, without the loss of one cent in bad accounts. Canners have dealt with us squarely and honorably.”

“We have stabilized the Eastern markets for fresh pears by diverting the surplus, which formerly used to bring about a regular disastrous slump in August, to driers and canners.”

“We are a group of 450 growers pulling harmoniously together, trying to serve faithfully both producer, manufacturer, and consumer. We’ve made a good beginning in our first two years. We can do more and better work in future years. Other growers’ associations are working along similar lines.”

“I’m glad I called,” said Jones. “Next time I hear earnest but misguided and ignorant politicians roasting the producer and his marketing associations I’ll call has bluff and demand less eloquence but more facts.”

And he departed, feeling better.

More Apple Storage Needed in Northwest

IF big losses are to be avoided in the marketing of the Northwestern apple crop, growers will be forced to give greater attention to equipping their properties with up-to-date storage houses than they have heretofore, says the Bureau of Markets, United States Department of Agriculture.

Because of increased production and an acute shortage of refrigerator cars last season, growers in the Northwest were unable to move their apples to market and thousands of boxes of fruit were caught unprotected in the orchards by an early freeze, while other fruit remained on the trees and was frozen because there was no place to store it.

Since 1900 the production of apples in the Northwest has increased enormously, until last year Washington, Oregon, and Idaho, with the help of Montana and Colorado, produced over one-quarter of the total crop of the United States, and with new acreage coming into bearing it is likely that the Northwest in a few years will be producing a much greater part of the country’s total crop.

Under present conditions it is impossible for the railroads to move the crop to market during the harvest season. And the growers with existing scarcity of labor can not grade, pack, and prepare the crop for market in a period of two or three months. This situation has brought home to growers the necessity of providing better storage facilities in the producing districts.

In response to many inquiries for information on storage houses, the Bureau of Markets, United States Department of Agriculture, has sent a specialist to the Northwest to assist growers and shippers in the planning and construction of common storage houses. The bureau points out that it is not enough to build a storage house, but that it must be built right, or the apples will not keep. Investigations have shown that much money has been wasted through improper construction of houses.

“Too often the grower builds by rule of thumb,” says the bureau, “and does not consider that a storage house must be built like a thermos bottle—to keep heat in when the weather is cold and out when it is warm. Houses must be well insulated and ventilated. Almost invariably apple storages fall short of actual requirements in ventilation. Small ventilators are used when large ones could be supplied at little more or no more expense, and the large ventilators would add 50 per cent to the efficiency of the storage house.”

The special bureau representative now in the Northwest is supplied with working drawings of storage houses that have been tested during the past five years, and is prepared to assist personally growers who expect to build during the spring and summer. His headquarters will be at the branch office of the Bureau of Markets, Yakima, Washington.

Canners Celebrate Centenary of Canning

By Frank Gorrell, Secretary National Canners' Association

THE National Canners' Association recently celebrated the centenary of canning at their annual meeting which was held at Cleveland, Ohio, at which there were in attendance several thousand members. The growth of the canning industry, which is carried on in the United States on a larger scale than in any other country in the world has been remarkable.

Canned food was unknown on this continent until one hundred years ago Ezra Daggett and Thomas Kensett of New York, succeeded in canning or packing in a crude way salmon, lobsters and oysters. Meanwhile, in Boston, William Underwood and Charles Mitchell, using heat, which we now call sterilization, in 1820 succeeded in packing some damsons, quinces, cranberries and currants.

Credit for the discovery of the method of keeping perishable food by heat and sealing in air tight containers, however, belongs to a Frenchman, Nicholas Appert. Appert, stimulated by an offer from Napoleon of 12,000 francs to anyone who would discover a method of conserving fresh food so that he could improve the diet of his troops, after fifteen years of experimenting, in 1810, discovered the method of using heat to preserve food in sealed jars. Appert, however, never understood the scientific basis of his discovery, nor did succeeding canners have any clear idea of why the process worked, until after the great bacteriologist, Louis Pasteur, discovered bacteria.

Using Pasteur's discovery, Prof. H. L. Russell of the University of Wisconsin, in 1895 found that the spoilage certain pea canners were having was due to bacteria which resisted their process and that higher temperature of sterilization was necessary. Professor Russell's experiments were confirmed in 1896 by Professors Prescott and Underwood of the Massachusetts Institute of Technology.

In 1840, Baltimore began the canning of oysters and in 1841 Maine started its sardine industry. It was not, however, until 1856 that canning began on the Pacific Coast. The first canning factory in the center of the country was established in 1860 for feeding troops in the Civil War.

More than three billion cans of food canned under modern American methods, were used to feed our own troops in the American Expeditionary Forces. It is largely due to the American canning industry that American diet can follow the flag wherever our soldiers and sailors protect our rights, or wherever American pioneers blaze new trails for American activities.

To the improvements developed by modern canning science every family owes its ability to get succulent food the year around; to have fish far from the fishing banks, to enjoy meats away from production and to have milk for adults and especially the babies in cow-



TOP DRESSING TALKS, No. 5

Which Source of Nitrogen is Best?

The advantages of Arcadian Sulphate of Ammonia are:

High Production: Pound for pound of nitrogen, *Arcadian Sulphate of Ammonia* will produce as much crop or more than any other nitrogenous top-dressing. It's dependable.

High Concentration: *Arcadian Sulphate of Ammonia* contains one-third more nitrogen than any other top-dressing. This lowers cost of handling, hauling and storing.

Quick Availability: *Arcadian Sulphate of Ammonia* acts quickly. The moisture in the soil immediately dissolves the crystals. In many cases a change in color of the foliage of plants has been noted within three days after application.

Non-Leaching: The ammonia is absorbed by the organic matter and by other soil constituents, and is not easily washed out, even from the lightest soils. It is made available by the same conditions of warmth and moisture that cause plant growth, and this acts as a reservoir of plant food in the soil, yielding a regular supply of nitrogen as it is needed.

Fine Mechanical Condition: The crystals of *Arcadian* are fine and dry. There is no appreciable absorption of moisture and it does not cake into hard lumps. This makes application easy and assures even distribution by hand or machine. No labor is required for grinding or screening.

These with other important advantages, including low price, make *Arcadian* the supreme top-dressing fertilizer. As a feeder of plants, it is *quick, enduring and satisfying*.

Write for bulletins on the proper use of

ARCADIAN

Sulphate of Ammonia

Sulphate of Ammonia is the well known standard article that has done you good service in your mixed fertilizers for years past.

Arcadian is the kiln-dried and screened grade, made fine and dry for top-dressing purposes. Ammonia 25 1/4% guaranteed. Made in U. S. A. It is "The Great American Ammoniate."

FOR SALE BY

CALIFORNIA: *San Francisco*, Hawaiian Fertilizer Co., Pacific Bone Coal & Fertilizing Co., Pacific Guano & Fertilizer Co., Western Meat Co., California Fertilizer Works; *Los Angeles*, Pacific Guano & Fertilizer Co., Pacific Bone Coal & Fertilizing Co., Agricultural Chemical Works, Hauser Packing Co., Hawaiian Fertilizer Co., Ltd., Southern California Fertilizer Co. OREGON: *Portland*, Swift and Co.

For information as to application, write

The *Barrett* Company

Agricultural Department

510 First National Bank Building, Berkeley, Cal.

less country, or when blizzards block the milk trains to our cities.

Even more important is the fact that through canning the plenteous fruits and vegetables of harvest seasons; the great catches from our fishing banks during spring, summer and fall; the juicy meat of the grazing season and the flood of summer milk can be held over for winter use when production is interrupted or lessened.

In addition to feeding our own population, Frank Gerber, of Fremont, Michigan, president of the National Canners' Association, feels that there will be a tremendous demand from all parts of the world for American perish-

able foods. Much of this demand Mr. Gerber believes can be supplied only if the canning industry exercises every effort to put under seal all fruit and vegetables not needed for immediate consumption.

Joining with the National Canners' Association in this convention were the National Canned Foods and Dried Fruit Brokers' Association, and the Canning Machinery and Supplies Association. Coincident with the opening of the second century of the canning industry is the campaign of education and advertising, and the extension of the voluntary inspection service.

Uplift in Methods, Slogan of Fruit Jobbers

THE annual convention of the Western Fruit Jobbers, held at San Francisco during the past month resulted in one of the largest gatherings in the history of the organization, the registration totaling over 2600. Many men prominent in all lines of the fruit industry were present and the proceedings showed an earnest desire to institute better methods of buying, handling and distributing. It was the consensus of opinion at the convention that methods should be adopted providing for wider publicity in keeping both the producer and consumer informed on the affairs of the jobbers and to show the public generally that the business was conducted on a fair and legitimate basis

instead of by dishonest methods, which, it was said, seemed to be the prevailing idea.

One of the things of most importance to the grower and shipper brought out was that there is a shortage of 10,000 refrigerator cars for use in the fruit industry and that greater transportation facilities must be provided to successfully handle the business. According to a report made at the convention, in 1914, at the beginning of the war, there were 114,000 refrigerator cars in use for the transportation of perishable products. Thirty-five thousand of these were reserved for the use of the meat packers while 79,000 were allotted to the fruit and vegetable industry. The

number of cars put out of use since then was stated to be 10,000, which have been taken from the supply allowed the fruit industry. In discussing transportation conditions the idea was put forth that the public must be patient with the railroads until such time as they could expand and build new roads, more cars and make other necessary improvements.

It was declared that fruit and produce prices as well as those of other commodities must seek lower levels before the business could be said to be on a stable basis and the maximum consumption expected.

While little definite action was taken by the convention among the most important was the decision to abolish bank guarantees on fruit and produce shipments. The procedure in future will be to take shipments on consignments when accompanied by satisfactory references, or to pay cash before the shipment is made. The tier pack for apples for trading purposes was adopted and a return to the minimum carload shipment in use in 1914 recommended, except where equipment is constructed providing for a larger capacity.

The social features provided for the entertainment of the visitors are said to have been the most lavish ever provided at a meeting of the fruit jobbers. During their sessions Governor Stephens and Mayor Rolph made addresses. At one of the meetings which was held at the University of California, in Berkeley, Dean Thomas F. Hunt delivered an address of welcome. Subjects discussed at the university were: "Transportation of Fruits," by H. J. Ramsey, California Fruit Growers' Exchange, Los Angeles; "Spraying Orchards," by W. L. Howard, head of the Division of Pomology of the University; "Recent Investigation of Cold Storage of Fruits," by E. Loverholzer, same division; "Grading, Packing and Standardization of Fruits," by G. H. Hecke, Department of Agriculture of Sacramento; "Investigation on Fruit Products," by A. W. Christie of the Viticulture department.



BETTER STRAWBERRIES

We have one of the largest stocks of pure Aroma and Klondike strawberry plants in the country. Also nice lot of Excelsior, Gandy and Early Ozark.

We have more orders booked than we ever had before at this time. Write for prices, we would like to book you before our supply is exhausted.

CHATTANOOGA NURSERIES
CHATTANOOGA, TENN.

"I Don't Need to Tell You" says the Good Judge



Why so many men are going to the *small chew* of this good tobacco.

You get real tobacco satisfaction out of this small chew. The rich taste lasts and lasts. You don't need a fresh chew so often. Any man who uses the Real Tobacco Chew will tell you that.

Put Up In Two Styles

RIGHT CUT is a short-cut tobacco

W-B CUT is a long fine-cut tobacco

Weyman-Bruton Company, 1107 Broadway, New York City

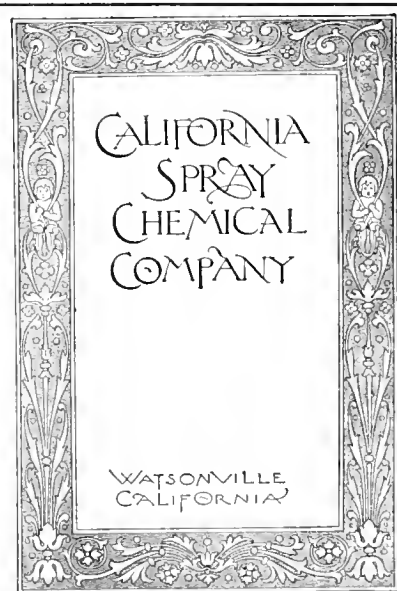

DOW

DEPENDABLE INSECTICIDES

PAY

Dow Powdered Lead Arsenate
 Dow Paste Lead Arsenate
 Dow Powdered Magnesium Arsenate

Dow Lime Sulphur Powder
 Dow Powdered Magnesium Bordo
 Dow Powdered Magnesium Bordo-Arsenate

GOOD PROFITS

Every successful grower of fruit realizes that it is impossible to produce good fruit without spraying. Satisfactory results cannot be obtained from inferior materials, and superior materials cannot produce the proper results if they are carelessly applied. Obviously it is not possible for the manufacturer of Insecticides to superintend the application of his products. This must be done by the grower. But, the manufacturer is responsible for the integrity of his materials. He should establish the highest possible standard for his goods and should maintain that standard always. To this latter phase—the manufacturer's responsibility, as applied to The Dow Chemical Company's line of Insecticides—we invite your attention.

OUR COMPANY

Was a large producer of war materials.
 Is the largest producer of Chloroform, Chlorine and Bromine products.
 Is the country's greatest producer of Indigo Blue.
 Owns one of the best chemical libraries in the country.
 Has made dependable Insecticides for many years.
 Has the confidence of America's largest fruit growers.

OUR PLANT

Covers over one hundred acres of ground.
 Includes over ten miles of railroad track within the property.
 Employs over 100 graduate chemists.
 Keeps busy over 1,500 loyal employees.
 Is run on the Profit Sharing plan.
 Has been built by honest service in the manufacture of essential chemicals.

DOW

INSECTICIDES ARE DISTRIBUTED AT IMPORTANT
 WESTERN FRUIT CENTRES

Get your copies of our new spraying leaflets. A postal will bring them.
 Ask for the name of the DOW DISTRIBUTOR near you.

THE DOW CHEMICAL CO.

INSECTICIDE DEPARTMENT

MIDLAND,



MICHIGAN

BETTER FRUIT

An Illustrated Magazine Devoted to the Interests
of Modern Fruit Growing and Marketing.

Published Monthly
by

Better Fruit Publishing Company

703 Oregonian Building
PORTLAND, OREGON

The Apple Marketing Situation.

The present condition of the apple market, which is reported dull and with much larger stocks in storage than was the case at this time last year was not altogether unanticipated. It is reported that the cause for this condition is that apple prices were started too high early in the season; that considerable tonnage was held for still higher prices; that the car shortage delayed the fruit from the Northwest in getting into consumption and that dealers on this account were unable to move the later flood of box fruit except at falling prices. The unexpected freeze also contributed to the unsettled condition of the box apple market on account of the shipping of frosted fruit or having it frozen enroute due to using unprotected cars. The limited foreign market also played an important part in the situation—and one other point, probably the most important of all—lack of national advertising.

In the June and September numbers of BETTER FRUIT attention was called to the possibility of the present condition of the apple market ensuing, with the exception of the freeze, a contingency so unusual in the Northwest that it can be largely discounted.

Of course alibis are now in order and the next few months will be replete with reports telling "how it happened." What the grower and shipper is most interested in, however, is not an alibi, but a possible remedy and it looks now as if a concerted movement would be made to obviate as far as possible in future the unfortunate conditions that characterized the present apple shipping season. More storage and more cars will undoubtedly be provided and it is only reasonable to expect that the foreign market for box apples must expand. The matters of price fixing, holding in storage for unreasonable values, flooding the market and stimulating consumption are the questions that require the most serious consideration.

These problems have been solved by the growers' marketing associations in California and there is no reason why the apple grower should not take a lesson from their book. The price is fixed before the fruit is sold on a basis that will move the entire crop, distribution controlled and consumption expanded by bringing the products to the attention of millions of people through advertising. This season while prunes, peaches, pears, raisins, oranges, walnuts and other fruits were being featured to reach the eyes of millions of readers the advertising for apples was almost negligible, the result being that in thousands of instances other fruits were substituted.

The Northwest apple grower must get into the marketing game on the

same basis as the grower of other fruits on the Pacific Coast to achieve the desired results. While his experience this year has been far from disastrous it should serve to guide him into other and better channels in future.

Commercial Fertilizers.

Commercial fertilizers have become recognized as one of the most valuable aids to the fruit grower as well as those engaged in other lines of agriculture. By their use new life is put into soils that are deficient in some crop producing constituent and heavier, and better quality yields are the result. A new angle is brought out in the use of commercial fertilizers in an article in this issue by Prof. Thornber in his statement that they are labor savers by taking the place of intensive tillage in securing the maximum production. In making this statement Prof. Thornber pre-supposes that the fertilizer will be intelligently applied and used on soils that have been heavily cropped.

The value of commercial fertilizers is in their being used at the right time in the right quantities and with the same care and discrimination that would be taken in using stable manure or any other soil enriching material. The benefits of standard brands of fertilizers are unquestioned, it is simply a case of knowing the condition of your soil and plant life.

The Fruit Box Supply.

Fruit growers and shippers are being warned by the big lumber companies on the Coast that unless they want to be caught without a supply of boxes this year they should place their orders early. The statement is forthcoming that the demand for lumber of all kinds is so great and prices so high that the supply of box material will be short. At first glance this statement gives the inference that the lumber companies are preparing to gouge the grower, but investigation shows that such is not the case. A report from the Federal Reserve Bank in this district shows that the car shortage, labor shortage and unfilled orders for lumber is of such a magnitude that the box output is a secondary consideration. The lumber companies have stated that they will do everything in their power to meet the needs of the fruit grower and canning industry, but in order to do so must be given estimates for boxes early in the season. As boxes are a vital need to both the fruit grower and the cannery, it will be the part of wisdom to heed the warning.

The Western Fruit Jobbers are preparing a publicity campaign to inform the public that they are not a bunch of crooks and that their business is carried on on a legitimate basis. The fruit jobbers, like those engaged in other branches of business have suffered from the odium of the few who have been unscrupulous. There is a concerted movement both in the East and the West to drive this character of dealer out of the business and his going will be highly appreciated.

According to Frank T. Swett of the California Pear Growers' Association, the grower gets the dime from a can of pears that sells for 60 cents and the canner, jobber and retailer gets the other four-bits and yet none of the handlers of this product receives an inordinate profit. The question is how long will consumption be maintained at the already high and increasing figures?

A lesson is learned from the Okanagan fruit growers who quickly constructed a warehouse of baled hay to save their apple crop from freezing. Growers in other districts who may not have baled hay, may have something else which will serve the purpose in case of an emergency.

What the Newspapers Interested in Fruit Are Saying.

A recent bill introduced in Congress provides for standard hampers, splint baskets and apple boxes. Thus the campaign for standard containers goes on. In the course of time it is probable that the dozens of different sizes and styles of containers seen on any market will be replaced by a few of standard size and style.—*The Packer*.

The tree doctor is again abroad in the land. Reports are coming in from various sections that men are going about the country doctoring trees in various ways. These ways are generally secret. Operations are performed on trees, money collected for the cure that is sure to follow and the doctor goes on his way, leaving a hopeful but sure to be disappointed owner in his wake.—*Southern Ruralist*.

The light tractor is making good in our Ontario orchards. It is only a couple of years since the light tractor was first introduced into Ontario as an experiment, but the past year has seen a tremendous increase in the number of these machines used on Ontario fruit farms. Shortage of help with its attendant necessity for greater accomplishments by the man power available has paved the way for the tractor and the low-down fast-working orchard implement.—*Canadian Horticulturist*.

With proper care and attention, there is no reason why budded and grafted trees will not be as long-lived as old time varieties. The earliest definite history of a grafted tree is a Summer Bonretien, from Europe, planted by Governor Stuyvesant at New Amsterdam in 1647. The trunk of this tree remained standing in New York City on the corner of Third Avenue and Thirteenth Street until 1866, when it was broken down by a dray running over it. Here we had a grafted tree standing at the ripe old age of 219 years. This seems to us to prove that the longevity of a tree is not necessarily determined by whether it is grafted or seedling.—*British Columbia Farmer*.

Farmers' institutes provide a contact between men who are giving their lives to scientific experiment, and the ordinary farmer, who can not afford to take time and to give up land for such purposes. The experiment station may make a dozen unsuccessful trials, for one that will work. But the one successful experiment may show results which would raise the production of some staple far above existing standards. It will pay the farmers to sacrifice some valuable time to attend these meetings. Information is constantly being given out that will raise agriculture to a more profitable level.—*Toppenish (Wash.) Tribune*.

TO OUR READERS

If you have a short story or have had an experience that you think will be of practical interest or value to the fruitgrower, send it to BETTER FRUIT. If you have a photograph to illustrate your idea or story send that too.

Harvesting and Marketing English Walnuts in Oregon

By Arthur S. Moulton, Mollalla, Oregon

LIKE many another, the author of this article is but one of the many Westerners who are enthused, confident and alive to the possibilities that lie in the development of the nut-growing industry on the Pacific Coast, and especially in the Willamette valley. The certainty of good returns, both financially and otherwise, and the comparative ease of handling the orchards and the annual crop of nuts, are two of the biggest inducements and attractions in this phase of horticultural work.

To attempt to write an article on the general subject of nut growing would require an entire magazine in itself, were the subject properly handled. However, the lack of material dealing with walnut culture, especially as regards certain phases of it, has induced the author to keenly peruse what little information there is available and together with his own experience and observations, to present a concise and at the same time a detailed article on this topic for the interest of those readers of BETTER FRUIT, who, too, have a more or less interest in the subject itself.

As in the case of the Italian prune, one of the most simple operations in the handling of the crop of walnuts is that of gathering them. The gathering commences in the middle of the fall at the time when the hulls of the nuts begin splitting and the nuts start dropping. In most orchards there are four pickings, that is, the work is so planned that each tree is gone over four times, at intervals of about four days, the picking crew being kept busy by starting at one side of the orchard and working straight across. By the time the entire orchard has been worked over, it is about time for the crew to start in again at the other side. During the first two or three gatherings, only those nuts lying on the ground are taken, while on the later rounds the branches of the trees are shaken by means of a hook attached to a light pole, care being taken, however, not to injure the branches of the trees.

As the nuts are gathered, they are usually divided into two grades, the nuts which are well-matured being segregated from the cull nuts, and later handled separately at the drier. During the gathering the nuts are either sacked under the trees, stacked in piles without being sacked, or else placed directly from the picker's bucket into the wagon, to be carted thence to the drier.

The next step in the handling of the crop is the drying of the nuts. On the coast here there are two methods of doing the drying, one by exposure to the sun, a method in use in the warmer regions of California, and the second by means of artificial heat, the common method in the Oregon sections. Under the California method, the nuts, after being thoroughly washed, are placed in broad, shallow trays and so arranged and assembled as to receive the maximum amount of sunlight. The principal disadvantages of this method, how-

ever, are that the sunlight is often unreliable, that the nuts cannot be exposed to a temperature greater than 90° Fahrenheit, and that the trays must be covered every night because of excessive dampness prevailing at that time of the year. Under the Oregon method of artificial drying, which is, by the way, the only practicable method of handling the crop in this section of the coast, the drying is all done in buildings either erected purposely for that process or in buildings previously used for drying prunes and which are readily converted into walnut driers by the addition of washing and grading

machines such as are used in the California orchards. Incidentally, too, an added advantage of the artificial drier here is that the owner of the orchard can literally "kill two birds with one stone" by planting Italian prune trees as fillers when he sets out the walnut orchard. In this manner the prune trees will furnish crops available for drying in the drier at a fine profit until such time as the walnuts come into heavy bearing. By that time the walnut trees so crowd the prune trees that the prunes are usually removed, incidentally, too, being disposed of at a time when the walnut trees are begin-

Continued on page 24.

Stimulation

To spray your trees yearly with **ZENO**
Is to practice ideal Orchard Prophylaxis.

To protect and defend your trees from disease
And parasites by the peculiarly cleansing and
Invigorating effect of **ZENO**

Trees sprayed with

ZENO

Have clean bark, vigorous limbs, greener leaves;
Green leaves mean more chlorophyll,
Chlorophyll is to the tree
What gastric juice is to the stomach;
It means better assimilation,
More life, more resistance to heat or cold,
Better fruit and more of it.

ZENO

Is an internationally used
Miscible oil spray, and these are reasons why
It has proved the best by years of test.

MANUFACTURED ONLY BY

Eastbay Chemical Co., Inc.

(formerly STANDARD CHEMICAL CO.)

of Emeryville Station [Oakland] California

T. O. McCLURE, Director of Research

SPORN & WING
Northwest Agents
223 Sherlock Building
Portland, Oregon

[Zeno may be had of your local Distributor, Fruit
Company, Exchange, or by writing to us direct]



ADDED POWER \diamond SAME WEIGHT

The Cletrac Way
Makes Farming Pay

The Cletrac's Day is Here

The tide has turned. The *big* demand to-day is for the small tank-type tractor—for the Cletrac—that goes further than the simple job of plowing and takes the place of horses over plowed ground and seedbed, working faster and at lower cost.

It wanted only the marvelous success of the Cletrac in 1919 to make the bulk of farmers *everywhere* put their "OK" on the small tank-type. And now because the Cletrac is the "fashion"—because a greatly increased output, means a lower manufacturing cost—we can offer a better Cletrac and still reduce the cost to you.

With more power and improved construction, 1920 will prove to any farmer, anywhere, that Cletrac farming is *profitable* farming.

The Cletrac is the right size and type for almost any farm, the one tractor adapted to all conditions. It has proved its ability to stand up to its work. And now that the public has recognized its worth, it is out in front to stay.

The quick popularity of the Cletrac is not an accident. Engineers and army experts long ago saw the great advantages of the endless track as a device for turning motor power into drawbar pull. The farming public only waited to see the same principle built into a *serviceable* small tractor. The Cletrac proved to be that tractor. It made lifelong friends from the start.

One Cletrac on the small farm—a "fleet" of them on the big ranch—makes an ideal all-year power plant. The Cletrac is light, but powerful, with plenty of pull for heavy plowing and work in the hills. And it rides the low spots or plowed ground without miring, but still pulls a profitable load.

Turns short and works the corners clean. Compact and low-set, ideal for orchard work. Travels faster and does more thorough plowing. Burns "gas", kerosene or distillate. Does *more kinds of work, more days in the year*, at lower cost. You can't go wrong on it.

The Cleveland Tractor Co.

19145 Euclid Avenue

Cleveland

Ohio

*Largest Producers
of Tank-type Tractors
in the World.*

*"Selecting Your Tractor" is a book you should have right away.
The Cletrac dealer has one for you, or we will gladly send one free.*

Cletrac

Name _____

Post Office _____ State _____

F. F. D. No. _____ Size of Farm _____ Acres _____

CLEVELAND TRACTOR CO.
19145 Euclid Ave., Cleveland, O.

- Send me your booklet "Selecting Your Tractor"
- Send me name of Cletrac dealer

Mail This
Coupon
Now

The Tide has turned to the
Small Tank-type Tractor —

The Cletrac has made so
many friends that increased
output lets us lower the price —

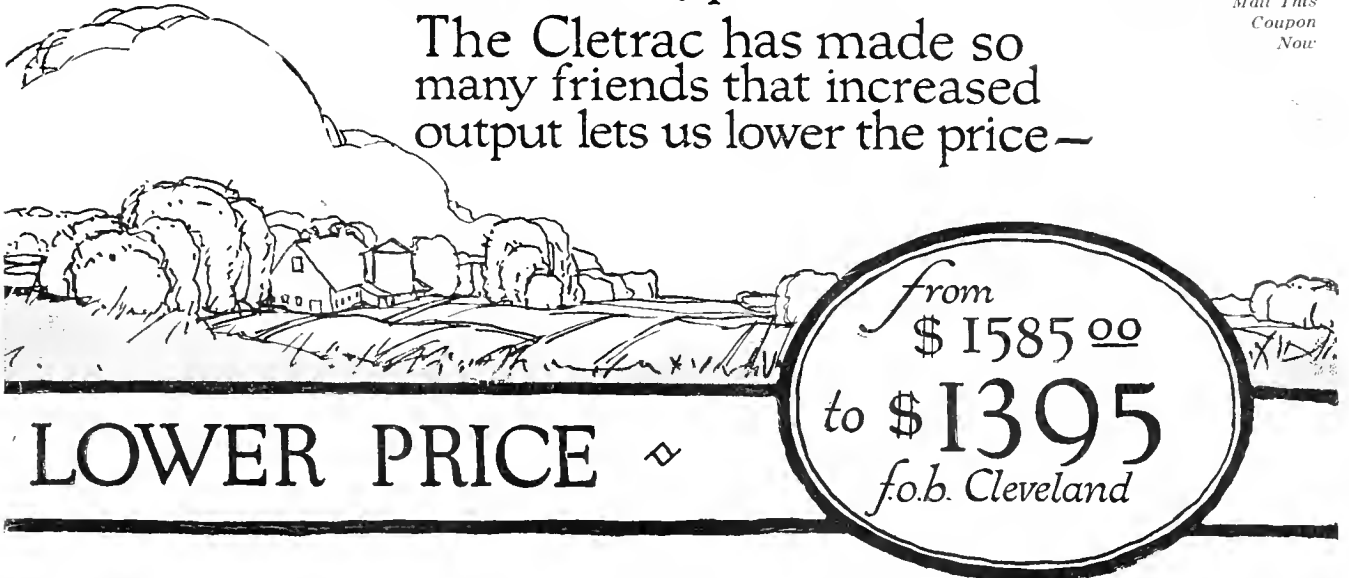

In the improved Cletrac you get all the little refinements an honest builder makes with each year of brass-tack experience. And you get certain big features that make it a better performer than ever.

A bigger motor and the added strength to handle the increased power are furnished with no extra weight and no more friction, saving you *all* the power we've added.

The new 8-inch track—one-third wider—means a lighter tread and stronger grip on the ground—makes the Cletrac that much more sure-footed and adds to the life of the tractor itself.

The Cletrac steering device, an exclusive feature, insures positive power to *both* tracks *all* the time and gives full power on the turns, as well as straightaway.

Our new water clarifier takes out all the air dust that would grind your pistons and overheat your motor—moistens the air and makes the engine run as smooth at noon as your auto on a dewy night.

Here is a tractor, always a vote-getter, now more powerful, now better built, and costing you less. No wonder the best tractor dealer in your community wants to handle it. A tractor that makes friends for itself makes satisfied customers for him.

Right through the year—hauling manure in the Winter—plowing, harrowing and seeding in the Spring—cultivating orchards all Summer long—road-building, ditching and grading—shelling corn and sawing wood—here's a tractor you can depend upon.

It's a tractor that has all-year service built into it, one that cuts farming costs by handling *all* jobs well, not just a few. And over 1200 distributors and dealers, with repair stocks near you, are backing it up to make every Cletrac owner a booster.

There's a good dealer close by who will gladly show you a Cletrac. Talk to him now. Get ready to start Cletrac farming this Spring. Line up with the majority and make power-farming really worth while.

More Kinds of Work
More Days in the Year

Send in the coupon, or see the Cletrac dealer at once.
Don't wait until Spring work starts—get ready now.

The Cleveland Tractor Co.

19145 Euclid Avenue
Cleveland Ohio

Sales Offices at

New York
Cleveland
Chicago
Atlanta
Minneapolis

Omaha
Oklahoma City
Los Angeles
San Francisco
Spokane
Windsor, Ontario, Canada

**TANK-TYPE
TRACTOR**

Continued from page 21.

ning to require the bigger portion of the grower's attention.

The method used in drying and washing the walnuts is similar to that used with the prune crop. The usual method of picking and drying is to have the crew pick one day and dry the next. After picking the nuts are placed in water and thoroughly washed to remove the dirt and other materials. A common method is to use the prune washers, with special arrangements of some sort to collect the fibre from the nuts, usually accomplished by means of false bottoms, as the fibre is generally given off in large quantities. A special note might well be added at this time, too, as to the possibilities lying in the utilization of the by-products from the nuts. The fibre given off may readily be dried and used for various purposes, while the present demand for dyes

tends to make the production of walnut dye very profitable, the color of the walnut dye being one that has not as yet been equalled.

After the nuts are thoroughly washed they are deposited in broad shallow trays, having a meshed wire of one-quarter to one-half inch for a bottom. The trays are then placed in tiers, arranged on a slight slant, on a truck, the trucks then being hauled into the drying rooms. Here the nuts are kept at a temperature varying from 75° to 90° Fahrenheit for two days and a night. During the drying extreme care is necessary to see that the stipulated temperature is maintained, for if the heat falls to below 70°, mold will quickly develop on the nuts, while if it exceeds 90° the nuts may crack open and the oil therein may become started, re-

sulting in the nuts rapidly becoming rancid and unfit for use.

As to the heating, the drier may be heated either by hot air or by steam pipes. The hot air method has proven highly satisfactory and is by far the cheaper, the principal objections to it being that the dryer itself must be carefully arranged so as to afford uniform heating and incidentally, that there is an extremely disagreeable odor given off at times if the furnace gets too hot. As to steam heat, it is by far the more expensive to install, there is always danger of the pipes leaking, and the pipes must all be carefully drained in the fall to prevent them from freezing.

While California growers make a common practice of bleaching their nuts, this practice has not become prevalent in the Oregon districts, the northern public readily and eagerly taking all of the Oregon output without requiring that the nuts be bleached. Though all of the California crop is put through the bleaching process, as long as the northern crop is so readily disposed of without being bleached, Oregon growers do not intend to do so, as it makes an additional expense item and is thought by some to be harmful to the walnuts.

After the nuts are dried thoroughly they are graded, although little grading has as yet been practiced in this state with walnuts. However, as the yield and demand for the Oregon nuts continues to increase, grading will become as essential as with other Oregon crops, the grading of the crop not only raising the market standard, but will readily repay the grower for the amount of labor involved.

The grading may readily be done by the use of any of a large number of mechanical devices on the market. In California a common practice is to place the nuts in large meshed trays, shaken by machinery, the graded nuts falling out and being conveyed by means of belts to the sacking room, the established grades there being grade one, composed of nuts larger than one inch in diameter, grade 2, of nuts between three-fourths and one-inch in diameter, and the culls.

After the grading process, the nuts are sacked, the usual container being the gunnysack, of the type commonly used for wheat, and holding about fifty pounds of nuts, although other types of containers are often used. When the nuts are graded No. 1, extra fancy, they are often put up in cartons and sold to high class trade. The cartons usually hold one or two pounds of nuts, and if attractively put up and labelled, are valuable in advertising one's product. Such an article seldom fails to attract the public, and invariably results in a repeated demand for the "_____ " brand of walnuts, grown at "_____ " by "_____ ." The cartons should be neat and attractive and plainly labelled with the grower's name, address and guarantee on the outside.

Prices received for the sale of the nuts on the market vary widely, from a quotation of thirteen cents for sec-

Last Big Block of Canadian Pacific Reserved Farm Lands

THIS announces the offering of the last big block of the Canadian Pacific Reserved Farm Lands. Until this block is disposed of you can secure at low cost a farm home in Western Canada that will make you rich and independent. The country is ideal for mixed farming as well as grain growing. Later, the same lands can be bought only from private owners — and naturally, prices will be higher. Never again on the North American Continent will farm lands be offered at prices so low.

Your Last Big Opportunity

This block contains both fertile open prairie and rich park lands in the Lloydminster and Battleford Districts of Central Alberta and Saskatchewan. You can buy farm lands on the rich prairies of Manitoba, Saskatchewan and Alberta at prices averaging about \$18.00 an acre. Or land in Southern Alberta under an irrigation system of unfailing water from \$50 an acre and up.

Twenty Years to Earn and to Pay

The Canadian Pacific offers you this land under a plan of long term, easy payments that is remarkable in the history of farm investments. You pay down 10%. Then you have no payment on the principal until the end of the fourth year, then fifteen annual payments. Interest is 6%. In central Saskatchewan, Seagar Wheeler grew the world's prize wheat. World's prize oats were grown at Lloydminster.

Lands Under Irrigation

In Southern Alberta, the Canadian Pacific Railway has developed the largest individual irrigation undertaking on the American Continent. This district contains some of the best lands in Canada. An unfailing supply of water is administered under the Canadian Government. Prices range from \$50 an acre up on the same easy payment terms. \$2,000 loan in improvements; twenty years to pay back.

M. E. THORNTON
Supt. of Colonization

Canadian Pacific Railway
960 First Street, E., Calgary, Alberta

For all information about Canada, ask the C.P.R.



No Taxes on Improvements

There is a small tax on the land—seldom more than 20c an acre for all purposes, but there are no taxes on your livestock, buildings, improvements, implements or personal effects. Good markets, modern schools, roads, churches, amusements, make farm life desirable and attractive. Here you can achieve independence.

No Sale Without Investigation

The Canadian Pacific will not sell you a farm until you have inspected it. You must be satisfied—and every question answered before taking up your home. Investigation is invited and made easy. Don't delay your investigation. This announcement calls attention to the last great block of Canadian Pacific Reserved Farm Lands.

Special Rates for Homeseekers and Full Information

Special railway rates for homeseekers make inspection easy. Send now for free illustrated pamphlets answering all questions and setting forth figures about land values, acreage yields, climate, opportunities, etc. Do not delay. Send coupon below for information.

M. E. THORNTON, Supt of Colonization
CANADIAN PACIFIC RY.
960 First St., E., Calgary, Alberta

I would be interested in learning more about:

- Irrigation farming in Sunny Alberta.
- Farm opportunities in Alberta, Saskatchewan and Manitoba.
- Special railway rates for homeseekers.
- Business and industrial opportunities in Western Canada.
- Town lots in growing Western towns.

My name _____
Address _____
Town _____ State _____

onds before the war up to fifty and sixty cents per pound, while the market itself is extremely large with a continued strong demand. Practically the entire crop of the United States is grown on the Pacific Coast, in Oregon and Washington, with the demand for the nuts growing far more rapidly than the production. As with some other crops, it is often a wise plan for the grower to hold the crop for a short time after it is ready for market. As a rule, the market price of the crop invariably drops when the new crop comes in in the fall, only to soar again as soon as it is disposed of. Then, too, still better prices are obtainable by the growers pooling their crops and thus marketing a large product as a unit. Good opportunities for making money in this manner are likewise open to the several growers in the unit in the cooperative buying of supplies which can often be secured in this way at considerable discount.

In conclusion, the author might add that the amount of available material dealing with walnut culture in this section has proven a distinct surprise to him and undoubtedly a marked hindrance to people who have become interested in the industry. The future lying in the development of nut culture in Oregon is ready cause for research work and practical experiments, especially as regards such matters as the effects of cross-pollination of varieties in the orchard, the effects of bleaching, the use of fillers in the walnut orchard, and the possibilities of further improvement of varieties.

Today the walnut industry is still comparatively in its infancy in this state, and although it is often humorously referred to as "an inheritance bequeathed to the next generation," it is never too late to set out an orchard and enter into an industry that rapidly promises to become one of Oregon's greatest and to converting the Willamette Valley of Oregon into the "walnut section" of the United States.

Tagging Trees

Linen cloth is being used in some of the experimental work of the United States Department of Agriculture for tagging trees and has been found to be successful. The linen tags are first soaked several days in water to remove the sizings and then dried and smoothed with a hot iron. Data is written in, with India ink, with a round pointed pen. The ink soaks in but does not run. Tags of this kind will last a year. When they are to be used for a longer period they are coated with paraffin after being labelled.

To Advertise Raisins Extensively

The California Associated Raisin advertising for this spring, according to Judicious Advertising will have a total combined circulation in the national magazines of 28,000,000. The advertising will contain suggestions to housewives of the varied uses for Sun-Maid Raisins.

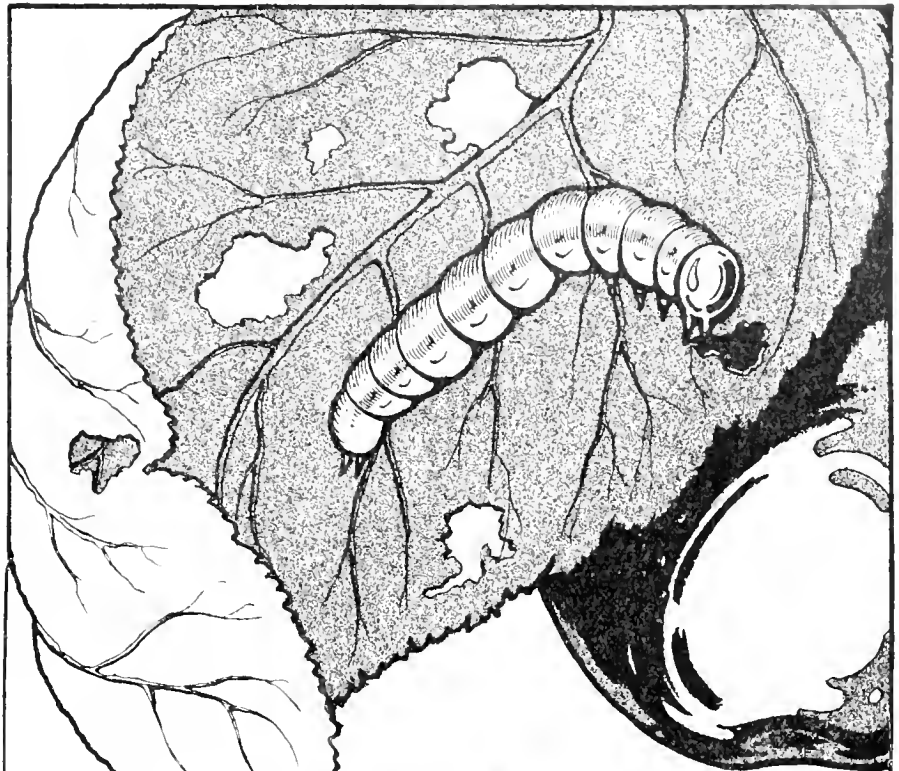

**\$2,000,000
To Save You From This
Fellow and His Allies!**

\$2,000,000 are appropriated yearly by the state and federal governments for tests, experiments and educational work aimed to destroy the myriad insects, bugs, worms, scale and fungi which cost each individual grower hundreds of dollars every season.

Profit by the experiences of the government specialists. Help them in their fight. Join forces by close co-operation with their efforts. Profit by their knowledge.

Don't Experiment With Spray Materials!

Let state and federal experimental stations be the testing ground for novelties, not *your* fields and orchards. Use only chemicals of unquestioned strength, standing and merit.

In case of doubt as to methods, mixture or brands, ask the nearest experimental station.

In every fruit-growing and farming section, you will find a distributor for the following Grasselli-Grade Specialties:

- Arsenate of Lead Paste and Powder
- Calcium Arsenate
- Lime Sulphur Solution
- Bordeaux Mixture
- Sulphate of Nicotine



**The Grasselli Chemical Co.
Cleveland**

G **RASSELLI GRADE**
Insecticides
and Fungicides

Recommendations for Winter-Injured Trees

By W. S. Brown, Chief of the Division of Horticulture, Oregon Agriculture College

THE damage that resulted to Oregon orchards during the middle of December from widespread low temperatures was rather spotted in its severity, some locations not suffering as much as the extreme cold would seem to indicate.

The most serious damage seems to be in the region of the tree immediately above the snow line, taking in the upper part of the trunk and the main limbs. It is indicated by a discoloring of the bark, the cambium layer and in some instances, the outer part of the wood. The tender growing point and sometimes the entire inside portion of the fruit spur may be affected. Combined with this bark and wood injury many buds are affected, especially on the sweet cherries and pears.

Cause of Injury.

The chief cause of the injury, which is usually found to extend entirely around the tree, is the combination of low temperature, coupled with the presence of considerable sap in the lower part of the trees at least. Another contributing factor which was very serious was the heat generated on the south and southwest sides of the trees by the sun's reflection on the snow. This caused a drying out of that portion of the bark and an injury much worse in some cases than is found on the north side of the tree.

It is found from this work that there is a great deal of difference in the severity of the injury, due to several causes, among them the condition of the trees at the time of freezing, and the variety and the location of the orchard. All gradations in injury are found.

In a few instances portions of the tree above the snow line are entirely killed, in others the bark and wood is not so seriously hurt but that it will probably recover, though the crop will not set for next year. In other cases some of the limbs of the tree, especially those on the south and southwest side may be killed and the rest of the tree may recover. Portions of bark may die on the sides of some limbs, necessitating the cutting off of this bark later and the subsequent painting of the wood, or bridge-grafting, or both.

Seriousness of Damage.

It is not possible to tell at present just how badly injured the trees are. Shortly after the freeze the division of horticulture of the college station sent out a great number of letters to different growers throughout the state asking them to send samples of injured material to the college. A great many limbs, twigs and buds have been sent in for examination. Some of the twigs containing buds have been placed in the greenhouse in water, to see if they have vitality enough to open the buds and function properly. Tissues from the larger limbs were given careful microscopic examination.

Naturally the question comes up what treatment can we give these trees. The answer is that we can do very little except to give nature as good a chance as possible to recoup herself.

Pruning Not Advised.

Every fruit grower is wondering what is best to be done about pruning. The horticultural division recommends, after having examined a great many

samples of injury and after several members of its staff have visited injured orchards in widely different parts of the state, that little or no pruning be practiced at this time. It will be better to leave the trees unpruned until April or May, and then notice the conditions of the individual trees before pruning. The reasonableness of this course is apparent when it is considered that some of the limbs that might be pruned out at this time may be needed next spring to take up the growth of the tree, especially if the other branches have been injured. Beside this fact the uninjured buds in the top of the tree are needed to pull up the sap to the tops of the twigs and limbs in the early spring. The more of these buds that are cut off, the less will be the pulling power. If this sap can be brought up to all parts of the tree, it will prevent the tree from drying out and will give the cambium a much better chance to recover.

Then, of course, there is the question of expense. If the tree has been killed by the freeze, it is only throwing away money to prune it at this time, especially when such pruning can do no good. Further, large cuts that are made by removing branches of good size in the trees expose considerable tissue to drying out at this time and therefore injure the circulation of the sap.

Pruning would seem permissible only when the trees had been neglected in previous years and had become too dense. In that case a very light thinning out might be permitted at this time if the tree has the appearance of being injured only slightly. If it is very severely injured no pruning should be done. In late spring or early summer, all cuts of any size, from one inch in diameter on up, should be carefully protected with some material such as white lead and raw linseed oil mixed with shellac or with a Bordeaux paste. In many respects the Bordeaux is the best as it keeps fungi from entering at this point.

Just what type of pruning the tree will need in late spring will depend upon the injury it has received. A statement will be issued on this subject by the experiment station horticulturists next spring.

Decrease in Nitrate Production

A decrease of about 50 per cent occurred in the production of nitrate in Chile during November, 1919, as compared with the corresponding month last year, according to the United States Consul in the Antofogasta. The exports showed a still greater decrease.

Canning and other methods of food preservation are receiving an impetus in all parts of the United States. This means that waste in the products of the farm and orchard will be reduced, wider markets created and the supplying of isolated districts with a greater variety of diet. It should also have an influence in reducing the cost of living.

BOLTON ORCHARD HEATER



Are you helping to pay the \$75,000,000 toll taken from the growers of the country annually by Jack Frost? The Bolton Heater is

The Safest Means of Frost Prevention

Don't experiment with makeshift methods. Bolton Orchard Heaters are sure. They maintain the temperature, distribute the heat uniformly, and prevent frost damage.

Send for Booklet 5

Tells you all about frost prevention. Filled with valuable information for the grower.

W. R. AMES CO.,
8th and Irwin Streets San Francisco, Calif.

Largest stock of Surface Irrigation Pipe and Pipe Equipment on the Pacific Coast

<p>MUSICAL MERCHANDISE</p> <hr/> <p>WRITE US</p>	<p>WE SAVE YOU MONEY!</p> <h2 style="margin: 0;">W. Martius Music House Inc.</h2> <p>1009 First Avenue, Seattle, Washington</p> <p>Everything Known in Music</p>	<p>SHEET MUSIC</p> <hr/> <p>WRITE US</p>
--	---	--

Baled Hay Saves Thousands of Boxes of Apples

By R. A. Laird

ANY notion that the farmer is less resourceful than the city man does not hold good in the Spokane country. The Okanogan, Washington, district produces high grade export apples in

of warehouse capacity, facing a heavy cash loss.

Did the farmers throw up their hands in despair? Not for a moment. There was some quick planning, the apples

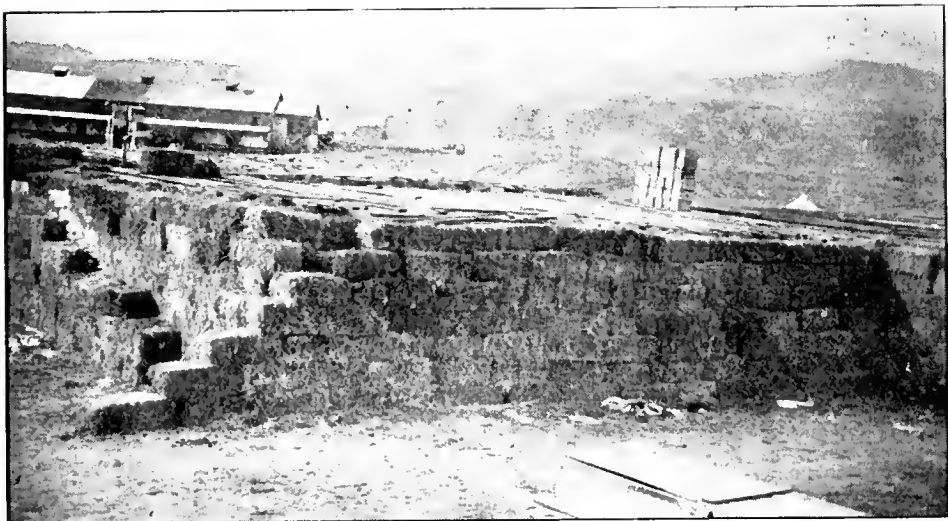

Apple storage house made of baled hay that saved thousands of boxes of apples in the Okanogan, Washington, district from freezing.

considerable quantities and had a big crop in 1919. Shipping was hampered by a car shortage, and an unexpectedly early cold snap found apple producers with several thousand boxes in excess

were assembled at a convenient point and piled in tiers. Then the owners bought every bale of hay in the district and built a frost proof structure of baled hay around the fruit.

The beauty of the whole matter was that the upward trend of forage prices netted the apple men a handsome profit on the hay after the hastily contrived warehouse was dismantled.

The accompanying picture is reproduced with the permission of the Fox Film Service.

Peanuts

Most people who eat peanuts, says the American Economist, believe that they are all grown in this country and will be surprised to learn that there were 70,947,036 pounds of these nuts imported during the fiscal year 1918, practically all of which came from China and Japan. Most of the imported peanuts are grown in China. The 1919 crop in that country is estimated at 33,000 tons.

Many Tractors in Missouri

According to the State crop reporting service, there are now in the state of Missouri 7202 tractors. How rapidly these are being bought and used is best indicated by the fact that nearly half of them have been purchased since the first of June of the present year.

The inspection service for shipments of fruits and vegetables started in 1917 by the Bureau of Markets, United States Department of Agriculture, has been extended to cover 150 designated markets. The certificates issued by inspectors upon request state the condition of interstate shipments as they arrive at market centers and are used as a basis for settling claims that may arise between shipper and consignee.

**In Orchard
Berryfield
Vineyard
or Farm**

It does the work

It Kills

- APHIS
- RED SPIDER
- CODLING MOTH
- CATERPILLAR
- CURCULIO
- CABBAGE WORM
- FRUIT WORM
- ANTHRACNOSE
- BLUE MOLD
- MILDEW
- RUST
- Etc.

Price \$20.00



The **American
Beauty
Dust Sprayer**

"it kills them"

THE CALIFORNIA SPRAYER CO.
6001-11 Pasadena Avenue, LOS ANGELES, CALIFORNIA

Green Tip Treatment for the Control of Apple Aphids

By W. S. Regan, Agricultural Experiment Station, Amherst, Massachusetts

IN carrying on field experiments for the control of potato plant lice, commercial lime-sulphur solution, among other materials, was tested as to its effectiveness. Although this was used at the rate of one gallon to 22 gallons of water, about twice the ordinary summer strength, and in spite of the fact that every precaution was taken to drench thoroughly all parts of the plants, the percentage of plant lice killed was so small, under ten per cent that it could in no way be considered of value as an aphidicide at a strength safe to use upon potato foliage.

Object of Comparative Tests

The results of these tests led the writer to question just how effective the usual dormant strength, one to eight, of lime-sulphur would prove against apple aphids when applied at the delayed dormant period, just after the eggs have hatched. With a view to determining this point, a number of tests were carried out. In these experiments commercial lime-sulphur solution was used alone and in combination with nicotine sulphate, and several brands of proprietary miscible oils were also tried out in comparison. Tests were also made to determine the effect of lime-sulphur and miscible oils upon the unhatched eggs.

Remarks might be prefaced here by the statement that the term dormant is taken to mean the condition of the buds in the winter or early spring before they begin to swell. By late dormant is meant the swollen condition of the buds at the time just before they split open, or in other words just before the buds show the least bit of green. This condition would normally be reached during the early part of April in Massachusetts. The term delayed dormant is applied to that period in the development of the cluster buds and foliage when they have expanded from a quarter to a half inch.

It is more or less axiomatic that the hatching of the aphid eggs is about coincident with the first splitting of the apple buds, and that by the time the buds have expanded from a quarter to a half inch, the delayed dormant period, practically all of the eggs have hatched and the young plant lice have migrated to the new growth for food. Observations have confirmed this. Twigs brought in from the field and examined on April 17 had numerous plant lice eggs upon them, but none of these had hatched. The buds were in the late dormant condition. Twigs brought in on April 19 were found to have a few newly hatched individuals, which had migrated to those buds just beginning

to expand and show the least bit of green available for feeding purposes. From the 19th to the 21st of April, newly hatched aphids appeared in increasing numbers. After the latter date only a few new individuals appeared, which could be readily determined by their size. It is evident from this that under favorable weather conditions such as existed during the period mentioned the time of maximum emergence is rather brief. The presence of a few newly hatched individuals on some of the twigs on May 1 indicated that a small number of belated aphids were still hatching from the eggs, but in no case observed had the foliage expanded beyond about half an inch before hatching was completed. No viviparously produced aphids were in evidence at this time.

Object of Delayed Dormant Spraying

In the past the practice of spraying with lime-sulphur for the control of San Jose scale has been confined for the most part to the dormant or late dormant season. Comparatively recently, however, the practice of delayed dormant spraying with lime-sulphur has been quite generally advocated, based on the assumption that such treatment is fully as effective as dormant or late dormant season applications against the San Jose scale, and that apple plant lice in their active stages would offer less resistance to this insecticide than the unhatched eggs. In other words, it is believed by some that a delayed application of lime-sulphur at full dormant season strength, just after the buds have split open and have expanded perhaps not over half an inch, will control the San Jose scale, and to quite an extent the apple plant lice as well. Applications at this time, practice has shown, can be made with little or no eventual injury to the foliage. Our tests, so far as the efficiency of the delayed applications of lime-sulphur in controlling plant lice is concerned, have by no means borne out this conclusion. From the standpoint of the fungicidal value of lime-sulphur, delayed dormant applications appear to have some advantage over those of the dormant season.

On the other hand it has been recognized by some that only by the addition of nicotine sulphate to the lime-sulphur solution, when this is applied as a delayed dormant spray, can the aphids be satisfactorily controlled. This would indicate that the nicotine sulphate is mainly responsible for the control of the plant lice, and that the only reason for delaying the lime-sulphur treatment and combining it with nicotine sulphate is to make necessary only one application instead of two. Then, too, some advocate the addition of an arsenical to the above combination, at the delayed dormant period, for the control

The House of A Hundred Necessities

Necessity No. I. **Bronkets.**

To stop that tickling throat and night coughing.
Fine for hoarseness and similar affections.
Bronkets are dependable. *25 cents the box.*

Necessity No. II. **Cla-Wood**

Grip and Cold Tablets. If you've neglected to use preventive measures, and feel that Grippy lameness coming on, get a box of **Cla-Wood** Grip and Cold Tablets at once, before something more serious develops. *25 cents the box.*

Both of these may be had at your druggist's, or we will send by mail, stamps accepted. Add 1 cent war tax for each 25 cents of purchase.

WOODARD-CLARKE & CO.
Wood-Lark Building, Portland, Oregon

of bud moth, case bearers, etc., making possible, theoretically at least, by this insecticide combination the control of San Jose scale, apple aphids and certain foliage feeders by one application.

Tests for Destruction of Aphid Eggs

The first tests were made for the purpose of determining the comparative efficiency of lime-sulphur solution and miscible oils against the unhatched aphid eggs. The lime-sulphur was a fresh sample of a commercial concentrate, having a density of 34° Baumé. This was used at the strength recommended upon the container for dormant applications, one to eight. Two proprietary miscible oils were tested, these being diluted one to fifteen, the usual dormant season strength. Although both samples were fresh from the manufacturers, one was evidently imperfect as there was some free oil present. In the tests, however, this imperfect sample showed to less advantage in destroying the eggs than the well-prepared sample, a rather unexpected outcome, perhaps, in view of the presence of free oil. These tests, as in the case of those following in which the aim was to determine the comparative killing efficiency, were carried out in the laboratory, where careful counts could

Teeth Grow Dingy

Because You Leave a Film

All Statements Approved by High Dental Authorities

Teeth Are Ruined by It

This is why the daily brushing so often fails to save the teeth.

The cause of most tooth troubles is a slimy film. You can feel it with your tongue. It clings to teeth, enters crevices and stays. Ordinary brushing methods do not end it. So, month after month, the film remains and may do a ceaseless damage.

That film is what discolors—not the teeth. It is the basis of tartar. It holds food substance which ferments and forms acid. It holds the acid in contact with the teeth to cause decay.

Millions of germs breed in it. They, with tartar, are the chief cause of pyorrhea—a common and serious trouble.



Based on Active Pepsin

Pepsodent is based on pepsin, the digestant of albumin. The film is albuminous matter. The object of Pepsodent is to dissolve it, then to constantly combat it.

The way seems simple, but for long it seemed impossible. Pepsin must be activated, and the usual agent is an acid harmful to the teeth. Now science has discovered a harmless activating method. And now active pepsin is embodied in an ideal tooth paste, modern in every way.

The results are quick and apparent. One sees at once that Pepsodent means whiter, safer teeth. Make this ten-day test in your own home, in justice to yourself.

Now a Way to Combat It

These facts have been known for years, but dental science found no way to effectively combat film. Now that way is found. Able authorities have proved it by careful tests. Leading dentists all over America are urging its adoption. And millions of teeth are now cleaned daily as they never were before.

The method is embodied in a dentifrice called Pepsodent. And to spread the facts, a 10-Day Tube is being sent to everyone who asks.

Pepsodent PAT. OFF.
REG. U.S.
The New-Day Dentifrice

A scientific film combatant now advised for daily use by leading dentists. Druggists everywhere are supplied with large tubes.

See What Ten Days Will Do

Send the coupon for a 10-Day Tube. Then note how clean the teeth feel after using. Mark the absence of the slimy film. See how teeth whiten as the fixed film disappears. Compare your teeth in ten days with your teeth today. Then decide for yourself what is best. Cut out the coupon now.

(349)

Ten-day Tube Free

THE PEPSODENT COMPANY,
Dept. 335, 1104 S. Wabash Ave.,
Chicago, Illinois.

Mail 10-Day Tube of Pepsodent to

Name _____

Address _____

Orchard For Sale
At Grants Pass, Oregon

280-acre ranch, about 60 acres young orchard, mostly pears, just coming into bearing. About 100 acres all told in cultivation. Fair house, large barn, also cement floor cow barn, cement silo; personal property. All for only \$35,000. Reasonable terms.

A. N. PARSONS, Grants Pass, Oregon.

Pull Stumps FREE!

Write for **FREE BOOK** Send No Money Try Kirstin 30 days **FREE** on your own stumps—6 months to pay. If not convinced return it. Money refunded.

Kirstin One-Man Stamp Puller

Weights less—costs less. Greater power speed and strength. *Lasts longer.* A few pounds pull on handle exerts tons on stump. **Free Book** gives full details. Shows One-Man and Horse Power models. **A. J. KIRSTIN COMPANY**
345 E. Morrison St., Portland, Or.

TREES AND SHRUBS

Fruit trees budded from bearing orchards. Apple, Pear, Cherry, Peach, Plum, Prune, Apricot, Quince, Grape Vines, Strawberry, Plants, Raspberries, Blackberries, Logan, Dewberries, Asparagus, Rhubarb, Flowering Shrubs, Roses, Vines, Hedge, Nut and Shade Trees. Carriage paid. Satisfaction guaranteed.

WASHINGTON NURSERY CO.
Toppenish, Washington.
Salesmen everywhere. More wanted.

be made and results checked. Dipping the infested apple twigs was resorted to rather than spraying, in order to insure uniformity of treatment, as by the latter method any variability of application might lead to an improper interpretation. On examination, shortly after the infested twigs were brought in from the field, it was impossible to make any estimate of the probable number of eggs that would hatch, since a large percentage of the eggs were apparently dead from some cause, as indicated by their shriveled condition. Twigs of as nearly the same size and degree of infestation as possible were selected for insecticide treatment and check, the average length of the twigs being about eight inches. No definite percentage of efficiency can be given for the tests against the eggs. The results should be taken as merely comparative and in the way of a generalization, and are perhaps in need of further verification both in the laboratory and under field conditions. The tests against the unhatched eggs were begun when the buds were in the late dormant condition and at such a short time before hatching occurred that it was impossible to carry out verification checks. The results are given in the following table:

COMPARATIVE EFFICIENCY OF LIME-SULPHUR AND MISCIBLE OILS AGAINST APPLE APHID EGGS IN THE LATE DORMANT PERIOD UNDER LABORATORY CONDITIONS.

Material and Dilution	Hatch on Treated Twigs	Hatch on Check	Injury to Twigs
Lime-sulphur, 1 to 8.....	No hatching on three twigs	Twenty-nine eggs hatched	No injury
Miscible oil A, 1 to 15.....	Thirty-six eggs hatched on three twigs.	Twenty-four eggs hatched	No injury
Miscible oil B, 1 to 15.....	Seven eggs hatched on three twigs.	Fifty-four eggs hatched..	No injury

Conclusions

1. The delayed dormant period is usually indicative of the complete hatching of apple aphid eggs. At this time the buds have expanded from a quarter to a half inch.

phur for San Jose scale. The percentage of efficiency will depend mainly upon thoroughness of application.

6. The ordinary dormant season treatment of apple orchards with miscible oil against San Jose scale, if applied thoroughly at the delayed dor-

2. Lime-sulphur solution at full dormant season strength is less than 10 per cent effective against the living aphids when applied at the delayed dormant period.

3. Lime-sulphur applied at the late dormant period, before the buds split open and just before the hatching of the aphid eggs, appears to be highly effective, under favorable conditions, in destroying the eggs, but the elements of thoroughness of application and unfavorable meteorological conditions present such uncertainty as to results that this treatment can hardly be recommended as an effective control.

4. If lime-sulphur is to be used as a control for San Jose scale and no special treatment for apple aphids is to be made later, best results against aphids, if present, are likely to be obtained by a late dormant season application just before the eggs hatch. Treatment at this time should also be thoroughly effective against the scale.

5. The application of the lime-sulphur (one to eight) and nicotine sulphate (one to 800) combination applied at the delayed dormant period gives practically a perfect control for apple aphids and makes unnecessary a separate earlier application of lime-sul-

phur, should result in practically a perfect control of apple aphids also.

7. Delayed dormant applications of full dormant season strength lime-sulphur, lime-sulphur and nicotine sulphate combined, and miscible oils, if perfect, can be made without material injury to apple foliage. Even when the foliage is considerably more advanced, little severe injury usually results. This fact, if taken into account, might make unnecessary separate applications for early and late budding varieties. As the foliage becomes more advanced, however, the success of the treatment involves greater difficulty, since the aphids are very difficult to reach when they have the spreading leaves for protection.

8. The action of lime-sulphur in destroying both the aphid eggs and living insects appears to be mainly mechanical by sticking them to the twigs.

9. The action of nicotine sulphate in killing the living aphids is slow, requiring from about half an hour to twenty-four hours or more for different individuals. Death appears to be due to paralysis.

10. Miscible oils are practically instantaneous in their killing action against the living aphids. The action is probably of a chemical nature.

Acknowledgments

The writer is greatly indebted to Mr. A. I. Bourne of the Massachusetts Agricultural Experiment Station staff for assistance in carrying out the insecticide tests, and to Dr. H. T. Fernald for his kind suggestions and assistance.

For Sale One of the finest apple orchards in the East. 180 acres planted to four leading commercial varieties, eight to twelve years old, on railroad twenty-four hours from Pittsburg, New York, Philadelphia, Washington or Baltimore. Orchard has had the very best care since planting and is located in the beautiful Shenandoah Valley of Virginia. Failing health compels owner to sell. This is a very high class proposition and will require considerable cash to handle, but excellent terms can be had on the balance. Address owner. **Box 126, Winchester, Virginia**

WANTED
A gentleman versed in organization, finance, accounts and management, with nine years' experience in the fruit business, California and Northwest, desires a connection with parties requiring such experience. Address
P. D. SPENCER
Sheridan Hotel, Telluride, Colorado.

Nice Bright Western Pine
FRUIT BOXES
AND CRATES
Good standard grades. Well made. Quick shipments. Carloads or less. Get our prices.
Western Pine Box Sales Co.
SPOKANE, WASH.

Apples and Pears
For European Distribution



Gerald Da Costa

Long Acre, Covent Garden, London
Cables: "Geracost, London." Codes: A. B. C. 5th Edition and Private

STRAWBERRY PLANTS
Etterberg 121, Best Shipper and Canner. Also Wilson and Gold Dollar. Thrifty, well rooted plants, dug fresh as ordered. Low quantity prices.
WARD K. RICHARDSON
2379 Front Street, Salem, Oregon

NOW is the time to send to
Milton Nursery Company
MILTON, OREGON
FOR THEIR 1919 CATALOG.
FULL LINE OF NURSERY STOCK.
"Genuineness and Quality"



3,000,000 Apples, only 7 with Scale

Mr. D. P. Miller, Supt. Sumner Fruit Co., Worcester, Mass., said he found about seven apples with scale out of a crop of 3,000,000 after spraying with S-W Dry Lime Sulfur. "In our six years of using your materials,

I have found your claims to be modest and fully met by the results we obtained. I am simply not interested in other brands. It is a pleasure to leave our spraying troubles all in your hands."

The Complete Line of Sherwin-Williams Insecticides and Fungicides is Now Sold in *Dry Powdered Form*

This saves buying tons of water and saves paying heavy water freight. It saves much loss by leakage and freezing and saves deterioration; all unused powder keeps over in prime condition to start next season's work. S-W Dry Insecticides haul light, mix right on the

spraying ground and work fresh at full poisoning power. They give the greatest solubility, bulk, suspension and fluffiness. Also the greatest uniformity of strength, extreme fineness of cover and long enduring adhesiveness.

S-W Dry Powdered Lime Sulfur

is in every respect equal to the liquid spray formerly used. It is the regular standard 33-degree Baume article in dry form, and therefore does everything the liquid can do. But it has many advantages peculiar to

Sherwin-Williams formulas and methods of manufacture. These advantages result in quicker and more thorough mixing, greater bulk, much longer suspension and longer duration of its killing power.

S-W DRY LIME SULFUR has by actual tests proven as effective as lime sulfur solution in the control of San José, Oyster Shell and Scurfy Scale, Blister Mite, Red Spider, Peach Leaf Curl, Peach Blight, Apple and Pear Scab and Brown Rot on plums and cherries.

Sprayers' Manual Free

This book is a complete encyclopedia of the newest methods of increasing yield, bettering grade and commanding highest market prices for fruits and vegetables. It gives valuable charts, schedules and information telling what, when and how to use the most efficient poison for every variety of pest or disease, on all garden and orchard growths. Address: The Sherwin-Williams Co., 602 Canal Road, N. W., Cleveland, O.

Combined Summer Spray

S-W Dry Powdered Lime Sulfur and Dry Powdered Arsenate of Lead mix with the greatest effectiveness as a combined spray for spring and summer use on apples, plums and cherries.

SHERWIN-WILLIAMS PRODUCTS

PAINTS AND VARNISHES, DYESTUFFS
PIGMENTS, CHEMICALS

INSECTICIDES, COLORS, DISINFECTANTS
AND WOOD PRESERVATIVES



F 117

Nails Retard Growth of Cherry Trees

Editor BETTER FRUIT, Portland, Oregon:

I am sending you a photograph of a Lambert cherry tree which has failed to make a satisfactory growth. Out of a planting of one hundred trees sixty or seventy show this same defect in a greater or less degree. The graft was made at the point indicated by the finger. In all the trees which failed to make a satisfactory growth there is a decided contraction in the trunk just above the graft. One tree had an open "sore" at that point and on investigation I found that the graft had been



Nine year old cherry tree showing poor growth and contracted trunk where graft was fastened with brad.

made secure by an iron band. Apparently the brad had been driven into the stock and the scion impaled on the upper end. In the tree just mentioned the effect of the rusting brad was to deaden and blacken the heart wood.

The tree shown in the photograph has been planted nine years and a comparison with the size of the hand shows clearly what a poor growth the tree has made. Every spring the trees would leaf out perfectly and appear all right until the dry weather came on. Then

the leaves would dry up, wither, and fall off. The branches made little if any growth and such fruit as did set did not mature properly. Only about three of the one hundred trees set out have died. I am quite fully convinced that the rusting of the brads, when the stock was small, destroyed the wood to such an extent that the passage of the sap was restricted.

This conclusion is borne out by an experiment I have made. For the purpose of pollinization I grafted onto the branches of quite a number of the trees another variety of cherry. This fact was very evident. On the trees that were growing well the grafts grew well also. On those which were not growing the grafts, though apparently set perfectly, made no growth. Two of the trees which had scarcely made any growth since setting out I cut off below the old graft and made the new graft on the trunk. Both of these made enormous growths compared to the others. This last season a great many of the trees had some very fair fruit on them and they stood the dry season better. I attribute it to the fact that they are getting of such a size that at the point of graft there is sound wood sufficient to protect the ascending sap from the effects of the rusting brads.

GEORGE B. COUPER.

Advices New Methods in Apple Handling

J. H. Dengal, Wenatchee district manager for G. M. H. Wagner & Sons, who recently returned from an extensive tour of the big eastern apple distributing cities, and who also attended the convention of the National Commission Merchants and Vegetable Shippers, in an interesting interview in the Wenatchee Advance calls attention to some very important phases of the apple industry which developed this year and advises new methods to combat them.

"The apple growing industry," said Mr. Dengal, "is now passing through one of the most critical periods in its history. The present season has been a disastrous one, not only for the shippers at this end, but for receivers at the other. In the first place the eastern distributors paid an abnormally high price for their apples, then the earlier

varieties failed to arrive at a seasonable time, and finally so many of them were frozen when they did arrive that the entire deal has been unsatisfactory and unprofitable.

"In order to preserve the box apple industry in the future it is absolutely necessary to secure better transportation, and more adequate warehouse facilities, both here and at eastern distributing points. It is also essential that some method be devised for shipping the various varieties of apples out at the proper season. In other words, Winter Bananas, Jonathans, King Davids and Delicious should all be moved out of the district first, followed by other varieties in seasonable rotation.

"However, there is much consolation to be gained from the fact that the railroads, the shipping and the distributing organizations and many other interests are working together for the purpose of solving these problems. In fact every one connected with the fruit industry seem to be interested in saving the situation except the grower. However, there is reason to believe that the growers will also wake up and take a hand in the game before this season is over.

"A plan is now under way to form a big holding company that will build many thousand refrigerator cars and lease or rent them to the railroads as needed. The railroads are cooperating in every way with this movement. Another big corporation is preparing to erect a large number of cold storage warehouses at producing points as well as in the distributing markets. Both of these plans have advanced to the stage where they seem to be assured."

Trimming Berry Bushes

If you have not done so, cut out all the old canes of raspberries which bore fruit last year and burn them so as to destroy any diseases and eggs of immature insects that are on them. The old canes if left, will rob the new shoots of much nourishment. When the new shoots reach a height of three and a half inches pinch out or cut off the growing tip to cause the shoots to branch. Cut out also all of the weak shoots, leaving only the strong ones. Blackberry bushes should be given the same treatment.

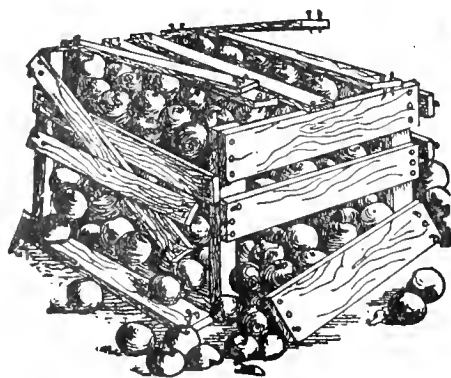

BEFORE using Cement Coated Nails

Western Cement Coated Nails for Western Growers

Our Cement Coated Nails are always of uniform length, gauge, head and count. Especially adapted to the manufacture of fruit boxes and crates. In brief, they are the Best on the Market.

Write for Growers' testimonials.

Colorado Fuel & Iron Co.

DENVER, COLORADO

Pacific Coast Sales Offices
Portland, Spokane, San Francisco
Los Angeles

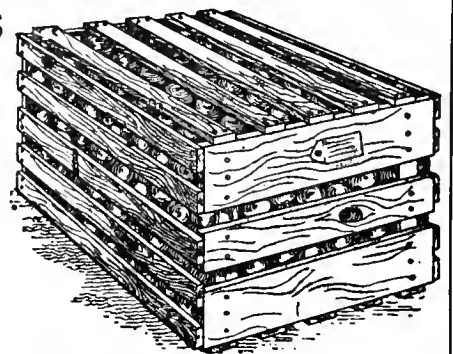

AFTER use of C. F. & I. Co.'s Cement Coated Nails

Timely Topics and Advice for the Fruitgrower

The high cost of copper, which is an essential ingredient of bordeaux mixture has led the Bureau of Entomology and Chemistry of the United States Department of Agriculture to experiments to determine whether a bordeaux mixture can not be prepared which will not be more effective for each unit of copper present than as usually prepared, thus resulting in a saving of this expensive constituent of this mixture. Studies will also be made of the manufacture of Paris green, lead arsenate and other compounds of arsenic. No systematic studies of all the compounds of arsenic that might be useful in spraying have been made and it is thought probable that such a study will lead either to the development of cheaper sprays, because the constituent elements are cheaper or to sprays that are more effective than the sprays now used.

Grapes should be pruned during the dormant season, but early enough in the spring to avoid bleeding, this is before the sap rises sufficiently to flow from the wounds. A common hand pruning shears is good for the work.

Prof. H. P. Barss, Plant Pathologist of the Oregon State Experiment Station advocates the pruning of fruit trees to aid disease control and to accomplish this says that fruit trees should be pruned so as to let light and air into the interior of the trees when in foliage. This can be accomplished by a judicious thinning out. Mere heading back will tend to promote a dense crown of foliage which will exclude light and prevent rapid air circulation within the tree, so necessary from a production standpoint but also to assist in keeping down many infections in such diseases, as scab, brown rot, or leaf spot diseases. These troubles come from spores that require the continued presence of moisture on the surface of leaves or fruit to germinate and infect. Open pruning tends to promote rapid drying off within the trees and makes it more difficult for the spores to start.

Anthrachnose of cane fruits, such as raspberries, blackberries, loganberries, etc., which prevents the plants from sending out fruiting branches except at the top, appears in chocolate brown spots on the new canes and spreads and kills the buds. To control this disease the new canes should be sprayed when about 16 or 18 inches high with bordeaux mixture 3-3-50; again about two weeks later and once more before picking time, this last spray to be applied usually between May 20 and June 15.

In commenting on the inoculation of leguminous seeds Ethelbert Johnson, Technical Assistant, Division of Plant Industry, of the California State Department of Agriculture says that a frequent assertion is that inoculated seed will give far greater yields than ordinary seed. Under certain conditions this is true. All leguminous are capable of harboring on their roots certain organisms which have the power to utilize nitrogen from the air transforming it into a form available to the plant. As nitrogen is a valuable plant food, and one in which soils are generally deficient, a legume will make a much larger growth when these organisms are present, and because of the added supply of available nitrogen in the soil, the crop following the leguminous crop will be benefited. Moreover, when the soil is low in available nitrogen, if the proper organisms are not present in the soil, it will usually be necessary to introduce the organisms in order to get the legume well started. If inoculated seed, therefore, is planted in soil in which the bacteria are not present, it will undoubtedly make a better growth than seed not inoculated. If, however, the bacteria were already present in the soil, the growth would be the same whether the seed were inoculated or not.

W. H. Wicks, director of the Idaho Bureau of Plant Industry in an article in the Weekly Markets Bulletin remarks that pruning should be begun in time to have it well finished before any spraying is done. It is a loss of labor and material to spray wood which is later to be removed, and, above all, the most thorough spraying is not done on trees improperly pruned. In large projects it is necessary to start pruning in late fall and continue at all times when the wood is not frozen, in order to finish before the first spray is applied.

Whenever the limb of a tree is blown off or becomes diseased, the stump should be sawed off even and painted with creosote or tar paint; otherwise decay will set in and spread to other parts of the tree. Oftentimes even a

nail hole will so injure the bark that it will come off leaving the wood underneath unprotected. If these spots are left bare, decay will set in and seriously endanger the tree. A coat of creosote or tar paint will prevent spread of decay and gradually the bark will grow over the bare place again.

The fruit of plums, prunes and cherries is subject to brown rot. This spreads from fruit to fruit in the tree and often becomes very destructive, especially to prunes. The color of this rot is distinctly brown and affected fruits are soon covered with a dusty dark grayish powder which is a mass of the spores causing the disease. Effective treatment for brown rot consists in spraying with bordeaux mixture 1-4-50 or self-boiled lime and sulphur 8-8-50 as follows: 1. Just before the blossoms open. 2. Just after the petals fall. 3. About two weeks later and again about a month before the fruit is ripe, omitting the last spray for cherries. A very beneficial practice also is to pick off all rotting fruit as it appears and later to pick off all the dried up fruit which remains clinging to the tree and burn it. Plowing the ground around the trees just before they blossom will destroy the fruiting stage of the fungus which grows out of the old fruit on the ground at that time.

To save apples for the market that have not been too badly frozen they should be covered with some material that will keep the air away from them and allowed to thaw slowly. Be careful to avoid handling them while they are in the process of thawing. The best method is to place the apples where the temperature is cold, but below the freezing point and then covering them over with some material that will exclude the air as much as possible.

Skookum Association Plans New Methods

As the result of a three days' meeting of the Skookum Packers' Association held at Seattle during the latter part of February to discuss better methods of marketing Northwest apples, it is stated that Washington orchardists will endeavor to secure the use of the Crown storage spaces, which will give control and housing of 60 per cent of the state's apple crop and regulate the returns to

growers. To bring this about the executive committee of the Skookum Association was directed by a vote taken at the meeting to open negotiations and report.

Changes that it is expected will be beneficial to apple marketing operations were brought to the attention of the Washington growers after listening to an address on the subject made by Aaron Sapiro, attorney for a number of cooperative fruit marketing associations in California.

Other measures contemplated after listening to Mr. Sapiro will include the building or lease of a central cold storage plant from which the apples will be shipped from time to time when the demand in the Eastern markets is favorable.

Among those who spoke at the meeting were A. R. Rule, vice president and general manager of the North American Fruit Exchange, W. F. Gwin, general manager of the Northwestern Fruit Exchange, and J. Curtis Robinson, traffic manager of the Northwestern Fruit Exchange. Mr. Rule, in his talk on cooperation, said that there were just as shrewd business men running orchards as were to be found in the marts of trade, but that the orchardist naturally centered all his energies on production, and that he must be aided by skilled selling agencies to market his product for him. This he said could be done at a small per capita expense through cooperative organizations.

Mr. Robinson, in showing how the shipments of Northwest apples were increasing, reported the shipment of 27,083 cars of apples from this district this season, as against 70,795 cars in the entire United States. This, he stated, shows an increase from the Yakima Valley of 32 per cent and from Wenatchee of 17 per cent over the preceding year.

Ridley, Houlding & Co.

COVENT GARDEN, LONDON

WE ARE

Specialists in Apples and Pears

CABLE ADDRESS: BOTANIZING, LONDON

Codes: A. B. C. 5th Edition and Modern Economy

"Year 'round—it serves
willingly and worthily—"

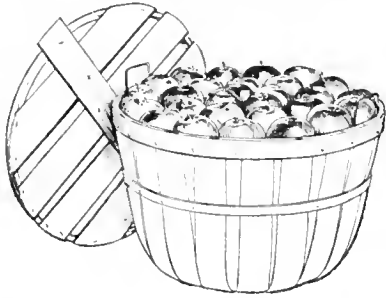

Universal Bushel Shipping Packages

Every day in the year the **Universal Bushel Shipping Package** guarantees the grower that his fruit and produce will reach the market in a splendid condition—bringing the highest price.

The sturdy center post running from bottom to cover in the **Universal Bushel Shipping Package** permits fruits and vegetables to be stacked in cars, trucks, or cold storage houses, without injury to contents.

Send for sample with this center post and cover. Send only 25c in coin or stamps to cover part of mailing expense.

Package Sales Corporation

106 East Jefferson Street South Bend, Indiana

Apple Seeds for Sale

Washington Dehydrated Food Co.
Yakima, Washington

Everything for the Garden

*Seeds
Trees
Bulbs*

1920 160-page Catalog Free

**Routledge
SEED & FLORAL CO.**
145 147 2nd St. PORTLAND ORE

What They're Doing in California

The plant introduction station of the United States Department of Agriculture at Chico is engaged in sending out 225,000 plants, shrubs, and trees of all kinds to nurserymen and other agriculturalists interested throughout the country. These plants have been gathered from all parts of the globe and propagated at the Chico station. They are now being sent out for trial to other parts of the country. No charge is made for these plants but the Chico station sends them out only on orders from the Department of Agriculture at Washington, D. C.

There are 15,000 tractors operating on California farms, according to L. J. Fletcher of the California Tractor and Implement Association. They have displaced 150,000 horses, he estimates.

Many young fruit trees are being set out in El Dorado County, principally Bartlett pears, prunes, plums, apples and peaches. Three water users' associations have been organized in El Dorado County for the purpose of securing better service from ditch companies. A big output of box shook and lumber is expected from this county this year. The lumber enterprises are getting their plants into shape. One firm, putting out box shook, has bought 1000 acres of pine timber on Plum Creek.

A project has been evolved to make use of the abandoned road houses which line the main highways throughout California and to turn them into fruit stands where ranchers can place their products on display to be sold to motorists who pass the places where they formerly stopped for liquid refreshments. The plan will be taken up at once by the automobile association and steps will be made to interest the ranchers in the project. At many places already the children of the ranchers may be found lining many of the highways peddling fruits and flowers to autoists.

Thirty-five dollars per ton is the price being offered for the coming season's wine grapes, in portions of the Sacramento Valley. It is planned to dry the grapes.

The value of 1919 soil and oil production for Orange County just compiled totals \$77,152,500. The Orange County walnut crop just harvested totals \$5,750,000 in value; the orange crop (90 per cent Valencia) represents a value of \$12,000,000 for 1919 and the lemon crop was worth \$3,500,000.

Fig growers of California are the latest to take steps toward perfecting a cooperative marketing association. The proposed organization will include growers who ship both dried and fresh figs and will embrace all sections of the state where figs are grown. The headquarters of the organization will be at Fresno.

The dried persimmon is the newest dried fruit to be commercially packed in California. After experiments lasting three years a process for drying persimmons has been perfected and they will be put on the market for the first time this year. The fruit is dried without additional sugar and when thoroughly processed is said to have the combined flavor of the date and the fig.

Raisin growers of California are jubilant over the success attained during the past year in drying raisins by the dehydrating process. They now feel that the safety of the raisin crop no longer depends on the weather. During the past year raisins that were only partly dried before the early rains came were taken to dehydrators and turned out as the finished product, without loss in quality.

Bits About Fruit, Fruitmen and Fruit Growing

Among the fruitmen from the Northwest who were in attendance at the meeting of the Western Fruit Jobbers at San Francisco were W. E. Nelson of the Wenatchee Northern Warehouse Company, D. L. Oliver, of the Clarke-Oliver Apple Company of Wenatchee, Washington, W. F. Gwinn, J. Curtis Robinson and J. B. Adams of the Northwestern Fruit Exchange of Seattle, C. W. McCullagh, sales manager of the Hood River Apple Growers' Association and R. H. C. Wood of Portland. Mr. Wood reported on his return that dealers were of the opinion that the price of apples must come down before they can be moved to the best advantage of both grower and dealer.

During the past month advices from the East were to the effect that the fall in foreign exchange has greatly reduced the export shipments of dried fruits. Should this situation continue long it is expected that the reduction in foreign shipments will affect prices very materially for domestic consumption. With the exception of raisins the market for other dried fruits such as prunes, peaches, pears and apples is reported dull.

As a result of the quarantine established on foreign nursery stock by the United States Agricultural Department the amount of stock requiring inspection by state officials has been greatly decreased. Action recently taken by the department is expected to further extend the quarantine, making the shipments still more limited.

Clinging to his faith in the Ben Davis apple, Louis Erb, one of the largest growers in the Ozark district of Missouri, says that notwithstanding the opinion of an unthinking public, this apple is just as good as it used to be. He opines that the Ben Davis has been decried by all sorts of people who don't know a good apple when they see it or taste it and that it will hold its own with other varieties in the future. In winding up his eulogy of this much abused apple Mr. Erb states flat-footedly that no matter what may be the case elsewhere the Ben Davis is the best variety to grow in Missouri.

Replying to a recent rumor that the selling agency of the Oregon Growers' Cooperative Association was to be assigned to the Northwestern Fruit Exchange, C. I. Lewis, organization manager of the growers' association emphatically denied that such was the case and asserts that the organization will have its own sales force and will sell its output under its own brands and through its own connections. Mr. Lewis stated that Robert C. Paulus, sales manager of the organization at the time the rumor was afloat was in the East, making selling connections and that the entire force was engaged in working out the original policy of the organization to harvest, store or ship and sell all the products that would be handled by the association under brands that would make Oregon fruits a household word everywhere.

The national prohibition law, which makes the sale of fruit juices containing more than one-half of one per cent alcohol unlawful, it is feared will deal a death blow to the cider making industry which flourished this year as never before and resulted in securing for growers a much higher price for their cull apples. Managers of cider making plants state that unless the law is modified, cider such as the public wants to drink cannot be manufactured. Due to the fact that prohibition stimulated the consumption of cider greatly, it is figured that 60 per cent of the 1919 cull apple crops in many orchard districts were utilized in making this beverage.

H. F. Davidson of Hood River, an extensive grower and handler of Northwest apples, calls attention to the fact that one of the most serious things confronting the sale of Pacific Coast apples is that cars which are being used in connection with a heater service have a style of heater that is generating a gas that gives the apples an unpleasant flavor. He says that many consumers of Northwest apples are complaining of the apples being flavored with coal oil smoke and are discriminating against them in favor of Eastern fruit. He advocates that either the heater service must be changed or some other method provided for transporting Pacific Coast apples so that they will arrive at their destination in the best condition. The car shortage he emphasizes has resulted in a loss to growers and shippers of such a large sum that it would be sufficient to construct a large number of refrigerator cars. As a result of this shortage Northwest apples were very much delayed in getting into consumption and consumers resorted to other fruits.

Robert L. Ringer, for three years in charge of the Portland office of the United States Bureau of Markets, recently resigned to accept a position with the Federal Farm Loan Bank as farm loan appraiser in the Oregon district. As head of the Portland office of the Bureau of Markets Mr. Ringer rendered efficient service to the fruit growers and shippers of the Northwest and his retirement is to be regretted as is also the announcement that the service is to be discontinued in this district.

*Our labels illuminate your goods
attracting the attention of the consumer*

Our labels are
thoughtfully
planned
and
carefully
executed



LABELS

Quality plus service
is our basis of value

SCHMIDT LITHOGRAPH CO.
SEATTLE - LOS ANGELES - FRESNO
PORTLAND - SACRAMENTO - HONOLULU
SAN FRANCISCO

Fruit Box Supply for 1920

Continued from page 14.

The meeting also discussed standard packages and the necessity for establishing a shock tariff to include specifications for all packages, standard and uniform footage for these packages with a view of bringing the manufacturers to a uniform basis in figuring stock required for production. It was found that various manufacturers in figuring the same box have varied as much as 10 per cent in their footage computation. It was decided to refer the matter of uniform footage to the separate associations.

Bees and Beekeeping

Next to disease in the colony, cold cellars are the biggest single cause of loss to beekeepers in climates that have cold winters according to H. F. Wilson, in charge of the Wisconsin Experiment Station Apiary. Too rapid use of stores, dysentery and mold on the combs may all result from a cold cellar. Cold cellars are always damp ones, because, as the temperature in the cellar falls, the bees produce more heat and the temperature in the cluster rises, more moisture being given off. This is especially true when the cellar temperature is as low as freezing. The production of more heat not only uses up more stores but, if the stores are had, the amount of refuse matter in the intestines of the bees is so increased that dysentery may result. The cold,

damp air causes moisture to collect in the hive and not only makes life miserable for the bees but develops mold on the combs and creates a general bad condition. Whether or not bees winter best in cellars makes little difference just now, according to Mr. Wilson. The point is that a poor cellar is almost as bad as none at all, and in some cases it is worse. In order to get the proper temperature around the cluster, 57 degrees or a little above, the bee cellar should be kept at a constant temperature of about 50 degrees. Any temperature below 40 degrees is too low and if the cellar is cold enough to permit frost on the walls the winter loss is greatly increased. Ventilation in the bee cellar is important only as it regulates the temperature, says Mr. Wilson. When bees come out of the hive and fly around it is likely to be due to either light or dysentery, certainly not to need of air. In fact, bees winter best in cellars where ventilation is provided only when the temperature rises above 55 degrees.

According to bee experts, bees, buckwheat and berries, with clover and cows on the side, are the three best bets for the fruit grower or farmer on light, sandy soils. Strawberries, raspberries, blackberries, clover blossoms and buckwheat are advocated for the bees and the market. The clover hay can be fed to the cows, while the clover seed and buckwheat can also be marketed.

Boys' and girls' bee clubs under the direction of a beekeeper as teacher are now being advocated in the public schools. The first club of this kind was organized recently in Wisconsin. The club now has eleven members, each of whom has from one to five colonies of bees. A prize will be offered for the best production of honey and care of the bees.

May had a swarm of bees,
Who just to save their lives,
Went everywhere that Mary went,
Because she had the hives.
—American Bee Journal.

One hundred and thirty-five colonies of bees with an average production of 185 pounds of honey to the colony was the record reported by John Heilman of Oak Point, Washington, from his apiary last year. Other yields reported by beekeepers in Washington were 90 pounds per colony. The total amount of honey produced by Mr. Heilman's colonies was 25,000 pounds.

Cannery Notes

The canned fruit pack of California exceeded that of 1918 by 4,753,676 cases. The number of cases of fruit put up in the state in 1919 were: Apricots, 4,395,204; pears, 1,071,687; freestone peaches, 1,962,700; clingstone peaches 5,096,249; other fruits, 1,170,563. Total, \$13,696,403 cases.

At a meeting recently held at Toppenish, Washington, attended by representatives of the Libby, McNeil & Libby canning plant and fifty farmers, the canning company discussed a proposal to increase the growing of cucumbers and spinach on the reservation. The company promised that if the farmers would increase the planting of these vegetables 75 to 100 acres that it would install a salting plant on the reservation.

A report from Chehalis, Washington, says that the Chehalis cannery of the Lewis County Canning Association will continue to be operated as an independent organization as originally planned, according to action recently taken. Dan W. Bush, who has been at the head of the local organization since it was founded in 1915, has worked out a plan whereby a number of the leading business men of the city have associated themselves with him in the project, and additional capital will be provided to give it ample financial backing. C. L. Brown, Dr. J. T. Coleman, M. S. Burnett, A. C. St. John, H. C. Coffman, L. H. Sticklin, T. R. Behrend, H. L. Petit, J. M. Slicher, A. E. Pollom and Hans Johnson, in addition to Mr. Bush and Carl V. Huber, will be heavily interested in the new plans, it is stated.

The gross sales of the canneries operated by the Eugene Fruitgrowers' Association at Roseburg, Oregon, in 1919, amounted to \$889,556.24, and the total number of cases of canned goods put up was 80,576. Fresh fruit totalling 32,944 boxes was sold; 266,465 boxes were manufactured by the box factory and 25,000 gallons of vinegar made by the vinegar plant. The total amount of fruit and vegetables canned and dried by the association was 6,507,391 pounds.

Although the canning and processing plant erected at Sutherlin, Oregon, last year was believed to be large enough to handle the output of that district for some time, Frank J. Norton, manager of the Sutherlin Fruit Products Company, announces that it is too small for the developing business. The result is that the directors of the company have just authorized the building of an additional structure that will be 60x100 feet, which will provide more space for the cannery and also additional room for another drier.

DIAMOND QUALITY

SEEDS

For 1920 Plant Only The Best—



The increased cost of farming makes necessary the careful selection of seeds—improved varieties that produce profitable crops.

A Safe Guide to Quality and Fair Price

Our Seed Catalog and Planter's Guide is the standard reference for growers of the Northwest, listing our complete lines of Seeds, Trees and Plants, Fertilizers, Poultry and Bee Supplies, Sprays and Sprayers, Dairy Supplies and Equipment.

Agents
"CORONA" Arsenate of Lead—
GOULDS SPRAY PUMPS—
SCALECIDE, Miscible Oil Spray—
 Spray materials, Pruners and Orchard Supplies for every requirement.

Your Name should be on our Mailing List
 ASK FOR CATALOG No. 200

Offices and Salesroom
 S.E. Cor.
 Front and Yamhill
 Sta.

PORTLAND SEED CO

PORTLAND, OREGON

Warehouse
 East First
 Alder
 and
 Second
 Sta.

WHEN WRITING ADVERTISERS MENTION BETTER FRUIT



5 GREAT NOVELTIES
20 cts. The glorious crimson **Woolflower** recently introduced by us has succeeded everywhere and proved to be the most showy garden annual. Nothing can surpass the mass of bloom which it shows all Summer and Fall.

We now have three new colors—pink, yellow and scarlet, as well as crimson. All these colors mixed. **20 cts. per pkt.**

With each order we send 1 trial pkt. each of **Giant Kochia**, most decorative foliage annual.

Salvia Hybrids, white, pink, striped, scarlet, plumed, etc., mixed.

Japan Iris, new hybrids, all colors. Magnificent.

Giant Centaurea, superb for garden or vases.

And our Big Catalog, all for 20 cts.

Big Catalog, free. All flower and vegetable seeds, bulbs, plants and new berries. We grow the finest Gladioli, Dahlias, Cannas, Irises, Peonies, Perennials, Shrubs, Vines, Ferns, Peas, Asters, Pansies, etc. All special prize strains, and many sterling novelties.

JOHN LEWIS CHILDS, Inc. Floral Park, N.Y.

WHEN WRITING ADVERTISERS MENTION BETTER FRUIT

Cultivating the Prune Tree

Continued from page 12.

prunes, are borne only on vigorous trees. In analyzing the wood of a typical prune tree, from 12 to 15 years of age this condition is generally found:

"First—There are a number of watersproutlike growths, or vigorous shoots springing from the main branches. Thus, these growths are always upright. This wood has a wonderful future.

"Second—There is a great deal of wood in the tree which grows out more or less horizontally, or is beginning to droop slightly. This wood has a wonderful past and a fair present, but has no future.

"Third—The remaining wood of the tree is a mass of drooping branches, crooked and weak, which analysis shows, has no present, and no future, but a wonderful past.

"In pruning our trees, we should encourage the new watersprout-like growths, by removing the wood near them, so that the long shoots can develop. Head back these long shoots, so that they will force out new laterals. In this way we are renewing the tree every few years, and this renewed wood will produce lots of prunes and big prunes. Wherever the horizontal type of growth interferes with the vertical type, it should be removed. The drooping wood is of little or no use. It should be largely removed. By thinning out from 25 to 50 per cent of it, the remainder can be somewhat reinvigorated and at times made productive.

"One of the quickest and cheapest ways of removing this old wood is to put on old gloves and break out the old wood in that way. One is soon able to tell very quickly by the feeling of the wood and will thus know what to leave and what to take out."

Quarantining Foreign Fruit Stocks

In order to prevent the entrance of a number of plant diseases and injurious insects from the Orient, the United States Department of Agriculture proposes to prohibit the importation of fruit stocks, cuttings, scions and buds from Asia, Japan, the Philippine Islands and Oceania. The diseases and insects that the department seeks to exclude by the quarantine include Japanese apple cankers, blister blight, and rusts, the Oriental fruit moth, the pear fruit borer, and the apple moth.

Tractor Demonstration Successful

At a tractor demonstration made at Hood River recently participated in by the agents for the Cletrac and Frageol, both these types of machines made a most creditable showing. The demonstration took place under adverse conditions, the soil being wet and muddy. All the tests, which were severe, were successfully carried through. As a result of the demonstration added interest in the tractor and additional purchases by orchardists are reported from the Hood River district.

When purchasing fertilizers, remember in
1919

Nitrate of Soda

received the stamp of approval of the U. S. Government, whose agents aided in the direct distribution of this plant food amongst farmers.

Why?

Because Nitrate of Soda has been found the best and cheapest source of Nitrogen, so essential to plant life. Nitrate of Soda contains 15% nitrogen—18% ammonia.

Immediately Available

As to the quantity and method of application, consult your County Agricultural Agent or write

The Nitrate Agencies

805 Hoge Building
Seattle, Washington



Eventually

*if you spray
with a "gun"
you will
get*

A HARDIE

The Hardie Mfg. Co.

55 North Front Street, Portland

THE CROP AND THE TREES

EACH is important. The crop for this year's income. The trees for your permanent income. You cannot afford to take chances on either.

Our interests are mutual. When you prosper we benefit. It is to our advantage to have you produce plenty of fine fruit.

For many years we have carefully and conscientiously studied fruit and tree pests. Our scientists in the chemical laboratory, and in the fruit orchards, have by research, experiments, tests and demonstrations proved what is necessary to eradicate these troubles.

Our final analyses determine beyond doubt that Orchard Brand Dry Powdered Arsenate of Lead is the surest protection.

There is a carefully prepared booklet dealing with the subject fully and in detail. A copy will be cheerfully sent you upon request.

Other spray materials, for specific purposes, we recommend are:

Orchard Brand Dry Powdered Arsenate of Lead.

Orchard Brand Arsenate of Lead, Standard paste.

Orchard Brand Atomic Sulphur (patented).

Orchard Brand Bordeaux Mixture paste.
Orchard Brand Powdered Bordeaux Mixture.

Orchard Brand Lime Sulphur Solution.

B T S Dry Sulphur Compound (patented).

Orchard Brand Weed Killer.

Universal Brand Dormant Soluble Oil.

Universal Brand Miscible Oil.

Universal Brand Distillate Oil Emulsion.

Liquid Whale Oil Soap.

Our interests are the same as yours. Write us about your tree troubles, and ask for Bulletin No. 3 on Dormant Spraying of Deciduous Fruit Trees.



General Chemical Company
770 Royal Insurance Building, Department A
SAN FRANCISCO, CALIFORNIA

The Currant and Gooseberry

Continued from page 10.

Varieties

Currants—For commercial plantations, vigorous, erect-growing productive varieties should be chosen. The more acid variety should be selected for jelly making and the milder varieties for dessert uses. The fruit should be large and firm and borne in compact clusters. Deep red varieties are pre-

ferred for the Pacific Coast. The varieties mentioned are only suggestive. In certain localities in the regions specified other varieties may be better adapted. The Fay, Perfection Cherry, White Grape, Red Cross and London have been found entirely hardy in North Dakota and should be hardy anywhere in the United States. Most growers prefer to plant one or two varieties. If two varieties are used, an early and a late one are selected.

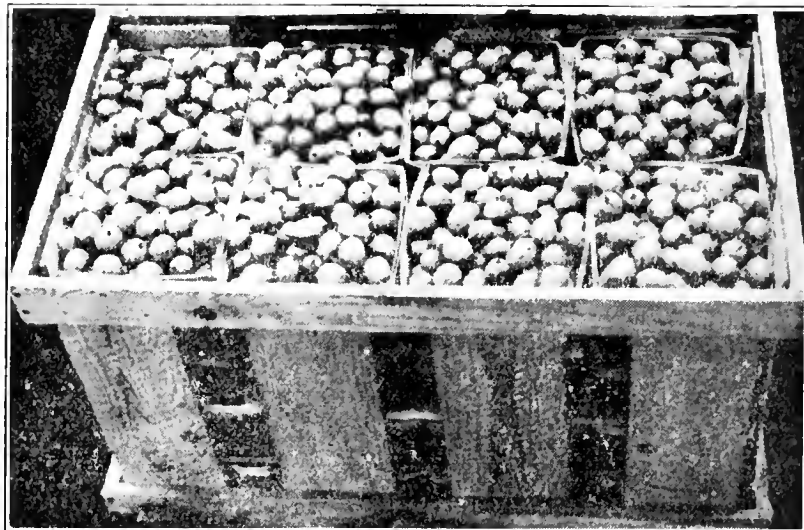

A 32-quart crate of Columbus gooseberries grown at Middlehope, New York, considered one of the most desirable of the European varieties.

ferred for the market. For dessert use in the home, the white currants are considered the best.

The following varieties are suggested for the sections named: Perfection, Wilder, Red Cross, and White Imperial for the northeastern part of the United States; London (London Market), Wilder, Red Cross and Perfection for Michigan and other parts of the Middle West; Perfection, London (London Market), Wilder, Red Cross, Fay and Vie-

Gooseberries

As already stated the American varieties of gooseberries are usually the most productive, are hardier and are considered by most Americans to be of better quality. The Downing, Oregon and Poorman are considered some of the best American varieties. Some of the best known European varieties which are larger and sell at a higher price than the American varieties are the Chautauqua, Columbus, Portage, Triumph, Industry, and May Duke.



WHAT EVERY HOME CANNER SHOULD HAVE

ONE of our **H. & A. Hand Power Double Seamers.** It is the only hand power seamer built that will seal all sizes of sanitary fruit and vegetable cans. Write for prices and descriptive matter to Department T.

HENNINGER & AYES MFG. CO., Portland, Ore.
Builders of Seamers and Steam Pressure Canning Outfits

G. L. Davenport

Grower and Shipper

MOSIER, OREGON

MAIN OFFICE

147 Front Street, PORTLAND, OREGON

BELL & CO.

Incorporated

WHOLESALE

Fruits and Produce

110-112-114 Front Street
PORTLAND, OREGON

Write us what you have to offer — Car lots or less

Commercial Fertilizers

Continued from page 7.

worked out for each district. If the soil is sour it must first be sweetened by the use of lime. The average careful observing fruit grower will have very little difficulty in determining what will be best for his orchard.

In a general way the following suggestions may be helpful in determining the method and fertilizer to use:

1. The physical condition of the soil must be normal.
2. There must be neither a deficiency nor a surplus of humus for the best results with commercial fertilizers.
3. Commercial fertilizers will not give positive results in very dry or very wet soils.
4. If the trees are making a very strong wood growth the probabilities are that there is a surplus of nitrogen already in the soil and that light applications of potash and phosphoric acid are needed.
5. If the trees are bearing light crops and making short wood growths the probabilities are that there is a shortage of available nitrogen in the soil.
6. If the trees blossom profusely each year and fail to set a crop and the other conditions are favorable, the chances are that there is a shortage of nitrogen in some form.



Cabbage patch fertilized with a well known brand of commercial fertilizer. The yield from this patch is reported at thirty-one tons to the acre.

MYERS POWER SPRAY GUN

**ONE MAN DOES THE SPRAYING.
NOZZLES EXTENSIONS AND
FITTINGS NOT REQUIRED.
UTILIZES ENTIRE CAPACITY
OF ANY
POWER PUMP**

Application of spraying mixtures under high pressure with a **MYERS POWER SPRAY GUN** gets results—reaches and penetrates into hidden cracks and crevices—thoroughly covers tree and foliage from base to tip with a powerful spray which literally exterminates scale, moth, scab and similar pests.

A wonderful improvement over former methods—Fast, economical, efficient—and one man does all the work in less time than formerly. Simple as A-B-C to operate. One third turn of handle adjusts from broad to long distance spray or shuts off entirely. Adapted for service with any power spray pump—will utilize its entire capacity. Thousands already in use—meets all requirements successfully. Built in one size only—circular and information on request.

Write
for copy of our new **SPRAY PUMP CATALOG—No. SP20**—just off the press and ready for distribution. It illustrates, describes and lists our complete line of dependable Spray Pumps—Hand or Power—and Spraying Accessories for every spraying service and devotes sixteen pages to "How and When to Spray" Instructions.

**Your Dealer Can Supply You —
If not, we will.**

F.E. MYERS & BRO.

NO. 135 ORANGE ST. ASHLAND, OHIO.

*Rough transportation never riles
The B-D box, it always smiles
At tossing hold or bumping track
And brings its contents up intact.*

Goods delivered promptly and in good condition keep customers satisfied. Exporters are having much trouble at present because containers break open in transit. **Bloedel Donovan** boxes are built to rough it. They have helped solve many shippers' problems.

BLOEDEL DONOVAN LUMBER MILLS
1018 White Building, Seattle, Wash.

Douglas Fir, Cedar, Spruce, Hemlock and Red Cedar Shingles, Box Shooks



In Times of Stress

such as when a man has to make out his income tax return, it is a great help to have kept up a checking account, with its accurate record of expenditures.

The assistance of this bank is given to its customers in business matters which involve more and wider experience than the ordinary individual possesses.

LADD & TILTON BANK

Oldest in the Northwest
PORTLAND, OREGON



7. The grower must remember however, that commercial fertilizers will not do alone what he has failed to do when using all good orchard practices common to the knowledge of man.

Light applications of nitrate of soda on bearing fruit trees have given extra fine results in many sections of the Northwest. Three to five pounds applied before growth started in the spring in many cases has increased the normal crop from two to ten times the first year and shown good increases the

first time and while it gave very promising results the year was so unfavorable that we are in doubt as to its real merits, on our soils, nevertheless the results were so promising that we feel it is very worthy of extended trials.

Blood meal and tankage are excellent fertilizers for all seasons' growth and while not so rapid in action gives excellent results in producing strong long wood growths.

While there is an apparently abundant supply of potash and phosphoric

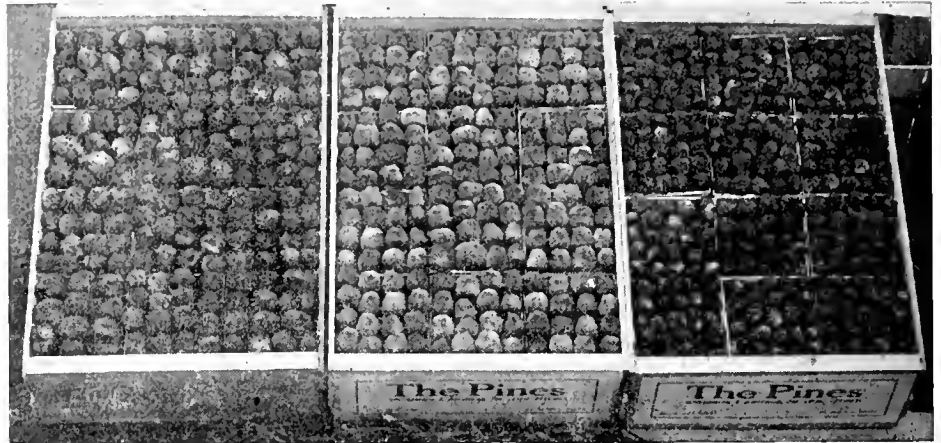

Strawberries fertilized with nitrate of soda, two hundred pounds to the acre. The feature of these berries is their very large size. In tests made at Hood River, Oregon, it was found that nitrate properly applied produced a larger yield and much larger berries.

second and third years. In addition to increasing the yields it has tended to increase the size and color of the fruit very materially. While we normally expected an increase in size we did not expect better color.

The trees showed increase in vigor and gave every evidence of strong response to the fertilizer.

Light applications on garden crops grown for foliage like lettuce, cabbage and spinach gave excellent returns.

With nitrate of soda at less than four cents per pound it is a splendid investment and one that the average fruit man and gardener cannot afford to pass up during these years of high prices of farm produce.

Sulphate of ammonia was tested out in our own orchards last year for the

acid in our soils, in a few instances light applications of these plant foods has apparently improved the quality and color of certain fruit crops; however, very little is known as yet as to their real merits on our soils.

Sulphur or gypsum may be used to advantage on leguminous crops and especially alfalfa and peas when used as cover crops in the orchard where a very heavy green growth is desired. The demonstrations with these fertilizers have given very striking results even on land that was considered rather dry.

All the results that are available at the present time indicate that commercial fertilizers can be profitably used in varying degree by a large proportion of fruit men and gardeners.

Established 1882

F. W. Baltes & Company Printers

WE print anything from the smallest to the largest and always welcome orders of any size or quantity, giving prompt, personal and efficient service.

Mail or phone inquiries are solicited. We do not specialize — experience and equipment enable us to print everything equally well. We render service in preparing copy and illustrations and furnish plans and estimates for catalogs, booklets, publications, billboard and any other kind of advertising.

First and Oak Streets
Main 165; Auto 511-65
Portland, Oregon

HOW ABOUT YOUR TREES FOR SPRING PLANTING?

We grow and "sell direct to planters," through our representatives, a full list of Fruit Bearing Trees, Shade and Ornamental Trees, Nut Trees, Bush Fruits, Roses, Vines, etc. You are not likely to want any good variety that we do not grow.

Have You Arranged for Your Loganberries, Strawberry Plants, or Italian Prune Trees?

Orengo Trees are known throughout the Northwest for their real value to the planter—their early fruiting and dependability. If you want value in trees for your money you'll always plant "Orengo Trees." If you have not provided for the nursery trees you need, why not do it now—while you have the matter in mind. If you don't know just what you want, we'll send you our beautiful and serviceable catalog, from which to make your selection. Just send five cents in stamps for postage.

OREGON NURSERY COMPANY, Orengo, Oregon

LABELS and CARTONS

*designed to strike
the underlying chord
of sales' appeal*

MADE BY



[10-43]

Traung

Label & Lithograph Co.

LABELS and CARTONS

"An institution that sticks to its last"

SAN FRANCISCO - STOCKTON - SEATTLE

Sales Offices Portland - Fresno
Sacramento

Northwest Fruit Notes from Here and There

OREGON

D. F. Fisher, plant pathologist and C. A. Reed, nut expert, both of whom are connected with the United States Agricultural Department report that damage to orchards and fruits generally in Marion County from cold weather is not as great as first thought and that in most instances the trees harmed will recover during the next few months. Mr. Fisher and Mr. Reed will spend two months in examining orchards in various parts of the state.

An unofficial report from Marion County is to the effect that loganberry growers there have been offered 10 cents a pound on contract for their fruit for the coming season. Few of these contracts it is said are being signed as growers expect an unprecedented demand for these berries this year. One large grower is reported to have set the price for his loganberries at 15 cents per pound and states that he will not dispose of them for less.

Shortage of water to irrigate the rapidly increasing fruit crops in the Ashland district is called attention to in the Ashland Tidings, which says that there should be no further planting in that district until growers are assured of sufficient irrigation to mature their crops. A conference of fruit growers in that district has been planned to discuss the situation with a view to taking steps to secure a larger supply of water for irrigation.

The capital stock of the Eugene Fruit Growers' Association was recently increased from \$100,000 to \$250,000 at a meeting of the stockholders. The association, which operates a large fruit packing warehouse, a cannery, vinegar factory, ice plant, box factory, fruit evaporator, and ice cream making plant in Eugene, has besides canneries at Junction City and Creswell. It has 781 stockholders and did a business during the past year of \$949,475.73.

A further examination of Hood River orchards by Leroy Childs, chief of the experiment station at Hood River, and Gordon C. Brown, horticulturist of this institution, for frost damage is reported to show that with the exception of a few isolated spots in the valley the damage will be slight in that district. Or-

chards in damp spots are said to have suffered severely and will need heavy pruning. This treatment, however, will not be applied until late in the spring, when a full opportunity will be given to learn exactly how serious the damage is.

The financial report made at a recent meeting of the Fruitgrowers' Union of Freewater, showed the largest profit in the history of the organization. The tonnage handled by the organization during the past year was the largest in five years. The members of the new board of directors are O. K. Goodman, Fred Elfert, L. A. Reihaman, Gleason B. Clark, A. Coffin, Herbert Tanks and Miss Minnie Kicker. Stanley Armstrong, who has been very successful in the management of the organization, was again selected for this position.

The recent shipment of a carload of Spitzenberg and Newtown apples by the Umpqua Valley Fruit Union located at Roseburg, marks the beginning of a considerable output of apples from this section of Oregon. The shipment came from the orchard of F. P. Wilbur, one of the many good sized orchards that are now coming into bearing in this district.

Blackberry vines in the Albany district are reported to have come through the heavy freeze with little injury and to be putting out buds. Even runners that were supposed to be dead are showing signs of life and a fairly normal crop of this fruit is expected in this district this year.

Jackson County fruit growers, numbering 106, and controlling 4,251 acres of orchards, recently joined the Oregon Growers' Cooperative Association at a meeting held at Medford. The enrollment followed talks made by C. I. Lewis and M. O. Evans, representing the association. A large part of the acreage signed up is in the Gold Hill and Talent section. A committee of representative orchardists was elected at the meeting to represent the association locally and to carry on the extension work of the organization.

Observations made in the Rogue River Valley to determine the amount of frost damage sustained in that section, by C. C. Cate, county

plant pathologist, and Prof. Reimer of the Southern Oregon Experiment Station, lead to the statement that the damage was light and that the situation is very encouraging. Many sections of the valley are reported as not damaged at all. In a few orchards Bosc pears were found to have received more or less injury. Careful attention and a good growing season, however, are expected to restore the damaged trees to their normal condition.

The large acreage of apple orchards in the Sutherlin district is now coming into bearing and shipments from this section will total a large tonnage in the near future. The largest tract in the Sutherlin country was set out a number of years ago by Mr. Luse. Originally it comprised several thousand acres set to standard varieties but has since been split up into smaller tracts. The site selected for this large planting was carefully chosen and good care has resulted in an excellent development. While most of this acreage is in apples a part of it is set to prunes.

According to W. E. Schimpff, manager of the Oregon Cranberry Association, Oregon and Washington growers are looking forward to a good output of this fruit this season. Cold weather resulted in no damage to the plants, most of the bogs being covered with snow while those that were not, were flooded to protect them. The condition of the terminal buds at the present time is said to indicate that a good crop can be expected in the Pacific Coast district this year.

Prospects for the prune crop in the Willamette Valley this year are reported good with the exception of defective trees that did not

Are You the Man?

If so, BETTER FRUIT offers you a chance to make good money

We want a representative in every fruit-growing community. In every such community there is some individual with a little time each month to spare, who, by representing BETTER FRUIT, can make a good income.

Perhaps it will be an elderly man?

A young fruit-grower just getting started?

A wife who wants to help out?

An ambitious boy or girl who wants to make extra money?

We want someone in *your* community to become our *permanent* representative—to secure new subscriptions for us and renew old ones.

We want two or three representatives in the Hood River Valley. Several in Yakima and Wenatchee—in the Willamette Valley, Rogue River, etc. In fact we want *permanent* representatives in every fruit district of the West.

Our proposition is a good one. Are you the man or woman for the job?

Write today, stating your qualifications.

BETTER FRUIT PUBLISHING COMPANY

OREGONIAN BUILDING, PORTLAND, OREGON

**Less Work With The
LIBERTY GARDEN CULTIVATOR**



The perfect tool for all-around garden cultivation. No downward pressure required. The Liberty Hand Cultivator is equipped with a special sickle design of cutting teeth which make quick and thorough work of destroying weeds. The teeth are of unbreakable malleable iron, with sharpened V-shaped cutting edges. Pulverizes top soil into perfect mulch which stimulates plant growth.

GILSON GARDEN TOOLS
(Hand or Wheel Outfits)

A complete variety for intimate garden cultivation. Send \$1.55 for 7 tooth Liberty Cultivator (under money-back guarantee) or have your dealer order for you.

J. E. GILSON COMPANY
Makers of Garden Tools
102 Western Ave.
Port Washington, Wisconsin

Wheel Outfit with 8-inch Weeder Blade

ADJUSTABLE FROM 4 TO 10 IN.

Free Book for the Asking



CUSHMAN

Light Weight Farm Engines

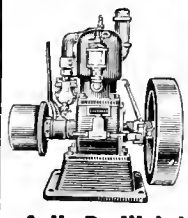

Built light, built right—for farmers who want an engine to do many jobs in many places, instead of one job in one place. Easy to move around. Equipped with Throttling Governor, Carburetor, Friction Clutch, Pulley and Water Circulating Pump. (32)

4 H. P. Weighs Only 190 Lbs.

Mounted on light truck, it may be pulled around by hand. Just the engine for power sprayers because of light weight and very steady speed, giving uniform distribution and a thorough job. 8 h. p., 2-cylinder, for heavier work, weighs only 320 lbs. Book on Light Weight Engines sent free.

CUSHMAN MOTOR WORKS
978 N. 21st Street Lincoln, Neb.
Northwest Branch: 248 Hawthorne Av., Portland, Ore.
Full Stock of Repairs at Portland

survive the December freeze. The number of these trees, however, is reported as negligible. Even in frost susceptible districts the buds were found to be about as hardy as the sapwood, both of which were found to be but little injured.

WASHINGTON

The Selah Fruit Growers, Inc., with a membership of 250 growers has taken over the big cold storage plant formerly operated by the Selah Fruit & Cold Storage Company. The plant has a capacity of 225 cars of cold and 25 cars of common storage and will be under the supervision of S. M. McKee, president of the growers' association. It is modernly equipped, having been built only two years ago. In addition to the recently purchased cold storage plant the organization owns a large warehouse and an evaporator which this season dried 4,000 tons of cull apples.

In a contest that was recently waged in the Yakima Valley to determine the largest returns in that section from one acre of fruit, C. L. Glidden showed a return of \$1,925 from an acre of 12-year-old Bing, Royal Anne and Black Republican cherry trees. In addition to this Mr. Glidden grew \$75 worth of other produce on the same acre. Another claimant for the blue ribbon was Warren F. Flagg, who submitted figures showing that he had sold \$1,703 worth of Winter Nellis pears from a one-acre tract. It was finally agreed, however, that C. A. Westaby, who brought figures showing that he had realized \$1,428 from three-fifths of an acre of Bing and Royal Anne cherries and had sold the cherries loose, eliminating the expense of packing and boxes was entitled to first honors.

The Perham Fruit Co., has announced that it will enter the Grandview fruit field this year and will build a warehouse there unless it is able to lease suitable warehouse space.

E. A. Mansfield, who has leased the warehouse formerly owned by the White Salmon Growers' Association at White Salmon, will enter the strawberry handling field in the mid-Columbia district during the coming season.

The Mt. Adams Farms Co., which has large orchard holdings near Gilmer, Washington, marketed 8,000 boxes of pears last fall that averaged \$2.95 a box. A large quantity of other fruit was also marketed. The company will build two new packing houses this year and install a large amount of new equipment. Five acres will be set out to strawberries this spring.

Young prune and walnut trees in the Washington district are reported to have been severely hit by frost during the winter. The trees that were damaged the most were those that had received intensive cultivation late in the fall and had been kept growing by the fall rains.

A jury at Yakima before whom was tried a suit brought by A. C. Heinie against the Pennington Fruit & Produce Co., to enforce the fulfilling of a contract, split the difference between the contending parties and awarded Heinie damages amounting to \$1,998, one-half the amount sued for. The contention of Heinie was that he had a contract with the produce company to purchase 20,000 boxes of peaches from him at 75 cents a box and that the company refused to fulfill the agreement. Between the time of marketing the fruit and the trial of the suit it was claimed by Heinie that an employe of the produce company had obtained the contract and burned it. The defense of the produce company was that the contract contained an optional cancellation clause.

P. B. Parks of Spokane, general manager of the Skookum Packers' Association, recently returned from a visit to California where he made a study of the operations of the cooperative fruit marketing associations of that state. Mr. Parker is strongly urging the growers of Washington to form similar organizations.

At a recent meeting of the Puyallup & Sumner Fruitgrowers' Association the shareholders adopted a resolution to distribute \$64,000 in profits and accumulated interest. It is expected that the distribution will be in the form of a 10 per cent cash dividend and the balance in stock in the canning company.

The Wapato Fruit & Cold Storage Company recently awarded a contract for the building of an addition to its plant which will be 100x100 feet and will adjoin its present building. The new building will be utilized for packing during the fruit season and for storing boxes and other supplies carried by the

company. It is the intention of the company also to add cold storage to the upper story of their present plant.

The annual convention of the Western Washington Horticultural Association which was held last month was marked by a good attendance and an interesting program. The speakers during the sessions of the convention were M. L. Dean, chief of the Division of Horticulture in the State Department of Agriculture; W. H. Paulhamus and George P. Stuart of Monroe, secretary of the association; J. A. Hays of Tacoma; Prof. R. J. Barnett of the Washington State College; John B. Wiley and Arthur Frank of the Western Washington Experiment Station. Robert T. Reid of Bellevue is president of the association.

In summing up the extent of the frost damage in the Grandview district, District Horticultural Inspector Close says that "cherry

ARE YOU PROGRESSIVE?



Why grow wicked, thorny berries when the Best Berry in the World is absolutely thornless?

NEW THORNLESS MAMMOTH BLACKBERRY

Cory's New Thornless Mammoth Blackberry will be the Great Money Maker of the future. It is the last word in Blackberries.

Unsurpassed in size, productivity, quality—Almost seedless and coreless—Sweet and delicious—Hardy as an oak and smooth as a grapefruit.

Delivered by mail postpaid to any address, one strong plant, 60 cents, 2 for \$1.00; \$1.00 per dozen. Catalogue of other exciting berries and specialties free.

ISAAC F. TILLINGHAST
Seed and Plant Grower SANTA ROSA, CALIF.



The **FRUIT GROWER** says—
"for tree planting
genuine **GIANT** is
most satisfactory"

The Giant Farm Powders—Eureka Stumping and Giant Stumping—loosen and pulverize the soil instead of packing it and throwing it high in the air.

Western fruit growers have used hundreds of tons of these Giant Powders for blasting beds for trees. They have proved that blasting with genuine Giant Powders provides free drainage, increases moisture-storage capacity and insures vigorous growth and early bearing.

"My trees planted three years ago in beds blasted with Giant Powder are 75 to 100 per cent bigger and better than the trees that I planted in dug holes," writes H. H. Smith, Oregon City.

You will enjoy reading "Better Farming with Giant Farm Powders." It describes all the new and money-saving methods of blasting beds for trees, subsoiling established groves and orchards, clearing land, ditching, etc. Write for it now.

THE GIANT POWDER CO., CON.
"Everything for Blasting"
202 First National Bank Bldg., San Francisco
Branch Offices: Denver, Portland, Salt Lake City, Seattle, Spokane

GIANT
FARM POWDERS
EUREKA
STUMPING

buds in most cases appear to be killed. I have found, however, many good buds on all the varieties that are common in this district. I do not look for anywhere near a full crop but there will be some cherries. The same holds true for the peach and pear buds. Winter Nellis and Anjou buds do not seem to be hurt any but the Bartlett and Comic buds seem to have suffered as bad as those of the soft fruits. As was pointed out by E. L. Robertson of the extension department at Pullman, the Bartlett tonnage is very apt to be greatly reduced. I believe the grape stock of our native varieties has not been hurt much. European varieties such as the Tokay and Thompson seedless appear to have suffered. Those varieties are not of commercial importance in this Valley."

The Pacific Fruit & Produce Company has commenced excavation for a new fruit and produce warehouse at Wapato that will be 155x200 feet. The building will be a one-story structure with a full basement 12 feet high, and will be constructed either of brick, concrete or tile. The rapidly increasing business of the company at this point made it necessary to secure greatly increased warehouse space.

A meeting of fruit growers was held at Milton, Oregon, at which Fred Benton of Pendleton, agricultural agent of Umatilla County, and Professor H. Weatherspoon, state

fruit inspector of Elgin, organized the East End Umatilla County Farm Bureau, which will embrace the fruit, stock, hay and grain sections adjacent to Milton and Freewater. The prime object is to eliminate orchard pests.

J. W. Dudley and Sons, managers of the Wenatchee-Stratford Orchard Company, east of Ephrata, estimate their crop of apples for 1918 at 80,000 packed boxes. They have already shipped to market 55 cars and have employed at the orchard from 30 to 78 persons continuously. The 1919 crop has already yielded over \$200,000, with more cars to be shipped.

At the Yakima Horticultural Association's annual meeting, the report of the treasurer, John P. Evans, showed an increase of about 41 per cent in business transacted during the year with about \$2,500,000 returned to growers. During the season 1,532 carloads of fruit were handled; of which 69 remain in Yakima and 39 are in storage in the East. The remainder has been sold. Average prices of fruits, all sizes, grades and varieties were: Apples, \$2.16 a box; pears, \$1.69; peaches, 65 cents; cherries, 15.8 cents per pound. During the fiscal year of the association the old outstanding surplus was distributed in the form of 100 per cent stock dividends with a 20 per cent cash dividend. The capital stock was in-

creased from \$40,000 to \$150,000. Supplies sold to growers through the association amounted to \$204,000. Property holdings total \$155,963. The organization is working on the construction of a cold storage plant at Yakima.

IDAHO

W. H. Wicks, director of the Idaho Bureau of Plant Industry publishes the following timely advice in the Idaho Weekly Markets Bulletin:

The time is fast approaching when all fruit growers should begin to consider the essential work of thorough and proper spraying. The necessity of having the pruning finished before any spraying is done has been mentioned in a previous article.

It is impossible to successfully combat insect enemies unless all orchards are thoroughly sprayed, and neglected orchards should be reported to the Bureau of Plant Industry, Department of Agriculture, for compulsory spraying or eradication.

The proper time and thoroughness of all spraying operations are absolutely necessary for success. Spraying for San Jose scale control can be given from now until buds open. Do not depend on summer spraying for this pest. Advantage should be taken of bright spring days without wind when the temperature is above freezing and trees are dormant and not wet. The material to use and time for spraying for other insects will be stated in due season.

Last year much difficulty was experienced by many growers who were unable to secure spray material, particularly lime-sulphur, or who secured it too late for proper use. Arsenate of lead and lime-sulphur will be used in large quantities this year and the wise fruit grower will lay in his supply early. Delaying your order makes it impossible for the spray manufacturer to keep up with deliveries.

Those who desire to use Sherwin-Williams' dry lime-sulphur for San Jose scale control should use it 16 pounds to 50 gallons of water, which is stronger than recommended at present by the manufacturer.

Miscible oil has been used successfully for San Jose scale control but we do not recommend this in preference to lime-sulphur. When a spray is applied only for brown mite and aphid eggs, when trees are dormant, use miscible oil according to directions on container in preference to lime-sulphur.

Good spraying can not be done with poor equipment. A steady pressure of 250 to 300 pounds is essential for best results and the grower should see that his outfit will maintain this constantly. It is better to have surplus pressure than insufficient, and a safe pressure range is from 250 to 300 pounds for successful work.

The spray rod and spray gun are both used successfully. The man behind the instrument is the determining factor. The clipper nozzle, or a nozzle which will give a similar effect, is desirable for use on the rod. Outfits should be equipped with a tower or step ladder in order to spray most efficiently for codling moth.



HIGH-cost-o'-living has little terror for those wise housewives who appreciate the deliciousness and food-value of Ghirardelli's Ground Chocolate. They find it "rounds out" a meal that, with any other beverage, might seem a bit scanty. For it provides real nourishment—both as a food and as a beverage.

Never sold in bulk—but in cans only.
In ½ lb., 1 lb. and 3 lb. sealed cans—
at the store where you do your trading.

Say "Gear-ar-delly"

Since 1852 D. GHIRARDELLI CO. San Francisco

(F5)

GHIRARDELLI'S Ground Chocolate

No Orchard or Farm is Complete
Without Our Latest Model

**COMMERCIAL SIZE
All Purpose Evaporator**

Write for Folder

**HOME EVAPORATOR CO.
ST. LOUIS, MISSOURI**

P. O. Box 817

Central Station

Pull Stumps

**Make More Money
in High-Priced Crops**

Stump land is too expensive for any farmer to own. Clear your land with a

HERCULES
All-Steel Triple Power
Stump Puller

Write for catalog and special introductory price, 3-year guarantee—30 days' free trial.

Hercules Mfg. Co.
969 28th St.
Creterville, Iowa

THE WORLD-
OUR ORCHARD

STEINHARDT & KELLY NEW YORK

UNQUESTIONABLY THE
MOST IMPORTANT FACTOR
IN THE DISTRIBUTION OF
THE COUNTRY'S FANCY
APPLES
AND OTHER FRUITS

OUR MARKET-
THE WORLD

Don't Send a Penny

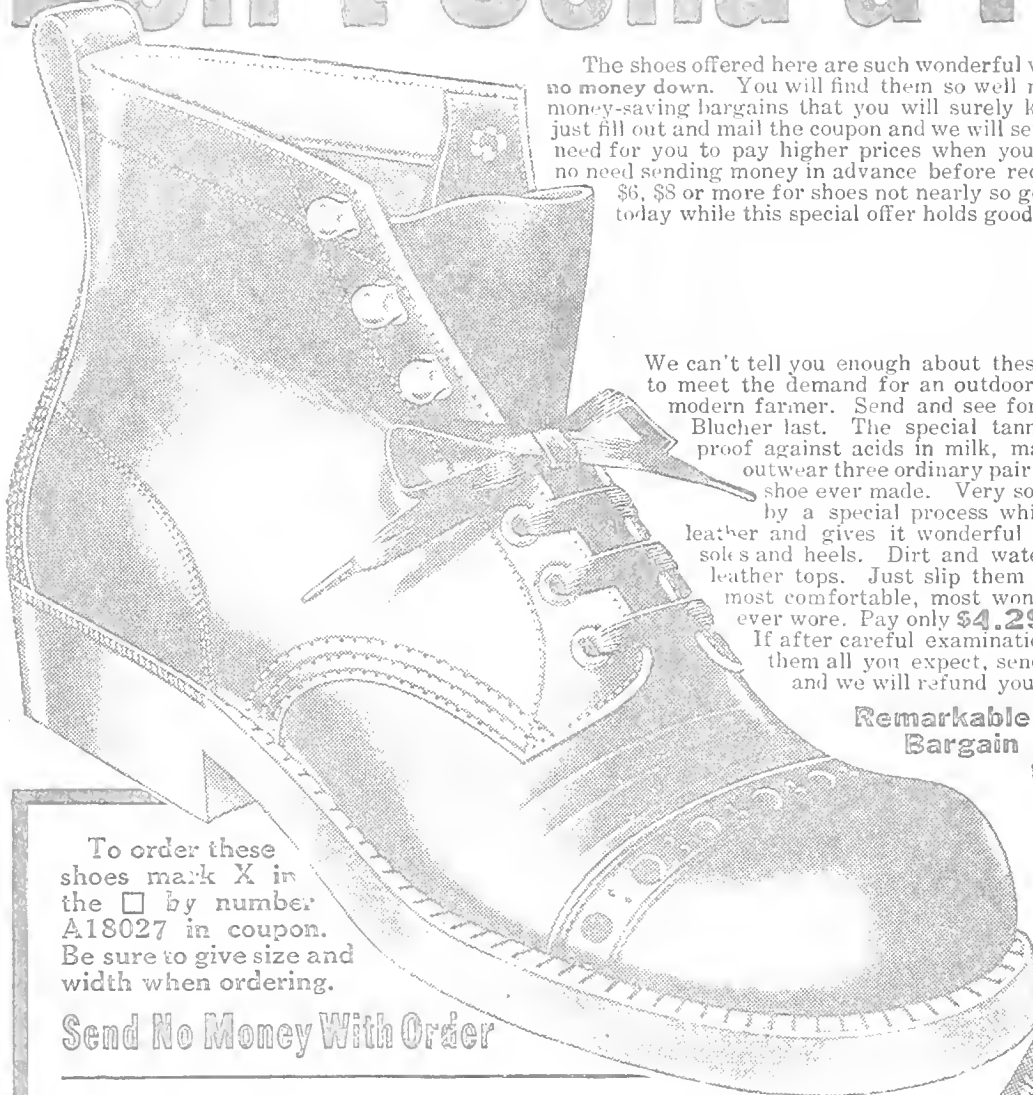

The shoes offered here are such wonderful values that we gladly send them, no money down. You will find them so well made and so stylish and such big money-saving bargains that you will surely keep them. So don't hesitate—just fill out and mail the coupon and we will send you a pair of your size. No need for you to pay higher prices when you can buy direct from us—and no need sending money in advance before receiving the shoes. Why pay out \$6, \$8 or more for shoes not nearly so good? Act now. Mail the coupon today while this special offer holds good. Pay only when shoes arrive.

We can't tell you enough about these shoes here. This shoe is built to meet the demand for an outdoor city workers' shoe and for the modern farmer. Send and see for yourself. Built on stylish lace Blucher last. The special tanning process makes the leather proof against acids in milk, manure, soil, gasoline, etc. They outwear three ordinary pair of shoes. Most comfortable work shoe ever made. Very soft and easy on the feet. Made by a special process which leaves all the "life" in the leather and gives it wonderful wear-resisting quality. Double soles and heels. Dirt and waterproof tongue. Heavy chrome leather tops. Just slip them on and see if they are not the most comfortable, most wonderful wearing work shoes you ever wore. Pay only \$4.29 for shoes on arrival. If after careful examination you don't find them all you expect, send them back and we will refund your money.

Remarkable Bargain

To order these shoes mark X in the by number A18027 in coupon. Be sure to give size and width when ordering.

Send No Money With Order

Special bargain to close out a limited stock of these smart Dress Shoes. Act quickly if you want a pair. Made in classy lace Blucher style. Splendid quality calf uppers. Splendid solid leather soles and heels. Come in black only. At our price these shoes challenge all competition. Make your own decision after you examine and try them on. Sent absolutely on approval. You must see them to appreciate the fine quality of material, workmanship and astonishing bargain value. No money with order. Pay only \$4.69 for shoes on arrival. And that returned if you don't keep the shoes.

Mark X in by number A15105 in coupon. Be sure to give size wanted.

Keep your money until shoes come. Not a cent to pay now. Sent direct to your home on approval. Then let the shoes themselves convince you of their bargain value or return them and get your money back. This is the modern, sensible way to buy—the way thousands are buying their shoes today direct from us—getting satisfaction—saving money. Fill out the coupon and send it now.



Leonard-Morton & Co.
Dept. 2865 Chicago

Send at once the shoes which I have marked X in below. I will pay price for shoes on arrival with the understanding that if I do not want to keep them I can send them back and you will refund my money.

Work Shoes No. A18027 \$4.29 Dress Shoes No. A15105 \$4.69

Leonard-Morton & Co.
Dept. 2865 Chicago

Size.....

Name.....

Address.....

BETTER FRUIT

VOLUME XIV

APRIL, 1920

NUMBER 10

FEATURES IN THIS ISSUE:

Growing the Almond in California
Dusting and the Spray Gun
Cold Storage Investigations
Cultivating the Loganberry
Low Temperatures and Fruit Buds

*Columbia Univ Libr
30dec20*



THE BARTLETT PEAR

Of all the varieties of pears the Bartlett has assumed the most important place in the fruit market during the past two years. Reports from California are to the effect that canners are already offering high prices for the coming season's crop.

20 Cents
The Single Copy

BETTER FRUIT PUBLISHING COMPANY, PUBLISHERS, PORTLAND, OREGON

Subscription \$2.00 per Year in the United States; Canada and Foreign, Including Postage, \$3.00, Payable in American Exchange



OUR LABELS
Protect Your Brands

*Our knowledge and
experience are at
Your service in cre-
ating, registering
and protecting
your brand names*



SCHMIDT LITHOGRAPH CO
SEATTLE LOS ANGELES FRESNO
PORTLAND SACRAMENTO HONOLULU
SAN FRANCISCO

Touring
Roadster
Coupe
Sedan

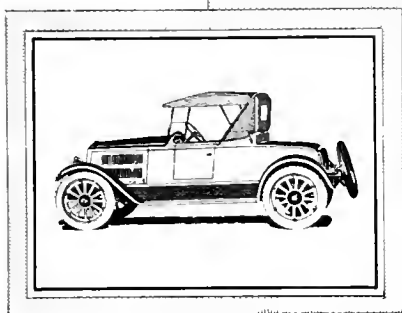
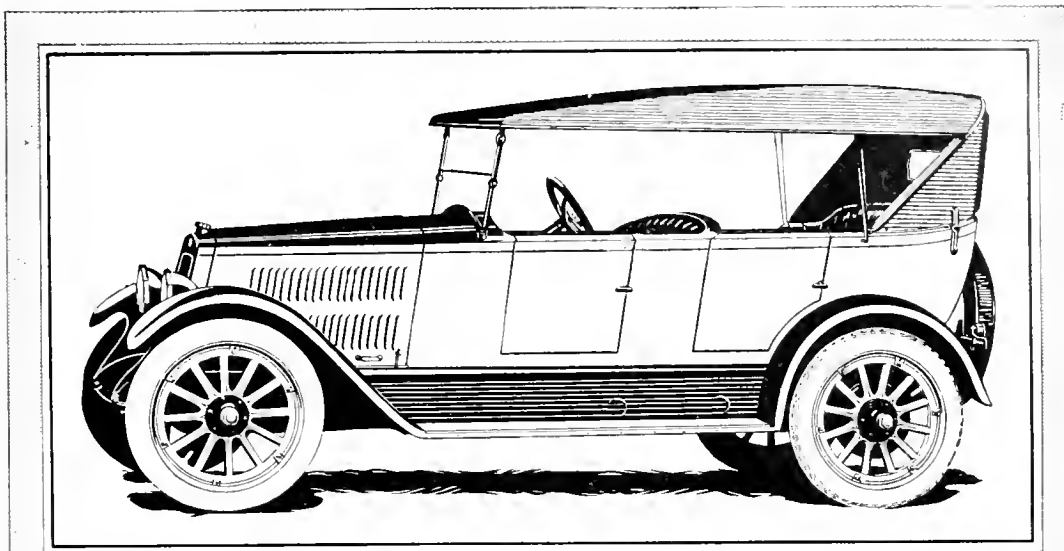

Mitchell

Built to stay new

Thus saving upkeep costs

WHILE we offer the latest in style, we are prouder of the mechanical perfections of this new Mitchell Six.

We have always built a lasting car — but the building of trucks for the Government taught us new accuracies, new ways to add endurance.

So in this new Mitchell we bring to you the limit in stability — without bringing heaviness. Here is an easy car to handle, one that has plenty of roomy comfort, yet built for strength.

We know the sturdiness of this car because we know how our "Parts Department" has been dwindling. Orders for replacements from Mitchell dealers have been growing less and less, and today we believe our replacement orders are of the

fewest. This means a car that stays new mechanically. And we've taken care that the body will stay new, too. More finishing costs, finer leather, hair and springs for upholstery. A new-day top. Throughout a car that will wear well.

All this means saving money for you — not only when you buy, but for all time. It means a finer car at a moderate price, it means a satisfactory car day in and day out.

Go to a Mitchell dealer. Or send for illustrated catalog. Examine this new Mitchell. Have him point out the features. Then place your order early, so as to insure early delivery.

MITCHELL MOTORS COMPANY, Inc.
Racine, Wisconsin

Mitchell Motor Cars distributed in
The Pacific Northwest by

Also sold by the leading dealers in nearly
every town in the Pacific Northwest



Portland and Spokane

Seattle Dealers, Mitchell Motors & Service Co.
Tacoma Dealers, Puget Sound Motors Co.

SIMONS, SHUTTLEWORTH & CO.

LIVERPOOL AND MANCHESTER

SIMONS, JACOBS & CO.

GLASGOW

GARCIA, JACOBS & CO.

LONDON

Agencies and Representatives in Every Important European Market

European Receivers of American Fruits

FOR MARKET INFORMATION ADDRESS

SIMONS, SHUTTLEWORTH & FRENCH CO.
204 Franklin Street, New YorkSIMONS FRUIT CO.
Toronto and MontrealSIMONS, SHUTTLEWORTH, WEBLING CO.
12 South Market Street, Boston

OUR SPECIALTIES ARE APPLES AND PEARS

Be On Guard with "BLACK LEAF 40" for Aphis

Aphis is a serious menace to your orchard profits.

Don't forget that the best time to spray is when the Bud shows the Green Tip.

"BLACK LEAF 40" is a spraying solution that can be used as recommended in "combination sprays" — with Lime-Sulphur, Arsenate of Lead, Bordeaux Mixture.

"BLACK LEAF 40" is endorsed by Experiment Stations and Agricultural Colleges throughout the United States and Canada.

Universally conceded by growers to be the most effective and practical material for the control of Aphis, Thrips, Pear Psylla, Leaf Hopper, Woolly Aphis and other soft-bodied, sucking insects.

Write us today for our complete spray chart leaflet and bulletins.

Order your supply early from your dealer.

Manufactured by

Tobacco By-Products & Chemical Corporation

Incorporated

Successors to The Kentucky Tobacco Product Company

Louisville, Kentucky



Sulphur

It has been proven and so recommended by the University of California that if you sulphur your grape vines and orchards 6 times they will not be affected by MILDEW or RED SPIDERS.

ANCHOR Brand Velvet Flowers of Sulphur, also EAGLE Brand, Fleur de Soufre, packed in double sacks, are the fluffiest and PUREST sulphurs that money can buy; the best for

vineyards; the best for bleaching purposes, LEAVING NO ASH.

VENTILATED Sublimed Sulphur — Impalpable Powder, 100% pure, in double sacks, for Dry Dusting and making Paste Sulphur.

For LIME-SULPHUR SOLUTION, use our DIAMOND "S" BRAND REFINED FLOUR SULPHUR. We can furnish you this sulphur at such a low price that it would pay you to mix your own solution.

To create additional available plant food, drill into the soil 110 to 220 pounds per acre DIAMOND "S" BRAND POWDERED SULPHUR, 100% pure. This has increased various crops up to 500%.

Also PREPARED DRY DUSTING MATERIALS, Tobacco Dust, Dusting Sulphur Mixtures, etc., Fungicides and Insecticides, carried in stock and mixed to order.

SAN FRANCISCO SULPHUR COMPANY
624 California Street, San Francisco, Cal.

We are equipped to make immediate shipments. Send for "ILLUSTRATED BOOKLET"; also booklet "NEW USES FOR SULPHUR," Price-list and Samples.

Please state for what purpose you use the sulphur, quantity needed and date of shipment preferred.



America's
Pioneer
Dog Medicines

HOOK ON DOG DISEASES And How to Feed

Mailed free to any address by
the Author

H. CLAY GLOVER CO., Inc.,
118 West 31st Street, New York

Bees and Better Fruit

We want to send you a handsome booklet entitled "Bees and Fruit." If you don't keep bees now, it will certainly convince you that you should. It will interest you, anyway. Ask, too, for our booklet, "Bees for Pleasure and Profit," that's full of information about bees and beekeeping. They are free for the asking, but tell us if you keep bees now or have ever kept bees. We can tell you how to start right in beekeeping and get a crop of honey and a better crop of fruit. We have been in the beekeeping business for 50 years and we will make our experience yours to use. A postal card will bring the booklet.



THE A. I. ROOT COMPANY
(Leaders in the Bee World) 1G
511 Main Street Medina, Ohio

BETTER FRUIT

EDITOR: W. H. WALTON

STATE ASSOCIATE EDITORS

OREGON—C. I. Lewis, Horticulturist.
WASHINGTON—Dr. A. L. Melander, Entomologist.
O. M. Morris, Horticulturist, Pullman.
COLORADO—C. P. Gillette, Director and Entomologist.
E. B. House, Irrigation Expert, State Agricultural College,
Fort Collins.
ARIZONA—E. P. Taylor, Horticulturist, Tucson.
WISCONSIN—Dr. E. D. Ball, Madison.
MONTANA—H. Thornber, Victor.
CALIFORNIA—C. W. Woodworth, Entomologist, Berkeley;
W. H. Volek, Entomologist, Watsonville; Leon D.
Batchelor, Horticulturist, Riverside.
INDIANA—H. S. Jackson, Pathologist, Lafayette.

An Illustrated Magazine Devoted to the Interests
of Modern, Progressive Fruit Growing
and Marketing.

PUBLISHED MONTHLY BY

Better Fruit Publishing Company

703 Oregonian Building

PORTLAND, OREGON

All Communications should be addressed and
Remittances made payable to

BETTER FRUIT PUBLISHING COMPANY

SUBSCRIPTION PRICE:

In the United States, \$2.00 per year in advance.
Canada and Foreign, including postage, \$2.00,
payable in American exchange.

ADVERTISING RATES ON APPLICATION

Entered as second-class matter April 22, 1918,
at the Postoffice at Portland, Oregon, under
the Act of Congress of March 3, 1879.

VOLUME XIV

PORTLAND, OREGON, APRIL 1, 1920

NUMBER 10

The Growing and Culture of Almonds in California

By R. H. Taylor

Published by the College of Agriculture, Berkeley, California

THE almond (*prunus communis*) is supposed to be native to the countries around the Mediterranean and at present the bulk of the world's supply is produced in that region. It resembles the peach somewhat in manner of growth and character of blossoms and leaves, but the wood is much harder and the tree is longer-lived under equally favorable conditions. The fruit, instead of having a thick, fleshy pericarp as in the case of the peach, has a thin, leathery pericarp or hull, which splits on ripening and generally opens when dry, exposing the nut inside.

California produces over 98 per cent of the entire American crop and has done so for many years. During the period from 1900 to 1913 the number of bearing trees remained approximately the same, new plantings having replaced old orchards that were being pulled out. The variation in California production from year to year prior to 1915, is due to seasonal variations rather than to change in acreage.

With the 1915 crop the production in California entered upon what appears to be a long prospective increase. The large acreage of almonds set out in the last four or five years is the result of greatly improved market conditions due to the successful work of the California Almond Growers' Exchange. The first of these new plantings are now coming into bearing, and each year for many years in the future will continue to see increased yields. Large acreages are still being planted so that the almond production in California bids fair to continue to grow.

Within the next few years California growers will, in all probability, be forced to accept lower prices for their almonds than they are now receiving. The American markets are fully supplied at present prices, yet constantly increasing acreage will inevitably result in a greatly increased tonnage. European almonds are being produced at a lower net cost and can be laid down on the Atlantic Coast more cheaply than is possible with the California product. This brings the grower face to face with the necessity of becoming more thoroughly familiar with the most economical methods of production and marketing if they are to continue to

make a profit. It is essential, therefore, that a careful study be made of all the factors concerned in the growth, production and final disposition of the almond crop.

Habits

The almond is the first of the deciduous fruit trees to start growth and come into bloom in the spring, and normally the last one to shed its leaves in the fall. In other words, it has a very short period of rest. When the trees are forced into premature dormancy by mites or lack of moisture, they soon reach the end of their normal rest period before the winter season is over. Then the first warm weather in spring will bring the trees into blossom. In some cases where moisture and temperature conditions are favorable late in the fall, they may actually blossom before the winter season. In young trees that have become dormant unusually early, the rest period may terminate and then the tips of the branches resume growth and continue to slowly develop new leaves at the

terminals throughout the winter. Trees which have been kept growing thriftily until the leaves have been forced to fall by the cold weather and frosts of winter, do not tend to blossom as early in the spring, nor do they open under the influence of a few days of warm weather in late winter or early spring.

Young trees blossom somewhat later than the older trees, and buds on sucker growth blossom later than the more mature portions of the same tree. The difference may amount to three or four days or almost a week. Well-grown trees carry large numbers of blossoms over the entire tree.

The wood of the almond is very hard and strong, enabling the tree to bear the weight of heavy crops where pruning has been given proper attention during the formative period of the young tree. As with other fruit trees, the almond is subject to heart-rot and care should always be exercised to prevent the checking and cracking of large wounds and consequent infection with decay organisms. The hardness of the



Courtesy College of Agriculture, Berkeley, California

Typical hillside orchard of Jordan almonds near Los Gatos. Trees are variable in size and some are missing. In the right foreground is a typical spot of missing trees resulting from oak fungus infection.



Courtesy College of Agriculture, Berkeley, California

Showing almond trees that have been deheaded and topworked. This illustration shows the trees after the tops have had two seasons' growth and just after they had been pruned.

wood makes it the finest kind of fuel and when old orchards are being dug up the returns from the sale of wood often more than pay for the expense of digging and cutting up the trees and burning the brush.

The nuts are of two general classes—sweet and bitter almonds. The former is primarily the almond of commerce, though the latter is used largely in the manufacture of almond oil and almond flavoring, as well as in the manufacture of prussic acid. The bitter almond is also used largely in nurseries as a root-stock upon which to bud the almond and some other fruits.

For a long time there has been considerable evidence to show that some varieties are always self-sterile while a few are sometimes self-fertile. Work done in 1916 and 1917 by Prof. Tufts shows that practically all varieties are self-sterile and that some of the self-sterile varieties are also inter-sterile. In these tests the principal commercial varieties were used. Blossoms of each variety were pollinized with pollen from its own blossoms and from each of the others. Checks were for natural pollination with each variety. The important results of this work are briefly summarized as follows:

The Nonpareil and I.X.L. are inter-sterile, although both are inter-fertile with the Ne Plus Ultra.

The Languedoc and Texas are inter-sterile.

The I.X.L. and Peerless are practically inter-sterile.

The California has proved the best pollenizer thus far tested, for all varieties that bloom near it.

The Drake is inter-fertile with the Nonpareil, I.X.L., Ne Plus Ultra, Peerless and Jordan, the only ones tested.

The I.X.L. is inter-fertile with the Drake, Jordan, California, Languedoc, Ne Plus Ultra and Texas.

The Ne Plus Ultra is inter-fertile with the California, Drake, I.X.L., Languedoc and Nonpareil.

Requirements

While the almond is in many ways an easy tree to grow where conditions are favorable, it is more particular in its requirements than most common orchard fruits and the grower may find

it difficult to produce a good, thrifty tree unless he chooses the proper location. Very often it will grow well and make a fine healthy tree, but owing to unfavorable conditions, will not bear regularly, if at all.

Climate

Heat—Where the conditions of soil and moisture are favorable the almond will endure the intense heat of the interior valleys and even of the Imperial Valley, provided it is pruned properly to shade the main branches so as to prevent sunburn. Where trees, by severe pruning, are opened up suddenly to the intense heat of the summer sun, almonds will sunburn, but if the necessary opening up is done gradually, the bark will become inured to the new conditions without danger. The nuts grow and ripen more satisfactorily in the greater heat of the interior than along the coast.

Frost—The almond tree is hardy and will endure fully as much cold as the hardest peach without injury. Trees are found growing well in Illinois, Ohio, New York and other Eastern states. In very favorable seasons they may even bear fruit, though this happens very seldom, due to the extremely early habit of blooming before the spring frosts are over. The first warm weather seems to start the trees into



Courtesy College of Agriculture, Berkeley, California

Typical Ne Plus Ultra almond tree in University Farm orchard at Davis, California, nine years old.

bloom, especially where the enforced dormant season of winter is very long.

The blossoms, on the other hand, are very tender. There is a great range in the degree of frost which will cause injury, depending largely on the condition of the tree during the time that the fruit buds are forming and developing, as well as on the duration and severity of the frost. Buds and blossoms on trees which have been forced into premature dormancy, either by lack of moisture or by severe attacks of red spider, are much more susceptible to frost than those on trees which have continued growth late enough in the fall to provide for the proper development and maturity of the buds. After differentiation of fruit buds commences in the summer, the almond leaves should remain on the tree until late into the fall in order to strengthen and develop the fruit buds and store up the elaborated food material for the use of the buds in their normal development through the winter. Studies of almond buds gathered from healthy trees which held their leaves until late fall frosts at Davis, showed the first evidence of differentiation between fruit and flower buds commencing about August 18, while the flower was not completely developed until February 18 following. During the intervening time development proceeded unchecked through the winter even though the tree was apparently dormant. During the time the crop is ripening on the trees, little is done toward storing food material for the buds. If the leaves turn yellow or drop soon after harvest, the trees do not have the opportunity of storing a sufficient supply of plant food for their normal requirements and the buds are insufficiently nourished during the winter period. The resulting buds are weakened and the indications are that they are unable to endure unfavorable climatic conditions in the spring, such as light frosts, continued cold weather

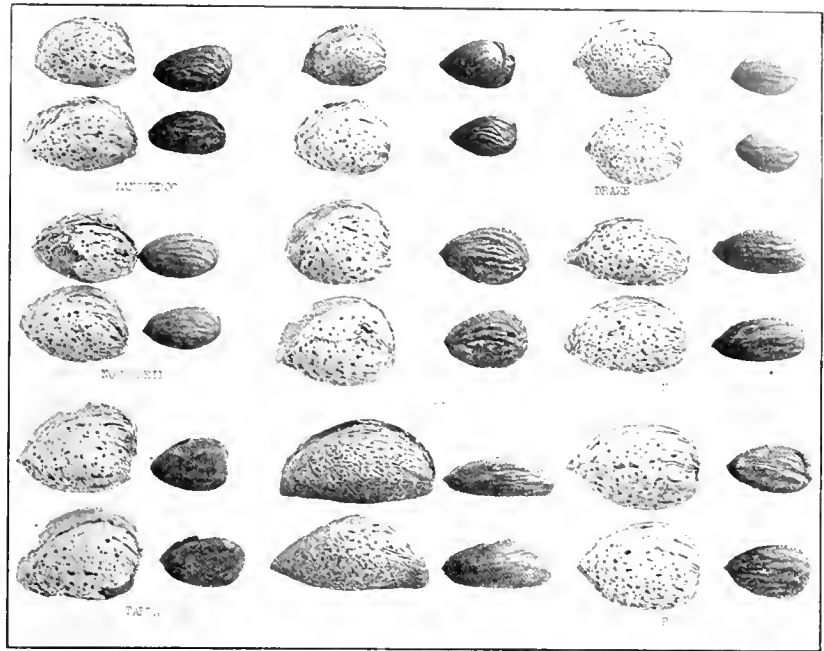

Courtesy College of Agriculture, Berkeley, California

Illustration showing some of the almond varieties grown in California.

or sudden changes from warm to cold weather.

The most tender stage in the blossoming and development of the young fruit seems to be immediately following the dropping of the calyx lobes from the young fruit as it first commences to swell rapidly. The blossom becomes more and more tender as it opens out and reaches the above stage. After the young fruit has attained the size of a pea it rapidly becomes more resistant to low temperatures. Blossoms with the petals exposed but not yet opened have been known to stand temperatures of 24 degrees F. and blossoms with petals beginning to fall have stood 28 degrees F. No records are available as to the duration of these temperatures.

In other cases, blossoms with the petals falling have been killed by temperatures of 30 and 31 degrees F. It must be remembered in this connection that the almond blooms earlier than other orchard fruits and, therefore, is often subjected to much more severe frosts than occur during the blooming period of the later fruits. The greatest injury is likely to occur when a frost follows one or more days of warm weather. When the mean temperature both day and night remains low, frosts that might otherwise kill the flowers or setting fruit do no harm. This is what occurred in February, 1917, at the University farm, when repeated frosts at blooming time did not harm whatever.

In determining the desirability of a location in regard to its freedom from frost, the possibility of adequate air drainage is an important item. For this reason the lands along the lower foothills immediately above the floor of the valleys are ordinarily much less subject to frost—because the cold air is free to drain away to the lower levels. Generally the lands along the banks of streams which have been built up higher than the other lands of the Great Valleys through which they flow, are less subject to frost by reason of the natural flow of the cold air from them to the lower lands adjacent. For the same reason the planting of almonds in the lower lands of the valleys, no matter how large the valleys may be, should be avoided, unless the locality has been thoroughly tested for a long period of years and has proved to be an exception to the rule because of some peculiar situation with favoring air currents or air drainage, such as might exist near a natural draw in the hills where the settling of the cold air in some portions of the adjacent valley might be prevented. Such locations are generally confined to very small areas. Oftentimes an opening or draw in the hills may serve as an outlet for the



Courtesy College of Agriculture, Berkeley, California

Harvesting almonds by knocking onto sheets spread on the ground.

drainage of much colder air from considerably higher elevations beyond, and then the danger from frost is very greatly increased. This is very common where cañons act as drains to conduct the cold air from the high Sierras to the valleys below.

Variable weather conditions, and especially as regards temperature in the spring after growth commences, are highly undesirable. Warm weather immediately followed by cold tends to produce sour-sap, fruit drop and kindred physiological ills. Oftentimes crops have been lost where no frosts occurred after blooming commenced, simply due to sudden changes in the weather. However, it is highly probable that the greater portion of the trouble with fruit dropping, when of the size of peas or larger, is due to improper pollination. When the soil is not sufficiently well drained at such a time, the sour-sap effect is greatly augmented.

Humidity—Foggy or moist weather during ripening or harvesting is highly objectionable. The nuts do not dry out rapidly enough on the trees to prevent the growth of molds and consequent darkening of the shells. The nuts then require much heavier bleaching to brighten them properly for the demands of the market. The damp weather prevents the rapid and thorough drying-out of the kernel; the sulphur fumes are absorbed by the moist kernel and it sometimes becomes rancid before it is six months old.

Much damp weather in the spring encourages the growth of "shothole" fungus in the blossoms and fruit, often causing the loss of a considerable portion of the crop; the loss of leaf surface from the fungus infection is sometimes so great as to materially affect the vigor and vitality of the tree.

Rainfall—It is impossible to state any definite amount of rainfall which will or will not maintain the trees and enable them to bear regular crops of nuts, for so much depends not only on the variation in rainfall in different sections and in different years, as regards distribution throughout the year, but also on the time and intensity of the fall, the character of the weather following the rains and the ability of the soil to receive and retain the rain that falls. Ordinarily, however, with the above factors favorable, it is conceded that where the winter rainfall averages sixteen inches, almonds can generally be grown without supplementing the water supply by irrigation, if the orchardist exercises reasonable care to conserve the moisture for the use of the trees. Where the rainfall is inadequate some means of irrigation must be found to make up the deficit.

In some sections the annual rainfall varies greatly from year to year. Often it falls in such a way that a large proportion of it is lost in the surface runoff. In many places the soil is so leachy that it is incapable of holding sufficient water for the use of the trees throughout the summer, much of the winter rainfall being lost in the underground drainage. Under either of these conditions, 40 inches of rainfall might not

be sufficient. Very often winter rains are followed by desiccating winds so that a considerable portion of the rain which falls is lost by evaporation before anything can be done to hold it.

Continued rainy, damp and cold weather at the time of blooming is apt to sour the pollen or actually wash it away and thus prevent the fertilization of the blossoms, without which a crop is impossible. Bees and other insects are the principal means of accomplishing the pollination of almonds and such weather prevents them from working.

Soil

The almond is a deep-rooting tree and draws heavily upon the plant-nourishing elements of the soil. In ripening the large number of seeds which it is required to do, the tree must draw upon a considerable area of soil in order to supply the large amount of mineral matter that is needed to develop and mature the seeds. Analyses of almonds, as compared with other commonly grown fruits and nuts, made by Colby, show that the almond leads in the total quantity of mineral matters withdrawn from the soil. Colby further states that "The stone fruits fall much below the almond in total ash (mineral matter) excepting the olive, the ash of which, however, is largely silica (nearly eight-tenths), an ingredient so plentifully distributed in all soils that it is of no pecuniary value." The table given illustrates this statement.

These figures suggest the necessity of having a deep, rich, well-drained soil for best results. For this reason and because of the deep-rooting habit of the almond, the soil should be at least ten or twelve feet deep.

Hardpan—Compacted substrata in the soil, whether they be hard clay layers or cemented layers of silicious, ferruginous or calcareous origin, are objectionable. They not only prevent the roots from foraging to a considerable depth as they normally tend to do, but they prevent proper drainage and aeration of the soil. If such layers are comparatively thin, that is, not more than two or three feet thick at the most, they may be shattered with dynamite so as to allow the moisture, air and roots to penetrate to the better soil below. Hardpan, therefore, should be avoided where it is too thick to be broken up or where it is not underlain by desirable soil.

Humus—A plentiful supply of humus in the soil is essential. It not only improves the physical condition of the soil, but assists drainage, moisture retention and in rendering the plant food available in sufficient quantities for the use of the trees and for the maturing

of full crops of almonds. Many orchards have been very light producers year after year because of a deficiency of humus in the soil.

Drainage—The almond root is very particular as to its air and moisture requirements in the soil. It will not endure standing water in the soil for any length of time, especially during the growing season. Exclusion of air by excessive moisture is believed to be one of the most productive causes of "sour-sap." If allowed to continue for any length of time such conditions will cause the death of many or even all the roots and with them the top.

Water Table—A factor which is very commonly overlooked in connection with the natural drainage of almond lands is the position of the water table at different seasons of the year. Great care must be exercised in choosing a location to be sure that the water table does not rise during the summer. This is a very serious problem in many irrigated sections. Where the water table during the winter months is less than 12 feet in depth it is highly desirable to have as little fluctuation as possible. Where fluctuations take place at a greater depth than 12 feet they are not generally serious. The ideal condition is where the water table is highest in winter and quickly drops after the winter rains are over, to a depth of from 10 to 12 or 15 feet, remaining at that point during the remainder of the growing season.

The soil in addition to being well drained, must be sufficiently retentive of moisture to supply the tree throughout a long, dry growing season. If the soil will not retain a sufficient amount of the winter and spring rains, recourse must be had to irrigation to supply the deficiency.

Alkali—Alkali lands are unsuited to almond culture and should be carefully avoided.

In summarizing the soil requirements for almond culture, it may be stated that the ideal almond soil is a medium loam, uniform in texture, or nearly so, to a depth of at least twelve feet, well drained and yet retentive of moisture for the use of the tree during the summer. Fortunately some of the best almond soils are situated along stream banks where the land is relatively high, and is, therefore, less subject to frost. These streams flowing from the mountains and foothills have built up their own beds by the detritus brought from the hills. The coarser particles being deposited first and nearest the stream itself, make the better drained soils, while the finer particles and the clays, deposited further back from the bank

Continued on page 40.

SOIL INGREDIENTS EXTRACTED BY THE ALMOND, AS COMPARED WITH OTHER ORCHARD TREES, AS SHOWN BY ANALYSES OF 1,000 POUNDS EACH OF THE CROPS IN A FRESH CONDITION.

	Potash, lbs.	Lime, lbs.	Phosphoric		Total Ash, lbs.	Nitrogen, lbs.
			Acid, lbs.			
Almond (hulled)	5.49	1.72	4.33	15.00	16.40	
Almond (not hulled).....	9.95	1.01	2.01	17.29	17.01	
Walnut (hulled).....	1.50	1.81	2.78	7.50	10.20	
Walnut (not hulled).....	8.18	1.55	1.47	12.98	5.41	
Chestnut (hulled).....	3.72	.71	1.89	8.20	8.00	
Chestnut (not hulled).....	3.67	1.20	1.58	9.52	6.40	
Prunes (green).....	2.66	.13	.53	4.03	1.48	
Apriots (green).....	2.85	.18	.71	5.16	2.29	
Olives.....	8.85	2.32	1.18	94.63*	5.85	

* 80.7 pounds of which is silica.

Dusting and the Spray Gun in Calyx Worm Control

By Leroy Childs, Entomologist and Pathologist, Hood River Experiment Station

EVER since the late Dr. A. J. Cook carried on some calyx worm control experiments in Michigan a half century ago entomologists have argued relative to the way and in the amounts this poison becomes established in the calyx cups. The correct type of nozzle and the kind of spray necessary to accomplish best results have been a much mooted question. In this connection some of our more enthusiastic colleagues have even gone so far as to believe that one well-timed calyx application would be sufficient to handle the codling moth under ordinary seasons of infestation.

Observations made by investigators in different parts of the country during recent years have pointed out that the percentage of calyx entrants is a very variable factor during different seasons in different sections. It has been the writer's observation that during some seasons a very high percentage of the worms enter through the calyx and during others the reverse would be true. During the past season the worms entered in about equal proportions through the calyx and side on Spitzenbergs, while in Newtowns, side entrants occurred in a much larger proportion. From information that I have received from various sources a condition of this sort was quite general throughout the Northwest during the past year.

It is not my purpose to in any way depreciate the importance of the calyx application in the minds of orchardists. The more stress that we can lay upon this and the cover sprays the better will be the results. However, over-emphasis of the calyx application has been harmful in that it has had a tendency to depreciate (in the minds of the growers) the value of cover sprays and much worminess has been the result.

The writer has been keeping in very close touch with codling moth activities in Hood River for six years. During the past four years experimental work with dust and sprays of various sorts have been under observation.

The dusting method of applying arsenate of lead and sulphur to apples for the control of various insects and plant diseases created much interest following the publication of the work of Reddick and Crosby (Bulletins 354 and 369, Agricultural Experiment Station, Cornell University) in 1914 and 1915. The results of their work indicated that apple insects and diseases of importance in the East, other than San Jose scale and the various apple aphids could be controlled in about the same degree as with the liquid. In the West we have to add to this list of uncontrollable troubles, powdery mildew, anthracnose, and the leaf roller as well as a few minor insect pests. This fact places very decided limit upon the general utility of the method and makes it a means of general control that we cannot recommend.

The results of Reddick and Crosby

are especially interesting to me as I have been able to duplicate their results with scab and codling moth control during the four years of the investigation. To the entomologist working on codling moth control, these results should be decidedly significant. Reddick and Crosby do not go into the critical analysis of the proportions of calyx and side worms yet their good results indicate that they accomplished calyx worm control. How can the advocate of the so-called driving calyx spray explain this control? The writer's work shows that this control is very decidedly accomplished. The dust cannot be driven. Quiet air-atmosphere is the carrying medium used in placing the dust particles on the surfaces which require protection. A wonderful coating can be given a tree even to its uppermost branches. Upper and under-surfaces of the leaves as well as the fruit alike are covered. This air conveyor being in motion a slight breeze, very light, upsets the plans of procedure. A breeze makes it almost impossible to hit the tops and even if this

comply results. Several of our growers have used the dusting method; for the most part their work has been done regardless of air movement. In 1918 the condition of the fruit in one of these orchards was checked up; a 33 per cent injury from the codling moth was found. None of the growers of the valley have depended upon the system during the past year. On account of the many handicaps and difficulties encountered I do not recommend the method to our growers except those located on steep hillsides and in sections where sufficient water for spraying is difficult to obtain.

The results, however, that have been obtained in calyx worm control have a very decided bearing on the results that can be expected with the spray gun when properly used. For this reason I will discuss some of the results that have been obtained in seasons past with both dust and liquid applications. These results are summarized on the accompanying chart. In 1917 the unsprayed check trees in an orchard which had been quite wormy for several seasons,



Apple blossoms just after the falling of petals; best time to spray for codling moth.

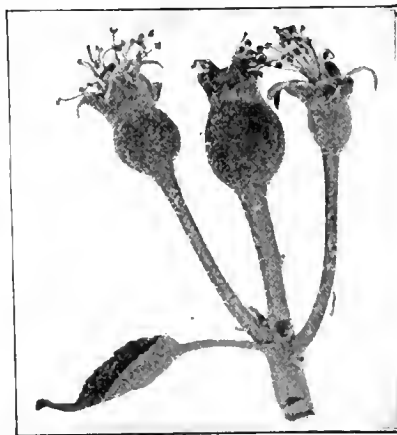

Almost too late for the most effective treatment. Observe that the calyx cup is nearly closed.

were accomplished the particles were moved past the surfaces so fast that only a very small percentage sticks. The remainder passes on and is wasted for the most part. When the air is quiet these particles will hover for a long time over a tree and gradually settle. Air currents destroy the plan of the system and applications made under such conditions can only result in disaster.

In order to avoid windy conditions it was found necessary to dust very early in the mornings; a calm usually occurs in most sections of the valley during this period of the day. However, with us during the spring months it is not uncommon for a wind of varying degree to occur continuously for several days at a time. Many times in the carrying out of the experimental work the dusting had to be postponed for more favorable weather. We are all familiar with the fact that successful applications of spray cannot be delayed to any great extent and at the same time ac-

complished an infestation of 65.13 per cent. Of this infestation 31.68 per cent were side worms and 68.32 per cent were calyx worms. The variety used in this set of experiments were Arkansas Blacks. This ratio did not hold true in all varieties. In an orchard of Spitzenbergs this ratio was 66.96 per cent side worms and 33.04 per cent calyx worms. In a Newtown block this ratio was 61.54 per cent to 38.46 per cent side and calyx worms respectively. In the block of Arkansas Blacks two dust experiments were checked against two blocks of trees sprayed with twelve foot rods. In experiments number 1 and 3 an early September application was omitted, resulting in a much more wormy condition than occurred in experiments 2 and 4. These different experiments are cited to show, that regardless of this marked difference in worminess the general relation of side and calyx worms remains fairly constant, though with the increase in total worminess the chances of calyx

entrants also increases. The very marked difference between the figures obtained on the check trees as compared to both dusted and sprayed indicate the influences that are brought to bear in calyx worm control. Experiment 2 (dust) gave the best calyx worm control during 1917 where the ratio was found to be 92.99 to 7.01, side and calyx worms respectively. Experiment 4 (rods) followed with an 80 to 20 ratio. The gun was not tested in this orchard in 1917. These blocks, as has been stated, were sprayed extra in September. The rods in the heavier infestation gave slightly better calyx control, 73.55 per cent being side entrants as compared to 71.6 per cent in the dust block.

Dusting work was not continued in the Arkansas Black orchard in 1918 but was continued in a block of Newtowns in a different orchard. As will be noted in experiment 6 the check block for this series of experiments developed a 17.64 per cent infestation. During this season throughout the district a greater percentage of side worms entered than calyx worms. The unsprayed checks developed 73.29 per cent side worms as compared to but 26.7 per cent calyx worms. However, regardless of this rather small percentage of calyx worms the difference of amount in calyx worm control is again pointed out in the results obtained. During this season calyx entrants were cut down to 5.2 per cent in the dust block. These results were checked against a block sprayed with a gun in the same orchard which developed but .44 per cent wormy fruit, and perfect control as far as calyx worm control is concerned. This work was continued in these same blocks in 1919, and though not presented on the chart gave the following results. The check trees developed 80 per cent side and 20 per cent calyx infestation. The figures in the dust block are 96.77 per cent side worms and 3.22 per cent calyx worms. The gun block, however, upheld the 1918 performance and developed not a single calyx worm in the apples counted. The figures look too good but nevertheless these are the ones obtained. At this point I might add that this orchard outside of the experimental work that has been conducted with dust, has been sprayed with a gun only since 1917.

Before being too firmly convinced of the relative merits of calyx worm control with dust and with spray gun a series of experiments were arranged in 1919 to compare the merits of the gun and rod in an orchard which had been quite wormy for several years. The orchard which was chosen for this work suffered a loss of 20 to 30 per cent damage in 1918. In 1917 the loss was even greater. In the spring of 1919 many worms were found on the trunks of trees so there was no doubt but that there would be plenty of insects with which to work. Three blocks were chosen through the center of the orchard. One was sprayed with the gun throughout the season (experiment 10). Another was sprayed with twelve foot rods throughout the season (exper-

iment 11). Experiment 9 gives the results obtained with the use of rods in the calyx application, guns being used for the other sprays. The varieties used in the tests were Jonathans, Newtowns, and Spitzenbergs. The trees were fifteen years of age. This discussion, presented in the accompanying table, with the exception given, includes the results obtained in the Spitzenberg block only. The spray was applied by the owner and his hired man under the supervision of the writer who followed behind the men while the trees were being sprayed in each application. Two guns were used.

This experiment, however, included the Newtown variety only. The unsprayed checks in this variety showed a much lower percentage of calyx worms, which naturally influences comparative ratios given in the table on a 3½ horse-power outfit of well known make. The work was well done and well timed throughout the season. Five applications of arsenate of lead were used during the year; the last one, as the season finally turned out, was not very important. A summary of the results not only show that the gun held its own in obtaining codling moth control but gave better control than the rods and also where the rods were substituted in the calyx application that the calyx cups might be filled. The check trees developed an infestation of 53.6 per cent; the ratio of side to calyx worms was 45.16 to 54.83 per cent. In experiments 9 and 10 (rods in the calyx and guns in other applications) the percentage of calyx entrants was found to be practically the same, .34 and .35 per cent. The ratio of side to calyx worms being 85.74 to 14.28 per cent for the rods and 84.24 to 15.71 per cent for the guns. It is interesting to note here that the field control obtained by the owner two rows away from the check trees ran .56 per cent wormy, the fruit being checked up at random at harvest time. This demonstrates what can be done in a badly infested orchard in a season.

Another point upon which there is no experimental information available is the matter of worm control in the tops of large trees with the guns. At picking time the fruit was segregated in the different experiments in lots from the ground to 12 feet and from 12 feet to the tops of the trees (experiment 12 and 13). The trees in question were quite tall, considerable fruit occurring from 20 to 25 feet from the ground. Up to a height of 20 feet effective control can be obtained, above this point, however, effectiveness rapidly decreases. For example, in one tall tree 123 apples (which are included in the results given in experiment 13) were picked at a height of 25 to 28 feet and 22 of them were found to be wormy. The results indicate that calyx worm control in the lower portion of the tree is superior to that obtained in the higher portions of the trees, yet the ratio of calyx control does not fall far below that of the average condition. In this experiment apples taken at a height of 12 feet to the tops of the trees developed 81.13 per cent side worms and 18.86 per cent calyx worms.

From figures which I have been accumulating it appears that the codling moth is inclined to deposit more eggs in the tops of the trees than nearer the ground. It is quite important then that the fruit should either not be grown at that height or should be very well sprayed in order to reduce worm infestation to the minimum.

The poor results that have been obtained with the spray gun are not due to the principal involved in applying the spray. Unsatisfactory control can be the result of the misuse of one of three—or perhaps better—the combination of three misused factors. These are poor equipment, poor work and irregularity of application. Of the three factors the first mentioned is probably the most important from the standpoint of the use of the gun. The other two factors are contingent upon the first. The spray gun is a useless accessory on a poor spray outfit. It is little better than nothing and will never give good results. Our up-to-date 3½ horse power sprayers are indeed too small to handle two guns effectively, they will handle one in good shape. A machine of this power, in order to throw a spray of the proper quality must maintain a pressure of at least 275 pounds. In the experimental work just referred to (orchard No. 4, table X) a machine of this character was used. In order to keep the spray in proper form it was tuned up and punished throughout the season. When you begin to punish a gas engine pump trouble begins, and the owner of this machine had his share. This condition of affairs existed in many orchards throughout the valley and was typical of no particular make of sprayer. A spray machine, in order to live the life that it should and at the same time deliver the goods must have a liberal reserve. A machine of 10 horse power is none too much. Such spray machines are now coming into use and it will be only a question of a very few years until all of the present so-called modern sprayers will go into the discard. The results given in orchard No. 1, table VIII, were obtained with one of these larger types of sprayers.

The gun where operated with small inferior equipment has given a very poor account of itself. I have carefully checked up the results obtained in several orchards where poor equipment has been used. The growers tried to do good work and timed their application well. Breakdowns and low pressure, which is usually the rule when a machine is not working right has led to very poor results. The lower fruits as a rule came through the season in fairly good shape. In 1918 in one of these orchards under observation the following records were made. Apples growing below 12 feet developed a worm infestation of 3.55 per cent. Apples growing between 12 feet and the tops of the trees developed an infestation of 17.63 per cent. There is only one explanation for this condition and that is the fact that the spray was not applied properly to the tops of the trees.

Continued on page 38.



Glidden Results Are Sure

For a sure result use Glidden Insecticides. They carry the necessary protecting poisons in full strength.

Glidden Insecticides stay in suspension and form an even film over the entire foliage. Used with standard types of sprayers, they never clog the nozzle and they are as economical as efficient.

Glidden Products in this line cover every possible requirement. Read carefully the following complete list:—Glidden Dry Powdered Arsenate of Lead, Glidden Dry Powdered Arsenate of Calcium, Glidden Dry Powdered Bordeaux Mixture, Glidden Dry Powdered Bordo-Arsenate, Glidden Dry Powdered Lime Sulphur and Glidden Paris Green.

Glidden dealers are located everywhere. They sell Glidden Insecticides in convenient one-pound cartons and on up to 200-pound drums. Nearest Dealer's name and instructive Spray literature, schedule, etc., sent on request.

Everywhere on Everything

"Everywhere on Everything" truly represents the scope of Glidden Service on the farm. With every kind of Paint, Varnish Stain and Enamel, as well as Insecticides and Fungicides in the Glidden line, it is a true expression of Glidden Usefulness.

THE GLIDDEN COMPANY

National Headquarters, Cleveland, Ohio Stocks in Principal Cities

Factories: Cleveland Chicago San Francisco Reading New Orleans St. Louis
Brooklyn St. Paul Toronto

Branches: New York Chicago Kansas City Detroit Boston Scranton
Evansville Birmingham Baltimore Pittsburgh Atlanta
Dallas Des Moines Montreal Winnipeg



The Department of Agriculture Cold Storage Plant

By Lon A. Hawkins, Plant Physiologist, Office of Horticultural and Pomological Investigation, Bureau of Plant Industry, United States Department of Agriculture

THE ever increasing demand for foodstuffs has led to the development of various methods of preserving and storing fruits and vegetables in season for use when fresh products are not readily obtainable. One of the most important of these methods is that of cold storage, that is, the storing of fruit and vegetables at temperatures low enough to slow down the life processes but not inhibit them. By such treatment the life of a fruit or vegetable, which might be only one or two weeks after removal from the plant, may be lengthened to several months, with only slight deterioration in its food value and attractiveness.

The mechanical phases of cold storage, that is, the means of producing and regulating low temperatures, are fairly well understood. Much less is known, however, concerning the reaction of the various kinds and varieties of fruits and vegetables to low temperatures, though considerable experimental work has, of necessity, been done by commercial cold storages to determine the best temperatures for the keeping of produce.

It was this dearth of information concerning the effect of low storage temperatures on fruits and vegetables that led the office of Horticulture and Pomology of the Bureau of Plant Industry to plan and erect a cold storage plant to be used for experimental work. This plant was designed with rooms large enough to give approximately commercial conditions of storage but not so large that the cost of operation and equipment for experimental purposes would be prohibitive. The plant was designed by Mr. S. J. Dennis, a refrigerating engineer formerly connected with this office.

The building is 100 ft. by 44 ft. on the outside and is two stories high, being 22 ft. from the top of the first floor to the plate. The exterior of the building is shown in figure 1. The walls and floors are of monolithic concrete. The gable roof is frame covered with fire proof shingles. The first floor of the plant, figure 2, is divided into engine room, storage space and handling room. The engine room is 26x42 ft. 4 inches inside, with an office about 10x12 ft. The ammonia compression system of refrigeration is used and

large tank of calcium chloride brine which is pumped through coils in the refrigerating chambers by means of a motor driven centrifugal pump. A gasoline engine connected to a two and a half kilowatt direct current generator furnishes power to drive the brine pump motor in case of interruption of the electric service.

The storage rooms are located next to the engine room. They are arranged in two rows of four rooms each (see figure 1) and open out into the insulated and refrigerated corridors which run along

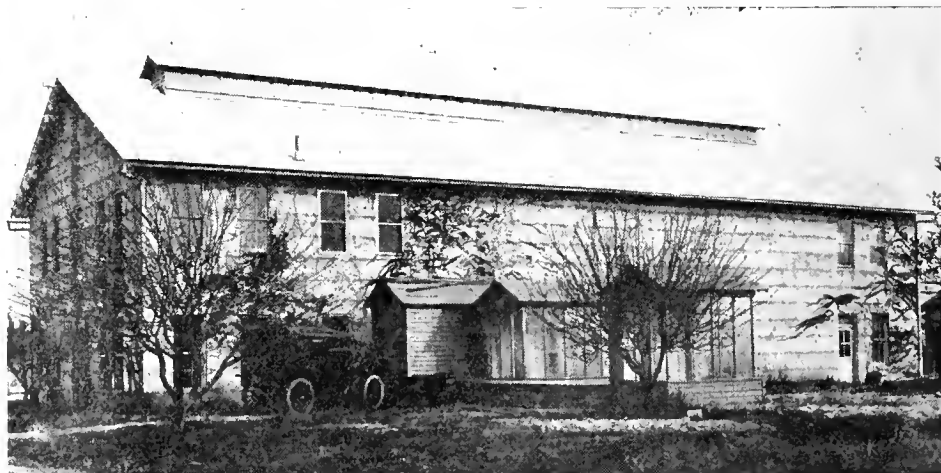

FIGURE 1—View of the experimental cold storage plant.

the engine room is equipped with two twelve-ton belt drive vertical ammonia compressors run by 25 horse, slow speed induction motors. A forty horse power gasoline engine is provided for auxiliary power in case of accident to the electric equipment. Refrigeration is by circulating brine. The ammonia expansion coils are immersed in a

both sides of the building. The rooms are about 8x14 ft. by 11 ft. 7 in. high over all, furnishing in round numbers 1300 ft. of space. The rooms are insulated with insulation made up of flax fiber, mineral wool and a binder. Four inches of insulation were laid on the outside corridor walls and the same on

Continued on page 36.

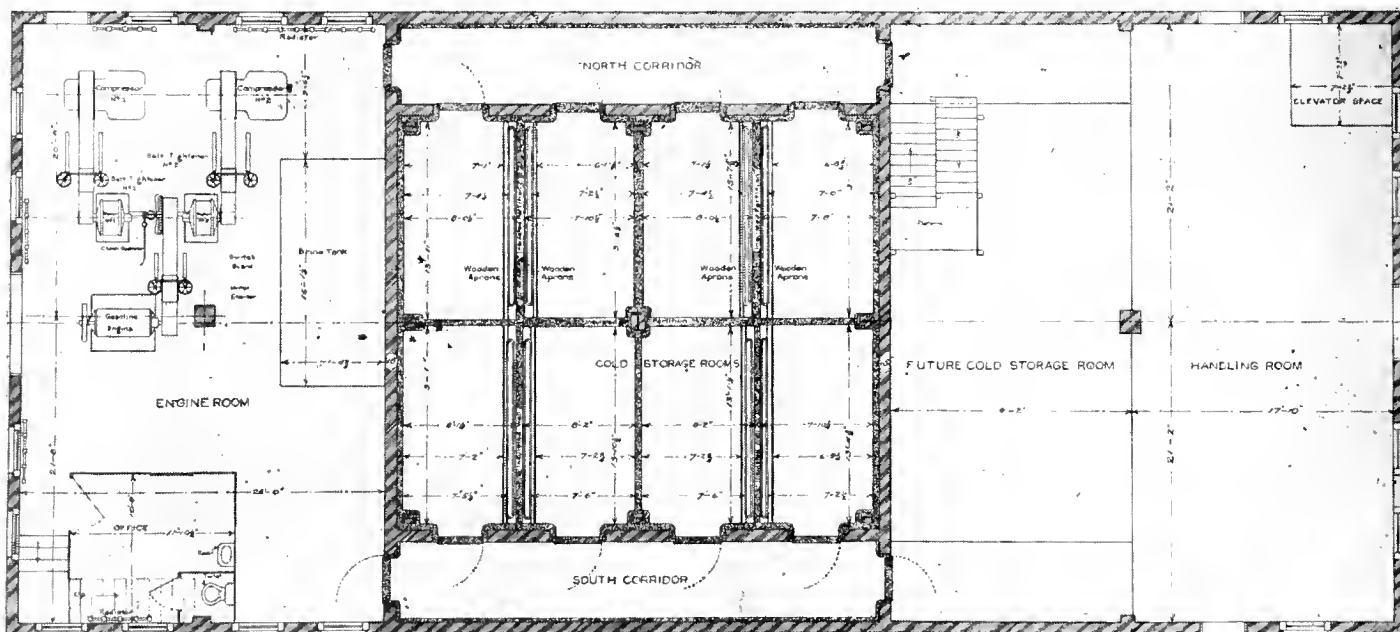
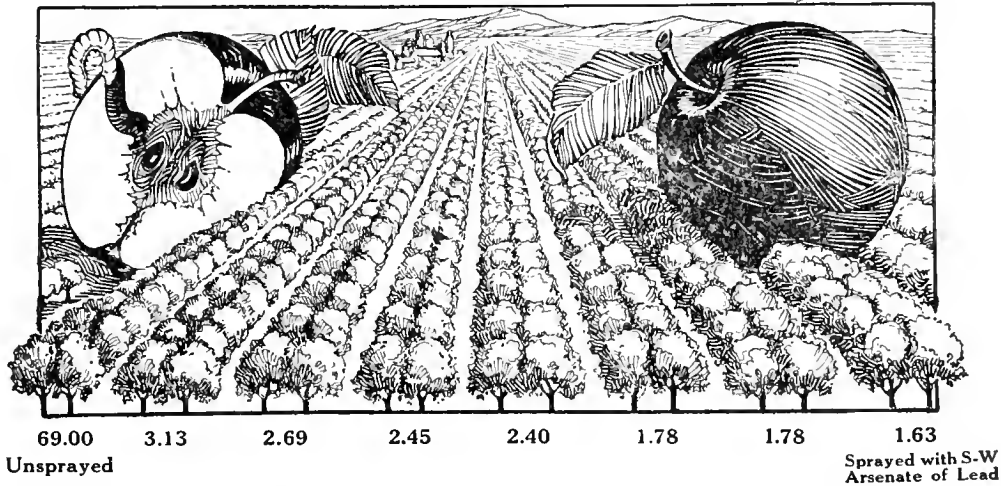

FIGURE 2—First floor plan of experimental cold storage plant, showing engine room, refrigeration chambers, unfinished refrigeration space and handling room.

How S-W Dry Powdered Arsenate of Lead was tested for Superiority



69.00% Wormy Fruit Reduced to 1.63%

IN an Oregon orchard the County Pathologist conducted a general insecticide test in a 12 year old Newton orchard near Phoenix. It was a year of serious Coddling Moth infection. Sixteen rows

of trees were used. Two rows were left entirely unsprayed, two were sprayed with Sherwin-Williams Dry Powdered Arsenate of Lead, and the remaining rows were sprayed with other insecticides.

2 Unsprayed Rows showed 69.00% Wormy Fruit
2 Sherwin-Williams Rows only 1.63% Wormy Fruit

At the end of the season the two unsprayed rows showed 69% wormy fruit; the Sherwin-Williams Rows only 1.63%; and the other insecticides ranged up to 3.13%.

while it developed three good sprays, it also proved that Sherwin-Williams Dry Powdered Arsenate of Lead is the most effective control of moth in preventing wormy fruit. (Copy of letter from County Pathologist sent on request.)

This test proved the great value of spraying, and

Better Working Qualities

S-W Dry Powdered Arsenate of Lead possesses maximum lightness and fluffiness. This results in maximum suspension, distribution and adhesiveness. It contains from 30 to 33% arsenic oxide, and less than 1% water soluble arsenic. These properties and proportions assume maximum killing, without danger of injury to foliage or fruit. It works effectively on

all fruits and vegetables as a liquid spray or in the form of a dust. It also combines effectively with S-W Dry Powdered Lime Sulfur as a summer spray.

Save 15c. Right now, just 10c will bring you the new 25c Revised Sprayer's Manual. Address The Sherwin-Williams Co., 602 Canal Road, N. W., Cleveland, Ohio.

SHERWIN-WILLIAMS PRODUCTS

PAINTS AND VARNISHES, DYESTUFFS
 PIGMENTS, CHEMICALS

INSECTICIDES, COLORS, DISINFECTANTS
 AND WOOD PRESERVATIVES



Planting and Cultivating the Loganberry

By Britt Aspinwall

LOGANBERRIES are started from plants obtained by tipping the old vines in the fall of the year. The selection of plants in setting out a new yard is very essential, as a poor plant will make a weak vine, which will seldom, if ever, make much of a growth or amount to anything.

We set our plants eight feet apart each way and cultivate them both ways during the first summer. This requires about 680 plants to the acre. Before setting them out the land should be put in first-class condition, then mark the ground both ways and take out a good shovelful of dirt for each plant, packing the loose dirt in around the roots with the hands so as to have them spread out as evenly as possible and keep them from drying out. We usually plant from the 25th of March to the middle of April, according to the season and the condition of the land. After the plants are set out they should be worked well each week or ten days during the summer with a disc harrow, springtooth and clodmasher to keep the ground loose and keep a dust mulch on the surface.

The vines will not make very much growth till about August, when they will begin to shoot out over the ground, and it will be necessary to turn them lengthwise of the rows and work the land only one way. At this time the holes should be dug and the posts set out for the trellis. We use good cedar posts, putting them not over thirty-two feet apart in the row and two feet in the ground. This makes a trellis five feet high. Anchor the end posts good, as there will be a heavy strain on the wires when they are filled with ripe

fruit. We use three No. 12 galvanized wires for the trellis, putting the top wire on top of the posts and the bottom one about 20 inches from the ground. In October the vines should be trained upon the trellis, spreading them out evenly so as to cover all the space possible and avoid bunches. It will be necessary to wind them around the wires but not too tight, and the top wire will carry the most weight. If more plants are wanted, train the vines over the wires with the ends down to the ground, and cover them 3 or 4 inches deep about the first to the middle of October. They will take root in the fall and winter and make good plants by the next March. We put ours down in this way and each year ship thousands of plants to all parts of the United States where they can be grown.

In the fall of the year plow the ground, throwing the dirt toward the rows, and leave it in this condition till spring. In the spring, as soon as the ground is in good condition to work, plow the dirt away from the hills, plowing very shallow closest to the rows so as not to disturb the roots. A vineyard plow is best for plowing the last two furrows, as one can get closer to the rows and between the hills without injuring the roots. It is a good plan to harrow close behind the plow if the weather is at all dry. This may be done either by hand or with a horse hoe. After hoeing them in good shape, which should be done soon after plowing, take a disc harrow and throw the dirt back to the rows, but be careful not to ridge them too much in the row, as it has a tendency to raise the roots

out of the ground. They should be worked with a spring-tooth harrow, or something similar, and a clodmasher every week or ten days during the summer and up into July. When the new shoots start in the spring they should be trained up in the center of the hills, allowing them to stick out over the wires unless they get too long, when they will have to be turned back. Never thin out any of the vines unless they get thick in the hills, as it is apt to bleed the roots. I prefer not to trim off the ends of the vines as we cannot see that they raise any larger berries, but fewer of them than when left as they naturally grow.

The picking season starts in from the middle of June to the first of July, and usually lasts about six weeks. It requires about four or five good pickers to the acre. As soon as we are through picking we cut out the old vines and train up the new ones, throwing the old ones between the rows, and cutting them up with a sharp disc harrow so they can easily be plowed under and serve as fertilizer. Loganberries should yield from one-third to one-half of a crop the next year after being set out, and thereafter a full crop. An average crop is from four to five tons of fresh fruit to the acre, although they sometimes yield as much as six and one-half tons on good, rich land. It requires five and one-half pounds of fresh fruit to make one of evaporated.



Harvesting the loganberry crop on the Aspinwall place near Brooks, Oregon.

UNQUESTIONABLY—

Modern methods applied to fruit growing have made the Northwest a great fruit growing center, with possibilities of extensive development.

Modern methods applied to banking have made the FIRST NATIONAL BANK pre-eminently the ally of the horticulturist. Its facilities, service and the personal interest of its officers are at your disposal.

THE FIRST NATIONAL BANK
OF PORTLAND OREGON
THE FIRST NATIONAL BANK WEST
OF THE ROCKY MOUNTAINS

TREES AND SHRUBS



Fruit trees budded from bearing orchards. Apple, Pear, Cherry, Peach, Plum, Prune, Apricot, Quince, Grape Vines, Shrubbery, Plants, Raspberries, Blackberries, Logans, Dewberries, Asparagus, Rhubarb, Flowering Shrubs, Roses, Vines, Hedge, Nut and Shade Trees. Carriage paid. Satisfaction guaranteed.

WASHINGTON NURSERY CO.
Toppenish, Washington.
Salesmen everywhere. More wanted.

Temperatures Which Will Damage or Kill Fruit Buds

By F. L. West and N. E. Edlefsen, of the Utah Agricultural College Experiment Station, Logan, Utah

EXPERIMENTS conducted at the Utah Agricultural Experiment Station, to determine the temperatures at which fruit buds receive injury from being frozen, are both valuable and interesting. These experiments were undertaken to assist growers in frost susceptible districts in the use of heaters in their orchards and also to know the drop in temperature necessary to cause the lighting of the heaters. Apart, however, from the value of this knowledge to the grower who may use heaters it is valuable to every grower to know what degree of frost will damage or kill fruit buds.

During the first two years that this work was being carried on the experiments consisted in removing branches from fruit trees and subjecting them to freezing temperatures in the laboratory. The damage done was then noted by counting the buds that had turned black and also the ones that were unaffected, and thus calculating the percentage of the buds that were damaged. As this method did not give sufficiently definite results, an apparatus was made for freezing the entire tree. The yields of the trees subjected to freezing temperatures were noted at harvest time after the buds on them had been checked up at the time of the freezing or shortly thereafter.

The apparatus for freezing the trees consisted of two double-walled half cylinders made of galvanized iron fastened to a wooden base that was put on runners, by means of which the apparatus could be moved by block and tackle or team from tree to tree. The cylinders were six feet high and six feet in diameter in the clear. Four inches of space was allowed for the ice and salt. When the iron cover was in place, ice and salt were spread over it and then canvas thrown over the whole to keep the heat out.

As the ice and salt took the temperature down, thermometers projecting through the sides showed the operator the approximate temperature inside the vessel. The temperature was modified by forcing varying quantities of air in at the temperature desired. This current of air, together with an electrically driven fan kept the temperature about the tree uniform to within a degree. Four standard minimum thermometers were hung at various elevations on the tree giving us accurately the minimum temperature attained and a thermograph also supported in the tree traced out the temperature changes as it cooled and then warmed up when the vessel was opened up, thereby giving us the rate of cooling and thawing. With this equipment trees were subjected to temperatures as low as 12 degrees Fahrenheit and by increasing the percentage of salt there is no doubt that temperatures still lower could be obtained.

In making these experiments check trees of the same size and kind with approximately the same number of buds and located near the frozen trees were

selected. After the freeze, a certain percentage of the buds were cut open to observe the discoloration and the same percentage were destroyed on the check trees so that both trees were thinned equally. The yields of both trees were observed in the fall. To note whether it made any difference when the buds were examined, they were cut open immediately after the freeze and then at varying intervals afterward.

It will be of interest to make a little study of the theory of the injury to fruit buds due to freezing.

When plant tissue freezes water passes out of the cells and ice forms in the intercellular space. It has been found that if the thawing is done slowly enough when working with tender plants, such as lettuce and matured fruits, the water will gradually pass back into the cells, and if the original freeze did not rupture the cell wall, the plant has suffered little harm from the ice formation. If, however, the thawing is done rapidly, the water does not get back into the cells and they die due to drying out. We must have then either a rupturing of the cell wall when the ice is formed or else ice formation and in many cases rapid thawing in order to kill the tissue.

Pure water freezes at 32 degrees Fahrenheit. When substances are dissolved in it, the water freezes at a lower temperature, the amount of lowering of the freezing point depending on how much material is dissolved in it, and on the nature of the substance that goes into solution. For example, a five per cent salt solution freezes at 27 degrees F., while a thirty per cent sugar solution only freezes at 29 degrees F. W. H. Chandler measured the freezing temperature of the juice that he extracted from twigs taken from various kinds of fruit trees and found that on an aver-

age the sap froze at from 28 to 29 degrees F. and in no case did it freeze below 28 degrees F. The sap from Elberta peach twigs extracted in March froze at 28.7 degrees F., while but two-thirds of the twigs of the same kind of fruit when subjected in March to a temperature of as low as 10 degrees F. froze.

In the orchard it is frequently found that some of the buds withstand temperatures as low as 20 degrees F. and mature, and these buds no doubt take up these low temperatures as the work of Wiegand shows.

Fruit buds have a protective covering over them supposedly for the purpose of checking evaporation, but this is not sufficient to keep them for any appreciable length of time at temperatures different from the surroundings. Wiegand found as a result of experimenting with horse-chestnut buds containing thermometers which he sealed inside of them, that when these buds were subjected suddenly to a change in temperature of 20 degrees or more, in about ten minutes they had taken on the new temperature to within two degrees, and had arrived completely at the new point in a half hour. In case of the natural freezes in the orchard, where the temperature is falling slowly from sundown until sunrise, there is little doubt that the fruit buds take on the resulting temperatures of the surrounding air. In artificial freezing therefore it should not take long for the buds to acquire the new temperature, especially if they are in full bloom and when they are smaller than the buds used in the experiment reported above.

As was mentioned earlier, the more concentrated the aqueous solution the lower is its freezing point and in general the amount of the substance, especially if it be an organic one, that will



Apparatus used in freezing entire tree in experiments made at the Utah Agricultural Experiment Station, to determine the temperatures at which fruit buds are damaged by frost.

dissolve in water is but slightly affected by the substances that are already in solution. This allows the possibility of a very concentrated solution, and each of these substances has its influence in lowering the freezing point of the water largely independent of the others. For these reasons, rather a low freezing point of a solution is possible. A very concentrated juice, therefore, in the buds would be expected to freeze at a fairly low temperature. In spite of this, however, the unusual hardness of some buds to freezing is really surprising. The difference in sensitiveness to cold of different buds on the same branch and of the same buds at different stages of development may be in part due to the difference in quality and concentration of the cell sap.

When liquids are cooled to their freezing points, if there be none of the solid material present, they rarely freeze. They may be cooled further several degrees and kept for days without solidification taking place. The introduction of as small an amount of the solid as one-hundred-thousandth part of a milligram is sufficient to cause freezing to commence. Enough solid will now separate out to raise the temperature of the whole to the melting point. The temperature now remains constant, and at the melting point until all of the liquid has become solid, the heat that is being lost by radiation being supplied by the heat that is always evolved when liquids solidify. In supercooled liquids that have not been inoculated, crystalline nuclei make their appearance spontaneously at different points in the liquid and then begin to grow. The chance of these nuclei appearing increases with the quantity of liquid present and it has been found experimentally that liquids may be cooled far below their freezing points and maintained at these low temperatures for long times when they are kept in capillary tubes. In these tubes the rate at which these nuclei form and grow is sufficiently slow to be measured. The rate of growth is approximately proportional to the degree of superfusion when that degree is not very great and the number of nuclei formed in a given volume in a given time at first increases with the degree of superfusion, but afterwards reaches a maximum, and begins to diminish as the liquid becomes highly supercooled. Liquids that have been very suddenly cooled far below their freezing points have been kept for months without freezing. The juice of the buds is confined in small capillary spaces and the above mentioned phenomena will help to explain in part the unusual hardness of the buds and the great difference in hardness of buds that appear to be very similar because they may thus be cooled below their freezing points and warmed again without ice forming.

A reading of the popular literature on the subject is likely to cause one to infer that buds have a certain freezing temperature, and that when they arrive at this temperature they all freeze. This, of course, is wide of the truth. There is a range of four

or five degrees between the highest temperature at which two or three per cent of the buds are injured, and the temperature at which all the buds are killed. It should be remembered that on the same branch are often found buds that have swollen but slightly when others are in full bloom. A freeze or two in the early spring will usually do no harm; they simply serve to thin the buds out, for it is generally known that there are many more buds on the tree than actually mature into fruit. The number that can be allowed to freeze without heating the orchard will naturally depend on how many there happen to be on the tree at that particular time. It is very rare that a tree has so few buds on it that it cannot lose one-half of them and yet mature an average crop in the fall. Where we have endeavored to select a critical temperature we have taken it as near as possible to the point where not more than 50 per cent of the buds will be killed by experiencing the cold mentioned.

Some of the more important conclusions which will be of interest to the orchardist, arrived at by these experiments are as follows:

To kill plant tissue by freezing, either the cell wall must be ruptured when ice forms, or else after the ice forms, it must thaw rapidly. An occasional case of ice formation and slow thawing without death resulting to the tissue has been observed.

Fruit buds will stand a lower temperature by several degrees than the freezing point of the expressed sap, and the sap freezes at three or four degrees below the freezing point of pure water.

The literature on the subject might lead one to infer that the buds have a definite freezing point and that when the orchard reaches this temperature, practically all of the buds are frozen and the crop for that year is to be a failure. This is not the case. The orchard can usually stand two or three freezes without losing more than half of its buds, and this number is usually sufficient for a normal crop.

It doesn't make any difference, in the first two or three days, as to when the injury to the buds by direct observation of them is determined.

The further developed the buds are, the more sensitive they are to frost.

There is a range of at least five de-

grees Fahrenheit between the temperature at which only about five per cent of the buds are damaged and the temperature that will kill all of them.

In the case of Double Nattie cherries when the fruit is setting, 29 degrees Fahrenheit caused no damage and 21 degrees killed practically all of them.

With Jonathan apple blossoms in full bloom, 28.5 degrees Fahrenheit caused no damage and 24 degrees killed about half of them.

Prune buds are slightly harder than those of the other kinds of fruit that we tested.

The temperatures which will kill about fifty per cent of the buds of the Elberta peach are as follows: When they are slightly swollen, 14 degrees; when well swollen, 18 degrees; when they are showing pink 24 degrees; when in full bloom 25 degrees; and when the fruit is setting, 28 degrees Fahrenheit.

**BEST SERVICE-
QUALITY & PRICES**



**PERFECTION IN
FRUIT
LABELS**

**THE
SIMPSON & DOELLER Co.**
1423-24 NORTHWESTERN BANK BLDG.
PORTLAND, OREGON.

E. SHELLEY MORGAN
NORTHWESTERN MANAGER

**WE CARRY—AND CAN SHIP IN 24
HOURS—STOCK LABELS FOR PEARS,
APPLES, CHERRIES & STRAWBERRIES.**

HOOD RIVER ORCHARD

One of Hood River's show places for sale. Thirty-three acres, all under irrigation; 22 acres in 18-year-old apples, mostly Spitzenberg and Newtown, with some Ortley and Jonathan; 4 acres in alfalfa. Regular producer, making good money. In the heart of the Pine Grove district, 6 miles from town on the new Mt. Hood loop. Local railroad stops on the place.

Exceptionally beautiful homesite. Ten-room modern house with every convenience except an electric elevator. Spring water under pressure and electricity in all buildings. Barn and packing house, tenant house, family orchard, gardens, grapes, strawberries, asparagus, equipment—everything.

Bank's appraiser puts the place at \$40,000. Sell for \$25,000 with terms. My only reason for selling is that I want funds for development of my other 100-acre place. Write **RALPH ROOT, R. F. D. 4, Hood River, Oregon**

Problems in Marketing Northwest Prunes

A Criticism, But Not A Knock

Editor BETTER FRUIT:

STATEMENTS have been appearing in the press of late in regard to the uncertainty of marketing Oregon prunes and also that reports from the East are to the effect that California prunes are selling for 3 cents a pound more than the Italian variety grown in Oregon and Washington. I wish, therefore to say a few words about the marketing of Northwest prunes and although prune men in this section may not take kindly to what I say I assure you that my interest in the prune industry of the Northwest is sincere from a standpoint of pride as well as because of the financial phase; nor do I want to appear pessimistic, but there are some plain facts that should be known to every prune grower and packer in Oregon and Washington.

There was no mistake made in planting prune orchards as a commercial industry nor was it a mistake in planting the variety that prevails in the Northwest, but there has been a continual disregard of care in curing and preparing for the market.

When our orchards first began to bear in quantities for other markets, packing facilities were limited; knowledge of how to handle them was lacking, so they were graded, put into sacks and forwarded East.

The very nature of the Italian prune is such that it is impossible to handle it with any degree of satisfaction and safety in bags. This fact was soon discovered by the buyer after sustaining some substantial losses from rejections. Sales were hard to make. The growers took a hand in shipping themselves, but finding in some instances that they were called on to pay freight, aside from losing their fruit, they too were sorely disappointed. Something had to be done—so the method of processing was adopted; packing them in 25 and 50 pound boxes, eliminating almost entirely shipping in sacks. Since that time, which dates back about 15 years, some progress has been made but we are far short yet of marketing a satisfactory, safe pack of prunes.

The nature of the Italian prune is such that it must be processed in order to assure the dealer a commercial package that he can handle safely and a product that the consumer will buy.

I am not going to tell you how to dry prunes, because I don't know, but I do know that there has been a large tonnage of inferior prunes put on the market each year. Lots of them should have been condemned and destroyed. No one has the right to pick up and dry decayed prunes; some that have split and the cracks full of mould; others that have decayed from over-ripeness. Such fruit is positively unfit for food. The consumer does not know it, as its defects are covered up in the process of drying. It is even difficult for the packer to detect the imperfections; probably some packers do not look for them, so they are bought,

packed and shipped East and to Europe. Frequently they look all right when they arrive.

When under-cured and over-processed fruit starts up fermentation or mould, lots of it spoils on the dealer's hands and it is sold at reduced prices to the consumer. It is positively unfit to eat and is not liked and many times no reason is given for this dislike. Nor does the consumer actually know what is wrong, but I assure you that a trial of such fruit is enough. I will match with big odds an Italian prune against any other food product, either dried or in cans, for covering up its dirt, imperfections and filth. I can take a sound, properly cured prune and put it by the side of one that is partially decayed and dried and one looks about as good as the other, but cook them and try

them out by taste and the difference is noticeable—distinctly so. One is either rancid or sour and very repulsive, while the other has a sweet tart taste and is the most delicious dried fruit to be had. A well cured, well cooked Italian Prune served in its juice or with cream is in a class of its own—nothing to compare with it in the dried fruit line.

I wish every one of you could have been with me on a trip East recently, when I called on the jobbing trade in nearly every large commercial center. A portion of my time was given to investigating the situation as to Oregon and Washington prunes. I was more than disappointed; in fact, greatly humiliated—there were several thousand boxes of the previous year's crop in the New York market. They had rotted and moulded and had been worked over and were selling at 50 to 75 cents per box of 25 pounds. "Oregon prunes have

MYERS HONOR BILT- SPRAY

Pumps, Nozzles and Accessories

For Spraying, Painting and Disinfecting

Your garden lot may be small—your fruit trees few in number—your truck acreage may be large—your orchards extensive. In either case you need spraying equipment to protect your crops.

No matter what your spraying requirements may be you can meet them successfully with a MYERS "Honor-Bilt" PUMP of such size and capacity as will just answer your purpose, for MYERS SPRAY PUMPS and SPRAYING ACCESSORIES come in many styles and sizes from the largest automatically controlled Power Spray Pumps and complete Power Spray Rigs to the medium capacity Easy Operating, Cog Gear Barrel and Tank Outfits, down to the Smallest Bucket and Garden Sprayers. And each Myers Spray Pump, regardless of size, is neat of design, extra well built, properly equipped with the best of hose and nozzles, and guaranteed for efficient and economical service.

Spraying time is here. If you have not already made provisions to spray, get a MYERS SPRAY PUMP from your dealer and do the work thoroughly. If he cannot supply you write us. 64-page Catalog—16 pages of "How and When to Spray" Instructions mailed, without any obligation whatever, on request. Drop us a card.

F. E. Myers & Bro.
No. 135 Orange St.
Ashland, Ohio







Other Important Myers Lines

- Pumps for Every Purpose
- Hay Unloading Tools
- Door Hangers

Pacific Northwest Distributors



Portland, Ore. Spokane, Wash.

BUY FROM THE LOCAL MITCHELL DEALER

a black eye in this market," I heard everywhere I went. "How about orders for this season's crop?" "If they are cheap enough, we will try a few again," was the answer I received.

I have been in Oregon 25 years; I love the State; I am proud of it and I hold the highest regard for its resources. On my trip when talking with others I met in hotels, on the trains or in the business houses, I took great pride in telling them of our lumber industry, our grain, apples, and dairy products. I want to feel as proud of our prune industry as of these.

Protect Your Shipments

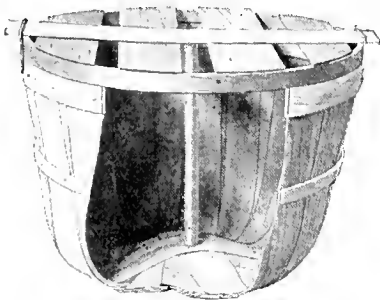

Universal Bushel Shipping Packages

safely marketed 10,000,000 bushels of fruits and vegetables last year. Ideal for all crops. Center-post gives rigidity of barrel. Pick right into package. Pack in the orchard—save rehandling. Covers fit on without nails. Easy to lift, handle and load in cars. Write for information showing how hundreds of shippers prove they save money and get better prices and larger **net profits** by shipping in Universal Bushel Shipping Packages.

Valuable Facts Free

Write for handsome free booklet "Shipping Profits"—filled with information of vital interest and profit to every fruit and vegetable shipper.

Package Sales Corporation
106 East Jefferson Street
South Bend, Indiana

We have produced in the last few years about 125 million pounds of dried prunes. During the same period, California has produced many more million pounds. Our packing facilities and selling ability are far greater per ton than California. Now with the small tonnage and ample marketing resources, our fruit has gone to the consumer at a much less price than theirs. This fact is evidence that something is wrong. It's true that the general demand is for a sweet prune. It's also true that there is a demand for a tart prune and this section grows them.

I want to make it clear to you that something must be done immediately. The prune acreage is increasing materially, both here and in California. France, Bosnia and Servia are factors in the industry. I predict that unless our fruit is cured and packed so as to increase the demand, you will see some pretty cheap prunes within three years.

I will admit that the Italian prune is more difficult to cure and pack than a sweet variety. It can be done; it has been done, but enough poor fruit has gone out to prevent progress for the past five years. If every dryer in the Northwest had taken from his orchards only sound, ripe fruit and cured it properly, then properly processed it, we would not have half enough prunes to supply the demand and at as good a price per pound as any district in the world gets.

We will never succeed as long as half ripe, split, mouldy and decayed fruit is

dried and then possibly not packed properly.

The manufacturer or any one producing or preparing anything for food, who has not observed the rapid growth of sanitation and marked development of cleanliness in the past few years, is falling far short of the times. People are particular about what they eat and they are going to be far more so in the future. Laws are doing much in this respect; a campaign of education for better, cleaner food is prevalent everywhere. Many canners, packers and manufacturers of food supplies invite public inspection. I visited one large plant East that required the services of three guides to take care of the visitors, each guide taking from ten to twenty-five people on a trip through this plant.

It pays to be clean. Would it increase the demand for our prunes if the public were invited to visit our prune dryers and packing houses when in operation? Have you any doubt about extending the invitation? There should be none.

In closing I want to say that the prune industry is going to progress. We are going to have better fruit. It will be one of the best paying industries we have. Commercial principles governing the demand for our prunes will in time correct abuses heretofore mentioned, but let us not wait until compelled to do something that we should voluntarily do ourselves. Let us all work together for a better Oregon and Washington prune.

Are You the Man?

*If so, BETTER FRUIT offers you
a chance to make good money*

We want a representative in every fruit-growing community. In every such community there is some individual with a little time each month to spare, who, by representing BETTER FRUIT, can make a good income.

Perhaps it will be an elderly man?

A young fruit-grower just getting started?

A wife who wants to help out?

An ambitious boy or girl who wants to make extra money?

We want someone in *your* community to become our *permanent* representative—to secure new subscriptions for us and renew old ones.

We want two or three representatives in the Hood River Valley. Several in Yakima and Wenatchee—in the Willamette Valley, Rogue River, etc. In fact we want *permanent* representatives in every fruit district of the West.

Our proposition is a good one. Are you the man or woman for the job?

Write today, stating your qualifications.

BETTER FRUIT PUBLISHING COMPANY

OREGONIAN BUILDING, PORTLAND, OREGON

Using Bees to Best Advantage During Flow

By George S. Demuth, Agricultural Assistant, Bee-Culture Investigations

BROOD rearing, which is of primary importance during the preceding period, becomes of secondary consideration at about the beginning of the honey flow, because this is nearing the limit beyond which time the resulting bees develop too late to take part in gathering and storing the crop of honey.

At this time therefore, there is a radical change in the purpose of the manipulations. Instead of continuing the expansion of the brood-chamber the policy of the beekeeper should now be rather a concentration of the workers and the brood. There is perhaps a limit to the number of workers that profitably can be kept in a single hive and set of supers, but this limit is seldom reached, the usual mistake being in having too few. Each colony should have its brood-chamber well filled with brood in a compact form and be so crowded with young and vigorous workers that they will immediately occupy the supers when the honey flow actually begins.

The brood-chambers of colonies occupying more than one hive body should at this time be reduced to one, any extra brood being used in colonies having less than one brood chamber full of brood. After this operation, should there be still some colonies left with the brood-chamber but partly filled with brood, they should be fitted with combs of brood and adhering bees (without the queen) draw from some colony or colonies too weak to work well in comb-honey workers.

This massing of the workers in strong colonies, so essential to the production of a fancy grade of comb honey renders necessary extremely careful and skillful management since the efforts of the beekeeper may be nullified in two ways:

(1) The bees, by swarming, may divide their forces into two or more parts, neither of which would be ready to work in the supers until the season is much advanced or perhaps closed entirely, or (2) being defeated in their

efforts to swarm or from lack of convenient storage space, etc., they may do very poor work even during a good honey flow simply because the conditions of the colony are such that the storage instinct is dominant.

To bring about the best results in comb honey, the entire working force of each colony must be kept undivided and the means employed in doing so must be such that the storing instinct remains dominant throughout any given honey flow.

Any increase made before or during the honey flow is made at the expense of the surplus honey unless it be made with brood that would emerge in time for the young bees to be of use during the honey-flow. In general, however, increases may be made at a much less expense by setting aside some of the colonies for that purpose. To keep the forces together and satisfied with the storing instinct dominant during a good honey-flow is the most difficult problem with which the producer of comb honey must deal.

Swarming-Preventive and Remedial Measures.

Colonies do not all behave alike as to swarming. (1) Certain colonies go through the season with apparently no thought of swarming. Such colonies do the very best work in the supers, and their numbers can be increased by skillful management. (2) Other colonies start queen cells preparatory to swarming, but can be persuaded to give it up by such mild measures as destroying the queen cells and other methods devised, but not extensively used by producers. Among these methods are fitting the sheet of foundation in place, then directing a fine stream of melted wax along its edges, or the use of split sections in which a sheet of foundation is continuous through a row of sections, extending through their sides and top.

Some super-construction is such that the sections may be placed directly in the super by the operator who puts in

the foundation. This work is usually done during the winter months when the bees require no special attention. Enough supers should be provided to take care of the largest possible crop, even though it is not often that all are used the same season. The beekeeper who is operating several apiaries cannot afford to take time to prepare supers for the bees during a good honey-flow. Supers of sections thus prepared in advance should be kept clean by storing them in piles and keeping the piles covered with dust.

Tree Planting

Editor BETTER FRUIT:—Every spring and fall some trees are planted. Many trees will be planted this spring and again many more will be planted this fall. To get the best results from our labor it must be done right. The old-fashioned way of planting trees is fast being replaced by one that is more modern and gives better results. Each year many trees are lost by not doing it right. Making a hole and sticking a tree in it is not planting trees. Of the trees that were planted this way, many died the first year or never started to sprout.

Apple Boxes

HIGHEST QUALITY
WESTERN YELLOW
PINE

If you wish to make sure of a supply of well made boxes at fair prices, let us place your orders.

Carloads Only

Spokane Fruit Growers Co.
SPOKANE, WASH.

NOW is the time to send to
Milton Nursery Company
MILTON, OREGON

FOR THEIR 1919 CATALOG.
FULL LINE OF NURSERY STOCK.

"Genuineness and Quality"

Steam
Hot Water
Vapor and
Exhaust
Heating

Sanitary
Plumbing

Central
Heating
Plants

How Much Did YOU Lose?

What did the freeze cost you, Mr. Grower?

The day of the old wood stove is past. Do not leave your valuables unprotected any longer, but take steps NOW to safeguard your crops.

Let us tell you how to heat and ventilate your packing house properly.

Dauch Heating & Engineering Co.

Specialists in Heating and Ventilating Installations

East End Burnside Bridge

PORTLAND, OREGON

Engines
Blowers
Fans
Motors
Compressor
Pumps

Steam
and
Plumbing
Supplies
Radiators

The person usually blamed for the trees not making a healthy growth, is the one who sold them, and in 90 out of 100 cases it was not his fault.

Not long ago I sat on a rail fence watching a man punch holes into the ground on my neighbor's place. At first I thought he was making holes for small posts, but on inquiring I found he was making bore holes, to blast holes for trees. I was interested and wanted to see the holes after they were blown. He told me that the next day he would shoot them. He was early on the job. I went over and examined some of the holes and on measuring found them to be two and one-half feet deep, and the hardpan penetrated. The blaster prepared the shots, then loaded all the holes. He used 25 per cent dynamite and went about it in this way: He cut the fuse in lengths of three feet, inserted the end of the fuse in the detonating cap and crimped it. He then made a hole in the stick of dynamite and inserted the cap, tying it securely to the dynamite. After he had all the sticks primed he started to load the holes. The dynamite was shoved down to the bottom of the hole with a broom handle and fine earth thrown in on it. Earth was put in the hole and tamped with the broom handle until the top of the hole was reached. He loaded all the holes and then started to fire them. I examined the holes after they were shot and found them to be about three feet wide and three feet deep. (By three feet deep I don't mean that the earth was blown out to the extent of three

feet but that the earth was loose to that depth.) He took out all the loose earth from one of the blasted holes and found that the subsoil was busted, (I use the term busted because in it I find I can exactly say just how it was.) The blaster being through with his work went home. My neighbor called his men and they started to plant the trees. There were only 45 to be planted, so it did not take long.

One man went ahead and dug out the holes. He made two piles of the earth. One pile was the topsoil and the other the subsoil; the neighbor and the other man did the planting. The topsoil was thrown into the hole until the right depth was reached; the tree after being pruned to a whip was set in the hole and the balance of the topsoil was firmly packed around the roots; on top of this was thrown the subsoil. On top of this a dressing of well-rotted manure was placed. I asked my neighbor the why for all this and he remarked, "The use of dynamite cracked that subsoil so that it will be impossible for the tree to die from lack of moisture. The young tree takes this moisture by sending its fine rootlets into this subsoil, thereby insuring it of a steady growth. The placing of the topsoil at the root-system, gives the fine roots a chance to get into the mellow earth; they could not do it so easy if they were stuck in the subsoil."

Regarding the cost he said, "The cost was a little more, but what is the use of planting a tree and not have it grow? Plant it right at the outset. By hiring

a blaster I could keep my men at their regular work until the trees were actually to be planted. The planting was done in half the time as with pick and shovel, and I am well satisfied."

Five months after these trees were planted I went over and examined them. The growth was fine, in fact wonderful for five months' growth and that, in my estimation, is the best monument to good preparation and care in planting. F.A.K.

Fruit Trees Good Investment.

The ordinary individual craves a certain amount of fruit in his diet. On the average farm fruit constitutes only about 6 per cent in value of all food consumed. The percentage could be increased to good advantage, making fruit a more important part of the diet, says the United States Department of Agriculture.

A small area of the farm devoted to apple trees, peach trees, berry plants, or other fruit suited to the region, is a good investment for any farmer.

Demand for Spray Material Heavy.

The demand for spray material in the Northwest is the heaviest this year ever known and includes all classes of sprays. The demand is credited to the excellent propaganda that has been carried on by the experiment stations and agricultural colleges and also on account of the prosperity that has come to the fruit grower during the past two years.



KILL THE PESTS

This man is Dusting twenty acres per day at a cost of less than one-half cent per tree, using the

American Beauty Dust Sprayer

Codling Moth
Red Spider
Curculio
Aphis
Caterpillar
Mildew, Etc.

Write us about it.

California Spray Co.

6001-29 Pasadena Ave.
Los Angeles, Cal.

The Value of the Different Roots as Stocks

By W. L. Howard, Deciduous Fruit Station, Mountain View, California

THE great shortage in nursery stock this planting season has caused an unusual amount of discussion about the value of different roots as stocks for deciduous trees. This year nurserymen were able to sell almost everything they had. In the past year there has been a slight demand for prunes on roots other than myrobalan. Every year a considerable acreage of prunes is planted on peach and almond stock. A few have, for various reasons, desired to have prunes on apricot roots. Many have inquired explicitly about the value of this stock for French prunes. We have very good evidence to show that apricot is not a safe rootstock for the French, although it seems to be safe enough for sugar prunes, and possibly for some other varieties. The French, however, makes a very poor union with the apricot root, and in the case of one orchard recently examined near Gilroy, the trees are rapidly breaking off at the age of five and six years. Other instances have come to my attention where the trees became much older than this before breaking, but eventually they do "pinch off." Some old orchards in Napa County where Imperial prunes were top-worked on Royal apricots many years ago are still in good condition. At the same time French worked on the Royal was a failure. Many growers have told me that sugar prunes do well on apricot root. Sugar prunes, on the other hand, make a very poor union with the peach, and should not be used for that purpose. Some plums behave similarly on the peach, the Diamond being a conspicuous example.

Owing to the propaganda during the last three or four years in favor of the Japanese pear as a rootstock, nurserymen have almost stopped using the French stock. Indeed, I am told that the large growers of seedling stock in Kansas and elsewhere have almost ceased to grow the French pear stock. The wide use of the Japanese pear stock has been advocated because it is so much more resistant to pear blight than the French stock, and furthermore because it has been found to very successfully resist attack by woolly aphid. Wherever pear blight is prevalent, there is no question that the Japanese stock is much safer to use than the French stock, although it is not wholly blight resistant by any means. In the coastal region, particularly in the Santa Clara Valley, where pear blight is no problem, there has always been considerable discussion as to the advisability of giving up the French stock, which has been thoroughly tried out and found to be satisfactory in every way, except that it is injured by woolly aphid. The big question in the bay region, especially in the lowlands adjacent to the southern end of San Francisco Bay, is to know whether the Japanese pear root will withstand as much water in the soil as the French. In that particular region, the woolly aphid is said not to give much trouble,

even to French stock. One nurseryman who furnishes considerable stock for the region under discussion thinks that the growers there should stick to the French pear stock by all means, but he complains that, on account of the general condemnation of French stock, it is now becoming almost impossible to procure it.

Undoubtedly a rootstock entirely resistant to blight will eventually be found. At the present time it is known that some of the Siberian seedlings give great promise; certain strains of varieties are, for all practical purposes, undoubtedly blight resistant, but the problem is to isolate these resistant strains

from closely related forms that are not resistant and get them in sufficient quantities to place them within the reach of all nurserymen and growers.

A few growers have been able to start trees that were blight resistant so far as trunk and the bases of main branches were concerned by bench-grafting long scions of the Surprise pear on Japanese roots. These grafts were planted deeply, so that the scions in most cases formed roots. If the resultant nursery trees are planted in the orchard so that the Japanese root is six or eight inches underground, there is practically no danger of sprouts arising from the seedling stock. The Surprise pear makes a fine, shapely tree, and is a vigorous grower. It is entirely safe as regards attacks from pear blight. The Surprise tree may be shaped up in the

DOW

DEPENDABLE

Spray Materials

are now available in virtually every important consuming section in the United States and many foreign countries.

This justly famous line is the product of one of the largest chemical manufacturers in the world, and every known modern device is necessary and is employed in the manufacture of—

Dow Powdered Arsenate of Lead
Dow Powdered Magnesium Arsenate
Dow Powdered Lime Sulphur
Dow Paste Arsenate of Lead
Dow Powdered Magnesium Bordo

The Dow Spray Calendar and name of the nearest distributor will be sent free upon request.

The Dow Chemical Company
 MIDLAND, MICHIGAN

GROWERS' AND PACKERS' EQUIPMENT

Labor Saving Devices for Handling Fruit and Vegetables

Automatic Elevators, Sizers, Box Presses, Box Making Benches, Ladders, Packers Supplies.

Write for catalog.

Price Manufacturing Co. Inc. Yakima Wash.

No Orchard or Farm is Complete Without Our Latest Model

COMMERCIAL SIZE All Purpose Evaporator

Write for Folder

HOME EVAPORATOR CO.
ST. LOUIS, MISSOURI

P. O. Box 817

Central Station

Are You Going to Build A Drier?

See me before building.

I can save you money.

\$20 gets blue prints complete.

I run six tunnels to one stove.

Have right ideas of size of air chamber and proper radiating surface.

Dried 82 tons of prunes at a total cost of \$16.50 per ton.

Every drier my type is a success.

EDWARD DENCER

R-3, Box 158

SALEM, OREGON

desired manner and the main branches top-worked to Bartlett about the third year. Many have asked if the Bartlett makes a safe union with the Surprise. All that can be said on this point at the present time is that four or five years of growth have shown no evidence of weakness.

Liming Soils

Farmers of acid soils have often wondered why liming increases the yield of crops on some acid soils and does not on others. Investigations by the Oregon Agricultural College experiment station chemists have developed the fact that increases may be expected wherever the calcium forms combinations with humus bodies.

Since the composition of the soil solutions is a governing factor in plant growth, the effect of lime on the composition of these soil solutions may be an index to the inconsistent action of lime acid soils, says the report of the chemists. The solutions from various acid soils were analyzed at successive intervals after liming with calcium carbonate, calcium oxide or calcium sulphate.

The analysis showed that nitrates increased in those soils that respond to lime treatment, large quantities of soluble potassium were caused in all soils treated with calcium sulphate, the calcium content remained nearly constant whatever the treatment, soluble phosphorus decreased slightly under all treatments, and sulfo-fication occurred in all soils responding to liming. Alkalinity was present in soils treated with the carbonate and oxide forms, while acidity was present in untreated soils and those treated with the sulphate forms.

These findings fortify the soils department findings that drainage of wet lands and incorporation of organic matter in rundown lands should precede

extensive liming. They do not indicate any lessening of the use of lime, but do go far to establish the soundness of Dean Cordley's recommendation that every farmer of acid soils conduct lime experiments to see whether his soils will respond, and then govern his orders for lime accordingly.

Bush Fruit Culture.

If a currant or gooseberry plantation is properly cared for, at least eight to ten crops may be expected before it becomes unprofitable because of its age. Productive fields over twenty years old are not uncommon in some sections. Although the number of years a plantation will continue in good bearing condition depends to some extent upon location and soil, the most important factor is the care which it receives. The period of productiveness of both currant and gooseberry plants is longer in northern regions than towards the southern limits of their culture and longer on heavy soil than on sandy soil.

Providing More Money for Higher Education

The splendid advance of progressive agriculture in Oregon as well as agricultural education and higher education in general, is threatened with a serious check unless the relief prayed for in the Higher Educational Tax act, to be voted on by the people of Oregon at the special election May 21, is granted.

The results of extensive research work by the experiment station at the Agricultural College, Corvallis, and the seven branch stations representing the peculiar climatic and soils conditions of the seven agricultural regions of the state, have been rapidly brought into intimate touch with the farmer through the extension service. The practice of these results in production and protection of farm crops, livestock, dairying, poultry raising and farm and soil management have increased tremendously the production of high class produce and at the same time tended toward reduction of production costs.

Rapid as has been this extension of scientific agriculture, it has scarcely kept pace with the growth of college attendance—a growth in which the State University has shared. Rising living costs, the costs of equipment, buildings, supplies and instruction have climbed continuously throughout the war and reconstruction periods, while the funds for support of the institutions and the research and extension work have remained about stationary in nominal proceeds, but in reality have shrunk about 100 per cent in purchasing power.

In view of these emergencies the college and the university and normal school have joined in asking for an additional 1.26 mills for relief, and the matter has been referred to the people by the legislature to be passed upon at the special election in May.

The boxes on this terrible ride
All gapped a joint or split a side;
Did we say all? Well, all but one—
The B-D box finds riding fun.

Your goods are safe
when packed in
Bloedel Donovan
super-strong boxes.

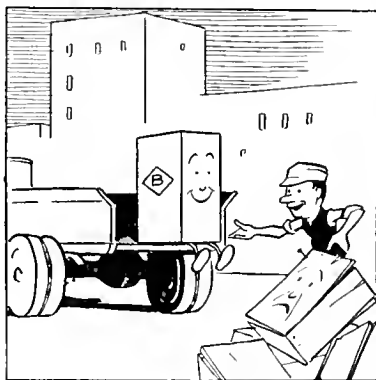

Sawed right, carefully graded, skillfully built
and delivered promptly.

BLOEDEL DONOVAN LUMBER MILLS
1020 White Building, Seattle, Wash.

Douglas Fir, Western Cedar, Hemlock, Spruce, Red Cedar Shingles

BETTER FRUIT

An Illustrated Magazine Devoted to the Interests of Modern Fruit Growing and Marketing.

Published Monthly
by

Better Fruit Publishing Company

703 Oregonian Building
PORTLAND, OREGON

Why Not Confer?

It is proposed that the various large fruit handling organizations of the Northwest hold a conference for the purpose of discussing matters in relation to fruit marketing that are of importance to both grower and shipper. The main object of this conference would be for the purpose of making an agreement to establish a bureau of information or a system by which each of these organizations would supply daily reports of the movement of fruit shipments that are being distributed from Northwest points. Other matters would no doubt be taken up at such a conference that would result in beneficial action.

Taking into consideration the handicap under which most of these organizations have been working during the past season, and other seasons for that matter, in competing for sales in the big markets, it would appear that if such an agreement could be made that there would be many advantages. The kind of fruit shipments that this system would more particularly apply to would be apples, the tonnage of which in the Northwest is increasing so rapidly that a cooperative scheme of marketing, if only on a limited basis, is very essential.

Fruit growers in the Northwest must wake up. They must be brought to realize that they must leave no stone unturned to keep the markets they have for their fruit, and to create new ones, for the big part played in this year's apple market by the fruit from the Pacific Northwest is causing the apple growing sections in the East and the Southwest to discuss the adoption of methods that are expected to give the fruit of those sections the preference.

A conference of the fruit handling organizations of the Northwest looking to the adoption of improved marketing methods is not only, as we have said, essential, but a necessity.

The Call of Education.

Now that the legislature of Washington has done its duty in the matter of providing additional funds for public education it remains for the voters in Oregon to keep pace with its sister state in keeping the torch of enlightenment bright and burning.

The measure to provide the Oregon Agricultural College, the University of Oregon and the State Normal school with additional funds will be voted on in Oregon at the primaries May 21. All of these institutions need the relief in the way of money asked for and the public needs the greatest efficiency they can render in the several branches of education in which they specialize. Larger classes, causing a need for enlarged accommodations and more equip-

ment, more instructors and increases in salaries to retain these instructors, owing to higher living costs, are among the vital things that make additional incomes for these institutions necessary.

As the fountain head from which flows the stream that leads to the higher things in life no public spirited Oregon voter will ignore this call. Oregon citizens must go on record as as progressive in the matter of education as the bordering states of California and Washington if they expect their state to forge ahead. With every progressive educational movement in these states being pushed they cannot afford to lag behind.

Cull Apples and Cider.

Reports from several sections of the country are to the effect that cider making plants that last year paid growers many thousands of dollars are going out of business or are being put to other uses because they cannot comply with the government regulation prohibiting the manufacture of any kind of fruit juice that contains over one-half of one per cent of alcohol. Therefore the prohibition law that seemed to be a boon to the apple grower is in reality a black eye.

The question now arises what is to be done with this grade of cull apple which is unfit for any other use. If the law is strictly complied with it cannot even be made into vinegar as the chemical action that takes place in the process between cider and vinegar exceeds the alcoholic content many times. Boiled cider, which is an attenuated form of apple butter, is not very highly relished as a beverage and other attempts to rob the pure juice of the apple of its slightly sparkling content and then market it, have not made anybody rich.

There seems to be but one hope for that old-time refreshing drink of our ancestors, and that is to have the law governing its alcoholic content modified. Considering its usually non-intoxicating qualities this should not be hard to accomplish for even a Maine or Kansas senator ought not to object to cider.

Information on Storage.

Experiments now being conducted by the United States Department of Agriculture in a specially constructed government plant to investigate diseases and other reasons for the deterioration of fruit in cold storage should result in the saving of thousands of dollars and also the more scientific management of plants for storing fruit. With a movement on foot to greatly increase the storage of apples in the Northwest and other sections of the country information of this nature will prove highly valuable.

While excellent results have already been accomplished in this line by the experts which the government has placed in the field the proper storage of fruit is a question the average grower and shipper needs much information on. Heretofore storage has been a part of the apple industry that has been left to a large extent to buyers and

shippers. From now on, however, it is apparent that the grower from the standpoint of self-protection intends to add storage to the other phases of the fruit industry and with this in mind will welcome complete information on this question.

Order Early.

From present indications it will be well for the fruit grower who has anything in the way of equipment and supplies to purchase to make arrangements to obtain them well in advance of the time they are needed. This advice applies to almost every appliance, material or thing of any kind necessary for an orchard or fruit farm. Manufacturers are already giving notice that they are experiencing difficulty in supplying retailers and the latter state that the demand is far in excess of the present supply. So order early if you would not be caught short handed as the season advances.

What the Papers Interested in Fruit Are Saying

According to *The Fruit World*, published at Melbourne, Australia, the quantity of apples that shippers wanted to export from that country to England during the present season was 1,600,000 bushels. The English government, however, which was providing the ships for the transportation of the fruit cut down the space for shipments to 750,000 bushels. The result was a number of indignation meetings and severe criticism of the government's action. Of the total quantity booked for shipment by the growers, Tasmania produced 800,000 bushels, Victoria, 400,000 bushels, West Australia, 350,000 bushels and South Australia, 50,000 bushels.

W. M. Yundt, who owns an apple orchard near Peshastin, Washington, has the distinction of having grown the largest apple in the United States in 1919. It was a Wolf River variety, measuring nineteen inches in circumference and weighed two pounds, ten ounces! —*Monthly News Letter*, Washington State Department of Horticulture.

Preliminary estimates of the tonnage of dried fruits in California tend to show more than 400,500 tons were handled in 1919 as compared with 265,700 in 1918. Raisins, 184,000 tons, constituted the largest variety. There were 135,000 tons of prunes, 35,000 tons of peaches, 14,500 tons of apricots, 11,000 tons of figs, 10,000 tons of apples and 5,000 tons of pears. The biggest increase was in prunes, the production having almost tripled that of 1918. The apricot yield was 500 tons lighter than the preceding year.—*The Evaporator*.

Are our agricultural colleges and experiment stations incapable of solving fertilizer questions in relation to the orchard? There is now an amazing lack of accurate and satisfying data and information on the subject. Experts on orcharding and specialists on fertilizers themselves testify to the apparent apathy of experimental institutions in this respect. At the November convention of the Ontario Fruit Growers' Association, Prof. F. C. Sears, of Amherst, Mass., said that the agricultural colleges had done less in the matter of solving orchard fertilizer problems than in solving any other problem of either orchard or farm. Mr. Henry G. Bell of Toronto, who knows as much about fertilizers in general as any man in Canada, said to the association: "I am convinced that one of the things that is holding back your net returns from orcharding in this province is a lack of specific information regarding fertilizers."

In studying fertilizer problems, experimenters seem to have chosen to follow the lines of least resistance. They have fled from the complex fertilizer problems of the orchard to other fields where results are more certain and more immediate. There have been very few long-continued experiments anywhere in Canada or the United States to ascertain, for instance, what the fertilizer requirements of the apple are, but long-continued experiments with fertilizers on field crops are numerous.—*Canadian Horticulturist*.

Pear Culture at Home and Abroad

By C. I. Lewis

FOR a number of years there has been a steady increase in interest in pear culture in the Pacific Northwest. This interest is due to a number of causes. One of these is that California developed the pear industry until it became the leading state in the Union in the production of this fruit, while the Bogue River Valley in Southern Oregon has become noted the world over for the high class pears which it produces. Again, there is the fact that while many states are planting apples very heavily, statistics show that very few states are giving the pear any attention, consequently more and more growers are favoring the pear above the apple. Pear culture in Europe has for a number of centuries attracted a great deal of attention. In fact the pear has in the past received, and is now receiving, more attention than the apple. In the early part of the last century Van Mons, the Belgian plant breeder, attracted world-wide attention by introducing a large number of new pears. The blight, which is the greatest scourge of the pear in this country being an American disease, was unknown to the Europeans.

The French have contributed more literature on pear culture than any other nation. Thousands of varieties are described by such men as Du Hamel, Decaisne, Le Roy and Mas. Many of these works give colored plates and very full descriptions of varieties. The early American books gave a great deal of space to pear culture and described many varieties of pears. During that period of American history when nurseries were few and far apart and the farmers planted seed for their orchards, many new varieties of fruit originated. During this epoch our leading varieties of apples were produced, and likewise many pears. Such varieties as Howell and Seckel are of American origin. During the early part of the last century the blight was raising such havoc among the orchards that pear growers were becoming very much discouraged. This gloom was brightened somewhat, however, by the introduction from Europe of the leading varieties of pears, and our American pomologists like Barry, Downing, Thomas and Warder became decidedly enthusiastic over these importations. The pears that were introduced into this country in the early days were of the European blood (*Pyrus communis*). A little later some of the sand pears (*Pyrus cinensis*) were introduced. They attracted, however, very little attention because the quality of the fruit was about equal to that of a raw potato. However, they hybridized with the former and as a result the Kieffer and later hybrids were produced. These hybrids were not so susceptible to blight and they extended pear culture southward, as the Oriental pear would stand warmer climatic conditions than the European pear.

What is the present status of pear culture in this country? Investigation

will show that only two or three states are gaining in acreage, a few are barely holding their own, while the great majority are losing ground. We find the pears of pure European blood succeed best where the trees make a moderate growth, and where the combination of climate and soil produces a firm wooded and hardy tree. For the Eastern States, New York, New England and Michigan seem to offer the best conditions for successful pear growing, and on the Pacific Coast California, Western Washington and Western Oregon are especially adapted for the production of this fruit. Those regions of the Pacific Coast that have rather warm climatic conditions during the growing season and must depend largely upon irrigation, will be able to grow pears only by using the greatest care in retarding the growth of the trees. The blight will probably always be a problem, but scientific methods of control will doubtless go a long way towards making pear culture successful in such regions. Concerning the growing of such pears as the Kieffer many of the Middle Western and Southwestern States are growing this variety successfully.

In choosing a location for a pear orchard the ideal conditions will be, first such climatic factors as produce slow growth; second, good air drainage so as to reduce the frost damage; third, the selection of congenial soil, and fourth, the planting of well adapted varieties. Having favorable climatic conditions and good air drainage, the question of the adaptability of the varieties to the soil is one of the most important factors. It has long been known that certain varieties of pears will grow on very heavy land—on land that is too heavy for apples. This has led many people to believe that any marshy or swampy land, which their farm contains, which is unadapted to any other crop, will grow pears successfully; and while it is true that some varieties of the pear will grow on very heavy land, it is essential, however, that this soil be drained if best results are to be hoped for. Standing water on the soil is not conducive to the best vigor and growth of the tree.

The question of variety and adaptability is largely a local one, and it will be some time before each community can satisfactorily answer this question. The Bartlett seems to be a variety which adapts itself to a great many conditions, growing well on many soils, from the heaviest to the lightest. The Bose is doing well on heavy soils. The Howell, while doing well on some of the lighter loams, is showing indication that it will do even better on heavier soils. The Winter Nelis requires a strong, rich soil and prefers the moist loams to the dry, light loams. The Anjou and Comice seem to prefer lighter loams, although many fine Anjous are gathered from rather heavy soils. Here in the Pacific Northwest very few varieties of the pears are being grown. The Clairgeau is about the only variety not men-

tioned that is being grown commercially. There are undoubtedly many varieties of pears which will succeed with us. To the pear grower I would suggest that he try a few varieties that are not now commonly grown, advising, of course, that the experiment be on a limited scale. Among the pears that I would advise him to look up and experiment with are Glout Moreceau, President Druard, Duchess Bordeaux, Forelle, Santa Claus and Charles Ernest.

The question of stocks to use is one which is largely in the experimental stage. Up to very recently our nurserymen were using what is known as the French seedling stock almost exclusively. This is of *Pyrus communis* blood. Recently, however, many Pacific Coast nurserymen are discarding this stock and are using the sand or Japanese pear. The reasons are that the French stock is attacked by the root louse, whereas the sand pear is not, and the latter is also more resistant to the blight. Where dwarf pears are to be used, the Angers Quince is the best stock. The Portuguese can be used, however, to good advantage where the climate is very mild. The quince should be worked to either Koonce or Angouleme, and these in turn are worked over to whatever varieties are desired.

Winesap, Delicious,
Winter Banana Apples
Bartlett Pears
Italian Prunes
Elberta, J. H. Hale,
Slappee Peaches
Bing, Lambert, Royal Ann
Cherries

Home Nursery Co.
RICHLAND, WASHINGTON

Every Stroke Counts—
WITH THE **GILSON WEEDER**



Backward and forward, every stroke counts with the double-edged blade of the Gilson Weeder. It cuts both ways under the soil surface, destroying weeds and forming a perfect mulch. A marvel in the garden, children can do as much work as grown-ups. You work away from the cultivated soil instead of tramping over it. The slide arms act as fenders protecting plants and shrubbery; just what you need for weeding flower beds and undershrubbery. Six-foot handle makes operation easy and eliminates backache. Made in four sizes—3½, 5, 6 and 8-inch.

GILSON GARDEN TOOLS
(Hand or Wheel Outfits)

A complete variety for intimate garden cultivation. Send \$1.35 for 6-in. Gilson Weeder (under money-back guarantee), or have your dealer order for you. Free—Booklet describing complete line of labor savers.



Free Booklet for the Asking

J.E. GILSON COMPANY
102 Western Avenue
PORT WASHINGTON, WIS.

THE NEWELL GRADER

To you growers who are contemplating buying a **Fruit Grader** this year, I want you to know that my machine is at last perfected and will be on the market in 30 days.

I have devoted my time and thought for the past two years to this **Grader**, profiting by the mistakes of others, studying the needs of the growers, and I now believe that the

Newell Weight Fruit Grader

is the best that can be built.

Sizes Accurately by Weight

Signed: TIMOTHY NEWELL.

Watch these pages for further information as to prices, etc.
or write direct to

HENNINGER & AYES MFG. CO.

80 North Fifth Street

PORTLAND, OREGON

To You WHO HAVE NEVER SHOT A "Friend"

Let us advise you to do so this season.

We handle the best spray gun made,

THE "FRIEND"

We also manufacture chemically perfect spray materials.

HOOD RIVER SPRAY COMPANY, Hood River, Oregon

Ridley, Houlding & Co.

COVENT GARDEN, LONDON

WE ARE

Specialists in Apples and Pears

CABLE ADDRESS: BOTANIZING, LONDON

Codes: A. B. C. 5th Edition and Modern Economy

The distance for planting pears will vary from twenty-two feet to thirty feet, according to soil and climate. Many varieties of pears are sterile and do not set fruit well with their own pollen. The Comice comes in this class, and the Anjou sets fruit poorly with its own pollen. In fact even with self-fertile varieties I would recommend planting so as to secure cross pollination. I would suggest two lists, early bloomers and late bloomers. For Oregon, the early bloomers are Bartlett, Clairgeau, Anjou, Howell, Kieffer; late bloomers, Angouleme, Bosc, Comice, Easter, P. Barry, Winter Nelis. Any two early bloomers or any two late bloomers will inter-pollenate satisfactorily. Plant from two to six rows of a variety, as they will produce more economical than mixing them in rows. In an article of this length it is impossible to go into all the details of pollination, soil treatment, pruning etc. The care of the soil is about the same as that given for apples. The open type of tree is the more approved form, as it is believed it is easier to fight blight with such a tree than where the central leader is allowed to remain. Care should be used, however, in starting the trees to get the main branches well spaced. The greater the distance between the branches the better. Should the blight get into the crotch of a tree, where the branches come from one point, the tree will become greatly weakened. After the trees come into bearing, moderate annual pruning should be the rule. It is believed by some growers that the Anjou will stand more pruning than some other varieties. Summer pruning will be beneficial in overcoming the tendency of some varieties to bear on the tips of branches.

Practically all Pacific Coast pears are being boxed, and by the use of pre-cooling, refrigeration cars and cold storage the season of most of our varieties of pears has been greatly lengthened. Howells and Comice keep until Christmas and Anjous until February. The export trade in pears is of considerable importance and our best trade in England will be for Christmas pears. Late winter pears will have to compete with South African Bartletts which reach English markets about the last of January. The canning of pears has become a tremendous industry and the planting of Bartletts for canning factory use, when conducted on a commercial scale, is proving a very satisfactory business.

There is a splendid opportunity to increase the consumption of pears. A campaign of education is necessary. For example, the Bosc pear is very little known, yet its quality is superb. But because of its unattractive color and form it is not a good show-stand fruit. When once known, however, it becomes very popular. There is no region in the world that can surpass the Pacific Coast in pear production. The quality is unexcelled and the flesh so firm that it stands shipping well. With such an asset we should be able to increase the consumption of pears very materially in the next decade.

Northwest Fruit Notes from Here and There

OREGON.

Owing to the fact that pear growers in the Rogue River Valley, Oregon, are being offered \$45 per ton for their pears for canning purposes this year the California Pear Growers' Association is advising the Oregon growers not to sell at that figure as indications are that canning pears will bring a much higher price. A telegram recently received at Medford from California advised the local Chamber of Commerce that buyers in the latter state were offering \$85 per ton for the same stock that they were trying to buy in Oregon for \$45. It is freely predicted at Medford that canning pears will sell for \$100 per ton before the season is over.

The fact that several million pounds of the 1919 crop of prunes remain unsold is causing operators in the prune industry considerable uneasiness, according to newspaper reports. This large amount of holdover stock is expected to affect the price of the new crop of prunes.

A fruit ranch sale of interest recently took place at Medford, when Lieutenant O. V. Morrow purchased Brookhurst, the large place formerly owned by E. B. Pickel, near Medford. The ranch, which consists of 153 acres, 60 acres of which are in pears, 6 acres in apples and the rest in barley and alfalfa sold for \$45,000. The entire acreage is under irrigation and is considered one of the best producing fruit farms in the Medford district.

According to E. M. Harvey, research man for the Oregon Agricultural College, who has been inspecting orchards in the Willamette River and Rogue River Valleys to determine the extent of the damage winter injury from frost, the damage is comparatively slight. In a recent statement Mr. Harvey says: "Greatest injury is noticed in the lower and central sections of the Willamette Valley. In these sections the damage was due to the fact that trees have not properly reached a dormant state of growth and were thereby more susceptible to injury from frost. The Upper Willamette Valley and Columbia Basin came through almost intact as the trees were in a better state of dormancy." An optimistic view of conditions in Southern Oregon is held by

Professor Harvey. Only a few isolated trees show fatal injury. No extensive damage is reported from the commercial orchards of the Umpqua and Rogue River Valleys. "In the Willamette Valley the discoloration of cambium tissue on south side of trees just above snow line caused alarm to fruit growers. This discoloration has cleared away in many cases and a vigorous growth has set in which would indicate the ultimate recovery of the trees."

Although the orchards in the Hood River Valley were hit a little by the severe cold weather in December, reports from that section are to the effect that strawberries came through in good shape and a fine yield and an early crop is now expected. Buyers for canneries are already reported to have been in the Hood River Valley offering 14 cents per pound for canning berries.

The Umpqua Valley Fruit Union located at Roseburg, which is winding up its apple shipments for the 1919-1920 season has shipped 150 cars of apples. The acreage of apples coming into bearing in this district is fast increasing and the next few years will see a large tonnage being shipped from this point. The plantings in this district are in fine condition and the apples being produced are of most excellent quality.

That the fame of the loganberry has reached Canada was shown in a recent purchase at Salem of 40,000 tips which will be set out in British Columbia. The tips were bought by L. Chevally, superintendent of the Borden Milk Company's plant at Sardis, B. C. Mr. Chevally, who owns a large acreage near that place will set part of it to loganberries.

Fruit growers in Lane County, near Eugene, are contemplating setting a large acreage to strawberries. The section that has been picked out for the new planting is known as Lower Fiddle Creek, where the soil is said to be especially adapted to this berry. In order to give the fruit growers of this district better transportation facilities the county authorities are preparing to build several miles of highway to reach the railroad direct. Canning berries in the Eugene district brought as high as 15 cents per pound last year.

The Phez Farms Corporation, a company connected with the Phez Company of Salem, is setting out 30,000 strawberry plants this spring. The planting is being done on a large acreage recently acquired in what is known as South Bottom. The varieties being set out are the Wilson, Trebia and Ettersburg.

The Hood River cider and vinegar plant recently completed its apple crushing operations for the season. The season's run was the heaviest in the history of the plant, the amount of fruit made into cider and vinegar approximating 10,000 tons.

Reports from Salem, the center of the loganberry industry, are to the effect that buyers are offering still higher prices for these berries for the coming season. Offers of 15 cents per pound were recently reported from that section with only a few contracts made at this price. The high figure is said to be due to the fact that the crops in many of the berry fields will be cut down by the injury from the freeze in December.

Britt Aspinwall, one of the heaviest producers of loganberries in the Willamette Valley, reports having received orders for 500,000 plants this spring. The orders for these plants have come from all sections of the Pacific Coast and although the price has jumped to \$50 per thousand, buyers are reported to be eager to buy them even at that figure.

The Phez Company of Salem, recently contracted for an acreage of strawberries from the place of C. W. Swallow, near Oregon City for \$160 per ton for 1920 and \$130 per ton for the crop in 1921. Several other contracts of this character are reported to have been made in the Oregon City district.

The announcement is made that Frank Moore of Walla Walla, Wash., who owns an apple orchard in the Upper Hood River Valley will soon commence the construction of a modern packing plant and storage house to handle his increasing apple crop. The building will be constructed of concrete and will be three stories high. In the upper story there will be accommodations for the help needed at harvest time.

FEATURES

Compactness

Mechanically and Scientifically Correct

Dependable in Operation

Standardized

Factory Built

Absolutely Guaranteed

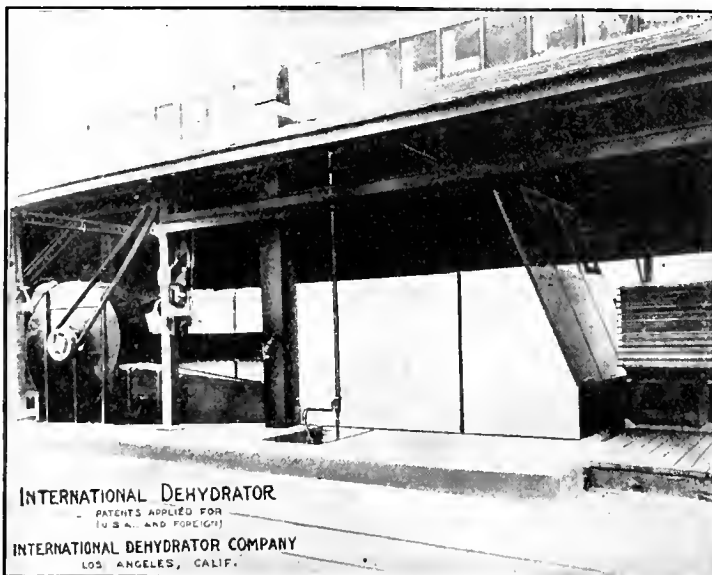

Plant operated by BEALES-KIMBALL FRUIT CO., Van Nuys, California

Photo (Side View) Showing Fan with Air Suction and Air Discharge. Under Deck Contains Condenser, Humidizer, Fire Box and Air Distributor

RECOMMENDED

BY

Satisfied Users

University of California

Scientific Men

Los Angeles Chamber of Commerce

Operates closed—making its own drying atmosphere—not dependent on outside conditions

INTERNATIONAL DEHYDRATOR

Is the only Dehydrating Plant Embracing and Containing Every Feature Recommended After Years of Research by the University of California

Make Us Prove It

Price Reasonable, Terms Convenient
Delivery Prompt on Immediate Orders

Fruit and Vegetables Now Lost
Will More Than Pay the Purchase Cost

WRITE OR WIRE

International Dehydrator Company
LOS ANGELES, CALIFORNIA

With 21,000 acres of fruit signed up by the Oregon Growers' Cooperative Association, the management of the organization is now turning its attention to providing the plants necessary to handle the tonnage during the coming season. While no announcement has been made as to just where these plants will be located as yet, the officers of the association have under consideration tentative plans which are expected to be put into execution shortly.

An innovation that is causing considerable interest among fruit men in the Medford district is the announcement of the installation by the Bardwell Fruit Company of two box making machines. These machines are the first of this kind to be installed in this district and will have a capacity of 2,000 boxes per day. The Bardwell Company is establishing equipment in its plant which it expects to almost entirely do away with hand labor in packing fruit. The equipment consists of a Cutler grading machine, Doig box nailing machine and a Matthews gravity conveyor system.

WASHINGTON.

Fruit growers and others interested in the better transportation of fruit and produce from the Wenatchee district are much encouraged over the outcome of a meeting recently held at Wenatchee to consider the proposition of building a railroad from that district to Pasco, to connect with the transcontinental lines which touch that point. At the meeting which was held under the auspices of the Wenatchee Commercial Club, 25 per cent of the cost of the road was pledged by Wenatchee citizens. With this amount of the cost of building the road assumed by popular subscription it is believed that the remaining amount necessary can be taken care of by issuing bonds. As planned the first link of the road, which would follow the Columbia River would extend from Wenatchee to Beverly, where it would connect with the Mil-

waukee railroad. Ultimately, however, it is planned to extend the road on to Pasco. The amount considered necessary to build the road is \$5,000,000. It is proposed to raise \$500,000 of this amount among the citizens of Northern Washington.

In addressing a meeting of 200 berry growers recently at Seattle, J. L. Stahl, horticulturist at the Western Washington Agricultural Experiment Station, advised prospective berry growers not to put all their fruit in one basket, or in other words to diversify. In this connection Mr. Stahl said: "If I had ten acres of land and was going into berry growing I would not devote it exclusively to one fruit. I would plant a variety. On the gravelly spots I would put in strawberries, in the light soil red raspberries, and in the heavier soils loganberries or blackberries. Occasionally, even in this favored country some crop will fail, and if your berry crops are diversified you will fare better."

In District No. 4, Mr. Darlington reports some damage to stone fruits, apricots and peaches showing the most injury, but he looks for a normal crop of apples. In the Yakima section, District 5, the conditions range about the same as in District No. 3. In some peach orchards we find a very large per cent of fly buds, enough to warrant a good crop, while in others the conditions are quite the reverse. Pears were also injured in some parts of the Yakima country, as well as cherries. In the sixth district, the prune section of the state, Mr. Fletcher reports a slight injury to the prune crop, but believes that under favorable conditions we have reason to expect a reasonable crop of prunes. In other counties on the west side, where we find the principal bush fruit interests, there is evidently some injury to the loganberry canes which were left on the trellises, but those which were still on the ground show but little injury. Mr. Huff has reported some damage to the raspberry canes, but he cannot tell the extent of it at this time.

At the annual meeting of the Yellow Pine Box and Lumber Company at Yakima, a report of the business for last year showed that 600,000 fruit boxes were manufactured and delivered and that all preferred stockholders received boxes at 13 cents a box. The company paid 8 per cent dividends to preferred stockholders, besides making a substantial surplus earning. Between 800,000 and 1,000,000 boxes will be manufactured this year. A limited portion of the output is now being sold to preferred stockholders at 23 cents per box.

The loading of apples in box cars for shipment east has been started in the Wenatchee district, and in the opinion of local shippers this method is the only one that offers any hope for moving the crop. Arrivals of empty refrigerator cars continue to be at a low ebb, only about 10 or 12 cars a day being received. Total shipments to date amount to 10,632 carloads of apples, leaving nearly 1500 cars still to be forwarded.

Plans for four new apple warehouses, to cost from \$10,000 to \$20,000 each, to be erected this year, have been favorably considered by trustees of the Spokane Fruit Growers' Company. The company contemplated the erection this summer of warehouses at Grant Orchards, Greenacres, Coeur d'Alene and Sunset. The proposed warehouses will have storage facilities for 40,000 to 80,000 boxes each. They will be frame construction with filled walls. The company's experience during the cold spell of last December was that fruit withstood the extreme weather better in such warehouses. They can be made ready for the 1920 crop. The erection of a fruit storage warehouse of several hundred cars capacity at Otis Orchards by the Earl Fruit Company, as an addition to the company's packing and storage plant already there, is being considered.

Indications are that Yakima cider plants, which annually pay growers of the valley in the neighborhood of \$75,000 for cull apples will go out of business this season and the plants be converted to other uses. Operators declare it is impossible to manufacture commercial cider which will not develop an alcoholic content in a short time exceeding the lawful amount.

A new cold storage warehouse of four stories and a capacity of 800 cars of apples, in addition to space for the storage of a vast quantity of other perishable food produce, will be erected in Spokane at an approximate cost of \$600,000. J. W. Turner, manager of the Arctic Cold Storage and Warehouse Company, is heading the project and it is supported by the allied interests of Spokane, including the Earl Fruit Company, the Spokane Fruit Growers,

G. L. Davenport
Grower and Shipper

MOSIER, OREGON

MAIN OFFICE

147 Front Street, PORTLAND, OREGON

Nice Bright Western Pine
FRUIT BOXES
AND CRATES

Good standard grades. Well made. Quick shipments. Carloads or less. Get our prices.

Western Pine Box Sales Co.
SPOKANE, WASH.

5 GREAT NOVELTIES
20 cts. The glorious **Woolflower** recently introduced by us has succeeded everywhere and proved to be the most showy garden annual. Nothing can surpass the mass of bloom which it shows all Summer and Fall.

We now have three new colors—pink, yellow and scarlet, as well as crimson. All these colors mixed, **20 cts. per pkt.**

With each order we send 1 trial pkt. each of **Giant Kochia**, most decorative foliage annual.

Salvia Hybrids, white, pink, striped, scarlet, plumed, etc., mixed.

Japan Iris, new hybrids, all colors. Magnificent.

Giant Centaurea, superb for garden or vases.

And our **Big Catalog**, all for **20 cts.**

Big Catalog, free. All flower and vegetable seeds, bulbs, plants and new berries. We grow the finest Gladioli, Dahlias, Cannas, Irises, Peonies, Perennials, Shrubs, Vines, Ferns, Peas, Asters, Pansies, etc. All special prize strains, and many sterling novelties.

JOHN LEWIS CHILDS, Inc. Floral Park, N.Y.



"CARO" FIBRE FRUIT WRAPPERS

This is the Point

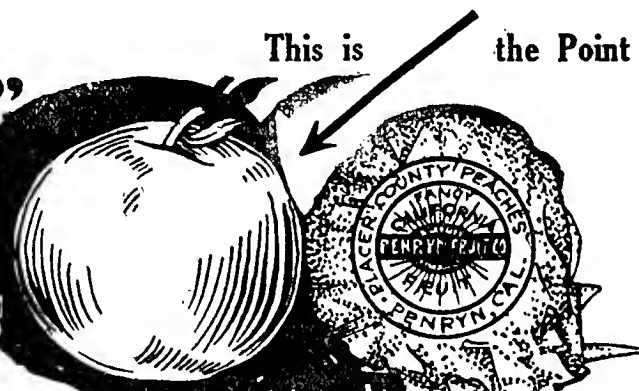

Chemically Treated "Caro" Protects
"Caro" from DessiCARE (to dry up)

"Caro" Prolongs the Life of Fruit Why?

Fruit decomposition starts from a bruise which opens tiny holes and permits the juice to escape and BACTERIA to enter. "Caro" clings closely and dries up the escaping juice. "Caro" ingredients harden the spot, kill the BACTERIA, arrests the decomposition—and thus **PROLONGS THE LIFE OF FRUIT.** If your fruit is worth shipping it is worth keeping in best condition.

Demand "CARO"—Wrap Your Fruit in "CARO"—The Fruit Buyer Knows "CARO"

Order from Any Fruit Company or American Sales Agencies Co., 112 Market St., San Francisco

the Northwest Fruit Growers' Exchange and individual capitalists. The plan is to form a new company to absorb the present Arctic Cold Storage and Warehouse Company, an established concern of many years' standing, with its miscellaneous cold storage business, consisting of butter, eggs, beef and other food products. This will be Unit C in the final plant. The building will be of reinforced concrete, four stories, with a foundation capable of bearing four more stories later. It will be modern in machinery and equipment and as first constructed will have a capacity of 800 carloads of apples at one time in addition to other products. When four more stories are added its apple capacity will be 1000 carloads. There will be 45,000 square feet of space to each floor and a total of a million and a half cubic feet of space. It is proposed to start work on the building so that it will be completed in November. This territory produces 20,000 cars of apples annually, but shippers cannot consign to Seattle for cold storage because of the back haul rates.

The Price Manufacturing Company of Yakima, is the name of a new company which has taken over the manufacture of the Price fruit sizer and other packing house equipment. The members of the new firm are A. W. Richter and C. A. Palmer. Mr. W. G. Price, who was the inventor of the apple sizing machine that bears his name will be retained by the new company in an advisory capacity. Mr. Richter, who is president of the new concern, is a graduate of Cornell University, having specialized in mechanical engineering. Mr. Palmer is a graduate of Whitman College and has been instructor in chemistry and physics at the Yakima High School for several years.

In commenting on the outlook for the fruit crop in the State of Washington for the coming season, M. L. Dean, chief of the division of horticulture of the Washington State Department of Agriculture, summarizes as follows: "It is impossible to tell the exact extent of winter injury to the stone fruits and bush fruits until growth starts. Hence, pruning of the soft fruits should be very carefully done so as not to destroy any prospective fruit buds. Beginning with District No. 1 in the vicinity of Walla Walla, our present observations are that along the Snake River territory, there will probably be about a 50 per cent crop of peaches and apricots, cherries running from 75 per cent to 90 per cent. In the vicinity of Clarkston there is little evident damage at the present time. In the Walla Walla section proper, there is not enough damage to perceptibly affect a normal crop. In the second district in the vicinity of Spokane we find some damage to pears and cherries, but no serious injury to apples. In the Kettle Falls country, Stevens County, the temperatures ranged below 20 and there is considerable damage in sight, especially to the stone fruits; pears are injured somewhat in that territory. In the third district, the lower Yakima country, the injury is spotted. There are places where the cherries and peaches seem to be practically all killed, with some blackening of the pear wood and evident injury to the bud, but in other places the damage is very slight and there is a promise of a 50 per cent crop. The apples do not show any serious injury."

IDAHO.

The addition of an entomologist, an assistant dairy specialist, and an assistant in rodent control to the staff of specialists of the University of Idaho Extension Division is announced. These, with the sheep specialist, whose employment was announced a little more than a week ago, will bring the number of specialists to twenty-three. Besides these, the federal predatory animal inspector for Idaho has taken offices with the extension staff and will work in cooperation with extension workers. Claude Wakeland of Fort Collins, Colorado, who has been assistant state entomologist for Colorado, is the new extension entomologist. He will begin his Idaho employment April 1. He will take up the fight against the alfalfa weevil, the codling moth, the grasshopper, cricket and other insect pests. One of his methods of fighting the weevil will be to demonstrate the use of a power sprayer on a Ford auto truck, a system which has been employed in Colorado. Propagation of parasites to destroy the weevil also will be undertaken. Other extension specialists who will be connected with the horticultural work of the University are: F. B. Hitchcock, soils specialist; E. R. Bennett, field horticulturist; B. F. Sheehan, field agronomist and state seed commissioner; C. B. Ahlson, assistant field agronomist; Jessie C. Ayres, state seed analyst; Claire Hobson, assistant state seed analyst.

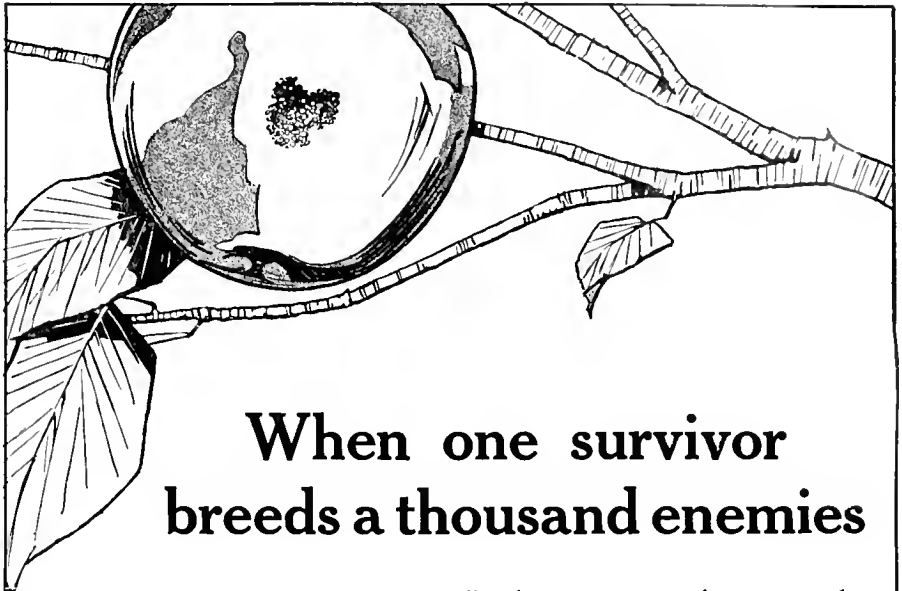

When one survivor breeds a thousand enemies

—you can't afford to spray with untested preparations or chemicals of unknown quality. One surviving codling moth, for example, lays from thirty to a hundred eggs. The hatched larvae soon develop into moths and produce a second generation — often a third brood may form in a season.

Use only chemicals of proved strength and merit, and mixtures approved by state and federal experimental stations.

- Grasselli Grade Specialties
- Arsenate of Lead Paste and Powder
- Calcium Arsenate
- Lime Sulphur Solution
- Bordeaux Mixture
- Sulphate of Nicotine

are time-tested products, made and backed by a firm 81 years old in the chemical field.

It will pay you to specify Grasselli Grade when ordering your spray materials. You will find Grasselli Dealers handily located in every fruit and farming section.



The Grasselli Chemical Co.

Founded in 1839
Cleveland

GRASSELLI GRADE

Insecticides and Fungicides

INJURY FROM FRUIT TREE PESTS

ETERNAL vigilance, and the prompt application of the most reliable and effective spraying materials is necessary to insure a profitable crop.

Some people may be able to afford gambling on some things, but mighty few fruit growers are willing to risk a crop failure by taking chances on spraying materials.

Our appeal is to the thoughtful fruit grower who fights shy of unsupported claims, and demands to be shown. It is to him, who, if he were raising live stock would own full blooded sires; or if corn, would see to it that the seed was perfect.

To such fruit growers we offer Orchard Brand Dry Powdered Arsenate of Lead as a crop and tree protection. It has been proved effective. Its results are known. We shall be glad to give you the names of many successful fruit growers who are enthusiastic about its results.

Suggestion: Write for the booklet.

Also write for Bulletin No. 3 on Dormant Spraying of Deciduous Fruit Trees.

Other spray materials, for specific purposes, we recommend are:

- Orchard Brand Dry Powdered Arsenate of Lead.
- Orchard Brand Arsenate of Lead, Standard paste.
- Orchard Brand Atomic Sulphur (patented).
- Orchard Brand Bordeaux Mixture paste.
- Orchard Brand Powdered Bordeaux Mixture.
- Orchard Brand Lime Sulphur Solution.
- B T S Dry Sulphur Compound (patented).
- Orchard Brand Weed Killer.
- Universal Brand Dormant Soluble Oil.
- Universal Brand Miscible Oil.
- Universal Brand Distillate Oil Emulsion.
- Liquid Whale Oil Soap.

Our interests are the same as yours. Write us about your tree troubles.



General Chemical Company
770 Royal Insurance Building, Dept. A
San Francisco, California

BETTER FRUIT Timely Topics and Advice for Fruitgrowers

As the spraying season is at hand it will be well to beware of the man who offers to spray your fruit trees for a few cents a tree. According to reports made on this question by various experts who have conducted experiments to determine the cost of spraying orchards it costs from 50 to 60 cents per tree to spray trees that have reached an age of 15 to 18 years with four sprays. Therefore it will be the part of wisdom to avoid the man who offers to spray your orchard at a very cheap figure.

If you are contemplating buying nursery stock do not go into the deal with your eyes closed. Patronize only reliable dealers and insist that the stock shall be entirely free from disease and in perfect condition. In disregarding this advice you are liable to introduce into your new orchard or berry patch troubles that it will take years to overcome.

In writing of the comparative merits of calcium arsenate and arsenate of lead, W. S. Regan of the Massachusetts Experiment Station at Amherst, says: "The killing efficiency for the powdered forms of arsenate of lead and calcium arsenate, pound for pound, is about equal, the former containing about 33 per cent of arsenic and the latter about 43 per cent. Based on an equal arsenical content for a given amount of spray solution, there is a slight advantage in killing power in favor of arsenate of lead. Arsenate of lead is the best poison to use alone. Calcium arsenate cannot be used safely alone upon foliage, but must be combined with milk of lime or a fungicide, such as lime sulphur or bordeaux mixture. If combined with milk of lime its cost is increased so that it is practically equal to that of arsenate of lead, thus giving the latter the preference because of superior killing power. Arsenate of calcium is the only arsenical which can be safely combined with lime sulphur or other sulphid sprays, and this combination is the logical orchard arsenical fungicide. Arsenate of lead seems to work slightly better with bordeaux mixture, but calcium arsenate is probably cheaper, so that the question of which to choose for use with this fungicide is mainly a matter of convenience. Prospective purchasers of calcium arsenate should buy only from reliable dealers, and should follow directions for application carefully."

Carbon bisulphide is now claimed to be the most effective means of ridding orchards and fields of ground squirrels and gophers. The treatment now being used is what is known as the waste ball method which when properly applied, it is said, will kill 90 per cent of rodent pests. The method of using the carbon bisulphide waste ball is after opening the

container to pour enough water on top of the liquid to completely cover it so as to prevent evaporation. In using a cork, seal with glue, mucilage or glycerine. Place the required number of waste balls in a bucket and pour in enough carbon bisulphide to completely cover them. Then place a waste ball in every burrow of the colony or village. Allow at least two minutes for the gas to permeate the burrows, and then ignite the gas in each burrow with a torch or match. Please be careful when igniting the gas; the operator should stand well to one side when doing this. The waste balls should be dropped as deeply as possible in the burrows and care should be taken not to cover them when closing the opening or mouth of the burrow. When all the burrows have been ignited close them up, using plenty of earth; pack the opening of the burrows tightly with the feet. Be careful in igniting the gas that there is no dry vegetation around the burrows as the burning gas is liable to start a fire.

In planting your cherry orchard do not forget your pollinizers. As you will probably plant Royal Annes, Bings or Lamberts, the varieties that will pollinize these standard cherries are the Long Stemmed Waterhouse, Tartarian, Black Republican, Coe, Elton, Wood and a number of seedlings. The Long Stemmed Waterhouse is considered the best as apart from its being one of the most efficient pollinizers it brings a price on the market almost equal to the Royal Ann, Bing, or Lambert.

Remarkable results are now being obtained by the use of sulphur for many soil crops and in preparing soils to secure more complete action from the use of other fertilizers. Some of the highly desirable results secured through the use of sulphur are that it improves alkali soils, promotes nitrification and transforms latent phosphates and potash into available plant food. If you are interested in using sulphur you will find it worth while to secure a bulletin on the subject from your nearest agricultural college experiment station.

The home garden on the fruit ranch should not be neglected or forgotten. To secure the best results the garden should be planted in long, straight rows and cultivated once a week with a horse, according to United States Department of Agriculture specialists. If this much is done by the men the work of the women will be materially reduced. The care of a home garden is not hard work if the fitting of the land and the main part of the cultivation is done with horse-drawn tools. Plan the farm garden right, work it right, and it will prove the most profitable piece of land on the farm.

Throws a Cloud of Spray



The Hardie Orchard Gun saves your time and muscle--no long, heavy rods to hold.

Turns a big job into a little one. One man with a Hardie Gun will do more work and do it better than two men with the old-fashioned rods.

Hardie Orchard Gun \$12

Low price made possible by big production--send for the Hardie Catalog today. Hardie Sprayers and spraying devices standard for 18 years.

Eventually

if you spray
with a "gun"
you will
get

A HARDIE

The Hardie Mfg. Co.

55 North Front Street, Portland

Handle Things by Gravity

EVERY pair of hands and legs you relieve from lugging, wheeling or hauling crates, barrels, boxes, etc., from place to place, immediately becomes available for more productive work. And when you do that costs start to drop; output and profits increase.

The Mathews steel ball-bearing Roller Conveyor not only takes the place of human labor, but it entails no expense for power. Gravity operates it!

The Mathews carries most anything most anywhere—over, under or around obstacles, or straight-away. Portable or permanent installation. No upkeep worth mentioning; never goes on strike; demands no pay envelope; incurs no power bills!

Our engineers' suggestions as to how and where the Mathews can be made profitable to you cost nothing. Write.

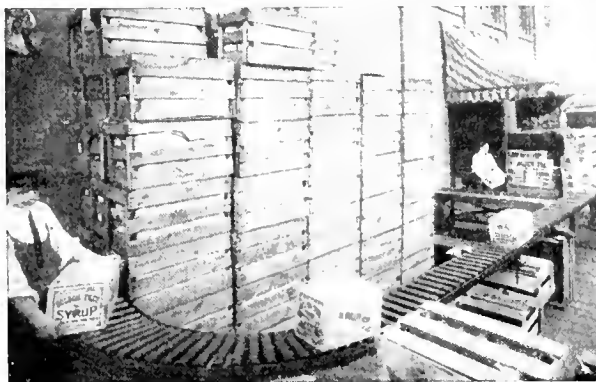

Packing, warehousing and shipping; loading and unloading cars, trucks and wagons—all can be accomplished more quickly and more cheaply with the Mathews Gravity Conveyor. A size and style for every purpose.

MATHEWS
SPEED ECONOMY
GRAVITY ROLLER CONVEYER

MATHEWS GRAVITY CARRIER CO.

133 Tenth Street, Ellwood City, Pa.

Branch Factories: Port Hope, Ontario—London, England

What They're Doing in California

Sufficient water for the coming growing season is reported to be the one big thing that is now occupying the attention of the farmers and fruit growers of California. In the Santa Clara Valley not only farmers and fruit growers, but the business men as well have been actively engaged for the past two months in the preliminary work of organizing to perfect some system of conserving and increasing the underground supply of water for irrigation purposes.

Good prune orchards in the Santa Clara Valley are reported to be still holding up in price and \$2,000 per acre is the figure quoted for good producing orchards. Many growers there, it is stated, have refused to sell at this price. Those who are looking into fruitland prices closely in California say that whether such values can be maintained depends upon the quantity and quality of the coming season's crop and the base price to be fixed by the California Prune and Apricot Growers' Association.

The diversity of fruit and vegetable shipments from some of the districts in California make interesting reading. As an instance: There were 5731 carloads of products shipped from Turlock during the year 1919, which is the largest in its history. Cantaloupes led the list with 2719 cars. The list as given out by the two railroads is as follows: Beans, 113 cars; barley, 98 cars; cantaloupes, 2719 cars; canned goods, 209 cars; casabas, 296 cars; dried fruit, 71 cars; grain, 220 cars; corn, 56 cars; grapes, 307 cars; hay, 13 cars; Honey Dew melons, 41 cars; livestock, 170 cars; peaches, 79 cars; peach pits, 3 cars; Persiau melons, 3 cars; spinach, 9 cars; sweet potatoes, 203 cars; watermelons, 1037 cars; miscellaneous, 84 cars.

P. J. Dreher was recently elected president of the California Fruit Growers' Exchange. Mr. Dreher has been identified with the citrus fruit industry of the state since 1886 and was one of the leaders in perfecting the system now in use there of cooperative marketing of citrus fruits.

Realizing the strength and permanency of the California Fruit Growers' Exchange it is reported that independent citrus fruit opera-

tors are contemplating an organization to represent them in their operations in the citrus fruit belt. This move is said to be due to the gradual extension of the cooperative organization which is reported to be handling 72 per cent of the citrus fruit crop of California. One of the features which the independent organization is proposing is to buy the fruit it handles on a spot cash basis.

Wine grape growers in California are so encouraged over the success attained last year in drying their product and the satisfactory prices received that they are now reported to have abandoned the idea of plowing up their vineyards. Contracts that are being made for wine grapes in California this year are said to run as high as \$70 per ton. It is also found that by blending the wine grapes with some of the dark red and purple varieties that a juice is obtained that makes a high grade commercial grape juice drink and grape syrup.

Pacific Coast headquarters for the United States Bureau of Entomology were opened in Sacramento this week. The bureau concentrates its attention on the study of insect pests that infect growing crops. Work in California, Nevada, Oregon, Washington, Arizona and New Mexico will be directed from the Sacramento headquarters.

Peach growers in the Sacramento Valley are expecting \$100 a ton for this year's crop. The highest price paid last year was \$85.

Bits About Fruit, Fruitmen and Fruit Growing

The market for Northwestern box apples picked up during the past month and showed a much stronger tone, but the car shortage handicapped shippers and prevented as large a distribution of fruit as the market was willing to take. Indications at the present time are that the stocks of box apples in the Northwest will be cleaned up at satisfactory figures and that cars will be more plentiful.

According to a recent statement of Charles J. Brand, general manager of the American Fruitgrowers, Inc., which owns large holdings of orchards in various sections of the country, the officers of that corporation are not worry-

ing about the future success of the apple industry. Mr. Brand says that the company he represents has faith in the future of the apple business or they would not have made such large investments in it. Continuing he remarked: "There may be years when apples will sell at less than the cost of production, but that is only what may be expected in any business. Such years will teach us to organize our productive and marketing methods upon a more efficient and economical basis and probably they may result in a general organization of all apple growers into some sort of an association for the protection and furtherance of mutual interests. This can never be done during prosperous years; hard times alone will bring producers together upon this kind of a basis."

The Joseph J. White Company of Lisbon, N. J., which is endeavoring to improve the huckleberry so that it will be grown and cultivated the same as other bush fruits, announces that its campaign last year to secure fine samples of these berries received widespread attention. Letters of inquiry in regard to the proposition were received from thirty-eight different states and also from Alaska and Canada. Over one hundred samples of blueberries were received, nearly all of which were smaller than those produced on plants already tried and discarded. No berries of the required size were sent, but one plant was purchased for \$25.00. This, from the Province of Quebec, Canada, had berries over five-eighths inches in diameter. It was of a northern species not likely to be of value in New Jersey, but was especially wanted for the breeding work of the United States Department of Agriculture. The offer of \$50.00 for a blueberry or huckleberry bush with berries as large as a cent (three-quarters inches across) is continued this summer. Plants with berries of this size are needed to cross with such plants already found in New Jersey. If they can be located in states north or south they will make possible the development of fine blueberries with a greater range of adaptability to climate.

While imports of fruits of various kinds are being brought into the United States it is something of an innovation to know that quite a large quantity of dried currants from Greece are finding their way to the ports of Uncle

Sam. During the month of February, according to a report from the United States consul at Patras, 1,500 tons of this dried fruit valued at over \$1,000,000 were sent to America. The total amount of stock for shipment at that time was reported to be 10,000 tons, a large part of which was being bought by American importers.

The amount of potash produced in Germany during 1919 was 916,000 short tons. Two hundred and sixty-four thousand tons of this amount was sold abroad, the remainder being retained for home requirements.

Cannery Notes

At the recent meeting of the Northwest Cannerymen's Association held in Portland, J. O. Holt of Eugene, was elected president; W. G. Allen of Salem, vice-president and D. I. Matthews of Portland, secretary-treasurer.

The Oregon Public Service Commission recently granted the A. Rupert Company, Inc., permission to construct a spur track at Falls City, Oregon, in order to allow the company to extend its shipping operations.

The Rogue River Valley Canning Company of Medford, is already making contracts for the 1920 season's pack of vegetables and all kinds of fruits.

The Washington Dehydrating Company, which operates plants at Yakima, Grandview, Wenatchee and Walla Walla, handled 7,000 tons of green fruit from July 1, 1919 to March 1 of the present year. The amount paid growers for fruit was over \$200,000.

Fruits and vegetables to the value of \$10,000 were put up by the cannery at Ashland, Oregon, during the past season. The quantity of product canned was as follows: Tomatoes, 200,000 pounds; apples, 143,000 pounds; peaches, 125,000; pears, 87,000; plums, 15,000; beans, 14,418; apricots, 4,418; cherries, 2,150; pumpkin, 2,500. The number of cans of all sizes used was about 120,000, of which over 50,000 were gallon containers.

According to cannerymen the price of canned goods will be higher this year than last. The high prices of fresh fruit and high labor costs are given as the reasons.

The plan to consolidate the Lewis County

cannery, located at Chehalis, Washington, with the Puyallup and Sumner Fruitgrowers' Canning Company has been abandoned and the plant will be operated during the coming season as an independent local company. A number of prominent business men in the county have become interested in the concern which has been placed under the management of Dan W. Bush.

Construction work has been started on a new \$10,000 cannery at Stockton, California. The plant will employ about 350 workers and expects to handle 2,000 tons of green fruit and to pack 2,000 tons of grapes and dried fruit. The new plant will be completed in time to start the season with the cherry crop.

Although there are now 38 fruit and vegetable canneries in San Jose and other sections of Santa Clara County, California, making it the fruit canning center of that state, extensive additions are being made to several of the plants in order to take care of an expected large increase in the business this year.

Sacramento Valley canneries started putting up spinach on March 9. The crop is exceptionally large.

Many Tractors Sold at Hood River.

The Hood River Glacier notes that the interest of orchardists in tractors as motive power for their industry is at high pitch here. Since the first of the year a total of 32 tractors has been sold at Hood River. The sales reported are as follows: Cletracs, 15; Fordsons, 9; Case, 3; Fageol, 3, and International Harvester Co., 2. Dealers declare that sales would have been heavier to date, had more machines been available.

Roads to Be Lined With Trees.

Through the generosity and public spirit of the Washington Nursery Company the principal roads leading into the town of Toppenish, Wash., are to be lined with hardwood shade trees. The trees which were donated by the nursery company consist of several hundred walnuts, elms and maples and will be planted by the local commercial club.

The Strawberry Weevil.

The New Jersey Experiment Station says the strawberry weevil can be fought off by dusting the plants as the buds appear. The dust is composed of one part dry arsenate of lead and five parts powdered sulphur. This does not kill all the weevils, but drives them away.

Cheesecloth bags, the naked hand and other devices were used by growers in New Jersey who did not care to buy the powder gun, but to Tony Rizotte belongs the honor of evolving the most ingenious hand device for sifting. He covered a common wire horse muzzle with one thickness of copper mosquito netting and drew the edges up to the rim. The inventor then bent a 3-foot hickory sapling, fastening it to opposite sides of the rim. This served as a handle by which the improvised basket filled with the powder could be twirled with more or less force, depending on the width of the rows.

Planting the Peach and Plum.

As soon as the trees are set out cut back the tops. Peaches and plums should be headed 18 inches from the ground and apples and pears 32 inches. Young trees require the best of care and cultivation. Practice frequent cultivation during the summer and plant a cover crop in the early autumn.

CONSULTING HORTICULTURIST

PROFESSOR W. S. THORNBUR

Formerly

HEAD OF THE DEPARTMENT OF HORTICULTURE
AND LANDSCAPE GARDENING

Later

DIRECTOR OF THE EXTENSION SERVICE
OF THE
STATE COLLEGE OF WASHINGTON

WILL ADVISE with fruit-growers upon all horticultural problems, including selection and preparation of orchard lands; propagation and care of nursery stock; planting and care of young orchards and small fruit plantations; the control of codling moth, San Jose scale, blight and other orchard pests; the preparation of lime-sulphur at home and the mixing of other sprays; economical orchard management; the irrigation and fertilization of orchard lands; the use of cover-crops and grass mulches; the pruning of fruit trees, shade trees, shrubs, bushes and vines; the renovation of old or neglected orchards, top-working or replacing of poor or unprofitable trees, and the examining and the working out of practical management plans for large orchards and orchard companies.

If your orchard has not been a financial success, and you wish to determine its possibilities or you wish to improve your orchard, reduce your losses and increase your returns I will assist you in working out your problem.

WRITE FOR TERMS

W. S. THORNBUR
LEWISTON, IDAHO

The Science of Dehydration

(From California Cultivator, March 13, 1920)

What is dehydration? We asked Dr. Clements of the Agricultural Department of the Los Angeles Chamber of Commerce this question and he answered:

"Dehydration means the reduction of organic materials to a desiccated condition without alteration of cellular structure or chemical change. In other words, the elimination of the greater part of the water content."

In addition, Dr. Clements said:

"Two years ago, while under stress of war, the British government made some interesting and very successful tests in the dehydration of berries and other highly colored fruits and vegetables in an atmosphere of nitrogen, but the process was far too expensive to be utilized in general manufacture. The object of the British government at that time was to overcome the enormous cost of \$3,000 per car Los Angeles to Port Sarnia—recognizing that one carload of dehydrated berries would be the equivalent of 20 carloads of the fresh iced material, the strawberries having been frozen in barrels and kept so until ready for preserving. I might add that the expense through dehydration in nitrogen was much greater than the 13,000 under icing.

"The necessity for this neutral atmosphere is due to the coloring matter of all fruits and vegetables being iron and iron salts, and to the instability of their chemical formation and susceptibility to oxygen and ozone. In any dehydration, either electrical or otherwise in which there is vibration or artificial wind drafts, the excess of oxygen, and a still more deleterious product—ozone—results in the blanching of the product.

"The International people seem to have stumbled upon this one principle accidentally—the use of carbonic acid gas, being a by-product of simple combustion in the creation of heat within the dehydration plant itself, carbonic acid gas being so much heavier than the normal atmosphere, forces it to the top of the container and excludes any possibility of ozone or excess of oxygen. Another item of interest is the embodiment of the humid principle, which has been accepted, lock, stock and barrel, by the United States government in the kiln drying of all woods necessary to the airplane. The humid atmosphere moistening the superstructure or envelope of the material to be dehydrated stimulates capillary attraction, making release of retained moisture even, and a uniform product results.

"This makes a very complicated problem and places dehydration directly in the hands of the chemist and biologist."

Import Many Pounds of Filberts.

During the year of 1919, 3,778,985 pounds of shelled and 16,767,304 pounds of unshelled filberts were imported into the United States. The value of these nuts was over \$7,500,000. The heaviest importation of filberts was from Italy, which furnished over 14,000,000 pounds.

Fight Film

To Save Your Teeth

All Statements Approved by High Dental Authorities



It is Film that Ruins Teeth

This is why brushed teeth discolor and decay. And why old methods of cleaning have proved so inadequate.

Your teeth are covered with a slimy film. It clings to them, enters crevices and stays. That film is the cause of most tooth troubles.

The tooth brush does not end it. The ordinary dentifrice does not dissolve it. So, month after month, that film remains and may do a ceaseless damage.

That film is what discolors—not the teeth. It is the basis of tartar. It holds food substance which ferments and forms acid. It holds the acid in contact with the teeth to cause decay.

Millions of germs breed in it. They, with tartar, are the chief cause of pyorrhea. Also of many other troubles.

Dental science, after years of searching, has found a way to combat that film. Able authorities have proved the method by many careful tests. And now, after years of proving, leading dentists all over America are urging its daily use.

Now Sent for Home Tests

For home use this method is embodied in a dentifrice called Pepsodent. And a 10-Day Tube is sent without charge to anyone who asks.

Pepsodent is based on pepsin, the digestant of albumin. The film is albuminous matter. The object of Pepsodent is to dissolve it, then to day by day combat it.

The way seems simple, but for long pepsin seemed impossible. It must be activated, and the usual agent is an acid harmful to the teeth. But science has discovered a harmless activating method. And millions of teeth are now cleaned daily in this efficient way.

Let a ten-day test show what this new way means. The results are important, both to you and yours. Compare them with results of old-time methods and you will then know what is best.

Cut out the coupon now so you won't forget.

Pepsodent PAT. OFF.
REG. U.S.

The New-Day Dentifrice

Now advised by leading dentists. Druggists everywhere are supplied with large tubes.

See What It Does

Get this 10-Day Tube. Note how clean teeth feel after using. Mark the absence of the slimy film. See how teeth whiten as the fixed film disappears. Learn what clean teeth mean.

350

Ten-Day Tube Free

THE PEPSODENT COMPANY,
Dept. 426, 1104 S. Wabash Ave., Chicago, Ill.
Mail 10-Day Tube of Pepsodent to

Name

Address

One tube to a family.

Soil and Climate Big Factors in Berry Growing

By D. E. Towle, Gresham, Oregon

THINKING your readers would be interested in learning something of the possibilities of berry farming in Eastern Multnomah County, especially in the territory tributary to Gresham, I concluded to ask you for a little space. If you will glance at the county map you will note Gresham's location, some 20 odd miles southeast of the confluence of the Willamette and Columbia rivers and on an air line towards Mt. Hood. It seems that nature believes in specializing and providing special localities for certain products—lo-wil, Hood River spells apples; Southern California Sunkist oranges, and Gresham berries. Why? Well, there is a reason and it can be expressed in two words—soil and climate.

The soil is different from the average soil of the coast country, being a mixture of volcanic ash and Columbia river sand forming a soil that is easily filled, very fertile and being underlaid with a water-bearing sand, the soil is sub-irrigated and with good cultivation holds an ample supply of moisture to mature the finest quality of strawberries, raspberries and loganberries in the driest seasons. There is also another peculiar local factor that helps to bring the berries to their high standard of perfection which in time will give them a world reputation for quality. It is that life-giving sea breeze that naturally rolls up the Columbia river during the summer season and spreads out over this favored locality. To convince yourself of this, please take another look at the map, and knowing as you do that the prevailing summer wind is from the Northwest, please draw a line from the mouth of the Columbia river in a southeast direction and you will be convinced that Gresham's berry territory gets the sea breeze direct.

I have briefly outlined the reason for our success in berry growing in soil and climate. The third reason is intelligence and industry by the farmer and then success is assured. This opinion is based on six years of observation and experience. The quality of the berries, especially raspberries and loganberries, is admitted as being superior by our leading coast canners. The berries all come to full maturity with good cultivation and this means good yields. The raspberry harvest usually extends over a six weeks' period. So you can see that the development is nearly perfect. The berries all mature, and the last picking yields the largest berries. The best yields I know of are four tons to the acre, three tons is a good crop, two tons fair and less poor. The picking cost takes about one-third, cultivation costs about one-third and at present values this leaves a good rental for the land. The price of land here ranges from \$200 to \$500 per acre. This price may seem high but good berry lands are worth more. I have no land for sale but have bought some very recently and it is not for sale.

Berry growing in this territory appeals equally to the man with capital

and to those with little means. The unit holding should be not less than five acres and ten acres is ideal for one man to operate and will produce a good living for an average family. Berry farming is not heavy work and is spread out well over the year. Cutting out the old canes and pruning can be done from October 1st to April 1st, and the plowing, cultivating and hoeing during the next three months, then the harvest and a thirty-day vacation season before you start the new berry year. In addition to an acreage of berries we recommend the keeping of a flock of 100 or 200 hens, a pig and a cow. The Gresham territory is well developed. We have a large mileage of hard surfaced roads and the balance of the roads are good the year around. Electricity is available in most of the territory for light and power purposes at a reasonable price. We also have city gas, telephones and special daily paper deliveries; rural mail delivery, good grade schools, a central Union High school. This is a union of five rural districts with Gresham. We have an enrollment of 225 students and a very efficient staff of instructors. The studies include a course in agriculture, manual training and domestic science. The fact is your child graduating from this school is well qualified to take up any line of work except the profession. We have a jitney service that calls for your child in the morning and returns it safely after school. Nearly all of the different religious denominations are organized in the district. To enumerate, Presbyterian, Methodist, Free Methodist, Baptist, Evangelical, Lutheran, Catholic and Christian Science, and if you cannot find a church house in these enumerated you are within an hour's ride of the city of Portland in which all sects can find a church home. Gresham has an hourly electric car service to Portland and also an auto jitney service. If this is not satisfactory use your own car. It is a beautiful 45-minute drive. Being near the city is no mean advantage for our locality, especially from a berry grower's standpoint, as berries must be picked and we look to Portland for the pickers. Berry picking is a school vacation-time job and affords a pleasant and profitable camping out vacation to the city women and boys and girls. The pickers express their delight in the change from the restrictions of city life to the freedom and pure air, sunshine and shade and the chance to commune with nature. Berry picking is not hard work but the work is good exercise. The picker is benefitted mentally by relaxation, physically by the exercise and materially by the cash received.

So, Mr. Editor, to sum up the outlook for berry growers in the Gresham district, I think you will agree with me, that the future prospect is really bright as the combination as enumerated is hard to beat. First, suitable soil and climate for production; second, a quality that is par excellence and third, the

territory adapted to these products is limited; fourth, being near the city insures the harvest help, fifth, we have a State Growers' Association, a State Manufacturing Association with the selling end in good hands. Sixth, at least six large going concerns, privately owned, who are in the market for ten times the berry product obtainable. Seventh, national prohibition and a substitute needed without a kick. Eighth, we have a healthy growers' coöperative association that is ready to help the newcomer and will try to steer him right as to location, methods of culture, etc.

Now a last word to the prospective berry grower. If you are convinced that what I have written is true and if you are interested and would like to better your circumstances by growing berries or if you are not sure of the truth of these claims made for this territory, all we ask you to do is to come out and look our locality over and satisfy yourself. Personally, I have no special interest in your welfare but I have that common interest in community development and the helping of my fellowmen that prompts the writing of this article.

Everything for the Garden

Seeds
Trees
Bulbs

1920 160-page Catalog Free

Routledge
SEED & FLORAL Co

145 147 2nd St. PORTLAND ORE

Try This Stump Puller

30 Days FREE

Send No Money!

If satisfied, keep puller. If not pleased, return at our expense. You don't risk a penny. Four easy ways to pay.

Kirstin

One-Man Stump Puller

Weights less — costs less — yet has greater speed, strength, power. Lasts longer! 3-year guarantee against breakage. One man alone pulls stubborn stumps in few minutes at low cost, due to wonderful leverage principle. One man and Horse Power models. Shipment from nearest distributor post pays time and freight. Write for FREE BOOK and Special Agent's Proposition—today!

A. J. KIRSTIN CO., 350 E. Morrison St., Portland, Or.

Pacific Evaporator

WANN PATENTS

Demonstration Plant will be Built in Oregon in Early Summer Produces Finest Quality of Prunes, Apples and Other Fruits

We have considered the problems of the fruit growers of Oregon and are preparing to demonstrate how they may be solved.

We expect to build a plant of commercial capacity in the heart of the prune district of Western Oregon in the early summer.

Pacific Evaporator is the need of the Oregon growers. It is the best in the market and will enable you to produce the best quality, get the maximum quantity and insure success.

You can build your own evaporator.

Right to build and operate, including plans and specifications, are for sale by Pacific Evaporator Company. Write for detailed information.

With these directions and the instruction of our superintendent, who will come to your ranch and explain to you or your contractor how to proceed, you can build for yourself, using your old materials, old buildings, surplus lumber, anything.

The construction is simple and inexpensive.

Or we can arrange to have sent to you a complete unit or units, practically all materials cut to size, with the same superintendence.

The heating plant will take almost any kind of fuel—oil, wood, coal, distillate. The complete control of the temperature and the circulation of air through the drying compartment enables the operator to prevent any harm to product under course of evaporation by holding sufficient humidity or running dry air, as the case may demand.

We would advise you not to take up any other plan until you have investigated ours.

If you will write now, stating variety of fruit and tonnage, we will give you an estimate of your needs. When the plant is built in Oregon we will notify you and make an appointment for an inspection.

Pacific Evaporator will efficiently dry any fruit or vegetable.

It will appeal particularly to the prune men.

We recommend it to the numerous growers of Italian prunes in Oregon.

The owners of Pacific Evaporator are thoroughly familiar with the handling of the Italian prune. They have planted several orchards in California and half of these are devoted to this variety.

Pacific Evaporator will greatly improve the quality of your product and increase your output.

John T. Wann, inventor of the Pacific Evaporator, was raised in Oregon, and is familiar with the needs of the orchardists of that state. He is also thoroughly familiar with the various types of evaporators now in use in Oregon.

Pacific Evaporator has proved successful in the prune districts of California. It has been used for years and has proved itself capable of quality production in commercial quantities.

As to quality, the prune, evaporated by this process, has proved itself superior to, and has sold at a premium over the famous sun-dried fruit of California.

Pacific Evaporator will give you a product that will command premium prices and the expense will be less to you than by any other method.

Professor W. V. Cruess of the Agricultural Experiment Station, University of California, speaking of evaporators and their advantages at a fruit growers' convention in Chico, said:

"The most beautiful dried prunes that have ever come to my attention were dried by the Wann brothers of Healdsburg."

The prunes to which he referred had been dried by the evaporator invented by John T. Wann, now known as Pacific Evaporator.

Write to Our Office and Give Us Your Requirements

Pacific Evaporator Company

WANN PATENTS

ROBERT C. NEWELL, WM. C. MURDOCH, JOHN T. WANN, 427 First National Bank Building

SAN FRANCISCO

WHEN WRITING ADVERTISERS MENTION BETTER FRUIT

Insects and Diseases of the Loganberry

By W. S. Brown, Chief of the Division of Horticulture, Oregon Agricultural College

THE loganberry is not affected by many serious insect pests. The three that seem to do the most damage are the raspberry cane maggot, the leaf hopper, and the raspberry rootborer.

The cane maggot causes the cane to wilt or droop. A careful examination will disclose a bluish ring just under the bark near the surface of the ground. The cane should be cut off just below this ring and destroyed. This will kill the maggots working within.

The leaf hoppers are sucking insects. They do their damage by sucking out plant juices from the leaves and young canes. They should be attacked while young or in the nymph stage. They may be killed by some contact remedy such as whale-oil soap, one pound to ten gallons of water; kerosene emulsion 10 per cent solution; or a mixture of Black-leaf 40, one-half pint, plus four pounds of whale-oil soap, to 100 gallons of water.

The root borer, when present, causes the infested plant to become yellowed and the berries to be small and seedy. Two years are required for the borer to mature. The first season it attacks the young canes, girdling them near the surface of the soil. The injured canes may be readily observed in late summer, lying flat on the ground with the foliage wilted. With a heavy pair of gloves the injured cane can be given a twist that will break it off at the girdle. In most cases the borer will remain in the detached cane, which should be removed from the field.

The most serious diseases are the crown gall, mushroom root rot, and anthracnose. When affected by crown gall the plants gradually turn yellow and lose their vigor. By a careful examination corky swellings will be found on the roots, usually near the surface of the ground, but often on the smaller roots. This trouble occurs very frequently as a swelling or canker along the side of the cane.

Mushroom root rot is a fungous trouble which attacks the roots of the plants, finally causing their death. The disease grows on old tree roots and stumps, and is more apt to affect plants set out on newly cleared land. When affected with either of the above diseases, the plants, with their roots, should be removed at once and burned. No new plants should be set in their places before three years have elapsed.

A fungous disease called anthracnose seems to have done more damage to the loganberry than any other trouble in the state. It is a disease causing lightish-gray spots to appear on the leaves and canes of the plant, and may attack the drupelets of the fruit, also, causing them to turn a light gray color. Ordinarily this disease can be kept under control by carefully cutting out the old vines after fruiting and burning them. If at this time some of the new canes are found to be infested seriously they should be thinned out, also. When the infection becomes serious, spraying

with bordeaux mixture 4-4-50 is recommended. The mixture is best applied with a resin fish-oil sticker, to improve the sticking and spreading qualities of the bordeaux. The first application should come about the time the first leaves have attained good size. The second spraying should be applied just before the blossoms open and the third may be put on about the end of summer,

in case new infections begin to make their appearance on the young canes and foliage. To protect the fruit, some colorless mixture, like Burgundy mixture, should be applied about two weeks after the petals fall. The resin fish-oil sticker should be used with this also. The formula for Burgundy mixture is as follows: Two pounds copper sulphate (bluestone), three pounds sodium carbonate (washing soda) and 100 gallons of water. Mix each of the chemicals separately with water before bringing them together.



GETTING breakfast isn't the tedious job it used to be, thanks to modern conveniences—and Ghirardelli's Ground Chocolate. Besides, the "Ghirardelli breakfast" is not only much easier to prepare, but it's also more wholesome, more nutritious, more sustaining! Ghirardelli's is food and drink both!

Never sold in bulk—but in cans only.
In ½ lb., 1 lb. and 3 lb. sealed cans—
at the store where you do your trading.

Say "Gear-ar-delly"

Since 1852

D. GHIRARDELLI CO.

San Francisco

(F6)

GHIRARDELLI'S Ground Chocolate



PLUNGER TREE PRUNER

THE MISSING LINK IN THE
ORCHARD PRUNING EQUIPMENT

Three times as speedy as the saw. Makes smooth cuts. Operator stands on ground to perform most of his work. Easy to keep sharp.

Write for circulars and prices.

D. H. WATTS, Kerrmoor, Pa.

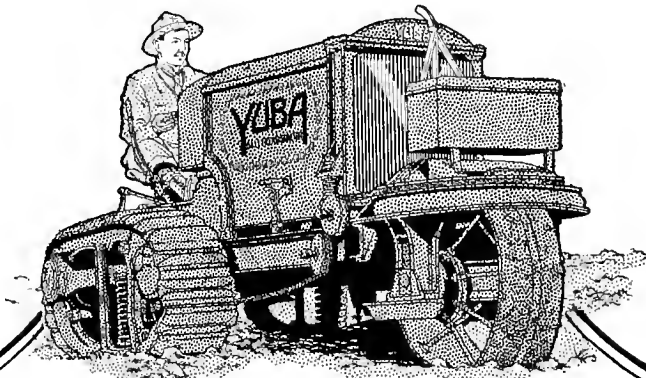

YUBA

Orchardists Say—

- “I bought my Yuba because—
- “I can get close to the trees—
- “It turns in a narrow headland—
- “It cultivates at high speed—
- “It’s a one-man outfit—
- “It’s big enough for a subsoiler—
- “I can work right after irrigation—

YUBA MANUFACTURING CO., 433 California St., San Francisco
 Factories: Marysville and Benicia, California

YUBA
 BALLTREADTRACTOR

Yuba Products Co.
 905 First Ave., Spokane, Wash.

Department of Agriculture, Etc.

Continued on page 10.

all rooms except the two middle rooms on the north side, which were equipped for special low temperature work and have two inches more insulation and correspondingly heavier doors. A brine coil is hung on one side of each room and is covered with a baffle board open at the top and bottom to permit the circulation of air over the coil. One section of this baffle board is hinged to allow access to the coils. Next to this block of finished rooms is space for four more rooms. It is planned to complete these in the near future. The handling room is located next to this space and is equipped with tables for sorting, scales, trucks, and the various paraphernalia of a cold storage plant. In one corner of this room is the elevator shaft.

The second floor is divided in the same general way as the first, eight cold storage rooms being directly over the first floor rooms and the unfinished storage space and handling room occupying the same relation to the storage rooms as in the first floor plan. The space over the engine room, 42x26 ft. is a well-equipped plant physiological laboratory. This laboratory is, of course, an exceedingly important part of the equipment, as the physiological aspects of storage are particularly emphasized in the work.

The importance of plant physiological work in connection with cold storage is evident when it is considered that most fruits and vegetables are stored alive and the problem is to keep them alive and in an attractive condition until they are to be used. The determination of the best condition for storage of any particular fruit or vegetables then requires a study of the life processes which go on in it after it is removed from the tree or the soil where it was grown, together with a study of the effect of the various environmental conditions obtaining in a storage plant upon these processes. The harvesting and handling of the produce before storage and the conditions under which it is grown often markedly influence the storage life. These factors must be considered in fundamental studies.

There are a number of problems relating to the storage of fruits and vegetables under investigation at the present time. One of particular interest is the determination of the effect of freezing temperatures on various kinds of fruits and vegetables. This includes determining the actual freezing points of the tissue, the temperature at which frost injury occurs, for it is, of course, possible that certain fruits or vegetables may be injured by low temperatures without the tissue actually freezing, and the effect of freezing on the produce. The development of methods for defrosting and methods for the utilization of frozen produce are also under investigation.

Another problem of rather wide application under investigation is the effect of gases, such as carbon dioxide,

carbon monoxide, and the various gases given off by car heaters, on fruits and vegetables. The effect of varying degrees of humidity on fruits and vegetables is also receiving considerable attention. Other problems of less general interest have been taken up, such as the cold storage of celery, and the changes which take place during storage in grapefruit, pears, apples and tomatoes.

The number of problems under investigation at any one time is, of course, limited by the size of the staff and the funds available. An effort will be made to take up, as rapidly as possible, the problems of fundamental importance to the cold storage of fruits and vegetables. It is hoped that results of value both to the producer and to the cold storage industry will be obtained in this plant.

Put WOOD-LARK on Guard

Gophers can't resist eating WOOD-LARK; eating it they must die. Sprinkle WOOD-LARK in the gopher runs now and stop the spring multiplying of these destructive pests.

If your Dealer Hasn't WOOD-LARK order today from

CLARKE-WOODWARD DRUG CO., PORTLAND, OREGON

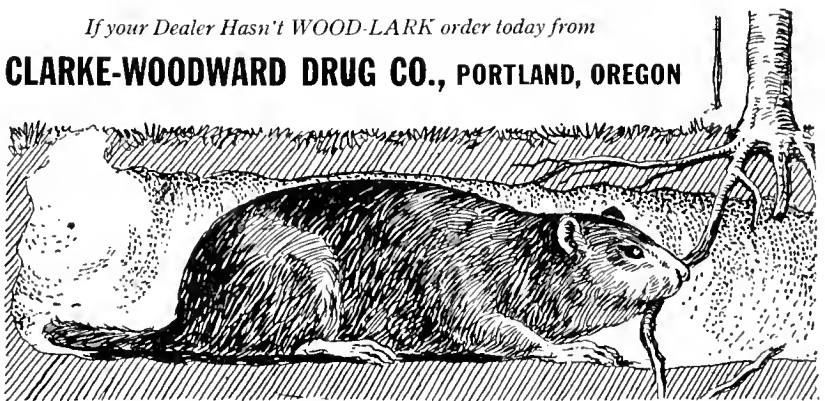

WHAT EVERY HOME CANNER SHOULD HAVE



ONE of our **H. & A. Hand Power Double Seamers.** It is the only hand power seamer built that will seal all sizes of sanitary fruit and vegetable cans. Write for prices and descriptive matter to Department T.

HENNINGER & AYES MFG. CO., Portland, Ore.
Builders of Seamers and Steam Pressure Canning Outfits

<p>MUSICAL MERCHANDISE</p> <hr/> <p>WRITE US</p>	<p>WE SAVE YOU MONEY!</p> <p>W. Martius Music House Inc.</p> <p>1009 First Avenue, Seattle, Washington</p> <p>Everything Known in Music</p>	<p>SHEET MUSIC</p> <hr/> <p>WRITE US</p>
--	---	--

BOLTON ORCHARD HEATER



Are you helping to pay the \$75,000,000 toll taken from the growers of the country annually by Jack Frost? The Bolton Heater is

The Safest Means of Frost Prevention

Don't experiment with makeshift methods. Bolton Orchard Heaters are sure. They maintain the temperature, distribute the heat uniformly, and prevent frost damage.

Send for Booklet 5

Tells you all about frost prevention. Filled with valuable information for the grower.

W. R. AMES CO.,
 8th and Irwin Streets San Francisco, Calif.

Largest stock of Surface Irrigation Pipe and Pipe Equipment on the Pacific Coast

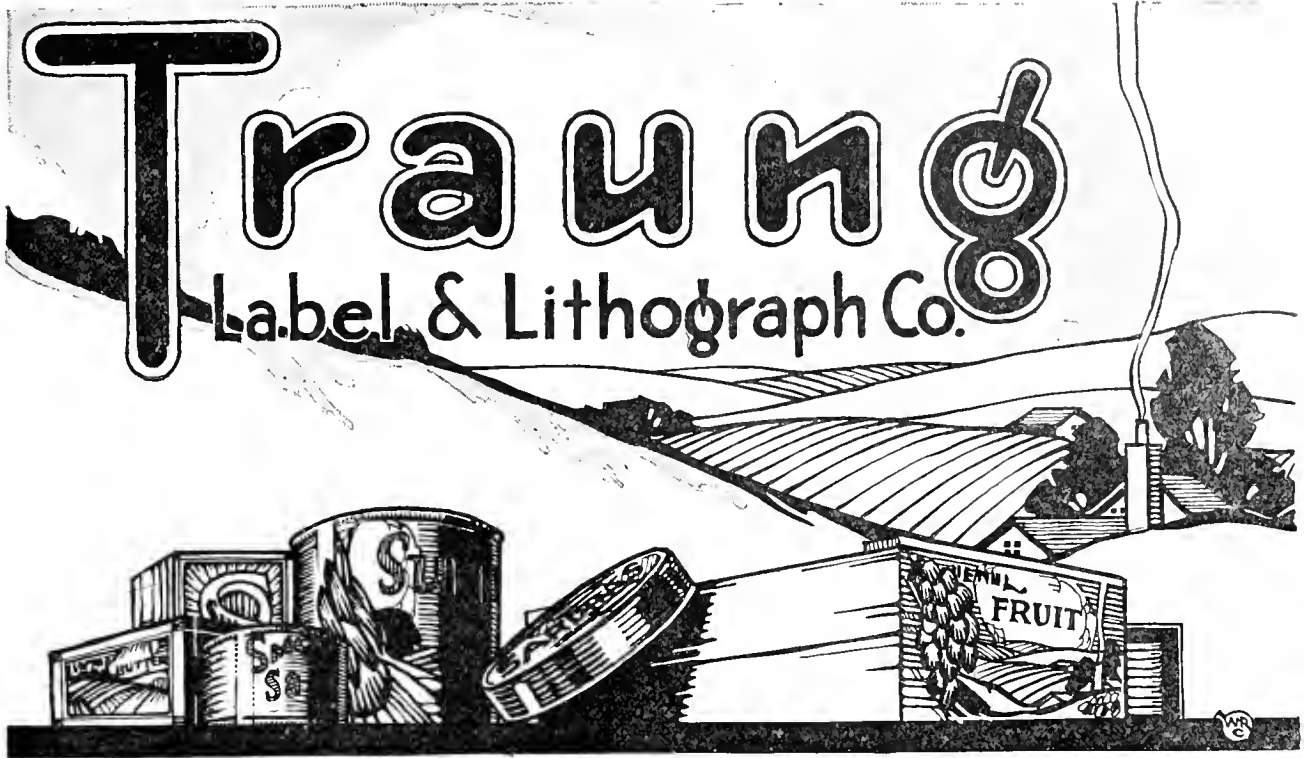

LABELS and CARTONS

Favored and used
by the largest
packers of fruits
and canned goods

"An institution that sticks to its last"
SAN FRANCISCO-STOCKTON-SEATTLE
Sales Offices-Portland-Fresno
Sacramento



The Successful Man Thinks Ahead

The man who wants to enjoy profits tomorrow must plan for them today.

Such a man must have adequate banking connection. The Ladd & Tilton Bank is equipped by experience and knowledge of modern methods to be of value to its customers in any phase of business.

LADD & TILTON BANK
 Oldest in the Northwest
 Portland, Oregon
 Washington and Third



Dusting and the Spray Gun, Etc.

Continued from page 8.

Low pressure from these small capacity outfits does not produce a spray of the proper consistency to accomplish a satisfactory coating. The liquid leaves the gun in a coarse, splattering stream. There is no fineness of division of the particles and the only way that a tree can possibly be covered is to drench and thereby waste much material. As I have said before, it is my belief that finely divided spray which has much the same consistency of the dust particles, which control calyx worms, operates in the case of properly applied liquid solutions. If this spray is not broken up into a light drifting mist the principal of calyx worm control is destroyed and poor results are bound to follow. There is no possible chance of obtaining much calyx protection in tops of trees with a gun throwing a coarse splattering spray. This might possibly be accomplished from a tower. Gravity is the factor which allows the poison to reach the calyx ends of the uppermost apples. The spray material must be placed there in the proper condition and in sufficient amounts to effect a coating as it falls. A coarse spray goes up in large droplets and comes down in much the same form; a large portion passing over the tree in the form of an arc. Unless a very excessive amount of spray material is

thrown into the top of the trees only a few of the calyx ends will receive much spray and these will be decidedly spotted.

In summarizing then, the successful use of the spray gun depends almost entirely upon the manner in which the spray is broken up. A pressure of 250 pounds on a large sprayer delivers a beautiful spray from two guns. This amount of pressure on a small outfit does not produce the same sort of spray. It takes at least 300 pounds with a 3½ horse power outfit to approach this spray and then it is nowhere nearly as good. I am not sufficiently versed in mechanics to explain just why this difference occurs. Nevertheless there is a difference and anyone who will handle the delivery from the small and large outfits can immediately feel the difference in the "life" of the spray. I am not conducting a propaganda for any one large type of sprayer, unfortunately at the present time there is only one on the market. Our other sprayer manufacturing companies must bring up their standards if they are to meet the demands of the orchardists for there will be a very great demand for these during the next few years. With the coming of increased facilities for proper spraying I firmly believe that we will see a marked improvement in our codling moth control and a yearly saving which will amount to many thousands of dollars.

TABLE 1—RELATION OF SIDE WORMS TO CALYX WORMS.
 Hood River, Oregon, 1917, 1918 and 1919.

Exp. No.	How Applied	Total Per cent Worms	Per cent Side Worms	Per cent Calyx Worms	Relation of Side to Calyx Worms in percentages
1917					
1.	Last dust spray omitted	12.96	9.28	3.68	71.6 to 28.4
2.	Dust applications	5.37	5.00	.37	92.99 to 7.01
3.	Last rods spray omitted	14.33	10.54	3.79	73.55 to 26.44
4.	Rods	1.43	1.11	.28	80.00 to 20.00
5.	Check	65.13	20.62	44.51	31.68 to 68.32
1918					
6.	Dust	2.68	2.54	.14	94.7 to 5.2
7.	Liquid (gun)	.44	.44	.00	100.00 to .00
8.	Check	17.64	12.9	4.7	73.29 to 26.7
1919					
9.	Rods in calyx, guns in others	2.39	2.05	.34	85.74 to 14.28
10.	Gun, all sprays	2.27	1.91	.35	84.24 to 15.71
11.	Rods, all sprays	3.41	3.12	.29	91.64 to 8.54
12.	Guns, 1 to 12 feet high	1.08	.99	.09	90.9 to 9.0
13.	Guns, 12 feet to tree top	5.1	4.2	.9	81.13 to 18.86
14.	Check (unsprayed)	53.6	24.2	29.4	45.16 to 54.83

Note—1917, five standard sprays applied unless otherwise stated; 1918, four standard sprays applied; 1919, five standard sprays applied.
 In experiment 12, fruit separated from ground to 12 feet. Experiment 13, from 12 feet to tops of trees.

Established 1882

F. W. Baltes & Company Printers

WE print anything from the smallest to the largest and always welcome orders of any size or quantity, giving prompt, personal and efficient service. Mail or phone inquiries are solicited. We do not specialize — experience and equipment enable us to print everything equally well. We render service in preparing copy and illustrations and furnish plans and estimates for catalogs, booklets, publications, billboard and any other kind of advertising.

First and Oak Streets
 Main 165; Auto 511-65
 Portland, Oregon

HOW ABOUT YOUR TREES FOR SPRING PLANTING?

We grow and "sell direct to planters," through our representatives, a full list of Fruit Bearing Trees, Shade and Ornamental Trees, Nut Trees, Bush Fruits, Roses, Vines, etc. You are not likely to want any good variety that we do not grow.

Have You Arranged for Your Loganberries, Strawberry Plants, or Italian Prune Trees?

Orengo Trees are known throughout the Northwest for their real value to the planter—their early fruiting and dependability. If you want value in trees for your money you'll always plant "Orengo Trees." If you have not provided for the nursery trees you need, why not do it now—while you have the matter in mind. If you don't know just what you want, we'll send you our beautiful and serviceable catalog, from which to make your selection. Just send five cents in stamps for postage.

OREGON NURSERY COMPANY, Orengo, Oregon

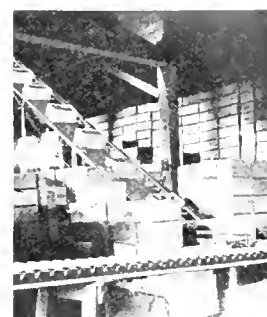
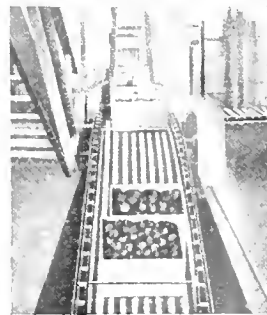

Brighter days and better ways are ahead for firms installing a Standard Conveying System for the rapid and economical indoor transportation of apples and fruit in the fruit-packing industry.

What We Have for You:

Standard portable Gravity roller conveyors for the rapid and economical movement of boxed and cased fruit.

Standard automatic elevators for the elevating of boxed and cased merchandise.

Standard Gravity spiral chutes to lower your empty cases and filled boxes of fruit from upper to lower floors.

A Standard Combination System for the indoor transportation of your fruit in the course of receiving, packing, boxing and shipping.

Wherever—Whatever your handling problems are, there is a Standard Service within immediate reach.

Get in immediate communication with our representative in your district and have him become your conveying-efficiency assistant in planning with you a **Standard System** to meet your specific needs.

Write for catalog for the fruit-packer.

Standard Conveyor Company

Formerly Minnesota Manufacturers' Association

North St. Paul, Minnesota

Representatives in All Principal Cities

Washington, Oregon and Montana Representatives:

D. E. Fryer & Co.

Main Office—Seattle, Washington

Branch Offices—Spokane, Washington
Tacoma, Washington
Butte, Montana
Portland, Oregon

California Representatives

Bannon-Bodinson & MacIntyre, San Francisco, California
Hazard-Gould & Co., San Diego, California
M. E. Canfield, Los Angeles, California

Colorado Representative

Mountain States Machinery, Denver, Colorado

Utah Representative

Hawley-Richardson-Williams, Salt Lake City, Utah

"I'll Tell the World" says the Good Judge

The man who doesn't chew this class of tobacco is not getting real satisfaction out of his chewing.

A *small* chew. It holds its rich taste. You don't have to take so many fresh chews. Any man who uses the Real Tobacco Chew will tell you that.



Put Up In Two Styles

RIGHT CUT is a short-cut tobacco

W-B CUT is a long fine-cut tobacco

Weyman-Bruton Company, 1107 Broadway, New York City

Growing and Culture of Almonds

Continued from page 6.

and in the lower lands, form the heavier soils.

The various conditions mentioned above are what the tree should have for best conditions of growth and production. Oftentimes these conditions may be approached without the soil being as deep as ten or twelve feet. Exceptions to this will be mentioned in discussing the various almond districts of the state. It is essential to understand that trees, while growing and bearing on shallow soils in some localities, do so because of other exceptionally favorable conditions; either the soil is exceptionally well drained and yet sufficiently retentive of moisture, or the humus in the soil is plentiful and the roots are able to work into the underlying partially decomposed rock for moisture and some plant food. In such localities the trees bear comparatively well because of the exceptional freedom from frost in the spring. Trees in these localities are generally smaller than on the deeper, richer soils, and where other conditions are equal, they bear crops in proportion to their size.

Almond Districts

Almonds are grown in nearly every county in California. In some counties the few trees growing only occasionally succeed in producing a crop of nuts. There are sections in nearly all parts of the state, however, where they are a success commercially. Within these sections may be found desirable and undesirable locations, depending upon soil and moisture conditions and freedom from injurious frosts. Any discussion of a district, therefore, does not necessarily mean that all lands within that district are uniformly adapted to almond culture. On this account it is impossible to define a district any more closely than to name the center and include with it the outlying districts. In the same way it is sometimes impossible to say just where one district begins and another ends. Adaptability of any special location can be determined only by careful study of the land itself and diligent inquiry of those familiar with it.

As far as possible, districts should be chosen where a definite cold winter season exists. Warm weather and lack of freezing temperatures do not hold the trees fully dormant and any frequent occurrence or unusual continuation of spring weather in the winter will start the trees into growth; cooler weather following, interferes with the normal flow of sap, results in injury to the tree and blossoms, and often causes gumming of the nuts which mature. This condition exists largely in the lower elevations in Southern California and especially in the coastal portion, where the ameliorating influence of the Pacific is felt. This same condition exists close to the coast in the northern portion of the state. Further inland and at higher elevations the winters are more pronounced, and where these are not too severe or prolonged the almond thrives best.



The Gasoline of Quality

Apples and Pears

For European Distribution



Gerald Da Costa

Long Acre, Covent Garden, London
Cables: "Geracost, London." Codes: A. B. C. 5th Edition and Private

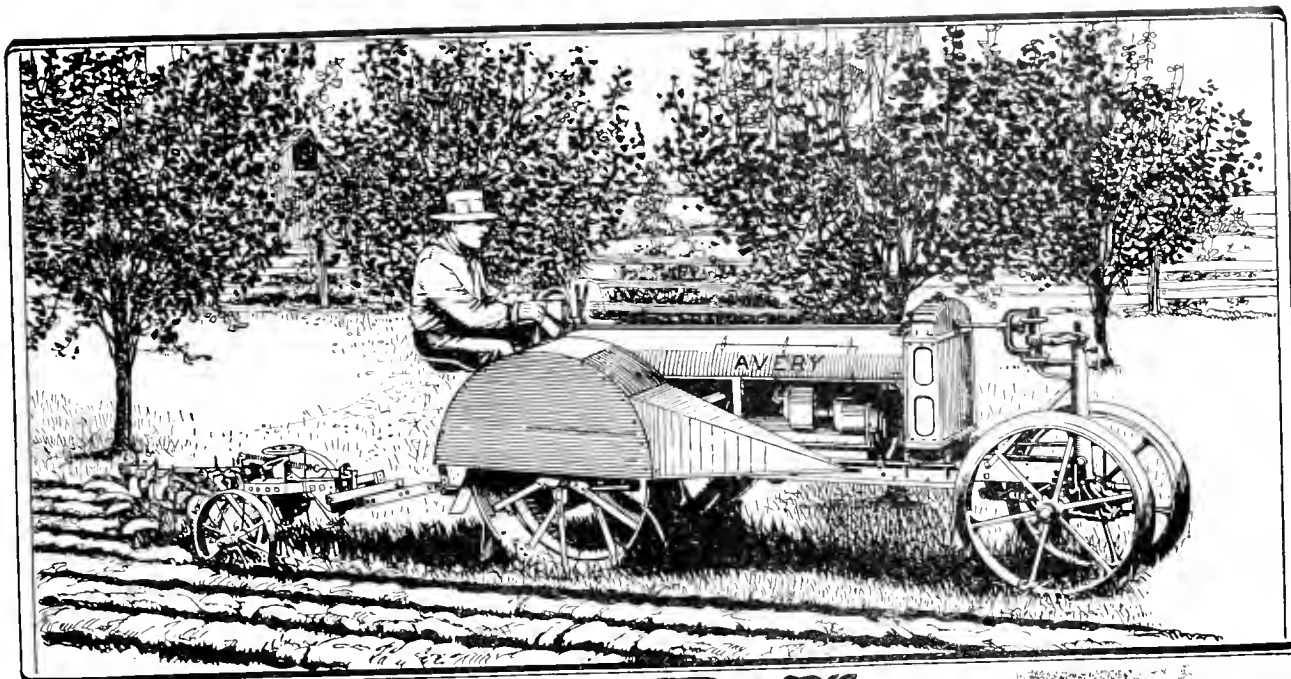

The Ideal Tractor Outfit for Orchard Work

This Avery Model "C" Six-Cylinder Tractor with special Avery Orchard Plow makes the ideal outfit for orchard work. It is built low enough to go under the branches and close up to the trees—it can be mounted with long rear wheel guards, as shown above, which gently raise low-hanging limbs and pass them up over the tractor without injury. The plow itself is extremely low in height and it too can be furnished with a guard to protect limbs as it passes under them. This tractor has a swinging drawbar which enables you to pull the plows to either side and break up the ground as close to the trees as you wish to go.

With this tractor you can Averyize your orchard—make it a better, more profitable investment. You can more easily conserve the moisture and soil under your trees. You can use it for all orchard work—you can turn under your cover crops with it and pull harrows and cultivators as well. You can use it for pulling your spraying outfit, and for all kinds of lighter belt work.

This Model "C" Avery Tractor is built with a powerful six-cylinder motor—designed and built complete in Avery factories especially and only for Avery Tractors. It is furnished complete with platform, seat, tool box, drawbar, air cleaner, etc.

Write for special circular describing this tractor and also the Avery 5-10 H. P. Model "B" Tractor illustrated below at the right.

THE AVERY LINE

includes in addition to these two small tractors, six sizes of tractors from 8-16 to 40-80 H. P. built with "Draft-Horse" Motors and "Direct-Drive" Transmissions; "Self-Lift" Moldboard and Disc Plows; Listers and Grain-Drills; "Self-Adjusting" Tractor Disc Harrows. Also Roller Bearing Threshers, Silo Fillers, etc. Write for the Avery Catalog.

AVERY COMPANY, 10708 Iowa Street, Peoria, Ill.
Feenaughty Machinery Co., Distributors, Portland, Oregon

AVERY

Motor Farming, Threshing
and Road Building Machinery

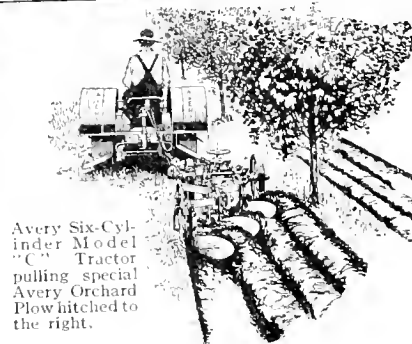

Avery Six-Cylinder Model "C" Tractor pulling special Avery Orchard Plow hitched to the right.

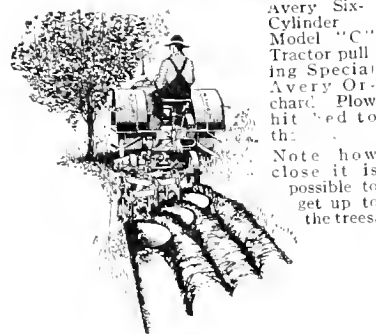

Avery Six-Cylinder Model "C" Tractor pulling special Avery Orchard Plow hitched to the trees. Note how close it is possible to get up to the trees.

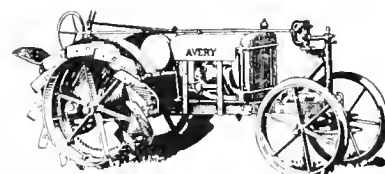

Avery 5-10 H.P. Model "B" Tractor
Here is an ideal tractor for a small orchard—sells at a low price—is a smaller tractor, but very similar to the Six-Cylinder Model "C" Avery. Is equipped with a four-cylinder motor.

Some Facts About Dry Lime Sulphur

By A. J. Gunderson, Horticulturist for Sherwin-Williams Company

WITHIN recent years the Sherwin-Williams Company has placed on the market a new spray product known as Dry Lime Sulfur. This has been brought about by a process of stabilizing 33° Baume lime sulphur solution by the addition of a stabilizing substance such as a carbohydrate or a sugar followed by a special process of drying. Orchardists and experiment stations have obtained excellent results with dry lime sulphur even when used in lesser amounts than would have been thought necessary when judged from the experience had with ordinary lime sulphur solution.

While this fact has proven of great interest to all orchardists and experiment stations it has been very disconcerting to a few critics who like to believe that since sulphur, chemically speaking is always sulphur, it is impossible for the sulphur in Sherwin-Williams' dry lime sulphur to be more efficient per unit of sulphur than the sulphur in old-fashioned lime sulphur solution. With equal assurance one might assert that carbon is always carbon and that willow charcoal, graphite and the diamond are equally efficient and yet we know that the diamond is worthless for kindling a fire and for writing on paper or as a component of gunpowder; likewise, willow charcoal is not a brilliant, sparkling gem in demand by jewelers nor can it be used to cut glass.

It has been definitely established that lime sulphur solution must be used at the rate of from one gallon to eight gallons in order to kill San Jose scale. Every fifty gallons of diluted spray therefore will contain approximately five and one-half gallons of lime sulphur solution, or a total of approximately fourteen pounds of sulphur in solution. On the other hand the results of experiments conducted in orchards infested with San Jose scale have shown that dry lime sulphur controlled San Jose scale just as effectively at strengths recommended by the Sherwin-Williams Company although containing considerably less amounts of sulphur in solution. Certain experiments conducted in the states of Washington and Illinois in the spring of 1919 have further confirmed such recommendations and in certain cases dry lime sulphur proved even more effective in the control of San Jose scale than lime sulphur solution.

Experiments conducted in certain other states have shown definitely that dry lime sulphur controlled apple scab and peach leaf curl just as effectively as lime sulphur solution. Furthermore it has been demonstrated that dry lime sulphur used in combination with arsenate of lead did not cause foliage injury and incidentally stimulated an unusual finish and color on red varieties of apples.

The explanation recognized by entomologists of this country as to how lime sulphur kills San Jose scale is that sulphur combined with calcium to form

polysulfides of calcium oxidizes after having been applied to the infested trees and that oxygen is removed from the scale, resulting in its chemical suffocation. It is very probable that entomologists have overlooked the fact that sulphuretted hydrogen or hydrogen sulfide is extremely toxic to both insect and plant life and that it plays an important role in sulphur insecticides.

Sulphuretted hydrogen is a gas which is not generally available commercially and if it were available it could not be applied easily and directly in such a manner as to kill the insect and not injure the tree. The most satisfactory method of applying sulphuretted hydrogen is the indirect one of using calcium polysulphide or so-called lime sulphur.

Lime sulphur solution is a water solution of a compound of calcium and sulphur known to the chemist as calcium polysulphide, together with lesser quantities of compounds of calcium sulphur and oxygen such as calcium thiosulphate, etc. This lime sulphur solution when diluted and used as a spray on scaly trees decomposes in the presence of carbonic acid yielding sulphur, hydrogen sulphide and calcium carbonate. Subsequently other reactions take place in which the sulphur, calcium thiosulphate and other sulphur compounds participate. If there is any difference in the toxic effect of a unit of sulphur in dry and liquid lime sulphur there must be reasons for that difference. Possibly we may never know all of the reasons, but we believe the phenomena may be explained in part as follows:

We believe that the spray made from dry lime sulphur has greater wetting and spreading and penetrating power. The film resulting from a spray of dry lime sulphur is less permeable to decomposing gases and vapors; and although more tenuous is more integral and coherent. The film resulting from a spray of dry lime sulphur dissolves and retains the liberated sulphuretted hydrogen for a longer time. The film directly in contact with the scale insect is decomposed by the carbonic acid and other organic acids produced by the transpiration of the insect perhaps to even a greater extent than by the carbonic acid of the air. Owing to the lesser permeability of the film from dry lime sulphur there is a greater concentration of the toxic vapors for the same length of time or an equal concentration for a greater length of time per unit of sulphur as compared with the film of ordinary lime sulphur solution. In other words, when dry lime sulphur is used a larger percentage of the sulphur content goes into the insect and less to the atmosphere than is the case when lime sulphur solution is used.

It is possible that the toxicity of the sulphur liberated from dry lime sulphur is somewhat greater than that liberated from ordinary lime sulphur solution for the reason that the former is in a state of extreme division, almost

colloidal in fact, and the stabilizer retains it as if it were in a sort of a gel.

Orchardists are interested more specially in what dry lime sulphur will accomplish under actual orchard conditions. In view of the fact that dry lime sulphur will give just as good results as lime sulphur solution in the same orchard, we believe that the explanation just given is a sound and satisfactory one.

The Sherwin-Williams Company has based its recommendations for the use of dry lime sulphur upon the results of careful orchard tests and further substantiates its claims for this product upon the fact that thousands of fruit growers are using dry lime sulphur with most excellent results. Dry lime sulphur will not only control effectively the insects and fungous diseases for which it is recommended but, furthermore, eliminates all of the objectionable features connected with lime sulphur solution. These include loss due to leakage, freezing, crystallization and great weight in handling. Orchardists everywhere are familiar with these objectionable features.

Dry lime sulphur is rapidly becoming a standard spray material and it is our prediction that it will entirely supplant lime sulphur solution in two or three years.

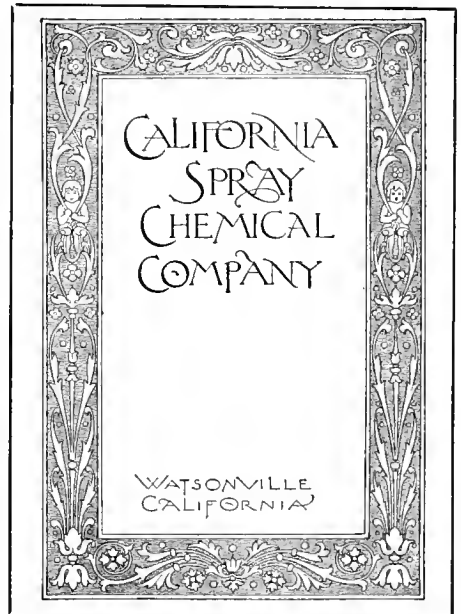

CUSHMAN

Light Weight Farm Engines



Built light, but right—for farmers who want an engine to do many jobs in many places, instead of one job in one place. Easy to move around. Equipped with Throttling Governor, Carburetor, Friction Clutch Pulley and Water Circulating Pump. (323)

4 H. P. Weighs Only 190 Lbs.

Mounted on light truck, it may be pulled around by hand. Just the engine for power sprayers because of light weight and very steady speed, giving uniform distribution and a thorough job. 8 h. p., 2-cylinder, for heavier work, weighs only 320 lbs. Book on Light Weight Engines sent free.

CUSHMAN MOTOR WORKS
 978 N. 21st Street Lincoln, Neb.
 Northwest Branch: 248 Hawthorne Av., Portland, Ore.
 Full Stock of Repairs at Portland



Hauling a Capacity Load on Plowed Ground. International 2-ton Motor Truck owned by Mr. K. Taguchi, the well-known Cantaloupe King of Rocky Ford, Col.

Where the Going is Hardest

On the clay roads of the Mississippi Basin —
 In the loose sandy soil of the California orchards and along Florida's sandy forest roads —
 On the steep and rocky slopes of the mountains of Pennsylvania, West Virginia, Colorado, and Tennessee, where the up-hill hauling is severest —
 In Montana, the Dakotas, and Minnesota, where the snows are deepest —
 In plowed fields, on country roads and mountain trails — wherever road and weather conditions make hauling most difficult —

You Will See International Motor Trucks

The toughest hauling problems are being solved with International Motor Trucks. They are conquering the difficult jobs. They are proving beyond all question that Internationals are built to do the work and keep going. They are making good where others fail.

That is why you find Internationals most numerous where hauling conditions are most stubborn — they stand the strain of constant daily grind — they can be depended on to force their way right ahead — they are always ready for hard jobs — they give dependable service day after day at low cost.

Your farming will be easier, more pleasant and more profitable when you are the owner of an **International Motor Truck**. Sizes to choose from, ¾-ton to 3½-ton. Branch houses, distributors and dealers everywhere. Write us for a catalog and let us answer your questions.

INTERNATIONAL HARVESTER COMPANY
 OF AMERICA

(INCORPORATED)

Billings, Mont. Cheyenne, Wyo. Denver, Colo. Helena, Mon.
 Los Angeles, Cal. Portland, Ore. Salt Lake City, Utah
 San Francisco, Cal. Spokane, Wash.



The Comparatively Low Cost of Spraying

By Chas. L. Robinson, District Horticultural Inspector, Yakima, Washington.

Notwithstanding the constant educational efforts to teach them, many fruitgrowers do not seem to realize how low the cost of spraying is in comparison with other orchard operations and therefore frequently neglect to follow up one of the most important phases of successful fruit growing. Naturally all growers are anxious to produce as large a percentage of extra fancy fruit as possible. In order to do this it is absolutely necessary for them to keep their trees free from disease and insect pests.

The following figures, therefore, compiled by a Washington apple grower will be of interest to those who balk at spraying on account of the cost. These figures which give the cost per box of applying the lime-sulphur and arsenate of lead sprays are as follows:

Age of Trees:	10 Years	15 Years	20 Years
Lime-sulphur—			
One spray.....	.045	.045	.047
Arsenate of Lead—			
One spray.....	.022	.02	.02
Five sprays.....	.11	.10	.10

The above figures are computed on a basis of a crop of 250 boxes to the acre on 10-year old trees, 400 boxes per acre from the 15-year old trees and 500 boxes per acre on 30-year old trees. Amount of material used is based on the recommendation of the horticultural department regarding amounts of material necessary for orchards of different ages. Labor costs are computed on a basis of \$15.00 per day for man, team and sprayer and 40 cents per hour for nozzlemen. Lead is computed on a basis of 30 cents per pound for arsenate of lead and 30 cents per gallon for the lime-sulphur solution, 32 degree concentrate.

There occurred at Wenatchee the past season an instance of which many have probably heard and which could be duplicated without a doubt in a number of districts here if growers would go together on a similar proposition. In brief the Sunnyslope district at Wenatchee had so many worms during the 1918 season that most of the fruit growers were becoming discouraged. Several orchards ran more than 40 per cent to 60 per cent worms and for the section as a whole 25 per cent of worms was considered a very low estimate. Last spring they got together, assessed themselves \$1.00 per acre for the district, which comprised a little over 1000 acres and through the horticultural department they hired a man to supervise their spraying. This plan was so successful that for the 1919 season the entire area averaged less than two per cent worms and a number of growers there have estimated that the \$1,000 investment saved them at least \$50,000.

From the above figures and results obtained in the Wenatchee district it will be seen that no fruit grower can afford not to spray.

OREGON GROWN



Our select Eclipse and Climax Seed Oats will give you 100 bushels per acre from Spring planting—maturing in 90 days

“Eclipse” side oats,
“Climax” tree oats,
“Senator” side oats,
Hulless oats and
select re-cleaned
White Seed oats.

SPRING WHEAT—Fancy re-cleaned stock of
Marquis — Blue Stem — Early Baart — Foise
SPRING RYE—**Speltz (Emmer)**—BARLEY

For complete list of Grains, Grasses, Farm and Field Seeds, see our 1920 Catalog.
Free on Request—Ask for Catalogue No. 200



A grade for each type of engine

More than half the cars on the Coast—

More than half the motorists of the Pacific Coast states use Zerolene. Such approval is given only as a reward to a product of highest quality. Use Zerolene for the Correct Lubrication of your automobile, truck or tractor.

STANDARD OIL COMPANY (California)

THE WORLD-
OUR ORCHARD

STEINHARDT & KELLY NEW YORK

UNQUESTIONABLY THE
MOST IMPORTANT FACTOR
IN THE DISTRIBUTION OF
THE COUNTRY'S FANCY
APPLES
AND OTHER FRUITS

OUR MARKET-
THE WORLD

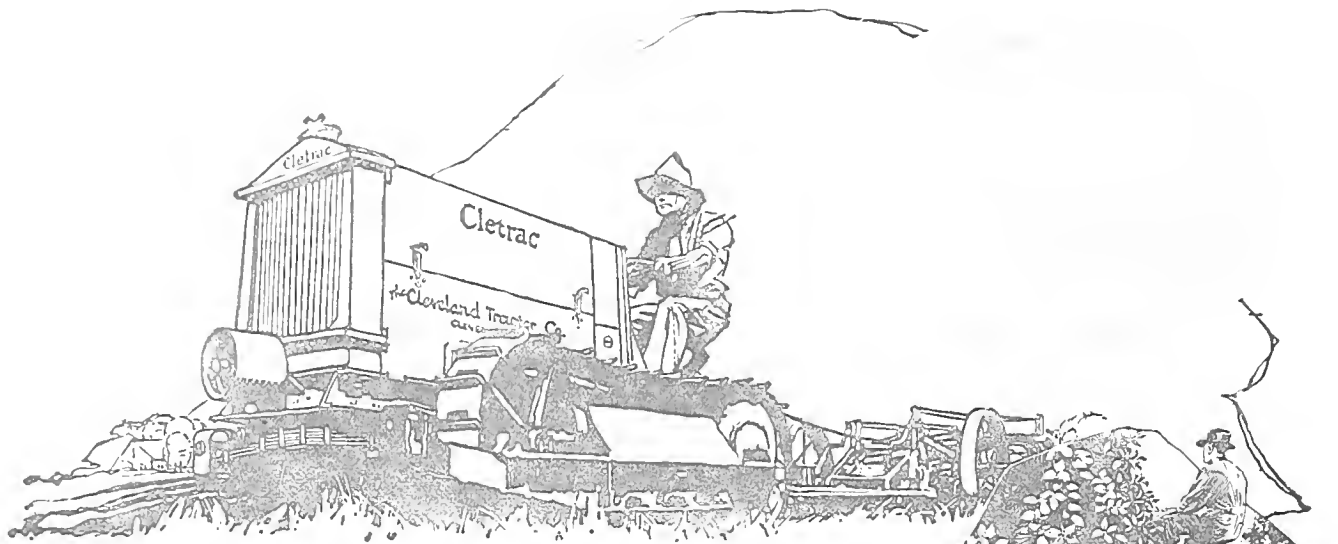

For Plowing and Discing ~ THE CLETRAC

Put a Cletrac to work this Spring. It will replace six to eight horses — do more kinds of work — more days a year — save time and cut costs. It will speed up your plowing and discing — allow you to put more acres under cultivation and produce bigger crops.

The Cletrac used alone or in "fleets" is the right size and type for almost every ranch — the one tractor adapted to all conditions.

No difference how soft and slippery the soil is — the Cletrac travels lightly over the surface on its own endless track without sinking in or packing. It is light, surefooted and powerful. The Cletrac "gets" all the corners also, because it can turn short. Swings back to the furrow quickly, without loss of time or power.

In the orchard, too, the Cletrac is at home. Low hung, with no projections, it weaves in and out among trees without injury to them. Use it to move your spray about.

And remember the Cletrac operates perfectly on kerosene, distillate or "gas".

Write today for that interesting booklet, "Selecting Your Tractor" — it's free.

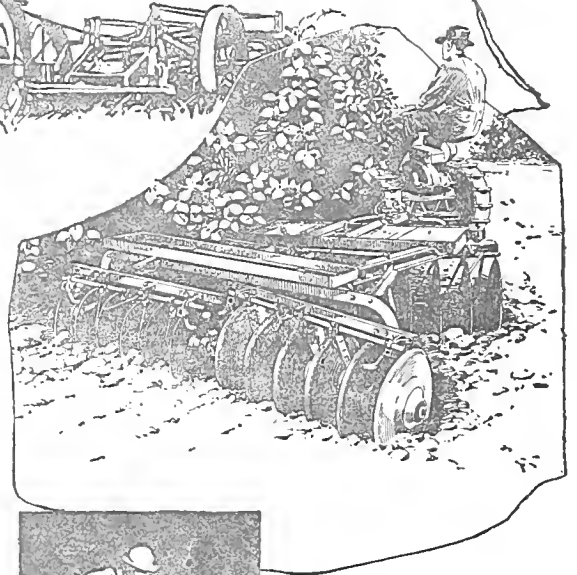

*Easy going
on a track,
the CLETRAC
way.*

Pacific Coast
Sales Offices:

LOS ANGELES, CAL.
SAN FRANCISCO, CAL.
SPOKANE, WASH.

The Cleveland Tractor Co.

19145 EUCLID AVENUE
CLEVELAND
OHIO

Largest producers
of Tank Type
Tractors
in the world.

One of the more than 1,200 CLETRAC dealers with repair stocks is near you.

MAY 21 1926

BETTER FRUIT

VOLUME XIV

MAY, 1920

NUMBER 11

SMALL FRUIT NUMBER

Columbia Univ Libr
30dec23



THE STRAWBERRY IN ALL ITS GLORY

20 Cents
The Single Copy

BETTER FRUIT PUBLISHING COMPANY, PUBLISHERS, PORTLAND, OREGON

Subscription \$2.00 per Year in the United States; Canada and Foreign, Including Postage, \$3.00, Payable in American Exchange

The Cutler Fruit Grader

For Box, Basket or Barrel Packing

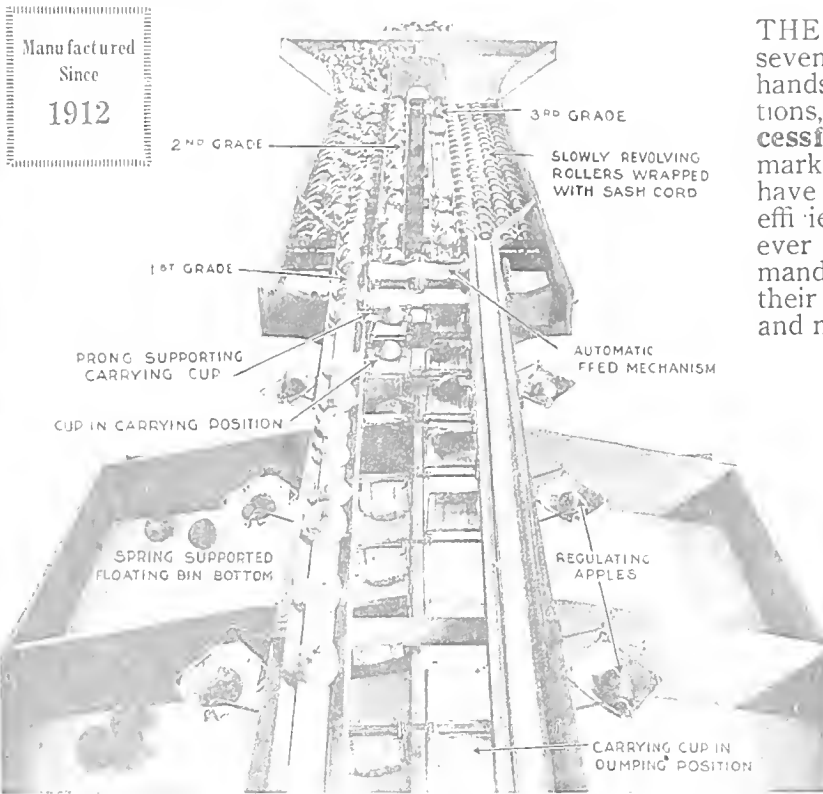

Upper View of a portion of the Four-Section Model for box packing, showing the Mechanical Sorting Table. No hand feeding necessary. The fruit is fed automatically. This table slowly revolves the fruit as it is moved forward before the sorters. Our belt type of sorting table can be furnished if desired.

THE CUTLER FRUIT GRADER, after seven years of manufacture and use in the hands of leading fruit growers and associations, stands preeminently **The Most Successful and Practical Fruit Grader** on the market today. With the improvements we have made our 1920 models are the most efficient and satisfactory machines we have ever manufactured and will meet the demands of all growers who want to handle their crops at the least expenditure of time and money.

New Features

We have perfected two extra attachments to our graders which we are putting out this season, viz:

(1) **Off-Grade Return Belts** which afford a means for bringing back to the sorters the off-grade fruit found in the bins. This makes an immediate check on the sorters and will result in a better grade of fruit being packed.

(2) **Separation of Cull Fruit into Canning and Cider Stock**
This attachment takes the place of the regular cull belt on all our tables and automatically separate the cull fruit into canning and and cider stock without any labor cost.

With a Cutler Grader you can handle your crop quicker at the least cost of sorting, packing and handling and you do not have to depend on skilled packers. A Cutler Grader will soon pay for itself in the saving made in the handling of the crop.

*Eventually You Will Buy a Cutler Grader
Why Not Now?*

Don't put off ordering your packing house equipment. The situation this year in the obtaining of material for manufacturing is such as to make the placing of early orders absolutely necessary.

Fill out the coupon below and mail to us today. You may regret not doing so.

Cutler Manufacturing Co.
353 E. Tenth St., Portland, Oregon.
Please send descriptive circulars and prices of the equipment as indicated below.
Check the equipment you are interested in.

Grader. Gravity Carrier.
Box Press. Grip Trucks.

Crop expected in 1920 _____ boxes.

Name _____

Address _____

Box Presses

See the the Cutler Press before buying. We have the best press on the market today.

Write today for Catalog and Prices

Cutler Manufacturing Co.

353 EAST TENTH STREET

PORTLAND, OREGON

A car of lasting newness

—that is the reputation built up by Mitchell

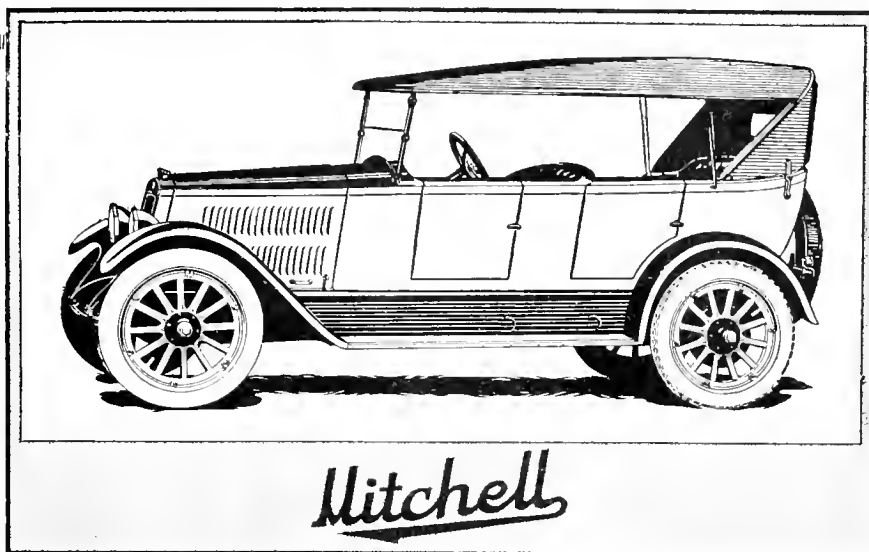

The new Mitchell Six is offered in four models: 5-passenger Touring Car, 3-passenger Roadster, 5-passenger Sedan and 4-passenger Coupe.

The Mitchell way is to build a car that stays new. So we include all the necessary betterments. We can afford to give *more* because of a finer factory and an efficient organization. We save in countless ways, and put the savings into the car. For instance, we build our own bodies, thus saving a profit to outside builders.

An example of how we put this back into the car is shown in the top. It is an extra cost feature, seldom built so fine on any car. It won't get shabby quickly. It is hand-tailored, bound to keep its shape and finish.

Throughout are other convincing examples — too many to mention here—of over-values. Costly shop practices bring new degrees in

fitting parts. We make the Mitchell complete, hence we control every process, every quality. So we insure dependability.

The new Mitchell also brings tomorrow's style, the final blending of lines. This advanced style has created a sensation the nation over. So in addition to a sturdy, dependable, economical car, this new Mitchell brings the latest in style and finish.

Investigate this extra-fine car of modest price before you buy. Go to a Mitchell Dealer, or write for our new catalog. You can't find its equal at the price. Then place your order at once, so as to insure early delivery.

MITCHELL MOTORS COMPANY, INC., RACINE, WISCONSIN

Mitchell Motor Cars distributed in
The Pacific Northwest by

Also sold by the leading dealers in nearly
every town in the Pacific Northwest



Portland and Spokane

Seattle Dealers, Mitchell Motors & Service Co.
Tacoma Dealers, Puget Sound Motors Co.

SIMONS, SHUTTLEWORTH & CO.

LIVERPOOL AND MANCHESTER

SIMONS, JACOBS & CO.

GLASGOW

GARCIA, JACOBS & CO.

LONDON

Agencies and Representatives in Every Important European Market

European Receivers of American Fruits

FOR MARKET INFORMATION ADDRESS

SIMONS, SHUTTLEWORTH & FRENCH CO.
204 Franklin Street, New YorkSIMONS FRUIT CO.
Toronto and MontrealSIMONS, SHUTTLEWORTH, WEBLING CO.
12 South Market Street, Boston

OUR SPECIALTIES ARE APPLES AND PEARS

Be On Guard

with

"BLACK LEAF 40"

for Aphis

Aphis is a serious menace to your orchard profits.

Don't forget that the best time to spray is when the Bud shows the Green Tip.

"BLACK LEAF 40" is a spraying solution that can be used as recommended in "combination sprays" — with Lime-Sulphur, Arsenate of Lead, Bordeaux Mixture.

"BLACK LEAF 40" is endorsed by Experiment Stations and Agricultural Colleges throughout the United States and Canada.

Universally conceded by growers to be the most effective and practical material for the control of Aphis, Thrips, Pear Psylla, Leaf Hopper, Woolly Aphis and other soft-bodied, sucking insects.

Write us today for our complete spray chart leaflet and bulletins.

Order your supply early from your dealer.

Manufactured by

Tobacco By-Products & Chemical Corporation

Incorporated

Successors to The Kentucky Tobacco Product Company

Louisville, Kentucky



Sulphur

It has been proven and so recommended by the University of California that if you sulphur your grape vines and orchards 6 times they will not be affected by MILDEW or RED SPIDERS.

ANCHOR Brand Velvet Flowers of Sulphur, also EAGLE Brand, Fleur de Soufre, packed in double sacks, are the fluffiest and PUREST sulphurs that money can buy; the best for

vineyards; the best for bleaching purposes, LEAVING NO ASH.

VENTILATED Sublimed Sulphur — Impalpable Powder, 100% pure, in double sacks, for Dry Dusting and making Paste Sulphur.

For LIME-SULPHUR SOLUTION, use our DIAMOND "S" BRAND REFINED FLOUR SULPHUR. We can furnish you this sulphur at such a low price that it would pay you to mix your own solution.

To create additional available plant food, and prevent smut in grain, drill into the soil 110 pounds per acre DIAMOND "S" BRAND POWDERED SULPHUR, 100% pure. This has increased various crops up to 500%. Send for Circulars No. 6 and 7.

Also PREPARED DRY DUSTING MATERIALS, Tobacco Dust, Dusting Sulphur Mixtures, etc., Fungicides and Insecticides, carried in stock and mixed to order.

SAN FRANCISCO SULPHUR COMPANY
624 California Street, San Francisco, Cal.

We are equipped to make immediate shipments. Send for "ILLUSTRATED BOOKLET"; also booklet "NEW USES FOR SULPHUR," Price-list and Samples.

Ask us for prices for Carbon Bisulphide, the surest remedy for destroying ground squirrels.

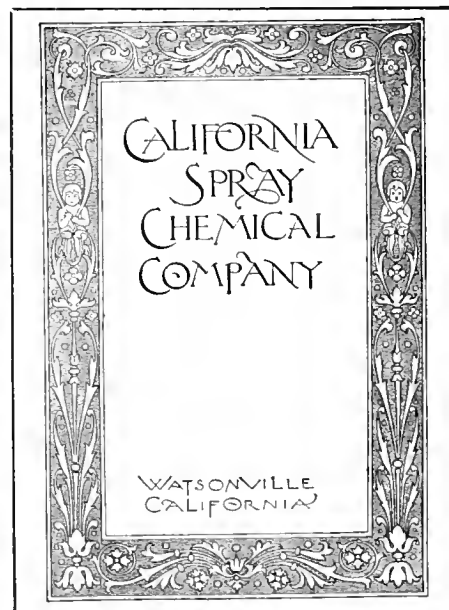

BETTER FRUIT

EDITOR: W. H. WALTON

STATE ASSOCIATE EDITORS

OREGON—C. I. Lewis, Horticulturist.
WASHINGTON—Dr. A. L. Melander, Entomologist;
O. M. Morris, Horticulturist, Pullman.
COLORADO—C. P. Gillette, Director and Entomologist;
E. B. House, Irrigation Expert, State Agricultural College,
Fort Collins.
ARIZONA—E. P. Taylor, Horticulturist, Tucson.
WISCONSIN—Dr. E. D. Ball, Madison.
MONTANA—H. Thornber, Victor.
CALIFORNIA—C. W. Woodworth, Entomologist, Berkeley;
W. H. Volek, Entomologist, Watsonville; Leon D.
Batchelor, Horticulturist, Riverside.
INDIANA—H. S. Jackson, Pathologist, Lafayette.

An Illustrated Magazine Devoted to the Interests
of Modern, Progressive Fruit Growing
and Marketing.

All Communications should be addressed and
Remittances made payable to

BETTER FRUIT PUBLISHING COMPANY

SUBSCRIPTION PRICE:

In the United States, \$2.00 per year in advance,
Canada and Foreign, including postage, \$3.00,
payable in American exchange.

ADVERTISING RATES ON APPLICATION

Entered as second-class matter April 22, 1918,
at the Postoffice at Portland, Oregon, under
the Act of Congress of March 3, 1879.

PUBLISHED MONTHLY BY

Better Fruit Publishing Company

703 Oregonian Building

PORTLAND, OREGON

VOLUME XIV

PORTLAND, OREGON, MAY 1, 1920

NUMBER 11

Raspberry Culture—Red, Black, Purple—In All Phases

By George M. Darrow, Scientific Assistant, Office of Pomological and Horticultural Investigations, U. S. Department of Agriculture

THREE types of raspberries (red, black and purple) are grown extensively in the United States. Red raspberries bear red fruit, have erect canes, and usually are propagated by the suckers which come from the roots of the parent plant. Some of the varieties under cultivation come from the European and the rest from the American wild red raspberry. Among the leading red varieties are the Culbert, Ranere and King.

Black raspberries, or blackcaps, bear black fruit, have arched canes which root at the tips in autumn, and are propagated by the plants formed at the tips. All black varieties come from the American black raspberry, which grows wild in the eastern part of the United States. Under cultivation they are not, however, as hardy as some of the red varieties which come from the American wild red raspberries. The Gregg, Ohio, and Cumberland are important commercial sorts of the black type.

The varieties under cultivation bearing purple-colored fruit are hybrids between the red and black raspberries and have canes that arch and root at the tips, as do the black raspberries. The Columbian and Cardinal are leading purple sorts.

Occasionally plants appear of both red and black types which bear yellow fruit, but the yellow varieties in cultivation belong to the red-fruited type. The Golden Queen is the leading yellow-fruited variety. It is rarely grown for the general market, but is adapted to home gardens and to special markets.

The cultivation of the raspberry is limited very largely to the northern part of the United States, chiefly to those sections in which the wild raspberries grow most abundantly.

The red raspberry sections, from which extensive shipments are made, are located in southern New Jersey, in the Hudson River Valley, in western New York, in western Michigan, in the Puyallup Valley of Washington, and about Sebastopol, California. The acreage in southern New Jersey and in the Puyallup Valley of Washington and some sections of Oregon has been in-

creasing rapidly in recent years and is now much larger than formerly.

Black raspberries are grown for commercial shipment in western New York, in western Michigan, in the sections about Waltham, Kansas, and Hagerstown, Maryland, and to a less extent in other places. There are few plantations in the southern states or on the Pacific Coast.

The purple varieties are grown extensively in western New York only, although for local market and home use their range is about the same as that of the blackcap.

Location of a Plantation.

Particular attention should be given to the locality in which the raspberry plantation is to be established.

The hot summers of the south are not favorable to the production of this fruit, which is a native of states having a cool climate. There are few plantations south of Virginia, Tennessee, and Missouri, and even the warmer parts of Virginia and Tennessee are not well

adapted to raspberry growing. The black and purple varieties have not proved to be well adapted to conditions in the Pacific Coast states, although red raspberries are grown very successfully in that part of the country. In most of the Great Plains area and in parts of the mountain states of the west the winters are too severe or the summers too hot and dry for raspberry growing.

The raspberry plantation should be located near a good market or good shipping point if it is to be most profitable. The roads to that market or shipping point should be such that the berries will not be injured when hauled over them. If the fruit is to be shipped long distances it is essential that quick transportation and refrigerator car service is available.

Site of a Plantation.

Three important factors which should be considered in the selection of a site are the soil type, the moisture supply, and the air drainage.

Although the raspberry will succeed



A field of Culbert red raspberries planted in accordance with the hedge system. The canes are pruned back in the spring, so that they will support the crop of fruit. Photo taken at Webster, New York.



A field of Cuthbert raspberries being grown under the linear system of culture. Two wires on either side hold the canes erect. The wires about four feet above the ground and the canes topped about six feet from the ground.
Photo taken at Puyallup, Washington.

on a wide range of soil types provided suitable moisture conditions prevail, the best results will be secured only by studying the peculiar requirements of the different varieties. A fine, deep, sandy loam is perhaps the most desirable soil for growing raspberries, because it is managed so easily. Equally good yields of some varieties will be secured on clay and on sandy soils if they are well managed. In general, however, though the black raspberries seem to do best on sandy soils, they are grown extensively and succeed well on clay soils. Among the red raspberries the Ranere does best on sandy types, but the June prefers a clay soil. Other varieties, such as the Cuthbert and the King, succeed on a wide range of soil types.

The most important, perhaps, of all the factors entering into the growing of raspberries is the moisture supply, and where there is the possibility of a choice, the soil which will furnish an ample supply of moisture at all times should be chosen. At no time, however, should there be wet places in the plantation. Thorough drainage as well as a full supply of moisture is essential.

Another important factor is air drainage. Cold air settles to the lower levels and plantations situated on land elevated above the surrounding fields will not be as subject to the extreme cold of winter as plantations on the lower levels. Winter injury to the canes may often be avoided by choosing a site higher than the surrounding country. Furthermore, plantations on the higher elevations are not as subject to frost injury in late spring as those not so favorably located.

In the southern states, a fourth factor in the selection of a site is of some importance. If raspberries are to be grown in those states, a northern or northeastern slope is preferred for the plantation, as humus and moisture are

retained better in fields on such slopes than on southern slopes.

For home gardens, the chicken yard is frequently a desirable place for the raspberry patch. Poultry keep down weeds and enrich the soil, and do not often injure the berries.

Preparing the Land.

The same thorough preparation of the soil should be given for a raspberry plantation as for corn or similar crops. For the best results the plants should never be set in a field which has just been in sod, but should follow some hoed crop. Land which produced a

crop of potatoes the previous year and which has later been plowed and thoroughly pulverized is in the best physical condition for setting the plants, and any field on which crops have been grown which leave the soil in a similar condition is prepared properly for raspberries.

Planting.

The time of planting raspberries varies in different parts of the United States, according to the local conditions. In general, however, the plants should be set in early spring in the eastern part of the United States, but on the Pacific Coast they should be set during the rainy season, whenever it is possible to do the work.

Because better plants of the black and purple varieties can be secured in the spring, that is the best season for setting them. Red raspberries, however, may be set in the autumn with good success in sections where the winters are mild or where there is a good covering of snow to protect the plants. Some of the advantages of autumn planting in sections where this is possible are the following:

(1) There is usually a much longer season in which the planting conditions are favorable than in the spring.

(2) During the winter the plants become thoroughly established in the soil and they start growth quickly in the spring.

(3) In the autumn the leader buds from which the new canes develop are dormant and are not broken easily. By spring, however, they have grown to a considerable length, often several inches, and then are broken very easily in planting. Unless the root is vigorous such plants may not develop new shoots.

Occasionally when growers wish to

Continued on page 35.

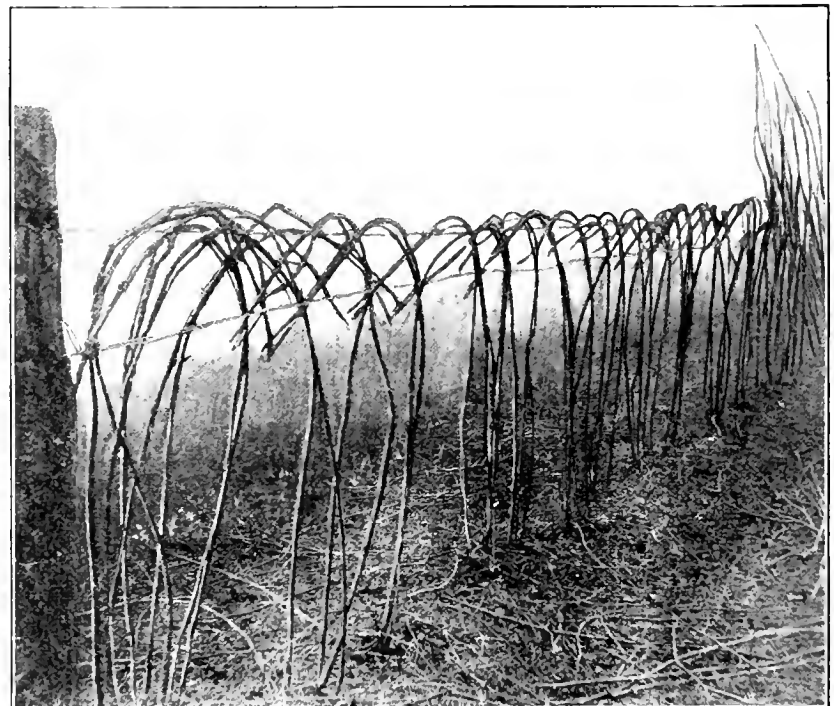

Raspberries planted on the linear system and trained to a wire trellis. The canes are arched over the wire, tied to the lower wire and the projecting ends cut off.
Photo taken at Sumner, Washington.

Planting and Care of Prune Orchard Up to Bearing Age

By George Zimmerman

THE first essentials to be considered in growing a prune orchard are deep, fertile soil, good water drainage and good nursery stock, and then with proper planting and care there is no reason why success should not crown the fruit of your labors. After a suitable location has been found the first thing to be considered is getting the land ready for planting. Plow well and deeply, say ten inches, and if the land has been previously farmed use the sub-soiler in connection with the plowing so as to break up the hard pan, for it cannot be done after the trees are planted except at great damage to the rooting system.

There has been a great deal said in regard to the different systems of setting out orchards, but considering all in all I prefer the square system, for the orchard is easier cultivated—that is, there are less rows to contend with and it is easier to get around with a team and wagon when it comes to gathering the fruit. The method which I prefer in orchard staking is by running control lines two to three hundred feet apart and staking with a wire between these lines. To get the best results control lines should be run with an instrument. If the planting is to be very large establish a base line through the planting and from this control line should be run at right angles. In staking it is very important that the wire should be kept as nearly level as possible to give accurate results. On uneven ground, it is necessary to drop a plumbob from the wire to the ground to locate the place of the stake. Rubber tape is used to indicate on the wire the distance apart the trees are to be set. When I set out my orchard I set the trees twenty-two feet apart or about 96 trees to the acre, but if I were to set out another orchard I would set the trees at least twenty-five feet apart. This may seem a waste of land to the new beginner, but as the orchard grows older, one will readily see the need for putting the trees this far apart. In my orchard, at six years of age, I found roots of trees of the opposite side of the row overlapping.

The selection of nursery stock is a very important factor toward success. Select one-year-old trees with good, clean roots and plenty of them, and a straight top from four to six feet high. If you are not a judge of trees, go to a reliable nurseryman, one who will stand back of his stock. Do not get your trees too early in the fall, for some of the nurserymen start to dig before the wood is mature, and the result is that the trees will soursap and die, a loss in time and money. As soon as you get your stock from the nursery heel in in good shape to prevent injury from drying out or injury from frost, for it must be remembered that the small rootlets are very sensitive to cold or lack of moisture. When you are planting keep a damp sack over the roots of the trees you are packing along, as this will guard against any injury.

Planting may be done at any time after the trees are dug in the fall until the buds show signs of activity in the spring, but at no time when the ground is wet enough to puddle or to pack around the roots. I prefer the early winter planting, as the soil has a chance to settle before spring. Before planting take a sharp knife and cut off the bruised ends of the roots where they have been cut when taken up from the nursery. This will insure the bruised roots to heal over readily and be less liable to disease infection. When you are ready for planting take the planting board (which is made by taking a one-inch by four-inch piece four feet long, cutting a notch in each end and one in the center), place it so that the stake which indicates where the tree is to be set will be in the notch in the center of the board and then place a stake in each notch at the ends. Remove the board and the center stake and you are ready to dig the hole. When planting dig a hole deep enough so that when

the top of the longest root going downward rests on the bottom of the hole, the tree will rest two or three inches deeper than it did in the nursery. Very great care should be taken so that the soil is well worked between the roots and that every root goes out naturally from the tree stock. If this is not done and the soil is thrown into the hole carelessly the roots will all be crowded together, which is very undesirable. After the tree is planted head back to about three feet and four inches, and then with proper pruning in later years the tree will be kept up so that cultivation will be done without great difficulty.

One of the greatest factors that has to do with moulding out the prune orchard is the cultivation given up to the bearing age. I practice clean cultivation and think it is the only cultivation that should be done in any orchard, especially during its formative period. I will give here the method that I use here in the Willamette Valley. In different sections of the state it will vary somewhat. Plow as early in the spring as can be done without injury to the physical condition of the soil. I use the heavy harrow, disc and roller if necessary in the early part of the season, say May 1 or May 10. The soil should be thoroughly worked down by this time so as to prevent too rapid drying out. After this I use the Kimball light harrow or other tool. These lighter tools are used to break capillarity and to form a dust mulch to retain the soil moisture. I use these tools up to about July 1; after this time we have very little rain to settle the soil and start capillary action and to start the weeds. Give your orchard a good start by thorough cultivation the first years of its life and you will have a healthier orchard, for I have found by practical experience that it is always the weaker trees that succumb to disease. There will be less resetting and your orchard will bear at least one year earlier.

Pruning may be done at any time after the leaves have fallen until the trees show signs of activity in the spring. There are a great many different opinions as to the methods of pruning a prune orchard, and they may all lead to a reasonable degree of success, but the following is a model that I have pictured in my mind and toward which I am constantly working. The object of pruning is, first, to mould the young trees as they grow into a uniform shape so as to produce the maximum amount of fruit without injury to the tree; second, for the size of the fruit; third, so that cultivation can be done without great injury to the lower branches and with a reasonable degree of comfort. It is the tendency of the prune tree to gradually droop down a little from year to year after it starts bearing. As previously stated, top the tree at three feet four inches. The first year the trees are planted every bud along the stem has a tendency to



Prune tree with its covering of blossoms.

Continued on page 33.

Points on Strawberry Growing for Beginners

Bureau of Plant Industry, United States Department of Agriculture

STRAWBERRIES are propagated commercially by the use of runner plants only and where nematodes and other diseases are not serious growers can raise their own stock from their bearing plants. In securing plants for planting the roots of the bearing plants should be disturbed as little as possible.

In most localities the season of planting will depend upon the period of the greatest rainfall, although it is not necessary to rely so largely on the rainfall where irrigation is used. As the period of rainfall is the heaviest in the winter and spring in Oregon, Washington and California, growers in these states gen-

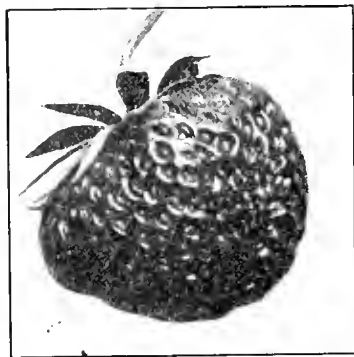

Hood River's berry specialty, the Clark seedling.

erally set their plants during the early winter and late spring. In Western Oregon and Washington and in the more northern parts of the irrigated regions in these states early spring planting is preferred by most growers as a severe winter is apt to injure the fall set plants. In most parts of California late fall and early winter are preferred as the climate is such in that state that plants set at this time make a good growth during the winter and allow of harvesting a considerable crop during the summer. Experience has taught strawberry growers in California that strawberry plants can be set at almost any time on sandy soils during the winter, but on heavy soils the best results are obtained by setting the plants just after the first rains. If heavy rains occur before the planting is finished, however, California growers prefer to wait until early spring to set plants.

The hill system and the matted row system are both used in planting strawberries in the Pacific Northwest, although the former system is more generally employed in the states of Oregon and Washington. When strawberries are to be grown under the hill system the plants are usually set 12 to 30 inches apart in the row and all runners removed as they appear. Under the matted row system the plants are set from 18 inches to four feet apart in rows and part of all the runners which appear are allowed to root. The most common practice in the irrigated sections is to allow each plant to make a definite number of new runner plants. These

plants are spaced from six to eight inches apart and all the others removed as fast as they develop. The spacing is done by covering the tips with earth as soon as they enlarge.

Both the hill and the spaced matted row systems are used extensively in irrigated regions. The particular system to use will depend much on local conditions. Where the soil is heavy and rather impervious to water, narrow beds must be made and the hill system should be adopted. In cases where the soil is penetrated readily to some distance by irrigation water, the beds may be wider and the spaced matted row system may be used. One advantage of the matted row is that the beds are wider and that there are fewer furrows to care for. Both systems, however, are dependent upon intensive cultivation for the best results, and if sufficient labor is available, one or the other should be used.

Where the labor supply is not abundant, however, and where it is not desirable to use the most intensive methods a matted row in which the plants are not spaced may be used. This system, however, is rarely adopted in irrigated regions.

In the Oregon and Washington sections where strawberries are extensively grown the hill system is almost exclusively used, the plants being set 12 to 18 inches apart in rows 30 to 32 inches in distance. In the Los Angeles region of California where the hill system is used, the plants are set at intervals of one foot in rows two feet apart. In light soil in this section the plants may be set four feet apart in rows three feet apart. In the Santa Rosa dis-

trict of California where the hill system is used the plants are usually set 18 inches apart in rows two feet apart; they are also set in rows with the plants one foot apart in rows three and one-half feet apart and in good soils with the plants eight inches apart in double rows 14 inches apart with an alley 28 inches wide between the beds. In the Sacramento section the spaced matted row system is much used, the beds being made eight feet apart from center to center. The plants are set about 18 inches apart along both edges of the furrows and a spaced matted row is formed from the runner plants.

The following table shows the number of plants needed to set an acre of ground when the plants are spaced in accordance with one of the planting systems commonly used.

TABLE 1.—NUMBER OF STRAWBERRY PLANTS REQUIRED TO SET AN ACRE OF GROUND WHEN SPACED DIFFERENT DISTANCES APART.

Distance Apart	Plants to the acre
2 feet by 1 foot.....	21,780
2 feet by 1½ feet.....	14,520
3 feet by 1 foot.....	14,520
2½ feet by 1 foot.....	12,146
2½ feet by 1½ feet.....	11,616
3 feet by 2 feet.....	7,260
3 feet by 3 feet.....	4,840
3 feet by 4 feet.....	3,630

Where there is little danger of loss of plants from any cause, only the number indicated will be needed. If such danger exists, a somewhat larger number should be secured in order to insure a full stand, as the expense of irrigating and caring for a field which has many blank spaces will be out of proportion to the value of the crop obtained.

Care of plants—When the plants are received from a nursery, they are usually tied in bundles. Good plants usually have bright, light-colored root systems. When grown on very dark



Harvesting the strawberry crop in Linn County, Oregon.

soil, however, they may be brown or yellowish in color. If the plants are at all dry upon arrival, the roots should be soaked in water for a few hours before planting or heeling in. If they can not be set at once, the bundles should be opened and the plants separated and heeled in. The soil packed about the roots of the plants should be thoroughly moistened.

The plants to be set should be protected from the sun and from drying winds while they are being distributed in the field, either by means of burlap, old sacks, or in some other effective way. An old fertilizer sack may be used for protecting the plants while dropping them.

Setting the Plants—When furrows and beds are made in preparing the soil they will show approximately the rows on which the plants are to be set. Care should be taken, however, to have the rows straight, and the exact place for the setting of each individual plant may be indicated by the use of a marker.

If the soil is very mellow, a place for the roots may be made with the hand, but in heavier soil a dibble or trowel or the tools known as punch and tongs may be used. One accustomed to their use can set 10,000 plants in eight hours and experts can set a much larger number.

Perhaps the most important points in setting plants are to place them at the right depth and thoroughly to firm the soil about the roots after they are set. If the plants are set too high or the soil is not sufficiently firm, they will dry out and die, while if they are set too low and the crown is covered with soil, the plants may rot.

Care After Planting—Where the plants are set in early spring, flower stems frequently appear in a short time. Unless the plants are thoroughly established in the soil these should be removed, as the production of fruit is too great a strain on plants not fully established. When a large number of runner plants are needed, the flower stems should also be removed, as experiments have shown that this practice will increase the number of runner plants that are made.

When all the runners that develop are allowed to root without any restrictions, too many plants form in the matted rows, and some means should be taken to thin them. Sometimes roller cutters are attached to cultivators and all runners extending into the furrows are removed by them. A distance of at least six inches should be maintained between plants in matted rows, and when necessary, the plants should be thinned with a hoe or by hand in order to prevent overcrowding.

When the plants in the matted row are spaced, the strongest runners are selected. As soon as the tip of a runner has enlarged and a leaf appears, it is covered with soil. Each runner is thus made to take root at a predetermined distance from the parent plant and from adjoining runner plants. Sometimes a large number of runner plants are made to root, either in distinct rows or at a distance of about seven or



Berries being grown between the trees in a Washington district.

eight inches from each other, and all runners except those used are removed by a hoe, knife, or in some other way.

Tillage is practiced to conserve moisture, to aerate the soil, and to keep down weeds. It should begin soon after the plants are set, and should be continued during the growing season. As soon as possible after each irrigation, the irrigation furrows should be cultivated. This leaves a dust mulch on the surface which conserves moisture and helps keep the soil in good condition. If the furrows are not cultivated, the soil may become water-logged and may shrink on drying so that large cracks appear. These cracks not only increase the loss of water by evaporation, but may even break the roots of the plants. One-horse cultivators are usually run through the furrows, and hand hoes or rakes used on the beds. In light soils, a horse cultivator may be used as often as once every four to six days, while in the heavier soils, once every week or two weeks usually will be sufficient.

Maintaining the Fertility of the Soil—The use of stable manure and fertilizers on strawberry fields is governed largely by the same principles that apply to other crops. As soils vary greatly in their composition, the use of fertilizers is chiefly a local matter, to be determined by each man for his own conditions. This can be done by applying the different plant foods, nitrogen, phosphoric acid, and potash, separately and in different combinations and varying quantities to small plats, and keeping records of the yields. In like manner, the effect of different applications of stable manure should be tested on small plats. If certain facts are kept in mind, such plats will be helpful in determining the quantities to use. A good crop of berries will remove considerable quantities of nitrogen, phosphoric acid and potash. Excepting coarse sand, most soils are so well sup-

plied with these plant foods that large crops can be produced without fertilizers, provided the physical condition of the soil is good. If, therefore, the soil is kept in a satisfactory condition by the addition of humus and by adequate irrigation and tillage, many soils will need no commercial fertilizer or stable manure. In many localities, however, growers have found the use of fertilizers profitable, but the applications which can be made with the greatest gains vary with different soils and different soil conditions. Much can be done to insure productive plantations by seeing to it that the soil is in the best possible state of fertility before the strawberry plants are set out.

Irrigating Strawberries—Strawberries must have an ample supply of moisture, not only during the season when they are bearing fruit, but also throughout the growing season. As the root system is shallow, the surface soil must be kept moist and the irrigations must be more frequent than for many plants whose roots penetrate the soil deeply, the number of irrigations, however, will depend largely on the character and frequency of the tillage used in conserving moisture and on the type and condition of the soil. If the furrows are thoroughly cultivated as soon as the moisture conditions permit after each irrigation, the number of applications of water can be materially reduced as compared with the number required when cultivation is neglected. In the lighter soils during the bearing season, the fields may be irrigated as often as every four to six days, and in heavy soils every week or two. During the months when the plants are not fruiting, irrigation need not be so frequent as when the crop is developing, only enough water to keep them in a thrifty growing condition being necessary.

During the fruiting period the usual

practice is to irrigate immediately after each picking. Sometimes, when there is danger that the water in the furrows may not be absorbed before the following picking, the field may be covered by two applications, alternate furrows being irrigated in turn. The pickers can then use the unirrigated furrows when at work.

In California the plants produce fruit for several months, from late in March or early in April until September or October; sometimes even until Decem-

ber. In that state, therefore, water will be needed for bearing plantations through a much longer season than in states where only an early summer crop is produced.

The Strawberry as An Intercrop—The strawberry is grown quite largely as an intercrop in orchards in most irrigated regions. In sections where the water supply is under control of the grower and a sufficient quantity can be used to supply both the trees which are being grown for the permanent crop

and the strawberries, this plan is practicable. If properly managed, the strawberries should pay a large part of the expense for the care of the orchard until it comes into bearing.

In a few locations strawberries are used as an intercrop in cherry and pear orchards, and to a slight extent in orchards of other fruits.

In non-irrigated regions the interplanting of orchards with strawberries is inadvisable except under well-considered restrictions.

Some Useful and Timely Hints on Peach Growing

By H. P. Gould

FOR various reasons it is sometimes desirable to change the top of a peach tree from one variety to another. A grower may find after his orchard begins to bear that he has a larger number of trees of some variety than he wants; a block of trees may prove to be some other variety than the one ordered; or, for some other reason, a variety is not well adapted to the needs of the owner. In such cases he has recourse to top-working the tree either by budding or grafting to a desirable variety.

The ordinary method of shield budding is the one more commonly used for this purpose. If the tree to be top-worked is not more than two or three years old it is usually practicable to insert the buds directly into the main limbs well down toward the point where they leave the trunk.

If the tree to be top-budded has reached the age when the bark on the main limbs has become too thick and firm to be manipulated readily for budding, it is necessary to head it back somewhat, as when the top is to be replaced with new growth of the same variety, and then insert the buds on the new branches that develop after the tree has been deheaded. When this course is followed the buds should be inserted in the new growth as near the trunk as is practicable, in order to have as large a portion of the top as possible of the new variety. This is also desirable on account of the subsequent management of the tree.

Top-working is sometimes done by grafting instead of budding. The ordinary cleft graft is generally used in such cases. However, budding is to be preferred, especially as the wounds made in grafting do not heal as readily in the case of the peach, though when properly done the union of stock and scion is generally strong enough to make a fairly serviceable tree. But trouble incident to the difficulties in the healing of the wounds is likely to occur.

Thinning the Fruit.

In the minds of some peach growers, to teach the thinning of fruit is to teach heresy. The thing most desired by them is the biggest peach crop possible. Then the heavier the "set" of fruit the better, and the last consideration is to pick off any of it until it is picked for market. This is their philosophy.

The matter of thinning the fruit on heavily loaded peach trees should require no special argument to establish the wisdom of the practice but the reasons for thinning may be briefly set forth in the present connection.

The fact is widely recognized that most varieties of peaches, as well as other fruits, for that matter, under favorable conditions, often set much more fruit than the tree can possibly develop to a good degree of perfection for commercial purposes. The inherent natural purpose of the tree is to perpetuate its kind. To this end, left to itself, its tendency is to develop the largest possible number of seeds, with each seed possessing the potential possibility of a new tree.

The grower's aim is for the tree to produce the largest possible amount of fruit that can attain the highest commercial standard. The inherent effort of the tree and the object desired by the growers impose, or at least tend to impose, incompatible requirements. The development of a great number of seeds is a tree-exhausting process. This is opposed to the development of large fruits. To meet his ends in this respect the grower has recourse to thinning the fruit.

There is perhaps no operation in the production of peaches, which requires keener judgment in order to reap its full benefits than does thinning the fruit. However, no fixed rules for it can be given. It is commonly advised to thin so that the fruits will not be nearer together than four to six inches. This direction is quite generally applicable yet it may have several important modifications under different conditions. The strength of the tree, the fertility of the soil, and especially the soil moisture are all co-ordinate factors governing this operation. These factors, together with the size of the crop, or, in other words, the number of fruits allowed to develop on the tree, govern very largely the size and perfection of the individual fruits, except as fungous diseases and insects may affect them.

Obviously, a vigorous tree growing under favorable conditions as to moisture, plant food, etc., can develop a larger number of fruits to good size than can a weak tree, or even the same tree when there is a marked deficiency either in the supply of moisture or of plant food.

The skill of the grower is shown in

his ability to adjust the size of the crop on his trees to the varying seasonal conditions. While he is powerless, of course, to add more fruit, it is quite within his power to reduce the number of fruits on the trees if the season becomes very dry as it progresses. Thus the grower should aim to control the size of the individual fruits by thinning and by tillage and pruning.

It is sometimes argued that the expense of thinning makes it prohibitive. But this is fallacious. While it may cost a relatively large amount per tree, it is the experience of the best growers that, as a rule, actually more high grade fruit is produced on a tree which bears only a moderate crop than on one which is heavily overloaded, and the average fruit on the tree with a moderate crop is of better grade than the best fruit on an overloaded tree.

Another factor is commonly overlooked when the cost of thinning is considered. The operation should be done after the "June drop"—which occurs usually from a month to six weeks after the blossoming period when the imperfectly fertilized and other weakly developed embryo fruits drop off, and before the pits begin to harden. After the "June drop" is over there is but very little dropping of peaches. Hence, practically all of the fruit which remains then will be on the trees at harvest time. It will have to be picked then, anyway. It is a fair assumption that it will cost no more and probably considerably less to pick a portion of the crop in June or July and drop the fruit on the ground than it will to pick it later and put it in a basket, where much of it will have to be handled over several times in grading and picking and packing and then finally discarded as culls because the fruits are so small. Moreover, the fruit on an overloaded tree will sometimes ripen less uniformly than on a tree that has a moderate crop.

It has already been stated that the development of the pits is an exhaustive process. Therefore, the limiting of the number of fruits tends to conserve the vitality of the tree. A large portion of the flesh of the peach is water; hence, if the soil is well supplied with moisture the development of the edible part of the fruit makes a relatively light demand on the strength of the tree.

Control of Insect Pests and Fungous Diseases.

Only incidental reference to insect pests and fungous diseases is consistent in the present connection. This reference is made primarily to call attention to the place which the control of insects and diseases hold in the successful management of a peach orchard and to indicate the sources of help and information which are available to peach growers.

After a grower has pruned intelligently, tilled and fertilized his orchard well, and irrigated it if it has been required, the orchard may be short lived and the crops financial failures if he neglects to give proper attention to the control of the insects and diseases which habitually occur in his region. While it is true that there are some rather serious peach parasites which are regional in their occurrence and some of those which are widely disseminated remain unknown thus far in certain districts, it is likewise true that a considerable number of both insect pests and fungous diseases are to be found pretty nearly everywhere in the country in which peaches are grown.

Every fruit grower should be in close touch with the agricultural experiment station in his state, so that he can refer emergency matters there without delay. Not infrequently, the securing of information regarding the control of some insect pest that has become suddenly threatening or concerning the most effective means of checking the spread of a disease hitherto unknown results in saving what would otherwise have been a serious loss.

Inquiries relating to any phase of fruit growing may also be referred at any time to the United States Department of Agriculture, where without cost, through the department's pathological, entomological and other experts as full information relative to the problems as can be given may be secured.

Interplanted Crops.

The growing of some annual crop between the trees during the first two or three seasons following the planting of an orchard, as an aid in meeting the maintenance cost during the unproductive age of the trees, is frequently an economic expediency. This practice, is seldom, if ever, any advantage to the trees in comparison with thorough tillage by itself, but if interplanted crops are wisely selected and properly managed with respect to their relation to the trees, they are not likely to result in any serious harm.

The interplanted crop ought to be one which needs essentially the same tillage that the peach trees should have. Where this is the case, the secondary crop does not seriously interfere with that operation. But the grower should realize that he is in effect, following a system of double cropping and that because of the interplanted crop he may need to give more attention to the maintenance of the fertility of the soil than he would for the peaches alone. After the trees reach bearing age, they should not be made to compete with another crop. Even if there is sufficient plant

food in the soil to produce successfully two crops at the same time, the peach tree will usually need all of the available soil moisture, except, of course, in sections where irrigation is practiced and there is an adequate supply of water for all purposes. Besides, an interplanted crop would be likely to interfere with the spraying of the trees, if that operation should be necessary, with the harvesting of the fruit, and in other ways.

Provided interplanted crops do not interfere with any of the operations required in the proper development of the trees, a considerable range of choice may be exercised by the grower as to what he shall use. The selection may be governed to some extent by the relative market value of different crops that can be grown in different regions. Muskmelons, beans, peas, cabbages and tomatoes, and other truck crops are extensively grown in this way in different sections. Potatoes are sometimes used but they are suitable only when the crop is so managed that the digging of the potatoes will not amount to a late cultivation, which may be attended with undesirable results. Corn, also, is fre-

quently used, but as very often managed is objectionable, because it shades the trees excessively. Whenever corn is interplanted, an open strip of considerable width should be left along the rows, so that the trees will be fully exposed to the sunlight throughout the season. If a very tall, strong growing variety of corn is used, a wider strip should be left unplanted than where a dwarf variety is used.

Peach trees are sometimes used as an interplanted crop, especially where apples comprise the permanent crop. This practice is both highly commended and emphatically condemned by fruit growers of wide experience. It is probably objectionable in that for a number of years both bearing and non-bearing trees occupy the same area, and it is sometimes desirable to treat a fruiting tree very differently from one that is not bearing, for the best results with each. On the other hand, where a site is particularly favorable for both fruits, a compromise treatment can often be effected, which yields fairly satisfactory results with both kinds of trees.

Winter Injury or Die-Back of the Walnut

By L. D. Batchelor and H. S. Reed, of the University of California, College of Agriculture

THIS article contains an account of studies made through several seasons on the so-called "Die-Back" or "Winter Injury" of the Persian walnut (*Juglans regia*.) In certain districts where walnuts are commercially grown the trees have suffered greatly from this trouble, and in some cases parts of orchards have died from this cause.

Unfavorable soil or climatic conditions which would show little or no effect upon many species of orchard trees, may seriously injure, if not actually kill, a walnut tree. The effect of such unfavorable conditions is often first clearly manifested in the early spring. At that time the tops of healthy trees make rapid growth, whereas the tops of injured trees show no growth whatever. Frequently unfavorable conditions not only cause the death of the uppermost twigs but also of some of the older branches.

"Winter Injury" is a term frequently applied to several conditions, the effects of which are particularly evident in the early spring. Usually "Winter Injury" is most clearly manifested by the death of the young twigs and small limbs and hence is frequently known as "Die-back." These terms will be considered as synonymous in the following discussion.

Winter injury may be considered as the final effect of one or more conditions which are adverse to the normal growth of walnut trees and which eventually cause them to die back in the tops. The following are the most common causes of winter injury: (1) Early autumn frosts, (2) winter drought, (3) high water-table, and (4) alkali soil.

1. Early Autumn Frosts—Young trees are more likely to suffer from early frosts than are mature bearing trees

because the latter go into a dormant condition earlier in the season. Walnut foliage which is still green and shows no sign of its normal autumn color, is apparently as subject to frost injury as are tender vegetables. Such injured foliage drops prematurely, and hence the green, immature twigs are fully exposed to the sun's heat during bright days in fall and winter. The moisture loss, following the dropping of the leaves, is much more rapid from the succulent twigs than from the more mature growth.

In many cases the twigs themselves are not actually injured by the frost, but are killed by sunburning following the loss of the leaves. This is substantiated by the fact that such twigs usually begin to show injury from sunburning about the middle of January. By early spring, more or less of the new growth is dead. In occasional instances, however, a portion of the north side of twigs thus injured may remain healthy and produce normal growth in the following spring. The death of the immature twigs is due not so much to the initial low temperature which killed the leaves as to the subsequent sunburning of the exposed bark. Vertical young shoots frequently show discolorations due to sunburn on the south side over their entire length, while horizontal or oblique branches usually show this sunburned area more strikingly on their upper sides. Such a sunburned appearance of the young limbs in the spring is a prevailing characteristic of trees which have been only mildly frosted the previous fall before the dormant period set in. Inasmuch as the root systems are not injured by this condition, such frosted and sunburned trees, as a general rule, produce a rank, succulent twig growth the sum-

mer following the initial injury. Such growth in turn is less likely to mature early and more likely to be injured by autumn frosts than the normal tree. When the cycle of events just described becomes established, it thus tends to perpetuate itself.

If the trees are kept thoroughly covered with whitewash during the winter months, the injury resulting from sunburn may be somewhat reduced. Such a treatment tends to maintain a lower temperature within the twigs. Too much reliance should not be placed upon this treatment, for it has been observed that at best it affords only partial protection. As a general rule it has been observed that frost injury to the foliage of immature twigs, is practically certain to be followed by die-back to some extent, in spite of any remedy known to the writers at the present time.

The coincidence of frosted foliage and subsequent die-back in a five-year-old grove is shown by Chart 1. The new wood on these trees was nearly mature when the first frost occurred in November, 1918. The observations on die-back were made in May, 1919. The majority of the trees that had been frosted showed die-back injury; none were frosted without subsequent die-back. Two trees which were not affected by the first frost still showed a slight injury from die-back. In a few cases, however, it was very apparent from the blackened condition of the twigs, especially the tips, that the wood had been actually killed by the frost at the time of the foliage injury. In such instances as the last it is clear that remedial measures will be of no avail.

CHART 1.—THE RELATION BETWEEN AUTUMN FROST INJURY AND DIE-BACK IN A FIVE-YEAR-OLD WALNUT GROVE.

10	9	8	7	6	5	4	3	2	1
x	x	x	x	x	o	o	x	a	o
x	x	x	x	x	a	o	x	x	x
x	x	x	x	x	x	x	x	x	o
x	x	x	x	x	x	x	x	o	x
x	x	x	x	o	x	o	o	o	x
x	x	x	x	x	o	a	a	x	x
x	x	x	x	x	x	x	x	x	o

Die-back trees, a; normal trees, o; trees showing both frost injury and die-back, x.

Injury from frost may be prevented if it is possible to mature the young walnut trees early in the autumn so that the leaves will turn yellow and normally fall from the tree before the first early frosts which usually occur from the 1st to the 15th of November, in many of the lowlands in Southern California. Early maturity can be promoted by withholding irrigation water in the late summer and early fall. Trees which are not irrigated after August 15th may be expected to mature earlier than trees watered in late August and September. Whenever the soil moisture is abundant in the autumn, due either to heavy summer irrigation or to

a high water-table, the trees will continue their growth so late as to be injured by autumn frosts. A high water-table and a frosty orchard site make winter injury a practical certainty. It is doubtful if walnuts can ever be successfully grown on such lands.

2. Winter Drought—We have very convincing evidence to show that trees which enter the dormant period in the fall in a perfectly normal and healthy condition may suffer from die-back due primarily to a lack of sufficient soil moisture during the winter months. During the winter, trees give off moisture through the limbs and twigs. If for a prolonged period there is not enough soil moisture available to the roots, the trees are unable to obtain sufficient water to offset the loss by evaporation from the branches. In that case young branches, the thin bark of which permits rapid loss of water from the wood, may die as a result of desiccation. This injury is first evident when such branches fail to produce new growth the following spring.

It is usually not difficult to distinguish between the injuries caused by autumn frosts and by winter drought. Frost injury is usually confined to one or two-year-old wood, but winter drought may kill back limbs eight years old. Winter sunburning is more common on shoots killed by autumn frosts than on those killed by winter drought, though the sunburned areas may not be clearly defined until January.

The principal contributing factors which bring about such a condition are dry winters and the lack of winter irrigation. Under such conditions the soil may have little or no moisture available for the tree roots below the surface foot and even this zone does not contain an optimum amount of moisture until mid-season of the winter rainy period.

The winter of 1917-18 was followed by a great deal of die-back injury to bearing walnut trees. An examination of walnut orchards during this winter showed that most of the soils were very dry. In several cases in orchards which subsequently showed die-back injury, the moisture in the first four feet of soil was below the wilting point until late winter. Thus the roots were unable to acquire sufficient moisture to replenish the loss from the trees and consequently the tips were killed by excessive desiccation.

We have found that winter-injured trees are more susceptible to die-back the year following the initial injury, than are normal trees. The increased susceptibility of injured trees is inevitable because of the succulent nature of much of the young growth produced. In the summer following the first "die-back," the amount of living wood is small in comparison with the root system, and is forced into very active growth. The type of growth produced is therefore similar to that following a severe pruning of the tree.

The relation between soil moisture and winter injury can be seen at a glance in Chart 1. For convenience in observing the winter-injury in this orchard, we have divided the trees into

three classes: first, trees not winter-killed; second, trees slightly winter-killed, and third, trees badly winter-killed. Reference to Chart 2 shows that the winter-injury was greatest in the lower section of the grove, less in the middle section, and least in the upper section. The two tree rows in this orchard below the lower section shows less injury than the section just above them, due apparently to the fact that no waste water is allowed to run off this orchard, but is held by a dike and thus the lower two rows get an extra amount of water. This orchard has been normally irrigated at the rate of only 1.8 acre inches per irrigation per month from May to October.

The actual number of trees injured in each section was as follows:

	No injury	Slight injury	Badly injured
Upper section.....	48	4	0
Middle section.....	12	26	14
Lower section*.....	1	16	34

*One tree is missing in this section.

This distribution and the fact that it cannot be due to chance, is clearly set forth by the diagram. A soil survey of this orchard shows no appreciable difference in the surface soil or subsoil types within seven feet of the surface. This and other examples which have been studied, point clearly to a lack of soil moisture as the important factor in causing winter injury of the walnut trees in this and many other orchards.

CHART 2.—DISTRIBUTION OF WINTER-KILLED TREES, O. W. MORROW GROVE, HEMET, MAY 15, 1919.

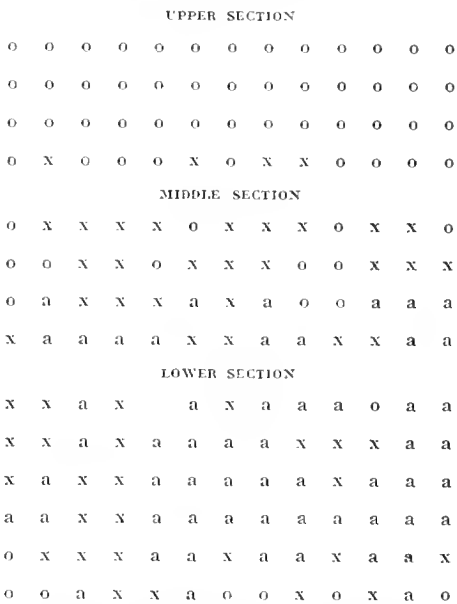

o, trees not winter-killed; x, trees slightly winter-killed; a, trees badly winter-killed.

In view of results such as those presented in the foregoing pages it seems evident that it is not difficult to prevent this type of die-back, or winter injury, due to winter drought. The application of sufficient irrigation water to reach the tree roots soon after the harvest season will tend to prevent such injuries. The grower should use a soil tube, or a soil auger, in the autumn to determine whether the soil to a depth of five feet contains enough moisture

Methods of Utilizing California Wine Grape

By Arthur L. Dahl

NATIONAL prohibition has been in effect for too short a period to speak with any certainty upon the effect of the closing of the wineries upon the wine-grape market, but in California the growers are very active in arranging to divert their 1920 production into new channels, and that more than one market will exist for the grapes is shown by sales being made at \$40 and \$45 a ton.

The most promising market for wine grapes this year appears to be the concerns that are planning to put on the market various kinds of table syrups made from wine grapes. One such company is going ahead on a big scale and is buying up considerable quantities of grapes for delivery this season, and by a national campaign of advertising it is hoped to create an immediate demand for grape syrup for table use and for the making of beverages, that will utilize considerable grapes, and what cannot be made into syrup at once will be dried and stored for future use.

Grape syrup is not a new thing in the wine industry, for practically every winery made it for use in sweetening some wines or in the manufacture of brandy, but the syrup thus made was valuable chiefly for its sugar content, and most of the flavor of the grapes was lost in the process. At a recent hearing to discuss wine grape matters, however, it was announced that a new and entirely distinct process for making grape syrup had been perfected by Mr. M. K. Scraillan by which all of the natural flavors and even aroma of the fresh grapes can be preserved and transmitted to the syrup, so that the new product is delightfully distinct in taste and ought to create for itself an extensive market if properly brought before the people.

In spite of the fact that there are now on the market a score or more of table syrups, some of which are manufactured much cheaper than the new grape syrup can be put on the market for, it is thought that the new product, by reason of its distinctive flavor, will appeal to a large number of people who are tired of the old flavors and who are constantly in search for something new. Since grapes have served as food and drink for mankind since the dawn of history, and their food values are so well known, a permanent market can be built up for the syrup. The fact, too, that grape syrup, when diluted with water, will make an excellent soft drink, naturally widens its possible markets, and an enormous quantity of the syrup could be used by the various soft drink parlors, confectioners and in the homes, where beverages are dispensed.

One of the problems on which the vineyardists are now working is to preserve the fresh juice of the grapes without having it ferment. As the wine grapes will all mature in a comparatively short season, and it will be necessary to press out the juice shortly after

they are picked from the vines, some adequate means must be devised to either work up this juice into syrup immediately, or else preserve the fresh juice in tanks or casks until it can be made into syrup. Under the direction of experts of the Department of Agriculture and the State University of California, experiments have been tried to preserve the fresh juice by using sulfuric acid. Preliminary experiments demonstrated that liquefied sulfuric acid or a water solution of sulfuric acid were the forms most suited for this purpose. Fumes of burning sulphur are hard to control and sulfites leave too much potash or other base in the product. Sulfurous acid can be completely removed. Tests were made on small laboratory samples of juice and on larger lots in 25 to 50 gallon barrels. Sulfurous acid was added in amounts ranging from .03 per cent to 0.2 per cent. All samples with 1000 milligrams or less fermented within a few weeks. The sample with 1250 milligrams kept perfectly for two months, when it was used. Fifty gallons in a barrel treated with 2000 milligrams kept from September until July of the following year. The large lots were stored in a shed where the temperature varied greatly and was often very hot. The juices containing sulfuric acid were all stored in wooden barrels, as the mixture should not come in contact with any metal.

During the present season a great many independent experiments, some on a commercial scale, will be tried out in California, looking to the saving of wine grape juice for the manufacture of syrups, and it is expected that some satisfactory plan will be devised whereby the grapes can be pressed as

they come from the field and the natural juices saved for sufficient periods to permit of their being processed for the making of food products. When this time comes, the vineyards of the state will again be upon a permanently prosperous basis, such as they were on before prohibition went into effect.

Many independent growers are refusing to sell their 1920 crop and expect to dry all their grapes and market them in the dried state. As the climate of most of the vineyard sections of California is such that sun-drying can be practiced, the vineyardist who chooses to dry all of his grapes can do so without elaborate equipment, and as dried grapes will keep for long periods, the crop is thus given a greater speculative element, as the grower can ship his product to distant markets, if an attractive demand exists there. Dried wine grapes have been used in the past for the making of wine, when fresh grapes were not available. France, on several occasions, when pests or blight ruined her own vines, imported large quantities of dried wine grapes from Spain and other districts, and is said to have made excellent wine therefrom. In the United States during 1918 and 1919 large quantities of dried wine grapes were shipped out of California for use in making wines for family use. Whether they can be marketed as dried grapes for wine making purposes, or as raisins, the prospective demand for the dried article is sufficiently strong at this time in California to lead many growers to plan to convert their season's crop into the dried form, and it is said that all owners of dried grapes of the 1919 season can now dispose of them at a price that will return a handsome profit.

Another prospective use to which wine grapes can be put is in the manufacture of vinegar. In all foreign grape

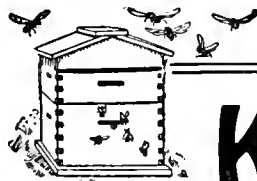

KEEP BEES!

If you own an orchard you must have bees if you would secure the largest crops of the most perfect fruits, as proper pollination is essential for best development and *bees are the only dependable pollenizing agents.*

You can keep bees anywhere that they can forage within a mile—they require but little attention and will often render you a splendid profit. We can start you right and save you unnecessary work and expense.

Our Bee Supply Catalog lists everything necessary for the successful production of honey; *tells how to care for and handle bees.*

Ask for Catalog Number. 203

Write us for
Queen Bees



Western Agents A. I. Root Co.

countries the vinegar made from grapes is considered the best and commands the highest prices. In this country, however, grape vinegar has not met with especial favor, principally because most of that placed on the market was made from spoiled wine by unskillful methods. When made from good material by proper methods it is as good here as in France, and as good grape vinegar contains about eight per cent of acetic acid, which is twice the legal standard, its use is more economical than ordinary vinegar, even though it costs double the price of cider or apple vinegar. Since the first steps in making vinegar are identical with those for making wine, a large part of the present equipment of a winery can be utilized for the new industry. Grape vinegar can be made for approximately the cost of wine or a little more, and it is possible to pay from \$15 to \$20 per ton for grapes, (or about what they are sold for wine-making purposes) and still make an excellent grade of vinegar to sell at 25 or

30 cents per gallon, wholesale. Although the market for vinegar is somewhat limited, it is thought that from one to two million gallons of grape vinegar can be disposed of annually in this country.

In an effort to devise all possible means for converting wine grapes into a profitable crop, the government scientists have reported that certain of the by-products of the manufacture of grape juice, syrup and vinegar can be saved and sold. The pomace from a ton of grapes weighs from 250 to 350 pounds, and contains valuable matters, such as sugar and cream of tartar, which can be extracted and used. The seed, which constitute about four per cent of the weight of the grapes contains an oil that is used for a number of purposes in the industrial world, and the press cake from which the oil has been extracted can be used for stock food, or it can be leached for the recovery of tannin.

the interflow of sap, weakening the tree, resulting in a yellowing of the foliage and small size of fruit, and in severe cases even in the death and decay of the roots.

While the elm and the apple are its principle alternate hosts, the woolly aphid can live on quince, pear and mountain ash. The pear is infested by two species of woolly aphids, a distinctive pear form and the apple species. Of the varieties of apples the Northern Spy is the least likely to be attacked, often remaining free while adjacent other varieties are seriously infested. Nursery stock is apt to become infested and thus the insect finds ready access to a new region. Any nursery plants that show traces of the woolly aphid should be destroyed, and the balance of the shipment should be carefully treated or rejected. The individual trees may be loosened and dipped in a well-emulsified 15 per cent kerosene emulsion, and allowed to dry singly before healing in. For large quantities of trees fumigation with the extremely poisonous cyanide gas may be a quicker process, but the trees then must be loosened so that the gas can penetrate to the roots.

Control of the woolly aphid above ground calls for a forceful spraying with some contact insecticide capable of wetting through the waxy wool. Owing to the present high cost of nicotine sprays probably the best agent to use is kerosene emulsion. This can be prepared by dissolving one-half pound or more of common soap in one gallon of boiling water, and away from the fire churn into the suds two gallons of kerosene. When emulsified and creamy add ten gallons of water whereupon the mixture is ready to use. This should be sprayed with pressure to wet into the colonies, drenching the crown of the tree where the aphids are likely to congregate. Two applications may be ne-

Continued on page 30.

Treatment of the Woolly Aphid of the Apple

By A. L. Melander, Entomologist State College of Agriculture, Pullman, Washington

THE Woolly Aphid is one of the most insidious and dangerous of apple pests. Unlike most plant lice this species lives underground on the roots as well as above ground on the branches, and it is the root form which often occurs unsuspected and which does the most harm. While the branch form can be controlled with comparative ease by contact insecticides it is practically impossible to stamp out the root aphids after they get a foothold.

The branch form clusters in colonies along water spouts, on the under side of twigs, about pruning scars, or among the loose bark of the crown of the trunk. Here throughout the summer they beget wingless woolly females that are able to reproduce without mating, each giving birth to from two to twenty young a day during a period of two or more weeks. Following a dozen such generations a brood of winged individuals is produced, usually in September, which fly to elm trees if they are to be found and there produce stunted wingless males and females, the only sexed individuals of the year. These diminutive creatures mate and in a couple of days each female deposits a single egg in the crevice of the elm bark. Rarely the September migrants locate on apple trees, and rarely winter-eggs are to be found in old colonies on the apple, but the woolly aphid is capable of maintaining its existence for years on the apple whenever the agamic females are able to survive the winter. Ordinarily winter weather in Eastern Washington is severe enough to destroy what individuals remain above ground, but in Western Washington and following mild winters in the central part of the state some of the branch aphids are able to live through the dormant condition to assist in repopulating the trees in the spring. Usually it is the mealy root form that tides the species over the winter on the apple.

In the spring of the year, with the

opening of the buds, the eggs on the elm trees hatch, and for several generations the woolly aphid lives on the under side of the leaves, curling and stunting them. Finally in early summer some winged individuals are produced, which fly from the elms to the apple and there complete the year's life cycle. It is interesting to note that while the insect lives on the elm tree it is a leaf-curling aphid, but when on the apple it rarely attacks the leaves, preferring the stems and woody parts of the tree.

The woolly aphid is a serious pest. It is more harmful to young trees than to old. When feeding on the twigs it poisons them, causing more or less prominent swelling. On the roots it forms nodules or galls which prevent

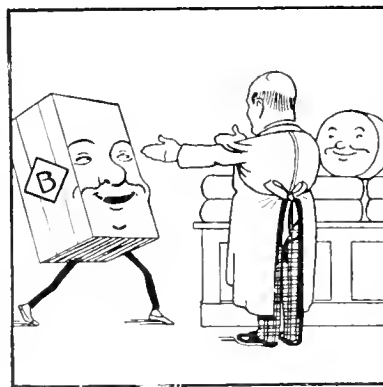

Jack Knox was without a box
In which to pack his cheese.
The best is none too good, quoth he,
As he ordered a strong "B-D."

Many other wise packers of precious products are ordering Bloedel Donovan Boxes, because they know they are strong, well sawed, carefully graded and cut from the best lumber the Pacific Northwest affords.

BLOEDEL DONOVAN LUMBER MILLS

1020 White Building, Seattle, Wash.

*Spruce, Douglas Fir, Western Cedar, Hemlock, Red Cedar Shingles
Box Shooks and Lumber*

1919-1920 Apple Season in the Northwest

A RECENT report issued by E. M. Scifert, Jr., of the United States Bureau of Markets, says that the unusually large crop of apples in the Pacific Northwest in the 1919 season, occurring in a period of high price levels, brought almost undreamed of returns to many orchardists and gave satisfaction to practically all growers. In many instances this year's apple crop paid for the entire farm, and many orchards changed hands at unprecedented prices.

To many of the buyers and dealers, however, the apple season did not prove so profitable. A number of very serious obstacles were encountered on their part. The prevailing high prices and good export demand in the spring of 1919, together with rumors of a prospective short crop, misled many early in the season. Opening high prices had a tendency to curtail consumption. Inadequate and congested storage facilities which tended to impair keeping qualities, together with two severe freezes, caused large quantities of poor fruit to be dumped on the markets. The severe declines in foreign exchange interfered seriously with the anticipated export movement, and the final realization that the apple crop over the United States as a whole was heavy instead of short also caused losses for many apple operators. Acute car shortages caused much trouble and loss. Many early f.o.b. sales were canceled because deliveries could not be made. Hundreds of cars were frozen in transit, resulting in serious monetary losses and the filing of huge damage claims against the railroads.

Quality and Pack.

The quality, generally, was good. The excessive worm injury last year caused heavier spraying this season, and the fruit was practically free from worms. However, much of the fruit was under-size and lacked in color. Some varieties, ripening early on the trees, were further rapidly ripened by unfavorable storage conditions. In February, re-packing from common storage in many instances showed as high as 50 per cent shrinkage. In many instances also, poor grading and packing was caused by labor shortage and the use of incompetent help.

The picking season was exceptionally short and many Winesaps, the last to come from the trees, were caught by the October freeze. Picking started with Jonathans between the 10th and 25th of September; Romes, September 25 to October 20, and Winesaps, October 10 to October 20.

A canvass of the Wenatchee, Yakima, Hood River, Spokane, Walla Walla and Southern Idaho districts was made to ascertain the percentages of the principal varieties grown in each district. From the estimated percentages of each variety grown and the total shipments from each district, the approximate proportion of the main varieties produced in the Northwest this year were determined. These percentages cannot be considered absolutely accurate, but

may be taken as a fairly close estimate. Winesaps 25%, Jonathans 18%, Romes 13%, Delicious 5%, Newtowns 7%, Spitzenburgs 9%, miscellaneous 23%.

Movement and Storage.

The production for the Pacific Northwest far exceeded expectations and the total crop was the largest in the history of that section. The heavy movement from the four Northwestern states and the rest of the country began October 1 and reached the peak on October 17, with a total on that date of 1,362 cars. The Pacific Northwest shipped 536 cars of this total and continued shipping thereafter at the rate of over 400 cars a day until October 28, when the car shortage reduced shipments to less than 300 cars a day. The December cold wave further reduced shipments to less than 100 cars a day, but later shipments increased slightly and continued steadily to a total of over 32,000 cars. Box cars were used in many instances, equipped with heaters and accompanied by messengers.

In 1918 practically all the early varieties were shipped by Thanksgiving and Winesaps were moving freely by that date. This year Romes and even some Jonathans and Delicious were not shipped until January, and many Winesaps were still in common storage long after the middle of March.

The inadequate storage facilities and limited car supply, in the face of increased production in the Northwest, is demanding the serious consideration of growers and shippers. Lack of sufficient storage space caused heavy losses this year. Barns, garages, stores and in

fact every available space was filled to overflowing with packed and unpacked fruit. While some fruit was frozen in these temporary and common storages during the extreme cold weather in December, the heaviest shrinkage and deterioration was probably caused by poor or no ventilation and overheating to keep out the frost.

Prices.

Growers sold earlier than ever before and prices throughout the season were attractive and profitable. Even those who did not sell at the early high prices realized good figures. Throughout the Northwest growers generally sold extra fancy Jonathans at \$2.10 to \$2.25, Romes at \$2.00 to \$2.25, Winesaps at \$2.25 to \$2.50, and other grades and varieties in proportion. The opening prices in terminal markets showed a very wide range, which continued throughout the season.

Many jobbers bought freely for future delivery in the early fall when prospects were bright, but when the car shortage became acute and other adverse factors became evident, many cancellations took place and a general depression set in. However, the consumptive demand increased the latter part of February and, assisted by the prevailing high prices for oranges, the market reacted and buying was resumed. This revival had a salutary effect upon the situation as a whole, but came too late to be of real general benefit.

In most instances the smaller market netted the best returns and took a big percentage of the Northwest crop. The larger markets where fruit could be sold at auction received much of the

PEERLESS

AUTOMOBILE

SPECIALTIES

**Make Old Cars
Look Like New**

Quality Goods

EVERY Owner should use the same goods himself that are used by the Automobile Painters. Never trust to luck. Use Peerless goods, with an established reputation. Sold for 10 years throughout the world.

All the goods needed by Auto Owners to keep their cars like new.

Some of the Goods are as follows:

<p>MOHAIR TOP DRESSING Waterproofs, dyes and renews leaking and faded Mohair tops.</p> <p>LEATHER TOP DRESSING Brightens, oils and softens all tops of Leather, Pantasote, etc.</p> <p>LINING DYE Dyes black stained, faded and spotted cloth linings.</p> <p>CUSHION DRESSING Brightens and renews dull upholstery. Dries quickly.</p> <p>FORD TOP DRESSING Renews and preserves rubber tops. Use Mohair Dressing on cloth tops.</p>	<p>TOUCH-UP BLACK Air dries quickly with a fine gloss finish. Use everywhere.</p> <p>FENDER JAPAN Heavy-bodied, air drying with a rich gloss finish.</p> <p>CYLINDER ENAMELS Black and grey enamels that resist heat, grease and gasoline.</p> <p>BODY POLISH A good body polish to revive dull finishes.</p> <p>GASKET SHELLAC Orange color. Heavy bodied, goes in tack quickly. A perfect sealer.</p>
--	--

Eight Color Finishes (Cover solid with one coat, no undercoat necessary. Owners use to paint their cars their favorite colors. Air dry over night.)

Manufactured Only by

The Columbus Varnish Co.

Varnish Mfgs. Columbus, Ohio, U. S. A.

inferior stock. Auction sales of frozen apples as low as 25 cents a box were recorded.

During the past season a greater number of cars were rolled unsold than in previous seasons and to prevent rejections many allowances or concessions were granted. Numerous diversion orders were placed in the effort to locate markets for the rolling cars.

A Dryland Orchard

By H. P. Misel.

Dryland orchards are a rarity around the irrigated district of Wenatchee. However, twelve years ago my father, G. W. Misel, set out an orchard, where no water was obtainable, in the cove of a hill near Wenatchee. Experience has shown how the setting might be improved for more profitable returns.

The original trees were principally Jonathan, White Winter, Pearmain and Rome Beauty apples and Moorpark apricots. Keen application was given to dry land methods of culture, spraying and pruning. A dust mulch preserved enough moisture to produce large wood growth, although the average rainfall is only around fifteen inches.

The apple trees started bearing at three years of age and produced marketable apples until about nine years old. The spring of 1917 the limbs were all filled with blossoms and the trees were loaded with a heavy crop of fruit. Although well thinned, all the apples except the Delicious failed to gain marketable size. Since then the Delicious

alone have produced apples worth marketing.

All the apple trees, except the Delicious, now adorn the woodpile. A little more time will be given to see if these too will meet that fate.

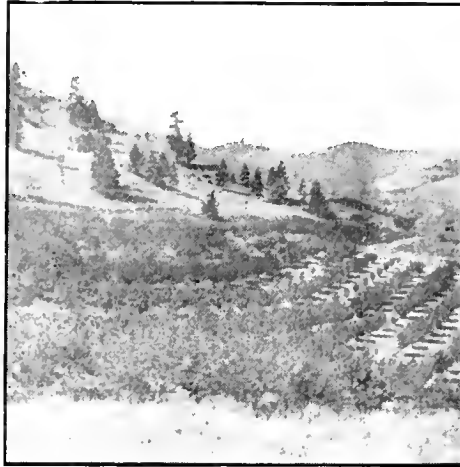

Dryland orchard maintained by a replanting system.

The apricots started bearing when they were two years old and increased greatly in yield each year. This fruit was unusually large in size and fine in quality. The yield per tree was also large and the demand has always been good. Within the last two years a few of the apricot trees have quit bearing, apparently from old age.

The practical plan now adopted is to replace the apple trees with nearly the

number of apricot trees desired and as the old apricot trees cease bearing to replace them with young trees. These will come into bearing at irregular periods, thereby keeping the production constant. The new orchard would therefore be made up of trees of one kind requiring less work to raise and producing a better and more regular crop.

Phosphorous A Necessary Plant Food

Phosphorous is one of the necessary plant food elements for the growth of all crops and is lacking in an available form in many Oregon soils, according to C. V. Ruzek, professor of soil fertility at the College Experiment Station. In most systems of farming phosphorous is lost from the soil, being absorbed in part by the plant. For this reason it must be supplied by purchasing phosphate fertilizer.

"Phosphorous affects the crops by increasing the percentage of grain as compared to the straw," said Professor Ruzek. "It also causes crops to mature from 16 to 19 days earlier. The rooting system, especially of young plants, is stimulated.

"There are three phosphate fertilizers available for agricultural use in Oregon—super or acid phosphate, bone meal, and rock phosphate. Super phosphate is used most extensively. It is manufactured by mixing a ton of rock phosphate with a ton of sulphuric acid.



And in the berry fields

THE American Beauty Dust Sprayer

Gives best protection
at lowest cost
per man and
per acre.
It is crop insurance

Price, \$22.50

The California Sprayer Co.
6001-11 Pasadena Avenue
Los Angeles, California

Bone meal may be treated in the same manner. The product thus formed is called acidulated bone meal.

"Large deposits of rock phosphate are being mined in Idaho and Utah now, and will soon be placed on the market. A considerable amount of this material is to be shipped to Japan through Portland. This should undoubtedly lower the price of super-phosphate in this section of the country, and make rock phosphate available for use as a fertilizer, which has not been true in the past."

Super-phosphate should be applied previous to seeding at the rate of 200 pounds per acre, advises Professor Ruzek. For truck crops larger amounts are applied. Steam bone meal is used at the rate of 300 to 500 pounds per acre. Where applied in combination

with organic matter the amount can be reduced.

To get the best results fertilizers should be thoroughly mixed or incorporated into the soil by a regular fertilizer distributor, or spread broadcast after plowing and disked or harrowed in.

"Phosphate fertilizers should be applied in combination with barnyard manure," continued Professor Ruzek. "Ordinary farm manure is low in phosphorous. A ton contains 10 pounds of nitrogen, five pounds of phosphoric acid, and 12 pounds of potash. It can be readily seen, therefore, that it is a good principle to reinforce manure with some form of phosphorous fertilizer. When super-phosphate is mixed with the calcium sulphate in the manure it prevents the escape of ammonia as a gas, from the manure."

A New Disinfectant for Blight Control Work

By F. C. Reimer, Southern Oregon Experiment Station, Talent, Oregon

IN the work of the Southern Oregon Experiment Station during 1918 it was found that bichloride of mercury 1 to 500 will not destroy pear blight bacteria (*Bacillus amylovorus*) on the wounds of pear trees, but that it will destroy them on the metal tools used in blight eradication work. It was also found that cyanide of mercury 1 to 500 will destroy the bacteria on the wounds of pear trees, but is not always effective in destroying them on metal tools.

It is very evident that the use of two disinfectants in blight control work is objectionable. A disinfectant should be found which will be effective on both the wounds and on the metal tools. In some preliminary experimental work during the summer of 1919 a combination of these two disinfectants was tried using one gram of cyanide of mercury and one gram of bichloride of mercury in 500 cc of water. This disinfectant in this preliminary work proved effective on both the wounds of pear trees to

which blight bacteria had been applied, and also on metal tools used in blight eradication work.

Extensive work with these and other disinfectants will be carried on during the summer of 1920.

The methods used in making these tests, and the results obtained during 1918, are fully described in BETTER FRUIT for April, 1919.

Oregon Loganberry Industry

More than a million dollars worth of loganberry juice was manufactured in Oregon in the year 1916, says Professor Henry Hartman of the Department of Horticulture at the Agricultural College. An extensive investigation of the loganberry districts shows that there has been a steady growth of the industry with many new growers going into the commercial field and with an extension of old plantations.

"The demand for loganberry plants

has been so great this year," said Professor Hartman, "that the available supply was bought up in a short time. This indicates that extensive plantings are to be made this spring, since a large crop of young plants were grown by the various nurseries last year."

The loganberry, like most brambles, does best in deep, well-drained, easily worked loam soil. It can be made profitable, however, on both heavy and light soils with sufficient fertilizer and moisture control. It is a gross feeder and will stand large amounts of fertility in the soil, barnyard manure being best. Commercial fertilizers where tried for new plantations have not proved of sufficient worth to warrant their use. Old plantations growing on light, sandy loam may be benefited by their use.

These berries may be propagated by allowing roots to start at ends or "tips" of old canes. In this manner it is possible to raise 1500 to 4000 "tips" per acre.

If these tips are used for planting it is better to plant them in the spring, whereas if older plants are used, plants of two seasons' growth, they may be set either in the spring or fall, at the convenience of the grower.

If lightish-gray spots appear on the leaves and canes or on the drupelets, the affected parts should be removed and burned. If new canes are seriously infected they should be sprayed with bordeaux mixture 4-4-50 which destroys this disease, known as anthracnose.

The average yield for loganberries is 300 to 400 24-pound crates to the acre, although yields up to 600 crates are not uncommon. When sold fresh or for cannery purposes, drying, or for juice manufacture, the price will range from 10 to 14 cents a pound. Gross returns per acre have been found to run from \$500 to \$800.

Peach Crop Estimate Cut 3,000,000 Bushels

The United States Bureau of Crop Estimates in a report issued recently says that the commercial peach crop is now passing through a critical stage in many parts of the country. The condition figure refers to conditions up until April 10. Late telegraphic reports indicate that many parts of the middle west and south have suffered from frosts the past few days so that any quantity estimate this time is tentative.

In general the crop promises to be practically full in California and Georgia, the two leading peach states. The crop in Ohio and Michigan promises to be good, as trees in these states wintered in good condition and are well set with buds. The Arkansas, Texas, Oklahoma, Missouri crop promises to be very light due to the severe freeze which occurred in these states the first week in April.

In the far west the Utah peach crop promises to be very much less than last year and many sections of the state are nearly a failure. The famous Palisade section of Colorado also suffered from winter injury and has about half a crop. The Northwest crop in Washing-

THERE IS JUST ONE DEHYDRATOR

Mechanically and Scientifically Correct and Absolutely Dependable

AND THAT IS

The International Dehydrator

BEST CROP INSURANCE IN THE WORLD

Get in touch with us at once if you want delivery for this year's use
Not a makeshift but a Factory Built Complete Plant

WRITE OR WIRE

International Dehydrator Company

CHAMBER OF COMMERCE

Los Angeles, California

Get our proposition before you decide on a plant

Friend Farmer and Housewife

If your family had contained 4 persons in 1913 and had an income of \$100 a month; and now, in 1920, it has 10 persons and an income of only \$45 a month, then—

Your Case Would Be the Same AS THAT OF THE Agricultural College University and Normal

Why? Because the fulltime attendance at these three schools has increased 150 per cent since 1913, while state support has increased less than 4 per cent. In addition, the great rise in prices has cut the buying power of a dollar to about 45 cents since 1913.

As a result, classroom, laboratory, equipment, student and faculty conditions are **desperate**. To rescue higher education the legislature has referred to the people the Higher Educational Tax Act for a vote on May 21. This act provides 1.26 mills for the three institutions.

Only One Argument is Made Against This Higher Educational Tax Act

That argument is taxes. Taxes are higher this year than last. But taxes are lower in the United States than in any other great civilized country. Why? **Because of the state-supported educational system of the United States.** This is the safest, freest, healthiest, wealthiest and happiest country on earth. **Education is largely responsible.**

The Surest Way to Increase Taxes Is to Cripple Education

The Agricultural College, State University and Normal add millions each year to the wealth of the state. Consider, for example, the wealth-making contribution of the Agricultural College through its work of improving grain yields, fighting pests, raising the egg output, improving livestock strains and its horticultural and garden experiments.

Where education is lowest, tax rates are highest; where education is best, wealth is greatest and tax rates lowest.

Protect Higher Education on May 21 By Voting 301 X Yes

This advertisement inserted by Colin Dymont in behalf of the Joint Alumni Relief Committee for Higher Education in Oregon.

ton, Idaho and Oregon, was for the most part winter killed. The same is true of New England, the Hudson Valley and many parts of Western New York.

The middle Atlantic states promise fully as good a crop as last year and orchards are in good condition, although acreage has declined materially in West Virginia and Maryland.

The prospects on April 1 were for about 77 per cent of a peach crop in the United States, as compared to prospects for 84 per cent of a crop last year at this time. Allowing for about ten per cent decline as is usually the case during the season, due to unfavorable blooming conditions, the crop would be about 67 per cent full as compared to 75 per cent final last year. The crop is now indicated at 29,240,000 bushels, as compared to the final production figure of 29,461,000 last year and 20,597,000 in 1918. Allowing for the normal decrease which usually occurs during the season, the crop will be about 3,000,000 bushels less than last year.

Replanting Students' Orchard

Editor BETTER FRUIT:—Several years ago Mr. H. E. Burdette, now with the Oregon Nursery Company, at Orenco, Oregon, was foreman of the Horticulture Department of the State College of Washington. In that position he supervised the planting of what was then known as a class orchard. This contained several varieties of stone fruits and grapes, apples, and pears. The orchard was an unqualified success in that it furnished a laboratory for class practice work in pruning, and tree and plant development. Mr. Burdette later graduated from the college and received his degree.

The work of the department has progressed, but in the development of the grounds and buildings the stone fruit orchard was sacrificed for building space. We had been planning to start a new student orchard because of its extreme value to class work. The Oregon Nursery Company heard of our plans and donated over 100 trees of select grade and variety for this purpose. The shipment has been received and is in process of being planted. Such donations are very great help to the institution and under the present financial stress provide material that could not otherwise be secured. Needless to say, it is very highly appreciated.

O. M. MORRIS,

Head, Department of Horticulture.

Rebuilding Spray Machines.

Blacksmith and machine shops in many fruit growing districts are reported to be doing quite a large business in equipping discarded sprayers with new gas engines. Another feature of this business is in supplying higher powered engines for machines that do not have enough power to suit their owners. In many instances these higher powered engines are being put on sprayers that are to use two or more spray guns.

If You Have Fresh Fruit to Pack

You Will Save Money by Reading this Announcement
which Tells of A Revolutionary Method of Packing Fruit

The Sykes System of Packing Fresh Fruit Saves Money and Labor.
It Keeps the Fruit Perfectly. Permits Thorough Inspection and
Allows a Good Display of the Fruit While in the Box.

SAVES LABOR

Experienced fruit packers with the individual wrap system are not made in a day, and there are not enough experienced packers, no matter how high the wage. With the Sykes wrap, children with but a short period of instruction can become rapid and efficient packers of fruit, and with this system fruit can be packed with both hands.

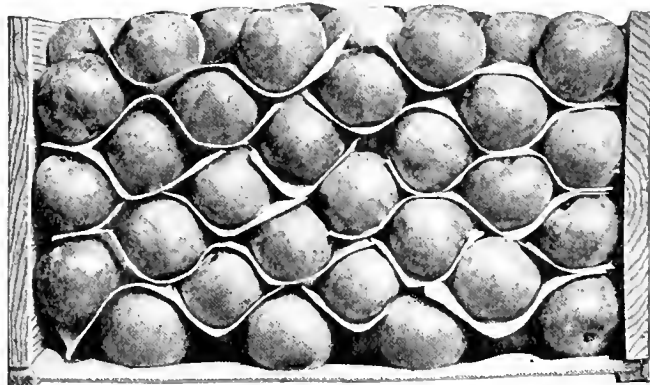

SAVES TIME

Fruit can be packed more rapidly under this system than under any other method where wrap is used. An experienced packer will greatly increase his output after a few days' packing. Experience has proved that 25 per cent less help than you now employ will turn out as much work.

SAVES MONEY

In addition to the saving in labor cost, the Sykes pack paper costs you less than hand wraps. The saving in paper alone is about one and a half to two cents a box, or about \$10 a car.

KEEPS FRUIT BETTER

Our reports from shipments made in 1919 show that fruit arrives in as good or better condition than when hand wrapped. The Sykes pack, owing to its construction, while it protects the fruit from friction rubs and bruises, still allows perfect ventilation of the fruit. The fruit ripens uniformly, ripens a better color, has better flavor, and does not shrink as much. It has proved that the fruit carries as well, arrives in as good condition and keeps in storage as well as the wrapped fruit.

Fruit Packed the Sykes Way brings as good prices as when each piece of fruit is wrapped separately, in the old slow, expensive way

Fruit Packed the Sykes Way Costs Little More than Packing Without Wraps

You Can Get Delivery If You Order Now

The Sykes System Packs Apples, Pears, Plums, Lemons, Oranges, Tomatoes

Proved Satisfactory by Shippers in 1919

Shipments of fruit in the Sykes Pack in auction cars brought top prices. The side of the box, when opened, makes a display so that the buyer at a glance can see the condition of the fruit.

FOR FURTHER INFORMATION, PRICES, ETC., ADDRESS

American Paper Company
Seattle, Washington

Spokane Paper and Stationery Co.
Spokane, Washington

Pacific Folding Box Factory
San Francisco, California

Blake-McFall Company
Portland, Oregon

School for Tractor Dealers is Inaugurated

IN these modern days of efficiency methods of manufacturing and selling, particularly machinery, automobiles, farm tractors, etc., the successful manufacturer has realized that his obligation to a customer does not end with the sale of his merchandise. A man buying a farm tractor, for instance, must be taught how to keep it in good

condition. Otherwise, accidents and breakdowns will work a hardship not only on the man who has already purchased but upon the manufacturer, inasmuch as the purchaser will become a knocker instead of a booster for the particular merchandise.

It is generally admitted by those who own tractors or who are connected in any way with the tractor industry, that the proper service organization is of the utmost importance. The experienced

owner realizes that the best sort of service is the preventative sort. In other words, to understand his machine thoroughly and thus be enabled to avoid breakdowns in the busiest seasons, is far better than to be left in ignorance, with the resulting unnecessary wear and breakage.

This sort of instruction, of course,



Dealers' Tractor School at San Francisco.

should start at the factory and reach the ultimate consumer through each dealer's selling and service organization. The Cleveland Tractor Company, makers of the Cletract tractor, in realization of this fact, are conducting an extensive campaign of this sort. The San Francisco district office of this company has just finished holding a one week's course of instruction, free of charge, for Cletract dealers and their service organizations. The instruction school was a great success and brought together service men from all parts of California, Nevada and Oregon, who were given the benefit of lectures and instruction by factory-trained men. The course covered in detail all parts of the tractor, and great emphasis was laid on the importance of delivering a tractor right—that is, seeing that the new owner is made thoroughly familiar with the proper care of his machine.

Shall We Bury Wormy Apples

Editor BETTER FRUIT:—During the thinning season of 1919, there was a great deal printed in the Yakima papers against the practice of burying wormy apples. In order to gain first hand information on the subject I tried the following experiment:

I set a joint of four-inch clay tile in the ground so that the bell was flush with the surface. I then tamped earth on the tile to within thirteen inches of the top. I took forty-three wormy apples, though it is not likely that each apple contained a live worm, and on the twenty-ninth day of June, I put them into the tile filling it to within six in-

ches of the top. I tamped moist earth on the apples with my fist, filling the remaining six inches of the tile. I put a piece of burlap over the end of the tile and a screen wire over that.

I examined it about once a week during the summer, but never a worm or moth appeared.

On October 12, 1919, I dug the apples out and examined them carefully. I found four larvae in cocoons on the sides of the apples. These would no doubt either have perished in the cocoons, or have hatched into moth, which would have been much less able to dig out than when in the larval stage.

L. M. COX.

Protect Your Shipments

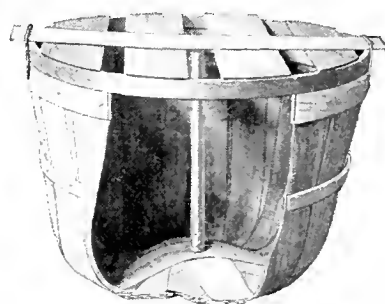

Universal Bushel Shipping Packages

safely marketed 10,000,000 bushels of fruits and vegetables last year. Ideal for all crops. Center-post gives rigidity of barrel. Pick right into package. Pack in the orchard—save rehandling. Covers fit on without nails. Easy to lift, handle and load in cars. Write for information showing how hundreds of shippers prove they save money and get better prices and larger net profits by shipping in Universal Bushel Shipping Packages.

Valuable Facts Free

Write for handsome free booklet "Shipping Profits"—filled with information of vital interest and profit to every fruit and vegetable shipper.

Package Sales Corporation

106 East Jefferson Street
South Bend, Indiana

Less Work With The LIBERTY GARDEN CULTIVATOR

The perfect tool for all-around garden cultivation. No downward pressure required. The Liberty Hand Cultivator is equipped with a special sickle design of cutting teeth which make quick and thorough work of destroying weeds. The teeth are of unbreakable malleable iron, with sharpened V-shaped cutting edges. Pulverizes top soil into perfect mulch which stimulates plant growth.

GILSON GARDEN TOOLS
(Hand or Wheel Outfits)

A complete variety for intimate garden cultivation. Send \$1.55 for 7 tooth Liberty Cultivator (under money-back guarantee), or have your dealer order for you.

J. E. GILSON COMPANY
Makers of Garden Tools
102 Western Ave.
Port Washington, Wisconsin

Wheel Outfit with 8-inch Weeder Blade
ADJUSTABLE FROM 4 TO 10 IN.

Free Book for the Asking

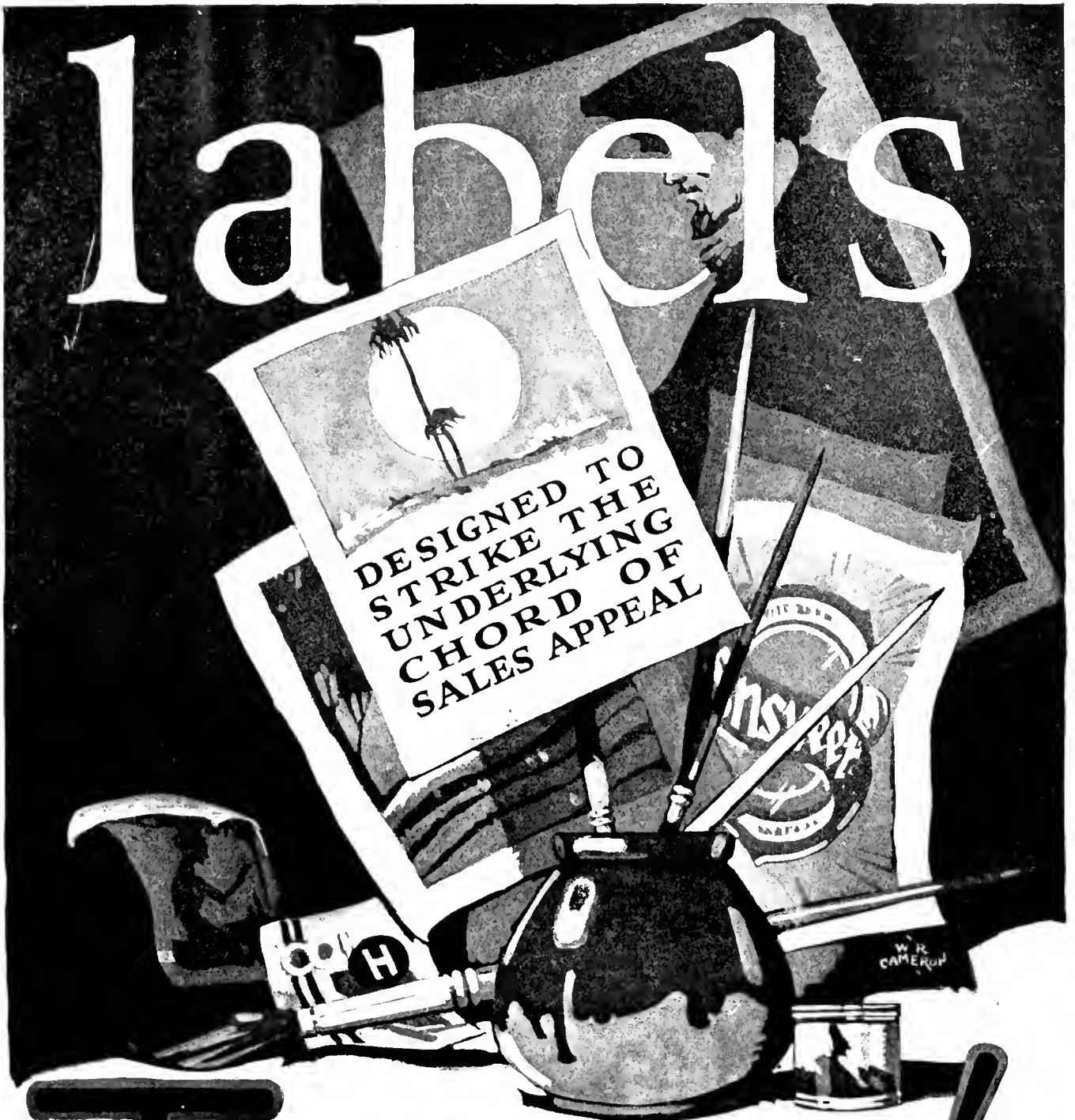

Trauno
Label & Lithograph Co.

LABELS and CARTONS

SAN FRANCISCO ~ STOCKTON ~ SEATTLE
PORTLAND ~ FRESNO
SACRAMENTO

WHEN WRITING ADVERTISERS MENTION BETTER FRUIT

BETTER FRUIT

An Illustrated Magazine Devoted to the Interests
of Modern Fruit Growing and Marketing.

Published Monthly
by

Better Fruit Publishing Company

703 Oregonian Building
PORTLAND, OREGON

Box Apple Distribution.

Notwithstanding a number of handicaps, statistics recently compiled by the United States Bureau of Markets show a wider distribution of Northwestern box apples during the past season than in any previous year. Almost every possible market was invaded, including the South and Southeast, where barreled apples usually reduce the sales of boxed fruit to a negligible quantity.

While this situation is accounted for to some extent by the light crop in the East it did not apply to the Southeastern section of the country, more particularly Virginia and West Virginia, where there was a good crop, but which sections were unable to market as many apples in the big eastern markets during the past season as in 1918, while sales of Northwestern box apples in 1919 greatly exceeded those of any former year. These facts are interesting in that the apple product of Virginia and West Virginia is the strongest competitor of the Western box apple in appearance, quality and pack, and as a rule is sold considerably cheaper.

What is more interesting, however, to the Northwest apple grower, is the announcement of a much wider distribution of Northwest apples in sections that have heretofore been largely untouched, for having once been introduced into these new markets in considerable quantities a demand has been created that should mean still greater shipments in a wider field in future.

More Scientific Pest Control.

In a timely article in the Oregon Grower, entitled "Modernized Control of the Codling Moth," A. L. Lovett, Entomologist at the Oregon Experiment Station, after discussing the necessity of moth control, says:

"The weak link in our chain of control is first hand knowledge of seasonal activities. Try as we will the station at Corvallis cannot properly advise distant fruit districts as to the exact spray schedule for their locality. A variation of 100 feet elevation means approximately four days variation in time of natural events.

"A well trained specialist in each fruit section would cost the district about \$5,000 a year, salary, expenses and all. If your average losses from codling moth have been 12 per cent and he reduces the losses for the district to 8 per cent, figure your crop for this year, add 4 per cent, estimate its value and decide if your section can afford to be without such a man. Where specialists are present they are rendering better service than that.

"It is simply a situation we face; in spite of our knowledge what to use, and

how to use it, the element of timely application is a limiting factor we can no longer ignore or deny.

"Through the aid of the Extension Service a system of mailed notices, similar in character to the weather bureau notices could be developed whereby every grower could be informed just when he should spray. The suggestion is sound, Oregon is ready for such a service. Where such specialists are available the value derived from their timely advice is beyond question. Are we ready to consider such a step, it is absolutely sane."

In summing up his conclusions for a more scientific and perfect control of the codling moth, Mr. Lovett is presenting a matter of dominant interest to the fruit grower. Partial tests along this line have proved to be the saving of many hundreds of dollars to growers. Why not supply the weak link in the chain?

Helping Oregon's Fruit Industry.

While the State Departments of Horticulture of California and Washington are receiving liberal appropriations to carry on the work of developing and improving the fruit industry in those states, Oregon is providing the officials who have this work in charge with an appropriation so small that their work is very much hampered.

Considering the limited amount of funds that the State Board of Horticulture of Oregon has to use in the important work that it is carrying on the board is rendering excellent service.

But the fruit industry in this state is now growing by leaps and bounds, and is fast becoming one of the state's greatest resources in the field of agriculture. To properly care for this already large and growing industry the scope of the Oregon State Board of Horticulture should be enlarged, its authority made more complete and a much larger appropriation made available at the next session of the legislature for it to carry its work on efficiently.

The Standard Apple Box.

The men interested in the fruit industry of the Northwest who successfully combatted the proposal to have Congress change the standard apple box to some other form of container and thereby undo work that it has taken several years to accomplish, are to be congratulated on their success. The standard apple box as the best container for shipping the crop of the Pacific Northwest was evolved after many experiments and conferences and to make any changes in it would be decidedly disadvantageous. With this big fruitgrowing section of the country shipping from one-third to almost one-half of the entire apple crop of the United States, it was entitled to its claims to weighty consideration at the hands of Congress. The Northwest is not objecting to the styles of containers used in other sections, but wants what it believes to be the best for its own uses.

What Newspapers Interested in Fruit Are Saying

Owing to the extreme high price of boxes for the coming season a large number of the Watsonville, California, apple packers have decided to ship a part of the coming season's crop in bulk, loose in the cars. This matter has been taken up generally with the packers and the following firms have agreed to ship at least one-half of the shipments loose: Loma Fruit Company, M. L. Kallich, M. N. Lettunich and T. J. Hogan.—*Fruit Trade Journal*.

Competition between boxed and barreled apples has been more active than usual this year. Northwestern fruit has been offered liberally in markets formerly supplied mainly with eastern barreled apples. Virginia and West Virginia comprise a distinct shipping section usually ranging second to New York but this year the two southeastern states have a combined volume of shipment exceeding that of New York, owing to the short crop in the latter state. The two Virginias are leading eastern centers for such varieties as York Imperial, Ben Davis, Grimes and Winesap. The commercial crop has been sold mostly in New York, Philadelphia, Baltimore and various cities of the southern states.—*The Market Reporter*.

It is impossible to write cheerfully of the present fruit season. Crops generally have been poor and fruit small. Particularly has this been the case with stone fruits, which suffered very badly from the drought. Pear growers are also complaining. In many cases these crops have been rendered almost valueless through the ravages of codling moth. This despite repeated and regular sprayings. True, local prices have been generally good, but this does not help us much when we have little fruit to market. The Cape growers have been the worst sufferers and there is no doubt that the effects of last season's disastrous conditions are still being felt. A really good manuring would be a wise tonic for many orchards but with Karroo manure at £10 per ton (as against £1 10s. 0d. normal price) and every other kind of fertilizer correspondingly dear, only the most wealthy growers are inclined to indulge their orchards in this way.—*South African Fruitgrower*.

The following item from the Dallas News is reprinted from Tropiko, the bulletin of the Porto Rico Fruit Exchange: "This state, which was noted for having the largest peach orchard in the country, is gradually losing its prestige as a peach state. The Standard orchard at Scottsville, which was set out and cultivated by the Verhalen Brothers, is like the others, losing its grip. The Big Standard orchard will soon be no more. Nearly 100 axmen have been busy this week cutting down the thousands of peach trees. The entire orchard has been leased by B. M. Baldwin, who will cultivate more than 2,700 acres in cotton and corn next year. It has been understood for some time that the orchard was not a paying proposition and the Standard was the last of the big orchards in this country to be abandoned."—*Big "Y" Bulletin, Yakima*.

One of the greatest pleasures of past generations was the pleasant thoughts of early days at the old homestead. In England there is many a home which has been handed down from father to son, until the years that it has been occupied by the same family runs into centuries. In America a generation or two ago old homesteads were common, but within the last quarter of a century the lure of health, wealth, and adventure have almost made the people of the United States a nation of shifting families. There is a great distinction between the words "shifting" and "shiftless." A shifting family is not a shiftless one but it does seem a pity that when the children of the thousands of shifting families reach manhood and womanhood, that in retrospection they cannot look back to any certain locality and no certain homestead and say "it was there that I spent my childhood."—*Southern Fruitgrower*.

The severe freeze that occurred in the middle west April third, fourth and fifth damaged the fruit crop more or less. Growers, however, have been prone to consider their losses much greater than in all probability they actually are. In the great majority of orchards that were injured to a certain extent there are still plenty of fruit buds left to produce a good crop of fruit, if the orchards are handled properly the rest of the season, and if no particularly unfavorable weather occurs later. Mention is made of this fact, by V. R. Gardner of the University of Missouri College of Agri-

culture, particularly at this time, because growers should be cautioned not to discontinue spraying on account of the injury that has been done by the freeze. Spraying should be even more general than before, so as to protect from injury the blossoms that are left, and thus more nearly insure a good crop.—*Missouri College Bulletin.*

Blossom Time Made a Festival

Apple blossom time in the Wenatchee Valley, Washington, in the Hood River Valley, Oregon and prune blossom time in the Willamette Valley, Oregon, were fittingly celebrated in these various districts this year. The commercial organizations of all of these sections invited the residents of the Pacific North-



Young Hood River apple orchard in bloom.

west to visit the orchards and hundreds of visitors took advantage of the occasion.

In Oregon processions of automobiles went from the city of Portland to Salem and Hood River while scores of machines full of visitors made the trip to Wenatchee from many sections in Washington. While each springtime season in recent years has seen many visitors in Northwest orchards during blossoming time the movement took on a wider significance this year than ever before.

An Innovation in Tractors.

The Midwest Utilitor Company, which handles a small type of tractor with the control centered in two handles similar to those on a plow, has established headquarters in Portland. The company is headed by R. H. Butler, E. R. Wells is vice-president and Ralph Krows, general sales manager. The field of operation of the company in regard to the Utilitor are the states of Oregon, Washington and Idaho.

While the Midwest Utilitor is adapted to almost any kind of cultivation of crops and can also be used as a stationary engine, it is particularly adapted to the needs of berry growers, nurserymen, truck raisers and florists. In operating it the operator grasps the two handles the same as on the old-fashioned plow and follows the tractor, just the same as the horse-drawn implement is followed. The control in the handles is on the same principal as that in a motorcycle. When it is used for mowing a seat is provided.



After 10 Days

Your teeth may also glisten

All statements approved by high dental authorities

Millions of teeth now glisten as they have not done before. You see them everywhere.

A new method of teeth cleaning has, in late years, come into very wide use. Thousands of dentists are urging it. Multitudes of people have proved it and adopted it. And every person is now offered a free ten-day test.

To combat the film

The purpose is to combat the film which causes most tooth troubles. Film is that viscous coat you feel. It clings to teeth, enters crevices and stays. In the months between your dental cleanings it may do a ceaseless damage.

It is the film-coat that discolors, not the teeth. Film is the basis of tartar. It holds food substance which ferments and forms acid. It holds

the acid in contact with the teeth to cause decay.

Millions of germs breed in it. They, with tartar, are the chief cause of pyorrhea.

Very few escape

Very few people have escaped some of these tooth troubles, despite the daily brushing. The ordinary tooth paste does not dissolve film, so the tooth brush has left much of it intact.

Dental research has for many years sought a way to fight this film, and the way has now been found. Many clinical tests have amply proved its efficiency. And now leading dentists everywhere are urging its adoption.

The method is embodied in a dentifrice called Pepsodent. And millions of people are now enjoying its benefits.

Sent to any one who asks

The Pepsodent results are quick and apparent. Everyone who sees them will desire them. So, to spread the facts, a 10-Day Tube is sent to anyone who asks.

Pepsodent is based on pepsin, the digestant of albumin. The film is albuminous matter. The object of Pepsodent is to dissolve it, then to day by day combat it.

A new discovery has made pepsin possible. Pepsin must be activated, and the usual agent is an acid harm-

ful to the teeth. But now a harmless activating method enables us to constantly fight the film coat in this way.

Send the coupon for a 10-Day Tube. Note how clean the teeth feel after using. Mark the absence of the viscous film. See how the teeth whiten as the film-coat disappears.

Do this now, for few things are more important. The results may be life-long in extent. Cut out the coupon so you won't forget.



The New-Day Dentifrice

A scientific film combatant combined with two other modern requisites. Now advised by leading dentists everywhere and supplied by all druggists in large tubes.

10-Day Tube Free 401

THE PEPSODENT COMPANY,
Dept. 521 1104 S. Wabash Ave.,
Chicago, Ill.

Mail 10-Day Tube of Pepsodent to

.....

.....

Only one tube to a family

Device Shows that Cool Fruit Keeps Better

A MECHANICAL apparatus has been devised by investigators of the United States Department of Agriculture which proves scientifically that, other things being equal, it is preferable to pick such small fruit as strawberries, cherries, and raspberries in the early morning while it is still cool, particularly if the fruit is to be kept some time or shipped a considerable distance. The advantage of early picking lies in the fact that when cool the epidermis, or skin, of the fruit is considerably tougher, generally speaking, than when warm, and so is less easily bruised, as shown by tests. Similarly, the skin of fruit immediately after it has been cooled is more resistant than it is at an

ordinary room temperature. However, after fruit has been in an ice box more than 24 hours, the resistance of its skin is in some cases not so great as that of freshly picked fruit, which has been cooled quickly to ice-box temperature. It seems possible, therefore, that the storing of fruit tends, after a time, to make the epidermis more tender and more easily ruptured.

The apparatus, while having many distinctive features, is a modified Jolly balance. It consists of an upright metal standard from the top of which an arm projects to one side supporting a sensitive coil spring. Attached to the lower end of the latter is a metal rod that passes through a glass tube, the latter

being held in place by an arm attached to the upright. A hair line on the tube and on the metal rod make it possible to determine the point at which tension on the spring balances a given weight. At the lower end of the metal arm a glass rod is attached, to which is cemented a small glass needle with a rounded end.

In operating the apparatus the fruit is placed on the stand of the instrument in a holder, and the stand so adjusted that the surface of the fruit just comes in contact with the tip of the glass needle, when the hair lines on the metal rod and glass tube coincide.

The tension on the spring is released by means of a rack and pinion adjustment permitting the standard to telescope slowly, thereby lessening the tension of the spring. The operator is able to tell the instant at which lessened tension permits the needle to puncture the fruit, because the movement of the needle is indicated by the movement of one of the hair lines. When this takes place he at once stops the telescoping of the standard. Then, by reading the scale on the side of the instrument the weight required to balance the tension on the spring is determined. The weight of the glass rod, minus the weight necessary to balance the tension on the spring, gives the pressure of the needle on the fruit at the time it punctures the skin.

A large number of tests were made with fruit when it was freshly picked, and cooled after washing it in tap water, also after the fruit had been kept in a refrigerator for 24 hours, and again after cooled fruit had been brought to room temperature.

The tests confirm the wisdom of a practice common in many regions, namely, the picking of berries in the morning when still cool. The presence of dew does not make the berries more susceptible to injury than dry ones.

It seems probable that the increased resistance of the surface of small fruits to mechanical injury when cool, has been an important factor, not fully appreciated heretofore, in the improved keeping quality which results in prompt cooling and refrigeration.

Standard Apple Box Retained.

Owing to the strong protest made by Northwest apple growers against changing the nature and size of the standard apple box as used in the Pacific Northwest, proposed legislation to that effect has been dropped. The protest was made in the nick of time as the committee in Congress having the matter in charge was getting ready to report out a bill making the dry bushel measure the standard for the Northwest as well as all other sections of the country.

NOW is the time to send to
Milton Nursery Company
 MILTON, OREGON
 FOR THEIR 1919 CATALOG.
 FULL LINE OF NURSERY STOCK.
 "Genuineness and Quality"

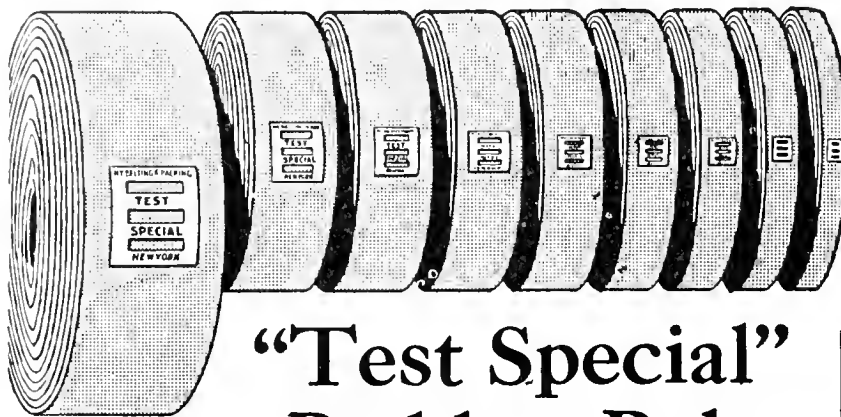

"Test Special" Rubber Belt

All sizes—All widths. "TEST SPECIAL" stocked in San Francisco in all popular sizes from 1 inch to 24 inches inclusive. Every "TEST SPECIAL" fully guaranteed to satisfactorily perform the service for which it is recommended.

Our Free Service Department

We maintain a department that will give you free of any cost any information you may require regarding your belt problems.

WRITE TODAY, giving the R.P.M., and Diameter of the driving pulley—also driven pulley, distance between centers of same, also give the rated horse-power of your motor or engine, and name kind of machinery you are operating.

We will reply immediately giving you our recommendation as to kind of Belt to use.

Write us today.

New York Belting and Packing Co.
 519 Mission Street, San Francisco
 Home Office: New York Branches in all principal cities



Cultivate More Acres - Produce Bigger Crops



Easy going on a track,
the CLETRAC way

The Cletrac will do it for you. It will speed up your plowing and discing—working 24 hours a day if necessary, 7 days a week. The Cletrac is the all-purpose tractor—adapted to all conditions. Used alone or in "fleets", it is the right size and type for almost any ranch.

Laying its own endless track, the Cletrac travels over the ground with a light, sure foot and a steady, powerful pull. The Cletrac is economical, too. Operates perfectly on kerosene, distillate or "gas"

Soft or sticky soil does not interfere with the Cletrac's performance. The endless track takes care of that. No danger from the Cletrac sinking

in or packing the soil. The Cletrac does not miss the corners either. Turns short, swings back to the furrow quickly without loss of time or power.

Don't wait until the rush hits you—be ready for it. Buy your CLETRAC at once and get prompt delivery.

Write today for that interesting booklet, "Selecting Your Tractor"—it's free.

Pacific Coast
Sales Offices:
LOS ANGELES, CAL.
SAN FRANCISCO, CAL.
SPOKANE, WASH.

The Cleveland Tractor Co.
19145 EUCLID AVENUE
CLEVELAND
OHIO

Largest producers
of Tank Type
Tractors
in the world

One of the more than 1,200 CLETRAC dealers with repair stocks is near you

Northwest Fruit Notes from Here and There

OREGON.

Prices for canning cherries were fixed at The Dalles April 17, when a contract was closed between the local cherry growers' union and the Libby, McNeil & Libby Canning Company, at 15 cents per pound. J. D. Riggs, manager of the cherry growers' union estimates that the crop of cherries at The Dalles this year will be 1,000 tons.

Pools recently closed on several varieties of apples handled by the Hood River Apple Growers' Association show that the high and low prices received were as follows: Jonathans, \$2.28 and \$1.33; Delicious, \$2.91 and \$1.51; Northern Spy, \$2.16 and \$1.45; Wageners, \$1.95 and \$1.34.

A local nurseryman at Hood River reports that a 200-pound shipment of seedlings that before the war cost \$25, according to present prices for nursery stock, cost him \$536. Notwithstanding this big increase it is claimed by some of the leading nurserymen that stock for planting has not yet reached the maximum figure.

Although loganberry prices are soaring the Salem Statesman, which has been keeping close watch on offers that are being received for these berries at the hub of this industry, says that it has been unable to find that more than 12 cents has been actually offered for loganberries this year. Predictions are being freely made, however, that they will go to 14 cents before the season is over. While the prospect for record prices for "logans" seems bright, some of the larger and older growers say that it will hurt the industry to boost the price so high that they will be out of reach of the consumer. A new feature that is reported to have been injected into the loganberry industry this year is the arrival on the coast of eastern buyers who are said to be buying these berries to be packed in barrels and shipped to the Atlantic coast in refrigerator cars to be processed in the east. Berry growers generally believe that prices considerably higher than those offered at the present time will prevail this year.

The market for strawberries in the Willamette Valley is reported to have been opened at 14 cents for eastern shipments while local canneries are quoting prices around 12 cents. Prices for berries on five and ten-year contracts

that have been offered are six cents a pound for strawberries, five cents a pound for loganberries, four cents for gooseberries and eight cents a pound for raspberries. These prices it is stated are the minimum, and with a stipulation in the contract that if open market conditions warrant it higher prices will be paid.

In order to secure the greatest degree of co-operation between the prune growers of Oregon and Washington, growers and managers of the Oregon Growers' Cooperative Association and a similar concern with headquarters at Vancouver recently held a conference in regard to marketing this year's prune crop. By keeping in close contact during the coming season the two organizations will work in harmony in regard to the several features necessary to place the prunes of Clarke County and the Willamette Valley on the market to the best advantage.

A good deal of sickness that has developed during the winter throughout the Northwest among horses and cattle in orchard districts through the eating of hay that has been taken from orchards that have been sprayed with arsenate of lead is causing experiments and investigations to be made by experts at the various agricultural colleges. The matter was brought to a head by the death of two horses at Hood River. Dr. J. W. Kalkus, head of the veterinary department at the Washington Agricultural College at Pullman, says that in its acute form the disease manifests itself suddenly and resembles very much a typical case of respiratory influenza. The course being recommended at present by these experts is for the orchardist to exercise greater care in seeing that spray apparatus is in good condition and to avoid allowing any large amount of spray to be deposited on intercrops that are being grown in orchards.

Following a meeting of the Oregon Growers' Cooperative Association recently held at Salem, it was announced that fruit packing and processing plants aggregating in cost more than \$100,000 would be built or taken over by the association. A prune packing plant will be built at Myrtle Creek and another at Riddle, while a plant will be erected at Grants Pass, for the handling of apples and pears. Com-

ination driers and prune packing houses will be constructed at Sheridan and Dallas. At Yamhill the association has already taken over the Drager prune drying and packing plant. J. O. Holt, cannery and packing house manager for the association, who has made a distinct success in managing the plants owned by the Eugene Fruit Growers' Association, will have charge of the plans for the new plants and announces that they will be built according to a standardization policy adopted by the growers' organization. This will include everything that is modern in the way of equipment to handle the various products which the association is to market.

At the annual meeting of the Hood River Apple Growers' Association, at which plans were discussed for the coming season the keynote was declared to be a more rigid inspection of fruit and a stronger enforcement of packing rules. Although the association handled the largest crop of fruit in its history the cost of handling was reduced per box below that of any previous year and the finances of the organization shown to be in a very satisfactory condition. The new directors elected are: J. C. Porter, R. J. McIsaac, E. W. Birge, A. F. Bickford, J. H. Jeffrey, J. D. Guttery, A. I. Graff, C. K. Benton, J. R. Nunnemaker, O. B. Nye, A. C. Staten. A. W. Stone remains as manager and W. C. McCullough, sales manager.

Probably one of the largest plantings of prunes and nuts made in the State of Oregon of late has just been completed by Peary Bros., in the Willamette Valley section. In the planting there are 3,000 filbert trees which is believed to be the largest tract of filberts in Oregon if not in the Northwest. The entire tract is owned by eastern people who have engaged the Peary Bros., who make a specialty of nuts, and fruits also, to handle and manage it for five years.

To demonstrate how a model fruit farm should be conducted, 10 acres of fruits and vegetables that can be used by a cannery will be planted near Albany. The farm will be used to teach prospective and actual fruit growers in that section the proper methods of fruit and vegetable growing. Stockholders in the Puyallup and Summer Fruitgrowers' Association, which has a cannery at Albany, will finance the farm.

Do It with Gravity

and you save both labor and power. Gravity costs nothing.

Put the Mathews Gravity Roller Conveyor in place of the labor or power you now employ on carrying, wheeling, trucking, loading and unloading work. Then watch your costs drop. Not only from the saving in labor and power, but in time, space, equipment upkeep, etc.

Each Mathews perfectly balanced steel ball-bearing roller is so responsive to gravity that only the most gentle incline is required to send boxes, cases, barrels, crates, etc., over great length of "trackage."

Mathews Gravity Conveyor systems can be fitted, section by section, portably or permanently, to any industry, plant or yard layout. Ask for further information.



MATHEWS
SPEED ECONOMY
GRAVITY ROLLER CONVEYER

MATHEWS GRAVITY CARRIER CO.

133 Tenth Street, Ellwood City, Pennsylvania

BRANCH FACTORIES

Port Hope, Ontario

London, England

Member of Material Handling Machinery Manufacturers Association

A novel way in which the Rupert Canning Company encourages and cooperates with fruit growers who do business with this company is to have them meet at the plant of the company located at Newberg once each year and have a "berry and small fruit growing school." The school lasts several days and experts in fruit and vegetable raising instruct and advise the farmers. The company turns a portion of the cannery into a large social hall and cafeteria and the farmers are the company's guests while attending the school. Much benefit has been derived by both the cannery and the farmers by reason of the school.

Thirty enthusiastic fruit growers representing all parts of Josephine County met recently at Grants Pass, Oregon, when a county-wide fruit program of the farm bureau was taken up and the goals set for 1920 approved. The question of organizing a county fruit growers' association was referred to a committee with instructions to formulate plans of organization to be presented at an early date. The meeting was presided over by Clyde E. Niles, president of the Farm Bureau, who spoke in general of the necessity of the various communities getting together on fruit problems of county-wide interest. The Farm Bureau fruit program of work for 1920 by organized communities was presented by the county agent. The program of work as outlined was endorsed and W. T. Reed pointed out the necessity of close cooperation on the part of the fruit men in working out the adopted program. The matter of perfecting a county organization of fruit growers to consider problems of local interest and those not handled by the state organization was discussed from various angles. The committee appointed consisting of W. T. Reed, Douglas Wood and C. H. Eisman, will formulate plans of organization and present same in the near future. The matter of preferred stock in the Oregon Growers' Association was presented by Mr. Niles and a number of the fruit men present signed up. J. O. Holt, packing manager of the Oregon Growers' Association has been in Grants Pass and has discussed plans for the construction of a packing plant.

WASHINGTON.

According to an estimate made by District Horticultural Inspector E. G. Wood of the Walla Walla district, most of the peach trees in that section were winter-killed. Apricot trees largely met the same fate while sweet cherries were injured to the extent of 33 per cent of the planting. The only part of the district to escape damage was a small belt along the Snake River between Bishop and Almota. Damage to apple trees is reported as spotted.

Unless H. M. Gilbert, one of the oldest orchardmen in the Yakima Valley is mistaken the apple crop in that section will be one of the largest in its history this season. Mr. Gilbert made this statement recently after an extended investigation of the valley.

A survey made recently in the Kennewick district shows that there is fully 100 acres more under irrigation in that section this year than last.

The total amount received in Yakima County for fresh and dried and canned fruit for the past season was over \$22,000,000.

A five-acre orchard located near the city of Wenatchee, highly improved and on which there is a modern dwelling recently sold for \$20,000, according to the Wenatchee Advance. The property belonged to George Scheidemantl and for a long time has been one of the show places at Wenatchee. Owing to the intensive methods used the yields from it have been very heavy.

It is estimated that apple boxes will cost Yakima growers \$1,000,000 more this season than last. Twenty-five to 28 cents is being asked for apple boxes and 22 to 25 cents for pear boxes. The opening price last year was 13 cents with 22 cents at the peak of the season.

Papers filed at Walla Walla reveal the sale of the Baker-Langdon orchard, a 600-acre tract of apple trees in bearing to the Stanton Investment Company, composed principally of Ohio capitalists. The price is \$1,050,000. The orchard was planted about eleven years ago and is the biggest commercial orchard in the valley. John W. Langdon will retain an interest in the company and continue as manager, it is announced. The company intends to construct a big cold storage warehouse this year and make other improvements. Production of the orchard this year is estimated at not less than 300,000 boxes and within five years at 750,000 boxes or 1000 carloads of boxed apples.

Stanley Armstrong, formerly state horticultural inspector in Spokane, has been appointed district field representative of the Northwestern Fruit Exchange in the Walla Walla territory. In establishing a Walla Walla office, the exchange will serve shippers throughout the region including Kennewick on the west, Lewiston and Clarkston on the east, Columbia points and Oregon on the south and embracing all of the Walla Walla, Milton, Freewater, Waitsburg, Dayton and Touchet districts.

Northwestern fruit growers rallied in defense of their standard apple box when it became known that a congressional committee was likely to adopt the bushel basket as the standard for the United States. Eastern growers who market their apples in barrels are declared to be behind the move which would have a tendency to discredit northwestern boxed apples in the eastern markets. M. L. Dean, state commissioner of agriculture at Olympia, wired the agricultural bureau of the Spokane Chamber of Commerce as follows: "House bill 12,350 proposes to standardize apple boxes. We have insisted upon the recognition of the northwestern standard and that any subdivision like a half-box or multiple like a box and one-half must be figured on the

northwestern standard. The department of agriculture favors a standard on the dry bushel basis with a provision that the northwestern box shall not be illegal. This creates double standards and makes the present box a side issue. The committee is inclined to the dry bushel basis. Suggest you wire your congressman, insisting on the northwestern standard only." The Bureau, the Spokane Fruit Growers' Company and the Earl Fruit Company immediately dispatched wires east urging action along the line suggested by Mr. Dean. As a result the bill for the new container was killed. Last year Idaho, Washington and Oregon produced 29,014,000 boxes of commercial apples as against a total for the United States of 73,200,000 bushels.

Joseph Di Giorgio of New York, president of the Earl Fruit Company of the Northwest, and known in the east as the "American Banana King," will be in Spokane next month on an annual tour of inspection of his apple and other interests in the Northwest. While in Spokane Mr. Di Giorgio will discuss with officers of the Palouse Corporation plans for the establishment of a dehydrating plant in Spokane County to handle cull apples. He is loaning the corporation \$75,000 this year. The

CONSULTING HORTICULTURIST

PROFESSOR W. S. THORNBUR

Formerly

HEAD OF THE DEPARTMENT OF HORTICULTURE
AND LANDSCAPE GARDENING

Later

DIRECTOR OF THE EXTENSION SERVICE
OF THE
STATE COLLEGE OF WASHINGTON

WILL ADVISE with fruit-growers upon all horticultural problems, including selection and preparation of orchard lands; propagation and care of nursery stock; planting and care of young orchards and small fruit plantations; the control of codling moth, San Jose scale, blight and other orchard pests; the preparation of lime-sulphur at home and the mixing of other sprays; economical orchard management; the irrigation and fertilization of orchard lands; the use of cover-crops and grass mulches; the pruning of fruit trees, shade trees, shrubs, bushes and vines; the renovation of old or neglected orchards, top-working or replacing of poor or unprofitable trees, and the examining and the working out of practical management plans for large orchards and orchard companies.

If your orchard has not been a financial success, and you wish to determine its possibilities or you wish to improve your orchard, reduce your losses and increase your returns I will assist you in working out your problem.

WRITE FOR TERMS

W. S. THORNBUR
LEWISTON, IDAHO

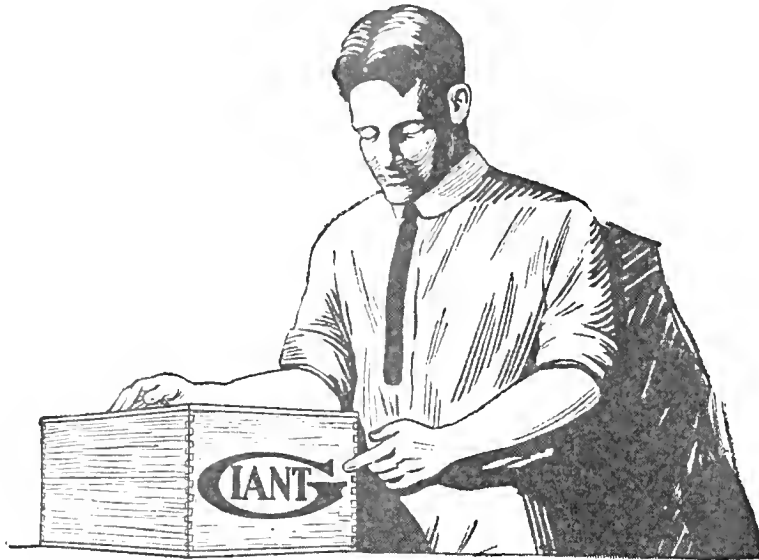

The **DEALER** says—
 “the **GIANT** mark
 protects you from
 imitations”

“It pays me to give my customers what they ask for,” says the retailer who knows what’s what. “When they ask for ‘Giant Powders’ I give them GIANT Powders—the real Giant, made by The Giant Powder Co., Con. I don’t tell them that ‘I have the same thing, only under another brand name,’ because it is not true.

“The name ‘Giant’ on a case or a stick of powder is evidence that the powder is made by the company that originated Giant Powders. Remember this: You can’t get Giant results when you use ordinary dynamites that look like Giant but aren’t marked Giant.”

Look into the new, money-saving methods of clearing land, blasting tree beds, ditches, boulders, etc. They are all described in our up-to-the-minute book, “Better Farming with Giant Farm Powders.” A post card will bring it by the first mail.

THE GIANT POWDER CO., CON.
 “Everything for Blasting”

202 First National Bank Bldg., San Francisco

Branch Offices: Butte, Denver, Los Angeles, Portland, Salt Lake City, Seattle, Spokane



STUMPING

EUREKA

How to Save Your Fruits at Ripening Time

There is no process known equal to canning and no better sellers than canned fruits and vegetables. We build canning outfits and plants to meet the requirements of the small and large growers—Hand and Belt Power Double Seamers for sealing sanitary cans. *Write for Catalog C, Dept. T.*

Henninger & Ayers Manufacturing Co.

If it's used in canning, we sell it.

Portland, Oregon, U. S. A.

Earl Company will sell the Palouse organization's tonnage this season for the first time. The problem of disposing of culls is becoming serious and last year local cider plants could not handle them and tons were shipped out of the district to be worked up in distant by-product plants. Mr. Di Giorgio has had considerable experience with dehydrators, operating one of the largest in the Northwest in Southern Idaho, for the treatment of prunes.

The second largest orchard sale in the history of North Central Washington was completed at Wenatchee, when the American Fruit Growers, Incorporated, took over the 160 acres owned by the Wells & Wade Orchard Company at Malott, paying \$156,000. There is about 110 acres of orchard just coming into bearing and 20 acres in alfalfa included in the tract purchased. The orchard was set out to winter apples in 1912 and produced 24,000 boxes last year. It was improved with a modern packing house and also with a concrete warehouse, located on the railroad at Malott.

Anticipating higher box prices this season, the Spokane Fruit Growers' Company has 200,000 boxes in its warehouse for the 1920 apple crop and has closed contracts for the delivery before October 1 next of 750,000 boxes. Box manufacturers are asking double the opening prices at this time a year ago. At that time some makers contracted to supply boxes at about 12 cents. Present prices run from 25 to 27 cents. The highest figure last season was 18 to 20 cents. The company this year will need approximately 375,000 pounds of paper for wraps in addition to labels for each box. This material is already ordered by the Skookum Packers' Association for all its members. The company buys spraying materials and nails and is placing orders and in some instances accepting delivery. Nails are scarce and higher than last year. Arsenate of lead, the biggest item in spraying costs is a little cheaper than it was last year. Most of the lime sulphur used against scale and scab is mixed by the company for the growers at the branches. Sulphur is a little cheaper than a year ago, but lime is slightly higher. Growers in the Spokane Valley have a new pest to fight this year in the leaf roller, which appeared throughout the valley for the first time last year. It must be combatted with miscible or soluble oil, which is sold to the growers at \$22 per barrel of 50 gallons.

The heaviest shipment of apples in one day from the Wenatchee district since the first of the year went forward recently when 119 cars were dispatched to eastern points in two solid trains. One was made up of 60 box cars, practically all loaded in Omak, and the other was composed of 38 refrigerators and 21 box cars picked up all over the district. Wenatchee has shipped over 11,400 cars of apples this season.

Homer J. Shinn of Spokane, has sold his 520-acre Keystone Fruit Company ranch at Entiat to J. Ellis Slater, a commission man and capitalist of Chicago and A. E. Brauns, a fruit and lumber man of Iron Mountain, Michigan, for a reported price of \$250,000. The Keystone brand and ranch has been owned by Mr. Shinn for 13 years and is one of the show places of the Entiat district. The water rights are perpetual and the ranch is irrigated by trough flumes from the Entiat river. Three hundred and ten acres are under cultivation, chiefly in apples and pears. The trees, planted by Mr. Shinn, are six or seven years old. The apple yield last year was 45,000 boxes.

W. A. Darling and J. S. Cardinal, with associates, have incorporated as the Wenatchee Fruit and Warehouse Company of Pehastin and will begin the construction of a warehouse which is estimated to cost \$45,000.

Skagit County in Northwestern Washington, is experiencing a big boom in the small fruit industry. Between 1500 and 2000 acres have been planted this spring and approximately an equal number will be set out next fall and spring. The plantings are about equally divided between strawberries, raspberries and loganberries and there has also been considerable planting of blackberries. In the Skagit

	BOOK ON DOG DISEASES And How to Feed
	Mailed free to any address by the Author
	H. CLAY GLOVER CO., Inc., 118 West 31st Street, New York

America's
 Pioneer
 Dog Medicines

River Valley there are thousands upon thousands of acres of sandy loam, the ideal berry soil, a large part of which when cleared, will probably be set out to small fruits. Interest has also been aroused in sour cherries and already quite an acreage of these has been put in. The people of this part of the state are also beginning to take more and better care of their numerous small home orchards. This is due to an entirely new market resulting from the establishment of several canneries in the county. Construction of independent canneries has already begun both in Sedro Woolley and in Burlington while next year the Everett Canning Company, anticipates the erection of a branch cannery in Mt. Vernon.

MONTANA.

The satisfactory prices received for the 1919 crop of apples have caused orchardists to center their attention upon their orchards. The mild weather since December has permitted most of them to complete pruning operations and an extensive cultural program is being planned. Special consideration is being given to the use of leguminous cover crops for the purpose of enriching the soil. Much of this is caused from the results of the cultural experiments conducted on the horticultural substation located in the Bitter Root Valley. As these have been in operation since 1908 some interesting as well as valuable information is available. One need not hesitate to decide the value of turning under a few crops of clover or peas—a glance at the trees in the different plots is sufficient.

State Horticulturist Wood is exerting every influence possible to secure adequate spraying. As outbreaks of codling moth appeared in several widely separated districts in Western Montana last year, attempts are being made to eradicate them and uphold the fame of Montana as the home of the "wormless" apple.

An outbreak of the "apple leaf roller" in the upper end of the Bitter Root Valley is receiving special attention. Already a car of oil for use in spraying has been ordered, and an attempt will be made to check the further spread of the insect. To assist in the control of this and the codling moth several spray outfits have been purchased by the state.

A breeding cage is being constructed on the horticultural substation to assist in the study of the life history of the codling moth and other insects of economic importance in Montana.

At present growers are receiving from six to eight cents per pound for potatoes, and contracts are being signed for the 1920 crop at from \$30 to \$35 per ton. A large acreage is expected.

The heavy rains which have fallen during the past month have resulted in an abundance of moisture in the soil. Conditions are ideal for a bumper crop both in the irrigated sections and on the dry-land farms.

What They Are Doing in California

The California Associated Raisin Company last year shipped to points in the United States 322,150,067 pounds of raisins.

The Hinkley-Beach Canning Company, which has secured five acres adjoining the townsite of Sanger, California, will construct an extensive canning plant in which they will handle all kinds of fruits and vegetables.

A recent investigation of crop damage to almonds in California is said to show a more serious condition than was at first reported. The damage is due to lack of rainfall and frost. In most districts the damage is reported as high as 50 per cent while in some of the others it is reported that there will not be enough nuts to pay for harvesting. The reports state that while some new acreage will come into bearing this year it will not be enough to offset the loss on old-bearing trees.

The announcement is made that the Guinda Almond Growers' Association has unanimously voted to affiliate with the California Almond Growers' Exchange. This association has heretofore been marketing almonds through other sources. The members of the Winters Dried Fruit Company also voted unanimously to affiliate with the California Almond Growers' Exchange and as a result the major portion of the almonds marketed through the Winters Dried Fruit Company heretofore, will in the future be marketed through the Winters Almond Growers' Association, a unit of the exchange. This will give the exchange very

close to 100 per cent of the almonds in those sections. Since January 1, approximately 500 new members have been secured, giving the exchange some considerable increase in its control of the crop.

On account of the unusually large numbers of adult grasshoppers depositing eggs in many localities in the late summer months in California in 1919 and the mild winter and lack of rains, California bug experts are looking for one of the most severe grasshopper seasons in the history of the state. The State Department of Agriculture has already taken hold of the matter through its office of pest control and will wage a vigorous warfare against these pests from now on.

The California Vegetable Union has moved its headquarters from Los Angeles to Sacramento, having contracted for the immense vegetable output of the Sutter Basin lands. The union expects to ship 3,000 carloads of vegetables out of Sacramento within the next year. The tremendous growth of the vegetable growing industry in Sacramento Valley led the union to its decision to establish headquarters in Sacramento, according to Thomas O'Neil, president.

The California Fruit Exchange announces the shipment of the first box of California cherries to the eastern market, on April 10. This is a week earlier than last year. The cherries were shipped from Vacaville.

California fruitmen, canners, shippers and all those who are connected with the fruit business in any way have every reason to feel

optimistic over the coming crop, says Charles B. Bills of the California Fruit Distributors. Bills has just returned from a trip of inspection through the fruit districts and says he has never seen conditions more ideal than they now are, with every indication of a bumper crop.

The strawberry season in the Sacramento Valley is under way—fifteen days earlier than last year. Carload shipments started on May 1 and indications are that prices will be about the same as last year. The crop will be considerably larger than last year, however, the production in the Florin district alone being estimated at 15,000 crates.

Cannery Notes

A. Rupert & Company, Incorporated, which is extending its already large operations in the canning industry took over during the past month the cannery of the Umpqua Valley Growers' Association at Roseburg. The Rupert Company also took over \$41,000 worth of canned goods which were on hand and agreed to find a market for them. The company made the deal according to the report, with the understanding that local interests take \$20,000 worth of the preferred stock. Should the Rupert Company finally close the deal it will erect a large warehouse in connection with its canning operations at Roseburg.

With the shipping of a carload of canned apples to San Francisco it is announced that the entire product of the cannery at Sunny-side, Washington, has been disposed of.

MIDWEST

UTILITOR

COMBINATION
TRACTOR
AND
STATIONARY
ENGINE



A tractor at a price within reach of all farmers and fruit growers—whether the farm or orchard is a mile square or four miles. The big point is that it will do everything expected of any tractor: Plow, harrow, pull small loads, disc, pulverize, seed, cultivate, cut hay, mow lawns, run separator, pump water, saw wood, run the electric light plant, even run the wife's washing machine—because it is a tractor and stationary engine all in one.

Live Dealers Wanted in Trade Centers



Dependable Power

NORTHWEST UTILITOR CO.

Sixth and Flanders PORTLAND, OREGON

Distributor Oregon, Washington, Idaho

DOW

DEPENDABLE

Spray Materials

are now available in virtually every important consuming section in the United States and many foreign countries.

This justly famous line is the product of one of the largest chemical manufacturers in the world, and every known modern device is necessary and is employed in the manufacture of—

Dow Powdered Arsenate of Lead
Dow Powdered Magnesium Arsenate
Dow Powdered Lime Sulphur
Dow Paste Arsenate of Lead
Dow Powdered Magnesium Bordo

The Dow Spray Calendar and name of the nearest distributor will be sent free upon request.

The Dow Chemical Company
 MIDLAND, MICHIGAN

The strawberry season was started in the Sacramento Valley April 15th. There is a 25 per cent increase in acreage over last year. Most of the crop has been contracted for at 14 cents per pound.

The new officers of the South Bend Canning Company who were recently elected are: Ben Armstrong, vice-president; A. P. Pederson, vice-president; E. Pederson, secretary; Theodore Myers and F. A. Hazeltine, trustees.

In order to do business on a much larger scale than heretofore the Rogue River Valley Canning Company, at Medford, is installing more equipment and providing for increased space. Having purchased additional land, the company is now building a new warehouse and cold storage plant 50x75 feet. The company has also purchased an additional half block near its new warehouse for a new cannery site.

The Brownsville Cannery Company, one of the oldest and most successful in Oregon, is reported to have been purchased by the Graves Cannery Company at Sheridan. The Brownsville Company has two branches, one at Forest Grove and one at Corvallis and both establishments have been a financial success.

Indications are now that Canby, Oregon, will have a cannery this year to take care of the berry crop in that section. At a recent meeting these growers were urged to plant additional acreage. The meeting was addressed by W. R. Scott of Albany, connected with the Puyallup and Sumner Fruit Growers' Canning Company who stated that if sufficient tonnage was secured a cannery would be erected at that point.

The largest and most modern lemon processing and packing plant in California has just been completed at Maxwell, Colusa County. It will handle the product from the greater portion of the Sacramento Valley, particularly the Mills Orchard Company's property, which has 700 acres of lemon trees.

The seven largest asparagus canneries in the world, located in Sacramento County's delta section, started operations for the season April 15. The 1920 pack will be in excess of 750,000 boxes. The price of unsorted asparagus to the owners ranges from six to eight cents a pound—the highest ever paid in the history of the industry.

Wine grapes in this section are being contracted for at as high as \$40 a ton for the 1920 crop. But none will be used in wine making. The greater part will go toward manufacturing the beverage that Bill Bryan made famous, while thousands of pounds will be dried.

According to the American consul at Tientsin, China, a considerable trade is being built up in that district for American canned goods. The American goods are sold in competition with the British, French, Australian and Japanese products. The American fruits that are imported are apricots, apples, cherries, grapes, plums, peaches and pears, but more peaches and pears are sold than fruits of any other kind. Dried prunes, apricots, apples and peaches are imported for the use of foreigners. The French and British goods are put up in the same sized tins as the American goods, namely, two and one-half pound tins which hold about one quart and are packed two dozen cans in a case. As to quality, American canned goods are quite equal to those from other countries on sale in this city. The packing and labeling of American goods is quite as attractive as that used in connection with the goods of any other country. About 60 per cent of the canned fruit sold in North China is what is known as second quality; that is, the syrup is of light and inferior grade and the fruit is not of selected quality. The British jams, jellies, and marmalades are by far the most extensively sold of any brands on this market, not only to foreigners, but the Chinese also buy in fairly large quantities. In addition, French jams and preserved fruits have a good sale. The latter are put up in one-pound glass jars, while the former are in one-pound tins. The French jams are put up in a more attractive manner and sell at a slightly higher price than the British. Crystallized fruits in glass bottles have also a limited sale.

The Oregon Growers' Coöperative Association which is rapidly getting into shape to handle the large tonnage of fruit placed under its management announces that it has taken over packing houses at Medford and Roseburg. The price paid for the Medford property was \$50,000.

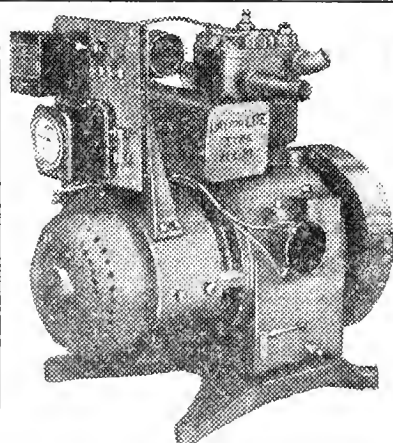

DAYTON LITE

Type HLM direct connected plant will give 50 lights from the generator with which you can get an ideal distribution of brilliant light in your PACKING HOUSE, making your packing day as long as desired, the packers satisfied, the work easier, quicker and more accurate. Will give current for the many electrically operated appliances about the ranch, THE GRADER, water system, etc., etc.

Also has a 3 HP engine which can be used for mechanical power, using no more kerosene or gasoline than smaller plants.

Also a small direct connected lighting plant, belted systems and pressure water system.

Write for Bulletins.

CHAS. W. RAYMOND

521 Oregon Building Portland, Oregon

LIVE DEALERS—We have some good territory still open in Oregon and Washington. Write today.

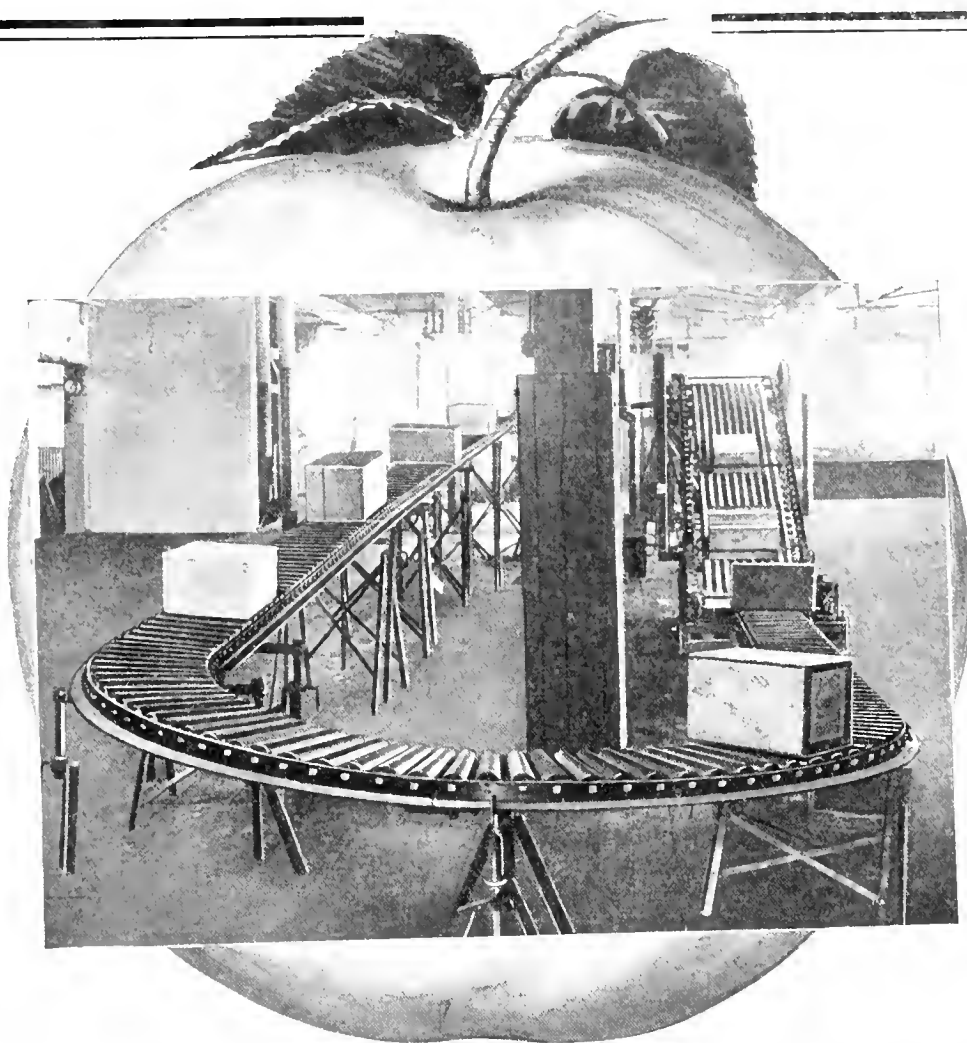

YOU cannot appreciate the advantages of STANDARD GRAVITY CONVEYOR UNITS or SYSTEMS until you have had an opportunity of seeing this indoor transportation system in actual operation in a modern and progressive apple-packing plant.

To observe an endless stream of boxed and cased apples moving forward at a rapid and controlled rate of speed, free from **mechanical aid and man-power**, is at first amazing as well as fascinating, but as the commercial value of this indoor transportation system unfolds itself, a desire for immediate possession takes place.

The apple-packing manager or owner can hardly wait until a similar system is at work in his plant, transporting loose apples from wagons to warehouse, progressively moving forward his product to packer—to storage—to trucks or cars for world distribution.

We want you to pause a moment and visualize a STANDARD SYSTEM comprised of labor-saving units of conveyors, replacing hard manual labor now used in the indoor movement of your product and let GRAVITY, with a world of force back of it, perform this work with ease and rapidity.

Act promptly and avoid being disappointed in securing STANDARD EQUIPMENT for this season's work, as the capacity of our manufacturing plant allotted to the needs of the apple-packing industry is already nearly taken up with accepted orders and contracts. Get in immediate touch with our representative in your territory and have him wire us a blanket reservation for the approximate units of conveying system you will require.

Standard Conveyor Company

FORMERLY MINNESOTA MANUFACTURERS' ASSOCIATION
NORTH ST. PAUL, MINNESOTA

Representatives in All Principal Cities

Washington, Oregon and Montana Representatives:

D. E. Fryer & Co

Main Office—Seattle, Washington

Branch Offices—Spokane, Washington
Tacoma, Washington
Butte, Montana
Portland, Oregon

California Representatives

Bannon-Bodinson & MacIntyre, San Francisco, California
Hazard-Gould & Co., San Diego, California
M. E. Canfield, Los Angeles, California

Colorado Representative

Mountain States Machinery, Denver, Colorado

Utah Representative

Hawley-Richardson-Williams, Salt Lake City, Utah

Treatment of Woolly Aphid, Etc.

Continued from page 12.

cessary and the spraying can be done at any time of the summer. There is little to be gained by spraying when the trees are dormant or in early spring. Possibly the best dates for treatment would be either in early June when the spring migrants have reached the apple and before the aphids have had a chance to penetrate to the roots, or in late August before the fall migrants have flown away. Distillate emulsion or proprietary summer sprays of miscible oil or the customary aphid spray of nicotine extract plus soap may be utilized against the woolly aphid. Even in case of light infestation, such amateur treatments as swabbing colonies with kerosene, gasoline or melted tallow may suffice.

Recent experiments by the U. S. Bureau of Entomology have developed a fairly successful treatment for the root form. This consists of soaking the ground around the infested trees, using a 1-10 of one per cent water solution of carbon disulphid. This is a saturated solution and can be prepared by injecting the carbon disulphid into the water and agitating until dissolved. The woolly aphid rarely occurs more than a foot below the surface and thus is within easy reach of this treatment, but the ground must be wetted completely under the tree as far from the trunk as the length of the branches. Only partially successful have been soil treatments with kerosene emulsion, lime sulphur, tobacco dust or cyanide solution.

STATEMENT OF THE OWNERSHIP, MANAGEMENT, CIRCULATION, ETC., REQUIRED BY THE ACT OF CONGRESS OF AUGUST 24, 1912.

of the Better Fruit, published monthly at Portland, Oregon, for April 1, 1920.

State of Oregon, County of Multnomah—Before me, a notary public in and for the state of Oregon, personally appeared D. L. Carpenter, who, having been duly sworn according to law, deposes and says that he is the business manager of Better Fruit, and that the following is, to the best of his knowledge and belief, a true statement of the ownership, management (and if a daily paper, the circulation), etc., of the aforesaid publication for the date shown in the above caption, required by the act of August 24, 1912, embodied in section 443, postal laws and regulations, printed on the reverse of this form, to-wit:

1. That the names and addresses of the publisher, editor, managing editor and business managers are: Publisher, Better Fruit Publishing Co., Inc., 800 Oregonian Building, Portland, Oregon.

Editor, E. E. Faville, 800 Oregonian Building, Portland, Oregon.

Managing editor, none.

Business manager, D. L. Carpenter, 800 Oregonian Building, Portland, Oregon.

2. That the owners are: (Give names and addresses of individual owners, or, if a corporation, give its name and the names and addresses of stockholders owning or holding 1 per cent or more of the total amount of stock.)

Owner, Better Fruit Publishing Co., Inc., Portland, Oregon.

Stockholders, D. L. Carpenter, 800 Oregonian Building, Portland, Oregon.

E. E. Faville, 800 Oregonian Building, Portland, Oregon.

A. W. Stipes, 800 Oregonian Building, Portland, Oregon.

3. That the known bondholders, mortgages and other security holders owning or holding 1 per cent or more of total amount of bonds, mortgages or other securities are: (If there are none, so state.) None.

4. That the two paragraphs next above, giving the names of the owners, stockholders and security holders, if any, contain not only the list of stockholders and security holders as they appear upon the books of the company, but also, in cases where the stockholder or security holder appears upon the books of the company as trustee or in any other fiduciary relation, the name of the person or corporation for whom such trustee is acting is given; also that the said two paragraphs contain statements embracing affiant's full knowledge and belief as to the circumstances and conditions under which the stockholders and security holders who do not appear upon the books of the company as trustees, hold stock and securities in a capacity other than that of a bona fide owner, and this affiant has no reason to believe that any other person, association or corporation has any interest, direct or indirect, in the said stock, bonds or other securities than as so stated by him.

5. That the average number of copies of each issue of this publication sold or distributed, through the mails or otherwise, to paid subscribers during the six months preceding the date shown above is: (The information is required from daily publications only.)

D. L. CARPENTER,
Business Manager.

Sworn to and subscribed before me this 90th day of March, 1920.

(Seal.) Notary Public for Oregon.
(My commission expires September 21, 1921.)

In treating the soil it is suggested to scrape back the upper few inches from the tree, and not to have the ground soaked with irrigation water before applying the carbon disulphid.

To prevent migration back and forth between the underground and branch forms, which takes place at any time during the summer, some growers advise banding the trunk with strips of burlap painted with a mixture of equal parts of rosin and castor oil melted together. Packing a good layer of loose sand around the base of the trunk is said to accomplish the same result since the aphids are too delicate to force their way through sand or compact earth and their movements are limited to cracks in the ground.

In conclusion the part played by the elm tree in the life cycle of the woolly aphid must not be overlooked when planning the control of the pest. Should fall migrants be observed flying to nearby elms, should winter eggs be discovered in the cracks of the bark, or should the opening leaves develop colonies of honey-dewed plant lice in the spring, the logical course is to check the insect before it spreads to the apple trees. The same kerosene emulsion may be used in the early spring against the leaf-curling generation on the elm.

Bits About Fruit, Fruitmen and Fruitgrowing

According to the Market Reporter, published by the U. S. Bureau of Markets, the Northwestern apple season, now closing, has been the greatest, from the viewpoint of production, in the history of the box apple industry. Two years ago almost 23,000 cars were shipped from the four states, Washington, Oregon, Idaho and Montana. This season, final shipment reports will probably show a total of 33,000 cars, which is far in excess of what was expected when the season opened. Dealers anticipated a comparative shortage of apples, taking the country as a whole. Remembering the heavy export demand last spring and the high prices they competed actively in producing sections. Buyers paid unusually high prices and the growers reaped a golden harvest. Final figures will show that the Wenatchee district shipped over 11,000 cars, Yakima district over 10,000 cars, Southern Idaho about 3,300 cars, Hood River approximately 3,400 cars, Spokane district 2,400 cars and the Walla Walla-Milton-Freewater district 1,200 cars. On March 1 it was estimated unofficially that the Northwest had from 3,200 to 3,500 cars still on hand, mostly in the Wenatchee and Yakima districts. Telegraphic reports of shipments during March showed that 2,200 cars had moved during the month, leaving somewhat over 1,000 cars still at points of shipment.

Shipment of apples to English markets practically ceased the second week in April. This condition was partly the result of the fact that Tasmanian apples are usually due to arrive in England by April 15.

While some of the recent shipments to the British Isles have netted high prices, the season as a whole, has been unsatisfactory. Recent sales of California Newton Pippins have brought \$1.62½ per box, while Ben Davis, Starks, and Bassets have brought as high as \$3.19½ per barrel.

The high prices which prevailed during the early domestic market season, together with the difference in exchange, resulted in many of the large operators handling export goods only in limited quantities.

The United Kingdom usually receives fully two-thirds of the total shipments of apples from the United States. In the 1918-19 season the United Kingdom received 1,016,945 barrels out of 1,576,348 barrels exported.

The 1917-18 figures suggest the effect of the shipping and trade embargoes in force at that time. Total exports dropped from 1,739,997 barrels in 1916-17 to 635,409 barrels the following season. Exports during the six months September to February, inclusive, 1919-20, show considerable activity, with total of 757,-

782 barrels compared with 1,077,432 barrels for corresponding months in 1918-19 and 494,747 barrels for same months in 1917-18, but still much below the figures for the same period in 1916-17, when shipments were 1,530,979 barrels.

The New York customs district leads in apple exports with 510,151 barrels in the season of 1918-19 and Massachusetts district ranks second, shipping 411,181 barrels in that season. Shipments from New York and Boston include much stock from some of the more distant producing sections.

H. F. Davidson, owner of extensive apple orchards at Hood River and a New York handler of apple crops from other sections of the Northwest, who recently returned to the coast after an examination of orchards at Hood River is of the opinion that notwithstanding the reported frost damage Hood River can expect another big apple crop this year. The Bartlett pear crop is expected to be light, while the cherry crop is expected to be about normal. Mr. Davidson calls attention to the fact that the warehousing situation at this end of the business must be greatly improved to secure better results and that steps must be taken to overcome the car shortage.

Joseph Steinhardt, the veteran New York fruitman, who suffered an attack of pneumonia following his visit to the Western Fruit Jobbers' Convention at Seattle, is now reported to have fully recovered and to have returned to the fruit marketing game with all his old-time vigor.

The Stark Brothers' Nursery Company, which originated the red and golden Delicious apple, now so well known in the Northwest, have inaugurated a contest to secure extra fine specimens of these varieties of apples. To conduct the contest the company has set aside \$3,000 which it will pay for the best ten specimens from each state in the United States, and from Canada and Mexico for three years. The annual prize in each state and Canada and Mexico amounts to \$20 per year—\$10 for each variety.

A circular letter recently sent out by J. H. Gourley, professor of horticulture at the New Hampshire College says that it is a startling fact that the apple crop in that state has declined from approximately a million barrels per year to about 125,000 barrels and that this decrease has come within a comparatively short time. This decrease Professor Gourley says is due largely to lack of care to the trees and he is calling upon the orchardists of the state to adopt modern methods in the management of their orchards.

In a ruling recently made by Richard T. Eddy, examiner for the Interstate Commerce Commission, he decided against any distance adjustment of freight rate increases on apples shipped east from the Northwest, as requested by the Public Service Commissions of Washington and Oregon in an action instituted on behalf of the apple industry, when the 25 per cent increase in freight rates generally was made two years ago, according to telegraphic advices received from Olympia.

Examiner Eddy, who heard evidence and argument at Portland last fall, maintains in his findings that Washington apples successfully compete with eastern-grown fruit in New York and other Atlantic markets, despite the increased freight charge from the Northwest, which will amount to 25 cents a hundred pounds, a total freight charge of \$1.25 a box, or 12½ cents a box in New York, added to the present selling price.

The Washington commission's opposition to a blanket increase of 25 per cent ordered by the railroad administration in 1918 was founded on the unequal application of the rate on long hauls and short hauls to competitive points. The 25 per cent increase on the 18-cent rate from Bochester, New York, to New York City amounted to slightly more than two cents, and from Winchester, Virginia, to less than six cents per 100 pounds, while the same ratio imposed 25 cents more on northwestern apples shipped to compete with the New York and Virginia fruit, the Northwest increase amounting to more than the total increased freight charge on New York and Virginia-grown fruit.

By a trip east, Commissioners Blaine and Cleland obtained a modification of the apple rate in 1918, which it was estimated, saved the Yakima and Wenatchee growers a million dollars on that year's crop.

In continuation of this fight, the Public Service Commission sent Assistant Attorney-General Burgunder to Washington to oppose affirmation by the Interstate Commerce Committee of the examiner's findings.

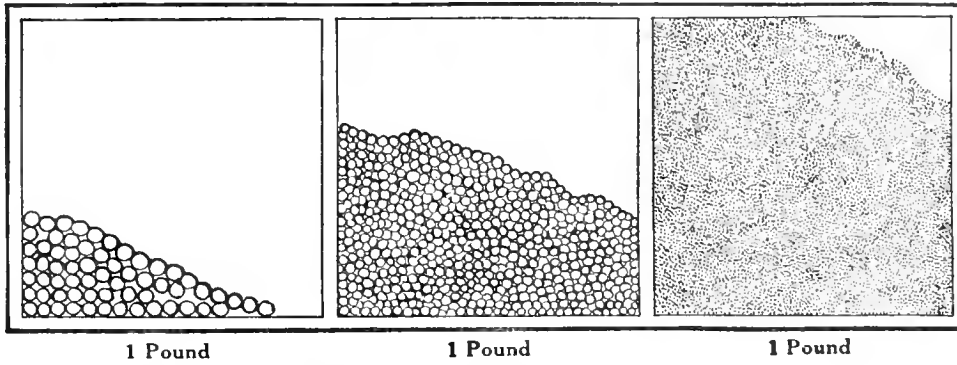

1 Pound

1 Pound

1 Pound

Take the Same Poundage of 3 kinds of Shot

say, 1 pound of buck-shot, 1 pound of B-B, and 1 pound of fine bird-shot. Then spread each batch out on a square foot of space. Remember, you have the same amount of *lead* in each case—1 pound. But you will see how much greater *spread* and how much closer *cover* the *fine* shot gives. Now apply that example to coarse and fine Arsenate of Lead. Then you will understand how S-W Dry Powdered Arsenate of Lead covers more foliage per pound than any other arsenate of lead spray.

Sherwin-Williams Lead products in Paints and Insecticides are famed the world over for extreme fineness. This is a vital necessity in Arsenate of Lead. That is the quality which gives the four great essentials of a spray—

Longest suspension in the tank, due to lighter specific gravity.

Uniform strength of spray throughout the entire batch.

Longer adhesion to the foliage.

Greater area of cover, more uniformity of cover and greater closeness of cover.

Every minute molecule of S-W Dry Powdered Arsenate of Lead

is a lead capsule, filled with arsenic. If the cover is close, insects have no chance to eat without biting into one of these millions of capsules; and one pellet is sure death when made as strong as Sherwin-Williams Arsenate of Lead. This product contains

30 to 33% arsenic oxide, which gives maximum poisoning strength and killing power. But with all its strength it is safest to use, because of the low percentage of water soluble arsenic, less than 1%.

Spray All Your Fruits and Vegetables

S-W Arsenate of Lead is most economical to use. It gives the desired results with fewer sprayings. Its greater effectiveness kills insects more promptly and allows growth to proceed with full vigor. The long duration of its poisoning power on foliage not only kills earlier pests, but protects against later invasions. *The New Jersey Agricultural Experi-*

ment Station used Sherwin-Williams Dry Powdered Arsenate of Lead and praised it for durability. They said: *"Foliage sprayed in spring and analyzed in fall showed arsenic yet present on the trees. Developing web-worms were killed off in September without further treatment."*

'Save 15c. Right now, just 10c will bring you the new 25c Revised Sprayer's Manual. Address The Sherwin-Williams Co., 602 Canal Road, N. W., Cleveland, Ohio.

SHERWIN-WILLIAMS PRODUCTS

PAINTS AND VARNISHES, DYESTUFFS

PIGMENTS, CHEMICALS

INSECTICIDES, COLORS, DISINFECTANTS

AND WOOD PRESERVATIVES



Winter Injury or Die-Back, Etc.

Continued from page 10.

for the welfare of the tree during the winter. The regular practice of fall irrigation in walnut groves may be considered as a profitable form of insurance since it is impossible to predict the occurrence or the volume of winter rains. We know that frequently the rains are too late and insufficient for the welfare of walnut groves. It goes without saying that trees on a light sandy type of soil are in greater danger of injury from winter drought than are trees on a heavier type of soil. In addition to soil types there are other factors involved in the production of winter injury, such as, the character of the rainfall, the rate and amount of evaporation, temperature, etc.

The growth of a winter inter-crop such as barley, during a normal season may bring about the same adverse soil moisture condition that the dry winter does, unless great care is taken to apply enough water for the needs of both trees and inter-crop. For example, if the barley is considered, the soil may become excessively dry about the time that the hay is maturing, which is the time the walnuts should be starting into active growth.

Unless fall irrigation is practiced the growth of summer inter-crops between the walnut trees may be conducive to winter injury of the trees. This is due to the fact that the moisture is reduced to such an extent at the end of the growing season that the trees are injured before the winter rains occur. Such a case is well shown by an orchard of three-year-old walnuts in Tustin which was interplanted to peppers. The peppers and trees were last irrigated August 28, 1918. There were no early fall frosts to complicate the case, as shown by the fact that peppers were harvested as late as November 15 in this grove. In the spring of 1919 the majority of the trees showed serious winter injury throughout the tops. Without question, the soil moisture during practically the entire dormant period of the trees was considerably below the wilting point, except in the surface foot of soil. The winter rains of 6.97 inches which fell in small intermittent amounts, penetrated the soil in nearby bean fields to the extent of only twelve to eighteen inches at the end of the rainy season.

The same results are often found where beans have been grown as an intercrop. Water is withheld from such groves during the latter part of the summer in order to ripen the beans. After the beans are harvested the soil of the grove is usually very dry. This condition may be of benefit to the walnut trees because it insures a state of maturity which will bring them through the winter in good condition. In such cases, however, winter irrigation is usually necessary and should be applied soon after the leaves fall from the walnut trees.

3. High Water-Table—A high water-table may be a contributing factor to the die-back of walnuts. When such a condition exists it is usually impossible

to bring about the early maturity of the walnut trees by withholding the late summer and fall irrigations.

In the presence of a high, more or less stationary water table, the twigs and foliage, especially on young trees, usually remain green and succulent until December, unless killed earlier by frosts.

Another condition which is equally critical and as apt to injure bearing trees, as well as young ones, is the occurrence of a fluctuating water-table. The sudden rise of a fluctuating water-table kills that portion of the root system which is located in the saturated stratum. In severe cases where the major portion of the root system is killed the twigs and young limbs of the tree later exhibit typical cases of "die-back." It might seem paradoxical that that top of the tree should dry out and die when the roots stand in an excessively wet soil, but there is nothing contradictory in the situation when it is seen that the death of the major portion of the roots makes it impossible for the top to receive the necessary moisture to sustain life.

4. Alkali Injury—Alkali injury is characteristic and may result in the death of the walnut tree. On a soil which contains alkali in harmful amounts, the edges of the leaves of walnut trees are often burned. This condition may often be seen as early as June or July and is followed by the shedding of the leaves in August and early September. The sudden and premature exposure of the twigs and limbs to the hot fall sunlight through the premature shedding of the leaves may cause severe sunburning. In such cases also the terminal portion of the twigs put forth a new crop of leaves in October which grow until killed by winter frosts. As in the typical frost injury, the twigs sunburn during the winter and much of the current year's growth dies back. In extreme cases of alkali injury, the whole tree dies after having suffered increasing injury for several years.

Summary—Winter injury or die-back of walnuts is characterized by a sudden death of the tops of the trees. Such injury is usually first noticeable during the early spring following the dormant period.

The most common causes of the winter injury or die-back are:

1. Early autumn frosts kill the immature, growing shoots. Young walnut trees are more subject to injury from this cause than older trees, because the former are usually later in maturing their new wood. Such frosts cause the foliage to drop prematurely and injure the growing tips of the twigs. The denuded twigs are subject to further injury from subsequent fall and winter sunburn. The presence or extent of this injury is usually overlooked until the following spring.

To reduce the danger from autumn frosts it is advisable to withhold the late summer irrigation in order to promote the early maturity of the trees.

2. Winter drought causes die-back in either young or bearing walnut groves. Trees suffering from this condition fail

to make new growth in the spring, except from the trunks or main limbs. The new growth on such trees has lost so much water during the winter that the buds are unable to develop in the spring. The cause of the die-back has been found to be due to an extremely low moisture content of the soil during a large part of the winter. Under such conditions the water lost from the young shoots during the winter cannot be replenished by the root system. Under such conditions the shoots die from desiccation.

Fall and winter irrigation of the walnut groves has been found to eliminate the injury from winter drought. The amount of irrigation will depend upon the type of soil, the amount of soil moisture present at the end of the harvest season, and the system of inter-cropping used.

3. A high water-table may be a contributing factor in killing walnut trees. A permanently high water-table causes the trees to prolong their growing season, with the result that they are killed by frosts. The sudden rise of a fluctuating water-table may kill a large part of the root system and produce a typical die-back in the tops, even though the wood is mature.

4. Alkali soils containing such a high salt content as to injure the root systems of walnut trees, also cause the tops of the trees to die back in response to the root injury. In the initial stages of alkali injury the leaves turn brown at the margin and fall prematurely. The denuded shoots sometimes put out a new set of leaves in the fall. The top of the trees gradually die back until the entire tree is lost.

The recovery of alkali-injured trees has never been noted by the writers. If injury is being caused by the use of irrigation water containing too much alkali evidently the use of such water should be discontinued.

The writers are pleased to acknowledge the assistance given by Mr. D. C. Wylie of the Field department of the California Walnut Growers, Association and by Mr. E. E. Thomas of the Citrus Experiment Station.

Apple Boxes

HIGHEST QUALITY
WESTERN YELLOW
PINE

If you wish to make sure of a supply of well made boxes at fair prices, let us place your orders.

Carloads Only

Spokane Fruit Growers Co.
SPOKANE, WASH.

TREES AND SHRUBS



Fruit trees budded from bearing orchards. Apple, Pear, Cherry, Peach, Plum, Prune, Apricot, Quince, Grape Vines, Strawberry, Plants, Raspberries, Blackberries, Logans, Dewberries, Asparagus, Rhubarb, Flowering Shrubs, Roses, Vines, Hedge, Nut and Shade Trees. Carriage paid. Satisfaction guaranteed.

WASHINGTON NURSERY CO.
Toppenish, Washington.
Salesmen everywhere. More wanted.

MYERS HONOR-BILT SPRAY PUMPS

Spraying days are here — trees, vines and shrubbery are blossoming and leafing out. Vegetables are in the ground and growth is advancing rapidly. The time is ripe for spraying. Development of tree and plant life brings numerous pests which attack and quickly destroy. Combat them successfully by using a MYERS "Honor-Bilt" SPRAY PUMP and your efforts will be well paid for by better and larger crops.

MYERS SPRAY PUMPS and ACCESSORIES come in many styles and sizes and meet all needs. Each Pump is carefully built and is equipped with the best of Accessories, works easily, and when properly operated applies the mixture uniformly and correctly. You can entrust your spraying to a MYERS PUMP with confidence for success. Catalog showing the complete line on request. Drop us a card.



MYERS PNEUMATIC SPRAYER—

Has Self-Locking D-Handle Screw Top. Galvanized Iron Tank. Brass Cylinder and Adjustable Long Distance Nozzle. Spray can be adjusted from broad fan like to long distance. Suitable for spraying Trees, Vines, Shrubby, Plants and Gardens.



Suitable for Spraying Trees, Vines, Shrubby, Plants and Gardens.

F.E. MYERS & BRO.
NO. 135 ORANGE ST. ASHLAND, OHIO.

PACIFIC NORTHWEST DISTRIBUTORS

PORTLAND, ORE.



SPOKANE, WASH.

BUY FROM THE LOCAL MITCHELL DEALER

Pulls 3 Plows on 20% Grade

Will work on 40% hillside

We can make delivery now. Write for Catalogue and Price.

BEST **TRACKLAYER** TRACTORS

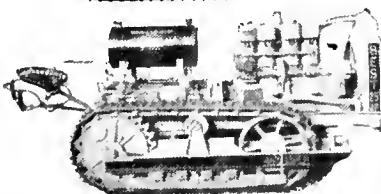

Western Farquhar Machinery Co.
Corner East Salmon and Water
Portland, Oregon

Planting and Care Prune Orchard

Continued from page 5.

shoot out, they should all be stripped down with the exception of the three top buds. Leave these to mature; they will give you the foundation from which to start. After the close of the first year the three branches that were left to mature should be topped back to four or five inches, according to the vigor of the tree, but always leaving the bud at the end of the limb on the top and on the inner side so that when this develops into a limb the tendency will be upward and inward. In later years when the tree begins to produce heavily this will act as a brace to keep it from spreading too much. At the close of the second year prune off all except the one shoot going upward on each of the three branches left the previous year. Prune these back to six or eight inches. This may seem a waste of time and tree energy, but it must be remembered now that we are laying the foundation for a prune tree to bear heavily in after years. The third year two branches may be left at the end of each of the three perviously mentioned. Prune these back to about sixteen inches. This will give you at the close of the third year a tree with six main body branches. I will say here that most generally there will be one or two of these that will not develop, so in reality we have a tree of four or five body branches. The next year two or three may be allowed, but cutting them back to twenty or twenty-four inches, according to the vigor of the tree. At the close of the fourth year the body is formed, and from that time on my object is to thin out whenever the branches seem to be too thick or crossing each other, or thinning for the size of the fruit. The fifth year the tree should begin to bear a paying crop.

Fertilization of the Young Prune Orchard—This may seem a waste of time and energy to some, but let me tell you it is one of the greatest problems facing the prune grower today. Our prune orchards, like our grain fields, will gradually produce less from year to year if they are not fertilized. It is unreasonable to think that an orchard will produce from one to two hundred boxes of fruit year after year and not impoverish the soil. The best time to begin to fertilize is when the orchard is young, before it suffers from the lack of proper nourishment. One of the best fertilizers that I know, and that one not only furnishes nitrogen but potassium and phosphorus as well, is barnyard manure. The first year put two to three tons per acre and increase this at the rate of one ton per year, and when your orchard is six or eight years old, you need not worry over its fertility. The first and second year the manure should be placed about two feet from the base of the tree. This will help to keep in the moisture. After this it should be scattered out evenly over the ground and worked in with a disc or harrow. The next best method for fertilizing the orchard is to plow down a good heavy crop of manure. For green manure sow vetch the last

of August or first of September. This will assure a good growth in the fall, and turn under not later than April 15th. I say April 15th, for if the growth is very heavy and turned under at a later date, there may be trouble in the soil drying out. If your orchard is large and you have not sufficient manure to cover the entire orchard each year, cover a section of it each year and plow down green manure on part.

Drainage for the Young Orchard—The drainage that I prefer for a prune orchard is good, deep, natural drainage. I mean by this a soil where water never stands and where the water table is from ten to twelve feet below the surface. In the valley here it is almost impossible to get a very large acreage but that some portions of it will need tile drainage. The proper time to put in drains is before the trees are set. This will allow the soil to sweeten before the trees are set, and after the trees are set they can send their roots

BEST SERVICE - QUALITY & PRICES

PERFECTION IN

FRUIT LABELS

THE **SIMPSON & DOELLER Co.**
1423-24 NORTHWESTERN BANK BLDG.
PORTLAND, OREGON.
E. SHELLEY MORGAN
NORTHWESTERN MANAGER
WE CARRY - AND CAN SHIP IN 24 HOURS - STOCK LABELS FOR PEARS, APPLES, CHERRIES & STRAWBERRIES.

GROWERS' AND PACKERS' EQUIPMENT

EQUIPMENT

Labor Saving Devices for Handling Fruit and Vegetables

Automatic Elevators, Sizers, Box Presses, Box Making Benches, Ladders, Packers Supplies.

Write for catalog.

Price Manufacturing Co. Inc. Yakima Wash.

Mulconroy Flexible Matalic Spray Hose

LIGHT
Weighs 6 oz. to foot.
STRONG
Tested to 2,000 lbs.
FLEXIBLE
Will coil in 3 in. circle.

**Can't Kink, Twist,
Burst, Collapse
or Chafe**



Protected against kinking, hard knocks, sharp turns, dragging over rough surfaces and other outside abuse. Tube especially compounded to resist the action of the oily and corrosive liquids and powders used in spraying.

Full capacity always, because **HOSE CANNOT KINK.**
When equipped with Mulconroy High Pressure Couplings, it makes **THE STRONGEST HOSE MADE.** Ask for No. 65 Folder.

MULCONROY CO., INC., Established 1887
PHILADELPHIA NEW YORK PITTSBURGH CHICAGO BOSTON

down deep where they will have greater pasturage and greater resistance. I would recommend that nothing less than four-inch tile be used and that they be put down three and a half to four feet. The idea of putting in nothing less than four-inch tile is to allow a better circulation of air through these mains.

In conclusion I will say that in taking care of a prune orchard there are problems to meet and overcome. There cannot be any set rules to follow because of the variation in the climatic conditions from year to year, the variation in the soil of different orchards, as for instance, the cultivation of an orchard where the soil was of a heavy clay mixture. By using good, sound judgment mixed with plenty of reasoning power, and then by watching someone who has made a success of growing an orchard, there is no reason why one should not succeed.

Pecan Growing Fast Developing

Hundreds of thousands of chestnut trees in the Eastern states have been killed by blight in recent years and the American production of nuts is said to be showing a tremendous reduction. In one recent year the importation of foreign nuts into the United States passed the \$20,000,000 mark and the influx is likely to continue until domestic production is heavily increased. The so-called English walnut of California and Oregon is in increasing supply, and walnut groves in those states are yielding splendid returns. However, the nut that is in highest favor just now is the thin hulled or paper shelled pecan, grown in many places in the lower south and showing its highest development in South Georgia.

The paper shell pecan is of comparatively recent importance in the market, but returns of \$400,000 for the South Georgia crop of 1919 indicate rapid increase in production although there are hundreds of acres in trees too young to bear a crop.

Government authorities underwrite the pecan as a sturdy tree, subject to few pests and diseases and bearing very heavy crops when properly cultivated. A few bearing groves in South Georgia have sold at \$1,000 the acre as against \$3,000 for walnut groves in California, but raw land suitable for pecans in South Georgia is very cheap as compared with virgin land in California.

The pecan does best on land with a good clay subsoil, a subsoil so stiff, in fact, as to require blasting the tree hole for planting out. On lighter soil the pecan makes a good growth but does not fill out the nuts so well nor bear so heavily. A careful survey of the growing trees in South Georgia indicates that the largest returns are from trees set in holes blasted in the clay subsoil.

The pecan comes into bearing about the eighth year and continues to grow indefinitely like the hickory, to which species it belongs. In South Georgia groves, field crops are grown between the trees until they get so large as to completely shade the ground.

MUSICAL
MERCHANDISE

WRITE
US

WE SAVE YOU MONEY!

W. Martius Music House Inc.

1009 First Avenue, Seattle, Washington
Everything Known in Music

SHEET
MUSIC

WRITE
US

TENTS, ROOFING PAPER WHILE THEY LAST

We secured 3,000 Wall Tents from the U. S. Navy which we can sell at the following prices:

7x9... each \$12.00	8x10... each \$14.00
9x9... each 14.00	10x12... each 20.00

Very special Roofing Paper offering, including cement and nails to each roll—
1-ply per roll \$1.25
2-ply per roll 1.75
3-ply per roll 2.35

Wagon Covers, 9x15, each \$7.50

Mail orders promptly attended to. Send along your orders.

201 Front Street—ALASKA JUNK CO.—Portland, Oregon

Ridley, Houlding & Co.

COVENT GARDEN, LONDON

WE ARE

Specialists in Apples and Pears

CABLE ADDRESS: BOTANIZING, LONDON

Codes: A. B. C. 5th Edition and Modern Economy

No Orchard or Farm is Complete Without Our Latest Model

**COMMERCIAL SIZE
All Purpose Evaporator**

Write for Folder

**HOME EVAPORATOR CO.
ST. LOUIS, MISSOURI**

P. O. Box 817 Central Station



GOPHER DEATH
TRADE MARK
Kills prairie dogs, ground hogs, ground squirrels, pocket gophers. Saves alfalfa. Experimental stations approve. 1000 tablets P. P. \$1.50. Warranted. Ask your druggist or send direct. Booklet Free. Address
FT. DODGE CHEMICAL CO., Ft. Dodge, Iowa

Raspberry Culture, Etc.

Continued from page 4.

set a new plantation they wait a month after growth starts in the spring and use the suckers that come up during that month in their established plantation. If the season is favorable, this practice may prove satisfactory. If, however, a drought occurs soon after, the young plants will suffer severely. Only in sections where the climate is favorable is this practice to be recommended.

Securing and Handling Nursery Stock.

It must be remembered, however, that the root systems of nursery plants of the different varieties vary greatly, and what constitutes a good nursery plant of one variety may be a poor plant of another variety.

In case the plants are not to be set immediately, they should be heeled in; that is, a trench should be dug and the roots placed in it and covered with moist soil. In order to work the soil thoroughly about the roots of each plant it will be necessary to open the bundles and spread the plants along the trench. Sometimes it is desirable to wet the roots, or, if they are very dry, to soak them for a few hours before heeling in the plants. Just before setting it is well to dip the roots of the plants in a puddle made of clay and water or cow manure and water. The roots are thereby partially protected from the wind and sun.

Plants affected with crown-gall should not be set. This disease can be recognized by the knots and swellings which appear on the roots and about the crown. Such diseased plants are very much less productive than healthy stock.

Systems of Culture.

Three systems of culture are used in growing raspberries, the hill, the linear and the hedge system. The term "hill system" is restricted to that method of tillage in which the horse cultivator is used on all sides of each plant. When the cultivator is run in only one direction and only the plants originally set are allowed to fruit, the term "linear system" is used. If some of the suckers which come from the roots of red raspberries are left to form a solid row and the cultivator is run in one direction only the term "hedge system" is employed.

The distance between the rows in each of these systems should be determined by economy in the cost of cultivation and in the use of land. Where the area of land available for planting is not limited, usually it will be found most desirable to make the spaces between the rows wide enough to allow the use of two-horse implements in cultivation. Where the area of land is limited, the rows may be placed closer together and one-horse implements used.

Planting Distances.

Under the hill system of culture the plants usually are set about 5 feet apart each way. This, however, allows the use of one-horse cultivators only. This

**A Profitable
Fruit Crop**

The successful control of codling moth is dependent upon the quality of the spraying material used, the time of application and the thoroughness with which the work is done.

Injury by this pest can be almost entirely prevented every year, by thorough spraying, at the right time, with Orchard Brand Dry Powdered Arsenate of Lead.

There is a carefully prepared booklet giving full directions for spraying, and offering many useful suggestions from years of experience, which will be sent you upon request.

It tells the story of Orchard Brand Dry Powdered Arsenate of Lead and how to use it to get a profitable fruit crop. It tells of the maximum concentration, chemical purity and mechanical condition.

Your fruit crop means everything to you. The quality of the spraying material used is very important. In fact it is all-important. Let us urge the necessity of looking into the subject with great care.

Other spray materials, for specific purposes, we recommend are:

- Orchard Brand Dry Powdered Arsenate of Lead
- Orchard Brand Arsenate of Lead, standard paste
- Orchard Brand Atomic Sulphur (patented)
- Orchard Brand Bordeaux Mixture Paste
- Orchard Brand Powdered Bordeaux Mixture
- Orchard Brand Lime Sulphur Solution
- B T S Dry Sulphur Compound (patented)
- Orchard Brand Weed Killer
- Universal Brand Dormant Soluble Oil
- Universal Brand Miscible Oil
- Universal Brand Distillate Oil Emulsion
- Liquid Whale Oil Soap

Our interests are the same as yours. Write us about your tree troubles.



General Chemical Company

770 Royal Insurance Building
Department A

San Francisco, California

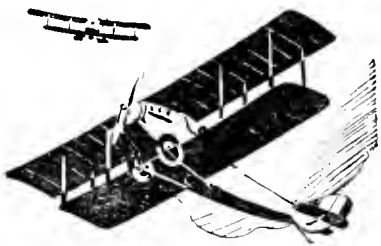

Aeroplanes

Developments in aeronautics have found us ready with a grade of Zerolene for each type of engine.

Thousands of gallons of Zerolene Liberty Aero Oil gave service to the U. S. and Allied Governments during the war.

There are grades of Zerolene for the Correct Lubrication of your automobile, truck and tractor. Ask your dealer or our representative.

STANDARD OIL
COMPANY
(California)



*A grade for each
type of engine*

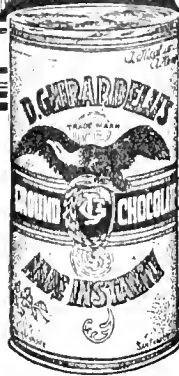

SHE has a good time at *her own party*—does the hostess who serves Ghirardelli's Ground Chocolate. Whether it's an "afternoon at home"—an informal evening—or some guests who "drop in" unexpectedly—Ghirardelli's offers the happiest solution to the refreshment problem. So delicious, so economical, so easily made!

Never sold in bulk—but in cans only. In ½ lb., 1 lb., and 3 lb. sealed cans—at the store where you do your trading.

Say "Gear-ar-delly"

D. GHIRARDELLI CO.

Since 1852

San Francisco

(F1)

GHIRARDELLI'S Ground Chocolate

is used to some extent in New York and other states in raising red raspberries. It has the advantage of requiring less hand work in keeping out grass and weeds, as the cultivator can be run in both directions; and the berries can be more easily harvested from fields under this system.

If the hedge or linear system is used the horse cultivator can be run in one direction only and more hand hoeing is necessary. Under these systems the red varieties usually should be set from 2 to 3 feet apart in rows which are 6 to 8 feet distant. In the eastern United States six feet is the most common and desirable distance between the rows for the shorter caned varieties, such as the Ruby and Marlboro, and seven and eight feet for the tall-caned varieties, like the Culbert. To use two horses in a plantation the rows must be at least eight feet apart. In the Pacific Northwest, where the canes grow very tall, the planting distance for red raspberries is usually two and one-half by seven or eight feet. In parts of Colorado and other states where irrigation and winter protection are necessary, the plants are usually set in rows which are seven feet apart.

Black raspberries are nearly always grown under the linear system, and in the United States east of the Rocky Mountains they should be planted in rows eight feet distant and three or four feet apart in the row. In Oregon and Washington they should be planted in rows seven or eight feet distant and from three to six feet apart in the row, depending upon the vigor of the growth in the particular locality.

The purple varieties also are grown under the linear system and should be planted four or five feet apart in rows which are seven or eight feet distant. The Columbian and other purple varieties of equal vigor should be at least five feet apart in the row, but the Royal may be set four feet apart.

If the plants are checked in both directions when set in accordance with either the hedge or linear system and are three or four feet apart in the row, it is possible to run a one-horse cultivator both ways for the first year. This will save much work and reduce the first year's expense.

In some sections, two plants of red raspberries are set together. This insures the grower against misses, and a larger crop is secured when the plantation is one year old. It will cost much more per acre to buy and set the extra plants, but in some sections the additional yield will make it profitable. However, if care is taken in setting, one plant in each place is usually sufficient.

Setting the Plants.

Before planting, the tops of the plants of all types should be cut back to six inches or less in height. To make it easy to handle the plants and to indicate the rows after setting, four to six inches of the cane should be left. If a garden patch is being planted, it is better to cut the canes back to within a few inches of the leader buds. The plants should be set slightly deeper than they

CUSHMAN

Light Weight Farm Engines

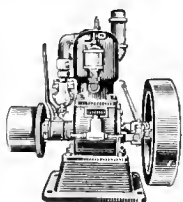

Built light, built right—for farmers who want an engine to do many jobs in many places, instead of one job in one place. Easy to move around. Equipped with Throttling Governor, Carburetor, Friction Clutch Pulley and Water Circulating Pump. (323)

4 H. P. Weighs Only 190 Lbs.

Mounted on light truck, it may be pulled around by hand. Just the engine for power sprayers because of light weight and very steady speed, giving uniform distribution and a thorough job. 8 h. p., 2-cylinder, for heavier work, weighs only 320 lbs. Book on Light Weight Engines sent free.

CUSHMAN MOTOR WORKS

978 N. 21st Street Lincoln, Neb.
Northwest Branch: 248 Hawthorne Av., Portland, Ore.
Full Stock of Repairs at Portland

Excelsior Roof Paint Direct to You

Not what you buy at the average paint store. 35 years' experience with preservative roof paint has taught me to give you a superior paint at less cost. Black, red, brown, green and yellow colors. Used for wood, tin, iron, slate, etc. **NO TAR.** It forms a thick rubber like water-proof coating over the surface to which it is applied and will withstand the hot sun, rain and snow. Applied with a brush.

Write today for samples and prices to

H. J. ARNOLD

Route 2, Box 10

Renton, Washington

formerly grew. Sometimes it is well to set red raspberries as much as three inches deeper than they grew, in order to protect them from drought. Black and purple raspberry plants should be set not more than an inch or two deeper than they formerly stood, as there is danger of smothering the tips.

An inexpensive method of setting the plants is to have the rows marked out previously and have the plants dropped every three feet along the row. The spade is thrust into the ground, the handle pushed forward, and the root placed in the space thus opened. The spade is next withdrawn and the earth firmed about the roots. Plants should not be dropped much ahead of those who are setting them, however, as exposure to the sun and wind weakens the roots.

Moisture Supply in the Soil.

From the time raspberry plants are set, they need an ample supply of moisture, and they are affected more quickly and seriously when it is deficient than most other fruit plants. In the sections where the highest average yields of red raspberries are obtained, often 6,000 quarts of fruit per acre are secured. The average for the whole country, however, is not more than 1,500 quarts and this difference is due almost wholly to a difference in the moisture supply. In the sections referred to as giving the highest yields, a deep soil furnishes a uniform and ample supply of moisture at all times. To secure the best results, therefore, the grower should, by tillage and by supplying humus, maintain a uniform and ample moisture content in his soil, not only during the growing and ripening of the fruit but also while the canes are developing. Some growers make it a regular practice each year to mulch their fields to a depth of several inches with straw, leaves, or green hay. When this practice is followed, the cost is great but the moisture supply is retained well.

In semi-arid and arid regions where irrigation is practiced, the fruiting season is longer than in most humid or non-

irrigated sections. The use of irrigation in the eastern states of late has extended the picking season and made the plants thriffter. Larger yields of fruit of the Ranere raspberry in the summer and fall have followed the irrigation of that variety and made it profitable in some sections of the East.

In the semi-arid and arid regions of the Pacific Coast, irrigation should begin almost as soon after the rainy season as is necessary for garden crops and should be continued at least until after the picking season is over. The frequency of irrigation will depend upon the local climate, the soil type, and the management of the soil. In Southern California, the plantations should be irrigated as often as every week during the fruiting season, and about once in two or three weeks during the rest of the dry season. A cultivator should be run between the rows after each application of water. When this is done the irrigation need not be so frequent, and the soil will be kept in better condition than without such tillage. Under such treatment the Surprise red raspberry will produce not only a good second crop of fruit during the late summer or early fall in some parts of California, but also some fruit almost continuously from the first picking in the spring until late autumn. In arid and semi-arid sections other than California such frequent irrigation is not often used; its frequency is determined by local conditions.

In the humid sections of the eastern states, irrigation should be used chiefly or entirely during the growth and ripening of the fruit and will pay only when an ample moisture supply can not be maintained by tillage. As the raspberry ripens its crop during the sum-

mer when droughts are likely to occur, growers have found irrigation profitable.

Intercropping.

In order to reduce the cost of intensive cultivation of a raspberry plantation during the first year after setting, other crops that need cultivation during the spring and early summer months may be grown between the rows. Among the crops best suited to this use are the tomato, cabbage, caul-

UNQUESTIONABLY—

Modern methods applied to fruit growing have made the Northwest a great fruit growing center, with possibilities of extensive development.

Modern methods applied to banking have made the FIRST NATIONAL BANK pre-eminently the ally of the horticulturist. Its facilities, service and the personal interest of its officers are at your disposal.

THE FIRST NATIONAL BANK
OF PORTLAND OREGON
THE FIRST NATIONAL BANK WEST
OF THE ROCKY MOUNTAINS

TENNESSEE, THE SOUTH'S GREATEST FRUIT ZONE

208 growing days, 55 inches rainfall, ideal soil, sunshine, climate and elevation combine to produce early bearing and heavy yields. If interested in horticultural opportunities, write Tennessee State Horticultural Society, F. D. Garrison, Field Agent, Knoxville, Tennessee.

**"CARO"
FIBRE
FRUIT
WRAPPERS**

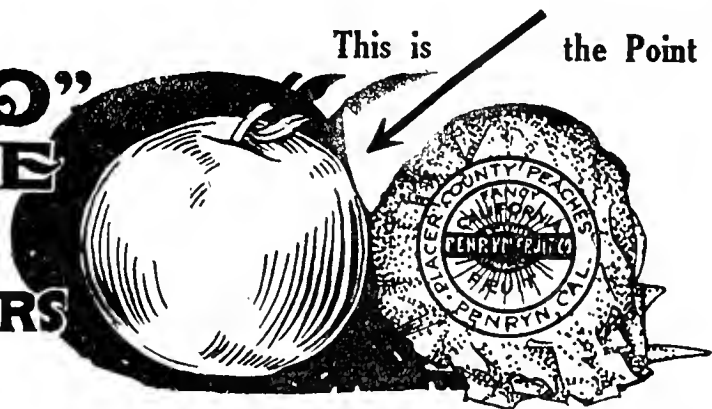

Chemically Treated
"Caro" Protects
"Caro" from DessiCARE (to dry up)

"Caro"
Prolongs the
Life of Fruit
Why?

Fruit decomposition starts from a bruise which opens tiny holes and permits the juice to escape and BACTERIA to enter. "Caro" clings closely and dries up the escaping juice. "Caro" ingredients harden the spot, kill the BACTERIA, arrests the decomposition—and thus **PROLONGS THE LIFE OF FRUIT**. If your fruit is worth shipping it is worth keeping in best condition.

Demand "CARO"—Wrap Your Fruit in "CARO"—The Fruit Buyer Knows; "CARO"

Order from Any Fruit Company or American Sales Agencies Co., 112 Market St., San Francisco

"Perhaps You Don't Know"

says the Good Judge



That nearly every wise tobacco chewer got over the big chew idea long ago.

A little of the Real Tobacco Chew gives you more tobacco satisfaction and saves you money. Its rich taste lasts a long time.

Any man who uses the Real Tobacco Chew will tell you that.

Put Up In Two Styles

RIGHT CUT is a short-cut tobacco

W-B CUT is a long fine cut tobacco

Weyman-Bruton Company, 1107 Broadway, New York City

Standardized Quality

No matter where you buy "Red Crown" you always get the same high-quality fuel. It is made to meet the requirements of your engine. Look for the "Red Crown" sign before you fill.

STANDARD OIL COMPANY
(California)



The Gasoline of Quality

Apples and Pears

For European Distribution



Gerald Da Costa

Long Acre, Covent Garden, London

Cables: "Geracost, London." Codes: A. B. C. 5th Edition and Private

flower, bean, pea, summer squash, and potato. Grain crops should not be used, as they are not cultivated and will take moisture and plant food needed by the raspberry plants. The second season no other crop should be grown, as the raspberry roots should occupy all the ground.

Tillage.

Tillage in raspberry fields must be thorough and more regular than for most other crops. If grass and weeds get a start, it is very difficult to clean the rows. Not only will it prove costly to clean them, but grass and weeds take the needed moisture and interfere with the development of new canes. If grass is allowed to make a sod in a field trained to the wide hedge system, it is usually cheaper to set out a new field than to clean out the sod.

Tillage should be thorough and regular in order to conserve moisture. Except in rainy weather, a cultivator or harrow should be used at least once each week up to picking time. Some growers consider it profitable to use it as often as twice each week, and this is sometimes necessary during periods of extended drought. The cultivation should stir the soil to a depth of two to three inches only, as part of the raspberry roots are shallow. Many growers shorten the cultivator or harrow teeth which run next to the plants, so as to disturb the young feeding roots near the surface as little as possible.

During the harvesting season the berries need an additional supply of moisture, and ordinarily the cultivation should be continued. Many growers cultivate after each picking, loosening the soil packed down by the pickers. If too much dust is carried to the fruit it may be necessary to cultivate only occasionally during the picking season. Also if no trellis or stakes are used and if the canes bend over under a crop of fruit it will be impossible to use a cultivator without knocking off too much fruit.

Later tillage is for the purpose of keeping down weeds and grasses. The fields should be free of weeds during the winter season, as many kinds start quickly in the spring and are difficult to destroy after the soil is in condition to work. Autumn tillage, however, tends to develop new growth, which is tender and somewhat more subject to winter injury than the older growth. Autumn tillage, therefore, should be avoided as much as possible where there is danger from severe winters.

The use of fertilizers in raspberry plantations is governed by the same principles that apply to their use with other fruits. As soils vary in the quantity and availability of the plant food they contain, the fertilizer problem is a local one which each grower must solve for himself. By using varying amounts of the different elements of plant food on different plots and keeping a record of the yields, each grower can determine readily what kinds and quantities of fertilizer to apply.

Good management, however, will insure a large amount of humus in the soil at all times.

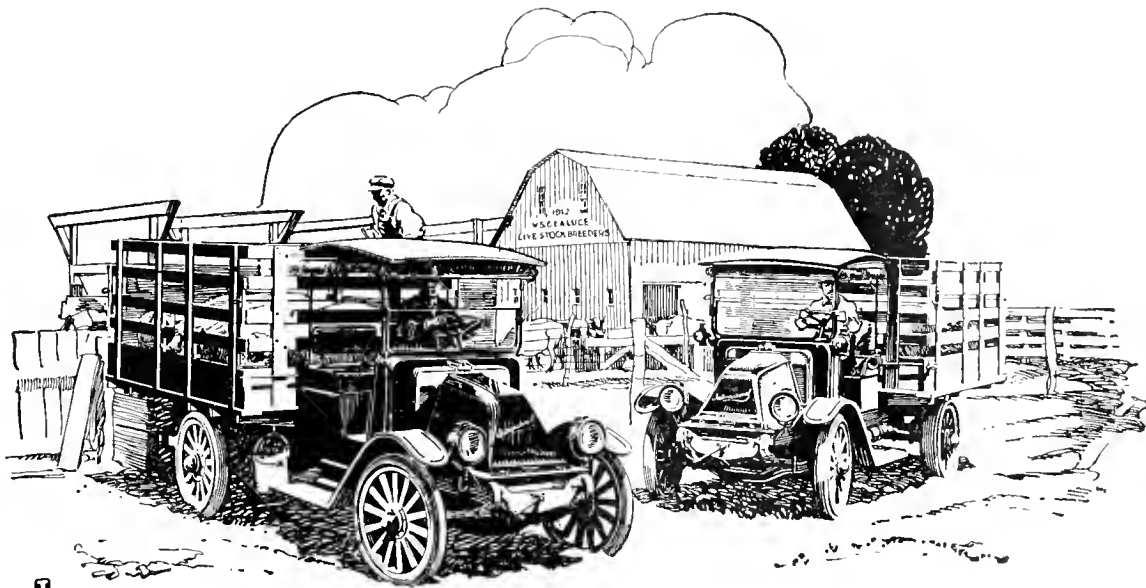

Your Rail-less Railroad

YOUR live stock and the produce from your fields, carried in freight trains to the cities, thunder past countless danger-signs with the warning, "Look Out for the Cars!" Each one of these marks the crossing-place of a country road—a road without rails, leading to railroad and town. Each one marks a farmer's right-of-way.

Since your farm is a 1920 enterprise, probably it is fitted with most of the following modern equipment—the telephone, good lighting and heating, a silo, a manure spreader, a cream separator, an automobile, an engine, a tractor.

But have your hauling problems found their proper solution? Are the time-losses and difficulties of a decade ago still impeding your endless carrying of farm loads?

Government statistics show that in

1918 alone, 350,000,000 tons of farm produce were transported to local shipping centers in motor trucks. The same national figures prove also that American farmers are the greatest users of motor trucks—among all industries. No progressive farmer can afford to overlook impressive *facts* like these.

Your name and address mailed to our office at Chicago will bring you descriptive folders that will prove interesting and instructive. Put an *International Motor Truck* at work on your farm and on the roads which are your right-of-way. Handle all your miscellaneous farm hauling with railway efficiency. The nine *International Motor Truck* sizes range from $\frac{3}{4}$ ton to $3\frac{1}{2}$ ton. Keep in mind that these trucks have been made for years by the makers of good and trusted farm machines.

INTERNATIONAL HARVESTER COMPANY OF AMERICA

(INCORPORATED)

Billings, Mont. Cheyenne, Wyo. Denver, Colo. Helena, Mon.
Los Angeles, Cal. Portland, Ore. Salt Lake City, Utah
San Francisco, Cal. Spokane, Wash.



Classified Advertisements

RATE, 4 CENTS PER WORD

NURSERY STOCK.

ITALIAN PRUNE TREES.

Cleaning up at wholesale price. State quantity and grades wanted. Don't delay. Only few more thousand to offer. Grafted walnuts, filberts, fruit trees, loganberries, raspberries, rhubarb, etc.

LAFAYETTE NURSERY CO.,
Lafayette, Oregon.

ORIENTAL FLOWERING PLANT—Japanese Fire flowering plant, beautiful ornamental foliage, bright red flowers, imported by grower, 10c package postpaid. J. A. Bean, East Seattle, Washington.

ETTERBERG 121 strawberry plants. Best canner and shipper. Heavy producer. Low quantity prices. Quality plants. Ward K. Richardson, Salem, Oregon.

EVERBEARING STRAWBERRY PLANTS—Fine healthy ones. Write for catalogue. Canyon Home Nursery, Ellensburg, Washington.

CHOICE Progressive Everbearing strawberry plants, \$2 per 100; \$12 per 1,000, postpaid. Durco Ranch, Boise, Idaho.

FOR SALE—Wilson strawberry plants, \$6 per thousand, postpaid. Wm. A. Bond, R. F. D. 6, Box 98, Salem, Oregon.

FOR SALE—Loganberry tips, 10c each, postpaid. Wm. A. Bond, R. 6, Box 98, Salem, Oregon.

SEEDS.

SEED PEAS.

Three tons per acre on unmanured upland soil; free circular on pea culture; 1917 crop sold for over \$600 per acre; also turnip and rutabaga seed, and earliest of all potatoes. W. H. Kaufman, route 2, Bellingham, Washington.

CANADIAN FIELD PEAS 6c per pound, 1/2-ton lots or more 5 1/2c per pound; Alaska peas 8c per pound, 1/2-ton lots or more 7 1/2c per pound. All our peas are reclaimed before shipped. Farmers' Alliance Warehouse Company, Fairfield, Washington.

SEEDS.

New seed catalogue mailed free—tested seeds for western planting—and experience of 26 years in the seed business. Write today, Woodruff-Boyce Seed Company, 89 Pike street, Seattle, Washington.

BANGOLIA PEAS FOR SALE—No weevil, none cracked, 6c pound F. O. B. Cheney; orders for 100 pounds or over only. Chris Betz, Cheney, Washington.

FARMS FOR SALE.

\$10,000.

AN IDEAL STOCK AND DAIRY RANCH—120 acres, all level; Stevens County, 20 miles to Spokane. All heavy sub-irrigated land; 80 acres in cultivation; fenced and cross-fenced. Excellent buildings, including stone milk house. Running spring water piped to house and barn. Bearing family orchard and 1 1/2 acres young orchard, choice varieties; 20 acres timothy meadow; 5 acres alfalfa; sufficient cord wood and saw timber to pay for place. Easy haul. Excellent location near Wild Rose Prairie. Here is your chance. Mr. Farmer. \$4,000 cash, balance to suit.

\$15,500.

AN IDEAL DAIRY FARM.

123 acres in Colville Valley, near Grays, railroad station on new state highway. Fair six-room house; excellent new barn and hay sheds, chicken-house and hog pens, etc.; 100 acres in hay, mostly alfalfa; about 20 acres in small timber, easily cleared. Running spring by house and in barnyard. Colville river runs through place, good trout fishing. No better dairy farm of same size anywhere. \$5000 cash, balance to suit.

THE BIG BENT LAND COMPANY,
Spokane, Washington.

400-ACRE STOCK FARM within 40 miles of Portland; vegetable loam, well watered; rolling, nearly all tillable; 50 acres under plow, 50 acres pasture; houses, barns, outbuildings and other improvements. Abundance and variety choicest fruit; 37 years continuous crops by owner, whose infirmity forces sale. \$20,000. Terms.

Clackamas County, 160 acres 35 miles from Portland; 36 acres cultivation; fenced, cross-fenced, orchard, house, barn, spring water supply, good road, adjoining school; best soil. \$8,000. Terms at 6 per cent.

Douglas County 160-acre mountain ranch near Ashland; good house, barn, outbuildings; partly fenced and cross-fenced; 12 acres cultivated; 2,000,000 feet saw timber; \$3000, terms.

E. PIERSON,

415 Chamber of Commerce Building,
Portland, Oregon.

FOR SALE—Ten and one-half acres of commercial orchard, lots 9 and 10, block 57, Lewiston Orchards. Seven acres in seven-year old apple trees, selected commercial varieties; three and one-half acres in cherries. In good condition; ideally situated near paved road; centralized school, church, and six miles from Lewiston, Idaho. Pipe line irrigation, fully equipped. \$8500. Discount for cash. David Olson, Kent, Ohio.

CUT-OVER LANDS.

23 miles north of Spokane, rich bottom lands, good for dairying and general farming, no irrigation, plenty of running water, free lumber, 10 years' time, 6 per cent. Call or write Deer Park Lumber Company, Deer Park, Washington, or 109 Stevens Streets, Spokane, Washington.

FOR SALE—Splendid Upper Valley Hood River Orchard Tract. Eighty acres, fifteen in best commercial varieties. Prospects 3000 to 4000 boxes this year. Balance brush land easily cleared; wonderful soil, cheap and plentiful irrigation water; good house, surpassing view. \$10,000. Hood River Abstract & Investment Company, Hood River, Oregon.

FOR SALE—\$2250 buys 50 acres of fine level land in Shasta County, California, under irrigation system, ditch on property; grows anything. Especially adapted to fruit and berries, olives, alfalfa. Latest enterprise proving great success is rice culture. About 30 acres ready for cultivation; balance slightly wooded. Address H. H. Shuffleton, Jr., Redding, California.

SNOHOMISH COUNTY, WASHINGTON—6000 acres of the finest dairy, berry or general high grade farm lands in the Northwest; rapidly improving section; no droughts; bumper crops; 1 to 80 acres; 10 yearly payments. This is your opportunity. Send for literature. Brownell Land Company, Department B, Birmingham, Washington.

CUT-OVER AND DEVELOPED LANDS, 15 to 25 miles N. E. Spokane; extra good soil; spring brooks; grows grain, vegetables, hay, fruits; several developed ranches; few stock ranches; \$10 to \$20 acre. Ten years time, 6 per cent interest. Free lumber. Write owners for free book. Edwards & Bradford Lumber Company, Elk, Washington.

MISCELLANEOUS.

CONSULTING HORTICULTURIST

Professor W. S. Thornber, formerly head of the Department of Horticulture and Landscape Gardening and later director of Extension Service of the State College of Washington, will advise with fruit growers upon all horticultural problems. If your orchard has not been a financial success and you wish to determine its possibilities or you wish to improve your orchard, reduce your losses and increase your returns, I will assist you in working out your problem. Write for terms. W. S. Thornber, Lewiston, Idaho.

TRESPASS SIGNS.

Don't allow trespassers to destroy your property. Our big waterproof and sunproof "No Trespassing" signs will keep out trespassers. Send \$1 for six signs, size 11x14 inches. Twelve for \$1.75. Sent postpaid. Out West Supply Company, Portland, Oregon.

COLORED PHOTOS—300 pictures, useful information in our 1920 Seed Catalogue. 'Tis different and free. Address Department 37, Lilly's, Seattle.

Predicts Bumper Crop of Apples.

M. L. Dean, in charge of the State Horticultural Department, after a trip that began in the upper end of the Yakima Valley and took him to Kennewick, states that the apple crop of the valley gives every indication of being equal to the bumper crop of 1919, trees appearing not to have suffered any serious damage last winter. Mr. Dean stated that the backward spring has had a tendency to retard blooming, which is encouraging. Mr. Dean was of the opinion that there will be a fairly good crop of cherries and all fruit except peaches and apricots, which will be light.

Nice Bright Western Pine

FRUIT BOXES AND CRATES

Good standard grades. Well made. Quick shipments. Carloads or less. Get our prices.

Western Pine Box Sales Co.

SPOKANE, WASH.



A Strong Banking Connection

adequate for ordinary business transactions, for export and import trade, and for investments, is offered you by this bank.

For sixty years conversant with the community problems of the Northwest, the Ladd & Tilton Bank can give you the advice of financial experts.

LADD & TILTON BANK

Portland, Oregon



Established 1882

F. W. Baltes & Company Printers

WE print anything from the smallest to the largest and always welcome orders of any size or quantity, giving prompt, personal and efficient service.

Mail or phone inquiries are solicited. We do not specialize — experience and equipment enable us to print everything equally well. We render service in preparing copy and illustrations and furnish plans and estimates for catalogs, booklets, publications, billboard and any other kind of advertising.

First and Oak Streets
Main 165; Auto 511-65
Portland, Oregon

THE WORLD-
OUR ORCHARD

STEINHARDT & KELLY NEW YORK

UNQUESTIONABLY THE
MOST IMPORTANT FACTOR
IN THE DISTRIBUTION OF
THE COUNTRY'S FANCY
APPLES
AND OTHER FRUITS

OUR MARKET-
THE WORLD

Labels

*the
distinguish
fruit of quality
by their own
quality*

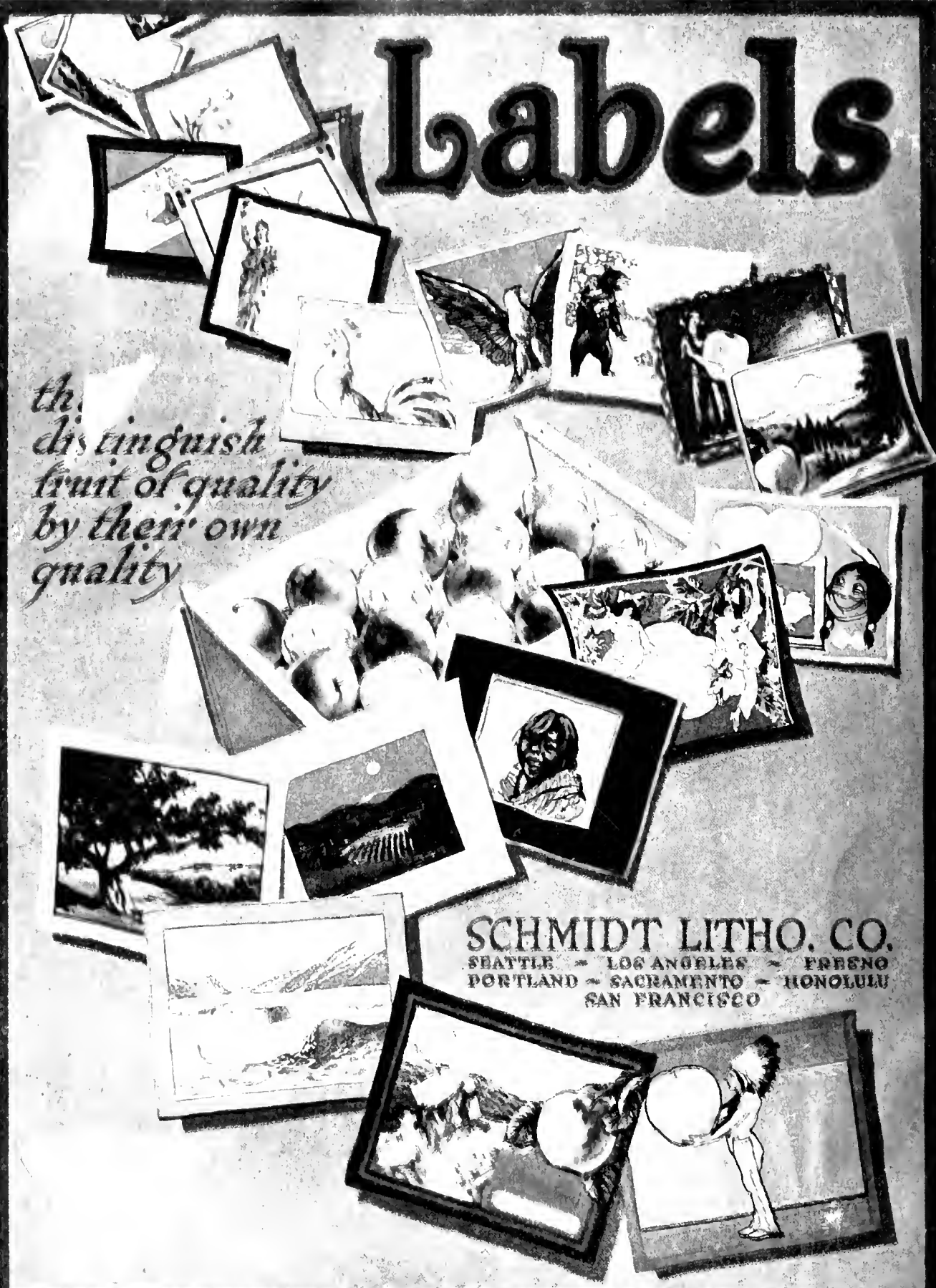

SCHMIDT LITHO. CO.
SEATTLE ~ LOS ANGELES ~ FRENO
PORTLAND ~ SACRAMENTO ~ HONOLULU
SAN FRANCISCO

JUN 16 1920

BETTER FRUIT

VOLUME XIV *Complete*

JUNE, 1920

NUMBER 12

FEATURES IN THIS ISSUE:

- The Flat-Headed Apple Tree Borer
- Birds—Their Benefit to Horticulture
- Bees as Pollenizers and Spray Injury
- Means of Accomplishing Orchard Tillage

Columbia Univ. Libr. 304dce20



FIELD OF CLOVER IN ONE OF THE DIVERSIFIED ORCHARD DISTRICTS OF THE NORTHWEST
PLANTED FOR BEE PASTURE AND FORAGE

20 Cents
The Single Copy

BETTER FRUIT PUBLISHING COMPANY, PUBLISHERS, PORTLAND, OREGON

Subscription: \$2.00 per Year in the United States; Canadian and Foreign, including Postage, \$3.00. Payment in Advance. Exchange

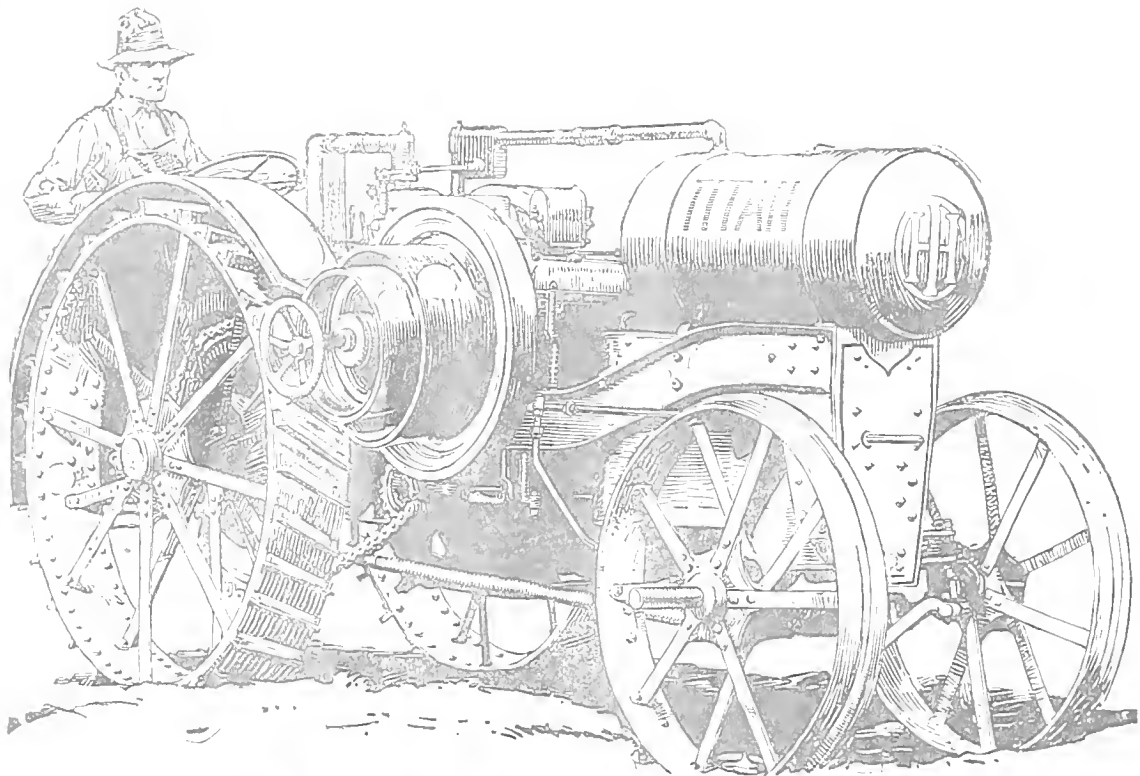

Drawbar Time— and Titan Tractors

FOR thorough reliability in drawbar time put your trust in Titan 10-20. Be sure that your new tractor is thoroughly right for plowing, seed-bed making, harvesting, etc.

Rely on the good material in Titan construction, and in kerosene economy. Be sure of practical details and conveniences—such as Titan wide fenders, comfortable platform and seat, and adjustable drawbar—making for day-after-day satisfaction in the field.

A little later when the belt-power season looms biggest, such essentials as the throttle governor, and the large, wide friction-clutch pulley in Titan 10-20 will demonstrate again the wisdom of your choice.

When you make your power investment, remember the reputation of the International Harvester tractors, and the security in International Service. *Early decision and action is necessary!*

INTERNATIONAL HARVESTER COMPANY
OF AMERICA

(INCORPORATED)
Billings, Mont. Cheyenne, Wyo. Denver, Colo. Helena, Mon.
Los Angeles, Cal. Portland, Ore. Salt Lake City, Utah
San Francisco, Cal. Spokane, Wash.

That great riding comfort found also in the New Mitchell

WITH all the betterments in the New Mitchell, we have not changed the suspension. We retain those famous cantilever springs that have already won approval everywhere.

Bodies are roomier, upholstering is finer and deeper—but it is impossible to design or make springs that are better. On thousands of Mitchells these especially designed cantilever springs have proved their worth. They bring the utmost in comfortable riding. And they never break.

The New Mitchell looks new and is new throughout, with such few exceptions as above.

Note the new body lines, bringing the latest and accepted style. Note the fine top, the real leather upholstery, all the equipment.

Then, like everyone else who inspects this creation, you will recognize its over-values. We are able to offer you a better car at a fair price because we built it *complete*. We do not assemble.

The New Mitchell is the sensation of the year. It is selling faster than we can build. That means that you should investigate it before you buy.

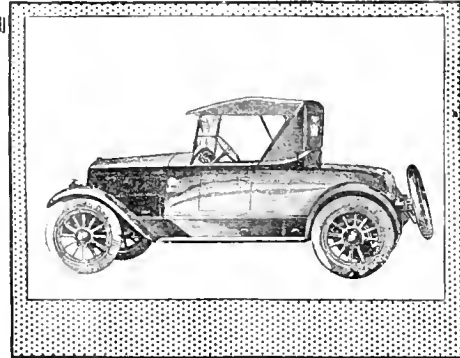

Built to stay new

THIS has been our idea in car building for four years. We have developed it to the limit. We have been able to prolong newness. By building with better materials, by adding extra finish.

We are able to build in those lasting qualities because we supervise every process, from buying raw materials to the completed job. We are not dependent upon outside parts makers.

So we not only save money for you, but we guard your interests in building for you a real economy car.

Upkeep and operating costs have been brought to a new minimum. We know, because our parts department has reached a low ebb in replacements.

The body as well as the mechanical unit is built to stay new. We build the bodies ourselves. We add extra strength, extra braces. We go to extremes that are rarely practiced in cars of this price. A finer body is impossible, for we follow, and have created, some of the accepted standards of custom building.

For a long-life, comfortable, economical and stylish car—at a saving in initial cost, as well as later, this New Mitchell commands your attention. We do not believe that you can find its equal at the price.

Go to a Mitchell dealer, make comparisons. See what this New Mitchell offers. Then, if you agree that it is the finest car at the price, place your order early, so as to insure early delivery.

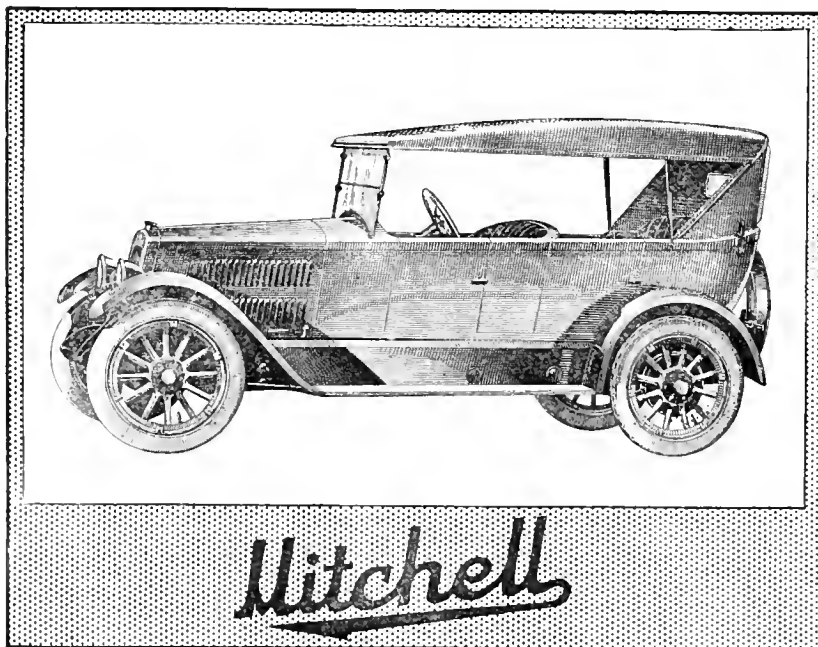

MITCHELL MOTORS COMPANY, INC., RACINE, WISCONSIN

Mitchell Motor Cars distributed in
The Pacific Northwest by

Also sold by the leading dealers in nearly
every town in the Pacific Northwest



Portland and Spokane

Seattle Dealers, Mitchell Motors & Service Co.
Tacoma Dealers, Puget Sound Motors Co.

The Cutler Fruit Grader

For Box, Basket or Barrel Packing

Manufactured
Since
1912

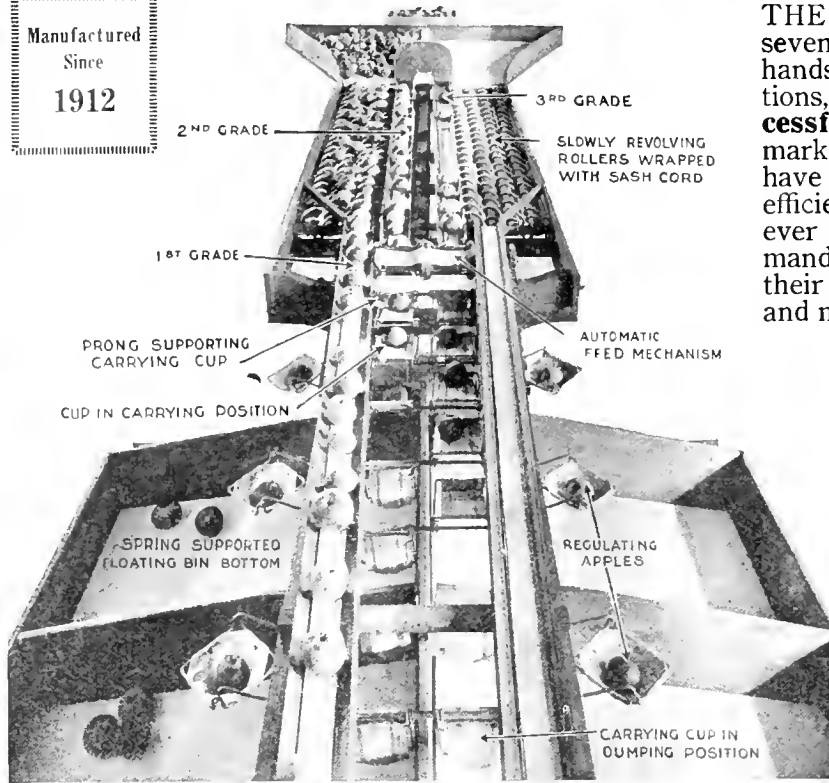

Upper View of a portion of the Four-Section Model for box packing, showing the Mechanical Sorting Table. No hand feeding necessary. The fruit is fed automatically. This table slowly revolves the fruit as it is moved forward before the sorters. Our belt type of sorting table can be furnished if desired.

THE CUTLER FRUIT GRADER, after seven years of manufacture and use in the hands of leading fruit growers and associations, stands preeminently **The Most Successful and Practical Fruit Grader** on the market today. With the improvements we have made our 1920 models are the most efficient and satisfactory machines we have ever manufactured and will meet the demands of all growers who want to handle their crops at the least expenditure of time and money.

New Features

We have perfected two extra attachments to our graders which we are putting out this season, viz:

(1) **Off-Grade Return Belts** which afford a means for bringing back to the sorters the off-grade fruit found in the bins. This makes an immediate check on the sorters and will result in a better grade of fruit being packed.

(2) **Separation of Cull Fruit into Canning and Cider Stock.** This attachment takes the place of the regular cull belt on all our tables and automatically separate the cull fruit into canning and and cider stock without any labor cost.

With a Cutler Grader you can handle your crop quicker at the least cost of sorting, packing and handling and you do not have to depend on skilled packers. **A Cutler Grader** will soon pay for itself in the saving made in the handling of the crop.

*Eventually You Will Buy a Cutler Grader
Why Not Now?*

Don't put off ordering your packing house equipment. The situation this year in the obtaining of material for manufacturing is such as to make the placing of early orders absolutely necessary.

Fill out the coupon below and mail to us today. You may regret not doing so.

Box Presses

See the the Cutler Press before buying. We have the best press on the market today.

We carry a stock of the CALIFORNIA GRIP TRUCKS

Write today for Catalog and Prices

Cutler Manufacturing Co.

353 EAST TENTH STREET

PORTLAND, OREGON

Cutler Manufacturing Co.

353 E. Tenth St., Portland, Oregon.

Please send descriptive circulars and prices of the equipment as indicated below.

Check the equipment you are interested in.

..... Grader. Gravity Carrier.
..... Box Press. Grip Trucks.

Crop expected in 1920.....boxes.

Name

Address

BETTER FRUIT

EDITOR: W. H. WALTON

STATE ASSOCIATE EDITORS

OREGON—C. I. Lewis, Horticulturist.
WASHINGTON—Dr. A. L. Melander, Entomologist;
O. M. Morris, Horticulturist, Pullman.
COLORADO—C. P. Gillette, Director and Entomologist;
E. B. House, Irrigation Expert, State Agricultural College,
Fort Collins.
ARIZONA—E. P. Taylor, Horticulturist, Tucson.
WISCONSIN—Dr. E. D. Ball, Madison.
MONTANA—H. Thorner, Victor.
CALIFORNIA—C. W. Woodworth, Entomologist, Berkeley;
W. H. Volk, Entomologist, Watsonville; Leon D.
Batchelor, Horticulturist, Riverside.
INDIANA—H. S. Jackson, Pathologist, Lafayette.

An Illustrated Magazine Devoted to the Interests
of Modern, Progressive Fruit Growing
and Marketing.

PUBLISHED MONTHLY BY

Better Fruit Publishing Company

703 Oregonian Building

PORTLAND, OREGON

All Communications should be addressed and
Remittances made payable to

BETTER FRUIT PUBLISHING COMPANY

SUBSCRIPTION PRICE:

In the United States, \$2.00 per year in advance,
Canada and Foreign, including Postage, \$3.00,
payable in American exchange.

ADVERTISING RATES ON APPLICATION

Entered as second-class matter April 22, 1918,
at the Postoffice at Portland, Oregon, under
the Act of Congress of March 3, 1879.

VOLUME XIV

PORTLAND, OREGON, JUNE 1, 1920

NUMBER 12

The Flat-Head Apple Tree Borer—Methods of Control

By Fred E. Brooks, Entomologist, Deciduous Fruit Insect Investigations U. S. Department of Agriculture

OF the several kinds of wood and bark boring insects which attack fruit trees in the United States, the flat-headed apple-tree borer is one of the most widely known. The adult form is a medium-sized beetle, native to American forests, which has attacked cultivated fruit trees since the pioneer days of orcharding in this country. It is now known to occur in nearly every state of the union and also in southern Canada. Throughout this region it injures every year a great variety of fruit trees, as well as many kinds of shade and forest trees.

Trees of almost any size after they are one or two years old may be attacked, but, as a rule, injury is confined to those that have already been weakened by some other agency, or that are abnormal either in their position or in general health. Trees that are newly transplanted, that have assumed a leaning position, that are deficient in vigor from starving or over-bearing, that have been subjected to the injury of the trunk or branches by sun-scald or other diseases or weather conditions, or that have suffered injury from tools, rodents, or insects, invite attack by this insect. On the other hand, trees that are normally vigorous, upright in growth, and have sound, healthy bark, very rarely, if ever, are injured by the flat-headed borer.

Location and Nature of Injury

Injury to trees is done by this insect only while it is in the larva or grub stage, and the species receives its common name from the fact that the grub is flat-headed. The grubs or borers enter the bark of the trunk of the larger branches and feed between the bark and sapwood until about full grown. They then usually burrow a short distance into the wood, where they pass the winter and, in the spring following, change to the pupa, or resting stage and a little later into beetles. The burrows in the bark and sapwood are broad and irregular in shape, the form depending very much upon the size of the tree and thickness of the bark. In old trees most of the feeding is done in the thick inner bark, and the wound made is often more or less circular in outline. In young trees the feeding is

mostly from the sapwood, and the wound is likely to be more elongate, often encircling the tree and killing it.

The borer while feeding keeps a clear space around itself to allow of free movement, but packs the excavation behind with a compact mass of digested wood particles. In large trees injury almost invariably is confined to the sunny side. In such a place a wound that was small in the beginning may be enlarged year after year by succeeding generations of the borers working around the borders of the wound at the point where the live and dead tissues of the tree meet.

Scarcely any castings are thrown out, and the place where borers are at work is not always clearly marked on the surface of the bark. Injured spots, however, usually can be detected from the outside by the darker color and slight depression of the bark and often by cracks which form in the bark, through which the frass (excrement) shows. Usually, where an area on the trunk of a tree is killed by borers, a strip of dying wood soon extends some distance above it, and this strip is in turn attacked and enlarged by the borers.

Food Plants

Following trees and shrubs are known to be attacked by the flat-headed apple tree borer: Apple, pear, peach, apricot, plum, prune, cherry, quince, currant, walnut, pecan, hickory, Carolina poplar, willow, weeping willow, beech,

chestnut, oak, elm, hackberry, sycamore, mountain ash, service berry, hawthorn, redbud, sugar maple, soft maple, horse-chestnut, linden, Japanese persimmon, and box elder. Where orchards are planted adjacent to woodlands, the beetles often come from the forest trees and deposit eggs in the fruit trees before they have recovered from the shock of transplanting. The borers hatching from the eggs deposited on the newly-set trees find the devitalized bark and wood exactly to their liking, and often girdle and kill many of the trees. After the trees have had one season's growth, they are usually safe from attack so long as they are kept in a vigorous condition.

Appearance and Habits of the Insect The Adult

The adult of the flat-headed apple-tree borer is a broad, flat beetle, averaging about half an inch in length by less than one-fourth of an inch in width, though individuals differ considerably in size. It tapers from the center towards both ends. The color of the back is dark brown, indistinctly marked with spots and irregular bands of dull gray, the whole, when viewed under certain conditions of light, having a slight brassy sheen. The underparts of the body are bronze, and the back beneath the wings is brilliant metallic greenish blue. In flight the beetles produce a musical buzzing sound not unlike the humming of a bee.

The beetles issue from the wood soon after the blooming period of the apple, and remain upon the wing for several weeks. They are active, run rapidly, and take flight quickly when disturbed. On hot, clear days they may be found on the sunny side of the trunks and larger branches of their host trees, where mating takes place and where the eggs are deposited. The female spends much time running with an intermittent gliding movement over the bark, feeling out places with her ovipositor for laying her eggs. When a suitable crack or opening in the bark is found she inserts her slender, tube-

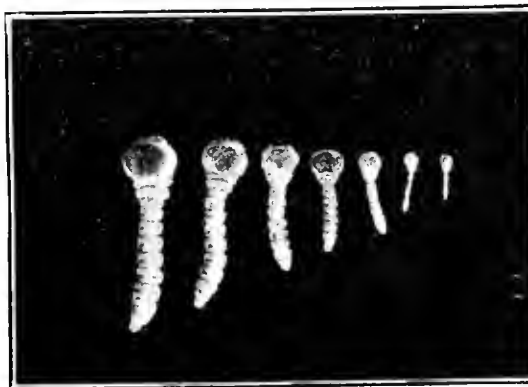

Flat-headed apple tree borers to be found in infested trees at almost any season of the year. Natural size.

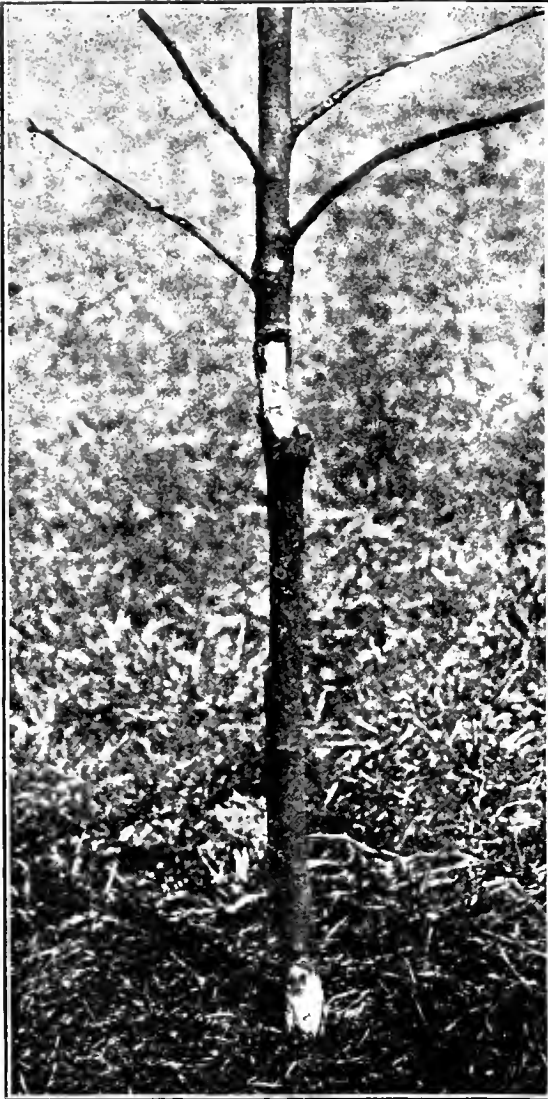

Apple tree first year after transplanting, girdled and killed by flat-headed apple tree borers.

like ovipositor into the opening and then remains quiet for a few seconds while the egg is being placed. After the egg is disposed of she moves on in search of other places for ovipositing. It very frequently occurs that one or more females, while engaged in egg laying, will visit a single opening in the bark several times, resulting in a small group of eggs being placed near together. The borers hatching from such groups of eggs feed away from the center in opposite directions, and often eat out a large connected series of burrows.

The Egg

The egg, which is pale yellow in color, is flattened, disk-like, and wrinkled, and is about one-twentieth of an inch in diameter. It is attached firmly to the bark by its flat surface and hatches in from 15 to 20 days. The eggs are usually concealed beneath a scale of bark or within a crack or wound in the bark. A single female probably produces on an average not far from 100 eggs.

The Larva

The larva is a yellowish-white, footless grub, which attains a length of about one inch. The three segments of

the body next to the head are swollen and flattened, which accounts for the names "flat-head" and "hammer-head," by which the species is commonly known. The larva is usually found curved like a horseshoe, and is sluggish and inactive except in very warm weather.

On hatching, the larvæ usually enter the bark from directly beneath the egg, and, if the wood is in favorable condition, burrow at once into the inner bark, where they feed on the bark and sapwood and develop rapidly. If, on the other hand, the tree is vigorous and full of sap, the borer is unable to thrive within the growing tissue and may soon die or may live for months just beneath the hard outer layer of bark, where it obtains barely sufficient food to maintain life. Under such conditions the borer sometimes lives for a year or longer, surviving the cold of winter but making scarcely any growth. In time it dies a slow death by starvation, unless that part of the tree where it is located should become sufficiently enfeebled for the borer to penetrate to the inner bark undisturbed by the flow of sap. Where such a condition arises the previously starved borer begins at once to grow and develop, but its period of existence in the tree may be lengthened by a year as a result of unfavorable conditions in its early life.

Under favorable conditions the transformation from egg to adult covers a period of one year, but where the development of the larva is retarded by insufficient food, as described above, the period may be lengthened to two years and possibly longer.

It not infrequently occurs that the bark of trees that are but slightly on the decline, or, especially, those that have assumed a leaning position so that the sun's rays fall directly upon the trunk, will contain constantly for years these little, starved flat-headed borers that are unable to come to maturity. If such trees continue to decline, the time is sure to come when the borers can penetrate to their favorite feeding place and complete their transformation. After this the injury to the tree is likely to increase rapidly.

Late in the summer the borers that are approaching maturity burrow abruptly into the wood to a depth of from less than an inch to several inches, and at the end of their slender gallery in the wood construct a flattened pupal chamber in which they pass the winter. After the borer settles in the pupal chamber its color changes to a deeper shade of yellow. In the southern part of its range pupation often takes place within a cell constructed between the bark and wood, adjacent to the feeding galleries.

The Pupa

The pupa averages one-half inch in length and one-fourth inch in width, and resembles in shape and dimensions a small pumpkin seed. When first formed it is yellowish-white, but later its rudimentary eyes, legs, thorax and other parts of the body take on a metallic brown color. In from three to five weeks it transforms to the adult stage and the beetles escape from the wood by means of the entrance galleries of the larvæ.

Natural Enemies

The flat-headed apple-tree borer falls a prey to a number of natural enemies which destroy it during its larval, pupal, and adult stages. Woodpeckers devour many of the insects by penetrating to their feeding places in the wood, and the United States Biological Survey has found the beetles in the stomachs of the common crow, kingbird, and red-eyed vireo. Among insects, ants seek out and devour both larvæ and pupæ while they are in the wood, and six hymenopterous parasites are known to attack the species.

Methods of Control

In the control of the flat-headed borer nothing is more important than such cultural methods as will keep the trees in a normally vigorous and growing condition. Such trees are rarely, if ever, injured. All the well-known orchard practices, such as cultivation, fertilization, spraying, and pruning, have an important effect in lessening the possibilities of injury from flat-headed borers. Such practices tend to keep the trees thrifty and resistant to borer attack.

Trees should be maintained in an upright position, and, where practicable, should be headed low in order to reduce the chances of sun-scald and winter crackling and killing of the bark, both of which invite borer attack. Low-

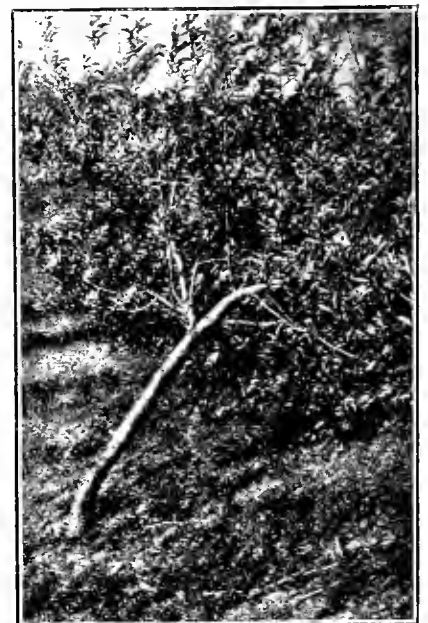

Leaning apple tree with trunk exposed to direct rays of the sun. Flat-headed borers may always be looked for in such trees.

headed trees also have their trunks shaded during the summer, and the sun-loving beetles will not alight upon them to deposit eggs.

Eggs may be deposited upon perfectly healthy bark, but the young borers which hatch from eggs so placed are not able to develop, probably for the reason that their burrows, as soon as they extend to the growing tissue, become filled with sap and the borer has to recede or be drowned.



Adult flat-headed apple tree borer. Enlarged.

Newly transplanted trees sustain the greatest loss from this insect because it is impossible to avoid a period of retarded growth following the removal of the trees. After being transplanted, trees should be watched carefully throughout the summer and the borers removed with a knife before they have had time to make deep wounds in the bark and wood. The knife should be used with great care to avoid unnecessary cutting of the bark at a time when the tree is already weakened. An excellent practice where trees are planted near woodlands, or in any position where flat-headed borers are likely to be numerous, is to shade the trunk of the tree by means of a board driven



Flat-headed apple tree borer feeding between the bark and wood of apple tree.



Pupae of flat-headed apple tree borer. Enlarged.

into the ground on the south side of and close to the tree. The shadow on the trunk repels the female beetles while they are looking for places in which to deposit eggs. Boards six inches wide and slightly longer than the trunks of the trees are suitable for this purpose.

The beetles during the period of egg-laying make short and frequent flights to examine all sorts of trees and logs. Through this habit they may be trapped by setting poles post-fashion in the orchard and covering them with some lasting sticky material that will en-



Flat-headed apple tree borer in pupal cell in heart of young apple tree.

tangle and hold the beetles when they alight. Newly cut logs of almost any size can be made to answer the same purpose by placing them in the orchard and treating the surface with some sticky substance. Oak, hickory, chestnut, willow, or almost any kind of poles or logs may be used, as the beetles do not appear to discriminate before alighting.

When trunks of trees are injured accidentally by cultivators or other tools the torn fragments of the bark should be pared away and the whole injured surface treated with a heavy coat of white lead paint or some good tree paint. This will prevent borers from entering around the borders and extending the wounded area.

Occasionally the bark of a tree is badly bruised by hail, the injury being followed by flat-headed borer attacks. In such cases, where possible, the trees should be stimulated by cultivation and fertilization to make a quick, strong growth in order to prevent or overcome borer injury. The bruised surface

of the trunk and larger branches should also be covered with a coat of paint.

In any case where paint is applied, it is well to see that the coat is in good condition immediately following the blooming period of apple, for it is at about this time that the beetles appear and begin egg laying. Kerosene emulsion, nicotine sulphate solutions, soapy and alkaline washes, and other penetrating caustic and poisonous materials have been applied as sprays and in other ways to infested trees in the hope that enough of the materials would soak through the bark to kill the borers. Such treatments, however, have usually proved disappointing, although in some cases, when applied early in the season, a considerable portion of the very small borers have been destroyed. Burlap or paper wrapped around the trunks of trees will prevent the beetles from ovipositing on the bark. When this method is used, the wrappers should extend from the ground to the branches, and should be tied at the top and mounded with earth at the bottom. The wrappers should be removed at the end of the egg-laying season.

Dying trees and newly cut logs and prunings should never be left standing or lying about the orchard from one season to another. This applies to trap poles and logs used to catch the beetles and to dying wood of fruit and forest trees of almost any kind. Such wood may contain numbers of flat-headed borers that would change to beetles in the spring and deposit eggs within the orchard trees, providing thereby for a new generation of borers. All such wood should be burned during the autumn or winter or in the early spring before the blooming time of apple trees.

UNQUESTIONABLY—

Modern methods applied to fruit growing have made the Northwest a great fruit growing center, with possibilities of extensive development.

Modern methods applied to banking have made the FIRST NATIONAL BANK pre-eminently the ally of the horticulturist. Its facilities, service and the personal interest of its officers are at your disposal.

THE FIRST NATIONAL BANK
OF PORTLAND OREGON
THE FIRST NATIONAL BANK WEST
OF THE ROCKY MOUNTAINS

Birds—Their Practical Benefit to Horticulture

By George A. Blair

BIRDS have a definite place to fill in the economy of nature. They are the principal check on insect life. For years the experts of the United States Biological Survey have been making tests to determine which birds are more useful to man. These investigations have shown that with rare exceptions birds are useful everywhere and that without their help successful agriculture would be impossible.

About thirteen thousand species of birds are known to science; twelve hundred of these species inhabit the United States. We find the sparrows, thrushes, wrens and many others, which feed on insects in or near the ground. Others, such as woodpeckers and sapsuckers are arboreal in their habits, preying on the many kinds of insects which infest our orchards and forest trees.

The bark of trees forms a favorite shelter for numerous insects. The wrens, nuthatches, warblers and creepers, with the sharpest of eyes and slenderest of bills detect our foes and dislodge them from crevice and cranny. The air is full of flying insects in spring and summer. It is the swallows, the purple martins and the swifts which take care of these. At nighttime the whippoorwills, night-hawks and chuckwills-willow keep up the good work while the swallows and martins sleep.

Thus, every family of birds plays its own part in the warfare against insects, and by so doing contributes to man's welfare. When the quail eats Texas fever carrying ticks (which southern quails do); when the killdeer and other shore birds eat hundreds of larva of the malaria and yellow fever carrying mosquitoes; when a nighthawk's evening lunch consists of five hundred of the adult mosquitoes; they contribute a great benefit to public health.

The economic value of birds to man lies in the service they render in preventing the undue increase of insects, in devouring small rodents, in destroying the seeds of harmful plants, and in acting as scavengers.

Mr. E. H. Forbush, ornithologist of the board of agriculture of Massachusetts, states that the crops of four chickadees contained 1,028 eggs of the cankerworm. The stomach of four other birds of the same species contained about 600 eggs and 105 female moths of the cankerworm. The average number of eggs found in 20 of these moths was 185, and it is estimated that a chickadee may eat 30 female cankerworm moths per day during the 25 days which these moths crawl up trees, it follows that in this period each chickadee would destroy 138,750 eggs of this noxious insect.

The benefit derived by having the seed of noxious weeds destroyed by our feathered friends cannot be overestimated. From late fall to early spring seeds form the only food of certain birds, and every keeper of cage-birds

can realize how many seeds a bird may eat in a day. Thus, while the chickadees, nuthatches, woodpeckers and some other winter birds are ridding the trees of myriads of insects' eggs and larvae, the granivorous birds are reaping a crop of seeds which, if left to germinate, would cause a heavy loss to our agricultural interests.

The service rendered to man by birds in killing the small rodents so destructive to crops is performed by hawks and owls—birds which the uninformed consider enemies. The truth is that, with two exceptions—the sharp-skinned and cooper's hawk—all our common hawks and owls are beneficial.

Here are a few records as to the value of certain bug eaters: A quail killed in a cotton field in Texas had in its crop the remains of 127 cotton boll weevils. Another killed in a potato field in Pennsylvania had in its crop the remains of 101 potato bugs. Another killed in a Kansas wheat field had in its crop the remains of over 1,200 chinchbugs.

Mrs. Margaret M. Nice, of Cambridge, Massachusetts, has made an exhaustive study of the food of Bob White. Instead of killing the birds and analyzing the contents of the crop, she has worked by the living feed-test method. That is, she has offered different foods to the birds and has counted and weighed the amount eaten. The total food for a day forms a natural unit in this work, and a great many of these daily dietaries have been studied, among them we may quote a few: 1,350 house flies eaten in one day by a laying hen, along with weed seeds and green food; also another time 5,000 aphids and 1,285 rose slugs; 37 grasshoppers and 2,400 seeds of pigeon grass by a six-weeks old chick; also 65 large black crickets, half of these must have been females and packed with eggs; 84 grasshoppers by a seven-weeks-old chick; 700 insects, 300 of them grasshoppers, by a laying hen in July; 48 grasshoppers by an adult hen in October.

Tests were made to determine how many weed seeds a quail would eat in a day. Some of the results are:

Curled dock	1,175
Pigweed	12,000
Plantain	12,500
Smartweed	2,250
Lambs quarter	15,000

The Bob White has been known to eat 135 different kinds of insects, many of them the most injurious we have: The potato beetle—which few other birds eat—cucumber beetle, cutworm, army worm, wire worm, chinch bug, cotton boll worm, and cotton boll weevil.

These studies, which constitute the most complete and careful investigations ever made of the food of any bird, have enabled Mrs. Nice to estimate that a Bob White hen will eat an average of 75,000 insects and 6,000,000 weed seeds in a year—about 7½ pounds insects and

100 pounds of weed seed. The natural life of a quail is about ten years, so that each of these birds may be supposed to eat during its lifetime 7,500,000 insects and 60,000,000 weed seeds. Yet there are thousands of men who delight to go out in the fall and kill every quail they can find! A dead quail is worth in the market possibly \$4. A man may eat it in a few minutes and forget it. What a shameful ending for such a useful and so valuable a friend of mankind. A few years ago there were millions of quail all over the southern, middle and eastern states; today they are almost extinct everywhere.

A pair of Bob Whites in domestication have produced 100 eggs in a season. Five hens laid an average of 65 eggs apiece. To hold the insects in check and to destroy the weed seeds we need to have our gardens, fields, pastures and roadsides literally alive with these useful birds. A prairie chicken killed in a cotton field in Texas had in its crop the remains of over 300 cotton boll weevils. A few years ago there were millions of prairie chickens in all the states. Today they are absolutely extinct in several states and on the verge of their finish in all others.

An ornithologist who has carefully studied the ruffed grouse (commonly called pheasant or partridge) has estimated that each adult bird of this species eats two and one-half bushels of insects every summer. There are nearly 200 species of insects that injure apple trees or apples, and nearly as large a number that attack pear trees, peach trees, plum trees and cherry trees. There are 107 species of bugs that prey on elm trees, 264 that attack poplar, 396 that prey on the birches, 154 that work on beech trees, and over 400 that attack oak trees.

Fitch once computed the number of plant lice on a single cherry tree to be 12,000,000. Chinch bugs have been found in a small clump of bunch grass eight inches in diameter to the number of 20,000. J. F. Parker of Manhattan, Kansas, says he counted 6,000 under similar conditions, but had to desist on account of more pressing duties. Wiley once computed that the hop aphid, developing thirteen generations in a single year, would, if unchecked to the end of the twelfth generation, have multiplied to the number of ten sextillions. C. L. Marlatt calculated that the Hessian fly damage to the wheat crop in 1900 was \$100,000,000. The chinch bug as early as 1864 damaged staple crops \$100,000,000, and Wiley placed the damage at \$73,000,000.

Beal says many crops of the Franklin gull showed 48 to 90 grasshoppers each. House martins, swallows and swifts eat rose beetles, May beetles, cucumber beetles and house flies, practically all which are caught on the wing. Otto Widman says 32 parent martins made 3,277 visits to their young with insects in one day. C. C. Musselman

Continued on page 23.



Easy going on a track,
the CLETRAC way.

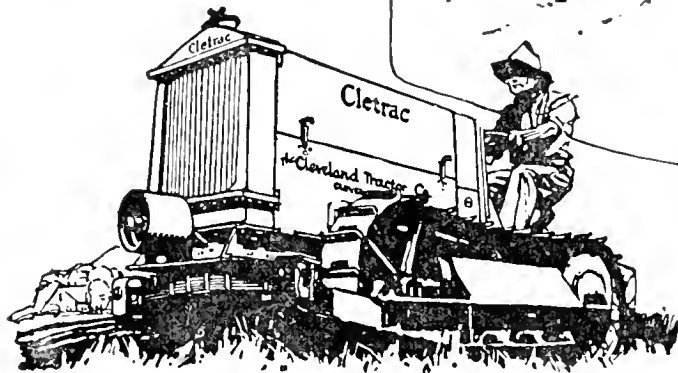

RAPID DISCING

Speed up your discing work by putting a CLETRAC on the job. This sturdy little tractor, powerful, rapid and tireless, will replace six to eight horses, work twenty-four hours a day if necessary and seven days a week. Used alone or in "fleets," the CLETRAC is the ideal tractor for every size ranch—for every type of work.

The CLETRAC travels lightly over the surface of the ground with a firm, sure tread, without sinking in or packing the soil. It gets the corners also because it can turn short. In the orchard, too, the CLETRAC is at home. Low hung, with no projections, it weaves in and out among the trees without injuring them. Let the CLETRAC shoulder *your* problems. Write today for that interesting booklet, "Selecting Your Tractor"—it's free.

Pacific Coast
Sales Offices:

LOS ANGELES, CAL.
SAN FRANCISCO, CAL.
SPOKANE, WASH.

The Cleveland Tractor Co.

19145 Euclid Avenue
CLEVELAND, OHIO

Largest producers
of Tank Type
Tractors
in the world.

One of the more than 1,200 CLETRAC dealers with repair stocks is near you.

Honey Bees as Pollenizers and Spray Injury

By Susan M. Howard, in Massachusetts Report State Board of Agriculture

TREATING the subject as a fruit grower as well as a beekeeper enables the writer to appreciate the inestimable value of the honey bee as a pollenizer of certain grains, small fruits, vegetables and tree fruits. The discussion is attempted in plain terms without resorting to confusing botanical technicalities. The writer will feel amply repaid if the article is stimulative of even a minor inquiry into the ways of bee nature.

Today the honey bee is more and more considered an invaluable ally of the farmer. The orchardist and small fruit grower consider their colonies as a part of their equipment, and their use as much a factor in the success of horticulture as is cultivation, application of fertilizers, the growing of cover crops, pruning, spraying and the like. To the farmer, especially if he be a fruit grower, a honey crop may be regarded as secondary, or as a by-product, while to the beekeeper it is the primary product. Thus while the ultimate aims of the horticulturist and beekeeper may be different, yet they are interdependent.

While the orchardist may profit by the visits of bees from nearby apiaries, or from a wild colony in a tree, roof or chimney, yet the uncertainty of their service is so great that the forehanded fruit grower provides a sufficient number of colonies at hand and among his trees. In this connection it may be said that it is not absolutely necessary to place the colonies actually in the orchard, yet they should be not far distant. Furthermore, the location of the bees should not prevent satisfactory cultivation.

As a factor of the importance of bees near by an orchard, it may be cited that the distance at which bees gather pollen is limited, seldom exceeding one-half mile, which emphasizes the desirability of bees at close range. On the other hand, bees will forage for honey at a greater distance, up to about three miles from the hive. Nevertheless, they prefer frequent and short trips. Thus if a radius of three miles be allowed,—that is, a diameter of six miles—the area of the circle would be 28 square miles, or 18,080 acres, a part of which territory would be imperfectly worked. It should be remembered that bees foraging for honey frequently serve as the bearers of pollen in cross-pollination, as well as bees foraging for pollen alone. It is this search of the bees for their food which prompts their inestimable service to the fruit grower. The means and mechanism of their operation, though mechanical yet intricate, is referred to below. Being mechanical, it might be accomplished by man at great expense and with exceeding labor, but this is generally recognized as impracticable from the commercial standpoint. Bee labor is far cheaper than human labor.

This expensive process of hand pollination is exceptional and only one case is reported. In this instance the process was resorted to by a cucumber grower to whom the sting of the honeybee was seriously poisonous. The process, however, is exceedingly old, and according to Herodotus is known to have been practiced five centuries before the Christian era. Much the same method is today reported as that used by this cucumber grower who has re-

sorted to hand pollination, and who employs the tip end of a stiff feather by which he transfers the pollen of one flower to the sensitive pistil of another. In contrast to this laborious method, the far more common practice of the growers of cucumbers under glass is to utilize a colony or more of honeybees in their greenhouses. Thousands of colonies of bees are thus used in the hothouses around Boston and in Massachusetts. Unfortunately, too, many or most of these are sacrificed, as the growers make little or no effort to save the colonies which have served them so faithfully in the tropical climate of the greenhouse—conditions adverse to their well-being.

The Function of the Honeybee in the Transfer of Pollen.

It is far from the purpose of this paper to enter the vast and intricate field of hybridization, involving the problems of plant selection, improvement and the production of new varieties. Neither can the details of the life history of the honeybee be given in detail, which is as unlimited and wonderful a field as are the intricacies of the plant world, yet it is desirable to make clear the relation and service of the honeybee to the setting of our common fruits and vegetables.

It should be remembered that in most plants the setting of the fruit involves a sexual process. In plants, in contrast to animals, the same individual may bear both sexes or the sexes may be apart in different individual flowers. More in detail these may be grouped under three headings:

1. Both Sexes in One Flower—Some plants produce perfect or bisexual flowers, that is, those in which both the male and the female organs of the flower, the stamen (male) and the pistil (female), are complete within the flower. As an example, Parson's Beauty strawberry may be cited.

2. The Sexes Separated in Individual Flowers—Other plants bear flowers which are individually staminate (male) and pistillate (female.) Yet both sexes appear on the same plant, as, for instance, in the squash, melon and cucumber.

3. The Sexes Separated in Individual Flowers Which Are Borne on Different Plants—As a further modification of the second class, there are also plants which produce only staminate (male) blossoms throughout the entire plant, and are spoken of as male trees or plants. Others produce pistillate (female) blossoms throughout the entire plant, and are spoken of as female plants. Examples of these are found in the willows and poplar. The Sample strawberry is pistillate (female.)

It at once becomes apparent in recognizing that most of our fruits and vegetables involve a sexual process or the union of the pollen and germ of the egg, that there must be some means of union, especially in the second and third classes of flowers, where the two sexes are respectively separated either in individual flowers or in individual flowers on separate plants. From practical experience, moreover, it is gener-



BETTER PROFITS

are secured by packing properly in containers that deliver safely and show off fruit to best advantage. The

Universal Package

is becoming the most popular shipping package in the country because it has advantages that mean the best NET PROFIT for growers and shippers.

PACKAGE SALES CORPORATION

106 East Jefferson Street, SOUTH BEND, INDIANA

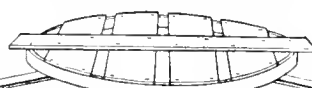

Ask Us Why

Write today for booklet "Shipping Profits." Every shipper and grower needs this valuable booklet. It's FREE. Filled with data that you can turn into profit—that means money saved. Mention how many trees you have.



ally conceded that the honeybee is the most important of the many agents in this service. Other insects render their service as well, but their service cannot be depended upon. Their numbers are uncertain and fluctuating. They may be absent at the very time when they are most needed, as, for instance, at the height of apple bloom. Thus it is claimed that the honeybee is first and foremost the most important, and that it should be provided and conserved by the farmer.

Since there are differences in pollen, however, it might be contended by some that the wind is active in transferring the pollen from tree to tree or blossom to blossom. To be sure, some pollen is lighter than others and easier carried by the wind, but in the provisions of nature, pollen which is light and transferable on the breezes is designed so to be carried, and trees which bear it are usually wind pollinated, those which are actually independent of insects. The pines furnish an example. Observations are not infrequent where the air has been seen filled with millions of pollen granules drifting with the wind. But among the fruits and vegetables the pollen is usually more heavy and inclined to be sticky or viscous, as is the case with the pear. This heavy pollen, in order to be transported, is dependent upon the service of some insect, usually the honeybee, and is capable of being carried by the wind to a very slight, if any, extent. In the case of apples, too, experiments have been conducted which tend to prove that little or no pollen in the apple orchard drifts on the wind.

The service of the honey bee, alluded to in transferring pollen, may be regarded as performed unconsciously or unintentionally while seeking for nectar or pollen in the flowers. In procuring the nectar, for instance, which flowers dependent upon the services of insects usually produce in abundance, there is a secretion in the nectary or honey-cup at the base of the flower. The bee, for illustration, dusts off particles of pollen which become entangled in her hair. Then the bee in quest of more nectar flies to another blossom and in the course of her search for nectar therein leaves some of the pollen on the female organ of the blossom (pistil). Thus, almost mechanically and accidentally, the function of the bee has been performed in this vital operation. Finally, the pollen lodged on the sensitive pistil germinates much as does seed, and sends forth or projects a slender growth or thread which gradually finds its way down through the pistil and reaches the true female element or ovule which is virtually the embryonic seed. Here, there is a fusion of the male and female elements which, when it occurs, perfects the process known as fertilization, wherefrom results a perfect seed.

Many plants are sterile to their own pollen and require pollen from another source. Furthermore, self-fertilization is thought to tend to weaken the offspring, and in contrast crossing or cross fertilization is thought to result in greater strength and productivity. Moreover, flowers are generally con-

structed to favor cross fertilization and to prevent perpetual self-pollination.

From the standpoint of the plant, the results of crossing become apparent especially in the second generation. Thus the Baldwin apple blossom may be fertilized by pollen from a Porter apple. The resulting apple will develop as a Baldwin, yet one or more of its seed when planted may produce a variety, differing in many respects from its parent. Thus the bees may serve to make new crosses and to increase varieties.

There is also another feature, namely, the apple requires five independent fertilizations for complete results. The lack of even one of these may impair its vigor and change its appearance, resulting in an imperfect development or malformed fruit. Incomplete fertilization also explains the dropping of apples, and suggests that the more complete service of bees might avoid this consequent loss.

Some light may be thrown on the dependence of flowers on bees by a few concrete examples. An experiment was conducted in which 100 clover blossoms were covered with netting in order to exclude bees, with the result that not a single seed was produced. Similarly 100 blossoms exposed to the visits of bees produced, in contrast, 2,720 seeds, showing conclusively the need of bees in seed setting in clover.

With the apple, 2,586 blossoms were covered and the entrance of bees prevented, with the result that only three apples matured.

It is not uncommon to observe from four to six bees eagerly at work gathering honey and pollen in a single squash blossom. The writer has noted eight bees simultaneously in a squash blossom; within an hour twenty-eight bees were counted flying from the same blossom.

The number of flowers a bee will visit may vary according to the amount of nectar being produced. A bee can visit ten to fifteen flowers a minute, yet she will remain longer on a flower if the nectar is flowing freely. In that case, she would secure her load without visiting as many flowers.

In attracting bees to a flower, there are several stimulative factors, namely, the nectar and pollen, color and odor. The multiplicity of trees in full bloom increases the attraction. Nevertheless, high color or extreme fragrance do not always induce the bees to visit, for the lilac and heliotrope are neglected, while some of the less conspicuous flowers prove enticing.

Besides the nectar in the flower, bees are in search of pollen as a food. This is a highly nutritious substance, supplying nitrogen and phosphorus—two needed elements in animal economy. To be sure, this pollen is provided vastly to the excess of the actual needs of bees, but its seeming over-production may be explained on the ground of an effort on the part of the plant to insure pollination.

It has been claimed that the honeybee sucks juices from fruits. Although bees are observed commonly on fruits, yet

Good Judgment Says:

Use Caution in Choosing Spraying Materials

Your crop depends on it. Whether your investment and your year's work will pay a profit depends on it. The health and producing ability of your trees, in future years, depends on it. Therefore, again, good judgment says: Use caution in choosing spraying materials.

Orchard Brand Dry Powdered Arsenate of Lead is positive in its effect, is certain and sure in its results when properly applied.

All that scientific experiment, laboratory tests, extensive field demonstrations and long use by practical fruit growers can do to establish this certainty has already been done.

It is always uniform, high in concentration, adhesive, lasting and spreads evenly without collecting in splotches. Its results show in clean, perfect fruit. A thorough coating on the leaves during the late summer and fall will prevent many worm "stings" and wormy fruit.

Other spray materials, for specific purposes, we recommend are:

Orchard Brand Dry Powdered Arsenate of Lead

Orchard Brand Arsenate of Lead, standard paste

Orchard Brand Atomic Sulphur (patented)

Orchard Brand Bordeaux Mixture Paste

Orchard Brand Powdered Bordeaux Mixture

Orchard Brand Lime Sulphur Solution

B T S Dry Sulphur Compound (patented)

Orchard Brand Weed Killer

Universal Brand Dormant Soluble Oil

Universal Brand Miscible Oil

Universal Brand Distillate Oil Emulsion

Liquid Whale Oil Soap

Our interests are the same as yours. Write us about your tree troubles. Also write for Bulletin No. 3 on Dormant Spraying of Deciduous Fruit Trees.



General Chemical Company

770 Royal Insurance Building
Department A

San Francisco, California

it is certain that the bee does not puncture a sound fruit as has been supposed. When fruits are worked by bees, an opening has previously been made by some bird or wasp or by decay. Thus the bees take up the work begun by another or afforded them through some other agency. Many orchardists have mentioned this to the writer who at the same time give due credit to the bee for the good she accomplished. It has also been the writer's privilege to dispel this idea through experimentation and by reference to high authorities who refute the charge against the bee. It should be borne in mind that the jaws of the bee are smooth and rounding and quite unfit to make an opening in a sound fruit. On the other hand, the jaws of the wasp are perfectly equipped for puncturing and opening fruit. In order to substantiate that bees are unable to puncture sound fruit, the writer has suspended a sound but over-ripe peach and pear in front of the entrance to a colony. These nevertheless remained untouched, even during a scarcity of nectar in the fields.

The Interrelation of Spraying and Beekeeping.

While the value of the honeybee as an agent in the distribution of pollen has been emphasized, it would be remiss to fail to mention correct spraying practices. To spray any plant while in flower, more especially fruit trees while in bloom, offers baneful results. It is the old story of killing the goose which lays the golden egg. Many colonies are either damaged or lost at the time of spraying, through poison deposited in the nectar cups of the flowers. If the loss is not apparent at the time, a colony may be so crippled as to preclude its successful wintering. It is now conceded by high authorities that spraying in fruit bloom is injurious not alone to the bee but to the flower. Any solution strong enough to kill the codling moth larvae may be harmful to the delicate reproductive organs of the flower. In erroneously spraying during fruit bloom the supposed aim has been to kill the codling moth. The eggs are usually laid on the foliage of the young shoots. The larvae hatch and travel ultimately to the young fruit. There they either burrow through the side of the fruit or usually through the calyx end into the core. Since these larvae of the codling moth are not hatched and present in the blossoms, it is a faulty method to try to kill them by sprays during the blooming period, especially since the spray may injure the setting of the fruit. Moreover, this poison may effectually be distributed over the foliage and into the calyx cups at any time within ten days after two-thirds of the petals have dropped. It should be borne in mind that it is the eating of the poison and not the contact with it which kills the codling moth.

Some states have enacted laws prohibiting spraying during fruit bloom, and have imposed penalties for their violation. To the intelligent fruit grower no such prohibition should be needed, as reason and judgment would dictate otherwise. Beekeepers and fruit growers all should strive in every way possible to spread this information concerning the time and kind of spray, and the reasons and seasons for spraying.

While it may be quite impossible to regulate and restrain individuals, yet it may be suggested that contract sprayers should be licensed in order to control or make certain that their methods conform to existing laws and customs. To the beekeepers it is a pitiable sight to see struggling, half-paralyzed worker bees staggering about the hive entrance and crawling up the grass blades unable to enter the hive. This is a violent shock to the colony.

Horticulturists, fruit growers and beekeepers must unite for mutual benefits to prevent the uncalled-for sacrifice of the honeybee. Similarly, every means that ingenuity can devise to improve the breed and management of bees should be adopted. Every possible provision should be made for housing, feeding and manipulating, especially before and after the fruit and garden bloom.

More bees and better bees, more trees and better trees! This will insure increased production of both fruits and honey.

The planting of linden or basswood trees, beloved by bees, is especially to be recommended for shade along the street and the highway, or as an ornamental tree in parks and on estates for forest plantations. It is of quick growth, symmetrical, with smooth bark. The wood is highly valued for lumber. It produces honey of exceptional quality and in abundance, which comes at a time of scarcity of nectar in most sections. The recommendation of the planting of this tree is inspired by a desire to increase its prevalence, thereby promoting beekeeping. Any advantage which it offers to the bee rebounds to the mutual good of the horticulturist, fruit grower and beekeeper. To one who has heard the incessant hum and medley of song of the honeybee flitting among the blossoms of the linden tree on a July day no description by pen or spoken word is adequate.

As a final word, the testimony of farmers in the vicinity of the writer's apiary is convincing even to the most skeptical as to the value of bees. This testimony has always been favorable and given without solicitation. There was but one answer to a physician who inquired the reason for the abundance of fruit in the orchards and occasional fruit trees in the vicinity of the writer's apiary, while in more remote sections of the town there was a noticeable scarcity of fruit. The favored district profited by the faithful work of the writer's honeybees.

Apple Boxes

HIGHEST QUALITY
WESTERN YELLOW
PINE

If you wish to make sure of a supply of well made boxes at fair prices, let us place your orders.

Carloads Only

Spokane Fruit Growers Co.
SPOKANE, WASH.

"You're the Man to be Satisfied"

says the Good Judge



You get a whole lot more satisfaction from a little of the Real Tobacco Chew than you ever got from the old kind.

The good, rich tobacco taste lasts so much longer. You don't need a fresh chew so often. That's why it costs you less.

Any man who uses the Real Tobacco Chew will tell you that.

Put Up In Two Styles

RIGHT CUT is a short-cut tobacco

W-B CUT is a long fine-cut tobacco

Weyman-Bruton Company, 1107 Broadway, New York City

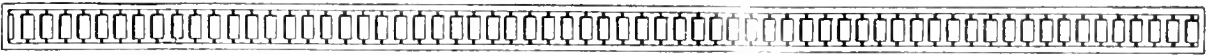

You may not require so pretentious a conveying system as that of the California Associated Raisin Company, shown above, but you can effect the same relative economy in your own establishment. (Note how the overhead system in this instance enables maximum utilization of floor space.)

Reducing "H. C. P."

The way to strike a body blow at High Cost of Production is to aim at the *non*-productive factors in your operating system. Cut down the "dead load"—on the labor, power and floor space you now devote to moving materials, boxes, cases, barrels, etc., from place to place.

Mathews Gravity Roller Conveyor systems not only release human and mechanical energy for today's real needs of industry, but they increase the value of every dollar put into actual production. They keep machines, work benches, trucks, cars "fed"—loaded—supplied—busy. They eliminate the body-wearing drudgery of lifting, lugging, toting, wheeling. They make working conditions more inviting and workers more contented.

There are no "ifs" or "buts" about the economy effected by the Mathews. No intangible theories. The possibilities are

obvious; facts bare; figures actual. The hands and dollars it saves can be counted!

Free Gravity is the force which operates the Mathews. Perfectly balanced drawn steel rollers, revolving on frictionless ball bearings, enable Gravity to keep objects on the move at inclines so slight as to excite wonder.

In a word, there is no argument that can be successfully mustered against the use of Mathews Gravity Conveyor system as an economy and speed-up measure. Isn't that a good reason for thinking the matter over *seriously*—then letting one of our sales engineers show you how much of a system *your* plant should have, what it should cost, and what it should *save*?

Write

MATHEWS GRAVITY CARRIER CO.

133 Tenth St., Ellwood City, Pa.

Branch Factories. Port Hope, Ontario - London, England

Member of Material Handling Machinery Manufacturers' Association

MATHEWS
SPEED ECONOMY
GRAVITY ROLLER CONVEYER

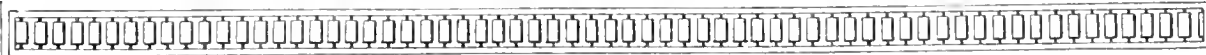

Successful Cherry Growing in Umpqua Valley, Oregon

By An Experienced Grower

THE Umpqua Valley in Southern Oregon is pre-eminently adapted to the production of cherries. The clay loam found on the hillsides, as well as the sandy river bottom soils, are especially favorable to this fruit. But it is of the hills in this hilly region, in relation to the successful growing of cherries, that I will speak of here.

The Umpqua Valley in Douglas County is in reality made up of hundreds of different smaller valleys or intervals, divided by hills of all shapes and sizes and in their wild state generally covered with a thick growth of oak and laurel. Many of these hills are too steep for orchard purposes, but numbers of them make ideal locations for growing fruit. The soil on them is usually of a reddish brown color which, when cultivated, falls apart readily and is underlaid with clay, which holds the moisture to a remarkable extent during the dry season. In the wet season, being high and more or less steep, they have splendid drainage of both air and water; also they soon warm up in the spring and being above the river levels, the late spring frosts which generally are found to seek the low levels along the rivers and bottoms of the valleys, leave these hillsides untouched. All of these conditions are absolutely ideal for the production of the cherry.

The Umpqua Valley has been proved to be the earliest producer of fruit and berries in the state of Oregon. It warms up there sooner than any other district in the entire state. The winters are very mild and open and it is a matter of record that produce is marketed first from this county practically every season.

This being the case we are able to get our Bings and Royal Annes on the market about ten days earlier than any other district, and as this is the first tree fruit that appears, our cherries are thus in great demand for eating purposes. As far back as 1911 I sent Bing cherries to Portland and received 15 cents for them and a neighbor got 17½c for some of his, 15c for the balance. Another cherry grower received 13c for his Royal Anns at the same time and we all had requests for far more than we had to ship, at these same prices. Then as the season advances and the Willamette Valley cherries come in the price is cut so the bulk of their fruit goes to the cannery at a much lower price per pound and even then there are very good profits to be made.

As the Bing, Lambert and Royal Ann cherry all grow to such perfection and also and chiefly as they are so early and such handsome returns can be obtained for them, it is a matter of surprise that we find so very few commercial cherry orchards here. True, that there are not so very many commercial orchards of any fruit, except prunes, in heavy bearing here yet, still one would have thought that the early settlers would have appreciated sooner what could have been realized from the early

sweet cherries, and that one would find numbers of fair sized orchards. Such however, is not the case. We have now a fair acreage of commercial cherry orchards, and as few people outside of this county realize, perhaps, an enormous acreage of young apple and pear orchards.

Now as we have the soil and climate for the production of these greatest of cherries, the Bing and Lambert, and as they grow here to best advantage as I firmly believe, of any spot on earth, on which they have been tried, added to the fact that they are the earliest in the Northwest, it will not be amiss for me to say a few words on the adaptability of these varieties to our hillsides.

As all orchardists know it is not satisfactory to try to cultivate too steep a hillside. You cannot turn earth uphill with a plow, nor can you keep a disc harrow from turning over if the hill be too steep, or prevent the cultivator from slipping down hill and skinning the trees sometimes. Therefore, in order to utilize these hills of ours, which are generally the cheapest lands to buy, we must plant something which does not require much, if any cultivation.

The cherry is the only fruit that conforms to that need. Despite opinions to the contrary held by men whose words carry weight and whom I should be the last to needlessly criticize, I maintain without fear of successful contradiction, that the cherry, after its fourth year, does not need cultivation, in fact is better off without it. Practically the only disease that attacks the cherry is gummosis. As far as known at present this disease is caused by an over-production of sap, which the tree, not using, gets rid of by pushing it out to the surface, where it occurs in gummy masses, which may be small or large, and there it continues to ooze out, rotting the wood around it and finally, in a great many cases, causes the death of the tree. This being the case, anything that stimulates the growth of the tree beyond a certain extent is harmful. Now we all know that cultivating and pruning a tree stimulates the production of growth and sap and in the case of the cherry it works a positive harm.

Now as cherries ripen in June the moisture has not gone from the soil before the crop has matured and in the case of a tree over four years old the root system has gone deep enough to find moisture enough to keep it healthy the balance of the dry season.

So that is the crop to raise on our hills we firmly believe. Dig big holes at planting time, hoe well the first year or two after each rain, dig around the trees each spring till they are four years old, then they will look after themselves. Also if one plows and cultivates these hillsides, the winter rains are constantly washing away the soil and in the course of years, more good,

rich dirt is lost than most people have any idea of. Let the natural sod remain, or better still, seed it down to a good mixture of grasses as I have done in part of my orchard and raise some hay. The grass in my cherry orchard is ready to cut by May 15. This grass forms a complete protection from soil erosion in winter and helps out on the feed bills in summer. The agricultural college at Corvallis kindly told me the mixture of grasses adapted to our hillsides here and they surely were right; it is the easiest crop to get a stand of I ever seeded. It also kills out most weeds.

Our cherry growers here do not practice much of any pruning except to cut away a limb that crosses another. Do not stimulate the growth on a cherry tree. Nature will grow it as fast as it ought to be grown and you will not be troubled much with gummosis.

Another point in favor of the cherry on the hillsides is it requires the least spraying of any fruit tree grown.

Let me add a few words in closing as to the fruit itself. The Bing is the favorite shipping cherry here. It grows to an enormous size. I have measured hundreds with a tape line and found that four inches in circumference is the size of the best. When ripe they are nearly black and when a 20-pound box is faced with these magnificent specimens it would seem they must be black plums, as their great size looks too great for a cherry. As to their holding qualities, one can hardly overstep the mark; they will go to New York and back again I believe, without showing any sign of decay. There are some Lamberts raised here too, but not many, although a few have been lately planted. They are a very fine cherry, probably as good as the Bing, but perhaps do not bear quite as well. Our Royal Anns are very fine and there are numbers of Black Republicans which latter, though hardly a commercial cherry, exceed all others in quantity to the tree.

No Orchard or Farm is Complete
Without Our Latest Model

**COMMERCIAL SIZE
All Purpose Evaporator**

Write for Folder

HOME EVAPORATOR CO.
ST. LOUIS, MISSOURI

P. O. Box 817

Central Station

NOW is the time to send to

Milton Nursery Company
MILTON, OREGON

FOR THEIR 1919 CATALOG.
FULL LINE OF NURSERY STOCK.

"Genuineness and Quality"

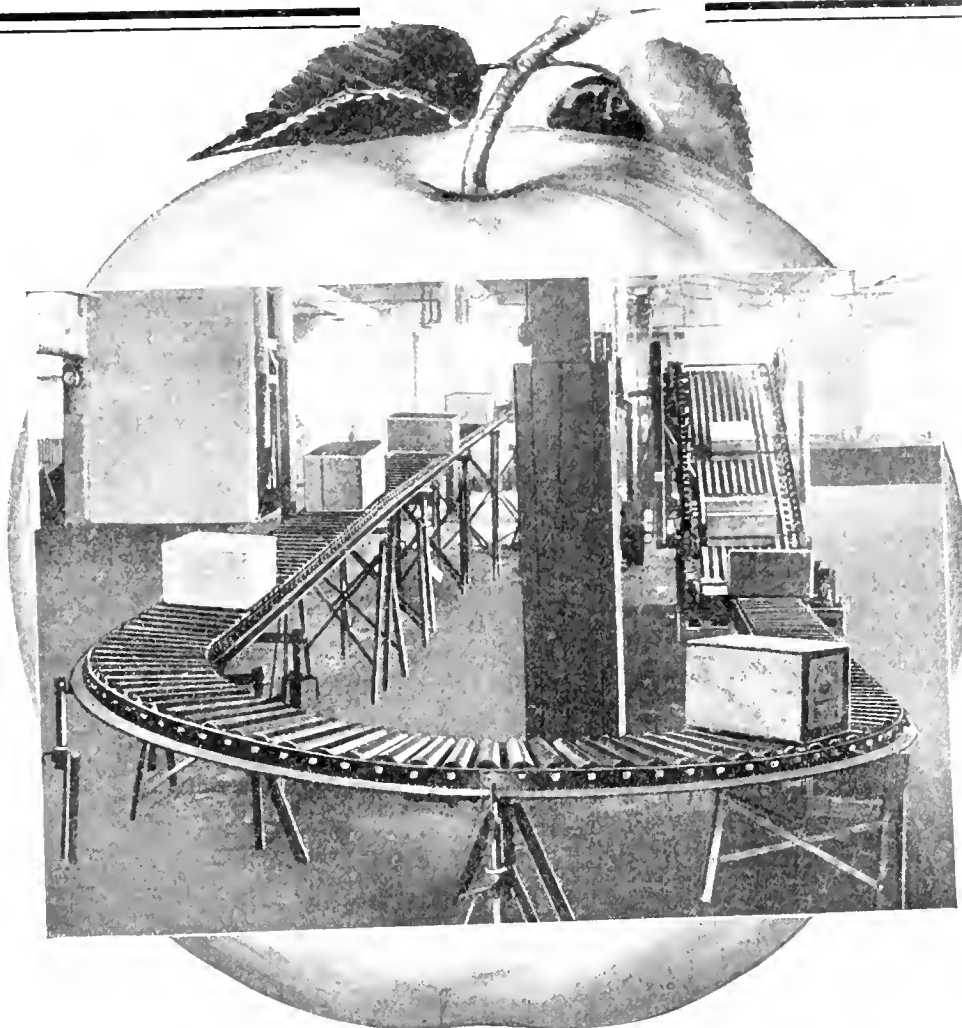

YOU cannot appreciate the advantages of STANDARD GRAVITY CONVEYOR UNITS or SYSTEMS until you have had an opportunity of seeing this indoor transportation system in actual operation in a modern and progressive apple-packing plant.

To observe an endless stream of boxed and cased apples moving forward at a rapid and controlled rate of speed, free from **mechanical aid and man-power**, is at first amazing as well as fascinating, but as the commercial value of this indoor transportation system unfolds itself, a desire for immediate possession takes place.

The apple-packing manager or owner can hardly wait until a similar system is at work in his plant, transporting loose apples from wagons to warehouse, progressively moving forward his product to packer—to storage—to trucks or cars for world distribution.

We want you to pause a moment and visualize a STANDARD SYSTEM comprised of labor-saving units of conveyors, replacing hard manual labor now used in the indoor movement of your product and let GRAVITY, with a **world of force back of it**, perform this work with ease and rapidity.

Act promptly and avoid being disappointed in securing STANDARD EQUIPMENT for this season's work, as the capacity of our manufacturing plant allotted to the needs of the apple-packing industry is already nearly taken up with accepted orders and contracts. Get in immediate touch with our representative in your territory and have him wire us a blanket reservation for the approximate units of conveying system you will require.

Standard Conveyor Company

FORMERLY MINNESOTA MANUFACTURERS' ASSOCIATION

NORTH ST. PAUL, MINNESOTA

Representatives in All Principal Cities

Washington, Oregon and Montana Representatives:

D. E. Fryer & Co

Main Office—Seattle, Washington

Branch Offices—Spokane, Washington
Tacoma, Washington
Butte, Montana
Portland, Oregon

California Representatives

Bannon-Bodinson & MacIntyre, San Francisco, California
Hazard-Gould & Co., San Diego, California
M. E. Canfield, Los Angeles, California

Colorado Representative

Mountain States Machinery, Denver, Colorado

Utah Representative

Hawley-Richardson-Williams, Salt Lake City, Utah

BETTER FRUIT

An Illustrated Magazine Devoted to the Interests
of Modern Fruit Growing and Marketing.

Published Monthly

by

Better Fruit Publishing Company

703 Oregonian Building
PORTLAND, OREGON

Spray-Covered Apples.

Mr. Dwight Woodruff, Eastern representative of several of the large Northwestern apple growers' associations, is issuing a timely warning to growers to exercise more care in order to avoid having an excessive amount of spray on the fruit. A portion of Mr. Woodruff's letter in regard to this was recently published in the excellent little bulletin which is now being issued monthly by the Yakima Fruit Growers' Association, and was occasioned by the action taken by Boston health authorities last winter who condemned several carloads of Northwest apples on account of the excessive amount of arsenate of lead spray on them. In discussing this subject Mr. Woodruff says:

"I think it is something that should have your early attention at the present moment, because I have talked with different factors in the East on this very subject and they all seem to think that the federal health authorities and the various boards of health throughout the country, especially in the big markets, are going to be on the lookout this season, and we might just as well plan to avoid trouble. All of this is to advise you so that you will not ignore the situation, and do not think for a moment that this is a Boston matter, because it is not."

To growers who do not wipe their apples before packing this is an important matter, notwithstanding the fact that experiments by experts have demonstrated that the number of apples that would have to be eaten to cause injury or sickness on account of the spray on them is beyond the consumption of any one human being. The point of the matter is in the fact that Eastern health authorities look on the substance left on the apples as highly poisonous and have evidently decided to discriminate against them if they are discolored by an excessive amount of spray material. With the keen competition that is now arising in the East from Eastern growers who admit that the markets for fancy apples are being taken away from them by the superior pack and finish of Western fruit, the Western grower should leave nothing undone to place his fruit on the market in the finest of conditions. It is easy to understand how a campaign against Western apples could be inaugurated by having the health authorities or others whose purposes would not be so altruistic declare that they were poisonous or unhealthy.

The safest plan will of course be to have the fruit wiped, but if this is not to be done, then Mr. Woodruff's suggestion of avoiding the excessive use of spray should be adopted.

By-Products.

Notwithstanding the very profitable prices received for fruit in the Pacific Northwest during the past two years, economy in production and handling has not received the attention it should have. In many instances prices for all kinds of fruit have ruled so high that growers have disregarded this element, which is so closely adhered to by other business enterprises which have figured out a way of handling or processing every part of raw materials.

While fruit growers are putting into use practices that are more and more reducing the handling cost of fruits, there is still room for a greater utilization of fruit by-products of all descriptions, and no fruit raising community which has any considerable degree of tonnage should be without its by-products plant. In many sections of the Northwest this phase of fruit raising is being taken care of by associations and private enterprises and this year will see the greatest quantity of fruit by-products of all kinds marketed in the history of the industry.

Figures given out by some of these plants for their last year's business show that even some of the parts of fruits heretofore regarded as pure waste, such as berry and apple pulp, when slightly reprocessed brought returns that were almost as profitable as the sale of the fresh fruit. Fruit growing communities, therefore, who are not familiar with this new innovation in the fruit industry should investigate what is being accomplished in this line in a number of the sections of the Northwest, more particularly in Western Oregon and Western Washington, and look to the establishing of one of these plants, which have become a most valuable asset in disposing of cull fruit and fruit-waste heretofore regarded as useless.

The Coming Fruit Crop.

Although reports are to the effect that the deciduous fruit crop of the Pacific Northwest will be nearly as large as it was last year, an analysis of these reports and investigations as to the actual conditions leads to the belief that the output will be far less than it was in 1919. In some districts the crops of fruit have been cut down almost a third and in others there will be scarcely any

fruit at all of some varieties. This is true of the soft fruits particularly. In some of the large apple growing districts also the damage by the freeze last winter was severe. In one well known apple growing section that last year marketed 2,500,000 boxes it is now estimated that the maximum crop that can be expected will be 1,500,000 boxes, while many of the other districts show a decided "spotted" condition.

Not until several weeks have passed will it be possible to know approximately what the tonnage to be shipped this year will be and guesses and misleading statements in regard to it should be carefully avoided. Early impressions in regard to crop prospects that are erroneous cause a false situation to arise between producers and buyers, and an unstable market.

The indications now are, taking the crop of all kinds of fruits in the Northwest as a whole, that there will be a large tonnage to market, but that it will not approach in magnitude by many hundreds of carloads the crop of the past year.

Packing Houses and Equipment.

In these days when the fruit industry is growing so rapidly in importance and necessity has stimulated the demand for labor-saving appliances of all kinds, the fruit grower should not neglect to get into touch with new equipment of many kinds that is being put onto the market and that means the saving of many dollars. This is particularly true of equipment for the handling of fruit in the packing house. Conveyors, graders, truck and other appliances are constantly being improved, giving to the grower greater facilities in the saving of time and money.

In almost every fruit raising center will be found dealers who are handling this equipment, and although you may think you do not need anything in this line it will pay to drop around occasionally and see what they have to offer.

New designs and features in packing houses are also being incorporated into almost every section of the Northwest this year where these buildings are being erected, and valuable information can be obtained from a visit to one of these structures in course of erection.

Distributing Irrigation Water In An Orchard

INVESTIGATION by experts of the United States Agricultural Department shows that in irrigating orchards by the furrow method the length of lateral ditches or furrows should be governed by the size of the orchard and character of the soil. These investigations point to the fact that it is doubtful if it ever pays to run water in furrows more than about 600 feet. Where the soil is open and water sinks readily through it, short furrows should be used, otherwise much water is lost in deep percolation on the upper part of the tract. Professor H. Culbertson of California, after a careful investigation

of this subject has reached the conclusion that on sandy or gravelly soil having a steep slope the proper length of furrows is 200 feet, whereas on heavier soils and flatter slopes the length may be increased to 600 feet.

The grade of furrows varies quite widely. In flat valleys it often is not possible to obtain a fall greater than one inch to 100 feet, whereas on steep slopes the fall may reach 20 inches per 100 feet. On ordinary soils a grade of three to four inches is to be preferred, and where the fall exceeds eight to ten inches to 100 feet the trees should be

set out in such a way as to decrease the slope of the furrows.

The number of furrows in orchards should depend on the age of the trees, the space between the rows, the depth of furrow, and the character of the soil. Nursery stock should be irrigated by one or two furrows and young trees by two to four. A common spacing for shallow furrows is two and one-half feet, but deeper furrows are three to four feet apart. The general trend of orchard practice is toward deep rather than shallow furrows, a depth of eight inches being used in many instances.

In spacing furrows chief consideration should be given to the lateral movement of moisture in the soil on each side of the furrows, so as to insure a fairly uniform distribution of moisture.

In the Payette Valley, Idaho, 200 or more miner's inches are turned into the head ditch and divided up by means of wooden spouts into a like number of furrows. On steep ground much smaller streams are used. The length of the

furrow varies from 300 feet on steep slopes to 600 feet and more on flat slopes. The time required to moisten the soil depends on the length of the furrow and the nature of the soil. In this locality it varies from three to 36 hours.

A 20-acre orchard tract under the Sunnyside canal in the Yakima Valley, Washington, is watered four times in each season with 14 miner's inches (0.35 cubic foot per second.) Three furrows are made between the rows, which are 40 rods long. The total supply is applied to one-half the orchard (ten acres) and kept on 48 hours.

On the clayey loams of the apple orchards on the east beach of the Bitter Root River, Montana, Professor R. W. Fisher, formerly horticulturist of the agricultural college of Montana, has found, as a result of experimenting, that it requires from 12 to 14 hours to moisten the soil in furrow irrigation four feet deep and three feet sideways.

The fourth table shows the comparison of two adjoining Winesap orchards on similar soils and on clean cultivated ground.

Well Thinned—950 boxes 4½ tier and larger and 50 boxes five tier.

Poorly Thinned—500 boxes 4½ tier and larger and 500 boxes five tier and smaller.

Figured in actual money loss per 1000 boxes it varies from \$152.50 in the case of the Jonathan orchards to \$535.60 in third table. Add to this the additional cost of handling the smaller apples because of there being more of them, the loss is still greater.

Another fact which might be brought out is that the larger apples invariably run a higher percentage to extra fancy than do the smaller apples. Following are figures from two orchards in the comparison tables showing some interesting figures. In the well thinned orchard the packout was:

Seventy-three per cent extra fancy; 10 per cent fancy and 17 per cent C grade.

In the poorly thinned orchard we have: 47 per cent extra fancy; 27 per cent fancy and 26 per cent C grade.

Later it was found that all the "fancies" had to be marked C grade on account of lack of color, making a total of 53 per cent C grade apples. The loss in the second orchard amounts to \$330.

The loss in money due to small fruit during the past year is the least item to be considered. The reason for the small fruit as shown in the tables is due to

A Practical Demonstration of Fruit Thinning

By C. A. Noren

NOW that the apples are packed and sold it is easy to obtain facts and figures relative to the value and advisability of thinning apples.

I have obtained four sets of comparisons of well thinned and poorly thinned orchards.

In three cases the orchards adjoin each other so that the conditions under which they were grown are very similar. Further, these figures were obtained from four different warehouses and therefore should be representative. The tables were figured on a basis of 1000 boxes to make the results more comparable.

The first comparison is that of two adjoining orchards, Jonathans, both of them well cultivated.

Well Thinned Orchard—990 boxes of 4½ tier and larger apples; 10 boxes of five tier apples.

Poorly Thinned Apples—675 boxes of 4½ tier and larger apples; 170 boxes of five tier apples; 155 boxes jumbles. The Jonathan being medium sized, there is no excuse for having so many small apples from this orchard. The owner did not think it paid to thin.

Table two is a comparison of two adjoining Winesap orchards on similar soils.

Eight hundred and twenty-six 4½ tier and larger; 77 boxes five tier, and 97 boxes jumbles.

This orchard had better than the average thinning.

Three hundred and eighty-seven 4½ tier and larger; 315 boxes of five tier and 298 boxes jumbles.

A poorly thinned orchard. From the above table it will be seen that the fruit runs 86.6 per cent 4½ tier and larger in the well thinned orchard as against 38.7 per cent.

The third table is that of two Winesap orchards not adjoining each other but on similar soil and both in alfalfa.

Well Thinned Orchard—963 boxes of 4½ tier and larger; 20 boxes of five tier and 17 boxes jumbles.

Poorly Thinned Orchard—200 boxes 4½ tier and larger; 447 boxes five tier and 353 boxes jumbles.

The first orchard runs 96.3 per cent 4½ tier and larger as against 20 per cent in the latter.

THE LADDER TO PROFIT

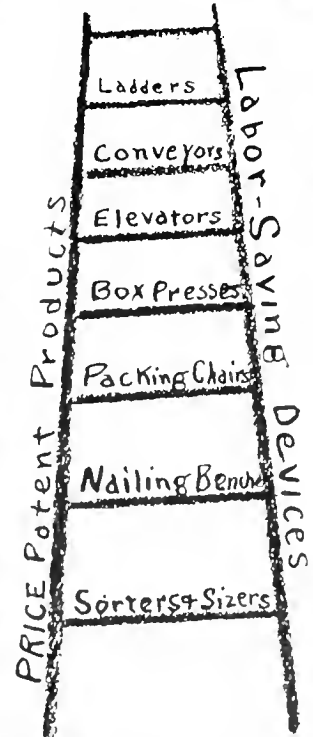

is the Elimination of Expense

The steps of the ladder are the appliances that efficiently eliminate labor. Price makes these ladders, complete in every step—all equipment needed for the most efficient handling, sorting, sizing and packing of fruit.

Price PRICE Products BEFORE YOU BUY

Information, Catalogues and Price Lists will be furnished on request.

Price Manufacturing Co., Inc.

YAKIMA, WASHINGTON

Our Consulting Office is "At Your Service"

the fact that the trees bore too many apples, or, in other words the trees were not properly thinned. It is a known fact that it requires greater effort on the part of the tree to mature the core of the apple than the edible portion. It must then follow that a tree can mature with less effort ten boxes of apples averaging 150 to the box than ten boxes averaging 200 to the box. A tree can properly mature a certain amount of fruit and anything over that will cut down the size of all the fruit as well as the quality.

If a tree overbore this year, due to lack of proper thinning, more fruit spurs bore fruit than was actually necessary. This put too great a strain on a large number of fruit spurs and as a consequence they did not set the necessary fruit buds for next year, and further, the trees did not make the normal growth. Now then, it can readily be seen that the possibility of heavily loaded trees this year having a normal crop next year is small.

Alternate Bearing

Now we have arrived at one reason for the alternate bearing of fruit trees which applies especially to the apple. Taking a period of ten years the most profitable orchard is the one which bears an average crop every year. The alternate method of bearing fruit requires about the same amount of care and expense on the off year as it takes to bring through a full crop.

A tree has its limitations in the amount of fruit it can bear just as

much as a man is limited in the amount of work he can do.

The real loss by allowing the tree to overbear one year comes the following year when a short crop is the result.

Overbearing retards normal growth of trees.

Overbearing one year does not give the tree a chance to set fruit buds the following year.

Orchard Heating

By C. K. Neilson, Paonia, Colorado

Editor BETTER FRUIT: I have been reading with much interest Mr. Calvert's article on orchard heating in your February issue. I have successfully practiced orchard heating for several years and I shouldn't consider fruit growing a sound business proposition without it. Fruit growing, like any other business, must be run to capacity in order to pay.

I should like, however, to take issue with Mr. Calvert in regard to his arrangement of heaters in relation to the trees. We place our heaters just as close as possible to the trees without danger of burning them, giving each tree its own heater. We tried the other method and found that by having the heater in the center of the square on very still nights, which are the most dangerous, the heat went straight up between the trees. According to our plan the heat goes up into each tree, and, there always being at least a slight motion of the air, we can see the smoke

gently distributing itself all through the tree, and naturally the heat follows the same course.

I may state that we use crude oil. It is, in my estimation, the only practical fuel. All coal heaters have been abandoned here on account of the excessive labor required, and the impossible labor required of regulating them in any way. This is the way I set my orchard heaters:

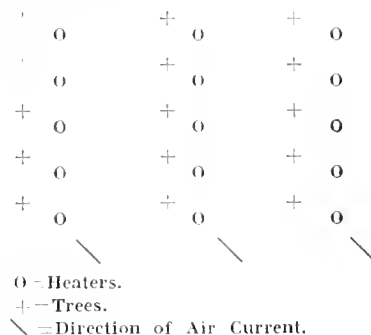

Combatting the Strawberry Weevil.

Thousands of dollars damage is done annually to strawberry beds by the strawberry weevil. This insect cuts the blossom stems so that fruit does not develop. This trouble can be entirely overcome by dusting with sulphur dust and arsenate of lead at the rate of one pound of lead arsenate to five of sulphur. Make two applications a week apart when the insects first appear.



Nicotine-Sulphur Dust

Is the greatest discovery of modern times in the control of insect pest and disease.

It kills Aphis, Thrips and Red Spider upon contact; death is almost instantaneous; thousands of insects fall dead from trees suspected of harboring only a few.

The application is rapid; with the **American Beauty Dust Sprayer** 12 to 15 acres per day per man, and the kill is sure.



USE THE
American Beauty Dust Sprayer
IT IS TRIED AND PROVEN

The California Sprayer Co.

6001-11 Pasadena Avenue Los Angeles, California

- SYKES SYSTEM OF FRUIT PACKING -

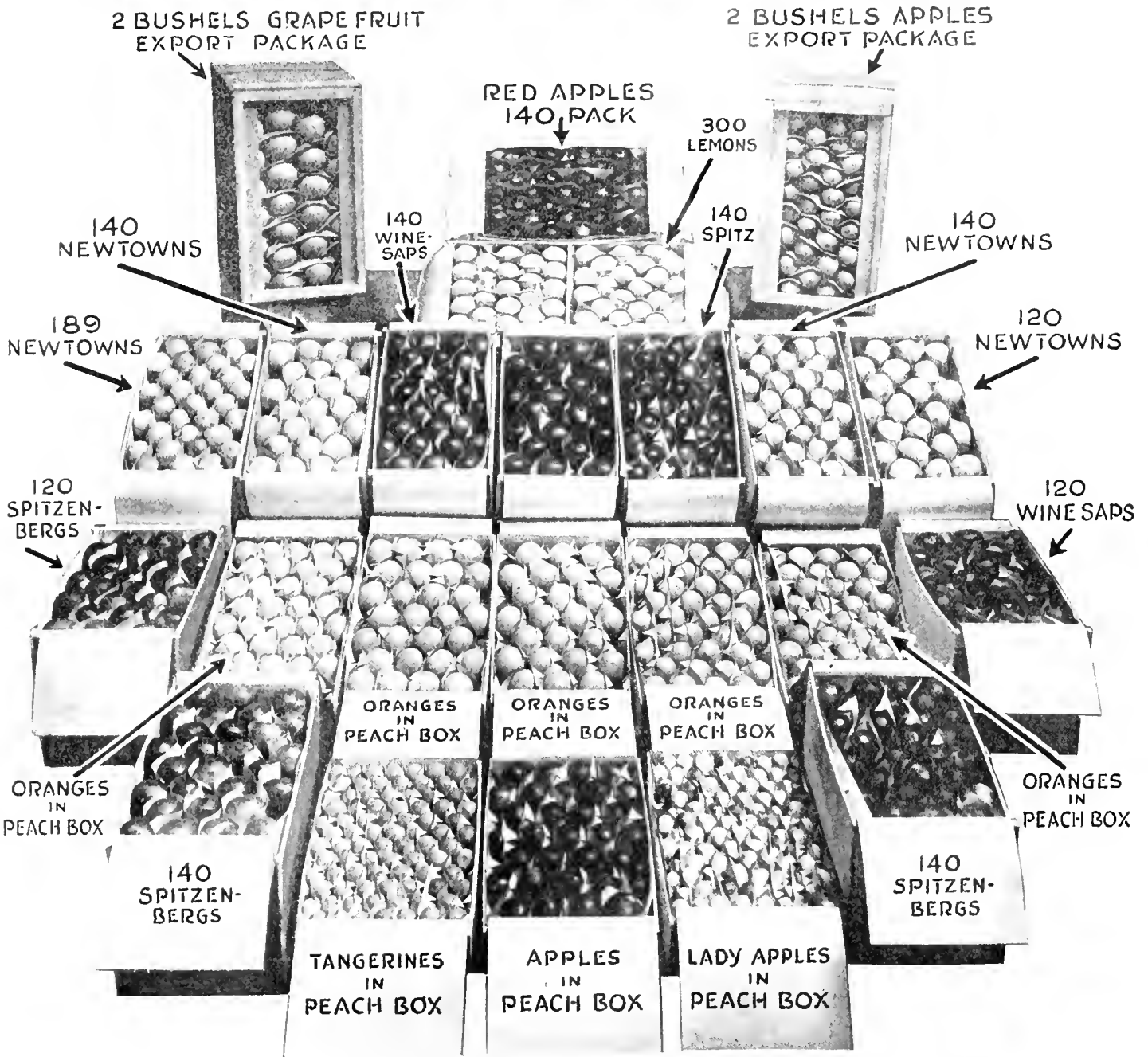

Ample Protection Proper Ventilation Thorough Refrigeration
 Effective Display Easier to Pack and Less Costly

A BETTER WAY

AMERICAN PAPER CO.
 Seattle, Washington

SPOKANE PAPER & STATIONERY CO.
 Spokane, Washington

BLAKE-McFALL CO.
 Portland, Oregon

PACIFIC FOLDING BOX FACTORY
 San Francisco, California

Northwest Fruit Notes from Here and There

OREGON

To reduce the cost of packing apples this year the Hood River Apple Growers' Association has decided to discontinue having fruit wrappers printed. The saving to be effected by this change it is estimated will be \$15,000 to the members of the association. Apple packing paper will cost the association this year \$150,000.

Reports from Cove are to the effect that the cherry yield in that district is very promising. While the freeze last winter did some damage a yield of 50 per cent is expected from old trees and 100 per cent from young trees. As in other districts the freeze affected old trees more seriously than young ones.

Roseburg is believed to have had the distinction this year of reporting the first ripe strawberries grown in Oregon. On May 7 two growers reported berries that were ready for the table.

The 1919 prune crop at Dallas was cleaned up recently by the shipment of nine cars to Eastern markets. During the latter part of the season the packing plant at Dallas processed 3,600 boxes of prunes daily.

Plans were recently put on foot in The Dalles to re-finance the Kings' Products Company, which operates dehydrating plants in the above named city and also at Salem and Portland. To bring this about a meeting was held by the Chamber of Commerce of The Dalles which agreed to endeavor to float \$150,000 worth of the stock of the company. Salem is being asked to take a like amount of the stock while Portland interests have agreed to furnish the rest of the capital required. The total amount involved in the re-financing of the company is \$1,000,000.

Dan Wuille & Company, the English apple exporting firm which already has extensive connections for the marketing of apples in Oregon, will erect warehouses in that state and in Washington this year which call for an expenditure of \$100,000. The warehouses are to be built at Underwood, Washington, at Odell, in the Hood River Valley and at Newberg, Oregon.

The first Oregon strawberries to be put on the market at Salem sold for 35 cents for a 12-ounce box. They were of the Oregon variety which was originated near Salem.

Frost damage in the Medford district this year was reduced to the minimum. Although growers in that section had their smudge pots ready there was very little use for them. Reports from Medford state that prospects for all fruit is promising although the crop is not expected to be as large as that of last year.

The Puyallup and Sumner Fruit Growers' Canning Company, which had been competing with other firms for loganberries in the Salem district, recently announced that it had temporarily withdrawn from the field, owing to the high prices being asked by growers for fruit and also on account of the soaring prices of sugar.

WASHINGTON

Profiting by the experience of growers in some of the other districts in Washington, Yakima County has organized a spraying district comprising 1,000 acres of land and has employed an inspector who will devote all his time to spraying problems. To pay the expense each member of the district has agreed to pay \$1.00 per acre for the work.

The Perham Fruit Company, located at Grandview, has authorized work to be begun on a cold storage plant at that place which will have a capacity of 250 cars. The plant will cost \$100,000 and will be 125 by 150 feet, two stories high and basement.

A report from the Mabton district says that warmer spring weather shows that few of the soft fruit trees were killed in that district by the freeze last winter but that the crop will be light.

The White Salmon Valley, one of the earliest berry districts along the Columbia River, shipped its first berries May 12. The berries brought \$12 a crate. Kennewick, which usually ships the first strawberries from the Columbia River district is reported to have been one day behind White Salmon this year in making its first shipment.

Selah reports that the pear crop in that section will be heavier than was at first expected, the freeze last winter not having done as much damage as was at first thought.

Reports from the Wenatchee district is to the effect that the fruit crop in that section this year will be as large, if not larger than that of last year. Local bankers who are looking into

the matter of financing the crop state that they look on the situation as very promising and will be able to handle all legitimate requests for loans.

It is estimated that canners in Washington will get more than one-half of the strawberry crop of that state at prices running from 15 to 20 cents in the field. Canning berries at Kennewick have been sold for 15 cents, in Western Washington for 18 cents and in the Puget Sound country for 20 cents. At the present time canners have been forced to reduce their offers owing to the sugar situation.

To relieve the car shortage situation in the Wenatchee district this year it has been proposed to utilize the Columbia River and ship by boat. To do this an expenditure of \$35,000 it is stated would be necessary to open a channel through the rapids below Wenatchee. By doing this the Chicago, Milwaukee and St. Paul Railroad could be reached by a comparatively short trip on the river.

A report from the Yakima Valley says that while pear trees in that section showed a mass of bloom, the blossoms dropped off quickly, causing growers to believe that they were blighted. Other districts in Washington report a similar condition and it is now expected that the pear yield generally in that state will be extremely light.

The Duddy-Robinson Company of Yakima, has taken out a permit to erect an \$80,000 cold storage warehouse, on which work will begin at once. H. C. Nead has been given the contract.

"The fruit industry of the Northwest already is paying its full share of the revenues needed by the railroads. If it can be established that such is not the case, the fruit growers are ready to carry their additional share, but the increase should be a horizontal one, based on cents per hundred pounds, and not a percentage increase. Treat fruit as wheat, lumber and cotton were treated." This statement sums up the attitude of Northwestern growers on the proposed 25 per cent increase in freight rates on fruits as expressed at the Portland conference, according to C. J. Webb, secretary of the North Pacific Fruit League. A 25 per cent increase means an increase of 12½ cents in the freight bill on every box out of the Northwest. On eastern apples, it means two, three or four cents. It is declared that Northwestern apples now are virtually shut out of some eastern markets until the eastern apples are sold because of the rate discrimination.

A definite decision has been reached by the Wells & Wade Fruit Company to construct one of the largest and most modern fruit warehouses in the Wenatchee district this summer, in time for the fruit shipping season of the fall. It will have a storage capacity of 200 cars of apples. The building will be arranged so that it can be equipped as a cold storage warehouse later.

The Skookum Packers' Association has set its goal this year at 10,000 cars of apples, as against 6000 in 1919, according to P. H. Parks, general manager of the Association. Its membership now includes 35 cooperative fruit shipping organizations and large growers of the Northwest, of which the Spokane Fruit Growers' Company is the largest. "We believe 1920 is going to be a great year for the cooperative organizations," says Mr. Parks. "The cash buyers were hard hit last year and are going to be wary this season. The growers realize that some of their fruit last year was sold for more than it was worth and they do not expect that condition to continue."

A deal has been consummated for the purchase of all assets of the Cashmere Apple Company by A. H. Bohlke, principal owner of the Bohlke Fruit Warehouse Company of Dryden. Mr. Bohlke takes over the two modern warehouses owned by the Cashmere Apple Company at Cashmere and Wenatchee, also real estate contracts covering some of the most productive and highly improved bearing orchards in the Wenatchee Valley. The consideration was \$185,000.

J. W. Wickers, manager of the Highland Fruit Company of Kennewick, is reported to have closed a deal for the sale of his 1920 apple crop at prices that are an advance over those received last year.

IDAHO

Apple trees in the Boise Valley of all descriptions are reported to have blossomed heavily and good crops of this fruit are now anticipated. A good yield of cherries and

PEERLESS

Make Old Cars
Look Like New

AUTOMOBILE

Quality
Goods

SPECIALTIES

EVERY Owner should use the same goods himself that are used by the Automobile Painters. Never trust to luck. Use Peerless goods, with an established reputation. Sold for 10 years throughout the world.

All the goods needed by Auto Owners to keep their cars like new.

Some of the Goods are as follows:

MOHAIR TOP DRESSING

Waterproofs, dyes and renews leaking and faded Mohair tops.

LEATHER TOP DRESSING

Brightens, oils and softens all tops of Leather, Pantasote, etc.

LINING DYE

Dyes black stained, faded and spotted cloth linings.

CUSHION DRESSING

Brightens and renews dull upholstery. Dries quickly.

FORD TOP DRESSING

Renews and preserves rubber tops. Use Mohair Dressing on cloth tops.

TOUCH-UP BLACK

Air dries quickly with a fine gloss finish. Use everywhere.

FENDER JAPAN

Heavy-bodied, air drying with a rich gloss finish.

CYLINDER ENAMELS

Black and grey enamels that resist heat, grease and gasoline.

BODY POLISH

A good body polish to revive dull finishes.

GASKET SHELLAC

Orange color. Heavy bodied, goes in tack quickly. A perfect sealer.

Eight Color Finishes

Cover solid with one coat, no undercoat necessary. Owners use to paint their cars their favorite colors. Air dry over night.

Manufactured Only by

The Columbus Varnish Co.

Varnish Mfgs.

Columbus, Ohio, U. S. A.

prunes is also expected. The yield of peaches and apricots is expected to be light. Spring frosts caused very little damage in this region this year and growers are reported to have been unusually busy in taking care of their orchards.

It is announced that a new addition will be built to the plant of the Buhl Canning Company in time to take care of the largely increased business expected this year.

In honor of the men who were members of the Idaho Technical School, who gave their lives for their country in the world war, trees were recently planted on the school ground at Pocatello.

By buying lime-sulphur solution in large lots this spring fruit growers in Boundary County estimate that they saved from \$3 to \$5 per barrel.

In order to test out the use of commercial fertilizers orchardists in Washington County will conduct a test on 22-year-old prune trees. One thousand pounds of a combination commercial fertilizer will be used on one plot and 200 pounds of nitrate of soda on another to test their comparative merits. Tests will also be made with apple trees.

Payette citizens are endeavoring to have a box factory located at that point. The proposition was started by the offer of A. J. Wilson to the local Commercial Club that if the citizens of the county would subscribe for \$10,000 worth of the stock the building would be erected before the payments on the stock are asked for.

Director W. H. Wicks of the Idaho State Agricultural Department is conducting a vigorous campaign this spring to have all fruit orchards in the state properly sprayed and to secure a uniform inspection system of pest inspection. Samples of spraying solutions used by growers will also be collected by the department and sent to the state chemist for analysis to determine whether they are up to the standard. The fruit inspectors who will work with the department this year are: North of Payette, A. S. Worth; Fruitland, east of Penn's Avenue, J. D. Baker; Fruitland, west of Penn's Avenue, L. E. Keeler; New Plymouth, H. T. Lewis; Payette, Washoe Bench and all nursery stock; Weiser district, A. R. Albee.

A two-story warehouse, 45 feet by 200 feet, to cost approximately \$25,000, is planned for Coeur d'Alene, Idaho, this summer by the Spokane Fruit Growers' Company as headquarters for the apple tonnage of the district and for the supplies handled by the company through its Coeur d'Alene branch. The growers interested at present represent 1,000 acres of orchard. The company expects to sign up 150 cars of apples this season to justify the erection of the new warehouse.

Examination of cherry trees in the Lewiston-Clarkston Valley shows almost no damage from frost and all signs point to a bumper crop in that section. During the last few years shipments of Bing, Lambert and Royal Ann cherries and sales to local canneries, have increased to a point where this fruit is one of the most dependable and profitable raised in Lewiston-Clarkston Valley. Growers are offered 10 cents a pound for canning cherries at present, but it is generally believed that competition for the local crop will bring the price above this. Consequently growers are not contracting to any extent.

Examination of fruit buds on apple trees in Lewiston Orchards indicate a light crop, due to the severe winter. Damage from scale has been almost completely done away with by continuous spraying. The freezing weather of last December tended to kill most of the scale and the trees are now in better shape than ever before. Nut crops will be small this year, but cherries and pears are promising in that section. Peaches have been seriously damaged.

What They Are Doing in California

The California Prune and Apricot Growers' Association has commenced the erection of a new packing plant at Reedley. This is the first plant of the association in this part of the valley.

A recent survey in the Linden and Bellota sections of the eastern part of San Joaquin County shows that there are 9,700 acres planted to fruits, nuts and grapes in that district. Some of the finest quality peaches that are grown in California come from this dis-

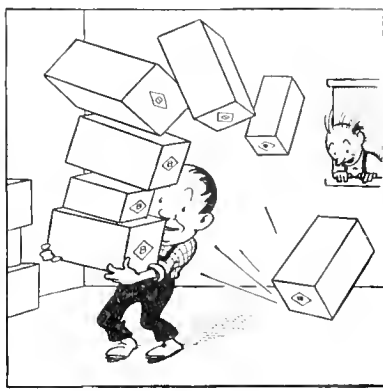

Boxes large and boxes small;
Boxes short and boxes tall;
And every box
Withstands its knock,
For they're "B-D" built—
that's all.

Selected spruce and hemlock,
carefully inspected, from choicest
stocks in the west, used to build

Bloedel Donovan Boxes

Your demands for containers that will carry your products
safely are met quickly. May we have your next order?

BLOEDEL DONOVAN LUMBER MILLS
1018 White Building
Seattle, U. S. A.

Spray and Garden Hose

¼-in. and ⅜-in. Spray Hose
Special Price of 10c foot

High pressure Garden Hose, just purchased
from U. S. Shipping Board, in 50-foot
lengths, while it lasts, **\$7.50** per 50 feet.

201 Front Street—ALASKA JUNK CO.—Portland, Oregon

Tents for Your Berry Pickers

We still have some of the U. S. Navy Wall
Tents left. If you want any of these bet-
ter order NOW.

7x7.....	each \$11.00
7x9.....	" 12.00
9x9.....	" 14.00

All sold out of 8x10 and 10x12.

Ridley, Houlding & Co.

COVENT GARDEN, LONDON

WE ARE

Specialists in Apples and Pears

CABLE ADDRESS: BOTANIZING, LONDON
Codes: A. B. C. 5th Edition and Modern Economy

tract. Other fruits that are grown there are apricots, pears, peaches, grapes and prunes. One of the largest walnut orchards in the world is located there. This orchard is 500 acres in extent and is three miles west of Linden.

More than 800,000 almond trees will be planted in San Luis Obispo County this year. Only the shortage of stock prevented the plantings from being much more extensive.

Two hundred thousand fruit trees of different varieties have been set out in Stanislaus County this season. Prospects of a greatly increased yield of fruits from old trees is being anticipated by the local canneries which are building additions to their present plants to take care of the increased production.

The apple production at Watsonville last year was one of the largest in the history of

Timely Topics and Advice for Fruitgrowers

Many growers says W. L. Close, horticultural inspector in Washington, who want grafting or budding done and who are not familiar with this phase of orchard work, neglect to get their scions until it is too late in the season. When a grower is planning on working over fruit trees he should locate some good thrifty trees of the variety he wishes to use for scions and make definite arrangements early enough to be sure of the best stock. It is better to cut the scions before pruning, but if this is not possible those from the prunings will do if gathered before they are dried out. Scions should be selected from good healthy last year's stock, but not from water sprouts of too rank a growth. This season growers should be especially careful to get scions as free from signs of winter injury as possible.

If your orchard is being attacked by apple aphids and you neglected to spray for them during the green tip period a later treatment is possible by the addition of nicotine sulphate one pint to each 100 of arsenate of lead or the same amount of nicotine sulphate to each 100 gallons of dilute lime-sulphur (1 to 40.) This should be applied about three weeks after the petals fall.

Ravages of the apple leaf hopper can be materially checked by a single spraying of 40 per cent nicotine sulphate in the proportions of 1 to 1,500, combined with soap. The solution should be applied against the first brood nymphs, the time being governed by whether the growing season is early or late.

W. L. Adams, a Zillah, Washington, strawberry grower, who has made a marked success of growing strawberries, in planting sets the plants in rows two feet wide and five feet apart, removing all the first buds from the slips and then turning the runners in the rows toward each other. The runners are kept thinned out making large sized slips and a large yield of fruit buds. The plants are reset or worked to new slips every third year.

If the fruit buds on your peach trees have been endangered during the winter by low temperatures it will be advisable to delay pruning until settled growing weather determines their conditions. This is especially advisable if heavy heading in of the previous season's growth is involved. The proportion of live buds will determine the extent to which the cutting back is necessary. In summer pruning the peach the trees should be observed constantly. Whenever a branch is seen that is so placed that it will need to be pruned at the heavy pruning time it should be taken off at once, thereby allowing more vigor to go to the rest of the tree.

In discussing the subject of thinning apples Gordon G. Brown, horticulturist at the Hood River Experiment Station, advises that the aim of the grower should be to secure a maximum crop of best quality apples each year rather than to sacrifice fruit with the idea of insuring larger crops in subsequent years. Mr. Brown bases his advice on his own observations and that of other experts who have secured data that indicates that excessive thinning to induce more regular annual bearing does not in all cases accomplish its purpose. "This is not," he says, "to suggest that no influence is exerted on subsequent crops by thinning, since such an inference would be manifestly unreasonable and contrary to general experience. If a tree is allowed to overbear it nearly always exhibits a tendency to short crops and weakened vitality especially during the following year. On the other hand

the Pajaro Valley. Figures that have recently been given show that 2,719,000 boxes of fresh fruit was packed out; 5,500 tons of dried apples put up; 2,100 tons of green apples canned and 60,000 boxes of apples used for cider.

At a meeting of the nurserymen of California recently held at Sacramento, called by George H. Hecke, director of the State Department of Horticulture for the purpose of discussing the standardization of the propagation of tree fruits it was decided to only propagate the varieties of fruit that the markets demand. The nurserymen in attendance at the meetings reported that the demand for nursery stock is unprecedented and bids fair to continue for some time. For this reason the California Nurserymen's Association has decided to keep the cost of propagation down to the lowest point by the elimination of undesirable varieties of fruit stock.

the point which it is desired to bring out is that there is little to support the idea that more regular annual bearing can be established by removing more fruit than the tree is capable of growing of the best quality. As a rule it is doubtful if a tree can mature even one fruit to every spur. This would apply particularly to older trees and less so to young ones. However, in few cases is the tree called upon to carry such a heavy burden. In many cases a good crop is insured if one spur in three or four bear."

Bits About Fruit, Fruitmen and Fruitgrowing

A report received from Middlesex County, Massachusetts, where growers have adopted the box pack is to the effect that large acreages of apples have been planted in that section during the past ten years. Some of the principal varieties grown are the McIntosh Red, Gravenstein and Baldwin. These varieties of apples from this section during the past season are reported to have brought from \$4 for extra fancies to \$1.75 for windfalls.

The Hood River Glacier reports that the cost of packing apples will soar this coming season. While the box market is still indefinite, indications point to 30-cent box shooks, as compared with an average of 18 cents last year. Growers will pay from 12½ cents a pound, for layer boards, to 17 and 18 cents for light weight wrapping paper for papers for their boxes this year. These prices are from 25 to 50 per cent higher than last year. The labor situation for orchardists is improving. While growers were finding it difficult two weeks ago to obtain men, an influx of new workers has struck the valley and the help supply now is fairly plentiful. Growers are paying from \$80 to \$100 a month.

Australia, May 19, put into effect an order removing the embargo against the importation of American apples. The prohibition against the importation of American apples was put into effect July 18, 1917.

According to reports from British Columbia jam plants in the strawberry growing districts in that province have contracted with growers this year for 250 tons of berries at 20 cents per pound, or three cents higher than the price paid last year.

The Package Sales Corporation, which manufactures basket containers for fruit has recently issued a booklet on how to load cars properly. The booklet contains a number of illustrations showing how to load and how not to load with explanations that are valuable to growers using this kind of a container. A copy of the booklet can be obtained by application to the company whose place of business is at South Bend, Indiana.

Falling in line with western packing and marketing methods New York apple growers are forming cooperative marketing associations to fit eastern conditions. Three of these associations have been formed in Monroe County, one of the heaviest apple growing districts under the direction of the County Farm Bureau.

The engineering department of the Cleveland Tractor Company is distributing a pamphlet treating on the proper method of laying out fields for tractor plowing. The pamphlet will be found useful to orchardists and others having occasion to use a tractor in plowing. It



WORTHLESS INVESTMENTS

have been fatal to the financial success of many men and women; and the tragedy of it all is that if they had consulted their bankers it might have been avoided.

Take your banker into your confidence; supplement your individual knowledge by his wider experience. Let him help you solve your business problems. But *select your bank connection carefully, first.*

LADD & TILTON BANK

(Oldest in the Northwest)

Portland, Oregon



Established 1882

F. W. Baltes & Company Printers

WE print anything from the smallest to the largest and always welcome orders of any size or quantity, giving prompt, personal and efficient service.

Mail or phone inquiries are solicited. We do not specialize — experience and equipment enable us to print everything equally well. We render service in preparing copy and illustrations and furnish plans and estimates for catalogs, booklets, publications, billboard and any other kind of advertising.

First and Oak Streets
Main 165; Auto 511-65
Portland, Oregon

is illustrated in a comprehensive way and can be obtained by applying to agents of the company.

A new volume entitled "Productive Small Fruit Culture," the work of Fred Coleman Sears, Professor of Pomology Massachusetts Agricultural College, and published by the Lippincott Company, has recently come from the press. Without being technical the work covers the subject from a highly intelligent point of view. Numerous illustrations show the many phases of growing, cultivating and packing small fruits and in many respects the volume will fill a demand in the fruit growing world as a ready reference book on the successful growing of small fruits.

Proposed increases in freight and express rates will increase the shipping bills of fruit growers in Washington and Oregon this year more than \$10,000,000, according to figures submitted at a meeting in Spokane of the executive committee of the North Pacific Fruit League. Walla Walla, Yakima, Wenatchee, Hood River and Spokane districts were represented. The league will wage a vigorous fight against all increases proposed. The 1919 apple crop of the four Northwestern states, it was pointed out, was 30,000 cars and of all fruits about 40,000 cars. There is every indication now that the 1920 crop will be as large. J. G. Wilson, of Portland, counsel for the league, has compiled figures showing that the 1919 freight bill of Washington and Oregon alone was approximately \$19,000,000 on apples, peaches and pears.

Fruit growers of the Wenatchee district, comprising Chelan, Okanogan, Douglas and Grant Counties, it is reported will have to pay nearly \$2,000,000 more for boxes, paper and nails used in the packing of this year's fruit crop than was expended by them in 1919. Within the last few days several big contracts have been signed up at prices ranging from 28 to 30 cents. Spruce boxes will sell to the grower at 28 cents under these contracts and pine boxes at 30 cents for the heavy dimension shooks. Some sales have been made at slightly less than the above figures, and hemlock boxes are now offered at about one cent below the price quoted for spruce. These prices are double what were prevailing one year ago today. If the total fruit crop of the Wenatchee district holds up to last year's figure with the natural increase resulting from the increasing bearing capacity of the trees, there should be 10,000,000 boxes of fruit packed out this year. That would mean a total cost to the grower of about \$3,000,000 for boxes. This compares with about \$1,500,000 last year. Wrapping paper presents a still more serious problem for the growers than does the box question. Wholesale houses and mills that formerly bid for this business are absolutely refusing to take orders for more than a portion of the amounts they usually sell. One large dealer was informed by the firm which has always supplied all its paper that only 60 per cent of the local dealers' requirements could be shipped this year.

Cannery Notes

The operations of the Ritter Root Canning Company in the Bitter Root Valley, Montana, are being extended this year by the purchase by J. W. McKinnon, Jr., manager of the cannery of 150 acres of productive land which will be planted to green peas. The company expects this year to put up 2,000 cases of peas or double the pack of last year.

The Oregon Growers' Coöperative Association recently closed a deal at Dallas, Oregon, with J. C. Shultz for a plot of ground along the Southern Pacific Railroad on which it will erect a packing plant to take care of the prune and other fruit crops which the organization will handle in that vicinity. It is planned to have a cold storage plant in connection with the new packing plant.

The Drager Fruit Handling Company, which operates in the Willamette Valley, Oregon, has commenced the erection of one of the largest fruit packing plants in the state at Roseburg. The new plant will be 160x50 feet with an annex. The main building will be three stories high and will cost, with improved equipment that will be added, \$25,000. V. T. Jackson, the local manager of the plant says that it is expected to have it entirely completed by September.

The Graves Canning Company, which recently purchased the string of canneries owned and operated by the Brownsville Canning Company announces through its head, Roy Graves, that

it is the intention of the company to pay more than the contract price for fruits to growers in case prices advance during the coming season. The company is now endeavoring to make contracts with growers for a term of five to eight years. Fifty additional acres are being put into berries in the Brownsville district this year and it is expected that 300 acres will be planted next year.

A trade interest of note is the fact that the British Board of Trade recently removed the export embargo on canned cherries. At the present time other canned fruits may be exported only under license.

The A. Rupert Company, Incorporated, which operates the largest number of canneries in Oregon, recently announced the election of Walter A. Frost, of Chicago to the presidency of that institution. H. F. Davidson, one of the largest fruit growers in the Hood River Valley was elected first vice-president and secretary, and D. C. Minor was appointed assistant to the president. Mr. Frost is the head of the Walter A. Frost Company of Chicago, one of the largest canned food and brokerage concerns in the middle west. He will make Portland his headquarters and following his election stated that the policy of expansion and cooperation with growers in the development of the fruit industry, adopted by the late A. Rupert would be continued. The program for expenditures for plant betterments and improvements this year calls for an expenditure of \$150,000 and the company expects to do a \$2,000,000 business in buying fruits in Oregon and Washington this year, provided fruit and sugar prices do not soar to a prohibitive figure.

Arrangements are being made for the installation of a by-products plant at Wapato, Washington, by the Sunset Fruit & Produce Company. The stockholders of the company recently agreed to an increase in the capital stock from \$10,000 to \$200,000 for improvements, the purchase of machinery and other equipment needed. The by-products plant will be housed in an added story to the large brick warehouse and packing plant which the company already owns at Wapato. The company proposes to manufacture all of the by-products of the apple, to make catsup, mince meat and other table foods and to install a mill for the manufacture of starch from cull potatoes.

The Idaho Canners Company, Incorporated, which has taken over the cannery at Payette, Idaho, is making arrangements to enlarge the building and re-equip the establishment with modern machinery that will permit the company to pack a complete line of fruits and vegetables. It has been actively engaged for several weeks in securing all the available fruit and vegetable tonnage for the cannery and will start the plant at the opening of the canning season. The new men interested in the cannery are F. M. Lane, Rochester, N. Y., and O. S. Pratt of Salt Lake. W. A. Coughanour and F. M. Ross, formerly with the old company are on the board of directors.

According to J. K. Armsby, president of the California Packing Corporation, the rising price of sugar will very materially increase

the price of California canned fruits this year and cut down the output. Mr. Armsby denies the statement that California canners had contracts for sugar covering a period of several years at prices less than are now prevailing and says that they have had to buy in the open market.

Sacramento canneries will turn out between \$14,000,000 and \$15,000,000 in canned goods this year, according to estimates. Libby, McNeill & Libby's Sacramento County plants have already put up 175,000 cases of spinach and 300,000 cases of asparagus. The canneries will pay approximately \$6,500,000 to growers and labor this year.

Fruit as First Aid to Convalescence

"Two Tons of Oranges—the Gift of the Alhambra-San Gabriel Red Cross Chapter, to the Sick and Disabled Soldiers at Letterman Hospital, San Francisco. Your Turn Next!"

This legend in bold letters on the side of a two-ton auto truck advertised the merits of fruit as a first aid to convalescence over a circuit of five hundred miles, as the golden cargo made its way along the valley from the Southern California town on to the Pacific Coast. Newspapers all along the route gave a still wider publicity to the generosity of the fruit growers of the Sunset state for in addition to the oranges there were quantities of lemons and grapefruit, while at Los Angeles the local Red Cross Chapter added a contribution of seventy-five pounds of candy.

Nice Bright Western Pine FRUIT BOXES AND CRATES

Good standard grades. Well made. Quick shipments. Carloads or less. Get our prices.

Western Pine Box Sales Co.
SPOKANE, WASH.

 <p>America's Pioneer Dog Medicines</p>	<p>BOOK ON DOG DISEASES And How to Feed</p> <p>Mailed free to any address by the Author</p> <p>H. CLAY GLOVER CO., Inc., 118 West 31st Street, New York</p>
--	---

How to Save Your Fruits at Ripening Time

There is no process known equal to canning and no better sellers than canned fruits and vegetables. We build canning outfits and plants to meet the requirements of the small and large growers—Hand and Belt Power Double Seamers for sealing sanitary cans. Write for Catalog C, Dept. T.

Henninger & Ayers Manufacturing Co.
If it's used in canning, we sell it. Portland, Oregon, U. S. A.

<p>MUSICAL MERCHANDISE</p> <p>WRITE US</p>	<p>WE SAVE YOU MONEY!</p> <p>W. Martius Music House Inc.</p> <p>1009 First Avenue, Seattle, Washington</p> <p>Everything Known in Music</p>	<p>SHEET MUSIC</p> <p>WRITE US</p>
--	---	--

A local packing house boxed the fruit for shipment free of charge and the use of the truck and driver for the long journey was contributed by a Los Angeles firm.

There was a unanimous response to the suggestion, "Your Turn Next," in every town where stops were made, all of which were referred to the Director of the Department of Military Relief of the Pacific Division Headquarters, Mr. Walter M. Case, who gave advice concerning the hospitals where such gifts would be acceptable. Not that there is any danger that fruit would ever come amiss, for the demand invariably exceeds the supply, but in order to insure

an equal distribution of the luscious food to every one impartially.

It is safe to say that in the cities where the principal stops were made the passage of the Red Cross Orange Van did more to make the housewives and restaurateurs think of desserts and salads in terms of fruit than the most tempting window displays or carefully worked out "psychological advertising appeals."

Wendell P. Chambers, an overseas man and member of the Alhambra Post, No. 139, was in charge of the truck and made the official presentation to the Red Cross Field Director upon arriving at Letterman.

Some Brief Observations on Summer Pruning

SUMMER pruning is a subject on which there are many ideas. The well known statement of fruit men to prune in winter for wood and in summer for fruit, does not, according to Professor C. I. Lewis, always work to advantage. Summer pruning, according to this authority, may be for wood or it may be for fruit, the amount and time of pruning and the age and kind of trees being the determining factors in summer pruning. In discussing this subject further Professor Lewis says:

"Summer pruning for wood applies especially to the first three years of the tree's life, or, in some cases, to trees somewhat older that have been overpruned in the winter, and, if allowed to grow until the succeeding spring, will become too rangy. In summer pruning young trees I would suggest that very little of it be done the first year, the pruning this season to consist of the removal of undesirable buds and young shoots which, if allowed to grow, would take nourishment away from the branches that should be retained for the framework of the tree. This pruning should always be light in character. During the second and third years of the tree's growth some growers feel that they can gain an entire season by pruning in June, and to some extent this is true.

"As soon as the leading branches have made a growth sufficient to allow the proper formation of the second laterals, these leading branches should be pinched back; and in place of a strong terminal growth there will be secured lateral branches on each leader and by fall they will have made sufficient growth so that practically an entire season has been gained in forming the framework of the tree. The amount of this pinching or pruning back should depend upon the variety and the growth the trees have made. It is probably better if it can be done without removing large quantities of foliage. Some people believe that such removal devitalizes the tree. However, this is a point which is open for further investigation. Where the pruning is done early, as in May or June, such trees will have ample opportunity to harden up their growth sufficiently before winter.

"When we speak of summer pruning, most growers think at once that we mean only pruning to induce fruitfulness, and undoubtedly most of the summer pruning that is done has this one object in view. In glancing over the literature on summer pruning, one is impressed by the fact that there seem to be several theories.

"One is that summer pruning changes leaf buds into fruit buds. Another is that summer pruning causes the immediate formation of fruit buds. These theories are probably incorrect. With most varieties of pomaceous fruits, such as apples and pears, I doubt if summer pruning will give very immediate effects as far as the succeeding fruit crop is concerned. I am inclined to believe it will affect more the crop of the second and third years and will induce some of the younger wood to come into heavy fruiting earlier than otherwise.

"Probably in the case of certain stone fruits like peaches and cherries and those varieties of pomaceous fruits that bear on terminal buds on one-year-old wood, or even on the current year's growth, fruit may follow the pruning of such varieties. But we can also answer that you get this fruit if you don't prune. Until more careful experiments have been conducted and good checks are kept, it will be impossible to prove what summer pruning will do for such varieties. Many growers feel that with peaches it is an advantage to prune in early summer, not so much to induce fruitfulness, because the peach bears only on one-year-old wood on the one hand or too weak wood on the other does not give an even distribution of large fruits.

"In summer pruning of pomaceous fruits it has been noticed that such pruning thickens up the wood very materially, which means that there is an accumulation of tissue, and very apt to give rise to fruiting wood; but it will affect the spurs that are growing next year. If you examine the trees carefully at the time the summer pruning is done you will find that the fruit buds and leaf buds are already there. An accumulation of tissues, however, will in all probability strengthen the fruiting areas."

Establishes String of Warehouses.

The American Fruit Growers, Inc., which last year acquired a number of large orchard tracts in the Northwest and is the largest orchard holding concern in the world, will establish a branch at Zillah, Washington. Other warehouses to be operated by the new concern in that state will be located at Yakima, Grandview and Selah.

Valuable Reports.

The annual reports of the Washington State Horticultural Association, the Idaho State Department of Agriculture and the Western Walnut Association, recently issued, are of valuable interest in their respective fields. All of these reports contain much that the fruit and nut grower will find handy to refer to and study.

For perfect maturity and increased yields of all fruits and vegetables, destroy the numerous enemies which attack them by spraying early and often with a MYERS SPRAY PUMP. Here is real protection — the kind that produces results and pays for time and effort expended for MYERS SPRAY PUMPS have been developed to meet the needs of all fruit growers and gardeners, and others who raise fruit or vegetables on the home lot. Large capacity Power Pumps and complete Power Rigs — Medium Capacity Tank and Barrel Outfits — Small Capacity Bucket Pumps and Atomizers, and a complete assortment of Nozzles and Accessories make up the Myers "Honor-Bilt" Line. Speed, ease of operation, correct and economical application of mixtures, better construction throughout with many patented features are Myers Talking Points.

☛ New Catalog No. SP20 shows the line and gives valuable spraying information. Mailed free to anyone — drop us a card.

Myers Handy Portable Sprayer has Cog Gear Pump, Heavy Galvanized Tank—holds 12½ Gallons—Steel Frame, Single or Tandem Wheels, 15 ft. Hose, 8 ft. Extension and Vermorel Nozzle, suitable for inside or outside spraying.

F.E. MYERS & BRO.
NO. 135 ORANGE ST. ASHLAND, OHIO.

PACIFIC NORTHWEST DISTRIBUTORS

PORTLAND,
ORE.

Mitchell
LEWIS & SHAW CO.

SPOKANE,
WASH.

BUY FROM THE LOCAL MITCHELL DEALER

WHEN WRITING ADVERTISERS MENTION BETTER FRUIT

GOPHER DEATH
TRADE MARK

Kills prairie dogs, ground hogs, ground squirrels, pocket gophers. Saves alfalfa. Experimental stations approve. 1000 tablets P. P. \$1.50. Warranted. Ask your druggist or send direct. Booklet Free. Address
FT. DODGE CHEMICAL CO., Ft. Dodge, Iowa

TREES AND SHRUBS



Fruit trees budded from bearing orchards. Apple, Pear, Cherry, Peach, Plum, Prune, Apricot, Quince, Grape Vines, Shrubbery, Plants, Raspberries, Blackberries, Logans, Dewberries, Asparagus, Rhubarb, Flowering Shrubs, Roses, Vines, Hedge, Nut and Shade Trees. Carriage paid. Satisfaction guaranteed.

WASHINGTON NURSERY CO.
Toppenish, Washington.
Salesmen everywhere. More wanted.

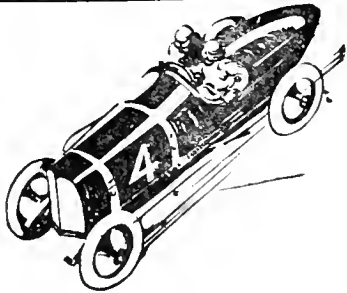

Actual tests

By exhaustive study and engine tests, our Board of Lubrication Engineers has determined the correct consistency of Zerolene for your make of automobile. Its recommendations are available for you in the Zerolene Correct Lubrication Charts. Get one for your car at your dealer's or our nearest station. Use Zerolene for the Correct Lubrication of your automobile, truck or tractor.

STANDARD OIL COMPANY
(California)



A grade for each type of engine

Birds—Their Practical Benefit to Horticulture

Continued from page 6.

saw martins feed their young 312 insects in 16 hours. Mr. Mosher made a record of a pair of yellow throat warblers eating plant lice in a birch tree at a rate of 68 a minute for 40 minutes. At this rate this one pair of birds would destroy 73,000 of these insects in a week.

Harvey found 500 mosquitoes in the stomach of a nighthawk and 60 grasshoppers in that of another bird of the same species. A scarlet tanager ate 35 gypsy moth caterpillars a minute for 18 minutes; a warbler ate 90 plant lice in a minute, and a pair fed at this rate for 40 minutes. A red-winged blackbird had 28 cutworms in its crop. Fifty-one species of birds are known to eat hairy caterpillars, and 38 species feed on plant lice. It is estimated that during the stay of the birds in New York state each season they destroy more than 3,000,000 bushels of injurious insects. Think of the consequences if the birds were all exterminated.

Is it worth while to try to save our forests, our shade trees, our fruit trees? If so, we must stop the killing of insect-eating birds. The gypsy moth, the brown-tail moth, the leopard moth, the elm tree beetle, and the tent caterpillar have killed millions of trees in the past few years, and today they are imperiling every tree on the continent!

The only way to check the increase of these insects is to stop the killing of insect-eating birds, and then let the birds increase to their normal numbers. Careful scientists tell us that if all insect-eating birds were destroyed, the whole continent would within three years become absolutely uninhabitable by reason of the myriads of insects that would spring up and devour every living thing. We are face to face with this possibility.

Ninety per cent of the normal bird life of this country has already been destroyed, and the other 10 per cent will go in the next five years unless drastic measures are employed to stop the slaughter. The farmers and fruit growers of this country are losing over \$1,000,000,000 a year by reason of the ravages of insects. Here are a few items in this appalling expense account.

The cotton growers of Texas are losing \$40,000,000 to \$50,000,000 a year by reason of the ravages of the boll weevil; and all because the quail and the prairie chicken, the natural enemies of that bug, have been practically exterminated in that great state. The cotton boll weevil is moving like a great army to the eastward and to the northward, and scientists sent down there to study the situation tell us it will go to the Atlantic ocean before it stops, and as far north as cotton is grown, unless the killing of birds is prohibited. The wheat growers of the United States are losing over \$100,000,000 a year by reason of the ravage of the chinch bug. Why? Because the quail, the natural enemy of that bug, has been almost exterminated. The farmers of the middle

BEST SERVICE-QUALITY & PRICES



THE SIMPSON & DOELLER CO.

1423-24 NORTHWESTERN BANK BLDG.
PORTLAND, OREGON.

E. SHELLEY MORGAN
NORTHWESTERN MANAGER.

WE CARRY—AND CAN SHIP IN 24 HOURS—STOCK LABELS FOR PEARS, APPLES, CHERRIES & STRAWBERRIES.

CUSHMAN

Light Weight Farm Engines

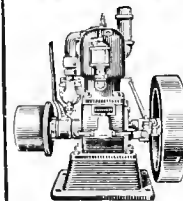

Built light, built right—for farmers who want an engine to do many jobs in many places, instead of one job in one place. Easy to move around. Equipped with Throttling Governor, Carburetor, Friction Clutch Pulley and Water Circulating Pump. (323)

4 H. P. Weighs Only 190 Lbs.

Mounted on light truck, it may be pulled around by hand. Just the engine for power sprayers because of light weight and very steady speed, giving uniform distribution and a thorough job. 8 h. p., 2-cylinder, for heavier work, weighs only 320 lbs. Book on Light Weight Engines sent free.

CUSHMAN MOTOR WORKS
978 N. 21st Street Lincoln, Neb.
Northwest Branch: 248 Hawthorne Av., Portland, Ore.
Full Stock of Repairs at Portland

Excelsior Roof Paint Direct to You

Not what you buy at the average paint store. 35 years' experience with preservative roof paint has taught me to give you a superior paint at less cost. Black, red, brown, green and yellow colors. Used for wood, tin, iron, slate, etc. **NO TAR.** It forms a thick rubber like water-proof coating over the surface to which it is applied and will withstand the hot sun, rain and snow. Applied with a brush.

Write today for samples and prices to

H. J. ARNOLD
Route 2, Box 10 Renton, Washington

and eastern states are paying out \$15,000,000 a year for Paris green to put on their potato vines. Why? Because the quail, the natural enemy of that bug, has been almost exterminated.

Each of the great apple producing states is paying \$1,000,000 to \$3,000,000 a year for spraying apple trees to keep down the codling moth. Why? Because the woodpeckers, the sapsuckers, the robins, the blue jays, the bluebirds, the orioles, the tanagers and other birds that formerly preyed on this insect have been killed off, and every man, woman and child who eats an apple or a potato helps to pay for this poison.

Of the 1,200 species of birds inhabiting the United States, about 335 visit Kansas; 175 of these nest in the state. In calculating some of the worth of

these birds to the state, we will use the Massachusetts estimate of five birds to the acre. Kansas, with her 51,200,000 acres, should have a bird population of 256,000,000. Insect-eating birds consume on a very conservative estimate 100 insects a day. Kansas birds would devour 25,000,000,000 every day (May to September, inclusive) for five months or 150 days.

That these figures can be better understood it has been computed that about 120,000 average-sized insects fill a bushel measure. This means that Kansas birds consume 213,333 1/3 bushels of insects a day. Then for 150 days (five months) they would use a total of 32,000,000 bushels of insects.

Again, by Mrs. Nice's careful observation we are enabled to state that 10,000

average insects weight one pound, and that one bushel of insects weigh twelve pounds, so Kansas birds, from May to October (five months), eat 384,000,000 pounds of insects. This estimate is good for about five months of the year, May to September, inclusive. During the remainder of the year the insect eggs and larvae destroyed by our late fall, winter and early spring migrants will be equivalent to half of this quantity. Kansas has a longer season than Massachusetts, and I will consider a full one-half in our estimate.

	Pounds
Five months' consumption of insects	384,000,000
Seven months' consumption (October to May) of insects	192,000,000
Grand total for the year.....	576,000,000

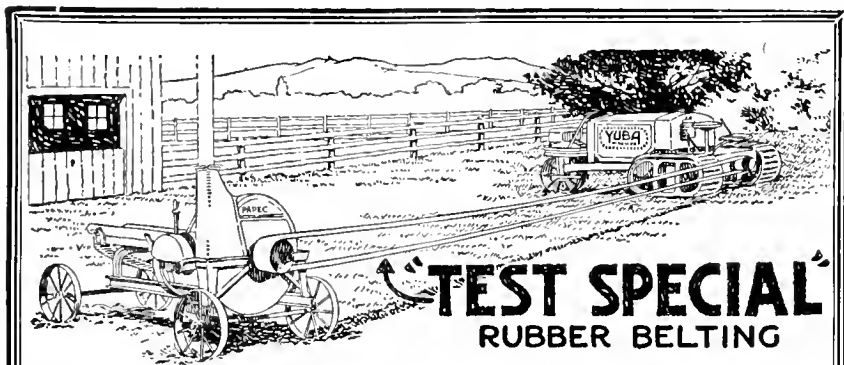

When it comes time to fill your Silo use a "TEST SPECIAL" RUBBER BELT. It is a safe guarantee against shutdowns or other delays due to the use of improper belting.

"TEST SPECIAL" is made for hard, out-door usage and fully guaranteed.

Our Free Service Department

If you are not getting the expected power or service from the belt you have, your trouble is undoubtedly due to an improper selection of belting.

WRITE TODAY, giving the R.P.M., and Diameter of the driving pulley—also driven pulley and distance between centers of same, also give the rated horse-power of your motor or engine, and name kind of machinery you are operating. We will reply immediately giving you our recommendation as to kind of belt to use.

Write us today.

New York Belting and Packing Co.

519 Mission Street, San Francisco

HOME OFFICE: NEW YORK

FAIRBANKS, MORSE & CO.,
951 First St., Portland, Oregon.

FAIRBANKS, MORSE & CO.,
550 First Ave. So., Seattle, Wn.

To elucidate further for my own edification (I cannot comprehend large numbers), let us see how many earloads (minimum weight 24,000 pounds) this will be—answer, 24,000 cars. Our railroad agent tells me 50 cars 42 feet long with the locomotive, tender and way car would make an average train. Then it would require 480 trains of 50 cars, measuring from cow catcher to rear of way car, a total of 2,200 feet, and if these 480 trains of 50 cars each were coupled together in one continuous straight line they would extend from the Kansas-Oklahoma state line on the south to the Kansas-Nebraska state line on the north, a distance of 200 miles.

Gentle reader, try to estimate the worth and practical benefit of Kansas birds to our great agricultural state.

What do these feathered protectors of our gardens, farms, plains and forests require for this service? A place in which to nest and rear their young in security. These friends and servants are constantly diminishing in numbers.

Are you devoting your spare time and affection to your house cat and her kittens? Each cat consumes on an average of fifty birds a year. Are you arming your boys with small guns that they may become sportsmen? It requires much practice to become a good shot, and any kind of a bird makes a good target. Are you constructing nest boxes for martins, bluebirds, wrens and woodpeckers? We have fairly good laws, but we need a better one providing for the teaching of ornithology in all the grades of our public schools. Identify yourself with some bird protection society, and let us all assist in saving one of our nation's most valuable assets, our native birds. Let their destruction go on and in a comparatively few years insect life will have multiplied to such an extent that trees will be denuded of their foliage. Plants will cease to thrive and agricultural crops cannot be raised. This is not fancy, but a truthful statement of plain facts, the evidence of which is observed every day in the disappearance of myriads of insect pests with the devastation which follows.

Means of Accomplishing Orchard Tillage

By Ralph Sundquist, Yakima, Washington

AS to the value of tillage versus cover crops, we have had considerable discussion. I will suppose that tillage in an orchard is desirable, at least part of the time, that is, we may rotate our orchards so that part is in cover crop and part in tillage, or that we have our orchard in tillage some years, and in cover crop other years, but at the same time clean tillage is desirable.

If our orchards are in clean tillage constantly, the hot sun of our apple valleys will burn out all organic substances in the soil, and if in cover crop constantly, it becomes difficult, in our irrigated regions, to distribute the water properly. With proper means of handling it, livestock, especially hogs, will no doubt rid the orchard of rodents.

Then, in the matter of tillage, it is necessary first to briefly review its purposes. Among ancient agricultural practices, we find that tillage was done entirely in order to eradicate weeds. In the course of time, however, it was discovered that the moisture content of the soil was increased by tillage. The scientific reasons for this were discovered a great deal later than the fact itself, however. But now we recognize these two reasons as the fundamental principles underlying soil tillage, though commonly we till to conserve moisture, and thus the weeds take care of themselves.

Now then, what are the peculiar requirements of proper tillage in an orchard? There are at least three.

1. We must work up the soil early in the spring, before it forms a crust on the surface.

2. The soil must be left in a pulverized condition, and as level as possible.

3. The tillage must be continued throughout the early summer, at least after each irrigation, in our irrigated valleys, which necessitates that in bearing orchards, the means of tillage must be such as to enable the operator to till as late as possible in the summer, without breaking the heavily laden branches or knocking down the fruit.

In this discussion I will speak principally from the point of view of requirements in irrigated districts, as the larger proportion of our fruit in Washington is grown in the irrigated regions.

Now let us consider these requirements, taking up the first two together. The early spring tillage must not be started until the soil has lost any tendency to puddle. A disk harrow is the best tool for pulverizing soil, but with horse cultivation, using the standard size of team disk harrow, the process of disking the soil is so slow that, if one has any appreciable acreage, a great many teams and harrows will be required to cover the ground in the allotted time. But this is not satisfactory. Furthermore, with present cost of horse feed and labor to care of teams, the keeping of additional horses for spring work brings up the cost of operation very rapidly. Spring tillage can be and always has been, done by horses, but is it entirely satisfactory? Naturally, in this age, our attention is drawn to the use of motor power. Our recently developed small size tractors are built to pull, all day long, a landem disk harrow, which would exhaust four horses in a few hours' time. With the wide cut and the greater spread of the tractor it is possible to cover the ground very quickly. As far as accomplishment is concerned, evidence seems to favor the tractor for early spring tillage in the orchard.

The tillage must be continued throughout the early summer, at least after each irrigation, in our irrigated valleys. It has been a custom among many fruit growers to till the soil in the spring, and until the weight of the fruit bends down the branches, but after this to leave the irrigation ditches permanently, depending on the shading from the trees to check an excessive evaporation. From observations on several orchards, it has been my conclusion that this practice results in small apples. Though the irrigation water is turned into these furrows every two or three weeks, the fruit suf-



Fine example of dust mulch to conserve moisture.

fers from a lack of moisture. The ground becomes packed and baked and will not absorb sufficient water, and the crust which has formed and the packed nature of the soil, favors capillarity to the extent that what little moisture does seep in is quickly lost by evaporation as soon as the water is turned off. Here the low built tractor which is capable of pulling a wide orchard tool, fills a place that no other means of tillage can fill. There are many tractors on the market each claiming superior points over others.

The main consideration in the choice of a tractor best suited for orchard conditions is that the machine must have extraordinary tractive ability. I say extraordinary, because more traction is required from a machine suited for orchard purposes than for any other. In the first place, this tractor must constantly operate in a very loose, deep soil mulch. Wheel tractors are limited in their tractive ability by the size of the wheels, the larger the wheels the better the traction, while the large size of wheels is at the same time disadvantageous in that it raises the tractor up too high and the high moving wheels are themselves a source of considerable breaking of limbs and knocking down of fruit. Furthermore, many of our best orchards are located on sloping land, the sites being especially

Mulconroy Flexible Matalic Spray Hose

LIGHT
Weighs 6 oz. to foot.
STRONG
Tested to 2,000 lbs.
FLEXIBLE
Will coil in 3 in. circle.

Can't Kink, Twist,
Burst, Collapse
or Chafe



Protected against kinking, hard knocks, sharp turns, dragging over rough surfaces and other outside abuse. Tube especially compounded to resist the action of the oily and corrosive liquids and powders used in spraying.

Full capacity always, because **HOSE CANNOT KINK.**

When equipped with Mulconroy High Pressure Couplings, it makes **THE STRONGEST HOSE MADE.** Ask for No. 65 Folder.

MULCONROY CO., INC., Established 1887

PHILADELPHIA NEW YORK PITTSBURGH CHICAGO BOSTON

chosen because of the frost free conditions, and such sloping or hilly land requires a tractor which will not "dig itself down" when it comes to loose soil or an especially heavy pull. We have here two opposing conditions which work against satisfactory design of wheel tractors for orchard work. On the one hand the machine must be built low to move about beneath the branches of the trees, and on the other hand, it needs especially large wheels to get traction in the exceptionally loose till of the orchards, many of which are located on gently sloping or hilly lands. Here again, the track-layer type is eminently suited to the requirements. A tractor with all of its weight on the "tracks" and these tracks extending the full length of the machine and only some two or three feet high,

embodies the best possible design for orchard work. Furthermore, it can be low and compactly built and has the ability to make very short turns, so theoretically, such a tractor ought to be the last word in design for orchard purposes.

But now let us make our deductions from these considerations. Track layers are eminently suited to orchard work, there can be no question about that. If an orchard is perfectly level, there is no question that a wheel tractor will be cheaper when interest on investment, depreciation, repairs, and cost of operating are concerned, but the work may not be done as well as with a track-layer and there may be some injury done to trees in turning and operating under heavily laden trees. But if there are any appreciable slopes in an

orchard a track-layer will be essential for satisfactory work. If a tractor must have its disk harrow or other tool only partly "set" in the ground in order to avoid "digging in" the work will be so ineffective that it hardly justifies the cost of traveling over the ground.

I have said nothing regarding the acreage necessary to justify a tractor in an orchard. It is probable that community ownership of tractors will not develop far because of the need of having fixed responsibility and preferably only a single driver for a tractor. If the site of the orchard is such that a wheel tractor will operate satisfactorily, it may be economical to use a machine on as small a tract as ten acres. I know of many small wheel tractors on tracts of ten acres, but in every case the owner does considerable tillage for neighbors, so the machine operates on from twenty to fifty acres. If it is necessary to have a track-layer, on account of the large initial cost it becomes a question whether it will be economy to use a tractor for less than twenty acres, but with the operator willing to hire out to his neighbors the machine will be justified on a smaller acreage. Of course in some cases where trees are bending low with fruit and horse tillage is impossible, the use of a tractor may conserve moisture and thereby increase the size of the fruit to such an extent that the added income in a single year will go far toward paying for a machine.

As to whether a tractor can entirely displace horses in an orchard, I would not yet venture an opinion. A tractor engine must run all day long in order to pull the sprayer a few yards at a time, and furthermore it needs the highest paid hired man on the place to operate it. It may be that if teams can be eliminated entirely, thus doing away with their care and feed all winter, it would be economy to pay the larger cost of operating the spray outfit during the spraying season, but so far I have found such a great need of at least one team for odd jobs, that I would not feel satisfied to be entirely independent of them.

CONSULTING HORTICULTURIST

PROFESSOR W. S. THORNBUR

Formerly

HEAD OF THE DEPARTMENT OF HORTICULTURE
AND LANDSCAPE GARDENING

Later

DIRECTOR OF THE EXTENSION SERVICE
OF THE
STATE COLLEGE OF WASHINGTON

WILL ADVISE with fruit-growers upon all horticultural problems, including selection and preparation of orchard lands; propagation and care of nursery stock; planting and care of young orchards and small fruit plantations; the control of codling moth, San Jose scale, blight and other orchard pests; the preparation of lime-sulphur at home and the mixing of other sprays; economical orchard management; the irrigation and fertilization of orchard lands; the use of cover-crops and grass mulches; the pruning of fruit trees, shade trees, shrubs, bushes and vines; the renovation of old or neglected orchards, top-working or replacing of poor or unprofitable trees, and the examining and the working out of practical management plans for large orchards and orchard companies.

If your orchard has not been a financial success, and you wish to determine its possibilities or you wish to improve your orchard, reduce your losses and increase your returns I will assist you in working out your problem.

WRITE FOR TERMS

W. S. THORNBUR
LEWISTON, IDAHO

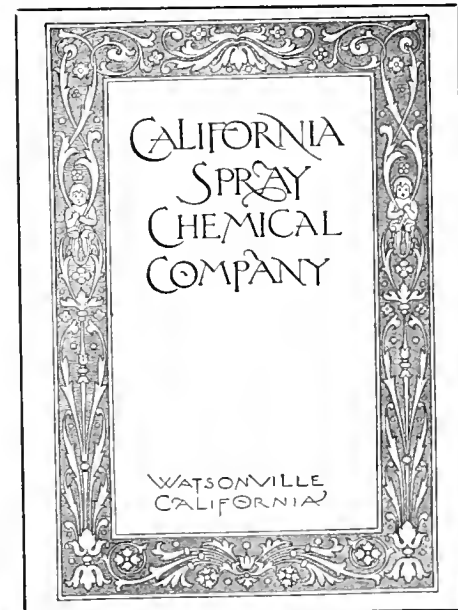

Ask the **SUN-MAID**

on the label
she'll doff her bonnet to

Traung

as a maker of
uncommonly good
cartons



No small part of the burden in exploiting any food product rests on the **CARTON**. It must carry through the underlying sales appeal of the product—whether of appetite, economy, luxuriousness, convenience—or a proper combination of these appeals.

TRAUNG LABELS and **CARTONS** have a sales appeal that cannot be ignored. **TRAUNG** service offers you a specialized organization whose delight is a good job rightly done.

TRAUNG

Label and Lithograph Co.

SAN FRANCISCO SEATTLE STOCKTON
Sales Offices
Portland Fresno Sacramento



**In Dainty Confections
—In Plain Foods**

Raisins make an irresistible appeal

IN CANADA in England wherever British people go, it is the dainty cakes, biscuits, tarts and cookies that are displayed most prominently in the shops.

That is because the British have a special liking for these things. And there is a real big reason.

But more also that their foods are filled with raisins and that they are displayed in the dainty shops.

It is the raisins that have created this demand—it is these dainty morsels of fruit that make the irresistible appeal.

Try it in your home

Wholesome, nutritious, delicious, raisins make a dainty morsel of food for everyone. A small, round, raisin, loaded in a small and dainty package with a little bit of the dainty morsel, is a dainty morsel of food for everyone. It is a dainty morsel of food for everyone. It is a dainty morsel of food for everyone. It is a dainty morsel of food for everyone.

Plain Cream Cake
This is a dainty morsel of food for everyone. It is a dainty morsel of food for everyone. It is a dainty morsel of food for everyone. It is a dainty morsel of food for everyone.

Plain Cream Cake
This is a dainty morsel of food for everyone. It is a dainty morsel of food for everyone. It is a dainty morsel of food for everyone. It is a dainty morsel of food for everyone.

Plain Cream Cake
This is a dainty morsel of food for everyone. It is a dainty morsel of food for everyone. It is a dainty morsel of food for everyone. It is a dainty morsel of food for everyone.

Plain Cream Cake
This is a dainty morsel of food for everyone. It is a dainty morsel of food for everyone. It is a dainty morsel of food for everyone. It is a dainty morsel of food for everyone.

SUN-MAID Raisins

The Finest Raisins

Our finest raisins are made from the best grapes. They are the finest raisins you can buy. They are the finest raisins you can buy. They are the finest raisins you can buy.

They are the finest raisins you can buy. They are the finest raisins you can buy. They are the finest raisins you can buy. They are the finest raisins you can buy.

10 in. Raisin Cakes, Delicious

These are the finest raisin cakes you can buy. They are the finest raisin cakes you can buy. They are the finest raisin cakes you can buy.

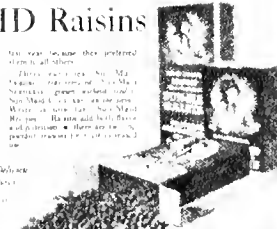

An Institution that sticks to its last

Traung

Label & Lithograph Co.



FACTORIES

- 1- San Francisco
- 2- Stockton
- 3- Seattle



SALES OFFICES

- Portland
- Fresno
- Sacramento
- Tacoma

SIMONS, SHUTTLEWORTH & CO.
LIVERPOOL AND MANCHESTER

SIMONS, JACOBS & CO.
GLASGOW

GARCIA, JACOBS & CO.
LONDON

Agencies and Representatives in Every Important European Market

European Receivers of American Fruits

FOR MARKET INFORMATION ADDRESS

SIMONS, SHUTTLEWORTH & FRENCH CO.
204 Franklin Street, New York

SIMONS FRUIT CO.
Toronto and Montreal

SIMONS, SHUTTLEWORTH, WEBLING CO.
12 South Market Street, Boston

OUR SPECIALTIES ARE APPLES AND PEARS



Sulphur

It has been proven and so recommended by the University of California that if you sulphur your grape vines and orchards 6 times they will not be affected by MILDEW or RED SPIDERS.

ANCHOR Brand Velvet Flowers of Sulphur, also EAGLE Brand, Fleur de Soufre, packed in double sacks, are the fluffiest and PUREST sulphurs that money can buy; the best for

vineyards; the best for bleaching purposes, LEAVING NO ASH.

VENTILATED Sublimed Sulphur — Impalpable Powder, 100% pure, in double sacks, for Dry Dusting and making Paste Sulphur.

For LIME-SULPHUR SOLUTION, use our DIAMOND "S" BRAND REFINED FLOUR SULPHUR. We can furnish you this sulphur at such a low price that it would pay you to mix your own solution.

To create additional available plant food, and prevent smut in grain, drill into the soil 110 pounds per acre DIAMOND "S" BRAND POWDERED SULPHUR, 100% pure. This has increased various crops up to 500%. Send for Circulars No. 6 and 7.

Also PREPARED DRY DUSTING MATERIALS, Tobacco Dust, Dusting Sulphur Mixtures, etc., Fungicides and Insecticides, carried in stock and mixed to order.

SAN FRANCISCO SULPHUR COMPANY
624 California Street, San Francisco, Cal.

We are equipped to make immediate shipments. Send for "ILLUSTRATED BOOKLET"; also booklet "NEW USES FOR SULPHUR." Price-List and Samples.

Ask us for prices for Carbon Bisulphide, the surest remedy for destroying ground squirrels.



Dependable Power

Down to the last drop "Red Crown" is high grade gasoline. It is made to meet the requirements of your engine. Look for the "Red Crown" sign before you fill.

STANDARD OIL COMPANY
(California)

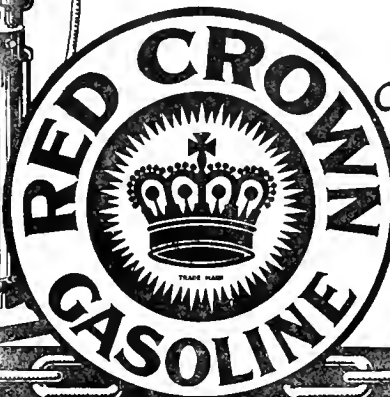

The Gasoline of Quality

"CARO" FIBRE FRUIT WRAPPERS

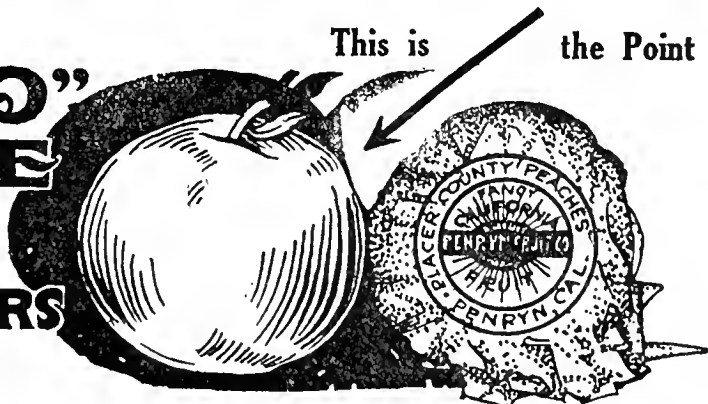

Chemically Treated
"Caro" Protects
"Caro" from DessicARE (to dry up)

"Caro"
Prolongs the Life of Fruit
Why?

Fruit decomposition starts from a bruise which opens tiny holes and permits the juice to escape and BACTERIA to enter. "Caro" clings closely and dries up the escaping juice. "Caro" ingredients harden the spot, kill the BACTERIA, arrests the decomposition—and thus **PROLONGS THE LIFE OF FRUIT**. If your fruit is worth shipping it is worth keeping in best condition.

Demand "CARO"—Wrap Your Fruit in "CARO"—The Fruit Buyer Knows, "CARO"

Order from Any Fruit Company or American Sales Agencies Co., 112 Market St., San Francisco

Classified Advertisements

RATE, 4 CENTS PER WORD

NURSERY STOCK.

ITALIAN PRUNE TREES.

Cleaning up at wholesale price. State quantity and grades wanted. Don't delay. Only few more thousand to offer. Grafted walnuts, filberts, fruit trees, loganberries, raspberries, rhubarb, etc.

LAFAYETTE NURSERY CO.,
Lafayette, Oregon.

ORIENTAL FLOWERING PLANT—Japanese Fire flowering plant, beautiful ornamental foliage, bright red flowers, imported by grower, 10c package postpaid. J. A. Bean, East Seattle, Washington.

ETTERBERG 121 strawberry plants. Best canner and shipper. Heavy producer. Low quantity prices. Quality plants. Ward K. Richardson, Salem, Oregon.

EVERBEARING STRAWBERRY PLANTS—Fine healthy ones. Write for catalogue. Canyon Home Nursery, Ellensburg, Washington.

CHOICE Progressive Everbearing strawberry plants, \$2 per 100; \$12 per 1,000, postpaid. Duroc Ranch, Boise, Idaho.

FOR SALE—Wilson strawberry plants, \$6 per thousand, postpaid. Wm. A. Bond, R. F. D. 6, Box 98, Salem, Oregon.

FOR SALE—Loganberry tips, 10c each, postpaid. Wm. A. Bond, R. 6, Box 98, Salem, Oregon.

MISCELLANEOUS.

CONSULTING HORTICULTURIST

Professor W. S. Thornber, formerly head of the Department of Horticulture and Landscape Gardening and later director of Extension Service of the State College of Washington, will advise with fruit growers upon all horticultural problems. If your orchard has not been a financial success and you wish to determine its possibilities or you wish to improve your orchard, reduce your losses and increase your returns, I will assist you in working out your problem. Write for terms. W. S. Thornber, Lewiston, Idaho.

TRESPASS SIGNS.

Don't allow trespassers to destroy your property. Our big waterproof and sunproof "No Trespassing" signs will keep out trespassers. Send \$1 for six signs, size 11x14 inches. Twelve for \$1.75. Sent postpaid. Out West Supply Company, Portland, Oregon.

COLORED PHOTOS—300 pictures, useful information in our 1920 Seed Catalogue. 'Tis different and free. Address Department 37, Lilly's, Seattle.

SITUATION WANTED as orchard foreman. Lifetime experience in horticulture; familiar with gas tractors, engines and pumps; able to handle help and produce results. Married. F. S., care Better Fruit.

WE WANT DISTRIBUTORS for our Miller Killer Traps throughout the Northwest. They catch the moths and save the fruit. The C. C. Fouts Company, Middletown, Ohio.

FARMS FOR SALE.

\$10,000.

AN IDEAL STOCK AND DAIRY RANCH—120 acres, all level; Stevens County, 20 miles to Spokane. All heavy sub-irrigated land; 80 acres in cultivation; fenced and cross-fenced. Excellent buildings, including stone milk house. Running spring water piped to house and barn. Rearing family orchard and 1½ acres young orchard, choice varieties; 20 acres timothy meadow; 5 acres alfalfa; sufficient cord wood and saw timber to pay for place. Easy haul. Excellent location near Wild Rose Prairie. Here is your chance, Mr. Farmer. \$4,000 cash, balance to suit.

\$15,500.

AN IDEAL DAIRY FARM.

123 acres in Colville Valley, near Grays, railroad station on new state highway. Fair six-room house; excellent new barn and hay sheds, chicken-house and hog pens, etc.; 100 acres in hay, mostly alfalfa; about 20 acres in small timber, easily cleared. Running spring by house and in barnyard. Colville river runs through place, good trout fishing. No better dairy farm of same size anywhere. \$5000 cash, balance to suit.

THE BIG BEND LAND COMPANY,
Spokane, Washington.

FOR SALE—Splendid Upper Valley Hood River Orchard Tract. Eighty acres, fifteen in best commercial varieties. Prospects 3000 to 4000 boxes this year. Balance brush land easily cleared; wonderful soil, cheap and plentiful irrigation water; good house, surpassing view. \$10,000. Hood River Abstract & Investment Company, Hood River, Oregon.



THE refreshment tray can always thank Ghirardelli's Ground Chocolate for its magic aid. Creamy hot chocolate to drink; cakes with possibly a chocolate filling and frosting; waxy squares of chocolate fudge—not to mention countless other "goodies"—appear in a twinkling when the hostess summons the ever-ready can of Ghirardelli's.

Never sold in bulk—but in cans only.
In ½ lb., 1 lb. and 3 lb. sealed cans—
at the store where you do your trading.

Say "Gear-ar-delly"

D. GHIRARDELLI CO.

Since 1852

San Francisco

(F2)

GHIRARDELLI'S Ground Chocolate

400-ACRE STOCK FARM within 40 miles of Portland; vegetable loam, well watered; rolling, nearly all tillable; 50 acres under plow, 50 acres pasture; houses, barns, outbuildings and other improvements. Abundance and variety choicest fruit; 37 years continuous crops by owner, whose infirmity forces sale. \$20,000. Terms.

Clackamas County, 160 acres 35 miles from Portland; 36 acres cultivation; fenced, cross-fenced, orchard, house, barn, spring water supply, good road, adjoining school; best soil. \$8,000. Terms at 6 per cent.

Douglas County 160-acre mountain ranch near Ashland; good house, barn, outbuildings; partly fenced and cross-fenced; 12 acres cultivated; 2,000,000 feet saw timber; \$3000, terms.

E. PIERSON,
415 Chamber of Commerce Building,
Portland, Oregon.

FOR SALE—\$2250 buys 50 acres of fine level land in Shasta County, California, under irrigation system, ditch on property; grows anything. Especially adapted to fruit and berries, olives, alfalfa. Latest enterprise proving great success is rice culture. About 30 acres ready for cultivation; balance slightly wooded. Address H. H. Shuffleton, Jr., Redding, California.

FOR SALE—Ten and one-half acres of commercial orchard, lots 9 and 10, block 57, Lewiston Orchards. Seven acres in seven-year old apple trees, selected commercial varieties; three and one-half acres in cherries. In good condition; ideally situated near paved road; centralized school, church, and six miles from Lewiston, Idaho. Pipe line irrigation, fully equipped. \$8500. Discount for cash. David Olson, Kent, Ohio.

CUT-OVER LANDS.

23 miles north of Spokane, rich bottom lands, good for dairying and general farming, no irrigation, plenty of running water, free lumber, 10 years' time, 6 per cent. Call or write Deer Park Lumber Company, Deer Park, Washington, or 109 Stevens Streets, Spokane, Washington.

CUT-OVER AND DEVELOPED LANDS, 15 to 25 miles N. E. Spokane; extra good soil; spring brooks; grows grain, vegetables, hay, fruits; several developed ranches; few stock ranches; \$10 to \$20 acre. Ten years time, 6 per cent interest. Free lumber. Write owners for free book. Edwards & Bradford Lumber Company, Elk, Washington.

FOR SALE—27-acre Idaho apple orchard, 7 years old; alfalfa between rows; water right. \$500 per acre. Write Box 694, Weiser, Idaho.

THE WORLD-
OUR ORCHARD

STEINHARDT
& KELLY
NEW YORK

UNQUESTIONABLY THE
MOST IMPORTANT FACTOR
IN THE DISTRIBUTION OF
THE COUNTRY'S FANCY
APPLES
AND OTHER FRUITS

OUR MARKET-
THE WORLD





3 5185 00259 1483

