



THE BIOLOGICAL BULLETIN

PUBLISHED BY
THE MARINE BIOLOGICAL LABORATORY

Editorial Board

- | | |
|--|--|
| DANIEL L. ALKON, National Institutes of Health and
Marine Biological Laboratory | MICHAEL G. O'RAND, Laboratories for Cell Biology,
University of North Carolina at Chapel Hill |
| ROBERT B. BARLOW, JR., Syracuse University | RALPH S. QUATRANO, Oregon State University at
Corvallis |
| WALLIS H. CLARK, JR., University of California at
Davis | LIONEL I. REBHUN, University of Virginia |
| DAVID H. EVANS, University of Florida | JOEL L. ROSENBAUM, Yale University |
| HARLYN O. HALVORSON, Brandeis University | DOROTHY M. SKINNER, Oak Ridge National
Laboratory |
| RONALD R. HOY, Cornell University | JOHN D. STRANDBERG, Johns Hopkins University |
| SAMUEL S. KOIDE, The Population Council,
Rockefeller University | JOHN M. TEAL, Woods Hole Oceanographic
Institution |
| FRANK J. LONGO, University of Iowa | J. RICHARD WHITTAKER, Boston University
Marine Program and Marine Biological Laboratory |
| CHARLOTTE P. MANGUM, The College of
William and Mary | GEORGE M. WOODWELL, Ecosystems Center, Marine
Biological Laboratory |

Editor: CHARLES B. METZ, University of Miami

DECEMBER, 1983

Printed and Issued by
LANCASTER PRESS, Inc.
PRINCE & LEMON STS.
LANCASTER, PA.

The BIOLOGICAL BULLETIN is issued six times a year at the Lancaster Press, Inc., Prince and Lemon Streets, Lancaster, Pennsylvania.

Subscriptions and similar matter should be addressed to The Biological Bulletin, Marine Biological Laboratory, Woods Hole, Massachusetts. Single numbers, \$13.00. Subscription per volume (three issues), \$32.50 (\$65.00 per year for six issues).

Communications relative to manuscripts should be sent to Dr. Charles B. Metz, Marine Biological Laboratory, Woods Hole, Massachusetts 02543 between May 1 and October 1, and to Dr. Charles B. Metz, Institute For Molecular and Cellular Evolution, University of Miami, 521 Anastasia, Coral Gables, Florida 33134 during the remainder of the year.

THE BIOLOGICAL BULLETIN (ISSN 0006-3185)

Second-class-postage paid at Woods Hole, Mass., and additional mailing offices.

LANCASTER PRESS, INC., LANCASTER, PA.

CONTENTS

NO. 1, AUGUST 1983

ANNUAL REPORT OF THE MARINE BIOLOGICAL LABORATORY	1
AGUDELO, MARIA I., KENNETH KUSTIN, GUY C. MCLEOD, WILLIAM E. ROBINSON, AND ROBERT T. WANG Iron accumulation in tunicate blood cells. I. Distribution and oxidation state of iron in the blood of <i>Boltenia ovifera</i> , <i>Styela clava</i> , and <i>Molgula manhattensis</i>	100
ANDERSON, WINSTON A., AND WILLIAM R. ECKBERG A cytological analysis of fertilization in <i>Chaetopterus pergamentaceus</i> . .	110
BICKELL, LOUISE R., AND STEPHEN C. KEMPF Larval and metamorphic morphogenesis in the nudibranch <i>Melibe leonina</i> (Mollusca: Opisthobranchia)	119
CRONIN, THOMAS W., AND RICHARD B. FORWARD, JR. Vertical migration rhythms of newly hatched larvae of the estuarine crab, <i>Rhithropanopeus harrisi</i>	139
FORWARD, RICHARD B., JR., AND KENNETH J. LOHMANN Control of egg hatching in the crab <i>Rhithropanopeus harrisi</i> (Gould) . .	154
HAND, STEVEN C., AND GEORGE N. SOMERO Energy metabolism pathways of hydrothermal vent animals: adaptations to a food-rich and sulfide-rich deep-sea environment	167
HILLER-ADAMS, PAGE, AND JAMES J. CHILDRESS Effects of feeding, feeding history, and food deprivation on respiration and excretion rates of the bathypelagic mysid <i>Gnathophausia ingens</i>	182
INCZE, LEWIS S., AND A. J. PAUL Grazing and predation as related to energy needs of stage I zoeae of the tanner crab <i>Chionoecetes bairdi</i> (Brachyura, Majidae)	197
MACKIE, G. O., AND C. L. SINGLA Coordination of compound ascidians by epithelial conduction in the colonial blood vessels	209
OLSON, RICHARD RANDOLPH Ascidian- <i>Prochloron</i> symbiosis: the role of larval photoadaptations in mid-day larval release and settlement	221
READ, LAURIE K., LYNN MARGULIS, JOHN STOLZ, ROBERT OBAR, AND THOMAS K. SAWYER A new strain of <i>Paratetramitus jugosus</i> from Laguna Figueroa, Baja California, Mexico	241
REED-MILLER, CHARLENE The initial calcification process in shell-regenerating <i>Tegula</i> (Archaeogastropoda)	265
RUTOWSKI, RONALD L. Mating and egg mass production in the aeolid nudibranch <i>Hermisenda crassicornis</i> (Gastropoda: Opisthobranchia)	276
SEBENS, KENNETH P. Settlement and metamorphosis of a temperate soft-coral larva (<i>Alcyonium siderium</i> Verrill): induction by crustose algae	286
SLOBODKIN, L. B., AND KENNETH DUNN On the evolutionary constraint surface of hydra	305

CONTENTS

SOUMOFF, CYNTHIA, AND DOROTHY M. SKINNER Ecdysteroid titers during the molt cycle of the blue crab resemble those of other Crustacea	321
WETHEY, DAVID S. Geographic limits and local zonation: the barnacles <i>Semibalanus (Balanus)</i> and <i>Chthamalus</i> in New England	330
NO. 2, OCTOBER 1983	
AYLING, AVRIL L. Growth and regeneration rates in thinly encrusting demospongiae from temperate waters	343
BENAYAHU, Y., AND Y. LOYA Surface brooding in the Red Sea soft coral <i>Parerythropodium fulvum fulvum</i> (Forskål, 1775)	353
DUNCAN, THOMAS K. Sexual dimorphism and reproductive behavior in <i>Almyracuma proximoculi</i> (Crustacea: Cumacea): the effect of habitat	370
ECKELBARGER, KEVIN J., AND JUDITH P. GRASSLE Ultrastructural differences in the eggs and ovarian follicle cells of <i>Capitella</i> (Polychaeta) sibling species	379
EYSTER, LINDA S. Ultrastructure of early embryonic shell formation in the opisthobranch gastropod <i>Aeolidia papillosa</i>	394
FREEMAN, JOHN A., TERRY L. WEST, AND JOHN D. COSTLOW Postlarval growth in juvenile <i>Rhithropanopeus harrisi</i>	409
KAPLAN, SAUL W. Intrasexual aggression in <i>Metridium senile</i>	416
MILLER, RICHARD L., AND KENNETH R. KING Sperm chemotaxis in <i>Oikopleura dioica</i> Fol, 1872 (Urochordata: Larvacea)	419
RAMOS-FLORES, TALIA Lower marine fungus associated with black line disease in star corals (<i>Montastrea annularis</i> , E. & S.)	429
SUGITA, HIROAKI, AND KOICHI SEKIGUCHI The developmental appearance of paternal forms of lactate dehydrogenase and malate dehydrogenase in hybrid horseshoe crabs	436
TSUJI, FREDERICK I., AND ELIZABETH HILL Repetitive cycles of bioluminescence and spawning in the polychaete, <i>Odontosyllis phosphorea</i>	444
VITTURI, R., A. MAIORCA, AND E. CATALANO The karyology of <i>Teredo utriculus</i> (Gmelin) (Mollusca, Pelecypoda) ...	450
WEDI, STEVEN E., AND DAPHNE FAUTIN DUNN Gametogenesis and reproductive periodicity of the subtidal sea anemone <i>Urticina lofotensis</i> (Coelenterata: Actiniaria) in California	458
YUI, MARY A., AND CHRISTOPHER J. BAYNE Echinoderm immunology: bacterial clearance by the sea urchin <i>Strongylocentrotus purpuratus</i>	473
ABSTRACTS OF PAPERS PRESENTED AT THE GENERAL SCIENTIFIC MEETINGS OF THE MARINE BIOLOGICAL LABORATORY	
Cellular, molecular biology, etc.	487
Developmental biology	499
Ecology, evolution, plant sciences	504
Gametes and fertilization	512

CONTENTS

Microbiology	520
Neurobiology, learning, behavior	523
Parasitology, pathology, aging	534
Photoreceptors, vision, rhythms	539
NO. 3, DECEMBER 1983	
BRENCHLEY, G. A., AND J. T. CARLTON Competitive displacement of native mud snails by introduced periwinkles in the New England intertidal zone	543
BRETOS, MARTA, ITALO TESORIERI, AND LUIS ALVAREZ The biology of <i>Fissurella maxima</i> Sowerby (Mollusca: Archaeogastropoda) in northern Chile. 2. Notes on its reproduction	559
CHORNESKY, ELIZABETH A. Induced development of sweeper tentacles on the reef coral <i>Agaricia agar- icites</i> : a response to direct competition	569
DEFUR, PETER L., BRIAN R. MCMAHON, AND CHARLES E. BOOTH Analysis of hemolymph oxygen levels and acid-base status during emersion 'in situ' in the red rock crab, <i>Cancer productus</i>	582
FREEMAN, GARY Experimental studies on embryogenesis in hydrozoans (Trachylina and Siphonophora) with direct development	591
GLADFELTER, ELIZABETH H. Circulation of fluids in the gastrovascular system of the reef coral <i>Acropora cervicornis</i>	619
HANLON, ROGER T., RAYMOND F. HIXON, AND WILLIAM H. HULET Survival, growth, and behavior of the loliginid squids <i>Loligo plei</i> , <i>Loligo pealei</i> , and <i>Lolliguncula brevis</i> (Mollusca: Cephalopoda) in closed sea water systems	637
LEVINTON, JEFFREY S. The latitudinal compensation hypothesis: growth data and a model of latitudinal growth differentiation based upon energy budgets. I. Interspecific comparison of <i>Ophryotrocha</i> (Polychaeta: Dorvilleidae)	686
LEVINTON, JEFFREY S., AND ROSEMARY K. MONAHAN The latitudinal compensation hypothesis: growth data and a model of latitudinal growth differentiation based upon energy budgets. II. Intraspecific comparisons between subspecies of <i>Ophryotrocha puerilis</i> (Polychaeta: Dorvilleidae)	699
NICCHITTA, C. V., AND W. R. ELLINGTON Energy metabolism during air exposure and recovery in the high intertidal bivalve mollusc <i>Geukensia demissa granosissima</i> and the subtidal bivalve mollusc <i>Modiolus squamosus</i>	708
REED-MILLER, CHARLENE Scanning electron microscopy of the regenerated shell of the marine ar- chaeogastropod, <i>Tegula</i>	723
SCOFIELD, VIRGINIA L., AND LAUREN S. NAGASHIMA Morphology and genetics of rejection reactions between oozoids from the tunicate <i>Botryllus schlosseri</i>	733
TELFORD, MALCOLM, ANTHONY S. HAROLD, AND RICH MOOI Feeding structures, behavior, and microhabitat of <i>Echinocyamus pusillus</i> (Echinoidea: Clypeasteroidea)	745
VACCA, LINDA L., AND MILTON FINGERMAN The roles of hemocytes in tanning during the molting cycle: a histochemical study of the fiddler crab, <i>Uca pugilator</i>	758

CONTENTS

WAHLE, CHARLES M.
 Regeneration of injuries among Jamaican gorgonians: the roles of colony
 physiology and environment 778

WIDDER, EDITH A., MICHAEL I. LATZ, AND JAMES F. CASE
 Marine bioluminescence spectra measured with an optical multichannel
 detection system 791

Short Report

GLADFELTER, ELIZABETH H.
 Spatial and temporal patterns of mitosis in the cells of the axial polyp of
 the reef coral *Acropora cervicornis* 811

INDEX TO VOLUME 165 816

THE BIOLOGICAL BULLETIN

PUBLISHED BY
THE MARINE BIOLOGICAL LABORATORY

Editorial Board

- | | |
|--|--|
| DANIEL L. ALKON, National Institutes of Health and
Marine Biological Laboratory | MICHAEL G. O'RAND, Laboratories for Cell Biology,
University of North Carolina at Chapel Hill |
| ROBERT B. BARLOW, JR., Syracuse University | RALPH S. QUATRANO, Oregon State University, at
Corvallis |
| WALLIS H. CLARK, JR., University of California at
Davis | LIONEL I. REBHUN, University of Virginia |
| DAVID H. EVANS, University of Florida | JOEL L. ROSENBAUM, Yale University |
| HARLYN O. HALVORSON, Brandeis University | DOROTHY M. SKINNER, Oak Ridge National
Laboratory |
| RONALD R. HOY, Cornell University | JOHN D. STRANDBERG, Johns Hopkins University |
| SAMUEL S. KOIDE, The Population Council,
Rockefeller University | JOHN M. TEAL, Woods Hole Oceanographic
Institution |
| FRANK J. LONGO, University of Iowa | J. RICHARD WHITTAKER, Boston University
Marine Program and Marine Biological Laboratory |
| CHARLOTTE P. MANGUM, The College of
William and Mary | GEORGE M. WOODWELL, Ecosystems Center, Marine
Biological Laboratory |

Editor: CHARLES B. METZ, University of Miami

AUGUST, 1983

Printed and Issued by
LANCASTER PRESS, Inc.

PRINCE & LEMON STS.
LANCASTER, PA.

THE BIOLOGICAL BULLETIN

THE BIOLOGICAL BULLETIN is published six times a year by the Marine Biological Laboratory, MBL Street, Woods Hole, Massachusetts 02543.

Subscriptions and similar matter should be addressed to THE BIOLOGICAL BULLETIN, Marine Biological Laboratory, Woods Hole, Massachusetts. Single numbers, \$10.00. Subscription per volume (three issues), \$27.00 (this is \$54.00 per year for six issues).

Communications relative to manuscripts should be sent to Dr. Charles B. Metz, Editor, or Pamela Clapp, Assistant Editor, at the Marine Biological Laboratory, Woods Hole, Massachusetts 02543 between May 1 and October 1, and at the Institute For Molecular and Cellular Evolution, University of Miami, 521 Anastasia, Coral Gables, Florida 33134 during the remainder of the year.

Copyright © 1983, by the Marine Biological Laboratory

Second-class postage paid at Woods Hole, Mass., and additional mailing offices.

ISSN 0006-3185

INSTRUCTIONS TO AUTHORS

The Biological Bulletin accepts outstanding original research reports of general interest to biologists throughout the world. Papers are usually of intermediate length (10–40 manuscript pages). Very short papers (less than 10 manuscript pages including tables, figures, and bibliography) will be published in a separate section entitled "Short Reports." A limited number of solicited review papers may be accepted after formal review. A paper will usually appear within four months after its acceptance.

The Editorial Board requests that manuscripts conform to the requirements set below; those manuscripts which do not conform will be returned to authors for correction before review.

1. **Manuscripts.** Manuscripts, including figures, should be submitted in triplicate. (Xerox copies of photographs are not acceptable for review purposes.) The original manuscript must be typed in double spacing (including figure legends, footnotes, bibliography, etc.) on one side of 16- or 20-lb. bond paper, 8½ by 11 inches. Manuscripts should be proofread carefully and errors corrected legibly in black ink. Pages should be numbered consecutively. Margins on all sides should be at least 1 inch (2.5 cm). Manuscripts should conform to the *Council of Biology Editors Style Manual*, 4th Edition (Council of Biology Editors, 1978) and to American spelling. Unusual abbreviations should be kept to a minimum and should be spelled out on first reference as well as defined in a footnote on the title page. Manuscripts should be divided into the following components: Title page, Abstract (of no more than 200 words), Introduction, Materials and Methods, Results, Discussion, Acknowledgments, Literature Cited, Tables, and Figure Legends. In addition, authors should supply a list of words and phrases under which the article should be indexed.

2. **Figures.** Figures should be no larger than 8½ by 11 inches. The dimensions of the printed page, 5 by 7¼ inches, should be kept in mind in preparing figures for publication. We recommend that figures be about 1½ times the linear dimensions of the final printing desired, and that the ratio of the largest to the smallest letter or number and of the thickest to the thinnest line not exceed 1:1.5. Explanatory matter generally should be included in legends, although axes should always be identified on the illustration itself. Figures should be prepared for reproduction as either line cuts or halftones. Figures to be reproduced as line cuts should be unmounted glossy photographic reproductions or drawn in black ink on white paper, good-quality tracing cloth or plastic, or blue-lined coordinate paper. Those to be reproduced as halftones should be mounted on board, with both designating numbers or letters and scale bars affixed directly to the figures. All figures should be numbered in consecutive order, with no distinction between text and plate figures. The author's name and an arrow indicating orientation should appear on the reverse side of all figures.

3. **Tables, footnotes, figure legends, etc.** Authors should follow the style in a recent issue of *The Biological Bulletin* in preparing table headings, figure legends, and the like. Because of the high cost of setting tabular material in type, authors are asked to limit such material as much as possible. Tables, with their headings and footnotes, should be typed on separate sheets, numbered with consecutive Roman numerals, and placed after the Literature Cited. Figure legends should contain enough information to make the figure intelligible separate from the text. Legends should be typed double spaced, with con-

Continued on Cover Three

THE MARINE BIOLOGICAL LABORATORY

EIGHTY-FIFTH REPORT, FOR THE YEAR 1982—NINETY-FIFTH YEAR

I. TRUSTEES AND STANDING COMMITTEES	1
II. MEMBERS OF THE CORPORATION	5
1. LIFE MEMBERS	5
2. REGULAR MEMBERS	7
3. ASSOCIATE MEMBERS	25
III. CERTIFICATE OF ORGANIZATION	28
IV. ARTICLES OF AMENDMENT	29
V. BYLAWS	30
VI. REPORT OF THE DIRECTOR	34
VII. REPORT OF THE TREASURER	43
VIII. REPORT OF THE CONTROLLER	45
IX. REPORT OF THE LIBRARIAN	58
X. EDUCATIONAL PROGRAMS	58
1. SUMMER	58
2. JANUARY	67
3. SHORT COURSES	71
XI. RESEARCH AND TRAINING PROGRAMS	76
1. SUMMER	76
2. YEAR-ROUND	84
XII. HONORS	89
XIII. INSTITUTIONS REPRESENTED	92
XIV. LABORATORY SUPPORT STAFF	97

I. TRUSTEES

Including Action of the 1982 Annual Meeting

OFFICERS

PROSSER GIFFORD, *Chairman of the Board of Trustees*, Woodrow Wilson International Center for Scholars, Smithsonian Building, Washington, D. C. 20560

DENIS M. ROBINSON, *Honorary Chairman of the Board of Trustees*, High Voltage Engineering Corporation, Burlington, Massachusetts 01803

ROBERT MAINER, *Treasurer*, The Boston Company, One Boston Place, Boston, Massachusetts 02106

PAUL R. GROSS, *President of the Corporation and Director of the Laboratory*, Marine Biological Laboratory, Woods Hole, Massachusetts 02543

EMERITI

FRANK A. BROWN, JR., Marine Biological Laboratory (Deceased May 1983)
 JOHN B. BUCK, National Institutes of Health
 AURIN CHASE, Princeton University
 ANTHONY C. CLEMENT, Emory University
 KENNETH S. COLE, San Diego, California
 ARTHUR L. COLWIN, University of Miami
 LAURA COLWIN, University of Miami
 D. EUGENE COPELAND, Marine Biological Laboratory
 SEARS CROWELL, Indiana University
 HARRY GRUNDFEST, Columbia University
 TERU HAYASHI, Miami, Florida
 HOPE HIBBARD, Oberlin College
 LEWIS KLEINHOLZ, Reed College
 MAURICE KRAHL, Tucson, Arizona
 DOUGLAS MARSLAND, Cockeysville, Maryland
 CHARLES B. METZ, University of Miami
 HAROLD H. PLOUGH, Amherst, Massachusetts
 C. LADD PROSSER, University of Illinois
 JOHN S. RANKIN, Ashford, Connecticut
 A. C. REDFIELD, Woods Hole, Massachusetts (deceased March 1983)
 MERYL ROSE, Waquoit, Massachusetts
 MARY SEARS, Woods Hole, Massachusetts
 CARL C. SPEIDEL, University of Virginia (no mailings)
 ALBERT SZENT-GYÖRGYI, Marine Biological Laboratory
 W. RANDOLPH TAYLOR, University of Michigan
 GEORGE WALD, Harvard University

CLASS OF 1986

GEORGE H. A. CLOWES, JR., Cancer Research Institute, Boston, Massachusetts
 GERALD FISCHBACH, Washington University
 JOHN E. HOBBIÉ, Ecosystems Center
 EDWARD A. KRAVITZ, Harvard Medical School
 THOMAS REESE, National Institutes of Health
 MARJORIE R. STETTEN, National Institutes of Health (Deceased May 1983)
 D. THOMAS TRIGG, Wellesley, Massachusetts
 J. RICHARD WHITTAKER, Marine Biological Laboratory

CLASS OF 1985

ROBERT W. ASHTON, Gaston Snow Beekman and Bogue, New York, New York
 HARLYN O. HALVORSON, Brandeis University
 JOHN G. HILDEBRAND, Columbia University
 THOMAS J. HYNES, JR., Meredith & Grew, Inc., Boston, Massachusetts
 SHINYA INOUÉ, Marine Biological Laboratory
 RICHARD P. MELLON, Richard King Mellon Foundation, Laughlintown, Pennsylvania
 JOHN W. MOORE, Duke University
 W. D. RUSSELL-HUNTER, Syracuse University
 EVELYN SPIEGEL, Dartmouth College

CLASS OF 1984

CLAY ARMSTRONG, University of Pennsylvania
 ROBERT B. BARLOW, JR., Syracuse University
 JUDITH GRASSLE, Marine Biological Laboratory
 HOLGER JANNASCH, Woods Hole Oceanographic Institution

BENJAMIN KAMINER, Boston University
 BRIAN SALZBERG, University of Pennsylvania
 W. NICHOLAS THORNDIKE, Boston, Massachusetts
 RICHARD W. YOUNG, Houghton Mifflin Company, Boston, Massachusetts

CLASS OF 1983

NINA ALLEN, Dartmouth College
 HAYS CLARK, Avon Products, Incorporated
 DENNIS FLANAGAN, Scientific American, New York, New York
 WILLIAM T. GOLDEN, New York, New York
 PHILIP GRANT, University of Oregon
 JOEL ROSENBAUM, Yale University
 ANN STUART, University of North Carolina
 ANDREW SZENT-GYÖRGYI, Brandeis University
 KENSAL VAN HOLDE, Oregon State University

STANDING COMMITTEES

EXECUTIVE COMMITTEE OF THE BOARD OF TRUSTEES

PROSSER GIFFORD*	JOHN HILDEBRAND, 1984
PAUL GROSS*	BENJAMIN KAMINER, 1984
ROBERT MAINER*	NINA ALLEN, 1983
HARLYN O. HALVORSON, 1985	SHINYA INOUÉ, 1983
J. RICHARD WHITTAKER, 1985	

BUILDINGS AND GROUNDS COMMITTEE

FRANCIS HOSKINS, Chairman	CLIFFORD HARDING, JR.
LAWRENCE B. COHEN	PHILIP PERSON
A. FARMANFARMAIAN	ROBERT PRUSCH
ALAN FEIN	THOMAS REESE
DANIEL GILBERT	EVELYN SPIEGEL
ROBERT GUNNING*	JAY WELLS

CAPITAL DEVELOPMENT COMMITTEE

HAYS CLARK	HARLYN O. HALVORSON
DENNIS FLANAGAN	RICHARD P. MELLON
PROSSER GIFFORD*	RICHARD YOUNG
WILLIAM T. GOLDEN	

COMPUTER COMMITTEE

JOHN HOBBIÉ, Chairman	WILLIAM S. LITTLE
WILLIAM J. ADELMAN	E. F. MACNICHOL, JR.
FRANCIS P. BOWLES	CONSTANTINE TOLLIOS
A. FARMANFARMAIAN	

EMPLOYEE RELATIONS COMMITTEE

CATHERINE NORTON, Chairman	LEE ANNE CAMPBELL
WILLIAM EVANS	LEWIS LAWDAY
JOHN HELFRICH	DONALD LEHY

FINANCIAL POLICY AND PLANNING COMMITTEE

GEORGE H. A. CLOWES, Chairman
 ROBERT ASHTON
 ELLEN GRASS
 THOMAS HYNES

ROBERT MAINER
 NICHOLAS THORNDIKE
 RICHARD WHITTAKER

HOUSING, FOOD SERVICE AND DAY CARE COMMITTEE

ANN STUART, Chairman
 DANIEL ALKON
 NINA ALLEN
 ROBERT BARLOW
 MONA GROSS

JOAN HOWARD
 RONALD JOYNER
 AIMLEE LADERMAN
 BRIAN SALZBERG
 HOMER P. SMITH*

INSTRUCTION COMMITTEE

SHELDON SEGAL, Chairman
 DANIEL ALKON
 ROBERT ALLEN
 JOHN DOWLING
 JOHN HOBBIE
 RONALD HOY

ROBERT JOSEPHSON
 MORTON MASER*
 MERLE MIZELL
 GEORGE PAPPAS
 J. RICHARD WHITTAKER

INVESTMENT COMMITTEE

W. NICHOLAS THORNDIKE, Chairman
 JOHN ARNOLD
 PROSSER GIFFORD*

WILLIAM T. GOLDEN
 MAURICE LAZARUS
 ROBERT MAINER*

JOINT USERS COMMITTEE FOR THE LIBRARY

EDWARD ADELBERG, Chairman
 WILFRED BRYAN
 JOHN DOWLING

ROBERT GAGOSIAN
 FREDERICK GRASSLE
 SHINYA INOUÉ

LIBRARY JOINT MANAGEMENT COMMITTEE

EDWARD ADELBERG, Chairman
 PAUL R. GROSS
 JOE KIEBALA

DEREK SPENCER
 JOHN STEELE

MARINE RESOURCES COMMITTEE

SEARS CROWELL, Chairman
 CARL J. BERG
 JUNE HARRIGAN
 TOM HUMPHREYS
 JACK LEVIN
 CYRUS LEVINTHAL

ROBERT PRENDERGAST
 ROBERT D. PRUSCH
 JOHN S. RANKIN
 JOHN VALOIS*
 JONATHAN WITTENBERG

RADIATION COMMITTEE

WALTER S. VINCENT, Chairman
 EUGENE BELL
 FRANCIS P. BOWLES
 RICHARD L. CHAPPELL
 PAUL DeWEER

JOHN HOBBIE
 ANTHONY LIUZZI
 E. F. MACNICHOL, JR.
 MORTON MASER*
 HARRIS RIPPS

RESEARCH SERVICES COMMITTEE

NINA S. ALLEN, Chairman	MORTON MASER*
JELLE ATEMA	BRYAN NOE
ROBERT BARLOW, JR.	BRUCE PETERSON
ROBERT GOLDMAN	BIRGIT ROSE
SAMUEL S. KOIDE	SIDNEY TAMM
RAYMOND LASEK	JAY WELLS

RESEARCH SPACE COMMITTEE

GERALD FISCHBACH, Chairman	MORTON MASER*
CLAY ARMSTRONG	JERRY MELILLO
JOHN ARNOLD	ALAN PEARLMAN
ARTHUR DUBOIS	JOEL ROSENBAUM
GEORGE LANGFORD	JOAN RUDERMAN
HANS LAUFER	BRIAN SALZBERG
EDUARDO MACAGNO	ANN STUART

SAFETY COMMITTEE

A. ROBERT GUNNING, Chairman*	E. F. MACNICHOL, JR.
DANIEL ALKON	MORTON MASER*
LOUIS KERR	MARK SILVA
LEWIS LAWDAY	RAYMOND STEPHENS
DONALD LEHY	PAUL STEUDLER
JANE LEIGHTON	FREDERICK THRASHER
	JAY WELLS

* *ex officio*

II. MEMBERS OF THE CORPORATION

Including Action of the 1982 Annual Meeting

LIFE MEMBERS

ABBOTT, MARIE, 259 High Street, R.D. 2, Coventry, CT 06238
 ADOLPH, EDWARD F., University of Rochester, School of Medicine and Dentistry, Rochester, NY 14642
 BEAMS, HAROLD W., Department of Zoology, University of Iowa, Iowa City, IA 53342
 BEHRE, ELLINOR, Black Mountain, NC 28711
 BERTHOLF, LLOYD M., Westminster Village #2114, 2025 E. Lincoln Street, Bloomington, IL 61701
 BISHOP, DAVID W., Department of Physiology, Medical College of Ohio, C.S. 10008, Toledo, OH 43699
 BOLD, HAROLD C., Department of Botany, University of Texas, Austin, TX 78712
 BRIDGMAN, A. JOSEPHINE, 715 Kirk Road, Decatur, GA 30030
 BURBANCK, MADELINE P., Box 15134, Atlanta, GA 30333
 BURBANCK, WILLIAM D., Box 15134, Atlanta, GA 30333
 BURDICK, C. LALOR, 900 Barley Drive, Barley Mill Court, Wilmington, DE 19807
 CARPENTER, RUSSELL L., 60 Lake Street, Winchester, MA 01890
 CHASE, AURIN, Professor of Biology Emeritus, Princeton University, Princeton, NJ 08540
 CHENEY, RALPH H., 45 Coleridge Drive, Falmouth, MA 02540
 CLARKE, GEORGE L., 44 Juniper Road, Belmont, MA 02178
 CLEMENT, ANTHONY C., Department of Biology, Emory University, Atlanta, GA 30322
 COLE, KENNETH S. 2404 Loring Street, San Diego, CA 92109

- COLWIN, ARTHUR, 320 Woodcrest Road, Key Biscayne, FL 33149
 COLWIN, LAURA, 320 Woodcrest Road, Key Biscayne, FL 33149
 COPELAND, D. E., 41 Fern Lane, Woods Hole, MA 02543
 COSTELLO, HELEN M., 507 Monroe Street, Chapel Hill, NC 27514
 CROUSE, HELEN, Institute of Molecular Biophysics, Florida State University, Tallahassee, FL 32306
 DILLER, IRENE C., 2417 Fairhill Avenue, Glenside, PA 19038
 DILLER, WILLIAM F., 2417 Fairhill Avenue, Glenside, PA 10038
 ELLIOTT, ALFRED M., 2345 Tarpon Road, Naples, FL 33992
 FERGUSON, JAMES K. W., 56 Clarkehaven Street, Thornhill, Ontario L4J 2B4 Canada
 FRAENKEL, GOTTFRIED S., Department of Entomology, University of Illinois, 320 Morrill Hall, Urbana, IL 61801
 FRIES, ERIK F. B., 3870 Leafy Way, Miami, FL 33133
 GILMAN, LAUREN C., Department of Biology, University of Miami, PO Box 24918, Coral Gables, FL 33124
 GREEN, JAMES W., Department of Physiology, Rutgers University, Piscataway, NJ 08854
 GRUNDFEST, HARRY, Department of Neurology, College of Physicians and Surgeons, Columbia University, New York, NY 10032
 GUTTMAN, RITA, 75 Henry Street, Brooklyn, NY 11210
 HAMBURGER, VIKTOR, Professor Emeritus, Washington University, St. Louis, MO 63130
 HAMILTON, HOWARD L., Department of Biology, University of Virginia, Charlottesville, VA 22901
 HARTLINE, H. KEFFER, The Rockefeller University, New York, NY 10021 (Deceased March 1983)
 HIBBARD, HOPE, 143 East College Street, Apt. 309, Oberlin, Ohio 44074
 HISAW, F. L., 5925 SW Plymouth Drive, Corvallis, OR 97330
 HOLLAENDER, ALEXANDER, Associated Universities, Inc., 1717 Massachusetts Avenue, NW, Washington, DC 20036
 HUMES, ARTHUR, Marine Biological Laboratory, Woods Hole, MA 02543
 JOHSON, FRANK H., Department of Biology, Princeton University, Princeton, NJ 08540
 KANAN, HELEN, 62 Locust Street, Falmouth, MA 02540
 KAHLER, ROBERT, P.O. Box 423, Woods Hole, MA 02543
 KILLE, FRANK R., 500 Osceola Avenue, Winter Park, FL 32789
 KLEINHOLZ, LEWIS, Department of Biology, Reed College, Portland, OR 97202
 LEVINE, RACHMIEL, 2024 Canyon Road, Arcadia, CA 91006
 LOCHHEAD, JOHN H., 49 Woodlawn Road, London SW 6 6PS, England, U. K.
 LYNN, W. GARDNER, Department of Biology, Catholic University of America, Washington, DC 20017
 MAGRUDER, SAMUEL R., 270 Cedar Lane, Paducah, KY 42001
 MANWELL, REGINALD, D., Syracuse University, Lyman Hall, Syracuse, NY 13210
 MARSLAND, DOUGLAS, Broadmead N12, 13801 York Road, Cockeysville, MD 21030
 MILLER, JAMES A., 307 Shorewood Drive, E. Falmouth, MA 02536
 MILNE, LORUS J., Department of Zoology, University of New Hampshire, Durham, NH 03824
 MOORE, JOHN A., Department of Biology, University of California, Riverside, CA 92521
 MOUL, E. T., 43 F. R. Lillie Road, Woods Hole, MA 02543
 NACHMANSHON, DAVID, Department of Neurology, College of Physicians and Surgeons, Columbia University, New York, NY 10032
 PAGE, IRVING H., Box 516, Hyannisport, MA 02647
 PLOUGH, HAROLD H., 31 Middle Street, Amherst, MA 01002
 POLLISTER, A. W., Box 23, Dixfield, ME 04224
 POND, SAMUEL E., P.O. Box 63, E. Winthrop, ME 04343
 PROSSER, C. LADD, Department of Physiology and Biophysics, University of Illinois, Urbana, IL 61801
 PRYTZ, MARGARET McDONALD, 21 McCouns Lane, Oyster Bay, NY 11771
 RANKIN, JOHN S., JR., Box 97, Ashford, CT 06278
 RENN, CHARLES E., Route 2, Hempstead, MD 21074

- REZNIKOFF, PAUL, 11 Brooks Road, Woods Hole, MA 02543
 RICHARDS, A. GLENN, Department of Entomology, Fisheries and Wildlife, University of Minnesota, St. Paul, MN 55101
 RICHARDS, OSCAR W., Pacific University, Forest Grove, OR 97462
 SCHARRER, BERTA, Department of Anatomy, Albert Einstein College of Medicine, 1300 Morris Park Avenue, Bronx, NY 10461
 SCHMITT, F. O. Room 16-512, Massachusetts Institute of Technology, Cambridge, MA 02139
 SHEMIN, DAVID, Department of Biochemistry and Molecular Biology, Northwestern University, Evanston, IL 60201
 SICHEL, ELSA, 4 Whitman Road, Woods Hole, MA 02543
 SONNENBLICK, B. P., Department of Zoology and Physiology, Rutgers University, 195 University Avenue, Newark, NJ 07102
 SPEIDEL, CARL C., 1873 Field Road, Charlottesville, VA 22903
 STEINHARDT, JACINTO, 1508 Spruce Street, Berkeley, CA 94709
 STUNKARD, HORACE W., American Museum of Natural History, Central Park West at 79th Street, New York, NY 10024
 TAYLOR, W. RANDOLPH, Department of Biology, University of Michigan, Ann Arbor, MI 48109
 TEWINKEL, LOIS E., 4 Sanderson Avenue, Northampton, MA 01060
 TRAGER, WILLIAM, The Rockefeller University, 1230 York Avenue, New York, NY 10021
 TRAVIS, DOROTHY F., 35 Coleridge Drive, Falmouth, MA 02540
 WALD, GEORGE, Higgins Professor of Biology Emeritus, Harvard University, Cambridge, MA 02138
 WICHTERMAN, RALPH, 31 Buzzards Bay Avenue, Woods Hole, MA 02543
 YOUNG, D. B., 1137 Main Street, N. Hanover, MA 02357
 ZINN, DONALD J., P.O. Box 589, Falmouth, MA 02541
 ZORZOLI, ANITA, Department of Botany, Vassar College, Poughkeepsie, NY 12601
 ZWEIFACH, BENJAMIN W., c/o Ames, University of California, La Jolla, CA 92037

REGULAR MEMBERS

- ACHE, BARRY W., Whitney Marine Laboratory, University of Florida, Rt. 1 Box 121, St. Augustine, FL 32084
 ACHESON, GEORGE H., 25 Quissett Avenue, Woods Hole, MA 02543
 ADEJUWON, CHRISTOPHER A., Chemical Pathology Department, University of Ibadan, Ibadan, Nigeria
 ADELBERG, EDWARD A., Department of Human Genetics, Yale University Medical School, New Haven, CT 06511
 AFZELIUS, BJORN, Wenner-Gren Institute, University of Stockholm, Stockholm, Sweden
 ALBERTE, RANDALL S., University of Chicago, Barnes Laboratory, 5630 S. Ingleside Avenue, Chicago, IL 60637
 ALKON, DANIEL, Section on Neural Systems, Laboratory of Biophysics, NIH, Marine Biological Laboratory, Woods Hole, MA 02543
 ALLEN, GARLAND E., Department of Biology, Washington University, St. Louis, MO 63130
 ALLEN, NINA S., Department of Biology, Dartmouth College, Hanover, NH 03755
 ALLEN, ROBERT D., Department of Biology, Dartmouth College, Hanover, NH 03755
 ALSCHER, RUTH, Department of Biology, Manhattanville College, Purchase, NY 10577
 AMATNIEK, ERNEST, 4797 Boston Post Road, Pelham Manor, NY 10803
 ANDERSON, EVERETT, Department of Anatomy, LHRRB, Harvard Medical School, Boston, MA 02115
 ANDERSON, J. M., Cornell University, Emerson Hall, Ithaca, NY 14850
 ARMSTRONG, CLAY M., Department of Physiology, University of Pennsylvania Medical School, Philadelphia, PA 19174
 ARMSTRONG, PETER B., Department of Zoology, University of California, Davis, CA 95616
 ARNOLD, JOHN M., Pacific Biomedical Research Center, University of Hawaii, 42 Ahui Street, Honolulu, HI 96813
 ARNOLD, WILLIAM A., 102 Balsam Road, Oak Ridge, TN 37830

- ASHTON, ROBERT W., Gaston Snow Beckman and Bogue, 14 Wall Street, New York, NY 10005
- ATEMA, JELLE, Marine Biological Laboratory, Woods Hole, MA 02543
- ATWOOD, KIMBALL C., 100 Haven Avenue, Apt. 21-E, New York, NY 10032
- AUGUSTINE, GEORGE JR., Department of Physiology and Anatomy, University of California, Los Angeles, CA 94720
- AUSTIN, MARY L., 506½ N. Indiana Avenue, Bloomington, IN 47401
- BACON, ROBERT, P.O. Box 723, Woods Hole, MA 02543
- BALDWIN, THOMAS O., Department of Biochemistry and Biophysics, Texas A & M University, College Station, TX 77843
- BANG, BETSY, 76 F. R. Lillie Road, Woods Hole, MA 02543
- BARKER, JEFFERY L., NIH Bldg. 36 Room 2002, Bethesda, MD 20205
- BARLOW, ROBERT B., JR., Institute for Sensory Research, Syracuse University, Merrill Lane, Syracuse, NY 13210
- BARTELL, CLELMER K., 2000 Lake Shore Drive, New Orleans, LA 70122
- BARTH, LUCENA J., 26 Quissett Avenue, Woods Hole, MA 02543
- BARTLETT, JAMES H., Department of Physics, Box 1921, University of Alabama, University, AL 35486
- BATTELLE, BARBARA-ANNE, National Eye Institute, Bethesda, MD 20205
- BAUER, G. ERIC, Department of Anatomy, University of Minnesota, Minneapolis, MN 55414
- BEAUGE, LUIS ALBERTO, Instituto de Investigacion Medica, Casilla de Correo 389, 5000 Cordoba, Argentina
- BECK, L. V., Department of Pharmacology, School of Experimental Medicine, Indiana University, Bloomington, IN 47401
- BEGG, DAVID A., LHRRB, Harvard Medical School, Boston, MA 02115
- BELL, EUGENE, Department of Biology, Massachusetts Institute of Technology, 77 Massachusetts Avenue, Cambridge, MA 02139
- BENNETT, M. V. L., Department of Neuroscience, Albert Einstein College of Medicine, 1300 Morris Park Avenue, New York, NY 10461
- BENNETT, MIRIAM F., Department of Biology, Colby College, Waterville, ME 04901
- BERG, CARL J., JR., Marine Biological Laboratory, Woods Hole, MA 02543
- BERMAN, MONES, NIH, Theoretical Biology NCI, Bldg. 10 Room 4B56, Bethesda, MD 20205 (Deceased August 1982)
- BERNE, ROBERT W., University of Virginia, School of Medicine, Charlottesville, VA 22908
- BERNHEIMER, ALAN W., New York University, School of Medicine, New York, NY 10016
- BEZANILLA, FRANCISCO, Department of Physiology, University of California, Los Angeles, CA 90052
- BIGGERS, JOHN D., Department of Physiology, Harvard Medical School, Boston, MA 02115
- BISHOP, STEPHEN H., Department of Zoology, Iowa State University, Ames, IA 50010
- BLAUSTEIN, MORDECAI P., Department of Physiology, School of Medicine, University of Maryland, 655 W. Baltimore Street, Baltimore, MD 21201
- BODIAN, DAVID, Department of Otolaryngology, Johns Hopkins University, Baltimore, MD 21205
- BOETTIGER, EDWARD G., 29 Juniper Point, Woods Hole, MA 02543
- BOGORAD, LAWRENCE, The Biological Laboratories, Harvard University, Cambridge, MA 02138
- BOOLOOTIAN, RICHARD A., Science Software Systems, Inc., 11899 W. Pico Blvd., W. Los Angeles, CA 90064
- BOREI, HANS G., Department of Zoology, University of Pennsylvania, Philadelphia, PA 19174
- BORGESE, THOMAS A., Department of Biology, Lehman College, Bronx, NY 10468
- BORISY, GARY G., Laboratory of Molecular Biology, University of Wisconsin, Madison, WI 53715
- BOSCH, HERMAN F., Whipple Hill, Richmond, NH 03470
- BOTKIN, DANIEL, Department of Biology, University of California, Santa Barbara, CA 93106
- BOWEN VAUGHN T., Woods Hole Oceanographic Institution, Redfield Bldg. 3-32, Woods Hole, MA 02543

- BOYER, BARBARA C., Department of Biology, Union College, Schenectady, NY 12308
- BOWLES, FRANCIS P., Box 674, Woods Hole, MA 02543
- BRINLEY, F. J., Neurological Disorders Program, NINCDS, 716 Federal Building, Bethesda, MD 20205
- BROWN, FRANK A., JR., Marine Biological Laboratory, Woods Hole, MA 02543 (Deceased May 1983)
- BROWN, JAY C., Department of Neurobiology, University of Virginia, Charlottesville, VA 22908
- BROWN, JOEL E., Department of Physiology and Biophysics, Health Sciences Center, SUNY, Stony Brook, NY 11794
- BROWN, STEPHEN C., Department of Biological Sciences, SUNY, Albany, NY 12222
- BUCK, JOHN B., National Institutes of Health, Laboratory of Physical Biology, Bethesda, MD 20205
- BURDICK, CAROLYN J., Department of Biology, Brooklyn College, Brooklyn, NY 11210
- BURGER, MAX, Department of Biochemistry, Biocenter of the University of Basel, Klingelbergstrasse 70, CH-4056 Basel, Switzerland
- BURKY, ALBERT, Department of Biology, University of Dayton, Dayton, OH 45469
- BUSH, LOUISE, 7 Snapper Lane, Falmouth, MA 02540
- CANDELAS, GRACIELA C., Department of Biology, University of Puerto Rico, Rio Piedras, PR 00931
- CARLSON, FRANCIS D., Department of Biophysics, Johns Hopkins University, Baltimore, MD 21218
- CASE, JAMES, Department of Biological Sciences, University of California, Santa Barbara, CA 93106
- CASSIDY, REV. J. D., O.P., Department of Biological Sciences, University of Illinois at Chicago Circle, Box 4348, Chicago, IL 60680
- CEBRA, JOHN J., Department of Biology, Leidy Labs, G-6, University of Pennsylvania, Philadelphia, PA 19174
- CHAET, ALFRED B., University of West Florida, Pensacola, FL 32504
- CHAMBERS, EDWARD L., Department of Physiology and Biophysics, University of Miami, School of Medicine, Miami, FL 33152
- CHAPPELL, RICHARD L., Department of Biological Sciences, Hunter College, Box 201, New York, NY 10021
- CHAUNCEY, HOWARD H., 30 Falmouth Street, Wellesley Hills, MA 02181
- CHILDS, FRANK M., Department of Biology, Trinity College, Hartford, CT 06106
- CITKOWITZ, ELENA, 410 Livingston Street, New Haven, CT 06511
- CLARK, A. M., Department of Biological Sciences, University of Delaware, Newark, DE 19711
- CLARK, ELOISE E., National Science Foundation, 1800 G Street, NW, Washington, DC 20550
- CLARK, HAYS, 26 Deer Park Drive, Greenwich, CT 06830
- CLARK, WALLIS H., JR., Aquaculture Program, Department of Animal Science, University of California, Davis, CA 95616
- CLAUDE, PHILIPPA, Primate Center, Capitol Court, Madison, WI 53706
- CLAYTON, RODERICK K., Cornell University, Section of Genetics, Development and Physiology, Ithaca, NY 14850
- CLOWES, GEORGE H. A., JR., The Cancer Research Institute, 194 Pilgrim Road, Boston, MA 02215
- CLUTTER, MARY, Cellular and Physiological Biosciences Section, National Science Foundation, 1800 G Street, Washington, DC 20550
- COBB, JEWELL P., President, California State University, Fullerton, CA 92634
- COHEN, ADOLPH I., Department of Ophthalmology, School of Medicine, Washington University, 660 S. Euclid Avenue, St. Louis, MO 63110
- COHEN, CAROLYN, Rosenstiel Basic Medical Sciences Research Center, Brandeis University, Waltham, MA 02154
- COHEN, LAWRENCE B., Department of Physiology, Yale University, 333 Cedar Street, New Haven, CT 06510

- COHEN, SEYMOUR S., Department of Pharmacological Science, SUNY, Stony Brook, NY 11790
- COHEN, WILLIAM D., Department of Biological Sciences, Hunter College, New York, NY 10021
- COLLIER, JACK R., Department of Biology, Brooklyn College, Brooklyn, NY 11210
- COLLIER, MARJORIE McCANN, Biology Department, St. Peter's College, Jersey City, NJ 07306
- COOK, JOSEPH A., The Edna McConnell Clark Foundation, 250 Park Avenue, New York, NY 10017
- COOPERSTEIN, S. J., University of Connecticut, School of Medicine, Farmington Avenue, Farmington, CT 06032
- CORLISS, JOHN O., Department of Zoology, University of Maryland, College Park, MD 20742
- CORNELL, NEAL W., 6428 Bannockburn Drive, Bethesda, MD 20817
- CORNMAN, IVOR, 10A Orchard Street, Woods Hole, MA 02543
- COSTELLO, WALTER J., College of Medicine, Ohio University, Athens, OH 45701
- COUCH, ERNEST F., Department of Biology, Texas Christian University, Fort Worth, TX 76129
- CREMER-BARTELS, GERTRUD, Universitäts Augenklinik, 44 Munster, West Germany
- CRIPPA, MARCO, Faculte de Sciences, Univeristats de Geneve, 20 quai Ernest-Ansermet, Geneve 4, Switzerland
- CROW, TERRY J., Department of Physiology, University of Pittsburgh, School of Medicine, Pittsburgh, PA 15261
- CROWELL, SEARS, Department of Biology, Indiana University, Bloomington, IN 47401
- DAIGNAULT, ALEXANDER T., W. R. Grace Company, 114 Avenue of the Americas, New York, NY 10036
- DAN, KATSUMA, Professor Emeritus, Tokyo Metropolitan Union, Meguro-ku, Tokyo, Japan
- DANEILLI, JAMES F., 185 Highland Street, Worcester, MA 01609
- DAVID, JOHN R., Seeley G. Mudd Bldg., Room 504, 250 Longwood Avenue, Boston, MA 02115
- DAVID, ROBERTA A., Seeley G. Mudd Bldg., Room 504, 250 Longwood Avenue, Boston, MA 02115
- DAVIS, BERNARD D., Bacterial Physiology Unit, Harvard Medical School, Boston, MA 02115
- DAVIS, JOEL P., Seapuit, Inc., P.O. Box G, Osterville, MA 02655
- DAW, NIGEL W., 78 Aberdeen Place, Clayton, MO 63105
- DEGROOF, ROBERT C., 511 Carpenter Lane, Philadelphia, PA 19119
- DEHAAN, ROBERT L., Department of Anatomy, Emory University, Atlanta, GA 30322
- DELANNEY, LOUIS E., Institute for Medical Research, 751 Bascom Avenue, San Jose, CA 95128
- DEPHILLIPS, HENRY A., JR., Department of Chemistry, Trinity College, Hartford, CT 06106
- DETERRA, NOEL, Marine Biological Laboratory, Woods Hole, MA 02543
- DETTBARN, WOLF-DIETRICH, Department of Pharmacology, School of Medicine, Vanderbilt University, Nashville, TN 37127
- DEWEER, PAUL J., Department of Physiology, School of Medicine, Washington University, St. Louis, MO 63110
- DISCH, ZACHARIAS, College of Physicians and Surgeons, Columbia University Eye Institute, 630 W. 165th Street, New York, NY 10032
- DIXON, KEITH E., School of Biological Sciences, Flinders University, Bedford Park, South Australia
- DOWDALL, MICHAEL J., Department of Biochemistry, University Hospital and Medical School, Nottingham N672 UH, U. K.
- DOWLING, JOHN E., The Biological Laboratories, Harvard University, 16 Divinity Street, Cambridge, MA 02138
- DRESDEN, MARC H., Department of Biochemistry, Baylor College of Medicine, Houston, TX 77025
- DUDLEY, PATRICIA L., Department of Biological Sciences, Barnard College, Columbia University, New York, NY 10027

- DUNHAM, PHILIP B., Department of Biology, Syracuse University, Syracuse, NY 13210
- EBERT, JAMES D., Office of the President, Carnegie Institution of Washington, 1530 P Street, NW, Washington, DC 20008
- ECKBERG, WILLIAM R., Department of Zoology, Howard University, Washington, DC 20059
- ECKERT, ROGER O., Department of Zoology, University of California, Los Angeles, CA 90024
- EDDS, KENNETH T., Department of Anatomical Sciences, SUNY, Buffalo, NY 14214
- EDDS, LOUISE, College of Osteopathic Medicine, Grosvenor Hall, Ohio University, Athens, OH 45701
- EDER, HOWARD A., Albert Einstein College of Medicine, 1300 Morris Park Avenue, Bronx, NY 10461
- EDWARDS, CHARLES, Department of Biological Sciences, SUNY, Albany, NY 12222
- EGYUD, LASZLO G., P.O. Box 342, Woods Hole, MA 02543
- EHRENSTEIN, GERALD, NIH, Bethesda, MD 20205
- EHRlich, BARBARA E., Department of Physiology, Albert Einstein College of Medicine, 1300 Morris Park Avenue, New York, NY 10461
- EICHEL, HERBERT J., 226 W. Rattininghouse Square, Philadelphia, PA 19174
- EISEN, ARTHUR Z., Chief of Division of Dermatology, Washington University, St. Louis, MO 63110
- ELDER, HUGH YOUNG, Institute of Physiology, University of Glasgow, Glasgow, Scotland
- ELLIOTT, GERALD F., The Open University Research Unit, Foxcombe Hall, Berkeley Road, Boars Hill, Oxford, England, U. K.
- EPEL, DAVID, Hopkins Marine Station, Pacific Grove, CA 93950
- EPSTEIN, HERMAN T., Department of Biology, Brandeis University, Waltham, MA 02154
- ERULKAR, SOLOMON D., 318 Kent Road, Bala Cynwyd, PA 19004
- ESSNER, EDWARD S., Kresge Eye Institute, Wayne State University, Detroit, MI 48201
- ETTIENE, EARL M., Department of Anatomy, Harvard Medical School, Boston, MA 02115
- FAILLA, PATRICIA M., Argonne National Laboratory, Office of the Director, Argonne, IL 60439
- FARMANFARMAIAN, A., Department of Physiology and Biochemistry, Rutgers University, New Brunswick, NJ 08903
- FAUST, ROBERT G., Department of Physiology, Medical School, University of North Carolina, Chapel Hill, NC 27514
- FEIN, ALAN, Laboratory of Sensory Physiology, Marine Biological Laboratory, Woods Hole, MA 02543
- FERGUSON, F. P., National Institute of General Medical Sciences, NIH, Bethesda, MD 20205
- FESSENDEN, JANE, Marine Biological Laboratory, Woods Hole, MA 02543
- FINKELSTEIN, ALAN, Albert Einstein College of Medicine, 1300 Morris Park Avenue, New York, NY 10461
- FISCHBACH, GERALD, Department of Anatomy and Neurobiology, Washington University, School of Medicine, St. Louis, MO 63110
- FISCHMAN, DONALD A., Cornell University Medical College, Department of Anatomy and Cell Biology, 1300 York Avenue, New York, NY 10021
- FISHER, J. MANNERY, Department of Biochemistry, University of Toronto, Toronto, Ontario, Canada M5S 1A8
- FISHMAN, HARVEY M., Department of Physiology, University of Texas, Medical Branch, Galveston, TX 77550
- FLANAGAN, DENNIS, Editor, *Scientific American*, 415 Madison Avenue, New York, NY 10017
- FOX, MAURICE S., Department of Biology, Massachusetts Institute of Technology, Cambridge, MA 02139
- FRANZINI, CLARA, Department of Biology G-5, School of Medicine, University of Pennsylvania, Philadelphia, PA 19174
- FRAZIER, DONALD T., Department of Physiology and Biophysics, School of Medicine, University of Kentucky Medical Center, Lexington, KY 40536
- FREEMAN, GARY L., Department of Zoology, University of Texas, Austin, TX 78172

- FRENCH, ROBERT J., Department of Biophysics, University of Maryland, School of Medicine, Baltimore, MD 21201
- FREYGANG, WALTER J., JR., 6247 29th Street, NW, Washington, DC 20015
- FULTON, CHANDLER M., Department of Biology, Brandeis University, Waltham, MA 02154
- FURSHPAN, EDWIN J., Department of Neurophysiology, Harvard Medical School, Boston, MA 02115
- FUSELER, JOHN W., Department of Cell Biology, University of Texas, Medical Branch, 53233 Harry Hines Blvd., Dallas, TX 75235
- FUTRELLE, ROBERT P., Department of Genetics and Development, 515 Morrill Hall, University of Illinois, Urbana, IL 68101
- FYE, PAUL, Woods Hole Oceanographic Institution, Woods Hole, MA 02543
- GABRIEL, MORDECAI, Department of Biology, Brooklyn College, Brooklyn, NY 11210
- GAINER, HAROLD, Section of Functional Neurochemistry, NIH, Bldg. 36 Room 2A21, Bethesda, MD 20205
- GALATZER-LEVY, ROBERT M., Suite 1813, 55 East Washington Street, Chicago, IL 60602
- GALL, JOSEPH G., Department of Biology, Yale University, New Haven, CT 06520
- GASCOYNE, PETER, Marine Biological Laboratory, Woods Hole, MA 02543
- GELFANT, SEYMOUR, Department of Dermatology, Medical College of Georgia, Augusta, GA 30904
- GELPERIN, ALAN, Department of Biology, Princeton University, Princeton, NJ 08540
- GERMAN, JAMES L., III, The New York Blood Center, 310 East 67th Street, New York, NY 10021
- GIBBS, MARTIN, Institute for Photobiology of Cells and Organelles, Brandeis University, Waltham, MA 02154
- GIBSON, A. JANE, Wing Hall, Cornell University, Ithaca, NY 14850
- GIFFORD, PROSSER, Woodrow Wilson International Center for Scholars, Smithsonian Building, Washington, DC 20560
- GILBERT, DANIEL L., NIH, Laboratory of Biophysics, NINCDS, Bldg. 36 Room 2A-29, Bethesda, MD 20205
- GIUDICE, GIOVANNI, Via Archirafi, 22 Palermo, Italy
- GLUSMAN, MURRAY, Department of Clinical Psychiatry, Columbia University, 722 W. 168th Street, New York, NY 10032
- GOLDEN, WILLIAM T., 40 Wall Street, New York, NY 10005
- GOLDMAN, DAVID E., 63 Loop Road, Falmouth, MA 02540
- GOLDMAN, ROBERT D., Department of Cell Biology and Anatomy, Northwestern University, 303 E. Chicago Avenue, Chicago, IL 60611
- GOLDSMITH, MARY H. M., Department of Biology, Yale University, New Haven, CT 06520
- GOLDSMITH, PAUL K., 5511 Oakmont Avenue, Bethesda, MD 20034
- GOLDSMITH, TIMOTHY H., Department of Biology, Yale University, New Haven, CT 06520
- GOLDSTEIN, MOISE H., JR., Johns Hopkins University School of Medicine, 720 Rutland Avenue, Baltimore, MD 21205
- GOODMAN, LESLEY JEAN, Department of Zoology and Comparative Physiology, Queen Mary College, Mile End Road, London E1 4NS England, U. K.
- GOTTSCHALL, GERTRUDE Y., 315 E. 68th Street, 9-M, New York, NY 10021
- GOUDSMIT, ESTHER M., Department of Biology, Oakland University, Rochester, MI 48063
- GOULD, ROBERT MICHAEL, Institute for Basic Research in Developmental Disabilities, 1050 Forest Hill Road, Staten Island, NY 10314
- GOULD, STEPHEN J., Museum of Comparative Zoology, Harvard University, Cambridge, MA 02138
- GRAHAM, HERBERT, 36 Wilson Road, Woods Hole, MA 02543
- GRANT, PHILIP, Department of Biology, University of Oregon, Eugene, OR 97403
- GRASS, ALBERT, The Grass Foundation, 77 Reservoir Road, Quincy, MA 02170
- GRASS, ELLEN R., The Grass Foundation, 77 Reservoir Road, Quincy, MA 02170
- GRASSLE, JUDITH, Marine Biological Laboratory, Woods Hole, MA 02543
- GREEN, JONATHAN P., Department of Biology, Roosevelt University, 430 S. Michigan Avenue, Chicago, IL 60605

- GREENBERG, MICHAEL J., Department of Biological Sciences, Florida State University, Tallahassee, FL 32306
- GREGG, JAMES H., Department of Zoology, University of Florida, Gainesville, FL 32611
- GREIF, ROGER L., Department of Physiology, Cornell University, Medical College, New York, NY 10021
- GRIFFIN, DONALD R., The Rockefeller University, 1230 York Avenue, New York, NY 10021
- GROSCH, DANIEL S., Department of Genetics, Gardner Hall, North Carolina State University, Raleigh, NC 27607
- GROSS, PAUL R., President and Director, Marine Biological Laboratory, Woods Hole, MA 02543
- GROSSMAN, ALBERT, New York University Medical School, New York, NY 10016
- GUNNING A. ROBERT, 377 Hatchville Road, Hatchville, MA 02536
- GWILLIAM, G. P., Department of Biology, Reed College, Portland, OR 97202
- HALL, ZACK W., Department of Physiology, University of California, San Francisco, CA 94143
- HALVORSON, HARLYN O., Rosenstiel Basic Medical Sciences Research Center, Brandeis University, Waltham, MA 02154
- HAMKALO, BARBARA A., Department of Molecular Biology and Biochemistry, University of California, Irvine, CA 92717
- HANNA, ROBERT B., SUNY, College of Environmental Science and Forestry, Syracuse, NY 13210
- HARDING, CLIFFORD V., JR., Kresge Eye Institute, Wayne State University, Detroit, MI 48210
- HAROSI, FERENC I., Laboratory of Sensory Physiology, Marine Biological Laboratory, Woods Hole, MA 02543
- HARRIGAN, JUNE F., Laboratory of Biophysics, Marine Biological Laboratory, Woods Hole, MA 02543
- HARRINGTON, GLENN W., Department of Microbiology, School of Dentistry, University of Missouri, 650 E. 250th Street, Kansas City, MO 64108
- HASCHEMEYER, AUDREY E. V., Department of Biological Sciences, Hunter College, New York, NY 10021
- HASTINGS, J. W., The Biological Laboratories, Harvard University, Cambridge, MA 02138
- HAYES, RAYMOND L., JR., Department of Anatomy, School of Medicine, Morehouse College, Atlanta, GA 30314
- HAYASHI, TERU, 7105 SW 112 Place, Miami, FL 33173
- HENLEY, CATHERINE, 7401 Westlake Terrace, Apt. No. 1516, Bethesda, MD 20034
- HERNDON, WALTER R., University of Tennessee, 506 Andy Holt Tower, Knoxville, TN 37916
- HESSLER, ANITA Y., 5795 Waverly Avenue, La Jolla, CA 92037
- HEUSER, JOHN, Department of Biophysics, Washington University School of Medicine, St. Louis, MO 63110
- HIATT, HOWARD H., Office of the Dean, Harvard School of Public Health, 677 Huntington Avenue, Boston, MA 02115
- HIGHSTEIN, STEPHEN M., Division of Cellular Neurobiology, Albert Einstein College of Medicine, 1300 Morris Park Avenue, Bronx, NY 10461
- HILDEBRAND, JOHN G., Department of Biological Sciences, Fairchild Center #913, Columbia University, New York, NY 10027
- HILL, ROBERT B., Department of Zoology, University of Rhode Island, Kingston, RI 02881
- HILLIS-COLINVAUX, LLEWELLYA, Department of Zoology, Ohio State University, Columbus, OH 43210
- HILLMAN PETER, Department of Biology, Hebrew University, Jerusalem, Israel
- HINEGARDNER, RALPH T., Division of Natural Sciences, University of California, Santa Cruz, CA 95064
- HINSCH, GERTRUDE W., Department of Biology, University of South Florida, Tampa, FL 33620

- HOBBIE, JOHN E., Ecosystems Center, Marine Biological Laboratory, Woods Hole, MA 02543
- HODGE, ALAN J., Marine Biological Laboratory, Woods Hole, MA 02543
- HODGE, CHARLES, IV, P.O. Box 4095, Philadelphia, PA 19118
- HOFFMAN, JOSEPH, Department of Physiology, School of Medicine, Yale University, New Haven, CT 06515
- HOLLYFIELD, JOE G., Baylor School of Medicine, Texas Medical Center, Houston, TX 77030
- HOLTZMAN, ERIC, Department of Biological Sciences, Columbia University, New York, NY 10027
- HOLZ, GEORGE G., JR., Department of Microbiology, SUNY, Syracuse, NY 13210
- HOSKIN, FRANCIS C. G., Department of Biology, Illinois Institute of Technology, Chicago, IL 60616
- HOUGHTON, RICHARD A., III, Ecosystems Center, Marine Biological Laboratory, Woods Hole, MA 02543
- HOUSTON, HOWARD, 2500 Virginia Avenue, NW, Washington, DC 20037
- HOWARTH, ROBERT, Ecosystems Center, Marine Biological Laboratory, Woods Hole, MA 02543
- HOY, RONALD R., Section of Neurobiology and Behavior, Cornell University, Ithaca, NY 14850
- HUBBARD, RUTH, The Biological Laboratories, Harvard University, Cambridge, MA 02138
- HUFNAGEL, LINDA A., Department of Microbiology, University of Rhode Island, Kingston, RI 02881
- HUMMON, WILLIAM D., Department of Zoology, Ohio University, Athens, OH 45701
- HUMPHREYS, SUSIE H., Gerontology Research Center, NIA, NIH, Baltimore City Hospital, Baltimore, MD 21224
- HUMPHREYS, TOM D., University of Hawaii, PBRC, 41 Ahui Street, Honolulu, Hawaii 96813
- HUNTER, BRUCE W., Box 321, Lincoln Center, MA 01773
- HUNTER, ROBERT D., Department of Biological Sciences, Oakland University, Rochester, NY 48063
- HUNZIKER, HERBERT E., Esq., P.O. Box 547, Falmouth, MA 02541
- HURWITZ, CHARLES, Basic Science Research Lab, Veterans Administration Hospital, Albany, NY 12208
- HURWITZ, JERARD, Albert Einstein College of Medicine, Department of Molecular Biology, 1300 Morris Park Avenue, Bronx, NY 10461
- HUXLEY, HUGH E., Medical Research Council, Laboratory of Molecular Biology, Cambridge, England, U. K.
- HYNES, THOMAS J., JR., Senior Vice President, Meredith and Grew, Inc., 125 High Street, Boston, MA 02110
- ILAN, JOSEPH, Department of Anatomy, Case Western Reserve University, Cleveland, OH 44106
- INGOGLIA, NICHOLAS, Department of Physiology, New Jersey Medical School, Newark, NJ 07103
- INOUE, SADUYKI, Electron Microscopy Laboratory, McGill University Cancer Center, 655 Drummond Street, Montreal, P.A., Canada, HG3 1Y6
- INOUE, SHINYA, Marine Biological Laboratory, Woods Hole, MA 02543
- ISENBERG, IRVING, Department of Biochemistry and Biophysics, Oregon State University, Corvallis, OR 97331
- ISSELBACHER, KURT J., Massachusetts General Hospital, Boston, MA 02114
- ISSADORIDES, MARIETTA R., Department of Psychiatry, University of Athens, Monis Petraki 8, Athens, 140 Greece
- IZZARD, COLIN S., Department of Biological Sciences, SUNY, Albany, NY 12222
- JACOBSON, ANTONE G., Department of Zoology, University of Texas, Austin, TX 78712
- JAFFE, LIONEL, Department of Biology, Purdue University, Lafayette, IN 47907
- JAHAN-PARWAR, BEHRUS, Worcester Foundation for Experimental Biology, 222 Maple Avenue, Shrewsbury, MA 01545
- JANNASCH, HOLGER W., Woods Hole Oceanographic Institution, Woods Hole, MA 02543
- JEFFERY, WILLIAM R., Department of Zoology, University of Texas, Austin, TX 78712

- JENNER, CHARLES E., Department of Zoology, University of North Carolina, Chapel Hill, NC 27514
- JENNINGS, JOSEPH B., Department of Zoology, Baines Wing, University of Leeds, Leeds LS 2 9-JT, England, U. K.
- JONES, MEREDITH L., Smithsonian Institution, Division of Worms, Washington, DC 20650
- JONES, RAYMOND F., Department of Biology, SUNY, Stony Brook, NY 11790 (Deceased August 1982)
- JOSEPHSON, ROBERT K., School of Biological Sciences, University of California, Irvine, CA 92664
- JOYNER, RONALD W., Department of Physiology, University of Iowa, Iowa City, IA 52242
- KABAT, E. A., Department of Microbiology, College of Physicians and Surgeons, Columbia University, New York, NY 10032
- KAFATOS, FOTIS C., The Biological Laboratories, Harvard University, Cambridge, MA 02138
- KALEY, GABOR, Department of Physiology, Basic Sciences Bldg., New York Medical College, Valhalla, NY 10595
- KALTENBACH, JANE, Department of Biological Sciences, Mount Holyoke College, South Hadley, MA 01075
- KAMINER, BENJAMIN, Department of Physiology, Boston University, School of Medicine, Boston, MA 02118
- KAMMER, ANN E., Division of Biology, Kansas State University, Manhattan, KS 66506
- KANE, ROBERT E., University of Hawaii, PBRC, 41 Ahui Street, Honolulu, HI 96813
- KANESHIRO, EDNA S., Department of Biological Sciences, University of Cincinnati, Cincinnati, OH 45221
- KAPLAN, EHUD, The Rockefeller University, 1230 York Avenue, New York, NY 10021
- KARAKASHIAN, STEPHEN J., 165 West 91st Street, Apt. 16-F, New York, NY 10021
- KARUSH, FRED, Department of Microbiology, School of Medicine, University of Pennsylvania, Philadelphia, PA 19174
- KATZ, GEORGE M., Department of Neurology, College of Physicians and Surgeons, Columbia University, New York, NY 10032
- KEAN, EDWARD L., Case Western Reserve University, Department of Ophthalmology and Biochemistry, Cleveland, OH 44101
- KELLY, ROBERT E., Department of Anatomy, College of Medicine, University of Illinois, P.O. Box 6998, Chicago, IL 60680
- KEMP, NORMAN E., Department of Zoology, University of Michigan, Ann Arbor, MI 48104
- KENDALL, JOHN P., Fanueil Hall Associates, One Boston Place, Boston, MA 02108
- KEYNAN, ALEXANDER, Vice President, Hebrew University, Jerusalem, Israel
- KING, THOMAS J., Division of Cancer Research Resources and Center, NIH, Bldg. 31 Room 10A03, Bethesda, MD 20205
- KINGSBURY, JOHN M., Department of Botany, Cornell University, Ithaca, NY 14853
- KIRSCHENBAUM, DONALD, Department of Biochemistry, SUNY, 450 Clarkson Avenue, Brooklyn, NY 11203
- KLEIN, MORTON, Department of Microbiology, Temple University, Philadelphia, PA 19122
- KLOTZ, I. M., Department of Chemistry, Northwestern University, Evanston, IL 60201
- KOIDE, SAMUEL S., Population Council, The Rockefeller University, 1230 York Avenue, New York, NY 10021
- KONIGSBERG, IRWIN, R., Department of Biology, Gilmer Hall, University of Virginia, Charlottesville, VA 22903
- KORNBERG, SIR HANS, Department of Biochemistry, University of Cambridge, Cambridge CB2 7QW, England, U. K.
- KOSOWER, EDWARD M., Department of Chemistry, Tel Aviv University, Tel Aviv, Israel
- KRAHL, M. E., 2783 W. Casas Circle, Tucson, AZ 85741
- KRANE, STEPHEN M., Massachusetts General Hospital, Boston, MA 02114
- KRASSNER, STUART M., Department of Developmental and Cell Biology, University of California, Irvine, CA 92717
- KRAUSS, ROBERT, FASEB, 9650 Rockville Pike, Bethesda, MD 20205

- KRAVITZ, EDWARD A., Department of Neurobiology, Harvard Medical School, Boston, MA 02115
- KRIEBEL, MAHLON E., Department of Physiology, B.S.B., Upstate Medical Center, 766 Irving Avenue, Syracuse, NY 13210
- KRIEG, WENDELL J. S., 1236 Hinman, Evanston, IL 60602
- KUHNS, WILLIAM J., University of North Carolina, 512 Faculty Lab Office Bldg. 231-H, Chapel Hill, NC 27514
- KUSANO, KIYOSHI, Illinois Institute of Technology, Department of Biology, 3300 South Federal Street, Chicago, IL 60616
- LADERMAN, AIMLEE, Box 689, Teaneck, NJ 07666
- LAMARCHE, PAUL H., Eastern Maine Medical Center, 489 State Street, Bangor, ME 04401
- LANDIS, DENNIS M. D., Department of Neurology, Massachusetts General Hospital, Boston, MA 02114
- LANDIS, STORY C., Department of Neurobiology, Harvard Medical School, Boston, MA 02115
- LANDOWNE, DAVID, Department of Physiology, University of Miami, R-430, P.O. Box 016430, Miami, FL 33101
- LANGFORD, GEORGE M., Department of Physiology, University of North Carolina, Medical Sciences Research Wing 206H, Chapel Hill, NC 27514
- LASH, JAMES W., Department of Anatomy, School of Medicine, University of Pennsylvania, Philadelphia, PA 19174
- LASTER, LEONARD, President, University of Oregon, Health Sciences Center, Portland, OR 97201
- LAUFER, HANS, Biological Sciences Group U-42, University of Connecticut, Storrs, CT 06268
- LAUFFER, MAX A., Department of Biophysics, University of Pittsburgh, Pittsburgh, PA 15260
- LAZAROW, JANE, 221 Woodlawn Avenue, St. Paul, MN 55106
- LAZARUS, MAURICE, Federated Department Stores, Inc., 50 Cornhill, Boston, MA 02108
- LEADBETTER, EDWARD R., Biological Sciences Group U-42, University of Connecticut, Storrs, CT 06268
- LEAK, LEE VIRN, Department of Anatomy, Howard University, Washington, DC 20001
- LEDERBERG, JOSHUA, President, The Rockefeller University, 1230 York Avenue, New York, NY 10021
- LEDERHENDLER, IZJA I., Laboratory of Biophysics, Marine Biological Laboratory, Woods Hole, MA 02543
- LEE, JOHN J., Department of Biology, City College, Convent Avenue and 138th Street, New York, NY 10031
- LEFEVRE, PAUL G., Department of Physiology, Health Sciences Center, East Campus—SUNY, Stony Brook, NY 11794
- LEIGHTON, JOSEPH, 1201 Waverly Road, Gladwyne, PA 19035
- LEIGHTON, STEPHEN, NIH, Bldg. 13 Room 3W13, Bethesda, MD 20205
- LENHER, SAMUEL, 50-C Cokesbury Village, Hockessin, DE 19707
- LERMAN, SIDNEY, Laboratory for Ophthalmic Research, Emory University, Atlanta, GA 30322
- LERNER, AARON B., Yale Medical School, New Haven, CT 06510
- LEVIN, JACK, Clinical Pathology Service, Veterans Administration Hospital—113A, 4150 Clement Street, San Francisco, CA 94120
- LEVINE, RACHMIEL, 2024 Canyon Road, Arcadia, CA 91006
- LEVINTHAL, CYRUS, Department of Biological Sciences, Columbia University, 908 Schermerhorn Hall, New York, NY 10027
- LEVITAN, HERBERT, Department of Zoology, University of Maryland, College Park, MD 20742
- LING, GILBERT, 307 Berkeley Road, Marion, PA 19066
- LIPICKY, RAYMOND J., Laboratory of Biophysics, NIH, Bldg. 36 Room 2A29, Bethesda, MD 20205
- LISMAN, JOHN E., Department of Biology, Brandeis University, Waltham, MA 02254
- LITTLE, E. P., 216 Highland Street, West Newton, MA 02158
- LIUZZI, ANTHONY, Department of Physics, University of Lowell, Lowell, MA 01854

- LLINAS, RODOLFO R., Department of Physiology and Biophysics, New York University, Medical Center, New York, NY 10016
- LOEWENSTEIN, WERNER R., Department of Physiology and Biophysics, University of Miami, P.O. Box 016430, Miami, FL 33101
- LOEWUS, FRANK A., Department of Agricultural Chemistry, Washington State University, Pullman, WA 99164
- LOTFIELD, ROBERT B., Department of Biochemistry, School of Medicine, University of New Mexico, 900 Stanford, NE, Albuquerque, NM 87105
- LONDON, IRVING, M., Massachusetts Institute of Technology, 16-512, Cambridge, MA 02138
- LONGO, FRANK J., Department of Anatomy, University of Iowa, Iowa City, IA 65442
- LORAND, LASZLO, Department of Biochemistry and Molecular Biology, Northwestern University, Evanston, IL 60201
- LURIA, SALVADOR E., Department of Biology, Massachusetts Institute of Technology, Cambridge, MA 02139
- LYNCH, CLARA J., 4800 Fillmore Avenue, Alexandria, VA 22311
- MACAGNO, EDUARDO R., 1003B Fairchild, Columbia University, New York, NY 10022
- MACNICHOL, E. F., JR., Laboratory of Sensory Physiology, Marine Biological Laboratory, Woods Hole, MA 02543
- MAHLER, ROBERT, Department of Biochemistry, Indiana University, Bloomington, IN 47401
- MAINER, ROBERT, Senior Vice President, The Boston Company, One Boston Place, Boston, MA 02108
- MALKIEL, SAUL, Sidney Farber Cancer Center, 35 Binney Street, Boston, MA 02116
- MANALIS, RICHARD S., RR #4, Columbia City, IN 46725
- MANGUM, CHARLOTTE P., Department of Biology, College of William and Mary, Williamsburg, VA 23185
- MARGULIS, LYNN, Department of Biology, Boston University, Boston MA 02215
- MARINUCCI, ANDREW C., The Ecosystems Center, Marine Biological Laboratory, Woods Hole, MA 02543
- MARSH, JULIAN B., Department of Biochemistry and Physiology, Medical College of Pennsylvania, 3300 Henry Avenue, Philadelphia, PA 19129
- MARTIN, LOWELL V., Marine Biological Laboratory, Woods Hole, MA 02543
- MARUO, TAKESHI, Department of Obstetrics and Gynecology, Kobe University, Ikuta-ku, Kobe 650, Japan
- MASER, MORTON, 100 Hackmatack Way, Falmouth, MA 02540
- MASTROIANNI, LUIGI, JR., Department of Obstetrics and Gynecology, University of Pennsylvania, Philadelphia, PA 19174
- MATHEWS, RITA W., c/o A. J. Johnson, New York University, Medical Center, New York, NY 10016
- MAUTNER, HENRY G., Department of Biochemistry and Pharmacology, Tufts University, 136 Harrison Avenue, Boston, MA 02111
- MAUZERALL, DAVID, The Rockefeller University, 1230 York Avenue, New York, NY 10021
- MAZIA, DANIEL, Hopkins Marine Station, Pacific Grove, CA 93950
- MCCANN, FRANCES, Department of Physiology, Dartmouth Medical School, Hanover, NH 03755
- MCCLOSKEY, LAWRENCE R., Department of Biology, Walla Walla College, College Place, WA 99324
- MCLAUGHLIN, JANE A., P.O. Box 187, Woods Hole, MA 02543
- MCMAHON, ROBERT F., Department of Biology, Box 19498, University of Texas, Arlington, TX 76019
- MEEDEL, THOMAS, Boston University Marine Program, Marine Biological Laboratory, Woods Hole, MA 02543
- MEINERTZHAGEN, IAN A., Department of Psychology, Life Sciences Center, Dalhousie University, Halifax, Nova Scotia, Canada B3H 4S1
- MEINKOTH, NORMAN A., Department of Biology, Swarthmore College, Swarthmore, PA 19081
- MEISS, DENNIS E., Department of Biology, Clark University, Worcester, MA 01610

- MELILLO, JERRY M., Ecosystems Center, Marine Biological Laboratory, Woods Hole, MA 02543
- MELLON, DEFOREST, JR., Department of Biology, University of Virginia, Charlottesville, VA 22903
- MELLON, RICHARD P., P.O. Box 187, Laughlintown, PA 15655
- METUZALS, JANIS, Department of Anatomy, Faculty of Medicine, University of Ottawa, Ottawa, Ontario, Canada K1N 9A9
- METZ, CHARLES B., Institute of Molecular and Cellular Evolution, University of Miami, 521 Anastasia Avenue, Coral Gables, FL 33134
- MIDDLEBROOK, ROBERT, 86 Station Road, Burley-in-Warfedale, West Yorks, England, U. K.
- MILKMAN, ROGER, Department of Zoology, University of Iowa, Iowa City, IA 52242
- MILLS, ERIC L., Institute of Oceanography, Dalhousie University, Halifax, Nova Scotia
- MILLS, ROBERT, 56 Worcester Court, Falmouth, MA 02540
- MITCHELL, RALPH, Pierce Hall, Harvard University, Cambridge, MA 02138
- MIZELL, MERLE, Department of Biology, Tulane University, New Orleans, LA 70118
- MONROY, ALBERTO, Stazione Zoologica, Villa Comunale, Napoli, Italy
- MONTROLL, ELIOTT W., Institute for Fundamental Studies, Department of Physics, Rochester, NY 14627
- MOORE, JOHN W., Department of Physiology, Duke University, Medical Center, Durham, NC 27710
- MOORE, LEE E., Department of Physiology and Biophysics, University of Texas, Medical Branch, Galveston, TX 77550
- MORAN, JOSEPH F., JR., 23 Foxwood Drive, RR #1, Eastham, MA 02642
- MORIN, JAMES G., Department of Biology, University of California, Los Angeles, CA 90024
- MORRELL, FRANK, Department of Neurological Sciences, Rush Medical Center, 1753 W. Congress Parkway, Chicago, IL 60612
- MORRILL, JOHN B., JR., Division of National Sciences, New College, Sarasota, FL 33580
- MORSE, RICHARD S., 193 Winding River Road, Wellesley, MA 02181
- MORSE, ROBERT W., Associate Director, Woods Hole Oceanographic Institution, Woods Hole, MA 02543
- MORSE, STEPHEN SCOTT, Department of Biological Sciences, Rutgers University, Nelson Biological Laboratories, New Brunswick, NJ 08903
- MOSCONA, A. A., Department of Biology, University of Chicago, 920 East 58th Street, Chicago, IL 60637
- MOTE, MICHAEL J., Department of Biology, Temple University, Philadelphia, PA 19122
- MOUNTAIN, ISABEL, Vinson Hall #112, 6251 Old Dominion Drive, McLean, VA 22101
- MULLEN, GEORGE, President, Mohawk Carpets, Amsterdam, NY 12010
- MUSACCHIA, XAVIER J., Graduate School, University of Louisville, Louisville, KY 40295
- NABRIT, S. M., 686 Beckwith Street, SW, Atlanta, GA 30314
- NACE, PAUL F., 5 Bowditch Road, Woods Hole, MA 02543
- NAKA, KEN-ICHI, National Institute for Basic Biology, Okazaki, Japan 444
- NAKAJIMA, SHIGEHIRO, Department of Biological Sciences, Purdue University, West Lafayette, IN 47907
- NAKAJIMA, YASUKO, Department of Biological Sciences, Purdue University, West Lafayette, IN 47907
- NARAHASHI, TOSHIO, Department of Pharmacology, Medical Center, Northwestern University, 303 East Chicago Avenue, Chicago, IL 60611
- NASATIR, MAIMON, Department of Biology, University of Toledo, Toledo, OH 43606
- NELSON, LEONARD, Medical College of Ohio, Department of Physiology, Toledo, OH 43699
- NELSON, MARGARET C., Section on Neurobiology and Behavior, Cornell University, Ithaca, NY 14850
- NICHOLLS, JOHN G., Department of Neurobiology, Stanford University, Stanford, CA 94305
- NICOSIA, SANTO V., Department of OB-GYN, Division of Reproductive Biology, University of Pennsylvania, Philadelphia, PA 19174
- NIELSEN, JENNIFER B. K., Waksman Institute for Microbiology, Piscataway, NJ 08854

- NOE, BRYAN D., Department of Anatomy, Emory University, Atlanta, GA 30345
- OBAID, ANA LIA, Department of Physiology and Pharmacy, University of Pennsylvania, School of Dental Medicine, 4001 Spruce Street, Philadelphia, PA 19104
- OCHOA, SEVERO, 530 East 72nd Street, New York, NY 10021
- ODUM, EUGENE, Department of Zoology, University of Georgia, Athens, GA 30701
- OERTEL, DONATA, Department of Neurophysiology, University of Wisconsin, 283 Medical Science Bldg., Madison, WI 53706
- O'HERRON, JONATHAN, Lazard Freres and Company, 1 Rockefeller Plaza, New York, NY 10020
- O'MELIA, ANNE F., George Mason University, 4400 University Drive, Fairfax, VA 22030
- OLSON, JOHN M., Institute of Biochemistry, Odense University, Campusvej 55, DK 5230 Odense M, Denmark
- OSCHMAN, JAMES L., Marine Biological Laboratory, Woods Hole, MA 02543
- PALMER, DOUGLAS W., 21 Stanford Road, Wellesley, MA 02181
- PALMER, JOHN D., Department of Zoology, University of Massachusetts, Amherst, MA 01002
- PALTI, YORAM, Department of Physiology and Biophysics, Israel Institute of Technology, 12 Haaliya Street, BAT-GALIM, POB 9649, Haifa, Israel
- PANT, HARISH C., Laboratory for Preclinical Studies, National Institute on Alcohol Abuse and Alcoholism, 12501 Washington Avenue, Rockville, MD 20852
- PAPPAS, GEORGE D., Department of Anatomy, College of Medicine, University of Illinois, 808 South Wood Street, Chicago, IL 60612
- PARDEE, ARTHUR B., Department of Pharmacology, Harvard Medical School, Boston, MA 02115
- PARDY, ROSEVELT L., School of Life Sciences, University of Nebraska, Lincoln, NE 27710
- PARMENTIER, JAMES L., Department of Anesthesiology, Duke University Medical Center, Durham, NC 27710
- PASSANO, LEONARD M., Department of Zoology, Birge Hall, University of Wisconsin, Madison, WI 53706
- PEARLMAN, ALAN L., Department of Physiology, School of Medicine, Washington University, St. Louis, MO 63110
- PEDERSON, THORU, Worcester Foundation for Experimental Biology, Shrewsbury, MA 01545
- PERKINS, C. D., National Academy of Engineering, 2101 Constitution Avenue, NW, Washington, DC 20418
- PERSON, PHILIP, Special Dental Research Program, Veterans Administration Hospital, Brooklyn, NY 11219
- PETERSON, BRUCE J., Ecosystems Center, Marine Biological Laboratory, Woods Hole, MA 02543
- PETHIG, RONALD, School of Electronic Engineering Science, University College of North Wales, Bangor, Gwynedd, LL57 1UT
- PETTIBONE, MARIAN H., Division of Worms, W-213, Smithsonian Institution, Washington, DC 20560
- PFOHL, RONALD J., Department of Zoology, Miami University, Oxford, OH 45056
- PIERCE, SIDNEY K., JR., Department of Zoology, University of Maryland, College Park, MD 20740
- POLLARD, HARVEY B., NIH, F Building 10 Room 10B17, Bethesda, MD 20205
- POLLARD, THOMAS, D., Director, Department of Cell Biology and Anatomy, Johns Hopkins University, 725 North Wolfe Street, Baltimore, MD 21205
- POLLOCK, LELAND W., Department of Zoology, Drew University, Madison, NJ 07940
- PORTER, BEVERLY H., 14433 Taos Court, Wheaton, MD 20906
- PORTER, KEITH R., 748 Eleventh Street, Boulder, CO 80302
- POTTER, DAVID, Department of Neurobiology, Harvard Medical School, Boston, MA 02115
- POTTER, H. DAVID, Neural Sciences Program, Chemistry Building, Indiana University, Bloomington, IN 47404
- POTTS, WILLIAM T., Department of Biology, University of Lancaster, Lancaster, England, U. K.
- POUSSART, DENIS, Department of Electrical Engineering, Universite Laval, Quebec, Canada

- PRENDERGAST, ROBERT A., Department of Pathology and Ophthalmology, Johns Hopkins University, Baltimore, MD 21205
- PRICE, CARL A., Waksman Institute of Microbiology, Rutgers University, P.O. Box 759, Piscataway, NJ 08854
- PRICE, CHRISTOPHER H., Biological Science Center, 2 Cummington Street, Boston, MA 02215
- PRIOR, DAVID J., Department of Biological Sciences, University of Kentucky, Lexington, KY 40506
- PROVASOLI, LUIGI, Haskins Laboratories, 165 Prospect Street, New Haven, CT 06510
- PRUSCH, ROBERT D., Department of Life Sciences, Gonzaga University, Spokane, WA 99258
- PRZYBYLSKI, RONALD J., Department of Anatomy, Case Western Reserve University, Cleveland, OH 44104
- QUIGLEY, JAMES, Department of Microbiology and Immunology, SUNY, Downstate Medical Center, Brooklyn, NY 11203
- RABIN, HARVEY, P.O. Box 239, Braddock Heights, MD 21714
- RAFF, RUDOLF A., Department of Biology, Indiana University, Bloomington, IN 47405
- RAKOWSKI, ROBERT F., Department of Physiology and Biophysics, Washington University School of Medicine, St. Louis, MO 63110
- RAMON, FIDEL, Departamento de Fisiologia y Biofisica, Centro de Investigacion y de Estudios Avanzados del IPN, Apurtado Postal 14-740, Mexico D. F., Mexico 07000
- RANZI, SILVIO, Department of Zoology, University of Milan, Milan, Italy
- RATNER, SARAH, Department of Biochemistry, Public Health Research Institute, 455 First Avenue, New York, NY 10016
- REBHUN, LIONEL I., Department of Biology, Gilmer Hall, University of Virginia, Charlottesville, VA 22901
- REDDAN, JOHN R., Department of Biological Sciences, Oakland University, Rochester, MI 48063
- REDFIELD, ALFRED C., 10 Maury Lane, Woods Hole, MA 02543 (Deceased March 1983)
- REESE, THOMAS S., Section on Functional Neuroanatomy, NIH, Bethesda, MD 20205
- REINER, JOHN M., Department of Biochemistry, Albany Medical College of Union University, Albany, NY 12208
- REINISCH, CAROL L., Tufts University School of Veterinary Medicine, 203 Harrison Avenue, Boston, MA 02115
- REUBEN, JOHN P., Department of Neurology, College of Physicians and Surgeons, Columbia University, New York, NY 10032
- REYNOLDS, GEORGE T., Department of Physics, Jadwin Hall, Princeton University, Princeton, NJ 08540
- RICE, ROBERT V., Carnegie Mellon Institute, 4400 Fifth Avenue, Pittsburgh, PA 15213
- RICKLES, FREDERICK R., University of Connecticut, School of Medicine, Veterans Administration Hospital, Newington, CT 06111
- RIPPS, HARRIS, Department of Ophthalmology, School of Medicine, New York University, New York, NY 10016
- ROBERTS, JOHN L., Department of Zoology, University of Massachusetts, Amherst, MA 01002
- ROBINSON, DENIS M., High Voltage Engineering Corporation, Burlington, MA 01803
- ROCKSTEIN, MORRIS, 335 Fluzia Avenue, Miami, FL 33134
- RONKIN, RAPHAEL R., 3212 McKinley Street, NW, Washington, DC 20015
- ROSBASH, MICHAEL, Rosenstiel Basic Medical Research Center, Department of Biology, Brandeis University, Waltham, MA 02154
- ROSE, BIRGIT, Department of Physiology R-430, School of Medicine, University of Miami, P.O. Box 016430, Miami, FL 33152
- ROSE, S. MERYL, Box 309W, Waquoit, MA 02536
- ROSENBAUM, JOEL L., Department of Biology, Kline Biology Tower, Yale University, New Haven, CT 06510
- ROSENBERG, PHILIP, School of Pharmacy, Division of Pharmacology, University of Connecticut, Storrs, CT 06268

- ROSENBLUTH, JACK, Department of Physiology, School of Medicine, New York University, 550 First Avenue, New York, NY 10016
- ROSENBLUTH, RAJA, 3380 West 5th Avenue, Vancouver 8 BC, Canada V6R 1R7
- ROSENKRANZ, HERBERT S., Department of Microbiology, New York Medical College, Valhalla, NY 10595
- ROSLANSKY, JOHN, Box 208, Woods Hole, MA 02543
- ROSLANSKY, PRISCILLA F., Box 208, Woods Hole, MA 02543
- ROSS, WILLIAM N., Department of Physiology, New York Medical College, Valhalla, NY 10595
- ROTH, JAY S., Division of Biological Sciences, Section of Biochemistry and Biophysics, University of Connecticut, Storrs, CT 06268
- ROWE, DOROTHY, 88 Chestnut Hill, Boston, MA 02165
- ROWLAND, LEWIS P., Neurological Institute, 710 West 168th Street, New York, NY 10032
- RUDERMAN, JOAN V., Department of Anatomy, Harvard Medical School, Boston, MA 02115
- RUSHFORTH, NORMAN B., Department of Biology, Case Western Reserve University, Cleveland, OH 44106
- RUSSELL-HUNTER, W. D., Department of Biology, 110 Lyman Hall, Syracuse University, Syracuse, NY 13210
- RUSTAD, RONALD C., Radiology Department, Case Western Reserve University, Cleveland, OH 44106
- SAGER, RUTH, Sidney Farber Cancer Institute, 44 Binney Street, Boston, MA 02115
- SALAMA, GUY, Department of Physiology, University of Pittsburgh, Pittsburgh, PA 15261
- SALMON, EDWARD D., Department of Zoology, University of North Carolina, Chapel Hill, NC 27514
- SALZBERG, BRIAN H., Department of Physiology, University of Pennsylvania, 4010 Locust Street, Philadelphia, PA 19174
- SANDERS, HOWARD, Woods Hole Oceanographic Institution, Woods Hole, MA 02543
- SANGER, JEAN M., Department of Anatomy, School of Medicine, University of Pennsylvania, 36th and Hamilton Walk, Philadelphia, PA 19174
- SANGER, JOSEPH, Department of Anatomy, School of Medicine, University of Pennsylvania, 36th and Hamilton Walk, Philadelphia, PA 19174
- SATO, HIDEKI, Sugashima Marine Biological Laboratory, Nagoya University, Sugashimacho, Toba-shi, Mie-Ken 517, Japan
- SAUNDERS, JOHN, JR., Department of Biological Sciences, SUNY, Albany, NY 12222
- SAZ, ARTHUR K., Medical and Dental Schools, Georgetown University, 3900 Reservoir Road, NW, Washington, DC 20051
- SCHACHMAN, HOWARD K., Department of Molecular Biology, University of California, Berkeley, CA 94720
- SCHIFF, JEROME A., Institute for Photobiology of Cells and Organelles, Brandeis University, Waltham, MA 02154
- SCHLESINGER, R. WALTER, Department of Microbiology, College of Medicine and Dentistry, Rutgers University, P.O. Box 101, Piscataway, NJ 08854
- SCHMEER, SISTER ARLINE C., Mercene Cancer Research Hospital of Saint Raphael, New Haven, CT 06511
- SCHNEIDERMAN, HOWARD K., Monsanto Company, 800 North Lindberg Blvd., DIW, St. Louis, MO 63166
- SCHOPF, THOMAS, J. M., Department of Geophysical Sciences, University of Chicago, 5734 South Ellis Avenue, Chicago, IL 60637
- SCHOTTE, OSCAR E., Department of Biology, Amherst College, Amherst, MA 01002
- SCHUEL, HERBERT, Department of Anatomical Sciences, SUNY, Buffalo, NY 14214
- SCHUETZ, ALLEN W., School of Hygiene and Public Health, Johns Hopkins University, Baltimore, MD 21205
- SCHWAB, WALTER E., Department of Biology, Virginia Polytechnical Institute and State University, Blacksburg, VA 24601
- SCHWARTZ, JAMES H., College of Physicians and Surgeons, Columbia University, New York, NY 10032

- SCHWARTZ, MARTIN, Department of Biological Sciences, University of Maryland, Baltimore County, Catonsville, MD 21228
- SCHWARTZ, TOBIAS L., Biological Sciences Group, University of Connecticut, Storrs, CT 06268
- SCOTT, ALLAN C., 1 Nudd Street, Waterville, ME 04901
- SCOTT, GEORGE T., 10 Orchard Street, Woods Hole, MA 02543
- SEARS, MARY, P.O. Box 152, Woods Hole, MA 02543
- SEGAL, SHELDON J., Director, Population Division, The Rockefeller Foundation, 1133 Avenue of the Americas, New York, NY 10036
- SELIGER, HOWARD H., Johns Hopkins University, McCollum-Pratt Institute, Baltimore, MD 21218
- SELMAN, KELLY, Department of Anatomy, College of Medicine, University of Florida, Gainesville, FL 32601
- SENF, JOSEPH, 378 Fairview Street, Emmaus, PA 18049
- SHANKLIN, DOUGLAS R., P.O. Box 1267, Gainesville, FL 32602
- SHAPIRO, HERBERT, 6025 North 13th Street, Philadelphia, PA 19141
- SHAVER, GAUIS R., Ecosystems Center, Marine Biological Laboratory, Woods Hole, MA 02543
- SHAVER, JOHN R., Department of Zoology, Michigan State University, E. Lansing, MI 48823
- SHEPARD, DAVID C., P.O. Box 44, Woods Hole, MA 02543
- SHEPRO, DAVID, Department of Biology, Boston University, Boston, MA 02215
- SHERMAN, I. W., Division of Life Sciences, University of California, Riverside, CA 92502
- SHILO, MOSHE, Head, Department of Microbiological Chemistry, Hebrew University, Jerusalem, Israel
- SHOUKIMAS, JONATHAN J., Laboratory of Biophysics, NINCCDS, Marine Biological Laboratory, Woods Hole, MA 02543
- SHRIVASTAV, BRIJ S., Department of Pharmacology, Duke University Medical Center, Durham, NC 27710
- SIEGEL, IRWIN M., Department of Ophthalmology, New York University, Medical Center, New York, NY 10016
- SIEGELMAN, HAROLD W., Department of Biology, Brookhaven National Laboratory, Upton, NY 11973
- SIMON, ERIC J., New York University, Medical School, New York, NY 10016
- SJODIN, RAYMOND A., Department of Biophysics, University of Maryland, Baltimore, MD 21201
- SKINNER, DOROTHY M., Biology Division, Oak Ridge National Laboratory, Oak Ridge, TN 37830
- SLOBODA, ROGER D., Department of Biological Sciences, Dartmouth College, Hanover, NH 03755
- SLOBODKIN, LAWRENCE B., Department of Biology, SUNY, Stony Brook, NY 11790
- SMITH, HOMER P., General Manager, Marine Biological Laboratory, Woods Hole, MA 02543
- SMITH, MICHAEL A., Foreign and Commonwealth Office, King Charles Street, London SW1A 2AH, England, U. K.
- SMITH, PAUL F., P.O. Box 264, Woods Hole, MA 02543
- SMITH, RALPH I., Department of Zoology, University of California, Berkeley, CA 94720
- SORENSEN, ALBERT L., Department of Physiology, Albert Einstein College of Medicine, 1300 Morris Park Avenue, Bronx, NY 10461
- SPECK, WILLIAM T., Department of Pediatrics, Case Western Reserve University, Cleveland, OH 44106
- SPECTOR, A., College of Physicians and Surgeons, Black Bldg. Room 1516, Columbia University, New York, NY 10032
- SPIEGEL, EVELYN, Department of Biological Sciences, Dartmouth College, Hanover, NH 02755
- SPIEGEL, MELVIN, Department of Biological Sciences, Dartmouth College, Hanover, NH 02755

- SPRAY, DAVID C., Department of Neurosciences, Albert Einstein College of Medicine, 1300 Morris Park Avenue, Bronx, NY 10461
- STARZAK, MICHAEL E., Department of Chemistry, SUNY, Binghamton, NY 13901
- STEELE, JOHN HYSLOP, Director, Woods Hole Oceanographic Institution, Woods Hole, MA 02543
- STEINACHER, ANTOINETTE, Department of Biophysics, The Rockefeller University, New York, NY 10021
- STEINBERG, MALCOLM, Department of Biology, Princeton University, Princeton, NJ 08540
- STEPHENS, GROVER C., Department of Developmental and Cell Biology, University of California, Irvine, CA 92717
- STEPHENS, RAYMOND E., Marine Biological Laboratory, Woods Hole, MA 02543
- STETTEN, MARJORIE R., NIH, Bldg. 10 9B-02, Bethesda, MD 20205 (Deceased May 1983)
- STETTEN, DEWITT, JR., Senior Scientific Advisor, NIH, Bldg. 16 Room 118, Bethesda, MD 20205
- STOKES, DARRELL R., Department of Biology, Emory University, Atlanta, GA 30322
- STRACHER, ALFRED, Downstate Medical Center, SUNY, 450 Clarkson Avenue, Brooklyn, NY 11203
- STREHLER, BERNARD L., 2235 25th Street, #217, San Pedro, CA 90732
- STUART, ANN E., Medical Sciences Research Wing 206H, Department of Physiology, University of North Carolina, Chapel Hill, NC 27514
- SUMMERS, WILLIAM C., Huxley College, Western Washington State College, Bellingham, WA 98225
- SUSSMAN, MAURICE, Department of Life Sciences, University of Pittsburgh, Pittsburgh, PA 15260
- SWENSON, RANDOLPHE P., JR., Department of Physiology G-4, University of Pennsylvania, Philadelphia, PA 19174
- SZABO, GEORGE, Harvard School of Dental Medicine, 188 Longwood Avenue, Boston, MA 02115
- SZAMIER, R. BRUCE, Harvard Medical School, Berman-Gund Laboratory, Massachusetts Eye and Ear Infirmary, 243 Charles Street, Boston, MA 02114
- SZENT-GYÖRGYI, ALBERT, Marine Biological Laboratory, Woods Hole, MA 02543
- SZENT-GYÖRGYI, ANDREW, Department of Biology, Brandeis University, Waltham, MA 02154
- TAKASHIMA, SHIRO, Department of Bioengineering, University of Pennsylvania, Philadelphia, PA 19174
- TAMM, SIDNEY L., Boston University Marine Program, Marine Biological Laboratory, Woods Hole, MA 02543
- TANZER, MARVIN L., Department of Biochemistry, Box G, Medical School, University of Connecticut, Farmington, CT 06032
- TASAKI, ICHII, Laboratory of Neurobiology, NIMH, NIH, Bethesda, MD 20205
- TAYLOR, DOUGLASS L., Biological Sciences, Mellon Institute, 4400 Fifth Avenue, Pittsburgh, PA 15213
- TAYLOR, ROBERT E., Laboratory of Biophysics, NINCDS, NIH, Bethesda, MD 20205
- TAYLOR, W. ROWLAND, 4800 Atwell Road, Shady Side, MD 20764
- TELFER, WILLIAM H., Department of Biology, University of Pennsylvania, Philadelphia, PA 19174
- THORNDIKE, W. NICHOLAS, Wellington Management Company, 28 State Street, Boston, MA 02109
- TIFFNEY, WESLEY N., 226 Edge Hill Road, Sharon, MA 02067 (Deceased January 1983)
- TRAGER, WILLIAM, The Rockefeller University, 1230 York Avenue, New York, NY 10021
- TRAVIS, D. M., Veterans Administration Medical Center, Fargo, ND 58102
- TREISTMAN, STEVEN N., Worcester Foundation for Experimental Biology, Shrewsbury, MA 01545
- TRIGG, D. THOMAS, 1215 Grove Street, Wellesley, MA 02181
- TRINKAUS, J. PHILIP, Osborn Zoological Labs, Department of Zoology, Yale University, New Haven, CT 06510

- TROLL, WALTER, Department of Environmental Medicine, College of Medicine, New York University, New York, NY 10016
- TROXLER, ROBERT F., Department of Biochemistry, School of Medicine, Boston University, 80 East Concord Street, Boston, MA 02118
- TURNER, RUTH D., Mollusk Department, Museum of Comparative Zoology, Harvard University, Cambridge, MA 02138
- TWEDELL, KENYON S., Department of Biology, University of Notre Dame, Notre Dame, IN 46656
- TYTELL, MICHAEL, Department of Anatomy, Bowman Gray School of Medicine, Winston-Salem, NC 27103
- URETZ, ROBERT B., Division of Biological Sciences, University of Chicago, 950 East 59th Street, Chicago, IL 60637
- VALIELA, IVAN, Boston University Marine Program, Marine Biological Laboratory, Woods Hole, MA 02543
- VALOIS, JOHN, Marine Biological Laboratory, Woods Hole, MA 02543
- VAN HOLDE, KENSAL, Department of Biochemistry and Biophysics, Oregon State University, Corvallis, OR 97331
- VILLEE, CLAUDE A., Department of Biological Chemistry, Harvard Medical School, Boston, MA 02115
- VINCENT, WALTER S., School of Life and Health Sciences, University of Delaware, Newark, DE 19711
- WAINIO, WALTER W., Box 1059 Nelson Labs, Rutgers Biochemistry, Piscataway, NJ 08854
- WAKSMAN, BYRON, National Multiple Sclerosis Society, 205 East 42nd Street, New York, NY 10017
- WALKER, CHARLES A., 3113 Shamrock South, Tallahassee, FL 32303
- WALL, BETTY, Marine Biological Laboratory, Woods Hole, MA 02543
- WALLACE, ROBIN A., Department of Anatomy, College of Medicine, University of Florida, Gainesville, FL 32610
- WANG, AN, Bedford Road, Lincoln, MA 01773
- WARNER, ROBERT C., Department of Molecular Biology and Biochemistry, University of California, Irvine, CA 92717
- WARREN, KENNETH S., The Rockefeller Foundation, 1133 Avenue of the Americas, New York, NY 10036
- WARREN, LEONARD, Department of Therapeutic Research, School of Medicine, Anatomy-Chemistry Building Room 337, University of Pennsylvania, Philadelphia, PA 19174
- WATERMAN, T. H., Yale University, 610 Kline Biology Tower, New Haven, CT 06510
- WATSON, STANLEY, Woods Hole Oceanographic Institution, Woods Hole, MA 02543
- WEBB, H. MARGUERITE, Marine Biological Laboratory, Woods Hole, MA 02543
- WEBER, ANNEMARIE, Department of Biochemistry, School of Medicine, University of Pennsylvania, Philadelphia, PA 19174
- WEBSTER, FERRIS, 800 25th Street, NW, Washington, DC 20037
- WEIDNER, EARL, Department of Zoology and Physiology, Louisiana State University, Baton Rouge, LA 70803
- WEISS, LEON P., Department of Animal Biology, School of Veterinary Medicine, University of Pennsylvania, Philadelphia, PA 19174
- WEISSMANN, GERALD, Division of Rheumatology, New York University, School of Medicine, New York, NY 10016
- WERMAN, ROBERT, Neurobiology Unit, The Hebrew University, Jerusalem, Israel
- WESTERFIELD, R. MONTE, The Institute of Neuroscience, University of Oregon, Eugene, OR 97403
- WHITTAKER, J. RICHARD, Director, Boston University Marine Program, Marine Biological Laboratory, Woods Hole, MA 02543
- WIERCINSKI, FLOYD J., Department of Biology, Northeastern Illinois University, 5500 North St. Louis Avenue, Chicago, IL 60625
- WIGLEY, ROLAND L., 35 Wilson Road, Woods Hole, MA 02543

- WILBER, CHARLES G., Department of Zoology, Colorado State University, Fort Collins, CO 80523
- WILSON, DARCY B., Department of Pathology, School of Medicine, University of Pennsylvania, Philadelphia, PA 19174
- WILSON, EDWARD O., Department of Zoology, Harvard University, Cambridge, MA 02138
- WILSON, T. HASTINGS, Department of Physiology, Harvard Medical School, Boston, MA 02115
- WILSON, WALTER L., Department of Biology, Oakland University, Rochester, MI 48063
- WITKOVSKY, PAUL, Department of Ophthalmology, New York University, Medical Center, New York, NY 10016
- WITTENBERG, JONATHAN B., Department of Physiology and Biochemistry, Albert Einstein College of Medicine, 1300 Morris Park Avenue, Bronx, NY 10461
- WOELKERLING, WILLIAM J., Department of Botany, Latrobe University, Bundoora, Victoria, Australia 3083
- WOLF, DON P., Department of OB-GYN, University of Texas Health Sciences Center, 6431 Fannin, Houston, TX 77030
- WOODWELL, GEORGE M., Director, Ecosystems Center, Marine Biological Laboratory, Woods Hole, MA 02543
- WU, CHAU HSIUNG, Department of Pharmacology, Northwestern University Medical School, Chicago, IL 60611
- WYTENBACH, CHARLES R., Department of Physiology and Cell Biology, University of Kansas, Lawrence, KS 06045
- YAMIN, MICHAEL A., The Rockefeller University, 1230 York Avenue, New York, NY 10021
- YEH, JAY Z., Department of Pharmacology, Northwestern University Medical School, 303 E. Chicago Avenue, Chicago, IL 60611
- YOUNG, RICHARD, 100 Royalston Road, Wellesley Hills, MA 02181
- YPHANTIS, DAVID A., Department of Biochemistry and Biophysics, University of Connecticut, Storrs, CT 06268
- ZIGMAN, SEYMOUR, School of Medicine and Dentistry, University of Rochester, 260 Crittenden Blvd., Rochester, NY 14620
- ZIMMERMAN, A. M., Department of Zoology, University of Toronto, Toronto 5, Ontario, Canada
- ZUCKER, ROBERT S., Department of Physiology, University of California, Berkeley, CA 94720

ASSOCIATE MEMBERS

- | | |
|--------------------------------------|-----------------------------------|
| ACKROYD, DR. AND MRS. FREDERICK W. | BERNSTEIN, MR. AND MRS. NORMAN |
| ADELBERG, DR. AND MRS. EDWARD A. | BIGELOW, MRS. ROBERT O. |
| ADELMAN, DR. AND MRS. WILLIAM J. | BLACKBURN, DR. AND MRS. GEORGE L. |
| AHEARN, MR. AND MRS. DAVID C. | BODEEN, MR. AND MRS. GEORGE H. |
| ALLEN, MISS CAMILLA K. | BOETTIGER, DR. AND MRS. EDWARD G. |
| ALLEN, DR. ROBERT D. AND NINA S. | BOLTON, MR. AND MRS. THOMAS C. |
| AMBERSON, MRS. WILLIAM R. | BORGESSE, DR. AND MRS. THOMAS A. |
| ANDERSON, DR. JAMES L. AND HELENE M. | BOTKIN, DR. AND MRS. DANIEL B. |
| ARMSTRONG, DR. AND MRS. SAMUEL C. | BOWLES, DR. AND MRS. FRANCIS P. |
| ARNOLD, DR. AND MRS. JOHN M. | BRADLEY, DR. AND MRS. CHARLES C. |
| ATWOOD, DR. AND MRS. KIMBALL C. | BRONSON, MRS. SAMUEL C. |
| BALL, MRS. ERIC G. | BROWN, MRS. DUGALD E. S. |
| BALLANTINE, DR. AND MRS. H. T., JR. | BROWN, DR. AND MRS. FRANK A., JR. |
| BANG, MRS. FREDERIK B. | BROWN, DR. AND MRS. THORNTON |
| BANKS, MR. AND MRS. WILLIAM L. | BUCK, MRS. JOHN B. |
| BARROWS, MRS. ALBERT W. | BUFFINGTON, MRS. ALICE H. |
| BEERS, DR. AND MRS. YARDLEY | BUFFINGTON, MRS. GEORGE |
| BENNETT, DR. AND MRS. MICHAEL V. L. | BURGER, DR. AND MRS. MAX M. |
| BERNHEIMER, DR. ALAN W. | BURROUGH, MRS. ARNOLD H. |
| | BURT, MR. AND MRS. CHARLES E. |

- BUTLER, MR. AND MRS. RHETT W.
 CALKINS, MR. AND MRS. G. N., JR.
 CAMPBELL, DR. AND MRS. DAVID G.
 CAMPBELL, MR. AND MRS.
 WORTHINGTON, JR.
 CAPOBIANCO, MR. AND MRS. PAT J.
 CARLSON, DR. AND MRS. FRANCIS
 CARLTON, MR. AND MRS. WINSLOW G.
 CASHMAN, MR. AND MRS. EUGENE R.
 CHAMBERS, DR. AND MRS. EDWARD L.
 CHENEY, DR. AND MRS. RALPH H.
 CLAFF, MR. AND MRS. MARK
 CLARK, MR. AND MRS. HAYS
 CLARK, MR. AND MRS. JAMES McC.
 CLARK, DR. AND MRS. LEONARD B.
 CLARK, MR. AND MRS. LEROY, JR.
 CLARK, MRS. W. VAN ALAN
 CLEMENT, DR. AND MRS. A. C.
 CLOWES FUND, INC.
 CLOWES, DR. AND MRS. ALEXANDER W.
 CLOWES, MR. ALLEN W.
 CLOWES, DR. AND MRS. G. H. A., JR.
 COHEN, DR. AND MRS. SEYMOUR
 COLEMAN, DR. AND MRS. JOHN
 CONNELL, MR. AND MRS. W. J.
 COOPER, MR. AND MRS. JOHN H., JR.
 COPELAND, MRS. D. EUGENE
 COPELAND, MR. AND MRS. PRESTON S.
 COSTELLO, MRS. DONALD P.
 CRAIN, MR. AND MRS. MELVIN C.
 CRAMER, MR. AND MRS. IAN D. W.
 CRANE, MRS. JOHN
 CRANE, JOSEPHINE B., FOUNDATION
 CRANE, MRS. W. CAREY
 CROSS, MR. AND MRS. NORMAN C.
 CROSSLEY, MR. AND MRS. ARCHIBALD M.
 CROWELL, DR. AND MRS. SEARS
 DAIGNAULT, MR. AND MRS.
 ALEXANDER T.
 DANIELS, MR. AND MRS. BRUCE G.
 DAVIS, MR. AND MRS. JOEL F.
 DAY, MR. AND MRS. POMEROY
 DICKSON, DR. WILLIAM A.
 DRUMMOND, MR. AND MRS. A. H., JR.
 DUBOIS, DR. AND MRS. ARTHUR B.
 DUNKERLEY, MR. AND MRS. H. GORDON
 DUPONT, MR. A. FELIX, JR.
 DYER, MR. AND MRS. ARNOLD W.
 EBERT, DR. AND MRS. JAMES D.
 EDWARDS, DR. AND MRS. ROBERT L.
 EGLOFF, DR. AND MRS. F. R. L.
 ELLIOTT, MRS. ALFRED M.
 ELSMITH, MRS. DOROTHY O.
 EPPEL, MR. AND MRS. DUDLEY
 EVANS, MR. AND MRS. DUDLEY
 EWING, DR. AND MRS. GIFFORD C.
 FENNO, MRS. EDWARD N.
 FERGUSON, DR. AND MRS. JAMES J., JR.
 FINE, DR. AND MR. JACOB
 FISHER, MRS. B. C.
 FISHER, MR. FREDERICK S., III
 FISHER, DR. AND MRS. SAUL H.
 FRANCIS, MR. AND MRS. LEWIS W., JR.
 FRIENDSHIP FUND
 FRIES, DR. AND MRS. E. F. B.
 FYE, DR. AND MRS. PAUL M.
 GABRIEL, DR. AND MRS. MORDECAI L.
 GAISER, DR. AND MRS. DAVID W.
 GARFIELD, MISS ELEANOR
 GARREY, DR. AND MRS. WALTER E.
 GELLIS, DR. AND MRS. SYDNEY
 GERMAN, DR. AND MRS. JAMES L., III
 GIFFORD, MR. AND MRS. JOHN A.
 GIFFORD, DR. AND MRS. PROSSER
 GILBERT, DR. AND MRS. DANIEL L.
 GILBERT, MRS. CARL J.
 GILDEA, DR. MARGARET C. L.
 GILLETTE, MR. AND MRS. ROBERT S.
 GLASS, DR. AND MRS. H. BENTLEY
 GLAZEBROOK, MRS. JAMES R.
 GLUSMAN, DR. AND MRS. MURRAY
 GOLDMAN, DR. AND MRS. ALLEN S.
 GOLDSTEIN, MR. AND MRS. MOISE H., JR.
 GRANT, DR. AND MRS. PHILIP
 GRASSLE, MR. AND MRS. J. F.
 GREEN, MISS GLADYS M.
 GREENE, MR. AND MRS. WILLIAM C.
 GREER, MR. AND MRS. W. H., JR.
 GROSCH, DR. AND MRS. DANIEL S.
 GROSS, MRS. PAUL C.
 GRUSON, MRS. MARTHA R.
 GUNNING, MR. AND MRS. ROBERT
 HAAKONSEN, DR. HARRY O.
 HALVORSON, DR. AND MRS. HARLYN O.
 HANDLER, MRS. PHILIP
 HARVEY, DR. AND MRS. RICHARD B.
 HASSETT, MR. AND MRS. CHARLES
 HASTINGS, DR. AND MRS. J. WOODLAND
 HEFFRON, DR. AND MRS. RODERICK
 HENLEY, DR. CATHERINE
 HIATT, DR. AND MRS. HOWARD
 HILL, MRS. SAMUEL E.
 HILSINGER, MR. AND MRS. ARTHUR
 HIRSCHFELD, MRS. NATHAN B.
 HOBBIE, DR. AND MRS. JOHN
 HOCKER, MR. AND MRS. LON
 HOFFMAN, REV. AND MRS. CHARLES
 HORWITZ, DR. AND MRS. NORMAN H.
 HOUSTON, MR. AND MRS. HOWARD E.
 HUETTNER, DR. AND MRS. ROBERT J.
 HUNZIKER, MR. AND MRS. HERBERT E.
 HYNES, MR. AND MRS. THOMAS J. JR.

INOUÉ, DR. AND MRS. SHINYA
 IRELAND, MRS. HERBERT A.
 ISSOKSON, MR. AND MRS. ISRAEL
 IVENS, DR. SUE
 JACKSON, MISS ELIZABETH B.
 JANNEY, MRS. F. WISTAR
 JEWETT, G. F., FOUNDATION
 JEWETT, MR. AND MRS. G. F., JR.
 JONES, MR. AND MRS. DEWITT C., III
 JONES, MR. AND MRS. FREDERICK, III
 JORDAN, DR. AND MRS. EDWIN P.
 KAAH, DR. HELEN W.
 KAHLER, MR. AND MRS. GEORGE A.
 KAHLER, MR. AND MRS. ROBERT W.
 KAMINER, DR. AND MRS. BENJAMIN
 KARUSH, DR. AND MRS. FRED
 KEITH, MRS. JEAN R.
 KELLEHER, MR. AND MRS. PAUL R.
 KENDALL, MR. RICHARD E.
 KEOSIAN, MRS. JESSIE
 KIEN, MR. AND MRS. PIETER
 KINNARD, MRS. L. RICHARD
 KIVY, DR. AND MRS. PETER
 KOHN, DR. AND MRS. HENRY I.
 KOLLER, DR. AND MRS. LEWIS R.
 KUFFLER, MRS. STEPHEN W.
 LADERMAN, MR. AND DR. AIMLEE EZRA
 LASH, DR. AND MRS. JAMES
 LASTER, DR. AND MRS. LEONARD
 LAUFER, DR. AND MRS. HANS
 LAVIGNE, MRS. RICHARD J.
 LAWRENCE, MR. FREDERICK V.
 LAWRENCE, MR. AND MRS. WILLIAM
 LAWRENCE SAUNDERS FUND
 LAZAROW, MRS. ARNOLD
 LEATHERBEE, MRS. JOHN H.
 LEMANN, MRS. LUCY B.
 LENHER, DR. AND MRS. SAMUEL
 LEVINE, DR. AND MRS. RACHMIEL
 LEWIS, MR. JOHN T.
 LITTLE, MRS. ELBERT
 LOEB, MRS. ROBERT F.
 LOVELL, MR. AND MRS. HOLLIS R.
 LOWE, DR. AND MRS. CHARLES W.
 LOWENGARD, MRS. JOSEPH
 MACKEY, MR. AND MRS. WILLIAM K.
 MACLEISH, MRS. MARGARET
 MACNARY, MR. AND MRS. B. GLENN
 MACNICHOL, DR. AND MRS. EDWARD F.,
 JR.
 MAHER, MISS ANNE CAMILLE
 MARKS, DR. AND MRS. PAUL A.
 MARSLAND, DR. DOUGLAS
 MARTYNA, MR. AND MRS. JOSEPH C.
 MARVIN, DR. DOROTHY H.
 MASER, DR. AND MRS. MORTON
 MASTROIANNI, DR. AND MRS. LUIGI, JR.
 MATHER, MR. AND MRS. FRANK J., III
 MATTHIESSEN, MR. AND MRS. G. C.
 MCCUSKER, MR. AND MRS. PAUL T.
 MCELROY, MRS. NELLA W.
 MCLANE, MRS. T. THORNE
 MEIGS, MR. AND MRS. ARTHUR
 MEIGS, DR. AND MRS. J. WISTER
 MELILLO, DR. AND MRS. JERRY M.
 MELLON, RICHARD KING, TRUST
 MELLON, MR. AND MRS. RICHARD P.
 MENKE, DR. W. J.
 METZ, DR. AND MRS. CHARLES B.
 MEYERS, MR. AND MRS. RICHARD
 MILLER, DR. DANIEL A.
 MIXTER, MR. AND MRS. WILLIAM J., JR.
 MONTGOMERY, DR. AND MRS. CHARLES
 H.
 MONTGOMERY, DR. AND MRS. RAYMOND
 P.
 MOORE, MR. AND MRS. BEERIEN, III
 MORSE, MR. AND MRS. CHARLES L., JR.
 MORSE, MR. AND MRS. RICHARD S.
 MOUL, DR. AND MRS. EDWIN T.
 NEWTON, MR. AND MRS. WILLIAM F.
 NICKERSON, MR. AND MRS. FRANK L.
 NORMAN, MR. AND MRS. ANDREW E.
 NORMAN FOUNDATION
 O'HERRON, MR. AND MRS. JONATHAN
 ORTINS, MR. AND MRS. ARMAND
 O'SULLIVAN, DR. RENEE BENNETT
 PALMER, MRS. DOUGLAS W.
 PAPPAS, DR. AND MRS. GEORGE D.
 PARK, MRS. FRANKLIN A.
 PARK, MR. AND MRS. MALCOLM S.
 PARMENTER, MISS CAROLYN L.
 PARMONTIER, MR. AND MRS. GEORGE L.
 PENDERGAST, MRS. CLAUDIA
 PENDLETON, DR. AND MRS. MURRAY E.
 PENNINGTON, MISS ANNE H.
 PERKINS, MR. AND MRS. COURTLAND D.
 PERSON, DR. AND MRS. PHILIP
 PETERSON, MR. AND MRS. E. GUNNAR
 PETERSON, MR. AND MRS. E. JOEL
 PETERSON, MR. RAYMOND W.
 PHILIPPE, MR. AND MRS. PIERRE
 PORTER, DR. AND MRS. KEITH R.
 PROSSER, DR. AND MRS. C. LADD
 PUTNAM, MR. ALLAN RAY
 PUTNAM, MR. AND MRS. WILLIAM A., III
 PYNE, MISS RUTH
 RAYMOND, DR. AND MRS. SAMUEL
 READ, MS. LEE
 REDFIELD, DR. AND MRS. ALFRED C.
 RENEK, MR. AND MRS. MORRIS
 REYNOLDS, DR. AND MRS. GEORGE

REYNOLDS, MRS. JAMES T.
 REZNIKOFF, DR. AND MRS. PAUL
 RICCA, DR. AND MRS. RENATO A.
 RIGGS, MR. AND MRS. LAWRASSON, III
 RIINA, MR. AND MRS. JOHN R.
 ROBB, MRS. ALISON A.
 ROBERTSON, MRS. C. STUART
 ROBERTSON, DR. AND MRS. C. W.
 ROBINSON, DR. AND MRS. DENIS M.
 ROGERS, MRS. JULIAN
 ROOT, MRS. WALTER S.
 ROSS, DR. VIRGINIA
 ROWE, MR. AND MRS. WILLIAM S.
 RUBIN, DR. JOSEPH
 RUGH, MRS. ROBERTS
 RUSSELL, MR. AND MRS. HENRY D.
 RYDER, MR. AND MRS. FRANCIS C.
 SAUNDERS, DR. AND MRS. JOHN W.
 SAUNDERS, MRS. LAWRENCE
 SAUNDERS, LAWRENCE FUND
 SAWYER, MR. AND MRS. JOHN E.
 SCHLESINGER, DR. AND MRS. R. WALTER
 SCOTT, DR. AND MRS. GEORGE T.
 SCOTT, MR. AND MRS. NORMAN E.
 SEARS, MR. AND MRS. HAROLD B.
 SEGAL, DR. AND MRS. SHELDON J.
 SHAPIRO, MRS. HARRIET S.
 SHEMIN, DR. AND MRS. DAVID
 SHEPRO, DR. AND MRS. DAVID
 SMITH, MRS. HOMER P.
 SMITH, MR. VAN DORN C.
 SNIDER, MR. ELIOT
 SOLOMON, DR. AND MRS. A. K.
 SPECHT, MRS. HEINZ
 SPIEGEL, DR. AND MRS. MELVIN
 STEELE, MRS. M. EVELYN
 STEINBACH, MRS. H. BURR
 STETSON, MRS. THOMAS J.
 STETTEN, DR. AND MRS. DEWITT, JR.
 STRACHER, DR. AND MRS. ALFRED
 STUNKARD, DR. HORACE
 STURTEVANT, MRS. A. H.
 SWANSON, DR. AND MRS. CARL P.
 SWOPE, MR. AND MRS. GERARD L.
 SWOPE, MRS. GERARD, JR.
 TAYLOR, DR. AND MRS. W. RANDOLPH
 TYLOR, MRS. MARJORIE G.
 TIETJE, MR. AND MRS. EMIL D., JR.
 TODD, MR. AND MRS. GORDON F.
 TOLKAN, MR. AND MRS. NORMAN N.
 TOMPKINS, MRS. B. A.
 TRAGER, MRS. WILLIAM
 TROLL, DR. AND MRS. WALTER
 TULLY, MR. AND MRS. GORDON F.
 VALOIS, MR. AND MRS. JOHN
 VAN BRUNT, MR. AND MRS. A. H., JR.
 VEEDER, MRS. RONALD A.
 WAINIO, MRS. WALTER
 WAITE, MR. AND MRS. CHARLES E.
 WAKSMAN, DR. AND MRS. BYRON H.
 WARE, MR. AND MRS. J. LINDSAY
 WATT, MR. AND MRS. JOHN B.
 WEISBERG, MR. AND MRS. ALFRED M.
 WHEATLEY, DR. MARJORIE A.
 WHEELER, DR. AND MRS. PAUL S.
 WHEELER, DR. AND MRS. RALPH E.
 WHITNEY, MR. AND MRS. GEOFFREY G.,
 JR.
 WICHTERMAN, DR. AND MRS. RALPH
 WICKERSHAM, MR. AND MRS. A. A.
 TILNEY
 WICKERSHAM, MR. AND MRS. JAMES H.,
 JR.
 WILHELM, DR. HAZEL S.
 WITMER, DR. AND MRS. ENOS E.
 WOLFINSOHN, MR. AND MRS. WOLFE
 WOODWELL, DR. AND MRS. GEORGE M.
 YNTEMA, MRS. CHESTER L.
 ZINN, DR. AND MRS. DONALD J.
 ZIPF, DR. ELIZABETH
 ZWILLING, MRS. EDGAR

III. CERTIFICATE OF ORGANIZATION

(On File in the Office of the Secretary of the Commonwealth)

No. 3170

We, Alpheus Hyatt, President, William Stanford Stevens, Treasurer, and William T. Sedgwick, Edward G. Gardiner, Susan Mims and Charles Sedgwick Minot being a majority of the Trustees of the Marine Biological Laboratory in compliance with the requirements of the fourth section of chapter one hundred and fifteen of the Public Statutes do hereby certify that the following is a true copy of the agreement of association to constitute said Corporation, with the names of the subscribers thereto:

We, whose names are hereto subscribed, do, by this agreement, associate ourselves with the intention to constitute a Corporation according to the provisions of the one hundred and

fifteenth chapter of the Public Statutes of the Commonwealth of Massachusetts, and the Acts in amendment thereof and in addition thereto.

The name by which the Corporation shall be known is THE MARINE BIOLOGICAL LABORATORY.

The purpose for which the Corporation is constituted is to establish and maintain a laboratory or station for scientific study and investigations, and a school for instruction in biology and natural history.

The place within which the Corporation is established or located is the city of Boston within said Commonwealth.

The amount of its capital stock is none.

In Witness Whereof, we have hereunto set our hands, this twenty seventh day of February in the year eighteen hundred and eighty-eight, Alpheus Hyatt, Samuel Mills, William T. Sedgwick, Edward G. Gardiner, Charles Sedgwick Minot, William G. Farlow, William Stanford Stevens, Anna D. Phillips, Susan Mims, B. H. Van Vleck.

That the first meeting of the subscribers to said agreement was held on the thirteenth day of March in the year eighteen hundred and eighty-eight.

In Witness Whereof, we have hereunto signed our names, this thirteenth day of March in the year eighteen hundred and eighty-eight, Alpheus Hyatt, President, William Stanford Stevens, Treasurer, Edward G. Gardiner, William T. Sedgwick, Susan Mims, Charles Sedgwick Minot.

(Approved on March 20, 1888 as follows:

I hereby certify that it appears upon an examination of the within written certificate and the records of the corporation duly submitted to my inspection, that the requirements of sections one, two and three of chapter one hundred and fifteen, and sections eighteen, twenty and twenty-one of chapter one hundred and six, of the Public Statutes, have been compiled with and I hereby approve said certificate this twentieth day of March A.D. eighteen hundred and eighty-eight.

CHARLES ENDICOTT
Commissioner of Corporations)

IV. ARTICLES OF AMENDMENT

(On File in the Office of the Secretary of the Commonwealth)

We, James D. Ebert, President, and David Shepro, Clerk of the Marine Biological Laboratory, located at Woods Hole, Massachusetts 02543, do hereby certify that the following amendment to the Articles of Organization of the Corporation was duly adopted at a meeting held on August 15, 1975, as adjourned to August 29, 1975, by vote of 444 members, being at least two-thirds of its members legally qualified to vote in the meetings of the corporation:

VOTED: That the Certificate of Organization of this corporation be and it hereby is amended by the addition of the following provisions:

“No Officer, Trustee or Corporate Member of the corporation shall be personally liable for the payment or satisfaction of any obligation or liabilities incurred as

a result of, or otherwise in connection with, any commitments, agreements, activities or affairs of the corporation.

“Except as otherwise specifically provided by the Bylaws of the corporation, meetings of the Corporate Members of the corporation may be held anywhere in the United States.

“The Trustees of the corporation may make, amend or repeal the Bylaws of the corporation in whole or in part, except with respect to any provisions thereof which shall by law, this Certificate or the bylaws of the corporation, require action by the Corporate Members.”

The foregoing amendment will become effective when these articles of amendment are filed in accordance with Chapter 180, Section 7 of the General Laws unless these articles specify, in accordance with the vote adopting the amendment, a later effective date not more than thirty days after such filing, in which event the amendment will become effective on such later date.

In Witness whereof and Under the Penalties of Perjury, we have hereto signed our names this 2nd day of September, in the year 1975, James D. Ebert, President; David Shepro, Clerk.

(Approved on October 24, 1975, as follows:

I hereby approve the within articles of amendment and, the filing fee in the amount of \$10 having been paid, said articles are deemed to have been filed with me this 24th day of October, 1975.

PAUL GUZZI
Secretary of the Commonwealth)

V. BYLAWS OF THE CORPORATION OF THE MARINE BIOLOGICAL LABORATORY

(Revised August 11, 1978)

I. (A) The name of the Corporation shall be The Marine Biological Laboratory. The Corporation's purpose shall be to establish and maintain a laboratory or station for scientific study and investigation, and a school for instruction in biology and natural history.

(B) Marine Biological Laboratory admits students without regard to race, color, sex, national and ethnic origin to all the rights, privileges, programs and activities generally accorded or made available to students in its courses. It does not discriminate on the basis of race, color, sex, national and ethnic origin in employment, administration of its educational policies, admissions policies, scholarship and other programs.

II. (A) The members of the Corporation (“Members”) shall consist of persons elected by the Board of Trustees, upon such terms and conditions and in accordance with such procedures, not inconsistent with law or these Bylaws, as may be determined by said Board of Trustees. Except as provided below, any Member may vote at any meeting, either in person or by proxy executed no more than six months prior to the date of such meeting. Members shall serve until their death or resignation unless earlier removed, with or without cause, by the affirmative vote of two-thirds of the Trustees then in office. Any member who has attained the age of seventy years or has retired from his home institution shall automatically be designated a Life Member provided he signifies his wish to retain his membership. Life Members shall not have the right to vote and shall not be assessed for dues.

(B) The Associates of the Marine Biological Laboratory shall be an unincorporated group of persons (including associations and corporations) interested in the Laboratory and shall be organized and operated under the general supervision and authority of the Trustees.

III. The officers of the Corporation shall consist of a Chairman of the Board of Trustees, President, Director, Treasurer and Clerk, elected or appointed by the Trustees as set forth in Article IX.

IV. The Annual Meeting of the Members shall be held on the Friday following the Second Tuesday in August in each year at the Laboratory in Woods Hole, Massachusetts, at 9:30 a.m. Subject to the provisions of Article VIII(2), at such meeting the Members shall choose by ballot six Trustees to serve four years, and shall transact such other business as may properly come before the meeting. Special meetings of the Members may be called by the Chairman or Trustees to be held at such time and place as may be designated.

V. Twenty five Members shall constitute a quorum at any meeting. Except as otherwise required by law or these Bylaws, the affirmative vote of a majority of the Members voting in person or by proxy at a meeting attended by a quorum (present in person or by proxy) shall constitute action on behalf of the Members.

VI. (A) Inasmuch as the time and place of the Annual Meeting of Members are fixed by these Bylaws, no notice of the Annual Meeting need be given. Notice of any special meeting of Members, however, shall be given by the Clerk by mailing notice of the time and place and purpose of such meeting, at least 15 days before such meeting, to each Member at his or her address as shown on the records of the Corporation.

(B) Any meeting of the Members may be adjourned to any other time and place by the vote of a majority of those Members present or represented at the meeting, whether or not such Members constitute a quorum. It shall not be necessary to notify any Member of any adjournment.

VII. The Annual Meeting of the Trustees shall be held promptly after the Annual Meeting of the Corporation at the Laboratory in Woods Hole, Massachusetts. Special meetings of the Trustees shall be called by the Chairman, the President, or by any seven Trustees, to be held at such time and place as may be designated. Notice of Trustees' meetings may be given orally, by telephone, telegraph or in writing; and notice given in time to enable the Trustees to attend, or in any case notice sent by mail or telegraph to a Trustee's usual or last known place or residence, at least one week before the meeting shall be sufficient. Notice of a meeting need not be given to any Trustee if a written waiver of notice, executed by him before or after the meeting is filed with the records of the meeting, or if he shall attend the meeting without protesting prior thereto or at its commencement the lack of notice to him.

VIII. (A) There shall be four groups of Trustees:

(1) Trustees (the "Corporate Trustees") elected by the Members according to such procedures, not inconsistent with these Bylaws, as the Trustees shall have determined. Except as provided below, such Trustees shall be divided into four classes of six, one class to be elected each year to serve for a term of four years. Such classes shall be designated by the year of expiration of their respective terms.

(2) Trustees ("Board Trustees") elected by the Trustees then in office according to such procedures, not inconsistent with these Bylaws, as the Trustees shall have determined. Except as provided below, such Board Trustees shall be divided into four classes of three, one class to be elected each year to serve for a term of four years. Such classes shall be designated by the year of expiration of their respective terms. It is contemplated that, unless otherwise

determined by the Trustees for good reason, Board Trustees shall be individuals who have not been considered for election as Corporate Trustees.

(3) Trustees ex officio, who shall be the Chairman, the President, the Director, the Treasurer, and the Clerk.

(4) Trustees emeriti who shall include any Member who has attained the age of seventy years (or the age of sixty five and has retired from his home institution) and who has served a full elected term as a regular Trustee, provided he signifies his wish to serve the Laboratory in that capacity. Any Trustee who qualifies for emeritus status shall continue to serve as a regular Trustee until the next Annual Meeting whereupon his office as regular Trustee shall become vacant and be filled by election by the Members or by the Board, as the case may be. The Trustees ex officio and emeriti shall have all the rights of the Trustees, except that Trustees emeriti shall not have the right to vote.

(B) The aggregate number of Corporate Trustees and Board Trustees elected in any year (excluding Trustees elected to fill vacancies which do not result from expiration of a term) shall not exceed nine. The number of Board Trustees so elected shall not exceed three and unless otherwise determined by vote of the Trustees, the number of Corporate Trustees so elected shall not exceed six.

(C) The Trustees and Officers shall hold their respective offices until their successors are chosen in their stead.

(D) Any Trustee may be removed from office at any time with or without cause, by vote of a majority of the Members entitled to vote in the election of Trustees; or for cause, by vote of two-thirds of the Trustees then in office. A Trustee may be removed for cause only if notice of such action shall have been given to all of the Trustees or Members entitled to vote, as the case may be, prior to the meeting at which such action is to be taken and if the Trustee so to be removed shall have been given reasonable notice and opportunity to be heard before the body proposing to remove him.

(E) Any vacancy in the number of Corporate Trustees, however arising, may be filled by the Trustees then in office unless and until filled by the Members at the next Annual Meeting. Any vacancy in the number of Board Trustees may be filled by the Trustees.

(F) A Corporate Trustee or a Board Trustee who has served an initial term of at least 2 years duration shall be eligible for re-election to a second term, but shall be ineligible for re-election to any subsequent term until two years have elapsed after he last served as Trustee.

IX. (A) The Trustees shall have the control and management of the affairs of the Corporation. They shall elect a Chairman of the Board of Trustees who shall be elected annually and shall serve until his successor is selected and qualified and who shall also preside at meetings of the Corporation. They shall elect a President of the Corporation who shall also be the Vice Chairman of the Board of Trustees and Vice Chairman of meetings of the Corporation, and who shall be elected annually and shall serve until his successor is selected and qualified. They shall annually elect a Treasurer who shall serve until his successor is selected and qualified. They shall elect a Clerk (a resident of Massachusetts) who shall serve for a term of 4 years. Eligibility for re-election shall be in accordance with the content of Article VIII (F) as applied to Corporate or Board Trustees. They shall elect Board Trustees as described in Article VIII (B). They shall appoint a Director of the Laboratory for a term not to exceed five years, provided the term shall not exceed one year if the candidate has attained the age of 65 years prior to the date of the appointment. They may choose such other officers and agents as they may think best. They may fix the compensation and define the duties of all the officers and agents of the Corporation and may remove them at any time. They may fill vacancies occurring in any of the offices. The Board of Trustees shall have the power to choose an Executive Committee from their own number as provided in Article X, and to delegate to such Committee such of their own powers as they may deem expedient in addition to those powers conferred by Article X. They shall from time to time elect Members to the Corporation upon such terms and conditions as they shall have determined, not inconsistent with law or these Bylaws.

(B) The Board of Trustees shall also have the power, by vote of a majority of the Trustees then in Office, to elect an Investment Committee and any other committee and, by like vote,

to delegate thereto some or all of their powers except those which by law, the Articles of Organization or these Bylaws they are prohibited from delegating. The members of any such committee shall have such tenure and duties as the Trustees shall determine; provided that the Investment Committee, which shall oversee the management of the Corporation's endowment funds and marketable securities, shall include the Chairman of the Board of Trustees, the Treasurer of the Corporation, and the Chairman of the Corporation's Budget Committee, as *ex officio* members, together with such Trustees as may be required for not less than two-thirds of the Investment Committee to consist of Trustees. Except as otherwise provided by these Bylaws or determined by the Trustees, any such committee may make rules for the conduct of its business; but, unless otherwise provided by the Trustees or in such rules, its business shall be conducted as nearly as possible in the same manner as is provided by these Bylaws for the Trustees.

X. (A) The Executive Committee is hereby designated to consist of not more than ten members, including the *ex officio* Members (Chairman of the Board of Trustees, President, Director and Treasurer); and six additional Trustees, two of whom shall be elected by the Board of Trustees each year, to serve for a three-year term.

(B) The Chairman of the Board of Trustees shall act as Chairman of the Executive Committee, and the President as Vice Chairman. A majority of the members of the Executive Committee shall constitute a quorum and the affirmative vote of a majority of those voting at any meeting at which a quorum is present shall constitute action on behalf of the Executive Committee. The Executive Committee shall meet at such times and places and upon such notice and appoint such sub-committees as the Committee shall determine.

(C) The Executive Committee shall have and may exercise all the powers of the Board during the intervals between meetings of the Board of Trustees except those powers specifically withheld from time to time by vote of the Board or by law. The Executive Committee may also appoint such committees, including persons who are not Trustees, as it may from time to time approve to make recommendations with respect to matters to be acted upon by the Executive Committee or the Board of Trustees.

(D) The Executive Committee shall keep appropriate minutes of its meetings and its action shall be reported to the Board of Trustees.

(E) The elected Members of the Executive Committee shall constitute as a standing "Committee for the Nomination of Officers," responsible for making nominations, at each Annual Meeting of the Corporation, and of the Board of Trustees, for candidates to fill each office as the respective terms of office expire (Chairman of the Board, President, Director, Treasurer, and Clerk).

XI. A majority of the Trustees, the Executive Committee, or any other committee elected by the Trustees shall constitute a quorum; and a lesser number than a quorum may adjourn any meeting from time to time without further notice. At any meeting of the Trustees, the Executive Committee, or any other committee elected by the Trustees, the vote of a majority of those present, or such different vote as may be specified by law, the Articles of Organization or these Bylaws, shall be sufficient to take any action.

XII. Any action required or permitted to be taken at any meeting of the Trustees, the Executive Committee or any other committee elected by the Trustees as referred to under Article IX may be taken without a meeting if all of the Trustees or members of such committee, as the case may be, consent to the action in writing and such written consents are filed with the records of meetings. The Trustees or members of the Executive Committee or any other committee appointed by the Trustees may also participate in meeting by means of conference telephone, or otherwise take action in such a manner as may from time to time be permitted by law.

XIII. The consent of every Trustee shall be necessary to dissolution of the Marine Biological Laboratory. In case of dissolution, the property shall be disposed of in such manner

and upon such terms as shall be determined by the affirmative vote of two-thirds of the Board of Trustees then in office.

XIV. These Bylaws may be amended by the affirmative vote of the Members at any meeting, provided that notice of the substance of the proposed amendment is stated in the notice of such meeting. As authorized by the Articles of Organization, the Trustees, by a majority of their number then in office, may also make, amend, or repeal these Bylaws, in whole or in part, except with respect to (a) the provisions of these Bylaws governing (i) the removal of Trustees and (ii) the amendment of these Bylaws and (b) any provisions of these Bylaws which by law, the Articles of Organization or these Bylaws, requires action by the Members.

No later than the time of giving notice of the meeting of Members next following the making, amending or repealing by the Trustees of any Bylaw, notice thereof stating the substance of such change shall be given to all Corporation Members entitled to vote on amending the Bylaws.

Any Bylaw adopted by the Trustees may be amended or repealed by the Members entitled to vote on amending the Bylaws.

XV. The account of the Treasurer shall be audited annually by a certified public accountant.

XVI. The Corporation will indemnify every person who is or was a trustee, officer or employee of the Corporation or a person who provides services without compensation to an Employee Benefit Plan maintained by the Corporation, for any liability (including reasonable costs of defense and settlement) arising by reason of any act or omission affecting an Employee Benefit Plan maintained by the Corporation or affecting the participants or beneficiaries of such Plan, including without limitation any damages, civil penalty or excise tax imposed pursuant to the Employee Retirement Income Security Act of 1974; provided, (1) that the Act or omission shall have occurred in the course of the person's service as trustee or officer of the Corporation or within the scope of the employment of an employee of the Corporation or in connection with a service provided without compensation to an Employee Benefit Plan maintained by the Corporation, (2) that the Act or omission be in good faith as determined by the Corporation (whose determination made in good faith and not arbitrarily or capriciously shall be conclusive), and (3) that the Corporation's obligation hereunder shall be offset to the extent of any otherwise applicable insurance coverage, under a policy maintained by the Corporation or any other person, or other source of indemnification.

VI. REPORT OF THE DIRECTOR

Introduction: Reaction Kinetics

Elementary processes may be discontinuous, all-or-none; but the behavior of macroscopic things is not. Time passes between the beginning and the end of change, and the course is, at least, a smooth curve; almost never a square-wave. For cells, organisms, societies, smoothness of the curve is an illusion: Occam's Razor aside, change in the people and institutions we know is never simple, nor smooth. There is always fine-structure: large transients are composed of small ones.

We have seen, recently, one of the transients of a broader process: the reconstruction of the MBL's physical plant. The initial state occupied much attention of standing committees of the Corporation, and was reported with many dire predictions, at Corporation meetings held in the 1970's. The final state is that condition of buildings, housing, and equipment which we have made our goal for the Laboratory's hundredth birthday in 1988. The recent transient was the start and suc-

successful finish of Phase One of the Second Century Fund campaign, between 1979 and 1982.

Fine new Library space and the \$1.5 million rehabilitation of Lillie are facts, as are the new Environmental Sciences Center, the handsome Candle House (which not only removed administrative offices from the laboratory and Library space they had preempted, and gave us some fine new lecture rooms, but even won the MBL an award this year), and a host of smaller, but not unimportant projects. Most of these changes were visible enough, in 1981–82, and they were discussed in the 1981 Director's Report and elsewhere.

If, however, it was physical change commanding attention that year, it is change in *operations and management* that accounts for most of the fine-structure in the year to which this Report refers. The change is not so immediately striking to the eye as a new or restored building; but in the end, it will be more important in determining the new equilibrium state of the MBL. By operations, I mean not only the work and leadership of the support Departments, where, after a longish period of quiescence, there have recently been a good many bumps on the curve. I refer also to the big issue of running year-round research and educational programs at the MBL, and the relationship thereof to the traditional summer activities.

We are not yet at the new plateau, as that was planned and set forth in my report for the Trustees in 1979, but the changes have been occurring faster and on a larger scale than at any time since they began in 1975. We are much closer now to the plateau than we are to the initial state. Although the changes have taken place quietly, they have made plenty of fine-structure during the past year.

The same holds for management of the Laboratory. There are new faces among the Department Heads and new people working in the Central Administration. The changes thus represented are, again, but component parts of a much larger change, which must occur over time in consonance with the change of operating scale and style. They, too, have made for not a little jiggling of the curve, which turns out, however, to be not noise, but signal.

This jiggling is a part of the fine-structure of change that I hope and expect will diminish somewhat for the next two or three years, for we must now return to emphasis upon the other aspects of the MBL's plan for itself: further improvements in the physical plant, including, notably, housing facilities; and even more urgently, the achievement of a higher level of financial independence than the Laboratory has ever enjoyed, through new, long-term funding of key programs, not solely by government, and through new and significant endowment funds.

I try here to provide an accurate impression, but as usual not a detailed account, of the changes in operations and management that were visible to those of us who were here the full year or last summer. They may not have been visible to those Corporation members who did not come to Woods Hole in 1982, or whose visits were brief; but all members should be aware of them and of what they signify.

*"Omnia mutantur, nos et mutamur in illis."*¹

Department Leadership: Changes

Robert Gunning, the popular Superintendent of Buildings and Grounds, remained at his post for a full year beyond what would have been his normal date of retirement. This was a generous decision on his part, and the Laboratory had the benefit, thereby, of his long years of experience while two important processes were

¹ Freely: "All things must change; we had better change with them."

brought to a conclusion: the Lillie rehabilitation and the selection of his successor. The work on Lillie was brought to a successful conclusion; and the succession has been seen to.

In this case the new Department Head is one of our own: Donald B. Lehy, himself a veteran of no short period of service to the MBL. Since Lehy had earlier shown his form on many occasions—serious work, no-nonsense attention to detail, high technical competence, loyalty to the institution—it is no surprise that the transition has been smooth. Bob Gunning was honored at a splendid party, with a sufficiency of chicken wings and wine, in the Meigs Room, organized by the support staff at the time of his retirement. He was presented with the key to the MBL. Some little trouble may be encountered in its use, since it is five feet long and a bit thick for most of our locksets, but that seems not to have cast any sort of pall over the occasion.

The departure of Dr. Morton Maser, whose position as Assistant Director for Research and Educational Services included leadership of the Research Services Department, left the Laboratory with several important management responsibilities unassigned. After much discussion among Corporation members and Trustees, the decision was made to divide those responsibilities, and appropriate searches for new people were instituted.

The Research Services Department was in any case due for some reorganization of its subdivisions, which include the stockrooms ("Chem. Room"), the graphics facility ("Photo Lab"), purchasing, machine shop, and the provision of specialized equipment and techniques through the apparatus department, the radiation laboratories, the general-use equipment rooms, and the electron microscopy facility. The management of such a spectrum of services is no small assignment, and we are very fortunate to have been able to attract an ideally-qualified person as the new Department Head.

He is Mr. Barry T. O'Neil, recently Steward of the Lemuel Shattuck Hospital in Boston, and a highly-experienced manager of people, machines, and services. As it happens, he is also a talented medical artist and scientific illustrator, and a sailor with a large family of sailors. Whence, as for many of us who reside here the year round, there come certain pleasures in the job that cannot be found elsewhere. There is every reason to expect that the new *esprit* of the Department, which is already evident, will be matched by a new efficiency in the Department's work, and by a new atmosphere of good cheer and cooperativeness.

The electron microscopy facilities are under the immediate supervision of Dr. Eugene Copeland, a colleague whose scientific achievements and expertise in academic management have on several occasions been made available, when they were most needed, to the Laboratory. Louis Kerr continues to be in charge of the radiation laboratories as well as to operate the EM services: a current issue of the MBL NEWSLETTER provides a properly laudatory review of his excellent work. A new committee of users has been formed to advise Gene Copeland, and the standing committee on radiation is in the process of expansion and reorganization. Dr. Anthony Liuzzi, who has been our Health Physicist and Radiation Officer for a good many years, continues in the post with an enlarged responsibility and an expanded schedule of visits to the MBL, during some of which he will carry on his own research.

Dr. Maser's responsibilities in management of the instructional program were very broad, and occupied much of his always-busy time. They included responsibility for Admissions, which office was operated by an Admissions Officer reporting to him, the initiation and management of short courses, oversight of the January se-

mester, and general coordination of facilities for the summer courses. This range of duties has been redefined so as to make it more tractable to the administrator and more readily understood by the faculties. Following a careful search and much discussion of the program by the Executive Committee and those concerned directly with the courses, including the Committee on Instruction, the job was assigned to Joan E. Howard, who was at the time the Laboratory's Grants and Contracts Administrator.

She had accumulated, in that office, much experience in handling the finances of the summer courses, most of which are supported in part by training grants, government and private. This was expected to prove helpful, as it has, in a period of transition for management of the instructional program. Ms. Howard continues to be in charge of grants and contracts, but she now oversees Admissions as well (where Joanne Foley is the Admissions Officer), and she coordinates the financing, budgeting, and equipping of all courses. In these activities she works effectively and closely with other staff, *e.g.*, with the Controller in finance and budget-making; with Mr. O'Neil in meeting the equipment needs of the courses; with Dr. Copeland; with Mr. Smith in the assignment of laboratory spaces; and with the Director in the design of a new and expanded program of non-summer courses. Her official title is "Coordinator for Grants and Educational Services." Here, too, a transition that might well have been troublesome has occurred with no more than minor dislocations, and in many respects the component responsibilities are being met better than ever before.

Dr. Wesley N. Tiffney, Director of the George M. Gray museum, died in January, 1983 after a long illness. He was an active and devoted curator as well as a valued colleague. Although the event occurred beyond the interval that is covered, formally, by this report, it is mentioned here because the museum *is* important to many MBL scientists, and in the minds of many of those, the museum *was*, at least recently, Wes Tiffney. Once again, we are fortunate in having had some depth in an important facility. Dr. Louise F. Bush, who works in the museum and shared the running of it with Tiffney, has kindly and articulately consented to take charge. Dr. Edwin T. Moul continues to assist with the identification of plant material, as do Dr. Arthur Humes for Crustacea and Dr. Ruth Turner for Mollusca.

There is evidence, from plans and suggestions offered by Dr. Bush, that far from a holding action, current work of the museum staff will make the facility more useful, and far busier in the immediate future than it was in the past. We look forward to participation of the museum staff in forthcoming discussions with architects who will be conducting a new feasibility study for the Marine Resources Center. The best possibility for a proper and permanent home for the museum is in that building.

Department Leadership: No Change

It would violate the intention of devoting this report to *change* were I to set down, systematically, the news from each of the operating departments, distributing kudos and concerns as judgment required. I can illustrate the pervasiveness of change, however, by reference to any one of the Departments in which there has *not* been a major change of leadership during the past year, and yet pointing up the implications of this or that new *activity*. Here, then, is my example, employing the words of John Valois, Manager of the Department of Marine Resources. He wrote them for me in his regular report of the year's work. They have to do with squid in 1982.

"The spring squid came late (May 11th), but the numbers and size were excellent . . . catches remained good through most of July, until the last week. The usual slow catches lasted into mid-August, and a slight revival was followed by three days of very poor catches. By September, there was some strengthening of size and numbers, until a large wave of adult squid came into the collecting areas in late September, and stayed until the last part of November. We are going to watch this change in the migration . . . hoping that if it remains . . . we might be able to encourage some of our neurobiologists to extend their research season . . . finally, it is doubtful that the majority of our squid users understand the financial effort that this Laboratory makes, and the skills that are used to supply squid to about forty laboratories.

". . . Dr. Louis Leibovitz and I have been interested in furthering observations . . . on holding squid in cold water. A remarkable improvement was made in 1982 in squid survival through redesigning squid tanks and improvement of water flow. With better-trained technicians, more time available for good record-keeping, and facilities purchased recently through the help of Dr. Leibovitz, the Department . . . has gained valuable information on the causes of mortality. We have designed a pilot system using cold water in the Marine Resources building for Dr. Leibovitz. There will be suitable controls . . . a copy of the design is enclosed . . . MBL sea water is monitored daily by a technician from the Water Quality laboratory . . . elements of the nitrogen cycle are sampled bi-weekly, as are . . . O₂, phosphates, etc. . . . We would like to begin a program of . . . exploration of plankton and its effect on sea water . . . seasonal variations must play an important role . . . the commonly-held belief that anoxia and mortality are directly related to overcrowding is an oversimplification.

". . . Most of our employees have a general understanding of the research goals at the MBL, but more importantly, they treat our scientists with respect and politeness."

This last reminds me to report the very sad news of the deaths of Lew Lawday and Bruno Trapasso, two members of the Department of whom it is just, indeed, to say that they had an understanding of research goals, and that they treated *everyone* with respect and politeness. They also got them in return.

The implication for change, in this extract from John Valois's report, should be clear. The MBL now has, in Dr. Leibovitz, a resident marine animal pathologist of the highest scientific stature: a functioning Laboratory of Marine Animal Health; and a strong and growing interaction between research in that field and the practical business of collecting and holding animals. Collaboration goes, in fact, much deeper than is evidenced in a casual glance. Ongoing and planned collaborative studies are concerned not only with *holding*, but with the *culture* of marine animals.

The transients implied by the quoted material are just that: local peaks of a broader and much larger variation, in which the final state will be the presence on this campus of a splendid new facility for Marine Resources. There, research and supply will operate side-by-side, with two goals: (1) the advance of knowledge of marine animals, in health and disease; their ecology, genetics, development, behavior, population biology, and pathologies; and (2) the development of entirely new, research-based techniques for collecting, holding, and culturing those animals, so as to free the Laboratory of day-to-day dependence upon the chances of fishing. In the end, the process could give scientists living marine material for research that is no less uniform, predictable, and available than the inbred rodents that are now so universally employed.

Financial Management; Development; Public Information

The arrival of Controller John Speer was reported last year, and is hence not, in itself, news. The consequent change is news, and I can do no more here than touch upon its components. Most important of all is the evidence that there is finally someone in charge, who has the knowledge, the technical background, the authority, and the will to *be* in charge, of so specialized and complex task as keeping the MBL in sound financial health. We have needed such a person—a Controller in fact—for a very long time. He has managed, with no significant enlargement of the regular staff, to routinize what was heretofore *ad hoc* in the system, to speed reporting and response, and in general to give outsiders dealing with the Laboratory confidence in its fiscal procedures.

The conversion of the MBL's accounting systems from manual to computer-based is nearly complete. This has already yielded some returns, and there will be many more in the year ahead. Tracking of income and expense is, for example, faster and more accurate than before. It is continuous: MBL people no longer have to wait days, or even weeks, for outside organizations to process data, issue checks, or prepare reports. The availability of administrative data processing and computing in-house has had another benefit, just now making itself felt throughout the Laboratory: word processing capability² alongside direct access to data in memory. Purchase, installation, and de-bugging of the system have not been without typical troubles; but the shakedown period is nearly over at the time of writing, and the consequences of a modern data-processing capability will be felt—as a great advance in convenience—by all who come here for the summer of 1983.

The long-delayed review and re-structuring of the MBL's overhead cost recovery system has begun, now that there are people here to be in charge of it and to communicate as peers with the government's cost-control people and auditors. The old system is, as I have so often tried to explain, *not* unfair to users of the MBL: it is unfair to the MBL as an institution. It was designed purposely to make income from overhead payments less than the actual operating expenses of the Laboratory. Some parts of the MBL's scientific mission, such as the instructional program, yield no overhead at all, by law, or allow a merely token amount.

The loss is *not* passed on to programs that do provide for overhead, *e.g.*, research. Please note that: *research does not pay for education*. It is simply a loss, made up from funds raised in the private sector. The result has been, for many years, that among places in which to conduct research, the MBL is one of the best bargains in the world, cheaper by several-fold than its neighbors. But the bargain has to be paid for. In this case it is paid for by private funds that could, and should, serve more important purposes than the mere payment of current bills. It is also paid for by the time of the Director, the Chairman of the Board, and all those engaged in fund raising for the MBL.

Our goals in the design and eventual establishment of a new system will be to bring overhead payments much closer to actual operating expense (which is lower than at universities operating laboratories of similar sophistication), and, at the same

² This had had no positive effects, so far as I can see, upon spelling, punctuation, or the use of the apostrophe. Neither, however, did my broadcast distribution of the paperback edition of Strunk & White, a few years ago. There is a strong movement toward the purchase of a software package that corrects spelling. I have resisted it mercilessly, out of pure anachronistic impulse. This I communicate here to balance the emphasis, in the text, upon "change."

time, to *reduce or eliminate entirely* the impact of MBL cost recovery upon the research grants and other resources of MBL investigators, summer and year-round. The reader may be reassured, if that sounds impossible, that it is not. It is merely very, very difficult.

About the state of the Laboratory's finances I need say little: appended reports from the Controller and from our excellent Treasurer cover the territory very well. It is important to note here, however, that with major efforts of the Controller's Department, and—since his arrival—close cooperation with other Departments, the MBL has achieved the remarkable result of completing a \$4.5 million campus rehabilitation, in a time of rampaging cost inflation, with a net overrun of less than ten percent on the original estimates. Most of that overrun was caused by changes in a single project, the Environmental Sciences Center; but those changes added far more than their instantaneous dollar value to the asset value of the facility. During the year, as a result, there was a temporary cash-flow problem—nothing in the slightest unusual for an academic organization engaged in major construction—which was dealt with firmly and properly by the Controller, the Treasurer, and the Executive Committee.

It is commonplace for financial officers and administrators to grumble, in research-centered organizations such as the MBL, “. . . we must get our costs under control.” A little study of the financial reports in this volume, including those of the Controller and Treasurer, will make it clear that the MBL *has* its costs under control, and quite tight control at that. It is *income* that the MBL must get under control, and I have the conviction, now as not in the prior four years, that we shall be able to do that before long.

To the extent that private-sector funds are now, and will remain for at least a few years, an important part of working income, independently of their use in the acquisition of new facilities and programs, the Development Office has its work cut out. Here, too, is change, and again, the change was reported last year, with notice that Ms. Carol Salguero had joined the MBL as Director of Development. Since then the conversion to a self-contained, in-house fund raising program has been accomplished. After the inevitable months of learning and form-fitting, it appears to have settled into decently routine operation. The flow of proposals outward and gifts inward has resumed, after a year and a half of slow-down; several events, in which the MBL's case has been put to appropriate listeners among Board Trustees, business executives, and philanthropists, have been organized and carried off with success. There will have to be an increasing number of those in the future.

In that connection, the MBL's regular publications, such as the NEWSLETTER, releases to the press, and occasional sponsored articles in magazines, are public “events” of a special importance. The new Public Information Officer, James Shreeve, gives evidence of being, not only a highly skilled writer, but—and this is critically important—a Quick Study, able to learn from reading and conversation what MBL scientists are doing and thinking about, and to turn what he has learned into accurate, comprehensible, and stimulating prose.

Public information is a domain in which, as many Trustees are aware, the MBL has been backward in relation to its peer-institutions. It is an activity in which the expository styles and approaches of proposal-writing, be it for public or private agencies, are not merely inappropriate, but actually counter-productive. Good public relations work requires its own kind of expository skill and imagination, and people who have or can learn those are very rare. The early indications are that James Shreeve and his assistant, Arch MacInnes, have picked up from where Barbara

Haskell left off, a year ago, and are moving to an altogether higher level of achievement in presenting the story of the MBL to the educated layman.

Research: The Year Round Programs

I have understood, from conversation with many Corporation members and by the precedent of former Directors, that these Director's Reports do *not* have, among their purposes, the citation or description of research achievements, except in very unusual cases. The reason for such a variance from the typical content of Presidents' and Directors' Reports is that the October *Biological Bulletin* prints abstracts from the General Scientific Meetings of the prior August, and those, in turn, represent accurately the activity of the scientific community of the MBL. Readers of these Director's Reports being almost all biologists themselves, my re-summarizing the summaries for them would be gilding the lily. So be it: I have, for that reason, not cited anything like *all* the important accomplishments of MBL investigators, nor even a representative set of them, in any year. To do so, in fact, would be (as I suggested in a musical digression last year) to court trouble.

This year's report is concerned with change, however, and to complete the representation of change in progress at the MBL, I must devote some little space to the year round research programs. I do so, not to illuminate specific advances or to comment upon progress, but to give the reader a sense of the magnitude and breadth of the program as it is today, roughly eight years after the decision was made to allow a growth of serious year-round science at the MBL. It is also four years after the contentious issue of year-round *versus* summer use of the facilities was addressed in my 1979 report to the Trustees.

The most important point of that report was as much an undertaking, or a promise, as it was a recommendation. It would surely never have received the unanimous approval voted had there *not* been a promise. My report called, in brief, for a considerable growth of the year round research program, in all—not just one—of the main disciplines of MBL biology, *i.e.*, Cell and Developmental Biology; Neurobiology and Biophysics; Ecology; and Marine Biomedicine. The promise was that such growth would be scrupulously controlled as to quality of the science and the scientists; and that excluding transient fluctuations over the course of one or two years, the absolute amount of space and the research facilities reserved for summer investigators and for teaching *would not decline*.

Among the Trustees there must have been some skeptics, even though I explained that the trick would be accomplished by the construction of new space. We have indeed acquired new space: the Candle House, in accommodating the Central Administration, made almost 6,000 square feet available in Lillie, most of which became the expanded Library, but some of which has become fine laboratories in use today. The Environmental Sciences Center provided a home for most (but not all) MBL ecologists, and released a large amount of valuable teaching space in Loeb. Some day the Marine Resources Center will provide us with thousands of square feet of still newer laboratories, and they will, by every test we can make, all be occupied.

In any case, the promise has been kept thus far: recommended growth of the year round scientific program has taken place, and we still have the full summer program. The resulting change has come about with minimum fanfare, but it is a change, and a big one. To indicate its dimensions, I will simply list programs—not all of them, but a good sampling—that today have a year round home at the MBL,

and that contribute to its international stature, without any one of them having infringed in an important way upon the MBL's indispensable teaching programs nor its "observatory" function.

The Ecosystems Center, one of the oldest of such programs, and perhaps the best known to readers of this Report from its own Annual Report.

The Laboratory of Shinya Inoué, a world resource for polarization microscopy, quantitative light microscopy, and for study of the molecular organization of motility processes in living cells.

The Laboratory of Sensory Physiology, headed by E. F. MacNichol, Jr., an unique center for the biophysical investigation of vision.

The Boston University Marine Program, whose Director is MBL Trustee J. R. Whittaker, and whose faculty are leaders in the following fields: developmental biology; animal behavior and invertebrate physiology; systematics; primitive motility processes; ecology; and marine biology. This program is responsible for the education of some thirty graduate students who are in residence at the MBL, and who have, since its founding, produced an outstanding crop of dissertations and research papers.

The Laboratory of Noel de Terra, who studies the mechanisms and control of cell division in the ciliate *Stentor*.

The Laboratory of Carl J. Berg, Jr., whose group investigates mariculture of marine animals and their reproductive biology, especially in relation to managed systems.

The Laboratory of Biophysics, headed by W. J. Adelman, in which two very large programs of the NIH (headed by Adelman—membrane biophysics—and Dan Alkon—cellular basis of learning in *Hermisenda*), totalling twenty investigators on the average, are on permanent location at the MBL.

The Laboratory of Raymond E. Stephens, which is recognized internationally for its research on tubulins and microtubules.

The Laboratory of Osamu Shimomura, whose head, the discoverer of Aequorin, pursues a lifelong quest for fundamental mechanisms, at the molecular and atomic levels, of bioluminescent processes.

The Laboratory of Judith P. Grassle, in which there is an expanding program of research on the population genetics; adaptation to special environments; and responses to pollutants, of marine invertebrate animals.

The National Vibrating Probe Facility, Lionel Jaffe, Director, in which, for the first time, a research and service facility is to be generally available for investigators wishing to analyze microscopic, bioelectric fields with the non-invasive vibrating probe system. The facility is expected to have several two-dimensional vibrating probes ("nutating") ready for visiting-scientist use in the summer 1983.

The Laboratory of D. E. Copeland, where Dr. Copeland continues his fine-structure and physiological studies on the eye and the swimbladder of fishes.

I stop the listing at this point, but not without noting again that it is incomplete; and that there will almost certainly be at least one distinguished addition next year, in a subdiscipline of neuroscience not already represented in the year round community. The list is not really different from one that appears, each year, in the Laboratory's Annual Bulletin. It is my hope, however, that by seeing it here, in the form and context given, Corporation members may get a more accurate idea than they would get from the Bulletin of the magnitude of the entire effort. It is, I am sure, something of which any great university would be proud, let alone a small, private laboratory, starting with no applicable endowment and no significant sources

of tuition or other direct income. It is, certainly, a change from just a few years ago. I see in it little to fear, much to take pride in and to consider with care.

It is this "consideration with care" that must be the final point. We have come about halfway in the plan that the Trustees received, debated, and approved without dissent in 1979. This is a good time to look at the results: at the MBL as it appears, as it works, as it *feels* to those several hundred biologists for whom it is, as it was for their predecessors, one of this country's scientific treasures.

Does it feel all right? Has the change so far—and I hope it is now clear that there has been plenty of change—been positive or negative? And when you have an answer to that, ask then: If positive, was it preordained, or automatic, or was it engineered? If negative, was it bound to happen anyway, as a consequence of the way the world works, or is it a result of policy? Even a minimal searching of souls in such terms will produce directed, apposite discussion and argument at the next Corporation meeting, and among the Trustees. That, after all, is what identifies the MBL. Unlike any other place known to you or me, this research and teaching organization is *owned* by the people who investigate and teach in it, and their questions and votes *do*, in fact, determine what happens next.

VII. REPORT OF THE TREASURER

In a separate report, the Controller will review the Laboratory's income and expenses for 1982. Here, I hope to contribute a perspective on MBL's financial affairs.

The MBL defines its purpose in terms of science and education. The Laboratory acquires, organizes, and applies talent and money to the pursuit of its purposes. Unlike a business enterprise, it does not seek to earn a surplus for the benefit of its owners. Thus, the MBL's financial objective each year is to match planned expenses against expected revenues; *i.e.* to maintain a balanced budget.

The MBL is not richly endowed. Therefore, its approach to financial management must be aggressive. The alternative to compromise in its scientific and educational purposes is to intensify its efforts to acquire resources. Although the MBL uses an annual iterative budgeting cycle to match plans to resources, the requirements for good science and good education tend to drive the revenue targets.

Looking back over the past ten years (see the accompanying Exhibit), one observes that the MBL has been ambitious in setting its revenue targets. In seven of the past ten years, the expenses of the Laboratory's endeavors exceeded its income. This was the case in 1982.

At the MBL, income generation is spread throughout the fiscal year while expenses are heavier during the peak activity of the summer months. Unavoidably, some expense commitments must be made before the year's income is precisely known. Nevertheless, both surpluses and deficits have been modest in relation to the MBL's total "throughput" (unrestricted funds plus restricted grants for research and programs). The total throughput is a better gauge of the management task than is the magnitude of expenses met with unrestricted funds. If the surplus or deficit in each of the past ten years is computed as a per cent of the total throughput, the average is less than 4 per cent and the range is narrow. Thus, in its efforts to strike a balanced budget each year, the MBL has missed its target by relatively small amounts and its performance has been stable. However, the challenge has been increasing; the throughput of unrestricted and restricted grant monies has more than trebled since 1973.

MARINE BIOLOGICAL LABORATORY

EXHIBIT
Key Financial Indicators, 1973-1982
(\$000's)

	1973	1974	1975	1976	1977	1978	1979	1980	1981	1982
<i>Unrestricted</i>										
1. Income	1,309	1,517	1,663	1,920	2,081	2,502	2,642	3,393	3,552	3,646
2. Expenses	1,396	1,597	1,985	1,814	2,167	2,538	2,611	3,070	3,595	3,807
3. Surplus/(Deficit)	(87)	(80)	(322)	106	(86)	(36)	31	323	(43)	(161)
<i>Restricted</i>										
4. Research & Program Grants	580	656	952	1,176	1,441	1,756	2,124	2,634	3,041	3,476
5. Throughput (Items 2 + 4)	1,976	2,253	2,937	2,990	3,608	4,294	4,735	5,704	6,636	7,283
Surplus/Deficit as % of Throughput	4.4%	3.6%	11.0%	3.5%	2.4%	0.8%	0.7%	5.7%	0.6%	2.2%
Fund Balance	(37)	(176)	(81)	(374)	627	545	721	808	689	164
Investments (Book)	4,123	4,260	5,022	5,398	4,935	5,382	5,836	6,305	6,668	6,825
Physical Plant	9,728	9,447	9,129	8,848	8,596	8,362	8,007	8,405	10,064	11,742
Private Gifts	124	614	1,019	1,043	997	1,134	1,812	1,760	1,813	883

The accompanying Exhibit also shows that the MBL has demonstrated increasing effectiveness in attracting resources over the past ten years. Private gifts in the early 1970s averaged a few hundred thousand dollars per year; more recently, the level of private support has been substantially greater. In 1982, a shift from dependence on outside consulting services to an internal development office resulted in a temporary discontinuity in the MBL's fundraising efforts. The Laboratory now has in place the capacity with which to raise in excess of \$1 million annually, and at that level of success the 1982 deficit would have been avoided.

I call attention to several other facts in the accompanying Exhibit. The MBL's Fund Balance account, which can be thought of as a surplus account, has remained positive since 1976. Investment and endowment funds have increased steadily over the past ten years; the figures shown are on the basis of book value, and market value would show even greater growth. After seven years of declining balances in the Physical Plant account due to the bookkeeping effect of annual depreciation, the recent infusions of capital into campus rehabilitation and new construction is apparent. Most significantly, the MBL remains unburdened by either long or short term debt.

Although I hope these observations have helped to place the MBL's 1982 results into a useful framework for understanding, I do not wish to suggest that the MBL can afford complacency. The Laboratory needs the direct and indirect assistance of every person friendly to its purposes. The challenge lies not so much in expense reduction, for the economical character of MBL's operations is well known, but rather in revenue development.

Before closing my report, I wish to highlight two particularly important accomplishments in 1982. The Investment Committee has given excellent policy guidance to the management of the MBL's investments. Invested funds increased 10 per cent in 1982 despite withdrawals totaling \$565,000 for construction and operating purposes. In another category of accomplishment, we are grateful to cooperative investigators and to diligent administrators who have helped in the reduction of MBL's receivables from \$623,658 at the end of 1981 to \$237,859 by the close of 1982.

Robert Mainer
Treasurer

VIII. REPORT OF THE CONTROLLER

The most obvious outcome of our 1982 audit is that we experienced an operating deficit of \$160,591. This, together with the drop in our fund balance, represents a problem that must be addressed in 1983 and beyond. While the operating deficit and the decrease in the fund balance are serious, they should not cause undue concern. We have achieved several important objectives which should enable us to improve the Laboratory's finances in the future. Among them are:

- (1) a firm plan to put the educational program on a financially sound basis, with the ultimate goal of a fair recovery of costs;
- (2) a newly developed financial management system that has already made a positive contribution to budgetary control;
- (3) several changes in policy to provide us with more sensitive and immediate control over our financial resources;
- (4) fundraising, that in the second half of 1982 increased significantly over the first half, reversing an earlier decline in private sector gifts.

The point of all this is that we must view 1982, and to some extent 1983, as years of transition that will lead to much better financial management in 1984 and beyond.

Having said that, let me now address the key financial indicators for this past year in more detail.

Revenues

Overall, our revenues increased by less than 3%, which for the second straight year amounts to "level funding." While we showed an increase of 13.5% in lab fees and 9.6% in Research Services, most other forms of income decreased or had very modest increases. Revenue generated by the Library, *The Biological Bulletin*, and Marine Resources was down, as were unrestricted gifts and investments. The need to increase revenues for 1983 is thus our most serious challenge. The keys to this are increased unrestricted gifts and more appropriate overhead recovery, principally from the year-round research and the educational programs.

Expenditures

"Unrestricted" expenditures increased by a very modest 5.8%, reflecting, in part a diminution in the inflation rate, but also a concerted effort on the part of all support staff to hold the line on expenditures. *Direct* costs of instruction were reduced by almost 45% from the previous year, the result of some selective actions that we hope will lead to a balanced education budget in 1983 and possibly even some small amount of overhead recovery. This is a major accomplishment given the reductions and changing emphasis in federal funding in training. We have also reduced the number of people on the regular payroll through a selective hiring freeze.

It is important to remember, however, that reductions in expenditures can have negative results, if they are not carefully applied. Reductions in capital expenditures for laboratory equipment, library periodicals, and deferred maintenance of the physical plant may appear attractive budget-balancers in the short run, but over time they can be devastating. Evidence of this can be shown in the summer cottages and in the capital equipment budget for Apparatus, because for the past several years both have been severely underfunded. We must continue to redress the neglect in the physical plant and in the replacement of capital scientific equipment, even while we hold overall expenditures in line with our (modest) revenue projections.

Looking ahead to 1983, we see challenges and opportunities in several areas. First, we must continue our efforts in development to support all facets of the MBL. Second, we must increase our overhead recovery through a better, more equitable system. Third, we must press on toward the goal of recovering the indirect costs of the educational programs. Finally, we must *increase* regular expenditures for capital equipment and in deferred maintenance, within the general context of a balanced operating budget.

John W. Speer
Controller

Coopers
& Lybrand

certified public accountants

To the Trustees of
Marine Biological Laboratory
Woods Hole, Massachusetts

We have examined the balance sheets of Marine Biological Laboratory as of December 31, 1982 and 1981, and the related statements of current funds revenue and expenses and changes in fund balances for the years then ended. Our examinations were made in accordance with generally accepted auditing standards and, accordingly, included such tests of the accounting records and such other auditing procedures as we considered necessary in the circumstances.

In our opinion, the financial statements referred to above present fairly the financial position of Marine Biological Laboratory at December 31, 1982 and 1981, and its current funds revenue and expenses and the changes in fund balances for the years then ended, in conformity with generally accepted accounting principles applied on a consistent basis.

Coopers & Lybrand

Boston, Massachusetts
April 22, 1983

MARINE BIOLOGICAL LABORATORY

BALANCE SHEETS

December 31, 1982 and 1981

<i>Assets</i>	<i>1982</i>	<i>1981</i>
<i>Current funds:</i>		
Unrestricted:		
Cash and savings deposits	\$ 198,102	\$ 212,262
Money market securities (Note F)	665,000	1,850,000
Accounts receivable, net of allowance for uncollectible accounts	237,859	623,658
Other assets	5,490	19,531
Due to restricted current funds	(192,134)	(597,747)
Due to invested funds	(93,335)	(90,133)
Due to restricted plant fund	(163,676)	(720,535)
Total unrestricted	<u>657,306</u>	<u>1,297,036</u>
Restricted:		
Accounts receivable	368,958	346,828
Investments, at cost (Notes B and F)	2,194,297	2,179,531
Due from unrestricted current fund	192,134	597,747
Due from invested funds	66,203	350,967
Total restricted	<u>2,821,592</u>	<u>3,475,073</u>
Total current funds	<u>\$ 3,478,898</u>	<u>\$ 4,772,109</u>
<i>Invested funds:</i>		
Investments, at cost (Notes B and F)	4,630,893	4,488,885
Due from unrestricted current fund	93,335	90,133
Due to restricted current funds	(66,203)	(350,967)
Total invested funds	<u>\$ 4,658,025</u>	<u>\$ 4,228,051</u>
<i>Plant funds:</i>		
Unrestricted:		
Land, buildings and equipment (Note C)	16,945,601	14,907,184
Less accumulated depreciation	<u>5,203,404</u>	<u>4,843,425</u>
Total unrestricted	<u>11,742,197</u>	<u>10,063,759</u>
Restricted:		
Due from unrestricted current fund	<u>163,676</u>	<u>720,535</u>
Total restricted	<u>163,676</u>	<u>720,535</u>
Total plant funds	<u>\$11,905,873</u>	<u>\$10,784,294</u>

The accompanying notes are an integral part of the financial statements.

MARINE BIOLOGICAL LABORATORY

BALANCE SHEETS

December 31, 1982 and 1981

<i>Liabilities and Fund Balances</i>	<i>1982</i>	<i>1981</i>
<i>Current funds:</i>		
Unrestricted:		
Accounts payable and accrued expenses	\$ 413,459	\$ 530,917
Deferred income	80,089	77,138
Fund balance	<u>163,758</u>	<u>688,981</u>
Total unrestricted	<u>657,306</u>	<u>1,297,036</u>
Restricted funds:		
Unexpended gifts and grants	2,792,419	3,373,696
Unexpended income of endowment funds	<u>29,173</u>	<u>101,377</u>
Total restricted	<u>2,821,592</u>	<u>3,475,073</u>
Total current funds	<u>\$ 3,478,898</u>	<u>\$ 4,772,109</u>
<i>Invested funds:</i>		
Endowment funds	2,184,297	2,218,669
Quasi-endowment funds	1,209,204	934,143
Retirement fund (Note D)	<u>1,264,524</u>	<u>1,075,239</u>
Total invested funds	<u>\$ 4,658,025</u>	<u>\$ 4,228,051</u>
<i>Plant funds:</i>		
Unrestricted	11,742,197	10,063,759
Restricted	<u>163,676</u>	<u>720,535</u>
Total plant funds	<u>\$11,905,873</u>	<u>\$10,784,294</u>

The accompanying notes are an integral part of the financial statements.

MARINE BIOLOGICAL LABORATORY
STATEMENTS OF CURRENT FUNDS REVENUE AND EXPENSES

for the years ended December 31, 1982 and 1981

	<i>Unrestricted</i>		<i>Restricted</i>		<i>Total</i>	
	1982	1981	1982	1981	1982	1981
<i>Revenue:</i>						
Grant reimbursement of direct costs:						
Instruction		\$ 401,901	\$ 388,763	\$ 359,884	\$ 388,763	\$ 359,884
Research	1,149,813	966,784	2,585,101	2,221,297	2,585,101	2,221,297
Other	49,324	53,554				
Recovery of indirect costs related to research and instruction:						
Summer program	\$ 415,636	\$ 401,901			415,636	401,901
Year-round program	1,149,813	966,784			1,149,813	966,784
Other	49,324	53,554			49,324	53,554
Tuition	246,382	252,265	12,000	16,900	258,382	269,165
Support activities:						
Dormitory	385,499	381,954			385,499	381,954
Dining hall	205,902	192,742			205,902	192,742
Library	139,674	144,154			139,674	144,154
Biological Bulletin	99,193	102,817			99,193	102,817
Research services	337,846	307,749			337,846	307,749
Marine resources	85,313	99,629			85,313	99,629
Other	80,849	118,865			80,849	118,865
Total support activities	1,334,276	1,347,910			1,334,276	1,347,910
Investment income	218,910	287,081	371,937	283,574	590,847	570,655
Gifts	231,780	242,023	118,425	159,617	350,205	401,640
Total revenue	3,646,121	3,551,518	3,476,226	3,041,272	7,122,347	6,592,790

	Unrestricted		Restricted		Total	
	1982	1981	1982	1981	1982	1981
<i>Expenses:</i>						
Instruction	309,853	366,177	207,744	200,564	517,597	566,741
Research	29,626	3,488	2,803,222	2,420,567	2,832,848	2,424,055
Scholarships and stipends			319,651	265,565	319,651	265,565
Support activities:						
Dormitory	219,912	184,034			219,912	184,034
Dining hall	208,775	192,282			208,775	192,282
Library	249,303	231,530	138,446	146,029	387,749	377,559
Biological Bulletin	116,138	105,535			116,138	105,535
Research services	483,407	483,946			483,407	483,946
Marine resources	297,917	269,680			297,917	269,680
Administration	977,607	872,917	3,901	5,983	981,508	878,900
Plant operation	914,174	885,800	3,262	2,564	917,436	888,364
Total support activities	<u>3,467,233</u>	<u>3,225,724</u>	<u>145,609</u>	<u>154,576</u>	<u>3,612,842</u>	<u>3,380,300</u>
Total expenses	<u>3,806,712</u>	<u>3,595,389</u>	<u>3,476,226</u>	<u>3,041,272</u>	<u>7,282,938</u>	<u>6,636,661</u>
Excess of expenses over revenue	<u>\$ (160,591)</u>	<u>\$ (43,871)</u>	<u>—</u>	<u>—</u>	<u>\$ (160,591)</u>	<u>\$ (43,871)</u>

The accompanying notes are an integral part of the financial statements.

MARINE BIOLOGICAL LABORATORY
STATEMENTS OF CHANGES IN FUND BALANCES
for the years ended December 31, 1982 and 1981

	Current Funds		Invested Funds			Plant Funds		Total All Funds
	Unrestricted	Restricted	Endowment	Quasi-Endowment	Retirement	Unrestricted	Restricted	
Balances at December 31, 1980	\$ 807,939	\$ 3,064,521	\$ 2,077,500	\$ 934,143	\$ 884,058	\$ 8,404,559	\$ 1,052,224	\$ 17,224,944
<i>Increases:</i>								
Unrestricted current funds revenue	3,022,414							3,022,414
Grants		3,709,400						3,709,400
Gifts	242,023	180,830	24,766				1,365,000	1,812,619
Investment income	287,081	303,878			46,745			637,704
Realized net gains on sale of investments								
Realized net gains on disposal of fixed assets		43,685	116,403		33,096			193,184
Addition to retirement fund					137,009	62,950		62,950
Tuition		16,900						137,009
								16,900
<i>Decreases:</i>								
Instruction, research and general expenses	(3,595,389)	(3,041,272)						(6,636,661)
Indirect costs		(667,869)						(667,869)
Payments to pensioners					(25,669)			(25,669)
Depreciation						(310,526)		(310,526)
Net change in fund balances before transfers	(43,871)	545,552	141,169		191,181	(247,576)	1,365,000	1,951,455
<i>Transfers to (from) funds</i>	(75,087)	(135,000)				1,906,776	(1,696,689)	—
Balances at December 31, 1981	688,981	3,475,073	2,218,669	934,143	1,075,239	10,063,759	720,535	19,176,399

	Current Funds		Invested Funds			Plant Funds		Total All Funds
	Unrestricted	Restricted	Endowment	Quasi-Endowment	Retirement	Unrestricted	Restricted	
<i>Increases:</i>								
Unrestricted current funds revenue	3,195,431							3,195,431
Grants		3,561,528					19,900	3,581,428
Gifts	231,780	277,069	26,937			98,361	249,050	883,197
Investment income	218,910	312,595			55,874			587,379
Realized net gains (losses) on sale of investments		22,293	299,036	81,736	(425)			402,640
Realized net gains on disposal of fixed assets						441		441
Addition to retirement fund		12,000			160,554			160,554
Tuition								12,000
<i>Decreases:</i>								
Instruction, research and general expenses	(3,806,712)	(3,476,226)					(6,404)	(7,289,342)
Indirect costs		(773,349)						(773,349)
Payments to pensioners					(26,718)			(26,718)
Depreciation						(360,812)		(360,812)
Net change in fund balances before transfers	(160,591)	(64,090)	325,973	81,736	189,285	(262,010)	262,546	372,849
<i>Transfers to (from) funds:</i>								
Acquisition of fixed assets	(364,632)	(573,911)		(182,500)				—
Reclassification (Note A)			(392,540)	392,540		1,940,448	(819,405)	—
Other		(15,480)	32,195	(16,715)				—
Balances at December 31, 1982	\$ 163,758	\$ 2,821,592	\$ 2,184,297	\$ 1,209,204	\$ 1,264,524	\$ 11,742,197	\$ 163,676	\$ 19,549,248

The accompanying notes are an integral part of the financial statements.

NOTES TO FINANCIAL STATEMENTS

A. Purpose of the Laboratory:

The purpose of Marine Biological Laboratory (the "Laboratory") is to establish and maintain a laboratory or station for scientific study and investigations, and a school for instruction in biology and natural history.

*B. Significant Accounting Policies:**Basis of Presentation—Fund Accounting*

In order to ensure observance of limitations and restrictions placed on the use of resources available to the Laboratory, the accounts of the Laboratory are maintained in accordance with the principles of "fund accounting." This is the procedure by which resources are classified into separate funds in accordance with specified activities or objectives. In the accompanying financial statements, funds that have similar characteristics have been combined.

Externally restricted funds may only be utilized in accordance with the purposes established by the source of such funds. However, the Laboratory retains full control over the utilization of unrestricted funds. Restricted gifts, grants, and other restricted resources are accounted for in the appropriate restricted funds. Restricted current funds are reported as revenue when expended for current operating or other purposes. Unrestricted revenue is reported as revenue in the unrestricted current fund when earned.

Endowment funds are subject to restrictions requiring that the principal be invested with income available for use by the Laboratory. Quasi-endowment funds have been established by the Laboratory for the same purposes as endowment funds; however, any portion of these funds may be expended.

Reclassifications

The financial statements for 1982 reflect certain changes in classification of revenue. Similar reclassifications have been made to amounts previously reported in order to provide consistency of the financial statements. In addition, certain invested funds' balances have been reclassified to appropriately reflect the donors' intentions.

Investments

Investments purchased by the Laboratory are carried at cost. Investments donated to the Laboratory are carried at fair market value at date received. For determination of gain or loss upon disposal of investments, cost is determined based on the average cost method.

Investment Income and Distribution

The Laboratory follows the accrual basis of accounting except that investment income is recorded on a cash basis. The difference between such basis and the accrual basis does not have a material effect on the determination of investment income earned on a year-to-year basis.

Investment income includes income from the investments of specific funds and from the pooled investment account. Income from the pooled investment account is distributed to the participating funds on the basis of the market value at the beginning of the quarter, adjusted for the cost of any additions or disposals during the quarter.

C. Land, Buildings and Equipment:

Following is a summary of the unrestricted plant fund assets:

<i>Classification</i>	<i>1982</i>	<i>1981</i>
Land	\$ 720,125	\$ 719,798
Buildings	14,360,395	12,535,197
Equipment	1,865,081	1,652,189
	<u>16,945,601</u>	<u>14,907,184</u>

Less accumulated depreciation	<u>5,203,404</u>	<u>4,843,425</u>
	<u>\$11,742,197</u>	<u>\$10,063,759</u>

Depreciation is computed using the straight-line method over estimated useful lives.

D. *Retirement Fund:*

The Laboratory has a noncontributory pension plan for substantially all full-time employees which complies with the requirements of the Employee Retirement Income Security Act of 1974. The actuarially determined pension expenses charged to operations in 1982 and 1981 were \$160,554 and \$137,009, respectively. The Laboratory's policy is to fund pension costs accrued, as determined under the aggregate level cost method. As of the latest valuation date, based on benefit information obtained January 1, 1983, the actuarial present values of vested and nonvested benefits, assuming an investment rate of return of 6%, were approximately \$1,076,652 and \$39,562, respectively. At January 1, 1983 net assets of the plan available for benefits, were approximately \$1,364,107.

In addition, the Laboratory has a pension plan funded by contributions to the Teachers Insurance and Annuity Association.

E. *Pledges and Grants:*

As of December 31, 1982 and 1981, the following amounts remain to be received on gifts and grants for specific research and instruction programs, and are expected to be received as follows:

	<u>December 31, 1982</u>		<u>December 31, 1981</u>	
	<i>Unrestricted</i>	<i>Restricted</i>	<i>Unrestricted</i>	<i>Restricted</i>
1982			\$20,000	\$ 96,800
1983	\$63,000	\$ 83,400		95,000
1984		<u>52,000</u>		<u>40,000</u>
	<u>\$63,000</u>	<u>\$135,400</u>	<u>\$20,000</u>	<u>\$231,800</u>

In February 1979, the Laboratory initiated the MBL Second Century Fund, a phased effort, to secure \$23,000,000 in support of capital rehabilitation, new construction, and endowment. As of December 31, 1982, the Laboratory has received pledges related to this effort of approximately \$4,553,000 of which a substantial portion has been collected.

F. *Investments:*

The following is a summary of the cost and market value of investment assets at December 31, 1982 and 1981, and the related investment income and disposition of investment income for the years ended December 31, 1982 and 1981.

	<i>Cost</i>		<i>Market</i>		<i>Investment Income</i>	
	1982	1981	1982	1981	1982	1981
<i>Invested funds:</i>						
U.S. Government securities	\$1,192,138	\$ 918,742	\$1,166,412	\$ 831,790	\$ 97,082	\$102,201
Corporate fixed income obligations	361,129	217,970	357,301	167,930	20,586	28,024
Common stocks	2,835,427	3,116,473	3,573,675	3,504,027	189,374	154,454
Money market securities	224,650	218,201	224,650	218,201	24,538	20,715
Real estate (market at cost)	17,549	17,549	17,549	17,549	—	—
Total	<u>\$4,630,893</u>	<u>\$4,488,885</u>	<u>\$5,339,585</u>	<u>\$4,739,497</u>	<u>331,580</u>	<u>305,394</u>
Less custodian fees					<u>(23,139)</u>	<u>(27,758)</u>
					<u>308,441</u>	<u>277,636</u>

	<i>Cost</i>		<i>Market</i>		<i>Investment Income</i>	
	1982	1981	1982	1981	1982	1981
<i>Current restricted funds:</i>						
U.S. Government securities	577,008	955,903	577,142	914,202	71,089	129,163
Corporate fixed income obligations	349,985	149,985	341,633	110,325	68,808	20,184
Common stocks	1,028,346	900,047	1,284,588	961,133	50,007	33,417
Money market securities	238,958	173,596	238,958	173,596	13,966	14,450
	<u>\$2,194,297</u>	<u>\$2,179,531</u>	<u>\$2,442,321</u>	<u>\$2,159,256</u>	<u>203,870</u>	<u>197,214</u>
Less custodian fees					<u>(10,999)</u>	<u>(9,126)</u>
					<u>192,871</u>	<u>188,088</u>
<i>Current unrestricted funds:</i>						
Money market securities	<u>\$ 665,000</u>	<u>\$1,850,000</u>	<u>\$ 665,000</u>	<u>\$1,850,000</u>	<u>86,067</u>	<u>171,980</u>
					<u>\$587,379</u>	<u>\$637,704</u>
<i>Disposition of investment income:</i>						
Restricted for current use:						
Utilized in current operations					371,937	283,574
Available for future operations					—	20,304
Utilized from prior years' income					<u>(59,342)</u>	<u>—</u>
Total restricted current funds					<u>312,595</u>	<u>303,878</u>
Retirement fund					55,874	46,745
Unrestricted—utilized in current operations					218,910	287,081
					<u>\$587,379</u>	<u>\$637,704</u>

IX. REPORT OF THE LIBRARIAN

1982 was the year that the walls literally came tumbling down on three floors of the Lillie Building that housed the Library and Administration offices. It was a strange time for the staff. We placed five staff members at reserved desks in the stack wing and the rest of the staff occupied four summer labs in the Crane wing. We communicated by intercom for five months.

The entire office area (copy center and catalog room) was renovated with new walls and lowered ceilings. The Reading Rooms remained intact and so did the five floors of stacks. Therefore we were able to operate with access to the collection on the usual 24 hour basis, provided that the users were able to concentrate with the jackhammers, drills, and DUST. It was surprising how many did and seemed oblivious to the din.

The contractors left in May and returned in September to complete the work. We moved the entire book collection to a new section of the Library on the third floor at the beginning of 1983, and the Rare Books collection was returned to the Library and placed on the first floor in what was formerly the Administration area.

The summer exhibits were moved from the Lillie Lobby to the first floor of Swope because of a confusing pattern of traffic due to the remodeling. We were able to accomodate more exhibitors due to the increased amount of space but the general opinion was that the lobby in Lillie is a more central area for viewing exhibits. They will return there in 1983.

The Library Users Committee spent a number of meetings discussing a grant from the Rockefeller Foundation which will enable us to conduct a major study of utilization patterns of our periodical collection. This User Study (carried out over a twelve month period) will enable us to develop long-range plans and policy, as well as establish cost effective procedures in acquisitions. The Study will start at the beginning of 1983.

X. EDUCATIONAL PROGRAMS

SUMMER

BIOLOGY OF PARASITISM

Instructor-in-chief

DAVID, JOHN, Harvard Medical School/Harvard School of Public Health

Other faculty, staff, and lecturers

ASKENASE, PHILIP, Yale University School of Medicine

AVERY, ROBIN, Harvard University

CANTOR, HARVEY, Sidney Farber Cancer Center

CAULFIELD, JOHN, Harvard Medical School

CROSS, GEORGE, Rockefeller University

DAVID, ROBERTA, Brigham and Women's Hospital

DESSEIN, ALAIN, Harvard Medical School

DWYER, DENNIS, National Institutes of Health

ENGLUND, PAUL, Johns Hopkins University School of Medicine

FEARON, DOUGLAS, Harvard Medical School

GIGLI, IRMA, New York University School of Medicine

GITLER, CARLOS, Weizmann Institute of Science, Israel

HALS, GARY, Capitol University

HARN, DONALD, Harvard Medical School

LANDFEAR, SCOTT, Harvard School of Public Health
 LODISH, HARVEY, Massachusetts Institute of Technology
 MARSDEN, PHILIP, Federal University of Brasilia, Brazil
 METZGER, HENRY, National Institutes of Health
 NATHAN, CARL, Rockefeller University
 NELSON, GEORGE, Liverpool School of Tropical Medicine, England
 NUSSENSWEIG, RUTH, New York University School of Medicine
 OTTESON, ERIC, National Institutes of Health
 PEREIRA, MIERCIO, Tufts University School of Medicine
 PERKINS, MARGARET, Rockefeller University
 PFEFFERKORN, ELMER, Dartmouth Medical School
 PRATT, DIANNE, Harvard Medical School
 RIFKIN, MARY, Rockefeller University
 ROBERTS, BRYAN, Harvard Medical School
 SAMUELSON, JOHN, Harvard Medical School
 SHER, ALAN, National Institutes of Health
 SHERMAN, IRWIN, University of California
 SPIELMAN, ANDREW, Harvard School of Public Health
 TRAGER, WILLIAM, Rockefeller University
 WALSH, CHRIS, Massachusetts Institute of Technology
 WIRTH, DYANN, Harvard School of Public Health
 WYLER, DAVID, Tufts University School of Medicine

Students¹

*AVRON, BOAZ, Weizmann Institute of Science, Israel
 *BANGS, JAMES, Johns Hopkins University School of Medicine
 *BARKER, ROBERT, Brown University
 *BOSWELL, CARL, Oregon State University
 BUCK, GREGORY, Institut Pasteur, France
 *DELAUW, MARIE-FRANCE, Beaumont, Belgium
 HALDAR, KASTURI, Massachusetts Institute of Technology
 *JUNGERY, MICHELE, University of Oxford, England
 *LANGER, PAMELA, Wellcome Trust Research Laboratories, Kenya
 *MORIEARTY, PAMELA, Fundacao Oswaldo Cruz, Brazil
 *PAMMENTER, MARTIN, Research Institute for Diseases in a Tropical Environment, South Africa
 *ROWSE-EAGLE, DEBRA, Yale University
 *TSENG, PETER, Johns Hopkins University School of Medicine
 *ULISSES DE CARVALHO, TECIA MARIA, Instituto de Biofisica, Brazil
 *ZEICHNER, STEVEN, University of Chicago
 *ZILBERSTEIN, DAN, Hebrew University, Israel

EMBRYOLOGY

Instructor-in-chief

RAFF, RUDOLF, Indiana University
 ANGERER, LYNNE, University of Rochester
 ANGERER, ROBERT, University of Rochester
 BÉDARD, ANDRÉ, McGill University, Canada
 BEGG, DAVID, Harvard Medical School

¹ All summer students listed completed the formal course programs. Asterisk indicates those completing post-course research sessions.

BENNETT, JEAN, University of California at Berkeley
 BLUMENTHAL, THOMAS, Indiana University
 BRANDHORST, BRUCE, McGill University, Canada
 CROUCH, MARTY, Indiana University
 DOHMEN, RENÉ, University of Utrecht, Netherlands
 EPEL, DAVID, Stanford University
 FREEMAN, GARY, University of Texas at Austin
 GERHARDT, JOHN, University of California at Berkeley
 GRAINGER, ROBERT, University of Virginia
 GROSS, PAUL, Marine Biological Laboratory
 HARKEY, MICHAEL, University of Washington
 HENDERSON, JUDY, State University of New York, Buffalo
 HENRY, JONATHAN, University of Texas at Austin
 HEREFORD, LYNNA, Sidney Farber Cancer Institute
 HILL, DAVID, Harvard Medical School
 HILLE, MERRILL, University of Washington
 HORVITZ, ROBERT, Massachusetts Institute of Technology
 HUMPHREYS, THOMAS, University of Hawaii
 JEFFERY, WILLIAM, University of Texas at Austin
 JOHNSON, MARTIN, Cambridge University, England, U. K.
 KALTOFF, KLAUS, University of Texas at Austin
 KAUFMAN, THOMAS, Indiana University
 KLEIN, WILLIAM, Indiana University
 KOMAROFF, LYDIA, University of Massachusetts Medical School
 LEAF, DAVID, Indiana University
 MAHOWALD, ANTHONY, Case Western Reserve University
 McCLAY, DAVID, Duke University
 MELTON, DOUGLAS, Harvard University
 NEWROCK, KENNETH, McGill University, Canada
 PENMAN, SHELDON, Massachusetts Institute of Technology
 POLISKY, BARRY, Indiana University
 POSAKONY, JAMES, Harvard University
 RAFF, BETH, Indiana University
 RENDER, JOANN, University of Texas at Austin
 RICH, JESSICA, Brown University
 RUDERMAN, JOAN, Harvard Medical School
 SADOWNICK, BRUCE, Harvard University
 SANDER, KLAUS, University of Freiburg, West Germany
 SOWERS, LOUIS, Indiana University
 STERNBERG, PAUL, Massachusetts Institute of Technology
 STUHL, KEVIN, Harvard Medical School
 TRINKAUS, JOHN, Yale University
 VACQUIER, VICTOR, Scripps Oceanographic, University of California at San Diego
 WHITTAKER, J. RICHARD, Boston University Marine Program
 WOOD, WILLIAM, University of Colorado

Students¹

*BROWN, NICHOLAS, Harvard University
 *EMERSON, JULIA, University of California at San Francisco
 *GOULD, MITCHELL, Emory University
 *HOUGAN, LINDA, McGill University, Canada
 *LEBLANC, JANINE, Wesleyan University
 *LESK, MARK, McGill University, Canada
 *LINGAPPA, JAIRAM, Harvard University
 *MAPLES, PHILLIP, Oklahoma University
 *MARTINDALE, MARK, University of Texas at Austin

- *MARTONE, ROBERT, University of Vermont
- *MERLINO, GLENN, National Institutes of Health
- *PEARMAN, BRADLEY, University of Tennessee
- *PERRY, HEATHER, University of Chicago
- *POZNANSKI, ANN, University of California at San Francisco
- *PULTZ, MARY ANNE, Indiana University
- *SUTHERLAND, ANN, University of California at San Francisco
- *ST. JOHNSTON, DANIEL, Harvard University
- *THOMSEN, GERALD, Washington University
- *VAFPOULOU-MANDALOS, XANTHE, University of Connecticut
- *VERAKALASA, PACHARA, University of Hawaii
- *WHARTON, KRISTI, Yale University
- *WILSON, LINDA, University of Texas at Austin
- *ZWIEBEL, LAURENCE, University of Michigan

MARINE ECOLOGY

Instructors-in-chief

- TEAL, JOHN, Woods Hole Oceanographic Institution
- VALIELA, IVAN, Boston University Marine Program/Marine Biological Laboratory

Other faculty, staff, and lecturers

- ALBERTE, RANDALL, University of Chicago
- ANDERSON, DONALD, Woods Hole Oceanographic Institution
- CONNELL, JOSEPH, University of California at Santa Barbara
- DACEY, JOHN, Woods Hole Oceanographic Institution
- DAVIS, CABELL, Boston University Marine Program/Marine Biological Laboratory
- DENNISON, WILLIAM, University of Chicago
- GIBLIN, ANNE, Woods Hole Oceanographic Institution
- GLIBERT, PATRICIA, Woods Hole Oceanographic Institution
- GRASSLE, FREDERICK, Woods Hole Oceanographic Institution
- GRASSLE, JUDITH, Marine Biological Laboratory
- GROSSBERG, RICHARD, Yale University
- HOBBIE, JOHN, Marine Biological Laboratory
- HUMES, ARTHUR, Marine Biological Laboratory
- JANNASCH, HOLGER, Woods Hole Oceanographic Institution
- JEFFRIES, ROBERT, University of Toronto, Canada
- KOEHL, MIMI, University of California at Berkeley
- LEVINTON, JEFFREY, SUNY at Stony Brook
- MADIN, LARRY, Woods Hole Oceanographic Institution
- MANN, ROGER, Woods Hole Oceanographic Institution
- NIXON, SCOTT, University of Rhode Island
- ODUM, WILLIAM, University of Virginia
- PETERSON, BRUCE, Marine Biological Laboratory
- PETERSON, SUSAN, Woods Hole Oceanographic Institution
- STOECKER, DIANNE, Woods Hole Oceanographic Institution
- TAGHON, GARY, Woods Hole Oceanographic Institution
- WATKINS, WILLIAM, Woods Hole Oceanographic Institution
- WIEBE, PETER, Woods Hole Oceanographic Institution
- WOODWELL, GEORGE, Marine Biological Laboratory

Students¹

- ABAD, MARK, University of Chicago
- *ANUTH, CRAIG, Oberlin College
- BOUTROS, OSIRIS, University of Pittsburgh

- BROWN, ALEXIS, California State University at Dominguez Hills
 DEMUTH, ROBIN, Childrens Hospital, Boston
 DOETKOTT, CURT, North Dakota State University
 ENGLER, MARLIES, Weiterbildungsschule/Diplommittelschule des Kantons Zug,
 Switzerland
 GROSS, CHARLES, Southeastern Massachusetts University
 KOWALLIS, GEORGE, New York Medical College
 LUBE, FATIMA, Rio de Janiero, Brasil
 *MARZOLF, ERICH, Colorado College
 MEROW, ALISON, Stanford University
 MORROW, LAURA, University of Texas at Austin
 OLSEN, SCOTT, Lehigh University
 REVELAS, EUGENE, State University of New York at Stony Brook
 *SENIE, ALLYSON, Ithaca College
 *SMITH, ROBERT, University of Chicago
 *STODDARD, JEFFREY, University of Wisconsin at Madison
 *TREGGOR, JOSEF, Central Connecticut State College
 *WEISSBURG, MARC, University of California at Berkeley

MICROBIAL ECOLOGY

Instructor-in-chief

HALVORSON, HARLYN, Brandeis University

Other faculty, staff, and lecturers

- ALEXANDER, MARTIN, Cornell University
 ATWOOD, KIMBALL, Columbia University
 BREZNAK, JOHN, Michigan State University
 CASTENHOLZ, RICHARD, University of Oregon
 DAVIS, BERNARD, Harvard Medical School
 DWORKIN, MARTIN, University of Minnesota at Minneapolis
 GARDNER, JEFFREY, University of Illinois at Urbana
 GREENBERG, PETER, Cornell University
 HANSON, RICHARD, University of Minnesota at Minneapolis
 JANNASCH, HOLGER, Woods Hole Oceanographic Institution
 KEYNAN, ALEX, Hebrew University of Jerusalem, Israel
 KORNBERG, HANS, Cambridge University, England, U. K.
 MARRS, BARRY, University of Connecticut at Storrs
 NICKERSON, KENNETH, University of Nebraska at Lincoln
 POINDEXTER, JEANNE, Public Health Research Institute, New York
 POTRIKUS, CATHERINE, Harvard University
 REZNIKOFF, WILLIAM, University of Wisconsin at Madison
 ROMESSER, JAMES, Dupont Corporation
 RUBY, EDWARD, University of California at Los Angeles
 SCHWEIGER, HANS, Max-Planck Institute, West Germany
 SINNIS, FRANNIE, Woods Hole Oceanographic Institution
 SLATER, HOWARD, Cambridge University, England, U. K.
 TAYLOR, CRAIG, Woods Hole Oceanographic Institution
 UHLINGER, DAVID, Florida State University
 VINCENT, WALTER, University of Delaware
 WEISBLUM, BERNARD, University of Wisconsin at Madison
 WHITE, DAVID, Florida State University

Students¹

- *BOUTROUS, SUSAN, University of Pittsburgh
 *BRATBAK, GUNNAR, University of Bergen, Norway

- *FATTUM, ALI, Hebrew University of Jerusalem, Israel
- *FOSNAUGH, KATHY, Cornell University
- *HALL, ROBERT, Nantucket High School
- *HAPPEL, ANNE, Purdue University
- *HEIMBROOK, MARGARET, University of Northern Colorado
- *HULLAR, MEREDITH, Tallahassee, Florida
- *KERKHOF, LEE, Harvard University
- *MAY, HAROLD, Virginia Polytechnic Institute and State University
- *PADEN, CYNTHIA, Scripps Institution of Oceanography
- *PERNACK, TINA, Arizona State University
- *SCHMIDT, THOMAS, Ohio State University
- *SCHNELL, DANNY, University of Nebraska at Lincoln
- *STAHL, DAVID, National Jewish Hospital and Research Center
- *VENTOSA, ANTONIO, University of Sevilla, Spain
- *WIER, PATRICIA, University of Colorado at Boulder
- *WOGGIN, NANCY, University of Massachusetts at Amherst

NEURAL SYSTEMS AND BEHAVIOR

Instructors-in-chief

- HOY, RONALD, Cornell University
- MACAGNO, EDUARDO, Columbia University

Other faculty, staff, and lecturers

- CALABRESE, RONALD, Harvard University
- CAREW, THOMAS, Columbia University
- ERBER, JOCHEM, Free University of Berlin, Germany
- FARLEY, JOSEPH, Princeton University/Marine Biological Laboratory
- GELPERIN, ALAN, Princeton University
- HARRIS-WARRICK, RONALD, Cornell University
- KELLEY, DARCY, Princeton University
- KROODSMA, DONALD, University of Massachusetts
- LEVINTHAL, CYRUS, Columbia University
- LLINAS, RODOLFO, New York University/Marine Biological Laboratory
- NELSON, MARGARET, Cornell University
- NOTTEBOHM, FERNANDO, Rockefeller University
- O'NEILL, WILLIAM, University of Rochester
- PALKA, JOHN, University of Washington
- WURTZ, ROBERT, National Eye Institute
- ZIPSER, BIRGIT, Cold Spring Harbor Laboratory

Students¹

- BERARDUCCI, ALBERT, University of Massachusetts Medical School
- CAHILL, GREGORY, University of Oregon Institute of Neurosciences
- CRAWFORD, JOHN, Cornell University
- EDGEComb, ROBERT, Purdue University
- FERME, PAOLA, Boston University
- HOCH, DAVID, Albert Einstein College of Medicine
- HOOPES, CHARLES, Wake Forest University
- *KRAFT, TIMOTHY, University of Minnesota
- LEWENSTEIN, LISA, New York Medical College
- *MARLER, JENNIFER, McGill University, Canada
- *NICOL, DIANNE, Dalhousie University, Canada
- *NORRIS, BRIAN, Texas Tech University
- PIRES, ANTHONY, Harvard College
- RANKIN, CATHERINE, City University of New York

REDMOND, TIM, Case Western Reserve University
 REHDER, VINCENT, Free University of Berlin, Germany
 RUSAK, BENJAMIN, Dalhousie University, Canada
 SAUNDERS, JAMES, University of Oklahoma
 SCHUTRUMPF, ANDREW, Northeastern University
 SMITH, KENNETH, Columbia University

NEUROBIOLOGY

Instructors-in-chief

HILDEBRAND, JOHN, Columbia University
 REESE, THOMAS, NINCDS/National Institutes of Health

Other faculty, staff, and lecturers

AUERSWALD, COLLETTE, Radcliffe College
 ARMSTRONG, CLAY, University of Pennsylvania
 BATTELLE, BARBARA, NEI/National Institutes of Health
 BURD, GAIL, Massachusetts General Hospital
 CHRISTAKIS, NICHOLAS, Yale College
 DUDAI, YADIN, Weizmann Institute, Israel
 DUNLAP, KATHLEEN, Tufts University Medical School
 FISCHBACH, GERALD, Washington University School of Medicine
 FURSHPAN, EDWIN, Harvard Medical School
 GOODMAN, COREY, Stanford University
 GOULD, ROBERT, New York Institute for Basic Research in Mental Retardation
 GOY, MICHAEL, Harvard Medical School
 GRAHAM, WILLIAM, NINCDS/National Institutes of Health
 GRANT, PHILIP, University of Oregon
 GRAYBIEL, ANN, Massachusetts Institute of Technology
 HALL, LINDA, Albert Einstein College of Medicine
 HERBERT, EDWARD, University of Oregon
 HORVITZ, ROBERT, Massachusetts Institute of Technology
 HUTTNER, SUSANNE, University of California at Los Angeles
 KACHAR, BECHARA, NINCDS/National Institutes of Health
 KENT, KARLA, Columbia University
 KRAVITZ, EDWARD, Harvard Medical School
 LAFRATTA, JAMES, Harvard Medical School
 LANDIS, DENNIS, Massachusetts General Hospital
 LANDIS, STORY, Harvard Medical School
 LANE, NANCY, University of Cambridge, England, U. K.
 LATORRE, RAMON, Harvard Medical School
 MANSOUR, RANDA, University of Rhode Island
 MATSUMOTO, STEVEN, Harvard Medical School
 NICHOLLS, JOHN, Stanford University
 NISHI, RAE, Harvard Medical School
 O'CONNELL, MAUREEN, NINCDS/National Institutes of Health
 O'LAGUE, PAUL, University of California at Los Angeles
 PAGANO, RICHARD, Carnegie Institution
 POTTER, DAVID, Harvard Medical School
 RAHAMIMOFF, RAMI, Hebrew University Medical School, Israel
 RAND, PETER, Brock University
 RAVIOLA, ELIO, Harvard Medical School
 REESE, BARBARA, NINCDS/National Institutes of Health
 SEJNOWKI, TERRANCE, Harvard Medical School
 SHEPHERD, GORDON, Yale University

WEINSTEIN, JOHN, NCI/National Institutes of Health
 WALROND, JOHN, NINCDS/National Institutes of Health
 WHITE, EDWARD, Boston University School of Medicine
 WIESEL, TORSTEN, Harvard Medical School
 WOLF, DAVID, Worcester Foundation for Experimental Biology
 ZIGMOND, RICHARD, Harvard Medical School

Students¹

*CHANG, DONALD, Baylor College of Medicine
 *COOK-DEEGAN, ROBERT, University of Colorado
 *DAVID, SAMUEL, Montreal General Hospital, Canada
 *FUJII, JOANNE, University of California at San Diego
 *HISHINUMA, AKIRA, Columbia University
 *HUETTNER, JAMES, Harvard Medical School
 *KELL, MICHAEL, Emory University School of Medicine
 *LERNER, MICHAEL, Washington University School of Medicine
 *LUMMIS, SARAH, University of Cambridge, England
 *MILLS, LINDA, McMaster University, Canada
 *NAWROCKI, LEON, University of Oregon
 *O'CONNOR, PATRICIA, University of California at Berkeley

PHYSIOLOGY

Instructor-in-chief

ROSENBAUM, JOEL, Yale University

Other faculty, staff, and lecturers

ACKERS, GARY, Johns Hopkins University
 ALBRECHT, GUENTER, Cold Spring Harbor Laboratory
 ALLEWELL, NORMA, Wesleyan University
 BARNARD, STEVE, Boston College
 BECKWITH, JON, Harvard Medical School
 BEYER, ANN, Worcester Foundation for Experimental Biology
 BORISY, GARY, University of Wisconsin
 BRADY, SCOTT, Case Western Reserve University
 BRANTON, DAN, Bio Labs
 BRAY, DENNIS, Medical Research Council, England, U. K.
 BROGLIE, RICHARD, Rockefeller University
 CHILD, ALICE, Tufts University
 CHISHOLM, REX, Massachusetts Institute of Technology
 CONDEELIS, JOHN, Albert Einstein College of Medicine
 CROUCH, MARTHA, Indiana University
 DEMAY, JAN, Janssen Pharmaceutical Laboratory of Oncology, Belgium
 DILL, KENNETH, University of Florida
 GOLDMAN, ROBERT, Northwestern University School of Medicine
 GRINNEL, FREDERICK, University of Texas Southwest Medical School
 HARTWELL, LEE, University of Washington
 HEREFORD, LYNNA, Brandeis University
 HOBBIIE, LAWRENCE, Yale University
 HUNT, TIM, Cambridge University, England, U. K.
 INOUÉ, SHINYA, Marine Biological Laboratory
 JAFFE, LIONEL, Marine Biological Laboratory/Purdue University
 JOHNSON, KENNETH, Pennsylvania State University
 KARN, JOHN, Medical Research Council, England, U. K.
 KILMARTIN, JOHN, Medical Research Council, England, U. K.

KORNBERG, ROGER, Stanford University Medical School
 KUMAR, AJIT, George Washington University Medical Center
 DELAYRE, JEAN, Harvard Medical School
 MATSUMURA, FUMIO, Cold Spring Harbor Laboratory
 MOOSEKER, MARK, Yale University
 MURRAY, ANDREW, Sidney Farber Cancer Research Institute
 OLMSTED, JOANNA, University of Rochester
 PEDERSON, THORU, Worcester Foundation for Experimental Biology
 POLISKY, BARRY, Indiana University
 RAFTERTY, MICHAEL, California Institute of Technology
 REID, MARTHA, Earlham College
 RICH, ALEXANDER, Massachusetts Institute of Technology
 ROSENTHAL, ERIC, Harvard Medical School
 SCHACHMAN, HOWARD, University of California at Berkeley
 SILFLOW, CAROLYN, University of Minnesota
 SLOBODA, ROGER, Dartmouth College
 SOLL, DAVID, University of Iowa
 SPUDICH, JOHN, Albert Einstein College of Medicine
 STEINBERG, JULIE, McAlester College
 SZOSTAK, JACK, Sidney Farber Cancer Institute
 TILNEY, LEWIS, University of Pennsylvania
 TRINKAUS, J. P., Yale University
 VILLA, LYDIA, University of Massachusetts Medical Center
 WANG, JAMES, Harvard University
 WEISENBERG, RICHARD, Temple University
 WHITMAN, GEORGE, Worcester Foundation for Experimental Biology
 WIEBEN, ERIC, Worcester Foundation for Experimental Biology

Students¹

*BRONSON, REBECCA, Boston University
 *CENTONZE, VICTORIA, Dartmouth College
 *COLUCCIO, LYNNE, Rensselaer Polytechnic Institute
 *CONZELMAN, KAREN, Yale University
 *DALEY, GEORGE, Harvard University
 *DISTEL, DANIEL, Scripps Institution of Oceanography
 *FATH, KARL, Case Western Reserve University
 *FINI, ELIZABETH, Dartmouth College
 *FRANCIS, RALPH, Oregon State University
 *GALLATI, MICHELE, George Washington Medical Center
 *GORBSKY, GARY, Princeton University
 GUYER, DAVID, Yale College
 *HANNEKEN, ANNE, Medical College of Wisconsin
 *JOSEPH-SILVERSTEIN, JACQUELYN, Hunter College of City University of New York
 *KAMIYA, RITSU, Nagoya University, Japan
 *KELLY, WILLIAM, University of Maryland
 *KULAKOSKY, PETER, University of Pennsylvania
 *LEE, HEIDE, Brown University
 LOUIE, DIANE, Yale College
 *LUFKIN, THOMAS, Cornell University Medical College
 *MORGANELLI, CHRISTINE, Dartmouth College
 *NELSON, JAMES, Purdue University
 *POOLE, THOMAS, Harvard Medical School
 *PORTER, DONALD, Scripps Institution of Oceanography
 *QUIGLEY, MICHAEL, University of Virginia
 *RAUSCH, DIANNE, Northwestern University
 *ROGELI, SNEZNA, Boston University

- *ROZDZIAL, MOSHE, University of California at Riverside
- *STEPHENS, LAURIE, University of Virginia
- *TAYLOR, LAVENTRICE, University of North Carolina
- *WILLIAMS, BENJAMIN, Yale University
- *YOUNGBLOM, JAMES, University of Minnesota

JANUARY

BEHAVIOR

Instructor-in-chief

ATEMA, JELLE, Boston University Marine Program/Marine Biological Laboratory

Other faculty, staff, and lecturers

BARLOW, ROBERT, Syracuse University
 BERG, CARL, Marine Biological Laboratory
 BRIDGES, ROBERT, Harvard Medical School
 BRISBIN, I. LEHR, Savannah River Ecology Program
 CALLARD, GLORIA, Boston University
 CAREY, FRANCIS, Woods Hole Oceanographic Institution
 DETHIER, VINCENT, University of Massachusetts
 DOLPHIN, WILLIAM, Boston University
 DORSEY, ELLIE, Payne Laboratories
 ELGIN, RANDALL, Boston University Marine Program/Marine Biological Laboratory
 FRANCIS, ELIZABETH, Bates College
 FRAZIER, JEAN, Boston University
 HAUSFATER, GLEN, Cornell University
 KALMIJN ADRIANUS, Scripps Institute of Oceanography
 KAMIL, AL, University of Massachusetts
 KREITHEN, MEL, University of Pittsburgh
 LANGBAUER, WILLIAM, Boston University Marine Program/Marine Biological Laboratory
 LEVINE, JOSEPH, Boston College
 MARLER, PETER, Rockefeller University
 MOLLER, PETER, American Museum of Natural History
 PAYNE, KATY, Lincoln, Massachusetts
 RISTAU, CAROLYN, Rockefeller University
 STUART, ALASTAIR, University of Massachusetts
 SWAIN, TONY, Boston University
 TERMAN, MICHAEL, Northeastern University
 TRANIELLO, JAMES, Boston University
 WILCOX, STIMSON, State University of New York, Binghamton
 WILLIAMS, JANET, Swarthmore College
 WILLIAMS, TIMOTHY, Swarthmore College

Students

FORBES, MARK, Acadia University, Canada
 GIORDANO, AMELIA, Station Marine D'Endoume, France
 GINSBURG, PAULETTE, State University of New York at Binghamton
 GULBRANSEN, THOMAS, University of Rhode Island
 HALL, VALERIE, Boston University
 JOHNSON, BRUCE, University of North Carolina Medical Center
 KOLLMER, MARY, Russel Sage College
 LEVIN, DEBORAH, Bowdoin College
 MCISAAC, HUGH, University of Pittsburgh
 MERRILL, CARL, University of Delaware

MICHAUD, JAYNE, University of Maine/Boston University
 MOONEY, SUSAN, Stonehill College
 MURPHY, SHAWN, New College of University of South Florida
 SPRINT, MICHELLE, Hollins College
 WOOD, SUSAN, St. Jude Childrens Research Hospital
 WEILGART, LINDA, Luther College
 YUEH-JUNG, CHANG, Mount Holyoke College

COMPARATIVE PATHOLOGY OF MARINE INVERTEBRATES

Instructors-in-chief

BANG, BETSY, Johns Hopkins University/Marine Biological Laboratory
 REINISCH, CAROL, Harvard University

Other faculty, staff, and lecturers

CHANG, PEI WEN, University of Rhode Island
 DAWE, CLYDE, National Institutes of Health
 DUCKLOW, HUGH, Columbia University
 EDDS, KENNETH, State University of New York, Buffalo
 ELSTON, RALPH, Battelle Marine Research Laboratory
 FARLEY, AUSTIN, National Marine Fisheries Service
 HOOVER, KAREN, National Institutes of Health
 JANNASCH, HOLGER, Woods Hole Oceanographic Institution
 LEIBOVITZ, LOUIS, Cornell University/Marine Biological Laboratory
 LEONARD, LESLIE, Johns Hopkins University
 LEVIN, JACK, School of Medicine, University of California at Los Angeles
 MICHELSON, EDWARD, Harvard School of Public Health
 PEARCE, JOHN, National Marine Fisheries Service
 PRENDERGAST, ROBERT, Johns Hopkins University
 SILVERSTEIN, ARTHUR, Johns Hopkins University
 SINDERMAN, CARL, National Marine Fisheries Service
 STRANDBERG, JOHN, Johns Hopkins University
 WEBB, MARGARET, Goucher Collge

Students

ANDERSON, LINDA, Seattle Pacific University
 BROWN, DENOLA, Texas Southern University
 BUCHANAN, JOANN, Northeastern University
 DOLL, JOHN, Smith Kline and French
 GODDARD, KATHRYN, Boston University
 HENDRICK, MATTIE, Tufts University Veterinary School
 HOLDERBAUM, ROXANNA, Falmouth, Massachusetts
 HORGAN, ERICH, Marine Biological Laboratory
 JOHNSON, BETTY, Memorial University of Newfoundland, Canada
 MANI, GNANA, State University of New York at Buffalo
 McCAIN, ELIZABETH, New College of University of South Florida
 MORRISON, REBECCA, State University of New York at Binghamton
 SAKAMOTO, HIDEMI, Tufts University
 SCOTT, ALAN, Johns Hopkins University
 WILLIAMS, ROBERT, Middleburg, Virginia

DEVELOPMENTAL BIOLOGY

Instructor-in-chief

EDDS, KENNETH, State University of New York, Buffalo

Other faculty, staff, and lecturers

BEGG, DAVID, Harvard Medical School
 BELL, EUGENE, Massachusetts Institute of Technology
 BURGESS, DAVID, Dartmouth College
 COLEMAN, ANNETTE, Brown University
 COLEMAN, JOHN, Brown University
 CROWTHER, ROBERT, Marine Biological Laboratory
 FUJIWARA, KUIGI, Harvard Medical School
 GROSS, PAUL, Marine Biological Laboratory
 HARRIGAN, JUNE, Marine Biological Laboratory
 HEIPLE, JEANNE, Boston University
 INOUÉ, SHINYA, Marine Biological Laboratory
 JAFFE, LAURINDA, University of Connecticut
 LUTZ, DOUGLAS, University of Pennsylvania/Marine Biological Laboratory
 MARCUS, NANCY, Woods Hole Oceanographic Institution
 MASER, MORTON, Marine Biological Laboratory
 O'LOUGHLIN, JOHN, Marine Biological Laboratory
 POCCIA, DOMINIC, Amherst College
 ROBINSON, KENNETH, University of Connecticut
 RUDERMAN, JOAN, Harvard Medical School
 SCHUEL, HERBERT, State University of New York, Buffalo
 TAMM, SIDNEY, Boston University Marine Program/Marine Biological Laboratory
 TAYLOR, D. LANSING, Dartmouth College
 WHITTAKER, RICHARD, Boston University Marine Program/Marine Biological Laboratory

Students

BERRY, FAITH, University of Maine at Farmington
 BRYANT, VIVIAN, Benedict College
 DAUM, HENRY, University of Mississippi Medical Center
 DOBRINSKY, BARBARA, Sarah Lawrence College
 DUGAN, PATRICIA, Kutztown State College
 HAMILTON, LAURA, University of New Hampshire
 HAZELL, RHONDA, Fairleigh Dickinson University
 HENSON, JOHN, Florida State University
 JOHNSON, KIMBERLY, Xavier University
 KANE, HELEN, Immaculata College
 KELLY, HERBERT, Dillard University
 MELVIN, WILLIE, Texas Southern University
 TEICHMANN, JEFF, Southampton College of Long Island University
 TICE, KIMBERLY, Southampton College of Long Island University
 VOPICKA, ELLEN, Mercy College
 WILL, CINDY, Marquette University

NEUROBIOLOGY

Instructor-in-chief

ALKON, DANIEL, National Institutes of Health/Marine Biological Laboratory

Other faculty, staff, and lecturers

ACOSTA-URQUIDI, JUAN, NINCDS, National Institutes of Health, and Marine Biological Laboratory
 ADELMAN, WILLIAM, JR., National Institutes of Health/Marine Biological Laboratory
 ATWOOD, HAROLD, University of Toronto, Canada

BAILEY, CLAUDIA, University of Arkansas
BARLOW, ROBERT, JR., Syracuse University
BRIGHTMAN, MILTON, National Institutes of Health
BRODWICK, MALCOLM, University of Texas Medical School
CLAY, JOHN, National Institutes of Health/Marine Biological Laboratory
CONNOR, JOHN, Bell Laboratories
CORSON, D. WESLEY, Marine Biological Laboratory
DEFELICE, LOUIS, Emory University of Medicine
DOWLING, JOHN, Harvard University
FARLEY, JOSEPH, Princeton University
FEIN, ALAN, Boston University Medical School/Marine Biological Laboratory
GART, SERGE, NINCDS, National Institutes of Health, and Marine Biological Laboratory
GILBERT, CHARLES, Harvard Medical School
GOVIND, C. K., University of Toronto, Canada
GRAHAM, WILLIAM, NINCDS, National Institutes of Health
HAROSI, FERENC, Boston University/Marine Biological Laboratory
HILL, RUSSELL, University of Toronto, Canada
JACKLET, JON, State University of New York, Albany
KAPLAN, EHUD, Rockefeller University
KRAVITZ, EDWARD, Harvard Medical School
KUZIRIAN, ALAN, NINCDS, National Institutes of Health/Marine Biological Laboratory
LEDERHENDLER, I. IZJA, NINCDS, National Institutes of Health/Marine Biological Laboratory
LLINAS, RODOLFO, New York University Medical Center
MOORE, JOHN, University of Massachusetts
NEARY, JOSEPH, NINCDS, National Institutes of Health/Marine Biological Laboratory
ODETTE, LOUIS, Eye Research Institute
PAPPAS, GEORGE, University of Illinois
POTTER, DAVID, Harvard Medical School
PRICE, CHRISTOPHER, Boston University
RASMUSSEN, HOWARD, Yale University School of Medicine
RAYMOND, STEPHEN, Massachusetts Institute of Technology
REESE, THOMAS, NINCDS, National Institutes of Health
RICHARDS, WILLIAM, Princeton University
SHEPHERD, GORDON, Yale University School of Medicine
SHOUKIMAS, JONATHAN, NINCDS, National Institutes of Health/Marine Biological Laboratory
SZUTS, ETE, Marine Biological Laboratory
WEISS, THOMAS, Massachusetts Institute of Technology

Students

BERTHIER, NEIL, University of California at Los Angeles
COULTER, DOUGLAS, University of Rhode Island
DESMOND, JOHN, University of Massachusetts
GIBSON, BARBARA, University of Rhode Island
HASLTON, JANE, Tufts University
HAY, BRUCE, Claremont McKenna College
HELM, JAMES, Medical College of Wisconsin
MILES, CLAUDIA, Wayland, Massachusetts
MILLER, AMELIA, Tufts University
POITRY, SERGE, University of Geneva, Switzerland/Rockefeller University
SCHMIDEK, HENRY, University of Vermont College of Medicine
SWATT, JOHN, Eisenhower College
TAKEDA, MAKIO, University of Massachusetts
WASHINGTON, SHEILA, Dillard University

SHORT COURSES

ANALYTICAL AND QUANTITATIVE LIGHT MICROSCOPY

Instructor-in-chief

INOUE, SHINYA, Marine Biological Laboratory

Other faculty, staff, and lecturers

ANDERSON, HELENE, Crimson Camera Technical Sales, Inc.
 BOGAN, JOHN, DAGE-MTI
 BRENNER, MEL, Nikon, Inc.
 CHIASSON, RICHARD, Olympus Corporation of America
 CLAYPOOL, DAVID, Crimson Camera Technical Sales, Inc.
 ELLIS, GORDON, University of Pennsylvania
 GRACE, JOHN, Crimson Camera Technical Sales, Inc.
 HAYES, THOMAS, University of North Carolina
 HEIPLE, JEANNE, Boston University
 HINSCH, JAN, E. Leitz, Inc.
 KELLER, ERNST, Carl Zeiss, Inc.
 KERR, LOUIS, Marine Biological Laboratory
 LANGENBACH, UWE, Jeoptik Jena G.m.b.H., West Germany
 LAWS, BRIAN, Crimson Camera Technical Sales, Inc.
 LUTZ, DOUGLAS, Marine Biological Laboratory
 MEYER, DAN, Seiler Instrument Company
 OLWELL, PATRICIA, E. Leitz, Inc.
 PRESLEY, PHILIP, Carl Zeiss, Inc.
 RIKUKAWA, KATSUJI, Nikon, Inc.
 SALMON, EDWARD, University of North Carolina
 SCHEIER, KURT, Nikon, Inc.
 SCOTT, ERIC, Venus Scientific
 TAYLOR, D. LANSING, Harvard University
 TAYLOR, RICHARD, Colorado Video
 THOMAS, PAUL, DAGE-MTI
 WICK, ROBERT, Carl Zeiss, Inc.

Students

BYERS, STEPHEN, Georgetown University
 DYM, MARTIN, Georgetown University
 HUI, CHIU SHUEN, Purdue University
 HYLTON, NOLA, Stanford University
 KACHAR, BECHARA, National Institutes of Health
 KILGREN, LESLIE, University of Pennsylvania
 MAYLIE, JAMES, Yale University
 ONOGI, KENJI, Nikon, Inc.
 PHILP, NANCY, National Eye Institute
 RIGNEY, DAVID, Institute for Cancer Research
 SAMUELSON, JOHN, Boston, Massachusetts
 SANGER, JEAN, University of Pennsylvania Medical School
 SILVER, FREDERICK, Rutgers Medical School
 STROME, SUSAN, University of Colorado
 SZOKA, FRANCIS, University of California School of Pharmacy
 USHIDA, KAZUO, Nikon, Inc.

AUTORADIOGRAPHY IN ELECTRON MICROSCOPY

Instructor-in-chief

WILLIAMS, MICHAEL, University of Sheffield, England, U. K.

Other faculty, staff, and lecturers

BAKER, JOHN, Ciba Geigy Pharmaceuticals Division, England, U. K.

GOULD, ROBERT, Institute for Basic Research in Mental Retardation

KERR, LOUIS, Marine Biological Laboratory

SUVERKROPP, CLAUS, Woods Hole, Massachusetts

Students

BERKLEY, KAREN, Florida State University

CARDELL, EMMA LOU, University of Cincinnati Medical Center

CHIEGO, DANIEL, University of Michigan Dental Research Institute

DAUGHERTY, CYNTHIA, Children's Hospital Medical Center

EDWARDS, CHRIS, University of Michigan Dental Research Institute

EISENBERG, BRENDA, Rush Medical Center

ERLICH, STEPHANIE, University of Southern California School of Medicine

GEISER, ALBERT, Philadelphia, Pennsylvania

GOULD, JACALYN, Gillette Company

HUNG, JULIA, University of Cincinnati

HUNT, RICHARD, University of Mississippi Medical Center

KAPLAN, NANCY, Boston City Hospital

LETOURNEAU, RICHARD, Arthur D. Little, Inc.

VAN ARSDALL, LINDA, University of Louisville School of Dentistry

WRATHALL, JEAN, Georgetown University

ELECTRON MICROSCOPY IN THE BIOLOGICAL SCIENCES

Instructors-in-chief

BOWERS, BLAIR, National Institutes of Health

MASER, MORTON, Marine Biological Laboratory

Other faculty, staff, and lecturers

ANTOL, JOE, Carl Zeiss, Inc.

COPELAND, D., EUGENE, Marine Biological Laboratory

GEISER, ALBERT, Hahnemann Medical Center

HOHMAN, THOMAS, National Institutes of Health

HOUGHTON, SUSAN, Marine Biological Laboratory

KERR, LOUIS, Marine Biological Laboratory

PEACHEY, LEE, University of Pennsylvania

PORTER, KEITH, University of Colorado

TRICHE, TIMOTHY, National Institutes of Health

Students

BIESIOT, PATRICIA, Woods Hole Oceanographic Institution

BLOCK, BARBARA, Duke University

CAREY, FRANCIS, Woods Hole Oceanographic Institution

CRONCE, DONNA JEAN, University of North Carolina

GOVINDARAJAN, SRINIVASA, East Windsor, New Jersey

KLEESE, WILLIAM, University of Arizona

KMETZ, JOHN, Kean College of New Jersey

ROMOSER, WILLIAM, Ohio University

WILLIAMS, DONALD, Vassar College

ENERGETICS AND TRANSPORT IN AQUATIC PLANTS

Instructor-in-chief

RAVEN, JOHN, The University of Dundee, Scotland

Other faculty, staff, and lecturers

ANDERSON, DONALD, Woods Hole Oceanographic Institution

BISSON, MARY, State University of New York, Buffalo

CHISHOLM, SALLIE, Massachusetts Institute of Technology

GOLDMAN, JOEL, Woods Hole Oceanographic Institution

MOREL, FRANCOIS, Massachusetts Institute of Technology

MORRIS, IAN, University of Maryland

PLATT, TREVOR, Marine Ecology Laboratory, Canada

STOLZENBACH, KEITH, Massachusetts Institute of Technology

SUNDA, WILLIAM, National Marine Fisheries Service

TAFT, JAY, Chesapeake Bay Institute

TAYLOR, CRAIG, Woods Hole Oceanographic Institution

WATERBURY, JOHN, Woods Hole Oceanographic Institution

WHEELER, PATRICIA, Oregon State University

Students

BINDER, BRIAN, Woods Hole Oceanographic Institution

BOUTROS, OSIRIS, University of Pittsburgh at Bradford

GLIBERT, PAT, Woods Hole Oceanographic Institution

HANDLEY, LINDA, University of Hawaii

HARRISON, GAIL, Massachusetts Institute of Technology

HERING, JANET, Massachusetts Institute of Technology

HOFFMAN, ROSANNE, State University of New York, Buffalo

KRAMER, JONATHAN, State University of New York, Marine Sciences Research Center

LAKICH, MELISSA, Woods Hole Oceanographic Institution

LUBE, FATIMA, Rio de Janeiro, Brasil

OLSON, ROBERT, Massachusetts Institute of Technology

RUETER, JOHN, JR., Portland State University

VAULOT, DANIEL, Woods Hole Oceanographic Institution

WEIDEMANN, ALAN, University of Rochester

WILLIAMS, SUSAN, West Indies Laboratory, Virgin Islands

OPTICAL MICROSCOPY AND IMAGING IN THE BIOMEDICAL SCIENCES

Instructor-in-chief

ALLEN, ROBERT, Dartmouth College

Other faculty, staff, and lecturers

ALLEN, NINA, Dartmouth College

ABRAMOWITZ, MORTIMER, Olympus Corporation of America

AMATO, PHILIP, Carnegie Mellon University

BROWN, DOUGLAS, Dartmouth College

BRUDER, LAWRENCE, Olympus Corporation of America

CHIASSON, RICHARD, Olympus Corporation of America

DECKER, MELVIN, JR., Opti-Quip, Inc.

FALLON, THOMAS, Datacopy Corporation
 GILBERT, SUSAN, Dartmouth College
 HANSEN, ERIC, Dartmouth College
 HARBISON, RICHARD, Carl Zeiss, Inc.
 INOUÉ, SHINYA, Marine Biological Laboratory
 KAY, JEFFREY, E. Leitz, Inc.
 KELLER, ERNST, Carl Zeiss, Inc.
 KLEIFGEN, JEROME, DAGE-MTI
 OLWELL, PATRICIA, E. Leitz, Inc.
 PRESLEY, PHILIP, Carl Zeiss, Inc.
 REDGRAVE, DAVID, Tech Plus
 ROGGENBUCK, PAUL, Kenneth Dawson Company
 SATO, MASAHIKO, Dartmouth College
 SCHEIER, KURT, Nikon, Inc.
 TAYLOR, D. LANSING, Carnegie Mellon University
 VACCARELLI, VINCENT, Nikon, Inc.

Students

BANK, HARVEY, Medical University of South Carolina
 BRIMIJOIN, STEPHEN, Mayo Clinic
 BURNS, ANDREW, Hanover, New Hampshire
 FLUCK, RICHARD, Franklin and Marshall College
 HAIGH, RAYMOND, Northwest Regional Health Authority, England
 HAYAKAWA, TSUYOSHI, Hamamatsu Systems, Inc.
 JOHNSON, RICHARD, University of Aberdeen, Scotland
 KAMIYA, KIYOSHI, Hamamatsu Systems, Inc.
 NEAL, RICHARD, Procter and Gamble Company
 PALATINI, DENNIS, American Cyanamid Company
 SACK, FRED, Boyce Thompson Institute, Cornell University
 SIMSON, ELKIN, Technicon Instruments Corporation
 SZIKLAS, ROBERT, Wauwinet Shellfish Company
 TEYLER, TIMOTHY, Northeastern Ohio University College of Medicine
 TRAUB, RICHARD, Havre-de-Grace, Maryland
 WISE, BENJAMIN, Keene State College
 YEANDLE, STEPHEN, Naval Medical Research Institute

QUANTITATIVE ANALYSIS OF ELECTRON MICROGRAPHS

Instructor-in-chief

PEACHEY, LEE, University of Pennsylvania

Other faculty, staff, and lecturers

BUSCHMANN, ROBERT, Chicago Veterans Administration Medical Center
 HASELGROVE, JOHN, University of Pennsylvania
 KERR, LOUIS, Marine Biological Laboratory
 MICHAUD, JAYNE, Marine Biological Laboratory
 PALMER, LARRY, University of Pennsylvania

Students

ALLEGRA, SALVATORE, St. Joseph's Hospital
 BROWNE, JOY, Tuskegee Institute
 BUZZELL, GERALD, University of Alberta, Canada
 CAPUZZO, JUDITH, Woods Hole Oceanographic Institution
 COHEN, SAMUEL, U. S. Army Natick Research and Development Laboratories
 DIAMOND, JACK, McMaster University, Canada

FLORIDA, ROBERT, Magee-Women's Hospital
 FORBES, MICHAEL, University of Virginia School of Medicine
 FRENCH, JOHN, National Institute of Environmental Health Sciences
 GILLOTT, MARCELLE, University of Illinois
 LAUBER, ROBIN, University of Vermont
 MACPHERSON, TREVOR, Magee-Women's Hospital
 NUTTALL, ROBERT, Emory University
 PARTHASARATHY, M. V., Cornell University
 ROBBOY, STANLEY, Massachusetts General Hospital
 SAWADA, GERIANNE, Upjohn Company
 SIMMERMAN, LINDA, University of Kentucky Tobacco and Health Research Institute
 SUNDELL, CYNTHIA, University of Pennsylvania

SCANNING ELECTRON MICROSCOPY IN THE BIOLOGICAL SCIENCES

Instructor-in-chief

WETZEL, BRUCE, National Institutes of Health

Other faculty, staff, and lecturers

ALBRECHT, RALPH, University of Wisconsin
 KENDIG, ESTHER, National Institutes of Health
 KERR, LOUIS, Marine Biological Laboratory
 LANE, W. CURTIS, National Institutes of Health
 MASER, MORTON, Marine Biological Laboratory
 TOUSIMIS, A. J., Tousimis Research Corporation

Students

AIKEN, GEORGE, Emory University
 BIELUNAS, JOAN, Medical College of Pennsylvania
 CHASE, ROBERT, Lafayette College
 ISENBERG, GEORGE, State University of New York College of Arts and Sciences at
 Potsdam
 MUÑOZ, ELIANA, Frederick Cancer Research Facility
 VISSCHER, GEORGE, Sandoz, Inc.

THREE AFTERNOONS TOWARD BETTER SCIENTIFIC WRITING

Instructor-in-chief

SCHWARTZ, SUSAN, Berkeley, California

Students

BODZNICK, DAVID, Woods Hole, Massachusetts
 BOUTROS, OSIRIS, Marine Biological Laboratory
 BOUTROS, SUSAN, Marine Biological Laboratory
 BROWN, ELLEN, Woods Hole Oceanographic Institution
 VON DER HEYDT, KEITH, Woods Hole, Massachusetts
 HUND, GRETCHEN, Woods Hole, Massachusetts
 LEVY, ELLEN, East Falmouth, Massachusetts
 MCKEE, TERRY, Woods Hole, Massachusetts
 METUZALS, JANIS, Marine Biological Laboratory
 REYNOLDS, LESLIE, Falmouth, Massachusetts
 RIETSMA, CAROL, Falmouth, Massachusetts
 SALGUERO, CAROL, Marine Biological Laboratory
 SCHMITT, RAYMOND, Woods Hole Oceanographic Institution
 TRUE, MARY, Woods Hole, Massachusetts

XI. RESEARCH AND TRAINING PROGRAMS

SUMMER

PRINCIPAL INVESTIGATORS

AGUAYO, ALBERTO, J., Montreal General Hospital, McGill University, Canada
ALBERTINI, DAVID F., Harvard University School of Medicine
ALLEN, NINA S., Dartmouth College
ALLEN, ROBERT D., Dartmouth College
ANDERSON, PETER A. V., Whitney Marine Laboratory, University of Florida
ARBAS, EDMUND A., Harvard University
ARMSTRONG, CLAY M., University of Pennsylvania
ARMSTRONG, PETER B., University of California at Davis
ARNOLD, JOHN M., Kewalo Marine Laboratory
BARLOW, ROBERT B., JR., Syracuse University
BARTLETT, GRANT R., Laboratory of Comparative Biochemistry
BENNETT, MICHAEL V. L., Albert Einstein College of Medicine
BEZANILLA, FRANCISCO, University of California at Los Angeles
BODZNICK, DAVID, Wesleyan University
BORGESE, THOMAS A., City University of New York, Lehman College
BORON, WALTER F., Yale University School of Medicine
BREUER, ANTHONY, Cleveland Clinic Foundation
BRODWICK, MALCOLM S., University of Texas Medical Branch
BROWN, JOEL E., State University of New York, Stony Brook
BURDICK, CAROLYN J., Brooklyn College
BURGER, MAX M., University of Basel, Switzerland
CARIELLO, LUCIO, Stazione Zoologica di Napoli, Italy
CHAPPELL, RICHARD L., Hunter College
CHOW, IDA, University of California at Irvine
COHEN, LAWRENCE B., Yale University School of Medicine
COHEN, WILLIAM D., Hunter College
COOPERSTEIN, SHERWIN J., University of Connecticut Health Center
COSTELLO, WALTER J., Ohio University
DENTLER, WILLIAM L., University of Kansas
DEWEER, PAUL J., Washington University School of Medicine
DEWLING, JOHN E., Harvard University
DUNHAM, PHILIP B., Syracuse University
DYBAS, LINDA K., Knox College
EATON, DOUGLAS, University of Texas Medical Branch
ECKERT, ROGER, University of California at Los Angeles
EHRENSTEIN, GERALD, National Institutes of Health
EHRING, GEORGE, Northwestern University Medical School
FAHIM, M. A., Case Western Reserve University
FARMANFARMAIAN, A., Rutgers University
FINGER, THOMAS F., University of Colorado School of Medicine
FISHMAN, HARVEY, M., University of Texas Medical Branch
FRENCH, ROBERT J., University of Maryland School of Medicine
GILBERT, DANIEL L., National Institutes of Health
GOODE, DENNIS M., University of Maryland
GOVIND, C. K., Scarborough College, Canada
GRINVALD, AMIRAM, Weizman Institute of Science, Israel
HAIMO, LEAH T., University of California at Riverside
HARDING, CLIFFORD V., Kresge Eye Institute
HASCHEMEYER, AUDREY E. V., Hunter College
HEPLER, PETER K., University of Massachusetts at Amherst
HIGHSTEIN, STEPHEN M., Albert Einstein College of Medicine

HILL, SUSAN D., Michigan State University
HOSKIN, FRANCIS C. G., Illinois Institute of Technology
INGOGLIA, NICHOLAS, New Jersey Medical School
IRELAND, LEONARD, Bermuda Biological Station, England, U. K.
JACKLET, JON W., State University of New York, Albany
KAMINER, BENJAMIN, Boston University School of Medicine
KAO, C. Y., State University of New York, Downstate Medical Center
KARWOSKI, CHESTER J., University of Georgia
KATZ, MICHAEL, Brown University
KING, GREGORY L., University of North Carolina School of Medicine
KIRK, MARK D., Rice University
LANDOWNE, DAVID, University of Miami
LANGFORD, GEORGE M., University of North Carolina School of Medicine
LASEK, RAYMOND J., Case Western Reserve University
LAUFER, HANS, University of Connecticut
LIPICKY, RAYMOND J., National Institutes of Health
LLINAS, RUDOLFO, New York University Medical Center
LOEWENSTEIN, WERNER R., University of Miami School of Medicine
LONGO, FRANK J., University of Iowa
LORAND, LASZLO, Northwestern University
MAGLOTT, DONNA R., Howard University
MERCIER, A. JOFFRE, JR., University of Calgary, Canada
METUZALS, J., University of Ottawa, Canada
MITCHELL, RALPH, Harvard University
MIYAMOTO, DAVID M., Seton Hall University
MOORE, JOHN W., Duke University Medical Center
MULLINS, L. J., University of Maryland School of Medicine
NAGEL, RONALD L., Albert Einstein College of Medicine
NARAHASHI, TOSHIO, Northwestern University Medical School
NELSON, LEONARD, Medical College of Ohio
NOE, BRYAN D., Emory University
OBAID, ANA LIA, University of Pennsylvania
O'MELIA, ANNE F., George Mason University
OXFORD, GERRY S., University of North Carolina
PAPPAS, GEORGE D., University of Illinois Medical Center
PAUL, DAVID L., Harvard Medical School
PIERCE, SIDNEY K., University of Maryland
POLLARD, HARVEY B., National Institutes of Health
POZNANSKY, MARK J., University of Alberta, Canada
PROENZA, LUIS M., University of Georgia
QUIGLEY, JAMES P., State University of New York, Downstate Medical Center
RANE, STANLEY, University of Massachusetts
RIPPS, HARRIS, New York University School of Medicine
ROSS, WILLIAM N., New York Medical College
RUDERMAN, JOAN, Harvard Medical School
RUSSELL, JOHN M., University of Texas Medical Branch
SALMON, EDWARD D., University of North Carolina
SALZBERG, BRIAN M., University of Pennsylvania
SANGER, JOSEPH W., University of Pennsylvania School of Medicine
SANGUINETTE, MICHAEL, University of California at Davis
SCHNEIDER, E. GAYLE, University of Nebraska Medical Center
SCHUEL, HERBERT, State University of New York
SCHWAB, WALTER E., Virginia Polytechnic Institute and State University
SEGAL, SHELDON, Rockefeller Foundation
SILVER, WAYNE, Monell Chemical Senses Center
SLUDER, GREENFIELD, Worcester Foundation for Experimental Biology

SPECK, WILLIAM T., Case Western Reserve University
 SPEIGEL, EVELYN, Dartmouth College
 SPEIGEL, MELVIN, Dartmouth College
 STIMERS, JOSEPH, University of California at Los Angeles
 STUART, ANN E., University of North Carolina
 SZAMIER, R. BRUCE, Massachusetts Eye and Ear Infirmary
 SZENT-GYÖRGYI, Andrew, Brandis University
 TANGUY, JOELLE, Ecole Normale Superieure, France
 TASAKI, ICHII, National Institutes of Health
 TAYLOR, ROBERT E., National Institutes of Health
 TELZER, BRUCE R., Pomona College
 TILNEY, LEWIS G., University of Pennsylvania
 TRIESTMAN, STEVEN N., Worcester Foundation for Experimental Biology
 TRINKAUS, J. P., Yale University
 TROLL, WALTER, New York University Medical Center
 TUCKER, EDWARD B., Vassar College
 TYTELL, MICHAEL, Bowman Gray School of Medicine
 WALLACE, ROBIN A., University of Florida
 WANG, GING KUO, Harvard University
 WEIDNER, EARL, Louisiana State University
 WEISSMANN, GERALD, New York University Medical Center
 WHITE, MICHAEL M., University of California at Los Angeles
 WOODY, CHARLES D., University of California Medical Center at Los Angeles
 WORTHINGTON, C. R., Carnegie-Mellon University
 ZIGMAN, SEYMOUR, University of Rochester School of Medicine
 ZIMMERMAN, ROGER P., Rush University

LIBRARY READERS

ADELBERG, EDWARD A., Yale Medical School
 ALBRIGHT, JOHN T., Harvard School of Dental Medicine
 ALLEN, GARLAND, Washington University
 ANDERSON, EVERETT, Harvard Medical School
 APOSHIAN, H. VASKEN, University of Arizona
 ARMSTRONG, MARGARET, University of California
 BANG, BETSY G., Marine Biological Laboratory
 BARKLEY, JOHN J., University of Massachusetts
 BASHOR, DAVID P., University of North Carolina at Charlotte
 BEAN, CHARLES P., General Electric Research and Development Center
 BECKER, FREDERICK F., M. D. Anderson Hospital & Tumor Institute
 BECKER, JOHN M., University of South Florida
 BEIDLER, LLOYD, Florida State University
 BELL, EUGENE, Massachusetts Institute of Technology
 BOURNE, DONALD W., Woods Hole Oceanographic Institution
 BROYLES, ROBERT H., University of Oklahoma Health Sciences Center
 BROWN, FRANK, Woods Hole, Massachusetts
 BUCK, JOHN, National Institute of Health
 CANDELAS, GRASIELA C., Universidad de Puerto Rico
 CARLSON, FRANCIS, John Hopkins University
 CARRIERE, RITA, State University of New York, Downstate Medical Center
 CHILD, FRANK M., Trinity College
 CLARK, ARNOLD, University of Delaware
 COHEN, SEYMOUR S., State University of New York, Stony Brook
 COLLIER, JACK R., Brooklyn College
 COLLIER, MARJORIE M., Saint Peter's College

COWLING, VINCENT F., State University of New York, Albany
DETTBARN, WOLF-D., Vanderbilt University Medical Center
DUNCAN, THOMAS, Marine Biological Laboratory
EBERT, JAMES, Carnegie Institute of Washington
ECKERT, BARRY S., State University of New York, Buffalo
ECKERT ROBERT T., University of New Hampshire
EDDS, KENNETH T., State University of New York, Buffalo
EDDS, LOUISE L., Ohio University
EDER, HOWARD A., Albert Einstein College of Medicine
ELLNER, JERROLD, University Hospitals, Cleveland, Ohio
EPEL, DAVID, Stanford University
FARMANFARMAIAN, A., Rutgers—The State University of New Jersey
FISHER, SAUL, New York University School of Medicine
FLATNES, OLAUG, Norway
FREINKEL, NORBET, Northwestern University Medical School
FRENCH, KATHLEEN, University of North Carolina School of Medicine
FUSSELL, CATHARINE P., Pennsylvania State University
GABRIEL, MORDECAI L., Brooklyn College
GARDNER, ELIOT L., Albert Einstein College of Medicine
GERMAN, JAMES L., The New York Blood Center
GLASSER, JANE E., University of Georgia
GRANT, PHILIP, University of Oregon
GROSCH, DANIEL S., North Carolina State University
GROSSMAN, ALBERT, New York University Medical Center
GOLDSTEIN, MOISE H., John Hopkins University
GUTTENPLAN, JOSEPH B., New York University College of Dentistry
GUTTMAN, RITA, New York University
HELLMAN, HAL, Leonia, New Jersey
HINSCH, GERTRUDE, University of South Florida
HOCK, ALAN K., Littleneck, New York
HUBBARD, RUTH, Harvard University
ILAN, JOSEPH D., Case Western Reserve University School of Medicine
ILAN, JUDITH, Case Western Reserve University School of Medicine
INOUE, SHINYA, Marine Biological Laboratory/University of Pennsylvania
ISSENBERG, IRVIN, Oregon State University
ISSIDORIDES, MARIETTA R., University of Athens, Eginition Hospital, Greece
JACKLET, JON W., State University New York, Albany
JONES, MEGAN, Harvard University
JOSEPHSON, ROBERT K., University of California
KANE, ROBERT E., University of Hawaii
KALTENBACH, JANE C., Mount Holyoke College
KASS-SIMON, GABRIELE, University of Rhode Island
KELLEY, ROBERT E., University of Illinois College of Medicine
KIRSCHENBAUM, DONALD M., State University of New York, College of Medicine
KLIEN, MORTON, Temple University Medical School
KOGUT, MARGOT, King's College, London, England
LADERMAN, AIMLEE D., Smithsonian Institution
LAZAROW, PAUL B., The Rockefeller University
LEE, JOHN J., City College of New York
LEIGHTON, JOSEPH, The Medical College of Pennsylvania
LEVINE, RACHMIEL, City of Hope Medical Center, California
LEVITZ, MORTIMER, New York University Medical Center
LOCKWOOD, ARTHUR H., Temple University Medical School
MAHLER, HENRY R., Indiana University
MARINE RESEARCH, Falmouth, Massachusetts
MASTROIANNI, LUIGI, Hospital of the University of Pennsylvania

MAUTNER, HENRY G., Tufts University School of Medicine
MAUZERALL, DAVID, Rockefeller University
MAY, SHELDON, Georgia Institute of Technology
MIZELL, MERLE, Tulane University
MONSANTO COMPANY, St. Louis, Missouri
MONROY, ALBERTO, Stazione Zoologica, Napoli, Italy
MORRELL, FRANK, Rush Medical College
MORSE, STEPHEN, Rutgers University
MULLINS, LORIN J., University of Maryland, Baltimore
OLINS, ADA L., University of Tennessee, Oak Ridge
OLINS, DONALD E., University of Tennessee, Oak Ridge
OSCHMAN, JAMES, Woods Hole, Massachusetts
OTTER, TIMOTHY, Albert Einstein College of Medicine
PALMER, JOHN D., University of Massachusetts
PEISACH, JACK, Albert Einstein College of Medicine
PERSON, PHILIP, V. A. Hopsital, Brooklyn, New York
PLOCKE, DONALD J., Boston College
POLLEN, DANIEL A., Barrow Neurological Institute, Phoenix, Arizona
POSTAL, BILL, North Falmouth, Massachusetts
RICE, ROBERT, Carnegie-Mellon University
RICH-MCCOY, LOIS, Palisades, New York
ROTH, EUGENE, Mount Sinai School of Medicine, New York
ROWLAND, LEWIS P., Neurological Institute, New York
RUSHFORTH, NORMAN B., Case Western Reserve University
RUSSELL-HUNTER, W. D., Syracuse University
SAGE, MARTIN, University of Missouri
SAGE, LINDA, University of Missouri
SAUNDERS, JOHN, Waquoit, Massachusetts
SCHWARTZ, MARTIN, University of Maryland Baltimore County
SEGAL, HAROLD L., State University of New York at Buffalo
SHEMIN, DAVID, Northwestern University
SHEPHARD, FRANK, Deep Sea Research
SHEPRO, DAVID, Boston University
SHERMAN, IRWIN W., University of California
SONNENBLICK, R. P., Rutgers University
SPECTOR, A., Columbia University
STEPHEN, MICHAEL J., Rutgers University
STETTEN, MARJORIE R., National Institute of Health
TASHIRO, JAY S., Kenyon College
TRAGER, WILLIAM, The Rockefeller University
TROXLER, ROBERT F., Boston University School of Medicine
TWEEDELL, KENYON S., University of Notre Dame
VAN HOLDE, KEN E., Oregon State University
WAGNER, ROBERT R., University of Virginia School of Medicine
WAINIO, WALTER, Rutgers University
WARREN, LEONARD, Instar Institute
WEBB, MARGARET, Woods Hole, Massachusetts
WEISS, LEON, Veterinary School of the University of Pennsylvania
WHEELER, GEORGE E., Brooklyn College
WILBER, CHARLES G., Colorado State University
WITTENBERG, BEATRICE A., Albert Einstein College of Medicine
WITTENBERG, JONATHAN B., Albert Einstein College of Medicine
YOW, FRANK W., Kenyon College
ZACKS, SUMNER I., Miriam Hospital
ZELESKI, ILENE, Deep Sea Research
ZIGMAND, RICHARD E., Harvard Medical School
ZIMMERMAN, MORRIS, Merck Sharp & Dohme Research Laboratories

OTHER RESEARCH PERSONNEL

ADAMS, CHERYL A., University of Wisconsin
ALLIEGRO, MARK C., State University of New York, Buffalo
ANDERSON, CATHLEEN, Syracuse University
ANTONELLIS, BLENDIA, University of Rochester
ARANOW, CYNTHIA, New York University School of Medicine
ARBAS, EDMUND, Harvard University
AUGUSTINE, GEORGE, University of California at Los Angeles
BAKER, ROBERT, New York University Medical Center
BENNETT, NICHOLAS, Riverdale, New York
BERES, LINDA S., University of California at Los Angeles
BETCHAKU, TEIICHI, Yale University Medical School
BIBKO, LISA, Syracuse University
BLUMER, JEFFERY, Case Western Reserve University
BOOKMAN, RICHARD, University of Pennsylvania
BOWER, JAMES M., New York University Medical Center
BRADY, SCOTT, Case Western Reserve University
BREITWIESER, GERDA E., University of Texas Medical Branch
BREUER, ANTHONY C., Cleveland Clinic Foundation
BROOKS, ALLYN, University of North Carolina at Chapel Hill
BROWN, DOUGLAS T., Dartmouth College
BRUNER-LORAND, JOYCE, Northwestern University
BYRD, WILLIAM, Louisiana State University
CAPUTO, CARLO, Centro de Biofisica, Venezuela
CARIELLO, LUCIO, Northwestern University
CARVALHO, ANTONIO, Albert Einstein College of Medicine
CLAPIN, DAVID F., University of Ottawa, Canada
COBUZZI, CAROL A., Mount Vernon, New York
COHEN, JEFFREY MARTIN, New York University Medical Center
COHEN, ROCHELLE S., University of Illinois Medical Center
COLLINS, STEHEN, Case Western Reserve University School of Medicine
CORK, DOUGLAS J., Illinois Institute of Technology
COTRAN, PAUL, Harvard Medical School
COWDER, WILLIAM, Kresge Eye Institute
CURTIS, NANCY, Cornell University
CZINN, STEVEN J., Rainbow Babies and Children's Hospital, University Hospital of Cleveland
DA-YUAN, CHEN, University of Iowa
DEFELICE, LOUIS, Emory University
DESIMONE, DOUGLAS, Dartmouth College
DICKER, ADAM D., New York University Medical Center
DIPOLO, REINALDO, Instituto Venezolano de Investigaciones Cientificas, Venezuela
DIXON, ROBERT, Winchester, Massachusetts
EHRlich, BARBARA, Albert Einstein College of Medicine
EISELE, LESLIE E., Syracuse University
EL-HAJ, ALICIA, University of Aberdeen, Scotland
ELLNER, JERROLD, Case Western Reserve University
FENNELLY, GLEN J., Dartmouth College
FELDMAN, SUSAN C., New Jersey Medical School
FERNANDEZ, JULIO M., University of California at Los Angeles
FONG, PEYING, Yale University School of Medicine
FORSCHER, PAUL, University of North Carolina
FRACE, ALAN M., University of Texas Medical Branch
FRAIZER, DAN, University of North Carolina
FRANK, DOROTHY M., Rainbow Babies and Children's Hospital
FRANZINI-ARMSTRONG, CLARA, University of Pennsylvania

FREEDMAN, JOSHUA, Yale University
GAINER, HAROLD, National Institute of Mental Health
GALLANT, PAUL E., National Institute of Mental Health
GARG, AJAY, Albert Einstein College of Medicine
GEDULDIG, ULLA, Saint Johns, Newfoundland, Canada
GILBERT, SUSAN P., Dartmouth College
GIUDITTA, ANTONIO, International Institute for Genetics and Biophysics, Italy
GLASS, NICHOLAS, Buxton School
GLUSMAN, STEVEN, Columbia University
GOULD, ROBERT M., New York Institute for Basic Research in Mental Retardation
GUCHARDI, JOHN, University of Toronto, Canada
GUTERMAN, LEE, Clarkson College
HAGELSTEIN, ERIC B., Northwestern University Medical School
HARONIAN, GRACE, University of Connecticut Health Center
HARRIS, A. L., Albert Einstein College of Medicine
HARRIS, EDWARD M., Duke University Medical Center
HAYASHI, JON H., University of North Carolina
HAYS, TOM, University of North Carolina
HILDESHEIM, RINA, Weissman Institute of Sciences
HILL, RUSSELL, Scarborough College, University of Toronto, Canada
HILL, LENA, Scarborough College, University of Toronto, Canada
HINES, MICHAEL, Duke University Medical Center
HOLEKAMP, LINDA C., Washington University School of Medicine
HOULIHAN, DOMINIC, University of Aberdeen, Scotland
IWASA, KINIHIKO, National Institute of Mental Health
JACOBSEN, FREDA, National Institutes of Health
JAMPEL, JAMES, Bloomfield Hills, Michigan
JASLOVE, STEWART W., Albert Einstein College of Medicine
KALIL, KATHERINE, University of Wisconsin
KAO, PETER N., Columbia University College of Physicians and Surgeons
KAPLAN, EHUD, Rockefeller University
KASS, LEONARD, Syracuse University
KELLER, RAYMOND E., University of California at Berkeley
KIMMEL, CHARLES B., University of Oregon
KIRCHMAN, DAVID, Harvard University
KOIDE, S. S., Population Council
KRACKE, GEORGE R., Washington University School of Medicine
KRAUTHAMER, VICTOR, New York Medical College
LARSEN, JAMES, University of Southern Mississippi
LAWRENCE, ADRIAN, University of North Carolina
LAYTON, BARRY S., Worcester Foundation for Experimental Biology
LEUCHTAG, H. RICHARD, University of Texas Medical Branch
LI, QING-YU, Vassar College
LIMAN, EMILY R., Princeton University
LLANO, ISABEL, University of California Medical School at Los Angeles
LO, WOO-KUEN, Kresge Eye Institute of Wayne State University
LOPEZ-BARNEO, JOSE, University of Pennsylvania
MACHIDA, KOICHI, University of Miami School of Medicine
MACKIN, ROBERT B., Carleton College
MANCINI, VIVIAN, Hunter College
MANCUSO, CAROL A., Morton, Pennsylvania
MATTESON, DONALD R., University of Pennsylvania
MAUGEL, TIMOTHY K., University of Maryland
MISEVIC, GRADIMIR, University of Basel, Switzerland
MORAN, MICHAEL N., Emory University
OHKI, SHINPEI, State University of New York, Buffalo

OLAND, LYNNE A., University of North Carolina
ORBACH, HARRY, Yale University School of Medicine
PANT, HARISH C., National Institute on Alcohol Abuse and Alcoholism
PAXHIA, TERESA, University of Rochester School of Medicine and Dentistry
PEARCE, JOANNE, Scarborough College, Canada
PERSELL, ROGER, Mercy College
POCHAPIN, MARK, University of Pennsylvania School of Medicine
POCRNJIC, ZVONIMIR, Hunter College
PURPURA, KEITH, Rockefeller University
QUINN, RICHARD, University of Maryland
RAKOWSKI, ROBERT F., Washington University School of Medicine
RAO, P. D., PRASADA, New York Medical College
REDDY, VINAY N., Kresge Eye Institute
REQUENA, JAIME, University of Maryland School of Medicine
ROSE, BIRGIT, University of Miami School of Medicine
SAIMI, YOSHIRO, University of Wisconsin
SALTZMAN, CHARLES, University of North Carolina School of Medicine
SANGER, JEAN M., University of Pennsylvania School of Medicine
SARMA, J. VIDYA, University of Maryland
SATO, EIMEI, Population Council
SATO, MASAHIKO, Dartmouth College
SCHAFER, THEO, Biozentrum der Universitat, Switzerland
SCHLUP, VERENA, Biozentrum der Universitat, Switzerland
SCRUGGS, VIRGINIA M., Northwestern University Medical School
SCULPTOREUANU, ADRIAN, Duke University
SELMAN, KELLY, University of Florida College of Medicine
SERHAN, CHARLES, New York University Medical Center
SEYAMA, ISSEI, Northwestern University
SHIMIZU, HIDEAKI, University of Pennsylvania
SIMON, SANFORD, New York University Medical Center
SMALL, MARIA, University of North Carolina
SO, FREDERICK, University of Iowa
SOCCI, ROBIN, Rutgers—The State University of New Jersey
SOMMER, HEIDI, Biozentrum der Universitat, Switzerland
SPRAY, DAVID C., Albert Einstein College of Medicine
STEINACHER, ANTONINETTE, Albert Einstein College of Medicine
STOCKBRIDGE, NORMAN, Duke University Medical Center
STOKES, PATRICIA J., Albert Einstein College of Medicine
STRASSMAN, ANDREW, Albert Einstein College of Medicine
SUGIMORI, MATSUYUKI, New York University Medical Center
SUSAN, STANLEY R., Kresge Eye Institute of Wayne State University
SZENT-GYRÖGYI, EVA S., Brandeis University
TAATGES, DOUGLAS J., Kansas State University
TAKEUCHI, KIYOSHI, Northwestern University
TANSEY, TERESE, Harvard Medical School
TAYLOR, KEVIN, T., University of Miami School of Medicine
TIMPE, LESLIE C., University of North Carolina
VARNER, JUDITH A., Biozentrum der Universitat, Switzerland
VERGARA, JULIO L., University of California at Los Angeles
VOGEL, STEPHEN M., Northwestern University
WALCH, MARIANNE, Harvard University
WANG, LIN-FANG, Population Council
WEISS, JERRY S., Northwestern University Medical School
WHITE, ROY, Albert Einstein College of Medicine
WHITTEMBURY, JOSE, Universidad Peruana Cayetano Heredia, Peru
WOLNIAK, STEPHEN M., University of Massachusetts at Amherst

WONG, TERENCE Z., Dartmouth College
 WORTHINGTON, A. R., Carnegie-Mellon University
 WRIGHT, ANSON E., Harvard University
 YAJEYA, JAVIER, University of Pennsylvania School of Medicine
 YEH, JAY Z., Northwestern University Medical School
 YOUNG, RON E., University of the West Indies, W. I.
 ZAKEVICIUS, JANE M., New York University School of Medicine
 ZAVILOWITZ, JOSEPH, Albert Einstein College of Medicine
 ZWEIFACH, ADAM, New York, New York

YEAR-ROUND PROGRAMS

(All of Marine Biological Laboratory unless otherwise indicated)

BOSTON UNIVERSITY MARINE PROGRAM (BUMP)

Director

WHITTAKER, J. RICHARD, Boston University/Marine Biological Laboratory

Staff (of Boston University unless otherwise indicated)

ALLEN, SARAH
 ATEMA, JELLE
 COGSWELL, CHARLOTTE, University of Connecticut
 CROWTHER, ROBERT
 GOVIND, C. K., University of Toronto
 HAHN, DOROTHY
 HANDRICH, LINDA
 HARTMAN, JEAN, University of Connecticut
 HILL, RUSSELL
 HUMES, ARTHUR
 LOESCHER, JANE
 MEEDEL, THOMAS
 MURRAY-BROWN, MARK
 PEARCE, JOANNE
 PRICE, CHRISTOPHER
 RIETSMAN, CAROL, State University of New York, New Paltz
 TAMM, SIDNEY
 TAMM, SIGNHILD
 TAYLOR, MARGERY
 VALIELA, IVAN
 VAN ETEN, RICHARD

Students (of Boston University unless otherwise indicated)

BARSHAW, DIANA	HOWES, BRIAN
BRYANT, BRUCE	JOHNSON, BRUCE
BRYANT, DONALD	LAVALLI, KARI
BUCHSBAUM, ROBERT	MACIOLEK-BLAKE, NANCY
CARACO, NINA	MERRILL, CARL
CHU, KEVIN	MOSS, ANTHONY
CLARKE, JOANN	NEIDINGER, RICHARD
COHEN, ROSALIND	PASCOE, NATALIE
COSTA, JOSEPH	POOLE, ALAN
COULTER, DOUGLAS	TAMSE, ARMANDO
DOJIRI, MASAHIRO	TROTT, THOMAS
FERME, PAOLA	WEBB, JACQUELINE
FOREMAN, KENNETH	WHITE, DAVID
FUJITA, RODNEY	WILLIAMS, ISABELLE
GODDARD, KATHRYN	WILSON, JOHN
HALL, VALERIE	

DEVELOPMENTAL AND REPRODUCTIVE BIOLOGY LABORATORY

Director

GROSS, PAUL R.

Staff

HALVORSON, LISA, Brandeis University

O'LOUGHLIN, JOHN

SIMPSON, ROBERT T., National Institutes of Health

THE ECOSYSTEMS CENTER

Director

WOODWELL, GEORGE M.

Staff and consultants

BADENHAUSEN, MARGUERITE M.

BEALE, ELEANORE, M.

BEARD, SARAH H.

BORETOS, DIANE

BOWLES, FRANCIS P.

CARLSON, CHRISTOPHER

CLARK, LYNETTE

COLE, JONATHAN

CORLISS, TERESA A. L.

CUCINATTO, JAMES

DUNCAN, THOMAS

DUNGAN, JENNIFER

ELDRED, KATE

GARRITT, ROBERT W.

GREGG, DAVID

GUTJAHR, RUTH E.

HARTMAN, JEAN

HELFRICH, JOHN V. K.

HOBBIE, JOHN E.

HOUGHTON, RICHARD A.

HOWARTH, ROBERT W.

JUERS, DAVID W.

KIJOWSKI, VOYTEK

LARSEN, CHERYL

LYNCH, CHRISTINE

MACALUSO, MARYANNE

MARINO, ROXANNE

MARINUCCI, ANDREW C.

MARQUIS, SALLY L.

MCNEILL, JOHN

MELILLO, JERRY M.

MERKEL, SUSAN

MILLINGER, MYRA

MONTGOMERY, ELLYN

MONTGOMERY, MARY LOUISE

MOSS, ANN H.

PALM, CHERYL A.

PARSONS, KATHERINE C.

PETERSON, BRUCE J.

QUICK, DEBORAH G.

SECHOKA, ELIZABETH M.

SEMINO, SUZANNE

SHAVER, GAIVUS R.

SIMMONS, NANCY S.

STONE, THOMAS

STEUDLER, PAUL A.

TURNER, ANDREA R.

UPTON, JOAN M.

Trainees

BOWDEN, WILLIAM B., North Carolina State University, Year-in-Science

CAVANAUGH, COLLEEN, Harvard University, Year-in-Science

GORDON, DORIA, Intern

SAMPOU, PETER, University of Rhode Island

WILLEY, JOANNE, Intern

LABORATORY OF BIOPHYSICS

Director

ADELMAN, WILLIAM, J., JR. NINCDS-NIH

Staff (of NINCDS-NIH unless otherwise indicated)

Section on Neural Membranes

ADELMAN, WILLIAM J., Chief

CLAY, JOHN R.

DEFELICE, LOUIS J., Emory University

DYRO, FRANCES M., Veterans Administration Medical Center

GOLDMAN, DAVID E., State University of New York, Binghamton

HODGE, ALAN J.

LEONARD, DOROTHY A.

MUELLER, RUTHANNE

RICE, ROBERT V., Carnegie-Mellon University

ROSLANSKY, PRISCILLA F., Bunting Institute of Radcliffe College

TYNDALE, CLYDE L.

VOLKMAN, MARY

WALTZ, RICHARD B.

Section on Neural Systems

ALKON, DANIEL L., Chief

ACOSTA-URQUIRDI, JUAN

COULTER, DOUG, Boston University

FARLEY, JOSEPH, Princeton University

GART, SERGE, University of Vermont

GOH, YASUMASA

HARRIGAN, JUNE F.

HAY, BRUCE

HILL, LENA

JACKLET, JON, State University of New York, Albany

KUZIRIAN, ALAN M.

KUZIRIAN, JEANNE

LEDERHENDLER, IZJA

LEIGHTON, STEPHEN, National Institutes of Health

LIMAN, EMILY, Princeton University

LING, LORRAINE, University of Minnesota

NEARY, JOSEPH T.

SHOUKIMAS, JONATHAN J.

STEELMAN, JAMES, Brown University

TENGLERSEN, LESLIE

WOOLF, THOMAS

LABORATORY FOR MARINE ANIMAL HEALTH

Director

LEIBOVITZ, LOUIS, New York State College of Veterinary Medicine

Staff

ABT, DONALD A., University of Pennsylvania

RICKARD, CHARLES C., Cornell University

STONE, AMY, Cornell University

LABORATORY OF SENSORY PHYSIOLOGY

Director

MACNICHOL, EDWARD F., JR.

Staff

COLLINS, BARBARA ANN
 COOK, PATRICIA B.
 CORNWALL, CARTER, Boston University School of Medicine
 CORSON, D. WESLEY
 FEIN ALAN
 HAROSI, FERENC I.
 HASHIMOTO, YOKO, Tokyo Women's Medical College
 LEVINE, JOSEPH S.
 LEVY, SIMON
 LIPETZ, LEO, Ohio State University
 MANSFIELD, RICHARD, Boston University School of Medicine
 PAYNE, RICHARD
 SZUTS, ETE ZOLTAN
 WALZ, BERND, University of Ulm, West Germany

NATIONAL FOUNDATION FOR CANCER RESEARCH

Director

SZENT-GYÖRGYI, ALBERT

Staff

GASCOYNE, PETER R. C.
 MCLAUGHLIN, JANE A.
 MEANY, RICHARD A.
 PETHIG, RONALD, University College of North Wales, U. K.

LABORATORY OF CARL J. BERG, JR.

Director

BERG, CARL J., JR.

Staff

ADAMS, NANCY
 ALATALO, PHILIP
 ORR, KATHERINE
 TURNER, RUTH D., Harvard University

LABORATORY OF D. EUGENE COPELAND

Director

COPELAND, D. EUGENE

LABORATORY OF JUDITH P. GRASSLE

Director

GRASSLE, JUDITH P.

Staff

GELFMAN, CECILIA
 MILLS, SUSAN

LABORATORY OF SHINYA INOUÉ

Director

INOUE, SHINYA, University of Pennsylvania/Marine Biological Laboratory

Staff

BROWN, CAROLYN, University of Pennsylvania

INOUE, THEODORE

LUTZ, DOUGLAS, University of Pennsylvania

WOODWARD, BERTHA M.

Visiting Investigators

HAMAGUCHI, YUKIHISA, Tokyo Institute of Technology

ORR, TIMOTHY, Albert Einstein School of Medicine

TILNEY, LEWIS G., University of Pennsylvania

WOODRUFF, RICHARD I., West Chester State College

LABORATORY OF ERIC KANDEL

Director

KANDEL, ERIC, Columbia University

Staff

CAPO, THOMAS, Columbia University

GREEN, ADAM, Southampton College

NADEAU, LLOYD, Boston University

PAIGE, JOHN A., Columbia University

PERRITT, SUSAN, Columbia University

SCHWARTZ, PETER

LABORATORY OF CAROL L. REINISCH

Director

REINISCH, CAROL L., Tufts University School of Veterinary Medicine

Staff

CHARLES, ANN M., Tufts University School of Veterinary Medicine

MORRIS, ELISABETH, Tufts University School of Veterinary Medicine

LABORATORY OF OSAMU SHIMOMURA

Director

SHIMOMURA, OSAMU, Princeton University

Staff

SHIMOMURA, AKEMI, Princeton University

LABORATORY OF RAYMOND E. STEPHENS

Director

STEPHENS, RAYMOND E., Marine Biological Laboratory/Boston University School of Medicine

Staff

PORTER, MARY E., Marine Biological Laboratory/University of Pennsylvania
 PRATT, MELANIE, Harvard Medical School
 STOMMEL, ELIJAH, Marine Biological Laboratory/Boston University School of Medicine
 SUPRENANT, KATHY, University of Virginia

LABORATORY OF NOEL DE TERRA

Director

DE TERRA, NOEL

LABORATORY OF J. RICHARD WHITTAKER

Director

WHITTAKER, J. RICHARD, Boston University/Marine Biological Laboratory

Staff (of Boston University)

CROWTHER, ROBERT
 LOESCHER, JANE L.
 MEEDEL, THOMAS H.

XII. HONORS

FRIDAY EVENING LECTURES

MARLER, PETER, Rockefeller University, January 8, "*Birdsong: Nature and Nurture Revised*"
 LLINAS, RODOLFO, New York University Medical Center, January 15, "*Role of Calcium in Synaptic Transmission*"
 GITLER, CARLOS, Weizmann Institute of Science, June 25, "*Entamoeba histolytica—A Remarkable Beast*"
 ATEMA, JELLA, Boston University, Marine Biological Laboratory, July 2, "*To Be a Lobster: The Biology of an Individual*"
 DAVIS, BERNARD, Harvard Medical School, July 9, "*Is Evolution Falsifiable?*"
 MOSCONA, ARON, University of Chicago, July 16, Zwilling Lecture, "*Embryology Revisited: Cell Interactions in Morphogenesis and Differentiation*"
 AGUAYO, ALBERTO, Montreal General Hospital, McGill University, July 22, 23, Forbes Lectures, I. "*Has the Mammalian CNS Lost its Capacity for Axonal Regeneration?*" II. "*Inherited Myelin Disorders of Mice and Men*"
 EISINGER, JOSEF, Bell Laboratories, July 30, "*Lead Astray*"
 NEHER, ERWIN, Max Planck Institute, August 6, "*Currents Flowing Through Individual Ionic Channels in Nerve and Muscle Membrane*"
 TRELSTAD, ROBERT, Rutgers University Medical School, August 13, Edds Lecture, "*Morphogenetic Musings While Peering Through a Spiraling Collagenous Lattice*"
 LLINAS, RODOLFO, New York University Medical Center, August 20, Lang Lecture, "*Of Neurons, Brains and Movement*"
 WORCEL, ABRAHAM, University of Rochester, August 27, "*Chromatin Structure of Genes*"

ASSOCIATES' LECTURE

ATKINS, ELISHA, Yale University, August 14, "*Bird Migration: Facts and Fancies*"

JOSIAH MACY, JR., FOUNDATION SCHOLARS

BRYANT, VIVIAN, Benedict College
 HAZELL, RHONDA, Fairleigh Dickinson University
 JOHNSON, KIMBERLY, Xavier University
 KELLY, HERBERT, Dillard University
 MELVIN, WILLIE, Texas Southern University
 WASHINGTON, SHEILA, Dillard University

STEPS TOWARD INDEPENDENCE FELLOWS

ANDERSON, PETER, Whitney Marine Laboratory
 COSTELLO, WALTER, College of Osteopathic Medicine, Ohio University
 DYBAS, LINDA, Knox College
 HILL, SUSAN, Michigan State University
 MIYAMOTO, DAVID, Seton Hall University
 OBAID, ANA, University of Pennsylvania School of Dental Medicine
 SCHNEIDER, E. GAYLE, University of Nebraska Medical Center
 SLUDER, GREENFIELD, Worcester Foundation for Experimental Biology
 TUCKER, EDWARD, Vassar College
 ZIMMERMAN, ROGER, Rush University

GARY N. CALKINS MEMORIAL SCHOLARSHIP

ANMUTH, CRAIG, Oberlin College
 DOETKOTT, CURT, North Dakota State University
 MARZOLF, ERICH, Colorado College

FRANCES S. CLAFF MEMORIAL SCHOLARSHIP

MARLER, JENNIFER, McGill University, Canada
 NICOL, DIANNE, Dalhousie University, Canada
 RANKIN, CATHERINE, City University of New York
 WILSON, LINDA, University of Texas at Austin

EDWIN GRANT CONKLIN MEMORIAL SCHOLARSHIP

MARZOLF, ERICH, Colorado College

LUCRETIA CROCKER SCHOLARSHIPS

ABAD, MARK, University of Chicago
 BROWN, ALEXIS, California State University at Dominguez Hills
 LESK, MARK, McGill University, Canada
 MARLER, JENNIFER, McGill University, Canada
 MARZOLF, ERICH, Colorado College
 MORROW, LAURA, University of Texas at Austin
 NICOL, DIANNE, Dalhousie University, Canada
 SMITH, ROBERT, University of Chicago
 ST. JOHNSTON, DANIEL, Harvard University

FOUNDERS SCHOLARSHIPS

In 1982, these Scholarships were given in memory of:

W. E. GARREY
CASWELL GRAVE
L. V. HEILBRUNN
J. LOEB
O. LOEWI

S. O. MAST
T. H. MORGAN
A. H. STURTEVANT
E. WITSCHI

Recipients:

ABAD, MARK, University of Chicago
BROWN, ALEXIS, California State University at Dominguez Hills
HOUGAN, LINDA, McGill University, Canada
LESK, MARK, McGill University, Canada
MARLER, JENNIFER, McGill University, Canada
MARZOLF, ERICH, Colorado College
NICOL, DIANNE, Dalhousie University, Canada
OLSEN, SCOTT, Lehigh University
REHDER, VINCENT, Free University of Berlin, Germany
REVELAS, EUGENE, State University of New York at Stony Brook
ST. JOHNSTON, DANIEL, Harvard University
WILSON, LINDA, University of Texas at Austin

ALINE D. GROSS SCHOLARSHIP

HOUGAN, LINDA, McGill University, Canada
MORROW, LAURA, University of Texas at Austin
RANKIN, CATHERINE, City University of New York

MERKEL H. JACOBS SCHOLARSHIP

STODDARD, JEFFREY, University of Wisconsin at Madison

ARTHUR KLORFEIN FUND

DAVID, SAMUEL, Montreal General Hospital, Canada
DOETKOTT, CURT, North Dakota State University
HISHINUMA, AKIRA, Columbia University
NAWROCKI, LEON, University of Oregon
PIRES, ANTHONY, Harvard College
SENIE, ALLYSON, Ithaca College
SMITH, ROBERT, University of Chicago
TREGGOR, JOSEF, Central Connecticut State College
WEISSBURG, MARC, University of California at Berkeley

JAMES S. MOUNTAIN MEMORIAL FUND, INC. SCHOLARSHIP

CONZELMAN, KAREN, Yale University
FRANCIS, RALPH, Oregon State University
MORGANELLI, CHRISTINE, Dartmouth College
RAUSCH, DIANNE, Northwestern University

SOCIETY OF GENERAL PHYSIOLOGISTS

HOCH, DAVID, Albert Einstein College of Medicine
 ST. JOHNSTON, DANIEL, Harvard University
 WILLIAMS, BENJAMIN, Yale University

XIII. INSTITUTIONS REPRESENTED

U.S.A.

Alabama, University of	California, University of, Irvine
Albany, Veterans Administration Hospital	California, University of, La Jolla
Albert Einstein College of Medicine	California, University of, Los Angeles
American Cyanamid Company	California, University of, Los Angeles, Medical School
American Museum of Natural History	California, University of, Riverside
Amherst College	California, University of, San Francisco
Anderson Hospital and Tumor Institute, M. D.	California, University of, Santa Barbara
Argonne National Laboratory	California, University of, Santa Cruz
Arizona, University of	California, University of, School of Pharmacy
Arizona State University	Capitol University
Arkansas, University of	Cancer Research Institute
Associated Universities, Inc.	Carleton College
Avon Products, Inc.	Carnegie Institution of Washington
Baltimore City Hospital	Carnegie Mellon University
Barnard College	Case Western Reserve University
Barrow Neurological Institute	Case Western Reserve University, School of Medicine
Bates College	Catholic University of America
Battelle Marine Research Laboratory	Central Connecticut State College
Baylor College, School of Medicine	Chesapeake Bay Institute
Bell Laboratories	Chicago, University of
Benedict College	Chicago, Veterans Administration Medical Center
Bio Labs	Childrens Hospital
Biological Science Center	Cincinnati, University of
Boston College	Cincinnati, University of, Medical Center
Boston City Hospital	City of Hope Medical Center
Boston Company, The	Claremont McKenna College
Boston University	Clark University
Boston University, School of Medicine	Clarkson College
Bowdoin College	Cleveland Clinic Foundation
Bowman Gray School of Medicine	Colby College
Brandeis University	Cold Spring Harbor Laboratory
Brigham and Women's Hospital	Colorado College
Brock University	Colorado State University
Brookhaven National Laboratory	Colorado Video
Brooklyn, Veterans Administration Hospital	Columbia University
Brown University	Columbia University, College of Physicians and Surgeons
Buxton School	Columbia University, Eye Institute
California Institute of Technology	Connecticut, University of
California State University, Dominguez Hills	Connecticut, University of, Health Center
California State University, Fullerton	Connecticut, University of, School of Medicine
California, University of, Berkeley	Cornell University
California, University of, Davis	

- Cornell University, Boyce Thompson
 Institute
 Cornell University Medical College
 Crimson Camera Technical Sales, Inc.
- DAGE-MTI
 Dartmouth College
 Dartmouth Medical School
 Datacopy Corporation
 Kenneth Dawson Company
 Dayton, University of
 Deep Sea Research
 Delaware, University of
 Dillard University
 Drew University
 Duke University
 Duke University Medical Center
 Dupont Corporation
- Earlham College
 Eastern Maine Medical Center
 Eisenhower College
 Emory University
- Fairleigh Dickinson University
 Fanueil Hall Associates
 Federated Department Stores
 Federation of American Societies for
 Experimental Biology
 Florida State University
 Florida, University of
 Florida, University of, College of Medicine
 Florida, University of, Whitney
 Marine Laboratories
 Franklin and Marshall College
 Frederick Cancer Research Facility
- Gaston Snow Beekman and Bogue
 General Electric Research and
 Development Center
 George Mason University
 George Washington University
 Medical Center
 Georgetown University, Medical
 and Dental Schools
 Georgia, University of
 Georgia Institute of Technology
 Gerontology Research Center
 Gillette Company
 Gonzaga University
 Goucher College
 W. R. Grace Company
 Grass Foundation, The
- Hahnemann Medical Center
 Hamamatsu Systems, Inc.
- Harvard Medical School
 Harvard School of Dental Medicine
 Harvard School of Public Health
 Harvard University
 Harvard University, The Biological
 Laboratories
 Haskins Laboratories
 Hawaii, University of
 High Voltage Engineering Corporation
 Hollins College
 Hopkins Marine Station, Stanford
 University
 Houghton Mifflin Company
 Howard University
- Illinois Institute of Technology
 Illinois, University of
 Illinois, University of, College of Medicine
 Immaculata College
 Indiana University
 Indiana University, School of
 Experimental Medicine
 Instar Institute
 Institute for Basic Research in
 Developmental Disabilities
 Institute for Fundamental Studies, New
 York
 Institute for Medical Research, California
 Iowa State University
 Iowa, University of
 Ithaca College
- Johns Hopkins University
 Johns Hopkins University, School of
 Hygiene and Public Health
 Johns Hopkins University, School
 of Medicine
- Kansas State University
 Kansas, University of
 Kean College of New Jersey
 Keene State College
 Kentucky, University of
 Kentucky, University of, Medical Center
 Kentucky, University of, Tobacco and
 Health Research Institute
 Kenyon College
 Kewalo Marine Laboratory
 Knox College
 Kresge Eye Institute
 Kutztown State College
- Laboratory of Comparative Biochemistry
 Lafayette College
 Lazard Freres and Company
 Lehigh University

- Leitz, Inc.
 Arthur D. Little, Inc.
 Louisiana State University
 Louisville, University of
 Louisville, University of, School of
 Dentistry
 Lowell, University of
 Luther College
- Macalester College
 Magee Women's Hospital
 Maine, University of
 Maine, University of, Farmington
 Manhattanville College
 Marine Research, Inc.
 Marquette University
 Maryland, University of
 Maryland, University of, School of
 Medicine
 Massachusetts Eye and Ear Infirmary
 Massachusetts General Hospital
 Massachusetts Institute of Technology
 Massachusetts, University of, Amherst
 Massachusetts, University of, Boston
 Massachusetts, University of, Medical
 School
 Mayo Clinic
 Medical College of Georgia
 Medical College of Ohio
 Medical College of Wisconsin
 Medical University of South Carolina
 Richard King Mellon Foundation
 Mellon Institute
 Mercene Cancer Research Hospital of
 Saint Raphael
 Merck, Sharp and Dome Research
 Laboratories
 Mercy College
 Meredith and Grew, Inc.
 Miami, University of
 Miami, University of, School of Medicine
 Miami University
 Michigan State University
 Michigan, University of, Dental Research
 Institute
 Michigan, University of
 Minnesota, University of
 Miriam Hospital
 Mississippi, University of, Medical Center
 Missouri, University of
 Missouri, University of, School of Dentistry
 Mohawk Carpets
 Monell Chemical Senses Center
 Monsanto Company
 Morehouse College, School of Medicine
 Mount Holyoke College
 Mount Sinai School of Medicine
- NINCDS, Neurological Disorders Program
 National Academy of Engineering
 National Eye Institute
 National Institute on Alcohol Abuse and
 Alcoholism
 National Institute of Environmental Health
 Sciences
 National Institutes of Health
 National Jewish Hospital and Research
 Center
 National Marine Fisheries Service
 National Multiple Sclerosis Society
 National Science Foundation
 Naval Medical Research Institute
 Nebraska, University of
 Nebraska, University of Medical Center
 Neurological Institute
 New College of California
 New Hampshire, University of
 New Jersey Medical School
 New Mexico, University of, School of
 Medicine
 New York Blood Center, The
 New York, City University of, Brooklyn
 College
 New York, City University of, City College
 New York, City University of, Hunter
 College
 New York, City University of, Herbert
 Lehman College
 New York Institute for Basic Research in
 Mental Retardation
 New York Medical College
 New York State College of Veterinary
 Medicine
 New York, State University of, Albany
 New York, State University of,
 Binghamton
 New York, State University of, Buffalo
 New York, State University of, Potsdam
 New York, State University of, Downstate
 Medical Center, Brooklyn
 New York, State University of, Marine
 Sciences Research Center
 New York, State University of, Stonybrook
 New York, State University of, Syracuse
 New York, State University of, Upstate
 Medical Center
 New York University, College of Dentistry
 New York University, School of Medicine
 Nikon, Inc.
 North Carolina State University
 North Carolina, University of, School of
 Medicine
 North Dakota State University
 Northeastern University
 Northeastern Illinois University

Northeastern Ohio University, College of
Medicine
Northern Colorado, University of
Northwestern University
Northwestern University Medical School
Notre Dame, University of

Oak Ridge National Laboratory
Oakland University
Oberlin College
Ohio State University
Ohio University, College of Medicine
Ohio University, College of Osteopathic
Medicine
Oklahoma, University of
Olympus Corporation of America
Opti-Quip, Inc.
Oregon State University
Oregon, University of
Oregon, University of, Institute of
Neurosciences

Pacific University
Payne Laboratories
Pennsylvania, Medical College of
Pennsylvania State University
Pennsylvania, University of
Pennsylvania, University of, Hospital
Pennsylvania, University of, School of
Dental Medicine
Pennsylvania, University of, School of
Medicine
Pennsylvania, University of, School of
Veterinary Medicine
Pittsburgh, University of
Pittsburgh, University of, Bradford
Pittsburgh, University of, School of
Medicine
Pomona College
Population Council
Portland State University
Princeton University
Procter and Gamble Company
Public Health Research Institute
Puerto Rico, University of
Purdue University

Radcliffe College
Rainbow Babies and Children's Hospital
Reed College
Rhode Island, University of
Rice University
Rochester, University of
Rochester, University of, School of
Medicine and Dentistry
Rockefeller Foundation, The

Rockefeller University
Roosevelt University
Rush Medical College
Rush University
Russell Sage College
Rutgers—The State University of New
Jersey
Rutgers University, College of Medicine
and Dentistry
Rutgers University Medical Center
Rutgers University, Waksman Institute for
Microbiology

Saint Joseph's Hospital
Saint Jude Childrens Research Hospital
Saint Peter's College
San Francisco, Veterans Administration
Hospital
Sandoz, Inc.
Sarah Lawrence College
Savannah River Ecology Program
Science Software Systems, Inc.
Scientific American
Scripps Institute of Oceanography
Seapuit, Inc.
Seattle Pacific University
Seiler Instrument Company
Seton Hall University
Sidney Farber Cancer Center
Smith, Kline and French
Smithsonian Institution
South Florida, University of
Southampton College
Southeastern Massachusetts University
Southern California, University of, School
of Medicine
Southern Mississippi, University of
Stanford University
Stonehill College
Swarthmore College
Syracuse University

Tech Plus
Technicon Instruments Corporation
Temple University
Temple University Medical School
Tennessee, University of
Texas, University of, Austin
Texas, University of, Galveston
Texas, University of, Medical School
Texas A and M University
Texas Christian University
Texas Southern University
Toledo, University of
Tousimis Research Corporation
Trinity College

Tufts University
 Tufts University School of Medicine
 Tufts University School of Veterinary
 Medicine
 Tulane University
 Tuskegee Institute

Union College
 Union University
 United States Army, Natick Research and
 Development Laboratories
 University Hospital of Cleveland
 Upjohn Company

Vanderbilt University School of Medicine
 Vassar College
 Venus Scientific
 Vermont, University of
 Vermont, University of, College of
 Medicine
 Virginia Polytechnical Institute
 Virginia, University of
 Virginia, University of, School of Medicine

Wake Forest University
 Walla Walla College

Washington State University
 Washington University
 Washington University School of Medicine
 Wauwinet Shellfish Company
 Wayne State University
 Weissman Institute of Sciences
 Wellington Management Company
 Wesleyan University
 West Chester State College
 Western Washington State College
 William and Mary, College of
 Wisconsin, University of
 Wisconsin, University of, Madison
 Woodrow Wilson International Center for
 Scholars
 Woods Hole Oceanographic Institution
 Worcester Foundation for Experimental
 Biology

Xavier University

Yale University
 Yale University Medical School

Carl Zeiss, Inc.

FOREIGN INSTITUTIONS

Aberdeen, University of, Scotland
 Acadia, University of, Canada
 Alberta, University of, Canada
 Athens, University of, Greece
 Basel, University of, Switzerland
 Bergen, University of, Norway
 Bermuda Biological Station, England
 Biozentrum der Universitat, Switzerland
 Calgary, University of, Canada
 Cambridge, University of, England
 Centro de Biofisica, Venezuela
 Centro de Investigacion y de Estudios
 Avanzados, Mexico
 Ciba Geigy Pharmaceuticals Division,
 England
 Dalhousie University, Canada
 Dundee, The University of, Scotland
 Ecole Normale Supérieure, France
 Federal University of Brasilia, Brazil
 Flinders University, South Australia
 Foreign and Commonwealth Office,
 England
 Free University of Berlin, West Germany
 Freiburg, University of, West Germany
 Fundacao Oswaldo Cruz, Brazil
 Geneva, University of, Switzerland

Glasgow, University of, Scotland
 Hebrew University, Israel
 Ibadan, University of, Nigeria
 Instituto de Biofisica, Brazil
 Instituto de Investigacion Medica,
 Argentina
 Institut Pasteur, France
 Instituto Venezolano de Investigaciones
 Cientificas, Venezuela
 International Institute for Genetics and
 Biophysics, Italy
 Israel Institute of Technology, Israel
 Janssen Pharmaceutical Laboratory of
 Oncology, Belgium
 Jeonptik Jena G. m. b. H., West Germany
 Jerusalem, University of, Israel
 King's College, England
 Kobe University, Japan
 Lancaster, University of, England
 Latrobe University, Australia
 Leeds, University of, England
 Liverpool School of Tropical Medicine,
 England
 Marine Ecology Laboratory, Canada
 Max-Planck Institute, West Germany
 McGill University, Canada

McGill University Cancer Center, Canada	Station Marine D'Endoume, France
McMaster University, Canada	Stazione Zoologica, Naples, Italy
Medical Research Council, England	Stockholm, University of, Wenner-Gren Institute, Sweden
Milan, University of, Italy	Tel Aviv University, Israel
Montreal General Hospital, Canada	Tokyo Institute of Technology, Japan
Nagoya University, Sugashima Marine Biological Laboratory, Japan	Tokyo Metropolitan Union, Japan
National Institute for Basic Biology, Japan	Tokyo Women's Medical College, Japan
Newfoundland, Memorial University of, Canada	Toronto, University of, Canada
North Wales, University College of, Wales	Ulm, University of, West Germany
Northwestern Regional Health Authority, England	Universidad Peruana Cayetano Heredia, Peru
Odense University, Sweden	Universitats Augenklinik, West Germany
Open University Research Unit, The, England	Universitats de Geneve, Switzerland
Ottawa, University of, Canada	Universite Laval, Canada
Ottawa, University of, Faculty of Medicine, Canada	University Hospital and Medical School, England
Oxford, University of, England	Utrecht, University of, Netherlands
Queen Mary College, England	Weiterbildungsschule/Diplommittelschule des Kantons Zug, Switzerland
Research Institute for Diseases in a Tropical Environment, South Africa	Weizmann Institute of Science, Israel
Scarborough College, Canada	Wellcome Trust Research Laboratories, Africa
Sevilla, University of, Spain	West Indies, University of, West Indies
Sheffield, University of, England	West Indies Laboratory, Virgin Islands

XIV. LABORATORY SUPPORT STAFF
Including Persons Who Joined or Left the Staff During 1982

Controller's Office

SPEER, JOHN W., Contoller
BINDA, ELLEN F.
CAMPBELL, RUTH B.
DAVIS, DORIS C.
ELLIS, NANCY L.

FERDINAND, SUSAN M.
HOBBS, ROGER W., JR
HOUGH, ROSE A.
WICHTERMAN, MARGARET

Director's Office

GROSS, PAUL R., President and Director
THIMAS, LISA MARIE

Associate Director's Office

PALMER, DOUGLAS, W., Associate Director
ZIEMER, CAROL ANN

General Manager's Office

SMITH, HOMER P., General Manager
BAKER, KAREN H.
BUTZ, FLORENCE S.

GEGGATT, AGNES L.
JOHNSON, FRANCES N.
ZIEMER, CAROL ANN

Development Office

SALGUERO, CAROL GANNON, Development Officer	WEISS, M. NAN
SCARBOROUGH, BONNIE M.	

Grants and Educational Services

HOWARD, JOAN E., Coordinator of Grants and Educational Services
 MASER, MORTON D., Assistant Director for Educational and Research Services
 ALLEN, GENEVIEVE
 FERZOLO, SUSAN J.

FOLEY, JOANNE A.
 LEIGHTON, JANE L.

Public Relations Office

HASKELL, BARBARA, Public Relations Officer
 CAMPBELL, LEE ANNE

CORBETT, MARGUERITE

Biological Bulletin

METZ, CHARLES B., Editor
 CLAPP, PAMELA L.

LANG, HELEN E.
 MOUNTFORD, REBECCA J.

Buildings and Grounds

GUNNING, A. ROBERT, Superintendent
 ANDERSON, LEWIS B.
 AVERETT, DONALD L.
 BALDIC, DAVID
 BERRIOS, HECTOR
 BERRIOS, JOSE R.
 BOURGOIN, LEE E.
 BRODERICK, MADELINE
 CAFARELLI, PETER A.
 CARINI, ROBERT J.
 COSTA, ROBERT A.
 DAVIS, MARK A.
 DEVEER, ROBERT L.
 DUTRA, STEVEN J.
 ENOS, GLENN R.
 EVANS, FRANCES G.
 FISH, STEPHEN
 FUGLISTER, CHARLES K.
 GEGGATT, RICHARD E., JR.
 GONSALVES, WALTER W., JR.
 IRISH, BRADFORD, D.

KLEINDINST, THOMAS N.
 KUIL, ELISABETH
 LEHY, DONALD B.
 LEWIS, RALPH H.
 LOCHHEAD, WILLIAM M.
 LOVERING, RICHARD A.
 LUNN, ALAN G.
 MACLEOD, JOHN B.
 MILLS, STEPHEN A.
 PELLIS, STANLEY
 REZENDES, PATRICK M.
 ST. JEAN, SIMONE
 SMART, MERILYN A.
 THRASHER, FREDERICK
 TORRES, DAVID E.
 VARAO, JOHN
 WARD, FREDERICK
 WEEKS, GORDON W.
 WHETHAM, CHARLES
 WHITTAKER, WILLIAM

Gray Museum

TIFFNEY, WESLEY, N., Curator
 BORETOS, C. DIANE
 BUSH, LOUISE

MONTIERO, EVA S.
 MOUL, EDWIN T.

Library

FESSENDEN, JANE, Librarian
 ASHMORE, JUDITH A.
 COOMBS, ROXANE
 DEVEER, JOSEPH M.
 GIBBONS, ROBERTO G.
 GRICE, JOAN H.
 HANLFY, JANICE S.

HOUGH, NANCY L.
 JOSEPH, E. LENORA
 MARGOLIN, JILL
 MOUNTFORD, REBECCA J.
 NORTON, CATHERINE N.
 SWAIN, LAUREL E.

Marine Resources

VALOIS, JOHN J., Manager
 CHILD, MALCOLM
 EARLY, JULIE
 ENOS, EDWARD G., JR.
 ENOS, JOYCE
 LAWDAY, LEWIS M.

MURPHY, CHARLES F.
 SMITH, A. DICKSON
 TASSINARI, EUGENE
 TRAPASSO, BRUNO
 VARAO, JOHN

Research Services

MASER, Morton D., Assistant Director for Educational and Research Services
 BARNES, FRANKLIN D.
 BARNES, JOHN S.
 EVANS, WILLIAM
 GOLDER, LINDA M.
 GOLDER, ROBERT J.
 KERR, LOUIS M.
 MARTIN, LOWELL V.
 NICHOLS, FRANCIS H., JR.
 SILVA, MARK S.
 SYLVIA, FRANK E.

Summer Support Staff

ALBERS, CHRISTINA E.
 ANDERSON, JANICE
 ASCI, MARGUERITE M.
 ASHMORE, JILL M.
 ASHMORE, MICHAEL W.
 BAKER, LISA B.
 BLACK, ROBERT W.
 BLAIR, RICHARD
 BLAKE, ANN
 BRINKMAN, PAULA
 COOMBS, GILLIAN
 COTRAN, NINA M.
 COURTRIGHT, MARYA J.
 CRONEY, MICHAELA
 CUSHMAN, BROOKE
 GREENE, AMY L.
 HAHN, ERIKA
 HAMMAR, KATHERINE M.
 HANSON, ANTHONY
 JOHNSON, JEFFREY
 KELLY, MICHAEL
 LAUTHER, GARY B.
 LEE, JAMES M.

LUNN, JEFFREY R.
 MACKEY, WILLIAM T.
 MAXWELL, BRETT
 MELLON, ARMOUR N.
 MICHAUD, JAYNE
 NADEAU, LLOYD J.
 PIERCE, RICHARD T.
 RENEK, NAOMI
 ROONEY, COLLEEN M.
 ROONEY, MARK
 ROONEY, MICHELE N.
 RUSHFORTH, LORNA A.
 SCUTT, DIANE H.
 SEGAL, JENNIFER A.
 SENFT, VALERIE
 SWOPE, STEPHEN P.
 TARBELL, LESLIE
 VALOIS, FRANCIS X.
 VINITSKY, ALEXANDER
 WARNER, ANNE P.
 WETZEL, ERNEST D.
 WHITTAKER, WILLIAM A.
 WYTTEBACH, ROBERT

IRON ACCUMULATION IN TUNICATE BLOOD CELLS. I.
DISTRIBUTION AND OXIDATION STATE OF IRON IN THE BLOOD
OF *BOLTENIA OVIFERA*, *STYELA CLAVA*,
AND *MOLGULA MANHATTENSIS*

MARIA I. AGUDELO¹, KENNETH KUSTIN^{1*}, GUY C. MCLEOD²,
WILLIAM E. ROBINSON², AND ROBERT T. WANG³

¹*Department of Chemistry, Brandeis University, Waltham, MA 02254;* ²*Harold E. Edgerton Research Laboratory, New England Aquarium, Boston, MA 02110;* ³*Department of Chemistry, Salem State College, Salem, MA 01970*

ABSTRACT

The iron concentration, oxidation state, and distribution in blood plasma and blood cells of three iron containing tunicates were determined. Preliminary studies are reported on the possible role of plasma proteins in iron uptake.

Iron(II) concentration in the millimolar range was found in the blood cell cytoplasm of all three species; no iron(III) in solution was detected in blood cells. Over 70% of the total iron in the cells is associated with the membranes.

Although the iron concentration in *S. clava* blood cells is substantially greater than that in *B. ovifera* cells, the iron to protein ratio by weight is similar in both species. SDS-electrophoresis of *B. ovifera* blood showed two protein subunits common to both plasma and blood cells. These two subunits are most likely the major components of the high molecular weight protein found in the plasma. This protein was shown to bind iron(III) when iron(III) citrate was added to the plasma.

INTRODUCTION

Mechanisms of metal ion transport and accumulation in living cells are now being investigated by new techniques (Marx and Aisen, 1981; Anderson and Morel, 1982), and new tools such as extended x-ray absorption fine structure, EXAFS (Tullius *et al.*, 1980). Of the essential metallic elements, iron presents one of the most difficult systems to study in terms of elementary steps at the organism/environment and cell/plasma barriers. Studies with bacteria (Emery, 1982) provide detailed information on elementary steps in uptake, although information on comparable processes in animals still remain obscure. Studies with tunicates have the potential to clarify several steps in the accumulation process.

Tunicates (class Ascidiacea) accumulate relatively high concentrations of selected metal ions in certain blood cells. Best known is the ability of members of the order Enterogona to accumulate vanadium (Millar, 1966; Swinehart *et al.*, 1974). We have identified several elementary steps in the selective vanadium uptake mechanism and a model for this process has been constructed (Dingley *et al.*, 1981). We have recently extended our investigations to include iron accumulating Pleurogona (Agudelo *et al.*, 1982; Agudelo *et al.*, 1983). In this paper we begin our analysis of the iron accumulation mechanism by detailing the distribution, concentration, and oxidation

Received 21 March 1983; accepted 25 May 1983.

Abbreviations. TEMED, N,N,N',N'-Tetramethylethylenediamine; SDS, sodium dodecyl sulfate; Bis, N,N'-Methylene-bis-acrylamide.

* Author to whom all correspondence should be sent.

state of the element in the blood of three iron-accumulating ascidians.

The iron concentration in these species is about one to two orders of magnitude less than that of the vanadium concentration in vanadium-containing tunicates. However, the iron concentration gradient is still very large, when compared with the iron in the aqueous phase of sea water. Like the *Enterogona*, the *Pleurogona* contain similar blood cell types, as well as tunichrome (Macara *et al.*, 1979).

MATERIALS AND METHODS

Materials

NaCl, BaCl₂, K₃Fe(CN)₆, K₄Fe(CN)₆, KSCN, 1,10-phenanthroline, hydrochloric acid, acetic acid, nitric acid, glycerine, and bromophenol blue dye were purchased from Fisher Scientific Co.

Sephadex G-75 and blue dextran were purchased from Pharmacia Fine Chemicals.

Acrylamide, Tris buffer, TEMED, SDS-MW70 molecular weight markers kit, albumin total protein standards and OsO₄ were obtained from Sigma Chemical.

Bis, Coomassie brilliant blue, glycine, ammonium persulfate, and 2-mercaptoethanol were obtained from Bio-Rad Laboratories.

ACS aqueous counting scintillant was obtained from Amersham Corporation.

⁵⁵FeCl₃ was obtained from New England Nuclear.

2,2'-bipyridine was obtained from Mallinckrodt and ascorbic acid from Schwarz/Mann, Inc.

All chemicals were used without further purification.

Specimens

Boltenia ovifera was collected by divers off East Point, Nahant, MA at 20 m depth. *Styela clava* was obtained from the Boston Harbor; *Molgula manhattensis* was purchased from Marine Biological Laboratory, Woods Hole, MA. Animals were all maintained in running sea water at 5–10°C. Blood of *B. ovifera* and *S. clava* was extracted as described previously (Agudelo *et al.*, 1982). Blood of *M. manhattensis* was obtained by cutting the tunic at the base of the animal and allowing the blood to drip into a test tube. Blood cell types were classified according to the criteria summarized by Wright (1981). Blood cells were fixed and stained with osmium tetroxide vapors (Kalk, 1963).

Blood cells were separated from the plasma by centrifuging at 1200 g for five minutes. Plasma was frozen for later analysis; cells were used immediately.

Iron oxidation state and concentration

For the oxidation state analysis of blood, cell samples were treated with 6*N* HCl, heated in a boiling water bath for five minutes and centrifuged at 18,400 g for twenty-five minutes. For plasma, the centrifugation step was omitted.

Total iron concentration in blood cells was determined by using a Perkin Elmer Model 305 atomic absorption spectrometer. The reduced iron concentration inside the cells was obtained by lysing the cells in 6*N* HCl and adding excess 1,10-phenanthroline. The Fe(Phen)₃²⁺ absorbance was measured at 510 nm using a Perkin Elmer 552A uv/vis spectrophotometer. The molar absorptivity coefficient of the tris(1,10-phenanthroline) iron(II) complex at 510 nm, pH 1 (HCl) and room temperature was determined to be $7.6 \times 10^3 \text{ cm}^{-1} \text{ M}^{-1}$.

The calculation of total cell volume in blood cell samples was based on the assumption of spherical cells with mean cell diameter 16 μm, and cell counts using

a Levy-Hausser Hemocytometer. Total protein content was determined by the Lowry method (Lowry *et al.*, 1951).

Electron paramagnetic resonance

Electron paramagnetic resonance (EPR) experiments were carried out at room temperature on a previously described spectrometer (Dingley *et al.*, 1981). The fluoride method (Levanon *et al.*, 1968) was used to gain maximum sensitivity in the detection of iron(III). The spectrometer settings for this experiment were: 9.55 GHz, 9mW power, time constant 1 s., modular amplitude 5.0, gain 12.5. Under these conditions, the minimum amount of iron(III) we could detect was approximately 10 micromoles. Concentrated solutions (approximately 1.3 M) of ammonium fluoride (NH_4F) were added to freshly drawn samples of blood producing a dilution factor of about one-third. The final pH was 6.5. This treatment ensured that the blood cells in the EPR tube were as intact as possible, and that the large excess of fluoride would convert even tightly chelated intracellular iron in solution to the FeF_6^{3-} form.

Chromatography and electrophoresis

The water soluble proteins in the plasma and blood cell cytoplasm were run through a size exclusion chromatography column 30 cm long and 1.5 cm in diameter packed with Sephadex G-75. The eluent was 0.5 M sodium chloride and 0.02 M HCl. Absorbance at 280 nm was monitored continuously using an ISCO UA5 absorbance monitor. Fractions were collected automatically and analyzed for iron either by atomic absorption spectrometry or by adding an excess of 2,2'-bipyridine and ascorbic acid and measuring the absorbance of the iron(II)-bipyridine complex at 520 nm (Macara *et al.*, 1979). Column void volume (V_0) and bed volume (V_t) were determined using blue dextran and vitamin B_{12} respectively.

SDS-acrylamide gel electrophoresis of *B. ovifera* blood cells and plasma was carried out by the Laemmli method (Laemmli, 1970) using vertical gel slabs; β -lactoglobulin (18,400 d), trypsinogen (24,000 d), egg albumin (45,000 d), and bovine albumin (66,000 d) were used as molecular weight standards. The gels were fixed for twelve hours with 10% trichloroacetic acid, stained with 0.25% Coomassie brilliant blue dye for four hours, and destained with 7% acetic acid. Independent of the molecular weight determination, and in order to avoid denaturation, electrophoresis of the native proteins in the plasma was run excluding SDS.

RESULTS

In the first section we report the iron concentration in tunicate blood plasma and blood cells, the oxidation state of the iron, the iron distribution in the plasma, cytoplasm, and the cell membranes (no differentiation between cell and intracellular membranes was made). Protein distribution is reported in the second section.

Iron

The oxidation state of the iron present in solution can be established before a quantitative determination of the total iron content of the plasma and blood cells is carried out. The advantage to this approach is that once the predominant oxidation state of the iron is known, more than one method for total iron determination can be employed, and the results compared.

TABLE I

Oxidation state analysis of iron obtained from blood cell cytolysis

Test reagent	Tunicate species		
	<i>B. ovifera</i>	<i>S. clava</i>	<i>M. manhattensis</i>
1,10-phenanthroline	+	+	+
K ₃ Fe(CN) ₆	+	+	+
K ₄ Fe(CN) ₆	-	-	-
KSCN	-	-	-

The results of the oxidation state analysis of the iron in the cell lysates (cytoplasm) of all three species are tabulated in Table I. The oxidation state of the iron in blood cells is found to be in the Fe(II) form as was previously reported for *Pyura stolonifera* (Edean, 1955). No precipitation occurred when barium chloride was added to blood cell lysates, indicating the absence of sulfate. After applying the same test reagents, shown in Table I, to plasma of *S. clava* acidified with concentrated HCl, we find that both iron(II) and iron(III) are present. Addition of barium chloride gave a white precipitate.

Osmium tetroxide (OsO₄) vapors were used to localize regions of the blood cell with reducing ability. As indicated by the staining results (Table II), it is concluded that most of the reducing substances are found in the vacuolated cells; *i.e.*, morula, compartment, and signet ring cells. Amoebocytes also show some staining.

Several attempts were made to detect iron(III) by the EPR method. Since the sensitivity depends on the total number of spins in the spectrometer, hence the cell count, blood samples from two or three specimens were pooled. The characteristic seven line spectrum of the FeF₆³⁻ complex was not observed in any of these experiments.

Since we found no iron(III) by the available methods, total iron concentration within the cell was determined by the 1,10-phenanthroline method, which is specific for iron(II). The accuracy of this method is limited by the accuracy of the volume determination of the blood cells based on the estimated average cell diameter and total cell count (10-15% error). To simplify calculations, it is assumed that all cell types have equal amounts of iron. Total iron concentration determination using

TABLE II

Osmium tetroxide staining of blood cells

Cell type	Tunicate species		
	<i>B. ovifera</i>	<i>S. clava</i>	<i>M. manhattensis</i>
Morula cell vacuoles	+++ or -*	+++	+++
Compartment cell vacuoles	**	+++	+++
Signet ring cells	+++	NI	NI
Amoebocytes	+ or -	++	+++
Lymphocytes	-	-	+ or -

* Some vacuoles are stained others are not.

** A few stained vacuoles; in general, clear vacuoles and stained cytoplasm.

NI not identified in blood smears.

TABLE III

*Iron concentration in blood cells as determined in pooled samples**

Species	Method	
	Fe(Phen) ₃ ²⁺	AA
<i>B. ovifera</i>	1×10^{-3} M	6×10^{-3} M
<i>S. clava</i>	$5-9 \times 10^{-3}$ M	7×10^{-2} M
<i>M. manhattensis</i>	8×10^{-3} M	—

* Relative accuracy is limited by volume determination ($\pm 10-15\%$) and/or iron detection.

atomic absorption spectrometry (AA) is also dependent on cell volume and cell count determination. The results for both methods are shown in Table III. The iron content of the plasma as determined by AA was 1.6–1.8 ppm for *S. clava* and *B. ovifera*.

There is an order of magnitude difference in iron concentration in the blood cells by the two methods. This difference is greater than that expected from error in cell volume and cell count determinations. Procedural differences between iron analysis methods account for this observation. In the phenanthroline method the cell membranes are discarded, while in the atomic absorption analysis the whole cells are digested and analysed. Therefore a large fraction of the iron in the cells is associated with cell membranes.

To determine how much of the iron is found in the cytoplasm and in the cell membranes, the following analysis was carried out: the blood cells were lysed with distilled water, the lysate was separated from the membranes by centrifugation at 18,400 g for 30 min. The cell membranes were then resuspended in 0.1 N HCl, mixed thoroughly, and separated again by centrifugation at 18,400 g for 30 min. The membranes were then digested with concentrated nitric acid for 3–4 hours until a clear solution was obtained. The results of the iron analysis by atomic absorption of the cell lysate, 0.1 N HCl wash and digested membranes are tabulated as percent iron in Table IV.

As shown in Table IV, over 70% of the iron is bound to the cell membranes. The 0.1 N HCl wash removes any iron that might have precipitated during cell lysis with distilled water, as well as any loosely bound surface iron. Since most of the iron is found in association with cell membranes, volume concentration units are illusory. Analysis of the iron content per weight of protein was therefore carried out. The results yield 0.05 ± 0.01 $\mu\text{g Fe/mg protein}$ in the plasma, and 1.1 ± 0.2 $\mu\text{g Fe/mg protein}$ in blood cells of *B. ovifera*. In the blood of *S. clava* we found 0.14 ± 0.1 $\mu\text{g Fe/mg protein}$ in the plasma and 1.11 ± 0.05 $\mu\text{g Fe/mg protein}$ in blood cells.

TABLE IV

Relative iron distribution in blood cells as determined in pooled samples

Species	Cell lysate	HCl wash	Cell membranes
<i>B. ovifera</i> (1)	14%	—	86%
" (2)	2%	7%	91%
<i>S. clava</i>	11%	16%	73%

Proteins

Size exclusion chromatography of the cell lysate (cells lysed with 0.1 N HCl) gave an absorbance profile with two main peaks. One peak eluted at the exclusion limit, V_o (molecular weight greater than 75,000). The second peak eluted at the bed volume, V_i (molecular weight less than 3000), and is assigned to tunichrome (Macara *et al.*, 1979), which has a lower molecular weight. Iron was eluted with both the high molecular weight protein and tunichrome fractions, some iron was eluted after the tunichrome peak at a k_{ave} of 1.2.

Slightly different results were obtained in chromatography of the plasma. Only a high molecular weight protein peak was observed. In a few cases a low molecular weight peak, attributed to tunichrome, was also found, probably because of cell lysis during centrifugation. The iron concentration in the plasma is very low, 1.6–1.8 ppm, and no iron was detected in the high molecular weight protein fractions. A small amount of iron was detected at a k_{ave} of 1.2.

For a better characterization of the proteins in the plasma and the water insoluble proteins found in the cell membranes, SDS-acrylamide gel electrophoresis of *B. ovifera* blood cells and plasma was carried out using the Laemmli method. The protein subunits found in the plasma and the cell membranes are shown in Figure 1. With 10% acrylamide gel two main bands were observed for the plasma corre-

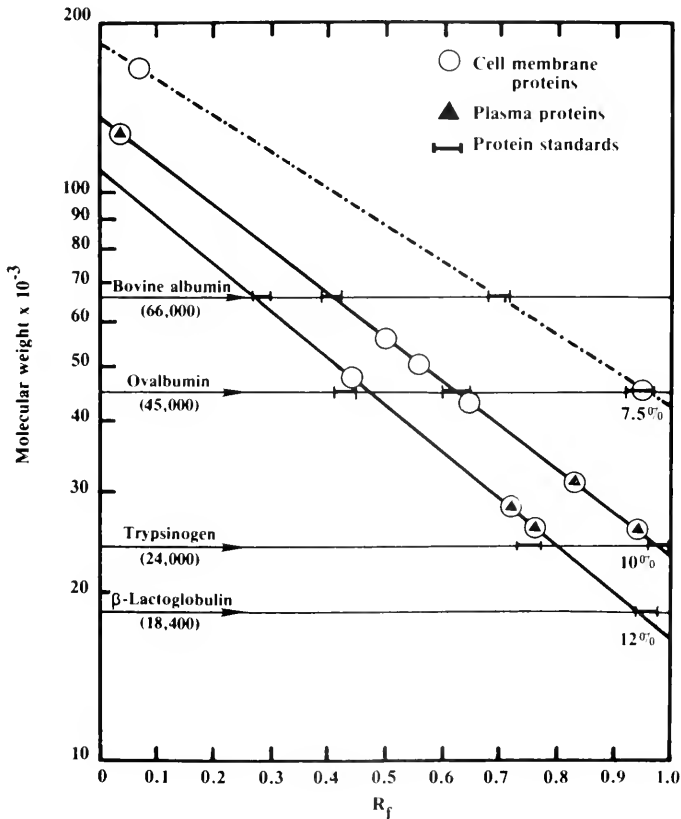

FIGURE 1. SDS-acrylamide gel electrophoresis (Laemmli method) of *B. ovifera* blood plasma (10% and 12% gels) and blood cells (7.5%, 10%, and 12% gels).

sponding to 31,000 and 26,000 d. The cell membrane samples showed a large number of proteins; only the most visible and clear bands are reported: a strong band at 130,000, two faint bands at 56,000, and 51,000; a strong band at 44,000, a medium band at 31,000, and a strong band at 26,000 d.

With 12% acrylamide gel results showed two bands for the plasma sample at molecular weights 28,000 and 26,500, which were also observed in the cell membranes. By referring to Figure 1, we see that these 12% acrylamide gel results correspond to the 31,000 and 26,000 bands in the 10% acrylamide gel experiment. These two bands are the only ones observed to occur in both the membranes and plasma. A strong band was also observed in the membrane sample at 48,000 d corresponding to the 45,000 d band observed in the 10% gel. The two faint bands observed at 56,000 and 51,000 with a 10% gel, and the 130,000 band were not observed.

To insure that the 130,000 molecular weight protein observed using a 10% acrylamide gel was not an artifact, a 7.5% acrylamide gel was run. Since no high molecular weight standards were available and our main concern was to determine the existence of a high molecular weight protein, and not its exact molecular weight, only two standards were used, bovine albumin and egg albumin. If a straight line is assumed to pass through the two molecular weight standards used when R_f values were plotted against $\log(\text{molecular weight})$ in Figure 1, the following conclusions can be drawn. The strong band observed at an R_f of 0.07 corresponds to an approximate molecular weight of 160,000, and the strong band observed at an R_f of 0.95 corresponds to a molecular weight of 45,000.

To determine the iron binding properties of the plasma proteins, we added to 1.0 ml of *B. ovifera* blood plasma 0.050 ml of an ^{55}Fe -citrate stock solution containing 1,000-fold excess citrate to prevent Fe(III) precipitation. The sample was allowed to stand for 15 minutes at 0°C . Gel electrophoresis of the native proteins was carried out, taking care not to denature the proteins by excluding SDS from the procedure, preventing any changes in the native protein configuration that would alter its Fe-binding properties. After the electrophoretic separation of the proteins, the gel was cut vertically into two pieces. One piece was fixed and stained as described in the methods section. To prevent any radioactive iron loss into the fixative solution, the other piece was not fixed. This gel was cut into 0.5 cm horizontal sections and analysed for ^{55}Fe by liquid scintillation counting. In the stained piece we observed one band. The largest ^{55}Fe activity was observed at the R_f value corresponding to this protein band, indicating that the native plasma protein has the ability to bind iron.

DISCUSSION

Oxidation state +2 predominates for iron found in the blood cell cytoplasm of the three ascidians *B. ovifera*, *S. clava*, and *M. manhattensis*. No iron in oxidation state +3 was detected. The blood plasma, however, contains both iron(II) and iron(III). This finding is not surprising; even if only iron(II) is present in the plasma, then as soon as the plasma is exposed to air, some of the iron will be oxidized to the +3 oxidation state. It is also possible that iron is in the +3 form in the plasma and is reduced as it goes into the cell. In this case, the +2 iron in the plasma arises from cell lysis, exchange, or leaching.

The iron concentration in blood cells varies from species to species, similar to the variation in vanadium concentration among vanadium-containing tunicates

(Hawkins, personal communication). Tunicates therefore accumulate iron against an approximately 10^5 – 10^6 concentration gradient (ratio of iron in tunicate blood cells, 10^{-3} – 10^{-2} M, to dissolved iron in sea water, 2×10^{-8} M (Kester *et al.*, 1975)).

Although there is considerable iron concentration in the cell cytoplasm, a large fraction of the total iron was found in the cell membranes (over 70%). We have not yet determined the oxidation state of the membrane-bound iron, which will require more complicated techniques than those we report in this paper.

The OsO_4 staining method has often been used to determine the metal ion distribution in cells (Henze, 1913; Edean, 1960; Kalk, 1963; Fuke, 1979). However, we encountered several problems in the interpretation of this method. OsO_4 is sensitive to many strong reducing agents. Along with Fe(II), tunicate blood cells contain tunichrome, a relatively strong reducing agent (Macara *et al.*, 1979) capable of reacting with OsO_4 to generate dark stains. There is also considerable variation in the results among similar cell types. Due to these considerations, OsO_4 staining leads us to conclude that there are one or more reducing agents (iron(II), tunichrome, or both) in the morula cell vacuoles of all three species as well as in compartment cell vacuoles. The staining of *B. ovifera* compartment cell cytoplasm and not vacuoles cannot be explained easily. Leaching of the vacuolar contents during the staining procedure would result in uniform staining throughout the cell. On the contrary, the vacuoles remained intact and clear, whereas the cytoplasm was stained deeply.

Metal ion content of blood cells is often given in volume-based concentration units, such as moles/liter (*e.g.*, Tullius *et al.*, 1980). However, since most of the iron is found in the cell membranes, and is probably associated with a specific protein, we find it more useful to report the iron content as μg Fe per mg of protein. With this unit we find a smaller difference in the iron concentrations of *B. ovifera* and *S. clava*; approximately 1 μg Fe/mg of protein in the blood cells of each species. This value is comparable to that of other iron-accumulating blood cells. For example, it is comparable to the concentration of 3.48 μg Fe/mg of protein in human erythrocytes if hemoglobin is used as the total protein content. The plasma value of 0.1–0.05 μg Fe/mg protein is higher than the value of 0.015 μg Fe/mg of protein in human plasma (Altman, 1961; Bishop and Surgenor, 1964).

Size exclusion chromatography of the cell lysate showed two main peaks: a high molecular weight protein that elutes at V_0 using Sephadex G-75, and a low molecular weight compound, tunichrome (Macara *et al.*, 1979). Iron was found in both peaks, and some iron was eluted after the second peak, probably free iron, because of the high acidity of the eluent.

Chromatography of the plasma resulted in the isolation of a high molecular weight protein; tunichrome was also observed in some cases, probably due to cell lysis during centrifugation. No iron was observed with the high molecular weight protein, however some iron was observed after the tunichrome peak.

In a comparative study on the distribution of metal ions in the plasma of ascidians *Pyura stolonifera* and *Ascidia ceratodes* (Hawkins *et al.*, 1980), results were obtained which relate closely to our experiments. In common with our study, their chromatography experiments show a protein that elutes at V_0 , and low molecular weight fractions that test positive for N-acetylaminosugar and negative for protein, and could be assigned to tunichrome. No iron was detected in the high molecular weight fraction. Some iron was found in the low molecular weight fractions when the eluent contained NaCl; however when distilled water was used as an eluent, no iron was detected. Although this result is explained as iron impurities in the NaCl, it is more likely that the iron binds to the gel due to the low ionic strength of the eluent (namely distilled water).

From SDS electrophoresis of the blood cells and plasma there are two protein components in the plasma that are found on the membranes as well (molecular weights 31,000 and 26,000 in the 10% acrylamide gel). These two components are probably obtained from the single denatured high molecular weight protein observed in gel chromatography of plasma proteins. Electrophoresis without SDS of the native plasma proteins yields one major protein band corroborating the chromatography results. Electrophoresis of plasma doped with iron(III)-citrate shows that this protein has an iron affinity high enough to compete with the citrate ligand. No attempt to determine the molecular weight of this ^{55}Fe -labeled protein was made.

Similar iron binding results were obtained by Webb and Chrystal (1981) using blood plasma of the ascidian *Herdmania momus* (order Pleurogona). However, in their experiments the iron(III) was added as iron chloride in 0.1 N HCl and then neutralized with bicarbonate. This procedure can cause the iron to precipitate or form high molecular weight iron hydroxide polymers in solution that could be eluted at the exclusion limit along with high molecular weight proteins.

ACKNOWLEDGMENTS

This research was supported in part by National Science Foundation Grant PCM-7824782, and in part by National Institutes of Health Grant HL-24225. We thank Mr. Paul Barrington for collecting *S. clava* for us.

LITERATURE CITED

- AGUDELO, M. I., K. KUSTIN, AND W. E. ROBINSON. 1982. Blood chemistry of *Boltenia ovifera*. *Comp. Biochem. Physiol.* 72A: 161-166.
- AGUDELO, M. I., K. KUSTIN, AND G. C. MCLEOD. 1983. The intracellular pH of the blood cells of the tunicate *Boltenia ovifera*. *Comp. Biochem. Physiol.* 75A: 211-214.
- ALTMAN, P. L. (comp.). 1961. *Blood and Other Body Fluids*; Federation of American Societies for Experimental Biology, Washington, D. C., D. S. Dittmer, ed. 540 pp.
- ANDERSON, M. A., AND F. M. M. MOREL. 1982. The influence of aqueous iron chemistry on the uptake of iron by the coastal diatom *Thalassiosira weissflogii*. *Limnol. Oceanogr.* 27: 789-813.
- BISHOP, C., AND D. M. SURGENOR. 1964. *The Red Blood Cell*. Academic Press, New York. 566 pp.
- DINGLEY, A. L., K. KUSTIN, I. G. MACARA, AND G. C. MCLEOD. 1981. Accumulation of vanadium by tunicate blood cells occurs via a specific anion transport system. *Biochim. Biophys. Acta* 649: 493-502.
- EMERY, T. 1982. Iron metabolism in humans and plants. *Am. Sci.* 70: 626-632.
- ENDEAN, R. 1955. Studies of the blood and tests of some Australian ascidians. I. The Blood of *Pyura stolonifera*. *Austr. J. Mar. Freshwater Res.* 6: 35-59.
- ENDEAN, R. 1960. The blood cells of the ascidian *Phallusia mammillata*. *J. Microsc. Sci.* 101: 177-197.
- FUKE, M. T. 1979. Studies on the coelomic cells of some Japanese ascidians. *Bull. Mar. Biol. Tohoku Univ.* 16: 143-159.
- HAWKINS, C. J., P. M. MEREFIELD, D. L. PARRY, W. R. BIGGS, AND J. H. SWINEHART. 1980. Comparative study of the blood plasma of the ascidians *Pyura stolonifera* and *Ascidia ceratodes*. *Biol. Bull.* 159: 656-668.
- HENZE, M. 1913. Untersuchungen uber das blut der ascidien. III. *Hoppe Seyler's Z. Physiol. Chem.* 86: 340-344.
- KALK, M. 1963. Intracellular sites of activity in the histogenesis of tunicate vanadocytes. *J. Microsc. Sci.* 104: 483-493.
- KESTER, D. R., R. H. BYRNE, JR., AND Y. J. LIANG. 1975. Redox reactions and solution complexes of iron in marine systems. Pp. 56-79 in *Marine Chemistry in the Coastal Environment*, Thomas M. Church, ed. ACS Symposium Series No. 18. Washington.
- LAEMMLI, U. K. 1970. Cleavage of structural proteins during the assembly of the head of *Bacteriophage T4*. *Nature* 227: 680-685.
- LEVANON, H., G. STEIN, AND Z. LUZ. 1968. The electron spin resonance spectrum of (FeF_6^{-3}) in aqueous solutions. *J. Am. Chem. Soc.* 90: 5292-5293.
- LOWRY, O. H., N. J. ROSEBROUGH, A. L. FARR, AND R. J. RANDALL. 1951. Protein measurement with the Folin phenol reagent. *J. Biol. Chem.* 193: 265-275.

- MACARA, I. G., G. C. MCLEOD, AND K. KUSTIN. 1979. Tunichrome and metal ion accumulation in tunicate blood cells. *Comp. Biochem. Physiol.* **63B**: 299-302.
- MARX, J. J. M., AND P. AISEN. 1981. Iron uptake by rabbit intestinal mucosal membrane vesicles. *Biochim. Biophys. Acta* **649**: 297-304.
- MILLAR, R. H. 1966. Evolution in ascidians. Pp. 519-534 in *Some Contemporary Studies in Marine Science*, H. Barnes, ed. George Allen and Unwin Ltd., London.
- SWINEHART, J. H., W. R. BIGGS, D. J. HALKO, AND N. C. SCHRODER. 1974. The vanadium and selected metal contents of some ascidians. *Biol. Bull.* **146**: 302-312.
- TULLIUS, T. D., W. O. GILLUM, R. M. K. CARLSON, AND K. O. HODGSON. 1980. Structural study of the vanadium complex in living ascidian blood cells by X-ray absorption spectroscopy. *J. Am. Chem. Soc.* **102**: 5670-5676.
- WEBB, J., AND P. CHRYSTAL. 1981. Protein binding of iron in blood plasma of the ascidian *Herdmania momus*. *Mar. Biol.* **63**: 107-112.
- WRIGHT, R. K. 1981. Urochordates. Pp. 565-626 in *Invertebrate Blood Cells*, vol. 2. *Arthropods and Urochordates, Invertebrates and Vertebrates Compared*, N. A. Ratcliffe and A. F. Rowley, eds. Academic Press, London.

A CYTOLOGICAL ANALYSIS OF FERTILIZATION IN *CHAETOPTERUS PERGAMENTACEUS*³

WINSTON A. ANDERSON¹ AND WILLIAM R. ECKBERG^{1,2}

¹*Department of Zoology, Howard University, Washington, DC 20059, and* ²*Marine Biological Laboratory, Woods Hole, MA 02543*

ABSTRACT

We have examined sperm-egg interaction in *Chaetopterus pergamentaceus* by electron microscopy. The initial contact between sperm and egg involved the membrane of the unreacted acrosome and either the tips of egg microvilli which penetrated the vitelline layer or jelly emanating from the tips of the microvilli. This resulted in an acrosome reaction and fusion between the inner acrosomal membrane and the tip of the microvillus. Sperm did not produce acrosomal processes like those of many other invertebrates, and no part of the sperm penetrated the vitelline layer until the sperm was incorporated into the fertilization cone. The fertilization cone was very small and was composed of egg microvilli. The sperm nucleus and mitochondrion were incorporated into the fertilization cone, but a recognizable sperm mitochondrion could not subsequently be seen in the egg cytoplasm. Although the axoneme of the sperm tail was present in the fertilization cone at early stages of sperm penetration, the sperm tail evidently detached in the later stages of incorporation because it could not be seen in the zygote cytoplasm after sperm incorporation. The sperm chromatin decondensed uniformly and became surrounded by a typical nuclear envelope. The results indicate that *Chaetopterus* provides an example of a previously undescribed model for sperm penetration of egg vestments in which the sperm needs neither to produce an acrosomal process nor to liberate vitelline layer lysins because it penetrates the vitelline layer passively after incorporation into the egg cytoplasm.

INTRODUCTION

Fertilization is characterized by a sequence of events. A gamete interaction triggers the acrosomal reaction that initiates initial sperm-egg attachment, subsequent gamete membrane fusion, zygote formation, and egg activation. Sperm incorporation ensues, and finally the genetic material of the two gametes combines.

In Spiralian, studies of gamete interactions have been limited to the molluscs *Barnea* (Pasteels, 1965), *Mytilus* (Longo and Anderson, 1969), *Spisula* (Longo and Anderson, 1970) and *Haliotis* (Lewis *et al.*, 1982), the annelids *Hydroïdes* (Colwin and Colwin, 1961a, b) and *Nereis* (Fallon and Austin, 1967) and the echiurid, *Urechis* (Tyler, 1965; Paul and Gould-Somero, 1976). Sperm-egg interaction in these forms appears to follow several plans.

In *Hydroïdes* and *Haliotis*, the sperm undergoes an acrosome reaction in association with the outer surface of the vitelline layer and penetrates the vitelline layer with the assistance of sperm lysins which partially dissolve the vitelline layer. In *Hydroïdes* (Colwin and Colwin, 1960), the mechanism of this penetration is not

known, but in *Haliotis*, the sperm lysin evidently acts by a non-enzymatic mechanism (Lewis *et al.*, 1982). In *Barnea* (Pasteels, 1965), *Urechis* (Tyler, 1965; Paul and Gould-Somero, 1976) and probably *Spisula* (Longo, 1976) a sperm acrosomal filament fuses with an egg microvillus and the sperm nucleus penetrates the vitelline layer after being incorporated into the fertilization cone.

We obtained evidence that the *Chaetopterus* vitelline layer played a role in preventing polyspermy, but did so without being structurally or functionally changed after fertilization (Eckberg and Anderson, 1983). Additionally, in preliminary studies, we did not obtain evidence for sperm lytic activity against the vitelline layer. Therefore, we initiated a study of sperm-egg interaction in this species. The results showed that the fertilizing sperm fuses with the tip of one or more egg microvilli which extend beyond the vitelline layer and is surrounded by a fertilization cone. We also found that egg microvilli retract from the vitelline layer after fertilization. Therefore the vitelline layer of the fertilized egg can become a physical barrier to sperm-egg fusion without being structurally or functionally altered by fertilization.

MATERIALS AND METHODS

Gametes were obtained and handled, fixed for 1 h at room temperature in 5% glutaraldehyde, 4% paraformaldehyde, 0.1 M sodium cacodylate, pH 7.8 in artificial sea water, and processed for light and electron microscopy as described (Eckberg, 1981a).

Inseminated eggs were fixed at intervals after fertilization (0.5, 1, 2, 3, 5, 9, and 14 min). Male pronuclear formation was complete by 14 min. Although the eggs examined in this study were polyspermic due to heavy insemination, sperm associated with the vitelline layer more than 1 min after insemination were supernumerary because this species has a complete block to sperm penetration by this time (Eckberg and Anderson, 1983). Polyspermic eggs develop synchronously with controls up to the time of cleavage. Although they fail to divide, they undergo differentiation without cleavage (Lillie, 1902; Eckberg, 1981b; Eckberg and Kang, 1981). Therefore the events of fertilization in such polyspermic eggs are very likely to be the same as those in monospermic eggs.

RESULTS

Oocyte surface

The *Chaetopterus* egg is normally inseminated at the first meiotic metaphase. The cytoplasmic organization of the oocyte at this stage has been described (Eckberg, 1981a). Since the sperm interacts with the vitelline layer and oocyte surface, this region will be described more fully here. The vitelline layer is fibrous and is organized into three distinct regions: an inner region composed of a dense fibrous meshwork, a middle region composed of fibers oriented parallel to the oocyte surface, and an outer region of electron-dense granules interspersed with the tips of microvilli (Figs. 1, 2). This is covered by an outer diffuse "jelly" layer (Figs. 1, 2). Jelly filaments originate from the granules and the microvillar tips.

Sperm

Mature sperm consist of a head and midpiece about $1 \mu\text{m} \times 4 \mu\text{m}$ and a long flagellum (Fig. 3). Transverse sections (not shown) reveal a single mitochondrion surrounding a centriole pair which serves as the origin of the flagellum. The acro-

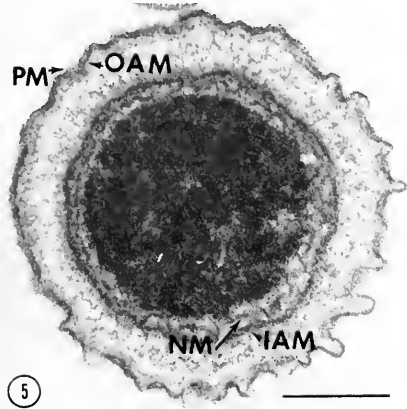
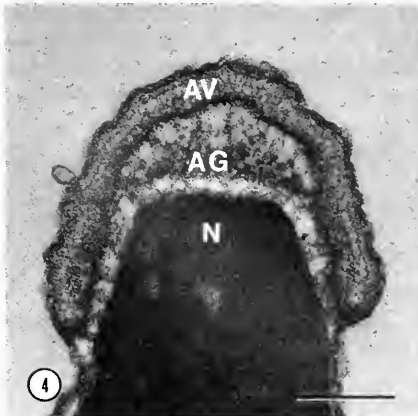
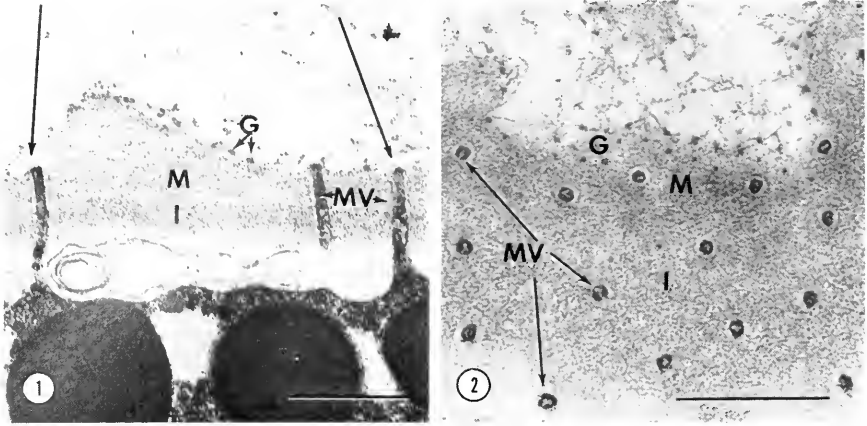

FIGURE 1. Surface of an unfertilized egg of *Chaetopterus*. Note the three regions of the vitelline layer: I = inner dense layer, M = middle layer, G = granules comprising the outer layer. Note also that microvilli (MV) penetrate the vitelline layer completely. Also note the fibrillar jelly coat originating from the tips of the microvilli and the granules of the vitelline layer (arrows). Bar = 1 μ m.

FIGURE 2. Tangential section of the vitelline layer and jelly coat of an unfertilized egg. Symbols are as given in the legend to Figure 1. Note that the granules of the outer region of the vitelline layer are numerous between the tips of the microvilli. Bar = 1 μ m.

FIGURE 3. Longitudinal section of a *Chaetopterus* sperm. A = acrosome, N = nucleus, M = mitochondrion, C = centriole, F = flagellum. Bar = 1 μ m.

FIGURE 4. Longitudinal section through the acrosomal region of a *Chaetopterus* sperm. Note the

somal region consists of a cup-like acrosomal vesicle containing fibrous material associated with its membranes and a region of granular material between the acrosomal vesicle and the apex of the nucleus. The acrosomal vesicle also covers the apical end of the sperm nucleus (Figs. 4, 5).

Gamete contact and fusion

The initial contact between sperm and egg involves the outer acrosomal membrane and the jelly in association with the microvilli (Fig. 6). Sperm with reacted acrosomes are oriented perpendicular to the oocyte surface (erect) (Fig. 7). The acrosome reaction involves the opening of the acrosomal vesicle and results in fusion between the inner acrosomal membrane and an egg microvillus (Fig. 8). Sperm do not produce acrosomal processes, and the tiny membranous projections which formed as the result of the acrosome reaction did not penetrate the vitelline layer.

Sperm incorporation

This process involves the formation of a tiny fertilization cone, barely visible in light micrographs (Fig. 8 inset), which consists of a few thickened microvilli surrounding the sperm (Figs. 9, 10). These microvilli contain longitudinal microfilament bundles (Fig. 10). The nuclear membrane of the newly-incorporated sperm becomes vesiculated and the sperm chromatin begins to disperse (Fig. 11).

After incorporation of the sperm head, a sperm tail protrudes from some, but not all residual fertilization cones (Fig. 10 insets). However, we never observed sperm flagella within the zygote other than short segments in the fertilization cone (Fig. 9). Nor did we observe recognizable sperm mitochondria in the zygote cytoplasm subsequent to sperm incorporation.

Fertilized egg surface

The vitelline layer is structurally unchanged after fertilization. All three regions are present and structurally similar to those of the unfertilized egg. However, the egg microvilli are generally absent from the vitelline layer (Fig. 12). Where they are present, they are greatly reduced in number and do not penetrate to the surface of the vitelline layer.

Formation of the male pronucleus

Sperm chromatin decondenses completely and uniformly (Fig. 13), and the nuclear envelope disappears (Fig. 14). Decondensed chromatin is frequently associated with small granules similar, but not identical to, the lipid granules of the oocyte (Fig. 14, 15). After complete decondensation, membrane vesicles surround the chromatin (Fig. 15) and eventually coalesce into a typical annulate pronuclear envelope (Fig. 16).

cuplike acrosomal vesicle (AV) containing fibrous material associated with the membranes and the granular material (AG) between the acrosomal vesicle and the nucleus. N = nucleus. Bar = 0.25 μm .

FIGURE 5. Transverse section through the acrosomal region of a *Chaetopterus* sperm. The plasma membrane (PM) is clearly separated from the outer acrosomal membrane (OAM) at a few points. The inner acrosomal membrane (IAM) is clearly separated from the nuclear membrane (NM). Fibrous material in the acrosomal vesicle can be seen, but the acrosomal granule is out of the plane of this section. Bar = 0.25 μm .

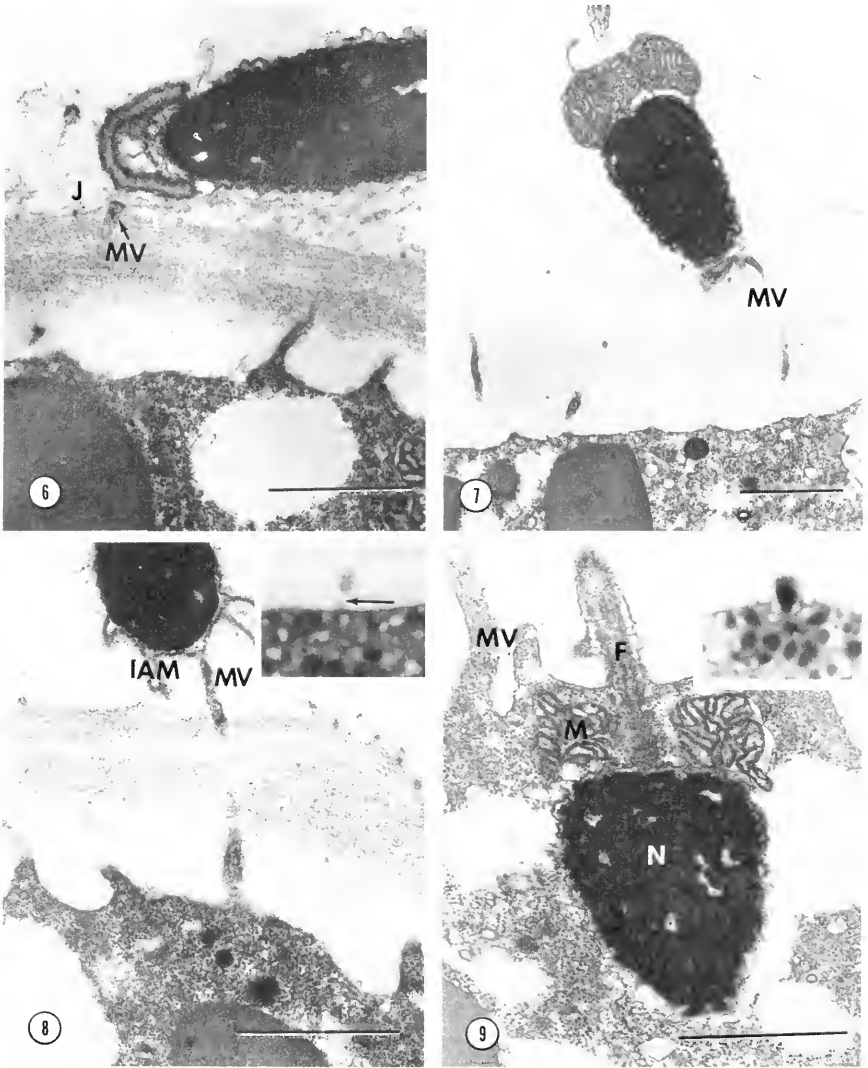

FIGURE 6. Initial interaction between a sperm and a microvillus prior to gamete fusion. Note that the plasma membrane over the acrosome is associated with a microvillus tip (MV) via the jelly (J). Bar = $1 \mu\text{m}$.

FIGURE 7. Erection of a sperm following initiation of the acrosome reaction and attachment of the sperm to a microvillus (MV). Bar = $1 \mu\text{m}$.

FIGURE 8. Gamete fusion involving the sperm inner acrosomal membrane (IAM) and an egg microvillus (MV). Bar = $1 \mu\text{m}$. Inset: light micrograph showing a sperm attached to an egg microvillus which has thickened to the point where it is visible at this level of resolution and can thus be called a fertilization cone (arrow).

FIGURE 9. Sperm incorporation into the *Chaetopterus* egg. Note that the sperm nucleus (N), mitochondrion (M) and base of the flagellum (F) have all been incorporated. Note also the microvilli (MV) which surround the sperm and make up the small fertilization cone. Bar = $1 \mu\text{m}$. Inset: light micrograph of a slightly earlier stage in fertilization cone formation showing several microvilli surrounding the incorporated sperm.

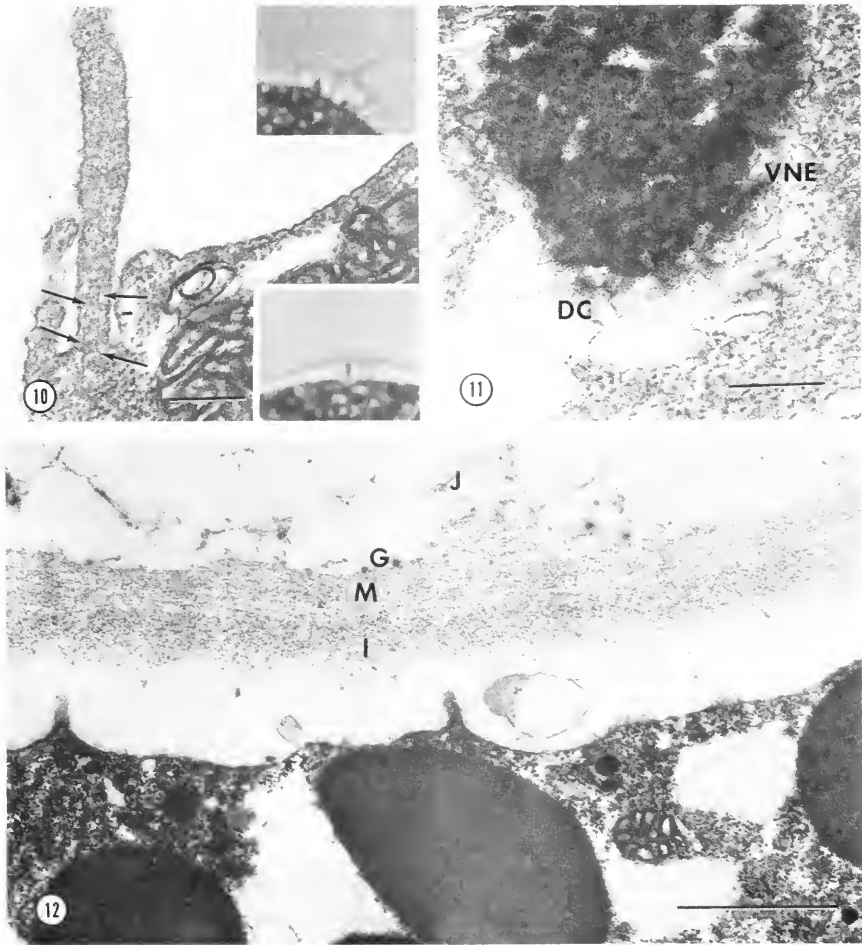

FIGURE 10. Higher magnification electron micrograph showing microfilaments (arrows) longitudinally-arranged in the microvilli of the fertilization cone. Bar = 0.25 μ m. Insets: light micrographs showing late stages in fertilization cone formation. In the upper inset, the sperm tail still protrudes from the fertilization cone; in the lower inset, the sperm tail has been lost.

FIGURE 11. Nucleus of a newly-incorporated sperm. The nuclear envelope has become vesiculated (VNE) and the chromatin appears to be beginning to decondense (DC). Bar = 0.25 μ m.

FIGURE 12. Surface of a fertilized egg 9 min after insemination. Note that the egg microvilli have shortened and no longer penetrate the vitelline layer, although all regions of the vitelline layer (I = inner, M = middle, G = granular) and the jelly (J) remain. Bar = 1 μ m.

DISCUSSION

The *Chaetopterus* oocyte surface was similar to that observed in other species. The outer diffuse jelly coat was evidently the substance initially contacted by the sperm and appeared to originate from the granules at the ends of the microvilli and at the outer region of the vitelline layer. Similar granules appear at the initial contact points in *Urechis* (Tyler, 1965), *Nereis* (Fallon and Austin, 1967), and *Hydroides* (Colwin and Colwin, 1961a). These may originate during oogenesis as buds from the tips of oocyte microvilli (L. E. Franklin, data presented in Metz, 1967). This

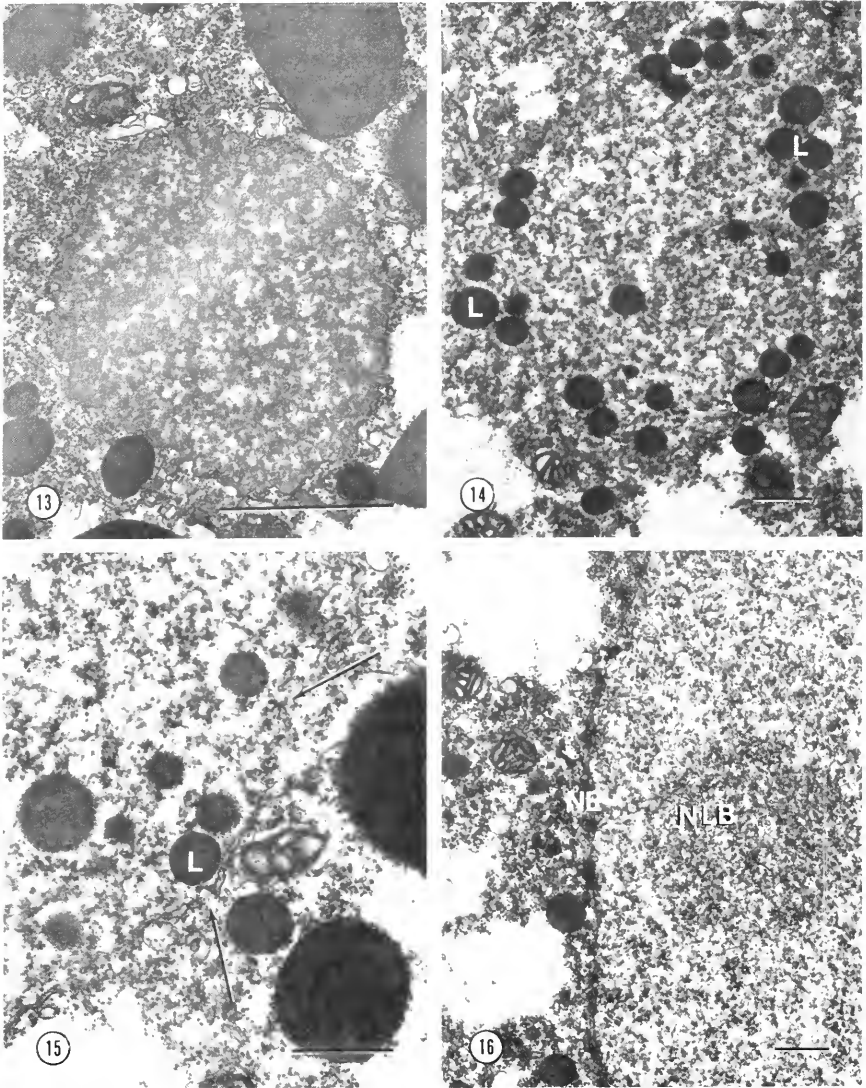

FIGURE 13. Decondensing sperm nucleus showing a stage slightly later than that in Figure 11. The sperm nuclear membrane remains vesiculated and the chromatin is decondensing uniformly throughout the nucleus. Bar = 1 μ m.

FIGURE 14. Fully decondensed sperm nucleus, without a nuclear envelope, in association with lipid granules (L). Bar = 0.5 μ m.

FIGURE 15. Fully-decondensed sperm nucleus showing association with lipid granules (L) and a vesiculated nuclear envelope (arrows). Bar = 0.5 μ m.

FIGURE 16. Male pronucleus showing annulate nuclear envelope (NE) and a dense nucleolus-like body (NLB) in the pronucleus. Bar = 0.5 μ m.

homology suggests similar function. We propose that these structures contain a receptor which initiates the acrosome reaction and is therefore analogous to the chondroitin-6-sulfate polysaccharide of sea urchin egg jelly (SeGall and Lennarz, 1979). Additional granules may initiate the acrosome reaction in supernumerary sperm (Eckberg and Anderson, 1983).

Gamete fusion took place via the inner acrosomal membrane of the sperm and the tips of egg microvilli. Sperm did not produce acrosomal processes. Other species which do not produce acrosomal processes generally fuse with the egg with the assistance of lysins which facilitate penetration of the vitelline layer (Colwin and Colwin, 1960; Lewis *et al.*, 1982). Such is evidently not the case in *Chaetopterus*, because (1) in preliminary experiments we could detect no evidence for sperm lysins, (2) sperm fused with the tips of egg microvilli which protruded through the vitelline layer, (3) in fertilized eggs such microvilli no longer penetrated the vitelline layer, (4) chemical disruption of the vitelline layer permitted refertilization (Eckberg and Anderson, 1983), presumably by making the oocyte surface available again to sperm, and (5) sperm were never observed to penetrate the vitelline layer until they were incorporated into the fertilization cone. The preceding observations also indicate that this microvillar retraction from the vitelline layer can provide a mechanism for a permanent block to polyspermy in this species.

Sperm of other species which produce acrosomal processes may (Pasteels, 1965; Tyler, 1965; Longo, 1976) or may not (Longo and Anderson, 1968) fuse with egg microvilli, but if they fuse with microvilli preferentially, they apparently do not fuse with the tips (Pasteels, 1965; Tyler, 1965). *Chaetopterus* thus provides an example of a previously undescribed model for sperm penetration of egg vestments in which the sperm needs neither to produce an acrosomal process nor to liberate vitelline layer lysins because it penetrates the vitelline layer passively after incorporation into the egg cytoplasm.

Sperm incorporation was mediated by a tiny fertilization cone (Morgan and Tyler, 1930), shown here to be composed of slightly thickened microvilli. Since such microvilli contained bundles of microfilaments, fertilization cone formation and action would appear similar in mechanism to that observed in other species (Tyler, 1965; Longo, 1978).

A recognizable sperm mitochondrion could not be seen in the zygote cytoplasm subsequent to incorporation. However, since it was present in the fertilization cone, the sperm mitochondrion must have been incorporated into the zygote. In *Mytilus*, the sperm mitochondrion reportedly becomes indistinguishable from egg mitochondria (Longo and Anderson, 1969). A similar situation may exist in *Chaetopterus*. This differs, however, from sea urchins, in which the sperm mitochondrion persists as an identifiable structure during cleavage and is metabolically active (Anderson, 1968; Anderson and Perotti, 1975).

The lack of complete incorporation of the sperm tail is similar to the situation in other spiralian (Tyler, 1965; Longo and Anderson, 1969, 1970), but different from that in sea urchins (Longo and Anderson, 1968) and mammals (Piko, 1969) in which sperm tails can be seen in the zygote cytoplasm long after fertilization. However, the sperm centriole is incorporated and sets up the first cleavage spindle (Mead, 1895).

ACKNOWLEDGMENTS

This research was supported in part by NIH grant RR08016 to W. R. Eckberg and a grant from the Mellon Foundation to W. A. Anderson. We thank Mr. Steven Lindsey, Ms. Ellen Strachan and Ms. B. J. Anderson for excellent technical assistance.

LITERATURE CITED

- ANDERSON, W. A. 1968. Structure and fate of the paternal mitochondrion during early embryogenesis of *Paracentrotus lividus*. *J. Ultrastruct. Res.* **24**: 311-321.

- ANDERSON, W. A., AND M. E. PEROTTI. 1975. An ultracytochemical study of the respiratory potency, integrity, and fate of the sea urchin sperm mitochondria during early embryogenesis. *J. Cell Biol.* **66**: 367-376.
- COLWIN, A. L., AND L. H. COLWIN. 1961b. Changes in the spermatozoon during fertilization in *Hydroides hexagonus* (Annelida). II. Incorporation with the egg. *J. Biophys. Biochem. Cytol.* **10**: 255-274.
- COLWIN, L. H., AND A. L. COLWIN. 1960. Formation of sperm entry holes in the vitelline membrane of *Hydroides hexagonus* (Annelida) and evidence of their lytic origin. *J. Biophys. Biochem. Cytol.* **7**: 315-320.
- COLWIN, L. H., AND A. L. COLWIN. 1961a. Changes in the spermatozoon during fertilization in *Hydroides hexagonus* (Annelida). I. Passage of the acrosomal region through the vitelline membrane. *J. Biophys. Biochem. Cytol.* **10**: 231-254.
- ECKBERG, W. R. 1981a. An ultrastructural analysis of cytoplasmic localization in *Chaetopterus pergamentaceus*. *Biol. Bull.* **160**: 228-239.
- ECKBERG, W. R. 1981b. The effects of cytoskeleton inhibitors on cytoplasmic localization in *Chaetopterus pergamentaceus*. *Differentiation* **19**: 55-58.
- ECKBERG, W. R., AND W. A. ANDERSON. 1983. Blocks to polyspermy in *Chaetopterus*. (Submitted for publication).
- ECKBERG, W. R., AND Y. H. KANG. 1981. A cytological analysis of differentiation without cleavage in cytochalasin B- and colchicine-treated embryos of *Chaetopterus pergamentaceus*. *Differentiation* **19**: 154-160.
- FALLON, J. F., AND C. R. AUSTIN. 1967. Fine structure of gametes of *Nereis limbata* (Annelida) before and after interaction. *J. Exp. Zool.* **166**: 225-242.
- LEWIS, C. A., C. F. TALBOT, AND V. D. VACQUIER. 1982. A protein from abalone sperm dissolves the egg vitelline layer by a nonenzymatic mechanism. *Dev. Biol.* **92**: 227-239.
- LILLIE, F. R. 1902. Differentiation without cleavage in the egg of the annelid *Chaetopterus pergamentaceus*. *Wilhelm Roux' Arch. Dev. Biol.* **14**: 477-499.
- LONGO, F. J. 1976. Ultrastructural aspects of fertilization in Spiralian eggs. *Am. Zool.* **16**: 375-394.
- LONGO, F. J. 1978. Effects of cytochalasin B on sperm-egg interactions. *Dev. Biol.* **67**: 249-265.
- LONGO, F. J., AND E. ANDERSON. 1968. The fine structure of pronuclear development and fusion in the sea urchin, *Arbacia punctulata*. *J. Cell Biol.* **39**: 339-368.
- LONGO, F. J., AND E. ANDERSON. 1969. Cytological aspects of fertilization in the lamellibranch, *Mytilus edulis*. II. Development of the male pronucleus and the association of the maternally and paternally derived chromosomes. *J. Exp. Zool.* **172**: 97-119.
- LONGO, F. J., AND E. ANDERSON. 1970. An ultrastructural analysis of fertilization in the surf clam, *Spisula solidissima*. II. Development of the male pronucleus and the association of the maternally and paternally derived chromosomes. *J. Ultrastruct. Res.* **33**: 515-527.
- MEAD, A. D. 1895. Some observations on maturation and fecundation in *Chaetopterus pergamentaceus*, Cuvier. *J. Morphol.* **10**: 313-317.
- METZ, C. B. 1967. Gamete surface components and their role in fertilization. Pp. 163-236 in *Fertilization: Comparative Morphology, Biochemistry and Immunology*, Vol. I, C. B. Metz and A. Monroy, eds. Academic Press, New York.
- MORGAN, T. H., AND A. TYLER. 1930. The point of entrance of the spermatozoon in relation to the orientation of the embryo in eggs with spiral cleavage. *Biol. Bull.* **58**: 59-73.
- PASTEELS, J. J. 1965. Aspects structuraux de la fécondation vus au microscope électronique. *Arch. Biol.* **76**: 463-509.
- PAUL, M., AND M. GOULD-SOMERO. 1976. Evidence for a polyspermy block at the level of sperm-egg plasma membrane fusion in *Urechis caupo*. *J. Exp. Zool.* **196**: 105-112.
- PIKO, L. 1969. Gamete structure and sperm entry in mammals. Pp. 325-403 in *Fertilization: Comparative Morphology, Biochemistry and Immunology*, Vol. II, C. B. Metz and A. Monroy, eds. Academic Press, New York.
- SEGALL, G. K., AND W. J. LENNARZ. 1979. Chemical characterization of the component of the jelly coat from sea urchin eggs responsible for induction of the acrosome reaction. *Dev. Biol.* **71**: 33-48.
- TYLER, A. 1965. The biology and chemistry of fertilization. *Am. Nat.* **99**: 309-334.

LARVAL AND METAMORPHIC MORPHOGENESIS IN THE NUDIBRANCH *MELIBE LEONINA* (MOLLUSCA: OPISTHOBRANCHIA)

LOUISE R. BICKELL¹ AND STEPHEN C. KEMPF²

¹*Department of Biology, University of Victoria, Victoria, British Columbia, Canada V8W 2Y2, and*

²*Department of Zoology, University of Washington, Seattle, Washington 98195*

ABSTRACT

Larval development and metamorphosis in the nudibranch *Melibe leonina* (Gould) are described from observations of living animals and from one micrometer histological sections. Larval morphogenesis is similar to that previously described for other species of planktotrophic opisthobranch larvae except the rudiments of the primary cerata and the oral hood of the post-metamorphic stage appear in the late stage larva. Unlike many other opisthobranch larvae, *M. leonina* does not appear to require a specific exogenous cue to induce metamorphosis. Metamorphosis involves loss of the shell, operculum, velar ciliated cells, and certain components of the larval stomach but the left and right digestive diverticula are retained. A rapid expansion of the primary cerata and the oral hood occurs and is accompanied by a large volume increase of the internal hemocoel of these structures and a flattening and vesiculation of their epithelial cells. Several neuronal somata within the pleural ganglia become notably larger than their neighbors during metamorphosis. At approximately 2.5 days after shell loss, *M. leonina* begins to employ the oral hood to capture ciliates and small benthic nauplii. Morphogenesis in *M. leonina* is compared to that of other opisthobranchs and the premetamorphic appearance of the cerata and the lack of an exogenous metamorphic trigger are discussed.

INTRODUCTION

A number of histological and ultrastructural studies of opisthobranch morphogenesis during the larval, metamorphic, and juvenile stages have been published during the last 25 years (Thompson, 1958; 1962; Tardy, 1970; Thiriot-Quévieux, 1970; 1977; Bonar and Hadfield, 1974; Bonar, 1976; Kriegstein, 1977a, b; Bickell, 1978; Bickell and Chia, 1979; Schacher *et al.*, 1979a, b; Bickell *et al.*, 1981; Kempf, 1982). Considered together, these works have elucidated a general pattern of development through metamorphosis in opisthobranchs having a free-swimming larval stage. However, in a comparative sense, the studies have also pointed out specific morphogenetic differences in the ontogeny of larval opisthobranchs with different taxonomic affinities. These include interspecific differences regarding the body size of the metamorphically competent larva, the derivation of the adult dorsal epidermis, the presence or absence of true detorsion of the gut, and the occurrence of characteristics such as the right digestive diverticulum and the rudiments of various adult structures (Bonar, 1978a review; Chia and Koss, 1978; Switzer-Dunlap, 1978; Bickell and Chia, 1979; Kempf, 1982).

The information that has accumulated on opisthobranch morphogenesis suggests several important objectives for future research. These are: 1) further histological and ultrastructural investigations on larval development and metamorphosis to

distinguish tissue and organ homologies between adults, thereby helping to solve taxonomic questions within the subclass, 2) clarification of the phenomenon of metamorphic induction and its ecological consequences, and 3) individual and comparative studies to examine neurodevelopment in both a morphological and behavioral sense.

Melibe leonina is a large dendronotid nudibranch that often reaches high population densities within eel grass and kelp beds along the west coast of North America (Agersborg, 1923a; Hurst, 1968; Ajeska and Nybakken, 1976). Like certain other members of the Dendronotacea, *M. leonina* exhibits a swimming behavior consisting of rhythmical bending movements of the body. The most distinctive characteristic of this species is the oral hood; a large, highly mobile expansion of cephalic tissue that extends over and around the mouth and bears a double row of inner and outer tentacles along its peripheral edge (Agersborg, 1923b) (Fig. 1). This oral hood expands and contracts through the action of muscles and pumped hemal fluids (Hurst, 1968) and is used to capture the small zooplanktonic organisms that comprise the prey of adult *M. leonina* (Agersborg, 1923a; Ajeska and Nybakken, 1976). Various organisms, notably crustaceans, are engulfed by the hood and subsequent cooperative actions of the hood and oral lips forces the prey into the mouth (Hurst, 1968). This novel method of prey capture is correlated with the absence of a radula in this species (Agersborg, 1923b).

The following study of morphological development during the larval and metamorphic stages of *M. leonina* was undertaken to provide information on larval and metamorphic morphogenesis for comparison with other opisthobranch species, to examine metamorphic induction and survival strategies in a nudibranch that feeds relatively non-specifically during the juvenile and adult stages, and to investigate the potential of *M. leonina* as a system for studying opisthobranch neurodevelopment.

MATERIALS AND METHODS

Adult *M. leonina* and their egg masses were collected from a number of eel grass and kelp beds located around the San Juan Archipelago (Washington, U. S. A.) and the southern end of Vancouver Island (British Columbia, Canada).

Laboratory hatched larvae were cultured at an initial density of 2 to 3 larvae/ml in bowls containing 100 ml of filtered (Millipore prefilter no. AP2004700) natural sea water with 10^4 cells/ml of the alga *Pavlova (Monochrysis) lutheri* (Carolina Biological Supply). The larvae were transferred to fresh culture medium at 1 or 2 day intervals and the antibiotics streptomycin sulfate (50 $\mu\text{m}/\text{ml}$) and penicillin G (60 $\mu\text{m}/\text{ml}$) (Switzer-Dunlap and Hadfield, 1977) were added at 2 to 6 day intervals. Cultures were maintained at a temperature of 12 to 14°C.

Young juveniles of *M. leonina* were fed a mixture of unidentified ciliates harvested from various types of decomposing animal tissue (sea urchin eggs, crushed limpets, chunks of sea pen). This diet was supplemented with nauplii of harpacticoid copepods.

Ten developmental stages were processed for histological examination. Larvae were fixed at hatching, mantle fold retraction, onset of mantle fold hypertrophy, and full development of the propodium. Metamorphic stages were fixed at the time of velum loss, at shell loss, and at 5, 10, 24, and 48 hours after loss of the larval shell. Primary fixation was accomplished in 2.5% glutaraldehyde and post-fixation in 2% osmium tetroxide as described previously (Bickell and Chia, 1979). Larval stages were anaesthetized prior to fixation by placing them in an incubation vessel containing 3 ml of sea water and 7 drops of 2% procaine. After 15 min at room

temperature, 0.5 ml of a saturated solution of chlorobutanol in sea water was added and the incubation vessel placed on ice for 10 min. Anaesthetized animals were placed in primary fixative for 30 min, followed by a 1 h treatment in a mixture of equal parts primary fixative and 10% ethylenediaminetetraacetic acid (disodium salt) to decalcify the larval shells (Bonar and Hadfield, 1974). Metamorphic stages were anaesthetized for 5 min in 1 part saturated chlorobutanol solution and 9 parts filtered sea water on ice and transferred to primary fixative for 1 h. All larval and metamorphic stages were post-fixed for 1 h. Fixed animals were dehydrated in ethanol and embedded in a plastic prepared by substituting Poly/Bed 812 (Poly-sciences) for Epon 812 in the recipe of Luft (1961). Embedded specimens were serially sectioned at 1 micrometer thickness and stained with Richardson's stain (Richardson *et al.*, 1960).

RESULTS

Structure of the larva at hatching

The veliger larvae of *Melibe leonina* hatch from the benthic egg mass approximately 10 days after oviposition and are structurally similar to the young planktotrophic veligers of other opisthobranchs. At hatching, the larval body is small and morphologically simple relative to the size and complexity that is achieved by the end of the obligatory larval stage (compare Figs. 2 and 3).

The veliger has two major body regions: a cephalopedal mass and a visceropallial mass. The cephalopedal mass consists of the two ciliated lobes of the velum that effect swimming and capture of food particles, and a small pointed foot that bears a circular operculum on its posterior face (Figs. 2, 4). A ciliary tract extends down the midventral surface of the foot and transports rejected particles away from the mouth.

The visceropallial mass includes a functional digestive tract, the so-called larval kidney complex, and the larval shell with its underlying perivisceral epithelium (Figs. 2, 4). The digestive tract is composed of an esophagus, a stomach, a large left and much smaller right digestive diverticulum, and an intestine (Figs. 2, 4, 5). The intestine leaves the postero-dorsal region of the stomach and recurves anteriorly to terminate at the anus located on the floor of the right mantle cavity (Fig. 5). The larval stomach has two major divisions that Thompson (1959) termed the ventral and dorsal stomach. The ventral stomach consists of a ciliated region that receives the openings of the esophagus and digestive diverticula and an area lined by a gastric shield (Fig. 4). The dorsal stomach is lined on three sides by a band of densely packed, transversely beating cilia (Fig. 6). A sparsely ciliated groove extends down the upper wall of the dorsal stomach (Fig. 6). The band of densely-packed cilia and the sparsely ciliated groove are structurally similar to the style sac ciliation and intestinal groove, respectively, of lamellibranch and some prosobranch molluscs (Graham, 1941). The manner in which food particles are transported and digested by the gut of opisthobranch veligers has been described previously (Thompson, 1959; Bickell *et al.*, 1981; Kempf, 1982). The anterior deflection of the intestine is evidence of partial torsion of the larval digestive tract.

The larval kidney complex is a cluster of distinctive yet heterogenous cells located adjacent to the anus on the right side of the veliger (Figs. 2, 4). The function of these cells, which degenerate at metamorphosis, is not clear. The two nephrocysts are located on either side of the esophagus (Fig. 6). They are uniquely larval structures whose function is enigmatic but may involve storage or excretion of waste material (Bonar, 1978a).

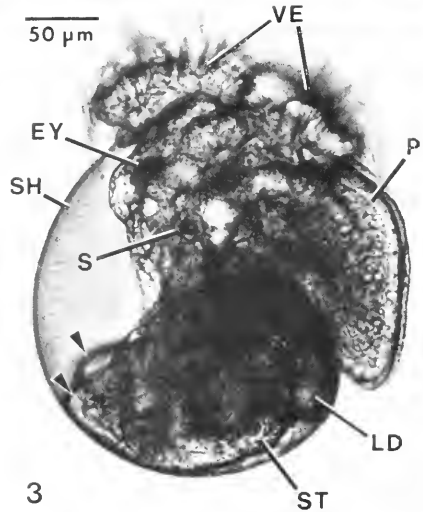
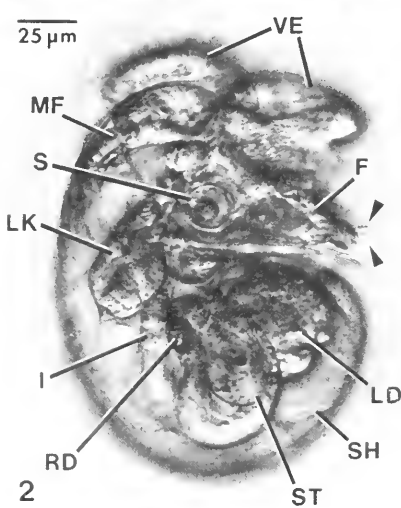
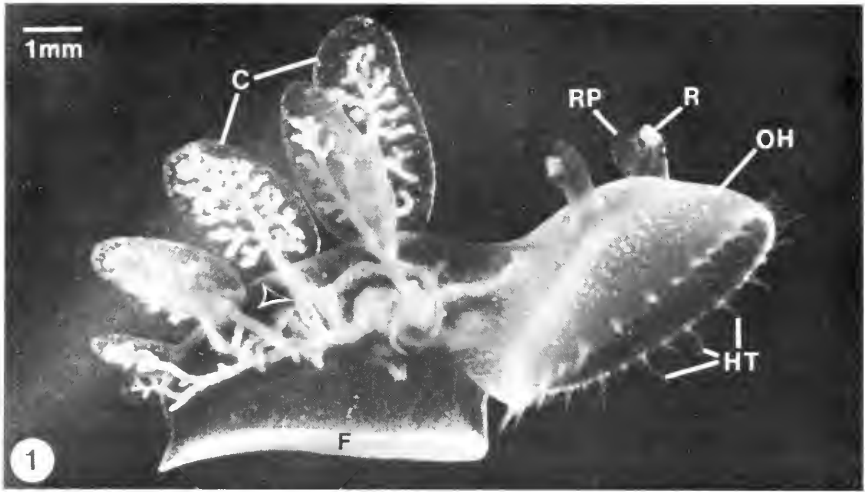

FIGURE 1. Juvenile of *Melibe leonina* at 2.5 months after metamorphosis showing the foot (f), double row of lobate cerata (C) containing dendritic branches of the digestive diverticula, and oral hood (OH) surrounding the mouth. The oral hood bears peripheral hood tentacles (HT) and a pair of rhinophores (R) mounted on a rhinophoral process (RP). The arrowhead indicates the position of the anus.

FIGURE 2. Larva of *M. leonina* immediately after hatching showing the velum (VE), foot (F), and stacyst (S) of the cephalopodal mass and the stomach (ST), right and left digestive diverticula (RD and LD, respectively), intestine (I), larval kidney complex (LK), mantle fold (MF), and shell (SH) of the visceropallial mass. The arrowheads indicate the tuft of long, stiff cilia at the apex of the foot.

FIGURE 3. Late stage larva of *M. leonina* showing the right eye (EY), propodium (P), enlarged stomach (ST), left digestive diverticulum (LD), and the shell (SH), stacyst (S), and velum (VE). The arrowheads indicate the rudiments of the primary cerata.

At the aperture of the shell, the associated perivisceral epithelium is termed the mantle fold and its cells are specialized for secretion of shell material (Fig. 7). The remainder of the mantle extends from the aperture of the shell to the cephalopodal mass and thus demarcates a shallow mantle cavity in the newly hatched veliger.

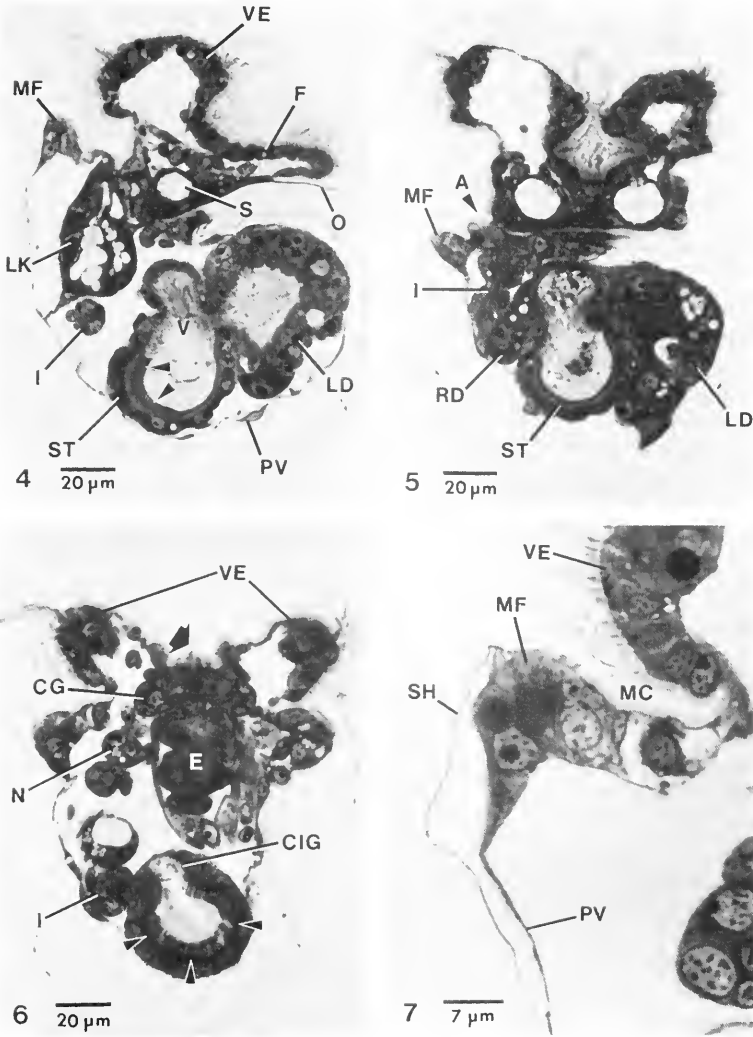

FIGURE 4. Oblique sagittal section of a newly hatched larva of *M. leonina* that passes through the foot (F), operculum (O), statocyst (S), and velum (VE) of the cephalopodal mass and the stomach (ST), left digestive diverticulum (LD), intestine (I), larval kidney complex (LK), perivisceral epithelium (PV), and mantle fold (MF) of the visceropallial mass. The section shows the vestibule (V) and gastric shield (arrowheads) of the larval stomach.

FIGURE 5. Frontal section through a newly hatched larva showing the small right and large left digestive diverticula (RD and LD, respectively) flanking the stomach (ST). Also note the torted intestine (I) that terminates at the anus (A) in the mantle cavity on the right side. Mantle fold (MF).

FIGURE 6. Frontal section through a newly hatched larva showing the sparsely ciliated groove (CIG) and band of dense cilia (arrowheads) within the dorsal part of the larval stomach (style sac). The cerebral ganglia (CG) are connected over the esophagus (E) by a commissure and an apical tuft of cilia (arrow) arises from the cephalic epithelium between the velar lobes (VE). Also note the nephrocyst (N) and intestine (I).

FIGURE 7. Detail of the mantle fold on the right side of a newly-hatched larva. The mantle fold (MF) is a continuation of the perivisceral epithelium (PV) and elaborates shell material (SH) at the shell aperture. A shallow mantle cavity (MC) is demarcated by the mantle and velar (VE) epithelia.

The muscle systems of the veliger of *M. leonina* extend through both the cephalopodal and visceropallial portions of the larval body. The base of the large larval retractor muscle is attached to the posterior end of the shell via specialized cells of the perivisceral epithelium (Bonar, 1978b) and branches extend anteriorly into the tissues of the foot and velum. A bundle of accessory pedal retractor muscles originates on the pedal epithelium underlying the operculum and extends over the ventral lip of the shell to insert on the perivisceral epithelium immediately ventral to the anus. Contraction of the larval retractor and accessory pedal retractor muscles pulls the larval body and operculum into the shell cavity. In addition, a diffuse system of slender visceral muscles are associated with the digestive tract and with the mantle fold and perivisceral epithelium.

At the time of larval hatching in *M. leonina*, the only central ganglia that are clearly recognizable in one micrometer sections are a pair of small cerebral ganglia; these are connected dorsally over the esophagus by the cerebral commissure (Fig. 6). Sensory structures include a pair of statocysts within the base of the foot (Figs. 2, 4), a tuft of stiff cilia extending from the apex of the foot (Fig. 2), and an apical organ that bears a long tuft of cilia and is located within the cephalic epidermis overlying the cerebral commissure (Fig. 6). Bonar (1978c) described the ultrastructure of the apical organ in larvae of the nudibranch *Phestilla sibogae* and suggested that it may be chemosensory.

Larval morphogenesis

The sketches in Figure 8 portray three stages of the larval development of *Melibe leonina*: the hatching stage, the eyespot—mantle retraction stage (16 to 20 days post-hatching), and the stage at which the larvae become capable of settlement and metamorphosis (30 to 48 days post-hatching). The shell increases in length from 149 μm (S.D. 9 μm) at hatching to 250 μm (S.D. 3 μm) (Fig. 8). As described below, morphogenetic events occur throughout the larval phase but tend to be concentrated within the latter half of development.

The mantle fold of *M. leonina* veligers undergoes a series of major morphogenetic changes during the larval stage. After secreting shell material during the initial portion of larval development, the mantle fold epithelium detaches from the rim of the shell and is pulled posteriorly (Figs. 8b, 9), presumably by slender muscles that extend from the mantle fold and larval kidney complex to various sites on the viscera and perivisceral epithelium. The cells of the retracted mantle fold epithelium subsequently proliferate and hypertrophy and cells of unknown origin accumulate along the hemal side of the retracted epithelium. Eventually, the mantle fold becomes composed of closely packed columnar cells and assumes the form of two large protuberances projecting from the postero-dorsal surface of the visceral mass (Figs. 3, 8c, 10). These structures are the rudiments of the primary cerata of the juvenile-adult stage. Hypertrophied mantle fold cells also extend a short distance over the latero-dorsal side of the large left digestive diverticulum and along the right side towards the anus.

The foot of the larva is enlarged considerably by proliferation of the pedal epithelial cells (compare Figs. 4, 9, 10). During the latter half of development, foot growth is accompanied by the differentiation of intrinsic pedal muscles and of large pedal glands that expand within the pedal hemocoel as they become filled with secretory product. These events ultimately result in the development of the propodium, a large swelling on the proximal, ventral surface of the foot (Figs. 3, 10). The full development of the propodium and the concurrent growth of a dense

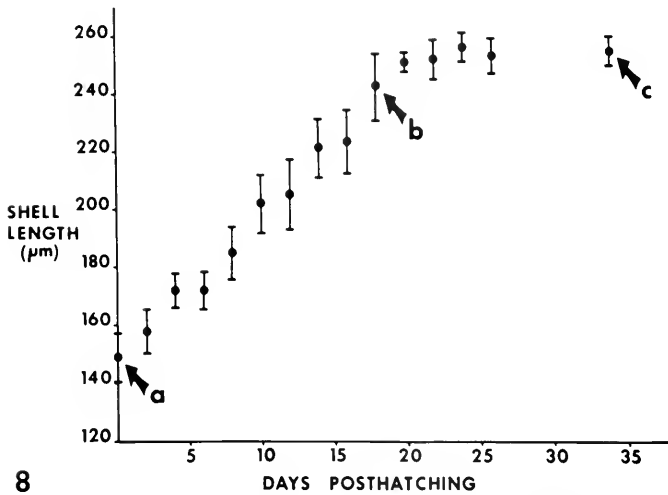
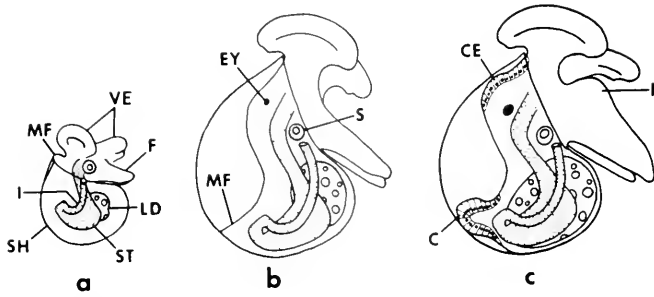

FIGURE 8. Growth rate of the shell during the larval development of *M. leonina*. The points indicate the mean length of a minimum of five larvae and the vertical bars show the standard deviation. Diagrams of the newly hatched stage (a), the mantle retraction stage (b), and the late larval stage (c) correspond in approximate size and age to the sites indicated by arrows on the graph. Abbreviations: C, ceras; CE, hypertrophied cephalic epithelium; EY, eye; F, foot; I, intestine; LD, left digestive diverticulum; MF, mantle fold; P, propodium; S, statocyst; SH, shell; ST, stomach; VE, velum.

covering of cilia over the ventral surface of the foot enables crawling behavior; a phenomenon that provides a convenient marker for the recognition of metamorphically competent opisthobranch veligers.

The cephalic epithelium that lies immediately dorsal and lateral to the velar lobes also exhibits proliferation and hypertrophy during the latter part of the larval development of *M. leonina* (compare Figs. 9, 10). This band of columnar cephalic epithelium will form the epidermis of the post-metamorphic oral hood.

The basic structure of the gut is preserved throughout the larval phase, although the digestive tract grows considerably and the cells of the stomach and left digestive diverticulum accumulate lipid deposits (Fig. 10). In late stage larvae, a vestigial radular rudiment becomes evident as a slight evagination of the ventral wall of the distal esophagus (Fig. 10), but neither radular teeth nor muscles differentiate in association with this outpocketing as typically occurs during the development of other opisthobranch larvae (Bonar, 1978a).

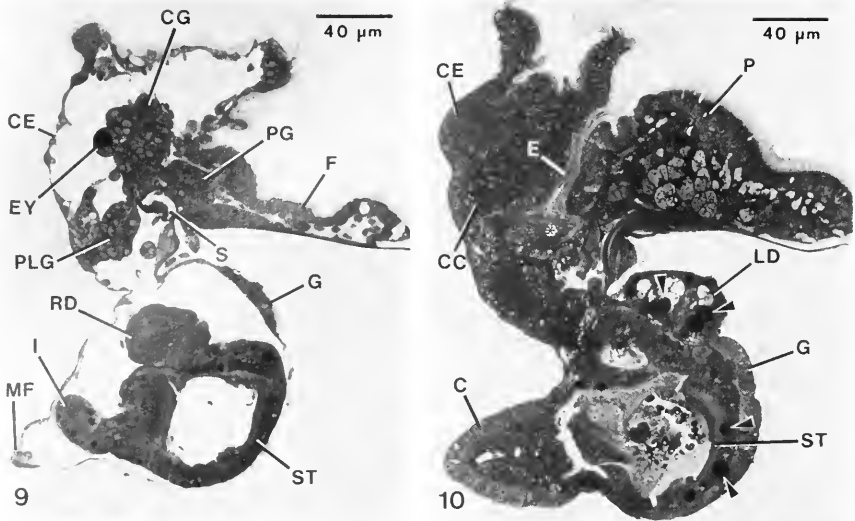

FIGURE 9. Sagittal section through a larva of *M. leonina* in which the mantle fold (MF) has retracted from the aperture of the shell. Note the eye (EY), statocyst (S), cerebral ganglion (CG), pedal ganglion (PG), and pleural ganglion (PLG) of the larval nervous system and the thin cephalic epithelium (CE), the elongate but low profile of the foot (F), and the gonadal rudiment (G). The section also passes through the stomach (ST), right digestive diverticulum (RD), and the intestine (I).

FIGURE 10. Mid-sagittal section through a larva of *M. leonina* just prior to the onset of metamorphosis showing the hypertrophied cephalic epithelium (CE), a ceratal rudiment (C), the propodial swelling (P) on the ventral surface of the foot, the gonadal rudiment (G), and the many large lipid deposits (arrowheads) within the walls of the stomach (ST) and left digestive diverticulum (LD). A vestigial radular rudiment (asterisk) has evaginated from the ventral wall of the esophagus (E) at the level of the cerebral commissure (CC).

The nervous system of *M. leonina* becomes extensively elaborated during larval development. By the time of mantle retraction, the pedal and pleural ganglia are clearly recognizable, the cerebral ganglia have enlarged, and a pair of eyespots have differentiated (Fig. 9). The pedal ganglia differentiate adjacent to the statocysts and are connected to each other by a pedal commissure and to their respective ipsilateral cerebral ganglion by a cerebropedal connective. Each pleural ganglion extends from the ipsilateral cerebral ganglion via a broad cerebropleural connective. Between the stages of mantle retraction and the onset of metamorphosis, the buccal and rhinophoral ganglia differentiate.

Three additional developments that occur during the larval phase of *M. leonina* are the development of the pulsatile larval heart soon after mantle retraction, the appearance of the adult kidney rudiment adjacent to the larval kidney complex and intestine, and the enlargement of the rudiment of the gonad (Fig. 10).

Metamorphosis

Larvae of *Melibe leonina* do not appear to require a specific, external chemical cue for the induction of metamorphosis. After full development of the propodium, the larvae of this species settle onto the foot, exhibit a brief period of crawling, and commence metamorphosis.

The events of metamorphosis that are seen during external inspection of this process are shown in Figures 11 through 16. The first superficial indication that

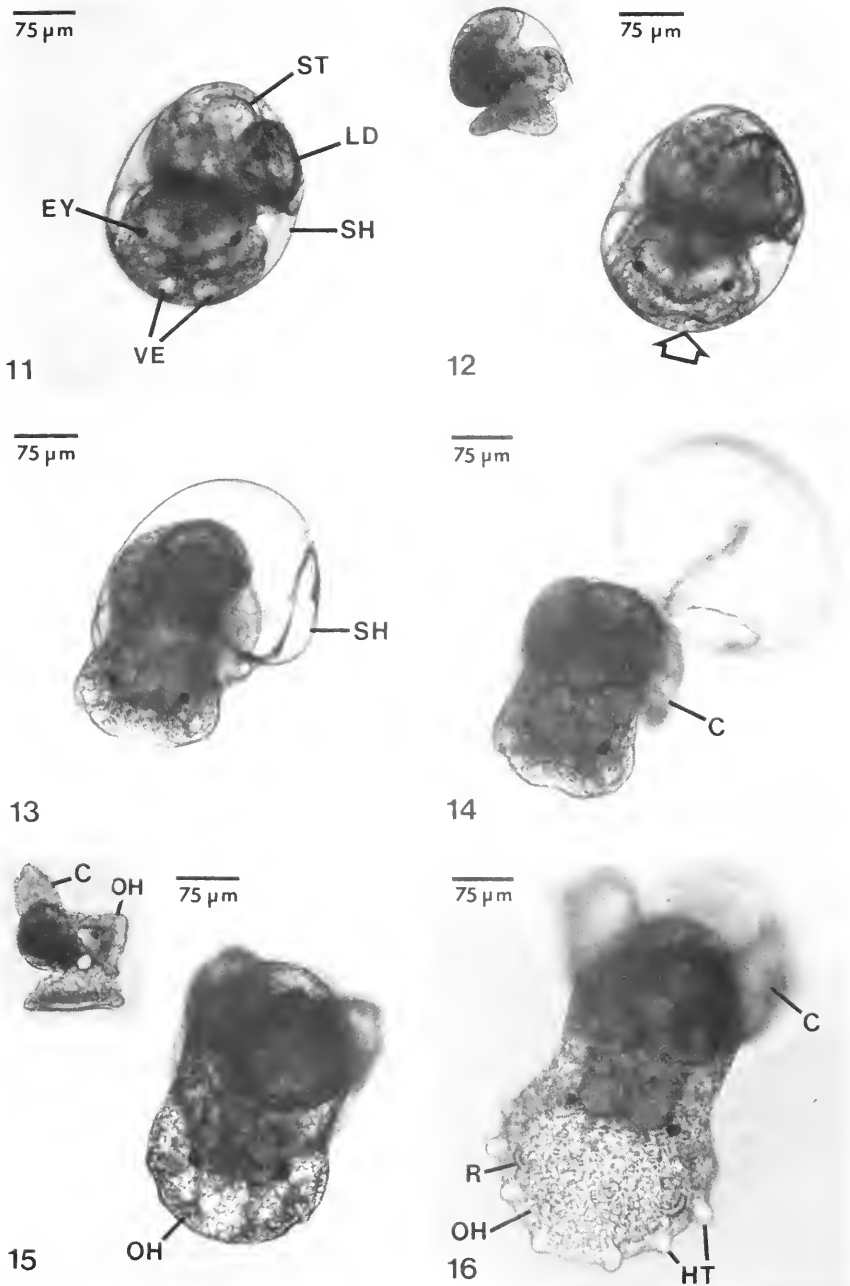

FIGURE 11. Dorsal view of a larva of *M. leonina* that has settled onto the foot in preparation for metamorphosis. The stomach (ST), left digestive diverticulum (LD) and eyes (EY) are visible through the transparent larval shell (SH). The velar lobes (VE) are retracted but still intact.

FIGURE 12. Onset of metamorphosis. The slurry of cells indicated by the arrow are dissociated velar cells. Inset: lateral view of a post-larva after loss of the ciliated velar cells.

FIGURE 13. Post-larva withdrawing the visceral mass from the shell (SH).

FIGURE 14. Post-larva immediately after shell loss. Note the left ceras (C).

FIGURE 15. Post-larva at 10 hours after shell loss showing the initial expansion of the cephalic epithelium to form the oral hood (OH). Inset: lateral view of a post-larva showing a ceras (C) and the oral hood (OH).

FIGURE 16. Post-larva at approximately 36 hours after shell loss showing the cerata (C), the dramatic enlargement of the oral hood (OH), and the buds of the initial hood tentacles (HT). The developing rhinophores (R) appear as two crescent-shaped ridges on the dorsal surface of the oral hood.

metamorphosis is irreversibly underway is the dissociation of the ciliated velar cells (Fig. 12). Many of these cells are ingested but some escape into the surrounding environment. Dissociation of the velar cells is followed by the loss of the operculum and the larval shell (Figs. 13, 14). The time interval between settlement and shell loss is variable but is usually between 12 and 24 hours. During and following shell loss, the cerata and the oral hood undergo a period of rapid and pronounced enlargement (Figs. 15, 16).

Serial sections of *M. leonina* fixed at various stages after settlement reveal that much structural reorganization and tissue morphogenesis occurs during metamorphosis. Some of these changes are illustrated schematically in Figure 17.

Beginning soon after the dissociation of the velar cells, the trunk of the larval retractor muscle becomes detached from the posterior wall of the shell. Subsequent contractions of this muscle appear to pull the visceral mass out of the shell in a manner similar to that described for other nudibranchs (Bonar and Hadfield, 1974; Bonar 1976; Bickell *et al.*, 1981). The larval retractor and accessory pedal retractor muscles degenerate following shell loss.

During and immediately following shell loss, the hypertrophied mantle fold epithelium spreads posteriorly and laterally over the stomach and digestive diverticula and anteriorly toward the hypertrophied epithelium of the presumptive oral hood (Figs. 17a-c). As the migrating edge of the mantle fold epithelium reaches the gonadal rudiment, the latter tissue invaginates and the converging margin of the spreading mantle tissue eventually fuses over the site of this internalization at the posterior extremity of the visceral mass (Figs. 17b, 18). The fate of the perivisceral epithelium is not apparent; it may be sloughed into the environment or overgrown and subsequently phagocytized. Nevertheless, the lateral and posterior margins of the mantle fold epithelium are continuous with the pedal epithelium by 5 hours after shell loss.

The loss of the shell and operculum at metamorphosis permits a broadening of the connection between the visceral mass and the foot (Figs. 17d-g). In *M. leonina*, this process appears to be facilitated by a large increase in the volume of the hemal space within the foot and surrounding the viscera. Inspection of living animals and histological sections of metamorphosing *M. leonina* give the impression that a large volume of external fluid has been pumped through the body wall and into the hemolymph. A similar but much more pronounced expansion of the hemal space accompanies the rapid enlargement of the cerata (compare Figs. 19 and 20) and the oral hood during and following shell loss. As these structures expand, the surface area of their covering epithelia is increased by conversion from a columnar to squamous epithelial type. A marked increase in the vesiculation of the epithelial cells occurs concurrently with their shape change (Figs. 19, 20, 21). Each cerata contains longitudinal muscle fibres and tufts of stiff cilia are distributed along the length of these structures (Figs. 20, 21).

The anus of *M. leonina* is displaced posteriorly following shell loss, presumably by the posterior migration of the mantle fold epithelium that surrounds the anus and by the broadening of the connection between the foot and visceral mass (Figs. 17a, b). Subsequently, the anus moves dorsally along the postero-lateral side of the post-larva. The latter movement appears to be effected by a dorsal shifting of mantle epithelium resulting from the inflation of the cerata and from a dorsally directed spread of pedal epithelium (Fig. 17c). Although the anus is moved posteriorly and dorsally, its definitive location is slightly to the right of the mid-sagittal plane of the post-metamorphic stage. Furthermore, the proximal end of the intestine continues to exit from the dorsal side of the posterior end of the stomach (Figs. 17g, 23). These

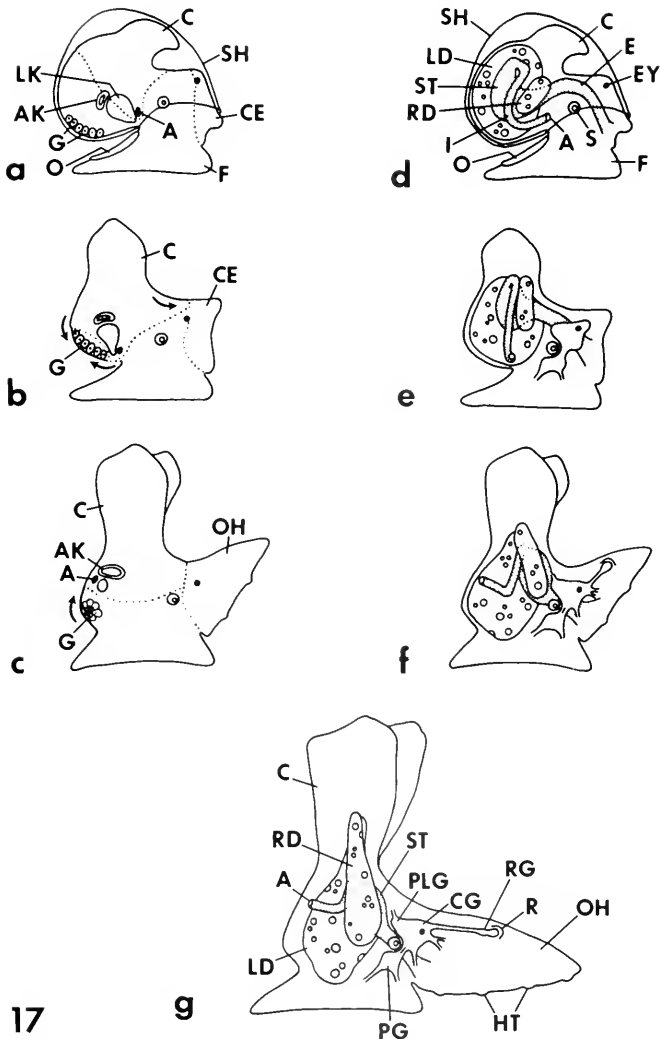

FIGURE 17. Sketches of successive stages during the metamorphosis of *M. leonina* drawn from reconstructions of serial, one micrometer sections. Figures 17a, 17b, and 17c show post-larva at the time of velum loss, and at 5 and 24 hours after shell loss, respectively. These three diagrams illustrate the migratory movements of the hypertrophied mantle fold and cephalic epithelia (the borders of these epithelia are demarcated by broken lines), the invagination of the gonadal rudiment, and the postero-dorsal displacement of the anus. The arrows indicate specific movements of the mantle fold epithelium. Figures 17d, 17e, 17f, and 17g show post-larvae at velum loss, and at 5, 24, and 48 hours after shell loss, respectively. These four diagrams illustrate the size and positional changes undergone by the component organs of the digestive system during metamorphosis. Abbreviations: A, anus; AK, adult kidney rudiment; C, ceras; CE, hypertrophied cephalic epithelium; CG, cerebral ganglion; E, esophagus; EY, eye; F, foot; G, gonadal rudiment; HT, hood tentacle; I, intestine; LD, left digestive diverticulum; LK, larval kidney complex; O, operculum; OH, oral hood; PG, pedal ganglion; PLG, pleural ganglion; R, rhinophore; RD, right digestive diverticulum; RG, rhinophoral ganglion; S, statocest; SH, shell; ST, stomach.

observations indicate that the digestive tract of *M. leonina* undergoes partial, but not complete detorsion at metamorphosis.

As shown diagrammatically in Figures 17a–c, the larval kidney complex and the

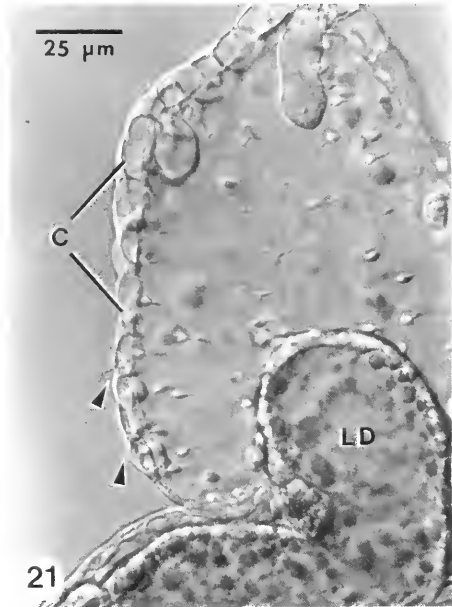
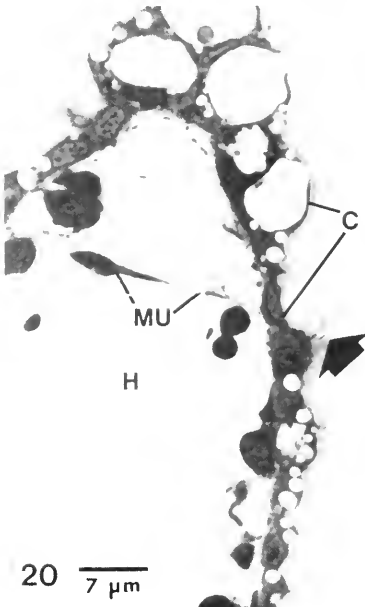
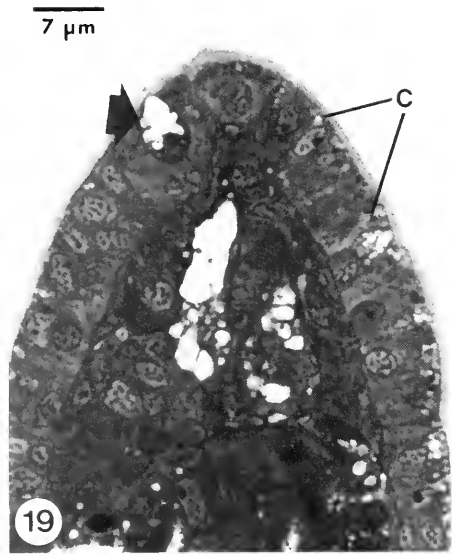
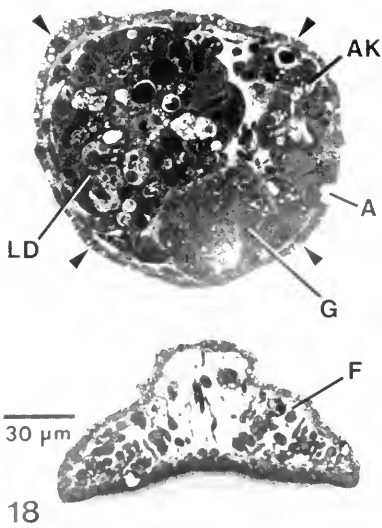

FIGURE 18. Cross section through the posterior portion of the foot (F) and visceral mass at 5 hours after shell loss. The epithelium of the mantle fold (arrowheads) has spread over the visceral mass so as to completely cover the large left digestive diverticulum (LD), the adult kidney (AK), and the invaginated rudiment of the gonad (G). The section also passes through the posterior margin of the anus (A).

FIGURE 19. Section through a primary ceras of a late stage larva of *M. leonina*. Occasional unicellular mucous glands (arrow) are embedded in the pseudostratified columnar epithelium of the ceratal (mantle fold) epithelium (C). The interior of the structure is packed with cells, some of which contain prominent vacuoles.

FIGURE 20. Section through the apical portion of a primary ceras at 5 hours after shell loss. The ceratal epithelium (C) is composed of highly vacuolated, squamous cells and occasional ciliated sensory cells (arrow). A transverse muscle fiber (MU) traverses the expanded hemocoel (H) of the ceras.

FIGURE 21. Photomicrograph using Nomarski differential interference optics of a primary ceras of *M. leonina* during metamorphosis showing the extension of the left digestive diverticulum (LD) into the ceratal hemocoel and patches of stiff cilia (arrows) arising from the ceratal epidermis (C). The photomicrograph indicates that the large vacuoles within the ceratal epidermis are not fixation artifacts.

rudiment of the adult kidney move posteriorly with the anus and distal end of the intestine. The larval kidney complex subsequently degenerates within the post-larval body, whereas the cells of the adult kidney rudiment begin to proliferate and the internal lumen enlarges (Fig. 18).

The diagrams shown in Figures 17d–g illustrate the positional changes exhibited by the organs of the larval digestive system during metamorphosis of *M. leonina*. Unlike the process of gut metamorphosis in the dorid nudibranch *Doridella steinbergae* (Bickell *et al.*, 1981), the stomach of *M. leonina* does not undergo additional torsional displacement at metamorphosis, nor does it shift to the mid-dorsal surface of the large left digestive diverticulum. Although the left digestive diverticulum continues to reside beside the stomach, a dramatic enlargement of the right digestive diverticulum gradually displaces the stomach to a central position within the visceral mass (Figs. 17g, 22). Soon after shell loss, both the left and right digestive diverticula begin to extend into the expanded hemocoel of their respective ceras (Figs. 21, 22).

The conversion of the phytoplanktrophic larva to the carnivorous juvenile—adult necessitates extensive changes of the tissues comprising the larval gut. The cells of the densely ciliated band (style sac) have completely dissociated by the time the post-larva has lost the shell and the gastric shield subsequently peels away from its underlying cells (Fig. 24). Soon thereafter, the cells that produced the larval gastric shield and the cells of the vestibule begin to produce the cuticular material that lines the stomach of the post-metamorphic animal (Agersborg, 1923b) (Fig. 25).

As previously stated, the enlargement of the oral hood is accompanied by the same types of events that occur during expansion of the primary cerata. The hypertrophied cells of the cephalic epithelium convert from a columnar to squamous shape, numerous intracellular vesicles appear, and the enclosed hemocoel becomes inflated. The initial hood tentacles appear as 8 small papillae distributed around the periphery of the hood (Fig. 16). In living animals, particularly after the onset of feeding, prominent nerve tracts extend from the cerebral ganglia to a small cluster of cells underlying each of the hood tentacles (Figs. 26, 27). Transmission electron microscopy has confirmed that these tracts are nerves rather than muscle bundles (Bickell, unpublished observations). The epithelium of each hood tentacle gives rise to several tufts of stiff cilia (Fig. 27) and additional ciliary tufts appear on the ventral surface of the hood during metamorphosis.

Differentiation of muscles within the periphery of the oral hood enables it to close (compare Figs. 26 and 28) if a tactile stimulus is applied to the ventral surface of the hood. *Melibe leonina* is able to capture and ingest ciliates using the oral hood and oral lips at approximately 2.5 days after shell loss.

Several morphological changes in the nervous system of *M. leonina* can be resolved in one micrometer sections of metamorphic stages. The parapedal commissure can be resolved at 10 hours after shell loss as a slender tract just posterior to the pedal commissure. The cerebrobuccal connectives also become distinguishable at this time and the pleuropedal connectives become distinct from the cerebropedal connectives. By 24 hours after shell loss, a lengthening of the pedal and parapedal commissures and of the cerebrobuccal connectives has occurred. The neuropile region of all the central ganglia enlarges during metamorphosis.

During the period of velum dissociation, a neuronal soma located medio-dorsally within the right pleural ganglion, at the level of the pleuropedal connective, becomes notably larger (10 μm diameter) than the surrounding ganglionic cell bodies (3 to 5 μm diameter) (Figs. 29, 30). By virtue of its size, position, and large nucleus containing a prominent nucleolus, this neuron can be re-identified in all subsequent metamorphic stages. Several other neuronal somata within the right and left pleural

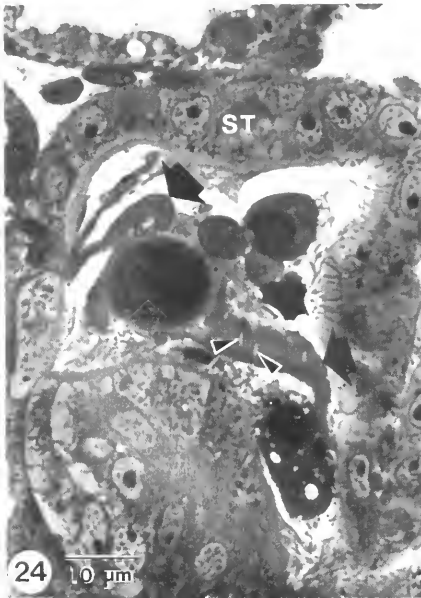
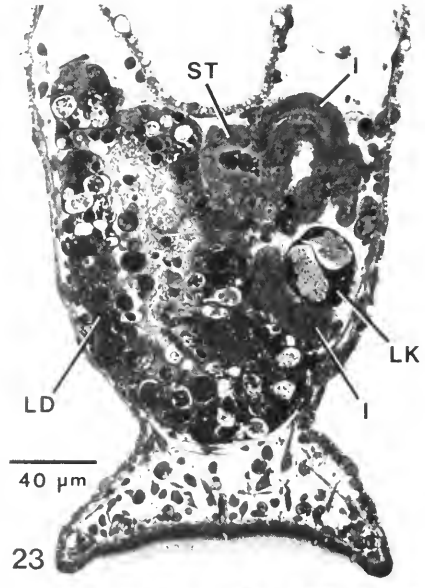
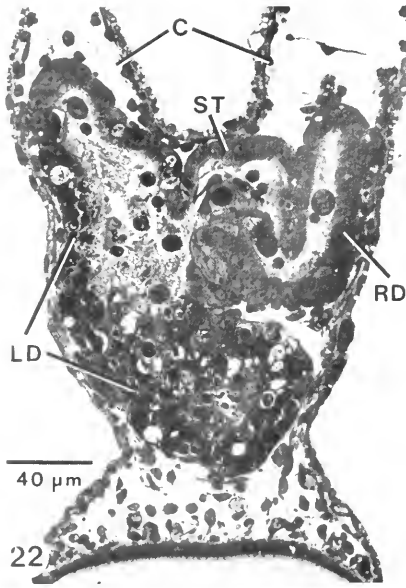

FIGURE 22. Cross section of *M. leonina* at 5 hours after shell loss that passes through the left and right digestive diverticula (LD and RD, respectively) where they enter the stomach (ST). Both diverticula are beginning to project into their respective ceras (C).

FIGURE 23. Cross section of *M. leonina* at 5 hours after shell loss showing the emergence of the intestine (I) from the dorsal side of the posterior end of the stomach (ST). The left digestive diverticulum (LD) and degenerating larval kidney complex (LK) are also shown.

FIGURE 24. High magnification of the stomach area of Figure 22. The larval gastric shield (large black arrows), which can be recognized by the presence of small hyaline rods (small arrowheads) embedded in the shield matrix, is sloughing into the lumen of the stomach (ST).

FIGURE 25. High magnification of the wall of the stomach (ST) at 24 hours after shell loss. The black arrows indicate the cuticle that lines the inner side of the gastric epithelium in post-metamorphic animals.

ganglia become notably larger than their neighbors during the period of metamorphosis.

At the time of shell loss, the rhinophoral ganglia are closely apposed to the antero-dorsal surface of their respective cerebral ganglion and the cells of the cephalic epithelium that directly overlie each of the rhinophoral ganglia are taller and more lightly staining than the surrounding epithelial cells. These patches of thickened epithelium, the presumptive rhinophores, and their associated rhinophoral ganglia are carried anteriorly as the cephalic epithelium expands to form the oral hood. As each rhinophoral ganglion moves away from its ipsilateral cerebral ganglion, the two remain connected by a thick rhinophoral nerve (Fig. 31). The epithelial cells of the presumptive rhinophores proliferate so as to form prominent bulges on the dorsal surface of the enlarging oral hood. Cells bearing tufts of stiff cilia differentiate within the rhinophoral epithelium by 5 hours after shell loss and patches of motile cilia appear during the following 2 days.

DISCUSSION

Although the developmental events that occur during the larval stage of opisthobranchs are similar in kind and sequence, various differences often occur between species. In some cases, these differences can be interpreted as ontogenic anticipation of unique structural features of the post-metamorphic stage or special features to facilitate the success of settlement and metamorphosis or the survival of young juveniles in the adult habitat (Chia and Koss, 1978; 1982; Switzer-Dunlap, 1978; Bickell and Chia, 1979). This phenomenon is illustrated by three unusual features of the late stage larva of *Melibe leonina*. These are: the absence of radular teeth, the appearance of presumptive oral hood tissue, and the precocious development of the primary cerata.

The almost complete omission of the radula—odontophore complex from the sequence of developmental events in *M. leonina* eliminates an unnecessary energy expenditure as this structure has no larval function and is not required for food capture or ingestion in the adult. However, the small size of newly metamorphosed nudibranchs may preclude feeding on the same type of prey or in the same manner as the adults of their species. At least one species of nudibranch utilizes its radula to graze on an organic surface film until sufficiently large to exploit the preferred prey of the adult stage (Perron and Turner, 1977). Juveniles of *M. leonina* cannot employ this type of interim feeding due to the lack of a radula. Instead, metamorphosis in *M. leonina* involves a rapid differentiation of the oral hood, thereby permitting young juveniles to capture small prey in a manner similar to that employed by the adult. Selective pressures acting to promote the rapid formation of the oral hood during metamorphosis may have resulted in the preliminary development of this structure during the final part of the larval stage. Furthermore, non-specific metamorphic induction and the active nature of the juvenile prey (*e.g.*, ciliates) confront newly metamorphosed *M. leonina* with the problems inherent in feeding on organisms having a patchy distribution in time and space. This challenge may have resulted in selection for the greater activity and tactile—positional awareness observed in newly metamorphosed juveniles of *M. leonina*. In response to ciliates colliding with various parts of their body, the juveniles can rapidly turn the anterior body, expand the oral hood, and make a directed and effective capture of the organism. The active prey searching behavior of young *M. leonina* juveniles and their high degree of responsiveness to tactile environmental stimuli contrasts with the behavior of recently metamorphosed juveniles of other opisthobranchs, which tend

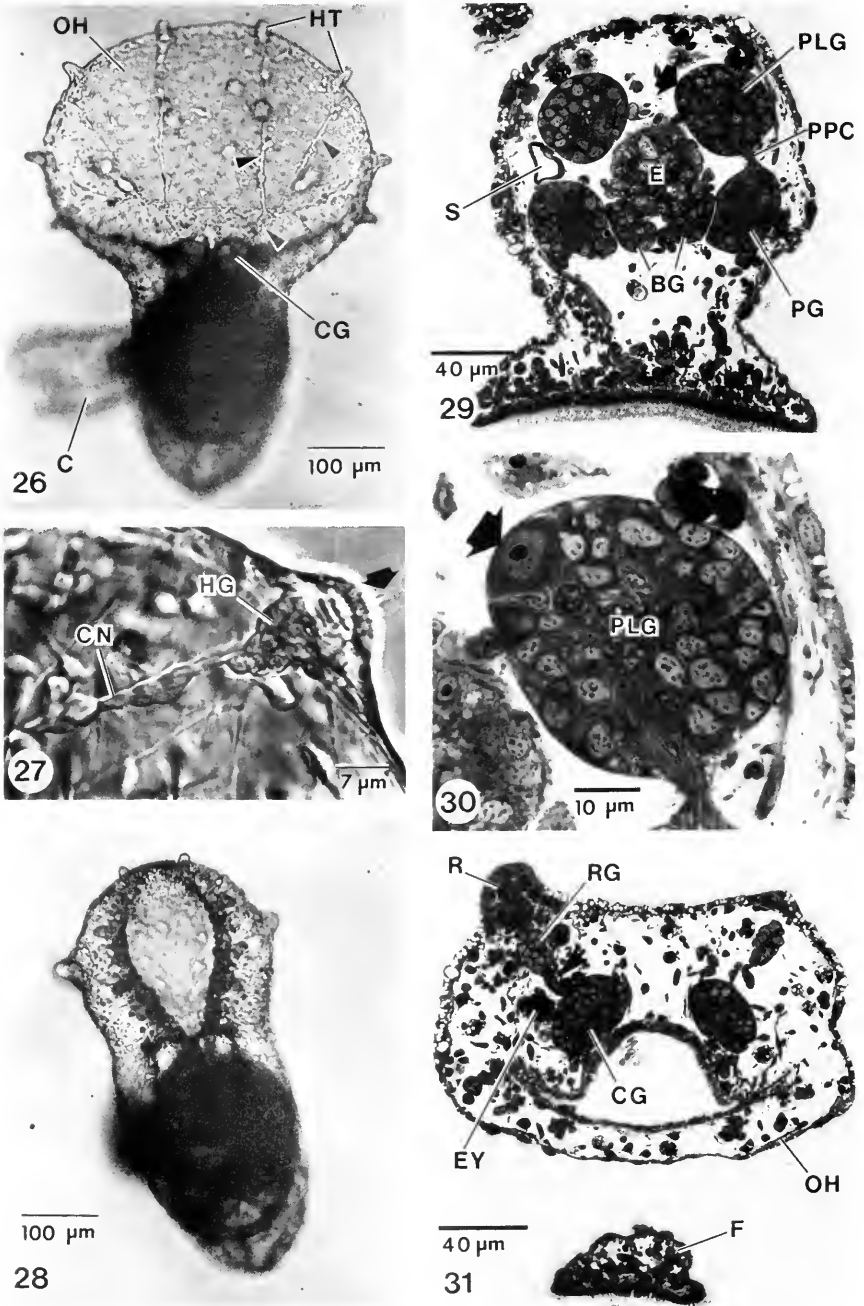

FIGURE 26. Ventral view of *M. leonina* at 5 days after shell loss showing the extended oral hood (OH). Nerve tracts (arrowheads) extend from the cerebral ganglia (CG) to the buds of the peripheral hood tentacles (HT). A ceras (C) is also visible.

FIGURE 27. Photomicrograph using Nomarski differential interference optics of a portion of the oral hood margin showing the terminal region of a cerebral nerve (CN) extending to a peripheral hood ganglion (HG) that underlies a hood tentacle bud. A tuft of stiff cilia (arrow) extends from the epithelium of the tentacle bud.

to be sluggish grazers on the prey organism that induced the metamorphosis of the preceding larval stage (Thompson, 1958; 1962; 1964; Tardy, 1970; Bonar and Hadfield, 1974; Kempf and Willows, 1977; Switzer-Dunlap and Hadfield, 1977; Chia and Koss, 1978; Bickell, 1978; and others).

The hypertrophy of the larval cephalic epidermis has not been noted in pre-metamorphic veligers of dorid nudibranchs, which tend to lack a large oral veil over the mouth, but is shown in drawings by Thompson (1962) of premetamorphic veligers of *Tritonia hombergi* (Dendronotacea) and by Tardy (1970) of *Aeolidiella alderi* (Aeolidacea). The juveniles and adults of both these species have a prominent oral veil that is derived from this hypertrophied cephalic tissue. These observations confirm that the oral hood of *M. leonina* and the oral veil of other nudibranchs are homologous structures.

The appearance of ceratal rudiments in the larval stage of nudibranchs has not been reported previously, although many aeolids and dendronotids have been reared in the laboratory. It has been suggested that the thin-walled cerata of nudibranchs provide an increased surface area for gas exchange with the environment (see Morton, 1958). This hypothesis is strengthened by the fact that the metabolically active digestive diverticula often extend into the cerata. Ajeska and Nybakken (1976) found that oxygen consumption/gm body weight was an inverse function of animal size in *M. leonina*. They suggested that the higher metabolic rate of young juveniles reflects the fact that they must actively seek-out their benthic prey, whereas larger animals simply extend their hood into the surrounding waters to intercept passing zooplankton. Of the 10 species of newly metamorphosed opisthobranchs that the present authors have observed, *M. leonina* young juveniles are most active. Together, these observations suggest that the development of ceratal rudiments during the larval stage of *M. leonina* and their rapid expansion and invasion by the digestive diverticula during metamorphosis may be necessary to sustain a high oxygen demand resulting from an active juvenile life style.

The present study of larval development and metamorphosis of *M. leonina* provides the second histological description of gut metamorphosis in a planktotrophic nudibranch veliger. As in the dorid nudibranch, *Doridella steinbergae* (Bickell *et al.*, 1981), the morphologically complex stomach of *M. leonina* veligers is transformed to the post-metamorphic stomach by dissociation of the cells comprising the ciliated band (style sac) and loss of the gastric shield. In *Doridella steinbergae*, Bickell *et al.* (1981) speculated that the gastric shield was lost by dissociation of the underlying cells. Observations made in the present study indicate that the gastric shield is simply sloughed from the gut wall; the underlying cells are retained and subsequently secrete a portion of the cuticle that lines the stomach of the post-metamorphic stage.

FIGURE 28. Same animal as that in Figure 26 showing closure of the oral hood by contraction of muscles extending along the hood periphery.

FIGURE 29. Slightly oblique cross section through the esophageal region (E) of *M. leonina* at 24 hours after shell loss. Note the left statocyst (S), buccal ganglia (BG), pleural ganglia (PLG), and pedal ganglia (PG). The arrowhead indicates the distinctive neuronal soma (see Fig. 30) that is situated dorso-medially within the right pleural ganglion at the level of the pleuro-pedal connective (PPC).

FIGURE 30. Enlargement of the pleural ganglion (PLG) from Figure 29 indicating the large neuronal soma (arrow) containing a prominent nucleolus.

FIGURE 31. Slightly oblique cross section through the base of the oral hood (OH) and the anterior end of the foot (F) at 24 hours after shell loss showing the developing rhinophore (R) and its underlying rhinophoral ganglion (RG) on the left side. A rhinophoral nerve (arrowhead) extends between the rhinophoral ganglion and the cerebral ganglion (CG). The section also passes through the left eyespot (EY).

The stomach of *M. leonina* does not undergo additional torsional displacement during metamorphosis, as observed in *D. steinbergae* (Bickell *et al.*, 1981), nor does it exhibit complete detorsion, as described for the aeolid nudibranch *Phestilla sibogae* (Bonar and Hadfield, 1974). In *M. leonina*, the dorso-lateral position of the anus and the fact that the intestine emerges from the dorsal aspect of the stomach are post-metamorphic vestiges of the torsted larval digestive tract.

As is typical of most opisthobranch veligers, those of *M. leonina* possess a large left and a much smaller right digestive diverticulum. The few histological investigations that have considered gut metamorphosis in opisthobranch larvae indicate that the right diverticulum 'disappears' at or soon after metamorphosis in the dorids *Adalaria proxima* (Thompson, 1958) and *Doridella steinbergae* (Bickell *et al.*, 1981). Thompson (1962) reported the persistence of this organ for a period of time after metamorphosis in the dendronotid *Tritonia hombergi* but noted that it eventually became impossible to differentiate the right diverticulum from the left. Nevertheless, on the basis of adult morphology, the right diverticulum appears to persist in the Dendronotacea, Arminacea, and Aeolidacea (see Hyman, 1967, p. 443). Our study of morphogenesis in larvae and juveniles of *M. leonina* shows that both the right and left diverticula are retained during metamorphosis. Each diverticulum proliferates into its ipsilateral ceras and opens separately into the stomach. This feature persists into the adult stage, although the main duct of the left digestive diverticulum, but not the right, eventually branches at its point of exit from the stomach (Agersborg, 1923b).

Larval settlement and metamorphosis has been observed in three species of dendronotid nudibranchs. *Tritonia hombergi* is typical of many opisthobranchs (see Hadfield, 1978) in that metamorphosis will occur only in the presence of its post-metamorphic prey, *Alcyonium digitatum* (Thompson, 1962). Metamorphosis of the larvae of *Tritonia diomedea* is promoted by the preferred pennatulacean prey of the adults, but metamorphosis will also occur without this external inducer. Kempf and Willows (1977) suggested that the absence of absolute dependence on an external metamorphic trigger in *T. diomedea* may relate to the fact that adults will also feed on several other pennatulaceans. In *M. leonina*, the presence of a substratum appears to be the only requirement for the onset of larval settlement and metamorphosis. The prey of young juveniles (which was benthic ciliates and crustacean nauplii in this study and benthic crustaceans and bivalve spat in the field study of Ajeska and Nybakken, 1976) probably occurs ubiquitously on marine substrates, and the zooplanktonic prey of larger juveniles and adults is continuously transported through coastal waters. Therefore, the need for specific metamorphic induction to ensure a benthic food source (Thompson, 1964) seems unnecessary in this species.

Despite the apparent absence of environmental induction of metamorphosis, populations of *M. leonina* are consistently found in eel grass and kelp beds located in protected waters (Agersborg, 1923a; Hurst, 1968; Ajeska and Nybakken, 1976). Pelagic individuals of this species, which include the larvae and post-metamorphic animals that have become dislodged from a surface (Hurst, 1968), may become passively concentrated in areas of reduced water flow. The buoyant fronds of eel grass and certain large kelp species that are typical of these locations might be expected to promote the survival of *M. leonina* because the plants provide a submerged, tidal adjusting attachment substratum (*M. leonina* cannot withstand atmospheric exposure) that is suspended within the upper levels of the water column where the flow of plankton-carrying currents is greatest.

Melibe leonina offers considerable potential for studies on opisthobranch neurodevelopment. Unlike many other species, reproductive adults and egg masses can

be collected throughout the year (Hurst, 1967). Furthermore, the successful rearing of juveniles on ciliates followed by commercially available *Artemia* nauplii simplifies the problem of obtaining a continuous supply of food for the post-metamorphic stage. The central ganglia of *M. leonina* include many large, identifiable neurons (Hurst, 1968) and the present study has shown that several neuronal cell bodies become morphologically distinct during metamorphosis. Finally, the rapid formation of cerebral nerve tracts innervating the oral hood and their visibility through the transparent epithelium of this structure may allow investigation of axonal guidance during neurodifferentiation.

ACKNOWLEDGMENTS

The authors thank R. O. Brinkhurst for providing some of the microscope equipment used during the preparation of this manuscript. G. O. Mackie offered comments on the manuscript and provided NSERC grant support for the research.

LITERATURE CITED

- AGERSBORG, H. P. VON WOLD KJERSCHOW. 1923a. A critique on Professor Harold Heath's *Chioraera dalli*, with special reference to the use of the foot in the nudibranchiate mollusk, *Melibe leonina* Gould. *Nautilus* **36**: 86-96.
- AGERSBORG, H. P. VON WOLD KJERSCHOW. 1923b. The morphology of the nudibranchiate mollusk *Melibe* (syn. *Chioraera*) *leonina* (Gould). *Q. J. Microsc. Sci.* **67**: 507-592.
- AJESKA, R. A., AND J. W. NYBAKKEN. 1976. Contributions to the biology of *Melibe leonina* (Gould, 1852) (Mollusca: Opisthobranchia). *Veliger* **19**: 19-26.
- BICKELL, L. R. 1978. *Larval Development, Metamorphosis, and Juvenile Feeding of Doridella steinbergae* (Lance) (Opisthobranchia: Nudibranchia). M.Sc. thesis, University of Alberta, 226 pp.
- BICKELL, L. R., AND F. S. CHIA. 1979. Organogenesis and histogenesis in the planktotrophic veliger of *Doridella steinbergae* (Opisthobranchia: Nudibranchia). *Mar. Biol.* **52**: 291-313.
- BICKELL, L. R., F. S. CHIA, AND B. J. CRAWFORD. 1981. Morphogenesis of the digestive system during metamorphosis of the nudibranch *Doridella steinbergae* (Gastropoda): conversion from phytoplanktivore to carnivore. *Mar. Biol.* **62**: 1-16.
- BONAR, D. B. 1976. Molluscan metamorphosis: a study in tissue transformation. *Am. Zool.* **16**: 573-591.
- BONAR, D. B. 1978a. Morphogenesis at metamorphosis in opisthobranch molluscs. Pp. 177-196 in *Settlement and Metamorphosis of Marine Invertebrate Larvae*, F. S. Chia and M. E. Rice, eds. Elsevier/North-Holland, New York.
- BONAR, D. B. 1978b. Fine structure of muscle insertions on the larval shell and operculum of the nudibranch *Phestilla sibogae* (Mollusca: Gastropoda) before and during metamorphosis. *Tissue Cell* **10**: 143-152.
- BONAR, D. B. 1978c. Ultrastructure of the cephalic sensory organ in larvae of the gastropod *Phestilla sibogae* (Aeolidacea, Nudibranchia). *Tissue Cell* **10**: 153-165.
- BONAR, D. B., AND M. G. HADFIELD. 1974. Metamorphosis of the marine gastropod *Phestilla sibogae* Bergh (Nudibranchia: Aeolidacea). I. Light and electron microscopic analysis of larval and metamorphic stages. *J. Exp. Mar. Biol. Ecol.* **16**: 227-255.
- CHIA, F. S., AND R. KOSS. 1978. Development and metamorphosis of the planktotrophic larvae of *Rostanga pulchra* (Mollusca: Nudibranchia). *Mar. Biol.* **46**: 109-119.
- CHIA, F. S., AND R. KOSS. 1982. Fine structure of the larval rhinophores of the nudibranch, *Rostanga pulchra*, with emphasis on the sensory receptor cells. *Cell Tissue Res.* **225**: 235-248.
- GRAHAM, A. 1941. The molluscan stomach. *Trans. R. Soc. Edinb.* **61**: 737-778.
- HADFIELD, M. G. 1978. Metamorphosis in marine molluscan larvae: an analysis of stimulus and response. Pp. 165-175 in *Settlement and Metamorphosis of Marine Invertebrate Larvae*, F. S. Chia and M. E. Rice, eds. Elsevier/North-Holland, New York.
- HURST, A. 1967. The egg masses and veligers of thirty north-east Pacific opisthobranchs. *Veliger* **9**: 255-288.
- HURST, A. 1968. The feeding mechanism and behavior of the opisthobranch *Melibe leonina*. *Symp. Zool. Soc. Lond.* **22**: 151-166.
- HYMAN, L. 1967. *The Invertebrates: Mollusca I*, Vol. VI. McGraw-Hill, New York. 792 pp.
- KEMPF, S. C. 1982. *Acquisition, Storage and Utilization of Nutrients by the Embryos and Larvae of Opisthobranch Molluscs*. Ph.D. thesis, University of Hawaii. 287 pp.

- KEMPF, S. C., AND A. O. D. WILLOWS. 1977. Laboratory culture of the nudibranch *Tritonia diomedea* Bergh (Tritonidae: Opisthobranchia) and some aspects of its behavioral development. *J. Exp. Mar. Biol. Ecol.* **30**: 261-276.
- KRIEGSTEIN, A. R. 1977a. Development of the nervous system of *Aplysia californica*. *Proc. Nat. Acad. Sci.* **74**: 375-378.
- KRIEGSTEIN, A. R. 1977b. Stages in the post-hatching development of *Aplysia californica*. *J. Exp. Zool.* **199**: 275-288.
- LUFT, J. H. 1961. Improvements in epoxy resin embedding methods. *J. Biophys. Biochem. Cytol.* **9**: 409-414.
- MORTON, J. E. 1958. *Molluscs: An Introduction to Their Form and Function*. Harper and Bros., New York. 232 pp.
- PERRON, F. E., AND R. D. TURNER. 1977. Development, metamorphosis, and natural history of the nudibranch *Doridella obscura* Verrill (Corambidae: Opisthobranchia). *J. Exp. Mar. Biol. Ecol.* **27**: 171-185.
- RICHARDSON, K. C., L. JARRETT, AND E. H. FINKE. 1960. Embedding in epoxy resins for ultrathin sectioning in electron microscopy. *Stain Technol.* **35**: 313-323.
- SCHACHER, S., E. R. KANDEL, AND R. WOOLLEY. 1979a. Development of neurons in the abdominal ganglion of *Aplysia californica*. I. Axosomatic synaptic contacts. *Dev. Biol.* **71**: 163-175.
- SCHACHER, S., E. R. KANDEL, AND R. WOOLLEY. 1979b. Development of neurons in the abdominal ganglion of *Aplysia californica*. II. Nonneural support cells. *Dev. Biol.* **71**: 176-190.
- SWITZER-DUNLAP, M. 1978. Larval biology and metamorphosis of aplysiid gastropods. Pp. 197-206 in *Settlement and Metamorphosis of Marine Invertebrate Larvae*, F. S. Chia and M. E. Rice, eds. Elsevier/North-Holland, New York.
- SWITZER-DUNLAP, M., AND M. G. HADFIELD. 1977. Observations on development, larval growth and metamorphosis of four species of Aplysiidae (Gastropoda, Opisthobranchia) in laboratory culture. *J. Exp. Mar. Biol. Ecol.* **29**: 245-261.
- TARDY, J. 1970. Contribution à l'étude des métamorphoses chez les nudibranches. *Ann. Sci. Nat. Zool.* **12**: 299-370.
- THIRIOT-QUIÉVREUX, C. 1970. Transformations histologiques lors de la métamorphose chez *Cymbulia peroni* de Blainville (Mollusca, Opisthobranchia). *Z. Morphol. Tiere* **67**: 106-117.
- THIRIOT-QUIÉVREUX, C. 1977. Végigère planctotrophe du doridien *Aegires punctilucens* (D.Orbigny) (Mollusca: Nudibranchia: Notodorididae): description et métamorphose. *J. Exp. Mar. Biol. Ecol.* **26**: 177-196.
- THOMPSON, T. E. 1958. The natural history, embryology, larval biology, and post-larval development of *Adalaria proxima* (Alder and Hancock) (Gastropoda, Opisthobranchia). *Phil. Trans. R. Soc. Lond.* **B242**: 1-57.
- THOMPSON, T. E. 1959. Feeding in nudibranch larvae. *J. Mar. Biol. Assoc. U. K.* **38**: 239-248.
- THOMPSON, T. E. 1962. Studies on the ontogeny of *Tritonia hombergi* Cuvier (Gastropoda, Opisthobranchia). *Phil. Trans. R. Soc. Lond.* **B245**: 171-281.
- THOMPSON, T. E. 1964. Grazing and the life cycles of British nudibranchs. Pp. 275-297 in *Grazing in Terrestrial and Marine Environments*, D. J. Crisp, ed. Blackwell Scientific Publ., Oxford.

VERTICAL MIGRATION RHYTHMS OF NEWLY HATCHED LARVAE OF THE ESTUARINE CRAB, *RHITHROpanopeus harrisii*

THOMAS W. CRONIN¹ AND RICHARD B. FORWARD, JR.

Duke University Marine Laboratory, Beaufort, NC 28516 and Department of Zoology, Duke University, Durham, NC 27706

ABSTRACT

Zoea larvae of the estuarine crab *Rhithropanopeus harrisii* were maintained in constant conditions in the laboratory, and their vertical migrations were followed for two or more days. Larvae which hatched in the laboratory, but which underwent embryonic development in an estuary having semidiurnal tides, often expressed circatidal rhythms in vertical migration. However, first-stage zoea larvae collected by plankton net in the same estuary had circatidal vertical migration rhythms of much greater amplitude and with a constant phase with respect to the natural tidal cycle. Laboratory-hatched larvae of crabs from an estuary with aperiodic tides had more variable vertical migrations, and field-caught larvae from the same habitat never expressed clear migration rhythms. When reared to the third zoeal stage in the laboratory under a diel light:dark cycle, larvae from both estuaries usually migrated arrhythmically under constant conditions. Vertical migration rhythms of larvae of this species appear to be strongly predisposed to entrainment by natural tidal cues. Such migrations probably contribute to estuarine retention of the developing larvae.

INTRODUCTION

Estuaries are characterized by rapidly changing environmental conditions which often stress the organisms inhabiting them. In spite of this, larvae of the estuarine crab *Rhithropanopeus harrisii* are capable of remaining within an estuary near parent crab populations throughout development (Sandifer, 1973, 1975; Cronin, 1982). Retention is assisted by means of vertical migrations between the landward-flowing and seaward-flowing layers of the estuary; these migrations are partly under endogenous control. Cronin and Forward (1979) showed that *R. harrisii* larvae from an estuary with strong semidiurnal tides continued tidal vertical migrations in constant laboratory conditions, whereas laboratory-reared larvae from an estuary with irregular tides expressed a weak circadian rhythm. The tidal vertical migration was probably due to a circatidal rhythm in activity (Forward and Cronin, 1980).

R. harrisii passes through 4 zoeal stages before molting to the postlarva (Connolly, 1925). In our previous study of rhythmicity in vertical migration, experiments began with the stage III zoea, which were collected directly from the plankton and thus had had several days in which to become entrained to the estuarine tidal cycle. Yet the first-stage larvae of this species also migrate vertically under natural tidal conditions (Cronin, 1982). We therefore initiated a series of experiments to learn

Received 24 January 1983; accepted 25 May 1983.

¹ Current address: Department of Biological Sciences, University of Maryland, Baltimore County, Catonsville, MD 21228.

whether newly hatched larvae also possess vertical migration rhythms. Migrations of larvae which hatched in the laboratory from crabs collected just before larval release occurred were compared to those of first stage larvae collected in the field. To understand better the origins of rhythmic behavior, we compared larvae from a population of crabs living in an estuary having semidiurnal tides with those from an estuary with irregular tides. Finally, the behavior of these newly hatched larvae was compared with that of later-stage larvae entrained under laboratory or field conditions. We found that newly hatched larvae could perform rhythmic migrations, but that the particular pattern of the migration varied with larval age and habitat.

MATERIALS AND METHODS

Preparation of larvae

Larvae from the estuarine crab *Rhithropanopeus harrisi* (Gould) were used exclusively in these experiments. Larvae were obtained from two populations of crabs in North Carolina, one population occurring in the Newport River estuary and the other in the Neuse River estuary. Conditions in these two estuarine systems differ strikingly (Forward *et al.*, 1982). The Newport River is strongly tidal with equal semidiurnal tides. It has extremely dark-colored water in its upper reaches (Cronin, 1982), and light intensities on the bottom, where *R. harrisi* adults live, are below the crabs' threshold (Forward *et al.*, 1982). The Neuse River has aperiodic tides (Roelofs and Bumpus, 1953) and contains rather transparent water.

Field-caught larvae were taken at each site by towing plankton nets within 1 m of the water's surface. These larvae were taken directly to the laboratory where the desired stage(s) of zoea larvae were identified using a dissecting microscope and placed into newly prepared water of identical salinity to that in which they were collected. Water of desired salinity was made by mixing filtered sea water with distilled water. In the Newport River, larvae were collected at high tide during the daytime by towing the sampling net from an outboard motor boat. Neuse River larvae were caught in plankton nets as we walked in shallow water at night. Temperatures at both collecting sites were between 25° and 30°C.

Laboratory-hatched larvae were obtained from recently collected crabs. Crabs were maintained in salinities similar to those of the collection site, in constant temperature ($28 \pm 1^\circ\text{C}$) and low-level light. These conditions are identical to those previously used for crabs originally entrained in natural environments (Forward *et al.*, 1982). In order that prior possible entrainment of larval rhythms be altered as little as possible, only hatches occurring within 4 days of collection were used. In the majority of cases (11 of 15 laboratory hatches), larvae hatched within 24 hours of collection of the mother crab. In a few experiments, larvae were reared to the third stage zoea before experiments were begun. These larvae were changed daily to clean water of appropriate salinity and fed newly hatched *Artemia salina* nauplii until the day of the molt to stage III.

In all cases, larvae were placed in clean water of identical salinity to that of previous field or laboratory exposure and allowed to feed on newly hatched *Artemia* nauplii for at least ½ hour before experiments began. Larvae were then transferred once more to clean water, and the desired number of individuals (usually 100, but occasionally fewer for field-caught larvae; see Table I) were added to a vertical lucite column. The dimensions of the enclosed water column were 190 cm tall \times 5.0 cm \times 7.5 cm.

TABLE I

Basic information about vertical migration experiments

Experiment Number	Starting date	Larval source estuary	Hatch location	Larval stage at start	Length of experiment (h)	Initial number of larvae
791	Aug 13, 1979	Newport	Laboratory	I	83	100
792	Aug 17, 1979	Newport	Laboratory	I	70	100
793	Aug 29, 1979	Newport	Field	I	77	100
794	Sept 7, 1979	Neuse	Laboratory	I	49	100
801	Aug 7, 1980	Neuse	Laboratory	I	52	100
802	Aug 13, 1980	Newport	Field	I	42	100
803	Aug 15, 1980	Neuse	Laboratory	I	69	100
804	Aug 22, 1980	Neuse	Laboratory	I	67	100
805	Aug 27, 1980	Newport	Laboratory	I	54	100
811	Aug 11, 1981	Newport	Laboratory	I	77	100
812	Aug 14, 1981	Neuse	Laboratory	I	71	100
813	Aug 19, 1981	Newport	Laboratory	I	62	100
814	Aug 26, 1981	Neuse	Field	I	54	100
815	Aug 31, 1981	Neuse	Field	I	45	100
816	Sept 3, 1981	Neuse	Field	I	46	100
817	Sept 10, 1981	Neuse	Field	I	51	100
821	July 7, 1982	Neuse	Field	IV	51	37
822	July 10, 1982	Neuse	Field	IV	56	24
823	July 15, 1982	Neuse	Field	III & IV	77	80
824	July 18, 1982	Neuse	Laboratory	III	83	100
825	July 22, 1982	Neuse	Field	III & IV	76	100
826	Aug 10, 1982	Neuse	Laboratory	III	105	100
827	July 26, 1982	Newport	Laboratory	III	97	100
828	Aug 4, 1982	Newport	Laboratory	III	108	100
829	Aug 31, 1982	Newport	Laboratory	III	102	100

Monitoring of larval vertical distributions

Once placed in the experimental column, larvae were maintained in constant darkness and temperature (experiments 791 and 792, $21 \pm 1^\circ\text{C}$; all others, $25 \pm 1^\circ\text{C}$). Because larvae were not fed again, the total length of each experiment was limited by the ability of each larval population to resist starvation. Experiments were usually permitted to run until larval mortality and deterioration left fewer than 20% of the original number of larvae in the water column; occasionally, experiments were terminated before this point if greater than 50 h of data had been obtained.

Distributions of larvae were determined by the method of Cronin and Forward (1979), the only difference being that the experimental column was backlit with diffuse infrared light passing through a Kodak Wratten 87 filter (50% transmission wavelength, 790 nm). Briefly, a closed-circuit TV camera equipped with a silicon-target vidicon vertically scanned the entire height of the lucite column once each half hour, and the camera's output was stored on videotape for later analysis. The infrared backlight was switched on only during the 2 min scan time; the camera also passed a clock on each scan to record the time of day.

Videotapes were analyzed during replay by counting the number of larvae in each 10 cm segment of the water column. Larvae actually on the bottom were not counted, since our experience has been that over 80 percent of well-fed larvae remain

in the water column. The two counts obtained each hour for each segment were summed and an hourly depth-weighted mean calculated. All analyses were performed on the time series of mean depth values.

Data analysis

These experiments were designed to reveal rhythmic behavior in crab larvae following entrainment in specific embryonic or early larval environments. The resulting data challenged straightforward time series analysis for several reasons (see the Figures). Records were short in length, usually less than 72 h. Data represented output from groups of larvae whose individuals did not necessarily have highly synchronous behavior. There commonly were long-term vertical trends. Larval vertical migrations were often of low amplitude and included considerable noise. Of benefit to data analysis, however, was the fact that we restricted our interest to rhythms of circatidal or circadian periods, since these were the periods observed in the earlier study (Cronin and Forward, 1979). Following consultation with J. Hartigan, Yale University Department of Statistics, we decided to analyze each data set using three statistical techniques and a visual evaluation of the data. Each statistical method of analysis approached the data from an independent point of view, and it was common for one method to indicate rhythmicity where the others did not. All analytical methods required complete time series. In the two cases in which some data were missing due to equipment failure, missing values were replaced with values calculated by linear interpolation between adjacent measured values. Because the use of the statistical analyses was useful for extracting information about larval rhythms from the raw data, they are described in some detail below.

Fisher's Periodogram Test. To perform a rough linear detrend, a regression line was fitted to the raw data and subtracted from all points. Detrended data were subjected to Fisher's periodogram test (Fuller, 1976). This test only applies to harmonics of the total time series; periods of significant cycles can be compared to the tidal or diel period, but because the tested cycles are harmonics of the series they do not always fall very near the precise environmental period. Fisher's test has the further limitation of examining only the frequency of largest amplitude in a time series.

Multiple Autoregression. Each data set was multiply regressed on itself at three lags. For the circatidal rhythm analysis, the 3 independent variables were the measured mean depth values at 1 h, 2 h, and 12 h or 13 h prior to the value at a given hour. (Both 12 h and 13 h were tested in order to bracket the average natural tidal period, which was 12.4 h in the Newport River.) For circadian rhythm analysis, the lags were 1 h, 2 h, and 24 h. Periodicity in the data was taken to be significant if the regression coefficient of the 3rd independent variable (lag of 12, 13, or 24 h) was significantly greater than 0. Multiple autoregression was relatively inefficient in finding rhythms in these experiments.

Analysis of Variance (ANOVA). ANOVA is not a traditional statistical tool for time series analysis. We were able to apply it because we restricted our analytical effort to periods approximating the natural diel and tidal cycles. Each data set was broken into a whole number of segments; for tidal analysis these segments were 12 h or 13 h in length, while for diel analysis they were 24 h long. To minimize the effects of long-term trends, the mean value in each segment was calculated and removed from all values in that segment. Next, a 1-way ANOVA was performed on the 12, 13, or 24 hourly values, with the number of replicates in each hour being the total number of segments in the data set. This analysis therefore tested whether

there was significant hour-to-hour variation in the data within blocks 12 h, 13 h, or 24 h in length. A significant result could occur when the averaged segments contained a monotonic trend, when high-frequency noise was present, when repeated smaller cycles fell within the total segment length, or when cycles of the total segment length occurred. Since only the last case was of interest, the sequence of hourly means was examined for rejection of misleading significance due to trends, noise, or internal cycles. ANOVA proved to be a powerful method for determining rhythms in our data, probably because the method of removing the mean from each section of data was an effective way to minimize the contributions of irregular long-term variations.

Subjective Evaluation of Data. Because of the nature of the process under study, it is probably at present impossible to obtain data which are completely amenable to statistical treatment. We have relied on the techniques described above to provide an objective base for drawing conclusions, but occasionally we also turned to a subjective evaluation of the data in hopes of increasing our understanding of larval rhythmic behavior. We encourage readers to inspect thoroughly the data we present so that they can decide whether to accept our conclusions.

RESULTS

Essential information about each experiment is given in Table I. When classed according to larval source (Newport vs. Neuse River), hatch location (laboratory vs. field), and larval stage at the beginning of the experiment (zoea I vs. zoea III or IV), a total of 7 types of experiments was performed. [Ideally, there should have been 8 possible combinations of categories, but results obtained with late-stage larvae collected in the Newport River have been reported earlier (Cronin and Forward, 1979)]. Experiments are grouped by type in Figures 1–7, and results of statistical analyses are given in Table II. For convenience in presenting results, each type of experiment will be described separately.

Newport River: Laboratory-hatched stage I zoea larvae

This series of experiments investigated rhythmic vertical migration behavior in newly hatched larvae which had been entrained as embryos in the strongly tidal conditions of the Newport River estuary, but which hatched in the laboratory. Five replicates were performed (Fig. 1), and of these, 4 revealed significant evidence of circatidal rhythmicity in larval vertical migration (Table II). The 5th experiment also illustrated circatidal periodicity after an initial 24 h rise in the water column (Table II, Fig. 1). Visual examination of Figure 1 reveals that low points in the larval migration were not particularly well synchronized with the time of low tide at the site of collection of the parent crab. No evidence was found in any analysis for circadian rhythmicity, nor is any circadian variation suggested in the individual graphs of Figure 1. Experiment 813 is a possible exception, since alternately deeper low points occurred near midnight (Fig. 1).

Neuse River: Laboratory-hatched stage I zoea larvae

These experiments were similar to those of the previous group except that prior entrainment occurred in the nontidal, well lit environment of the Neuse River estuary. All larvae hatched near the time of sunset on the night the experiment began, as is typical of larval hatches of crabs from this location (Forward *et al.*, 1982). The results were more varied than those obtained with Newport River larvae (Fig. 2). Data analysis revealed significant circatidal periodicity in 2 cases (experi-

TABLE II

*Results of statistical tests for periodicity performed on the time series of each experiment's data**

Experiment type	Experiment number	Fisher's test	Multiple autoregression	Analysis of variance
Newport River, First Stage, Lab-Hatched	791	+	+	+
	792	11.7 h	—	12 h, 13 h
	805	—	—	12 h
	811	—	—	12 h
	813	—	13 h	—
Neuse River, First Stage, Lab-Hatched	794	—	—	—
	801	13.0 h	—	12 h, 13 h
	803	34.5 h	—	—
	804	—	—	24 h
	812	—	—	12 h, 24 h
Newport River, First Stage, Field-Caught	793	12.8 h	12 h, 24 h	12 h, 13 h
	802	14.0 h	12 h, 13 h, 24 h	12 h, 13 h
Neuse River, First Stage, Field-Caught	814	—	—	—
	815	—	—	—
	816	—	—	—
	817	—	—	—
Newport River, Late Stage, Lab-Hatched	827	—	—	—
	828	—	—	12 h, 13 h
	829	—	—	—
Neuse River, Late Stage, Lab-Hatched	824	—	—	—
	826	—	—	—
Neuse River, Late Stage, Field-Caught	821	25.5 h	—	—
	822	18.7 h	—	—
	823	—	—	—
	825	—	—	—

* Included are all results of statistical tests giving $P < 0.05$. Significant results are given for Fisher's Periodogram Test only if the significant period was not equal to the entire length of the time series.

† In experiment 791, no test yielded a significant result for the entire 83 h of the time series. However, if the first 24 h of data (during which there was a continuous rise) were eliminated, Fisher's Test indicated a significant period of 11.8 h, and ANOVA gave significant results for periods of 12 h and 13 h.

ments 801 and 812, Table II); circadian periodicity was indicated in 2 experiments as well (804 and 812). In spite of the heterogeneous mixture of vertical migration patterns, one migration feature was consistently observed. All groups of larvae initially migrated downward until near midnight (near dawn in experiment 794), when they reversed their course and rose for the succeeding several hours (Fig. 2). This pattern is not simply a response to being placed in the experimental column, since it was not observed in Newport River larvae (Fig. 1). Subsequent pre-dawn rises are also visible in several cases (Experiments 801, 803, 804, and 812).

Newport River: Field-caught stage I zoea larvae

In these experiments, larvae were taken from the plankton and thus had an opportunity to experience conditions in the Newport River as free-living individuals for some time prior to being placed under constant conditions. Only two experiments were performed since the results were very clearcut. Larvae were strongly circatidally rhythmic (Table II), reaching the low points of their migrations just after the time

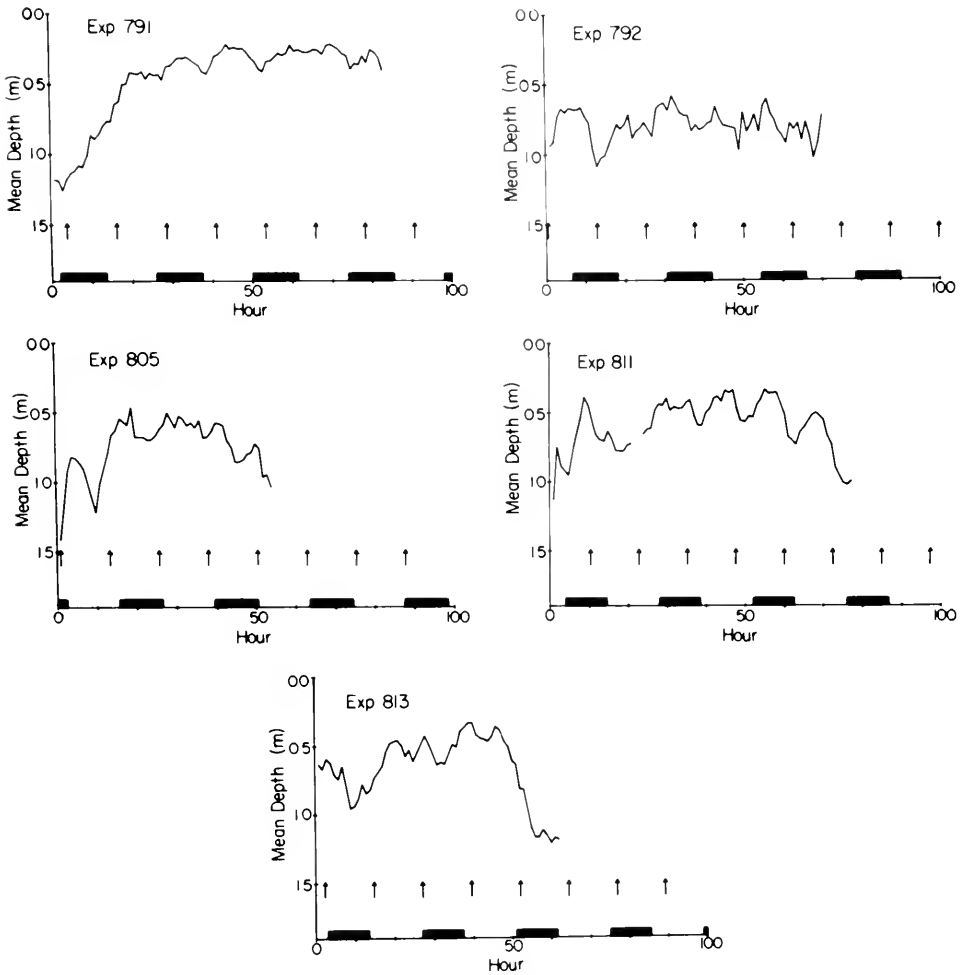

FIGURE 1. Hourly positions of the mean depths of populations of first-stage *Rhithropanopeus harrisii* larvae maintained in constant darkness and at constant temperature. Each panel represents the results obtained with larvae of a single hatch from a crab collected in the Newport River estuary. Dark and light bands on the abscissa indicate the times of natural night and day, respectively. Arrows indicate times of low tide at the collection site. Gaps correspond to missing data due to equipment failure.

of low tide at the collection site (Fig. 3). Such a pattern duplicates results already obtained for field-entrained late-stage Newport River *R. harrisii* larvae (Cronin and Forward, 1979). Autoregression analysis also showed that larval depths were significantly predicted by those 24 h earlier in the record (Table II), but we feel that this is actually a correlation with the second previous tidal cycle. The other statistical tests found no 24 h rhythmicity, and inspection of Figure 3 shows no sign of circadian activity.

Neuse River: Field-caught stage I zoea larvae

Here, larval sample populations were taken in nighttime plankton tows in the Neuse River. The majority of the larvae almost certainly hatched on the same night

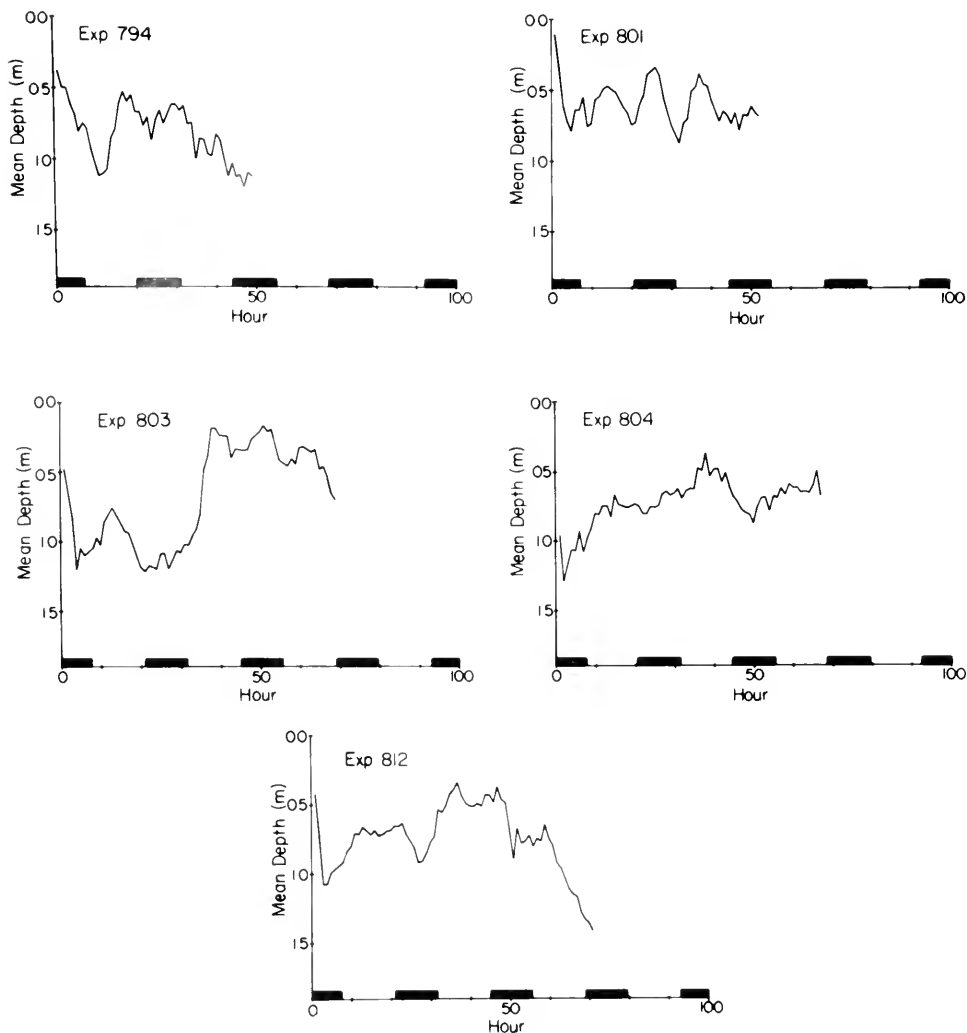

FIGURE 2. Hourly positions of the mean depths of populations of first-stage *Rhithropanopeus harrisii* larvae maintained in constant darkness and at constant temperature. Each panel represents the results obtained with larvae of a single hatch from a crab collected in the Neuse River estuary. Dark and light bands on the abscissa indicate the times of natural night and day, respectively.

on which they were collected (see Discussion). Four replicates were completed. Results revealed a variety of irregular migration patterns (Fig. 4), but in no case was there any significant circadian or circatidal rhythmicity (Table II). However, the pattern described earlier for laboratory-hatched Neuse River larvae was again present. Larvae usually moved downward until late in the first dark phase, at which time they reversed course and rose in the water column. In these experiments, however, there was little evidence for repeated cycling (Fig. 4).

Newport River: Laboratory-hatched and reared late-stage zoea larvae

We have previously reported that Neuse River larvae reared in constant temperature and in a 12 h light:12 h dark cycle performed a low-amplitude circadian

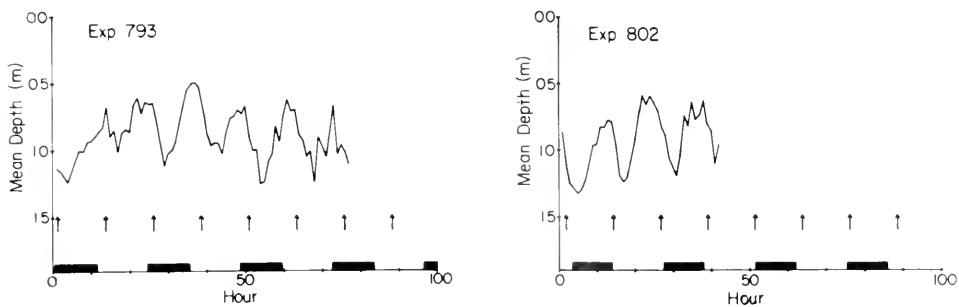

FIGURE 3. Hourly positions of the mean depths of populations of first-stage *Rhithropanopeus harrisi* larvae maintained in constant darkness and at constant temperature. Each panel represents the results obtained with larvae caught in plankton net tows taken in the Newport River estuary. Dark and light bands on the abscissa indicate the times of natural night and day, respectively. Arrows indicate times of low tide at the collection site.

rhythm of vertical migration, reaching their lowest position near midnight and their greatest height near midday (Cronin and Forward, 1979). We were interested to learn whether the same result would obtain with laboratory-reared Newport River larvae; therefore, on 3 occasions we reared laboratory-hatched Newport River larvae to zoea III before placing them in experimental conditions. Larvae were maintained in a 14 h light:10 h dark cycle which closely matched the actual times of sunrise

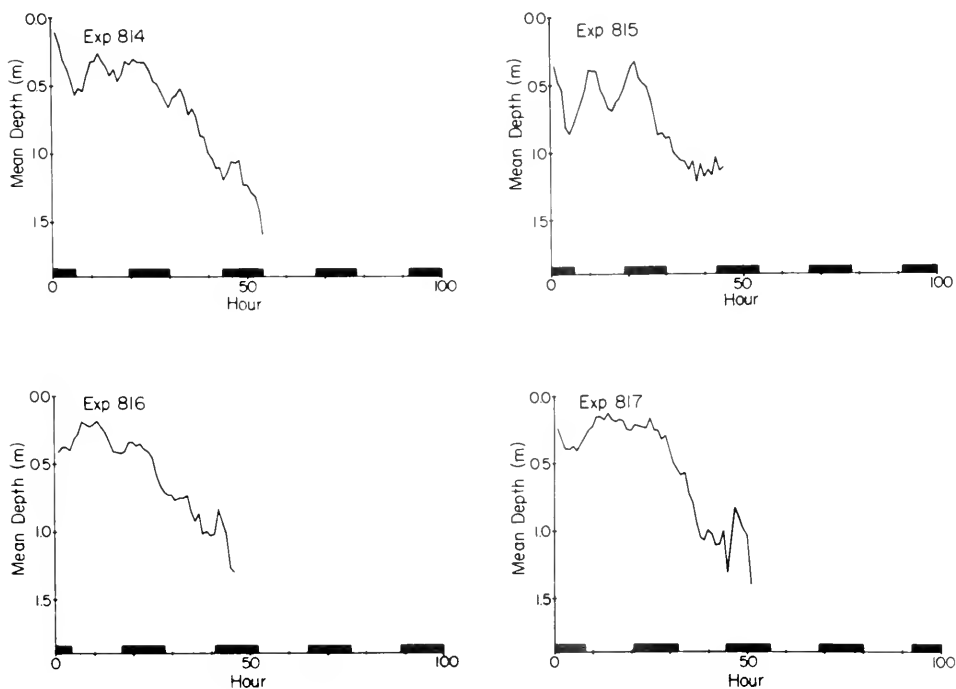

FIGURE 4. Hourly positions of the mean depths of populations of first-stage *Rhithropanopeus harrisi* larvae maintained in constant darkness and at constant temperature. Each panel represents the results obtained with larvae caught in plankton net tows taken in the Neuse River estuary. Dark and light bands on the abscissa indicate the times of natural night and day, respectively.

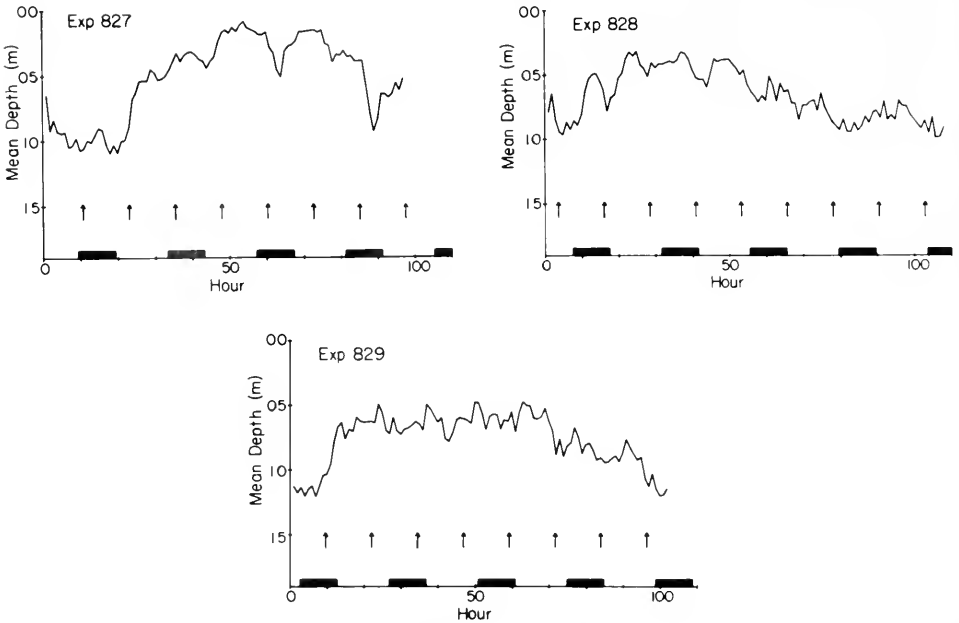

FIGURE 5. Hourly positions of the mean depths of populations of late-stage *Rhithropanopeus harrisii* larvae maintained in constant darkness and at constant temperature. Each panel represents the results obtained with larvae of a single hatch from a crab collected in the Newport River estuary, which were reared to zoeal stage III before the experiment began. Light and dark bands on the abscissa indicate the light:dark cycle to which the larvae were exposed during rearing. Arrows indicate times of low tide at the collection site.

and sunset. Migration patterns were largely random (Fig. 5), but in one case (experiment 828) ANOVA indicated the presence of circatidal rhythmicity (Table II).

Neuse River: Laboratory-hatched and reared late stage zoea larvae

For these 2 experiments, Neuse River larvae were prepared under identical conditions to the Newport River larvae just described. Once more, the light:dark cycle

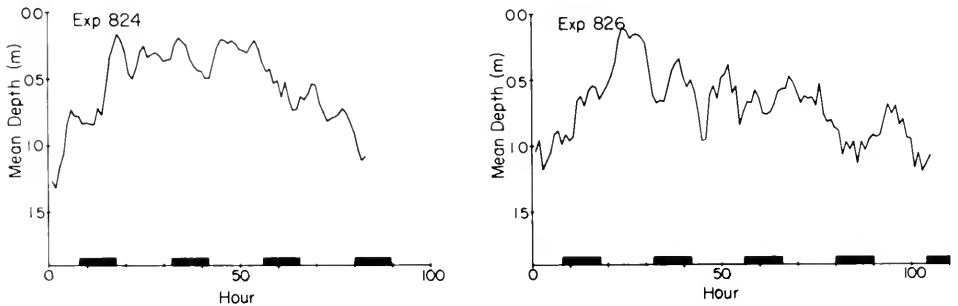

FIGURE 6. Hourly positions of the mean depths of populations of late-stage *Rhithropanopeus harrisii* larvae maintained in constant darkness and at constant temperature. Each panel represents the results obtained with larvae of a single hatch from a crab collected in the Neuse River estuary, which were reared to zoeal stage III before the experiment began. Light and dark bands on the abscissa indicate the light:dark cycle to which the larvae were exposed during rearing.

consisted of 14 h of light alternating with 10 h of dark, instead of the 12 h:12 h cycle previously used (Cronin and Forward, 1979). In contrast to the results of that work, no rhythmicity was indicated, either statistically or by visual inspection of the data (Fig. 6, Table II). Essentially random movements of the center of the larval population occurred.

Neuse River: Field-caught late-stage zoea larvae

Larvae were collected in an identical way to the first-stage Neuse River larvae. Four replicates were performed (Fig. 7); there was some statistical evidence in two of them of circadian rhythmicity (experiments 821 and possibly 822, Table II). However, the form of the circadian pattern is difficult to recognize in the figures, and all the graphs reveal considerable random movement.

DISCUSSION

Larvae of the estuarine crab *Rhithropanopeus harrisi* are known to possess endogenous rhythms of vertical migration by the time they attain the third zoeal stage (Cronin and Forward, 1979). The period lengths of these rhythms can approximate the period of either the tidal cycle or the diel cycle, depending on the prior entrainment regime and the larval source. We designed the experiments described in this paper to answer the questions of whether these rhythms are expressed early in larval life and whether it is possible for larvae to become entrained to

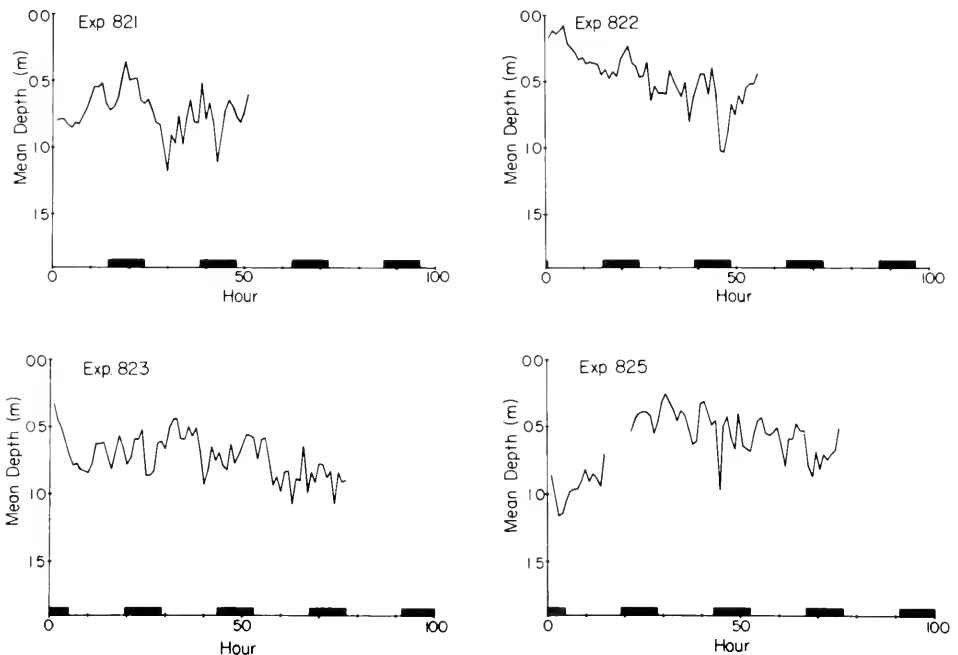

FIGURE 7. Hourly positions of the mean depths of populations of late-stage *Rhithropanopeus harrisi* larvae maintained in constant darkness and at constant temperature. Each panel represents the results obtained with stage III and/or stage IV larvae collected by plankton net in the Neuse River estuary. Dark and light bands on the abscissa indicate the times of natural night and day, respectively. Gaps correspond to missing data due to equipment failure.

environmental cycles during their embryonic development. The results, although more equivocal than the ones obtained previously, suggest that both questions may be answered in the affirmative. However, conditions which vary between estuaries, and which also differ in their effects on larvae before and after hatching, strongly modify the rhythmic aspects of larval migrations. Furthermore, there probably exist differences among larval cohorts or larval populations which also affect expression of larval rhythms.

Stage I zoea larvae from the Newport River performed vertical migrations in the constant conditions of the laboratory, even if they had never experienced the strong tidal influences of this estuary as free-living individuals. The apparent circatidal rhythms of laboratory-hatched larvae were probably entrained during embryonic development. While the larvae are developing, the parent crab with the egg mass remains at depths where the diel light:dark cycle is imperceptible (Forward *et al.*, 1982), so the lack of circadian rhythmicity is not surprising. The observed rhythmicity could be a product of embryonic entrainment by tidal cycles of pressure and/or salinity, as both are known to induce circatidal rhythmicity in crustaceans (Naylor and Atkinson, 1972; Taylor and Naylor, 1977). Pressure receptors have not been described in larval brachyurans, much less in their embryos; but *R. harrisi* larvae are highly responsive to pressure changes (Bentley and Sulkin, 1977; Wheeler and Epifanio, 1978). They also respond to small salinity changes (Latz and Forward, 1977; Harges and Forward, 1982).

The mother crab could assist in entraining larval rhythms by manipulating the egg masses at a specific phase in the tidal cycle, since mechanical stimulation is effective in entraining circatidal rhythmicity (Enright, 1963, 1965). We have never observed such behavior in crabs in the laboratory. Hatching itself could be a "one-shot" synchronizer since larval release is precisely timed with respect to environmental cycles in *R. harrisi* (Forward *et al.*, 1982) as well as in other estuarine crabs (DeCoursey, 1979; Bergin, 1981; Saigusa, 1981). This seems unlikely since crabs from the Neuse River have a larval release rhythm, but their larvae do not always reveal circatidal rhythms after hatching. Furthermore, unpublished observations suggest that the time of hatching is more likely controlled by the embryos themselves than by the mother crab.

In any case, much stronger rhythms are expressed by stage I larvae from the Newport River after a short time in the plankton. Our field-caught larvae were probably less than 3 days old, since the first zoeal stage is passed in 2-3 days at environmental temperatures in the laboratory (Costlow and Bookhout, 1971). In the few tidal cycles after hatching, the larval rhythms became enhanced in amplitude and, probably, coherency (seen as reduced noise, c.f. Fig. 1 and 3), and thus became very similar to rhythms of late-stage *R. harrisi* larvae from the same location (Cronin and Forward, 1979). The entraining stimuli, whether the same or different, are clearly much more effective upon free-living larvae than on developing embryos.

Compared to Newport River larvae, stage I zoea larvae from the Neuse River were much more variable in their expression of vertical migration rhythms. Two experiments showed statistical evidence of circadian rhythmicity and 2 of circatidal rhythmicity, while one group of laboratory-hatched larvae and all field-caught larval groups were arrhythmic. The statistical results agree reasonably well with the subjective appearance of the results (Fig. 4). Circadian rhythmicity is not unexpected in this population since hatching time is under circadian rhythmic control (Forward *et al.*, 1982) and late-stage larvae of crabs from this estuary can show circadian rhythms of vertical movement (Cronin and Forward, 1979). The crabs were collected from shallow depths in quite transparent water, so entrainment by the daily

light:dark cycle was possible. In all these experiments there was an initial nighttime sinking phase followed by an upward migration early the next day (experiment 816 did not have the initial descent, but this experiment began just before dawn). The results thus resemble the single-cycle "hourglass" timing of the vertical migrations of some marine zooplankton, which require resetting by external inputs each day (Enright and Hamner, 1967). It appears that newly-hatched larvae from the Neuse River can express a weak, rapidly-damping circadian rhythm in vertical migration.

Evidence that at least some cohorts of Neuse River larvae have circatidal rhythms is surprising. Tides in this estuary are reportedly aperiodic (Roelofs and Bumpus, 1953). We measured changes in salinity and depth at one of our collection sites in the Neuse River for 24 h and found no evidence of regular tidal influence. However, *R. harrisii* from this estuary have circatidal hatching rhythms once placed in natural tidal conditions (Forward *et al.*, 1982). Until further experiments are done, it will be impossible to know whether the 12–13 h rhythms observed here are expressions of this innate tidal clock.

Only laboratory hatches of Neuse River larvae had significant rhythms. This probably reflects the fact that in each experiment, larvae had identical developmental histories and a single hatching time. In the field samples, first-stage *R. harrisii* larvae were much more abundant than later stages, and were most easily obtained soon after dark. Therefore, the ones used in our experiments had most likely hatched on the night they were collected, but they had experienced a range of developmental conditions and probably had hatched over a period of hours (see Forward *et al.*, 1982). The irregular vertical movements of these larval groups evidently result from the lack of synchrony among the individual larvae of the experiment. This contrasts with the greater synchrony seen in the migrations of Newport River larvae entrained in the field. Evidently, tidal variables of latter estuary are much more effective synchronizers than the diel variations in the Neuse River environment.

In their essential features, the migration patterns of laboratory-hatched stage I zoea larvae from each estuary were similar to those of first-stage larvae collected from the plankton of that estuary. In contrast, late-stage larvae reared in the laboratory had vertical migrations which resembled neither those of field-caught larvae of similar age nor those of the first-stage larvae. Newport River larvae which lived in natural field conditions until the third zoea had dramatic migration rhythms when placed in constant conditions (Cronin and Forward, 1979). When reared to the same stage in the laboratory in an imposed light:dark cycle, these larvae were usually arrhythmic (Fig. 5). In one case, statistical analysis indicated that a cycle of circatidal period was present (Table II). It therefore remains possible that an initial circatidal rhythm can continue throughout development, though it is not clear how coherency among larval individuals could be maintained.

In neither laboratory-reared nor field-caught groups of stage III Neuse River larvae do vertical migration patterns commonly show significant rhythmicity. To the eye, these migrations appear essentially random. Larvae from this source are capable of expressing circadian migration rhythms when reared on a 12 h:12 h light:dark cycle (Cronin and Forward, 1979). The present results suggest that the circadian tendency is rather weak.

Taken as a whole, the results of this study indicate that entrainment of vertical migration rhythms may occur during embryonic development. Larvae of *R. harrisii* seem strongly biased towards circatidal, rather than circadian, rhythmicity. Entrainment to the tidal cycle is dramatically enhanced once larvae become free living, whereas entrainment to the diel cycle is clearly no more effective on free-living than on embryonic larvae. Our failure to find strong circadian rhythms after rearing

larvae in an imposed light:dark cycle is especially impressive when compared to results of a previous experiment which studied vertical migration of late-stage *R. harrisii* larvae when exposed to an external light:dark cycle (Cronin and Forward, 1982). In this case, exogenously driven diel vertical migrations occurred over most of the 1.9 m height of the experimental column. Such migrations have not been observed in field populations of these larvae (Cronin, 1982), and the importance of the diel light:dark cycle in controlling larval behavior of *R. harrisii* remains to be understood.

Several other species of estuarine crabs have circatidal rhythms of larval release (DeCoursey, 1979; Bergin, 1981; Saigusa, 1981), and field sampling by Christy and Stancyk (1982) strongly suggested that virtually all crab species in a South Carolina estuary release larvae near local high tide times. One might therefore expect circatidal rhythms in the larvae of these crabs. Yet *R. harrisii* stands alone among species yet studied in having highly effective mechanisms for larval retention in estuaries (Cronin, 1982); the other larval species all apparently undergo rapid export from estuaries, perhaps to reduce predation pressure (Christy, 1982). Estuarine retention of *R. harrisii* larvae is thought to be assisted by their tidal vertical migrations (Cronin and Forward, 1979, 1982; Cronin, 1982). Studies of the circatidal rhythms of other species of estuarine crab larvae, as well as of the endogenous and exogenous controls on these rhythms, should prove highly informative to our understanding of the bases of larval ecology.

ACKNOWLEDGMENTS

We thank W. Hunnings for assistance with design, construction, and maintenance of the monitoring system; K. Lohmann and M. Butka for helping with the collection of animals; and J. Hartigan for patient advice on the use of statistical techniques. R. Cole and T. Seeley provided useful comments on the manuscript. This material is based on research supported by the National Science Foundation under grant no. OCE-8007434.

LITERATURE CITED

- BENTLEY, E., AND S. D. SULKIN. 1977. The ontogeny of barokinesis during zoeal development of the xanthid crab *Rhithropanopeus harrisii* (Gould). *Mar. Behav. Physiol.* **4**: 275-282.
- BERGIN, M. E. 1981. Hatching rhythms in *Uca pugilator* (Decapoda: Brachyura). *Mar. Biol.* **63**: 151-158.
- CHRISTY, J. H. 1982. Adaptive significance of semilunar cycles of larval release in fiddler crabs (genus *Uca*): test of an hypothesis. *Biol. Bull.* **163**: 251-263.
- CHRISTY, J. H., AND S. E. STANCYK. 1982. Timing of larval production and flux of invertebrate larvae in a well-mixed estuary. Pp. 489-503 in *Estuarine Comparisons*, V. S. Kennedy, ed. Academic Press, New York.
- CONNOLLY, C. J. 1925. The larval stages and megalopa of *Rhithropanopeus harrisii* (Gould). *Contr. Can. Biol.* **2**: 329-334.
- COSTLOW, J. D., JR., AND C. G. BOOKHOUT. 1971. The effect of cyclic temperatures on larval development in the mud-crab *Rhithropanopeus harrisii*. Pp. 211-220 in *Fourth European Marine Biology Symposium*, D. J. Crisp, ed. Cambridge Univ. Press, Cambridge.
- CRONIN, T. W. 1982. Estuarine retention of larvae of the crab *Rhithropanopeus harrisii*. *Estuarine Coastal Shelf Sci.* **15**: 207-220.
- CRONIN, T. W., AND R. B. FORWARD, JR. 1979. Tidal vertical migration: an endogenous rhythm in estuarine crab larvae. *Science* **205**: 1020-1022.
- CRONIN, T. W., AND R. B. FORWARD, JR. 1982. Tidally timed behavior: effects on larval distributions in estuaries. Pp. 505-520 in *Estuarine Comparisons*, V. Kennedy, ed. Academic Press, New York.
- DECOURSEY, P. 1979. Egg hatching rhythms in three species of fiddler crabs. Pp. 399-406 in *Cyclic Phenomena in Marine Plants and Animals*, E. Naylor and R. G. Hartnoll, eds. Proceedings of the 13th European Marine Biology Symposium, Pergamon Press, Oxford.

- ENRIGHT, J. T. 1963. The tidal rhythm of activity of a sand-beach amphipod. *Z. Vgl. Physiol.* **46**: 276-313.
- ENRIGHT, J. T. 1965. Entrainment of a tidal rhythm. *Science* **147**: 864-867.
- ENRIGHT, J. T., AND W. M. HAMMER. 1967. Vertical diurnal migration and endogenous rhythmicity. *Science* **157**: 937-941.
- FORWARD, R. B., JR., AND T. W. CRONIN. 1980. Tidal rhythms of activity and phototaxis in an estuarine crab larva. *Biol. Bull.* **163**: 295-303.
- FORWARD, R. B., JR., K. LOHMANN, AND T. W. CRONIN. 1982. Rhythms in larval release by an estuarine crab (*Rhithropanopeus harrisi*). *Biol. Bull.* **163**: 287-300.
- FULLER, W. A. 1976. *Introduction to Statistical Time Series*. J. Wiley, New York. 470 pp.
- HARGES, P., AND R. B. FORWARD, JR. 1982. Salinity perception by larvae of the crab *Rhithropanopeus harrisi* (Gould). *Mar. Behav. Physiol.* **8**: 311-331.
- LATZ, M. I., AND R. B. FORWARD, JR. 1977. The effect of salinity upon phototaxis and geotaxis in a larval crustacean. *Biol. Bull.* **153**: 163-179.
- NAYLOR, E., AND R. J. A. ATKINSON. 1972. Pressure and the rhythmic behaviour of inshore marine animals. *Symp. Soc. Exp. Biol.* **26**: 395-415.
- ROELOFS, E. W., AND D. F. BUMPUS. 1953. The hydrography of Pamlico Sound. *Bull. Mar. Sci. Gulf Carib.* **3**: 181-205.
- SAIGUSA, M. 1981. Adaptive significance of a semilunar rhythm in the terrestrial crab *Sesarma*. *Biol. Bull.* **160**: 311-321.
- SANDIFER, P. A. 1973. Distribution and abundance of decapod crustacean larvae in the York River estuary and adjacent lower Chesapeake Bay, Virginia, 1968-1969. *Chesapeake Sci.* **14**: 235-257.
- SANDIFER, P. A. 1975. The role of pelagic larvae in recruitment to populations of adult decapod crustaceans in the York River estuary and adjacent lower Chesapeake Bay, Virginia. *Estuarine Coastal Mar. Sci.* **3**: 269-279.
- TAYLOR, A. C., AND E. NAYLOR. 1977. Entrainment of the locomotor rhythm of *Carcinus* by cycles of salinity change. *J. Mar. Biol. Assoc. U.K.* **57**: 273-277.
- WHEELER, D. E., AND C. E. EPIFANIO. 1978. Behavioral response to hydrostatic pressure in larvae of two species of xanthid crabs. *Mar. Biol.* **46**: 167-174.

CONTROL OF EGG HATCHING IN THE CRAB *RHITHROANOPEUS HARRISII* (GOULD)

RICHARD B. FORWARD, JR. AND KENNETH J. LOHMANN

*Duke University Marine Laboratory, Beaufort, NC 28516 and Department of
Zoology, Duke University, Durham, NC 27706*

ABSTRACT

Ovigerous females of the crab *Rhithropanopeus harrisi* were collected from an estuary having irregular tides. When monitored under constant conditions in the laboratory, the crabs have a circadian rhythm in larval release. Eggs removed from the female within 2 days of hatching hatched at about the same time as larvae were released by the female. Hatching became increasingly desynchronized with longer removal times. Upon exposure to water in which the larvae hatched, ovigerous females displayed increased abdomen pumping, a behavior observed at the time of larval release. The active substance was released at the time of egg hatching but not by newly hatched larvae. Homogenized eggs of different ages and homogenized larvae induced similar behavior. There was no change in female sensitivity with clutch age or time of day. Active pumping by the female only induced hatching at times predicted by the larval release rhythm, not at other times during the solar day. These results indicate that an interaction between the eggs and female is responsible for synchronized development while the actual timing of hatching is controlled by the embryo. At this time an active substance is released. This substance induces abdomen pumping by the female which serves to synchronize larval release.

INTRODUCTION

Precisely-timed rhythms in larval release are common among crustaceans. The timing may be related to lunar phase (Christy, 1978, 1982; Saigusa and Hidaka, 1978; Wheeler, 1978; Saigusa, 1981), time of day (Ennis, 1973, 1975; Branford, 1978; Moller and Branford, 1979), or phase of the tide (DeCoursey, 1979; Bergin, 1981). Detailed studies of fiddler crabs (DeCoursey, 1979) and lobsters (Ennis, 1973) indicate that larval release lasts only a few minutes and is associated with rapid movements of the ovigerous female's abdomen and pleopods. Since larval release is a short, precisely-timed event, an important question is whether the timing is controlled by the female or the developing embryos.

Previous studies produced divergent results. DeCoursey's (1979) work with the fiddler crab *Uca minax* suggests that physical stimulation of hatching by the female is necessary for larval release. For the lobster *Homarus gammarus*, Branford's (1978) results indicate that larval release is regulated by the female and that her role in the hatching process is under endogenous control. Alternatively, other investigators (Pandian, 1970; Ennis, 1973) have suggested that for this lobster species the clock which sets the hatching time is in the egg itself.

The estuarine crab *Rhithropanopeus harrisi* also releases its larvae over a short time interval (Forward *et al.*, 1982). In the laboratory under constant conditions, larval release by crabs from an estuary lacking regular tides occurs mainly in the

2 h interval after the time of sunset, which suggests the presence of a circadian rhythm. In contrast, releases in the laboratory by crabs from an estuary with semi-diurnal tides generally begin at the time of high tide in the field and continue for 2 h, suggesting a circatidal rhythm. The present study examines whether the female or the embryo is controlling the timing of hatching.

Using crabs with a circadian rhythm, we first determined whether the detached eggs hatch at the same time as eggs attached to the female. Since the timing was similar, we then experimented to determine if a chemical cue from the hatching eggs induced the female to undergo the behavioral sequence observed during larval release.

MATERIALS AND METHODS

The crab *Rhithropanopeus harrisi* (Gould) was collected from the Neuse River estuary (North Carolina). Oviparous females were obtained either from the field or from a breeding population in a laboratory habitat (described in Forward *et al.*, 1982). Females were maintained in an environmental chamber (Sherer Gillett Co., Model CEL 4-4) at 26–27°C in 8 ppt sea water which was filtered to remove particles larger than 5 μ . A 14 h light:10 h dark photoperiod was employed. Under these conditions, females from both the field and the laboratory habitat release larvae in the interval beginning at the end of the light phase and concluding about 2 h later (Forward *et al.*, 1982). The general experimental procedures are described below while specific modifications are explained in the Results section. The term "eggs" refers to the combination of outer covering, enclosed non-living material, and the developing embryo before hatching.

The first series of experiments was designed to determine whether detached eggs can hatch and if so, whether the time of hatching is similar to that of larval release by the female. Hatching was monitored under 3 conditions: detached eggs in still water, detached eggs on a mechanical shaker, and eggs attached to the female. Crabs with eggs which would hatch within 1 day (based on eye development and yolk consumption) were used. For monitoring hatching by detached eggs in still water 100–200 eggs were removed from each female about 3 h before the end of the light phase and placed in a 7.9 cm diameter finger bowl containing 8 ppt sea water filtered to remove particles larger than 5 μ . Preliminary observations indicated that most of the eggs hatched in a several hour interval just after the beginning of the dark phase. To quantify this sequence, hatching was monitored over a 5 h sampling time beginning 1 h before the end of the light phase. At 0.5 h intervals, the number of free swimming zoeae was counted and removed by pipette from the finger bowl. Care was taken not to swirl the bowl water during removal. After the day phase ended the eggs were placed in constant low level light (photographic safe light containing a 15 W bulb and fitted with a Kodak OA filter; wavelength maximum = 573 nm, half band pass 37 nm, intensity = 10^{-2} W/m²) at 27° ± 1°C. A microscope illumination lamp (American Optical Co.) interference filtered to 660 nm (Ditric Optics Inc., half band pass 11 nm) was used briefly to see the larvae each half hour. Larvae are very insensitive to this wavelength (Forward and Cronin, 1979). If eggs remained at the end of the 5 h sampling interval, then they were maintained under constant conditions, and the observation procedure was repeated at the next monitoring time, 19 h later.

In order to simulate the pumping action of the female a similar group of eggs was placed in a finger bowl on a mechanical shaker (Eberbach Corp.). Eggs were shaken at a rate of about 1 cycle/s. Shaking began 1 h before the beginning of the

dark phase and continued until hatching occurred. Thus eggs which hatched at the time of the second night in constant conditions had actually been shaken continuously for at least the preceding 24 h. The bowl was briefly removed from the shaker to count swimming zoeae.

Simultaneously, we also determined the time of larval release by the parent female with attached eggs. Crabs were subjected to the same conditions as the eggs. During the 5 h sampling interval, the female was transferred every 30 min to a new 7.9 cm diameter finger bowl. At the end of the sampling period, she was placed in a 10.4 cm diameter finger bowl and if eggs remained, the procedure was repeated at the next monitoring time. The number of larvae released within each 30 min interval was recorded. Crabs and detached eggs were monitored only for 2 consecutive nights in constant conditions.

The detached eggs hatched over several hours (see Figs. 1A and 1C for typical profiles). For the females with eggs, most larvae are released within a 30 min interval, though a few commonly appear in the intervals immediately preceding and following the peak (Fig. 1B). The mean time of hatching by the eggs and larval release by the female was calculated by multiplying the number of larvae observed in each 30 min interval by that interval, taking the sum of these products over all intervals and dividing this sum by the total number of larvae. In this way a single 30 min interval was designated as the time of hatching/larval release.

The next series of experiments was designed to test for the presence of chemical communication between the eggs and the female. At the time of larval release the female elevates her body upon her walking legs, then repeatedly flexes her abdomen. Larvae are released with each "pump."

The frequency of abdomen pumping was used to quantify the inclination of the female to undergo larval release behavior. The procedure was to first place the female in a 7.9 cm diameter finger bowl containing 40 ml of 8 ppt sea water filtered to remove particles larger than 0.2μ and at $27 \pm 1^\circ\text{C}$. The number of pumps in the initial 2 min interval was counted by a stationary observer. The crab was then placed in 40 ml of the test solution (*e.g.*, water in which hatching had occurred) and the number of pumps in the initial 2 min period was similarly recorded. The control consisted of placing previously untested crabs sequentially in clean 8 ppt sea water. The control level did not change with embryo development and is reported for females with eggs that would hatch within 3 days. Each crab was used only once in a particular test solution. Initial experiments were conducted during the 5 h interval after the beginning of the dark phase, because this is the time of normal larval release. In this case the crabs were observed under red light. Since we subsequently found that responsiveness by the crabs does not vary over the day, later trials were conducted under room lighting during the day.

RESULTS

Hatching by separated eggs

A typical hatching profile of eggs removed from the female and kept in still water is shown in Figure 1A. Hatching of detached eggs is not as synchronized as larval release by the female (Fig. 1B). It usually begins shortly before the time of greatest release by the female and continues over about the next 3 to 4 hours.

Most of the crabs (95%) both released their larvae and had their detached eggs hatch shortly after the beginning of the night phase. For all of the eggs monitored in still water (Fig. 2), an average of 96% (SE = 0.8%) of each group hatched within the 5 h sampling interval. These results clearly indicate hatching can occur inde-

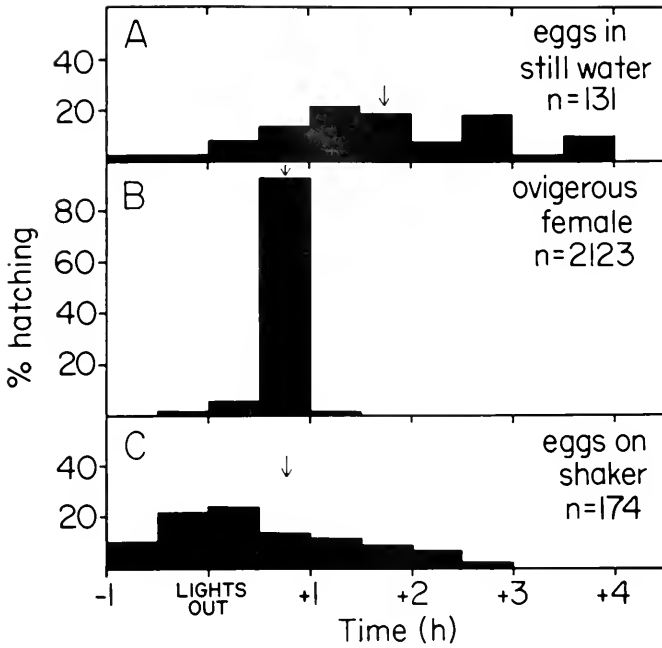

FIGURE 1. The percentage of eggs hatching (ordinate) from one crab over time (abscissa) as related to the time of the normal end of the light phase (lights out). The eggs in still water (A), left upon the ovigerous crab (B), and eggs shaken continuously (C), were placed under constant conditions about 24 h before hatching. The arrows indicate the mean time of hatching. n is the number of hatched eggs.

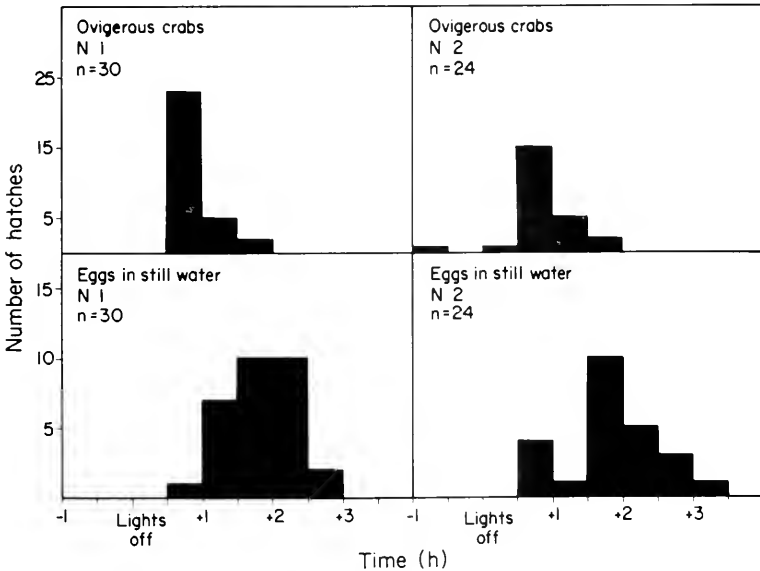

FIGURE 2. Distribution of mean times of larval release by ovigerous females and of hatching by their detached eggs for different numbers of crabs (ordinate) relative to time (abscissa) of end of the light phase. After "lights off" on the first night (N-1), crabs and separated eggs were maintained in constant conditions and monitored again at the time of the next night (N-2). n indicates the number of hatches or releases measured for each condition.

pendently of the female and is not randomly occurring over the solar day. Thus it is possible to compare the mean time of hatching by detached egg to the mean time of larval release by the female. On all nights and conditions (Fig. 2) hatching times are not uniformly distributed over the 5 h sampling interval ($P < .05$, Kolmogorov-Smirnov test for goodness of fit). The greatest number of females released larvae between 30–60 min after the beginning of the dark phase, while for the detached eggs the time is about 1 h later (Fig. 2). This relationship was further verified by specifically comparing the mean hatch time of the detached eggs to the mean time of larval release by the parent female. The modal time of hatching by detached eggs was 1 h later. In conclusion: eggs detached within 2 days of hatching hatch at about the same time as those attached to the female, but the former do so more variably and about 1 h later.

The differences between the two situations may result from the females' behavior, that is, vigorous female pumping may assist the opening of the egg covering, resulting in the release of most of the larvae over a shorter period of time. To test this hypothesis the previous experiment was expanded to include a group of detached eggs which were placed on a mechanical shaker. The eggs were shaken continuously to determine whether mechanical agitation alone causes hatching at times other than the interval just after the end of the day phase. The female does not pump her abdomen continuously.

A typical hatching sequence for this group is shown in Figure 1C. Hatching occurred earlier in the night, as compared to eggs in still water (Fig. 1A). However, larval release by the female was still more synchronized. Most of the crabs (91%) both released their larvae and had their detached eggs on the shaker hatch shortly after the end of the day phase. For these detached eggs (Fig. 3), an average of 99% (SE = 0.4%) of each group hatched within the 5 h sampling interval. Therefore, hatching is not occurring randomly and agitation assists hatching only during the time interval at the beginning of the dark phase.

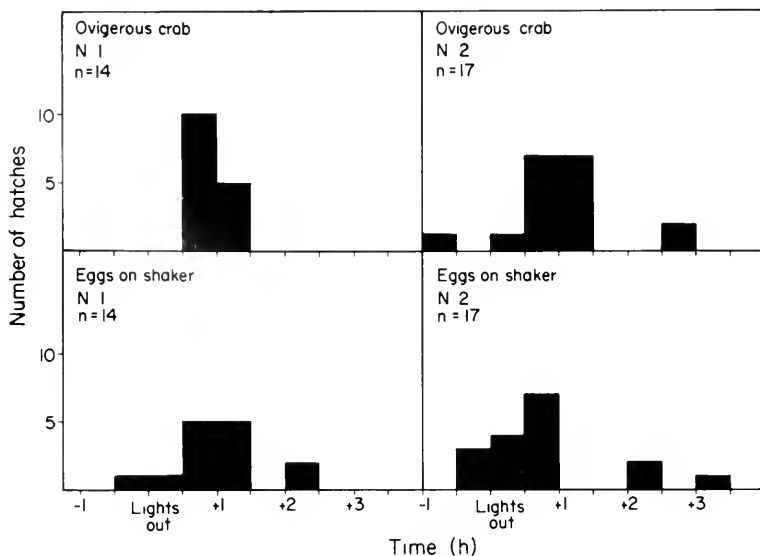

FIGURE 3. Distribution of larval releases and of hatching by eggs on shaker relative to the end of the light phase. Symbols, as in Figure 2.

On all nights and conditions (Fig. 3), hatching times are not uniformly distributed over the 5 h sampling interval ($P < .05$). In general, hatching by detached eggs on the shaker occurs near the times of larval release by the females (Fig. 3). If the mean hatching time of the shaken eggs is compared to the mean time of larval release by the parent female, the modal difference in timing is zero ($n = 30$). Thus the shaken eggs hatch at about the same time as eggs attached to the female, and mechanical agitation seems to mimic abdomen pumping.

For all but two crabs, larval release occurred on a single night. In the two exceptions the crabs released one group of larvae on the first night and the rest at the time of the second night. This is not unusual (Forward *et al.*, 1982). For these crabs, detached eggs were also monitored in still water and on the shaker. In both cases some of the eggs hatched on the first night with the remaining eggs hatching about 24 h later. These results further support the conclusion that hatching in the detached eggs occurs at about the same time as larval release by the female.

Although this conclusion is consistent for eggs removed within 2 days of hatching, a further question is whether eggs, which are removed from the female earlier, hatch in synchrony with eggs attached to the female. We selected 3 crabs with eggs which would hatch in about 9 days and entrained them for 4 days to a 14 h light:10 h dark photoperiod having the beginning of the dark phase at 1200. The time of end of the day phase was shifted so that hatching would occur at a convenient time. Four days is sufficient to shift the timing of the rhythm (Forward *et al.*, 1982). Beginning 5 days before the expected time of hatching, a group of approximately the same number of eggs (average difference = 26%) was removed from each crab at daily intervals. The eggs and female were maintained in aerated 8 ppt sea water filtered to remove particles larger than 0.2μ and to which the antibiotic chloramphenicol was added (5 mg/l). Extremely clean water containing the antibiotic was necessary to permit viable embryo development. Only 1% of the removed embryos died. Chloramphenicol at this concentration does not affect biological rhythms in eukaryotes (*e.g.*, Goodenough *et al.*, 1981). The water was changed every other day. The eggs and female were maintained at $27^\circ \pm 1^\circ\text{C}$ on the LD cycle throughout the experiment. On the day when hatching was expected, larval release by the females and hatching by the free eggs was monitored in still water at 1 h intervals beginning 2 h before the end of the light phase.

The hatching cycles are shown in Figure 4. Since the number of eggs removed each day from each female was similar, the total numbers of eggs hatched in all 3 broods were combined, and the absolute numbers presented for each 1 h interval. For the ovigerous females the number of released larvae differed greatly. To combine these data, the percentages of larvae released in each 1 h interval were averaged. Eggs removed on the final day of development hatched at about the same time as larvae were released by the females. For eggs removed for longer times, hatching was never uniform ($P < .05$, Kolmogorov-Smirnov test for goodness of fit) over the 32 hours that hatching was monitored. However, hatching became increasingly desynchronized with longer removal times. Since the eggs were maintained on the LD cycle, synchrony does not result only from entrainment on a LD cycle. This result suggests that some aspect of the female-egg interaction is important in establishing synchronized hatching.

Cues from the eggs

The next series of experiments was designed to answer several questions. First, is there a chemical cue released at the time of hatching which induces pumping

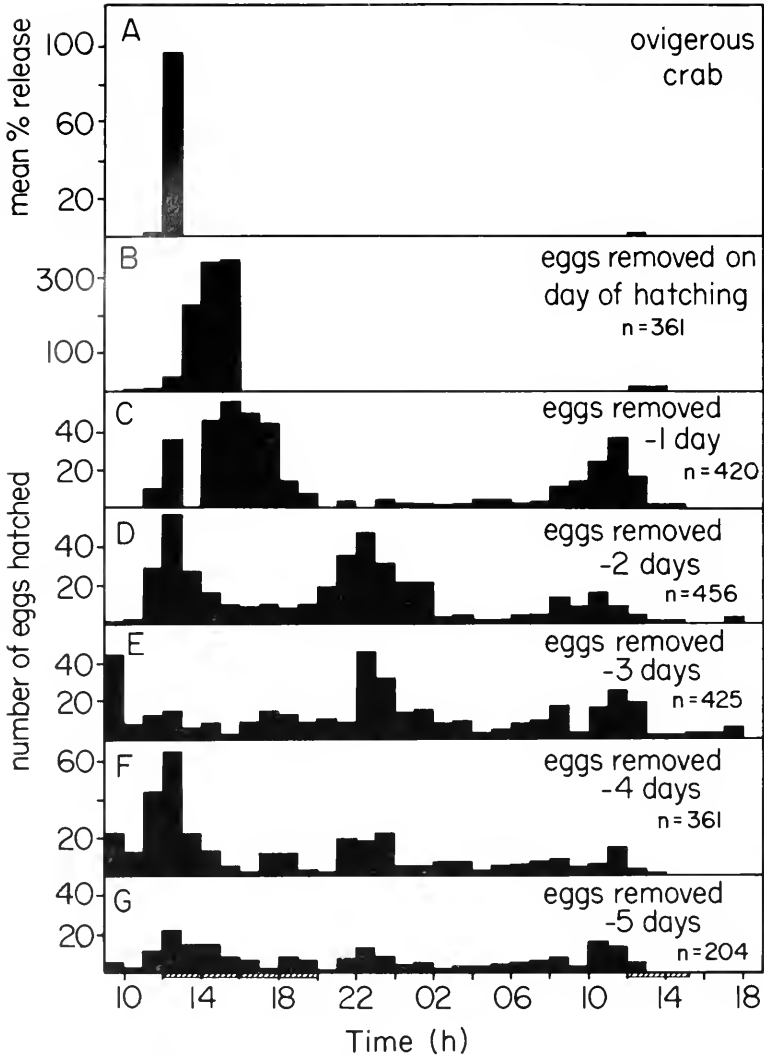

FIGURE 4. Distribution of larval releases by 3 females (A) and of hatching of their detached eggs (B-G) relative to time in the LD cycle. Eggs from only 2 crabs were used for G. The cross hatched bars indicate the time of the dark phase. In all cases greater than 94% of the eggs hatched during the observation time. *n* indicates the number of eggs hatched for the different conditions.

behavior by ovigerous females? If so, does receptivity to the cue change with age of the female's embryos?

After a female released her larvae into a volume of clean water (filtered initially to 0.2μ), she was quickly removed. The water was filtered to remove the larvae, and the larvae were counted. The water was diluted so that there was 1 ml for each 40 larvae released. This concentration of "larval water" was selected because pilot experiments showed that it induced a strong pumping response (Fig. 5). Upon exposure to this larval water, ovigerous females showed an initial period of agitated movement (0.25 to 1.5 min), after which they elevated their bodies on the walking

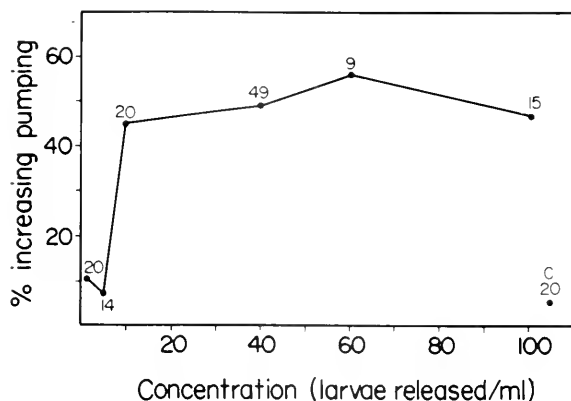

FIGURE 5. The percentage of crabs increasing their pumping rate (ordinate) upon exposure to water in which different concentrations of larvae hatched (abscissa). The number near each point is the total number of crabs tested at that concentration. C is the control and indicates the percentage of crabs increasing their pumping rate upon sequential exposure to clean 8 ppt sea water.

legs and vigorously pumped their abdomens. Pumping by ovigerous crabs with different age embryos (determined by eye development and yolk consumption) was monitored first in clean water and then in the larval water.

The percentage of crabs which showed an increase in pumping rate in the larval water was significantly greater ($P < .05$, Z statistic for comparing proportions) for all ovigerous crabs, as compared to non-ovigerous females (Table I). There was also a significant increase in the mean pumping rate (Student's t test, $P < .05$) when exposed to larval water. However, the rates were not significantly different between crabs with different age embryos (One-way ANOVA, model I).

These results indicate that the water in which the larvae were released contained a chemical which induced behavior observed during larval release by the female. In addition, even though the largest response occurred among crabs with the oldest embryos, there was little change in responsiveness throughout embryonic devel-

TABLE I

Variation in female pumping response with embryonic development

Estimated time until egg hatching (days)	n	% crabs increasing pumping	Number of pumps/2 min			
			clean water		hatch water	
			m	SE	m	SE
0-1	18	61	1.1	0.5	8.3	2.1
2-3	31	42	1.5	0.5	4.5	1.4
4-5	19	53	1.2	0.5	4.6	1.4
6-7	33	33	0.6	0.3	3.6	1.4
>7	35	46	0.4	0.2	5.4	1.4
NOF	22	14	1.2	1.2	2.5	1.5

The percentages of crabs displaying an increase in pumping in the hatch water as compared to pumping in clean water and the mean (m) number of pumps/crab are shown. NOF indicates non-ovigerous females. n is the sample size and SE is standard error.

opment. For uniformity in future experiments, tests were run with crabs having embryos which were expected to hatch within 3 days.

To test for a change in female responsiveness to different concentrations of the chemical cue, the water in which the larvae were released was diluted to a range of concentrations (Fig. 5). Responsiveness varied with concentration. Concentrations of 1 and 5 larvae/ml induced responses indistinguishable from the controls. Responses to concentrations of 10 larvae/ml or higher were significantly greater ($P < .01$) but were not significantly different from another.

Is the chemical cue released at the time of egg hatching or is it emitted by newly hatched larvae? To answer this question larvae, immediately upon hatching, were twice transferred to clean water in finger bowls. This served to wash them and dilute any chemical cue in the hatch water from which the larvae were transferred. The larvae were then placed in clean water (concentration 40 larvae/ml) for 2 h, then removed by filtration through clean plankton netting. This water was tested against clean water for its ability to induce increased pumping by ovigerous crabs. Only 15% ($n = 20$) of the crabs tested showed an increase in pumping rate in the larval water. The expected response at this concentration is 49% (Fig. 5), which is significantly greater ($P < .02$). Furthermore the per cent response is not significantly different from that of control crabs tested in clean sea water (5% response; $n = 20$). The results indicate that the active chemical is not emitted by the larvae but rather is released at the time of egg hatching.

To learn if the response can be elicited by crushed eggs, and if so, whether there is a difference in effectiveness with embryo age, we removed eggs which would hatch within 1 day (oldest embryos) or within about 8–10 days (youngest embryos). The eggs were homogenized in clean water, and the homogenate was then diluted to the appropriate concentration. There was an increase in pumping response with egg concentration (Fig. 6). The percent response was significantly greater ($P < .05$) than

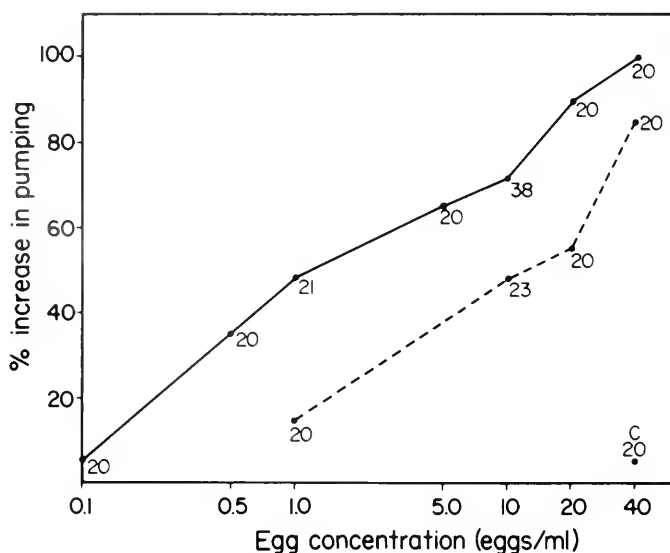

FIGURE 6. The percentage of crabs increasing their pumping rate (ordinate) upon exposure to different concentrations of homogenized eggs (abscissa). Solid line, responses to eggs expected to hatch within 1 day; dashed line, responses to eggs expected to hatch in 7 or more days. Numbers of females tested are shown adjacent to each point. C, controls tested sequentially with clean (8 ppt) sea water.

the control level at all but the lowest test concentrations (0.1 egg/ml older embryo; 1.0 egg/ml young embryo). At all concentrations the crabs were more responsive to the older embryos ($P < .04$), which indicates that the amount of the active chemical increases with embryonic age.

The potency of the crushed older eggs may be a cumulative result of the embryo, its embryonic fluid, and egg membrane. This suggestion is supported by two observations. First, the levels of response to different concentrations of the larval water (Fig. 5) were below levels shown in response to comparable concentrations of crushed eggs (Fig. 6). Secondly, if newly hatched zoeae were homogenized and the resulting mixture diluted to a concentration of 10 larvae/ml, the response level was 40% ($n = 25$), which is significantly ($P < .03$) lower than that for 10 eggs/ml (67%; Fig. 6). Thus, the egg parts produce responses which were below those of the eggs themselves.

Is there a rhythm in female responsiveness to the chemical cue over the day? This was tested by collecting crabs expected to release larvae in 2 days and maintaining them on a 14 h light:10 h dark cycle in phase with field LD cycle. Starting the morning after collection, the crabs were tested every 4 h in clean water and then in a solution having a concentration of 10 homogenized eggs/ml. The test solution was prepared from eggs which would probably hatch within 1 day. This concentration was used because it induces a substantial but not a maximal response (Fig. 6). Crabs were maintained in clean water between trials. At night, pumping was monitored under red light. Preliminary tests indicated that the test solution retained its activity for at least 36 h if refrigerated. Therefore a stock solution was prepared. A 40 ml aliquot was removed from the refrigerator 3 h before each test and allowed to warm to experimental temperatures (27°C). Responsiveness did not change over the day (Fig. 7), as neither the percentage of crabs showing an increase in pumping nor the average pumping rates varied significantly.

To test if induced female pumping can cause the eggs to hatch, we maintained crabs on a 14 h light:10 h dark cycle in the laboratory until the expected day of larval release. Crabs were then tested at 0.5 h intervals beginning shortly before the predicted time of larval release. These crabs were sequentially tested in clean water and in a solution having a concentration of either 20 or 40 homogenized eggs/ml. The eggs were predicted to hatch in 1 day. These concentrations were used because they induce strong responses (Fig. 6). After testing, crabs were rinsed in clean water and then returned to a new holding bowl also containing clean water. The number of pumps in 2 min for each trial and the number of larvae released into each bowl were recorded.

Even though the egg solution induced strong repetitive pumping in all tests, in no case did this action cause an early mass release of the larvae (Table II). Only an occasional larva appeared. This result indicates that egg hatching is not induced by vigorous pumping, except at times when the larvae are predicted to hatch.

DISCUSSION

The embryos of *R. harrisii* can complete development and hatch as viable larvae even when removed from the parent female. If eggs are removed within 2 days of hatching, they hatch at approximately the same time as larval release by the females. Forward *et al.* (1982) showed that crabs maintained under the constant conditions used for the present study have a circadian rhythm in larval release. The similarity in the timing suggests that the detached eggs also have a circadian rhythm. The conditions of the experiment, however, do not fully meet the requirements for demonstrating the presence of a circadian rhythm. The cycle in hatching was only

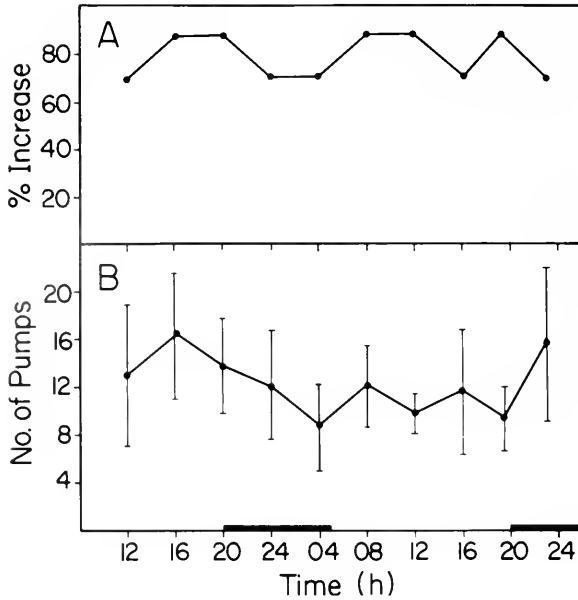

FIGURE 7. The percentage of crabs ($N = 8$, used throughout) increasing their pumping rate (A) and the average number of pumps/2 min for all tested crabs (B) upon exposure to a solution having a concentration of 10 crushed eggs/ml at different times of day (abscissa). Brackets are SE. The time of the dark phase is indicated by the heavy black bar.

measured in eggs maintained under constant conditions for the last two days of embryo development, and hatching time was measured as the mean time for a population of eggs from one female. The requirements for the endogenous rhythm to persist for 5–10 cycles in a single individual under constant conditions cannot be fulfilled. Thus the results only suggest the presence of a circadian rhythm in the detached eggs.

The results with *R. harrisi* eggs differ from those of Branford (1978) for hatching in the lobster *Homarus gammarus*. In that case detached eggs hatched rhythmically under a LD cycle but arrhythmically in constant light or darkness. His procedure may contribute to these results, since the eggs were removed and held under constant conditions for 3 days before hatching was monitored. Eggs removed from *R. harrisi* for longer than 2 days (Fig. 4) become progressively desynchronized in their hatching, even when exposed to a LD cycle.

Ovigerous *R. harrisi* show rhythmic larval releases after up to 5 days in constant conditions (Forward *et al.*, 1982). The difference between the persistence of the larval release rhythm by ovigerous females in constant conditions and the loss of hatching synchrony by detached eggs in a LD cycle (Fig. 4) suggests that some unknown aspect of the maternal environment is responsible for the establishment or maintenance of developmental synchrony, apparent during the last 2 days of embryonic development.

Although detached eggs hatched in still water, they were not as synchronized as the larval release by the female (Fig. 1). The rapid, vigorous pumping of the females' abdomen during hatching must enhance synchrony, since groups of larvae are released with each pump. This suggestion is supported by data (Figs. 1, 3) showing that hatching synchrony in detached eggs was improved by shaking.

Since pumping improves synchrony it is important to know whether egg hatching

induces pumping. Females placed in water in which larval release occurred showed an increase in pumping. This indicates chemical and not mechanical cues are involved. For *R. harrisi*, the active chemical is apparently released at the time of egg hatching, since newly hatched larvae did not excrete a substance which induced pumping. Responsiveness is confined to females carrying eggs, as nonovigerous females showed a very low level of response. These nonovigerous females were newly collected, and it was possible that the few responsive individuals had either recently released larvae or were about to oviposit.

Responsiveness did not vary in the female. There was no diel rhythm or change in responsiveness with embryonic development. Pumping was induced by hatch water, crushed eggs of different ages, or crushed larvae. Nevertheless, the females were fairly sensitive to the chemical cue, as the lowest concentrations to induce significant responses were 10 larvae/ml of the hatch water and 0.05 crushed eggs/ml. The identity of the substance which induces pumping is currently under investigation.

Our initial question was whether the time of hatching is controlled by the female or the developing embryo. The time of hatching of a clutch depends upon those events which synchronized development of the embryos and those which control the actual hatching. An interaction between the eggs and female is responsible for synchronized development, while the embryo controls the actual event of hatching. The latter conclusion is supported by observations that the eggs hatched rhythmically independently of the female and upon hatching released a substance which induced pumping by the female. Pumping alone, however, did not cause hatching (Table II). Ennis (1973) similarly found that shaking the pleopods of the lobster *H. gammarus* did not induce egg hatching. Thus the conclusion reached by Pandian (1970) for this lobster, that the eggs control the actual event of hatching, also applied for *R. harrisi*.

The foregoing considerations allow us to speculate about the sequence of events during larval release. Some unknown aspect of maternal care is important in synchronizing embryo development. At the appropriate time the eggs are easily broken open. Initially, a few eggs hatch either by themselves or due to breakage by the female's normal body movements. A chemical cue is released which induces the female to move into position for larval release and to pump her abdomen. Pumping causes more eggs to hatch, which increases the concentration of the chemical cue,

TABLE II

Pumping response of crabs to clean water and a solution of homogenized eggs at concentrations of 20 eggs/ml (A) and 40 eggs/ml (B)

	Time before hatching (h)	# Pumps/2 min in clean water		# Larvae released in clean water	# Pumps/2 min in egg water		# Larvae released in egg water
		m	SE		m	SE	
A	-1.5	1.2	0.6	0	14	4.0	1
	-1	0.4	0.3	4	16.3	3.5	2
	-0.5	0.6	0.3	1	10.1	2.7	2
B	-1.0	0.75	0.5	0	10.5	5.2	0
	-0.5	2.25	0.75	0	19.0	9.5	0

The mean (m) number of pumps and the total number of larvae released in all experiments in the test bowls (clean water or egg homogenate) are shown. The number of crabs tested in A was 12 while 4 were tested in B. Tests were performed at 0.5 h intervals before the actual time of larval release, which occurred in the holding bowls shortly after the end of the day phase.

thereby causing further pumping. This sequence continues until all eggs which are ready have hatched.

A final consideration concerns the functional significance of having the actual time of hatching controlled by the embryo. Nocturnal larval release probably lowers mortality of larvae and adults due to predators which visually sight and actively pursue their prey (Ennis, 1975; Branford, 1978; DeCoursey, 1979; Bergin, 1981). Nevertheless, the female must expose herself at or near the entrance of her burrow during larval release making her still somewhat vulnerable to predation. By responding only when the appropriate chemical cue is present, the female does not try to release larvae at inappropriate times but rather concentrates her efforts on the times when the greatest number of larvae will be released. The consequence is synchronized hatching. In addition to inducing hatching, abdomen pumping also serves the function of oxygenating the embryos. If the female alone controlled larval release by regulation of pumping activity, then normal pumping during oxygenation could potentially release undeveloped embryos.

ACKNOWLEDGMENTS

This material is based on research supported by the National Science Foundation under Grant No. OCE80-07434. We thank M. Budka for his technical assistance and Dr. T. Cronin for his critical comments on the manuscript.

LITERATURE CITED

- BERGIN, M. E. 1981. Hatching rhythms in *Uca pugilator* (Decapoda: Brachyura). *Mar. Biol.* **63**: 151-158.
- BRANFORD, J. R. 1978. The influence of daylength, temperature and season on the hatching rhythm of *Homarus gammarus*. *J. Mar. Biol. Assoc. U. K.* **58**: 639-658.
- CHRISTY, J. H. 1978. Adaptive significance of reproductive cycle in the fiddler crab *Uca pugilator*: A hypothesis. *Science* **197**: 453-455.
- CHRISTY, J. H. 1982. Adaptive significance of semilunar cycles of larval release in fiddler crabs (Genus *Uca*): Test of an hypothesis. *Biol. Bull.* **163**: 251-263.
- DECOURSEY, P. 1979. Egg hatching rhythms in three species of fiddler crabs. Pp. 399-406 in *Cyclic Phenomena in Marine Plants and Animals*, Proceeding of the 13th European Marine Biological Symposium, E. Naylor and R. G. Hartnoll, eds. Pergamon Press, Oxford.
- ENNIS, G. P. 1973. Endogenous rhythmicity associated with larval hatching in the lobster *Homarus gammarus*. *J. Mar. Biol. Assoc. U. K.* **53**: 531-538.
- ENNIS, G. P. 1975. Observations on hatching and larval release in the lobster *Homarus americanus*. *J. Fish. Res. Board Can.* **32**: 2210-2213.
- FORWARD, R. B., JR., AND T. W. CRONIN. 1979. Spectral sensitivity of larvae from intertidal crustaceans. *J. Comp. Physiol.* **133**: 311-315.
- FORWARD, R. B., JR., K. LOHMANN, AND T. W. CRONIN. 1982. Rhythms in larval release by an estuarine crab (*Rhithropanopeus harrisi*). *Biol. Bull.* **163**: 287-300.
- GOODENOUGH, J. E., V. G. BRUCE, AND A. CARTER. 1981. The effects of inhibitors affecting protein synthesis and membrane activity on the *Chlamydomonas reinhardtii* phototactic rhythm. *Biol. Bull.* **161**: 371-381.
- MOLLER, T. H., AND J. R. BRANFORD. 1979. A circadian hatching rhythm in *Nephrops norvegicus* (Crustacea: Decapoda). Pp. 391-397 in *Cyclic Phenomena in Marine Plants and Animals*, Proceedings of the 13th European Marine Biological Symposium, E. Naylor and R. G. Hartnoll, eds. Pergamon Press, Oxford.
- PANDIAN, T. J. 1970. Ecophysiological studies on the developing eggs and embryos of the European lobster *Homarus gammarus*. *Mar. Biol.* **5**: 154-167.
- SAIGUSA, M. 1981. Adaptive significance of a semilunar rhythm in the terrestrial crab *Sesarma*. *Biol. Bull.* **160**: 311-321.
- SAIGUSA, M., AND T. HIDAKA. 1978. Semilunar rhythms in zoeae-release activity of the land crab. *Sesarma. Oecologia (Berl.)* **37**: 163-176.
- WHEELER, D. E. 1978. Semilunar hatching periodicity in the mud fiddler crab *Uca pugnax* (Smith). *Estuaries* **1**: 268-269.

ENERGY METABOLISM PATHWAYS OF HYDROTHERMAL VENT ANIMALS: ADAPTATIONS TO A FOOD-RICH AND SULFIDE-RICH DEEP-SEA ENVIRONMENT

STEVEN C. HAND AND GEORGE N. SOMERO

Department of Biology, University of Southwestern Louisiana, P.O. Box 42451, Lafayette, Louisiana 70504, and Marine Biology Research Division, A-002, Scripps Institution of Oceanography, University of California, San Diego, La Jolla, California 92093

ABSTRACT

The activities of enzymes of the major pathways of energy metabolism (glycolysis, the citric acid cycle, and the electron transport system) were measured in tissues of animals from the deep-sea hydrothermal vent site at 21°N latitude. Enzymic activities of related shallow-living marine animals were assayed for comparison. Vent species studied were the large pogonophoran tube worm, *Riftia pachyptila*, the clam, *Calyptogena magnifica*, the crab *Bythograea thermydron*, the polychaete worm, *Alvinella pompejana*, and an unidentified zoarcid fish. In general, the enzymic activities found in the tissues of the vent animals were qualitatively and quantitatively similar to those of phylogenetically related shallow-living marine species, suggesting that the types of energy metabolism pathways, and the potential flux rates through these pathways, are similar in both groups. The enzymic activities of the vent zoarcid fish were much higher than those of all other deep-sea fishes studied to date. Despite the occurrence in the vent waters of high concentrations of hydrogen sulfide (HS^-), a potent inhibitor of the cytochrome c oxidase system, most of the vent animals possessed cytochrome c oxidase activities comparable to those of related shallow-living species. The cytochrome c oxidase systems of the vent species and shallow-living species so examined were half-inhibited by HS^- concentrations in the nanomolar to micromolar range. The mechanisms by which the vent animals avoid poisoning of respiration by HS^- are discussed. *Calyptogena magnifica* was the only vent species that appeared to have a minimal capacity for aerobic respiration, as judged by extremely low activities of the cytochrome c oxidase system and citrate synthase in its tissues compared to other bivalves. We propose that *C. magnifica* may rely largely on anaerobic pathways of energy metabolism.

INTRODUCTION

The unusual water chemistry and biological characteristics of the deep-sea hydrothermal vent habitats may favor a number of adaptations in the energy metabolism pathways of the vent animals. Unlike typical deep-sea regions, the hydrothermal vents have a dense biomass (Spiess *et al.*, 1980) which appears to be supported by primary production by chemolithotrophic bacteria, especially sulfide oxidizing species. These bacteria are free-living in the sea water (Karl *et al.*, 1980; Tuttle *et al.*, 1983) and symbionts of dominant members of the vent fauna, including the large pogonophoran tube worm, *Riftia pachyptila* (Cavanaugh *et al.*, 1981; Felbeck, 1981; Felbeck and Somero, 1982), the clam, *Calyptogena magnifica* (Felbeck *et al.*, 1981; Cavanaugh, 1983), and the unnamed vent mussel (Felbeck *et al.*, 1981). The presence at the vents of a rich food supply, by deep-sea standards, may permit

Received 11 April 1983; accepted 25 May 1983.

a relatively high rate of energy metabolism in the vent animals compared to animals from the typical deep sea. The latter animals may have oxygen consumption rates that are only a few percent of those of related shallow-living species (Childress, 1971, 1975; Smith and Hessler, 1974; Smith, 1978; Torres *et al.*, 1979; Somero *et al.*, 1983), and these extremely low rates of metabolism may reflect adaptations to the low food availability in non-vent deep-sea habitats.

Despite the occurrence of a rich food supply in the vent habitats, however, the presence of high (up to 1 mM; Edmond *et al.*, 1982) concentrations of hydrogen sulfide (HS^-) in the vent waters could potentially block the abilities of vent animals to metabolize aerobically at high rates. HS^- is a potent inhibitor of the cytochrome c oxidase (CO) system and, therefore, of aerobic respiration (Hydrogen Sulfide, 1979; Powell and Somero, 1983). Thus it is of interest to determine if the energy metabolism pathways utilized by vent animals include the same types of reactions found in marine animals from habitats with low HS^- concentrations, or if the vent animals are unusually dependent on anaerobic mechanisms of energy metabolism.

The present studies examined several animals thought to be endemic to the deep-sea hydrothermal vents, including *R. pachyptila*; *C. magnifica*; the brachyuran crab, *Bythograea thermydron*; the polychaete worm, *Alvinella pompejana* (Pompeii worm); and an unidentified fish of the family Zoarcidae. We sought answers to the following questions. First, are the types of aerobic and anaerobic energy metabolism pathways used by the vent animals similar to those found in phylogenetically related shallow-living marine animals? Second, if the vent animals do utilize aerobic respiration, as judged by the presence of the CO system, is this enzyme system less sensitive to poisoning by HS^- than the homologous systems of animals from habitats where HS^- is not present in high concentrations? Third, are the quantities of enzymic activity similar in tissues of vent and non-vent animals? An answer to this question bears directly on the point concerning metabolic rates in the vent animals, since enzymic activity measurements have proven to be a useful means for obtaining estimates of respiration rates of shallow- and deep-living marine animals (cf. Childress and Somero, 1979).

MATERIALS AND METHODS

The hydrothermal vent animals were collected at the 21°N latitude vent site on the East Pacific Rise (Spiess *et al.*, 1980). Except for the two specimens of the zoarcid fish, which were generously provided by Dr. Harmon Craig following the Pluto Expedition to this site in late 1981, all specimens were collected during the Oasis Expedition in April–May 1982. The fish were frozen (−20°C) shortly after recovery at the surface, and were held frozen until the enzymic activity measurements were made. The enzymes studied in the fish are all known to be stable during freezing (Childress and Somero, 1979). All enzymic activities in the invertebrates were made using tissues from live, freshly collected adult animals. The tissues sampled in the different species are given in the legend to Figure 1. In most cases activities were measured within a few hours of retrieval of the specimens, which were collected at a depth of approximately 2600 m by the DSRV Alvin. The specimens were transported from the collection site to the surface in an insulated box, and were judged in all cases to be in healthy condition. When specimens were maintained alive aboard ship (RV New Horizon), they were held in circulating sea water (2–5°C) at a pressure of 120 atmospheres and used within 2 days. The animals survived for at least several days under these holding conditions.

Live specimens of animals from non-vent habitats were obtained as follows. The stone crab, *Menippe mercenaria*, and the hardshell cockle, *Chione undatella*, were

collected subtidally off La Jolla, California. *Mercenaria mercenaria* (the quahog clam) were collected on the East Coast of the U. S. and purchased from a local seafood supplier. *Solemya reidi*, a gutless bivalve found in sulfide-rich habitats, were collected at depths of approximately 120 m near the Hyperion sewage outfall off Los Angeles, California, using the RV Veleró. Specimens of *S. reidi* were maintained in aquaria in the presence of 1 mM HS⁻ until analyzed.

Enzymic activity determinations

For all invertebrates, tissue samples taken from live specimens were homogenized immediately in ice-cold buffer (20 mM potassium phosphate, pH 7.4). In the case of the vent species, motion of the ship prevented accurate measurement of tissue weights, so precise dilutions of the tissue samples with homogenization buffer could not be made. Consequently, enzymic activities for the invertebrates are expressed in terms of international units (μ moles substrate converted to product per min) per mg protein in the supernatants. The tissues were homogenized using a Duall-23 ground glass surfaced homogenizer (Kontes Glass Co., Vineland, NJ) driven by hand. The homogenates were centrifuged at 2500 g for 10 minutes, and the supernatants were saved and used without further purification for the activity assays. Enzymic activities were measured immediately at a temperature of 20 \pm 0.2°C, using Varian-Techtron 634 or 635 spectrophotometers. The activities presented were all determined at 1 atm pressure. A survey of pressure effects on these enzymes from vent organisms showed that *in situ* pressures (approximately 260 atms) had only minimal effects on activities under our assay conditions using saturating substrate concentrations. Maximal inhibition noted was 7%, and maximal activation was 9%. Thus, the use of 1 atm pressure in these studies is not likely to have led to artifacts.

The enzymic activities in muscle of the vent zoarcid fish were measured in La Jolla, California, using tissue samples from two deep frozen specimens. Muscle samples were removed from the area just behind the operculum and above the lateral line; these samples appeared to be entirely of white muscle. Samples were homogenized in 10 mM Tris/HCl buffer (pH 7.5 at 10°C), and the homogenates were centrifuged at 2500 g for 10 minutes. Enzymic activities were measured at 10 \pm 0.2°C, and are expressed as international units per g fresh (wet) weight of tissue. This normalization of activity on a fresh weight basis for the fish enzymes was done to enable comparisons to be made with data gathered under identical experimental conditions in studies of other deep- and shallow-living marine fishes (Childress and Somero, 1979; Sullivan and Somero, 1980; Siebenaller and Somero, 1982; Siebenaller *et al.*, 1982).

The following enzymes were studied in some or all of the species: L-lactate dehydrogenase (LDH, EC 1.1.1.27; L-lactate: NAD⁺ oxidoreductase); pyruvate kinase (PK, EC 1.7.1.40; ATP: pyruvate phosphotransferase); phosphofructokinase (PFK, EC 2.7.1.11; ATP: D-fructose-6-phosphate 1-phosphotransferase); L-malate dehydrogenase (MDH, EC 1.1.1.37; L-malate: NAD⁺ oxidoreductase); citrate synthase (CS, EC 4.1.3.7; citrate: oxaloacetate lyase (CoA-acetylating)); and cytochrome c oxidase (CO, EC 1.9.3.1; ferrocyclochrome c oxygen oxidoreductase).

Measurements of LDH, PK, MDH, and CS activities were performed following the protocols given in Somero and Childress (1980). PKF activities were measured in an assay medium containing 33 mM Tris-acetate buffer (pH 8.0 at 20°C), 2 mM Mg-acetate, 2 mM ATP, 2 mM fructose-6-phosphate, 40 mM KCl, 4 mM NH₄Cl, 0.16 mM NADH, 400 μ g of aldolase, 20 μ g of triose phosphate isomerase, and 50 μ g of glycerol-3-phosphate dehydrogenase, as described by Hand and Somero (1982).

CO activities were measured using the protocol of Yonetani and Ray (1965). The assay solution contained 0.1 M potassium phosphate buffer (pH 6.0), 1 mM EDTA, and 0.1 mM reduced cytochrome c, in a total volume of 2.0 ml. The reaction was followed by recording the decrease in absorbance at 550 nm, using an extinction coefficient for cytochrome c of $18.5 \text{ mM}^{-1} \text{ cm}^{-1}$ (reduced minus oxidized). Reduced cytochrome c (horse heart, Type III, Sigma Chemical Co., St. Louis, Missouri) was prepared as follows. A stock solution of cytochrome c (final concentration of 1 mM) was prepared in 10 mM potassium phosphate buffer, pH 7.0, containing 1 mM EDTA. The buffer stock was saturated with N_2 and stored tightly-capped. The cytochrome c solution was reduced by adding trace amounts of sodium dithionite. A change in solution color from reddish-brown to bright red-orange indicated quantitative reduction of cytochrome c. Excess dithionite and its breakdown products were removed by gel sieving with Sephadex G-25, utilizing the centrifugation method of Helmerhorst and Stokes (1980). Sephadex G-25 was hydrated with distilled water and then equilibrated with 10 mM potassium phosphate buffer, pH 7.0, containing 1 mM EDTA. Next, 3 ml syringes (tips plugged with glass wool) were filled with hydrated G-25 and placed into conical centrifuge tubes. The syringes were centrifuged for 2 minutes at approximately 1900 g. The liquid that collected in the bottom of the tubes was discarded, and the reduced cytochrome c solution was added to the syringes. For a syringe with a 3 ml bed volume, about 0.4 ml of solution can be added per syringe. The syringes were then centrifuged as above, and the liquid at the bottoms of the centrifuge tubes was collected. Prepared in this fashion, the cytochrome c is at least 95% reduced. The rate of autooxidation is only about 1–2% per day when the solution is stored tightly stoppered at 2°C.

In view of the occurrence of CO activities in most of the tissues of the vent animals so examined (Fig. 1), it was important to determine if this enzyme system was resistant to inhibition by HS^- in these species. HS^- concentrations in the micromolar range or below typically are strongly inhibitory of CO (Hydrogen Sulfide, 1979; Powell and Somero, 1983).

Except for *R. pachyptila*, the CO activities were determined using the crude supernatant fractions prepared as described above. For the CO of *R. pachyptila* additional tests were run using partially purified CO prepared by sequential acid precipitation of the enzyme system ("once acid precipitated" and "twice acid precipitated"). In this case, the crude supernatant was titrated to pH 5.6 with cold 1.0 M acetic acid and then centrifuged at 2500 g for 10 minutes. Four to nine concentrations of HS^- were used to determine each K_i value. The stock solution of HS^- was prepared by dissolving freshly washed crystals of Na_2S in deoxygenated distilled water. The data for CO of *R. pachyptila* are derived from data in Powell and Somero (1983).

Protein concentration measurements

For all of the invertebrate tissues the protein concentration of the supernatant fractions was measured using the technique of Peterson (1977).

RESULTS

Enzymic activities of invertebrates from vent and non-vent habitats

Figure 1 presents the activities of the glycolytic, citric acid cycle, and electron transport system enzymes that were analyzed in the different invertebrate species. As a broad generalization the types of pathways and the flux potentials through

CYTOCHROME c OXIDASE

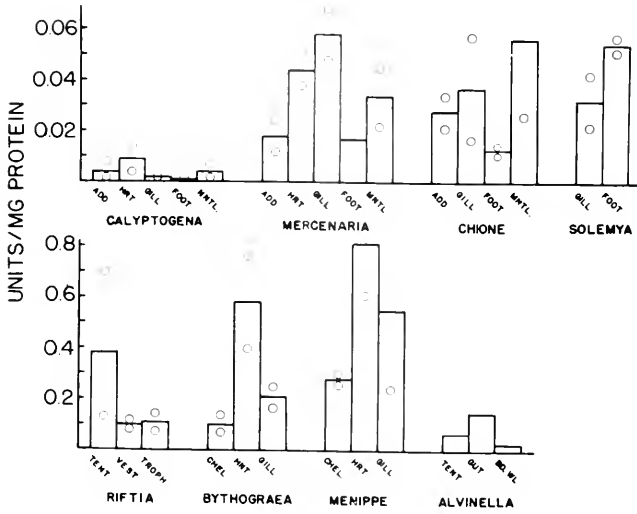

CITRATE SYNTHASE

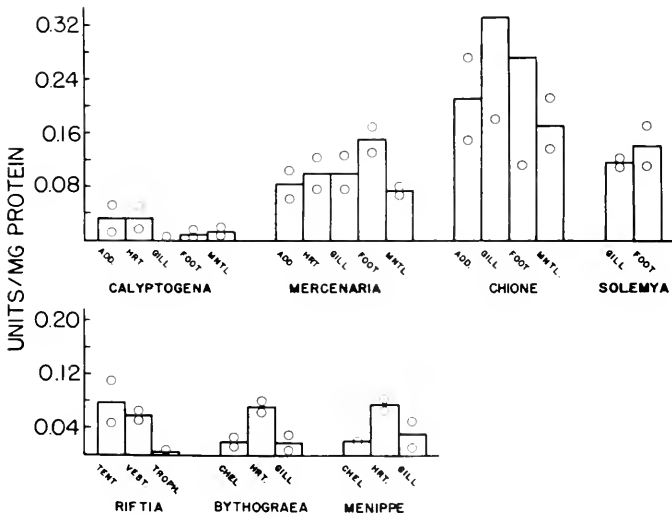

FIGURE 1. Enzymic activities in different tissues of invertebrates from hydrothermal vent and shallow marine habitats. Activities are expressed as international units (μ moles substrate converted to product per minute) per mg protein in the supernatant fractions used as sources of enzyme. The heights of the bars indicate the average values for each tissue; the open circles indicate the measured values. In most cases two individuals of a species were measured. The tissues are abbreviated on the abscissa of each graph as follows: add. (adductor muscle), hrt. (heart), mntl. (mantle), tent. (tentacle), vest. (vestimental muscle), troph. (trophosome), chel. (cheliped), bd. wl. (body wall). The habitats of the species are given in Materials and Methods.

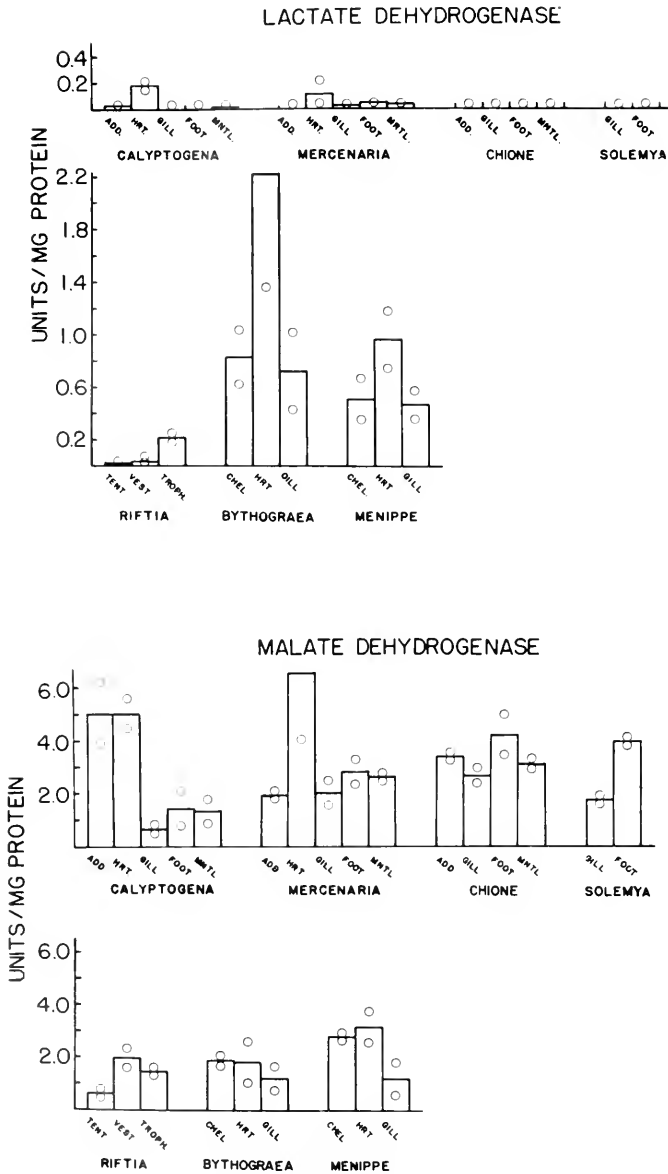

FIGURE 1. (Continued)

these pathways appear similar in related vent and non-vent species. For the two crabs, *B. thermydron* and *M. mercenaria*, the types and quantities of enzymic activities found in the tissues studied (cheliped, heart, and gill) were strikingly similar. In both crabs heart tissue displayed the highest aerobic capacity, as judged by activities of CO, a direct indicator of potential for aerobic respiration, and CS, a strong indicator of citric acid cycle flux potential. Activities of these two enzymes were lower in cheliped and gill. The activity of PFK, an indicator of total (aerobic plus

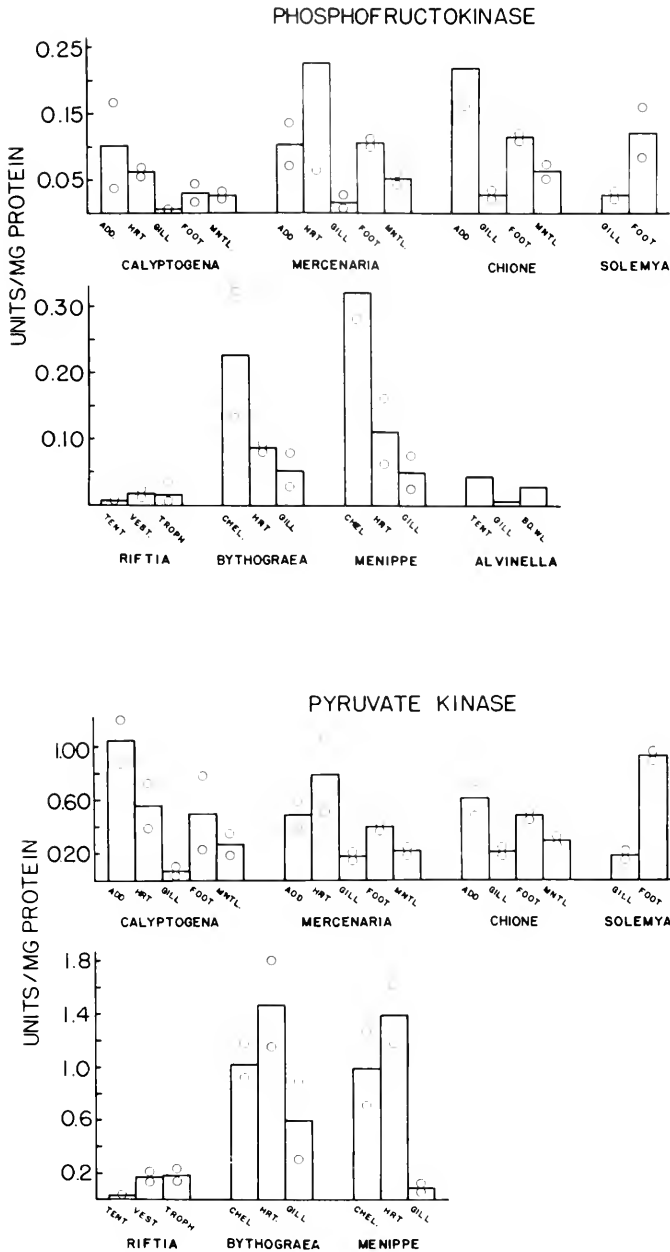

FIGURE 1. (Continued)

anaerobic) glycolytic flux potential, was highest in cheliped, as was the activity of PK, another indicator of glycolytic potential. LDH activity, an indicator of a locomotory muscles' capacity for anaerobic glycolysis, also was highest in cheliped. Thus, based on these enzymic activity measurements, there would appear to be a

similar capacity for energy metabolism in the vent crab and subtidal crab, a conclusion that is consistent with oxygen consumption determinations of *B. thermydron* and shallow-living crustaceans under laboratory conditions (Mickel and Childress, 1982).

For the pogonophoran tube worm, *R. pachyptila*, no phylogenetically similar species was available for comparisons. The enzymic activities measured in tissues of *R. pachyptila* do allow, however, for conclusions to be drawn about the abilities of the animal to conduct different types of energy metabolism. The occurrence of CO and CS activities at levels similar to those found in the two crabs suggests that, despite living continuously in the presence of high concentrations of HS^- , *R. pachyptila* is capable of sustaining aerobic respiration. Tentacle (plume) tissue displayed the highest activities of these two enzymes. The tentacle is highly vascularized, and serves as the major site of gas and nutrient exchange between the animal and its environment (Jones, 1981). The aerobic poise of metabolism in tentacle is further suggested by the relatively low levels of activity of the glycolytic enzymes, PFK, PK, and LDH, compared to CO and CS activities. Vestimental muscle, which functions to hold the worm in its tube and to power withdrawal of the tentacle, displayed lower aerobic capacities than tentacle, but it had higher levels of glycolytic activity. The high activities of MDH found in vestimental muscle may be indicative of a high capacity for the type of anaerobic scheme found in many invertebrates, which involves the channeling of phosphoenolpyruvate towards succinate production *via* the intermediates, oxaloacetate, malate, and fumarate (Hochachka, 1980; see Discussion). The trophosome of *R. pachyptila* is a soft, highly vascularized tissue that fills much of the animal's coelom. The trophosome is a complex tissue, containing high densities of bacterial symbionts (up to approximately 10^9 bacteria per g fresh weight; Cavanaugh, 1983; Cavanaugh *et al.*, 1981). Bacterial enzymes may have made the dominant contribution to the enzymic activities measured in trophosome. Like the tentacle and vestimental muscle, trophosome displayed capacities for both glycolytic and electron transport functions.

For the polychaete worm, *A. pompejana*, which grows abundantly on the walls of white smoker chimneys and may be exposed to very high concentrations of sulfide (Desbruyeres and Laubier, 1980; Spiess *et al.*, 1980), limitations in specimen availability precluded making an extensive enzyme survey. However, the Pompeii worm exhibited both PFK and CO activities, suggesting that both glycolysis and aerobic respiration occur in this animal.

Among the four bivalve molluscs we studied, some interesting similarities and differences were noted. The activities of enzymes associated with glycolysis in bivalves, PFK, PK, and MDH, were generally the highest of all enzymic activities, and the capacities for glycolytic flux seemed generally similar in a given tissue among species. LDH activity was very low, in keeping with the fact that MDH, rather than LDH, is the major reaction of glycolytic redox balance in the anaerobic metabolic scheme of bivalves.

Although as a group, bivalves' CO values were considerably lower than those of other species, the most striking difference among the bivalves was the apparently very low capacity for aerobic respiration in *C. magnifica*. CO activities were extremely low in all tissues examined, and were barely measurable in foot. CS activities also were extremely low compared to the other bivalves studied, suggesting that *C. magnifica* has a low capacity for aerobically poised citric acid cycle function. It is noteworthy that another clam from a sulfide-rich habitat, *S. reidi*, which was collected in a sewage outfall habitat where HS^- concentrations of up to 25 mM have been measured (J. J. Childress, personal communication) had CO and CS activities

similar to those of *C. undatella* and *M. mercenaria*, two bivalves that do not encounter such high HS^- concentrations in their habitats. Thus a variety of metabolic strategies may be present in bivalves that occur in sulfide-rich environments (See Discussion). In *C. magnifica* and *S. reidi* the gills contain high densities of bacterial endosymbionts (Felbeck *et al.*, 1981; Cavanaugh, 1983; Felbeck, 1983). Thus, as in the case of trophosome tissue of *R. pachyptila*, a significant fraction of the enzymic activities measured in the gills of these two bivalves may be of bacterial origin.

Enzymic activities of the vent zoarcid fish

In keeping with the trends noted for the crustacean and molluscan species examined, the enzymic activities in the vent zoarcid fish were very similar to activities found in many shallow-living fishes. Activities of LDH, PK, and MDH in white muscle of the vent zoarcid were 216 (185, 246), 36 (28, 43), and 41 (19, 62) units per g fresh weight at 10°C, respectively (mean and values for two fish are given). For LDH and PK these activities are compared with data gathered using identical protocols on a number of other marine teleost fishes having different minimal depths of occurrence (Fig. 2). The LDH and PK activities of the vent zoarcid are the highest found for any deep-sea fish, *i.e.*, for any fish having a minimal depth of occurrence greater than approximately 200–300 m, and these activities are within the range noted for many shallow-living, demersal species (cf. Sullivan and Somero, 1980, for discussion of the other species indicated in Fig. 2). MDH shows a similar trend (cf. Sullivan and Somero, 1980).

Sensitivities of cytochrome c oxidase systems to HS^-

Using crude supernatant fractions and, for *R. pachyptila*, partially purified CO, we determined the sensitivities of the CO systems of several animals (Table I). In all cases, half-inhibition (K_i) concentrations of HS^- were in the range of 10^{-9} to 10^{-5} M. Even though the CO system of tentacle tissue of *R. pachyptila* appears less sensitive to HS^- than the other CO systems studied (however, see Discussion), in all cases the CO systems of the vent animals were inhibited by HS^- concentrations that were much lower than environmental levels and, in *R. pachyptila*, were vastly lower than the HS^- concentrations found in the animal's blood, where HS^- concentrations up to 1.1 mM have been measured (Arp and Childress, 1983). The bases for the interspecific differences in CO sensitivity to HS^- , and possible mechanisms for resistance to poisoning by HS^- are discussed below.

DISCUSSION

The major conclusion resulting from these comparisons of enzymic activities of animals from the hydrothermal vents habitat and shallow marine habitats is that, in almost all cases, the tissues of the vent animals have similar types of energy metabolism pathways, and similar potentials for flux through these pathways, to tissues of shallow-living marine species of similar phylogenetic status. These qualitative and quantitative similarities in the energy metabolism pathways of these two groups of organisms merit discussion in terms of the physical, chemical, and biological characteristics of the hydrothermal vent habitats.

The generally similar activities of the diagnostic enzymes of glycolysis, the citric acid cycle, and electron transport in the tissues of vent animals and shallow-living animals suggest that these two groups of organisms have very similar metabolic rates. Childress and Somero (1979) showed that activities of enzymes of energy

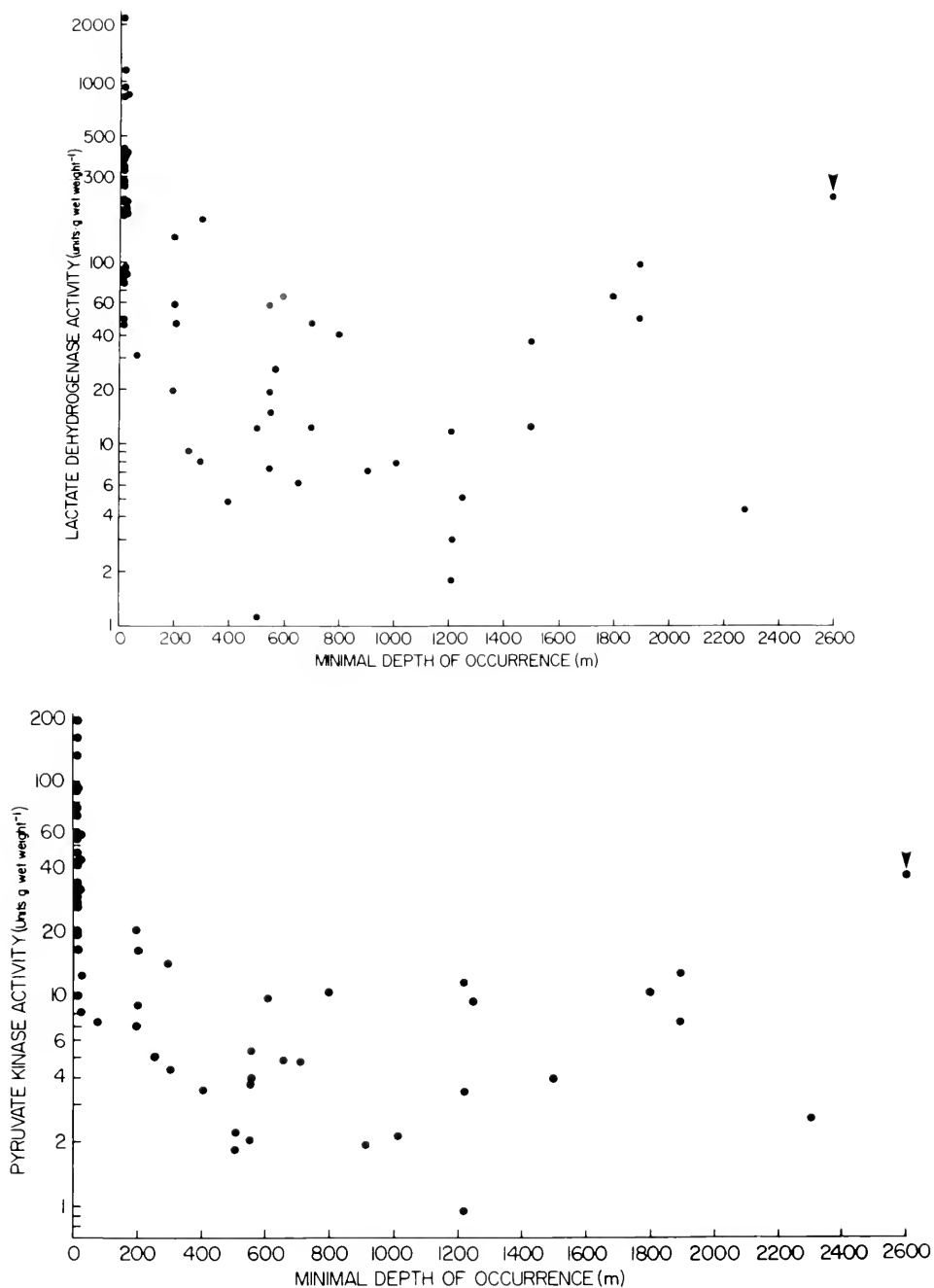

FIGURE 2. Activities of lactate dehydrogenase and pyruvate kinase assayed at 1 atm in white skeletal muscle of marine teleost fishes having different minimal depths of occurrence. Values for the vent zoarcid fish are indicated by the arrow above the point at 2600 m minimal depth of occurrence. Each point represents a different species, and is based on from one to several individuals. Data are from Childress and Somero (1979), Sullivan and Somero (1980), Siebenaller and Somero (1982) and Siebenaller *et al.*, (1982).

metabolism correlate well with rates of oxygen consumption in marine fishes, and the generality of this relationship is further suggested by several other studies of activities of enzymes of energy metabolism in organisms having widely different metabolic capacities (cf. Simon and Robin, 1972; Sugden and Newsholme, 1973; Alp *et al.*, 1976; Zammit *et al.*, 1978; Somero and Childress, 1980; Siebenaller and Somero, 1982). The similarities in amounts of activity of enzymes of energy metabolism in the vent animals and related shallow-living species were noted for the crustaceans, molluscs, and fishes we compared, and although no shallow living pogonophorans were available for comparison (most members of this phylum are endemic to the deep sea; Southward and Southward, 1982), the enzymic activities found in *R. pachyptila* also indicate a substantial capacity for energy metabolism. The vent animals thus contrast sharply with deep-sea animals from non-vent habitats. Animals from non-vent regions in the deep sea have been shown to have extremely low metabolic rates (Childress, 1975; Smith and Hessler, 1974; Smith, 1978; Torres *et al.*, 1979) and very low amounts of activity of enzymes of energy metabolism in their tissues (Fig. 2; Childress and Somero, 1979; Sullivan and Somero, 1980; Siebenaller and Somero, 1982; Siebenaller *et al.*, 1982). For example, the activities of LDH in fish locomotory muscle differ by almost three orders of magnitude between highly active, shallow-living fishes and sluggish deep-sea fishes (Fig. 2).

The finding that animals from the hydrothermal vent habitat have a high potential for energy metabolism is further evidence that the low temperatures and elevated hydrostatic pressures of the deep sea are not, in and of themselves, important factors in selecting for low metabolic rates in deep-sea organisms. At the 21°N site where the vent species used in this study were collected, pressure was approximately 260 atms (depth of 2600 m), and the temperature of the water in the immediate vicinity of the animals was below approximately 20°C and, in almost all cases, was probably within one or two degrees of the ambient bottom water's temperature (near 2°C) (J. J. Childress, personal communication). The Pompeii worm was the only species likely to experience temperatures much above 2–5°C, since this polychaete forms burrows on the sides of white smoker chimneys (Desbruyeres and Laubier, 1980).

Waters issuing from the vents are rich in HS^- , methane, and hydrogen (Edmond *et al.*, 1982), all of which are energy-rich compounds that can be oxidized by chemolithotrophic bacteria. The base of the food chain at the vents is thought to be bacteria, *e.g.*, sulfide-oxidizing chemoautotrophic bacteria, that occur free-living in the sea water (Karl *et al.*, 1980), on the surfaces of rocks and animals, and within certain tissues of *R. pachyptila*, *C. magnifica*, and the vent mussel (Cavanaugh *et al.*, 1981; Felbeck, 1981; Felbeck *et al.*, 1981; Felbeck and Somero, 1982; Cavanaugh, 1983). The existence of primary production by bacteria at the vents may preclude the vent animals from having to rely significantly on reduced carbon and nitrogen compounds descending from the surface, a conjecture supported by stable carbon and nitrogen isotope ratios (Rau and Hedges, 1979; Rau, 1981a, b; Williams *et al.*, 1981). Although this point remains to be proven, the rates of primary production at the vents may be high enough to allow the vent animals to sustain metabolic rates comparable to those found for animals in food-rich, shallow marine habitats. High metabolic capacities are noted for vent animals containing bacterial endosymbionts (*R. pachyptila* and *C. magnifica*), and for species that graze on bacteria or prey on the vent animals. It bears mentioning that one of the two zoarcid fishes used in this study contained fresh trophosome tissue of *R. pachyptila* in its gut (Somero, personal observations).

TABLE I

Inhibition by HS⁻ of the cytochrome c oxidase systems of vent and non-vent marine invertebrates

Species [enzyme preparation]	Inhibition constant (K_i)($[HS^-]$ yielding 50% inhibition)
<i>Bythogrea therymydron</i> [heart supernatant]	2.0×10^{-9}
<i>Riftia pachyptila</i> [tentacle supernatant]	1.4×10^{-5}
[once acid precipitated]	3.5×10^{-6}
[twice acid precipitated]	1.8×10^{-6}
<i>Mercenaria mercenaria</i> [heart supernatant]	1.4×10^{-7}
<i>Menippe mercenaria</i> [heart supernatant]	2.0×10^{-7}

In all of the vent animals examined except *C. magnifica* the levels of CO activity present in different tissues suggested a significant capacity for aerobic respiration. The occurrence of the CO system in animals exposed to HS^- concentrations known to be adequate to completely inhibit respiration (Hydrogen Sulfide, 1979; Powell and Somero, 1983) suggest that the vent animals, as well as species like *S. reidi* that live in other sulfide-rich marine habitats, may have evolved mechanisms for prevention of poisoning by HS^- of aerobic respiration. We found no evidence of sulfide-insensitive variants of the CO system in these species. Thus, half-inhibiting concentrations of HS^- for the vent species ranged between $2 \times 10^{-9} M$ (*B. therymydron*) and $1.4 \times 10^{-5} M$ (crude supernatant of tentacle of *R. pachyptila*). Concentrations of HS^- in the vent waters can approach 1 mM (Edmond *et al.*, 1982), albeit HS^- concentrations are much lower in the waters immediately surrounding the animals, and blood sulfide levels in *R. pachyptila* of up to 1.1 mM have been found (Arp and Childress, 1983). Thus, in the absence of mechanisms for preventing HS^- from coming into contact with the CO system, there would appear to be a strong likelihood that aerobic respiration would be sulfide poisoned in the vent animals. In *R. pachyptila* one possible mechanism for prevention of poisoning of aerobic respiration by HS^- entails essentially quantitative binding of HS^- to blood-borne sulfide binding (transport) proteins (Arp and Childress, 1983; Powell and Somero, 1983). The increase in sensitivity of the CO system of tentacle of *R. pachyptila* to HS^- with successive acid precipitation purification steps (Table I) reflects the removal of these sulfide binding proteins from the system. Thus, even though the CO system of *R. pachyptila* displays a somewhat reduced sensitivity to HS^- compared to the other CO systems studied, we predict that the inherent sensitivities of completely purified CO systems from all of these animals would be essentially equal.

In addition to sulfide binding proteins that may function both in protection of respiration and in sulfide transport to bacterial endosymbionts (Arp and Childress, 1983), systems for oxidizing HS^- to less toxic, or non-toxic, sulfur metabolites may be present in the cells of animals from sulfide-rich environments. For example, we have found high activities of these types of reactions in foot of *S. reidi* (Powell and Somero, in prep.). In assays of CO activity that use crude supernatant fractions that contain sulfide oxidizing enzyme systems as well as CO activity, the K_i value obtained may be artifactually high due to the removal of HS^- from the assay solution by the sulfide oxidizing system. Thus, the K_i values listed in Table I should be viewed as upper limits to the K_i values that would be found in the absence of sulfide binding

proteins or sulfide oxidizing systems, both of which can effectively reduce the amount of free HS^- present in the assay medium.

Calyptogena magnifica was the only vent species to show marked differences in metabolic potentials relative to the shallow-living comparison species. Although tissues of *C. magnifica* had activities of PFK, PK, and MDH that were comparable to, and often higher than, the corresponding activities in the other bivalve molluscs examined, levels of CS and CO were extremely low in the vent clam. Thus, the enzyme profiles of *C. magnifica* are suggestive of a very high reliance on anaerobic metabolism. In certain marine bivalves a substantial fraction of energy metabolism occurs via anaerobic pathways even in the presence of oxygen (DeZwann and Wijsman, 1976). The diagnostic enzymes for high potentials for the types of anaerobic schemes common in marine bivalves include MDH, the enzyme showing the highest activity in adductor and heart muscle of *C. magnifica*. The basis for this species' reliance on anaerobic metabolism may be the nature of the microhabitat in which the clam is found. *Calyptogena magnifica* at the 21°N study site were almost invariably found along cracks in the basaltic seafloor through which sulfide-rich waters issued (personal observations). The large foot of the clam was sometimes extended deeply into the crack, and thus was exposed to high concentrations of HS^- . The steady flux of high quantities of HS^- into the clam may preclude the possibility of detoxifying HS^- by the mechanisms discussed above, and without the means for preventing contact between HS^- and the CO system, aerobic respiration is not possible. It is important to point out, however, that *C. magnifica* does "respire" in the sense that the intact symbiosis consumes oxygen at an appreciable rate (Kenneth L. Smith, Jr., personal communication), as has recently been reported for *Calyptogena pacifica* (Childress and Mickel, 1982), which also harbors bacterial endosymbionts in its gills (Felbeck *et al.*, 1981). As Childress and Mickel (1982) emphasize, caution must be exercised in attempts to attribute specific fractions of oxygen uptake to the animal's tissues, on the one hand, and the sulfide oxidizing bacterial endosymbionts, on the other. The very low CO activities found in *C. magnifica* suggest that by far the larger share of oxygen consumption by the intact symbiosis may be due to the sulfide oxidizing activities of the endosymbionts.

ACKNOWLEDGMENTS

These studies were supported by National Science Foundation grants OCE80-24251 to GNS, and OCE80-24895 to Dr. Kenneth L. Smith, for support of the Oasis Expedition. Travel funds to SCH were provided by the University of Southwestern Louisiana. We gratefully acknowledge the assistance of expedition leader, Dr. K. L. Smith, Ms. R. Baldwin, Ms. G. Niles, and the captains and crews of the research vessels RV New Horizon, RV Lulu, RV Melville, and DSRV Alvin. Discussions of this work with Drs. J. J. Childress and H. Felbeck are gratefully acknowledged. This is contribution number 11 of the Oasis Expedition.

LITERATURE CITED

- ALP, P. R., E. A. NEWSHOLME, AND V. A. ZAMMIT. 1976. Activities of citrate synthase and NAD^+ -linked and NADP^+ -linked isocitrate dehydrogenase in muscle from vertebrates and invertebrates. *Biochem. J.* **154**: 689-700.
- ARP, A., AND J. J. CHILDRESS. 1983. Sulfide binding by the blood of the hydrothermal vent tube worm *Riftia pachyptila*. *Science* **219**: 295-297.
- CAVANAUGH, C. M. 1983. Symbiotic chemoautotrophic bacteria in marine invertebrates from sulphide-rich habitats. *Nature* **302**: 58-61.

- CAVANAUGH, C. M., S. GARDINER, M. K. JONES, H. W. JANNASCH, AND J. B. WATERBURY. 1981. Prokaryotic cells in the hydrothermal vent tube worm *Riftia pachyptila* Jones: possible chemoautotrophic symbionts. *Science* **213**: 340-342.
- CHILDRESS, J. J. 1971. Respiratory rate and depth of occurrence of midwater animals. *Limnol. Oceanogr.* **16**: 104-106.
- CHILDRESS, J. J. 1975. The respiratory rates of midwater crustaceans as a function of depth of occurrence and relation to the oxygen minimum layer off southern California. *Comp. Biochem. Physiol.* **50A**: 787-799.
- CHILDRESS, J. J., AND T. J. MICKEL. 1982. Oxygen and sulfide consumption rates of the vent clam, *Calyptogena pacifica*. *Mar. Biol. Lett.* **3**: 73-79.
- CHILDRESS, J. J., AND G. N. SOMERO. 1979. Depth-related enzymic activities in muscle, brain and heart of deep-living pelagic marine teleosts. *Mar. Biol.* **52**: 273-283.
- DESBRUYERES, D., AND L. LAUBIER. 1980. *Alvinella pompejana* gen. sp. nov., ampharetidae aberrant des sources hydrothermales de la ride Est-Pacifique. *Oceanol. Acta* **3**: 267-274.
- DEZWAAN, A., AND T. C. M. WIJSMAN. 1976. Anaerobic metabolism in bivalvia (Mollusca) Characteristics of anaerobic metabolism. *Comp. Biochem. Physiol.* **54B**: 313-324.
- EDMOND, J. M., K. L. VON DAMM, R. E. MCDUFF, AND C. I. MEASURES. 1982. Chemistry of hot springs on the East Pacific Rise and their effluent dispersal. *Nature* **297**: 187-191.
- FELBECK, H. 1981. Chemoautotrophic potential of the hydrothermal vent tube worm, *Riftia pachyptila* Jones (Vestimentifera). *Science* **213**: 336-338.
- FELBECK, H. 1983. Sulfide oxidation and carbon fixation by the gutless clam *Solemya reidi*: An animal-bacteria symbiosis. *J. Comp. Physiol.* in press.
- FELBECK, H., AND G. N. SOMERO. 1982. Primary production in deep-sea hydrothermal vent organisms: Roles of sulfide-oxidizing bacteria. *Trends Biochem. Sci.* **7**: 201-204.
- FELBECK, H., J. J. CHILDRESS, AND G. N. SOMERO. 1981. Calvin-Benson cycle and sulphide oxidation enzymes in animals from sulphide-rich habitats. *Nature* **293**: 291-293.
- HAND, S. C., AND G. N. SOMERO. 1982. Urea and methylamine effects on rabbit muscle phosphofructokinase. Catalytic stability and aggregation state as a function of pH and temperature. *J. Biol. Chem.* **257**: 734-741.
- HELMERHORST, E., AND G. B. STOKES. 1980. Microcentrifuge desalting: A rapid, quantitative method for desalting small amounts of protein. *Anal. Biochem.* **104**: 130-135.
- HOCHACHKA, P. W. 1980. *Living Without Oxygen*, Harvard, Cambridge. 181 pp.
- Hydrogen Sulfide*. 1979. Subcommittee on hydrogen sulfide, Division of Medical Sciences, National Research Council, University Park Press, Baltimore. 183 pp.
- JONES, M. L. 1981. *Riftia pachyptila* Jones: Observations on the vestimentiferan worm from the Galapagos Rift. *Science* **213**: 333-336.
- KARL, D. M., C. O. WIRSEN, AND H. W. JANNASCH. 1980. Deep-sea primary production at the Galapagos hydrothermal vents. *Science* **207**: 1345-1347.
- MICKEL, T. J., AND J. J. CHILDRESS. 1982. Effects of temperature, pressure, and oxygen concentration on the oxygen consumption rate of the hydrothermal vent crab *Bythograea thermydron* (Brachyura). *Physiol. Zool.* **55**: 199-207.
- PETERSON, G. L. 1977. A simplification of the protein assay method of Lowry *et al.* which is more generally applicable. *Anal. Biochem.* **83**: 345-356.
- POWELL, M. A., AND G. N. SOMERO. 1983. Blood components prevent sulfide poisoning of respiration of the hydrothermal vent tube worm *Riftia pachyptila*. *Science* **219**: 297-299.
- RAU, G. H. 1981a. Low ¹⁵N/¹⁴N in hydrothermal vent animals: ecological implications. *Nature* **289**: 484-485.
- RAU, G. H. 1981b. Hydrothermal vent clam and tube worm ¹³C/¹²C: Further evidence of nonphotosynthetic food sources. *Science* **213**: 338-340.
- RAU, G. H., AND J. I. HEDGES. 1979. Carbon-13 depletion in a hydrothermal vent mussel: Suggestion of a chemosynthetic food source. *Science* **203**: 648-649.
- SIEBENALLER, J. F., AND G. N. SOMERO. 1982. The maintenance of different enzyme activity levels in congeneric fishes living at different depths. *Physiol. Zool.* **55**: 171-179.
- SIEBENALLER, J. F., G. N. SOMERO, AND R. L. HAEDRICH. 1982. Biochemical characteristics of macrourid fishes differing in their depths of distribution. *Biol. Bull.* **163**: 240-249.
- SIMON, L. M., AND E. D. ROBIN. 1972. Relative anaerobic glycolytic capacity and pyruvate kinase activity of rabbit tissues. *Int. J. Biochem.* **3**: 329-332.
- SMITH, K. L., JR. 1978. Metabolism of the abyssopelagic rattail *Coryphaenoides armatus* measured *in situ*. *Nature* **274**: 362-364.
- SMITH, K. L., JR., AND R. R. HESSLER. 1974. Respiration of benthopelagic fishes: *In situ* measurements at 1230 meters. *Science* **184**: 72-73.
- SOMERO, G. N., AND J. J. CHILDRESS. 1980. A violation of the metabolism-size scaling paradigm:

- Activities of glycolytic enzymes in muscle increase in larger-size fish. *Physiol. Zool.* **53**: 322-337.
- SOMERO, G. N., J. F. SIEBENALLER, AND P. W. HOCHACHKA. 1983. Biochemical and physiological adaptations of deep-sea animals. (In press) in *The Sea, Vol. 8*, G. T. Rowe, ed. Wiley, New York.
- SOUTHWARD, A. J., AND E. C. SOUTHWARD. 1982. The role of dissolved organic matter in the nutrition of deep-sea benthos. *Am. Zool.* **22**: 647-659.
- SPIESS, F. N., K. C. MACDONALD, T. ATWATER, R. BALLARD, A. CARRANZA, D. CORDOBA, C. COX, V. M. DIAZ GARCIA, J. FRANCHETEAU, J. GUERRERO, J. HAWKINS, R. HAYMON, R. HESSLER, T. JUTEAU, M. KASTNER, R. LARSON, B. LUYENDYK, J. D. MACDOUGALL, S. MILLER, W. NORMARK, J. ORCUTT, AND C. RANGIN. 1980. East Pacific rise: Hot springs and geophysical experiments. *Science* **207**: 1421-1433.
- SUGDEN, P. H., AND E. A. NEWSHOLME. 1973. Activities of hexokinase, phosphofructokinase, 3-oxo acid coenzyme A-transferase and acetoacetylcoenzyme A thiolase in nervous tissue from vertebrates and invertebrates. *Biochem. J.* **134**: 97-101.
- SULLIVAN, K. M., AND G. N. SOMERO. 1980. Enzyme activities of fish skeletal muscle and brain as influenced by depth of occurrence and habits of feeding and locomotion. *Mar. Biol.* **60**: 91-99.
- TORRES, J. J., B. W. BELMAN, AND J. J. CHILDRESS. 1979. Oxygen consumption rates of midwater fishes off California. *Deep-Sea Res.* **26A**: 185-197.
- TUTTLE, J. H., C. O. WIRSEN, AND H. W. JANNASCH. 1983. Microbial activities in the emitted hydrothermal waters of the Galapagos rift vents. *Mar. Biol.* **73**: 293-299.
- WILLIAMS, P. M., K. L. SMITH, E. M. DRUFFEL, AND T. W. LINICK. 1981. Dietary carbon sources of mussels and tubeworms from Galapagos hydrothermal vents determined from tissue ¹⁴C activity. *Nature* **292**: 448-449.
- YONETANI, T., AND G. RAY. 1965. Studies on cytochrome oxidase. VI. Kinetics of the aerobic oxidation of ferrocytochrome c by cytochrome oxidase. *J. Biol. Chem.* **240**: 3392-3398.
- ZAMMIT, V. A., I. BEIS, AND E. A. NEWSHOLME. 1978. Maximum activities and effects of fructose bisphosphate on pyruvate kinase from muscles of vertebrates and invertebrates in relation to the control of glycolysis. *Biochem. J.* **174**: 989-998.

EFFECTS OF FEEDING, FEEDING HISTORY, AND FOOD DEPRIVATION ON RESPIRATION AND EXCRETION RATES OF THE BATHYPELAGIC MYSID *GNATHOPHAUSIA INGENS*

PAGE HILLER-ADAMS AND JAMES J. CHILDRRESS

Marine Science Institute, Department of Biological Sciences, University of California, Santa Barbara, Santa Barbara, California 93106

ABSTRACT

Groups of the large bathypelagic mysid *Gnathophausia ingens* were fed at different frequencies for at least three months in the laboratory, then starved for five weeks or alternately fed and starved over shorter periods of time. Oxygen consumption and ammonia excretion rates were determined before and after feeding and during starvation. Prolonged differences in the amount of food eaten prior to starvation affected the animals' initial responses to starvation. In the first 3 weeks, animals which had been more frequently fed maintained higher respiration and ammonia excretion rates relative to rates after this time. Animals fed less frequently maintained stable rates throughout the 5 week period of starvation. After a maximum of 3 weeks, starved individuals relied largely on nonnitrogenous energy stores, presumably lipids, regardless of feeding frequency prior to starvation. The high lipid content of *G. ingens* and the low metabolic rate of starved individuals are advantageous for life in the energy-poor deep-sea.

We have observed transient postfeeding increases in respiration and excretion rates. Excretion rate (E, in micromoles NH_3/h) increased with amount eaten (F, in mg ash-free dry weight of food) ($E = 0.038F$). Respiration rate (R, in micromoles O_2/h) increased with excretion rate ($R = 1.40 + 1.03E$). Measurements of respiration and excretion rates using postdigestive individuals of *G. ingens* therefore underestimate average field rates by an amount proportional to food intake. The energetic effects of feeding on the metabolism of *G. ingens* are not negligible. We estimate that about 29% of the energy in the laboratory ration ingested by *G. ingens* is expended in the postfeeding increase in respiration.

INTRODUCTION

The dramatic decrease in biomass of the world's oceans with increasing depth, and the generally patchy distribution of animals living in the water column, suggest that food scarcity is one of the most physiologically important characteristics of the deep sea. Food scarcity may in part be responsible for characteristics of the chemical composition (Childress and Nygaard, 1973, 1974), metabolic rates (Childress, 1971a, 1975; Smith and Hessler, 1974; Torres *et al.*, 1979), and life histories (Childress and Price, 1978; Childress *et al.*, 1980) of deep-sea animals. Information on the metabolic responses of deep-sea animals to feeding and to food deprivation should therefore add to our knowledge of the physiological and energetic adaptations of deep-sea animals to their environment. The responses may also be compared to those of shallow water animals which live in an environment which is physically more variable. This paper presents the results of an investigation of the effects of feeding, food

deprivation, and feeding history on the respiration and excretion rates of the large bathypelagic mysid *Gnathophausia ingens* Dohrn. We have investigated the effects of feeding frequency prior to prolonged periods of starvation on respiration and excretion rates during starvation and on the substrates metabolized during starvation. We have also quantified the relationships between food intake and transient postfeeding increases in respiration and excretion by this species, and estimated the energetic importance to *G. ingens* of these increases.

G. ingens is well-suited to such a study since individuals can be obtained in relatively large numbers off the coast of southern California, and may be maintained for relatively long periods in the laboratory (up to 2.5 years: Childress and Price, 1978). The life history of *G. ingens* is well known (Childress and Price, 1978). Females brood their young at depths between 900 and 1400 m. Newly released young ascend to depths of about 175–300 m. On reaching the fifth instar (carapace length between 14.2 and 17.7 mm: Childress and Price, 1978) they descend to depths of 650–750 m, dispersing at night to depths of 400–900 m. After the fifth instar, individuals live permanently beneath the photic zone.

MATERIALS AND METHODS

Animal capture and maintenance

Individuals of *Gnathophausia ingens* were captured in San Clemente and San Nicholas Basins off the coast of southern California during January and April 1979, using an opening and closing 3.3 m × 3.3 m Tucker trawl equipped with a thermally protecting cod-end (Childress *et al.*, 1978). We removed live individuals from the cod-end as soon as it arrived on deck, wrapped them loosely in nylon mesh, placed them in 1 gallon jars filled with sea water, and maintained them at approximately 5°C. On our return to the laboratory, each animal was unwrapped and put in a container of about 700 ml of chilled sea water, and placed in the laboratory cold room (5.5°C). The room was dark except for occasional short (several minutes) periods during the day when laboratory personnel entered. After two weeks in captivity, each animal was assigned a number and all the animals were alternately fed salmon muscle and ridgeback shrimp (*Sicyonia incertus*) tails according to the feeding regimes described below. Maintenance water was changed once every 2–3 weeks, and after each feeding.

All animals were maintained at atmospheric pressure. We believe that this does not bias the results since this species can live and grow in the laboratory for periods of up to 2.5 years at atmospheric pressure (Childress and Price, 1978). Further, research in this laboratory has shown that the respiration rates and activity of this and other midwater species are relatively unaffected by a pressure of 1 atm (Meek and Childress, 1973; Mickel and Childress, 1982). Our studies have also shown that *G. ingens* swim continuously at a rather fixed rate which does not decline in captivity (Quetin *et al.*, 1978; Quetin and Childress, 1980; Mickel and Childress, 1982). Our experience with this mysid therefore leads us to believe that our results are reasonably representative of the field situation.

Feeding

Individuals were fed either 6×/mo for 3.5 months ("6×/mo, 1st series"), 6×/mo for 5 months ("6×/mo, 2nd series"), 1×/mo for 3–4 months ("1×/mo"), or 6×/mo for 2 months followed by 3 months of feeding 2×/mo ("2×/mo"). Individuals were not offered food for two weeks after they had molted since they generally do

not accept food prior to this time. Feedings within each group were evenly spaced over time. Experiments in which respiration and excretion rates were determined began at the end of these feeding periods. *G. ingens* were fed shrimp during the experiments, except for two 1X/mo individuals which were fed salmon at the start of the experiment using 1X/mo animals. Only shrimp meals are considered in the analysis of postfeeding increases in respiration and excretion since all but two of the metabolic measurements were made after the animals had fed on shrimp.

To feed the animals, and to determine the amount eaten by each individual, a small preweighed piece of food was held near each animal until it grasped the piece with its pereopods. Four to six hours later the remaining food was removed with forceps and with a perforated spoon which facilitated the removal of smaller pieces of food. All visible pieces of food were removed, and the water in each animal's container was replaced with fresh, chilled (5.5°C) sea water. The food which had been removed was placed in tared pans, dried to constant weight at 60°C and weighed (dry weight), then ashed to constant weight at 500°C and weighed again (ash weight). The difference between the dry weight and ash weight constituted the ash-free dry weight (AFDW) of the uneaten food. For each feeding, two preweighed pieces of food were placed in sea water without an animal for the duration of the feeding period and were similarly dried and ashed. These pieces served as controls for the loss of material from the food due to immersion. The AFDW available to the animals was estimated by multiplying the fresh weight of each piece fed to an animal by a conversion factor which was the average ratio of AFDW/fresh weight determined from the two control pieces. The ash-free dry weight of the food eaten by each individual could then be calculated as the difference between the "available" AFDW and final AFDW of its food.

We chose AFDW for quantification of food eaten because it is a measure of total organic matter and as such is a better estimator of food value than wet or dry weight, each of which include substantial amounts of inorganic material. Use of AFDW also avoids the complication of variable amounts of salt water on the surface of the left-over food. The method which we have used is a way to approximate the actual ingestion since some additional material may be leaked from the food during external chewing. The error from this source is probably minor since these animals typically ingest small pieces of food immediately after removing them from the main chunk.

The salmon and shrimp meals were the only significant sources of food for *G. ingens* since the species is not suited for filtering fine particles from the water (setae on the pereopods are sparse), and since several studies have failed to detect significant uptake of dissolved amino acids by aquatic crustaceans (Stephens and Schinske, 1961; Stephens, 1972; Ferguson, 1982).

Protocol for respiration and excretion measurements

In a typical experiment, animals were removed from their open maintenance containers and placed in individual one-liter flasks containing sea water (5.5°C) to which 50 mg/l each of streptomycin and neomycin had been added. The sea water had been filtered either through a 0.45 micron membrane filter or through glass wool. The flasks, including two control flasks which contained only sea water and antibiotics, were closed with rubber stoppers. Care was taken to exclude all air bubbles. At the end of the experiment water samples were removed for oxygen and ammonia analyses and the animals were replaced in their maintenance containers. All experiments were conducted in the dark at 5.5°C.

Each experiment lasted from 8.5 to 10 hours. The duration was adjusted to

obtain measurable decreases in oxygen contents of the flasks without allowing the oxygen content to decrease below the level at which respiration rates become dependent on the partial pressure of oxygen (Childress, 1971b; Mickel and Childress, 1978).

Oxygen

Oxygen was analyzed using standard Winkler techniques (Strickland and Parsons, 1972). Flasks were unstoppered at the end of each experiment. A water sample for analysis of oxygen content was carefully siphoned from each newly opened one-liter flask into a 125 ml glass-stoppered flask, and Winkler reagents were added. Sample concentrations of oxygen were corrected for changes in the oxygen content of the control flasks. These changes were always less than 3% of the starting concentrations, which varied between 497 and 692 micromoles O₂/l. Oxygen consumption rates determined from duplicate titrations of single samples differed by an average of less than 2%.

Ammonia

The ammonia content of a 50 ml subsample from each one-liter flask was determined using an ammonia electrode (Orion Research, Inc., Cambridge, MA). Electrode potentials were converted to ammonia concentrations using an average of two standard calibration curves, one made immediately before and one immediately after sample analysis. To make each curve, known amounts of a standard ammonium chloride solution were added successively to 50 ml of sea water made basic (pH about 11) with sodium hydroxide. The sea water was continuously mixed with a magnetic stirrer at low speed. After each addition, the electrode was allowed to stabilize before the electrode potential was recorded. The two curves for an experiment generally differed by less than 0.5 micromole/l for a given electrode potential in the sample concentration range. Consecutive measurements were repeatable to $\pm 4\%$. Electrode drift was minimized by placing the electrode in sea water adjusted to pH 11 for 30 minutes prior to use. Concentrations of ammonia in the control flasks did not change detectably during any of the experiments.

Analysis of results

In comparing the physiological responses to food deprivation by animals on different feeding regimes, we considered only data for those individuals which survived the initial feeding period and the experimental period in which respiration and excretion rates were determined, and did not molt during the experimental period. There were four such 6 \times /mo (1st series) individuals (6.5–18.6 g), five 1 \times /mo individuals (5.5–11.8 g), four 6 \times /mo (2nd series) individuals (5.2–9.2 g), and two 2 \times /mo individuals (5.2 and 9.4 g) of an initial 9, 5, 6, and 4 individuals, respectively. Six of the original 24 animals (25%) died during the initial feeding period or during the experiment, and 3 (13%) molted and were not considered.

It is important to note that in each experiment in which individuals were starved we have compared and contrasted the trends in, rather than the levels of, respiration and excretion since the number of individuals available was small. Consistent differences in individual rates which in a small sample might unduly affect comparisons of means between groups, will not affect comparisons of individuals followed over a long period of time.

For analysis of short-term responses to feeding (responses occurring within a few days after feeding), we considered data from those individuals which did not molt or die within one week of respiration and excretion measurements ($n = 28$).

In all cases, data are expressed as a mean \pm one standard error of the mean.

RESULTS

Experiments A

Two series of experiments were conducted to determine the effects of a long (35 day) period of starvation on oxygen consumption and ammonia excretion by individuals of *G. ingens*, and to determine the influence of feeding history on these effects. In the first experiment, oxygen consumption and ammonia excretion rates of the five 1 \times /mo animals were determined prior to feeding. The animals were then fed on shrimp ($n = 3$) or salmon ($n = 2$). Respiration and excretion rates were determined again 12 hours after the food was removed (Day 1), and periodically throughout the 35 days of starvation. After 35 days, the animals were fed shrimp, and respiration and excretion rates were determined 12 hours (Day 1) and 60 hours (Day 3) after the food had been removed. In the second series of experiments, food was withheld for 35 days from animals previously fed 6 \times /mo (1st series). Respiration and excretion rates were determined periodically. After 35 days the animals were fed shrimp. Respiration and excretion rates were determined a final time 12 hours after removing the food.

Results of Experiments A

For the reasons stated in "Materials and Methods—Analysis of results", we have compared and contrasted the trends in rates in respiration and excretion, rather than the rates themselves.

The mean oxygen consumption rate of animals previously fed 1 \times /mo did not change significantly during 35 days of starvation (Fig. 1): the highest (Day 35) and lowest (Day 14) mean respiration rates are not significantly different ($P > 0.90$, paired *t*-test).

The mean ammonia excretion rate of these animals increased after the initial feeding and returned within 5–9 days to the prefeeding level of 0.253 ± 0.043 micromoles NH_3/g wet weight/h. By the fourteenth day the mean excretion rate had stabilized at a lower rate (0.114 ± 0.021 micromoles NH_3/g wet weight/h) and remained stable through the 35th day of starvation. Subsequent feeding again produced a large increase in mean ammonia excretion rate. The geometric mean atomic O:N ratio decreased on Day 1 as a result of the large increase in ammonia excretion, then increased gradually through the third week. Feeding again produced a sharp decrease in the O:N value.

The mean oxygen consumption rate of animals previously fed 6 \times /mo was stable through the twenty-first day of starvation, then decreased through the 35th day (Fig. 1). The final mean rate of 1.28 ± 0.20 micromoles O_2/g wet weight/h was 64% of, and significantly lower than, the initial post-digestive (Day 3) rate of 1.87 ± 0.17 micromoles O_2/g wet weight/h ($P < 0.05$, paired *t*-test). Subsequent feeding increased the mean oxygen consumption rate measured on Day 1 to 1.51 ± 0.18 micromoles O_2/g wet weight/h.

Ammonia excretion rates (Fig. 1) dropped rapidly in the first 5 days after feeding. The mean rate dropped again between the third and fourth weeks, and did not change significantly in the fifth week. Subsequent feeding produced a large increase

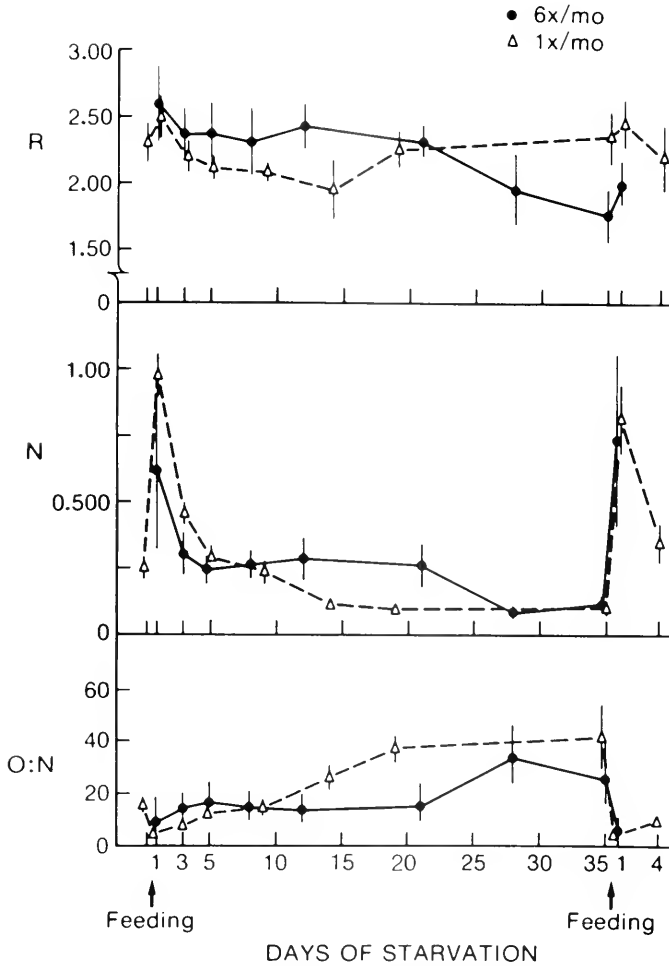

FIGURE 1. Oxygen consumption rates (R), ammonia excretion rates (N) and atomic O:N ratios of individuals previously fed either 6x/mo ($n = 4$) or 1x/mo ($n = 5$), during five weeks of starvation. Oxygen consumption and ammonia excretion rates are expressed in $\mu\text{moles/g wet weight h}^{-1}$. Mean \pm standard error.

in mean ammonia excretion rate on Day 1. The geometric mean atomic O:N ratio was stable at values of 24–26 from Day 3 through the third week of starvation and increased significantly in the fourth and fifth weeks ($P < 0.002$ for both weeks, when compared with Day 21, paired t -test).

The early response to starvation therefore differed between the two groups. The respiration and excretion rates of animals previously fed 6x/mo were higher in the first three weeks of starvation relative to rates after 35 days of starvation. The respiration rates of animals previously fed 1x/mo were more stable, and ammonia excretion rates stabilized within 2 weeks. The slower stabilization of the excretion rates of the 1x/mo animals, which caused a gradual increase in the O:N ratio, is probably due to the fact that, on the average, 1x/mo animals ate 2.5 times more per gram of animal weight at the initial meal than did animals fed 6x/mo.

Experiments B

Two series of experiments were conducted to determine the effects of feeding, feeding history, and food deprivation over shorter periods of time, on respiration and excretion rates. Respiration and excretion rates of animals previously fed 6×/mo (2nd series) or 2×/mo were measured periodically during two sequential periods of food deprivation, the first lasting 12 days and the second for 10 days. The experiments in each period began with individual measurements of rates made a few days before feeding. At the end of the 10 day fast, the animals were fed again and respiration and excretion rates determined 12 hours (Day 1) and 60 hours (Day 3) after food removal.

Results of Experiments B

The mean oxygen consumption rates of the two 2×/mo individuals were higher than those of the 6×/mo individuals in the first 12 day period (Fig. 2). The two groups did not otherwise differ in their responses to feeding or to this period of starvation, although a larger sample size is needed before conclusions can be drawn concerning differences between effects of these feeding frequencies on responses to short-term starvation.

The data indicate, however, that feeding induces transient increases in respiration and excretion rates in individuals of both groups. Mean oxygen consumption rates and ammonia excretion rates increased immediately after each feeding, then decreased to or below prefeeding levels sometime between Day 1 and Day 3 to Day 7. Feeding restored respiration and excretion rates to pre-starvation levels. However, the feeding "peaks" only briefly interrupted the continuing decreases in ammonia excretion rates in both groups. Consequently, the O:N ratios for individuals in both groups generally decreased on Day 1, indicating protein metabolism, and increased between feedings, indicating increasing reliance on non-nitrogenous energy sources. The more rapid increase in O:N ratios during the second period of starvation suggests that the metabolic shift to non-nitrogenous compounds occurred more quickly.

Meal size and animal weight

The amount of shrimp eaten at each feeding increased with increasing animal weight (Fig. 3). Meals eaten by an individual within a week before molting or dying and the first meal eaten after molting are omitted since the former are often small due to softening of the exoskeleton, and the latter are sometimes atypically large, probably due to the two week fast imposed after molting. The regression includes only data on the average meal sizes of animals which had been fed at least two quantified shrimp meals and were not affected by molting or death. There was no significant difference between the regressions for the three feeding regimes ($P > 0.75$, F-test). The overall regression of average meal size on animal wet weight is $M = 33.59 + 11.32W$ ($r = 0.70$, $n = 14$), where M = average mg AFDW eaten/meal, and W = wet weight of *G. ingens*, in grams.

Feeding "peaks"

We determined the correlation between increases in ammonia excretion rates and oxygen consumption rates which often followed feeding, and between the increases in each rate and the amount of food eaten, using the 28 data sets which satisfied the following criteria: (1) oxygen consumption and ammonia excretion rates

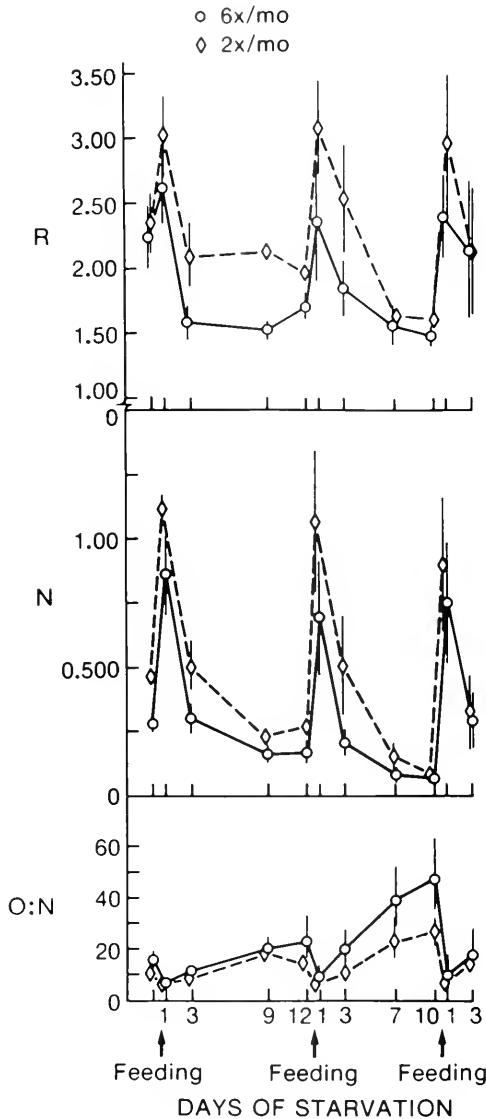

FIGURE 2. Oxygen consumption rates (R), ammonia excretion rates (N) and atomic O:N ratios of individuals which were alternately fed and starved. Individuals had previously been fed 6x/mo (n = 4) or 2x/mo (n = 2). Oxygen consumption and ammonia excretion rates are expressed in $\mu\text{m/g}$ wet weight h^{-1} . Mean \pm standard error.

were determined within two days before the animal fed (prefeeding rates), and again on Day 1 (12 hours) and Day 3 or 4 (60 and 84 hours, respectively) after feeding ceased (postfeeding rates); (2) the individual fed on shrimp, and (3) did not molt or die within one week after the meal. A "peak" was considered to have occurred in respiration or excretion if the rate measured on Day 1 was greater than both the prefeeding and postfeeding rates. The magnitude of the peak was calculated as the difference between the rate measured on Day 1 and the average of the pre- and post-

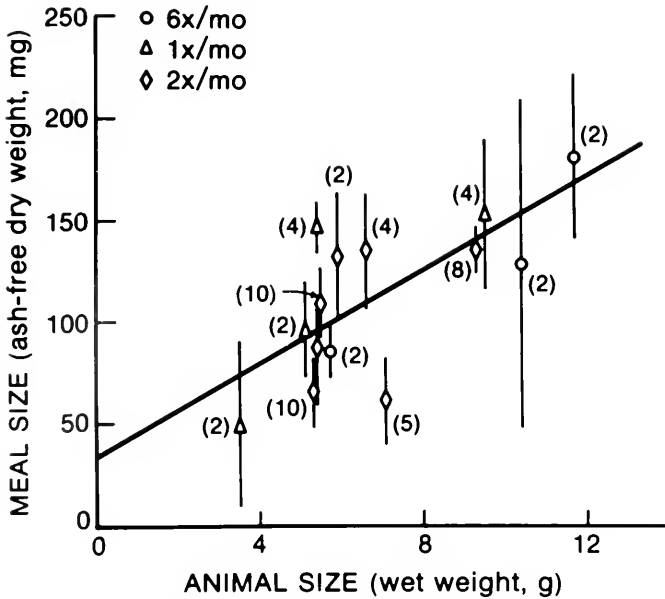

FIGURE 3. Meal size as a function of animal weight. Individuals were fed 1×/mo, 2×/mo or 6×/mo. Numbers in parentheses indicate number of shrimp meals contributing to the data point (mean \pm standard error). Meals eaten by an individual within a week before molting or dying, and the first meal eaten after molting, are omitted. $y = 33.59 + 11.32x$ ($r = 0.70$).

feeding rates. Peaks in ammonia excretion occurred in all 28 data sets, which involved 12 animals in the 6×/mo (2nd series), 1×/mo and 2×/mo groups. Peaks occurred in oxygen consumption in 71% of the sets (20 of 28).

The linear regressions of increase in ammonia excretion rate (E , in micromoles NH_3/h) on amount eaten (F , in mg AFDW) did not differ between the three regimes (Fig. 4; $P > 0.25$, F-test). The regression is $E = 0.038F$ if it is constrained to pass through the origin, *i.e.*, if one assumes that the peaks in excretion are due to feeding. This regression does not differ significantly from the unconstrained regression ($P > 0.10$, F-test). Since 75% of the ash-free dry weight of the shrimp fed to *G. ingens* is protein (Childress, unpublished data), the regression of the increase in ammonia excretion (12 hours after feeding) on protein ingested (P , in mg) is $E = 0.051P$. The correlation between animal wet weight (y , in grams) and the magnitude of the postfeeding ammonia peak (x , in micromoles NH_3/h) is $y = -4.98 + 10.44x$ ($P < 0.001$, t -test for significant slope). This is consistent with the positive correlation between meal size and the weight of *G. ingens*.

Although there was no significant linear correlation between the magnitudes of post-feeding oxygen peaks and the amount of food eaten ($P > 0.10$, t -test for significant slope), the probability of a peak in oxygen consumption occurring after feeding was much higher than the probability of a peak occurring in a set of three sequential measurements not separated by a meal ($P < 0.005$, $\times 2$ test on a 2×2 contingency table). It is likely that measurements made over a longer period of time, or at a different point in the time course of the change in respiration rate, would have revealed a correlation between the magnitude of the peak in respiration rate and the amount of food eaten, since there is a significant positive correlation between the increases in rates of respiration and ammonia excretion (Fig. 5). The least-

squares linear regression of the increase in oxygen consumption (R , in micromoles O_2/h) on the increase in ammonia excretion (E , in micromoles NH_3/h) is $R = 1.396 + 1.027E$ ($r = 0.74$, $n = 20$).

DISCUSSION

The data obtained for individuals starved for 35 days indicate that the respiration rates of previously well-fed individuals are stable for several weeks of food deprivation before beginning to decrease. This suggests that activity levels of animals which have fed frequently prior to food deprivation may also be maintained during this period. A similar transient "plateau" in respiration rate, followed by a rate decrease, has previously been observed for two benthic, shallow water crustacean species during starvation (Wallace, 1973; Regnault, 1981). The stable mean respiration rate of the $1\times/mo$ animals suggests that the respiration rates of the $6\times/mo$ individuals would have stabilized at a lower level.

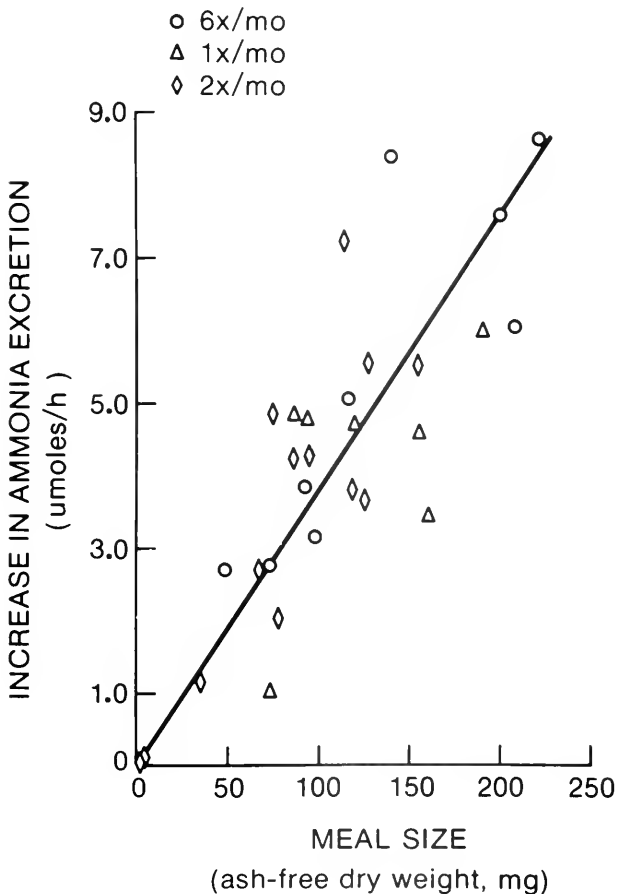

FIGURE 4. Postfeeding increase in ammonia excretion rate as a function of meal size. Shrimp were used for all meals. The increase in excretion rate is the difference between the rate measured 12 hours after feeding and the average of the rates measured before and 3–4 days after feeding. The regression is constrained to pass through the origin. $y = 0.038x$.

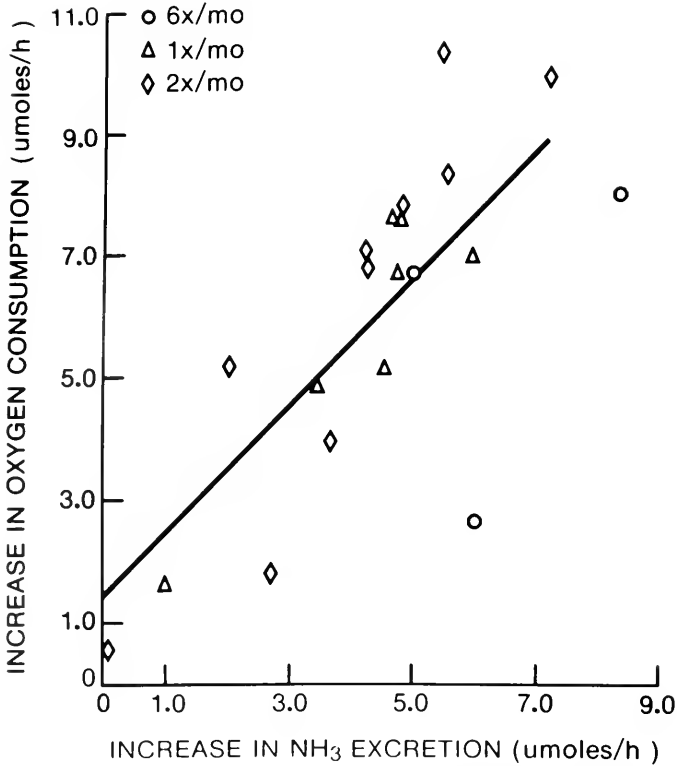

FIGURE 5. Postfeeding increase in oxygen consumption rate as a function of the postfeeding increase in ammonia excretion rate. The increase in each rate is the difference between the rate measured 12 hours after feeding and the average of the rates measured before and 3-4 days after feeding. $y = 1.40 + 1.03x$ ($r = 0.74$).

The mean O:N ratios of the 6x/mo (1st series) individuals suggest that, when first deprived of food, previously well-fed individuals of *G. ingens* metabolize a large proportion of protein or other nitrogen-containing compounds relative to lipids and carbohydrates. The increase in the mean O:N ratios of starved individuals, which was also observed by Quetin *et al.* (1980), indicates that more lipid and/or carbohydrate is oxidized by the animals as the length of time without food increases. Lipids are probably a more important energy source for *G. ingens* during starvation than are carbohydrates since lipid typically comprises about 45%, and carbohydrate only about 0.6%, of the ash-free dry weight of an individual (Childress and Nygaard, 1974).

The responses of *G. ingens* to starvation are not unusual. Rates of respiration (Wallace, 1973; Mayzaud, 1976; Regnault, 1981) and ammonia excretion (Mayzaud, 1976) of a number of shallow water benthic and epipelagic crustacean species also decrease during starvation. This is not surprising since reduced energy expenditures are potentially advantageous during a prolonged period without food. Many invertebrate species appear to rely primarily on large lipid and/or carbohydrate reserves during starvation (Conover, 1964; Chaisemartin, 1971), while some species metabolize protein concurrently with lipid, as *G. ingens* appears to do (Schafer, 1968; Chaisemartin, 1971; Ikeda, 1971). A few species soon rely primarily on protein

metabolism when their smaller lipid and carbohydrate reserves have been exhausted (Covey and Corner, 1963; Regnault, 1981).

Two factors suggest that *G. ingens* is better able to survive prolonged periods without food than are many shallow water species. The metabolic rates even of freshly-captured individuals of *G. ingens* and of other midwater animals are lower than those of shallower-dwelling marine animals (Childress 1971a, 1975), and the lipid content of *G. ingens* and of many midwater crustaceans is higher than that of many species living in shallower water (Childress and Nygaard, 1974). Considered together, the high lipid content, low metabolic rate, and similarity in response of individuals of *G. ingens* to starvation regardless of feeding history suggest that *G. ingens* and perhaps other midwater crustaceans are able to survive relatively long periods of food deprivation. This capability may be essential in a food-poor or patchy environment.

The similarities in the responses to starvation by all four groups of individuals suggest that the responses of field individuals to artificially imposed starvation will be similar in all seasons, and that the responses of individuals fed and starved in the laboratory are similar to the responses of field individuals confronted with natural variations in food availability.

The elevation in respiration rate after an animal has ceased feeding has been referred to as the "specific dynamic action," "calorigenic effect," and "heat increment" of food. Although protein ingestion appears to produce a greater increase in respiration rate than does ingestion of lipid or carbohydrate, the effect of each varies with the total composition of the food (Forbes and Swift, 1944). The importance of postfeeding increases in oxygen consumption to a valid estimation of a species' energy budget depends on the magnitude of the increases, which, for *G. ingens*, depends on meal size and feeding frequency. An estimate of the potential energetic importance of these peaks to *G. ingens* may be obtained by combining data on the probable average daily caloric intake by an individual with data on the caloric content of the ridgeback shrimp on which *G. ingens* was fed (0.515 cal/mg AFDW; Childress, unpublished data). Hiller-Adams (1982) has estimated that a 2.8 g instar 7 individual of *G. ingens* requires about 32 calories/day for growth and metabolism. This is equivalent to 156 mg AFDW of ridgeback shrimp every 60 hours. [The data on which the caloric requirement is based were obtained using individuals in instar 7; 2.8 grams is the mean weight of individuals in this instar (Childress and Price, 1978).] This would produce an ammonia peak of 5.9 micromoles/h (Fig. 4) and an increase in respiration of 7.5 micromoles O₂/h (Fig. 5). Since the height of the postfeeding peak was calculated as the difference between the 12-hour postfeeding rate and the average of the prefeeding and 60-hour (or 84-hour) postfeeding rates, we assume that the additional oxygen respired may be approximated by the area of the triangle bounded by the peak and the average of the prefeeding and postfeeding rates. The "base" of the triangle is then 60 hours long, and the area is (30 hours) × (peak height, in micromoles O₂/h), or in this case, 225.3 micromoles O₂. If one assumes that a mmole of oxygen consumed represents an energy expenditure of 103.7 calories (Brett and Groves, 1979), 23.4 calories are expended in the postfeeding increase in respiration. This represents 29% of the calories ingested, and an 85% increase in the estimated average respiration rate of 4.4 micromoles O₂/h for an animal of this size. (The average respiration rate is calculated from the empirical relationship between size and respiration rate in Childress, 1971b). Since the protein content of fish and crustaceans which live in shallower water (and the shrimp on which *G. ingens* were fed in the laboratory) tends to be higher than that of pelagic midwater species (Childress and Nygaard, 1937, 1974), and since protein may cause

a relatively large portion of the postfeeding increases, we expect that the increases which occur in nature are somewhat smaller than those we have measured in the laboratory.

The percent increase in respiration which we have observed appears to be considerably larger than the 17–37% increase reported for juvenile lobsters (Capuzzo and Lancaster, 1979), and the 7–40% increase reported for juvenile *Macrobrachium rosenbergii* (Nelson *et al.*, 1977). The two species were fed several diets which differed in composition. These are the only other crustaceans of which we are aware for which quantitative data have been published. However, we determined the duration of the postfeeding increases. This was not determined in the previous two studies (postfeeding measurements were made within 24 hours of feeding), and might well affect estimates of the energetic importance of the postfeeding increases. Additionally, the percent increase for *G. ingens* is calculated relative to a postdigestive metabolic rate which is quite low relative to that of other crustaceans (Childress, 1971a). Among fish, "specific dynamic activity" accounted for 4–45% of the energy ingested by young coho salmon (Averett, quoted by Warren, 1971), $14 \pm 4\%$ (mean \pm standard deviation) for largemouth bass (Beamish, 1974), and 5–24% for bluegill sunfish (Pierce and Wissing, 1974).

Data regarding the magnitude of the postfeeding increase in oxygen consumption by animals have often been expressed as a percent of the postdigestive metabolic rate in determining correlations with other parameters. However, since the increase in respiration is due to the food eaten by the animal it is not dependent on, and so should not be expressed (as many workers have) as a function of an animal's postdigestive metabolic rate in determining correlations. In addition, the data are more useful expressed as increases in the absolute amount of oxygen consumed, as we have done, rather than as a percent of postdigestive metabolic rate since the usual size-dependency of metabolic rates (larger animals tend to respire at a lower weight-specific rate) prevents the extrapolation of percent data to animals and meals of other sizes.

It should also be noted that our data indicate that metabolic measurements made within a day or two after feeding may not represent postdigestive rates, as has often been assumed for other species. Up to a week may be required before *G. ingens* achieves predigestive rates after having fed. Other investigators, working with teleosts (Beamish, 1974, Pierce and Wissing, 1974) have also found that several days may be required before animals are postdigestive.

The transient increase in ammonia excretion rates of recently fed individuals suggests that a significant portion of the amino acids in protein assimilated by *G. ingens* is rapidly deaminated. If one assumes that (1) 75% of the AFDW of the shrimp food is protein (Childress and Price, unpublished data), (2) the protein is 16% nitrogen by weight (Kleiber, 1961), and (3) the total quantity of ammonia excreted as a result of feeding is the area of the triangle bounded by the postfeeding peak and the average of the prefeeding and 60-hour postfeeding rates, then *G. ingens* deaminated about 11% of the shrimp protein ingested within 60 hours of feeding. The remainder of the ingested protein apparently is incorporated into the animal's body.

The pronounced increases in respiration and excretion by *G. ingens* after feeding indicate that average respiration and excretion rates of individuals in the midwater environment depend strongly on ingestion. Post-digestive respiration and excretion rates may considerably underestimate average field rates of a species when food intake in the ocean is high.

In summary, *G. ingens* appears to rely largely on protein or other nitrogen-containing compounds when first deprived of food. Lipid reserves become more important to previously well-fed individuals after about three weeks without food. Respiration and excretion rates begin to decrease at this time. The stability of the respiration rate of 1X/mo individuals suggests that respiration stabilizes at a lower level. Transient postfeeding increases in respiration and excretion indicate that measurements of respiration and excretion rates using postdigestive animals underestimate the average rates in nature by an amount directly proportional to food intake. The energy expended in increased respiration is not negligible: about 29% of the caloric value of the ingested laboratory ration may be expended in postfeeding increases in respiration by an instar 7 individual.

ACKNOWLEDGMENTS

The smooth operation of the RV *Velero IV* by its captain and crew facilitated capture of the animals. The research was made possible by grants OCE 78-08933 and OCE 81-10154 to Dr. J. J. Childress.

LITERATURE CITED

- BEAMISH, F. W. H. 1974. Apparent specific dynamic action of largemouth bass, *Micropterus salmoides*. *J. Fish. Res. Board Can.* **31**: 1763-1769.
- BRETT, J. R., AND T. D. D. GROVES. 1979. Physiological energetics. Pp. 279-351 in *Fish Physiology, Vol. VIII*, W. S. Hoar and D. J. Randall, eds. Academic Press, New York.
- CAPUZZO, J. M., AND B. A. LANCASTER. 1979. The effects of dietary carbohydrate levels on protein utilization in the American lobster. *Proc. World Maricul. Soc.* **10**: 689-700.
- CHAISEMARTIN, C. 1971. Mobilisation des reserves de metabolites chez les Astacidae: influences comparees de la stabulation a jeun et de certains etats pathologiques. *C. R. Soc. Biol. Paris* **165**: 671-676.
- CHILDRESS, J. J. 1971a. Respiratory rate and depth of occurrence of midwater animals. *Limnol. Oceanogr.* **16**: 104-106.
- CHILDRESS, J. J. 1971b. Respiratory adaptations to the oxygen minimum layer in the bathypelagic mysid *Gnathopausia ingens*. *Biol. Bull.* **141**: 109-121.
- CHILDRESS, J. J. 1975. The respiratory rates of midwater crustaceans as a function of depth of occurrence and relation to the oxygen minimum layer off southern California. *Comp. Biochem. Physiol.* **50A**: 787-799.
- CHILDRESS, J. J., AND M. H. NYGAARD. 1973. The chemical composition of midwater fishes as a function of depth of occurrence off southern California. *Deep-Sea Res.* **20**: 1093-1109.
- CHILDRESS, J. J., AND M. H. NYGAARD. 1974. Chemical composition and buoyancy of midwater crustaceans as a function of depth of occurrence off southern California. *Mar. Biol.* **27**: 225-238.
- CHILDRESS, J. J., AND M. H. PRICE. 1978. Growth rate of the bathypelagic crustacean *Gnathopausia ingens* (Mysidacea: Lophogastridae). I. Dimensional growth and population structure. *Mar. Biol.* **50**: 47-62.
- CHILDRESS, J. J., A. T. BARNES, L. B. QUETIN, AND B. ROBISON. 1978. Thermally protecting cod ends for the recovery of living deep-sea animals. *Deep-Sea Res.* **25**: 419-422.
- CHILDRESS, J. J., S. M. TAYLOR, G. M. CAILLIET, AND M. H. PRICE. 1980. Patterns of growth, energy utilization and reproduction in some meso- and bathypelagic fishes of southern California. *Mar. Biol.* **61**: 27-40.
- CONOVER, R. J. 1964. Food relations and nutrition of zooplankton. *Occ. Publ., Narragansett mar. lab* **2**: 81-91.
- COWEY, C. B., AND E. D. S. CORNER. 1963. Amino acids and some other nitrogenous compounds in *Calanus finmarchicus*. *J. Mar. Biol. Assoc. U. K.* **43**: 483-493.
- FERGUSON, J. C. 1982. A comparative study of the net metabolic benefits derived from the uptake and release of free amino acids by marine invertebrates. *Biol. Bull.* **162**: 1-17.

- FORBES, E. B., AND R. W. SWIFT. 1944. Associative dynamic effects of protein, carbohydrate and fat. *J. Nutr.* **27**: 453-468.
- HILLER-ADAMS, P. 1982. Effects of feeding and food deprivation on the bathypelagic mysid *Gnathophausia ingens*. PhD dissertation, University of California, Santa Barbara.
- IKEDA, T. 1971. Changes in respiration rate and in composition of organic matter in *Calanus cristatus* (Crustacea Copepoda) under starvation. *Bull. Fac. Fish. Hokkaido Univ.* **21**: 280-298.
- KLEIBER, M. 1961. *The Fire of Life*. John Wiley and Sons, New York. 454 pp.
- MAYZAUD, P. 1976. Respiration and nitrogen excretion of zooplankton. IV. The influence of starvation on the metabolism and the biochemical composition of some species. *Mar. Biol.* **37**: 47-58.
- MEEK, R. P., AND J. J. CHILDRESS. 1973. Respiration and the effect of pressure in the mesopelagic fish *Anoplogaster cornutus* (Beryciformes). *Deep-Sea Res.* **20**: 1111-1118.
- MICKEL, T. J., AND J. J. CHILDRESS. 1978. The effect of pH on oxygen consumption and activity in the bathypelagic mysid *Gnathophausia ingens*. *Biol. Bull.* **154**: 138-147.
- MICKEL, T. J., AND J. J. CHILDRESS. 1982. Effect of pressure and pressure acclimation on activity and oxygen consumption in the bathypelagic mysid *Gnathophausia ingens*. *Deep-Sea Res.* **29**: 1293-1301.
- NELSON, S. G., A. W. KNIGHT, AND H. W. LI. 1977. The metabolic cost of food utilization and ammonia production by juvenile *Maerobrachium rosenbergii* (Crustacea: Palaemonidae). *Comp. Biochem. Physiol.* **57A**: 67-72.
- PIERCE, R. J., AND T. E. WISSING. 1974. Energetic cost of food utilization in the bluegill (*Lepomis macrochirus*). *Trans. Am. Fish. Soc.* **103**: 38-45.
- QUETIN, L. B., T. J. MICKEL, AND J. J. CHILDRESS. 1978. A method of simultaneously measuring the oxygen consumption and activity of pelagic crustaceans. *Comp. Biochem. Physiol.* **59A**: 263-266.
- QUETIN, L. B., AND J. J. CHILDRESS. 1980. Observation on the swimming activity of two bathypelagic mysid species maintained at high hydrostatic pressures. *Deep-Sea Res.* **27A**: 383-391.
- QUETIN, L. B., R. M. ROSS, AND K. UCHIO. 1980. Metabolic characteristics of midwater zooplankton: ammonia excretion O:N ratios, and the effect of starvation. *Mar. Biol.* **59**: 201-209.
- REGNAULT, M. 1981. Respiration and ammonia excretion of the shrimp *Crangon crangon* L.: metabolic response to prolonged starvation. *J. Comp. Physiol.* **141**: 549-555.
- SCHAFFER, H. J. 1968. Storage materials utilized by starved pink shrimp, *Penaeus duorarum* Burkenroad. *Proc. World Sci. Conf. Biol. Cult. Shrimps. FAO Fish. Rep.* **57**: 393-403.
- STEPHENS, G. C. 1972. Amino acid accumulation and assimilation in marine organisms. Pp. 155-184 in *Nitrogen Metabolism and the Environment*, J. W. Campbell and L. Goldstein, eds. Academic Press, New York.
- STEPHENS, G. C., AND R. A. SCHINSKE. 1961. Uptake of amino acids by marine invertebrates. *Limnol. Oceanog.* **6**: 175-181.
- SMITH, K. L., AND R. R. HESSLER. 1974. Respiration of benthopelagic fishes: *in situ* measurements at 1230 meters. *Science* **184**: 72-73.
- STRICKLAND, J. D. H., AND T. R. PARSONS. 1972. A practical handbook of seawater analysis. *Fish. Res. Board Can. Bull.* **167**: 310 pp.
- TORRES, J. J., B. W. BELMAN, AND J. J. CHILDRESS. 1979. Oxygen consumption rates of midwater fishes as a function of depth of occurrence. *Deep-Sea Res.* **26**: 185-197.
- WALLACE, J. C. 1973. Feeding starvation and metabolic rate in the shore crab *Carcinus meanas*. *Mar. Biol.* **20**: 277-281.
- WARREN, C. E. 1971. *Biology and Water Pollution Control*. W. B. Saunders, Philadelphia. 434 pp.

GRAZING AND PREDATION AS RELATED TO ENERGY
NEEDS OF STAGE I ZOEAE OF THE TANNER CRAB
CHIONOECETES BAIRDI (BRACHYURA, MAJIDAE)*

LEWIS S. INCZE^{1,**} AND A. J. PAUL²

¹*School of Fisheries WH-10, College of Ocean and Fishery Sciences, University of Washington, Seattle, Washington 98195, and* ²*Institute of Marine Science, University of Alaska, Seward Marine Center, Seward, Alaska 99664*

ABSTRACT

The ability of first-feeding stage I zoea larvae of *Chionoecetes bairdi* to obtain energy from phytoplankton was investigated using a range of phytoplankton cell sizes and cell densities. An early first stage zoea requires approximately 6.8×10^{-3} calories or $0.60 \mu\text{g}$ carbon (approximately 4% body C) per day for metabolic needs at 5°C. Experiments with dinoflagellates and large centric diatoms demonstrated that the larvae are capable of capturing and ingesting these cells. However, the zoeae grazed at rates which satisfied less than 15% of basal metabolic energy requirements at cell concentrations similar to those prevailing in coastal and shelf sea environments where the crabs are found. Grazing on smaller cells, including chain-forming species common in nature, was not detected. In the laboratory, first-feeding zoeae were capable of consuming zooplankton prey at rates which provided up to 308% of basal metabolic requirements.

INTRODUCTION

Laboratory studies have demonstrated that availability and nutritional adequacy of food are among the most important factors affecting survival of crab larvae (Roberts, 1974; Sulkin, 1975, 1978; Sulkin and Epifanio, 1975; Christiansen and Yang, 1976; Sulkin and Norman, 1976; Anger and Nair, 1979). Generally, laboratory diets consisting primarily of zooplankton have provided the highest survival rates (Brick, 1974; Roberts, 1974; Sulkin, 1975, 1978; Bigford, 1978). There is a high degree of morphological similarity of the feeding appendages of crab larvae and numerous reports of their attacking single zooplankton prey (Sato and Tanaka, 1949; Knudsen, 1960; Herrnkind, 1968; Gonor and Gonor, 1973). This evidence has led to the widely held belief that phytoplankton is of limited dietary importance. However, there is evidence that phytoplankton may be a common component of the diet of some larvae in nature (e.g., LeBour, 1922, 1927). Laboratory studies with the larvae of a brachyuran crab (Hartman and Letterman, 1978) and a pandalid shrimp (Stickney and Perkins, 1981) indicated that phytoplankton diets can significantly prolong the life of these larvae compared to unfed control animals, even though both larvae showed markedly better survival on zooplankton diets. Both studies noted that specimens collected at sea contained phytoplankton in the stomachs. Roberts (1974) and Sulkin (1975) reported that the larvae of crabs used in their experiments (an anomuran and brachyuran crab, respectively) consumed phy-

Received 21 January 1983; accepted 25 May 1983.

* Contribution No. 618 of the School of Fisheries, University of Washington and No. 523 of the Institute of Marine Science, University of Alaska.

** Present address: National Marine Fisheries Service, 2725 Montlake Blvd. East, Seattle, WA 98112.

toplankton in laboratory studies and that this prolonged survival slightly compared to unfed zoeae. In contrast, Atkins (1955) and Bousquette (1980) were able to rear the larvae of pinnotherid (brachyuran) crabs through all zoeal stages to the megalops stage with phytoplankton alone, but the authors did not specify survival times of unfed controls. Despite the large body of evidence that zooplankton are the primary prey for larvae of most species of crab, it appears that a functional role for phytoplankton cannot be ruled out for all species.

In the genus *Chionoecetes*, both zoeal stages of *C. opilio* have been successfully cultured when fed the nauplii of *Artemia* sp. alone (Motoh, 1973) and combined with rotifers, *Brachionus plicatilis* (Kon, 1970, 1979). Using natural prey, Paul *et al.* (1979) reported that stage I zoeae of *C. bairdi* can consistently capture copepods, copepodids, and copepod nauplii when these prey are offered at densities of 20–40 per liter. However, the requirement of prey concentrations above 20 per liter for consistent prey capture suggested that there may be times when zooplankton prey are not present in sufficient numbers to ensure successful feeding by the zoeae.

An alternate, or supplementary, food source might be phytoplankton, which are more abundant than zooplankton and are perhaps more easily captured. Bright (1967) reported that the principal stomach contents of Tanner crab zoeae collected from Cook Inlet, Alaska, were unidentified diatoms; little zooplankton material was reported. In the southeastern Bering Sea, thecate dinoflagellates were found along with parts of copepods, pteropods, tintinnids, and other zooplankters in the stomachs of stage I and stage II zoeae of *Chionoecetes* spp. (K. O. Coyle, Univ. of Alaska, pers. comm.). Examining specimens from the same region in later years. Incze and Armstrong (unpubl. observations) found little evidence of zooplankton in the stomachs of stage I and stage II zoeae, but frequently found solitary and chain-forming centric diatoms. Although these observations suggest that phytoplankton may be an important component in the diet of these zoeae, the relative value of this material to these larvae is unknown.

Currently, there exists little information on relationships between type and availability of prey and feeding success of crab zoeae in the ocean. Consequently, we know little about this major determinant of larval survival. The objective of this study is to evaluate the relative value of phytoplankton in supplying the energy (calories) or material (carbon) needed for maintenance metabolism and growth of the first feeding stage I zoeae of *C. bairdi* (for a description of this stage, refer to Haynes, 1973). First-feeding zoeae were used because they (1) are unaffected by previous feeding experience and (2) co-occur with the spring phytoplankton bloom which precedes development of the zooplankton community in Alaskan waters.

MATERIALS AND METHODS

Several egg-bearing female crabs captured near Kodiak, Alaska, were held in circulating sea water tanks at 4–5°C. Zoeae hatched continually and tanks were drained each day before an experiment so that only freshly hatched, actively swimming zoeae were used. All respiration and feeding experiments were conducted at 5°C. Stage I zoeae normally encounter temperatures of 4 to 6°C in Alaskan waters.

Respiration rates of 12-hour old stage I zoeae were measured in a glass differential syringe manometer (Umbreit *et al.*, 1972). The 15 ml respirometer vessel held 4 to 6 unfed zoeae, 6.0 ml of 1.0 μm filtered sea water, and 0.1 ml 20% KOH to absorb CO₂. The active zoeae were acclimated to vessel temperature for one hour before the manometers were sealed. Observations of oxygen uptake were made after a minimum of five hours. Shaking of the respirometers was restricted to the last 10 minutes of the final observation. There were eight replications for respiration rate

(VO₂) measurement. Oven dried weights (60°C) of the zoeae from each observation of VO₂ were determined with an electrobalance. Values of VO₂ were converted to calories using the conversion $4.73 \times 10^{-3} \text{ cal} \cdot \mu\text{l O}_2^{-1}$ (Brody, 1945). Carbon equivalents of VO₂ were calculated using a respiratory quotient (RQ) of 0.90 for phytoplankton prey and 0.75 for zooplankton prey and unfed zoeae. Values of RQ (Giese, 1973) were assigned based on the approximate proportion of carbohydrate, lipid and protein in phytoplankton (Parsons *et al.*, 1961) compared to zooplankton (Corner and Cowey, 1968) and *Chionoecetes* spp. zoeae (Incze, 1983). Adjusting RQ values to account for the possible range of substrate proportions in phytoplankton and in zooplankton produces minor changes in the estimated carbon equivalents of VO₂.

Ingestion rates of one day old zoeae were measured using animal and plant prey in several ways. Rates of ingestion of newly hatched *Artemia* sp. nauplii (San Francisco Bay variety) by one day old zoeae were determined by placing 50 nauplii in 500 ml of 1 μm filtered sea water in a lightly aerated 550 ml black plastic beaker containing five zoeae. The zoeae were allowed to feed for 24 hours in a 12 hour light, 300 lux:12 hour dark cycle at 5°C. Three hundred lux was approximately 2% of light intensity at sea surface during the experiments. Nauplii remaining after 24 hours were counted under a microscope. Forty replicate prey consumption measurements were made. A caloric value of 8.7×10^{-3} cal (calculated from data of Levine and Sulkin, 1979) and a carbon value of 1.2 $\mu\text{g C}$ (present study) per nauplius were used to estimate the value of the ingested ration. Carbon was measured on a Perkin-Elmer Model 240 elemental analyzer. Six beakers containing only nauplii were used to demonstrate that all prey were recovered during subsequent recounts. An assimilation efficiency of 0.70 (Conover, 1966) was assumed.

Rates of ingestion of various phytoplankton cells by one day old zoeae were investigated by (1) comparing chlorophyll concentrations in initial, grazed, and control containers using cultured algae, and (2) counting cells in initial, grazed, and control containers for selected algal species. Phytoplankton cells representative of the shape and size of those found in the planktonic environment and stomachs of *C. bairdi* zoeae were used. Mono-specific cultures of *Phaeodactylum tricorutum*, *Chaetoceros compressus*, *Gonyaulax grindleyi* (*Prorocentrum reticulatum*), and an unidentified thecate dinoflagellate (referred to here as F16) were among the algae used. Grazing experiments were also conducted with large centric diatoms (*Coscinodiscus* spp. and *Thalassiosira* spp.) removed from plankton samples collected with a vertical tow using a 44 μm mesh net. All experiments were conducted at 5°C in a 12 hour light, 300 lux:12 hour dark cycle. Experimental containers were placed on a slowly rotating wheel. The size and shape of phytoplankton cells used in these experiments are provided in Table I.

Different container sizes were used for cultured versus sorted, natural phytoplankton. Grazing experiments and controls using the cultured algae were conducted in 250 ml translucent polyethylene bottles. Approximately 100 zoeae were placed in each bottle; accurate counts of zoeae were made at the end of each experiment. Four algal food concentrations corresponding to chlorophyll concentrations of approximately 2, 10, 50, and 100 $\mu\text{g chl a}$ per liter were used. Replicates of all experimental conditions were run. Gut fluorescence of zoeae and chlorophyll concentrations of initial, grazed and control media were measured using a Turner Model 111 fluorometer, media sample volumes up to 200 ml, and extraction volumes of 10 ml (Strickland and Parsons, 1968).

From a separate series of cell count experiments with *G. grindleyi* cultures, cell count samples (40–60 ml) were preserved from initial, experimental and control vessels with 0.2 ml Lugol's solution. Cells were counted using a settling chamber

TABLE I

Approximate size and shape of phytoplankton cells used in grazing experiments with the first zoeae of Chionoecetes bairdi

<i>Phaeodactylum tricorutum</i>	pennate, $7 \times 21 \mu\text{m}$
<i>Chaetoceros compressus</i>	individual centric cells, $10 \mu\text{m}$ diameter; average chain length, 8–11 cells, $90\text{--}120 \mu\text{m}$; average chain width (with spines), $90 \mu\text{m}$.
dinoflagellate F16	$10 \times 15 \mu\text{m}$
<i>Gonyaulax grindleyi</i>	$35\text{--}45 \mu\text{m}$, roughly symmetrical but irregularly shaped
<i>Conscinodiscus</i> spp.	centric, $71 \mu\text{m}$ (height) \times $222 \mu\text{m}$ (diameter)
<i>Thalassiosira</i> spp.	centric, $100 \mu\text{m}$ (height) \times $168 \mu\text{m}$ (diameter)

and an inverted microscope (Utermohl, 1958). A minimum of 400 cells was counted for each estimate of cell density (Lund *et al.*, 1958) and three to four replicate counts were made of each sample (initial, control, and experimental) at the highest and lowest cell densities. To determine carbon content of phytoplankton cells, samples of culture were collected with a $500 \mu\text{l}$ Oxford pipette and dispensed in a carefully measured volume of filtered sea water for cell counts and on pre-combusted Gelman Type A/E glass fiber filters for CHN analysis. Carbon content of the cells was measured using a Perkin-Elmer Model 240 elemental analyzer.

Grazing experiments and controls using *Coscinodiscus* and *Thalassiosira* cells removed from natural phytoplankton were conducted in 60 ml translucent plastic bottles containing five zoeae each. Cells were individually counted before and after a 24 hour feeding period. Cell carbon content was estimated from cell volume according to the method of Strathmann (1967).

Average cell concentrations during each experiment were calculated according to the method prescribed by Frost (1972) which assumes that the number of cells during an experiment changes at a constant exponential rate. The equation corrects for the growth of phytoplankton measured in control containers. All relationships between ingestion and cell concentration were calculated using the average cell concentration value. The functional response of zoeae grazing on dinoflagellates at various cell densities was plotted using the Holling "disc" equation (Holling, 1959) which treats each capture of a food particle as an independent event.

Carnivorous feeding activity of zoeae on *Artemia* sp. nauplii was compared in the presence and absence of a natural spring bloom phytoplankton assemblage collected in Resurrection Bay, Alaska. A 10 liter Niskin bottle, cast at approximately 1 m depth, was used to collect the phytoplankton. A sample from the bottle was concentrated by pouring the sea water through a $40 \mu\text{m}$ mesh sieve resting in an over-flow vessel. All conspicuous zooplankton and most conspicuous micro-zooplankton were removed from this sample under a microscope. The remaining phytoplankton was diluted with filtered sea water to return the sample to its original volume for use in feeding observations. Two subsamples were examined to obtain the initial phytoplankton concentration (Lund *et al.*, 1958). Large solitary cells and long chain-forming species were retained at approximately their original concentrations by the procedure; these are the cell types seen in the stomachs of zoeae from plankton collections. The assemblage contained *Chaetoceros* spp. chains at approximately 5.5×10^4 cells l^{-1} and large centric diatoms at approximately 1.2×10^1 l^{-1} . Four groups of five zoeae each were placed in 250 ml vessels containing the following

prey assemblages: 60 nauplii l⁻¹, 96 nauplii l⁻¹, 60 nauplii l⁻¹ and bay phytoplankton, and 96 nauplii l⁻¹ and bay phytoplankton. There were 10 replicates for each prey assemblage. At the end of the experiments, surviving nauplii were counted and zoea stomachs were examined under a microscope for phytoplankton cells.

RESULTS

Oxygen consumption rates (VO₂) of one day old stage I *C. bairdi* zoeae averaged 1.3 μl O₂ · mg dry wt⁻¹ h⁻¹ at 5°C (Table II). The average dry weight of an individual zoea within 24 hours of hatching was 47.8 ± 7.6 μg, so the corresponding value of VO₂ was 0.06 μl O₂ zoea⁻¹ h⁻¹. The energy required for respiratory metabolism (R) of first feeding zoeae at this temperature was estimated to be 6.8 × 10⁻³ cal zoea⁻¹ d⁻¹. Carbon equivalents of respiration were 0.59 and 0.71 μg C zoea⁻¹ d⁻¹ using respiratory quotients (RQ) of 0.75 and 0.90, respectively. Stage I zoeae were approximately 33% C (based on dry weight); therefore, respiratory energy needs ranged from 3.7 to 4.5% body C zoea⁻¹ d⁻¹.

The average daily feeding rate of one day old zoeae was one *Artemia* nauplius per zoea (range: 0.2 to 2.2) at 5°C when prey were offered at initial densities of 100 per liter (Table II). The average assimilated carbon values of prey consumed in individual experiments ranged from 28 to 308 percent of the mean respiratory energy needs of each zoea.

The Student *t*-test comparing predation rates in the presence and absence of phytoplankton showed no significant differences (*P* < 0.05) in the number of nauplii consumed in the two groups. At 60 prey per liter, the average daily consumption rates per zoea were 1.0 ± 0.5 and 0.9 ± 0.4 nauplii in the presence and absence of phytoplankton, respectively. Corresponding values at 96 prey per liter were 1.4 ± 0.5 and 1.0 ± 0.2 nauplii zoea⁻¹ d⁻¹. No phytoplankton cells were found in the stomachs of the zoeae at the end of the experiment.

Chlorophyll *a* measurements (μg liter⁻¹) of replicate initial, control and experimental grazing bottles showed no detectable difference for *P. tricornerutum*, *C. compressus*, or F16 experiments at any of the chlorophyll concentrations employed. Likewise, no discernible difference in gut fluorescence between fed and unfed zoeae was found in any of the above experiments. A slight decrease was found in some of the grazed bottles of *G. grindleyi* cells, and some measurements of gut fluorescence of zoeae from these experiments showed higher levels in fed than unfed animals. However, all measurements were at the limits of sensitivity of the methods and, when the experiments were repeated, results were not consistent between trials or between replicates.

Data from the cell count experiments with *G. grindleyi*, *Coscinodiscus* spp. and *Thalassiosira* spp. are summarized in Table III, along with a comparison of ingested ration (carbon) and respiratory requirements of the zoeae. No phytoplankton growth was observed in control vessels. Over the range of cell concentrations used, zoeae obtained an average of 1.4 to 14% of their respiratory energy requirements from phytoplankton. The relationship between ingestion (grazing) rate of zoeae and average cell concentration is shown in Figure 1 for dinoflagellates and Figure 2 for large centric diatoms. The functional response of zoeal ingestion rate to increases in dinoflagellate abundance demonstrated a leveling at cell concentrations above 8.0 × 10⁴ l⁻¹ (Fig. 1).

The coefficient of variation of replicate cell counts of samples from the *G. grindleyi* experiments was less than 9% at the lowest cell densities used and less than 5% at the highest. No subsampling variability was associated with the *Coscinodiscus*

TABLE II
 Oxygen consumption (VO_2), respiratory requirement (R) and ingested ration (I) of 24 hour old zoeae preying on nauplii of *Artemia* sp. at 5°C. Percent contribution of ingested ration to metabolic requirement (%R) is estimated

	VO_2		Dry wt. ($\mu\text{g zoea}^{-1}$)	$R(\text{zoea}^{-1} \text{d}^{-1})$		$I(\text{zoea}^{-1} \text{d}^{-1})$		%R ¹		
	$\mu\text{l} \cdot \text{mg dry wt}^{-1} \text{h}^{-1}$	$\mu\text{l} \cdot \text{zoea}^{-1} \text{h}^{-1}$		$\text{cal} \times 10^{-3}$	$\mu\text{g C}$	No. nauplii	$\text{cal} \times 10^{-3}$	$\mu\text{g C}$	cal	C
\bar{X}	1.3	0.06	47.8	6.8	0.60	1.0	8.7	1.2	89	140
sd	0.3	0.01	7.6	1.1	0.13	0.9	7.8	1.1	80	128
Range	1.06-1.89	0.05-0.07	38.0-56.0	5.7-7.9	.48-.87	0.2-2.2	1.7-19.0	0.24-2.64	18-196	28-308

¹ Calculation is based on the mean respiratory requirement and assumes an assimilation efficiency of 0.70.

TABLE III

Ingestion rate (I) of 24 hour old zoeae grazing on phytoplankton (*Gonyaulax grindleyi*, *Coscinodiscus* spp., *Thalassiosira* spp.) at various cell concentrations ($\langle C \rangle$) at 5°C, and percent contribution to respiratory requirement (%R)

Cell type	Carbon ($\mu\text{g cell}^{-1}$)	$\langle C \rangle$ (cells l^{-1})	I (zoea $^{-1}$ d $^{-1}$)		%R ¹
			No. cells	$\mu\text{g C}$	
<i>G. grindleyi</i>	2.9×10^{-3}	7.3×10^3	4.3	1.2×10^{-2}	1.4
		3.1×10^4	19.0	5.0×10^{-2}	5.8
		6.5×10^4	33.6	9.7×10^{-2}	11.3
		1.2×10^5	39.9	1.2×10^{-1}	14.0
<i>Coscinodiscus</i> spp.	2.66×10	7.8×10^2	2.6	6.8×10^{-2}	7.9
		8.40×10^2	2.9	7.6×10^{-2}	8.9
		8.80×10^2	2.7	7.0×10^{-2}	8.2
		9.40×10^2	2.4	6.3×10^{-2}	7.4
		9.83×10^2	2.3	6.0×10^{-2}	7.0
		9.83×10^2	2.3	6.0×10^{-2}	7.0
		1.68×10^3	2.2	5.7×10^{-2}	6.6
		1.68×10^3	2.5	6.6×10^{-2}	7.7
<i>Thalassiosira</i> spp.	2.30×10	6.26×10^2	1.5	3.6×10^{-2}	4.2
		1.66×10^3	2.7	6.4×10^{-2}	7.5

¹ Calculation is based on a mean respiratory requirement of 0.6 $\mu\text{g C zoea}^{-1} \text{d}^{-1}$ (from Table II), an RQ of 0.9 and an assimilation efficiency of 0.70.

or *Thalassiosira* experiments since all cells were individually added to, and removed from, the experimental and control vessels and counts were double-checked.

DISCUSSION

Respiration rates measured at 5°C in this study are lower than those reported for many decapod larvae that inhabit warmer environments (see Mootz and Epifanio, 1974; Schatzlein and Costlow, 1978; Levine and Sulkin, 1979). However, the hourly weight-specific rates for stage I *C. bairdi* zoeae ($\bar{X} = 1.3 \mu\text{l O}_2 \cdot \text{mg dry wt}^{-1} \cdot \text{h}^{-1}$) are similar to those of first stage zoeae of *Cancer borealis* ($1.3 \mu\text{l O}_2$) and *C.*

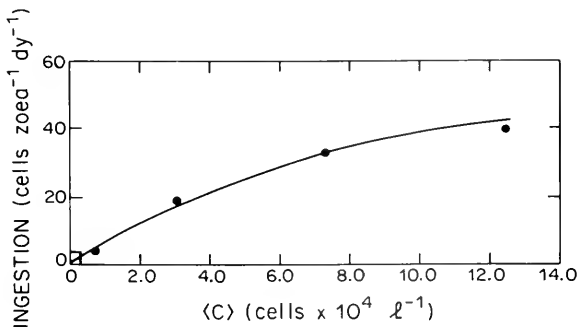

FIGURE 1. Relationship between ingestion (I) and average cell concentration ($\langle C \rangle$) of *G. Grindleyi*. The curve was fit using the Holling equation (Holling, 1959). Area of $1/\langle C \rangle$ observations for large centric diatoms (Fig. 2) shown by box in lower left corner.

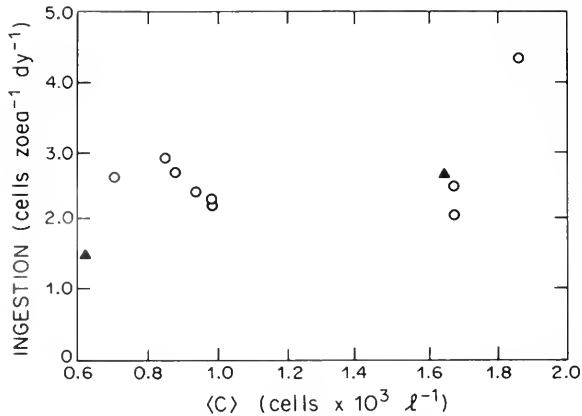

FIGURE 2. Relationship between ingestion (I) and average cell concentration ($\langle C \rangle$) of large centric diatoms: *Coscinodiscus* spp. (O); *Thalassiosira* spp. (▲).

irroratus (1.7 $\mu\text{l O}_2$) measured at 5°C by Sastry and McCarthy (1973). Furthermore, the respiration rates measured in this study are corroborated by estimated *in situ* stage I growth rates and by VO_2 measurements of stage II zoeae captured at sea. The estimated growth rates of *C. bairdi* first stage zoeae from the southeastern Bering Sea (3.9 to 4.7% body C zoea $^{-1}$ d $^{-1}$; Incze, 1983) are almost identical to the carbon equivalents of respiration measured in this study (3.7 to 4.5% body C zoea $^{-1}$ d $^{-1}$). This agrees with the findings of laboratory studies of other crab species where zoeal respiration and growth of early stages were approximately equal (Mootz and Epifanio, 1974; Levine and Sulkin, 1979). In another study (Incze, 1983), measurements of VO_2 of 550 to 590 μg dry weight stage II *C. bairdi* zoeae captured with a plankton net were obtained with a Radiometer blood-gas analyzer following methods of Laughlin *et al.* (1979) and using incubation volumes of 10 and 20 ml. The allometric equation relating respiration (R) to dry body weight using the results of the stage I and stage II measurements provides a weight exponent of 0.72 ($R = 1.198 W^{0.72}$; Incze, 1983), a value similar to those reported for other decapod larvae (Schatzlein and Costlow, 1978) and for animals in general (McMahon, 1973). Estimated *in situ* growth rates of stage I zoeae and respiration rates of stage II zoeae therefore substantiate the results obtained from the small-volume manometric methods used on first stage larvae in this study.

The ability to feed on a wide variety of prey particles is one adaptation for procuring food in a diverse and dispersed community. Many planktonic organisms employ this strategy of omnivorous feeding, though they may do so to different degrees (Marshall, 1973; Landry, 1981). Despite its advantages, omnivory may involve compromises in structure and function of feeding appendages which decrease feeding performance on certain types of prey. For instance, Robertson and Frost (1977) found that *Aetideus divergens* could feed efficiently on large diatoms and *Artemia* nauplii, but was inefficient at ingesting small diatoms when compared with herbivorous calanoid copepods.

Measurements made in this study demonstrate that *C. bairdi* zoeae are omnivorous and consume some phytoplankton. Since large phytoplankton cells were captured and ingested in the absence of zooplankton prey, directed grazing activity is indicated. However, in these experiments, grazing rates were too low to meet respiratory energy requirements, even assuming that variations in individual zoeal

grazing rates existed. The functional response (Fig. 1) of zoeae grazing on dinoflagellates indicates that ingestion rates would not increase substantially at cell concentrations higher than 2×10^5 , presumably because feeding ability is saturated. Consequently, cells of this size could not sustain the zoeae. Even the large diatoms, which contained about ten times as much carbon per cell as the dinoflagellates, could not sustain zoeae under most natural conditions. It would require approximately 2×10^5 of these large cells per liter to satisfy the respiratory requirements of *C. bairdi* first-feeding zoeae, assuming the same functional feeding response to large diatoms and dinoflagellates at high cell concentrations. However, this would be an extraordinarily high concentration for diatoms of this size in the upper 20 m of the ocean where most of the larvae are found (Incze, 1983). When growth requirements averaging about 4.3% body C zoea⁻¹ d⁻¹ (see above) are added to respiratory requirements, the contribution of phytoplankton to total energy needs is further diminished. However, a nutritional role for phytoplankton, such as providing micro-nutrients, is not ruled out by these findings.

The chlorophyll method employed with the grazing experiments which used cultured algae was useful as a screening process to see if measurable chlorophyll depletion (cell consumption) occurred with any of the cells used. The technique verified that there were no instances where rates of consumption satisfied basal metabolic needs, since these rates would have been detected. However, the method was clearly not sensitive enough to measure the low grazing rates observed in cell count experiments using *G. grindleyi*.

The measurements of carnivorous feeding rates in the presence and absence of a natural phytoplankton assemblage collected at the time that *C. bairdi* zoeae were hatching in Resurrection Bay indicated that zoeal predation was unaffected by the phytoplankton. Since none of the conspicuous chain-forming diatoms from the assemblage were found in the stomachs of the zoeae at the end of the experiments, it appears that little or no grazing occurred. However, it is not known whether the apparent lack of grazing in these experiments reflects specific predatory behavior directed at the larger zooplankton or simply a high probability of predator-nauplius encounter at the prey densities used. It may be that diatoms and dinoflagellates appear frequently in the stomachs of zoeae collected from the plankton because more time is spent grazing when zooplankton prey are less available than in these experiments. When phytoplankton cells are consumed, they may only appear quantitatively important because their thecae are conspicuous and may not be digested rapidly. Soft-bodied prey, such as nauplii, have few hard parts which can be identified in zoea stomachs, and the hard parts of other zooplankters may be rejected during feeding (Fowler *et al.*, 1971; Mauchline, 1980). Their stomachs could also contain phytoplankton if zoeae proved to be coprophagous feeders (see data on fecal pellet sizes and contents presented by Urrère and Knauer, 1981). Additional laboratory observations on the ability of zoeae to consume specific species and developmental stages of zooplankton, as well as fecal pellets, are necessary to complement the stomach analysis of individuals feeding *in situ*.

In the zooplankton prey consumption rate experiments, it is likely that some non-feeding zoeae were included, since only individuals no more than 24 hours old and with no previous feeding experience were used. Work by Kon (1979) suggests that a three day "critical" period exists during which first stage zoeae must initiate feeding before subsequent mortality increases markedly. Thus it is probable that newly molted stage I zoeae of this genus have some stored energy that can be used to meet metabolic energy requirements. The occurrence of some non-feeding individuals in experiments may explain why, on the average, only enough energy was

obtained to meet metabolic requirements. We stress, however, that there were some groups of zoeae which consumed zooplankton prey at rates which provided over 300% of daily carbon needs. It is reasonable to assume that similar differences occur during predation on natural prey. The relative abundance of first-feeding larvae which are competent predators under various planktonic conditions may be an important aspect of year-class survival.

Although appropriate zooplankton prey must be rare compared with phytoplankton, they are probably a major component of the zoeal diet of *C. bairdi*. Zoeae of this species do not appear to be well adapted to handling a large number of small prey. These experiments used only 24 hour old first-feeding zoeae, but the larvae demonstrated competence at feeding by capturing and ingesting *Artemia* nauplii (present study) and active zooplankton prey (Paul *et al.*, 1979). Larval growth should increase the relative disadvantage of the predator-prey size relationship with respect to phytoplankton. Unless behavioral or morphological changes occur which favor grazing, phytoplankton should remain a comparatively minor source of energy in larval development of this species.

ACKNOWLEDGMENTS

We thank J. M. Paul and J. Erickson for technical assistance, S. Hall for providing dinoflagellate cultures, and K. O. Coyle for sharing unpublished data with us. M. Landry, C. Greene, M. Ohman, S. Smith, and R. Strathmann provided helpful discussions during the course of this work, and J. Vidal, D. Armstrong, and R. Lasker offered constructive comments on the manuscript. The use of laboratory facilities of the Institute of Marine Science, University of Alaska Seward Marine Station, is gratefully acknowledged. Adult crabs were provided by the Alaska Department of Fish and Game. This study was supported by the National Science Foundation (PROBES, Grant DPP-76-23340) and the National Marine Fisheries Service (Grant 82-ABH-1082).

LITERATURE CITED

- ANGER, K., AND K. C. NAIR. 1979. Laboratory experiments on the larval development of *Hyas araneus* (Decapoda, Majidae). *Helgol. Wiss. Meeresunters.* **32**: 36-54.
- ATKINS, D. 1955. The post embryonic development of British *Pinnotheres*. *Proc. Zool. Soc. Lond.* **124**: 687-715.
- BIGFORD, T. E. 1978. Effect of several diets on survival, development time, and growth of laboratory-reared spider crab, *Libinia emarginata* larvae. *Fish. Bull.* **76**: 59-64.
- BOUSQUETTE, G. D. 1980. The larval development of *Pinnixia longipes* (Lockington, 1877) (Brachyura: Pinnotheridae), reared in the laboratory. *Biol. Bull.* **159**: 592-605.
- BRICK, R. W. 1974. Effects of water quality, antibiotics, phytoplankton and food on survival and development of larvae of *Scylla serrata* (Crustacea: Portunidae). *Aquaculture* **3**: 231-244.
- BRIGHT, D. B. 1967. *Life histories of the king crab, Paralithodes camtschatica, and the Tanner crab, Chionoecetes bairdi*, in Cook Inlet, Alaska. Ph.D. thesis, Univ. Southern California, Los Angeles. 265 pp.
- BRODY, S. 1945. *Biogenetics and growth*. Rheinhold, NY. 1023 pp.
- CHRISTIANSEN, M. E., AND W. T. YANG. 1976. Feeding experiments on the larvae of the fiddler crab, *Uca Pugilator* (Brachyura, Ocipodidae), reared in the laboratory. *Aquaculture* **8**: 91-98.
- CONOVER, R. J. 1966. Factors affecting the assimilation of organic matter by zooplankton and the questions of superfluous feeding. *Limnol. Oceanogr.* **11**: 346-354.
- CORNER, E. D. S., AND C. B. COWEY. 1968. Biochemical studies on the production of marine zooplankton. *Biol. Rev.* **43**: 393-426.
- FOWLER, S. W., G. BENAYOUN, AND L. F. SMALL. 1971. Experimental studies on feeding, growth and assimilation in a Mediterranean emphausiid, *Thalassia Jugosl.* **7**: 35-47.
- FROST, B. W. 1972. Effects of size and concentration of food particles on the feeding behavior of the marine planktonic copepod *Calanus pacificus* *Limnol. Oceanogr.* **17**: 805-815.

- GIESE, A. C. 1973. *Cell Physiology*. W. B. Saunders. 741 pp.
- GONOR, S. L., AND J. J. GONOR. 1973. Feeding, cleaning and swimming behavior in larval stages of porcellanid crabs (Crustacea: Anomura). *Fish. Bull.* **71**: 225-234.
- HARTMAN, M. C., AND G. R. LETTERMAN. 1978. An evaluation of three species of diatoms as food for *Cancer magister* larvae. Pp. 271-276 in *Ninth Ann. Meeting, World Mariculture Soc.* J. Avault, ed.
- HAYNES, E. 1973. Description of the prezoaea and Stage I zoea of *Chionoecetes bairdi* and *C. opilio* (Oxyrhyncha, Oregoniinae). *Fish. Bull.* **71**: 769-775.
- HERRNKIND, W. F. 1968. The breeding of *Uca pugilator* (Bosc) and mass rearing of the larvae with comments on the behavior of the larval and early crab stages (Brachyura, Ocypodidae). *Crustaceana*, Suppl. **2**: 214-223.
- HOLLING, C. S. 1959. Some characteristics of simple types of predation and parasitism. *Can. Entomol.* **91**: 385-398.
- INCZE, L. S. 1983. Larval life history of Tanner crabs, *Chionoecetes bairdi* and *C. opilio*, in the south-eastern Bering Sea and relationships to regional oceanography. Ph.D. dissertation, Univ. Washington, Seattle. 192 p.
- KNUDSEN, J. W. 1960. Reproduction, life history and larval ecology of the California xanthidae, the pebble crabs. *Pac. Sci.* **14**: 3-17.
- KON, T. 1970. Fisheries biology of the Tanner crab. IV. The duration of planktonic stages estimated by rearing experiments of larvae. *Bull. Jpn. Soc. Sci. Fish.* **36**: 215-224.
- KON, T. 1979. Ecological studies on crabs belonging to the genus *Chionoecetes*. I. The influence of starvation on the survival and growth of the zuwai crab. *Bull. Sci. Fish.* **45**: 7-9.
- LANDRY, M. R. 1981. Switching between herbivory and carnivory by the planktonic marine copepod *Calanus pacificus*. *Mar. Biol.* **65**: 77-82.
- LAUGHLIN, R. B., H. W. WOFFORD, AND J. M. NEFF. 1979. Simple potentiometric method for the rapid determination of respiratory rates of small aquatic organisms. *Aquaculture* **16**: 77-82.
- LEBOUR, M. V. 1922. The food of plankton organisms. *J. Mar. Biol. Assoc. U. K.* **12**: 644-677.
- LEBOUR, M. V. 1927. Studies of the Phymouth Brachyura. I. The rearing of crabs in captivity with a description of the larval stages of *Inochus dorsettensis*, *Macropodia longirostris* and *Maia squinado*. *J. Mar. Biol. Assoc. U.K.* **14**: 795-821.
- LEVINE, D. M., AND S. D. SULKIN. 1979. Partitioning and utilization of energy during the larval development of the xanthid crab, *Rithropanopeus harrisi*. *J. Exp. Mar. Biol. Ecol.* **40**: 247-257.
- LUND, J. W. G., C. KIPLING, AND E. D. LECREN. 1958. The inverted microscope method of estimating algal numbers, and the statistical basis of estimation by counting. *Hydrobiologia* **11**: 143-170.
- MARSHALL, S. M. 1973. Respiration and feeding in copepods. *Adv. Mar. Biol.* **11**: 57-120.
- MAUHLIN, J. 1980. The biology of mysids and euphausiids. *Adv. Mar. Biol.* **18**: 373-677.
- MCMAHON, T. 1973. Size and shape in biology. *Science* **179**: 1201-1204.
- MOOTZ, C. A., AND C. E. EPIFANIO. 1974. An energy budget for *Mennipe mercenaria* larvae fed *Artemia nauplii*. *Biol. Bull.* **146**: 44-55.
- MOTOH, H. 1973. Laboratory-reared zoeae and megalopae of zuwai crab from the Sea of Japan. *Bull. Jpn. Soc. Sci. Fish.* **39**: 1223-1230.
- PARSONS, T. R., K. STEPHENS, AND J. D. H. STRICKLAND. 1961. On the chemical composition of eleven species of marine phytoplankters. *J. Fish. Res. Board Can.* **18**: 1001-1016.
- PAUL, A. J., J. M. PAUL, P. A. SCHOEMAKER, AND H. M. FEDER. 1979. Prey concentrations and feeding response in laboratory reared stage-one zoeae of king crab, snow crab, and pink shrimp. *Trans. Am. Fish. Soc.* **108**: 440-443.
- ROBERTS, M. H. 1974. Larval development of *Pagurus longicarpus* Say reared in the laboratory. V. Effect of diet on survival and molting. *Biol. Bull.* **146**: 67-77.
- ROBERTSON, S. B., AND B. W. FROST. 1977. Feeding by an omnivorous planktonic copepod, *Aetidius divergens* Bradford. *J. Exp. Mar. Biol. Ecol.* **29**: 231-244.
- SASTRY, A. N., AND J. F. MCCARTHY. 1973. Diversity in metabolic adaptation of pelagic larval stages of two sympatric species of brachyuran crabs. *Neth. J. Sea Res.* **7**: 434-446.
- SATO, S., AND S. TANAKA. 1949. Study on the larval stages of *Paralithodes camtschatica* (Tilesius). II. On the rearing. *Sci. Pap. Hokkaido Fish. Sci. Inst.* **3**: 18-30.
- SCHATZLEIN, F. C., AND J. D. COSTLOW. 1978. Oxygen consumption of the larvae of the decapod crustaceans, *Emerita talpoida* (Say) and *Libinia emarginata* Leach. *Comp. Biochem. Physiol.* **61**: 441-450.
- STICKNEY, A. P., AND H. C. PERKINS. 1981. Observations on the food of the larvae of the northern shrimp, *Pandalus borealis* Kroyer (Decapoda, Caridae). *Crustaceana* **40**: 36-49.
- STRATHMANN, R. R. 1967. Estimating the organic carbon content of phytoplankton from cell volume or plasma volume. *Limnol. Oceanogr.* **12**: 411-418.

- STRICKLAND, J. D. H., AND T. R. PARSONS. 1968. A practical handbook of seawater analysis. *Fish. Res. Board Can. Bull.* **167**: 310 pp.
- SULKIN, S. D. 1975. The significance of diet in the growth and development of larvae of the blue crab, *Callinectes sapidus* Rathbun, under laboratory conditions. *J. Exp. Mar. Biol. Ecol.* **20**: 115-135.
- SULKIN, S. D. 1978. Nutritional requirements during larval development of the portunid crab, *Callinectes sapidus* Rathbun. *J. Exp. Mar. Biol. Ecol.* **34**: 25-41.
- SULKIN, S. D., AND C. E. EPIFANIO. 1975. Comparison of rotifers and other diets for rearing early larvae of the blue crab, *Callinectes sapidus* Rathbun. *Estuarine Coastal Mar. Sci.* **3**: 109-113.
- SULKIN, S. D., AND K. NORMAN. 1976. A comparison of two diets in the laboratory culture of the zoeal stages of the branchyuran crabs, *Rithropanopeus harrisi* and *Neopanope* spp. *Helgol. Wiss. Meeresunters.* **28**: 183-190.
- UMBREIT, W. W., R. H. BURRIS, AND J. F. STAUFFER. 1972. *Manometric and Biochemical Techniques*. Burgess Publ. Co., Minneapolis. 308 pp.
- URRÈRE, M. A., AND G. A. KNAUER. 1981. Zooplankton fecal pellet fluxes and vertical transport of particulate organic material in the pelagic environment. *J. Plankton Res.* **3**: 369-385.
- UTERMOHL, H. 1958. Zur Vervollkommnung der quantitativen phytoplankton methodik. *Mitt. Int. Ver. Theor. Angew. Limnol.* **9**: 1-38.

COORDINATION OF COMPOUND ASCIDIANS BY EPITHELIAL CONDUCTION IN THE COLONIAL BLOOD VESSELS†

G. O. MACKIE AND C. L. SINGLA

Biology Department, University of Victoria, Victoria, British Columbia, V8W 2Y2

ABSTRACT

Bursts of electrical potentials propagate at *ca.* 2.0 cm s^{-1} within the colonial vascular system of *Botryllus*, *Botrylloides*, and *Metandrocarpa*, serving to coordinate contractions of the vascular ampullae and mediating protective closure and ciliary arrest in zooids. Nerves are absent from the vessels and ampullae. Impulses are presumed to propagate from cell to cell in the vascular epithelium via gap junctions, shown to be present by electron microscopy.

INTRODUCTION

Colonial ascidians of the Family Styelidae produce zooids by budding as described for *Botryllus* (Berrill, 1941; Sabbadin, 1955) and for *Botrylloides* (Berrill, 1947). The buds, instead of separating as in most ascidians, remain permanently attached *via* the vascular system which consists of an elaborate colony-wide network of blood vessels, details of which are given by Brunetti and Burighel (1969). Blind-ending swellings, or ampullae, are produced at various points, chiefly around the edges of the colony (Figs. 1, 2). Regular cycles of expansion and contraction occur in these ampullae causing a tidal ebb and flow of blood within the connecting vessels, as first described by Bancroft (1899). Bancroft noted that as many as 50 ampullae within an area of about $4\text{--}5 \text{ mm}^2$ can exhibit coordinated contractions. Contractions occur not only in the ampullae, but in the blood vessels as well (Mukai *et al.*, 1978). Contraction is attributable to bundles of microfilaments in the epithelial cells forming the vascular walls (DeSanto and Dudley, 1969) but the mechanism responsible for coordination has not been satisfactorily explained. Bancroft's observations suggested variations in blood pressure as the principal means of coordination, as did those of DeSanto and Dudley (1969). However, Mukai *et al.* (1978) found that coordination could best be explained on the assumption that signals of some kind are conducted along the vessels. As nerves have never been described in the vessels, these workers proposed epithelial conduction as the signalling mechanism. This possibility was also advanced by V. L. Scofield (pers. comm.) on the basis of her observation that ampullar rhythms of recently settled larvae immediately come into synchrony when the larvae undergo fusion. Torrence and Cloney (1981) favored epithelial conduction as the probable basis for coordination of ampullae in *Molgula*, and showed that gap junctions are present between the living cells.

The present study demonstrates that electrical impulses propagate throughout the vascular network and ampullae, and shows that these signals are not only responsible for coordination of ampullar rhythms but also serve to coordinate protective responses of the interconnected zooids.

Received 21 February 1983; accepted 23 May 1983.

† Dedicated to N. J. Berrill on the occasion of his 80th birthday, April 6th, 1983, in appreciation of his many important contributions to tunicate biology.

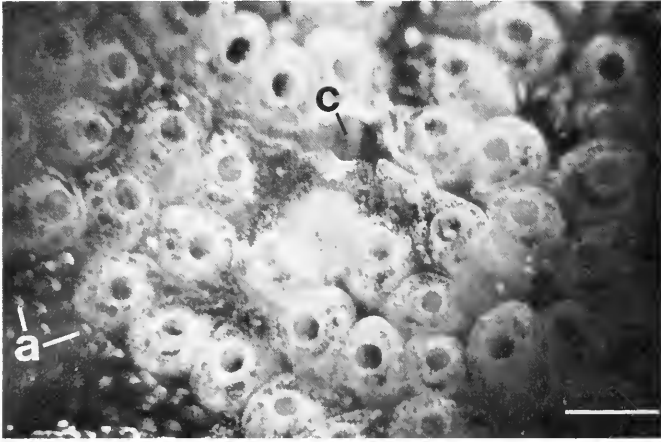

FIGURE 1. Edge of a colony of *Botrylloides*. a, ampullae; c, common cloacal siphon. Bar represents 1 mm.

MATERIALS AND METHODS

During February and March 1982 colonies of *Botryllus* sp. (the "Monterey Botryllus" of Scofield *et al.*, 1982) and *Botrylloides diegensis* were collected from rocks in Monterey Bay, California and maintained in the sea water system at the Hopkins

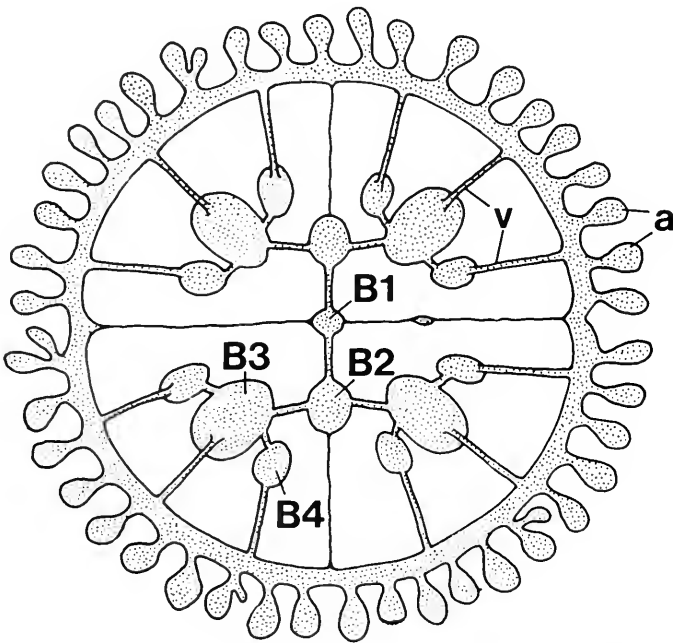

FIGURE 2. Scheme showing the circulatory system and zooid interrelationships in a young colony of *Botryllus*. a, ampullae; B1–B4, first four generations of blastozooids; v, connecting vessels (from Brunetti and Burighel, 1969).

Marine Station. Larvae were settled and grown on glass or plastic sheets. Dr. D. P. Abbott made available a colony of *Metandrocarpa taylori* found growing in a water table in the basement of the Agassiz Building.

Botryllus specimens were fixed in 4% glutaraldehyde in 0.2 M cacodylate buffer (pH 7.4) for one hour at room temperature, rinsed in the cacodylate buffer and post fixed in 1% osmium tetroxide in the same buffer for one hour at 4°C. The material was rinsed with distilled water, dehydrated progressively in acetone, transferred to propylene oxide, and embedded in Epon 812. Thin sections were stained with uranyl acetate and lead citrate and were examined in Philips EM 300.

Botrylloides larvae were fixed while attached to acetate sheets. The acetate dissolved in the acetone used for dehydration.

For the electrophysiological recordings, fine polyethylene suction electrodes (30–50 μm I.D.) were used. Recorded potentials were amplified and displayed on a Tektronix storage oscilloscope and on a Brush chart recorder. A thermistor flow meter was used to detect variations in siphonal currents.

RESULTS

Fine structure

We have examined *Botryllus* and *Botrylloides* to 1) determine if nerves are present in the vascular vessels and ampullae, and 2) to confirm that the junctional specializations reported by Torrence and Cloney (1981) for *Molgula* are also to be found in our species.

Except for the specialized glandular cells of the ampullar tips ("pad cells", Katow and Watanabe, 1978) the cells forming the vascular lining are of a single type equivalent to the "parietal cells" of Torrence and Cloney (1981). These cells may be columnar or squamous depending on the state of contraction at the moment of fixation. Their inner borders become somewhat folded in the contracted state (Fig. 3a), and a layer of micro-filaments can be seen running close beside the luminal border, as first noted by DeSanto and Dudley (1969). Nerves have not been seen in any part of the system.

Tight junctions (*zonulae occludentes*) are located at the outer ends of the line of apposition between adjacent cells (Fig. 3a, c). These junctions are of the punctate type common in tunicates. No such junctions occur on the inner (luminal) side. Gap junctions are seen at intermediate points along the line of apposition (Fig. 3b). The intercellular space along most of the line of apposition is about 15–20 nm wide, but in the gap junction, the two membranes are separated by about 2 nm.

General activity and responses to stimulation

The following comments refer equally to *Botryllus* and *Botrylloides*. Colonies maintained in clean water pump water continuously through the branchial sac, showing occasional arrests of the branchial cilia along with siphon contractions when large particles strike the siphons. No regular pattern of ciliary arrests or muscular contractions was observed in the zooids. The hearts of the different zooids beat rhythmically at their own individual frequencies, reversing periodically. Peristaltic waves pass along the gut, and feces are eliminated at regular intervals.

Movement of blood is not confined to the zooids but takes place throughout the colonial vascular network. The vascular ampullae associated with these vessels can be seen swelling and contracting rhythmically. In newly settled zooids and in larger colonies as noted by Bancroft (1899) contractions of the ampullae are syn-

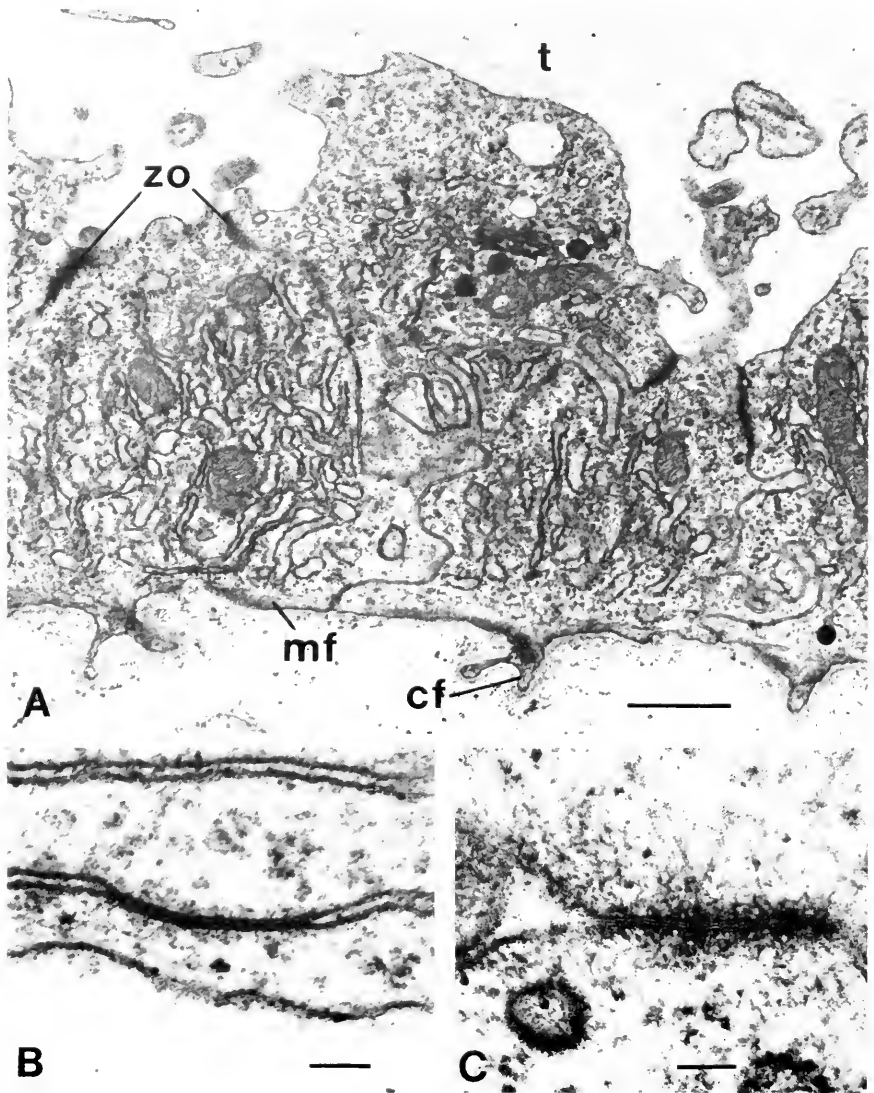

FIGURE 3. Fine structure of parietal cells forming the ampullar wall in *Botrylloides*. (A) shows several partially contracted cells. On the inner side, contractile folds (cf) are seen, and microfilaments (mf) lie against the membrane. On the outer side, next to the tunic (t), the cells are joined by zonulae occludentes (zo). (B) shows a gap junction between two parietal cells and (C) shows detail of the zonula occludens. Bar in (A) is 1 μm , in (B) and (C) 0.1 μm .

chronized. Blood flow through the colonial vascular network appears to be due chiefly to the contractions of the ampullae, and is affected only locally by the actions of the hearts of the zooids. Bancroft (1899) showed that the rhythmic flushing of blood through the vascular network continued in anaesthetized colonies after the hearts of the zooids had stopped beating, and that coordinated ampullar contractions persisted in regressive colonies after the zooids had degenerated. In the present study, regular, synchronized ampullar contractions were seen in strips cut from the edge

of a colony which contained no zooids. Torrence and Cloney (1981) showed that individual ampullae, when isolated, continued to pulsate rhythmically.

In intact colonies, contractions of the ampullae drive blood into the zooids, causing them to swell (DeSanto and Dudley, 1969). The slow rising and falling of the surface of the colony allows results to be recorded with flow meters placed over the oral or cloacal siphons. Each time the colony swells, the siphons are brought nearer to the sensor and a surge in flow rate is recorded (Fig. 4A). Short term changes in flow rate due to siphon contractions or ciliary arrests do not affect the overall rhythm, which is manifested throughout the whole colony, or large parts of it. Coordination was demonstrable in one colony over a distance of 1 cm.

When the surface of a zooid is touched lightly with a needle, the zooid contracts its oral siphon and its portion of the common cloacal passage, while the branchial cilia show a brief arrest. Slightly stronger stimulation causes contractions and ciliary arrests in adjacent zooids within the same group ("system") sharing a common cloacal opening. Spread to adjacent systems takes place with still stronger or repetitive stimulation. Spread appears to occur more readily within a system than between systems, regardless of proximity to the site of stimulation. When excitation reaches a new system several zooids usually contract together almost synchronously, rather than in a wavelength-like sequence. These observations suggest that contrac-

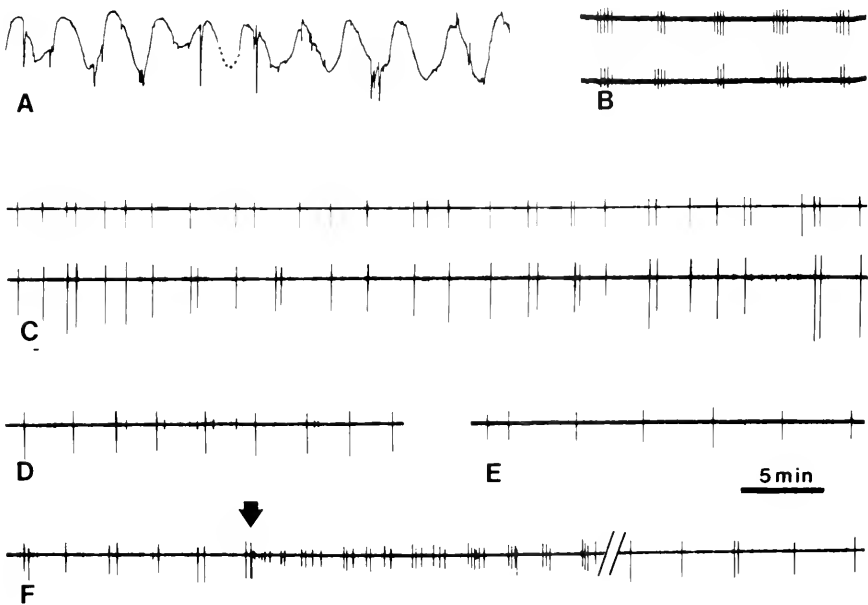

FIGURE 4. Ampullar rhythms monitored with a flow meter (A) and electrically (B-F). (A) *Botrylloides*: variations in water flow past sensor placed over cloacal siphon as colony rises and falls (retouched to remove artefacts). (B) *Botryllus*: electrical record of multiple NP bursts from two ampullae, 2 mm apart. Although contractions were perfectly synchronized the number of NB bursts at each contraction varied at the two sites. (C) *Botrylloides*: NP burst record from two points 1.5 cm apart, in a large colony. Most but not all contractions are synchronized at the two sites. (D) *Botrylloides*: NP bursts from an ampulla of a recently settled larva (oozooid). (E) *Metandrocarpa*: NP bursts from an ampulla. (F) *Botrylloides*: ampullar NP burst record. At the arrow, a scalpel blade was drawn along near the edge of the colony separating a group of about 200 ampullae, including the one with recording electrode attached, but excluding all zooids. Activity is shown immediately after the cut, and after a break in the record lasting 18 h. The 5 min bar applies to all records.

tions are probably not mediated mechanically, but instead are due to impulse conduction. This conclusion is further supported by the observation that zooids can be made to contract by stimulation of nearby ampullae. The responding ampulla moves so little that a mechanical effect on adjacent zooids is scarcely conceivable.

The effects of electrical stimulation resemble those produced by tactile stimulation. Colonies adapt readily to maintained stimulation. A stimulus which would cause a spreading response in a rested colony may cause only a small local response after the colony has been stimulated for a period of time.

Electrical monitoring of ampullar rhythms

Suction electrodes attached to ampullae or zooid walls pick up a rapid burst of potentials, or several such bursts, each time the ampullae contract. Monitoring from the ampullae is preferable, as an electrode on the zooid wall picks up ciliary arrest potentials as well as the events correlated with ampullar contraction. These events are termed network potentials (NPs) as they propagate throughout the vascular network interconnecting the ampullae and zooids. NPs characteristically occur in short bursts. Recorded at slow chart speeds, these bursts appear as single events (Figs. 4B–F). This method of monitoring ampullar rhythms is very simple, and causes minimal disturbance to the colony. The NP burst coincides with the start of the ampullar contraction phase. As many as five bursts (each consisting of several individual NPs) may accompany a single contraction (Fig. 4B). The larger numbers are typical of colonies subjected to damage or overstimulation. Rested colonies maintained in slowly running water usually show only one NP burst at each contraction. Recordings from two ampullae within the same colony show coordination of ampullar rhythms, although in large colonies (<1.0 cm wide, as in Fig. 4C) some loss of coordination may be apparent. In six colonies of *Botrylloides*, contractions occurred at mean intervals of 2.2–4.0 minutes ($\bar{X} = 2.6$, SD = 0.6 min overall). Values for *Botryllus* fell within the same range (Fig. 4D). Records from *Metandrocarpa* gave a mean value of 4.2 min (Fig. 4E).

While the NP burst lasts less than a second, the contraction phase of the ampullar cycle lasts for more than a minute. It appears that the NP burst is essentially a triggering event serving to initiate contractions simultaneously throughout the network. Electrical or mechanical stimulation, or damage, evokes NP bursts and may reset the ampullar rhythm, and alter its pattern, as seen in Figure 4F.

Generation and conduction of network potentials

The composite nature of the NP burst is readily observed when the burst is displayed at higher sweep speeds on the oscilloscope, but the component potentials are not well resolved in suction electrode recordings, but merge into an irregular wave. In the clearest recordings the event can be broken down into about 6–8 separate potentials, 50–70 ms apart. No two bursts are the same, and the same burst may show different time relationships when recorded at two different places (Figs. 5 A, B). Initial attempts by the first author to insert glass microelectrodes into the epithelial cells forming the wall of the ampullae were unsuccessful, but later A. N. Spencer succeeded in obtaining an intracellular recording of an action potential of duration *ca.* 50 ms, rising from a 48 mv resting potential (Fig. 5C). The thinness of the epithelium and the lack of firmness of the tissue generally makes microelectrode work difficult in this material. The one successful recording was of brief duration, and probably provides a somewhat attenuated version of the spike. Though

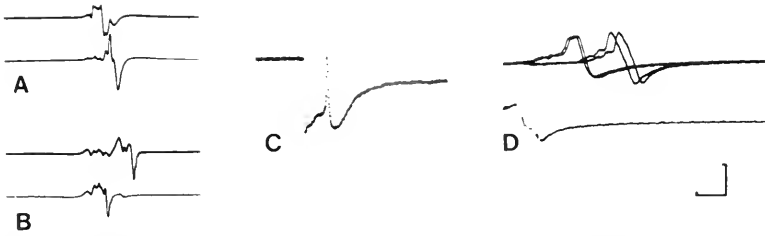

FIGURE 5. Network potentials (NPs) recorded from ampullae of *Botryllus* (A, B, D) and *Botrylloides* (C). (A), NP burst recorded at two different ampullae in a 2-zooid colony. (B), same preparation as in (A), another NP burst. (C), intracellular recording of a single NP. (D), time relationships within an NP burst. Triggering from the lower trace reveals two sets of NPs within a single burst in terms of wave form and arrival time on upper trace. Bars represent 500 μv , 200 ms in (A) and (B), 20 mv, 200 ms in (C) and 1 mv, 50 ms in (D).

preliminary in nature, this result does confirm that the ampullar wall is the site of impulse conduction. Taking into account the absence of nerves, and the presence of gap junctions we can conclude that the excitable elements are the cells of the vascular epithelium itself.

Measurement of conduction velocities is hampered by the irregular configuration of the vascular network along which the signals are conducted and by the composite nature of the NP itself. Values ranging from 0.5–1.9 cm s^{-1} ($\bar{X} = 0.9$, $\text{SD} = 0.59$) have been obtained. The distances between the electrodes in these experiments were measured directly and no allowance was made for deviousness in the actual conduction pathways. The highest velocity values were obtained from strips near the margin of the colony where a major vessel runs circumferentially (Fig. 2), and the electrodes were placed along this line. Thus, the 'true' conduction velocity is probably close to 2 cm s^{-1} .

As noted above, simultaneous recordings from two ampullae in the same general vicinity show differences in the time relationships of bursts arriving at the two sites (Figure 5A, B) as well as in the numbers of potentials comprising the bursts, and the intervals between them (Fig. 4B). It seems likely that bursts are produced by interaction of many different pacemaker sites. Figure 5D shows an example of an apparent shift in the pacemaker site during the course of a single burst.

Coordination of protective responses in the zooids

Like a number of other ascidians, both compound and solitary (Mackie, 1974, Mackie *et al.*, 1974) botryllid zooids show characteristic, large potentials when stimulated, termed ciliary arrest potentials (CAPs). The CAP system is under nervous control from the brain. Muscles in the siphons and mantle usually contract concurrently with ciliary arrest, but the potentials due to muscle contraction are small. Botryllids differ from other ascidians by showing a second major type of electrical signal in recordings from their zooids. These events appear indistinguishable from NPs recorded from the ampullae, and it is concluded that NPs are conducted through the vascular network, to the zooids. Here they may merge giving a composite irregular sort of electrical event (Fig. 6A) or remain recognizable as discrete events (Fig. 6B). Although the distances are small, conduction velocities have been measured in isolated strips of tissue cut from the surface of *Botryllus* zooids between the oral and cloacal siphons. Such strips give NP conduction velocities in the order of 2.0 cm s^{-1} . The NP conducting tissues in such strips have not been identified.

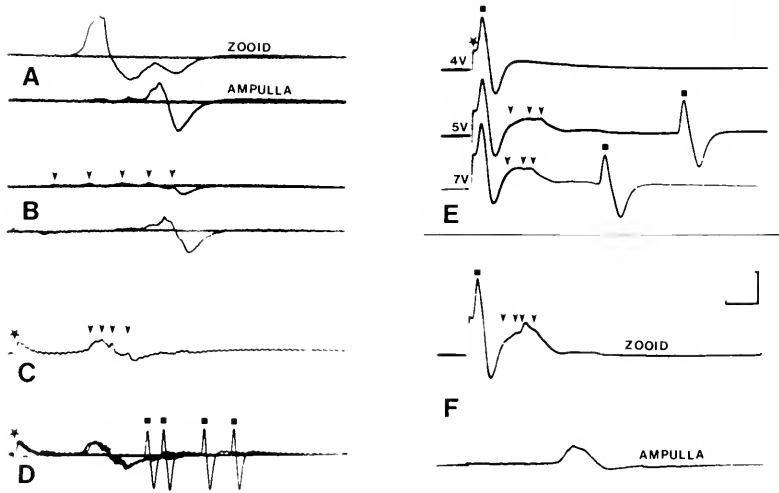

FIGURE 6. Two way transmission of NPs (arrow heads) between ampullae and zooids of *Botryllus* (A, B, E, F) and *Botrylloides* (C, D). (A), a tactile stimulus (needle prick) to an ampulla evokes a NP burst which propagates to a zooid causing it to contract and to another ampulla. (B), same as in (A), but spontaneous NP burst, for comparison. The zooid did not contract. (C), following a shock (asterisk) on a zooid an NP burst is recorded on another zooid. (D), same as in (C), several sweeps superimposed. The NP burst fails to reach the recording site on some occasions. NP bursts which do arrive trigger CAPs (spots) after variable latencies. (E), stimulating and recording on same zooid. With 4v shock, only a CAP is evoked. Stronger shocks caused repetitive firing of CAPs and triggered NP bursts. (F), same as in (E), but with a second electrode on an ampulla. The CAP does not spread to the ampulla, but the NP burst does. Bars represent 500 μ v, 50 ms in (A) and (B), 500 μ v, 100 ms in (C) and (D), and 1 mv, 50 ms in (E) and (F).

They could be the blood vessels of the mantle, or the inner or outer mantle epithelia. No other organs were in the strips in question.

Stimulation of a zooid can evoke a NP burst which propagates to other zooids (Fig. 6C, D) and may trigger the usual effector responses (CAPs and muscle twitches) in them. There is a delay of at least 100 ms between the arrival of the NP burst and the production of the triggered events, which suggests that excitation passes into and through the central nervous system of the zooid before entering the ciliary and muscular effectors. It is not known how NPs, as epithelial events, enter the nervous system, but epithelio-neural transmission steps have been identified in other tunicates, e.g., *Oikopleura* (reviewed by Bone and Mackie, 1982). Stimulating the surface of a zooid at low voltage may evoke one or a series of CAPs, with muscle twitches, but slightly stronger shocks can evoke NPs as well (Fig. 6E). Both of these electrical events, CAPs and NPs, are evoked after delays indicating passage through the nervous system rather than being due to the direct action of stimulating current across the body wall. The delay is greater in the case of NPs, which might reflect the greater length of the motor pathway involved. NPs evoked in this way can propagate to other zooids and to ampullae (Fig. 6F). CAPs never spread outside the zooid they are evoked in, but they can be elicited indirectly in other zooids by propagated NPs (Fig. 6D).

NPs cannot spread between zooids by way of the upper surface of the colony, even though the mantles of the adjacent zooids are closely applied to one another

in this region (Fig. 1). The routes in and out of zooids must lie deeper, and are presumably the vascular connections.

NPs do not always spread beyond the confines of a stimulated zooid, and they do not always enter zooids when spreading through the vascular network. When they do enter, they may or may not cause CAPs. Conduction barriers must exist. It seems likely, but has not been proven, that the time relationships and number of NPs in a burst is critical in overcoming these barriers. There is some evidence that conduction velocity declines within a burst. If so, the intervals between the pulses in a burst would increase with distance from the site of stimulation, which might account for activation of effectors in zooids near the stimulus, while distant ones remain unaffected. Better evidence is needed on this point.

DISCUSSION

The findings reported here are of interest first because they throw new light on the question of how contractions of the vascular ampullae are coordinated, secondly because they reveal the existence of a capability for coordination of protective responses hitherto unrecognized in ascidian colonies, and finally for the interest attaching to a new case of a conducting epithelium.

Coordination of ampullae

The findings make it clear that the ampullae are coordinated by electrical impulses. NP bursts always accompany ampullar contractions, and are phase locked to the contraction cycle. Alterations in the ampullar rhythm due to stimulation or injury, for example, are faithfully mirrored in the changed pattern of electrical impulses. The rhythm, and accompanying NP burst pattern, is shown by small groups of ampullae isolated from parts of the colony containing zooids, showing that the peripheral vascular system generates the rhythm and provides the coordinating pathway for the contractions. The observed conduction velocity of *ca.* 2 cm s⁻¹ though slow compared with most nervous and non-nervous conduction suffices to keep large colonies up to and beyond 1.0 cm in diameter well coordinated. Conduction in the vascular epithelium may take place by direct current flow through the gap junctions shown to be present between the cells. The observation that the ampullar rhythms of two colonies come into synchrony at the moment of fusion suggests that a critical step in the self-recognition process is the ability to form gap junctions with cells derived from another oozoid. While the present observations clarify the problem of how the ampullae are coordinated, they still do not tell us how the ampullar rhythm is generated. The evidence suggests multiple dispersed pacemaker sites, but the identity of the cells generating the rhythm remains to be determined.

Coordination of zooid responses

A number of functions have been associated with the vascular network and ampullae of botryllids and other ascidians including respiration, circulation of metabolites, secretion of tunic and substrate adhesive, and elimination of cells liberated by degenerative processes (Abbott, 1953; Mukai *et al.*, 1978; Katow and Watanabe, 1978; Torrence and Cloney, 1981). During asexual reproduction in *Metandrocarpa* the vascular ampullae "withdraw the buds from the parental mantle and pull them over the substrate to points some distance from the parent" (Abbott, 1953). Whether

or not two botryllid colonies fuse during growth is determined by processes of self-nonsel discrimination at the ampullae, which are the only contact points between the two colonies (Scofield *et al.*, 1982; Watanabe and Taneda, 1982).

Another function can now be added to this list: the ampullae and vascular vessels provide a conduction pathway mediating defensive behavior in the zooids. Any sharp or damaging stimulus to the ampullae or connecting vessels causes siphonal retraction and closure along with ciliary arrest in nearby zooids, equivalent to the well known protective squirting of solitary sea squirts. Similar systems exist in other colonial forms, both sessile and pelagic. Most animal colonies are coordinated by nervous or non-nervous conduction pathways, sometimes by both. The closest parallels to the botryllid system are to be found in certain hydroid colonies where non-nervous impulses are conducted along the stolons interconnecting the polyps. The polyps retract protectively on receiving the excitation (reviewed by Spencer and Schwab, 1982). Colonies of some other hydroids and of bryozoans and corals are coordinated by nerves, but the responses are again protective in character (reviewed by Shelton, 1982; Thorpe, 1982).

Conducting epithelia can provide an adequate pathway for simple impulse conduction over considerable distances, but the responses they mediate are complex and labile, and at the effector end they are nearly always organized by nerves (*e.g.*, Anderson and Bone, 1980; Mackie and Carré, 1983). In the botryllid system, there is no reason to suspect the involvement of nerves in the coordination of ampullar rhythms, but the effector responses of muscle contraction and ciliary arrest in the zooids are almost certainly organized by nerves. In every zooid two-way epithelio-

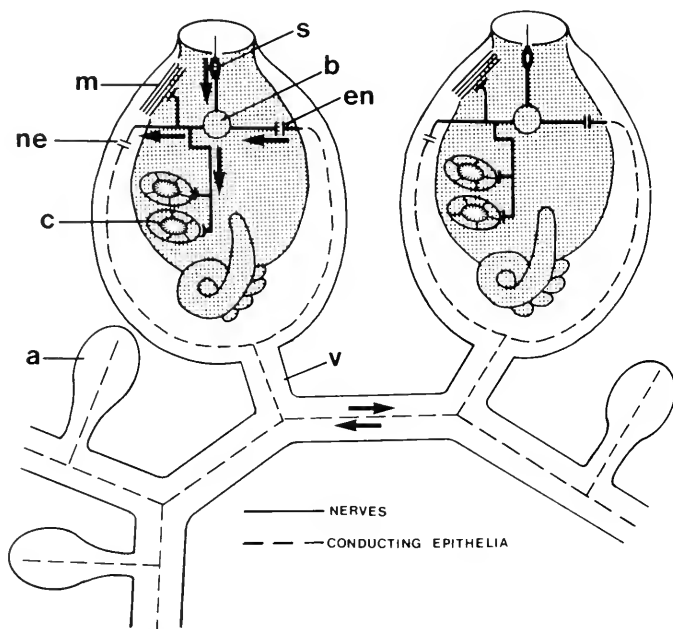

FIGURE 7. Wiring diagram of an idealized botryllid colony. Nerves are shown as solid lines, conducting epithelia as broken. a, ampulla; b, brain; c, ciliated cell of branchial sac; en, epithelio-neural transmission step; m, muscle in mantle wall; ne, neuro-epithelial step; s, sensory cell; v, vascular network. Exact locations of the transmission steps between nerves and epithelia are unknown. This diagram is designed to be understood in terms of Figure 11.23 in Bone and Mackie (1982).

neural transmission links must exist by which NPs can excite impulses in afferent nerves and be excited in turn by efferent nerves (Fig. 7). Nothing is known about these links except that they exist. Another poorly understood feature is the mechanism responsible for incremental spread of excitation through the system. Such spread is also known in corals and hydrozoan colonies and various mechanisms have been proposed for it, but the evidence from botryllids is still too rudimentary to justify further discussion here.

A new tunicate conducting epithelium

The skins of some larvaceans and of one ascidian tadpole (*Dendrodoa*) are known to be capable of impulse conduction, and conducting epithelia are widespread in salps (reviewed by Anderson, 1980; Bone and Mackie, 1982). In each case, the epithelium is a covering layer, and a 'pure' conducting epithelium, not a myoepithelium. The botryllid system described in this paper is a system of blood vessels, and it is contractile in at least some regions, due presumably to the actin-like microfilaments in the lining cells. Thus it more closely resembles the tunicate heart, a myoepithelium which conducts the impulses for its own contraction (Kriebel, 1970). Like the heart, the vascular ampullae generate a rhythm. Nerves do not appear to be involved in either case. It might appear then that the contractility, rhythmicity and conducting ability are inherent properties of tunicate vascular tissue. However it is worth noting that the vascular ampullae and vessels are of epidermal origin, and that the epidermis of at least one tunicate tadpole larva is excitable. Perhaps then, the excitability of the botryllid vascular network is ontogenetically or phylogenetically linked to excitability in the larval epidermis. Whatever its origins, the system does not fit neatly into any existing category and must be classed as a new type of conducting epithelium. A study of the compound ascidian *Distaplia* failed to reveal any conduction between the zooids (Mackie, 1974) and the zooids in *Pyrosoma* colonies are not coordinated, except by serial photic auto-excitation (see Bone and Mackie, 1982). Botryllids differ from these organisms in being truly colonial: their zooids are interconnected by the vascular network. It may prove to be the case that zooid coordination by propagated impulses is only developed in those ascidian colonies which, like the botryllids, have direct vascular interconnections.

ACKNOWLEDGMENTS

The physiological work reported here was carried out during a visit by the first author to the Hopkins Marine Station, Stanford University, at Pacific Grove, California, with assistance in the form of an International Collaborative Research Grant from the National Sciences and Engineering Research Council of Canada (NSERC). This help, and the cooperation of the director and staff of the station is gratefully acknowledged. D. P. Abbott, A. Harrington, and V. L. Scofield collaborated in various phases of the work. We thank A. N. Spencer, University of Alberta, for contributing Figure 5C. The electron microscopy was carried out by the second author at the University of Victoria, with support from a NSERC operating grant.

LITERATURE CITED

- ABBOTT, D. P. 1953. Asexual reproduction in the colonial ascidian *Metandrocarpa taylori* Huuhtman. *Univ. Cal. Publ. Zool.* **61**: 1-78.
- ANDERSON, P. A. V. 1980. Epithelial conduction: its properties and functions. *Prog. Neurobiol.* **15**: 161-203.

- ANDERSON, P. A. V., AND Q. BONE. 1980. Communication between individuals in salp chains II. Physiology. *Proc. Roy. Soc. B.* **210**: 559-574.
- BANCROFT, F. W. 1899. A new function of the vascular ampullae in the Botryllidae. *Zool. Anz.* **22**: 450-462.
- BERRILL, N. J. 1941. The development of the bud in *Botryllus*. *Biol. Bull.* **80**: 169-184.
- BERRILL, N. J. 1947. The developmental cycle of *Botrylloides*. *Q. J. Microsc. Sci.* **88**: 393-408.
- BONE, Q., AND G. O. MACKIE. 1982. Urochordata. Pp. 473-535 in *Electrical conduction and behaviour in 'simple' invertebrates*, G. A. B. Shelton, ed. Clarendon Press, Oxford.
- BRUNETTI, R., AND P. BURIGHEL. 1969. Sviluppo dell'apparato vascolare coloniale in *Botryllus schlosseri* (Pallas). *Publ. Staz. Zool. Napoli* **37**: 137-148.
- DESANTO, R. S., AND R. L. DUDLEY. 1969. Ultramicroscopic filaments in the ascidian *Botryllus schlosseri* (Pallas) and their possible role in ampullar contractions. *J. Ultrastr. Res.* **28**: 259-274.
- KATOW, H., AND H. WATANABE. 1978. Fine structure and possible role of ampullae on tunic supply and attachment in a compound ascidian, *Botryllus primigenus* Oka. *J. Ultrastr. Res.* **64**: 23-34.
- KRIEBEL, M. E. 1970. Wave front analyses of pulses in tunicate heart. *Am. J. Physiol.* **218**: 1194-1200.
- MACKIE, G. O. 1974. Behaviour of a compound ascidian. *Can. J. Zool.* **52**: 23-27.
- MACKIE, G. O., D. H. PAUL, C. L. SINGLA, M. A. SLEIGH, AND D. E. WILLIAMS. 1974. Branchial innervation and ciliary control in the ascidian *Corella*. *Proc. Roy. Soc. B* **187**: 1-35.
- MACKIE, G. O., AND D. CARRÉ. 1983. Coordination in a diphyid siphonophore. *Mar. Behav. Physiol.* **9**: 139-170.
- MUKAI, H., SUGIMOTO, K., AND TANEDA, Y. 1978. Comparative studies on the circulatory system of the compound ascidians *Botryllus*, *Botrylloides* and *Symplegma*. *J. Morphol.* **157**: 49-78.
- SABBADIN, A. 1955. Osservazione sulla sviluppo, l'accrescimento, e la riproduzione di *Botryllus schlosseri* (Pallas) in condizioni di laboratorio. *Boll. Zool.* **22**: 243-263.
- SCOFIELD, V. L., J. M. SCHLUMBERGER, AND I. L. WEISMANN. 1982. Colony specificity in the colonial tunicate *Botryllus* and the origins of vertebrate immunity. *Am. Zool.* **22**: 783-794.
- SHELTON, G. A. B. 1982. Anthozoa. Pp. 203-242 in *Electrical Conduction and Behaviour in 'Simple' Invertebrates*, G. A. B. Shelton, ed. Clarendon Press, Oxford.
- SPENCER, A. N., AND W. E. SCHWAB. 1982. Hydrozoa. Pp. 73-148 in *Electrical Conduction and Behaviour in 'Simple' Invertebrates*, G. A. B. Shelton, ed. Clarendon Press, Oxford.
- THORPE, J. P. 1982. Bryozoa. Pp. 393-439 in *Electrical Conduction and Behaviour in 'Simple' Invertebrates*, G. A. B. Shelton, ed. Clarendon Press, Oxford.
- TORRENCE, S. A., AND R. A. CLONEY. 1981. The rhythmic contractions of the ampullar epidermis during metamorphosis of the ascidian *Molgula occidentalis*. *Cell Tissue Res.* **216**: 293-312.
- WATANABE, H., AND Y. TANEDA. 1982. Self and non-self recognition in compound ascidians. *Am. Zool.* **22**: 775-782.

ASCIDIAN-*PROCHLORON* SYMBIOSIS: THE ROLE OF LARVAL PHOTOADAPTATIONS IN MIDDAY LARVAL RELEASE AND SETTLEMENT

RICHARD RANDOLPH OLSON

Museum of Comparative Zoology, Harvard University, Cambridge, Massachusetts 02138

ABSTRACT

Colonies of the algal-ascidian symbiosis *Didemnum molle* at Lizard Island, Australia, release more than 95% of their larvae daily between 11:00 and 14:00 with a peak around 12:30, shortly after meridian passage of the sun. In shallow-water habitats, larvae are photoadapted to lower light environments than are adult colonies. Unlike adult colonies, larvae lack spicules and brown pigmentation in their tunic. They also have a lower chlorophyll a/b ratio than do their parent colonies. In the field, larvae seek a light intensity of approximately $100 \mu\text{E m}^{-2}\text{s}^{-1}$ and settle preferentially on dark or shaded substrata. Settled larvae that were transplanted into full sunlight perished after 4 days. Larvae observed in the field swam for less than 10 minutes before settling. When denied a shaded substrate, larvae swam for up to 1.5 hours and eventually settled in full sunlight (an unsuitable habitat). Larvae in total darkness swam for at least 2 hours before settling. The larval photoadaptations, settlement behavior, and mortality of *D. molle* juveniles in full sunlight suggest that the release of larvae at midday, when sunlight is greatest, enables larvae to search for settlement sites when conditions are most severe, minimizing the chance they will settle in unsuitable habitats.

INTRODUCTION

The availability of suitable habitats for the settlement of larvae of sessile marine invertebrates is known to vary spatially (Grosberg, 1981; Palmer and Strathmann, 1981; Sebens, 1981; Keough and Downes, 1982) as well as temporally (Grosberg, 1982). Although considerable research has been conducted on factors that induce larvae to settle (Meadows and Campbell, 1972), very little is known about the ecological significance of the time of day that larvae are released. Many species of sessile invertebrates have larvae that swim for less than an hour before settling [*e.g.*, some ascidians (Crisp and Ghobashy, 1971), bryozoans (Ryland, 1974), and corals (Lewis, 1974)]. Such a short time between larval release and settlement potentially enables the parent to control the time of day its larvae will settle.

Colonial ascidians are commonly members of fouling communities in temperate waters (Millar, 1971) and cryptic communities on coral reefs (Jackson, 1977). Eighteen species of one family (Didemnidae) possess symbiotic unicellular algae (Kott, 1980). These species are found only in the tropics and commonly occur, not in cryptic communities, but in fully sunlit areas on coral reefs. Although considerable research has been conducted on the symbiotic algae, there is little known about the ecology of the animals or their larvae.

Of the eighteen species of ascidian-algal associations, two species possess algae of the genus *Synechocystis* (Lafargue and Duclaux, 1979; Olson, 1980), a cyanophyte

which contains phycobilin pigments. The other species contain algae of the recently discovered genus *Prochloron* (Newcomb and Pugh, 1975). The algae are unique in that they have a cell structure (Whatley, 1977), cell wall (Moriarty, 1979), and genome which resemble procaryotes (Seewaldt and Stackebrandt, 1982), but contain chlorophyll b and lack phycobilin pigments, typical eucaryotic features (Lewin and Withers, 1975). This contradiction has led to their designation as a new genus and provisional new division, the Prochlorophyta (Lewin, 1976).

Colonial ascidians studied to date, which do not have symbiotic algae, have been reported to release their larvae primarily at dawn or upon first light after a period of darkness. Of the thirteen species listed in Table I, nine release their larvae in the morning, two release at midday, and two release larvae throughout the day-night cycle. Duyl *et al.* (1981) (Table II) reported the first case of a species in which larval release takes place only during the midday hours. The larvae of this species, *Trididemnum solidum*, possess symbiotic algae and are released between 10:15 and 14:00. Here I report on another species of colonial ascidian with symbiotic algae which releases 95 percent of its larvae between 11:00 and 14:00. Experimental field

TABLE I

Larval release times for colonial ascidians without symbiotic algae

Species	Time of release	Location	Reference
<i>Aplidium constellatum</i>	dawn	Woods Hole, MA	Mast (1921)
	all morning	Woods Hole, MA	Scott (1924)
	dawn	Woods Hole, MA	Costello and Henley (1971)
<i>Botrylloides mutabilis</i>	morning	Tokyo Bay, Japan	Yamaguchi (1975)
<i>Botrylloides nigrum</i>	morning	Puerto Rico	Morgan (1977)
<i>Botryllus schlosseri</i>	all day with a peak at midday	Woods Hole, MA	Grave and Woodbridge (1924)
	all day with a peak at midday	Woods Hole, MA	Grave (1937)
<i>Cystodytes lobatus</i>	3-4 hours after dawn, all day	Pacific Grove, CA	Lambert (1979)
<i>Diplosoma listerianum</i>	all day, peak at midday	Menai Bridge, North Wales	Crisp and Ghobashy (1974)
<i>Distaplia occidentalis</i>	morning	Friday Harbor, WA	Watanabe and Lambert (1973)
<i>Ecteinascidia turbinata</i>	morning	Puerto Rico	Morgan (1977)
<i>Leptoclinum mitsukurii</i>	morning	Tokyo Bay, Japan	Yamaguchi (1975)
<i>Metandrocarpa taylori</i>	continuous over day/night cycle	Pacific Grove, CA	Abbott (1955)
	morning	Friday Harbor, WA	Watanabe and Lambert (1973)
<i>Perophora viridis</i>	early morning	Woods Hole, MA	Grave and McCosh (1924)
	8:00-11:00	Woods Hole, MA	Costello and Henley (1971)
<i>Polyandrocarpa tinctoria</i>	morning	Tortugas, FL	Grave (1936)
<i>Symplegma viride</i>	continuous over day/night cycle	Tortugas, FL	Grave (1937)

TABLE II

Larval release times of colonial ascidians with symbiotic algae

Species	Time of release	Location	Reference
<i>Didemnum molle</i>	11:00–14:00 midday	Lizard Island, Australia Palau, Caroline Islands	This paper Olson, unpublished data
<i>Diplosoma similis</i>	midday	Lizard Island, Australia	Olson, unpublished data
<i>Lissoclinum patella</i>	midday	Palau, Caroline Islands	Lewin, pers. comm.
<i>Lissoclinum voeltzkowi</i>	11:45–13:30	Lizard Island, Australia	Olson, unpublished data
<i>Trididemnum solidum</i>	10:15–14:00	Curacao	Duyf <i>et al.</i> (1981)

evidence is presented showing that light intensity of the habitat in which a larva settles can be very important to its eventual growth and survival.

The colonial ascidian *Didemnum molle* Herdman, lives on coral reefs throughout the Indo-West Pacific (Kott, 1980). All colonies contain symbiotic algae of the genus *Prochloron*, which are extracellularly attached to the walls of the cloacal chambers of the ascidian. The algae are shielded from full sunlight by the ascidian tunic which contains spherical calcareous spicules (40–80 μm diameter) and a dark brown pigment (Fig. 1a). The larva of *D. molle* (Fig. 2a) is relatively large (2.5 mm length) and can be seen easily underwater. Its large size, midday release, short swimming time, and relatively large amount of algae (0.39 μg chlorophyll a/larva, s.d. = 0.09) enabled me to study aspects of its larval ecology in the field which have not been examined previously in an algal-invertebrate symbiosis.

MATERIALS AND METHODS

All experiments reported, unless otherwise noted, were conducted at a depth of 2 m on a patch reef approximately 200 m directly offshore of the Lizard Island Research Station, Lizard Island, Australia (14 40' S. lat, 145 28' N. long.) from August to December 1981. Few laboratory experiments were performed because *D. molle* colonies will seldom survive for more than a day in aquaria, and experiments conducted underwater on the reef more closely resemble the light and temperatures to which the larvae are acclimated. All times reported are local mean time (LMT) which is zone time corrected for longitude and the equation of time. LMT means that the sun is directly overhead at exactly 12:00.

According to Kott (1980), *D. molle* colonies may be brown or white in color. Recent findings (Olson, in prep.) suggest that the two color morphs are different species. Brown colonies and their larvae were used for all experiments reported in this paper.

“Settling panels” were 20 cm \times 20 cm squares of 3 mm thick asbestos fiberboard with 3 cm long wooden legs at each corner. The legs supported the panels slightly above the substrate so that larvae could settle on the shaded undersides. “Juveniles” were sexually immature (less than 0.1 g wet weight) colonies that have a transparent tunic and are not heavily spiculated. Such colonies appear green due to the algae they contain (Figs. 2b, 2c). Sexual maturation occurs at 0.5 g wet weight (unpublished data). “Edge distance” is the distance between a newly settled larva on the underside of a settling panel and the nearest edge of the panel.

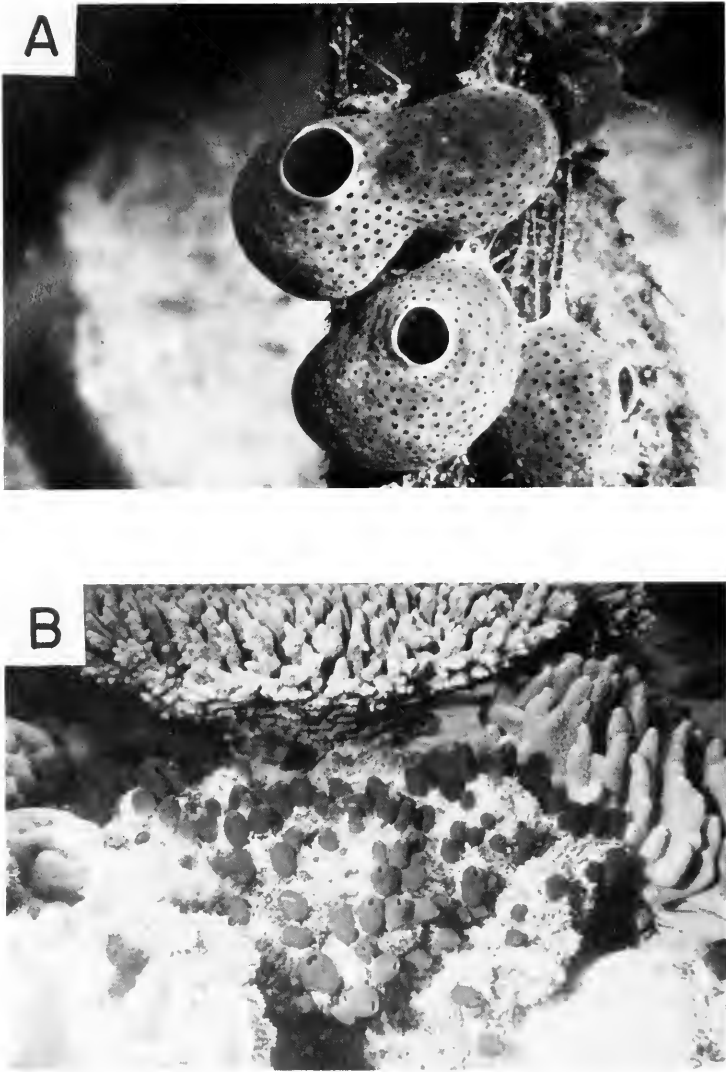

FIGURE 1. A—Adult colonies of *D. molle* fully expanded showing their single large exhalant opening and many, small inhalant openings of individual zooids. Note hair-like projections from edge of lower colony. These are extensions of the test, used for whole colony movement. B—*D. molle* habitat. This aggregation of approximately 150 colonies at 2 m depth was used for larval release observations. Colonies are in full sunlight. Juvenile colonies could be found on the underside of the boulder to which the colonies are attached.

Field observations of larval release

The timing of larval release was studied by observing one clump of approximately 150 colonies, closely aggregated on a piece of coral rubble approximately 0.5 m \times 0.5 m across. Colonies were observed continuously from 11:00 to 15:00 for three consecutive days every two weeks (on the full and new moons) from August to December, 1981. As larvae were released from the colonies their time of release was recorded. The data were grouped into 15 minute intervals.

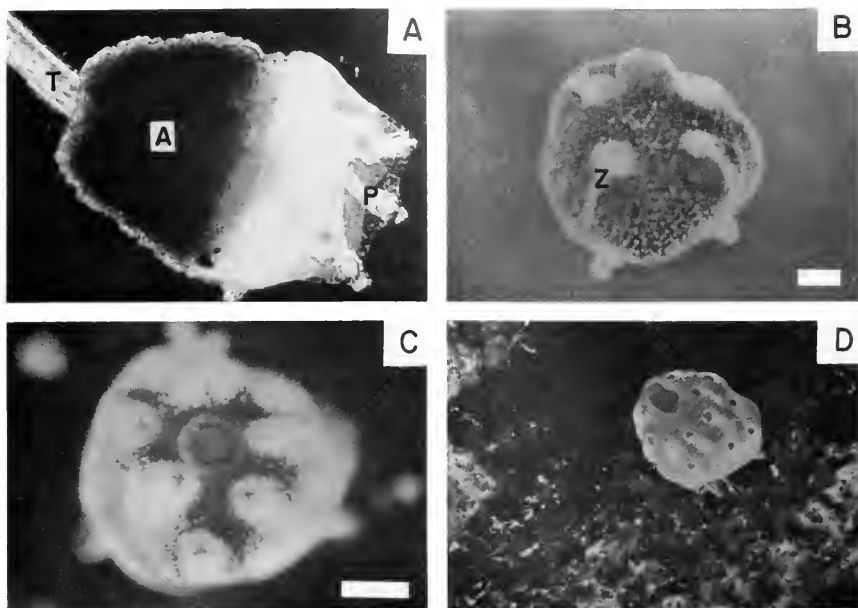

FIGURE 2. A—Larva of *D. molle*. Note three adhesive papillae (P). *Prochloron* algae (A) are attached to hair-like projections from the posterior end of the larval body according to Kott (1980). Distance from the base of the tail (T) to the tip of the middle adhesive papilla is approximately 1 mm. Larva contains three blastozoids. B—3 day-old juvenile. The colony has three zooids. White areas are spicules. Note that spicules are located around zooids (Z). The rest of the colony is green from the algae. Individual algal cells can be seen in this photo. Protrusions of test at base of colony are used for whole colony locomotion. Bar equals 0.25 mm. C—12 day-old juvenile. The colony has approximately 9 zooids. This photo was taken in the laboratory so colony is tightly contracted. The colony has no brown pigmentation. Bar equals 0.5 mm. D—Field photo of colony of approximately 30 zooids fully expanded. This colony was found on the underside of a coral rubble boulder at 2 m depth. In the original color photo, the colony can be seen to have a small amount of brown pigmentation on its topside.

Chlorophyll determinations

Chlorophyll content of whole colonies was measured by macerating individual colonies in the dark in 20 to 40 ml (depending on colony size) of 90 percent acetone buffered with $MgCO_3$. Samples were extracted overnight at 10°C, then centrifuged for 5 minutes at 2200 g. Samples were analyzed on a Varian spectrophotometer for absorbance at 647 and 664 nm wavelengths. Chlorophyll a and b concentrations were calculated with the equations of Jeffrey and Humphrey (1975).

Chlorophyll content of larvae was measured by the same methods. Larvae were collected as they were released from freshly collected colonies in aquaria. 5 ml of 90 percent acetone were used for extraction of groups of 30 to 40 larvae.

Light intensity measurements

Light intensities were measured using a Li-Cor light meter with a cosine corrected submersible quantum sensor. All measurements were taken on a calm, cloudless day in February between 12:00 and 13:00. To estimate light levels beneath the settling plates, holes were drilled at different distances from the edge. The holes were the same diameter as the light probe so that the plate could be placed on the bottom

with the light probe inserted upside down. The holes were drilled at 8, 20, and 35 mm distances from the edge. The first two distances correspond to the mean distances of larval settlement at 4 and 2 m depths, respectively. Light readings were taken at 2 and 4 m depths.

Survivorship experiment

The importance of settling in a shaded habitat was investigated by comparing survivorship of juveniles placed in a variety of light conditions. Larvae were allowed to settle on the undersides of settling panels at 2 m depth. The panels were inverted and subjected to one of the following three treatments: 1) shade—panel was covered by another panel of identical dimensions mounted 3 cm above it, 2) full sunlight, 3) clear plexiglas roof—a control for alterations in sedimentation and flow in the shade treatment. Juveniles on the undersides of uninverted panels served as controls for the inversion. Survivorship was recorded after four days. The experiment was replicated three times.

Swimming experiments

To determine how long larvae are capable of swimming, two experiments were conducted—one in the lab, the other in the field. In the field experiment, larvae were captured underwater with a 10 ml plastic syringe just as they were released from their parent colony. Each replicate consisted of ten larvae captured within 2 minutes time to assure that they were all at approximately the same developmental stage. The larvae were injected into plastic boxes measuring 12 cm \times 8 cm \times 6 cm. In the dark treatment, the entire box was painted black on the outside with latex paint and wrapped with two layers of aluminum foil. The dark roof treatment was a clear box with the outside of the roof of the box painted black. The shade treatment was a clear box placed 20 cm beneath a 80 cm \times 60 cm white plastic shade. The clear treatment was a clear box left in full sunlight. Each treatment was checked every ten minutes for one hour except for the dark treatment which was checked only at the end.

In the lab experiment, larvae were obtained from freshly collected colonies in aquaria and placed into 500 ml beakers which were then wrapped in black plastic and placed in a darkroom. After two hours the beakers were uncovered and the larvae were censused.

Larval swimming observations

Larval swimming times were recorded for 89 larvae by visually tracking the larvae underwater using scuba gear. Although eighty-four percent of the larvae followed were lost as they swam among corals or when they reached the surface water where surface waves would toss them around, 14 larvae were followed all the way to settlement. The longest that any larvae were followed was 15 minutes, with the exception of one larva which was swept off of the reef and swam for over 25 minutes over the sand flats.

RESULTS

Larval release observations

The larvae of *D. molle* are easily visible underwater. They are approximately 2.5 mm total length with the main body approximately 1 mm in length (Fig. 2a).

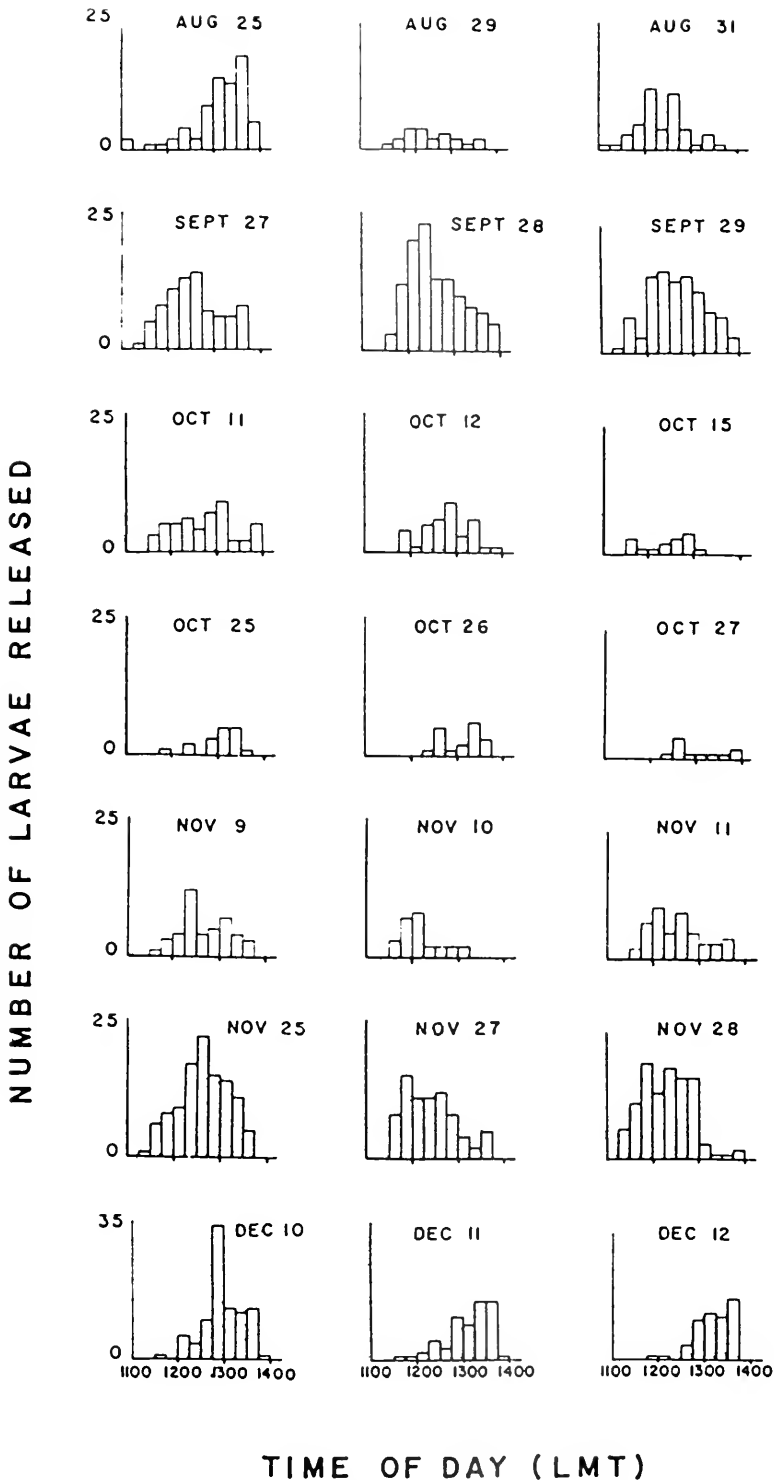

FIGURE 3. Daily larval release observations of 1981 showing the consistency of midday release times between days. The ordinate is number of larvae released during each 15 minute interval from the group of approximately 150 colonies shown in Figure 2B. The total number of colonies observed varied from day to day due to colonies dividing, migrating, and mortality.

The clump of bright green *Prochloron* algae attached to the larva make it easily discernable as a dark spot against a light background. Larvae release themselves by rupturing through the wall of the common cloaca where they have been developing, then swim vigorously out of the large common cloacal aperture (Kott, 1980). Similar to other colonial ascidian larvae (Millar, 1971), *D. molle* larvae are attracted to bright light during the beginning of their swimming stage. Larvae generally swim towards the surface, then drift back downward. After a short period of time (1–10 minutes) the larvae begin to seek dark surfaces. When visually following larvae, I had to maintain a distance of at least 0.5 m to prevent them from swimming towards my black wet suit.

A total of 88 larvae were followed in the field from their time of release. Of these, 14 were followed all the way to settlement. Their swimming times ranged from 40 seconds to 370 seconds, with a mean of 201 seconds (s.d. = 121). This value is, of course, skewed to the lower end since longer swimming larvae have a lesser chance of being followed all the way to settlement. However, it does show that many larvae swim for a very short period of time.

Of the 14 larvae that were followed all the way to settlement, twelve settled on the undersides of coral rubble and two settled on polyps of *Porites* coral. Fourteen observations were made of pomacentrid fish ingesting *D. molle* larvae. In all instances, the larvae were immediately egested and continued to swim, apparently unharmed. One larva disappeared into the inhalent siphon of a solitary ascidian (*Polycarpa* sp.). Several larvae were observed temporarily snagged on coral tentacles (acroporids and poritids), but they managed to free themselves. It thus appears that there are no major predators on the swimming stage of *D. molle*.

Larvae are released near midday. During a two week period larval settlement on settling plates was monitored every day at 11:00 and 16:00. Ninety-three percent of the recruitment took place during the midday interval. During hundreds of hours underwater, no larvae were ever seen before 10:30 or after 15:00. Figure 3 shows clear peaks in the daily time of larval release. The compilation of this data (Fig. 4)

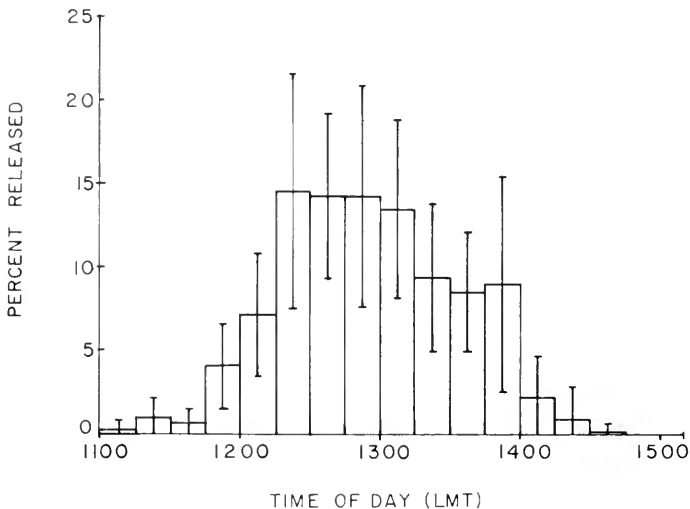

FIGURE 4. Compiled larval release times for all days of observation in which more than 40 larvae were released (N = 15 days, 1126 larvae). Bars represent 95% confidence limits. Note that 95% of all larvae were released between 11:00 and 14:00. Mean time of larval release is 12:54 (S.E. = 12.7 minutes).

gives a mean time of release of 12:54 (SE = 12.5 minutes). The data do not differ significantly from a normal distribution [Kolmogorov-Smirnoff, $d_{max} = 0.053$, $P > 0.1$ (Sokal and Rohlf, 1969)].

The symbiotic algae of *D. molle* are extracellular to the animal host. In an adult colony, the algae line the walls of the common cloaca. In a larva, the algae are attached to small hairlike projections at the posterior end of the larval body (Kott, 1980). Although no data exist on the physiological importance of the algae to the larva, it is doubtful that they contribute much to the larva's nutrition, considering their external location.

Photoadaptations of the algae

The ratio of chlorophyll a to chlorophyll b is generally regarded as a relative indicator of the light levels to which a plant is photoadapted (Boardman, 1977). Chlorophyll b is an accessory photosynthetic pigment, absorbing light primarily around 470 nm and 650 nm. It is usually produced in higher quantities in lower light environments. This appears to hold true for the *D. molle* colonies analyzed (Fig. 5). Adult colonies living deeper have greater amounts of chlorophyll b relative to chlorophyll a. However, examination of larvae collected from shallow water colonies (2 m depth) shows that their chl a/chl b ratio is less than that of their parent colonies. The larvae thus appear to be photoadapted to lower light regimes than the habitat of the parent colonies.

How can the larval algae have a lower chl a/chl b ratio than the parent from which it was released? Although current research suggests that some phytoplankton can alter their chlorophyll ratio in very short periods of time (Falkowski, 1980), it is doubtful that this is the case for *D. molle* larvae since they have such a brief swimming period and are exposed to a wide range of light intensities. The values presented in Figure 5 represent averages for extracts from whole colonies. There is undoubtedly a great deal of self-shading within a colony so that much less light

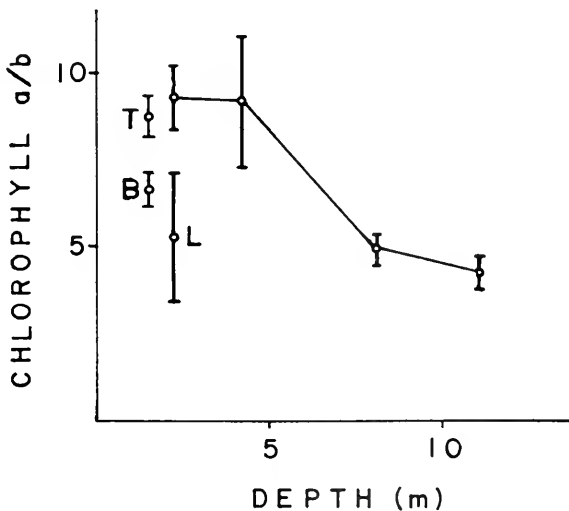

FIGURE 5. Chlorophyll a/b ratios of adult colonies (unlabeled points, $N = 5$ for each point), larvae (L) ($N = 8$ extractions of 30-40 larvae), and 3 colonies bisected into top (T) and bottom (B) halves. Error bars are standard deviations.

reaches the bottom of the colony than the top. Three colonies from 2 m depth were bisected with a razor blade into upper and lower halves. Each portion was analyzed for chlorophylls. The results are points T (top) and B (bottom) in Figure 5. The lower half has a chl a/chl b ratio approaching the larvae, suggesting that the larvae gather their algae from the lower portion of the colony. Unfortunately, it was not possible to observe larvae within the colony previous to release.

Substrate choice experiments

In the substrate choice experiment (Table III), the larvae almost unanimously chose the dark substrata, indicating that they are capable of differentiation between dark and light surfaces.

Larvae settled in a somewhat distinct band around the outer edge of the undersides of settling panels. Figure 6 shows the frequency distributions of larvae settled on panels at 2 and 4 m depths. Table IV gives the mean values for the edge distances. Although there was considerable variation, there was a clear tendency for larvae to settle closer to the edge at the deeper site. Comparison of observed edge distances with the expected distribution based on random settlement and area alone, shows that larvae settled predominantly near the edge (Fig. 7).

Light intensities were measured beneath the settling plates at the mean edge distances (Table IV) of settled larvae. The light intensity at the mean edge distance measured at the shallow and deep sites was 100 and 110 $\mu\text{E m}^{-2}\text{s}^{-1}$, respectively (Fig. 8). Thus larvae appear to seek a light intensity of approximately 100 $\mu\text{E m}^{-2}\text{s}^{-1}$. This means that at deeper sites, where light intensity on the top of surfaces is less than 100 $\mu\text{E m}^{-2}\text{s}^{-1}$, larvae should settle on the upper surfaces of substrata. At Lizard Island, this light intensity occurs around 15 m depth. At this depth, juveniles were found living in unshaded sites.

There are rare instances when newly settled larvae are found in unshaded habitats in shallow water, but these are certainly the exception. As a part of another study of *D. molle* recruitment at Lizard Island, settlement of larvae on settling panels at 2 m depth was recorded over five days every two weeks. Of over 3000 settled larvae, only three settled on the topside of the settling panels. The rest settled on the undersides or occasionally on the legs of the panels. Juvenile colonies were never observed living in full sunlight. They are generally found on the undersides of coral plates. Figure 9 shows the size distribution of *D. molle* colonies on the topside and underside of a coral plate collected from 2 m depth. The 0.1 gm size class of the underside population was composed primarily of newly settled juveniles, still green in color. None of the topside colonies were green.

TABLE III

*Substrate choice experiment**

Trial	N	Roof		Bottom	Side	Not Attached
		Black	White			
1	35	65	0	6	3	26
2	33	40	3	30	24	3
3	71	79	0	15	6	0

* Roof of chamber was painted with black and white squares. Data are percent of all larvae in treatment (N).

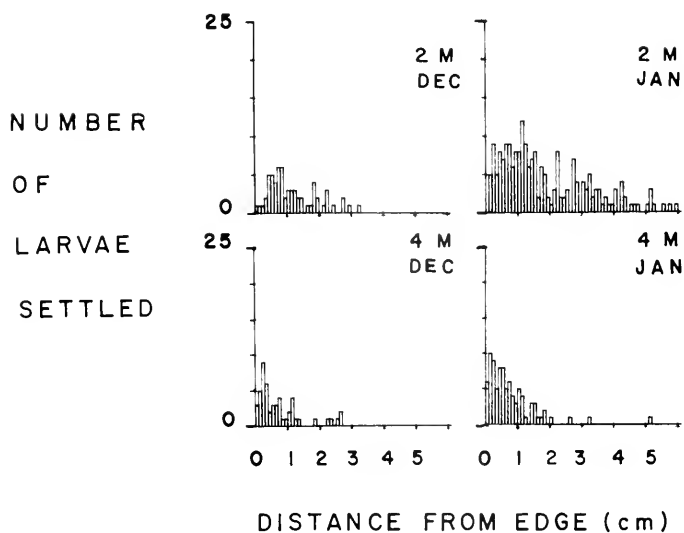

FIGURE 6. Distributions of edge distances of larvae that settled on the undersides of settling panels at 2 and 4 m depth during one week in December, 1981, and January, 1982.

Survivorship experiment

Four days of full sunlight was lethal to the newly settled larvae (Table V). Healthy juveniles are colored bright green by their symbiotic algae. They have few spicules and thus the algae can be seen through the tunic. Juveniles exposed to full sunlight changed from bright green to light green to grayish-brown, then withered and died. Colonies in the shade appeared healthy and of normal size and color, as did the control colonies. Colonies beneath the clear plexiglas roof did not die as rapidly as those fully exposed, probably because they were shaded by a small amount of sediment which accumulated each day on the plexiglas roof. They did, however, show the same evidence of deterioration and their mortality was also high. This is interesting since plexiglas is an effective filter of ultraviolet radiation (Jagger, 1977).

Larval swimming time experiments

D. molle larvae are capable of swimming for more than an hour if they do not find a suitable site for settlement (Fig. 10). In the clear treatment, all nonsettled

TABLE IV

Mean edge distances (\bar{X}) of larvae settled on the bottoms of settling panels at 2 and 4 m depths*

Depth (m)		December sample	January sample
2	\bar{X}	1.75	1.95
	s.d.	1.09	1.55
4	\bar{X}	0.80	0.78
	s.d.	0.70	0.78

* Measurements are cm from the edge of the panel. s.d. = standard deviation.

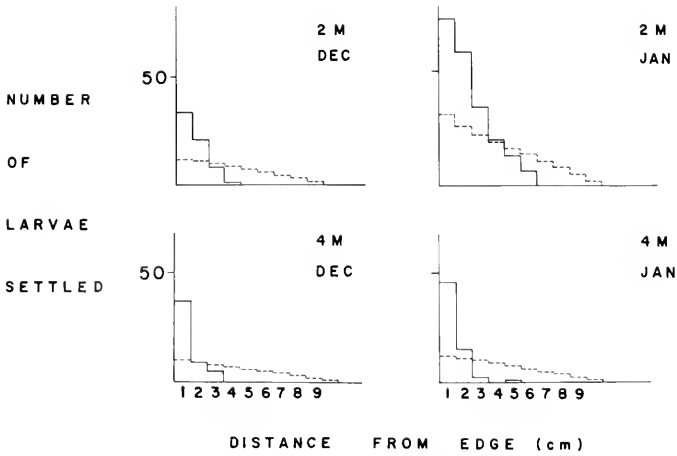

FIGURE 7. Comparison of observed (solid line) and expected random (dashed line) distributions of edge distances of settled larvae. Expected distributions were calculated by multiplying the total number of larvae by the amount of area in the distance interval.

larvae were lying on the bottom of the chamber after one hour, only occasionally swimming up off the bottom. By 1.5 hours, all larvae had ceased swimming. This is in contrast to the dark experiment in the lab (Table VI) in which almost half of the larvae were still active after two hours. Thus it appears that larvae can swim longer in lower light environments. This would be important to larvae swept into deeper water.

What happens if larvae do not find a suitable substratum for settlement? It has already been shown that larvae prefer dark substrata over light (Table III). This result is seen again in the larval swimming experiment (Fig. 10). In the roof and shade treatments the majority of larvae settled within the first twenty minutes. The

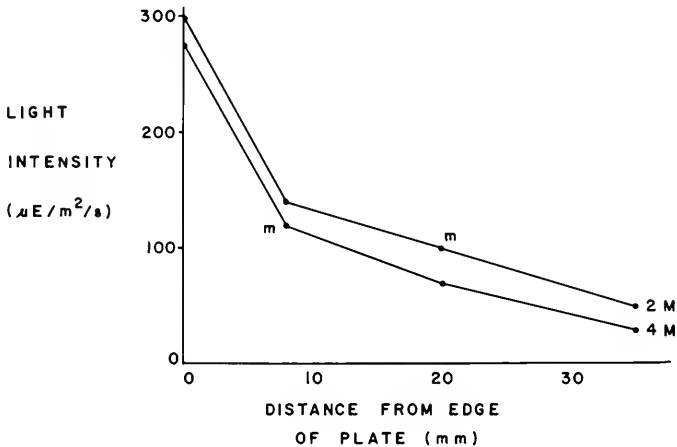

FIGURE 8. Light intensities measured on the undersides of settling panels. Points labeled "m" correspond to mean "edge distances" of settled larvae at respective depths.

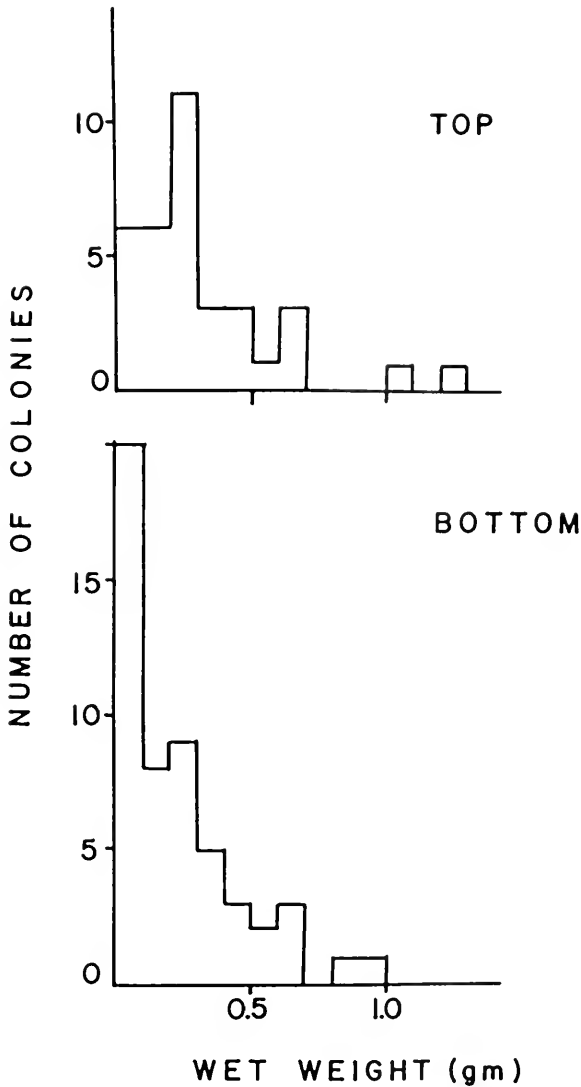

FIGURE 9. Size distributions of colonies on the top and bottom of a dead coral plate collected from 2 m depth. Note that the largest size class of colonies on the underside of the plate is the 0.1 g size group.

larvae settled primarily on the top of the chamber in the roof and shade treatments (Table VII).

In the clear treatment, where larvae were given no dark substrata or shade, the larvae swam continuously upward. After about 45 minutes, most of the larvae lay on the bottom, still swimming, but seldom raising above the bottom. Eventually most of these larvae attached themselves to the bottom where they metamorphosed. The survivorship experiment (Table V) showed that an unshaded settlement site is lethal. Thus the denial of a suitable site (shade) eventually results in the larvae settling in a much less suitable or certain-death habitat.

TABLE V

*Juvenile survivorship experiment**

Treatment	Total number of larvae	Mean % survivorship after 4 days	Standard deviation	Level of significance
Shade	34	77.3	28.0	—
Control	54	82.2	12.6	N.S.
Clear plexiglas	35	38.3	20.5	$P < 0.01$
Full sunlight	28	2.7	4.6	$P < 0.001$

* See text for explanation of treatments. Data tested for significant difference from shade treatment using single factor analysis of variance ($F_s = 12.23$, $P < 0.01$) with Student-Newman-Keuls multiple comparisons test. Data were arcsine transformed (Zar, 1974). Each treatment was replicated 3 times.

The ability of larvae to delay their settlement is important in an habitat like the Lizard Island lagoon. Patch reefs provide plenty of suitable habitats for the larvae, but between them lie bright white sand flats with little or no shaded substrata. By postponing settlement, larvae can drift over the sand flats until they encounter another patch reef, thus achieving inter-reef recruitment.

DISCUSSION

The larval stage of *Didemnum molle* is not substantially different from the typical colonial ascidian larval phase as described by Millar (1971). Upon release, larvae are positively phototactic, swimming towards bright light. They gradually change to negative phototaxis and negative geotaxis, swimming upwards and settling on the undersides of dark surfaces. What appears to be distinguishing about *D. molle* (and perhaps all ascidian-algal associations, see Table II) is that the larvae are released only in the middle of the day with a peak shortly after meridian passage of the sun. This phenomenon held true for *D. molle* during the three seasons (spring, summer, winter) in which it was studied. Duyl *et al.* (1981) reported a similar midday timing of larval release for *Trididemnum solidum*, a Caribbean ascidian-algal symbiosis.

Larval release by colonial ascidians has previously been reported to occur primarily at dawn or first light after a long period of darkness (Table I). However, as Kott (pers. comm.) notes, most of the ascidians studied have been temperate species. In all of the papers cited in Table I, there is little speculation as to the functional

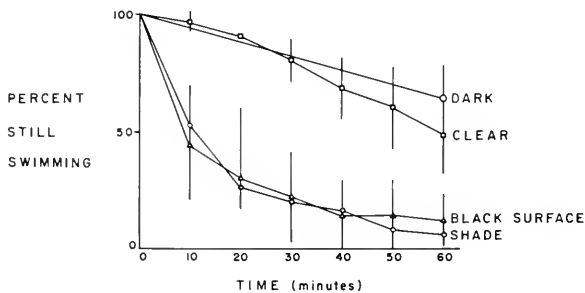

FIGURE 10. Larval swimming time experiment. See text for explanation of treatments. Bars represent 95% confidence limits. Dark treatment was examined only at 60 minutes. Each treatment was replicated four times, except the dark treatment ($N = 3$). Each replicate contained ten larvae.

TABLE VI

Percent larvae swimming (sw), metamorphosed and attached (m/a), and metamorphosed but not attached (m/na) after two hours in total darkness

Trial	N	sw	m/a	m/na
1	25	48	40	12
2	16	44	44	12
3	12	33	33	33

significance of the timing of larval release. Watanabe and Lambert (1973) noted that the larvae of *Distaplia occidentalis* are released only during daylight and primarily in the morning. Their behavior and settlement is closely attuned to light conditions, with the larvae settling in dark habitats. This presumably enables them to find cracks and crevices which provide refuge from predators and physical stress such as strong currents. But no experiments were performed to test whether survivorship is greater in cracks and crevices.

Experiments with the larvae of *D. molle* suggest a clear purpose for the midday timing of larval release. The light intensity of the juvenile habitat appears to be a very important (if not the most important) factor determining the suitability of the settlement site. Too much light is lethal to the juvenile (Table V), too little light reduces the growth and photosynthetic rate of the algae which probably has a direct effect on the growth of the ascidian. By releasing larvae at midday, when light intensity is greatest, adult colonies enable their larvae to search for settlement sites

TABLE VII

Settlement sites of larvae in swimming experiment conducted on reef*

Treatment		Larval settlement site					Multiple comparison				
		Sw	T	B	Si	M	Sw	B	Si	T	M
Clear	X%	47.5	10.0	30.0	12.5	0.0	<u>Sw</u>	<u>B</u>	<u>Si</u>	<u>T</u>	<u>M</u>
	X% _a	47.5	5.0	24.0	12.23	0.0					
	s _a	1.0	7.7	11.8	0.5	0.0					
Shade	X%	5.0	45.0	15.0	35.0	0.0	<u>T</u>	<u>Si</u>	<u>B</u>	<u>Sw</u>	<u>M</u>
	X% _a	2.6	43.6	2.0	28.8	0.0					
	s _a	3.4	14.2	11.4	19.1	0.0					
Black Surface	X%	12.5	50.0	27.5	7.5	2.5	<u>T</u>	<u>B</u>	<u>Sw</u>	<u>Si</u>	<u>M</u>
	X% _a	9.1	49.6	25.4	3.8	0.6					
	s _a	5.5	5.1	5.7	5.4	2.5					
Dark	X%	3.3	6.7	20.0	56.7	13.3	<u>Sw</u>	<u>B</u>	<u>M</u>	<u>T</u>	<u>Si</u>
	X% _a	0.3	1.4	11.7	56.8	5.3					
	s _a	1.0	4.0	8.8	1.4	4.0					

* See text for explanation of treatments. Results of treatments underlined at right were not significantly different from each other using Student-Newman-Keuls multiple comparisons test ($P < 0.05$). N = 4 trials for each treatment, except for dark treatment (N = 3). Each trial included ten larvae. Sw—larvae still swimming; T—settlement on top of chamber; B—settlement on bottom of chamber; Si—settlement on side of chamber; M—larvae that metamorphosed but did not attach; X%—mean percent settlement; X%_a—mean percent settlement using arcsin transform on data, then back transforming; s_a—standard deviation of transformed data.

under the most extreme conditions, minimizing the chance of settling in a location that is too bright.

Given that the algae within the parent colony are photoadapted to different light levels according to their depth in the colony (Fig. 5), why should the larvae have evolved to collect algae from the more shade adapted portion of the parent colony? The larvae and juveniles lack the photoadaptations of the adult colonies and thus must settle in a low light habitat. Adult colonies contain calcareous stellate spicules [40–80 μm in diameter (Kott, 1980)] and a dark brown animal pigment (D. Parry, pers. comm.) in the outer test of the colony. These materials shield the algae from much visible and ultraviolet radiation. The test of the larvae and young juveniles is transparent, lacking both the spicules and brown pigment. Juveniles are the color of their symbiotic algae due to this transparency. After two days, juveniles begin to produce spicules which originate around each zooid (Fig. 2b). Although calcareous spicules are found in many colonial ascidians without symbiotic algae (Van Name, 1945), in the algal-ascidian symbioses they appear to have been modified into a photobiological role. The Caribbean species *Trididemnum solidum* produces a significantly higher proportion of spicule versus tissue in higher light intensity habitats (Olson, 1980).

At about two weeks of age, brown pigmentation begins to appear in the test of juvenile *D. molle* colonies. Experiments by Jokiel (1980) have demonstrated a lethal effect of ultraviolet radiation on invertebrates that normally live in the shade. *D. molle* has obviously evolved a means of protecting itself in the adult stage from the damaging effects of ultraviolet radiation. It is probably the spicules and brown pigment that achieve this. By gathering shade-adapted algae prior to release from the parent colony, the larva is prepared to settle in a low light environment and thus does not require spicules and brown pigment for a shield. The small size of the larvae probably prohibits them from already possessing these photoadaptations upon release.

Examination of dead coral plates and rubble on the shallow reefs around Lizard Island shows that the undersides are the nurseries for *D. molle* (Fig. 9). Juvenile colonies (green in color) are found only on the undersides of such substrata. It appears that juveniles grow on the undersides until they have acquired the proper photoadaptations (spicules and pigment), then migrate around the edge of the coral plates into the full intensity of sunlight (up to $2600 \mu\text{E m}^{-2}\text{s}^{-1}$) (Fig. 11). Colonial ascidians have long been known to move, through the extension of stolonial test vesicles (Carlisle, 1961). Birkeland *et al.* (1981) documented whole colony movement by didemnid ascidians in general, and Cowan (1981) reported movement by *D. molle*. I attempted to follow juveniles through this stage in the field by placing markers beside them, but this proved impossible since it required daily monitoring for more than a month. When occasional rough weather interrupted the monitoring, the colonies were lost. Nevertheless, juveniles are found on the undersides and adults are found mostly on the topsides (Fig. 9). The migration probably takes several weeks.

Larval ecology of algal-invertebrate symbioses

Relatively little research has been conducted on the larval ecology of algal-invertebrate symbioses. The findings of this study of *D. molle* are relevant to other invertebrates with lecithotrophic larvae containing algae. These include corals such as *Pocillopora damicornis* (Edmundson, 1929; Kawaguti, 1941; Harrigan, 1972), *Seriotopora hystrix* (Atoda, 1951), and *Favia fragum* (Lewis, 1974).

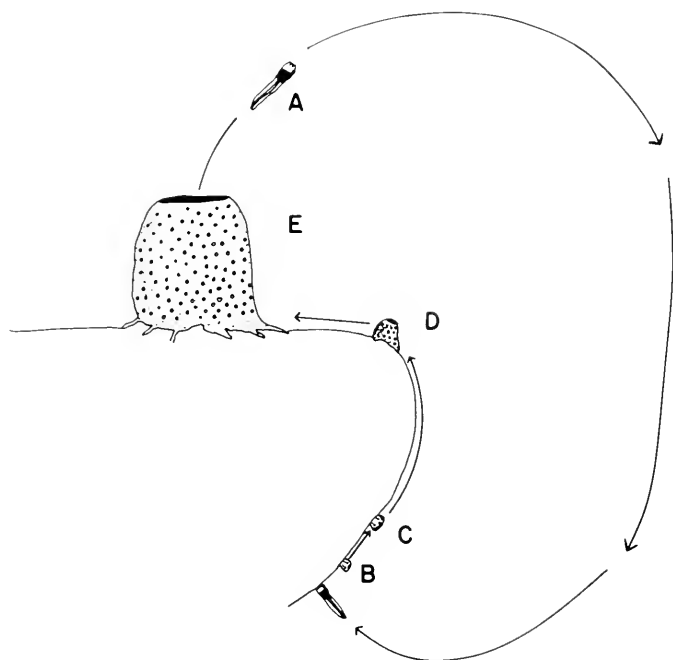

FIGURE 11. The life cycle of *D. molle*. Stages A–D correspond to photos in Figure 1. Larvae are released and settle at midday. Tail resorption by the larva is completed approximately 20 minutes after attachment. Complete metamorphosis takes approximately 3 hours. By late afternoon most colonies have three functioning zooids (B). At six days all zooids divide to form a total of 6 zooids. Another synchronous division usually occurs at 12 days, after which division is asynchronous. As a colony produces more spicules and acquires brown pigmentation (D) it presumably migrates into full sunlight (E).

Lewis (1974) studied settlement of the hermatypic coral *Favia fragum* in the laboratory. The larvae showed a preference for dark surfaces and settled primarily on the undersides of substrata in dishes. When the substrata were inverted shortly after settlement, the larvae detached themselves and moved to the underside again. Lewis, surprised that a photosynthetic organism would settle in the shade, conjectured that it was probably a predator avoidance phenomenon. No consideration was given to the differences in photoadaptations between the adults and larvae. It is possible that the juveniles of *F. fragum*, similar to *D. molle*, cannot survive in full sunlight. Harrigan (1972) found that the larvae of *P. damicornis* also prefer to settle on dark surfaces.

Goreau *et al.* (1981) examined settling patterns and mortality of planulae larvae from the coral *Porites porites*. Larvae which settled on the sides of aquaria had a much higher mortality rate than those which settled on the bottom. They suggested that this might be due to reduced food availability. However, no consideration was given to light as a factor. Juveniles on the side were illuminated from all sides, whereas those on the bottom were dark on their undersides as well as being deeper in the water. Survivorship of larvae in shade was not investigated. Mortality was greatly reduced once the juveniles produced a skeleton. This may be analogous to spicule production in *D. molle* juveniles which results in a tolerance for greater light intensities.

Birkeland (1977) found that Caribbean corals at 9 m depth recruited more frequently on the sides and undersides of cement blocks than upper surfaces. At deeper sites the recruitment shifted towards the upper surface. Birkeland *et al.* (1981) report the same result for Pacific corals around Guam. His explanation is that macroalgae and sediment on the upper surface inhibit coral larval settlement. No mention is made of possible differences in photoadaptations between larvae and adults. The shift towards the upper surfaces at greater depths is similar to larval settlement edge distances for *D. molle* (Figs. 6, 7). Loya (1976) also found that the coral *Stylophora pistilata* settled and survived primarily on the undersides of surfaces in shallow-water habitats at Eilat, Israel.

Competition for space among sessile invertebrates is a popular explanation of community structure on coral reefs (Lang, 1973; Jackson and Buss, 1975; Connell, 1976; Bak *et al.*, 1977; Sheppard, 1979; Benahayu and Loya, 1981). It has been assumed that adult sessile invertebrates usurp potential larval settlement area (Maguire and Porter, 1977; Benahayu and Loya, 1981). If coral planulae are unable to withstand full sunlight, then adults may generate more suitable settlement space (their shade and undersides) than they consume. For the colonial ascidian *Didemnum molle*, there is little overlap between the habitats of the adults and newly metamorphosed larvae. Many other algal-invertebrate symbioses, upon close inspection, may follow the same pattern.

ACKNOWLEDGMENTS

The Lizard Island Research Station and the Australian Institute of Marine Sciences generously provided research facilities. C. Cavanaugh, C. Crockroft, P. Filmer-Sankey, B. and L. Goldman, V. Harriot, M. Harriss, T. Givnish, R. Grosberg, R. Pardy, M. Patterson, H. Sweatman, K. Sebens, and L. Vail contributed helpful discussion. Figure 2a was kindly provided by P. Parks. P. Mather donated collecting materials. M. Harriss, H. Olson, and M. Patterson gave endless moral support for which I am grateful. Lastly, I thank R. T. Paine and T. Suchanek for their initial encouragement. This research was supported by the Franklin B. Knox Fellowship of Harvard University and NSF grant OCE 81-14299.

LITERATURE CITED

- ABBOTT, D. P. 1955. Larval structure and activity in the ascidian *Metandrocarpa taylori*. *J. Morphol.* **97**: 569-594.
- ATODA, K. 1951. The larval and postlarval development of some reef building corals. V. *Seriotopora hystrix* Dana. *Sci. Rep. Tohoku Univ. Fourth Ser.* **19**: 33-39.
- BAK, R. P. M., J. J. W. M. BROUNS, AND F. M. L. HAYS. 1977. Regeneration and aspects of spatial competition in the scleractinian corals *Agaricia agaricites* and *Montastrea annularis*. *Proc. 3rd Int. Symp. Coral Reefs* **1**: 143-148.
- BENAYAHU, Y., AND Y. LOYA. 1981. Competition for space among coral-reef sessile organisms at Eilat, Red Sea. *Bull. Mar. Sci.* **31**(3): 514-522.
- BIRKELAND, C. 1977. The importance of rate of biomass accumulation in early successional stages of benthic communities to the survival of coral recruits. *Proc. 3rd Int. Symp. Coral Reefs* **1**: 15-21.
- BIRKELAND, C., L. CHENG, AND R. LEWIN. 1981. Motility of didemnid ascidian colonies. *Bull. Mar. Sci.* **31**: 170-173.
- BIRKELAND, C., D. ROWLEY, AND R. H. RANDALL. 1981. Coral recruitment patterns at Guam. *Proc. 4th Int. Coral Reef Symp.* **2**: 339-344.
- BOARDMAN, R. K. 1977. Comparative photosynthesis of sun and shade plants. *Ann. Rev. Plant Physiol.* **28**: 355.
- CARLISLE, D. B. 1961. Locomotory powers of adult ascidians. *Proc. Zool. Soc. Lond.* **136**: 142-146.

- CONNELL, J. H. 1976. Competitive interactions and the species diversity of corals. Pp. 51-58 in *Coelenterate Ecology and Behavior*, G. O. Mackie, ed. Plenum Press, N. Y.
- COSTELLO, D. P., AND C. HENLEY. 1971. *Methods for obtaining and handling marine eggs and embryos*, 2nd ed. Mar. Biol. Lab., Woods Hole, MA.
- COWAN, M. E. 1981. Field observations of colony movement and division of the ascidian *Didemnum molle*. *Mar. Ecol. Prog. Ser.* **6**: 335-337.
- CRISP, D. J., AND A. F. A. GHOBASHY. 1971. Responses of the larvae of *Diplosoma listerianum* to light and gravity. Pp. 443-465 in *4th European Mar. Biol. Symp.*, D. J. Crisp, ed.
- DUYL, F. C. VAN, R. P. M. BAK, AND J. SYSBESMA. 1981. The ecology of the tropical compound ascidian *Trididemnum solidum*. I. Reproductive strategy and larval behaviour. *Mar. Ecol. Prog. Ser.* **6**: 35-42.
- EDMONDSON, C. H. 1929. Growth of Hawaiian corals. *Bull. Bernice P. Bishop Mus.* **58**: 1-38.
- FALKOWSKI, P. G. 1980. Light-shade adaptation in marine phytoplankton. Pp. 531-549 in *Primary Production in the Sea*, P. G. Falkowski, ed. Plenum Press, New York.
- GOREAU, N. I., T. J. GOREAU, AND R. L. HAYES. 1981. Settling, survivorship and spatial aggregation in planulae and juveniles of the coral *Porites porites* (Pallas). *Bull. Mar. Sci.* **31**(2): 424-435.
- GRAVE, C. A. 1936. Metamorphosis of ascidian larvae. *Carnegie Inst. Wash. Pap. Tortugas Lab.* **29**: 209-291.
- GRAVE, C. A. 1937. Notes on the culture of eight species of ascidians. Pp. 560-564 in *Culture Methods for Invertebrate Animals*, P. S. Galtsoff, F. E. Lutz, P. S. Welch, and J. G. Needham, eds. Comstock Press, Ithaca, NY.
- GRAVE, C. A., AND G. MCCOSH. 1923. *Perophoris viridis* Verrill: The activities and structure of the free swimming larvae. *Wash. Univ. Stud. Sci. Ser.* **11**: 89-116.
- GRAVE, C. A., AND H. WOODBRIDGE. 1924. *Botryllus schlosseri* (Pallas): The behavior and morphology of the free swimming larva. *J. Morphol.* **39**: 207-247.
- GROSBURG, R. K. 1981. Competitive ability influences habitat choice in marine invertebrates. *Nature* **290**: 700-702.
- GROSBURG, R. K. 1982. Intertidal zonation of barnacles: the influence of planktonic zonation of larvae on vertical distribution of adults. *Ecology* **63**(4): 894-899.
- HARRIGAN, J. F. 1972. Behavior of the planula larva of the scleractinian coral *Pocillopora damicornis* L. *Am. Zool.* **12**: 723.
- JACKSON, J. B. C. 1977. Competition on marine hard substrata: the adaptive significance of solitary and colonial strategies. *Am. Nat.* **111**: 743-767.
- JACKSON, J. B. C., AND L. W. BUSS. 1975. Allelopathy and spatial competition among coral reef invertebrates. *Proc. Nat. Acad. Sci. U.S.A.* **72**(12): 5160-5163.
- JAGGER, J. 1977. Phototechnology and biological experimentation. Pp. 1-26 in *The Science of Photobiology*. Plenum Press, New York.
- JEFFREY, S. W., AND G. F. HUMPHREY. 1975. New spectrophotometric equations for determining chlorophylls a, b, c1, and c2 in higher plants, algae and natural phytoplankton. *Biochem. Physiol. Pflanz.* **167**: 191-194.
- JOKIEL, P. 1980. Solar ultraviolet radiation and coral reef epifauna. *Science* **207**: 1069-1071.
- KAWAGUTI, S. 1941. On the physiology of reef corals V. Tropisms of coral planulae considered as a factor of distribution. *Palao Trop. Biol. Sta. Stud.* **2**: 319-328.
- KOTT, P. 1980. Algal-bearing didemnid ascidians in the Indo-West Pacific. *Mem. Queensl. Mus.* **20**(1): 1-47.
- KEOUGH, M. J., AND B. J. DOWNES 1982. Recruitment of marine invertebrates: the role of active larval choices and early mortality. *Oecologia* **54**: 348-352.
- LAFARGUE, F., AND G. DUCLAUX. 1979. Premier exemple en Atlantique tropical d'une association symbiotique entre une ascidie didemnidae et une cyanophycee chroococcale: *Trididemnum cyanophorum* nov. sp. et *Synechocystis trididemni* nov. sp. *Ann. Inst. Oceanogr. Paris* **55**: 163-184.
- LAMBERT, G. 1979. Early post-metamorphic growth, budding and spicule formation in the compound ascidian *Cystodytes lobatus*. *Biol. Bull.* **157**: 464-477.
- LANG, J. C. 1973. Interspecific aggression by scleractinian corals. 2. Why the race is not only to the swift. *Bull. Mar. Sci.* **23**: 260-279.
- LEWIN, R. A. 1976. Prochlorophyta as a proposed new Division of algae. *Nature* **261**: 697-698.
- LEWIN, R. A., AND N. W. WITHERS. 1975. Extraordinary pigment composition of a prokaryotic alga. *Nature* **256**: 735-737.
- LEWIS, J. B. 1974. The settlement behavior of planulae larvae of the hermatypic coral *Favia fragum* (Esper). *J. Exp. Mar. Biol. Ecol.* **15**: 165-172.
- LOYA, Y. 1976. Settlement, mortality and recruitment of a Red Sea scleractinian coral population. Pp. 89-100 in *Coelenterate Ecology and Behavior*, G. O. Mackie, ed. Plenum Press, New York.

- MAGUIRE, L., AND J. W. PORTER. 1977. A spatial model of growth and competition strategies in coral communities. *Ecol. Model.* **3**: 249-271.
- MAST, S. O. 1921. Reactions to light in the larvae of the ascidians, *Amaroucium constellatum* and *Amaroucium pellucidum* with special reference to photic orientation. *J. Exp. Zool.* **34**: 149-187.
- MEADOWS, P. S., AND J. I. CAMPBELL. 1972. Habitat selection by aquatic invertebrates. *Adv. Mar. Biol.* **10**: 271-382.
- MILLAR, R. H. 1971. The biology of ascidians. *Adv. Mar. Biol.* **9**: 1-100.
- MORGAN, T. O. 1977. Growth rate, age at sexual maturity, longevity, and seasonality in three West Indian colonial ascidians. Masters thesis, Univ. Puerto Rico.
- MORIARTY, D. J. W. 1979. Muramic acid in the cell walls of *Prochloron*. *Arch. Microbiol.* **120**: 191-193.
- NEWCOMB, E. H., AND T. D. PUGH. 1975. Blue-green algae associated with ascidians of the Great Barrier Reef. *Nature* **253**: 533-534.
- OLSON, R. R. 1980. Sun-shade adaptations of a colonial ascidian with a procaryotic symbiont. *Am. Zool.* **20**: 778.
- PALMER, A. R., AND R. R. STRATHMANN. 1981. Scale of dispersal in varying environments and its implications for life histories of marine invertebrates. *Oecologia* **48**: 308-318.
- RYLAND, J. S. 1974. Behavior, settlement, and metamorphosis of bryozoan larvae. *Thalassia Jugosl.* **10**: 239-262.
- SEBENS, K. P. 1981. Recruitment in a sea anemone population: Juvenile substrate becomes adult prey. *Science* **213**: 785-787.
- SEEWALDT, E., AND E. STACKEBRANDT. 1982. Partial sequence of 16S ribosomal RNA and the phylogeny of *Prochloron*. *Nature* **295**: 618-620.
- SCOTT, S. F. M. 1954. Metamorphic differentiation in *Amaroucium constellatum* treated with nitrogen mustard. *J. Exp. Zool.* **127**: 331-365.
- SHEPPARD, C. R. C. 1979. Interspecific aggression between reef corals with reference to their distribution. *Mar. Ecol. Prog. Ser.* **1**: 237-247.
- SOKAL, R., AND F. ROHLF. 1969. *Biometry*. W. H. Freeman Co., San Francisco, CA. 776 pp.
- VAN NAME, W. G. 1945. The North and South American ascidians. *Bull. Am. Mus. Nat. Hist.* **84**: 1-45.
- WATANABE, H., AND C. C. LAMBERT. 1973. Larva release in response to light by the compound ascidians *Distaplia occidentalis* and *Metandrocarpa taylora*. *Biol. Bull.* **144**: 556-566.
- WHATLEY, J. M. 1977. The fine structures of *Prochloron*. *New Phytol.* **79**: 309-313.
- YAMAGUCHI, M. 1975. Growth and reproduction cycles of the marine fouling ascidians *Ciona intestinalis*, *Styela plicata*, *Botrylloides violaceus*, and *Leptoclinium mitsukurii* at Aburatsubo-Moroiso Inlet (Central Japan). *Mar. Biol.* **29**: 253-259.
- ZAR, J. H. 1974. *Biostatistical Analysis*. Prentice-Hall, Inc. Englewood Cliffs, NJ. 620 pp.

A NEW STRAIN OF *PARATETRAMITUS JUGOSUS* FROM LAGUNA FIGUEROA, BAJA CALIFORNIA, MEXICO

LAURIE K. READ¹, LYNN MARGULIS¹, JOHN STOLZ¹, ROBERT OBAR²,
AND THOMAS K. SAWYER³

¹*Department of Biology and* ²*Department of Chemistry, Boston University, Boston, MA 02215, and*

³*National Marine Fisheries Service, U. S. Department of Commerce, Oxford, MD 21654*

ABSTRACT

A euryhalic, moderately temperature tolerant, fast growing strain of the amoebomastigote¹ *Paratetramitus jugosus* was isolated from the North Pond flat laminated microbial mat at Laguna Figueroa, Baja California del Norte, Mexico. The morphology was studied with phase contrast, differential interference contrast, scanning, and transmission electron microscopy. On the basis of its life cycle characteristics, growth rate, salt and heat tolerance, fluorescence excitation and emission spectra, and isozymes, the organism was determined to be a new strain, *P. jugosus baja californiensis*. This new strain, unlike the type specimen (ATCC 30703), grows vigorously on half strength sea water and slowly at 0.51 M (nearly 3 per cent) sodium chloride. It tolerates the hypersaline conditions of the evaporite flat that prevail when the North Pond mats are dominated by *Microcoleus* and other bacteria, growing well during periods of influx of fresh water. Its cysts survive complete dryness of the sediment for at least three years.

The microbial mats in which this *Paratetramitus jugosus* has been found are thought to have Archean analogues over 3 billion years old. The discovery of resistant abundant small eukaryotes within a setting dominated by bacteria may be important for the interpretation of the Proterozoic microbial fossil record.

INTRODUCTION

We report here the isolation and identification of an extremely fast growing, hardy, desiccation resistant new strain of the amoebomastigote (=amoeboflagellate)¹ *Paratetramitus jugosus* from the North Pond of Laguna Figueroa, Baja California del Norte, Mexico (Fig. 1).

The living microbial mats of Laguna Figueroa, Baja California, have been compared with the 3400 million year old carbon-rich Fig Tree cherts of the Swaziland System of rocks from South Africa (Margulis, *et al.*, 1980). These laminated rocks, as well as others also deposited over 3 billion years ago from western Australia (Lowe, 1980), show a textural and paleoecological resemblance to the flat laminated bacterial mats of Baja California. Fossils of bacteria have been found in some of the most ancient cherts (Knoll and Barghoorn, 1977; Awramik *et al.*, 1983) and there is a continuous record of such microfossils from over three billion years ago to the present. However, the time of appearance of the first eukaryotic microorganisms

Received 8 November 1982; accepted 18 May 1983.

¹ The terms "flagella" and "flagellate" are ambiguous since they refer to both flagellin-containing bacterial structures and tubulin (9 + 2) eukaryotic structures, and the organisms which bear them, respectively (Margulis, 1980). In this paper we restrict "flagella" and "flagellate" to the bacteria we describe and use "undulipodia" for the eukaryotic structures and "mastigote" for the organism that bears them. We replace "amoeboflagellate" with "amoebomastigote."

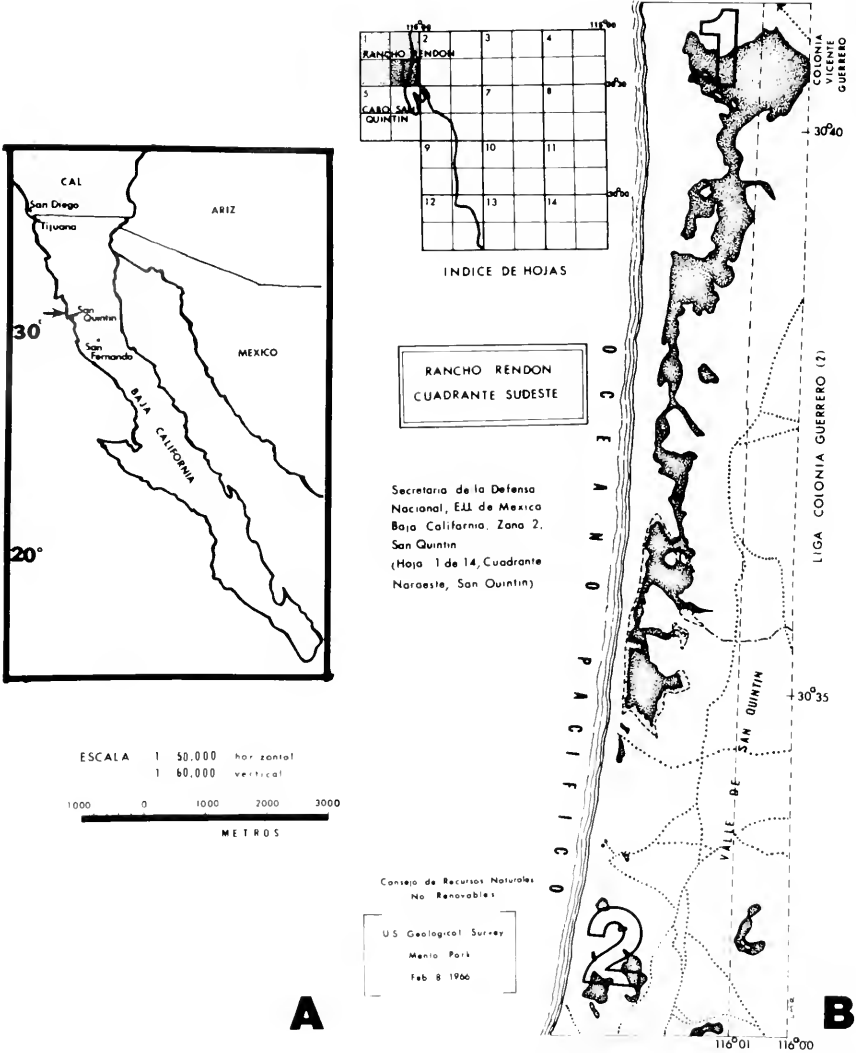

FIGURE 1. Map of Baja California del Norte. A. Location of Laguna Figueroa and field sites. B. The organism has been isolated from North Pond (site 1) and South Salinas (site 2).

in the fossil record is not known with certainty (Francis *et al.*, 1978). The first protists are thought to have appeared before 1400 million years ago (Knoll, 1982). We initiated this study on the protistan composition of the bacterial mats to identify the major eukaryotes in ecosystems overwhelmingly dominated by bacteria in the hope of providing a better interpretation of the fossil record of laminated mats and microorganisms preserved in cherts.

During the spring of 1979 an unusually severe flood occurred at Laguna Figueroa, submerging the mats under one meter of fresh water until late August. The flood water, which contained terrigenous sediment from the neighboring alluvial plains, subsided by the late summer of 1979 but the rains of winter 1979-80 were even more severe. From December 1979 until late summer 1981 the mats were

continuously flooded with fresh water. Never during the entire summer of 1980 did the *Microcoleus* community emerge and grow. These episodes drastically altered the composition of the mats from their relatively stable former state (described by Horodyski *et al.*, 1975, 1977). When the fresh water finally subsided, the productive cyanobacterial community was replaced by a different community of heterotrophs and purple photosynthetic sulfur bacteria, mainly by thiocapsoids (Margulis *et al.*, 1983; Stolz, 1983a). From both submerged samples of the *Microcoleus* mat and from reemerged samples, *Paratetramitus jugosus* amoebae were recovered in impressive numbers from every mat sample transferred onto permissive plates.

Several features of this amoebomastigote including its morphology, fluorescence, as well as salt, heat, and desiccation tolerance are described here. The Baja California isolate is compared with the original American Type Culture Collection strain (ATCC 30703).

MATERIALS AND METHODS

Growth and isolation

The two kinds of media used in this study (modified K and manganese acetate, Table I) were taken to the field study site at North Pond, Laguna Figueroa, Baja

TABLE I

<i>Media</i>	
<i>Modified K medium</i>	
MnSO ₄ · 4H ₂ O	0.1 g
Bacto-Peptone	1.0 g
Yeast extract	0.25 g
Agar	7.5 g
500 ml ASW (autoclaved together)	
<i>Manganese acetate medium</i>	
Mn(C ₂ H ₃ O ₂) ₂ · 4H ₂ O	0.002 per cent (w/v) in ASW
(unless other concentration specified, <i>i.e.</i> , from 2×10^{-5} to 10^{-3})	
<i>Artificial sea water (ASW)</i>	
CaCl ₂ · 2H ₂ O	1.45 g
MgSO ₄ · 7H ₂ O	12.35 g
KCl	0.75 g
NaCl	17.55 g
Tris buffer (1.0 M, pH 7.5)	50 ml
Distilled water	950 ml
<i>Tris buffer</i>	
HCl (conc)	33.3 ml
Trizma Base	60.55 g
bring to 500 ml with distilled water	
<i>Sawyer medium</i>	
Malt extract	0.1 g
Yeast extract	0.1 g
Difco agar	10 g
Distilled water	1000 ml

California (Margulis *et al.*, 1980). About 1 mm² samples of the flat laminated microbial mat (Margulis *et al.*, 1980; Stolz, 1983a) were placed directly on sterile plates.

After 48 hours plates were then covered with about 1 ml of sterile distilled water to resuspend the organisms and initiate a new growth cycle. After vigorous growth occurred, cysts and amoebae were repeatedly subcultured on fresh medium by streaking with a sterile platinum loop. In the final step of the isolation the organisms were inoculated onto plates of modified K or manganese acetate medium with 2.4 per cent sodium chloride and checked for uniformity of cyst morphology. They were then transferred from this medium to different conditions for study.

The organisms were routinely grown on modified K medium or manganese acetate (McAc) medium (both of which contain half-concentrated sea water), or on nonnutrient fresh-water agar with or without *Klebsiella* as food (Sawyer medium, Table I). Growing cultures were kept at room temperature or in an incubator at 30°C. The major food source for *P. jugosus* was a gram positive, flagellated, facultatively aerobic rod which grew readily on modified K and MnAc media, and was called the B bacillus.

Mastigotes were obtained by adding distilled water to agar plates of young cultures 24–48 h old. Samples taken on the following day revealed that approximately one third of the organisms had transformed into mastigotes, generally with more than 2 undulipodia each.

American Type Culture Collection (ATCC) *Paratetramitus jugosus* strain no. 30703 was obtained in axenic medium no. 1034 (ATCC catalog, 1982). MnAc plates containing 0.1 M NaCl were inoculated with the food inoculum dominated by the B bacillus and the ATCC *P. jugosus*. The ATCC *P. jugosus* grew better on this medium with the food bacillus than on medium no. 711, the one routinely used (ATCC catalog, 1982).

Storage of live material

The isolate was most easily preserved by storage of desiccated agar plates at 4°C. Over the past 3 years cultures have been resuscitated within two or three days by replating on modified K or MnAc medium. Healthy cultures have also been reestablished from desiccated field samples or desiccated plates. A portion of the dry sample was placed on fresh medium and flooded with about 1 ml of sterile distilled water for at least 10 minutes.

P. jugosus also survived freezing. About 2 ml of sterile distilled water was placed on each of several plates, 48–72 h old, containing healthy cultures of rounded forms and cysts. The organisms were pipetted into centrifuge tubes, spun in a desk top centrifuge at medium or high speed for about 10 min, and then resuspended in Page's salt solution (Table I, ATCC catalogue, 1982, p. 633). The cyst concentration was from 10⁶ to 10⁷ organisms per ml as determined by a counting chamber. The amoeba suspension was then diluted by half with Tris buffer (Table I) to which 15 per cent dimethylsulfoxide (DMSO) had been added to yield a final DMSO concentration of 7.5 per cent (v/v). The DMSO-buffer-*P. jugosus* suspension was divided into 1 ml plastic capped vials and frozen at -70°C. For resuscitation of the culture contents of the vials were poured onto plates containing fresh medium.

Light microscopy

Living amoebae and cysts were observed using wet mounts with bright field Nomarski, phase contrast and fluorescence optics (Nikon Optiphot and Fluorophot). Agar coated slides were prepared to observe growing cultures. Alcohol-cleaned slides

were dipped into hot 1.5 per cent agar, and the undersides were wiped clean with sterile cheesecloth. The cooled slides were inoculated down the center by streaking the slide with a sterile platinum needle. Sterile cover slips, held up with bits of plasticene, were placed on the inoculated preparations. The slides were incubated in sterile Coplin jars or petri plates to which a few drops of sterile distilled water were added from time to time. Growing amoebae and food bacteria could be maintained for at least a week under these conditions with very little contamination. Measurements of live amoebae and cysts were made with a calibrated ocular micrometer. Fifty amoebae and fifty rounded forms including mature cysts were measured.

Nuclear division patterns were studied after staining with Kernechtrot (Darbyshire *et al.*, 1976). Prior to staining, blocks of agar containing amoebae and cysts were transferred, upside down, into distilled water on microscope slides. These were allowed to sit for about 45 min, in which time the amoebae swam into the water and away from the agar. The agar was removed and the amoebae were fixed for 15 s in Nissenbaum's fixative (Nissenbaum, 1953) and treated with saturated iodine alcohol. The fixed amoebae were then stained for 8 min in Kernechtrot (0.1 g in a 5 per cent aqueous solution of $Al_2(SO_4)_3$). The preparations were dehydrated in ethanol (70, 95, and 100 per cent) and xylene. For Protargol staining, the methods of Zagon (1969) were used with modifications as suggested by Eugene Small, University of Maryland (pers. comm.).

Electron microscopy

For transmission electron microscopy, amoebae and cysts were fixed, embedded and observed according to the methods described in Margulis *et al.*, 1983.

For scanning electron microscopy organisms were suspended in distilled water to produce mastigotes. The distilled water from suspensions harvested from several petri plates was collected and the organisms were washed 12 times in 0.5 artificial sea water (ASW, Table I) using a desk top centrifuge. The resuspended organisms were fixed for 5 min in Parducz's fixative (6 parts 2 per cent osmium tetroxide in 0.5 ASW to 1 part saturated $HgCl_2$ in distilled water) and washed 10 times in distilled water. Amoebae were affixed to broken pieces of coverslip with 1 per cent polylysine in distilled water. They were then dehydrated in a series of alcohols, dried in a critical point dryer (Denton DC31), evaporated with a vacuum evaporator (Denton DV502) and observed using SEM (AMR 1000) at 10 Kv at the University of Massachusetts at Boston.

Salt tolerance

Growth of *P. jugosus* as a function of salt concentration was measured between 0.0 and 0.60 M NaCl. An inoculation of 0.1 ml of the suspended culture in 5 ml of distilled water was plated on each test plate. From the 3rd until the 26th day plates were scored every 2 to 3 days for appearance of cysts relative to their food bacteria. Using a dissecting microscope, outlines of areas covered by bacteria only were compared to outlines of areas of bacterial colonies riddled with cysts. The outlines were pencil-copied onto filter paper, cut out and weighed. The weight of each cyst-covered outline was divided by the weight of the bacteria-covered outline to yield relative amounts of amoeba growth. Since *P. jugosus* growth is limited to the very surface of the plate and the results were consistent from experiment to experiment, we felt this procedure was adequate to estimate the relative growth as a function of salt and temperature. Growth was defined as continued production

of amoebae and cysts after three transfers 9 days apart. These experiments were repeated three times for the new Baja California isolate, and twice for the ATCC strain.

Heat tolerance

Growth of the amoebae as a function of temperature was measured by incubating plates made with MnAc media at temperatures from 4°C to 48°C. Ability to survive high temperatures was tested by suspending samples of *P. jugosus* and their food bacteria in distilled water and exposing them to elevated temperatures in water baths for 10 min. The samples were then poured onto plates containing MnAc media and incubated at 30°C to check for growth, which was defined as in the salt experiments.

Fluorescence

Chlorophyll fluorescence was used routinely to aid in the identification of cyanobacteria in mixed cultures on media designed to enrich for photosynthetic microbes. On such plates the yellow-green fluorescence associated with the cysts of *P. jugosus* was observed. The Nikon Fluorophot microscopic observations were documented with a 35 mm mounted camera back and supplemented by measurements of the excitation and emission peaks using a Perkin-Elmer MPF-44A Fluorescence Spectrophotometer. Approximately 0.2 ml of concentrated mature cysts from plates about two weeks old was spread on alcohol cleaned microscope slides which were secured in the spectrophotometer either with tape or with a model no. 063-0502 solid sample holder attachment.

Enzyme analysis

Starch gel electrophoretic techniques for enzyme patterns were conducted under a contract with the American Type Culture collection, Rockville, MD (Nerad and Daggett, 1979). Both strains were tested for three isoenzyme systems: propionyl esterase, leucine aminopeptidase and acid phosphatase (Daggett and Nerad, 1983).

RESULTS

Field studies and isolation

Recognition of cysts. Many of the mat samples plated in the field in 1979 and 1980 showed sporadic clumps of cysts. Some field sample plates were overrun by cysts and others apparently lacked them entirely. Unidentified cysts appeared in low numbers on media designed to enrich for manganese oxidizing bacteria in the summer of 1980. Samples of mixed bacteria and cysts were prepared for transmission electron microscopy. A separate ultrastructural study of mat organisms, coccoid chlorophytes grown on photosynthetic medium containing no carbon source (ASN III, Rippka *et al.*, 1979), also revealed cysts. These were very similar to those previously seen in the bacterial cultures (Fig. 2). Cysts on the photosynthetic medium were well fixed and more abundant than those on heterotrophic media (Margulis *et al.*, 1983). Easily overlooked by light microscopy, the cysts could be differentiated from the coccoid algae by their fluorescence spectra. Transfer of cysts onto fresh low nutrient heterotrophic media (Table 1) resulted in a higher yield of clearly distinguishable cysts. Characterization of the cyst ultrastructure led to the recognition of the same cysts *in situ* from 1977 laminated mat dominated by the cyanobacterium *Microcoleus chthonoplastes* (Stolz, 1983a, b).

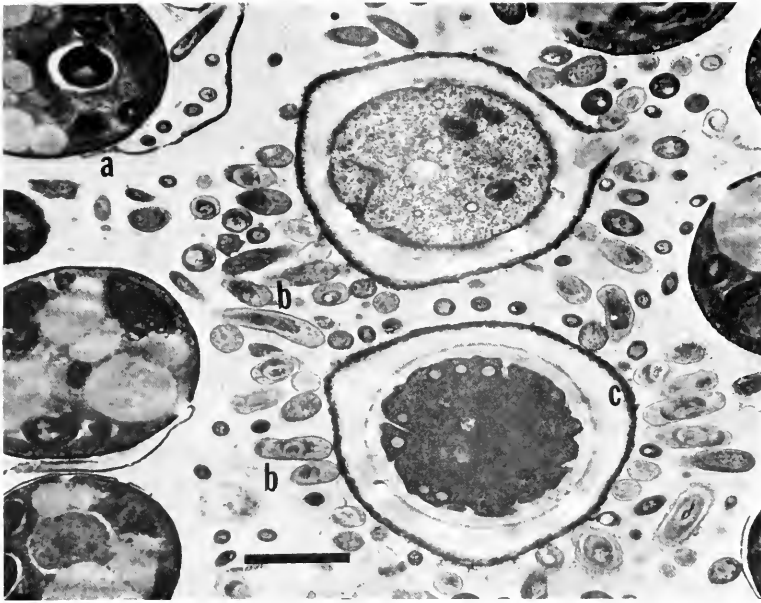
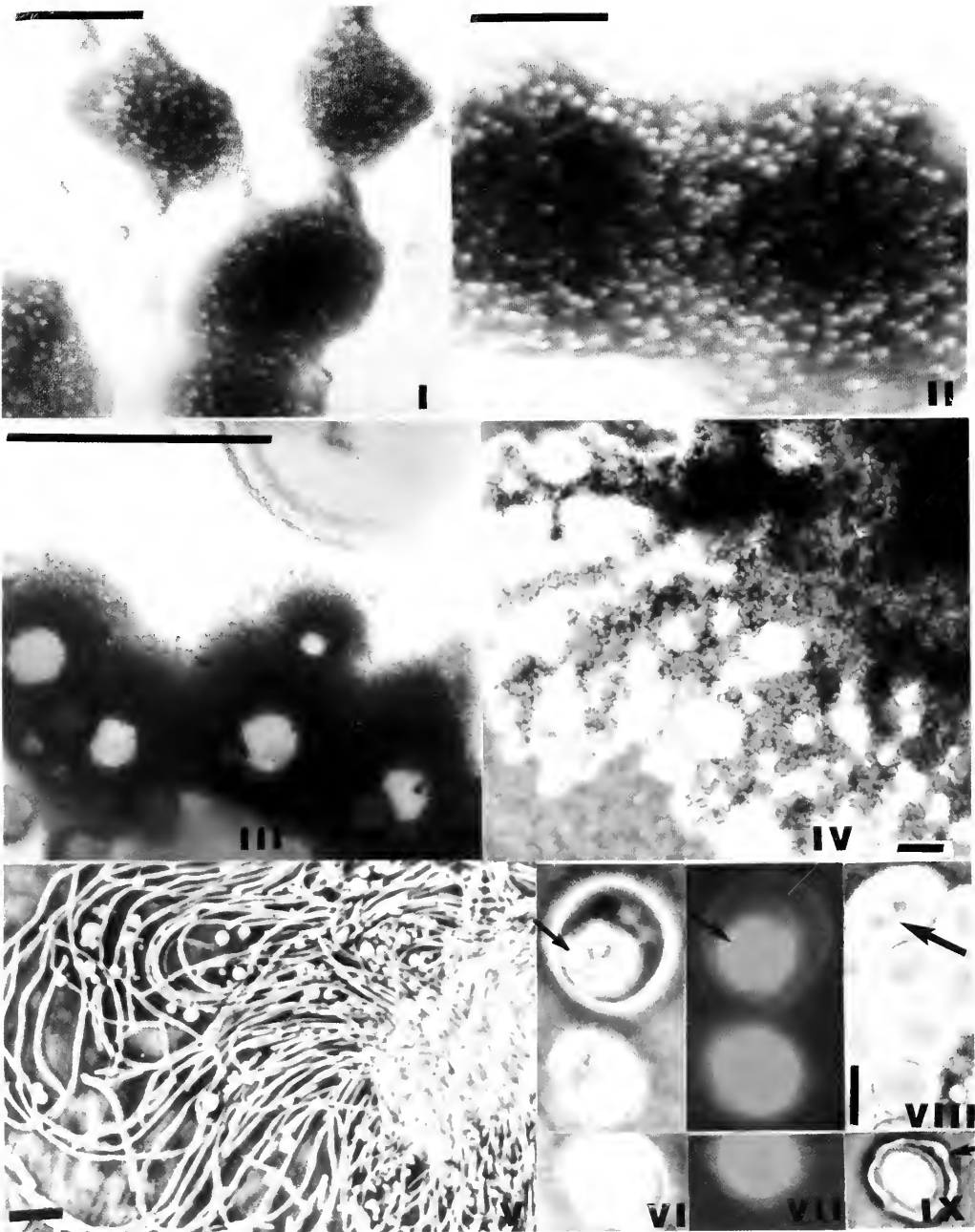

FIGURE 2. TEM of cysts in an algal culture, showing different stages of cyst development. Note pore in younger, lighter cyst. a = alga, b = bacterium, c = cyst. Bar = 2 μm

The amoebomastigote was subsequently recognized easily within 48 h on several types of mixed culture plates: manganese acetate, K medium, or various photosynthetic media either fresh from the field or in transferred or stored samples. The appearance of white spots in dark colonies of manganese oxidizing bacilli (color plate I, II, III) were taken as a presumptive test for the presence of cysts. With higher magnification (200 \times or greater) the numerous amoeba cysts were seen among clumps of manganese-coated spores (color plate IV) and distended food bacteria (color plate V). The abundance of bacilli decreased as they were fed upon by the amoebae and the area covered by white spots (which are the cysts) increased over time as the amoebae digested the bacteria.

The food bacillus. The B bacillus was easily recognized: it measured about 4 μm long and 1 μm wide (Fig. 3A). It produced subterminal spores (Fig. 3B, C) and formed smooth colonies that were beige and became brown centered in a few days. When first isolated from the Laguna Figueroa mats in 1980 it oxidized manganese, coating its spores within 4–7 days of incubation (Margulis *et al.*, 1983). During subculture this ability to oxidize manganese was lost. In the presence of *P. jugosus* these colonies became spotted with white cysts, then riddled with cysts, and finally replaced entirely by cysts (color plate I, II, III, IV). However at least three other types of bacteria were also present in this “B + cyst” inoculum in far smaller numbers (Fig. 4). The B bacillus has been isolated in pure culture on at least two occasions by taking advantage of the spores’ resistance to temperatures up to 85°C for at least ten minutes. This treatment killed the amoebae and cysts and all but one or occasionally two of the bacterial types in the inoculum. The B bacillus colonies were then easily picked and transferred to sterile plates and maintained indefinitely. When inocula of *P. jugosus* were introduced into a pure culture of B bacilli, however, they brought with them several other types of bacteria, presumably by adherence to their



COLOR PLATE

I. Dark bacterial colonies riddled with light cysts after 2 days growth. Bar = 600 μm .

II. Dark bacterial colonies riddled with light cysts after 4-5 days growth. Bar = 1.2 μm .

III. Colonies of manganese oxidizing (dark) and other heterotrophic bacteria taken directly from the field. The "plaques" or cleared areas represent the growth of *P. jugosus* within colonies of manganese oxidizing bacteria. At the lower left an entire dark colony has been converted to cysts. Bar = 100 μm .

IV. At higher power cysts can be seen among the manganese coated bacterial spores. Bar = 10 μm .

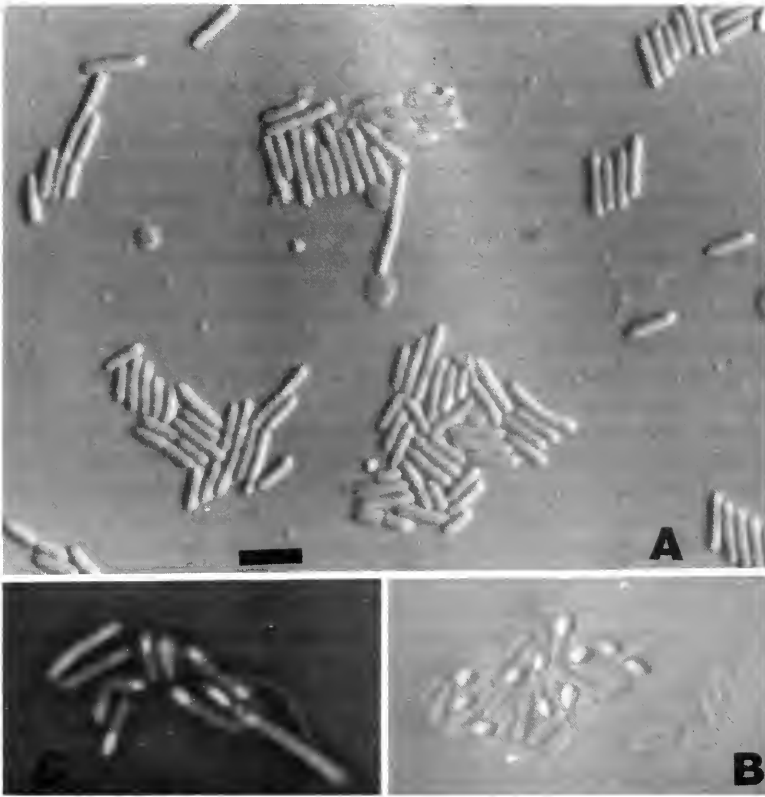

FIGURE 3. B bacillus colonies with cysts. A. Agar slide preparation of a young culture prior to spore formation (less than 1 day old) Nomarski differential interference microscopy. B. Subterminal spores phase contrast microscopy C. Same as 3B. but Nomarski optics. Bar = 5 μm .

cysts. For this reason the *P. jugosus* cultures contained several bacterial types but in fewer numbers than the B bacillus.

Morphology

Amoebae. The amoeboid form was monopodial when moving forward (Fig. 5A–C). When stationary the amoebae often exhibited bulging forms typical of vahlkampfs (Fig. 6A–C). Monopodial forms range in length from 12–24 μm , averaging 17.2 μm . This fell in the lower part of the size range reported by Darbyshire (*et al.*, 1976) for other strains of *P. jugosus*. The average length:breadth ratio was 3.2:1. Occasional binucleate amoebae were seen, but fewer than the 7 per cent reported

V. Spaghetti-like masses of B bacillus in young culture infected with ectoplasmic forms, phase contrast Bar = 20 μm .

VI. Phase contrast white light micrograph of fluorescent cysts. Bar = 5 μm .

VII. Matching fluorescence micrograph. Note dense granules which may correspond to autolysosomal or even chromatin bodies (arrows) (see figure 8D). Bar = 5 μm .

VIII. Mature cysts, note the binucleate cyst (arrow), phase contrast. Bar = 5 μm .

IX. Mature cyst with pore (arrow). Bar = 5 μm .

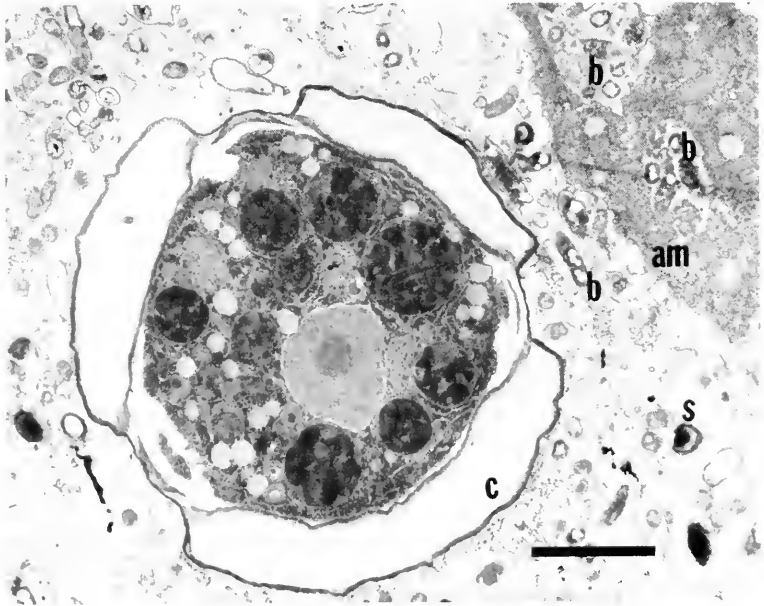

FIGURE 4. TEM of a cyst in a mixed bacterial culture. Bar = 2 μm . Amoeba at upper right. am = amoeba, b = bacteria, c = cyst, s = spore.

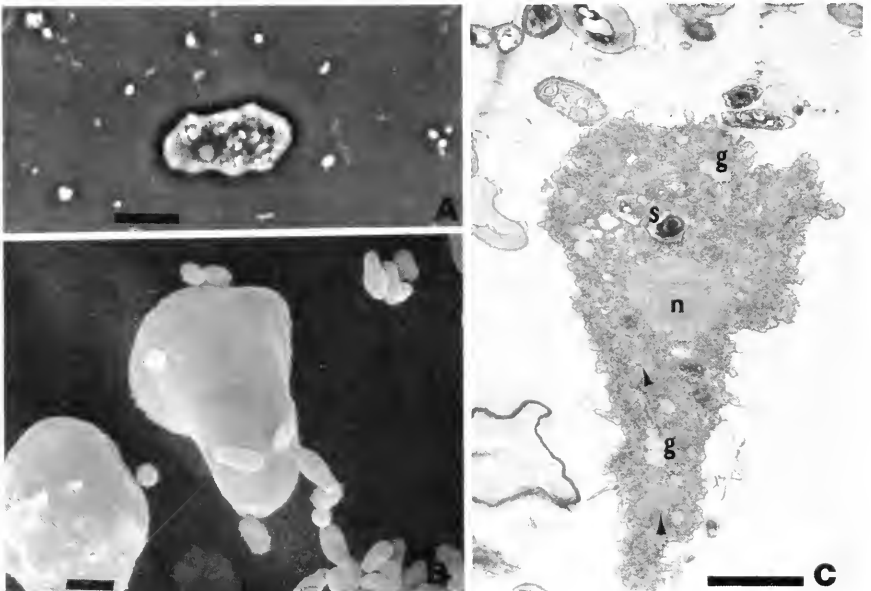

FIGURE 5. Monopodial amoebae. A. Phase contrast Bar = 5 μm . B. SEM Bar = 2 μm . C. TEM Note mitochondria with tubular cristae and granules. arrows = mitochondria, g = granules, n = nucleus, s = spore. Bar = 2 μm .

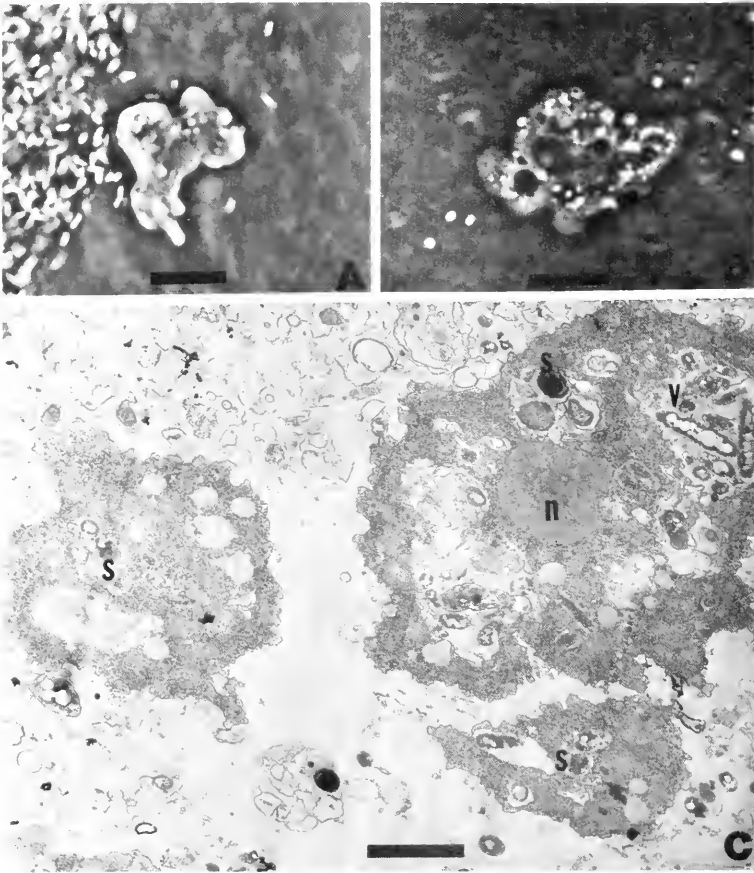

FIGURE 6. Irregular vahlkampfid. A. Feeding, phase contrast, Bar = 5 μm . B. Contractile vacuole (black) and nucleus phase contrast, Bar = 5 μm . C. TEM with bacteria in food vacuoles. n = nucleus, s = spore, v = food vacuole, Bar = 2 μm .

by Page (1967, 1976) for some strains. The cytoplasm contained many granules and conspicuous vacuoles which contained bacteria, interpreted to be food vacuoles.

Ectoplasmic and small rounded forms. In actively growing cultures rounded forms with thin or indistinct walls and often with an outer clear ectoplasmic layer were by far the most obvious forms on the plates (Fig. 7A–H). These forms ranged from 3–15 μm and often had large vacuoles containing bacteria, bacterial spores and cytoplasmic granules. Except for occasional bulging the rounded forms were stationary. In those with a distinct ectoplasm, the inner granular cytoplasm was observed in various positions of protrusion beyond the ectoplasmic layer (Fig. 7E). We surmise that the bulging cytoplasm protrudes through an organized opening. Up to three such pore-like openings per rounded form could be distinguished by phase microscopy (color plate IX) and in electron micrographs (Fig. 4).

Small rounded forms from less than 3 to about 5 μm in diameter were extremely conspicuous in young healthy cultures and more mature ones which had been flooded with distilled water to stimulate more growth. The small forms even outnumbered the larger cyst-sized forms, especially in low salt medium. We compared

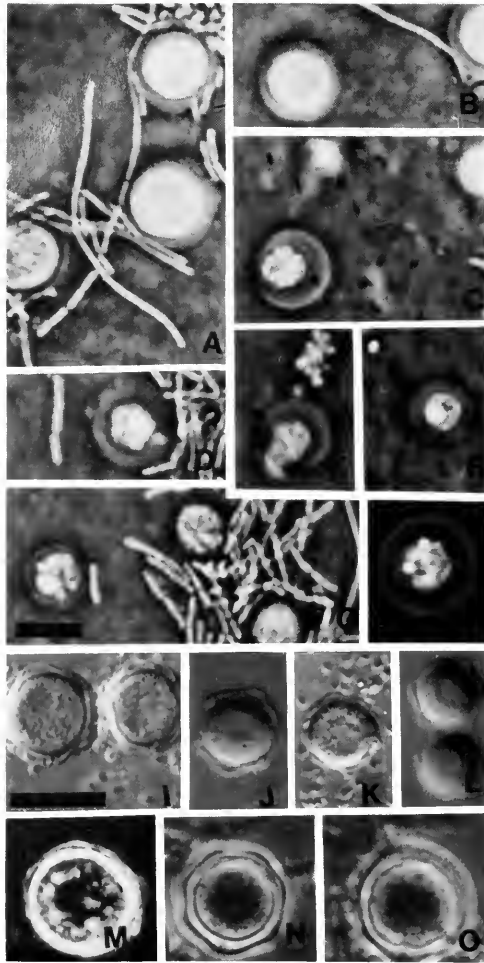

FIGURE 7. A-H. Ectoplasmic forms and affected bacteria, all of these are common in active cultures, Bar = 5 μ m. I-O. Mature cysts. I-L. Nomarski optics. M-O. Phase contrast. Bar = 5 μ m.

the ATCC *P. jugosus* in axenic liquid medium immediately after it was received. That culture also was filled with small bodies and rounded forms. We suggest that these forms are stages in the life cycle of *P. jugosus* and certainly not contaminants, possibly precysts or encysting amoebomastigotes.

Mature cysts. The mature cysts which appeared on the second or third day generally had a distinct smooth round endocyst and an irregular ectocyst (Fig. 7 I-O). At some points the ectocyst contacted the endocyst. Cysts averaged 8 μ m in diameter and ranged from 5.5-10 μ m. The majority of the cysts were uninucleate but binucleate cysts were seen occasionally (color plate VIII). Mature cysts tended to become smaller as they aged and desiccated further. They also became more and more fluorescent as they desiccated. Fluorescent materials seen as granules in moistened cysts may be transferred to the walls as maturation proceeds. Bodies traditionally referred to as "autolysosomal bodies" in electron micrographs of rounded forms are assumed to be related to breakdown of cell material and to rapid wall

formation (Page, 1981). However, these bodies, which apparently contained ribosomes, and material that resembled chromatin may be related to the rapid proliferation of *P. jugosus*. These bodies were very conspicuous in rewet cysts and growing cultures, like the nucleus they stained green with acridine orange. It is our judgment, whatever their nature and development, that these intracellular bodies seen in the electron micrographs (Fig. 8A–C) correspond to the bright bodies seen with phase contrast microscopy (Fig. 8D) and are the source of fluorescence observed on the light micrographic level (color plate VI, VII).

Mastigotes. Mastigotes were never observed on routine culture plates. We were not aware of the ability to form a mastigote stage until it was brought to our attention by F. C. Page of the Culture Centre of Algae and Protozoa, Cambridge, England. Page, on the basis of the morphology of live cultures sent to him, kindly identified the organism as *P. jugosus*. When suspended in distilled water overnight about one third of the organisms transformed into mastigotes overnight. The mastigote stage persisted for 1–2 days. Mastigotes were spherical, or more frequently, elongated in shape; they had 2, sometimes more, forward directed undulipodia (Fig. 9). They tend to be smaller than the amoebae. Bacterial spores could be seen in food vacuoles through the transparent mastigotes. Whether or not the mastigote form actively feeds is unknown; undigested bacteria and spores may have been residues from feeding immediately prior to transformation.

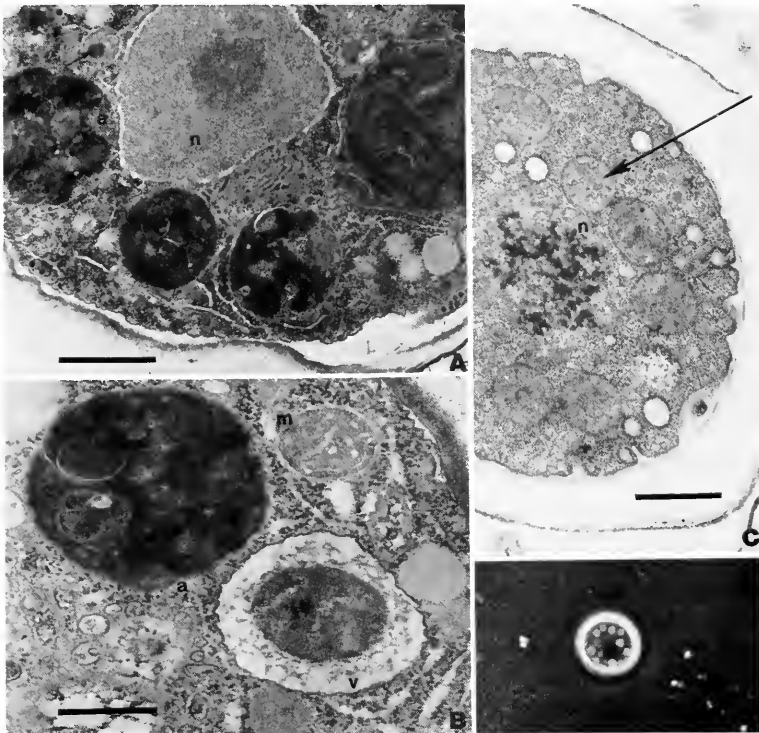

FIGURE 8. Intracellular inclusions in cysts. A. TEM of "autolysosomal bodies" (a) and mitochondria (m). Note the unidentified crystals inside the mitochondria (arrow). Bar = 1 μ m. B. Cysts contain food vacuoles (v) and "autolysosomal" bodies with ribosomes. Bar = 0.5 μ m. C. Cyst with bodies that may contain chromatin (arrow), n = nucleus. Bar = 1 μ m. D. Phase contrast light micrograph. Bar = 1 μ m.

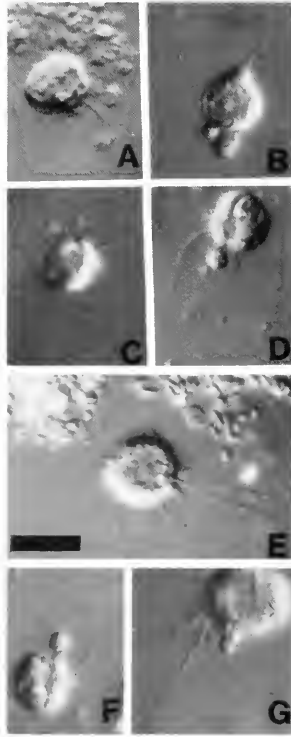

FIGURE 9. Mastigotes. A-G The number of undulipodia per cell vary from 1 to as many as 11. Bar = 5 μ m.

Growth and reproduction

The new strain of *P. jugosus* grew extremely rapidly. New isolates from the field entirely covered the B bacillus colonies with cysts within 3 days at room temperature (color plate I-IV). About sixty cysts per colony developed from plated colonies using a loop. After about a year in culture the growth rate slowed somewhat: it took from 4 to 5 days to entirely replace the food colonies with cysts. The ATCC *P. jugosus* grew more slowly, not forming visible cysts at all until after the 12th day. It never formed populations as dense as the Baja California isolate on any media tested (for example the maximum number of cysts per colony was about 30 in the same test that the Baja California strain developed about 60 cysts per colony). Even after transfer from higher salt concentration (0.1 M NaCl) the ATCC *P. jugosus* grew very slowly and to low cell densities on our routine MnAc media (Fig. 16).

We interpret the rounded forms to be active feeding stages. In young cultures virtually devoid of monopodial amoebae the effects of *P. jugosus* on bacteria were easily seen. Motility was lost and the bacteria became severely clumped and elongated. Apparently *P. jugosus* arrested bacterial cell division, for when infected with *P. jugosus* the bacilli would grow to up to 10 times their normal length and in some cases spaghetti-like masses of unhealthy-appearing bacteria were seen (color plate V, Fig. 10A, compare with Fig. 3). Thread-like material in which bacteria were embedded could be seen in scanning electron micrographs (Fig. 10B). The material,

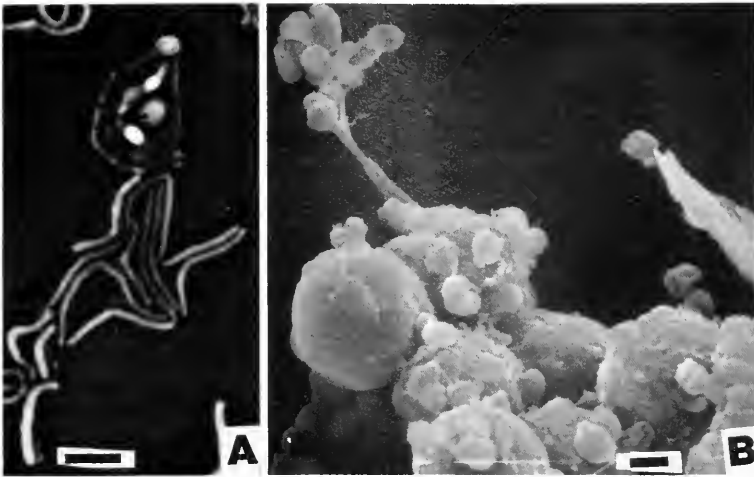

FIGURE 10. B bacillus infected with *P. jugosus* A. Swollen, elongated bacteria with ectoplasmic forms, phase contrast. Bar = 20 μm . B. Ectoplasmic forms, bacteria and apparent exudate SEM. Bar = 2 μm .

consistently seen as cotton-like fluff in all active amoebae cultures and absent in pure cultures of the B bacillus, may be part of the feeding process. Typical engulfing by pseudopods was rare as it was for at least one other vahlkampfid described by Page (1967). It is likely that *P. jugosus* can digest bacillus spores, even manganese-coated ones. As *P. jugosus* grow on older colonies of bacteria which have all transformed to manganese-encrusted spores, cyst-ridden plaque-like holes on plates replace the bacteria. Electron micrographs show bacterial spores in the cytoplasm of the amoebae (Fig. 11).

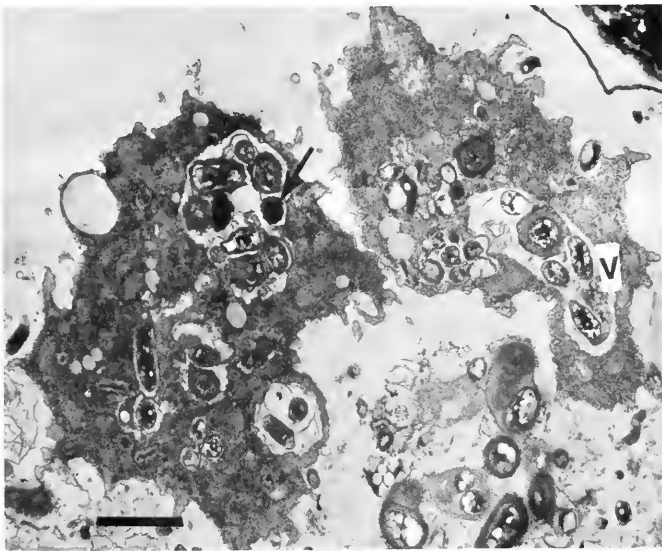

FIGURE 11. TEM of two vahlkampfid amoebae with spores (arrow) and bacteria in food vacuoles (V). Bar = 2 μm .

When divisions were seen they were promitotic, characterized by the persistent nuclear envelope as seen in two other vahlkampfid s (Fig. 12). However, in over two years of continuous and frequent observation including close monitoring of agar slide cultures, divisions were rarely observed. Samples taken from 1–2 day old cultures at frequent intervals (1 to 2 hours) failed to reveal any divisions after examination with oil immersion microscopy. Indeed, there were few amoebae. Similarly, amoebae stained with Kernechtrot or Protargol (Fig. 13) showed only a few figures that could be interpreted as in division. However, these same active cultures were replete with great numbers of small round bodies. These bodies contained yellow-green fluorescent granules (such fluorescence is absent in pure cultures of food bacillus). We suggest that these bodies may be involved in reproduction, thus explaining the scarcity of vegetative amoebae and of their mitotic figures. The frequency of amoebae was highest on moist plates. Generally fewer than 10 percent of the forms in growing young cultures were amoebae and sometimes none at all were seen. Protargol staining confirmed this observation. Small bodies appeared entirely purple whereas only the nuclei of vegetative amoebae retained the stain. The large round bodies contained purple nuclei and cytoplasmic bodies which also stained (Fig. 13, A, B). As the cysts desiccated and matured, the entire round bodies, large and small, stained heavily (Fig. 13 C–I). Both wall material and chromatin stain heavily. On many occasions small round bodies associated with cysts were observed (Fig. 14). These tiny rounded amoebae-like forms were often clumped in groups of seven or eight. Their abundance and association with cysts and large amoebae suggest they may be the product of a rapid series of standard mitoses or multiple fission. Some of the released bodies were fecal pellets that were seen in the amoebae (Fig. 15A) and in the medium (Fig. 15B). Fecal bodies, which are striped and contain partially digested bacteria (Fig. 15C), could be distinguished from the small amoeboid-like bodies. Nothing short of a sequential, carefully timed ultrastructural study of development will solve the question. However, the astonishingly fast reproductive rate, paucity of dividing amoebae, and the omnipresence of spherical bodies which appear to contain chromatin suggest another mode of division in addition to promitotic binary fission of amoebae.

Apparently, only amoebae transform directly into mastigotes. Plates containing abundant amoebae formed mastigotes whereas old plates, predominantly mature cysts, produced very few mastigotes when flooded.

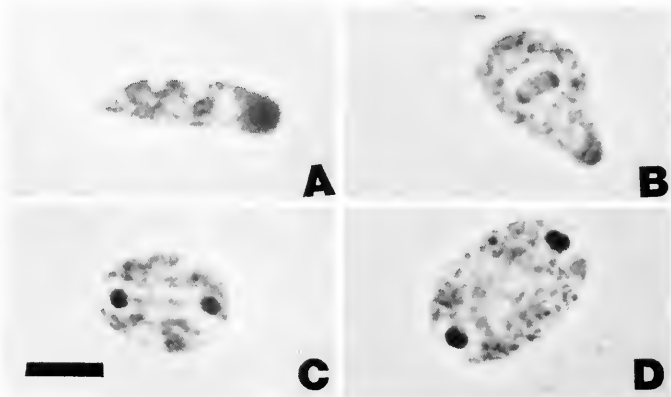

FIGURE 12. Mitosis (A–D Bar = 5 μ m): A. Interphase, B. Metaphase, C. Anaphase, D. Telophase.

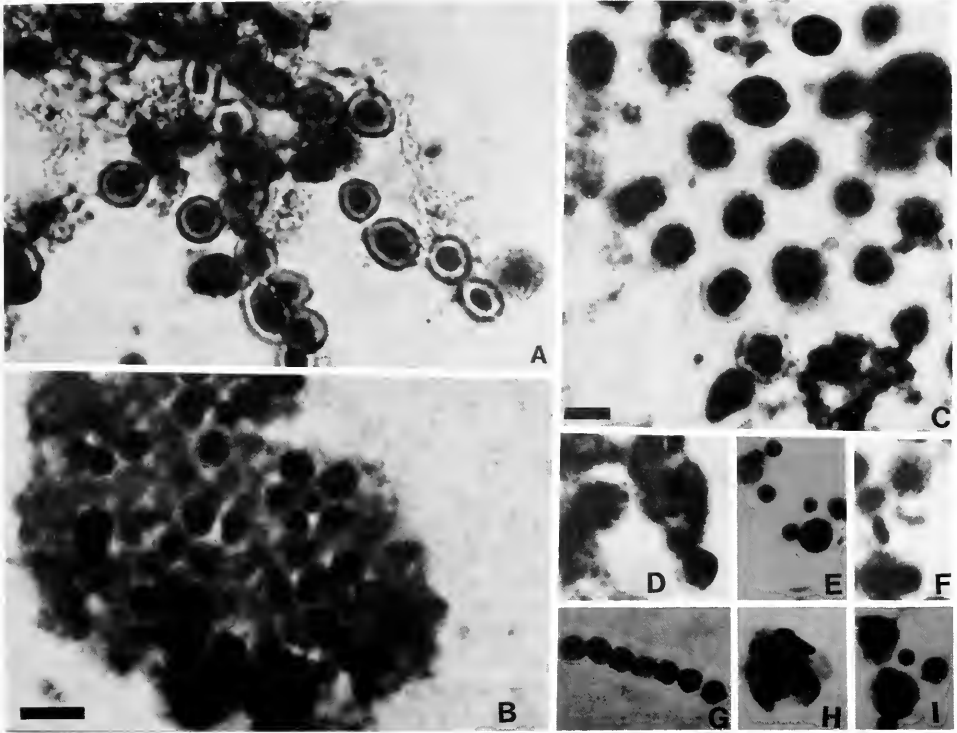

FIGURE 13. Protargol stained preparations. Bar = 5 μ m. A. 12 day old cultures. B. 65 day old cultures. C-I. Ectoplasmic, small rounded, granulated forms all of which are typical of young cultures. Bar = 5 μ m.

When old plates with mature cysts were moistened and carefully observed, amoebae could be seen to emerge from the encysted form. On one occasion a single cyst was seen to convert to the monopodial amoeba form in about 10 minutes.

Salt

Although the growth of this *P. jugosus* isolate was most rapid in media made with distilled water, it also grew well in half strength sea water medium (1.7 per cent NaCl). Furthermore growth occurred in NaCl concentrations up to 0.50 *M* (2.92 per cent). Figure 16A shows typical data from one of three experiments in which growth was shown to be an inverse function of NaCl concentration. When the inoculum size was large, growth was more vigorous even on 0.4 *M* (2.34 per cent) NaCl, and the cysts covered the food bacterial colonies within 7 days. There was even some continued growth (through three transfers) at 0.55 *M* (transferred from 0.05 *M*). The ATCC *P. jugosus* strain also grew optimally in media without NaCl, but did not grow in concentrations of salt above 0.3 *M* (Fig. 16B).

Cyst morphology changed as a function of salt, as is common in encysting amoebae (Fig. 17). Presumably due to shrinkage of the cell, the space between the endo- and the ectocyst widened at higher concentrations of salt and the cysts became more refractile (Fig. 17C, F).

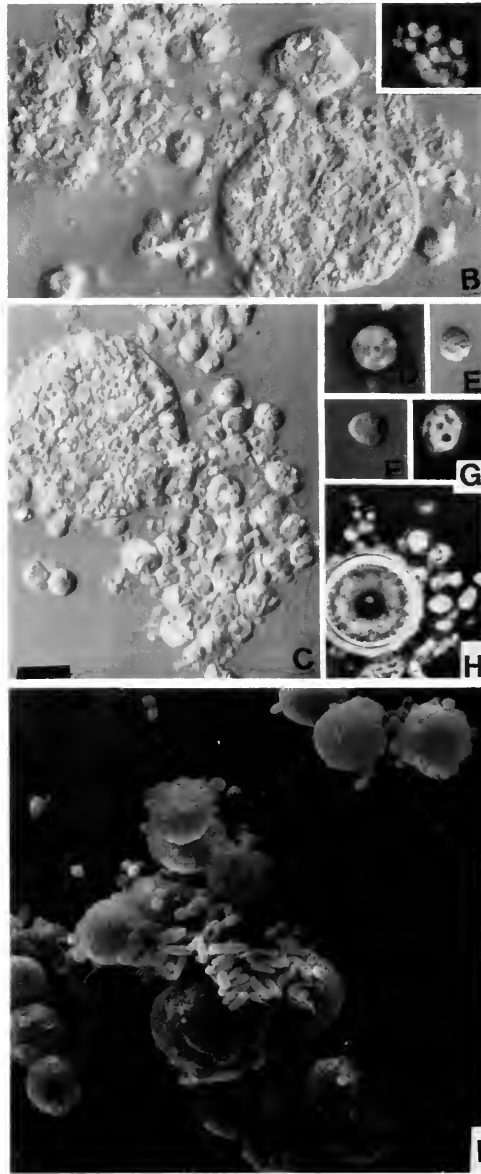

FIGURE 14. Small bodies released? (A., D., E., F., G., Phase contrast; B., C., Nomarski optics. Bar = 5 μm). A. Clump of newly released amoebae? B. and C. enormous cyst from which (A., D. E., F., G., H.) have young amoebae been released? I. SEM spherical small amoebae? Bar = 2 μm .

The small, round wall-less forms so conspicuous in actively growing cultures were less frequent at higher salt concentrations. The correlation of these bodies with media that support the most rapid growth rate reinforces the hypothesis that these bodies are directly involved in reproduction.

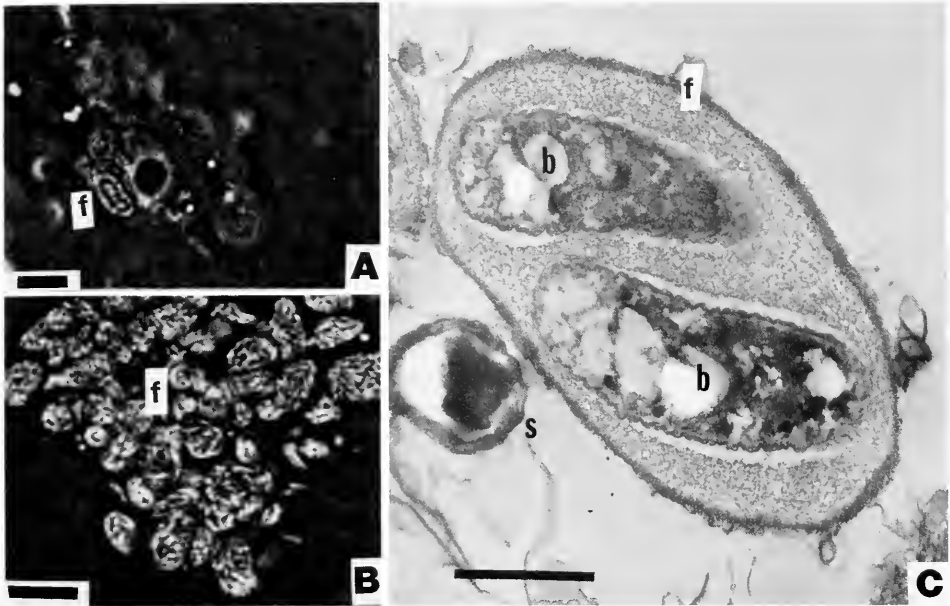

FIGURE 15. Fecal pellets. A. Amoeba containing fecal pellet (Bar = 1 μm). B. Clumps of fecal pellets (f) (Bar = 1 μm). C. TEM thin section of fecal pellet with disintegrating bacteria (b). s = spore. Bar = 0.5 μm .

Temperature

The Baja California strain of *P. jugosus* grew well between 20 and 36°C. It did not grow at 37°C. It survived temperatures up to 56°C for 10 minutes, but did not survive heat treatment for 10 minutes at 59°C. The ATCC *P. jugosus* also survived temperatures up to 56°C for ten minutes. However, it did not grow when incubated at 36°C, but grew well at 30°C. No temperatures were tested between these two points.

Fluorescence

Yellow-green fluorescence emission from vahlkampfidis is unreported. Yet in our studies of Baja California microbial communities we have seen this phenomenon consistently not only in small amoebic cysts but in larger unidentified acanthamoebids. From the fluorescence data in Table II it can be seen that the two strains of *P. jugosus* differ from one another in their emissive properties. Little is known about the chemical basis or possible significance of this fluorescence, but the possibility of its use as a tool in diagnostics is obvious.

Fluorescence in these amoebomastigotes was strongly correlated with life cycle stage. Amoebae do not fluoresce, yet the small rounded bodies had faint fluorescence. The larger round bodies usually contained 2–6 strongly fluorescing bodies that measured from 1–3 μm (Color plate VI, VII). Mature cyst walls fluoresced most strongly; the cysts themselves fluoresced more and more strongly as they desiccated. Although Page (1967) did not report fluorescence data he did describe cytoplasmic granules in *Vahlkampfia ornata*. Dense spherules (1.5 to 2 μm in diameter) were

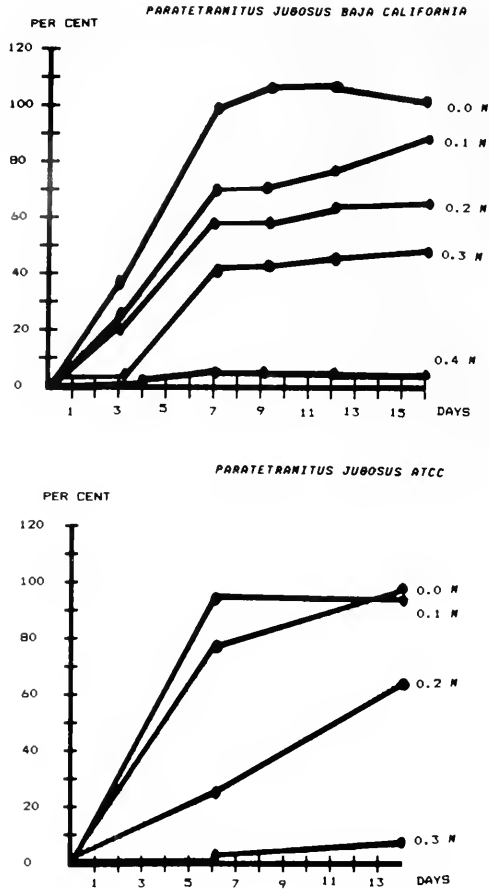

FIGURE 16. Growth of *P. jugosus* as a function of salt. A. The Baja California strain: area of colony covered by cysts in media made up from 0.0 to 0.4 *M* (2.34 per cent) sodium chloride. B. The ATCC strain: area of colony covered by cysts in media made up from 0.0 to 0.3 *M* sodium chloride.

present in immature *V. ornata* cysts whereas mature cysts showed only fine granulation. There is most likely a relationship between the fluorescent material, the granules, and the conspicuous autolysosomal bodies seen in electron micrographs (Fig. 8).

Isoenzymes

The electrophoretic mobility pattern for three different enzymes of *P. jugosus* from Baja California was compared with that from the *P. jugosus* from the ATCC. The patterns for propionyl esterase and leucine aminopeptidase were nearly identical. However, there were conspicuous differences between the two stains with respect to their alkaline phosphatase (Fig. 18).

DISCUSSION

Paratetramitus jugosus was proposed by Darbyshire (*et al.*, 1976) as a new genus and species of amoebae isolated from a stream near Moscow, Idaho. Before the

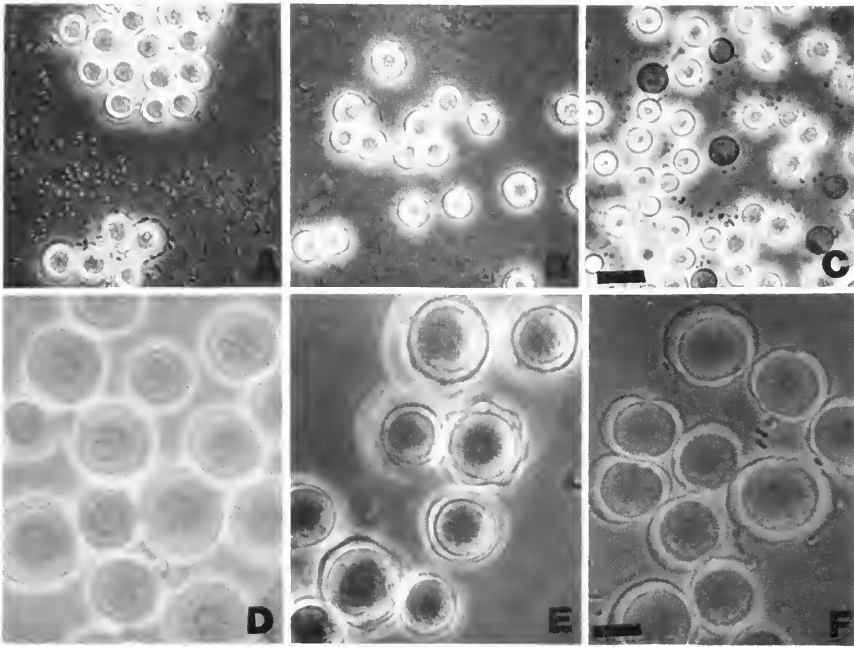

FIGURE 17. Cyst morphology as a function of salt concentration. A. and D. 0.5 per cent. B. and E. 1.2 per cent. C. and F. 2.4 per cent. A., B., and C. Bar = 10 μm . D., E., and F. Bar = 5 μm .

mastigote stage had been seen, *P. jugosus* had been introduced by Page (1967) into the literature as *Vahlkampfia jugosus*. These amoebae have a closed nuclear division pattern (promitosis), eruptive monopodial pseudopods, and temporary amoebomastigote stages. They belong to the family Vahlkampfiidae (Page, 1976).

Different geographical strains have been isolated from Scottish soil samples, fresh water lakes and streams in England and in the United States (Darbyshire *et al.*, 1976), and from a Czech swimming pool (Cerva, 1971). All of the strains originally identified as *Vahlkampfia jugosus* also transformed into mastigotes and thus were reclassified by Page (1976) as *Paratetramitus jugosus*.

We believe that the differences in growth rate, salt and heat tolerance, isoenzyme pattern, fluorescence emission maxima, and extraordinary desiccation resistance constitute enough difference to recognize this protist as a new strain, *Paratetramitus jugosus baja californiensis*.

On the coastal evaporite flat of Laguna Figueroa the protist survives but does not grow during normal periods of cyanobacterial organic mat deposition and ex-

TABLE II

Fluorescence of mature cysts

Strain	Maxima	
	Excitation (nm)	Emission (nm)
<i>Paratetramitus jugosus</i> BC	488	611
<i>Paratetramitus jugosus</i> ATCC	488	592

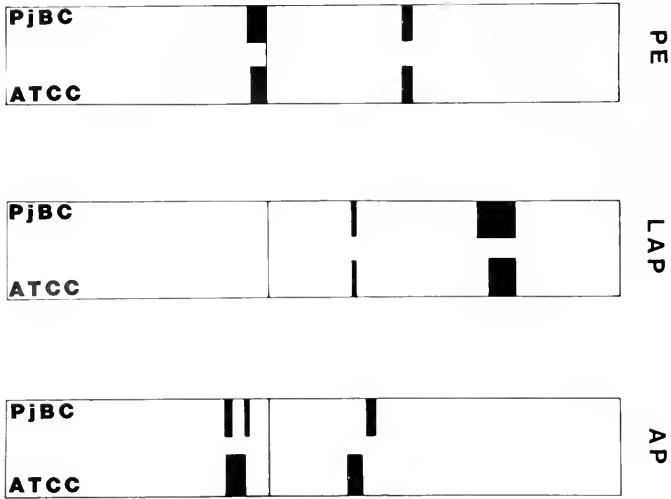

FIGURE 18. Isoenzymes: PE = propionyl esterase, LAP = leucine aminopeptidase, AP = acid phosphatase. Starch gel electrophoresis, movement right to left.

tremely high evaporation rates. Once a year during winter-spring rains, however, conditions become ideal for the rapid growth of *P. jugosus*; blooms become obvious. The unusual weather conditions of 1979–1980 conspired to retain such superb growing conditions for *P. jugosus* that even after severe desiccation three years later it was the dominant organism enriched from mat material in the laboratory.

During the winter and spring of 1982 there was extremely little or no rainfall at the field site. As the flood water evaporated, the mat condition became more saline, recolonization by halophilic bacteria began, and the growth of *P. jugosus* diminished, decreasing the frequency with which the protist was isolated in the summer of 1982. We conclude that this amoebomastigote is highly adapted to the transient appearance of fresh water.

As described elsewhere in detail (Margulis *et al.*, 1983; Stolz, 1983a, b), during the summer of 1982 the laminated microbial mat which developed from before 1965 thru 1979, although covered by several centimeters of terrigenous sediment due to the flood, was found buried from 10–15 cm below the surface of newly forming mat. Between the older laminated mat and the new growth we observed a smooth organic-rich mud smelling of sulfide which contained remains of cyanobacterial sheaths, and heterotrophic bacteria of many kinds. It also contained the abundant *P. jugosus*. If silicified, this smooth black mud layer, as it lithified to chert, would likely preserve entrapped microbes and their remains. Because of their high population densities, euryhalinity and environment of deposition, hardness, and resistance, *P. jugosus* is likely to have a high preservation potential. Indeed it is possible that it has already been reported in the microbial fossil record as “acritarchs” or other problematica (Knoll, 1982; Vidal and Knoll, 1983).

Only further study can solve the mystery of the mode of reproduction in young, relatively dry cultures on agar plates that contain many spheres and nearly no amoebae. Multiple fissioning of some kind that produces small spheres may occur. In studies of similar small amoeboid forms from oysters, Hogue (1914) diagrammed amoebal multiple fission uncannily similar to what we have seen. Even though it is likely that Hogue’s studies were plagued by mixed cultures of protists we think

her suggestion of multiple fission deserves reconsideration. The ubiquitous small spheres may be the active feeding and multiplying forms of *P. jugosus*. Either very rapid mitosis or multiple fission to produce small spherical forms occurs.

ACKNOWLEDGMENTS

This work was inspired by the NASA program of Planetary Biology and Microbial Ecology (1980, University of Santa Clara) and supported by NASA-NGR-004-025 and the Boston University Graduate School. We acknowledge with gratitude the aid of Mary Smith and the University of Massachusetts Boston, with the scanning electron microscopy as well as F. C. Page and B. Dexter-Dyer Grosovsky in both the work and the manuscript. We are grateful to Lorraine Olendzenski, Susan Lenk, Geronimo Sahagun, and Evelyn Ball for lab and field assistance as well as to Zachary Margulis for help with the computer-related aspects of this project. We are grateful to Pierre-Marc Daggett and Tom Nerad, American Type Culture Collection, Rockville, MD for performing the isoenzyme analyses and to Shawn Bodammer, Natl. Marine Fisheries Lab., Oxford MD who performed the initial staining studies, devoting many hours searching for the very few specimens undergoing nuclear division. Prof. Lindsey Olive, University of North Carolina, suggested the malt extract-yeast extract culture medium.

LITERATURE CITED

- American Type Culture Collection Catalogue of Strains*. 15th Ed. 1982. P.-M. Daggett, R. L. Gherna, P. Pienta, W. Nierman, J. Shun-Chang, H. Hsu, B. Brandon, and M. T. Alexander, eds. ATCC, Washington, DC.
- AWRAMIK, S. M., J. W. SCHOPF, AND M. R. WALTER. 1983. Filamentous fossil bacteria from the Archean of Western Australia. *Precambrian Res.* **20**: in press.
- CERVA, L., 1971. Studies of limax amoebae in a swimming pool. *Hydrobiologia* **38**: 141-161.
- DAGGETT, P.-M., AND T. A. NERAD. 1983. The biochemical identification of Vahlkampfia amoebae. *J. Protozool.* **30**: 126-128.
- DARBYSHIRE, J. F., F. C. PAGE, AND L. P. GOODFELLOW, 1976. *Paratetramitus jugosus*: an amoeboid flagellate of soils and fresh water, type-species of *Paratetramitus* nov. gen. *Protistologica* **12**: 375-387.
- FRANCIS, S., L. MARGULIS, AND E. S. BARGHOORN. 1978. On the experimental silicification of microorganisms II. On the time of appearance of eukaryotic organisms in the fossil record. *Precambrian Res.* **6**: 65-100.
- HOGUE, M. J. 1914. Studies in the life history of an amoeba of the Limax group. *Arch. Protistenkd.* **35**: 154-163.
- HORODYSKI, R. J. 1977. *Lyngbya* mats at Laguna Mormona, Baja California, Mexico: comparison with Proterozoic stromatolites. *J. Sediment. Petrol.* **47**: 680-696.
- HORODYSKI, R. J., AND S. J. VONDER HAAR, 1975. Recent calcareous stromatolites from Laguna Mormona (Baja California), Mexico. *J. Sediment. Petrol.* **45**: 894-908.
- KNOLL, A., 1982. Microorganisms from the late Precambrian Draken conglomerate, Ny Friesland, Spitzbergen. *J. Paleontol.* **56**: 7755-7790.
- KNOLL, A., AND E. S. BARGHOORN. 1977. Archean microfossils showing cell division from the Swaziland System of South Africa. *Science* **198**: 396-398.
- LOWE, D. R. 1980. Stromatolites 3400 million years old from the Archean of Western Australia. *Nature* **284**: 441-443.
- MARGULIS, L. 1980. Undulipodia, flagella and cilia. *Biosystems* **12**: 105-108.
- MARGULIS, L., E. S. BARGHOORN, D. ASHENDORF, S. BANERJEE, D. CHASE, S. FRANCIS, S. GIOVANNONI, AND J. STOLZ. 1980. The microbial community in the layered sediments at Laguna Figueroa, Baja California, Mexico: Does it have Precambrian Analogues? *Precambrian Res.* **11**: 93-123.
- MARGULIS, L., B. D. D. GROSOVSKY, J. F. STOLZ, E. J. GONG-COLLINS, S. LENK, D. READ, AND A. LOPEZ-CORTES, 1983. Distinctive microbial structures and the prephanerozoic fossil record. *Precambrian Res.* **20**: (in press).
- NASA Planetary Biology and Microbial Ecology Summer Course Report*. 1980. University of Santa Clara. NASA Life Sciences Office, Washington, DC. 203 pp.

- NERAD, T. A., AND P. -M. DAGGETT, 1979. Starch electrophoresis; an effective method for separation of pathogenic and non-pathogenic *Naeglaria* strains. *J. Protozool.* **26**: 613-615.
- NISSENBAUM, G. 1953. A combined method for the rapid fixation and adhesion of ciliates and flagellates. *Science* **118**: 31-32.
- PAGE, F. C. 1967. Taxonomic criteria for limax amoebae with descriptions of three new species of *Hartmanella* and three of *Vahlkampfia*. *J. Protozool.* **14**: 499-521.
- PAGE, F. C. 1976. A revised classification of the Gymnamoebia (Protozoa:Sarcodina). *Zool. J. Linn. Soc.* **58**: 61-77.
- PAGE, F. C. 1981. A light- and electron microscopical study of *Protacanthamoeba caledonica* n. sp., type-species of *Protacanthamoeba* n. g. (Amoebida, Acanthamoebidae). *J. Protozool.* **28**: 70-78.
- RIPPKA, R., J. DERUELLES, J. B. WATERBURY, M. HERDMAN, AND R. Y. STANIER. 1979. Generic assignments, strain histories and properties of pure cultures of cyanobacteria. *J. Gen. Microbiol.* **110**: 1-61.
- STOLZ, J. F. 1983a. Fine structure of the stratified microbial community at Laguna Figueroa, Baja California, Mexico. I. Methods of *in situ* study of the laminated sediments. *Precambrian Res.* **20**: 479-492.
- STOLZ, J. F. 1983b. Fine structure of the stratified microbial community at Laguna Figueroa, Baja California, Mexico II. Transmission electron microscopy as a diagnostic tool in studying microbial communities *in situ*. In *The Woods Hole Microbial Mat Symposium*. R. Castenholz, H. O. Halvorson, and Y. Cohen, eds., Alan Liss, Inc., New York.
- VIDAL, G., AND A. H. KNOLL. 1983. Proterozoic plankton. *Geol. Soc. Am. Mem.* (in press).
- ZAGON, I. S. 1969. Electron microscopic observations of protargol stain deposition in *Carchesium polypinum*. *J. Protozool.* **16**(Supp.): 7-8.

THE INITIAL CALCIFICATION PROCESS IN SHELL-REGENERATING *TEGULA* (ARCHAEOGASTROPODA)

CHARLENE REED-MILLER

Department of Geology, Florida State University, Tallahassee, FL 32306

ABSTRACT

Shell regeneration was induced in the marine archaeogastropod, *Tegula*, by cutting a window in the first body whorl of the shell. At six hour intervals for six days after the shell window was cut, the mantle, foot, and hepatopancreas were prepared for transmission electron microscopy, and the shell window was prepared for scanning electron microscopy. Transmission electron microscopy of the three tissues showed an increase in rough endoplasmic reticulum, Golgi complexes, and mitochondria, followed by the appearance of three types of inclusions. Later, intracellular space increased and spherites were visible. Scanning electron microscopy showed initial crystal deposition in the shell window to be in the form of small doubly-pointed crystallites associated with an organic membrane. These spindle-shaped crystals were frequently aggregated into radiating clusters or rosettes which coalesced until a thin sheet of mineralized material covered the shell window, within six days of shell injury.

INTRODUCTION

The regeneration or repair of molluscan shell is a subject of great interest. Most of the studies of repair of mineralized tissues in molluscs have concerned terrestrial or freshwater species (Wagge, 1951; Tsujii, 1960; 1976; Beedham, 1965; Saleuddin, 1967; Abolins-Krogis, 1968; Saleuddin and Wilbur, 1969; Kapur and Gupta, 1970; Meenakshi *et al.*, 1975; Blackwelder and Watabe, 1977). Reports on shell regeneration in marine molluscs include work on the cephalopod, *Nautilus macromphalus* (Meenakshi *et al.*, 1974), and the bivalve, *Mytilus edulis* (Meenakshi *et al.*, 1973; Uozumi and Ohata, 1977; Uozumi and Suzuki, 1979). One impression from these studies is that marine molluscs require more time to repair their shells than do terrestrial or freshwater species.

Meenakshi *et al.* (1974) report that it takes 45 days for shell regeneration to occur in *Nautilus*, and 30–32 days must elapse following shell injury before the first evidence of mineral deposition occurs in *Mytilus* (Meenakshi *et al.*, 1973). Furthermore, it takes at least eight weeks before the regenerated shell takes on a normal appearance in *Mytilus* (Meenakshi *et al.*, 1973; Uozumi and Ohata, 1977; Uozumi and Suzuki, 1979). These chronologies are impressively long compared to the time required for substantial calcium deposition in the land snails *Helix* and *Otala*, *e.g.*, two to three days (Wilbur, 1973). The freshwater snail, *Heliosoma*, and the freshwater bivalve, *Anodonta*, require a somewhat longer time for mineral deposition—at least five days (Chan and Saleuddin, 1974) and about 14 days (Tsujii, 1976) respectively. But these freshwater molluscs still repair damaged shell faster than their marine counterparts.

Preliminary observations showed that initial mineral deposition occurred about 24 to 48 hours after the creation of a shell window in the first body whorl of the marine snail, *Tegula* (Reed-Miller *et al.*, 1980). On the average, six days were required for a thin sheet of mineralized tissue to cover the shell window (Reed-Miller, unpub. ob.). This paper describes the events of the first six days of shell repair in the marine archaogastropod, *Tegula*. Both scanning and transmission electron microscopy were used. Preliminary accounts of this work were presented to the American Society of Zoologists (Reed-Miller, 1981).

MATERIALS AND METHODS

Snails, *Tegula funebris* and *Tegula eiseni*, were obtained from the Pacific Biomarine Laboratories, Inc., Venice, CA. They were maintained in aquaria in filtered, aerated sea water from the Gulf of Mexico (32 ppt), at 15°C. The animals were fed marine algae from a laboratory culture.

A 4 mm² section of shell was carefully removed from the first body whorl of the shell using a Dremel "Moto-tool," jeweler's saw, and a triangular file. Care was taken not to injure the underlying tissue. The opening in the shell, or window, was covered with a small piece of a plastic coverslip, and that in turn was covered with warm dental wax, sealing the window from the external environment.

Small pieces of the mantle from directly underneath the shell window, foot, and hepatopancreas were carefully dissected from the animals six hours to six days after the window was cut. As controls, the same tissues from normal, non-regenerating snails were always prepared with those from shell regenerating animals. The experiments were repeated at least three times with at least four experimental animals examined each time.

Transmission electron microscopy

The soft tissues were dissected out and fixed at room temperature in 1% glutaraldehyde in filtered sea water (pH 7.2). The tissue was then washed three times in a 1:1 sea water:glass distilled water solution. Following the third wash, the material was postfixed for one hour in 1% osmium tetroxide in filtered sea water, rinsed with glass distilled water, dehydrated through a graded series of ethanol, taken through two changes of propylene oxide, and embedded in Medcast (Ted Pella, Inc., Tustin, CA). Silver to gold sections were cut with a diamond knife, and stained with uranyl acetate and lead citrate. The specimens were observed in a Philips 201 transmission electron microscope operated at 60 kV.

Scanning electron microscopy

After removal of the soft parts, the shell was preserved in 70% ethanol. Then the shell was carefully cut around the shell window with a rotary rock saw, until a small frame of shell (about 3 mm wide) surrounded the window on all sides. This frame and the shell window with the regenerated material were rinsed with distilled water and air dried. The samples were mounted on aluminum scanning electron microscopy stubs with nail polish, coated with 100–200 Å of gold palladium (60:40), using a E5100 Polaron Sputter Coater. The material was observed with a Cambridge S4-10 scanning electron microscope operated at 20 kV.

RESULTS

The structures of the three tissues from normal, nonregenerating snails were unexceptional, and, in fact, identical to descriptions from transmission electron microscope studies of those tissues appearing in the literature (Abolins-Krogis, 1961; 1963; Tsujii, 1976; Watabe *et al.*, 1976). The purpose of this paper is to describe the ultrastructural changes in the tissues during shell regeneration. The sequence of events was consistent for each snail in the experimental group. However, the time after the shell window was cut until each ultrastructural change was seen showed some individual variation. Consequently, the results are outlined in time frames following the creation of the shell window.

14-48 hours of regeneration

Three ultrastructural changes took place in the soft tissues during this stage of shell regeneration. First, the amount of rough endoplasmic reticulum increased, typically in the form of whorls or spirals (Fig. 1). Second, the number of Golgi complexes also increased (Fig. 2), and third, juxtaposed with the Golgi complexes, were open vesicles containing condensed or fibrous material (Fig. 3).

The shell window had small, doubly pointed or spindle-shaped crystals in and on an organic membrane (Fig. 4). This was the first appearance of mineralized material in the injured area of the shell. Often these crystals were aggregated into radiating clusters or small rosettes (Fig. 5).

48-72 hours of regeneration

The predominant feature in the soft tissues during this phase of regeneration were membrane-bound clusters of vesicles or vacuoles (Fig. 6). These inclusions took several forms, some were aggregates of very dense vesicles with some of the

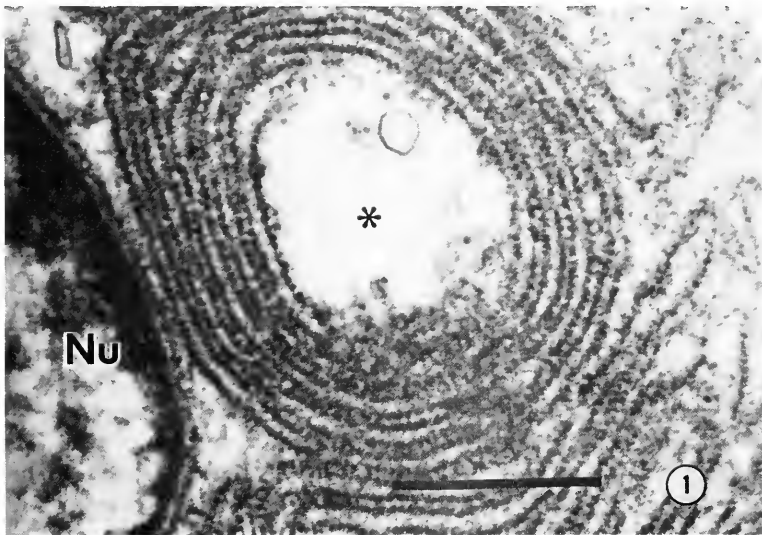

FIGURE 1. Foot epithelium, 36 hours of regeneration, showing a whorl of rough endoplasmic reticulum (*), Nu = nucleus, Bar = 500 nm.

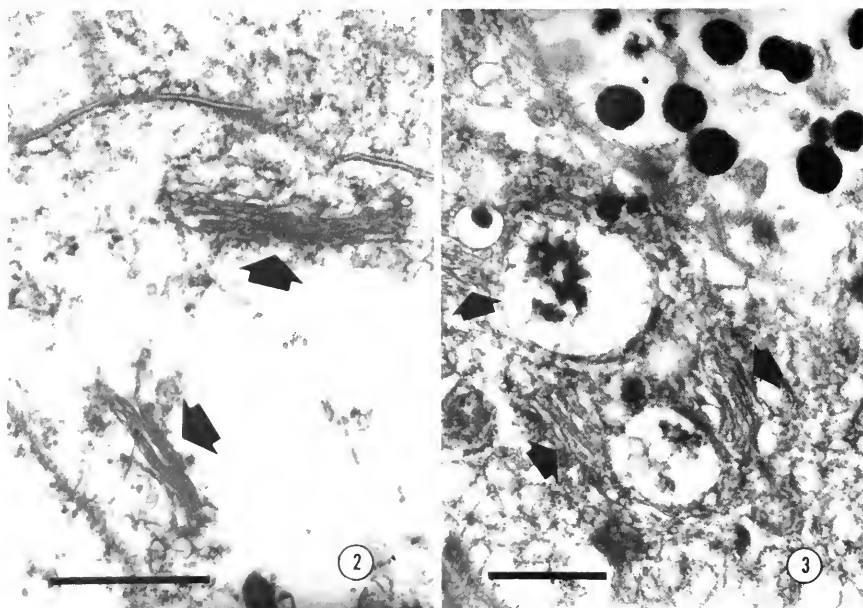

FIGURE 2. Mantle epithelium, 24 hours of regeneration, showing two Golgi complexes (arrows). Note the light fibrillar material near the Golgi complexes. Bar = 1 μ m.

FIGURE 3. Foot epithelium, 48 hours of regeneration with several Golgi complexes (arrows) and associated vesicles containing some condensed material. Bar = 1 μ m.

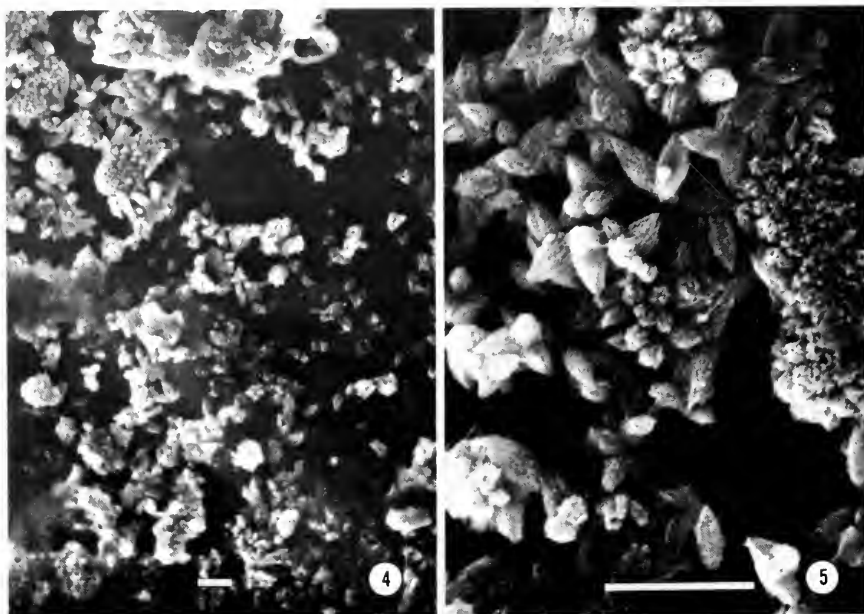

FIGURE 4. Scanning electron micrograph of the shell window, 48 hours of regeneration, showing small crystals associated with an organic matrix. Bar = 10 μ m.

FIGURE 5. Higher magnification scanning electron micrograph of the shell window, 48 hours of regeneration, showing clusters of doubly-pointed crystallites. Bar = 10 μ m.

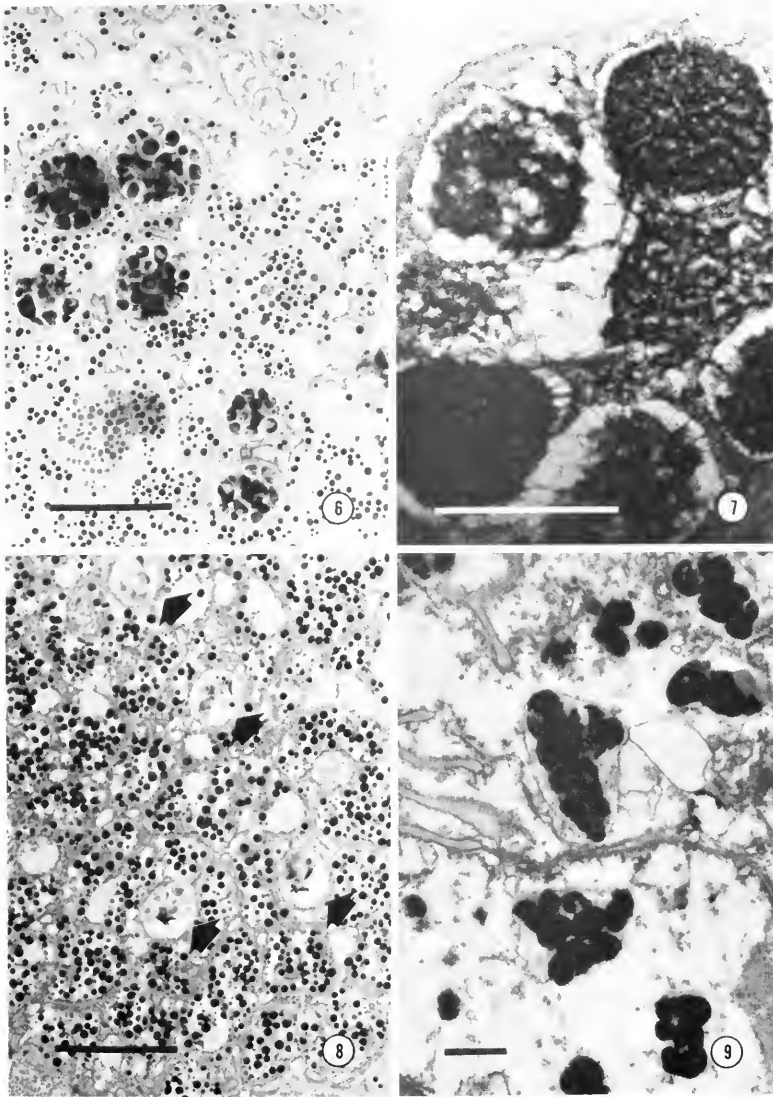

FIGURE 6. Mantle epithelium, 54 hours of regeneration, showing several inclusions containing dark vacuoles. The small dark droplets are melanin. Bar = 10 μ m.

FIGURE 7. Mantle epithelium, 72 hours of regeneration, showing granular and fibrous material associated with a Type I inclusion. Bar = 500 nm.

FIGURE 8. Foot epithelium, 48 hours of regeneration, showing Type II inclusions (arrows). Small dark droplets are melanin. Bar = 10 μ m.

FIGURE 9. Hepatopancreas, 72 hours of regeneration, with Type III inclusions. Bar = 1 μ m.

individual vesicles appearing granular and connected to the other vesicles and the delimiting membrane by a fibrous network (Fig. 7, Type I inclusions). In another form (Type II inclusions), the entire inclusion was round, and the vacuoles were less electron-dense than Type I inclusions (Fig. 8). The third form consisted of aggregates of two to 15 or more dark vacuoles (Fig. 9, Type III inclusions). These

three inclusions were not correlated with any particular tissue, that is, all three morphologies were found in all three of the tissues during this stage of regeneration.

The regenerated material in the shell window consisted of spindle-shaped crystals, and was virtually identical to the description for 14–48 hours of regeneration.

72 hours–six days of regeneration

As shown in Figure 10, transmission electron microscopy of the mantle, foot, and hepatopancreas showed widened intracellular spaces and spherules. A fibrous network linked the cores of the spherules with the surrounding membrane (Fig. 11).

By this stage of regeneration, *e.g.*, as early as 72 hours, but no later than six days after the shell window was cut, a thin sheet of material formed by the coalescence of spindle-shaped crystals covered the shell window (Figs. 12 and 13).

DISCUSSION

The present study shows that the mantle, foot, and hepatopancreas of *Tegula* undergo ultrastructural alterations during the first six days of shell repair. Each of these tissues has been implicated in shell repair and calcification (Abolins-Krogis, 1970a, b; Burton, 1972; Watabe *et al.*, 1976; Tsujii, 1976; Watabe and Blackwelder, 1980). However, few studies concern the involvement of all three tissues at the same time.

Since of the three tissues studied, the mantle is the one usually associated with molluscan shell formation (Wilbur, 1964; 1972; 1976; Crenshaw, 1980), the ultra-

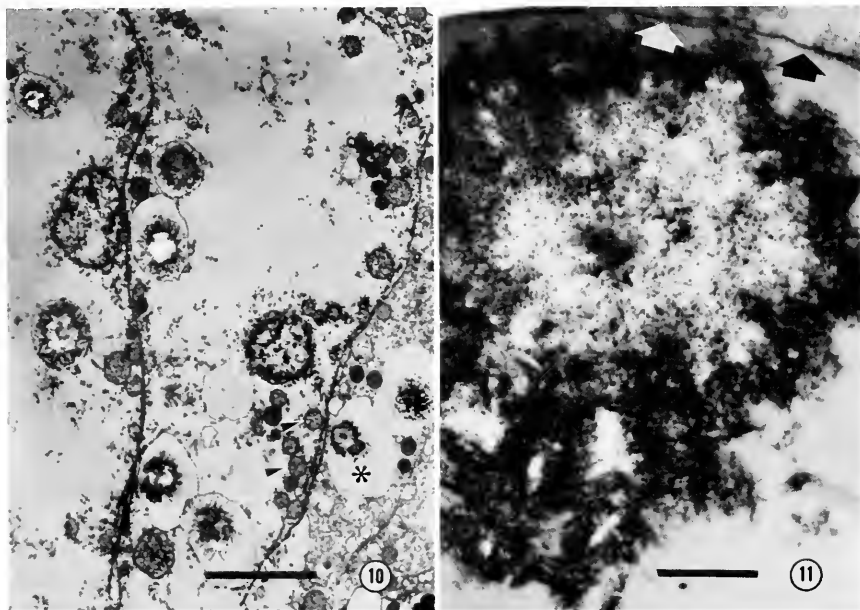

FIGURE 10. Mantle, 4 days of regeneration, showing wide intracellular spaces and spherules. Arrowheads indicate some mitochondria. Bar = 5 μ m.

FIGURE 11. Mantle, 4 days of regeneration, showing at higher magnification the spherule indicated with a * in Figure 10. Note the membrane (arrow) and the granular-fibrillar appearance of the dark material surrounding the lucent core. Bar = 100 nm.

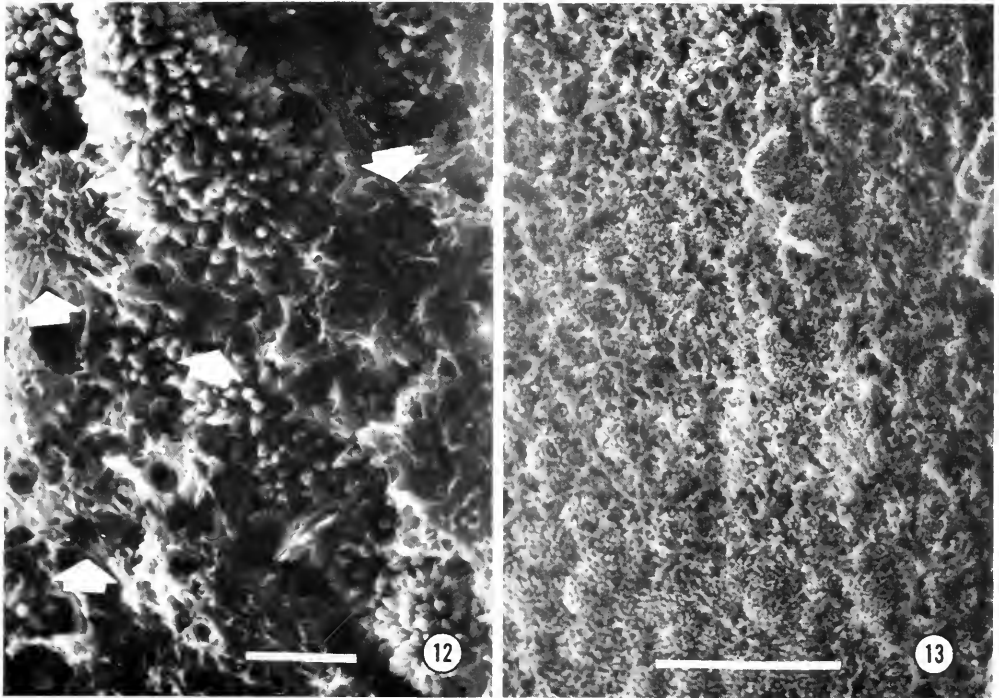

FIGURE 12. Scanning electron micrograph of the shell window, 6 days of regeneration, showing rosettes of spindle-shaped crystals associated with an organic matrix (arrowheads). Bar = 10 μ m.

FIGURE 13. Scanning electron micrograph of the shell window, 6 days of regeneration, showing the coalescence of spindle-shaped crystals and rosettes to cover the window. Bar = 100 μ m.

structural observations are discussed with regard to the role of this organ. The function of the foot and the hepatopancreas in shell repair will be compared to previous work of these tissues in other molluscs.

The mantle edge is the region actively involved in shell growth (Tsujii, 1976; Crenshaw, 1980). In this study, the site of shell regeneration was the first body whorl of the shell which lies over the central zone of the mantle—an area not usually involved in shell formation (Tsujii, 1976; Crenshaw, 1980). Following the initiation of shell regeneration, this zone of the mantle showed ultrastructural changes that may indicate an increased role in shell maintenance. These include a proliferation of rough endoplasmic reticulum, typically in whorls or spirals. Comparable changes have been reported in the mantle edge of *Heliosoma* (Saleuddin, 1976), *Helix* (Saleuddin, 1970, Fig. 11), and marine bivalves (Bubel, 1973a, b).

An increase in Golgi complexes was evident in the mantles of the shell-regenerating gastropods in this study. Moreover, as was the case for rough endoplasmic reticulum, increased numbers and activity in Golgi complexes have been described in active regions of the mantle in other molluscs. For instance, during periostracum or shell repair in *Mytilus edulis* and *Helix pomatia* (Saleuddin, 1970; Bubel, 1973c). Precursors of the periostracum were observed in Golgi cisternae in the gland cells of the mantle of *Littorina* (Bevelander and Nakahara, 1971), and Watabe *et al.* (1976) found that the formation of calcareous spherules in *Pomacea paludosa* was preceded by large vacuoles near the Golgi apparatus.

There was also an increase in mitochondria. Saleuddin (1970) noted 24 hours after shell injury to *Helix pomatia*, that the number of mitochondria increased. The calcium cells of *Pomatia paludosa* contained numerous mitochondria (Watabe *et al.*, 1976). In fact, these workers suggest that their findings lend support to the notion that the mitochondria are involved in the uptake and release of calcium and phosphate for calcification (Spiro and Greenspan, 1969; Lehninger, 1970; Saleuddin, 1970; Elder and Lehninger, 1973; Becker *et al.*, 1974). Certainly this could also be the role of the increased mitochondria in the tissues of shell-regenerating *Tegula*.

Three types of inclusions were noted. Their appearance was preceded by proliferation of rough endoplasmic reticulum and Golgi complexes. Vacuoles in the inclusions and fibrous, matrix-like material were found in close proximity to the Golgi complexes. Presumably, these inclusions are derived from the reticulum-Golgi complex system as in other calcifying systems (see Spangenberg, 1976; Watabe *et al.*, 1976; and Simkiss, 1980, for examples and discussions of the Golgi vesicle-reticulum system in calcification).

Distinctions as to the possible functions of each of the three types of inclusions are impossible to make with the current data, but some speculation on their roles is possible. It is conceivable that one role may be to provide matrix material for the deposition of mineral for regenerated shell. The most likely candidates for this part are the Type I and Type II inclusions, based on the similarity in their ultrastructural appearance to inclusions that do serve as mineral deposition sites in other systems (See Watabe *et al.*, 1976, and Watabe and Blackwelder, 1980, for discussions of Golgi-derived vacuoles and vesicles in another gastropod under normal and shell-regenerating conditions).

The Type III inclusions may represent another morphology of calcifying vesicle or vacuole, or it may be involved in cellular detoxification. Calcification and mineralization involve a high degree of cellular activity, and there must be a way of ridding the cells of the resulting waste. Mason and Simkiss (1982), Kingsley and Watabe (1982), and Simkiss (1980) discuss similar inclusions in invertebrates and their role in detoxification.

If the inclusions are involved in providing sites for deposition of calcium in this system, the calcium must be mobilized to the site of shell regeneration. It is interesting that the appearance of the inclusions is followed by the occurrence of lucent cored spherules. These spherules may be similar to the naturally decalcified spherule found in the calcium cells of *Pomacea paludosa* (Watabe *et al.*, 1976; Watabe and Blackwelder, 1980).

Since the ultrastructural picture was similar to that for the mantle, it would be repetitive to consider in detail the changes in the foot and the hepatopancreas reported here. However, there are some points to be made about the possible roles of these tissues in shell repair. For example, when calcareous spherule development was not evident, prominent Golgi complexes and abundant rough endoplasmic reticulum and mitochondria occurred in the calcium cells of the foot and the albumin-capsule gland complex as well as in the mantle of *Pomacea paludosa* (Watabe *et al.*, 1976). Later work showed that spherule calcium was used for shell regeneration (Watabe and Blackwelder, 1980). The spherules described in the foot of the shell-regenerating *Tegula* in this study may be contributing calcium for shell repair as did those in *Pomacea*.

The role of the hepatopancreas in molluscan shell regeneration has been debated. Burton (1972) suggested that calcium from the hepatopancreas of *Helix* was used for shell repair, but did not show it to be mobilized. Work on the hepatopancreas of shell-regenerating *Helix pomatia* showed calcium spherites developed in protein-

containing Golgi saccules (Abolins-Krogis, 1970a), and alterations in the ultrastructure of this organ (Abolins-Krogis, 1970b; 1972). Simkiss (1980) found that spherules from the mantle and the foot of *Helix aspersa* were soluble in saline, while those from the hepatopancreas were not. He suggested different functions for the two types of spherules—those from the foot and the mantle would be involved in mineralization, while the more insoluble ones would be responsible for cellular detoxification (Simkiss, 1980; Mason and Simkiss, 1982). Campbell and Boyan (1976) suggested that the function of calcium spherules in the gastropod hepatopancreas is as a phosphate reserve. The hepatopancreas of *Tegula* may provide calcium for shell repair, as well as detoxifying the animal and providing phosphate.

Regenerated shell may be different from or similar to the normal shell ultrastructure (Saleuddin and Wilbur, 1969; Wilbur, 1972; Wong and Saleuddin, 1972). The small doubly-pointed crystals and the stellate shapes they formed have been described for both normal and regenerated shell in other molluscs. Spherulitic aggregates have been shown in another archaeogastropod, *Cittarium pica* (Wise and Hay, 1968a, b; Erben, 1971), and in the regenerated shell of *Pomacea paludosa* and *Cepaea nemoralis* (Blackwelder and Watabe, 1977; Watabe, 1981). The crystals formed during early shell regeneration in *Nautilus macromphalus* are doubly-pointed, associated with an organic matrix, and form stellate aggregates which grow until a spherulitic prismatic layer is formed (Meenakshi *et al.*, 1974). Therefore, the spindle-shaped crystals described in the regenerated shell of *Tegula* appear to be a common morphology of calcium carbonate in some archaeogastropods as well as in regenerated molluscan shell.

ACKNOWLEDGMENTS

Thanks go to William I. Miller, III for expert assistance with the scanning electron microscopy, and to Dennis Cassidy for the use of the darkroom in the Antarctic Research Facility in the Department of Geology at FSU. I am grateful to Dr. Charles B. Metz for a helpful review of the manuscript. Supported by N.I.H. Grant #DE05491. This is contribution number 195 from the Tallahassee, Sopchoppy and Gulf Coast Marine Biological Association.

LITERATURE CITED

- ABOLINS-KROGIS, A. 1961. The histochemistry of the hepatopancreas of *Helix pomatia* (L.) in relation to the regeneration of the shell. *Ark. Zool.* **13**: 59–202.
- ABOLINS-KROGIS, A. 1963. The histochemistry of the mantle of *Helix pomatia* (L.) in relation to the repair of the damaged shell. *Ark. Zool.* **15**: 461–474.
- ABOLINS-KROGIS, A. 1968. Shell regeneration in *Helix pomatia* with special reference to the elementary calcifying particles. *Symp. Zool. Soc. Lond.* No. **22**: 75–92.
- ABOLINS-KROGIS, A. 1970a. Electron microscope studies of the intracellular origin and formation of calcifying granules and calcium spherites in the hepatopancreas of the snail, *Helix pomatia* L. *Z. Zellforsch.* **108**: 501–515.
- ABOLINS-KROGIS, A. 1970b. Alterations in the fine structure of cytoplasmic organelles in the hepatopancreatic cells of shell-regenerating snail, *Helix pomatia* L. *Z. Zellforsch.* **108**: 516–529.
- ABOLINS-KROGIS, A. 1972. The tubular endoplasmic reticulum in the amoebocytes of the shell-regenerating snail, *Helix pomatia* L. *Z. Zellforsch.* **128**: 58–68.
- BECKER, G. L., C-H. CHEN, J. W. GREENWALT, AND A. L. LEHNINGER. 1974. Calcium phosphate granules in the hepatopancreas of the blue crab *Callinectes sapidus*. *J. Cell Biol.* **61**: 316–326.
- BEDDHAM, G. E. 1965. Repair of the shell in species of *Anodonta*. *Proc. Zool. Soc. Lond.* **145**: 107–125.
- BEVELANDER, G. B., AND M. NAKAHARA. 1971. The formation and growth of the prismatic layer of *Pinctada radiata*. *Calc. Tiss. Res.* **7**: 31–45.
- BLACKWELDER, P. L., AND N. WATABE. 1977. Studies on shell regeneration II. The fine structure of normal and regenerated shell of the freshwater snail, *Pomacea paludosa*. *Biom mineralization* **9**: 1–10.

- BUBEL, A. 1973a. An electron-microscope investigation of the cells lining the outer surface of the mantle in some marine molluscs. *Mar. Biol.* **21**: 245-255.
- BUBEL, A. 1973b. An electron-microscope study of periostracum formation in some marine bivalves. II. The cells lining the periostracal groove. *Mar. Biol.* **10**: 222-234.
- BUBEL, A. 1973c. An electron-microscope study of periostracum repair in *Mytilus edulis*. *Mar. Biol.* **20**: 235-244.
- BURTON, R. F. 1972. The storage of calcium and magnesium phosphates and of calcite in the digestive glands of pulmonata (Gastropoda). *Comp. Biochem. Physiol.* **43A**: 655-663.
- CAMPBELL, J. W., AND B. D. BOYAN. 1976. On the acid-based balance of gastropod molluscs. Pp. 109-133 in *The Mechanisms of Mineralization in the Invertebrates and Plants*, N. Watabe and K. M. Wilbur, eds. Univ. South Carolina Press, Columbia.
- CHAN, J. F. Y., AND A. S. M. SALEUDDIN. 1974. Acid phosphatase in the mantle of the shell-regenerating snail, *Helisoma duryi duryi*. *Calcif. Tissue Res.* **15**: 213-220.
- CRENSHAW, M. A. 1980. Mechanisms of shell formation and dissolution. Pp. 115-132 in *Skeletal Growth of Aquatic Organisms*, D. C. Rhoads and R. A. Lutz, eds. Plenum Press, New York.
- ELDER, J. A., AND A. L. LEHNINGER. 1973. Respiration dependent transport of carbon dioxide into rat mitochondria. *Biochemistry, N. Y.* **12**: 976-982.
- ERBEN, H. K. 1971. Anorganische und organische schalenkomponenten bei *Cittarium pica* (L.). (Archaeogastropoda). *Biom mineralization* **3**: 51-64.
- KAPUR, S. P., AND A. S. GUPTA. 1970. The role of amoebocytes in the regeneration of shell in the land pulmonate *Euplecta indica* (PFIEFER). *Biol. Bull.* **139**: 502-509.
- KINGSLEY, R. J., AND N. WATABE. 1982. Ultrastructural investigation of spicule formation in the gorgonian *Leptogorgia virgulata* (Lamarck) (Coelenterata: Gorgonacea). *Cell Tissue Res.* **223**: 325-334.
- LEHNINGER, A. L. 1970. Mitochondria and calcium ion transport. *Biochem. J.* **119**: 129-138.
- MASON, A. Z., AND K. SIMKISS. 1982. Sites of mineral deposition in metal-accumulating cells. *Exp. Cell Res.* **139**: 383-391.
- MEENAKSHI, V. R., P. L. BLACKWELDER, AND K. M. WILBUR. 1973. An ultrastructural study of shell regeneration in *Mytilus edulis* (Mollusca: Bivalvia). *J. Zool. Lond.* **171**: 474-484.
- MEENAKSHI, V. R., A. W. MARTIN, AND K. M. WILBUR. 1974. Shell repair in *Nautilus macromphalus*. *Mar. Biol.* **27**: 27-35.
- MEENAKSHI, V. R., P. L. BLACKWELDER, P. E. HARE, K. M. WILBUR, AND N. WATABE. 1975. Studies on shell regeneration—I. Matrix and mineral composition on the normal and regenerated shell of *Pomacea paludosa*. *Comp. Biochem. Physiol.* **50A**: 347-351.
- REED-MILLER, C., S. W. WISE, JR., AND H. J. SIEGEL. 1980. Correlated techniques for identifying mineral phases and morphologies in regenerated archaeogastropod shells: A progress report. Pp. 73-78 in *The Mechanisms of Biom mineralization in Animals and Plants*, M. Omori and N. Watabe, eds. Tokai University Press, Tokyo.
- REED-MILLER, C. 1981. Transmission and scanning electron microscopy of gastropod shell regeneration. *Am. Zool.* **21**: 1037.
- SALEUDDIN, A. S. M. 1967. The histochemistry of the mantle during the early stage of shell repair. *Proc. Malacol. Soc. Lond.* **37**: 371-380.
- SALEUDDIN, A. S. M. 1970. Electron microscopic study of the mantle of normal and regenerating *Helix*. *Can. J. Zool.* **48**: 409-416.
- SALEUDDIN, A. S. M. 1976. Ultrastructural studies of the structure and formation of the periostracum in *Heliosoma*. Pp. 309-337 in *The Mechanisms of Mineralization in the Invertebrates and Plants*, N. Watabe and K. M. Wilbur, eds. Univ. South Carolina Press, Columbia.
- SALEUDDIN, A. S. M., AND K. M. WILBUR. 1969. Shell regeneration in *Helix pomatia*. *Can. J. Zool.* **47**: 51-53.
- SIMKISS, K. 1980. Detoxification, calcification and the intracellular storage of ions. Pp. 13-18 in *The Mechanisms of Biom mineralization in Animals and Plants*, M. Omori and N. Watabe, eds. Tokai University Press, Tokyo.
- SPANGENBERG, D. B. 1976. Intracellular statolith synthesis in *Aurelia aurita*. Pp. 131-144 in *The Mechanisms of Mineralization in the Invertebrates and Plants*. N. Watabe and K. M. Wilbur, eds. Univ. South Carolina Press, Columbia.
- SPIRO, I., AND J. GREENSPAN. 1969. Are mitochondria directly involved in biological calcification? *Calcif. Tissue Res.* **3**: 100-102.
- TSUJII, T. 1960. Studies on the mechanisms of shell- and pearl-formation. XI. The submicroscopical observations on the mechanism of formation of abnormal pearls and abnormal shell. *Rep. Fac. Fish. Prefect. Univ. Mie.* **6**: 59-66.
- TSUJII, T. 1976. An electron microscopic study of mantle epithelial cells of *Anodonta* sp. during shell regeneration. Pp. 339-353 in *The Mechanisms of Mineralization in the Invertebrates and Plants*, N. Watabe and K. M. Wilbur, eds. Univ. South Carolina Press, Columbia.

- UOZUMI, S., AND S. OHATA. 1977. Scanning electron microscopy and electron probe microanalysis of initial mineralization in marine shell regeneration. *J. Geol. Soc. Jpn.* **83**: 425-432.
- UOZUMI, S., AND S. SUZUKI. 1979. "Organic membrane-shell" and initial calcification in shell regeneration. *J. Fac. Sci. Hokkaido Univ. Ser. IV.* **19**: 37-74.
- WAGGE, L. E. 1951. The activity of amoebocytes and of alkaline phosphatase during the regeneration of the shell of the snail *Helix aspersa*. *Q. J. Microsc. Sci.* **92**: 307-321.
- WATABE, N. 1981. Crystal growth of calcium carbonate in the invertebrates. Pp. 99-147 in *Inorganic Biological Crystal Growth*, B. R. Pamplain, ed. Pergamon Press, Oxford.
- WATABE, N., V. R. MEENAKSHI, P. L. BLACKWELDER, E. M. KURTZ, AND D. G. DUNKELBERGER. 1976. Calcareous spherules in the gastropod, *Pomacea plaudosa*. Pp. 283-308 in *The Mechanisms of Mineralization in the Invertebrates and Plants*, N. Watabe and K. M. Wilbur, eds. Univ. South Carolina Press, Columbia.
- WATABE, N., AND P. L. BLACKWELDER. 1980. Ultrastructure and calcium localization in the mantle epithelium of the freshwater gastropod, *Pomacea plaudosa* during shell regeneration. Pp. 131-144 in *The Mechanisms of Biomineralization in Animals and Plants*, M. Omori and N. Watabe, eds. Tokay University Press, Tokyo.
- WILBUR, K. M. 1964. Shell formation and regeneration. Pp. 243-282 in *Physiology of Mollusca*, K. M. Wilbur and C. M. Yonge, eds. Academic Press, New York.
- WILBUR, K. M. 1972. Shell formation on molluscs. Pp. 103-145 in *Chemical Zoology. Vol. VII. Mollusca*, M. Florkin and B. T. Scheer, eds. Academic Press, New York.
- WILBUR, K. M. 1973. Mineral regeneration in echinoderms and molluscs. *Ciba Found. Symp.* **11** (new ser.): 7-33.
- WILBUR, K. M. 1976. Recent studies of invertebrate mineralization. Pp. 79-108 in *The Mechanisms of Mineralization in the Invertebrates and Plants*, N. Watabe and K. M. Wilbur, eds. Univ. South Carolina Press, Columbia.
- WISE, S. W., JR., AND W. W. HAY. 1968a. Scanning electron microscopy of molluscan shell ultrastructure. I. Techniques for polished and etched sections. *Trans. Am. Microsc. Soc.* **87**: 411-418.
- WISE, S. W., JR., AND W. W. HAY. 1968b. Scanning electron microscopy of molluscan shell ultrastructure. II. Observation of growth surfaces. *Trans. Am. Microsc. Soc.* **87**: 419-430.
- WONG, V., AND A. S. M. SALEUDDIN. 1972. Fine structure of normal and regenerated shell of *Helisoma duryi duryi*. *Can. J. Zool.* **50**: 1563-1568.

MATING AND EGG MASS PRODUCTION IN THE AEOLID
NUDIBRANCH *HERMISSENDA CRASSICORNIS*
(GASTROPODA: OPISTHOBRANCHIA)

RONALD L. RUTOWSKI

Department of Zoology, Arizona State University, Tempe, AZ 85287

ABSTRACT

Interactions leading to copulation in the aeolid nudibranch, *Hermisenda crassicornis*, have a duration of only a minute or two, and intromission lasts only a few seconds (Longley and Longley, 1982). This paper reports additional details on the temporal structure and variation in structure of these interactions. It is also shown that sperm from a single copulation are sufficient to fertilize only 2 to 3 egg masses and that the state of an animal's sperm supply affects the rate at which it produces egg masses but not the size of the masses produced. In the discussion the results are compared to information on other simultaneous hermaphrodites in an effort to assess the possible adaptive advantages of the structure of the reproductive behavior of *H. crassicornis*.

INTRODUCTION

Longley and Longley (1982) reported recently that copulation in the nudibranch, *Hermisenda crassicornis*, is much briefer than that reported for many other opisthobranchs. In particular, copulation in this simultaneous hermaphrodite involves an explosive and reciprocal eversion of the penises with intromission lasting only a few seconds. In contrast, copulation in most other sea slugs lasts for many minutes or hours.

The gross sequential and temporal features of copulatory interactions in *H. crassicornis* are known, in part by default (Zack, 1975; Rutowski, 1982). Copulation is most likely to occur in interactions that begin when two animals meet head-to-head. After initial contact the participants stop forward movement and reciprocally touch each other with their tentacles. These repeated contacts were termed "flagellation" by Zack and last for about 45 s (Fig. 1A). The animals then begin moving slowly toward one another until they begin to pass, with the head of each animal moving along the right side of the other (Fig. 1B). Zack called this "sidling", and it brings the gonopores on the right side of the body a little behind the head into apposition. In Zack (1975) and Rutowski (1982) the cerata prevented observation of the eversion of the penises that occurs when the gonopores come into contact (Fig. 1C). Hence, interactions with sidling were not known to be copulatory until Longley and Longley's (1982) report. About 5 s after the beginning of sidling both animals erect their cerata and begin to move apart. This separation is often concurrent with lunging and biting by one or both animals directed at its partner (Fig. 1D). Within 20 s after erection of the cerata, the animals are fully separated.

The data presented in this report are directed at answering two questions about the intriguing mating behavior of *H. crassicornis*. First, what are the details of these

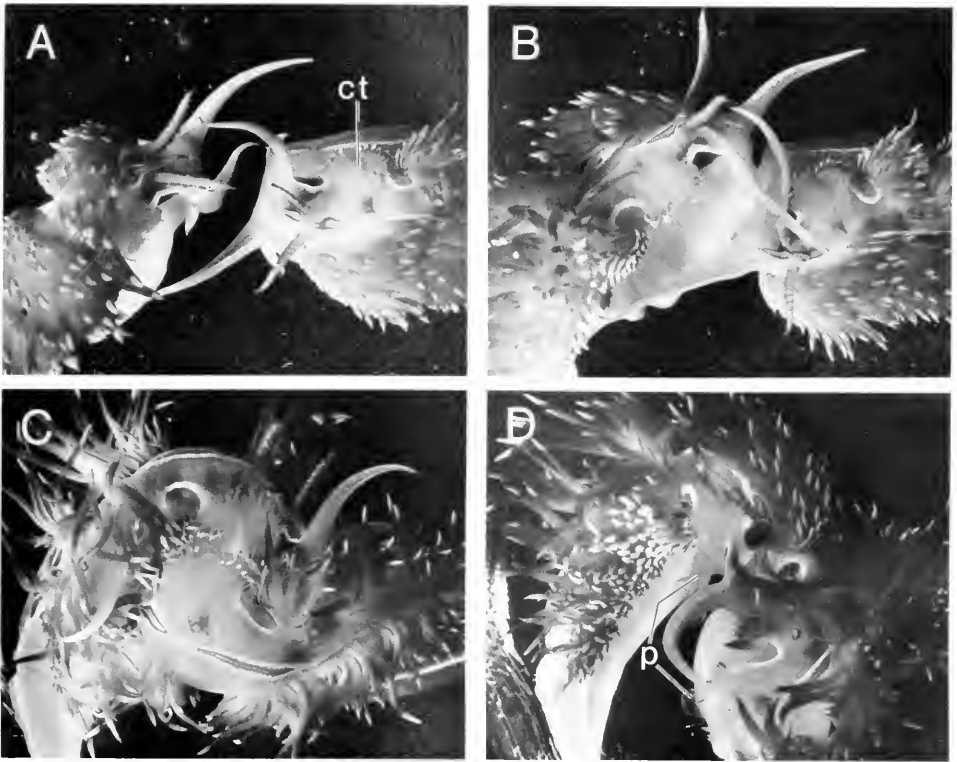

FIGURE 1. Events in a copulatory interaction in *Hermissenda crassicornis*. (A) Flagellation (ct, area above gonopore from which cerata have been cleared); (B) beginning of sidling; (C) the moment of intromission; (D) shortly after withdrawal (p, withdrawn but unretracted penis).

copulatory interactions? Second, how are egg fertility and output related to copulation? Special attention will be devoted to determining how long the sperm from a single copulation lasts relative to the duration of an individual's reproductive life. Quantitative and detailed answers to these questions are of interest because the Longleys' observations were largely qualitative and because the behavior of simultaneous hermaphrodites is generally so little known (Fischer, 1980). The discussion examines the adaptive features of the mating behavior of *H. crassicornis* relative to that of other opisthobranchs and other simultaneous hermaphrodites.

MATERIALS AND METHODS

Hermissenda crassicornis was collected between January and June in 1982 in the intertidal *Zostera marina* beds in Elkhorn Slough, Monterey County, CA. All animals were taken to the Long Marine Laboratory, Santa Cruz County, CA, where they were housed individually in small plastic cups (about 250 ml) each with its own supply of fresh running sea water (approximately 11–13°C) from a holding tank on the station property (Rutowski, 1982). The animals were fed either fresh mussel (*Mytilus californianus*) or, rarely, fresh squid mantle (*Loligo* spp.) every other day. At each feeding cups were cleared of food remaining from previous feedings and any detritus introduced by the sea water system.

The production and fertility of egg masses were carefully monitored for all isolated animals. If an animal produced an egg mass the animal was removed from its container and placed in a new one. The egg mass diameter was measured and then incubated undisturbed in unfiltered running sea water for 4 to 7 days at which time the shells of developing veligers become clearly visible (Williams, 1980). At this time the proportion of fertilized eggs in each mass was assessed by estimating, to the nearest 25%, the proportion of eggs that had developed into shelled veligers. In the results, any egg mass in which less than 50% of the eggs developed into veligers is referred to as an "infertile" egg mass. Those with 50% or more of the eggs developing into veligers are called "fertile" egg masses.

Isolated animals were, under conditions of constant observation, permitted to contact and mate with other individuals. The staging and videotaping of these interactions followed the techniques described in Rutowski (1982) except that larger containers (12 cm diameter watchglass or dish) were typically used.

Throughout the study the area above and slightly behind the gonopore of each animal was kept free of cerata (Fig. 1). This was done about once every week or two by plucking away with watchmakers forceps any cerata that might impede observations of penis eversion and intromission.

All parametric summary statistics are given as: mean \pm standard deviation. Statistical evaluations were made at the 0.05 level of significance.

RESULTS

Form of copulatory interactions

Over 60 interactions leading to sidling and copulatory attempts were observed during the course of this study. Of these, 43 were videotaped and analysed for the timing of events before and after penis eversion (Table I, Fig. 1).

The form of all these interactions was similar to the copulatory interactions described by Longley and Longley (1982) and for interactions with flagellation and sidling described by Zack (1975) and Rutowski (1982). I would add that during flagellation there is a pronounced swelling of the gonopore region that continues until penis eversion. If flagellation is terminated for some reason the swelling decreases and a small amount of semen is released from the gonopore. Also, new temporal information to add to these descriptions includes the time from the beginning of sidling (1) to penis eversion and (2) until both animals have uncoupled (Table I). These data confirm the relatively rapid progression of events in these matings. The average duration of intromission was only about 4 s, and in all but a few cases differences in the time of eversion between participants were not resolvable with the video system used.

TABLE I

The timing of events in a copulatory interaction from the beginning of sidling until the animals begin to retreat or move apart

Event	Time of occurrence relative to beginning of sidling (s)	Source
Cerata movement	4.11 \pm 0.859 s (n = 19)	Rutowski, 1982
Intromission	6.53 \pm 2.77 s (n = 39)	This study
Withdrawal	10.5 \pm 2.88 s (n = 31)	This study
Begin retreat	13.1 \pm 6.2 s (n = 19)	Rutowski, 1982

Sidling does not always lead to intromission. First, on a few rare occasions one or both animals did not evert the penis. When neither animal attempted intromission, they simply moved apart after a brief apposition of the gonopores. Second, as pointed out by the Longleys, not all penis eversion resulted in intromission. Typically, during the process of eversion in such an interaction, the penis appeared to ricochet off the body wall of the partner next to its gonopore and ejaculated the semen at the moment of full extension. Of the 41 videotape records of interactions with sidling and penis eversion, 37 were of adequate quality to determine whether or not penis eversion with intromission occurred. In 38% of these both animals attained intromission. However, in another 49%, although both animals tried, one animal missed the other's gonopore. In the remaining interactions neither animal attained intromission either because both missed (8%) or because one missed and one did not attempt intromission (5%). Interactions in which neither animal attempted penis eversion were not included in this count. In summary, sperm transfer was not reciprocal in almost 50% of the interactions in which penis eversion by both animals occurred.

After penis eversion and separation a new behavior pattern was observed which was directed at the mass of semen that was frequently seen in the vicinity of the gonopore particularly if intromission did not occur. An animal stopped, turned its head so that the mouth was positioned near the gonopore, and consumed all or part of the semen in the vicinity of the gonopore (Fig. 2). Data on the frequency of occurrence of this behavior was not recorded. It also occurs in land snails in the genus *Partula* (Lipton and Murray, 1979).

Effect of copulation on egg production

Rates of egg production: fertile versus infertile. If an individual of *H. crassicornis* is isolated and denied contact with conspecifics it will typically produce a few com-



FIGURE 2. *Hermisenda crassicornis* immediately after copulation ingesting semen from the vicinity of the gonopore.

pletely (100%) fertile egg masses and then either stop producing eggs or begin to produce masses with an increasing proportion of infertile eggs (Table II). In egg masses with fertile and infertile eggs, the infertile eggs are concentrated in the outer loops of the spiral while those eggs near the middle of the spiral are mostly fertile. The average interval between fertile egg masses (as defined earlier) was 4.32 ± 2.22 days (Fig. 3). The time between the last fertile mass produced by an animal and the first infertile mass was 9.35 ± 10.06 days, which is significantly different from the interval between fertile masses (Wilcoxon rank sum test, $P = 0.00007$; $t = 5.47$, $P < 0.001$). The average interval between masses of mostly infertile eggs was 7.36 ± 6.5 days which was also significantly longer than the time between two fertile masses (Wilcoxon rank sum test, $P = 0.00005$; $t = 5.19$, $P < 0.0001$) but not significantly different from the time between the last fertile and the first infertile egg mass (Wilcoxon rank sum test, $P = 0.17$; $t = 1.17$, $P > 0.2$).

Another way of summarizing these data is to ask, if an animal produces a fertile egg mass how does the probability that the next mass will be infertile change with the time elapsed between the two? As Table III shows, if the interval is greater than 11 days the probability that the next mass is infertile is 100%. Hence for purposes of this study an animal was regarded as sperm depleted if (1) it had produced 2 or more infertile egg masses, or (2) if it had not produced a fertile egg mass in 20 days or more.

Egg mass size: fertile versus infertile. Egg mass size is known to be a function of the size of the producer in *H. crassicornis* (Harrigan and Alkon, 1978). To minimize this effect I examined the diameter of egg mass pairs that were sequentially produced by the same animal, although no more than 11 days apart, and that varied by at least 50 percent in the proportion of eggs fertilized. Of 28 pairs of egg masses produced the more fertile mass was the larger of the two in 14 while the opposite situation appeared in 13 pairs. In one pair there was no difference. I conclude that the state of an animal's sperm supply has no consistent effect on the size of the egg mass that it produces.

Effect of copulation on the rate of fertile egg mass production. Thirty-eight animals that were sperm depleted (by the criteria above) were each permitted to engage in one sidling interaction with another animal and then returned to isolation. As indicated by the videotape records, 28 of these animals were successfully intromitted, while 15 were not. For 93% of those that were successfully intromitted, the next egg mass they produced was fertile. All produced egg masses an average of 2.64 ± 1.33 days after the copulation. These included 11 animals that had not produced an egg mass in over 20 days. In contrast, of the 15 animals that were not inseminated, none produced fertile egg masses within 20 days of the interaction with sidling. In

TABLE II

A summary of the fertility of egg masses produced after the last completely (100%) fertile egg mass produced

Egg mass after last 100% fertile mass	Percent of egg masses in which the % of eggs that developed was:				Sample size
	0-24	25-49	50-74	75-100	
First	11%	48%	15%	26%	27
Second	63%	31%	6%	0%	16
Third	100%	0%	0%	0%	11
Fourth and beyond	100%	0%	0%	0%	6

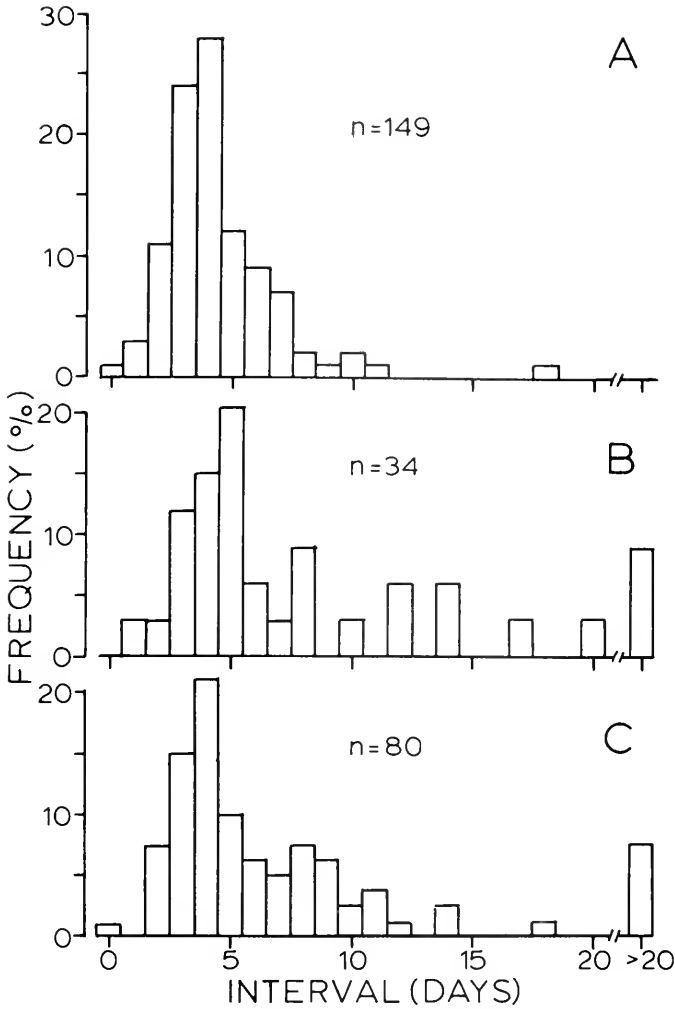

FIGURE 3. Intervals between successive egg masses. (A) Fertile to fertile; (B) fertile to infertile; (C) infertile to infertile.

fact, 5 of these animals did not produce any egg mass in the first 20 days after the interaction.

The likelihood that an isolated animal will produce an infertile egg mass increases with the number of egg masses produced since the last successful copulation (Table IV). By the fifth egg mass after copulation the probability that the mass is infertile is 50% or greater. The average number of fertile masses produced by an isolated animal after a single copulation and before it shows clear signs of sperm depletion is 2.65 ± 1.66 masses ($n = 20$).

Egg production of isolated wild-caught individuals

Ten animals were isolated from the time of capture in the field and their subsequent egg production was monitored in the laboratory for a period of 24 days.

TABLE III

The relationship between the fertility of an egg mass and the time of its production relative to the last fertile egg mass (no intervening masses)

Interval (days)	% Infertile	Sample Size
0-2	12.5	16
3-5	18.2	99
6-8	23.3	30
9-11	33.3	6
12 or more	100	10

During this time all produced at least one fertile egg mass; but before the end, 7 showed signs of sperm depletion. Two of these 7 produced infertile egg masses while the other five did not produce any egg masses during the final 10 days or more of isolation. The average number of fertile egg masses produced during the 24 day period was 3.7 ± 2.5 . This information suggests that about 80% of these animals carried stored sperm from a recent copulation or recent copulations.

DISCUSSION

Comparison with reports on copulation in other opisthobranchs

These data confirm Longley and Longley's (1982) report that copulation in *H. crassicornis* is a rapid affair. Copulatory interactions last a few minutes, but the actual duration of intromission is only a few seconds. It appears that one consequence of such a rapid attempt at intromission is the high frequency of unsuccessful attempts.

The Longleys point out that the hesitant approach and high willingness to turn away from contact that characterize the behavior of participants in the early phases of all interactions in *H. crassicornis* may be an effort on the part of one or both animals to avoid cannibalism, which has been observed in several studies of this animal (Zack, 1975; Rutowski, 1982). It may also be that the speed of copulation also reflects an adaptation that minimizes the duration of contact with potentially cannibalistic conspecifics. Supporting this notion is the observation that cannibalism and apparently cannibalistic attacks on conspecifics have not been reported for species of nudibranchs in which intromission is known to last many minutes or hours, such as *Embletonia fuscata* (Chambers, 1934), *Coryphella stimpsoni* (Morse, 1971), *Precuthona peachii* (Christensen, 1977), *Tritonia hombergi* (Thompson,

TABLE IV

A summary of the fertility of egg masses produced by initially sperm depleted animals that were intromitted

Egg mass after copulation	% Infertile	Sample Size
First	7.1	28
Second	18.5	27
Third	38.5	26
Fourth	65	20
Fifth	50	10
Sixth	57	7
Seventh and Eighth	80	5

1961), and *Chromodoris zebra* (Crozier, 1918). Longley and Longley (1982) report a very brief copulation in *Aeolidia papillosa* in which I have observed cannibalistic attacks on conspecifics. However, the tectibranch, *Navanax inermis*, is also known to feed readily on conspecifics but its copulation is prolonged (Paine, 1965).

The continued production of egg masses in spite of sperm depletion is known for a number of nudibranchs (Hadfield, 1963; Harris, 1975; Rivest, 1978; Christensen, 1977) and is puzzling. Why an animal continues even at a reduced rate to invest energy and resources in egg production when most will not develop is not currently clear.

Comparisons with other simultaneous hermaphrodites

In the opisthobranchs, reciprocal and internal fertilization is the rule (Costello, 1938; Beeman, 1977). In most, reciprocal insemination is simultaneous. Only in *Aplysia* has the assumption of single sex roles by individual animals been reported (Lederhendler and Tobach, 1977). In *Hypoplectrus nigricans*, a simultaneously hermaphroditic serranid fish, fertilization is external but reciprocal in that the animals take turns playing male and female roles in mating interactions (Fischer, 1980). The prevalence of reciprocity in these simultaneous hermaphrodites is in some ways unexpected. The best interests of the male and female functions of a hermaphrodite's reproductive tract are not the same. Charnov (1979) points out that in simultaneous hermaphrodites copulation is probably primarily an effort to give sperm rather than receive it. In other words, the fitness through male function can best be maximized through repeated copulation. It follows then that in mating interactions simultaneous hermaphrodites should be more often willing to play a male than a female role. One might expect to see more one-way inseminations or efforts on the part of individuals to give sperm without receiving it. However, at any given time in a population there will be many more animals willing to give sperm than to receive it so that to maximize the rate of giving sperm an animal must reduce its reluctance to receive it. As Charnov states, "each should be inclined to accept sperm in order to give its sperm away." In this respect the mating behavior of simultaneous hermaphrodites is more like that expected in cooperative interactions than those of gonochoric organisms. This view has been promulgated by Axelrod and Hamilton (1981) in their analysis of the selection pressures shaping the form of cooperative interactions in animals.

There are two ways in which this analysis might be relevant to understanding the reproductive behavior of *H. crassicornis*. First, it is possible that the missed intromissions represent efforts by animals to give sperm without receiving it by actively deflecting the penis of the other individual. Second, it is at least plausible that the rapidity of intromission is a result of animals attempting to give sperm quickly without giving the other animal a chance to intromit. These ideas both seem unlikely, however, in that most of the missed individuals in this study were animals in a sperm-depleted state who could have greatly benefited from receiving as well as giving sperm.

Evolution of simultaneous hermaphroditism in H. crassicornis

The data presented here and elsewhere permit a partial evaluation of the applicability of competing hypotheses for the adaptive significance of simultaneous hermaphroditism in *H. crassicornis*. Currently, there are three major explanations of this sort. The first two have been summarized by Ghiselin (1969). First, simultaneous hermaphroditism may increase an animal's reproductive efficiency by per-

mitting self-fertilization. This idea does not apply to *H. crassicornis* because this animal has never been observed to self-fertilize (Harrigan and Alkon, 1978; this study). The second explanation is the low density model which suggests that simultaneous hermaphroditism will be favored in organisms with low population densities in which contacts with conspecifics are rare or infrequent. Any conspecific is then an appropriate mate. Although this model is often invoked to explain the occurrence of simultaneous hermaphroditism in nudibranchs (e.g., Todd, 1978) it does not appear to fit *H. crassicornis* well. If contact with conspecifics are rare, one might expect that (1) sperm from a single copulation would last the better part of an individual's active reproductive life and (2) individuals should readily mate in any contact with a conspecific. Neither of these conditions is met in *H. crassicornis*. Individuals of *H. crassicornis* live several months in the laboratory (Harrigan and Alkon, 1978; pers. obs.) and presumably in the field as well. The sperm from a single copulation is sufficient to fertilize most eggs in about 3 egg masses which if produced once every 4 to 5 days will last an animal about 15 days or less. This coupled with the surprisingly high frequency of unsuccessful copulation attempts suggests that these animals must mate several times during their life to maintain a maximal egg production rate. The lack of precision in intromission and in the production of fertile eggs is also not to be expected if the low density model were in force. Furthermore, as Zack (1975) points out, most contacts and interactions in *H. crassicornis* do not end in the sidling that often leads to copulation. If anything, the animals appear more inclined to cannibalize than to copulate with conspecifics. In sum, the behavior of these animals does not conform to some simple expectations about behavior derived from the low density model.

The third explanation is a form of Maynard Smith's (1978) resource allocation model, which states that the fitness return per egg will diminish as the number of eggs produced increases, especially in species that produce myriads of small propagules. Hence, over evolutionary time selection might favor a partitioning of reproductive energies into both male and female modes. The only observation supporting the application of this model to *H. crassicornis* is that they do appear readily able to produce millions of eggs (Williams, 1980) and so simultaneous investment in male functions might well payoff. Of the three adaptationist models, this one, largely by elimination, appears to be the most likely explanation for the evolution of simultaneous hermaphroditism in this nudibranch.

In closing, it cannot be discounted at this time that the occurrence of simultaneous hermaphroditism may be a result of phylogenetic inertia. In other words, this reproductive mode need not be adaptive in *H. crassicornis* but may have retained during evolution as an incidental effect of other advantageous life history traits. This view is supported by the prevalence of this reproductive mode in other opisthobranchs which suggests that the ancestors of *H. crassicornis* were simultaneous hermaphrodites. Hence, this model and the resource allocation model appear to be the major competing hypotheses for the explanation of simultaneous hermaphroditism in *H. crassicornis*.

ACKNOWLEDGMENTS

I thank: the Director and staff of the Long Coastal Marine Laboratory for the space and support services they provided, Patricia Rutowski for assistance in the field, Drs. John Alcock and Richard Satterlie for their comments on an earlier draft of the manuscript, and John Schaefer for his assistance in preparation of the manuscript.

LITERATURE CITED

- AXELROD, R., AND W. D. HAMILTON. 1981. The evolution of cooperation. *Science* **211**: 1390-1396.
- BEEMAN, R. D. 1977. Gastropoda: Opisthobranchia. Pp. 115-179 in *Reproduction of Marine Invertebrates, Volume 4*, A. C. Giese and J. S. Pearse, eds. Academic Press, New York.
- CHAMBERS, L. A. 1934. Studies on the organs of reproduction in the nudibranchiate mollusks, with special reference to *Embletonia fuscata* Gould. *Bull. Amer. Mus. Nat. Hist.* **66**: 599-641.
- CHARNOV, E. L. 1979. Simultaneous hermaphroditism and sexual selection. *Proc. Nat. Acad. Sci.* **76**: 2480-2484.
- CHRISTENSEN, H. 1977. Feeding and reproduction in *Precuthona peachii* (Mollusca, Nudibranchia). *Ophelia* **16**: 131-142.
- COSTELLO, D. P. 1938. Notes on the breeding habits of the nudibranchs of Monterey Bay and vicinity. *J. Morphol.* **63**: 319-343.
- CROZIER, W. J. 1918. Assortive mating in a nudibranch, *Chromodoris zebra* Heilprin. *J. Exp. Zool.* **27**: 247-292.
- FISCHER, E. A. 1980. The relationship between mating system and simultaneous hermaphroditism in the coral reef fish, *Hypoplectrus nigricans* (Serranidae). *Anim. Behav.* **28**: 620-633.
- GHISELIN, M. T. 1969. The evolution of hermaphroditism among animals. *Q. Rev. Biol.* **44**: 189-208.
- HADFIELD, M. G. 1963. The biology of nudibranch larvae. *Oikos* **14**: 85-95.
- HARRIGAN, J. F., AND D. I. ALKON. 1978. Larval rearing, metamorphosis, growth and reproduction of the aeolid nudibranch *Hermisenda crassicornis* (Eschscholtz, 1831) (Gastropoda: Opisthobranchia). *Biol. Bull.* **154**: 430-439.
- HARRIS, L. G. 1975. Studies on the life history of two coral-eating nudibranchs of the genus *Phestilla*. *Biol. Bull.* **149**: 539-550.
- LEDERHENDLER, I. I., AND E. TOBACH. 1977. Reproductive roles in the simultaneous hermaphrodite *Aplysia dactylomela*. *Nature* **270**: 238-239.
- LIPTON, C. S., AND J. MURRAY. 1979. Courtship of land snails of the genus *Partula*. *Malacologia* **19**: 129-146.
- LONGLEY, R. D., AND A. J. LONGLEY. 1982. *Hermisenda*: agonistic behavior or mating behavior? *Veliger* **24**: 230-231.
- MAYNARD SMITH, J. 1978. *The Evolution of Sex*. Cambridge University Press, Cambridge. 222 pp.
- MORSE, M. P. 1971. Biology and life history of the nudibranch mollusc, *Coryphella stimpsoni* (Verrill 1879). *Biol. Bull.* **140**: 84-94.
- PAINE, R. T. 1965. Natural history, limiting factors and energetics of the opisthobranch *Navanax inermis*. *Ecology* **46**: 603-619.
- RIVEST, B. R. 1978. Development of the eolid nudibranch *Cuthona nana* (Alder and Hancock, 1942) and its relationship with a hydroid and hermit crab. *Biol. Bull.* **154**: 157-175.
- RUTOWSKI, R. L. 1982. The temporal structure of behavioral interactions in *Hermisenda crassicornis* (Opisthobranchia). *Veliger* **24**: 227-229.
- THOMPSON, T. E. 1961. The structure and mode of functioning of the reproductive organs of *Tritonia hombergi* (Gastropoda Opisthobranchia). *Q. J. Microsc. Sci.* **102**: 1-14.
- TODD, C. D. 1978. Gonad development of *Onchidoris muricata* (Muller) in relation to size, age, and spawning (Gastropoda: Opisthobranchia). *J. Molluscan Stud.* **44**: 190-199.
- WILLIAMS, L. G. 1980. Development and feeding of larvae of the nudibranch gastropods *Hermisenda crassicornis* and *Aeolidia papillosa*. *Malacologia* **20**: 99-116.
- ZACK, S. 1975. A description and analysis of agonistic behavior patterns in an opisthobranch mollusc, *Hermisenda crassicornis*. *Behaviour* **53**: 238-267.

SETTLEMENT AND METAMORPHOSIS OF A TEMPERATE SOFT-CORAL LARVA (*ALCYONIUM SIDERIUM* VERRILL): INDUCTION BY CRUSTOSE ALGAE

KENNETH P. SEBENS

*Biological Laboratories and Museum of Comparative Zoology,
Harvard University, Cambridge, MA 02138*

ABSTRACT

The temperate soft-coral *Alcyonium siderium* Verrill has a demersal planula larva which usually settles and metamorphoses on vertical rock surfaces near the parent colony. Such surfaces are covered by a variety of encrusting invertebrate species and by three common crustose algae (*Lithothamnium glaciale*, *Phymatolithon rugulosum*, and *Waernia mirabilis*). Larvae settle and metamorphose most frequently on these three algal species in the field (Sebens, 1983).

Contact with each of the three crustose algae induced settlement and metamorphosis within 1–5 days in laboratory experiments. Rock or shell fragments, even with naturally filmed surfaces, did not induce metamorphosis in the same time period. A few larvae did metamorphose on the rock, shell, and glass or plastic surfaces of the containers, taking up to 30 days to do so. Larvae were kept alive up to 194 days but their competence to metamorphose declined significantly after ten days. The half-life of larvae that did not metamorphose was approximately 25 days. Larvae presented with coralline algae in darkness delayed metamorphosis by approximately 10–20 days, but most of them did metamorphose by 30 days. Neither sea water incubated with coralline algae, nor coralline algae in close proximity (4–5 mm) to the larvae, but without contact, induced metamorphosis. Induction of settlement and metamorphosis is thus mediated by surface contact with the algae and probably not by a dissolved chemical. Presence of the colonial ascidian, *Aplidium pallidum*, inhibited metamorphosis even when larvae were able to contact coralline algae, and also caused early larval death.

INTRODUCTION

The planulae of octocorals are usually brooded by the adult colony to a swimming stage (Matthews, 1917; Gohar, 1940; Hartnoll, 1975, 1977; Weinberg, 1979; Weinberg and Weinberg, 1979) which settles and crawls on the substratum. They may also be released as demersal crawling larvae (Hartnoll, 1977). The swimming larvae are similar in morphology and behavior to those of certain scleractinian corals (Abe, 1937; Atoda, 1947a, b, 1951a, b, c, 1953; Kawaguti, 1941, 1944; Harrigan, 1972a, b; Lewis 1974), hydroids (Nishihara, 1967a, b, 1968a, b; Donaldson 1974), scyphozoans (Brewer, 1976a, b; Neumann, 1979), and sea anemones (Chia and Spaulding, 1972; Siebert, 1973). Behavior of the demersal planulae is similar to that described for scleractinian corals (Gerrodette, 1981; Fadlallah and Pearse, 1982; Fadlallah, 1983), certain hydroids (Williams, 1965, 1976), and hydrocorals (Ostarrello, 1973, 1976). Settlement and substratum choice has been studied for few anthozoans [reviewed by Chia and Bickell (1978)], and for even fewer octocorals (Théodor, 1967; Chia and Crawford, 1973; Weinberg, 1979; Weinberg and Weinberg, 1979).

Received 23 November 1982; accepted 1 April 1983.

The soft-coral *Alcyonium siderium* Verrill is common on vertical rock surfaces at 6–17 m depth along the coast of Northern Massachusetts and further north in the Gulf of Maine. It broods lecithotrophic demersal planulae which are released in late July or August (Feldman, 1976). The released planulae either drift with the current or crawl down the parent colony and onto the nearby substratum. *Alcyonium hibernicum* in the British Isles has a similar demersal larva (Hartnoll, 1977) which differs from the better-known swimming larva of *Alcyonium digitatum* (Hartnoll, 1975, 1977).

I observed larval settlement and metamorphosis of *Alcyonium siderium* planulae in the field during August of 1978, 1979, 1980, and 1981 and quantified availability of substratum types and frequency of larval metamorphosis on all available substrata (Sebens, 1983). Two species of coralline algae (*Lithothamnium glaciale*, *Phymatolithon rugulosum*) and one fleshy red crustose alga (*Waernia mirabilis* proposed, R. Wilce manuscript) were by far the most common substrata chosen by the larvae. Laboratory studies were then designed to find out if metamorphosis could be induced by the presence of these algae or whether larvae were just attaching to any piece of hard substratum near the parent colony. The following questions were addressed experimentally: 1. Can any of the three algal species induce settlement and metamorphosis?, 2. Is this induction mediated by surface contact or by substances dissolved in sea water?, 3. Can any of the common encrusting larval invertebrates be used as substratum or induce metamorphosis?, and 4. How long can larvae survive, and are they competent to settle and metamorphose if they do not receive the appropriate stimulus within the first few days? There is good evidence that certain bryozoan larvae can avoid settling near colonial ascidians which are known to overgrow established bryozoan colonies (Grosberg, 1981; Young and Chia, 1981). Small *Alcyonium* colonies are overgrown by the ascidian *Aplidium pallidum* in the field (Sebens, 1982). Therefore, additional laboratory experiments were designed to test whether *Alcyonium* larval settlement would be inhibited in the presence of *Aplidium*.

MATERIALS AND METHODS

Fifteen large colonies of *Alcyonium* were collected at the Shag Rocks, Nahant, MA (42°24'50" N; 70°54'20" W) from vertical rock surfaces at 6–9 m depth. Corals were scraped off carefully and placed in plastic containers. Only colonies with visible planulae in the anthocodia were taken. Collections were made during August of each year (1980–1982) when ambient temperature ranged from 8–21°C for the month. Larvae were visible in most colonies in early August (1978–1982) but were present in very few colonies by the end of each August. Colonies were maintained in the laboratory in aerated sea water at 11–13°C overnight.

Colonies were slit lengthwise along the lobes with a razor blade, then swished back and forth in filtered (80 μ mesh) sea water to remove the larvae. The larvae and sea water were passed through 80 μ Nitex, followed by two rapid washes in clean filtered sea water. The mesh was then quickly inverted into clean filtered sea water. Larvae, eggs, and some colony fragments settled to the bottom of the dish, from which colony fragments were then removed individually. Elongate crawling planulae (2 mm long) were removed by pipette for each experimental replicate (15 in 1980, 30 in 1981, 1982). This technique probably prevented larvae which were still at early stages of development from being included in the experiment.

Settlement experiments were carried out either in a refrigerated chamber (11°C, 1980, 1981) or in a cold room (13°C, 1982). Containers for the 1980 experiments

were glass vials 5 cm tall, 2 cm diameter. Those for the 1981 experiments were plastic Petri dishes 4.5 cm diameter. All vessels had been soaked in flowing sea water for 60 days prior to the experiments, then rinsed in fresh water to remove the organic film. The 1980 and 1981 containers held 6 ml of filtered sea water. The 1982 experiments used wide mouth jars (3 cm tall, 4 cm bottom diameter) containing 12 ml of filtered sea water 1 cm deep. All vessels (1981, 1982) were mounted on a rocking platform that stirred the water by tilting to 15° each 5 seconds. In the 1982 experiments 12 hours of agitation were alternated with 12 hours at rest because the constant agitation in the 1981 experiments caused many larvae to metamorphose without attaching. Water was replaced every 48 hours by pipetting off the old water and adding fresh filtered sea water. Two fluorescent bulbs (40 watt) at 30 cm from the containers were used as the light source. Darkened treatments were kept on the same apparatus in an aluminum foil box with spaces to allow air flow. The 1980 experiments were not continuously agitated, but instead were aerated with an air pump and pipette twice daily. Water was changed daily.

Substrata to be used in treatments were collected from the same site as were the corals, on rock (1982) or mussel (*Modiolus modiolus*) shell (1980, 1981). The rock or shell was fractured and trimmed to produce pieces $\leq 1 \times 1 \times 0.5$ cm with appropriate test substratum on the upper side. Controls were the same rock or shell without algae on the surface. At least one surface of the shell or rock was the original exposed surface but without algae or invertebrates. *Lithothamnium glaciale*, *Phymatolithon rugulosum*, the red crustose alga *Waernia mirabilis*, the sponge (*Halisarca dujardini*), and colonial tunicates (*Aplidium pallidum*) accounted for most of the space cover on walls with *Alcyonium* (Sebens, 1982, 1983). Each of these organisms was also used as an experimental substratum.

Controls were prepared with only the glass or plastic container as substratum, in both light and darkness. In the 1982 series of experiments, vigorously aerated treatments were also included. Glass tubing from a vibrator aquarium pump was used to bubble air through these containers. This treatment was an attempt to determine whether the oxygen production of crustose algae alone could have induced settlement.

If the presence of any of the experimental substrata induced metamorphosis, it would be of interest to determine whether induction could be mediated by chemicals released by the substratum and dissolved in sea water. In the 1980 experiments, sea water was incubated with each substratum for 24 hours at 11°C (termed 'supernatant') before being poured off and used in the experimental treatment. This would allow metabolic products of the algae or invertebrates to concentrate before being introduced into the larval containers. This treatment was repeated daily with fresh supernatant.

The 1980 experiments indicated that coralline algae could induce metamorphosis. An experiment was thus designed in 1981 to find out whether contact with the alga was necessary. In this experiment, the *Lithothamnium* substratum was suspended by fine monofilament line 4–5 mm above the bottom of the container without touching the walls. This design would allow exudate from the algae to contact the larvae but would prevent contact with the algal surface.

Abalone larvae settle on coralline algae and can be induced to settle by the presence of algal extracts or by the chemical GABA (γ -aminobutyric acid) (Morse *et al.*, 1979). Since coralline algae induced settlement in *Alcyonium siderium* (1980 experiments), it was of interest to test for possible mediation by GABA. Groups of larvae were kept in the light with GABA in sea water (1 μ M/l, 50 μ M/l, 1 mM/l),

changed daily, since induction of metamorphosis by coralline algae occurred much more rapidly in the light.

Statistical analysis of data (Analysis of variance (ANOVA), Student-Newman-Keuls multiple comparisons test (SNK test) and Chi-squared nonparametric test) were based on methods in Sokal and Rohlf (1969). Table I summarizes the experimental protocol, conditions, and results for all three years.

RESULTS

Survey of potential substrata

The first set of experiments (August 1980–May 1981) pointed out the importance of coralline algae as inducers of metamorphosis. *Lithothamnium* was the only substratum that induced settlement within the first three days, and was certainly the only substratum which caused large numbers of larvae (27 of 45) to metamorphose. The sea water control treatment had three larvae metamorphose between days 3 and 5 and *Waernia* had only one after 49 days (Table II, Fig. 1). *Alcyonium* colonies did not induce settlement and metamorphosis ruling out larval aggregation around adult colonies as a result of adult chemical mediation. *Halisarca* did not induce settlement, but some larvae remained alive until the end of the experiment. *Aplidium* did not induce settlement either, but most larvae died within the first week.

Sea water incubated for 24 hours with each of the substrata (termed 'supernatant') failed to induce metamorphosis. Since *Lithothamnium* supernatant did not have the same effect as *Lithothamnium* itself, it appeared that there was no chemical dissolved in sea water that was mediating the effect of the coralline alga. It was also evident that settlement of the larvae in the presence of corallines did not necessarily occur on the surface of the alga itself. In fact, more larvae metamorphosed on the bottom of the glass vials. There was also no larval swimming or negative geotaxis (*i.e.*, crawling up the walls of the vial). All settlement was on the bottom. A few larvae, however, did crawl to the top surface of the shell fragment and attached directly to the alga or to the shell surface.

This set of larval settlement and metamorphosis experiments had several less than optimal conditions. The temperature ranged from 8–12°C, the water was not agitated constantly, and treatments were kept in darkness most of each day. The temperature range was well within that observed for the August period in the field (8–21°C). However, later experiments pointed out the importance of light in inducing settlement and the short light period may have slowed down the rate of settlement. Agitation of the water did not appear necessary for larval survival, which continued for up to nine months (at 5°C for months 3–9), even without daily aeration.

Mechanism of induction of metamorphosis by coralline algae: effects of contact and light regime

During the August–September 1981 experiments temperature was kept constant ($11 \pm 1^\circ\text{C}$), treatments were continuously agitated, and were maintained under constant low irradiance. The percentage of larvae that settled in the presence of coralline algae, and the rapidity with which they metamorphosed, indicated that this set of conditions was more conducive to their substratum selection process. Constant slow agitation did prevent a fairly large percentage (10–40) of the metamorphosed individuals from attaching to any surface during the entire experiment.

TABLE I

Summary of experiments for induction of settlement and metamorphosis of *Alcyonium planulae*

Experiment	Date	H Light	H Dark	Purpose	Significant Settlement
<i>Lithothamnium</i> on shell	1980	3	21	Test for possible induction by this substratum	Y
<i>Waernia</i> on shell	1980	3	21	Test for possible induction by this substratum	N
<i>Halisarca</i> on shell	1980	3	21	Test for possible induction by this substratum	N
<i>Aplidium</i> on shell	1980	3	21	Test for possible induction by this substratum	N
<i>Alcyonium</i> on shell	1980	3	21	Test for possible induction by this substratum	N
Shell substrate alone	1980	3	21	Control for effects of other substrata	N
<i>Lithothamnium</i> supernatant	1980	3	21	Test for possible induction by soluble chemicals released by this substratum	N
<i>Waernia</i> supernatant	1980	3	21	Test for possible induction by soluble chemicals released by this substratum	N
<i>Halisarca</i> supernatant	1980	3	21	Test for possible induction by soluble chemicals released by this substratum	N
<i>Aplidium</i> supernatant	1980	3	21	Test for possible induction by soluble chemicals released by this substratum	N
<i>Alcyonium</i> supernatant	1980	3	21	Test for possible induction by soluble chemicals released by this substratum	N
<i>Lithothamnium</i> on shell	1981	24	0	Test for induction by this substratum in light	Y
<i>Lithothamnium</i> on shell	1981	0	24	Test for induction by this substratum in dark	Y
<i>Lithothamnium</i> on shell	1981	12	12	Test for induction by this substratum in light/dark cycle	Y
<i>Lithothamnium</i> on shell suspended	1981	24	0	Test for induction by this substratum without direct contact	N
<i>Lithothamnium</i> on shell using old larvae	1981	24	0	Test for competence of larvae denied induction stimulus for 10 days	N
<i>Lithothamnium</i> on shell with <i>Aplidium</i>	1981	24	0	Test for inhibition of induction by <i>Aplidium</i>	N
<i>Phymatolithon</i> on shell	1981	24	0	Test for induction by this substrate in light	Y

TABLE I (Continued)

Experiment	Date	H Light	H Dark	Purpose	Significant Settlement
Shell substratum alone	1981	24	0	Control for effects of other substrata in light	N
Shell substratum alone	1981	0	24	Control for effects of other substrata in dark	
Sea water alone	1981	24	0	Control for effects of shell substratum in light	N
Sea water alone	1981	0	24	Control for effects of shell substratum in dark	N
GABA in sea water, 3 concentrations	1981	24	0	Test for induction by GABA	N
<i>Lithothamnium</i> on rock	1982	24	0	Test for induction by this substratum in light (repeat of 1981 treatment)	Y
<i>Lithothamnium</i> on rock	1982	0	24	Test for induction by this substratum in dark (repeat of 1981 treatment)	Y
<i>Phymatolithon</i> on rock	1982	24	0	Test for induction by this substratum in light (repeat of 1981 treatment)	Y
<i>Waernia</i> on rock	1982	24	0	Test for induction by this substratum in light (conditions different than in 1980)	Y
Rock substratum alone	1982	24	0	Control for effects of other substrata	N
<i>Lithothamnium</i> on rock with <i>Aplidium</i>	1982	24	0	Test for inhibition of settlement by <i>Aplidium</i>	N
Sea water alone, aerated	1982	24	0	Test for induction of settlement by increased oxygen tension alone, as might occur with crustose algae in the light	N

Lithothamnium again induced metamorphosis of the greatest numbers of larvae (Table III, Fig. 2). *Phymatolithon*, the other coralline alga, also induced a large proportion of larvae to metamorphose. Note that there was a great difference between two subsequent sets of three replicate groups with both *Lithothamnium* and *Phymatolithon* (A and B in Table III). In a light/dark cycle (12h each), metamorphosis in the presence of *Lithothamnium* was comparable to that with constant light (Fig. 3). In constant darkness, most larvae did not metamorphose until after 10 days (Fig. 3). However, almost all larvae did metamorphose by 30 days.

When *Lithothamnium* was separated from the larvae by 4–5 mm, metamorphosis was drastically reduced (not statistically different from the control, Fig. 3). This agrees with the previous year's results that indicated that the induction was not mediated by a chemical diffused through sea water, and that contact with the

TABLE II

Alcyonium larval metamorphosis experiments conducted during August 1980 to May 1981

	<i>Lithothamnium</i>	<i>Waernia</i>	Sea Water Control
Days			
1	0	0	0
2	1.0 ± 1.0	0	0
3	3.0 ± 1.0**	0	0
5	5.0 ± 2.6	0	1.0 ± 1.7
10	6.3 ± 2.3**	0	1.0 ± 1.7
49	8.3 ± 4.7**	0	0
194	8.3 ± 4.7**	0.3 ± 0.6	0

Treatments without metamorphosis: *Halisarca* (sponge), *Aplidium* (tunicate), *Alcyonium*, *Lithothamnium* supernatant, *Waernia* supernatant, *Halisarca* supernatant, *Aplidium* supernatant, *Alcyonium* supernatant. All treatments were given 2-3 hours light per day at 8-12°C, then 5°C after day 49. Values are mean number of larvae metamorphosed, out of an initial 15, ±S.D. for three replicates.

** Denotes treatments significantly different than the control (ANOVA, $P < 0.05$ at least).

coralline alga was necessary. Constant aeration of sea water alone (1982) did not induce metamorphosis. Therefore, it is unlikely that the addition of oxygen to the water by the crustose algae could, by itself, be the factor mediating induction of metamorphosis. I considered using dead coralline algal skeletons to see if the induction was mediated by surface texture rather than by contact chemoreception. However, this would not differentiate the potential role of surface texture of the live

ALCYONIUM SIDERIUM METAMORPHOSIS

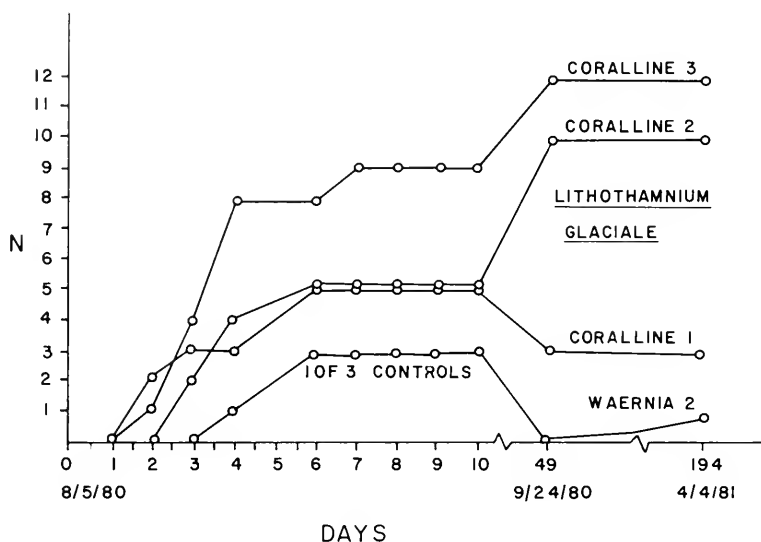

FIGURE 1. Number of larvae that had metamorphosed (of initial 15), during the 1980 experiments, on each of the three coralline algae replicates (*Lithothamnium glaciale*), and on the crustose red alga *Waernia mirabilis*. One of the 3 replicates in the control group also had some metamorphosis.

TABLE III

Alcyonium larval metamorphosis experiments conducted during August to September 1981

DAYS	LITHO LIGHT		LITHO LT/DK	LITHO LIGHT SEP.	LITHO DARK	LITHO APLID	LITHO OLD LARVAE	PHYM LIGHT		CONTROL LIGHT	CONTROL DARK	SEA WATER		SEA DARK
	A	B						A	B			LIGHT	DARK	
1	1.3 ± 1.1	0	1.0 ± 1.7	0	0	0.3 ± 0.7	0	0.3 ± 0.7	0	0	0	0	0	1.0 ± 1.7
2	12.3 ± 2.1 **	0	2.0 ± 2.6	0	0	0.3 ± 0.7	0.7 ± 1.2	1.3 ± 1.5	0.3 ± 0.7	0.3 ± 0.7	0	0.7 ± 1.2	0	0
5	20.0 ± 1.7 **	4.5 ± 2.1 **	6.0 ± 9.5	0.3 ± 0.7	1.3 ± 0.6	0.7 ± 1.2	0.3 ± 0.7	1.0 ± 1.7	1.6 ± 0.6	0.3 ± 0.7	0.5 ± 0.7	0.7 ± 1.2	0	0
10	20.0 ± 1.1 **	16.0 ± 12.7	12.0 ± 11.3	1.7 ± 0.6	3.3 ± 5.8	1.0 ± 1.7	0	0.7 ± 1.2	4.7 ± 2.3 **	0.7 ± 0.6	0.5 ± 0.7	0.7 ± 1.2	0	0
36	21.0 ± 3.8 **	10.5 ± 3.5 **	17.0 ± 10.4 *	6.0 ± 6.1	29.0 ± 0.6 **	0	1.3 ± 2.3	1.3 ± 2.3	9.7 ± 6.1 **	4.6 ± 4.0 **	2.0 ± 1.4	0.7 ± 1.2	0	**

Treatments had constant low light (11° ± 1°C). Values are mean number of larvae metamorphosed ± S.D., of an initial 30, for 3 replicates per treatment.

** Denotes treatments significantly different than the control (light) (ANOVA, $P \leq 0.05$ at least).* Denotes treatments different from the control at the $P \leq 0.10$ confidence level (ANOVA).LITHO (*Lithothamnium*) A, B refers to two subsequent treatments (3 replicates each), as does PHYM (*Phymatolithon*) A, B. 'OLD LARVAE' were kept without substratum for 10 before contact with *Lithothamnium*.

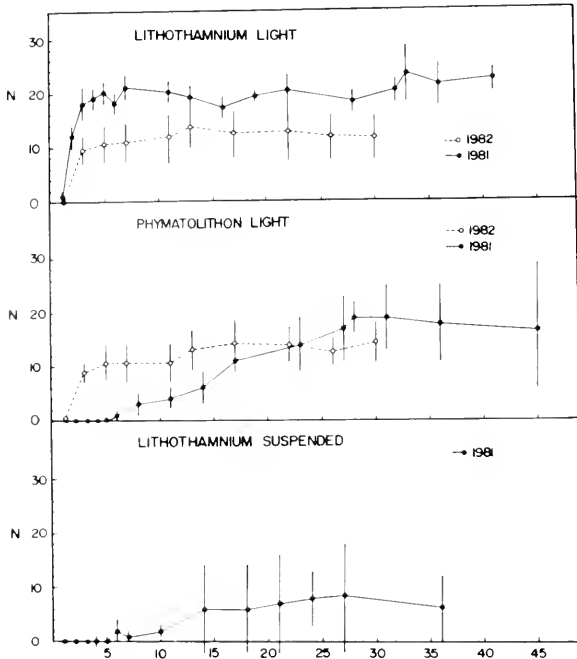

FIGURE 2. Cumulative number of larvae metamorphosed (of initial N = 30 planulae) in treatments with *Lithothamnium* (in light and suspended in light) and *Phymatolithon* (in light). Values are mean number of metamorphosed larvae \pm S.D. for three replicates of each treatment (1981 or 1982).

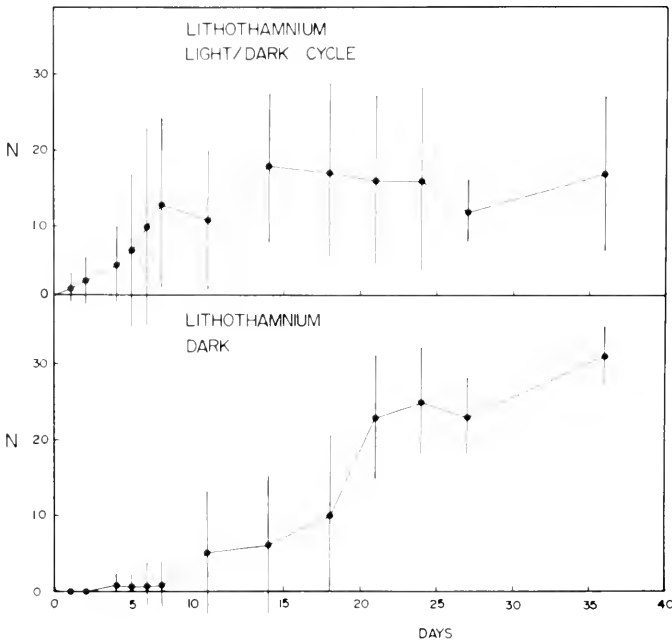

FIGURE 3. Cumulative number of larvae metamorphosed (of initial N = 30 planulae) in treatments with *Lithothamnium* (in light/dark cycle, and in the dark). Values are mean number of metamorphosed larvae \pm S.D. for three replicates of each treatment (1982).

alga. The surface contacted by the larva is living cell surface, not the carbonate skeleton.

Control treatments included the same rock or shell material that the algae were growing on, with its natural surface. This surface was probably covered with a bacterial film, known to induce settlement in several invertebrate larvae (Crisp and Ryland, 1960) including bryozoans (Mihm *et al.*, 1981; Brancato and Woollacott, 1982), polychaetes (Kirchman *et al.*, 1982), hydroids (Spindler and Müller, 1972), and scyphozoans (Brewer, 1976b; Neumann, 1979). Treatments with naturally filmed rock or shell surfaces alone did not cause more larvae to metamorphose than sea water controls with only the cleaned glass or plastic surfaces available (Table III, Fig. 5). However, bacterial films can develop in a matter of hours and the artificial surfaces were probably also covered with bacteria since the experiments lasted for many days. Neither rock, shell, nor the artificial surfaces ever had the rapid effects of the crustose algae, and it is unlikely that bacteria alone are inducing settlement in the *Alcyonium* larvae, unless there are specific bacteria associated with the algal surface that are being recognized.

Larvae that were kept for 10 days in filtered sea water (old larvae, Table III) had very low rates of metamorphosis even with *Lithothamnium* present. This is surprising since many of the larvae kept with *Lithothamnium* in the light metamorphosed between days 5 and 20 (B, Table III) and most of those in the dark metamorphosed between days 10 and 36. The results of the 1980 experiments indicated that some larvae remained competent even after 49 days. Clearly there is some reduction in the larvae's ability to metamorphose given increased time without a stimulus.

There was no induction of settlement (attachment) or metamorphosis by GABA at any of the experimental concentrations. The only visible effect of GABA at the highest concentration (1 mM/l) was that the planulae were thin and extremely elongate, up to twice as long as normal. Crawling was discerned at the 1 μ M/l and 50 μ M/l concentrations but not at 1 mM/l. The lack of attachment or metamorphosis in the presence of GABA argues for a different mediation by corallines from that suggested for abalones (Morse *et al.*, 1979) or for chitons (Rumrill and Cameron, 1983). It is possible that introduction of GABA occurred before larvae were competent. This sometimes prevents larvae from ever responding to the stimulus (*e.g.*, gastropods, Hadfield, 1977). However, presence of the known inducer, *Lithothamnium*, did induce metamorphosis in larvae from the same batch (Table III). The attachment and initial change from elongate to rounded morphology takes many hours and some larvae had completed this process within the first 24 hours. Larvae were thus competent initially or became so rapidly during the first day.

Experiments with Waernia

The experiments conducted during August–September 1982 ($13^{\circ} \pm 1^{\circ}\text{C}$, constant low light) introduced intermittent agitation so that metamorphosing larvae had time to become firmly attached. In fact, only 0–20 percent of metamorphosed individuals in each treatment were unattached by the end of the experiment. As in the previous year's experiments, *Lithothamnium* and *Phymatolithon* were strong inducers of metamorphosis (Table IV, Fig. 2). *Waernia* was tested again because many larvae in the field metamorphosed on it (Sebens, 1983). This time *Waernia* was as successful in inducing settlement as were the corallines (Fig. 4). The control had slightly more metamorphosis this year than previously (Fig. 5). The lit control had more larvae metamorphose than did *Lithothamnium* in the dark, but the differences were not significant.

TABLE IV

Alcyonium larval metamorphosis experiments conducted during August to September 1982

DAYS	PHYM LIGHT	WAER LIGHT	LITHO LIGHT	LIGHT CONTROL	LITHO DARK	APLIDIUM + LITHO	AERATED SEAWATER
1	0.7 ± 1.2	0.3 ± 0.6	0	0	0	0	0
3	9.0 ± 1.7*	9.0 ± 3.0*	9.7 ± 2.5*	4.3 ± 2.5	1.7 ± 2.1	1.7 ± 2.0	0**
5	10.7 ± 3.2*	9.3 ± 3.1*	10.3 ± 3.5*	5.3 ± 2.3	2.3 ± 3.2	1.7 ± 2.1	0**
11	10.7 ± 3.2	11.0 ± 2.7*	11.7 ± 4.7*	7.3 ± 2.5	3.0 ± 3.6	1.7 ± 2.1**	0**
30	14.0 ± 3.5**	11.6 ± 2.1*	11.3 ± 4.0*	7.0 ± 2.5	4.7 ± 3.8	0**	0**

Experiments were run at 13°C with low light levels and intermittent slow stirring. Values are mean number of larvae metamorphosed, out of an initial 30, ±S.D. of 3 replicates in each treatment.

** Denotes treatments significantly different than the light control (ANOVA, $P \leq 0.05$ at least).

* Denotes treatments different from the light control at the $P \leq 0.10$ confidence level (ANOVA).

LITHO = *Lithothamnium*, PHYM = *Phymatolithon*, WAER = *Waernia*.

Effects of Aplidium

The 1980 experiments had no settlement in treatments with the tunicate *Aplidium*, with the sponge *Halisarca* or with the *Alcyonium* colonies present. Field experiments (Sebens, 1983) showed that settlement did not occur on sponge or

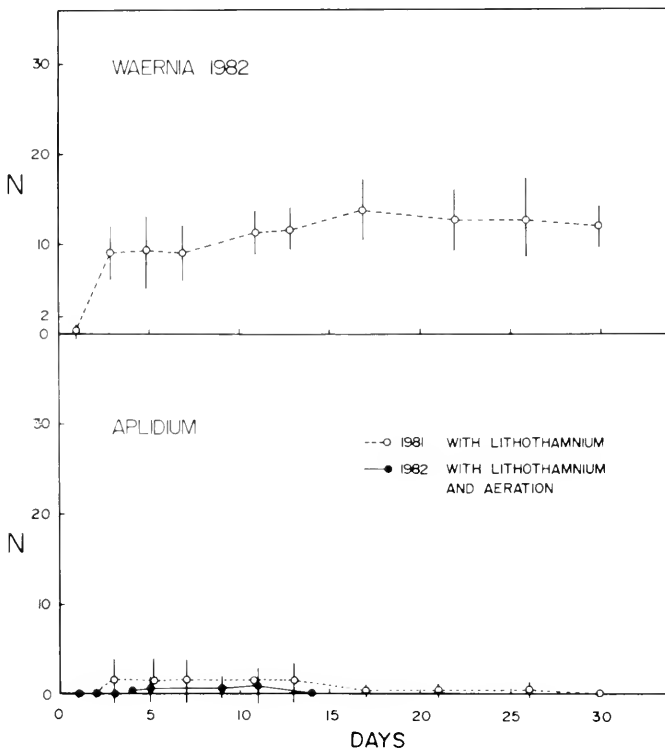

FIGURE 4. Cumulative number of larvae metamorphosed (of initial $N = 30$ planulae) in treatments with *Waernia* (in light 1982) and *Aplidium* plus *Lithothamnium* (in light 1981, in light with aeration 1982). Values are mean numbers of metamorphosed larvae ± S.D. for three replicates of each treatment.

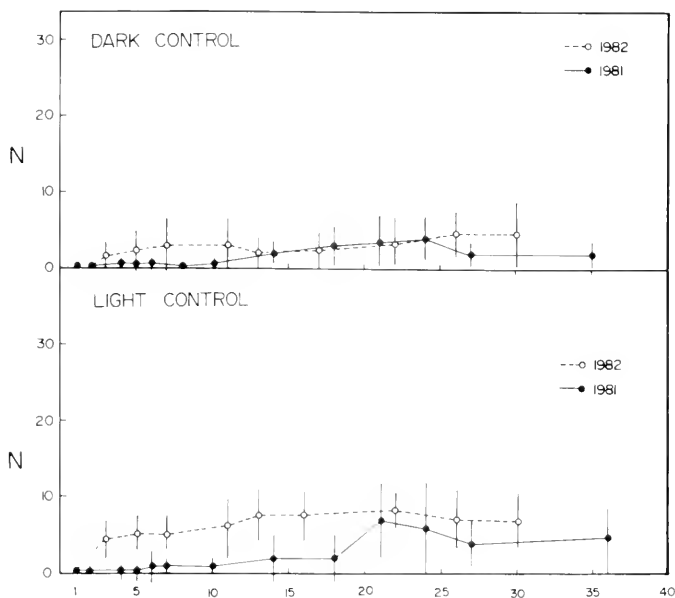

FIGURE 5. Cumulative number of larvae metamorphosed (of initial $N = 30$ planulae) in control treatments with only rock (1982) or *Modiolus* shell (1981) substratum. Values are mean number of metamorphosed larvae \pm S.D. for three replicates of each treatment.

tunicate surfaces. Since there seemed to be a negative effect of *Aplidium* on larvae in 1980, I examined its effect in the presence of a known inducer of metamorphosis (*Lithothamnium*).

When *Aplidium* was present with *Lithothamnium*, larval metamorphosis and survivorship were again poor (Table IV, Fig. 4). This time the treatments were constantly aerated to reduce the possibility that the *Aplidium* was depleting available oxygen during the experiments. Colonies of *Aplidium* remained alive and apparently healthy throughout this set of experiments. However, all such experiments were within containers, allowing maximum concentration of released metabolites or other chemicals.

Substratum orientation by larvae

In all three years of experiments, many larvae metamorphosed on the bottoms of the glass or plastic containers, but never on the walls. Larvae never swam (as suggested by Feldman, 1976) after removal from adult colonies or during natural release. The corner where the bottom met the wall was the most common site of attachment but there was no evidence of aggregation. When the number of metamorphosed larvae on the rock or shell surface was compared to that on the bottom of the container (corrected for surface area), there was no difference in treatments with *Phymatolithon* or *Waernia* in the light, or in the lit controls (1981, 1982 combined) (Table V). However, there was significant preference for the rock or shell substratum in the *Lithothamnium* (light or dark) and dark control treatments (Table V). When there was a preference shown, it was always for the natural substratum. The large number of larvae metamorphosing on the glass or plastic argues against

TABLE V

Metamorphosis of Alcyonium larvae after 30 days, on the container bottom (plastic or glass) and on the rock or shell material used as substratum (1981 and 1982)

TREATMENT	ON			χ^2	P
	ON CONTAINER (9.6 cm ²)	CONTAINER (CORRECTED) (3.0 cm ²)	ON ROCK OR SHELL (3.0 cm ²)		
LITHOTHAMNIUM (light)	84	26	57	20.5	<0.01
PHYMATOLITHON (light)	47	15	22	1.95	>0.05
WAERNIA (light)	23	7	5	0.76	>0.05
LITHOTHAMNIUM (dark)	9	3	64	156.03	<0.01
LIGHT CONTROL	22	7	12	2.61	>0.05
DARK CONTROL	10	3	35	69.30	<0.01

Top (with crustose algae) and bottom of the rock (without) were combined for this comparison. The number of larvae on the container bottom (9.6 cm²) was corrected to 3.0 cm².

χ^2 = chi-squared statistic, P = significance level.

thigmotaxis for coralline or other algal surfaces, although surface texture recognition by the larvae is certainly possible.

There were several treatments in which it appeared that larvae were primarily on the bottom, or the top, of the substratum offered. When *Phymatolithon* covered the upper surface of the rock or shell, significantly more larvae settled on the bottom and sides than on the top (algal) surface in the lit treatments (Table VI). There was also less attachment on the top surface of *Waernia* and *Lithothamnium* (light or light/dark cycle). Only *Lithothamnium* in darkness had more settlement on the top (algal surface) than expected by its area. In the lit controls, most settlement was on the top surface. This indicates that while contact with the crustose algae induces settlement, the algae may also be able to deter settlement directly onto their living surfaces.

Larval survivorship

It was clear from the 1980 experiments that long-term survival of actively crawling planulae was possible (to at least nine months). Survivorship was better in

TABLE VI

Metamorphosis of Alcyonium larvae on the top or bottom of the rock or shell substratum after 30 days (1981 and 1982)

TREATMENT	SUBSTRATE		χ^2	P
	TOP	BOTTOM		
LITHOTHAMNIUM (light)	16	41	0.9	>0.05
LITHOTHAMNIUM (light/dark)	8	14	2.1	>0.05
LITHOTHAMNIUM (dark)	32	30	8.9	<0.05
WAERNIA	2	5	0	>0.05
PHYMATOLITHON	9	47	8.0	<0.05
LIGHT CONTROL	11	1	8.3	<0.05
DARK CONTROL	18	15	0.3	>0.05

The top of the rock was covered with the encrusting algae in the first 5 treatments.

χ^2 = chi-squared statistic, P = significance level.

Area of top surface = 34%, area of bottom and sides combined = 64% of total area.

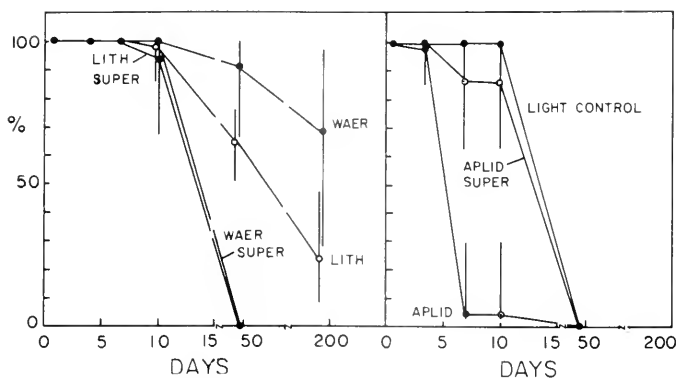

FIGURE 6. Survivorship of planulae during the 1980 experiments expressed as the percentage of all initial larvae that did not go on to metamorphose. Values are mean \pm S.D. for arcsine transformed data, backtransformed for the graph. At days 1 and 3 treatments were statistically indistinguishable. At days 7 and 10 the *Aplidium* treatment was significantly different than all others ($P \leq 0.05$, ANOVA and Student-Newman-Keuls (SNK) multiple comparisons test). At days 49 and 194 the *Lithothamnium* and *Waernia* treatments were different from the rest (SNK test). All other combinations of treatments at each time were indistinguishable (statistical analysis from Sokal and Rohlf 1969). Abbreviations as follows: LITH = *Lithothamnium*, light, WAER = *Waernia*, LITH SUPER = *Lithothamnium* supernatant, WAER SUPER = *Waernia* supernatant, APLID = *Aplidium*, APLID SUPER = *Aplidium* supernatant.

treatments with crustose algae than in treatments with other substrata or in controls. Survivorship was worst in treatments with *Aplidium* (Fig. 6). Data on numbers of live planulae were not taken regularly during 1981. During the 1982 experiments, live planulae were again counted every other day. In this set of experiments mean survivorship was between 11 and 39 percent for 30 days for larvae that never did metamorphose (Fig. 7). 28 percent of the light control group, and 61 percent of the

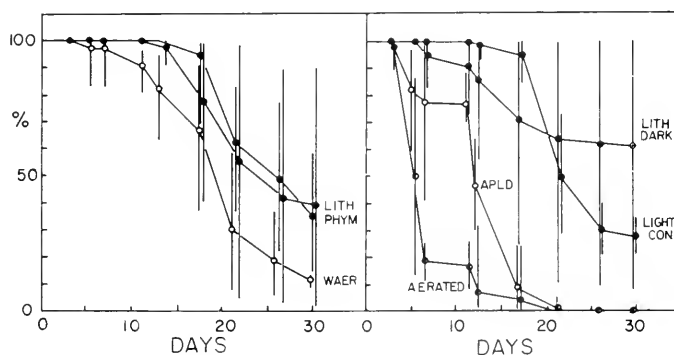

FIGURE 7. Survivorship of planula larvae during the 1982 experiments expressed as percentage of all initial larvae that did not go on to metamorphose. Values are mean \pm S.D. for arcsine transformed data, backtransformed for the graph. At days 1 and 3 all treatments were statistically indistinguishable. At days 5, 7, and 11 the aerated treatment was different from the rest ($P \leq 0.05$, ANOVA and SNK test). At days 17 and 22 the *Aplidium* and aerated treatments were indistinguishable but different from all but the dark control group (on day 17) and the *Lithothamnium* and *Waernia* treatments (on day 22); all other treatments were indistinguishable from each other. At day 30 the 5 treatments that still had living larvae (all but aerated and *Aplidium* treatments) were indistinguishable (statistical treatment based on methods in Sokal and Rohlf (1969)). Abbreviations as follows: LITH = *Lithothamnium*, PHYM = *Phycolithon*, WAER = *Waernia*, APLD = *Aplidium*, LITH DARK = *Lithothamnium* in darkness, LIGHT CON = control, in light.

dark control group were still alive after 30 days. All larvae in the aerated treatments and in the treatments with *Aplidium* died within the 30 day period. Aeration may have increased the larvae's metabolism causing them to lose their energy reserves rapidly. On the other hand, the agitation itself may have caused the larvae to damage themselves by hitting the walls of the container.

DISCUSSION

The crustose coralline algae, *Lithothamnium glaciale* and *Phymatolithon rugulosum*, as well as the fleshy red crustose alga *Waernia mirabilis*, induced settlement of *Alcyonium siderium* planulae in laboratory experiments. Rock surfaces around *Alcyonium* colonies in the field are covered with colonial invertebrates (tunicates, sponges, hydroids) and the three crustose algae used in this experiment (Sebens, 1982, 1983). Field studies of larval settlement (Sebens, 1983) showed significant metamorphosis only on these algae and on adjacent bare rock, although settlement on *Lithothamnium* was less than expected by its percent cover and settlement on *Waernia* was greater.

Any of the three algae, but not the common encrusting invertebrates *Aplidium pallidum*, *Halisarca dujardini*, or the mussel shell (*Modiolus modiolus*), can induce metamorphosis in laboratory experiments. Once the inducing substratum has been contacted metamorphosis can then occur on nearby rock surfaces, but not necessarily on the algal surface itself. Even so, there was no field settlement of planulae on any of the encrusting invertebrates adjacent to algal crusts (Sebens, 1983). In a few vertical rock wall community samples collected by scraping rock surfaces, I have noted single polyps of *Alcyonium* attached to erect bryozoans, small red algal fronds, or to the sides of *Aplidium* colonies that were encrusted with detritus (unpublished observations). In the field studies, some larvae settled in the mat of small polychaete tubes, amphipod tubes, and bound detritus that sometimes covers the encrusting algae (Sebens, 1983). These individuals were probably attached directly to the algal surface beneath.

There was distinct inhibition of metamorphosis in darkness, even with *Lithothamnium* present. It is possible that *Lithothamnium* does not produce or release the stimulus in the dark. It is more likely that the larvae are inhibited from receiving, or responding to, the stimulus in darkness. This mechanism would allow them to discriminate between deep crevices, underhangs, and open vertical rock surfaces, especially since they often crawl for several days before metamorphosis. Inhibition of settlement in darkness may keep them out of microhabitats that are likely to be far from the greatest water flow thereby allowing the best chance of capturing zooplankton prey. Weinberg (1979) found a positive photokinesis in a Mediterranean gorgonian coral planula (*Eunicella singularis*), and a total lack of light-related response in that of a second species (*Corallium rubrum*). It is not clear that *Alcyonium* shows either a phototaxis or photokinesis, but instead simply fails to attach and metamorphose in the dark. Although *Alcyonium siderium* has a similar habitat distribution (vertical walls) to *Corallium rubrum* (Weinberg, 1979), it does not appear to share a negative geotaxis that would lead the planula up walls or to the undersides of rock ledges. Release of larvae directly onto the substratum surrounding the parent colony may alleviate any need for this behavior.

Larvae did not settle significantly, nor survive well, in the presence of the compound ascidian *Aplidium pallidum*, even when treatments were aerated intermittently (1980) or continuously (1982). Field studies (Sebens, 1982) indicate that *Aplidium* overgrows, and probably kills, small colonies of *Alcyonium*. Larvae will,

however, settle near *Aplidium* in the field (Sebens, 1983). Grosberg (1981) demonstrated that swimming bryozoan larvae avoid settling on experimental plates with the compound ascidians *Botryllus schlosseri* and *Botrylloides leachi*. Both ascidians overgrew established bryozoan colonies. Young and Chia (1981) found a similar result in laboratory studies of bryozoan larvae in the presence of other compound ascidians. In both the present study and that of Young and Chia (1981), larvae were confined with the ascidians in relatively small volumes of water. In Grosberg's study, settling plates were suspended in the relatively still water of the Eel Pond, Woods Hole, MA. In all such cases ascidian metabolites or other exuded chemicals could concentrate at levels that would not be found in more turbulent conditions such as the field sites where *Alcyonium* has been studied (Sebens, 1982, 1983). Bryozoan larvae can swim away if they contact the ascidians; the *Alcyonium* planulae can only crawl. Thus, *Alcyonium* is probably not absolutely restricted from settling near *Aplidium* in the field, thereby avoiding overgrowth. If there is a chemical recognition of the ascidian by the larva, it probably keeps the planula from crawling onto the ascidian rather than preventing nearby settlement.

The vertical rock wall community is in constant spatial flux. Invertebrates are often observed overgrowing coralline algae, *Waernia*, and sometimes small *Alcyonium* colonies. The presence of uncovered algal crusts indicates either that a grazer (e.g., the sea urchin *Strongylocentrotus droebachiensis*) has recently cleared off the tunicates, sponges, or hydroids, or that those encrusting organisms have receded on their own (after reproduction or starvation). On vertical walls, such algae are ideal settlement sites for the soft-coral in that they are hard, stable surfaces that will persist for long periods of time. Horizontal surfaces adjacent to the vertical walls are completely covered by *Lithothamnium*, *Phymatolithon*, and other corallines but are constantly grazed by sea urchins. Nothing that settles on these algae survives such grazing very long. On vertical surfaces, grazers are much less common and *Alcyonium* can probably grow to a size sufficient to be avoided before the area is grazed. Planulae would probably be induced to metamorphose if they were to drift onto horizontal surfaces with corallines, but they would not survive.

Coralline algae induce settlement in mollusks which later graze the algal surface (chitons, Barnes andonor, 1973; Rumrill and Cameron, 1983; abalone Morse *et al.*, 1979). Harrigan (1972a, b) found that *Pocillopora damicornis* planulae would settle on coral rubble with coralline algae on its surface. Breitburg (1983), however, found that settlement of a variety of invertebrates and algae in the field was less successful on the surface of corallines than on scraped rock areas. She notes that corallines are easily overgrown by invertebrate colonies expanding laterally onto them rather than by direct settlement onto their living surface. *Alcyonium* will certainly settle on coralline surfaces under both field and laboratory conditions. However, there is some evidence that it prefers to settle on the rock, shell, or glass adjacent to the coralline algae rather than on the algal surfaces after having contacted the algae in the laboratory. This agrees with field evidence that bare rock is preferred to corallines (Sebens, 1983).

Alcyonium larvae leave the parent colony and crawl across the substratum for periods up to several days (Sebens, 1983). However, it appears that most larvae settle within a few centimeters of the adult colonies. They probably do not have a chance to leave the local habitat unless they are washed off the colony by wave surge as they emerge. Similar local dispersal by crawling demersal planulae has been shown for the temperate Pacific coral *Balanophyllia elegans* (Gerrodette, 1981; Fadlallah, 1983). Substratum choice is not a matter of settlement, testing and then swimming away as in barnacle cyprids (Crisp, 1965, 1974), polychaete larvae (Wilson, 1948,

1952, 1954, 1968), hydroid planulae (Nishihara, 1967a, b; 1968a, b; Spindler and Müller, 1972, Müller, 1973), and many other invertebrate larvae (reviewed by Milikowsky, 1971; Meadows and Campbell, 1972). Crawling larvae are in constant substratum contact and must respond by either settlement, continued crawling, or active avoidance of each substratum type. Substrata may be either suitable surfaces for metamorphosis, or less suitable attachment sites but still inducers of metamorphosis. Larvae will settle on non-inducing substrata (rock, shell, glass) after having contacted *Lithothamnium*, *Phymatolithon*, or *Waernia*. These algae serve as indicators of suitable habitat for the larva rather than as necessary attachment sites.

ACKNOWLEDGMENTS

I thank the following for their field and laboratory assistance: M. Ashenfelder, D. Denninger, D. Levitan, S. Norton, R. Olson, M. Patterson, J. Sigda, D. Smith, W. Stotz, and T. VanWey. Edward Elbers and JoAnn Resing helped set up and monitor substantial portions of the laboratory experiments. I also thank R. Olson for reading and commenting on the manuscript and R. Steneck and R. Wilce for algal identification.

The Marine Sciences and Maritime Studies Center of Northeastern University, the Museum of Comparative Zoology and the Biological Laboratories of Harvard University provided laboratory space and equipment. The research was supported by NSF grants OCE 78 08482 and OCE 80 07923 and the Milton Fund of Harvard University. This is M.S.M.S.C. Contribution no. 117.

LITERATURE CITED

- ABE, N. 1937. Post-larval development of the coral *Fungia actiniformis* var. *palawensis*. *Palao Trop. Biol. Stn. Stud.* **1**: 73-93.
- ATODA, K. 1947a. The larva and postlarval development of some reef-building corals. I. *Pocillopora damicornis cespitosa* (Dana). *Sci. Rep. Tohoku Univ.* (4, biol.) **18**: 24-47.
- ATODA, K. 1947b. The larva and postlarval development of some reef-building corals. II. *Stylophora pistillata* (Esper). *Sci. Rep. Tohoku Univ.* (4, biol.) **18**: 48.
- ATODA, K. 1951a. The larva and postlarval development of the reef-building corals. III. *Acropora briiggemanni* (Brook). *J. Morphol.* **89**: 1-13.
- ATODA, K. 1951b. The larva and postlarval development of the reef-building corals. IV. *Galaxea aspera* Quelch. *J. Morphol.* **89**: 17-30.
- ATODA, K. 1951c. The larva and postlarval development of some reef-building corals. V. *Seriatopora hystrix* Dana. *Sci. Rep. Tohoku Univ.* (4, biol.) **19**: 33-39.
- ATODA, K. 1953. The larva and postlarval development of the reef-building coral. *Sci. Rep. Tohoku Univ.* (4, biol.) **20**: 105-121.
- BARNES, J. R., AND J. J. GONOR. 1973. The larval settling response of the lined chiton *Tonicella lineata*. *Mar. Biol.* **20**: 259-264.
- BRANCATO, M. S., AND R. M. WOOLLACOTT. 1982. The effect of microbial films on larval settlement in three species of *Bugula* (Bryozoa). *Mar. Biol.* **71**: 51-56.
- BREITBURG, D. L. 1983. Residual effects of grazing: inhibition of competitor recruitment by *Lithothamnion*. *Ecology* in press.
- BREWER, R. H. 1976a. Larval settling in *Cyanea capillata* (Cnidaria: Scyphozoa). *Biol. Bull.* **150**: 183-189.
- BREWER, R. H. 1976b. Some microenvironmental influences on attachment behavior of the planula of *Cyanea capillata* (Cnidaria: Scyphozoa). Pp. 347-354 in *Coelenterate Ecology and Behavior*, G. O. Mackie, ed. Plenum, New York.
- CHIA, F. S., AND B. J. CRAWFORD. 1973. Some observations on gametogenesis, larval development and substratum selection of the sea pen *Ptilosarcus guerneyi*. *Mar. Biol.* **23**: 73-82.
- CHIA, F. S., AND J. R. SPAULDING. 1972. Development and juvenile growth of the sea anemone *Tealia crassicornis*. *Biol. Bull.* **142**: 206-218.
- CHIA, F. S., AND L. R. BICKELL. 1978. Mechanisms of larval attachment and the induction of settlement and metamorphosis in coelenterates: a review. In *Settlement and Metamorphosis of Marine Invertebrate Larvae*, F. S. Chia and M. Rice, eds. Elsevier North-Holland, New York.

- CRISP, D. J. 1965. Surface chemistry, a factor in the settlement of marine invertebrate larvae. *Bot. Gothoburg* 3: 51-65.
- CRISP, D. J. 1974. Factors influencing the settlement of marine invertebrate larvae. Pp. 177-265 in *Chemoreception in Marine Organisms*, P. T. Grant and A. M. Mackie, eds. Academic Press, New York.
- CRISP, D. J., AND J. S. RYLAND. 1960. Influence of filming and of surface texture on the settlement of marine organisms. *Nature* 185: 119.
- DONALDSON, S. 1974. Larval settlement of a symbiotic hydroid; specificity and nematocyst responses in planulae of *Proboscoidactyla flavicirrata*. *Biol. Bull.* 147: 573-585.
- FADLALLAH, Y. H. 1983. Population dynamics and demography of the solitary coral *Balanophyllia elegans*. *Oecologia* in press.
- FADLALLAH, Y. H., AND J. S. PEARSE. 1982. Sexual reproduction in solitary corals: overlapping oogenic and brooding cycles, and benthic planulas in *Balanophyllia elegans*. *Mar. Biol.* 71: 223-232.
- FELDMAN, S. L. 1976. Validation of the species of soft coral *Alcyonium siderium*: description and reproductive biology. M. S. Thesis, Northeastern University. 54 pp.
- GERRODETTE, T. 1981. Dispersal of the solitary coral *Balanophyllia elegans* by demersal planular larvae. *Ecology* 62: 611-619.
- GOHAR, H. A. F. 1940. The development of some Xeniidæ (Alcyonaria) (with some ecological aspects). *Publ. Mar. Biol. Stn. Al Ghardaqa* 3: 27-79.
- GRIGG, R. W. 1979. Reproductive ecology of two species of gorgonian corals: relations to vertical and geographical distribution. Pp. 49-59 in *Reproductive Ecology of Marine Invertebrates*, S. E. Stancyk, ed. University of South Carolina Press, Columbia, SC.
- GROSBERG, R. K. 1981. Competitive ability influences habitat choice in marine invertebrates. *Nature* 290: 700-702.
- HADFIELD, M. G. 1977. Chemical interactions in larval settling of a marine gastropod. Pp. 403-413 in *Marine Natural Products Chemistry*; D. J. Faulkner and W. H. Fenical, eds. Plenum, New York.
- HARRIGAN, J. F. 1972a. The planula larva of *Pocillopora damicornis*: lunar periodicity of swarming and substratum selection behavior. Ph.D. Thesis, University of Hawaii.
- HARRIGAN, J. F. 1972b. Behavior of the planula larva of *Pocillopora damicornis* (L.). *Am. Zool.* 12: 723.
- HARTNOLL, R. G. 1975. The annual cycle of *Alcyonium digitatum*. *Estuarine Coastal Mar. Sci.* 3: 71-78.
- HARTNOLL, R. G. 1977. Reproductive strategy in two British species of *Alcyonium*. Pp. 321-328 in *Biology of Benthic Organisms*, B. F. Keegan, P. O. Ceidigh, and P. J. S. Boaden, eds. Pergamon Press, New York.
- KAWAGUTI, S. 1941. On the physiology of reef corals, 5. Tropisms of coral planulae, considered as a factor of distribution on the reefs. *Palao Trop. Biol. Stn. Stud.* 2: 319-328.
- KAWAGUTI, S. 1944. Zooxanthellae as a factor of positive phototropism in those animals containing them. *Palao Trop. Biol. Stn. Stud.* 2: 681-682.
- KIRCHMAN, D., S. GRAHAM, D. REISH, AND R. MITCHELL. 1982. Bacteria induce settlements and metamorphosis of *Jamia (Dexiospira) brasiliensis* Grube (Polychaeta: Spirorbidae). *J. Exp. Mar. Biol. Ecol.* 56: 153-164.
- LEWIS, J. B. 1974. The settlement behavior of planulae larvae of the hermatypic coral *Favia fragum* (Esper). *J. Exp. Mar. Biol. Ecol.* 15: 165-172.
- MATTHEWS, A. 1917. The development of *Alcyonium digitatum* with some notes on early colony formation. *Q. J. Microsc. Sci.* 62: 43-94.
- MEADOWS, P. S., AND J. I. CAMPBELL. 1972. Habitat selection by aquatic invertebrates. *Adv. Mar. Biol.* 10: 271-382.
- MIHM, J. W., W. C. BANTA, AND G. I. LOEB. 1981. Effects of adsorbed organic and primary fouling films on bryozoan settlement. *J. Exp. Mar. Biol. Ecol.* 54: 167.
- MILEIKOWSKY, S. A. 1971. Types of larval development in marine bottom invertebrates, their distribution and ecological significance: a reevaluation. *Mar. Biol.* 10: 193-213.
- MORSE, D. E., N. HOOKER, H. DUNCAN, AND L. JENSEN. 1979. γ -aminobutyric acid, a neurotransmitter, induces planktonic abalone larvae to settle and begin metamorphosis. *Science* 204: 407-410.
- MÜLLER, W. A. 1973. Metamorphose-induction bei planularlarven I. *Wilhelm Roux' Arch.* 173: 107-121.
- NEUMANN, R. 1979. Bacterial induction of settlement and metamorphosis in the planula larvae of *Cassiopea andromeda* (Cnidaria: Scyphozoa, Rhizostomeae). *Mar. Ecol. Prog. Ser.* 1: 21-28.
- NISHIHARA, M. 1967a. Observations on the selection of algal substrata by hydrozoan larvae, *Sertularella miurensis* in nature. *Bull. Mar. Biol. Sta. Asamushi* 13: 35-48.
- NISHIHARA, M. 1967b. Dispersal of the larvae of a hydroid, *Sertularella miurensis*. *Bull. Mar. Biol. Sta. Asamushi* 13: 49-56.

- NISHIHARA, M. 1968a. Experiments on the algal selection by the larvae of *Coryne uchidai* Stechow (Hydrozoa). *Bull. Mar. Biol. Sta. Asamushi* **13**: 83-89.
- NISHIHARA, M. 1968b. Brief experiments on the effect of algal extracts in promoting settlement of the larva of *Coryne uchidai* Stechow (Hydrozoa). *Bull. Mar. Biol. Sta. Asamushi* **13**: 91-101.
- OSTARELLO, G. L. 1973. Natural history of the hydrocoral *Allopora californica* Verrill (1866). *Biol. Bull.* **145**: 548-564.
- OSTARELLO, G. L. 1976. Larval dispersal in the subtidal hydrocoral *Allopora californica* Verrill. Pp. 331-337 in *Coelenterate Ecology and Behavior*, G. O. Mackie, ed. Plenum, New York.
- RUMRILL, S. S., AND R. A. CAMERON. 1983. Effects of gamma-aminobutyric acid on the settlement of larvae of the black chiton *Katharina tunicata*. *Mar. Biol.* **72**: 243-247.
- SEBENS, K. P. 1982. Competition for space: growth rate, reproductive output, and escape in size. *Am. Nat.* **120**: 189-197.
- SEBENS, K. P. 1983. The larval and juvenile ecology of the temperate octocoral *Alcyonium siderium* Verrill. I. Substratum selection. *J. Exp. Mar. Biol. Ecol.* **70**: 1-17.
- SIEBERT, A. E. 1973. A description of the sea anemone *Stomphia didemon* sp. nov. and its development. *Pac. Sci.* **27**: 363-376.
- SOKAL, R. R., AND F. J. ROHLF. 1969. *Biometry*. W. H. Freeman, San Francisco.
- SPINDLER, K. D., AND W. A. MÜLLER. 1972. Induction of metamorphosis by bacteria and by a lithium pulse in the larva of *Hydractinia echinata* (Hydrozoa). *Wilhelm Roux' Arch.* **169**: 271-280.
- THÉODOR, J. 1967. Contribution à l'étude des gorgones (VII): écologie et comportement de la planula. *Vie Milieu* **18**: 291-301.
- WEINBERG, S. 1979. The light-dependent behavior of planula larvae of *Eunicella singularis* and *Corallium rubrum* and its implication for octocorallian ecology. *Bijdr. Dierkd.* **49**: 16-30.
- WEINBERG, S., AND F. WEINBERG. 1979. The life cycle of a gorgonian: *Eunicella singularis* (Esper, 1791). *Bijdr. Dierkd.* **49**: 1-15.
- WILLIAMS, G. B. 1965. Observations on the behavior of the planulae larvae of *Clava squamata*. *J. Mar. Biol. Assoc. U. K.* **45**: 257-273.
- WILLIAMS, G. B. 1976. Aggregation during settlement as a factor in the establishment of coelenterate colonies. *Ophelia* **15**: 57-64.
- WILSON, D. P. 1948. The relation of the substratum to the metamorphosis of *Ophelia* larvae. *J. Mar. Biol. Assoc. U. K.* **31**: 413-438.
- WILSON, D. P. 1952. The influence of the nature of the substratum on metamorphosis of the larvae of marine animals, especially the larvae of *Ophelia bicornis* Savigny. *Ann. Inst. Oceanog. Monaco* **27**: 49-156.
- WILSON, D. P. 1954. The attractive factor in the settlement of *Ophelia bicornis* Savigny. *J. Mar. Biol. Assoc. U. K.* **33**: 361-380.
- WILSON, D. P. 1968. The settlement behavior of the larvae of *Sabellaria alveolata* (L.). *J. Mar. Biol. Assoc. U. K.* **48**: 387-435.
- YOUNG, C. M., AND F. S. CHIA. 1981. Laboratory evidence for delay of larval settlement in response to a dominant competitor. *Int. J. Invertebr. Reprod.* **3**: 221-226.

ON THE EVOLUTIONARY CONSTRAINT SURFACE OF HYDRA

L. B. SLOBODKIN AND KENNETH DUNN

Department of Ecology and Evolution, State University of New York, Stony Brook, L.I., NY 11794

ABSTRACT

Food consumption, body size, and budding rate were measured simultaneously in isolated individual hydra of six strains. For each individual hydra the three measurements define a point in the three dimensional space with axes: food consumption, budding rate, and body size. These points lie on a single surface, regardless of species. Floating rate and incidence of sexuality map onto this surface. We suggest that this surface is an example of a general class of evolutionary constraint surfaces derived from the conjunction of evolutionary theory and the theory of ecological resource budgets. These constraint surfaces correspond to microevolutionary domains.

INTRODUCTION

While there may be many conceivable solutions to the ecological and evolutionary problems faced by organisms, not all of these solutions are equally practicable from the standpoint of the organisms themselves (Wright, 1932). An ideally designed organism, able to meet all contingencies, need neither evolve nor reproduce. However, organisms are constrained in their structure and capacities as if, as noted by Bateson (1963), there were an "economics" of somatic response and evolution. As a rule, while the existence of these constraints is accepted, they cannot be explicitly and completely described for any group of organisms, due primarily to gaps in our knowledge of natural history and development. As a rule, properties to be studied are selected for either interest or convenience and there is no attempt at explicitly describing any organism's complete evolutionary strategy (in the sense of Slobodkin and Rapoport, 1974, and Plotkin and Odling-Smee, 1981). This is due, in part, to the inherent complexity of most organisms.

Hydra seemed simple enough in anatomy and sufficiently restricted in their behavior to facilitate an attempt at a reasonably complete explicit description and quantitative analysis of evolutionary restrictions. We present part of this description here. Further descriptive experiments are underway and a mathematical analysis, suggested by the descriptive work to date, is being developed by Gatto, Matessi, and Slobodkin (in prep.).

Hydra are generally similar in shape. Species differ in body size, budding rate, and the presence or absence of symbiotic algae. The spectrum of physiological and behavioral responses does not differ markedly among hydra species, but they do differ in the circumstances which elicit these responses. It was hypothesized by Slobodkin (1979) that perhaps all individual hydra, regardless of species, could be considered to show the same basic patterns of growth and development, differing only in the way that a given amount of food energy is partitioned between the maintenance of the adult's body and reproduction.

This hypothesis was presented in geometric form as a curved surface in a three

dimensional space, with the axes steady-state body size, steady-state budding rate, and food consumption. In Slobodkin (1979) this was referred to as an "Adaptive Response Surface." Since then the word "Adapted", and its etymological relatives, have become embroiled in almost polemical discussions. We would therefore prefer to use the term "Constraint" Surface. The term "steady-state" restricts predictions to hydra individuals that have had a relatively constant food supply for long enough that neither body size nor budding rate are changing. It is implicitly assumed that senescence does not occur in hydra. That is, any hydra, regardless of species was assumed to lie on a two-dimensional surface in the space defined by the three dimensions body size, food income, and budding rate. This hypothetical surface is shown in Figure 1.

The hypothesis also asserts that either a clone of hydra in which a series of individuals are each equilibrated to a different food level or a single individual with a very slowly changing food supply, will trace a line on the surface. The animals are assumed to have already completed their transition from bud to potentially reproductive adult.

The shape of the surface takes account of the well known fact that budding rate increases with food consumption of individual hydra, that larger hydra species reproduce more slowly than smaller ones at any given food supply, and that hydra stop budding and become smaller when starved (Slobodkin, 1964; Stiven, 1965; Hecker and Slobodkin, 1976; Gurkewitz *et al.*, 1980; i.a.).

It is not tautological that a single surface should account for the variation between hydra species. It is possible to imagine, for example, that all hydra partition energy

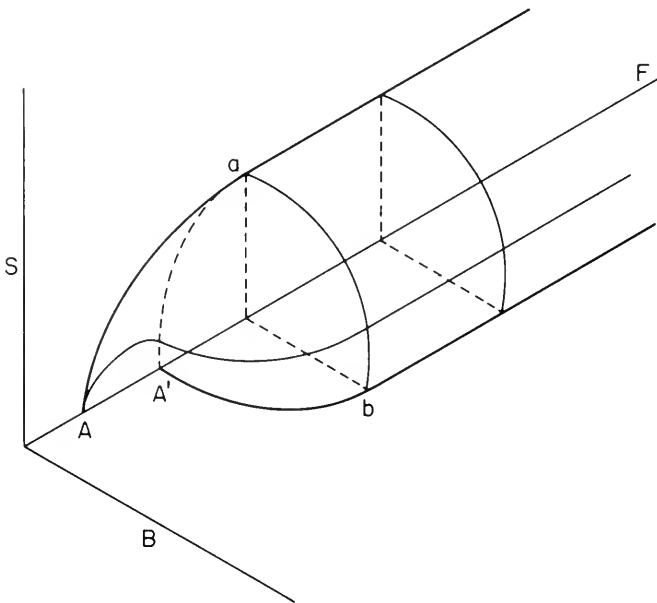

FIGURE 1. A surface relating body size, budding rate, and food supply for all species of hydra, hypothesized by Slobodkin (1979). Each meridional line represents the locus of a particular genotype in the size, budding rate, and food space. The possible states of individuals of a particular species would be represented by a stripe on this surface, covering several such lines. It is assumed that below some food level, A, all hydra will die of starvation. It is further assumed that there exists a food level A', such that at food levels between A and A', even the smallest species are considered unable to reproduce.

between growth and reproduction but that the efficiency of the growth and reproductive processes themselves differ between species or with age. If this were so we would expect a cloud of points in three dimensional space, whose upper bound might be similar to Figure 1. To be on a single surface requires that the organisms be relatively constant in efficiency and that a sufficient number of dimensions has been considered.

Several questions are immediately apparent:

1. Is there in fact such a surface?
2. If the surface does exist, can we map significant physiological or ecological properties on it?
3. What are the theoretical implications of positive answers to 1 and 2 with reference to hydra and other organisms?

These questions will be considered in turn, after consideration of our methods.

MATERIALS AND METHODS

The experimental animals were taken from a variety of strains all of which are being maintained in our laboratory. All of the strains had been in the laboratory for at least a year prior to the start of the experiments, some as long as ten years. Green hydra were represented by a small strain collected in the Nissequogue River on Long Island. Studies on other properties of this strain are discussed in Bossert and Slobodkin (1983). *Hydra americana* were from the laboratory of Richard D. Campbell, as were *Hydra cauliculata*. *Hydra fusca* were from Lago Maggiore, Italy. There was also a very large strain ("Connetquot") from the Connetquot River, Long Island and a slightly smaller brown hydra ("5-tentacle") from the Carmans River, Long Island. These animals are available to investigators on request. We have not attempted rigorous identification of the wild caught strains, since our experiments refer to the genus *Hydra* in its entirety. These strains have persisted in having different sizes and slightly different coloration over many months of culture under closely similar conditions.

M solution was used for all stocks and experimental animals (Lenhoff and Brown, 1970). The animals were maintained in controlled temperature chambers under constant overhead illumination at seventeen degrees centigrade. The experimental animals were fed *ad lib* with *Artemia* nauplii. The *Artemia* nauplii had been hatched within twenty-four hours and washed briefly in distilled water, before being suspended in M solution and offered to the hydra.

Experimental hydra were maintained as isolated individuals in the laboratory for periods of from three weeks to two months. They were offered large numbers of *Artemia* nauplii as food and after each feeding the number of nauplii actually ingested was determined by shining light through the gastric region and counting them in the gastric cavity. The feeding counts were made after the animals had stopped "swallowing" but before digestion made counting too difficult.

To estimate size of the hydra, the animals were photographed. All photographs were taken prior to feeding. The photographic procedure was constant and standard throughout. The single lens reflex camera was on a permanent frame used for this purpose only. Focus and enlargement were not changed. Standards were photographed at each photography session to check on the possibility of inadvertent rearrangements of the apparatus. The length and area were measured using a brightness thresholding algorithm on computer digitized video images of photographic

negatives, which is part of an optical measurement computing program, SPOT, under development by Rohlf and Ferson, at Stony Brook.

One source of error in this procedure is that moribund tissue at the pedal end of a hydra need not be sloughed off immediately. A sausage-like post-peduncle may persist for a while and then drop off quite suddenly. This occurs most often in the larger species.

While every effort was made to standardize the state of contraction of the hydra during the photography, there was the possibility of a major source of error being introduced by differences in contractile state. We assumed that each hydra was a constant volume cylinder lying on its side so that projected area would be a function of length. The relevant equation is:

$$\ln A = \frac{1}{2}(\ln V + \ln 4 - \ln \pi + \ln l)$$

in which l is the observed length, A is projected area, and V is the constant volume.

When a series of photographs of hydra individuals in different contractile states was made it was found that the curves of area against length for individual animals of all species conform to this simple equation. The average of the slopes of the relation between log length and log projected area for eleven animals of three species was .514 with standard deviation $\pm .0110$ with an average coefficient of determination of $.95 \pm .0122$. With the apparent verification of the above model, volume can be computed. This measure of volume, being demonstrably independent of contractile state, was taken as our size estimate. Mass, determined as freeze-dried weight, was found to correlate well with calculated volume (Fig. 2).

Budding rate could be immediately determined, since animals were maintained in isolation. Ambiguity was avoided by counting buds after they have dropped off their mothers and using an average budding rate over the period of observation. Other times of origin of buds, as for example, appearance of first tentacles etc., could have been considered without changing things, since there is effectively no death of buds. Any buds that were on animals at the initiation of the period of experimental

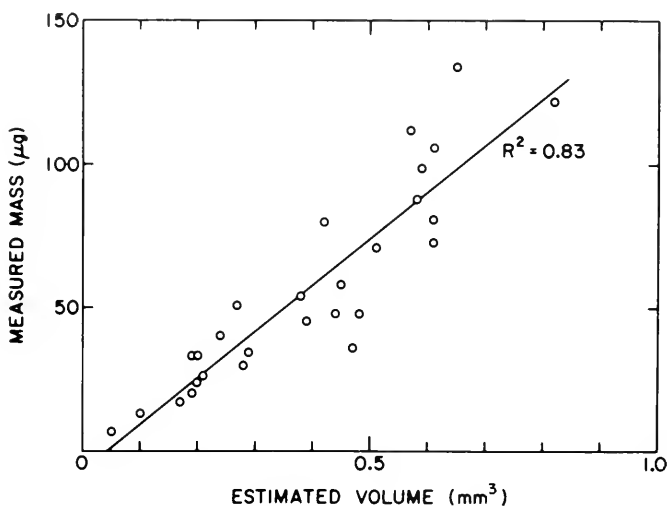

FIGURE 2. The relation between estimated volume, based on a single photograph for each animal, and freeze dried mass of 28 hydra weighed individually on a Cahn Electronic Microbalance.

observation were not included in the bud counts, but buds that were attached at the time of termination of the experiment were included.

Floating and sexuality were noted for one subset of experimental animals.

Notice that the animals had all been taken from stock cultures, so that there was a non-equilibrated transition period during the early portion of their history in isolation. Also we have no guarantee that all animals equilibrated during the observation period. One set of animals was maintained under experimental conditions for ten days and the remainder for twenty-one days prior to the first collecting of data. Rather than arbitrarily omitting data, all of the data were used, and the non-equilibrium may be assumed to have added to our variance.

RESULTS

We now return to the questions listed in the Introduction.

1. Is there in fact a surface of the sort indicated?

The series of measurements for each hydra produced a single point (measured as the triplet; mean body size, mean budding rate, and mean feeding rate). It was found that the green hydra were discordant, having excessively high budding rate and body sizes per unit food consumption, in comparison with the brown species. Since it is known (Muscatine, 1961; Slobodkin, 1964; Stiven, 1965;) that green hydra can receive approximately three times as much energy from their algae as from animal food, the measured food consumption of the green hydra was multiplied by four and the product was used as our estimate of their food consumption. A similar procedure was followed in Slobodkin, (1964). This is obviously a first approximation, and may also have introduced variance. We are now performing experiments designed to estimate the fraction of energy that actually comes from algae under different circumstances. (See also Bossert and Slobodkin, 1983.)

The data for each animal are presented in Table I, and as a three dimensional graph in Figure 3.

The complete set of points using a total of 39 hydra of six strains was tested for fit to a two-dimensional surface embedded in three space.

While the shape of the surface will prove of importance (cf. Gatto, Matessi and Slobodkin, in prep.), our immediate concern is the presence or absence of a surface, rather than its precise shape.

Consider a resource budget consisting of a set of mutually exclusive ways of expending resources, which sum to the total resources income. In our case, bud production and body size maintenance are the result of these expenditures. The resources expended for bud production plus those expended in body maintenance are assumed to equal total resource income. If different strains of hydra apportion resources differently between these expenditures, but the efficiencies are constant between strains (*i.e.*, body size per unit resource expended for body maintenance and buds per unit resource allotted to bud production), then the measurements of individual hydra will generate a monotonic surface in the space whose dimensions consist of an axis for resource income and an axis for each of the modes of expenditure. The term "monotonic surface" requires definition in the present context. The intuitive meaning is of a surface with neither hills nor valleys. In three dimensional space a monotonic surface, in our sense, is one in which the locus of the points of intersection between the surface itself and any flat plane that intersects the axis of resource income will be a monotonic curve passing through the origin.

If the surface in Figure 1 is a monotonic plane folded in three space, rankit

TABLE I

Data for individual hydra

STRAIN	INDIVIDUAL	# OF DAYS	# OF PHOTOS	MM ³ MEAN SIZE	MEAN FEED	MEAN BUD	OBSERVED DAYS SEXUAL	OBSERVED DAYS FLOATING	NUMBER OBSERVED	FEEDINGS/WEEK	FOOD/MEAL
CAULICULATA	1	62	5	.4048	3.613	.2581			25	2.82	8.96
	2	62	7	.4023	4.339	.3065			25	2.82	10.76
	3	62	6	.4341	3.774	.3065			25	2.82	9.36
	4	62	5	.4533	3.726	.2742			25	2.82	9.24
	5	39	6	.3912	6.026	.2632	0	0	12	2.15	19.58
	6	39	6	.2604	3.974	.1842	0	0	12	2.15	12.92
	7	39	6	.3064	4.462	.2368	0	0	12	2.15	14.50
	8	39	6	.3327	6.667	.2105	0	0	12	2.15	21.67
NISSEQUOGUE	1	62	7	.3877	4.452*	.2903			25	2.82	11.04
	2	62	7	.3782	6.065*	.3871			25	2.82	15.04
	3	62	8	.4631	7.419*	.5323			25	2.82	18.40
	4	62	8	.3405	4.258*	.2419			25	2.82	10.56
	5	28	4	.1662	3.286*	.3571	0	0	9	2.25	10.22
	6	14	2	.2438	7.143*	.3571	2	0	5	2.50	9.20
	7	25	4	.1629	4.160*	.1667	0	0	7	1.96	14.86
	8	25	2	.2884	5.120*	.2917	1	0	8	2.24	16.00
AMERICANA	1	62	8	.4115	4.371	.3065			25	2.82	10.84
	2	62	5	.4044	3.935	.2742			25	2.82	9.76
	3	62	8	.3133	3.500	.2742			25	2.82	8.63
	4	62	6	.4085	4.774	.3710			25	2.82	11.84
	5	39	6	.5404	3.692	.2105	7	11	12	2.15	12.00
	6	39	6	.5008	4.410	.1842	11	5	12	2.15	14.33
	7	39	6	.5955	3.256	.2368	9	12	12	2.15	10.58
	8	39	6	.3717	3.231	.1053	11	8	12	2.15	10.50
CONNETQUOT	1	62	8	.7710	3.919	.3065			25	2.82	9.72
	2	62	8	.8864	4.597	.3871			25	2.82	11.40
	3	62	7	.8438	4.629	.3065			25	2.82	11.48
	4	39	6	.6116	4.205	.2105	10	12	12	2.15	13.67
	5	39	6	.6260	3.667	.1579	10	11	12	2.15	11.92
	6	39	6	.5275	3.590	.1579	10	12	12	2.15	11.67
	7	62	7	.5524	4.065	.0968			25	2.82	10.08
	8	62	8	.4613	3.258	.1129			25	2.82	8.08
FUSCA	3	39	6	.5962	3.154	.2105	2	7	12	2.15	10.25
	4	39	6	.7895	2.513	.1579	0	12	12	2.15	8.17
	5	39	6	.4923	3.179	.2105	1	12	12	2.15	10.33
	1	39	5	.3584	2.590	.0526	11	11	12	2.15	8.42
	2	39	6	.2620	3.410	.0263	5	5	12	2.15	11.08
5-TENTACLE	3	39	6	.4680	3.923	.1842	8	7	12	2.15	12.75
	4	39	6	.3515	3.462	.1053	12	2	12	2.15	11.25

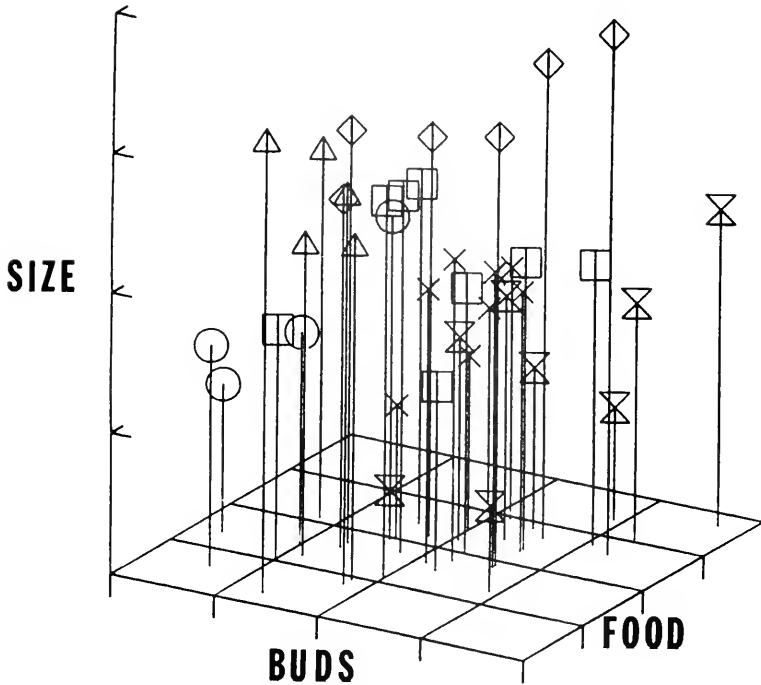

FIGURE 3. Rankit transformed data from Table I, plotted as a three dimensional graph with axes food consumption, body size and budding rate. Both a three dimensional and one dimensional representation of these data can be rejected by Bartlett's test of sphericity at $P > .001$. (Key to symbols—box: *H. americana*, hourglass: Nissequogue strain, triangle: *H. fusca* Italian strain, cross: *H. cauliculata*, diamond: Connetquot strain, circle: 5-tentacle strain).

transformation will project the data onto a flat plane. Principal components analysis and associated tests of significance can then be used to test the fit of the transformed data to a two dimensional surface. The data were therefore converted to rankits (Rohlf and Sokal, 1969). The rankit transformation discards information about the particular shape of the curves relating food, budding rate and size. This transforms any monotonic curve to a plane. The use of rankit transformation in facilitating statistical tests of energy budget data is being addressed, in detail, elsewhere (Wartenburg, Slobodkin and Dunn, in prep.). We assume nothing about the shape of Figure 1 other than its monotonicity.

Principal components for the rankit converted data were calculated using the NTSYS program of Rohlf *et al.* (1982). The first, second, and third eigenvalues and their power to explain variance were 1.627, 1.037, and .3354 with elimination of 54%, 35%, and 11%, respectively, of the data variance.

The rankit data meet the assumptions for Bartlett's Test for Sphericity (Bartlett, 1950; Green and Douglas Carroll, 1978). This test permits assignment of a probability value to the null hypotheses that the data in Figure 3 are adequately represented by a spherical cloud of points (*i.e.*, require three dimensions), or by a cigar shaped cloud varying around a line (*i.e.*, require only one dimension). Both of these hypotheses can be rejected at $P < .001$. That is, we can assert that a three dimensional representation is not necessary, while a one dimensional representation is inadequate, hence we conclude that two dimensions are an appropriate representation.

Departure from three dimensions was checked by Monte Carlo simulation in which the food income, size estimate and budding rate, expressed as rankits, for each hydra were randomized among hydra. The distribution of the resultant triplets was then tested. This was done one hundred times, and the actual, non-randomized data was found to more closely approximate a plane surface than any of these one hundred replicates. We conclude that, in fact, the surface exists.

All of the animals in our experiments were sufficiently well fed to permit budding. We believe that we were in a relatively narrow range of the possible feeding rates. While we intend to study more fully the actual shape of the constraint surface, the region for which we now have data shows a significant correlation between food consumption and budding rate, but not between food consumption and body size. We suggest that hydra more readily adjust their budding rate than their body size to food consumption, once they are sufficiently well fed to bud at all. Otto and Campbell (1977) and Hecker (1978) found that body size does respond to feeding rate at high food levels, and also reported that, at very high food intake rates, hydra may lose the capacity to maintain a steady state in size.

2. Does position on the surface matter to the physiology of the animals?

Slobodkin (1979) suggested that the surface presented in Figure 1 would be divisible into regions, within which hydra would have particular properties. This hypothesis is presented graphically in Figure 4.

At low levels of food intake not only are budding rate and body size reduced but also particular physiological responses are found (Fig. 5).

Large individuals float more readily (see Lomnicki and Slobodkin, 1966). Sexuality was found predominantly in intermediate sized, low food level, brown animals. The green hydra were in general smaller than the brown.

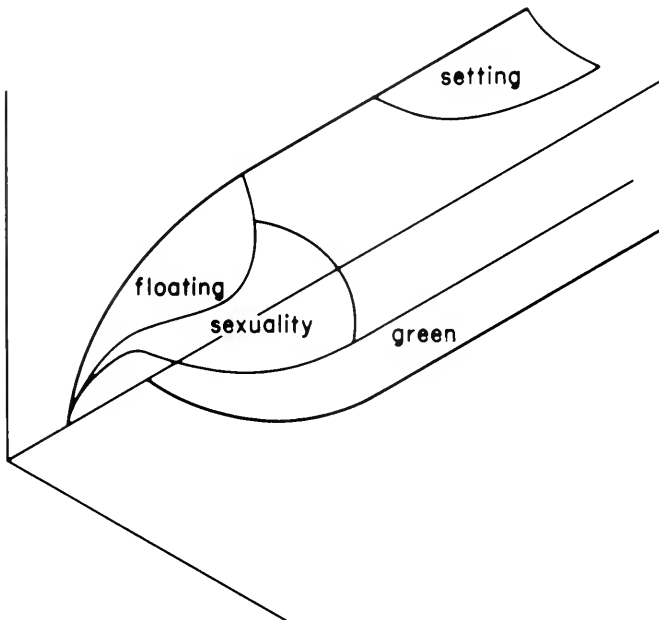

FIGURE 4. Localizations of physiological and behavioral properties on the surface of Figure 1 as hypothesized by Slobodkin (1979).

In short, position on the surface is related to physiological state, as predicted by Slobodkin (1979). Obviously, the ecological relationships of a floating animal are different than those of a settled animal in many ways. We have thus demonstrated an affirmative answer to the question of whether position on the surface matters both physiologically and ecologically.

DISCUSSION

The third question stated in the introduction, (*i.e.*, the possible significance of these results), will now be addressed. The results will be discussed in four contexts—the idea of constraints in evolution; the relation between constraint systems and resource budgets; the search for other, similar, constraint systems; and finally the implications of our findings for the natural history of hydra.

Evolutionary constraint systems

Clutton-Brock and Harvey (1979), in their review of constraint systems, distinguish between “generic constraints” and “evolutionary constraints”. Generic constraints are those sets of properties which are found to be correlated with physiological or ecological categorizations of organisms, without being, necessarily, confined to single taxonomic categories. For example, herbivory may imply the co-occurrence of one set of properties, while carnivory implies another. All homeotherms may share certain characteristics, all poikilotherms another. Evolutionary constraints, in contrast, are inferred from comparisons between members of different subcategories within a larger taxonomic category. We consider that we have demonstrated an evolutionary constraint system in hydra. Note, however, that both Clutton-Brock and Harvey (1979) and Gatto, Mattessi and Slobodkin (*in prep.*) discuss the fact that an apparent surface may actually consist of a series of separate surfaces, each perhaps representing a genotype or species, that resemble a single surface on the generic level in much the same way that the individual slats of a “Venetian blind” are seen as one surface from across the room. Our data are indeterminate on this issue.

Individual hydra can equilibrate at various locations on the surface as a consequence of environmental factors. The fact that, at least within the statistical limits of our data, different species share the same surface, leads us to believe that microevolutionary changes in hydra would tend to move them about on the surface rather than orthogonal to it.

Gould (1980) has presented the metaphor of objects resting on a surface to help explain what is meant by an evolutionary constraint. In this metaphoric context, denial of the existence of constraints on evolutionary direction is taken as imagining a ball rolling on a flat plane. This is taken by Gould and Lewontin (1979) as the image underlying what they refer to as the “Adaptationist Programme.” How far the ball rolls depends only on the force with which it is pushed, not on the direction. Gould goes on to suggest that evolutionary changes for any particular kind of organism may be more restricted in their direction, resembling a polygonal solid, whose motion will depend on both force and direction of the propulsive forces, as well as on which of its faces it is resting. An actual polygonal solid cannot roll, but can be more readily tipped over in certain directions. In a sense we have explored this metaphor. We believe that on experimental and theoretical grounds we have demonstrated explicitly a set of ecological and physiological constraints on the genus *Hydra*. On the basis of this demonstration we suggest adding to Gould’s metaphor

DAYS FLOATING OUT OF 12 DAYS OBSERVED

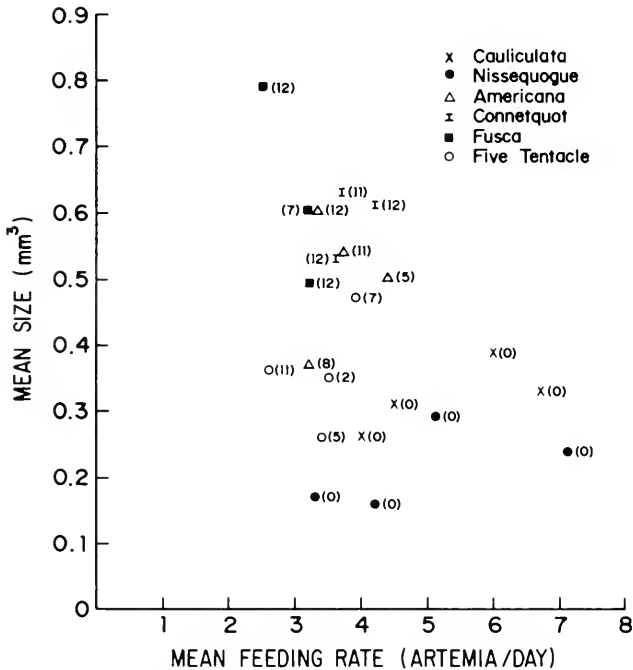

FIGURE 5a. The relation between fraction of days during which animals were floating, body size estimated photographically, and mean number of *Artemia* nauplii consumed. The P value associated with this distribution arising at random was determined by the Spearman Rank Correlation Coefficient of the order of the points when projected onto a line with a negative forty five degree slope and their order in floating rate. P was less than .001.

the image of a non-spherical solid with rounded edges, or perhaps no clear edges at all, which is capable of rolling easily in only certain directions, and must be toppled over if it is to roll in other ways. The mental image is that of the conical egg of the murre, which rolls in tight curves, thereby avoiding falling off ledges (Heinroth and Heinroth, 1958).

Constraint systems as consequences of resource budgets

There is an obvious connection between analyses of budgets and constraints and discussions of ecological and evolutionary "strategies." Various theories of evolutionary strategy build on the assumption that organisms are constrained so that their capacity to do a particular thing or have a particular property carries a "cost" which interferes to some degree with their capacity to do another thing or have another property. This approach is recently summarized by Townsend and Calow (1981) and McCleery (1978).

The analyses of energy, material, and time budgets for individuals and for populations demonstrate that there are restrictions on the present activities of organisms. Energy used for running can not be used for growth. Material used for seeds can

DAYS SEXUAL OUT OF 12 DAYS OBSERVED

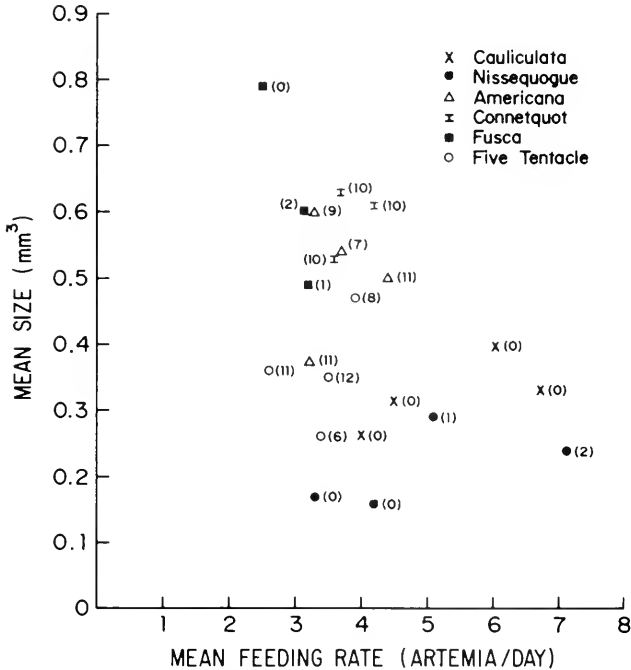

FIGURE 5b. The relation between the occurrence of gonads, body size and food consumption. The values are not randomly distributed ($.05 > P > .01$) nor are they monotonically distributed along the axes of food consumption and body size. Sexuality occurs most often at intermediate levels of food and body size.

not make leaves. Time spent preening can not be used for feeding, etc. A sufficient number of inverse correlations have been demonstrated between properties of organisms that excellent summaries now appear in elementary texts [for example, Begon and Mortimer's chapter on "Life history strategies" (1981)].

The observed constraint surface in hydra, which would be included in the category of "evolutionary constraints" of Clutton-Brock and Harvey (1979), may be considered an elementary consequence of energy budget considerations.

If any two activities or properties of a single organism require sufficiently large allotments or utilization rates of energy or some other resource, development of one of these properties will tend to inhibit or reduce the development of the other. If we consider several organisms, all similar in developmental and physiological potentialities, but differing somewhat as a result of environmental differences, then those individuals that have enhanced one of our hypothetical properties will to some degree have reduced the other. It is possible for organisms to have the same, or very similar anatomy and developmental properties, but to differ genetically in how they partition available resources between the two properties. In particular, this applies to organisms which are of different, but closely related species. In fact, the term "closely" in the previous sentence may be defined by the existence of such simi-

larities. Such pairs of properties meet Clutton-Brock and Harvey's criterion for being under evolutionary constraint. Only if the development of the pair of properties use different resources, or use resources very sparingly, can both properties be increased in the same organisms and under the same circumstances.

We are not confined to considering only pairs of properties. As larger sets of properties are taken into consideration the development of all the properties of the set is more and more likely to constitute a significant fraction of the organisms' resources, and constraints are more likely to become apparent over the set as a whole, whether they are in evidence for any pair of properties. Notice that any property that is found to always be enhanced as some other property is increased is likely to be artifactual, in the sense of Gould and Lewontin's (1979) discussion of the primate chin.

Assume that the degree of development of the properties in question can be measured in the same units as the resource income. If the income of energy, or any other resource, to an individual organism or population of organisms is known, then for any set of properties which are under physiological constraint, it is possible to construct a budget by assuming that the total supply of the resource in question allotted to the set of behaviors is equal to the measured income of that resource. The usual technique would be by multi-dimensional regression analysis. Examples and discussions of this procedure in this context may be found in Slobodkin (1980) and McFarland (1976).

The two properties, body size and budding rate in hydra both require the production and maintenance of tissue. The tissues of a bud are not noticeably different from those of its mother, and our data indicate that evolutionary constraint exists on this pair of properties. No hydra can simultaneously increase both its body size and budding rate above the constraint surface unless it can make a fundamental improvement in the efficiency of its biochemical processes. This apparently has not been possible. In this sense, the area above the constraint surface is free of hydra due to thermodynamic limitations.

Notice that green hydra have energy resources that are unavailable to brown ones. We estimated the amount of energy supplied by the algae, and this permitted us to consider green and brown hydra to be on the same surface. If we think in terms of a constraint set by animal food income, then the green hydra must be thought of as being above the constraint surface. We expect that there exists a constraint surface for all species of green hydra. In this sense, evolutionary loss or gain of the capacity to maintain symbiosis with algae would constitute a macro-evolutionary step for hydra.

The area beneath the surface is kept free of hydra by evolutionary considerations. Conceivably some hydra with a low capacity to maintain tissue and at the same time a low budding capacity could perhaps have some kind of selective edge. For example, hydra are unable to eat certain kinds of cladocera. One of these, *Anchistropus*, actually feeds on hydra (Hyman, 1926; Borg, 1935; Griffing, 1965; Personal Observation, L.S.). If *Anchistropus* were to become extremely common, we might expect that a strain of hydra that was immune to its attack, or even capable of feeding on it, might have a selective advantage. Under these circumstances we might expect that efficiency of growth and reproduction would be evolutionarily unimportant.

We have some evidence that aposymbiotic *Hydra viridis* might fall below the observed surface (Stiven, 1965; Pardy and Dieckmann, 1975; but see Cantor and Rahat, 1982). There is no evidence that aposymbiotic *Hydra viridis* occur in nature.

The search for other constraint systems

Raup and Stanley (1971) studying snail shell evolution, Hutchinson (1968) for Bdelloid rotifers, and Porter (1976) for some of the Scleractinian corals, among others, all have evidence for restrictions on evolutionary possibilities. Raup and Stanley present their data in the space defined by the mathematical representation for a coiling shell, which contains three parameters. Both Hutchinson and Porter present their data as clouds in two dimensions. On purely formal grounds it is understood that often data which appear as points on a surface of a given dimensionality will, when projected onto a space of lower dimension, appear as a cloud. Conversely, we believe that many of the taxonomically restricted scatter diagrams published in ecological literature will appear as surfaces if third or higher dimensions are added, and that some of these surfaces will permit mapping of particular physiological or behavioral properties. We expect that, while which, and how many, measurement axes will define a surface for a particular group of organisms is not obvious, all such sets of axes will share certain properties. We believe that they all will be related to resource budgets. One axis will consist of some resource and the others will be different ways in which that resource is expended. This will guarantee suitable concavity and monotonicity of the surfaces.

Principal components analyses test dimensionality. Our hypothesis, presented in Figure 1, assumes monotonic curves. Fortunately the rankit transformation maps monotonic curves onto flat planes, permitting our use of the Bartlett's test for sphericity. For reasons presented above, we expect that most evolutionary constraint surfaces will also project as monotonic curves in a space of sufficient dimensionality. In general, sufficient dimensionality will have been achieved in a constraint surface when rankit transformed data can be significantly explained by a number of components one less than the total number of measured variables. Principle components analysis, combined with either special tests, of the sort we used, or Monte Carlo simulations, may provide probability estimates for measuring the quality of the surfaces.

The natural history of hydra

Note that Figure 1 is drawn as if the entire surface were available for hydra. We believe that the edges will tend not to be occupied by actual organisms. This is due to the fact that the particular environmental problems which arise for hydra at various points on the surface are likely to differ.

Excessively large hydra have very high maintenance costs, so that budding can only occur if the food supply is very abundant. The capacity to float may permit these larger hydra to survive in an unpredictable environment. They are capable of surviving for an extended period without food. During this period floating animals may encounter richer concentrations of prey. Being excessively small probably narrows the range of possible food items and also narrows the time available for a hydra to starve between meals and still be large enough to capture prey. Floating until new feeding grounds are encountered does not seem as useful for small hydra, since not only is their ability to survive starvation while floating limited, but their range of acceptable animal foods is restricted. Symbiotic algae may serve small hydra in essentially the same way that floating serves large ones, since the symbionts extend the period that these animals can survive between feedings. Bossert and Slobodkin (1983), Thorington and Margulis (1980), and others (cf. Hyman, 1940; Kaenev,

1969) have shown that at least the largest of the green hydra may, under some circumstances, suffer damage from their algal symbionts. That is, at particular regions on this surface of constraints special ecological problems arise. Particular mechanisms for solving these problems have evolved. These include symbiotic algae supplementing the food supply and the capacity to float to richer food areas.

We believe that environmental changes may distort or rotate the constraint surface. We know that those species of hydra so far examined have a lower budding rate and larger body size at lower temperatures (Hecker, 1976) and that floating rate is sensitive to temperature (Slobodkin, 1979).

In hydra the empirical evidence suggests that a reasonably complete and explicit description of the constraints of both physiological and evolutionary responses consists of a surface embedded in a three dimensional space, on which physiological and behavioral properties may be mapped. We suggest the possibility that similar descriptions, consisting of a mapped surface in a minimum of three dimensions may exist in other groups of closely related species. It seems likely that physiological, developmental, or evolutionary alterations which result in movement on such a surface occur more frequently than alterations which successfully permit changes which are orthogonal to the surface. This may relate to the problems of the contrast between micro- and macro-evolution.

Constraint surfaces of this type may be viewed as consequences of resource budget considerations in groups of organisms that share most of their developmental and anatomical properties, but differ in their "Policy" (in the sense of Gatto, *et al.*, in prep) of apportioning resources to different uses. There is an intimate connection between evolutionary constraint surfaces, optimality theory, and resource budgets.

ACKNOWLEDGMENTS

These studies were supported by grants from the Biological Sciences Division of the U. S. National Aeronautics and Space Agency, the Mobil Oil Foundation, and the Italian National Research Council. Profs. R. Armstrong, L. Ginzberg, J. Rohlf, and H. Lyman of Stony Brook provided criticism, encouragement, and advice. Scott Ferson, Dan Wartenburg, and Patricia Bossert, graduate students in the Ecology and Evolution Department each provided their own kind of help. Several undergraduate students were invaluable. These include Jay Fader, who did most of the photography, John Le Guyader and Heidi Chapnick who participated in the experimental work and who, along with Louise Holbrook helped in the tedious work of maintaining stocks. The animals from Central Park were provided by Mike Lewandowsky. R. De Bernardi of Pallanza, Italy, facilitated the collection of *Hydra fusca*. The Ist. di Genetica, Biochemica, ed Evolutionistica, C.N.R. at Pavia provided hospitality and an opportunity for discussion. This is contribution number 452 from the Ecology and Evolution Program, SUNY, Stony Brook.

LITERATURE CITED

- BARTLETT, M. S. 1950. Tests of significance of factor analysis. *Brit. J. Psychol.* (Statistical Section) **3**: 77-85.
- BATESON, G. 1963. The role of somatic change in evolution. *Evolution* **7**: 529-539.
- BEGON, M., AND M. MORTIMER. 1981. *Population Ecology: A Unified Study of Plants and Animals*. Sinauer Associates. Sunderland, MA. 200 pp.
- BORG, F. 1935. Zur kenntniss der Cladoceran-gattung *Anchistropus*. *Zool. Bidr. Upps.* **15**: 289-330.

- BOSSERT, P., AND L. B. SLOBODKIN. 1983. The effect of fast and regeneration in light vs. dark on regulation in hydra-algal symbiosis. *Biol. Bull.* **164**: 396-405.
- CANTOR, M. H., AND M. RAHAT. 1982. Regulation of respiration and photosynthesis in *Hydra viridis* and in its separate cosymbionts: Effect of nutrients. *Physiol. Zool.* **55**: 281-288.
- CLUTTON-BROCK, T. H., AND P. H. HARVEY. 1979. Comparison and adaptation. *Proc. R. Soc. Lond. Ser. B* **205**: 547-565.
- GATTO, M., C. MATESSI, AND L. B. SLOBODKIN. (In prep.) Evolution within ecological and physiological constraints: Explicit predictions for hydra.
- GOULD, S. J. 1980. The evolutionary biology of constraint. *Daedalus, Proc. Am. Acad. Arts Sci.* **109**: 39-52.
- GOULD, S. J., AND R. C. LEWONTIN. 1979. The spandrels of San Marco and the Panglossian paradigm: A critique of the adaptationist programme. *Proc. Roy. Soc., London, Ser. B* **205**: 581-598.
- GREEN, P. E., AND J. DOUGLAS CARROL. 1978. Pp. 361-364 in *Analyzing Multivariate Data*. Dryden Press, Hinsdale, IL.
- GRIFFING, T. 1965. *Dynamics and Energetics of Brown Hydra*. Ph.D. Thesis in the Department of Zoology, University of Michigan, Ann Arbor.
- GURKEWITZ, S., M. CHOW, AND R. D. CAMPBELL. 1980. Hydra size and budding rate: influence of feeding. *Int. J. Invert. Reprod.* **2**: 199-201.
- HECKER, B. 1978. *Adaptive Responses in Hydra oligactis*. Ph.D. Thesis in the Department of Ecology and Evolution, S.U.N.Y., Stony Brook.
- HECKER, B., AND L. B. SLOBODKIN. 1976. Responses of *Hydra oligactis* to temperature and feeding rate. Pp. 175-183 in *Coelenterate Ecology and Behaviour*, G. O. Mackie, ed. Plenum Press, New York.
- HEINROTH, O., AND K. HEINROTH. 1958. *The Birds*. University of Michigan Press, Ann Arbor, MI.
- HUTCHINSON, G. E. 1968. When are species necessary? Pp. 177-186 in *Population Biology and Evolution*, R. C. Lewontin, ed. Syracuse University Press.
- HYMAN, L. 1926. Note on the destruction of hydra by a Chydorid Cladoceran, *Anchistropus minor* Birge. *Trans. Am. Microsc. Soc.* **45**: 298-301.
- HYMAN, L. 1940. *The Invertebrates: Protozoa through Ctenophora*. McGraw-Hill Book Company, NY 726 pp.
- KANAEV, I. I. 1969. *Hydra: Essays on the Biology of Freshwater Polyps*. Translated by E. T. Burrows and H. M. Lenhoff; H. M. Lenhoff, editor and publisher. Miami. 452 pp.
- LENHOFF, H. M., AND R. D. BROWN. 1970. Mass culture of hydra: an improved method and its application to other aquatic invertebrates. *Lab. Anim.* **4**: 139-154.
- LOMNICKI, A., AND L. B. SLOBODKIN. 1966. Floating in *Hydra littoralis*. *Ecology*. **47**: 881-889.
- McFARLAND, D. J. 1976. Form and function in the temporal organization of behaviour. Pp. 55-93 in *Growing Points in Ethology*, P. G. Bateson and R. A. Hinde, eds. Cambridge University Press.
- MCCLEERY, R. H. 1978. Optimal behaviour sequences and decision making. Pp. 377-410 in *Behavioural Ecology, an Evolutionary Approach*, J. R. Krebs and N. B. Davis, eds. Sinauer Associates, Sunderland, MA.
- MUSCATINE, L. 1961. Symbiosis in marine and freshwater coelenterates. Pp. 255-264 in *The Biology of Hydra and Some Other Coelenterates*, H. M. Lenhoff and W. F. Loomis, eds. University of Miami Press, Coral Gables.
- OTTO, J. J., AND R. D. CAMPBELL. 1977. Tissue economics of hydra: regulation of cell cycle, animal size, and development by controlled feeding rates. *J. Cell Sci.* **28**: 117-132.
- PARDY, R. L., AND C. DIECKMANN. 1975. Oxygen consumption in the symbiotic hydra *Hydra viridis*. *J. Exp. Zool.* **194**: 373-378.
- PLOTKIN, H. C., AND F. J. ODLING-SMEE. 1981. A multiple level model of evolution and its implications for sociobiology. *The Behavioral and Brain Sciences* **4**: 225-268.
- PORTER, J. W., 1976. Autotrophy, heterotrophy, and resource partitioning in Caribbean reef-building corals. *Am. Nat.* **110**: 731-742.
- RAUP, D. M., AND S. M. STANLEY. 1971. *Principles of Paleontology* W. H. Freeman and Co., San Francisco. 388 pp.
- ROHLF, F. J., AND R. R. SOKAL. 1969. *Statistical Tables*. W. H. Freeman and Co., San Francisco. 253 pp.
- ROHLF, F. J., J. KISHPAUGH, AND D. KIRK. 1982. NT-SYS, numerical taxonomy of multivariate statistical programs. *Technical Report*, State University of New York, Stony Brook.
- SLOBODKIN, L. 1980. *Growth and Regulation of Animal Populations*, Second Enlarged Ed. Dover Publications Inc., New York. 234 pp.

- SLOBODKIN, L. 1964. Experimental populations of Hydrida. In British Ecological Society Jubilee Symposium, A. Macfadyen and P. J. Newbould, eds. *J. Anim. Ecol.* **33**(Suppl.): 131-148.
- SLOBODKIN, L. B. 1979. Problems of ecological description: The adaptive response surface of hydra. In *Proc. Symp. "Biological and Mathematical Aspects of Population Dynamics,"* R. de Bernardi, ed. Mem. Ist. Idrobiol. Suppl. **37**: 75-93.
- SLOBODKIN, L. B., AND A. RAPOPORT. 1974. An optimal strategy of evolution. *Q. Rev. Biol.* **49**: 181-200.
- STIVEN, A. E. 1965. The relationship between size, budding rate, and growth efficiency in three species of hydra. *Res. Popul. Ecol.* **7**: 1-15.
- THORINGTON, G., AND L. MARGULIS. 1981. *Hydra viridis*; Transfer of metabolites between hydra and symbiotic algae. *Biol. Bull.* **160**: 175-188.
- TOWNSEND, C. R., AND P. CALOW, eds. 1981. *Physiological Ecology: An Evolutionary Approach to Resource Use*. Sinauer Associates, 393 pp.
- WRIGHT, S. 1932. The roles of mutation, inbreeding, crossbreeding and selection in evolution. *Proc. Sixth Intern. Cong. Genetics.* **1**: 356-366.

ECDYSTEROID TITERS DURING THE MOLT CYCLE OF THE BLUE CRAB RESEMBLE THOSE OF OTHER CRUSTACEA

CYNTHIA SOUMOFF AND DOROTHY M. SKINNER

*University of Tennessee-Oak Ridge Graduate School of Biomedical Sciences and Biology Division,
Oak Ridge National Laboratory, Oak Ridge, Tennessee 37830*

ABSTRACT

Callinectes sapidus is the only true crab (brachyuran) whose pattern of ecdysteroid titers has been described as departing from the pattern seen in other decapods. While ecdysteroids in other crabs reach a peak just prior to ecdysis, those of *C. sapidus* were claimed to reach their maxima after ecdysis. The data reported here challenge these findings. We have measured ecdysteroids in hemolymph, ovaries, and whole animal extracts of blue crabs using a radioimmunoassay. In hemolymph and whole animals, ecdysteroid levels rose during premolt to a maximum at stage D₃. Ecdysteroids declined rapidly from late premolt stage D₄ through postmolt stage A₂, increased slightly at postmolt stage B, and returned to low levels where they remained during intermolt stage C. Ecdysteroid levels in males and immature females were not significantly different but mature females, having reached a terminal anecdysis, had significantly lower ecdysteroid levels. Ovaries of mature females accumulated ecdysteroids during vitellogenesis while the concentration of ecdysteroids in hemolymph was low.

INTRODUCTION

Ecdysteroids in crustaceans, measured in whole animals or hemolymph, rise during proecdysis, reach peak levels shortly before ecdysis, and decline to basal levels before or soon after ecdysis (Spindler *et al.*, 1980; Skinner, in press). This pattern is consistent with the role of 20-hydroxyecdysone (20HE) in initiating premolt. When ecdysteroids were examined in female blue crabs *Callinectes sapidus*, 20HE, inokosterone, and makisterone A were identified and, surprisingly, the ecdysteroid peak, consisting principally of 20HE, occurred after ecdysis (Faux *et al.*, 1969). It was suggested that the hormone peak during postmolt was involved with hardening of the exoskeleton (Faux *et al.*, 1969). Because of the decline in hormone titers following ecdysis in the crayfish *Orconectes limosus*, Willig and Keller (1973) concluded that calcification of exoskeleton was independent of hormonal control.

Until the experiments described here, there has been no investigation of circulating ecdysteroid titers nor of ecdysteroids in individual tissues of *C. sapidus*. These are important data since many arthropods regulate ovarian maturation and embryonic development by sequestering ecdysteroids in the ovaries during the reproductive stage; regulation of the molt cycle is distinguished by changes in circulating ecdysteroids. Several insects accumulate ecdysteroids in the ovary (Garen *et*

Received 12 January 1983; accepted 16 May 1983.

By acceptance of this article, the publisher or recipient acknowledges the U. S. Government's right to retain a nonexclusive, royalty-free license in and to any copyright covering the article.

Research supported by the Office of Health and Environmental Research, U. S. Department of Energy, under contract W-7405-eng-26 with the Union Carbide Corp. C.S. is a Postdoctoral Investigator supported by subcontract 3322 from the Biology Division of ORNL to the University of Tennessee.

al., 1977; Lagueux *et al.*, 1977; Hoffman *et al.*, 1980) as do the crabs *Carcinus maenas* (Lachaise and Hoffman, 1977) and *Acanthonyx lunulatus* (Chaix and De Reggi, 1982). Although *Carcinus* continues to molt after its reproductive phase, *Acanthonyx* and other oxyrhyngans enter a terminal anecdysis (stage C₄T; Carlisle, 1957) at the puberty molt. Similarly, *Callinectes*, a brachyrhyncan, enters terminal anecdysis after reaching the puberty molt (Churchill, 1919). It was therefore important to determine ecdysteroid concentrations in both hemolymph and ovaries of crabs in this terminal anecdysis. To that end we examined the ecdysteroid titers in hemolymph, ovaries, and whole animals at different stages of the molt cycle using a radioimmunoassay (RIA; Soumoff *et al.*, 1981). We compared males and females to determine whether there were any hormonal differences between sexes and compared sexually immature females which still undergo ecdyses with sexually mature females that are in a terminal anecdysis.

MATERIALS AND METHODS

Animals

Crabs were collected off the Virginia coast during June and July of the molting season. They ranged in size from 6.3 cm to 11.4 cm carapace width. Animals collected in various phases of the molt cycle were staged by the coloration on the distal segments of the swimming legs (Churchill, 1919) and by the extent of skeletal resorption at the epimeral suture (Warner, 1977; Passano, 1960). Initially, four stages were examined: intermolt (C₄), early premolt (D₁ or green crabs), late premolt (D₃ or peeler crabs) and postmolt (A₁-B₂ or soft crabs). A second series of experiments examined crabs divided into several substages from A₁ through D₄ (see Passano, 1960; Skinner, 1962; Warner, 1977 for descriptions of stages). Mature females, immature females, and males were distinguished by the characteristic shapes of the abdomen.

Treatment of biological material

Hemolymph was withdrawn by syringe puncture through the pericardial space, the arthrodial membrane at the base of a limb, or the mid-joint of a claw. Clotted hemolymph was disrupted and centrifuged to obtain serum. Aliquots were taken for radioimmunoassay (RIA) and the remaining serum was pooled by stage and sex. Ovaries and bursa copulatrix were excised from mature females, blotted dry, and weighed prior to exhaustive hemolymph removal or hemolymph, bursa, and ovary removal. Individual tissues or whole animals were homogenized in 75% MeOH and centrifuged. Pellets were reextracted in 75% methanol and supernatants were evaporated under reduced pressure and resuspended in a small volume of 75% methanol. Samples were examined by RIA.

Radioimmunoassay

Antiserum was that of Soumoff *et al.* (1981) produced from 20-hydroxyecdysone 2-hemisuccinate conjugated to thyroglobulin. [³H]ecdysone (S.A. 50 Ci/mmol or 80 Ci/mmol) was the tracer ligand. 20HE (Simes, Italy) was used as a standard to estimate ecdysteroid levels. All titers are given as 20HE equivalents, although the antiserum has different reactivities toward closely related ecdysteroids (Soumoff *et al.*, 1981). The RIA protocol has been described elsewhere (Chang and O'Connor, 1979).

RESULTS

An initial survey revealed that serum ecdysteroids were at basal levels in intermolt crabs, began rising in early premolt crabs, and reached peak titers in late premolt crabs (Fig. 1A). By postmolt serum titers dropped, but not as low as intermolt levels. Males and females showed no statistically significant differences at any given stage. Variance was greater among males than females and was not related to size or limb loss. Blue crabs readily autotomize limbs as a result of handling; most of the animals lost from 1 to 4 limbs while two crabs lost six limbs. Regenerating limb buds from previously autotomized limbs were small on intermolt crabs but

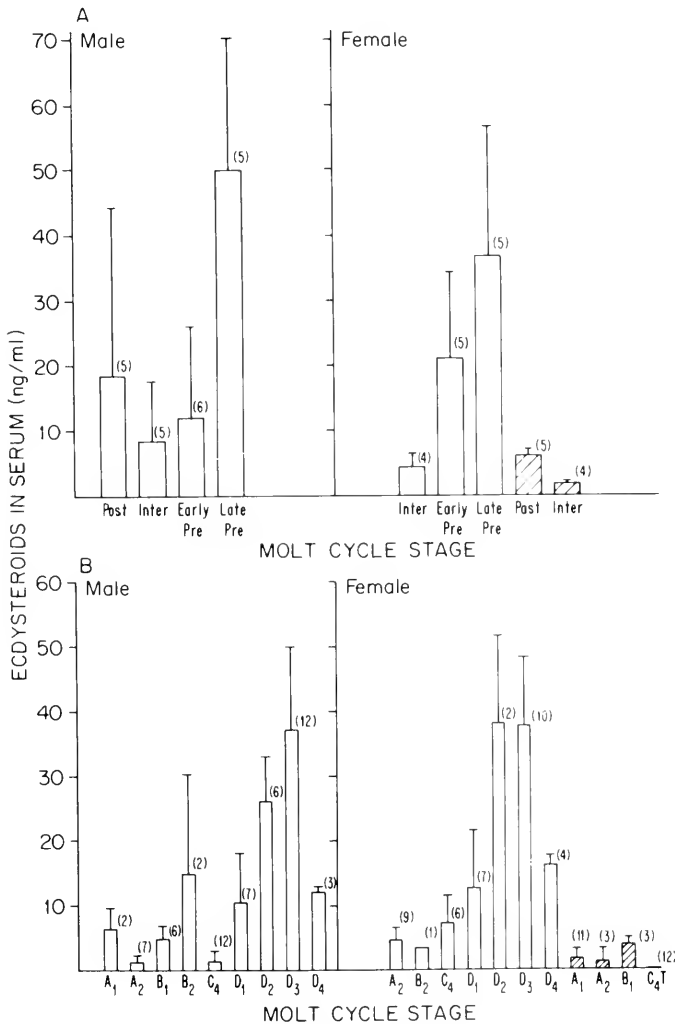

FIGURE 1. Serum ecdysteroid levels during the molt cycle in male and female blue crabs collected in (A) June, 1981 and (B) June, 1982. Values are the means \pm standard deviations. Number of animals assayed are given in parentheses. Hatched bars represent mature females. Ecdysteroids were calculated as 20HE equivalents.

were large on premolt crabs. It has been shown that ecdysteroid titers are elevated in crabs in advanced stages of limb regeneration (Soumoff and Skinner, 1980). Multiple autotomy acts as a stimulus to molt (Skinner and Graham, 1970, 1972; Holland and Skinner, 1976; Mykles and Skinner, 1981) and limb regeneration is a sign that a crab is in the premolt stage (Emmel, 1906, 1907; Bliss, 1956).

Since the puberty molt is the final molt for females of this species, mature females are found only in the postmolt and subsequent C₄T stages. Although immature females should be available in all stages of the molt cycle, we were unable to obtain postmolt immature females during this initial survey. Mature C₄T females had lower serum ecdysteroids than immature intermolt females. The difference was significant ($P < .05$) and is probably related to changes in hormone production and metabolism causing the terminal anecdyosis of mature females. In one case an immature female was assayed in late premolt, completed the molt to maturity overnight, and was reassayed in postmolt. The premolt ecdysteroid level, 43.4 ng/ml, decreased to 6.7 ng/ml overnight.

A second examination of serum ecdysteroid levels was undertaken during the next annual molting season (Fig. 1B) and the molt cycle stages were defined more precisely. The observed hormone levels confirmed the data obtained previously (Fig. 1A). Ecdysteroid concentrations rose during the initial stages of premolt, declined in stage D₄ and continued to decline through stage A₂. There was a slight rise in ecdysteroid concentration in stage B₁. The apparent rise in stage B₂ males was caused by one exceptionally high value that may have been an artifact. There were no significant differences between males and females throughout premolt. Mature females had significantly lower ecdysteroid levels than immature females at stages A₂ and C ($P < .05$) and males at stages A₁ and C ($P < .02$). Among thirteen mature C₄T females examined, twelve showed no detectable ecdysteroids and one had a level of 5 ng/ml. Intermolt juvenile females averaged 7.1 ng/ml and intermolt males averaged 1.3 ng/ml.

Some crabs that survived several premolt and postmolt stages in captivity were sampled in consecutive stages. Figure 2A shows that serum ecdysteroids rose in individual specimens as they proceeded from stage D₁ to stage D₃. Crabs that were collected at later premolt stages had rapidly declining serum ecdysteroids (Fig. 2B). These data illustrate that although there may be wide variations between crabs, a pattern is maintained within individuals of rising ecdysteroids through stage D₃ and declining ecdysteroids from stage D₄ through A₂.

In several species of insects (Luu *et al.*, 1976; Lagueux *et al.*, 1977; Ohnishi *et al.*, 1977; Bollenbacher *et al.*, 1978) and in the crab *C. maenas* (Lachaise and Hoffmann, 1977) reproductively active ovaries contain ecdysteroids which regulate vitellogenesis (Hagedorn *et al.*, 1975; Handler and Postlethwait, 1978) and embryonic development (Hoffmann *et al.*, 1980). We examined the ecdysteroid concentration in ovaries of mature female blue crabs to determine whether they stored significant amounts of ecdysteroids. As a control tissue we examined the bursa copulatrix, the storage sacs for sperm introduced during copulation.

The reproductive stages were determined according to criteria which distinguish changes in the gross appearance of the ovaries (Hard, 1942). Stage I describes crabs immediately following the puberty molt when ovaries are small. Stage II describes the period during which the ovary enlarges and becomes orange as vitellogenesis progresses. Stage III describes the mature ovary which is very large and bright orange.

The ecdysteroid content of ovaries of *C. sapidus* increased as vitellogenesis progressed (Table I) although ecdysteroid concentration per unit weight declined 2.5-

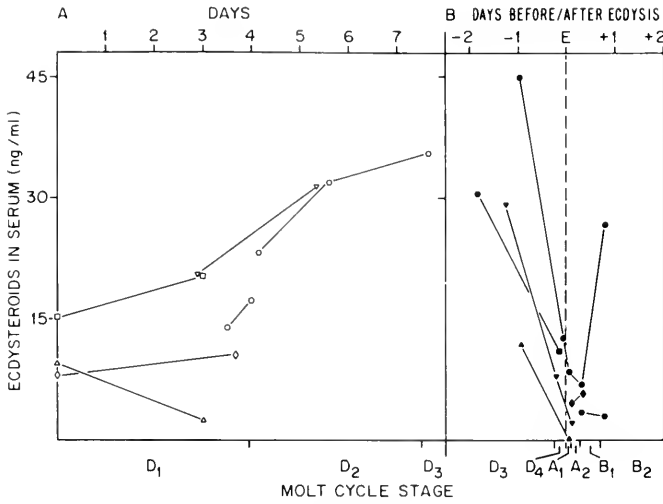

FIGURE 2. Serum ecdysteroid levels in individual crabs at consecutive stages of the molt cycle. Each symbol represents a single crab whose serum was examined at the intervals shown. At each interval, the stage of the cycle was determined by the condition of the exoskeleton and coloration of an appendage. (A) Crabs in stages D₁ through D₃. The upper axis shows the number of days between measurements. (B) Crabs in stages D₃ through B₂. All animals reached ecdysis. The upper axis shows the number of days between measurements in relation to the time of ecdysis.

fold during yolk deposition as the weight of the ovary increased almost thirty-fold. In contrast, ecdysteroids in the closely associated bursa copulatrix decreased from stage I to stage III. Ecdysteroid accumulation in the ovaries of C₄T females occurred at a time when ecdysteroids were low in both serum (Fig. 1) and whole animals (Table II). Although ovaries accumulated ecdysteroids during vitellogenesis, their content of ecdysteroids did not contribute significantly to the whole animal titer.

Total ecdysteroid content in both males and females rose to maximum levels during late premolt and declined precipitously by postmolt (Fig. 3). The pattern of ecdysteroid titers measured throughout the molt cycle is similar to the pattern for serum or carcass alone. These results are contrary to those of Faux *et al.* (1969) who observed maximal ecdysteroids during postmolt in whole animal extracts of females.

TABLE I

Ecdysteroid levels in female reproductive tissue

Tissue	Stage	N	Weight (mg/organ pr)	Ecdysteroid Conc.	
				(ng/organ pr)	(ng/g)
Ovary	I	5	130 ± 20	0.35 ± 0.12	2.86 ± 1.19
	II	3	660 ± 80	1.39 ± 0.12	2.14 ± 0.44
	III	3	3240 ± 40	3.56 ± 1.09	1.10 ± 0.35
Bursa Copulatrix	I	5	710 ± 190	3.35 ± 1.38	4.70 ± 1.57
	II	3	1120 ± 620	1.58 ± 1.01	1.45 ± 0.36
	III	3	180 ± 60	0.54 ± 0.32	3.22 ± 1.27

TABLE II

Mature female whole animal ecdysteroids

Stage	N	Weight (g)	Ecdysteroid (ng/g)
A ₁	4	94.08 ± 11.06	6.34 ± 2.25
C ₄ T	6	117.73 ± 19.99	2.48 ± 1.19

DISCUSSION

Contrary to previous results in which ecdysteroids reached a peak after ecdysis (Faux *et al.*, 1969) the results described here indicate that ecdysteroid concentrations in *Callinectes sapidus* are at basal levels during intermolt, increase an average of seven-fold by late premolt, and decline in postmolt. Whole animal ecdysteroid titers for both sexes average 10.4 ng/g fresh weight, 74.8 ng/g fr. wt. and 15.8 ng/g fr. wt. respectively at these stages. The antiserum we used has varying sensitivity toward different ecdysteroids. It is three-fold more sensitive to ecdysone than to 20HE while its sensitivity toward all other ecdysteroids tested is less than that to 20HE (Soumoff *et al.*, 1981). This will have some effect on measurements of complex mixtures of ecdysteroids. The concentrations we observed, however, are consistent with ecdysteroid levels in other crustaceans. Titters measured in the crab *Carcinus maenas* (Adelung, 1969) range from 5 ng/g at intermolt to 110 ng/g during premolt. In the amphipod *Orchestia gammarella*, the range is from 12 ng/g at intermolt to 63 ng/g at late premolt (Blanchet *et al.*, 1976). Ecdysteroids in the crayfish *Orconectes limosus* range from 0.3 ng/g during intermolt to 60 ng/g during premolt (Willig and Keller, 1973). In adult female lobsters (*Homarus americanus*) ecdysteroids are 6 ng/g at postmolt (Gagosian *et al.*, 1974). Quantitation of the values for *Orchestia* was by RIA, for *Carcinus* and *Orconectes* by bioassay, and for *Homarus* by high pressure liquid chromatography and gas chromatography. Although the method of quanti-

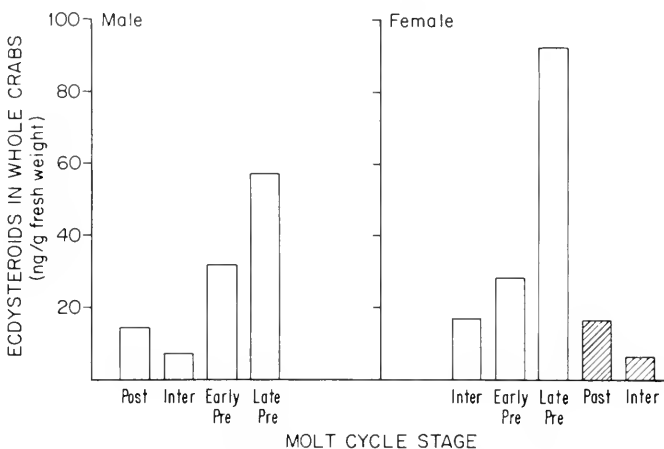

FIGURE 3. Whole animal ecdysteroid levels in male and female blue crabs at different stages of the molt cycle. Hatched bars represent mature females. Ecdysteroids were calculated as 20HE equivalents. Three or four animals from each stage were pooled and assayed. Hemolymph from both sexes and ovary and bursa from mature females at each stage were assayed separately from remaining carcass and the values were added to calculate the titers in whole animals.

tation determines, to some extent, the titer of hormone measured, these examples, utilizing several different techniques, are consistent with each other.

Ecdysteroids measured by Faux *et al.* (1969) for female blue crabs are inconsistent with the values reported here. In that analysis, the peak of ecdysteroids was observed after ecdysis (280 ng/g 20HE and 24 ng/g makisterone A) and was twelve-fold greater than the concentration at late premolt (20 ng/g inokosterone and 4 ng/g 20HE). The method of quantitation of ecdysteroids was not specified and may account for the discrepancy. One other example of a major peak of hormone titer during postmolt was reported for *O. gammarella* (Blanchet *et al.*, 1976). The hormone titer reached a maximum in late premolt, declined by stage A, but showed some indication of a second peak during stage B; a large standard deviation at this stage made interpretation of the data difficult.

Measurements of circulating ecdysteroids are more variable between species than are whole animal titers. However, all species exhibit a trend of increasing ecdysteroid levels during premolt to a maximum prior to ecdysis, followed by a decline to basal intermolt levels. The range of ecdysteroids in *Callinectes* serum, 5 ng/ml at intermolt to 44 ng/ml in late premolt, is comparable to hemolymph titers of the crayfish *Orconectes sanborni* ranging from 4 ng/ml to 30 ng/ml (Stevenson *et al.*, 1979). Ecdysteroids in hemolymph of the crab *Pachygrapsus crassipes* vary from near zero just after ecdysis to 120 ng/ml in premolt (Chang and O'Connor, 1978). The crab *Gecarcinus lateralis* has a minimal titer of 10 ng/ml at intermolt and a maximum of 150 ng/ml at D₃ when induced to molt by multiple limb autotomy (Soumoff and Skinner, 1982). Serum levels are in that same range in the fiddler crab *Uca pugnator* (Hopkins, In press) during a natural molt cycle. Lachaise *et al.* (1976) reported circulating ecdysteroid titers ranging from 62–470 ng/ml for the crab *C. maenas*, while titers of 30–15,000 ng/ml hemolymph for this species have also been reported (Andrieux *et al.*, 1976). Juvenile lobsters, *Homarus americanus*, exhibited basal levels of ecdysteroids of less than 35 ng/ml and peak titers of 350 ng/ml (Chang and Bruce, 1980). These values were all quantitated by RIA.

Whole animal and serum ecdysteroid titers in mature *Callinectes* females during postmolt were significantly higher than those in mature females at the subsequent intermolt stage. Despite this, intermolt ovaries contained higher levels of ecdysteroids than postmolt ovaries; the former were vitellogenic while the latter were not. Similarly, the ecdysteroid concentration in ovaries increased at vitellogenesis while the ecdysteroids in hemolymph remained low in *C. maenas* (Lachaise and Hoffmann, 1977) as well as in the spider crab *Acanthonyx lunulatus* (Chaix and de Reggi, 1982).

Females of the oxyrhynchan species *Maja squinado* and *A. lunulatus* reach reproductive maturity at their last molt, when they enter terminal anecdyis. Their Y-organs become inactive and degenerate (Carlisle, 1957; Chaix *et al.*, 1976) and hemolymph ecdysteroids decline (Chaix and de Reggi, 1982). Similarly for male isopods (*Sphaeroma serratum*), the Y-organs degenerate following the puberty molt, a terminal anecdyis is reached, and ecdysteroids gradually disappear from the hemolymph (Charmantier, 1980). The very low hemolymph ecdysteroids in mature C₄T females of *C. sapidus* is consistent with these observations and, similarly, may result from degenerative changes in the Y-organs.

ACKNOWLEDGMENTS

We are grateful to Dr. C. P. Mangum for the use of the facilities at the Virginia Institute of Marine Sciences, East and for help in the early stages of this work. We thank Dr. M. Castagna and the staff at VIMS for their generous assistance and Dr.

P. Hopkins for critical reading of the manuscript. The ecdysteroid antiserum was kindly supplied by Dr. J. D. O'Connor (Univ. of California, Los Angeles), and the [^3H]ecdysone by Dr. D. S. King.

LITERATURE CITED

- ADELUNG, D. 1969. Die Ausschüttung und Funktion von Häutungshormon während eines Zwischenhäutungs-Intervalls bei der Strandkrabbe *Carcinus maenas* L. *Z. Naturforsch.* **24B**: 1447-1455.
- ANDRIEUX, N., P. PORCHERON, J. BERREUR-BONNENFANT, AND F. DRAY. 1976. Détermination du taux d'ecdysone au cours du cycle d'intermue chez le Crabe *Carcinus maenas*; comparaison entre individus sains et parasités par *Sacculina carcini*. *C. R. Acad. Sci. Paris* **283**: 1429-1432.
- BLANCHET, M.-F., P. PORCHERON, AND F. DRAY. 1976. Étude des variations du taux des ecdysones au cours du cycle d'intermue chez le mâle d'*Orchestia gammarella* Pallas (Crustacé Amphipode) par dosage radioimmunologique. *C. R. Acad. Sci. Paris* **283**: 651-654.
- BLISS, D. E. 1956. Neurosecretion and the control of growth in a decapod crustacean. Pp. 56-75. in *Bertil Hanström. Zoological Papers in Honour of his 65th Birthday*. K. G. Wingstrand, ed. Zool. Inst., Lund.
- BOLLENBACHER, W. E., H. ZVENKO, A. K. KUMARAN, AND L. I. GILBERT. 1978. Changes in ecdysone content during postembryonic development of the wax moth, *Galleria mellonella*: the role of the ovary. *Gen. Comp. Endocrinol.* **34**: 169-179.
- CARLISLE, D. B. 1957. On the hormonal inhibition of moulting in decapod Crustacea. II. The terminal anecysis in crabs. *J. Mar. Biol. Assoc. U. K.* **36**: 291-307.
- CHAIX, J. C., AND M. DE REGGI. 1982. Ecdysteroid levels during ovarian development and embryogenesis in the spider crab *Acanthonyx lunulatus*. *Gen. Comp. Endocrinol.* **47**: 7-14.
- CHAIX, J. C., J. P. TRILLES, AND G. VERNET. 1976. Dégénérescence de l'organe Y chez les mâles pubères d'*Acanthonyx lunulatus* (Risso) (Crustacea Decapoda Oxyrhyncha). *C. R. Acad. Sci. Paris* **283**: 523-525.
- CHANG, E. S., AND J. D. O'CONNOR. 1978. *In vitro* secretion and hydroxylation of α -ecdysone as a function of the crustacean molt cycle. *Gen. Comp. Endocrinol.* **36**: 151-160.
- CHANG, E. S., AND J. D. O'CONNOR. 1979. Arthropod molting hormones. Pp. 797-814 in *Methods of Hormone Radioimmunoassay*. 2nd ed., B. M. Jaffe and H. R. Behrman, eds. Academic Press, New York.
- CHANG, E. S., AND M. J. BRUCE. 1980. Ecdysteroid titers of juvenile lobsters following molt induction. *J. Exp. Zool.* **214**: 157-160.
- CHARMANTIER, G. 1980. Contrôle endocrine et neuroendocrine de la mue de puberté chez les mâles de *Sphaeroma serratum* (Fabricius, 1787) (Crustacea, Isopoda, Flabellifera). *Gen. Comp. Endocrinol.* **41**: 349-364.
- CHURCHILL, E. P., JR. 1919. Life history of the blue crab. Bulletin, U. S. Bureau of Fisheries for 1917-1918 **36**: 93-136.
- EMMEL, V. E. 1906. The relation of regeneration to the molting process in the lobster. *Ann. Rep. Comm. Inland Fish., Rhode Island*, **36**: 258-313.
- EMMEL, V. E. 1907. Relations between regeneration, the degree of injury, and molting of young lobsters. *Science* **15**: 785.
- FAUX, A., D. H. S. HORN, E. J. MIDDLETON, H. M. FALES, AND M. E. LOWE. 1969. Moulting hormones of a crab during ecdysis. *Chem. Commun.* 175-176.
- GAGOSIAN, R. B., R. A. BOURBONNIERE, W. B. SMITH, E. F. COUCH, C. BLANTON, AND W. NOVAK. 1974. Lobster molting hormones: isolation and biosynthesis of ecdysterone. *Experientia* **30**: 723-724.
- GAREN, A., L. KAUVAR, AND J.-A. LEPESANT. 1977. Roles of ecdysone in *Drosophila* development. *Proc. Nat. Acad. Sci. USA* **74**: 5099-5103.
- HAGEDORN, H. H., J. D. O'CONNOR, M. S. FUCHS, B. SAGE, D. A. SCHLAEGER, AND M. K. BOHM. 1975. The ovary as a source of α -ecdysone in an adult mosquito. *Proc. Nat. Acad. Sci. USA* **72**: 3255-3259.
- HANDLER, A. M., AND J. H. POSTLETHWAIT. 1978. Regulation of vitellogenin synthesis in *Drosophila* by ecdysterone and juvenile hormone. *J. Exp. Zool.* **206**: 247-254.
- HARD, W. L. 1942. Ovarian growth and ovulation in the mature blue crab, *Callinectes sapidus* Rathbun. *Chesapeake Biol. Lab. Bull.* **46**: 1-17.
- HOFFMANN, J. A., M. LAGUEUX, C. HETRU, M. CHARLET, AND F. GOLTZENE. 1980. Ecdysone in reproductively competent female adults and in embryos of insects. Pp. 431-465 in *Progress in Ecdysone Research*, J. A. Hoffmann, ed. Elsevier/North-Holland Biomedical Press, Amsterdam.

- HOLLAND, C. A., AND D. M. SKINNER. 1976. Interactions between molting and regeneration in the land crab. *Biol. Bull.* **150**: 222-240.
- HOPKINS, P. M. 1983. Patterns of serum ecdysteroids during induced and uninduced proecdysis in the fiddler crab, *Uca pugilator*. *Gen. Comp. Endocrinol.* In press.
- LACHAISE, F., M. LAGUEUX, R. FEYEREISEN, AND J. A. HOFFMAN. 1976. Métabolisme de l'ecdysone au cours du développement de *Carcinus maenas* (Brachyura, Decapoda). *C. R. Acad. Sci. Paris* **283**: 943-946.
- LACHAISE, F., AND J. A. HOFFMANN. 1977. Ecdysone et développement ovarien chez un Décapode, *Carcinus maenas*. *C. R. Acad. Sci. Paris* **285**: 701-704.
- LAGUEUX, M., M. HIRN, AND J. A. HOFFMANN. 1977. Ecdysone during ovarian development in *Locusta migratoria*. *J. Insect Physiol.* **23**: 109-119.
- LUU, B., M. LAGUEUX, M. HIRN, AND J. A. HOFFMANN. 1976. Identification par chromatographie en phase vapeur et spectrométrie de masse de l'ecdysone synthétisée dans les ovaires de femelles adultes de *Locusta migratoria* (Insecte Orthoptère). *C. R. Acad. Sci. Paris* **283**: 1081-1084.
- MYKLES, D. L., AND D. M. SKINNER. 1981. Preferential loss of thin filaments during molt-induced atrophy in crab claw muscle. *J. Ultrastruct. Res.* **75**: 314-325.
- OHNISHI, E., T. MIZUNO, F. CHATANI, N. IKEKAWA, AND S. SAKURAI. 1977. 2-Deoxy- α -ecdysone from ovaries and eggs of the silkworm, *Bombyx mori*. *Science* **197**: 66-67.
- PASSANO, L. M. 1960. Molting and its control. Pp. 473-536 in *The Physiology of Crustacea*, Vol. 1, T. H. Waterman, ed. Academic Press, New York.
- SKINNER, D. M. 1962. The structure and metabolism of a crustacean integumentary tissue during a molt cycle. *Biol. Bull.* **123**: 635-647.
- SKINNER, D. M. In press. Interactions between molting and regeneration. In *The Biology of Crustacea*, D. E. Bliss, and L. H. Mantel, eds. Academic Press, New York.
- SKINNER, D. M., AND D. E. GRAHAM. 1970. Molting in land crabs: stimulation by leg removal. *Science* **169**: 383-385.
- SKINNER, D. M., AND D. E. GRAHAM. 1972. Loss of limbs as a stimulus to ecdysis in Brachyura (true crabs). *Biol. Bull.* **143**: 222-233.
- SOUHOFF, C. AND D. M. SKINNER. 1980. Effect of Y-organectomy and autotomy on circulating ecdysteroid levels and regeneration in the crab *Gecarcinus*. *Amer. Zool.* **20**: 933.
- SOUHOFF, C., AND D. M. SKINNER. 1982. *In vitro* assay of hydroxylase activity in the crab *Gecarcinus lateralis*. *Amer. Zool.* **22**: 938.
- SOUHOFF, C., D. H. S. HORN, AND J. D. O'CONNOR. 1981. Production of a new antiserum to arthropod molting hormone and comparison with two other antisera. *J. Steroid Biochem.* **14**: 429-435.
- SPINDLER, K.-D., R. KELLER, AND J. D. O'CONNOR. 1980. The role of ecdysteroids in the crustacean molting cycle. Pp. 247-280 in *Progress in Ecdysone Research*, J. A. Hoffmann, ed. Elsevier/North-Holland Biomedical Press, Amsterdam.
- STEVENSON, J. R., P. W. ARMSTRONG, E. S. CHANG, AND J. D. O'CONNOR. 1979. Ecdysone titers during the molt cycle of the crayfish *Orconectes sanborni*. *Gen. Comp. Endocrinol.* **39**: 20-25.
- WARNER, G. F. 1977. In *The Biology of Crabs*. Van Nostrand Reinhold Co., New York.
- WILLIG, A., AND R. KELLER. 1973. Molting hormone content, cuticle growth and gastrolith growth in the molt cycle of the crayfish *Orconectes limosus*. *J. Comp. Physiol.* **86**: 377-388.

GEOGRAPHIC LIMITS AND LOCAL ZONATION: THE BARNACLES
SEMIBALANUS (BALANUS) AND *CHTHAMALUS*
IN NEW ENGLAND

DAVID S. WETHEY

*Department of Biology and Marine Science Program,
University of South Carolina, Columbia, SC 29208*

ABSTRACT

The interactions between the intertidal barnacles *Semibalanus (Balanus) balanoides* and *Chthamalus fragilis* were examined in order to determine whether the factors which influence local zonation in the intertidal also contribute to the establishment of geographic limits.

Both physical and biotic factors influence intertidal zonation at the northern limit of *Chthamalus* in New England. On sloping surfaces *Semibalanus* died at all shore levels higher than mid tide level, apparently as a result of desiccation associated with high summer temperatures. *Chthamalus* settlement occurred at all shore levels above mean tide level, and postsettlement mortality apparently restricts *Chthamalus* to high shore locations where *Semibalanus* growth and survival is inhibited. North of the northern limit of *Chthamalus*, *Semibalanus* does not suffer summer heat death, so it occupies the zone where *Chthamalus* would have a refuge from competition further south.

The northern limit of *Chthamalus* is set not by factors directly related to cold acting on *Chthamalus*. Rather the northern limit appears to be set by cold which allows the dominant competitor to exclude *Chthamalus* from its refuge zone. South of the northern limit the competitor, *Semibalanus*, is excluded from the high shore by high summer temperatures.

INTRODUCTION

One of the goals of ecology is to determine the mechanisms responsible for the patterns of distribution and abundance of organisms. The rocky intertidal zone has been used very successfully to make experimental tests of a wide variety of hypotheses about the organization of communities and the dynamics of assemblages of species. Much of this work has been designed to elucidate patterns of local distribution and abundance, rather than large scale geographic patterns. Here I examine whether the same mechanisms that control local zonation are responsible for large scale geographic patterns, those of geographic limits of species.

The strong physical gradient in the intertidal zone was long considered to be fully responsible for the zonation patterns observed. Upper and lower limits of distribution were thought to be set by physiological tolerances (Colman, 1933; Hewatt, 1937; Doty, 1946). Upper limits on the shore are now known to be generally determined by physical factors. Foster (1969) and Hatton (1938) demonstrated that barnacles die if transplanted above their usual shore zone, and that both heat and moisture influence the rate of death. There is little field evidence that intolerance of submersion sets the lower limit of marine species in the intertidal zone. The

majority of the evidence is consistent with the hypothesis (Connell, 1961a, b) that local lower limits are set by interactions with predators or competitors (*e.g.*, reviews by Connell, 1972; Paine, 1974; Menge, 1976; Lewis, 1977; Lubchenco and Menge, 1978; Schonbeck and Norton, 1978; Lubchenco, 1980).

Geographic limits have been correlated with physical conditions in much the same way as have local zonation patterns. Hutchins (1947) hypothesized that the most likely factors limiting geographic distribution were lethal temperatures for adults and what he termed critical temperatures within which reproduction is successful. In some cases the lethal physiological limits of species as determined in laboratory studies correspond to geographic limits (*e.g.*, Vernberg and Tashian, 1959; Vernberg and Vernberg, 1967), but in other cases, geographic ranges are narrower than predicted from studies of lethal limits (*e.g.*, Barnes, 1958; Southward, 1958). Since local zonation is not entirely controlled by lethal physiological limits, and biotic interactions are often locally dominant, it is likely that biotic interactions also play an important role in determining geographic limits.

In this paper I discuss biotic and physical factors which appear to strongly influence the northern geographic limit of the intertidal barnacle *Chthamalus fragilis* on the Atlantic coast of North America. *Chthamalus fragilis* ranges from the Caribbean to Cape Cod (Dando and Southward, 1980). At the northern end of its distribution it is restricted to a narrow zone at the upper levels of the intertidal. Below this zone lives an arctic barnacle species *Semibalanus balanoides*. This type of zonation is also found near the northern limit of *Chthamalus* in Scotland, where Connell (1961a) demonstrated that the upper shore limit of *Chthamalus* was set by desiccation and the lower shore limit was set by competition with *Semibalanus*. *Semibalanus* was renamed by Newman and Ross (1976); it is referred to as *Balanus balanoides* in all previous literature.

MATERIALS AND METHODS

This study was carried out 100 km north and 150 km south of the recorded northern limit of *Chthamalus* on Cape Cod, Massachusetts. The northern site was East Point, Nahant, Massachusetts (42° 25' N, 70° 54' W), near the Northeastern University Marine Science Institute. At this location only *Semibalanus* is present. Here, the tidal range is approximately 3.5 meters. The southern sites were the Yale University Peabody Museum Field Station at Guilford, Connecticut (41° 16' N, 72° 44' W), and nearby Horse Island in the Long Island Sound (41° 15' N, 72° 45' W). At these sites, both *Semibalanus* and *Chthamalus* coexist. The tidal range at these sites is approximately 1.9 meters. *Semibalanus* settles at all sites between March and May, and *Chthamalus* settles in Connecticut in August and September.

The zonation patterns of *Semibalanus* and *Chthamalus* were quantified by transects of contiguous 0.5 m × 0.5 m quadrats, which were photographed with a 70 mm camera held perpendicular to the shore with a focal framer. Permanent quadrats were marked with stainless steel screws set in the corners. Percent cover of live and dead organisms was estimated by placing a transparent plastic sheet with 49 uniformly plotted dots on its surface over enlargements of the photographs. Percent cover was then estimated by counting the number of dots overlying each species (*e.g.*, Menge, 1976). Transects were established in a variety of locations in order to determine the influence of shore orientation and aspect. Heights of the marker screws relative to mean low water were estimated by the tables in the Tide Tables (NOAA, 1982). Percent cover data are based on samples taken in August and October.

Settlement of *Chthamalus* in the absence of *Semibalanus* was estimated by removing *Semibalanus* with a paint scraper in a checkerboard pattern in permanently marked quadrats. In this way *Semibalanus* removals were performed at all shore levels. Removals were performed in August 1982, at the beginning of the *Chthamalus* settlement season. Settlement was measured in mid October, 1982, by counting newly settled spat in 4 cm \times 4 cm quadrats in the field.

RESULTS

In Connecticut, *Chthamalus* occupies a narrow zone near mean high water of neap tides (Figs. 1-4). The zonation is strongly influenced by slope and aspect. On north-facing vertical surfaces, *Chthamalus* occupies a very narrow zone on the high shore (Fig. 1). Maximum percent cover is 50% near mean high water of neap tides (Fig. 1). Below this level, *Semibalanus* occupies 100% of the space (Fig. 1). On south-facing vertical surfaces, *Chthamalus* occupies a wider zone. Its upper shore limit is similar to that on north facing surfaces, but its lower limit is 25 cm lower (Fig. 1). Its maximum percent cover is almost 100% on west facing vertical surfaces (Fig. 1). *Semibalanus* occupies 100% of the space below *Chthamalus*, down to mid-tide level. Below this zone, predation by the gastropod *Urosalpinx* apparently reduces the percent cover of *Semibalanus*. *Urosalpinx* densities are as high as 200 per square meter at mean low water of neap tides. On horizontal surfaces, *Chthamalus* occupies a wider zone, and *Semibalanus* reaches its abundance peak very low on the shore (Fig. 1). In the region below the *Chthamalus* zone, there was evidence of widespread death of small *Semibalanus* (3 mm to 5 mm basal diameter) on sloping and horizontal surfaces. Settlement of *Semibalanus* occurred throughout the intertidal zone in March, and the newly settled individuals died in mid-summer on much of the shore above mid-tide level. The dead individuals were tightly crowded, indicating that the *Semibalanus* settlement had occupied almost 100% of the space below the *Chthamalus* zone. The most likely cause of death of small individuals on horizontal surfaces is desiccation related to summer high temperatures. There was no evidence of *Chthamalus* death from desiccation.

More evidence of *Semibalanus* death resulting from high temperatures may be seen in the zonation on a surface with a 70° slope which has a slow drip from a deep crevice in the rock surface. Two transects were enumerated within the permanent 0.5 m \times 0.5 m quadrats. The transects were 0.25 m apart. One ran through the area with the water drip, and the parallel transect was dry. In the area with the water drip, the upper shore limit of *Semibalanus* was 25 cm higher than in the adjacent dry transect (Fig. 2). In the dry transect there were tightly crowded small dead *Semibalanus* at the same shore level where individuals survived in the damp location.

The influence of shade is clearly seen in a series of three parallel transects set up close to the laboratory dock. In the partial shade of the dock the *Chthamalus* zone is very narrow. *Semibalanus* occupies most of the space in the mid shore, and *Fucus* occupies all space at mid tide level and below (Fig. 3A). In a parallel transect 0.5 meters away from the dock, there is less shade, the *Chthamalus* zone is wider, and *Semibalanus* occupies a narrower zone, with *Fucus* at mid tide level (Fig. 3B). In a third parallel transect 0.5 meters farther still from the dock, there is little shade, the *Chthamalus* zone is even wider, and the upper shore limit of *Semibalanus* is 0.5 meters lower than it was in full shade (Fig. 3C).

The summer heat death documented here was common on all sloping shores near the Yale Field station, and on the island shores visible en route to Horse Island

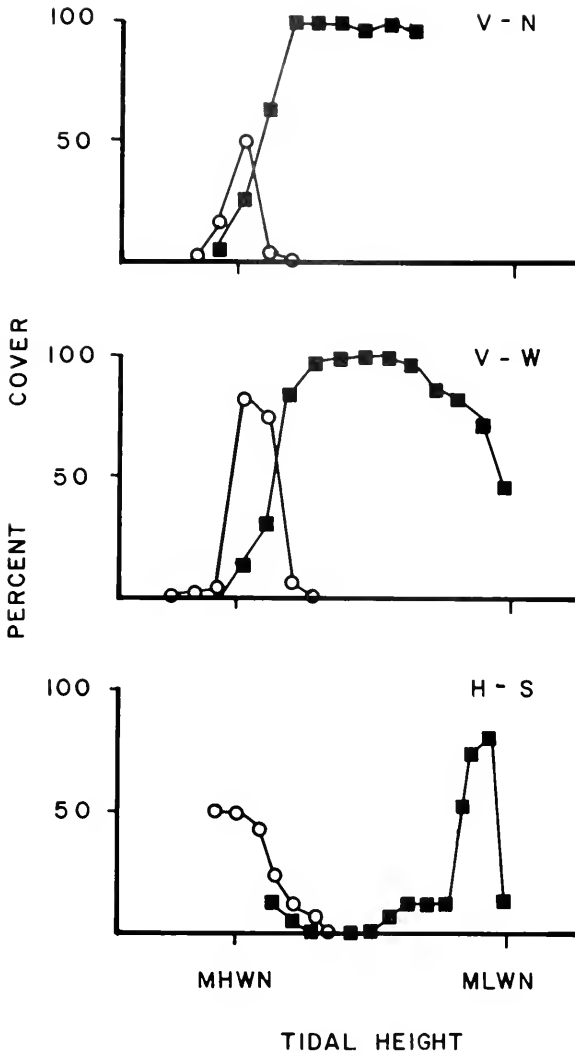

FIGURE 1. Percent cover of *Chthamalus* (open circles) and *Semibalanus* (solid squares) as a function of tidal height on transects at Horse Island, Connecticut. Tide levels are mean high water of neap tides (MHWN) and mean low water of neap tides (MLWN). Top panel is a vertical north facing surface (V-N), center panel is a vertical west facing surface (V-W), bottom panel is a 10 degree slope facing south (H-S).

in Long Island Sound. The total length of shoreline observed exceeded 5 kilometers. This appeared to be a widespread mortality event on the high shore.

In order to test the hypothesis that the lower limit of *Chthamalus* was set by postsettlement mortality associated with the presence of *Semibalanus*, a series of *Semibalanus* removals were set up at all shore levels. Smothered individuals of *Chthamalus* were encountered several times during the process of scraping *Semibalanus* off the rock during establishment of the *Semibalanus* removals. *Chthamalus* subsequently settled in the *Semibalanus* removal areas. The heaviest settlement of

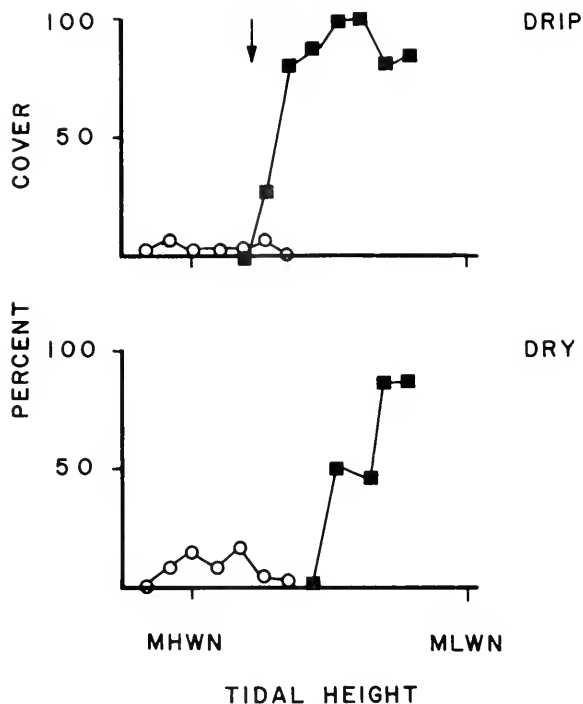

FIGURE 2. Percent cover of *Chthamalus* (open circles) and *Semibalanus* (solid squares) as a function of tidal height on transects at the Yale Field Station in Guilford, Connecticut. Tide levels marked as in Figure 1. The two panels are from parallel transects 25 cm apart. Upper panel transect has water seepage from a deep crevice in the rock surface located at the position of the arrow. Lower panel transect is dry. Note the upward displacement of *Semibalanus* in the damp area below the water seepage.

Chthamalus on vertical surfaces was near mid tide level, in the zone where individuals usually die as a result of overgrowth by *Semibalanus* (Fig. 4). There was very little settlement in the *Chthamalus* zone itself (Fig. 4). On horizontal surfaces, settlement was most intense near mid tide level, in the zone where *Semibalanus* died as a result of summer heat (Fig. 4).

Semibalanus removals were established in August, and settlement of *Chthamalus* occurred prior to the October samples (Fig. 4). These sites were surveyed at the end of April, at the height of the *Semibalanus* settlement season. *Semibalanus* had settled at densities in excess of 50 per square centimeter. In the vertical sites (Figs. 1,4), at all but the highest shore levels, *Chthamalus*, in the *Semibalanus* removal quadrats, were overgrown by newly settled 2-week-old *Semibalanus*. When the nearly 100% cover of newly settled *Semibalanus* was removed with a toothbrush, live *Chthamalus* were found beneath it. Presumably these totally smothered *Chthamalus*, although tolerant of desiccation (Foster, 1971a), would die within a few weeks with no direct access to food, water, or oxygen.

Approximately 5% of the live *Chthamalus* (approximately 5 mm diameter) were being undercut (*sensu* Connell, 1961a), lifted from the substratum, and expelled from the growing surface of *Semibalanus* spat (approximately 1 mm diameter). No crushing of *Chthamalus* by newly settled *Semibalanus* was observed. *Semibalanus* spat were completely occluding the opercular valves of the majority of *Chthamalus* in the zone where the adults of the two species co-occur, yet there was no settlement

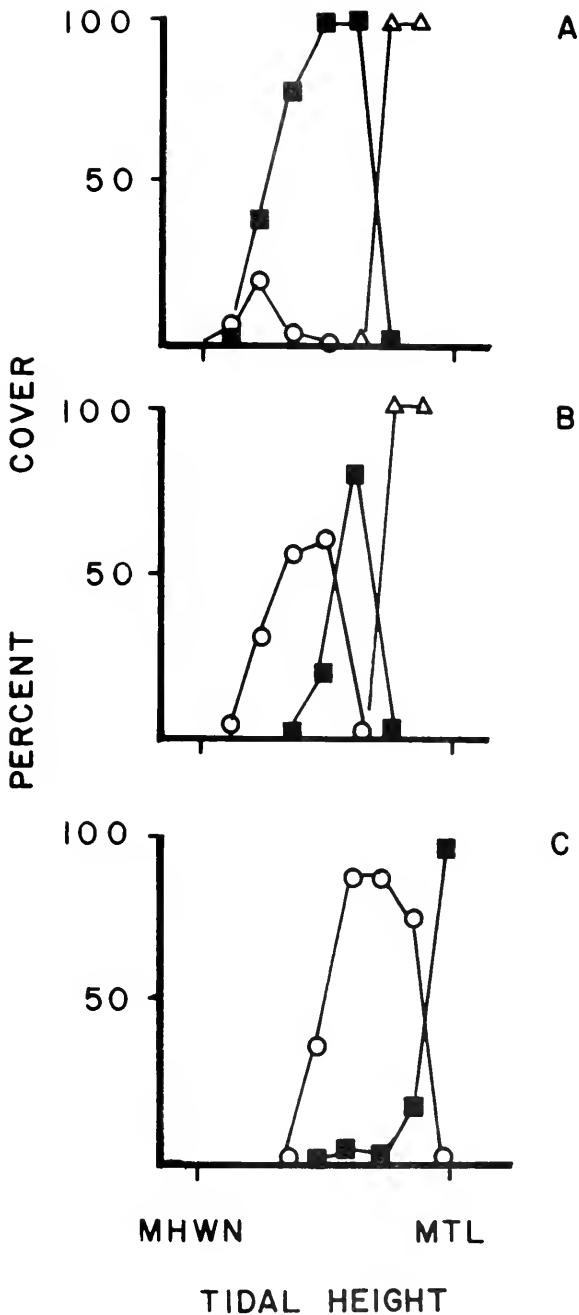

FIGURE 3. Percent cover of *Chthamalus* (open circles) and *Semibalanus* (solid squares) and *Fucus* (open triangles) as a function of tidal height on transects at the Yale Field Station in Guilford, Connecticut. Tide levels are mean high water of neap tides (MHWN) and mean tide level (MTL). The panels are from three parallel transects separated from one another by 0.5 m. Panel A is adjacent to the laboratory dock and is shaded for most of the day. Panel B is 0.5 meters farther from the dock and has more exposure to sun. Panel C is 0.5 meters still farther from the dock and is exposed to sun for more than half of the day. Shore has a 45 degree slope and faces east. Note the downward displacement of the *Semibalanus* upper shore limit as the shore receives more sun.

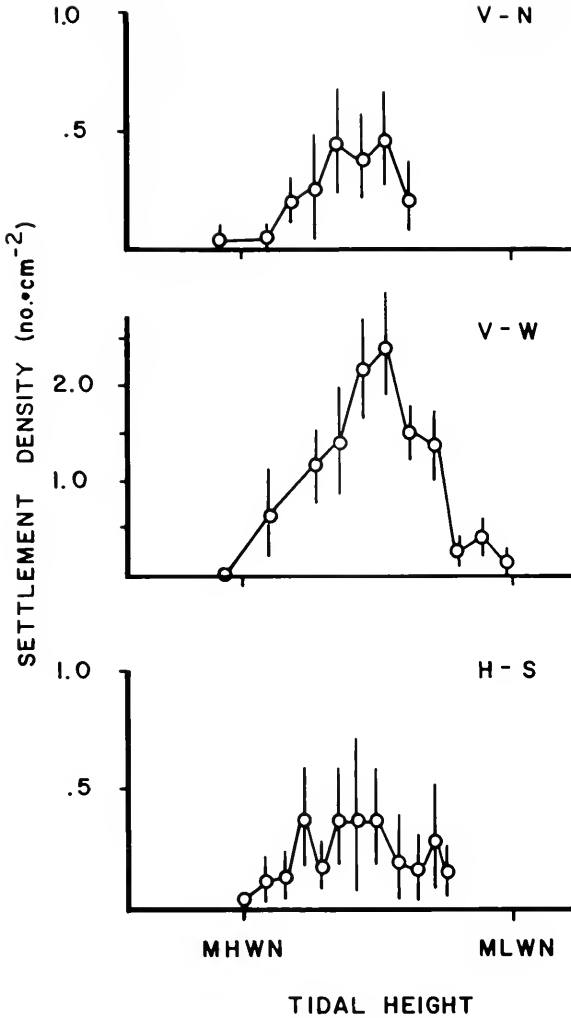

FIGURE 4. Settlement density of *Chthamalus* in numbers per cm² in *Semibalanus* removals. Means and standard deviations from 5 to 10 replicate counts of 4 cm × 4 cm quadrats are reported as a function of tidal height. Symbols and locations are as in Figure 1.

on the opercular valves of adjacent *Semibalanus* individuals. In sites where *Semibalanus* settlement was less intense (shore sites used for Figs. 2 and 3), *Semibalanus* had not yet overgrown *Chthamalus* but were likely to do so by June or July.

These results indicate that *Chthamalus* is capable of settlement and survival for at least 8 months (August through April) at mid-tide level in the absence of *Semibalanus*. Postsettlement mortality as a result of competition with *Semibalanus* is the most likely mechanism causing the restriction of *Chthamalus* to the high shore. Although *Chthamalus* settles most heavily in the mid-shore, it survives only in its refuge from competition high on the shore, where *Semibalanus* is restricted by desiccation. Postsettlement mortality of *Chthamalus* is likely to be very intense in spring when *Semibalanus* settlement occurs, thereby smothering *Chthamalus*.

In the northern site, beyond the northern limit of *Chthamalus*, zonation varies as a function of slope and aspect, but there was no evidence of the widespread heat death that characterized sloping shores in Connecticut. On vertical surfaces, the upper shore limit of *Semibalanus* is higher on north-facing localities than in south-facing shores (Fig. 5). On sloping surfaces *Semibalanus* survives from mean high water of neap tides down to mid-tide level, where it is excluded by competition with the mussel *Mytilus* (Fig. 5). In the seven summers for which I have data on the distribution and abundance of barnacles (1976–1982), *Semibalanus* populations in northern Massachusetts have never suffered summer heat death of the kind documented from the Connecticut shore in 1982 (Wethey, 1979; personal observation).

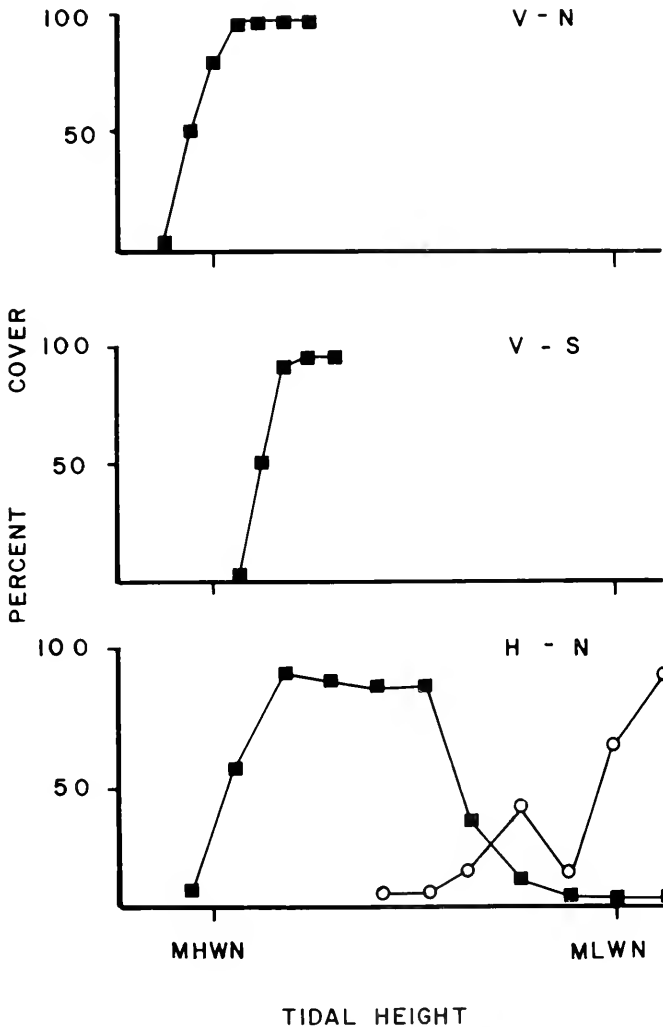

FIGURE 5. Percent cover of *Semibalanus* (solid squares) and *Mytilus* (open circles) as a function of tidal height on transects at Nahant, Massachusetts. Tide levels are as in Figure 1. Top panel is a vertical north facing surface (V-N), center panel is a vertical south facing surface (V-S), bottom panel is a 30 degree slope facing northwest (H-N).

DISCUSSION

This study was set up to determine whether the factors which influence local zonation in the intertidal might also contribute to the establishment of geographic limits. Both physical and biotic factors appear to influence zonation at the northern limit of *Chthamalus* in New England. The upper shore limit of *Semibalanus* is apparently set by desiccation associated with high summer temperatures. In damp or shaded locations, *Semibalanus* occupies the shore up to mean high water of neap tides (Figs. 1–3). In sunny locations the upper shore limit of *Semibalanus* is lower than in shaded locations (Figs. 1–3). On sloping surfaces *Semibalanus* died apparently as a result of desiccation at all shore levels higher than mean tide level (Figs. 1, 2). *Chthamalus* survives in locations where *Semibalanus* fails to persist (Figs. 1–3). Settlement of *Chthamalus* occurs at all shore levels down to mean tide level (Fig. 4), and apparently post-settlement-mortality subsequently limits *Chthamalus* to locations where *Semibalanus* growth is restricted. Warmer, drier sites have wider *Chthamalus* zones because these locations are apparently too hot or dry for *Semibalanus* (Figs. 1–3). These same factors may also be important in setting the northern limit of *Chthamalus*. North of the northern limit of *Chthamalus*, *Semibalanus* does not suffer summer heat death, so it occupies the zone where *Chthamalus* would have a refuge from competition further south (Fig. 5). In the absence of a refuge, any *Chthamalus* larvae that settle on the high shore are likely to be crushed or overgrown by *Semibalanus*. This in turn reduces the pool of adult *Chthamalus* which contribute larvae to the plankton. The reduced number of larvae available for settlement and the reduced settlement success as a result of competition presumably combine to restrict *Chthamalus* from more northern locations. Thus the northern limit of *Chthamalus* is not set by factors which are directly related to cold acting on *Chthamalus*. Rather, the northern limit appears to be set by cold which allows the dominant competitor to exclude *Chthamalus* from its refuge zone. South of the northern limit the competitor, *Semibalanus*, is excluded from the high shore by high summer temperatures. The northern limit of *Chthamalus* is likely to be more strongly influenced by competition between *Semibalanus* and *Chthamalus* than by direct physiological limitation of *Chthamalus* itself.

These results are consistent with those of Connell (1961a), who documented the importance of competition in setting local limits of zonation in *Semibalanus balanoides* and *Chthamalus* near the northern limit of *Chthamalus* in Scotland. *Chthamalus* was successful in the zone where *Semibalanus* suffered mortality from desiccation. *Chthamalus* settled at shore levels below the zone where adults survived. Post-settlement mortality as a result of competition with *Semibalanus* limited *Chthamalus* to the high shore (Connell, 1961a). Barnes (1956) maintained *Chthamalus* (on stones from Connell's 1961a experiments) under conditions of total submersion on a raft for two years. He found that the growth rate under these conditions was equivalent to that of individuals in the intertidal zone. He reported that post-settlement mortality of *Chthamalus* as a result of space competition with *Semibalanus* restricted it from the low shore: on the raft "a 6-month-old *Chthamalus* settlement (2 mm long) was obliterated in a few weeks by a moderate spat fall of [*Semi*] *Balanus* and full grown *Chthamalus* (9–15 mm) were completely overgrown in 2 months."

All of these results are consistent with the hypothesis that competition with *Semibalanus* is a major determinant of local distribution and abundance of *Chthamalus*. The restriction of *Semibalanus* to shaded habitats in more southern locations has been reported by Barnes (1958) for Woods Hole, where summer heat apparently

killed off 95% of 5 mm basal diameter individuals on south-facing and horizontal surfaces in 1956. On north-facing surfaces mortality was only 50% in the same period (Barnes, 1958). These individuals were about the same size as those found dead in the present study (3 mm basal diameter). Several authors (Southward and Crisp, 1956; Lewis, 1957, 1964; Crisp and Southward, 1958; Bowman, 1983) have reported effects of shore slope and aspect similar to those described here. Near its northern limit in Scotland, *Chthamalus* is more common on south-facing vertical surfaces which dry out at low tide, while *Semibalanus* dominates at the same tide levels in more horizontal locations which remain wet. The most favorable location for *Semibalanus* in southwest England is under rocks and overhangs (Southward and Crisp, 1954). *Semibalanus* in southwest England is almost completely absent from the south facing coast, is rare on the west-facing portion, and is abundant on the north-facing section (Crisp and Southward, 1958). On the north Cornwall coast, *Semibalanus* becomes rare along the eastern section where more of the coast faces west (Crisp and Southward, 1958). Summer heat death of *Semibalanus* in 1976 in northern Scotland resulted in a lowering of the lower limit of *Chthamalus* on those shores (Bowman, 1983). These distribution patterns are consistent with the hypothesis that *Semibalanus* is limited by desiccation and high temperatures on the high shore and in the more southern localities. Direct tests of the temperature tolerances of *Semibalanus* and *Chthamalus* indicate that the latter species is far more tolerant of desiccation and high temperatures, and that the larval stages and newly metamorphosed spat are more susceptible than are adults (Southward, 1958; Crisp and Ritz, 1967; Foster, 1969, 1971a, b).

Southward and Crisp (1956) hypothesized that year to year fluctuations in temperature influenced the relative abundance of *Semibalanus* and *Chthamalus* by changing the intensity of competition between the species. Many details of the geographic distribution of *Semibalanus* and *Chthamalus* were recorded in the 1930's (Moore, 1936; Moore and Kitching, 1939), and these distributions have been studied at the same localities by Southward and Crisp. After a number of warm years *Chthamalus* increased in abundance, and after a number of cold years *Semibalanus* increased (Southward and Crisp, 1956; Southward, 1967; Crisp *et al.*, 1981). They argued that the mechanism might be related to competition for food (Southward and Crisp, 1956, p. 220). Lewis (1964, pp. 251–252) hypothesized that the principal effect of temperature was mediated through competition for space with *Semibalanus*.

The evidence for cold limitation of *Chthamalus* is far less strong than that of heat limitation of *Semibalanus*. Crisp (1950) transplanted *Chthamalus* beyond its northern limit to Whitley Bay in Northumberland on the North Sea coast of England. The individuals survived two winters and produced viable larvae. In the extremely cold winter of 1962–1963, there was no increased mortality of *Chthamalus* in North Wales or in the south or southwest coasts of England (Crisp, 1964). Mortality was higher than usual in south Wales in Mumbles Pier, where there was 25% mortality on horizontal surfaces (Crisp, 1964). During this particular winter a number of species including the commercial oyster and the New Zealand barnacle *Elminius modestus*, suffered extremely high mortality as a result of cold (Crisp, 1964). Southward (1967) stated that the decreases in *Chthamalus* during 1963 were more strongly influenced by the previous cool summer than by the exceptionally cold winter. He suggested that very cold winters were not a major factor controlling the distribution of *Semibalanus* and *Chthamalus* (Southward, 1967). At the northern limit of its geographic distribution, *Chthamalus* is found at the highest shore levels, where the effect of cold air temperatures would be the most severe in winter. If it were not tolerant of cold, *Chthamalus* ought to die in winter at its northern limit,

but it does not appear to do so (e.g., Crisp and Southward, 1958; Lewis, 1964, pp. 251–252). All of these data indicate that direct limitation of the geographic distribution of *Chthamalus* by cold is unlikely.

The northern limit of *Chthamalus* in New England appears to be influenced by temperature as mediated through competition with *Semibalanus*. Post-settlement mortality of *Chthamalus* within the *Semibalanus* zone apparently excludes it from living low on the shore. *Chthamalus* survives in southern New England in the zone where *Semibalanus* dies from desiccation and/or heat stress (Figs. 1–3). The northern limit of *Chthamalus* occurs where *Semibalanus* no longer dies from desiccation on the high shore (Fig. 5). The absence of adult *Chthamalus* in northern New England is also likely to contribute to a reduced pool of larvae available for settlement, because reproductive populations exist only south of Cape Cod. Failure of larval or juvenile stages has been suggested as setting the northern limit of *Chthamalus* in Scotland (Lewis *et al.*, 1982). In northern Scotland, recruitment declines regularly towards the geographic limit of *Chthamalus* (Lewis *et al.*, 1982; Bowman, 1983). It is likely that this comes about partly because of the progressive restriction of *Chthamalus* by competition with *Semibalanus* to narrower and narrower zones at the highest levels on the shore.

ACKNOWLEDGMENTS

This work was supported by grants from the National Science Foundation (OCE 8208176, OCE 7726503) and a grant from the Research and Productive Scholarship Fund of the University of South Carolina. M. P. Morse, N. W. Riser, R. B. Shepard, and H. Werntz allowed access to the Massachusetts site at the Northeastern University Marine Science Institute at Nahant, and provided laboratory space. M. P. Morse provided housing and transportation. L. W. Buss allowed access to the Connecticut sites at the Yale University Peabody Museum Field Station and Horse Island and provided lab space, housing, and transportation. L. Haas took the photographs at Nahant and M. W. Reed took the photographs at Guilford Connecticut. S. A. Woodin, J. P. Sutherland, and S. Ortega provided field assistance during establishment of the permanent sites. J. R. Lewis sparked my interest in geographic limits while I was at his laboratory as a National Needs Postdoctoral Fellow (NSF Grant SPI-7914910). S. A. Woodin and an anonymous reviewer provided many helpful comments.

LITERATURE CITED

- BARNES, H. 1956. The growth rate of *Chthamalus stellatus* (Poli) *J. Mar. Biol. Assoc. U.K.* **35**: 355–361.
- BARNES, H. 1958. Regarding the southern limits of *Balanus balanoides* (L.). *Oikos* **9**: 139–157.
- BOWMAN, R. S. 1983. The role of stochastic events in *Balanus/Chthamalus* interactions on Scottish shores. ms.
- COLMAN, J. S. 1933. The nature of intertidal zonation of plants and animals. *J. Mar. Biol. Assoc. U.K.* **18**: 435–476.
- CONNELL, J. H. 1961a. The influence of interspecific competition and other factors on the distribution of the barnacle *Chthamalus stellatus*. *Ecology* **42**: 710–723.
- CONNELL, J. H. 1961b. The effects of competition, predation by *Thais lapillus*, and other factors on natural populations of the barnacle *Balanus balanoides*. *Ecol. Monogr.* **31**: 61–104.
- CONNELL, J. H. 1972. Community interactions on marine rocky intertidal shores. *Ann. Rev. Ecol. Syst.* **3**: 169–192.
- CRISP, D. J. 1950. Breeding and distribution of *Chthamalus stellatus*. *Nature* **166**: 311–312.
- CRISP, D. J., ed. 1964. The effects of the severe winter of 1962–63 on marine life in Britain. *J. Anim. Ecol.* **33**: 165–210.
- CRISP, D. J., A. J. SOUTHWARD, AND E. C. SOUTHWARD. 1981. On the distribution of the intertidal barnacles *Chthamalus stellatus*, *Chthamalus montanqui* and *Euraphia depressa*. *J. Mar. Biol. Assoc. U. K.* **61**: 359–380.

- CRISP, D. J., AND A. J. SOUTHWARD 1958. The distribution of intertidal organisms along the coasts of the English Channel. *J. Mar. Biol. Assoc. U. K.* **37**: 157-208.
- CRISP, D. J., AND D. A. RITZ 1967. Changes in the temperature tolerance of *Balanus balanoides* during its life cycle. *Helgol. Wiss. Meeresunters.* **15**: 98-115.
- DANDO, P. R., AND A. J. SOUTHWARD. 1980. A new species of *Chthamalus* (Crustacea Cirripedia) characterized by enzyme electrophoresis and shell morphology; with a revision of the other species of *Chthamalus* from the western shores of the Atlantic Ocean. *J. Mar. Biol. Assoc. U. K.* **60**: 787-831.
- DOTY, M. S. 1946. Critical tide factors that are correlated with the vertical distribution of marine algae and other organisms along the Pacific coast. *Ecology* **27**: 315-328.
- FOSTER, B. A. 1969. Tolerance of high temperature by some intertidal barnacles. *Mar. Biol.* **4**: 326-332.
- FOSTER, B. A. 1971a. Desiccation as a factor in the intertidal zonation of barnacles. *Mar. Biol.* **8**: 12-29.
- FOSTER, B. A. 1971b. On the determinants of the upper limit of intertidal distribution of barnacles (Crustacea: Cirripedia). *J. Anim. Ecol.* **40**: 33-48.
- HATTON, H. 1938. Essais de bionomie explicative sur quelques especes intercotidales d'algues et d'animaux. *Ann. Inst. Oceanogr.* **17**: 241-348.
- HEWATT, W. B. 1937. Ecological studies on selected marine intertidal communities of Monterey Bay, California. *Am. Midl. Nat.* **18**: 161-206.
- HUTCHINS, L. W. 1947. The bases for temperature zonation in geographical distribution. *Ecol. Monogr.* **17**: 325-335.
- LEWIS, J. R. 1957. Intertidal communities of the northern and western coasts of Scotland. *Trans. R. Soc. Edinb.* **63**: 185-220.
- LEWIS, J. R. 1964. *The Ecology of Rocky Shores*. Hodder & Stoughton, London.
- LEWIS, J. R. 1977. The role of physical and biological factors in the distribution and stability of rocky shore communities. Pp. 417-424 in *Biology of Benthic Organisms*, B. F. Keegan, P. O'Ceidigh, and P. J. S. Boaden, eds. Pergamon, Oxford.
- LEWIS, J. R., R. S. BOWMAN, M. A. KENDALL, AND P. WILLIAMSON, 1982. Latitudinal variations in population dynamics: possibilities and realities in some littoral species. *Neth. J. Sea Res.* **16**: 18-28.
- LUBCHENCO, J. 1980. Algal zonation in the New England rocky intertidal community: an experimental analysis. *Ecology* **61**: 333-344.
- LUBCHENCO, J., AND B. A. MENGE. 1978. Community development and persistence in a low rocky intertidal zone. *Ecol. Monogr.* **59**: 67-94.
- MENGE, B. A. 1976. Organization of the New England rocky intertidal community: role of predation, competition and environmental heterogeneity. *Ecol. Monogr.* **46**: 355-393.
- MOORE, H. B. 1936. The biology of *Balanus balanoides*. V. Distribution in the Plymouth area. *J. Mar. Biol. Assoc. U. K.* **20**: 701-716.
- MOORE, H. B., AND J. A. KITCHING. 1939. The biology of *Chthamalus stellatus* (Poli). *J. Mar. Biol. Assoc. U. K.* **23**: 521-541.
- NATIONAL OCEANIC AND ATMOSPHERIC AGENCY. 1982. *Tide Tables, East Coast of North and South America including Greenland*. U. S. Government Printing Office, Washington.
- NEWMAN, W. A., AND A. ROSS. 1976. Revision of the Balanomorph Barnacles; including a catalog of the species. *San Diego Soc. Nat. Hist. Mem.* **9**: 1-108.
- PAINE, R. T. 1974. Intertidal community structure: experimental studies on the relationship between a dominant competitor and its principal predator. *Oecologia* **15**: 93-120.
- SCHONBECK, M., AND T. A. NORTON. 1978. Factors controlling the upper limits of Fucoid algae on the shore. *J. Exp. Mar. Biol. Ecol.* **31**: 303-313.
- SOUTHWARD, A. J. 1958. Note on the temperature tolerance of some intertidal animals in relation to environmental temperature and geographic distribution. *J. Mar. Biol. Assoc. U. K.* **37**: 49-66.
- SOUTHWARD, A. J. 1967. Recent changes in the abundance of intertidal barnacles in south west England: a possible effect of climatic deterioration. *J. Mar. Biol. Assoc. U. K.* **47**: 81-95.
- SOUTHWARD, A. J., AND D. J. CRISP, 1954. Recent changes in the distribution of the intertidal barnacles *Chthamalus stellatus* Poli and *Balanus balanoides* L. in the British Isles. *J. Anim. Ecol.* **23**: 163-177.
- SOUTHWARD, A. J., AND D. J. CRISP 1956. Fluctuations in the distribution and abundance of intertidal barnacles. *J. Mar. Biol. Assoc. U. K.* **35**: 211-229.
- VERNBERG, F. J., AND R. E. TASHIAN. 1959. Studies on the physiological variation between tropical and temperate zone fiddler crabs of the genus *Uca*. I. Thermal death limits. *Ecology* **40**: 589-593.
- VERNBERG, F. J., AND W. B. VERNBERG. 1967. Thermal limits of southern hemisphere *Uca* crabs. Studies on the physiological variation between tropical and temperate zone fiddler crabs of the genus *Uca*. IX. *Oikos* **18**: 118-123.
- WETHEY, D. S. 1979. Demographic variation in intertidal barnacles. Ph.D. Dissertation, University of Michigan (University Microfilms No. 80-07857).



Continued from Cover Two

secutive Arabic numbers, on a separate sheet at the end of the paper. Footnotes should be limited to authors' current addresses, acknowledgments or contribution numbers, and explanation of unusual abbreviations. All such footnotes should appear on the title page. Footnotes are not normally permitted in the body of the text.

4. **A condensed title** or running head of no more than 35 letters and spaces should appear at the top of the title page.

5. **Literature cited.** In the text, literature should be cited by the Harvard system, with papers by more than two authors cited as Jones *et al.*, 1980. Personal communications and material in preparation or in press should be cited in the text only, with author's initials and institutions, unless the material has been formally accepted and a volume number can be supplied. The list of references following the text should be headed LITERATURE CITED, and must be typed double spaced on separate pages, conforming in punctuation and arrangement to the style of recent issues of *The Biological Bulletin*. Citations should include complete titles and inclusive pagination. Journal abbreviations should normally follow those of the U. S. A. Standards Institute (USASI), as adopted by BIOLOGICAL ABSTRACTS and CHEMICAL ABSTRACTS, with the minor differences set out below. The most generally useful list of biological journal titles is that published each year by BIOLOGICAL ABSTRACTS (BIOSIS List of Serials; the most recent issue). Foreign authors, and others who are accustomed to using THE WORLD LIST OF SCIENTIFIC PERIODICALS, may find a booklet published by the Biological Council of the U.K. (obtainable from the Institute of Biology, 41 Queen's Gate, London, S.W.7, England, U.K.) useful, since it sets out the WORLD LIST abbreviations for most biological journals with notes of the USASI abbreviations where these differ. CHEMICAL ABSTRACTS publishes quarterly supplements of additional abbreviations. The following points of reference style for THE BIOLOGICAL BULLETIN differ from USASI (or modified WORLD LIST) usage:

- A. Journal abbreviations, and book titles, all underlined (for *italics*)
- B. All components of abbreviations with initial capitals (not as European usage in WORLD LIST e.g. *J. Cell. Comp. Physiol.* NOT *J. cell. comp. Physiol.*)
- C. All abbreviated components must be followed by a period, whole word components *must not* (i.e. *J. Cancer Res.*)
- D. Space between all components (e.g. *J. Cell. Comp. Physiol.*, not *J.Cell.Comp.Physiol.*)
- E. Unusual words in journal titles should be spelled out in full, rather than employing new abbreviations invented by the author. For example, use *Rit Visindafjélags Islendinga* without abbreviation.
- F. All single word journal titles in full (e.g. *Veliger, Ecology, Brain*).
- G. The order of abbreviated components should be the same as the word order of the complete title (i.e. *Proc. and Trans.* placed where they appear, not transposed as in some BIOLOGICAL ABSTRACTS listings).
- H. A few well-known international journals in their preferred forms rather than WORLD LIST or USASI usage (e.g. *Nature, Science, Evolution* NOT *Nature, Lond., Science, N.Y.; Evolution, Lancaster, Pa.*)

6. **Reprints, charges.** *The Biological Bulletin* has no page charges. However, authors will be requested to help pay printing charges of manuscripts that are unusually costly due to length or numbers of tables, figures, or formulae. Reprints may be ordered at time of publication and normally will be delivered about two to three months after the issue date. Authors (or delegates or foreign authors) will receive page proofs of articles shortly before publication. They will be charged the current cost of printers' time for corrections to these (other than corrections of printers' or editors' errors).

CONTENTS

ANNUAL REPORT OF THE MARINE BIOLOGICAL LABORATORY	1
AGUDELO, MARIA I., KENNETH KUSTIN, GUY C. MCLEOD, WILLIAM E. ROBINSON, AND ROBERT T. WANG Iron accumulation in tunicate blood cells. I. Distribution and oxidation state of iron in the blood of <i>Boltenia ovifera</i> , <i>Styela clava</i> , and <i>Molgula manhattensis</i>	100
ANDERSON, WINSTON A., AND WILLIAM R. ECKBERG A cytological analysis of fertilization in <i>Chaetopterus pergamentaceus</i>	110
BICKELL, LOUISE R., AND STEPHEN C. KEMPF Larval and metamorphic morphogenesis in the nudibranch <i>Melibe leonina</i> (Mollusca: Opisthobranchia)	119
CRONIN, THOMAS W., AND RICHARD B. FORWARD, JR. Vertical migration rhythms of newly hatched larvae of the estuarine crab, <i>Rhithropanopeus harrisi</i>	139
FORWARD, RICHARD B., JR., AND KENNETH J. LOHMANN Control of egg hatching in the crab <i>Rhithropanopeus harrisi</i> (Gould)	154
HAND, STEVEN C., AND GEORGE N. SOMERO Energy metabolism pathways of hydrothermal vent animals: adaptations to a food-rich and sulfide-rich deep-sea environment	167
HILLER-ADAMS, PAGE, AND JAMES J. CHILDRESS Effects of feeding, feeding history, and food deprivation on respiration and excretion rates of the bathypelagic mysid <i>Gnathopausia ingens</i>	182
INCZE, LEWIS S., AND A. J. PAUL Grazing and predation as related to energy needs of stage I zoeae of the tanner crab <i>Chionoecetes bairdi</i> (Brachyura, Majidae)	197
MACKIE, G. O., AND C. L. SINGLA Coordination of compound ascidians by epithelial conduction in the colonial blood vessels	209
OLSON, RICHARD RANDOLPH Ascidian- <i>Prochloron</i> symbiosis: the role of larval photoadaptations in midday larval release and settlement	221
READ, LAURIE K., LYNN MARGULIS, JOHN STOLZ, ROBERT OBAR, AND THOMAS K. SAWYER A new strain of <i>Paratetramitus jugosus</i> from Laguna Figueroa, Baja California, Mexico	241
REED-MILLER, CHARLENE The initial calcification process in shell-regenerating <i>Tegula</i> (Archaeogastropoda)	265
RUTOWSKI, RONALD L. Mating and egg mass production in the aeolid nudibranch <i>Hermisenda crassicornis</i> (Gastropoda: Opisthobranchia)	276
SEBENS, KENNETH P. Settlement and metamorphosis of a temperate soft-coral larva (<i>Alicyonium siderium</i> Verrill): induction by crustose algae	286
SLOBODKIN, L. B., AND KENNETH DUNN On the evolutionary constraint surface of hydra	305
SOUMOFF, CYNTHIA, AND DOROTHY M. SKINNER Ecdysteroid titers during the molt cycle of the blue crab resemble those of other Crustacea	321
WETHEY, DAVID S. Geographic limits and local zonation: the barnacles <i>Semibalanus (Balanus)</i> and <i>Chthamalus</i> in New England	330

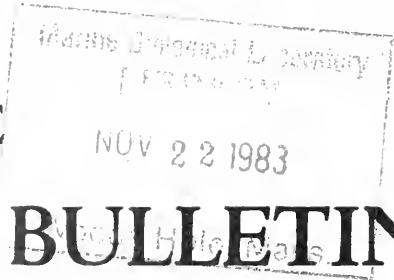

THE BIOLOGICAL BULLETIN

PUBLISHED BY
THE MARINE BIOLOGICAL LABORATORY

Editorial Board

DANIEL L. ALKON, National Institutes of Health and
Marine Biological Laboratory

MICHAEL G. O'RAND, Laboratories for Cell Biology,
University of North Carolina at Chapel Hill

ROBERT B. BARLOW, JR., Syracuse University

RALPH S. QUATRANO, Oregon State University at
Corvallis

WALLIS H. CLARK, JR., University of California at
Davis

LIONEL I. REBHUN, University of Virginia

DAVID H. EVANS, University of Florida

JOEL L. ROSENBAUM, Yale University

HARLYN O. HALVORSON, Brandeis University

DOROTHY M. SKINNER, Oak Ridge National
Laboratory

RONALD R. HOY, Cornell University

JOHN D. STRANDBERG, Johns Hopkins University

SAMUEL S. KOIDE, The Population Council,
Rockefeller University

JOHN M. TEAL, Woods Hole Oceanographic
Institution

FRANK J. LONGO, University of Iowa

J. RICHARD WHITTAKER, Boston University
Marine Program and Marine Biological Laboratory

CHARLOTTE P. MANGUM, The College of
William and Mary

GEORGE M. WOODWELL, Ecosystems Center, Marine
Biological Laboratory

Editor: CHARLES B. METZ, University of Miami

OCTOBER, 1983

Printed and Issued by
LANCASTER PRESS, Inc.
PRINCE & LEMON STS.
LANCASTER, PA.

THE BIOLOGICAL BULLETIN

THE BIOLOGICAL BULLETIN is published six times a year by the Marine Biological Laboratory, MBL Street, Woods Hole, Massachusetts 02543.

Subscriptions and similar matter should be addressed to THE BIOLOGICAL BULLETIN, Marine Biological Laboratory, Woods Hole, Massachusetts. Single numbers, \$10.00. Subscription per volume (three issues), \$27.00 (this is \$54.00 per year for six issues).

Communications relative to manuscripts should be sent to Dr. Charles B. Metz, Editor, or Pamela Clapp, Assistant Editor, at the Marine Biological Laboratory, Woods Hole, Massachusetts 02543 between May 1 and October 1, and at the Institute For Molecular and Cellular Evolution, University of Miami, 521 Anastasia, Coral Gables, Florida 33134 during the remainder of the year.

Copyright © 1983, by the Marine Biological Laboratory

Second-class postage paid at Woods Hole, Mass., and additional mailing offices.
ISSN 0006-3185

INSTRUCTIONS TO AUTHORS

The Biological Bulletin accepts outstanding original research reports of general interest to biologists throughout the world. Papers are usually of intermediate length (10–40 manuscript pages). Very short papers (less than 10 manuscript pages including tables, figures, and bibliography) will be published in a separate section entitled "Short Reports." A limited number of solicited review papers may be accepted after formal review. A paper will usually appear within four months after its acceptance.

The Editorial Board requests that manuscripts conform to the requirements set below; those manuscripts which do not conform will be returned to authors for correction before review.

1. **Manuscripts.** Manuscripts, including figures, should be submitted in triplicate. (Xerox copies of photographs are not acceptable for review purposes.) The original manuscript must be typed in double spacing (including figure legends, footnotes, bibliography, etc.) on one side of 16- or 20-lb. bond paper, 8½ by 11 inches. Manuscripts should be proofread carefully and errors corrected legibly in black ink. Pages should be numbered consecutively. Margins on all sides should be at least 1 inch (2.5 cm). Manuscripts should conform to the *Council of Biology Editors Style Manual*, 4th Edition (Council of Biology Editors, 1978) and to American spelling. Unusual abbreviations should be kept to a minimum and should be spelled out on first reference as well as defined in a footnote on the title page. Manuscripts should be divided into the following components: Title page, Abstract (of no more than 200 words), Introduction, Materials and Methods, Results, Discussion, Acknowledgments, Literature Cited, Tables, and Figure Legends. In addition, authors should supply a list of words and phrases under which the article should be indexed.

2. **Figures.** Figures should be no larger than 8½ by 11 inches. The dimensions of the printed page, 5 by 7¾ inches, should be kept in mind in preparing figures for publication. We recommend that figures be about 1½ times the linear dimensions of the final printing desired, and that the ratio of the largest to the smallest letter or number and of the thickest to the thinnest line not exceed 1:1.5. Explanatory matter generally should be included in legends, although axes should always be identified on the illustration itself. Figures should be prepared for reproduction as either line cuts or halftones. Figures to be reproduced as line cuts should be unmounted glossy photographic reproductions or drawn in black ink on white paper, good-quality tracing cloth or plastic, or blue-lined coordinate paper. Those to be reproduced as halftones should be mounted on board, with both designating numbers or letters and scale bars affixed directly to the figures. All figures should be numbered in consecutive order, with no distinction between text and plate figures. The author's name and an arrow indicating orientation should appear on the reverse side of all figures.

3. **Tables, footnotes, figure legends, etc.** Authors should follow the style in a recent issue of *The Biological Bulletin* in preparing table headings, figure legends, and the like. Because of the high cost of setting tabular material in type, authors are asked to limit such material as much as possible. Tables, with their headings and footnotes, should be typed on separate sheets, numbered with consecutive Roman numerals, and placed after the Literature Cited. Figure legends should contain enough information to make the figure intelligible separate from the text. Legends should be typed double spaced, with con-

Continued on Cover Three

THE BIOLOGICAL BULLETIN

PUBLISHED BY
THE MARINE BIOLOGICAL LABORATORY

Editorial Board

- | | |
|--|--|
| DANIEL L. ALKON, National Institutes of Health and
Marine Biological Laboratory | MICHAEL G. O'RAND, Laboratories for Cell Biology,
University of North Carolina at Chapel Hill |
| ROBERT B. BARLOW, JR., Syracuse University | RALPH S. QUATRANO, Oregon State University at
Corvallis |
| WALLIS H. CLARK, JR., University of California at
Davis | LIONEL I. REBHUN, University of Virginia |
| DAVID H. EVANS, University of Florida | JOEL L. ROSENBAUM, Yale University |
| HARLYN O. HALVORSON, Brandeis University | DOROTHY M. SKINNER, Oak Ridge National
Laboratory |
| RONALD R. HOY, Cornell University | JOHN D. STRANDBERG, Johns Hopkins University |
| SAMUEL S. KOIDE, The Population Council,
Rockefeller University | JOHN M. TEAL, Woods Hole Oceanographic
Institution |
| FRANK J. LONGO, University of Iowa | J. RICHARD WHITTAKER, Boston University
Marine Program and Marine Biological Laboratory |
| CHARLOTTE P. MANGUM, The College of
William and Mary | GEORGE M. WOODWELL, Ecosystems Center, Marine
Biological Laboratory |

Editor: CHARLES B. METZ, University of Miami

OCTOBER, 1983

Printed and Issued by
LANCASTER PRESS, Inc.

PRINCE & LEMON STS.
LANCASTER, PA.

The **BIOLOGICAL BULLETIN** is issued six times a year at the Lancaster Press, Inc., Prince and Lemon Streets, Lancaster, Pennsylvania.

Subscriptions and similar matter should be addressed to The Biological Bulletin, Marine Biological Laboratory, Woods Hole, Massachusetts. Single numbers, \$10.00. Subscription per volume (three issues), \$27.00 (\$54.00 per year for six issues).

Communications relative to manuscripts should be sent to Dr. Charles B. Metz, Marine Biological Laboratory, Woods Hole, Massachusetts 02543 between May 1 and October 1, and to Dr. Charles B. Metz, Institute For Molecular and Cellular Evolution, University of Miami, 521 Anastasia, Coral Gables, Florida 33134 during the remainder of the year.

THE **BIOLOGICAL BULLETIN** (ISSN 0006-3185)

Second-class-postage paid at Woods Hole, Mass., and additional mailing offices.

LANCASTER PRESS, INC., LANCASTER, PA.

ERRATA

The Biological Bulletin, Volume 165, Number 1, Page 2.

The following correction should be made in the Marine Biological Laboratory's Eighty-fifth Report, for the Year 1982, Ninety-fifth Year:

Joel P. Davis, Seapuit, Inc. should be added to the Class of 1984—Trustees.

The Biological Bulletin, Volume 165, Number 1, Page 203.

The following corrections should be made in the paper by L. S. Incze and A. J. Paul entitled, Grazing and predation as related to energy needs of stage I zoeae of the tanner crab, *Chionocetes bairdi* (1983, *Biol. Bull.*, 165: 197–208):

The exponent -2 was deleted from two equations in Table III. The table should appear as follows:

TABLE III

Ingestion rate (I) of 24 hour old zoeae grazing on phytoplankton (Gonyaulax grindleyi, Coscinodiscus spp., Thalassiosira spp.) at various cell concentrations ($\langle C \rangle$) at 5°C, and percent contribution to respiratory requirement (%R)

Cell type	Carbon ($\mu\text{g cell}^{-1}$)	$\langle C \rangle$ (cells l^{-1})	I ($\text{zoea}^{-1} \text{d}^{-1}$)		%R ¹
			No. cells	$\mu\text{g C}$	
<i>G. grindleyi</i>	2.9×10^{-3}	7.3×10^3	4.3	1.2×10^{-2}	1.4
		3.1×10^4	19.0	5.0×10^{-2}	5.8
		6.5×10^4	33.6	9.7×10^{-2}	11.3
		1.2×10^5	39.9	1.2×10^{-1}	14.0
<i>Coscinodiscus</i> spp.	2.66×10^{-2}	7.8×10^2	2.6	6.8×10^{-2}	7.9
		8.40×10^2	2.9	7.6×10^{-2}	8.9
		8.80×10^2	2.7	7.0×10^{-2}	8.2
		9.40×10^2	2.4	6.3×10^{-2}	7.4
		9.83×10^2	2.3	6.0×10^{-2}	7.0
		9.83×10^2	2.3	6.0×10^{-2}	7.0
		1.68×10^3	2.2	5.7×10^{-2}	6.6
		1.68×10^3	2.5	6.6×10^{-2}	7.7
<i>Thalassiosira</i> spp.	2.30×10^{-2}	6.26×10^2	1.5	3.6×10^{-2}	4.2
		1.66×10^3	2.7	6.4×10^{-2}	7.5

¹ Calculation is based on a mean respiratory requirement of $0.6 \mu\text{g C zoea}^{-1} \text{d}^{-1}$ (from Table II), an RQ of 0.9 and an assimilation efficiency of 0.70.

GROWTH AND REGENERATION RATES IN THINLY ENCRUSTING DEMOSPONGIAE FROM TEMPERATE WATERS

AVRIL L. AYLING¹

Marine Laboratory, University of Auckland, Leigh, New Zealand

ABSTRACT

Thinly encrusting species of subtidal sponge grow at slow but measurable rates over natural surfaces by lateral spreading. Of the eleven species studied here, *Aplysilla rosea* had the highest undisturbed rate of growth and *Microciona* sp. the lowest with an overall negative change in size. Using the mean growth rate it can be estimated that the largest sponge patches observed in the field may be over seventy years old. Growth rates of individual patches were varied but this variation was not synchronous within a species nor did it show any regular temporal pattern. Similarly, no relation between the normal thickness of the species, the wet weight, or true organic content of the species with undisturbed rates of growth could be found. However, the mean patch size of the species was correlated with the undisturbed growth rates. If the tissues of the sponges were damaged, rapid regeneration was initiated at rates many times greater than the undisturbed growth rate of the species. It was also found that even very small sponge patches could recover after almost all living tissue was scraped from the rock.

INTRODUCTION

Almost no data exists on the rates of growth and regeneration, or estimates of the age of, thinly encrusting species of marine sponge. Similarly, little information is available for other invertebrate groups with a sheet-like growth form such as compound ascidians, crustose bryozoans and corals (Jackson, 1979). It is thought that growth in these types of sessile organisms is indeterminant, the colony increasing exponentially in size with time (Jackson, 1977). From studies of sponge explant outgrowths it has been shown that the tissue initially spread out is undifferentiated and only slowly thickens and develops functional units (Simpson, 1963). The rate of growth in subtidal thinly encrusting sponges is apparently slow. Bryan (1973) studying a tropical species of *Terpios* over several weeks found that it could grow over unoccupied space at a rate of 0–0.02 mm²/cm border/day but this rate increased to 0.08–0.10 mm²/cm border/day when the sponge grew over living coral. In a temperate water community A. M. Ayling (1981) found over a month's study period that *Stylopus* sp. grew at an undisturbed mean rate of increase of 0.02 mm²/cm border/day.

The growth of intertidal sponges (usually of thickly encrusting habit) has been studied in a little more detail. Although these species are not directly relatable to the subtidal thinly encrusting forms because of their seasonal life history modifications (see Fell, 1976), some of the features of their actual growth are pertinent. Fell and Lewandrowski (1981) found that the smallest and largest sponge patches of *Halichondria* sp. grew the most slowly. Patches of these sponges could also merge

Received 20 December 1982; accepted 1 July 1983.

¹ Present address: P.M.B. 1, Daintree, Queensland 4873, Australia.

and disintegrate (Elvin, 1976; Johnson, 1978; Fell and Lewandrowski, 1981), a feature also observed in corals (Hughes and Jackson, 1980). The rates of such fission and fusion processes may have an important bearing on estimates of age in these organisms.

A. M. Ayling (1981) found that when the thinly encrusting sponge *Stylopus* sp. was damaged in an experiment simulating the effects of urchin grazing, the sponge tissues regained lost space at a rate 200 times the normal growth rate of the species. This regeneration rate refers to the formation of a thin layer of tissue over the lost space, not to the production of the normal thickness of the species. The large difference between growth and regeneration rates may help explain the abundance of thinly encrusting forms of sponges in areas subject to grazing and other disturbances (Jackson and Palumbi, 1978; A. M. Ayling, 1981). The high 'growth' rates attributed to sponges in recolonization experiments (Kay and Keough, 1981) may also involve this regeneration process. Other examples of regeneration rates reported by A. M. Ayling (1981) range from 1.6 mm²/cm border/day for *Tedania* sp. (orange) to 4.0 mm²/cm border/day for *Anchinoe* sp. (yellow).

This paper provides growth rates for eleven species of thinly encrusting subtidal sponge taken from two years monitoring of sponge patches in the natural habitat. From these data estimates of longevity were derived. Data were also collected on wet and dry weights and true organic content and related to the growth rate. Similarly, the effect of seasonal and reproductive state of the sponges on growth rates is considered. The regeneration rates of the sponges were experimentally determined and the ability of small sponges to survive damage also investigated.

MATERIALS AND METHODS

Description of study area

With the exception of one species, all the thinly encrusting sponges were located on the walls of a narrow canyon, 12 m in depth, on the exposed north-easterly side of Goat Island, a small island near the Leigh Marine Laboratory off the north coast of New Zealand (38° 16'S: 174° 48'E). The other species, *Eurypon* sp., was found only in the Sponge Garden at a depth of 18 m north-west of Goat Island. This species was abundant beneath a layer of sand between 2 and 5 cm in depth. The physical characteristics of the Goat Island area are summarized in Leum and Choat (1980) and A. M. Ayling (1981). The abundance of the sponges is given in A. L. Ayling (1978).

Wet weight, dry weight, and composition of living sponges

Five or more pieces of each species were collected still attached to the rock substratum and transferred to the laboratory where the area of the sponge was traced onto acetate sheet and thickness measured. The tissues were then carefully removed with a scalpel and paint brush, placed on filter paper and weighed. Sponges were placed in a drying oven at 90°C until constant weight was obtained. A wet weight/dry weight ratio was calculated and the dried residue of the sponge further examined for ash (assumed to be all SiO₂ for siliceous sponges), water of hydration and organic fractions. At normal drying temperatures (80–100°C) the water of hydration is only partly removed from the siliceous skeleton. As ash values can thus be underestimated (Vinogradov, 1953; Paine, 1964) corrections were made by measuring the weight loss of spicule samples after incineration. Spicule samples were collected from two

species. Tissue samples from the two species were digested in Sodium hydroxide and then repeatedly washed in distilled water. Cleared spicules were dried at 90°C, weighed and incinerated at 500°C for four hours. All species were ashed at 500°C for four hours.

Growth rates of sponges over natural habitat

Ten or more patches of varying sizes of each encrusting species were selected and marked with labeled masonry nails driven into the rock adjacent to the sponge patch. At the end of the study only those patches which had not suffered visible damage from grazing or other sources of disturbance were chosen for estimating growth rates. It is possible that some of these 'undamaged' sponges may have suffered minor injuries and regenerated between monitoring intervals. Preliminary monitoring of growth at weekly then monthly intervals showed no measurable changes in size in most of the species and hence monitoring was continued at three monthly intervals over a two year period (June, 1976–June, 1978). Sponge patches were photographed and the color negatives projected at actual size onto graph paper and the outlines of the sponge traced. The area cover of each sponge was recorded with an estimated error of $\pm 0.5\%$.

Damage simulation experiments

A ten centimeter square was outlined on the surface of the sponge and then scraped almost clean of tissue to simulate the grazing activities of the abundant urchin *Evechinus chloroticus*. Five sponge patches of each species were then cleared and black and white photographs were taken of the damaged areas. Cleared areas were rephotographed a month later and percentage regeneration measured.

Can small sponges survive damage?

The recovery capability of small sponges was investigated by scraping patches of between 0.1–42.0 cm² area of the species *Microciona* sp. and *Stylopus* sp. almost completely off the rock. After two weeks the percentage recovery of the original area was recorded.

RESULTS

Wet weight, dry weight and composition of living sponges

Wet weight and dry weight per unit area of the sponge is shown in Table I. The species with the highest wet weight per centimeter square tissue were *Tedania* sp. (orange) and *Hymedesmia* sp. (orange). The high wet weight of *Chondropsis* sp. is due to the inclusion of sand in its skeleton.

A wet/dry weight ratio was calculated and the ash, water of hydration and the organic fractions of each species obtained (Table II). Results from this analysis indicate that the species with the least proportion of organic matter in their body include species where spongin forms a major part of the skeleton (*Chelonaplysilla* sp.), or sediments (*Chondropsis* sp.) or the sponge produced large quantities of mucus (*Tedania* sp. (orange)). In general these temperate water encrusting sponges had a greater proportion of organic matter, but less water content than the species from Antarctica analyzed by Dayton *et al.* (1974).

TABLE I

Thickness, mean patch size, wet weight, and dry weight of thinly encrusting sponges

Species	No. samples	Thickness (mm)	Mean patch size (cm ²)	Wet weight g/cm ² tissue		Dry weight g/cm ² tissue	
				\bar{X}	S \bar{x}	\bar{X}	S \bar{x}
<i>Stylopus</i> sp.	6	3-10	58.4	0.16	0.06	0.05	0.02
<i>Hymedesmia</i> sp. (orange)	5	5	8.2	0.19	0.08	0.08	0.04
<i>Hymedesmia</i> sp. (red)	8	2	13.6	0.14	0.02	0.09	0.03
<i>Microciona</i> sp.	14	3	22.2	0.07	0.01	0.03	0.004
<i>Anchinoe</i> sp.	5	2-15	21.9	0.06	0.01	0.03	0.01
<i>Stylopus</i> sp. (pink)	10	2-5	30.7	0.13	0.08	0.02	0.003
<i>Tedania</i> sp. (orange)	7	5-15	14.5	0.19	0.04	0.04	0.01
<i>Chondropsis</i> sp.	16	5-20	45.8	0.37	0.03	0.16	0.01
<i>Aplysilla rosea</i>	7	2-6	151.8	0.09	0.02	0.04	0.01
<i>Chelonaplysilla</i> sp.	7	3-5	83.8	0.09	0.02	0.05	0.01
<i>Eurypon</i> sp.	10	1-2	7.8	0.03	0.003	0.02	0.01

Natural growth rates

The thinly encrusting sponges grew in slow but measurable increments over the two year study period. In the majority of cases this growth was not a steady uninterrupted process; during a year a single sponge patch could stop growing or retract from areas it had occupied. Whether this retraction was spontaneous or due to

TABLE II

*Composition of living sponges**

Species	N ₁	A		B		C		D		E	
		Proportion H ₂ O ± SE	Proportion dry (1.000 - A)	N ₂	Proportion of dry wt. that is false ash ± SE	Proportion true ash B × C/0.91	Proportion true organic matter (B-D)				
<i>Stylopus</i> sp.	6	.695 ± .026	.305	5	.645 ± .047	.196	.109				
<i>Hymedesmia</i> sp. (red)	8	.502 ± .030	.498	5	.327 ± .066	.115	.383				
<i>Hymedesmia</i> sp. (orange)	5	.664 ± .058	.335	5	.569 ± .017	.209	.126				
<i>Stylopus</i> sp. (pink)	10	.560 ± .174	.440	5	.454 ± .017	.219	.221				
<i>Tedania</i> sp. (orange)	7	.787 ± .014	.213	5	.710 ± .061	.166	.047				
<i>Microciona</i> sp.	14	.544 ± .033	.456	5	.581 ± .011	.201	.165				
<i>Anchinoe</i> sp.	5	.457 ± .180	.643	5	.409 ± .021	.289	.354				
<i>Chondropsis</i> sp.	16	.564 ± .010	.436	5	.692 ± .160	.414**	.022				
<i>Chelonaplysilla</i> sp.***	7	.425 ± .070	.575	5	.938 ± .043	.516	.034				
<i>Aplysilla rosea</i> ***	7	.542 ± .075	.458	5	.418 ± .023	.191	.267				
<i>Eurypon</i> sp.	5	.716 ± .041	.283	—	—	—	—				

* N₁ = number specimens used for determination of proportion H₂O (A); N₂ = number of specimens used for determination of proportion of false ash (C). True ash is false ash/0.91 - water held by spicules. The composition of sponges is given by (A) = (D) + (E).

** True ash is false ash/0.729 - sand and spicules.

*** Sponges without spicules, true ash (B) (C).

undetected disturbance could not be determined in this study. When individual changes in patch size were graphed no correspondence in fluctuations were apparent or referable to seasonal or reproductive cycles (see A. L. Ayling, 1980 for the reproductive cycles of four of the species studied here).

A mean growth rate was calculated for each species of sponge, the large standard errors reflecting the above mentioned fluctuations in size. Growth rates are presented as millimeter square area change in size per centimeter border per day in Table III. Patches of *Aplysilla rosea*, *Stylopus* sp. (pink) and *Chondropsis* sp. grew relatively rapidly at 0.28, 0.23, and 0.13 mm²/cm border/day respectively. It is estimated that a *Stylopus* sp. (pink) of one centimeter diameter growing undisturbed could reach a size of 15 cm diameter in ten years and the larger patches of this species observed on the walls of the canyon which were one meter in diameter may be 78 years old (based on the mean growth rate shown in Table III). If grazing was more frequent than detected then these estimates of longevity should be considered minimum age estimates. *Eurypon* sp. grew the most slowly of all the sponges, and patches of this species were easily recognized even after six and a half years as the outlines of the sponges changed very little (Fig. 1).

No significant relationship was found using the Spearman Rank Correlation coefficient r_s between wet weight and growth rates ($r_s = 0.52$), thickness and growth rates ($r_s = 0.508$) or true organic content and growth rates ($r_s = 0.167$). However, a significant correlation was found between the mean patch size of a species and growth rates ($r_s = 0.64$; $0.5 > P > 0.01$). Thus, in general, large species such as *Aplysilla rosea* and *Chelonaplysilla* sp. grew more rapidly than the smaller species e.g., *Hymedesmia* sp. (orange) and *Eurypon* sp.

The smaller sponges were more likely to fluctuate in size than the large individuals. This is shown for six of the species in initial size-increment graphs in Figure 2.

Effect of grazing on sponges (regeneration rates)

The regeneration rates of the sponges are shown in Table IV. Sponges could regenerate into disturbed areas at rates 22 to 2,900 times the natural growth rate.

TABLE III

Growth rates of thinly encrusting sponges over natural habitat

Species	Number patches	mm ² /cm border/day		Postulated diameter of a 10 yr old sponge using mean rate of increase (cm)
		\bar{X}	$S\bar{x}$	
<i>Aplysilla rosea</i>	3	0.28	0.19	20.03
<i>Stylopus</i> sp. (pink)	11	0.23	0.09	15.39
<i>Chondropsis</i> sp.	16	0.13	0.09	9.31
<i>Tedania</i> sp. (orange)	22	0.08	0.05	5.70
<i>Stylopus</i> sp.	12	0.08	0.06	5.71
<i>Chelonaplysilla</i> sp.	13	0.06	0.05	5.00
<i>Hymedesmia</i> sp. (red)	10	0.05	0.03	4.31
<i>Hymedesmia</i> sp. (orange)	5	0.02	0.03	2.32
<i>Anchinoe</i> sp.	9	0.01	0.06	1.66
<i>Microciona</i> sp.	25	-0.01	0.003	—
<i>Eurypon</i> sp.	9	0.0003	0.031	1.02

Growth rates are presented as mean growth over a two year period.

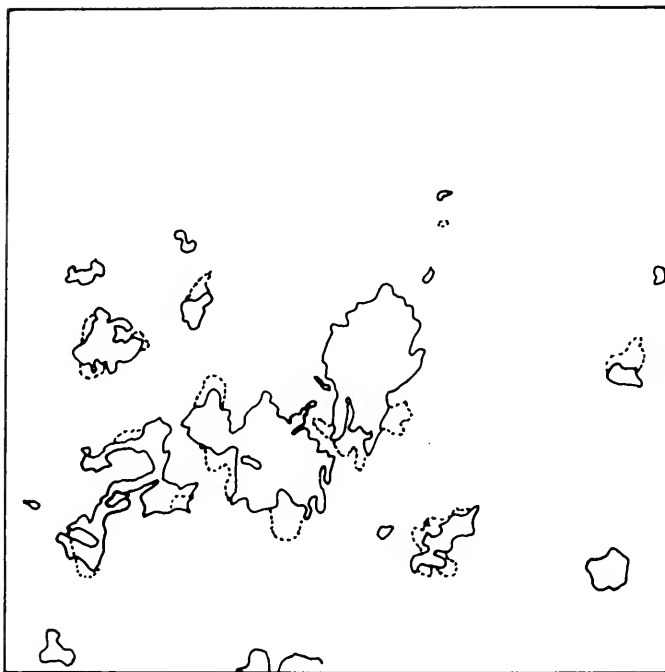

FIGURE 1. Changes in outlines of patches of *Eurypon* sp. taken from color photographs over the period June, 1975 (—) to February, 1982 (---) in a 25 cm² area of the Sponge Garden.

The tissue covering these disturbed areas is initially thinner than the normal thickness of the species. The species that most rapidly recovered space after damage were *Stylopus* sp. (pink), *Aplysilla rosea*, *Chondropsis* sp. and *Stylopus* sp. However the greatest magnitude of difference between growth and regeneration rates occurred in the slow growing species *Eurypon* sp. and *Anchinoe* sp. Using the Spearman Rank Correlation coefficient some relationship was found between regeneration rates and undisturbed growth rates ($r_s = 0.91$; $P < 0.01$) and regeneration rates and the mean patch size of the species ($r_s = 0.64$; $0.5 > P > 0.1$).

Can small sponges survive damage?

All patches of the rapidly growing species, *Stylopus* sp. reoccupied some of the lost space, the smallest patches recovering all of their former space in less than two weeks. In some cases however, the slower growing species, *Microciona* sp. did not recover any space nor the entire area even over a month (Fig. 3).

DISCUSSION

Growth over natural surfaces in thinly encrusting sponges from temperate subtidal waters is very slow. The most rapid mean rate of growth recorded in this study was that of a thin fleshy sponge, *Aplysilla rosea*, at 0.28 mm²/cm border/day. A settled larvae of this species growing undisturbed could reach a size of 20 cm diameter in ten years based on this mean rate of growth. Some of the patches of this species growing on the walls of the canyon reached a meter diameter and these could be a minimum of 50 years old. The slowest growing species was *Eurypon* sp., growing at

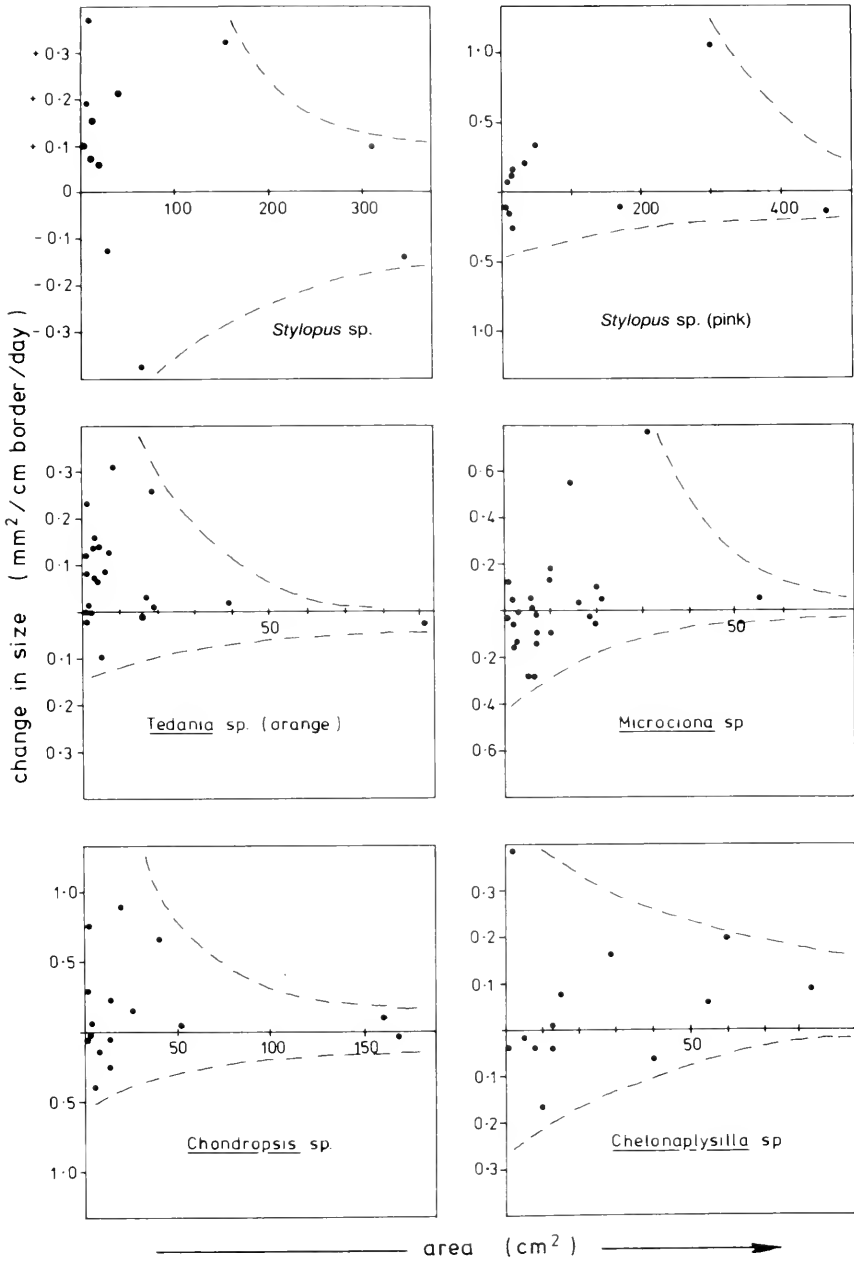

FIGURE 2. Initial size-increment graphs of thinly encrusting sponges showing how small patches generally fluctuated more in size than larger patches. Dashed lines outline the areas where there are no points.

a mean rate of 0.0003 mm²/cm border/day. In ten years the settled larvae of this species would only grow to a size of one centimeter diameter. This species is very thin and in the natural habitat forms small patches up to 10 cm in diameter, the

TABLE IV

Regeneration rates of thinly encrusting sponges*

Species	mm ² /cm border/ day		Times magnitude greater than the natural growth rate
	\bar{X}	$S\bar{x}$	
<i>Aplysilla rosea</i>	6.18	0.98	22.07
<i>Stylopus</i> sp. (pink)	6.98	0.78	30.35
<i>Chondropsis</i> sp.	5.70	0.83	43.85
<i>Tedania</i> sp. (orange)	4.18	1.34	52.25
<i>Stylopus</i> sp.	4.60	0.70	65.70
<i>Chelonaplysilla</i> sp.	4.08	1.20	68.00
<i>Hymedesmia</i> sp. (orange)	0.53	0.43	26.50
<i>Anchinoe</i> sp.	3.65	0.89	365.00
<i>Microciona</i> sp.	0.63	0.23	—**
<i>Eurypon</i> sp.	0.88	0.44	2,900

* Regeneration rates were obtained by stimulating damage to the sponge, five replicate simulations per species. *Hymedesmia* sp. (red) is not included in the table as it was too small and divaricate to use in the experiment.

** Undisturbed growth in this sponge was negative over the period of study.

outlines of which change very little over long periods of time. *Microciona* sp. had an overall negative growth rate although the positively growing individuals of this species achieved a growth rate of 0.02 mm²/cm border/day.

Every species had some individual patches which regressed over the two year study period. In some cases the patch could increase over several months then decrease in size. As fluctuations in size did not occur contemporaneously between individuals no relationship could be found between changes in size and seasonal and reproductive cycles. Changes in size did not occur over the entire border line of the sponges but were restricted to certain sections of the border. Thus while sections of the border could remain unchanged during the study other sections could

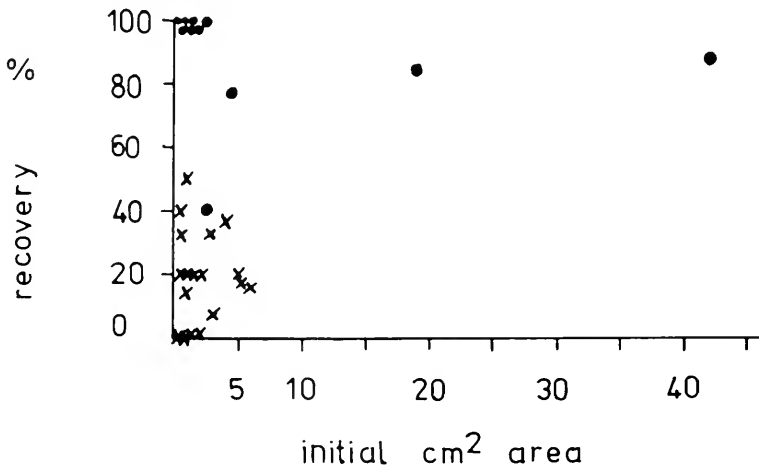

FIGURE 3. Can small sponges survive damage? Sponges were scraped almost entirely off the rock and recovery of space was recorded after two weeks time. × = *Microciona* sp.; ● = *Stylopus* sp.

expand outwards or contract inwards. Neighboring sponges may help maintain static border outlines and explain some tissue retractions (A. L. Ayling, in press) but whether the removal of surrounding invertebrates may stimulate growth is uncertain (A. M. Ayling, 1981).

The longevity of these thinly encrusting sponges may not be estimated correctly if only the mean rate of increase is considered. Like corals (Hughes and Jackson, 1980) and intertidal sponges (Elvin, 1976; Fell and Lewandrowski, 1981), these subtidal sponges could be broken into several fragments some of which may later join. Thus a single patch may be the result of several fissions and fusions over time, and the size of the sponge may not be indicative of the age of the patch. In general these thinly encrusting sponges are likely to occupy space in the community for long periods of time and consequently would be expected to play an important part in the structuring of these encrusting communities where they are abundant.

The sponge species' tissue thickness did not affect the rate at which the sponge grew over the substratum. For example, the thinnest sponge, *Eurypon* sp. grew the slowest, while the thickest species *Chondropsis* sp. grew relatively rapidly. Nor did the undisturbed growth rate of the different species relate to the wet weight or true organic content. However, it was found that the larger species grew more rapidly than the smaller species.

When thinly encrusting sponges are damaged a rapid regeneration mechanism is activated and the sponge spreads out a thin layer of tissue over the disturbed area, regaining the lost space. This thin tissue may be similar to the explant tissue examined by Simpson (1963) which was undifferentiated and contained only a few cell types. The highest rate of regeneration recorded in the present study was that of *Stylopus* sp. (pink) at 6.98 mm²/cm border/day, a magnitude of 30 times greater than the undisturbed growth rate of the species. Even the slowest growing species, *Eurypon* sp., rapidly regenerated tissue at a rate of 0.88 mm²/cm border/day, a magnitude of 2,900 times the undisturbed growth rate of the species. This rapid rate of encroachment after damage has obvious advantages in communities where grazers are abundant. The survival chances of newly recruited sponges would also be enhanced by this regeneration mechanism.

ACKNOWLEDGMENTS

I would like to thank Dr. Tony Ayling, Dr. Howard Choat, Dr. David Schiel, and Dr. P. R. Bergquist for their helpful discussion of the project. This research was supported by a grant from the Roche Pharmaceutical company of Australia.

LITERATURE CITED

- AYLING, A. L. 1978. The relation of food availability and food preferences to the field diet of an echinoid *Evechinus chloroticus* (Valenciennes). *J. Exp. Mar. Biol. Ecol.* **33**: 223-235.
- AYLING, A. L. 1980. Patterns of sexuality, asexual reproduction and recruitment in some subtidal marine Demospongiae. *Biol. Bull.* **158**: 271-282.
- AYLING, A. L. In press. Factors affecting the spatial distributions of thinly encrusting subtidal sponges from temperate waters. *Oecologia*.
- AYLING, A. M. 1981. The role of biological disturbance in temperate subtidal encrusting communities. *Ecology* **62**: 830-847.
- BRYAN, P. G. 1973. Growth rate, toxicity and distribution of the encrusting sponge *Terpios* sp. (Hadromerida: Subertidae) in Guam, Marianas Islands. *Micronesica* **9**: 237-242.
- DAYTON, P. K., G. A. ROBILLIARD, R. T. PAINE, AND L. B. PAINE. 1974. Biological accommodation in the benthic community at McMurdo Sound, Antarctica. *Ecol. Mon.* **44**: 105-128.
- ELVIN, D. W. 1976. Seasonal growth and reproduction of an intertidal sponge, *Haliclona permollis* (Bowerbank). *Biol. Bull.* **151**: 108-125.

- FELL, P. E. 1976. Analysis of reproduction in sponge populations: an overview with specific information on the reproduction of *Haliclona loosanoffi*. Pp. 51-67 in *Aspects of Sponge Biology*, F. W. Harrison and R. R. Cowden, eds. Academic Press, New York.
- FELL, P. E., AND K. B. LEWANDROWSKI. 1981. Population dynamics of the estuarine sponge, *Haliclondria* sp., within a New England eelgrass community. *J. Exp. Mar. Biol. Ecol.* **55**: 49-63.
- HUGHES, T. P., AND J. B. C. JACKSON, 1980. Do corals lie about their age? Some demographic consequences of partial mortality, fission, and fusion. *Science* **209**: 713-715.
- JACKSON, J. B. C. 1977. Competition on marine hard substrata: the adaptive significance of solitary and colonial strategies. *Am. Nat.* **111**: 743-767.
- JACKSON, J. B. C. 1979. Morphological strategies of sessile animals. Pp. 499-555 in *Biology and Systematics of Colonial Organisms*, G. Larwood and B. R. Rosen, eds. Academic Press, London.
- JACKSON, J. B. C., AND S. R. PALUMBI. 1978. Regeneration and partial predation in cryptic coral reef environments: Preliminary experiments on sponges and ectoprocts. Pp. 303-308 in *Biologie des Spongiaires*, C. Levi and N. Boury-Esnault, eds. C. N. R. S., France.
- JOHNSON, M. F. 1978. Recruitment, growth, mortality and seasonal variations in the calcareous sponges *Clathrina coriacea* (Montagu) and *C. blanca* (Miklucho-Maclay) from Santa Catalina island, California. Pp. 271-282 in *Biologie des Spongiaires*, C. Levi and N. Boury-Esnault, eds. C. N. R. S., France.
- KAY, A. M., AND M. J. KEOUGH. 1981. Occupation of patches in the epifaunal communities on pier pilings and the bivalve *Pinna bicolor* at Edithburgh, South Australia. *Oecologia* **48**: 123-130.
- LEUM, L. L., AND J. H. CHOAT. 1980. Density and distribution patterns of the temperate water marine fish *Cheilodactylus spectabilis* (Cheilodactylidae) in a reef environment. *Mar. Biol.* **57**: 327-337.
- PAINE, R. T. 1964. Ash and caloric determination of sponge and Opisthobranch tissues. *Ecology* **48**: 384-387.
- SIMPSON, T. L. 1963. The biology of the marine sponge *Microciona prolifera* (Ellis and Solander). A study of cellular function and differentiation. *J. Exp. Zool.* **154**: 135-152.
- VINOGRADOV, A. P. 1953. The elementary chemical composition of marine organisms. *Sears Found. Mem.* **2**: 1-647.

SURFACE BROODING IN THE RED SEA SOFT CORAL
PARERYTHROPODIUM FULVUM FULVUM (FORSKÅL, 1775)

Y. BENAYAHU* AND Y. LOYA

*Department of Zoology, The George S. Wise Center for Life Sciences,
Tel Aviv University, Tel Aviv 69978 Israel*

ABSTRACT

Parerythropodium fulvum fulvum (Forskål, 1775) is an encrusting soft coral commonly found between 3 and 40 m, at the coral reefs of the Gulf of Eilat. The annual gonadal development and sexual reproduction of this species were studied both in shallow water (3–5 m) and in the deep reef zone (27–30 m). *P. f. fulvum* is a dioecious species. Sex ratio of the shallow population favors higher abundance of females, while on the deep reef a 1:1 sex ratio was recorded. These differences are probably due to local aggregations of colonies of the same sex caused by asexual reproduction. Oocytes and sperm sacs are found even in very young colonies (1–3 years). The frequency of sexually mature males is higher than mature females among small corals.

Young oocytes appear annually in August and within 10–11 months reach their maximal diameter. Sperm sacs start to develop later and mature after 7–9 months. A marked synchronization in the development of the oocytes and the testes exists among different polyps within each colony. Spawning occurs at dusk, and is fully synchronized by lunar periodicity (a few days after the new moon and a few days preceding its last quarter). Fertilization takes place inside the polyp cavities. The shallow water population breeds prior to the deeper one with the whole reproductive period lasting approximately two months (end of June, beginning of August).

Among anthozoans, *P. f. fulvum* represents a unique mode of sexual reproduction and planulae development. This species is oviparous, yet eggs cleave on the surface of the female colonies while entangled in a mucoid suspension. We term this mode of planula development "surface brooding". Within 6 days after fertilization the planulae complete their development, detach from the surface of the colony, and sink to the bottom.

The encrusting growth form of *P. f. fulvum* is characterized by a thin coenenchyme and short polyp cavities, yet the eggs exhibit a large diameter (500–700 μm). Egg production of *P. f. fulvum* is rather low (18–24 eggs per polyp), but it is compensated for by surface brooding, which protects the offspring during embryogenesis. It is suggested that surface brooding is an adaptation to the encrusting shape of the colony and it maximizes fecundity.

INTRODUCTION

The soft corals (order Alcyonacea) are a large and diverse group of species among the Octocorallia. Several studies deal with alcyonacean distribution emphasizing their importance as space utilizers (Cary, 1931; Maragos, 1974; Veron *et al.*, 1974; Schuhmacher, 1975; Pearson, 1981). Other investigations discuss their ecological

Received 14 March 1983; accepted 25 July 1983.

* Present address: Florida International University College of Arts and Science, Department of Biological Sciences, Tamiami Campus, Miami, Florida 33199.

importance in the Red Sea coral reefs (Fishelson, 1970, 1973; Benayahu and Loya, 1977, 1981). Despite their abundance on many Indo-Pacific coral reefs (Bayer, 1973), little information exists on their life history and reproductive tactics.

Most of our knowledge on the reproduction of alcyonacean corals is based on early literature dealing with the widespread boreal species *Alcyonium digitatum* (Linnaeus, 1758) (Lacaze-Duthiers, 1865; Hickson, 1895; Hill and Oxon, 1905; Matthews, 1917). More recently, this species has been investigated by Hartnoll (1975, 1977). Extensive studies have been carried out on the Red Sea soft corals of the family Xeniidae (Gohar, 1940a, b; Gohar and Roushdy, 1961). These studies are mainly concerned with the biology and reproduction of *Heteroxenia fuscescens* (Ehrenberg, 1834). Recently, Yamazato and Sato (1981) have studied the reproductive biology of *Lobophytum crassum* Von Marenzeller, 1886.

Approximately 200 alcyonacean species have been recorded from the Red Sea (Benayahu and Loya, in prep.), but little is known about their life histories. The present work summarizes the results of a four-year quantitative study on the ecology and the reproductive pattern of *Parerythropodium fulvum fulvum* (Forskål, 1775) (family Alcyoniidae). This species was originally described from the Red Sea, but its present zoogeographical distribution extends to the reefs of Madagascar and east to Indonesia (Verseveldt, 1969).

Colonies of *P. f. fulvum* have an encrusting membranaceous growth form (Fig. 1), and is among the most abundant soft corals on the coral reefs of the Gulf of Eilat (Benayahu and Loya, 1977). This paper is concerned with the distribution and reproductive strategy of *P. f. fulvum* in shallow water (3–5 m) and in deeper reef zones (27–30 m). We have studied the annual development of gonads, sex ratio, colony size at first reproduction, and the mode and duration of sexual reproduction. In addition, we examined the chronology of planulae embryogenesis, as well as the post-larval development and morphogenesis. This study describes surface brooding, a unique mode of external planulae development among the alcyonacean corals.



FIGURE 1. A living colony of *Parerythropodium fulvum fulvum*.

MATERIALS AND METHODS

The present study was carried out at two reef localities. One site was Muqebla', 12 km south of Eilat, where the shallow water population at 3–5 m depth was studied, the deep water population (27–30 m) was studied near the Marine Biological Laboratory of Eilat. Distributional studies and the correlation between spawning periodicity and depth were also carried out at this location. Sampling, underwater measurements, and observations were carried out by SCUBA diving. The living coverage and abundance of *P. f. fulvum* were studied by a series of line transects (10 m each) following the method described by Loya and Slobodkin (1971).

In order to determine the relationship between colony size and the onset of sexual maturity, small colonies were collected prior to the breeding season. These colonies were carefully removed from the substrate by forceps and were preserved in 4% buffered formalin. In the laboratory, each colony was numbered, its boundaries outlined on paper and then the drawings cut out by scissors. Each piece of paper was separately weighed using an analytical balance with a precision of 10^{-4} g. The weight of the paper pieces increased linearly with the colonies surface, and they represented the size of the corals.

The populations at the two reef sites were studied during approximately 4 years, from November 1977 to July 1981. Almost every month, fragments of 10–20 large colonies were randomly sampled in Muqebla' (3–5 m) and in the Marine Biological Laboratory (M.B.L.) reef (27–30 m). Ten large colonies were numbered with plastic tags in shallow water and on the deep reef. Fragments of these colonies were sampled every month during 3 years, to study the annual sequence of gonadal development within the same colony.

The polyp cavities of the formalin-fixed material were examined with a binocular stereoscope for genital development and sex determination. Additionally, wet mounts of septa with gonads from 25 polyps of each colony were examined microscopically; the diameter of the oocytes and sperm sacs was measured. Paraffin sections (10 μ m) were employed to study gonadal structure. Sections were stained in hematoxylin (Delafield) and eosin after decalcification in formic acid-citrate (Rinkevich and Loya, 1979a).

Preliminary observations during the summers of 1978 and 1979 revealed that spawned eggs of *P. f. fulvum* remained on the surface of the colonies. During the summers of 1980 and 1981, prior to the breeding season, female colonies were collected and maintained in aquaria with running sea water. Determination of the exact timing of egg expulsion was done by continuous observations in the laboratory, and in the field along a depth gradient to 30 m. Fertilized eggs were reared in aerated sea water containers. Cleavage stages were compared to field material collected successively every 12 h. Synchronization of egg cleavage was studied by examining hundreds of embryos.

Material for scanning electron microscopy was fixed in 2% glutaraldehyde. After dehydration in a series of graded ethyl alcohols, the samples were dried from liquid CO_2 by the critical point method. The dried preparations were coated with gold and examined with a Jeol-S35 scanning electron microscope at 25 kV.

RESULTS

Abundance and depth distribution

The abundance of *P. f. fulvum* in shallow water is extremely variable. Previous results indicated that its coverage varies from 1.1% to 44.0% on different reef flats

and from 7.0% to 45.6% on different fore-reef zones (Benayahu, 1975). The present study across the M.B.L. reef indicates a lower living coverage ($5.1 \pm 2.3\%$) per 10 m transect at 18–40 m depth. The colonies tend to aggregate: young colonies are almost always found growing near larger ones. The smaller individuals are often found in poorly illuminated environments such as crevices or the undersides of dead stony corals.

Colonies of *P. f. fulvum* exists in two color morphs: yellow-brown and gray, but there is no taxonomic difference between them (Verseveldt, 1969). Figure 2 exhibits the depth distribution of the two morphs from shallow water to a depth of 30 m. Coral abundance is expressed as number of colonies per 10 m transect. The yellow brown colonies are the most common, while the gray corals are less abundant. Whereas the yellow-brown morph is found along the whole depth range studied, the gray morph is common only below 20 m. This pattern of distribution was qualitatively observed in many other reef localities along the coral reefs of the Gulf of Eilat.

Gonadal development

P. f. fulvum is a dioecious species. In both sexes the gonads develop on the four lateral and two ventral mesenteries of the polyp. Each polyp produces 18–24 genital products. The oocytes and the testes are located on the middle part of the mesentery and directed towards the center of the polyp cavity. Occasionally, few colonies of *P. f. fulvum* contain parts with thick coenenchyme. In such polyps the mesenteries may exceed a length of 6–12 mm, whereas in the most common ones they are only a few mm long. In the thick coenenchyme polyp-type, where much more space is

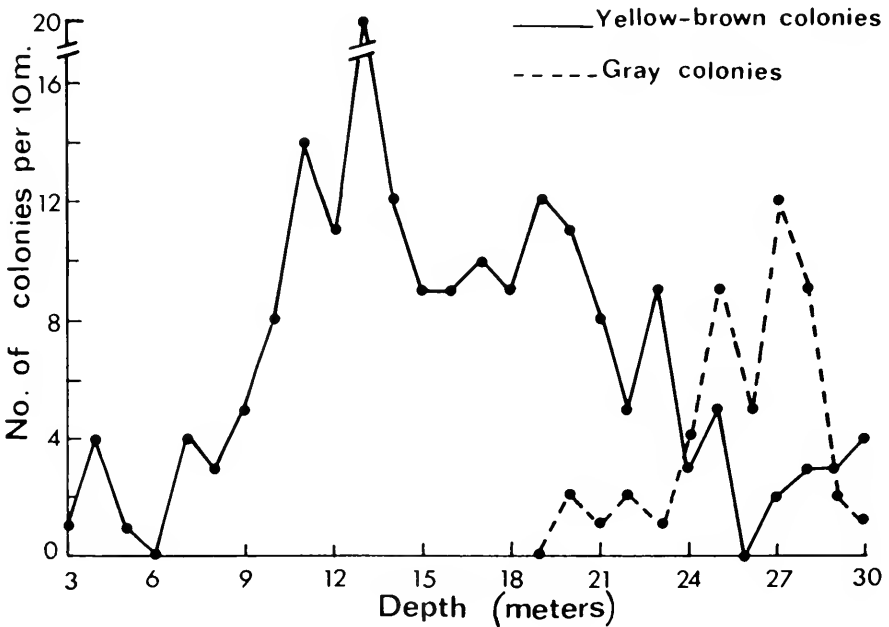

FIGURE 2. Depth distribution of the two color morphs of *Parerythropodium fulvum fulvum*. The abundance in terms of number of colonies per 10 m transect.

available, up to 100 eggs or sperm sacs may develop. Measurements of the diameter of the oocytes and sperm sacs indicate a marked synchronization in the reproductive state among different polyps within each colony (see below). No sex changes were detected during the study within the 20 tagged colonies.

Oocytes of living colonies of the abundant morph are characterized by a lemon-yellow color, while sperm sacs are transparent yellow. After preservation in formalin or alcohol their color becomes paler. The oocytes of the gray colonies are opaque-gray, while the testes are very transparent.

Size at sexual maturity and sex ratio

A few weeks before the spawning period (early June), 216 small (young) colonies were randomly collected in order to determine the minimum size at sexual maturity. We define a sexually mature specimen as one having either ripe spermatozoa or ripe oocytes (see below). The surface area of the sampled colonies ranged from less than 1 cm² to a maximum size of 5–7 cm². Table I represents the breeding state of these colonies in all size groups. Oocytes and sperm sacs are found even in the smallest colonies, but the frequency of mature males is higher than that of mature females. In addition, the percent of colonies with gonads increases with colony size.

Information on the population sex ratio was derived from samples collected during May–June, throughout the entire study. In shallow water 281 large colonies were examined, of which 60% were females. A X² test, at 0.05 level, indicates a significant deviation from a 1:1 sex ratio. A total of 220 colonies collected at 30 m depth resulted 54% males, indicating a 1:1 sex ratio ($P > 0.050$).

Annual cycle of gonadal development

Figure 3 demonstrates the relative percentage of colonies with oocytes or testes in each monthly sample. Figure 3a represents the results obtained from shallow water and Figure 3b represents the results obtained from the deep-reef. The percentage of colonies in the population without gonads fluctuates during an annual cycle, due to the timing of their development. Yet, Figure 3 shows that only a low percentage of colonies does not contain gonads prior to the spawning season.

TABLE I

Relationship between the size of young colonies and onset of reproduction of Parerythropodium fulvum fulvum

Group size (weight)*	No. of colonies	No. of males	No. of females	No. of immature colonies	Percent colonies with gonads
1–10	60	4	1	55	8.3
11–20	77	14	0	63	18.2
21–30	26	11	2	13	50.0
31–40	21	10	2	9	57.1
41–50	16	6	5	5	68.8
51–60	6	4	2	0	100.0
>60	10	3	7	0	100.0
Total	216	52 (24.1%)	19 (8.8%)	145 (67.1%)	

* Weight of paper images (in g 10⁻⁴) determined the size group (see Materials and Methods for further explanation).

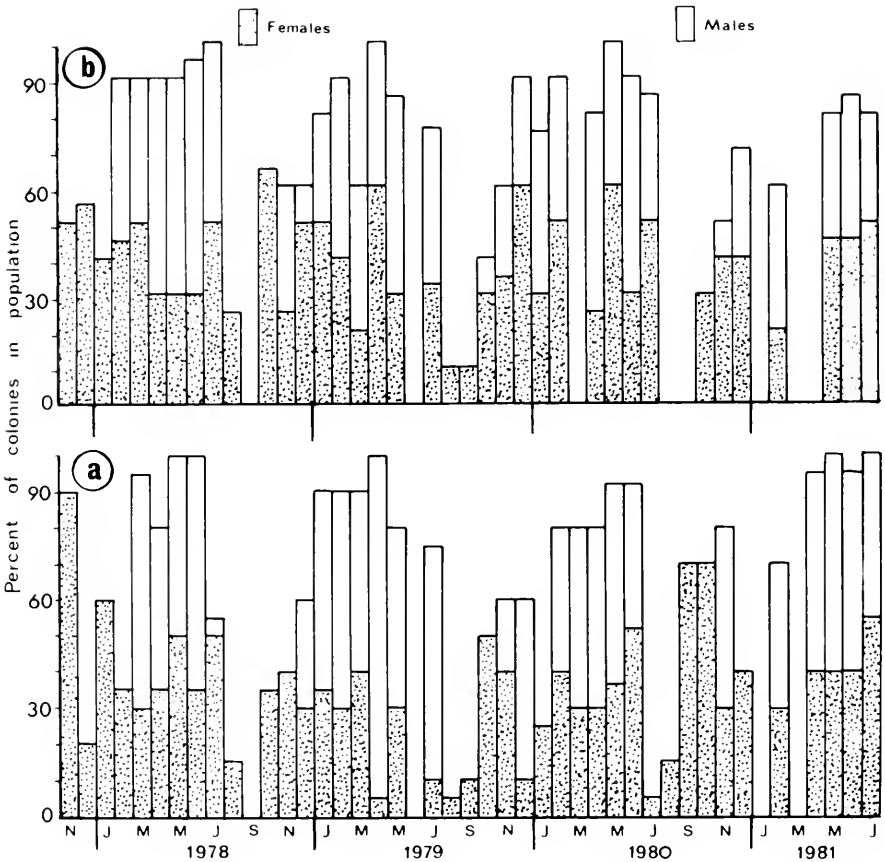

FIGURE 3. Abundance of female and male colonies of *Parerythropodium fulvum fulvum* with gonads in each monthly sample. Figure 3a represents results obtained from 3 m depth and Figure 3b represents the results from 30 m depth. The blank spaces in some of the months indicate that no sampling was done that period.

Figure 4 represents the annual changes in the mean maximal diameters of oocytes and sperm sacs in shallow water (Fig. 4a) and in deep water (Fig. 4b). The first young oocytes appear in August. They grow rapidly and within 10–11 months reach their maximal size. The diameter of the largest oocytes was 700 μm , however, the majority of the ripe oocytes ranged in size from 400 to 600 μm . Figure 4 also demonstrates that the annual development of the sperm sacs starts a few months after oocyte initiation. The first young spermaries are found every year during October, although their appearance can be delayed in part of the population until December. The development of the sperm sacs generally takes 7–9 months. The largest reach 480 μm , although the common diameter at maturity is about 400 μm . Spawning occurs mainly during June–July. The annual development of female and male gonads exhibited the same pattern throughout the research period (Fig. 4). This pattern is markedly synchronized within the population as indicated by the low standard deviations around the mean maximal diameters of the oocytes and sperm sacs.

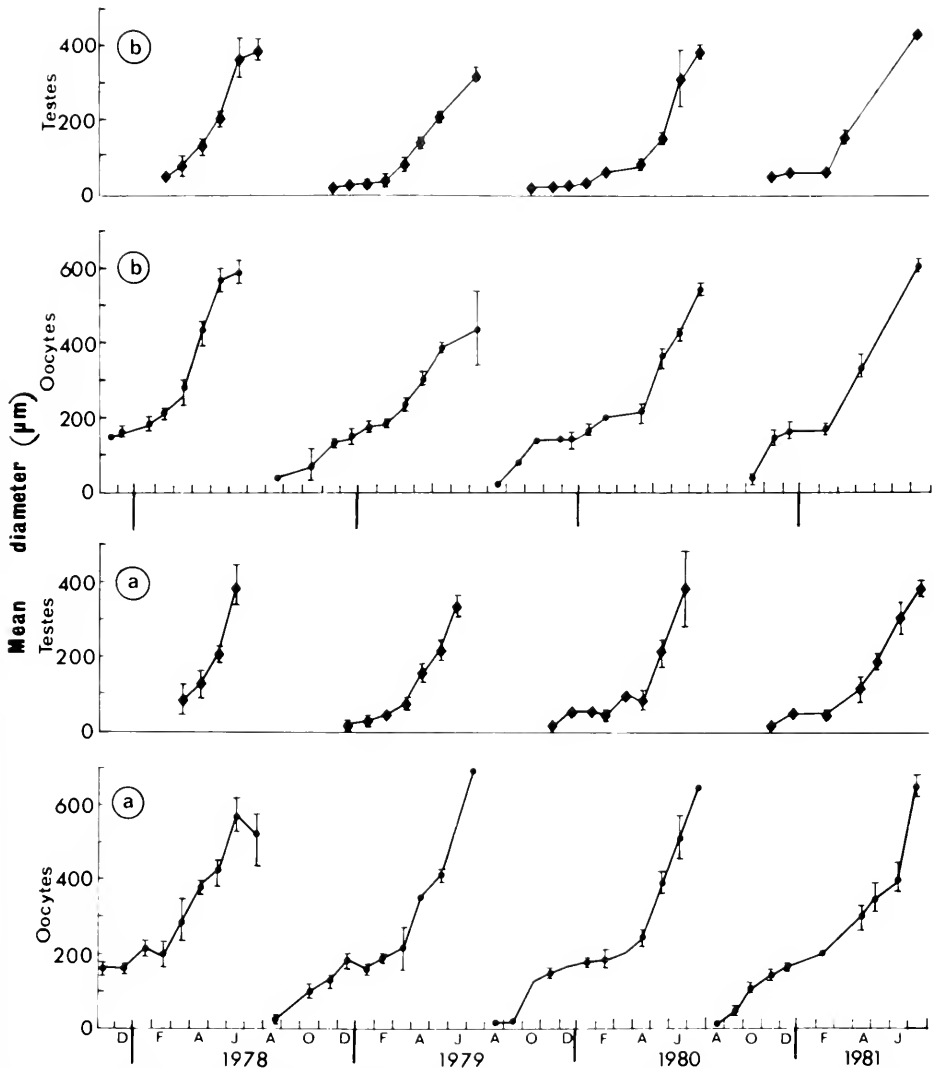

FIGURE 4. Mean maximal diameters of oocytes and sperm sacs of *Parerythropodium fulvum fulvum* at 3 m depth (Fig. 4a) and 30 m depth (Fig. 4b).

Ultrastructure of the gonadal surface

The oocytes and the sperm sacs of *P. f. fulvum* are surrounded by a ciliated follicular layer (Fig. 5a, b). These cells are derived from the endodermal epithelium of the septa. Each oocyte or testis is attached to the mesentery by a pedicle of approximately 100 µm (Fig. 5a). The cells of the polyp cavity are covered by cilia of about 20 µm in length. The flagella of the gonadal surface and that of some other endodermal cells are located in small pits. Each flagellum is surrounded at its base by 8 elevated folds of cell surface, in a palisade formation (Fig. 5c), similar to the arrangement described by Mariscal and Bigger (1976) in other octocorals. SEM

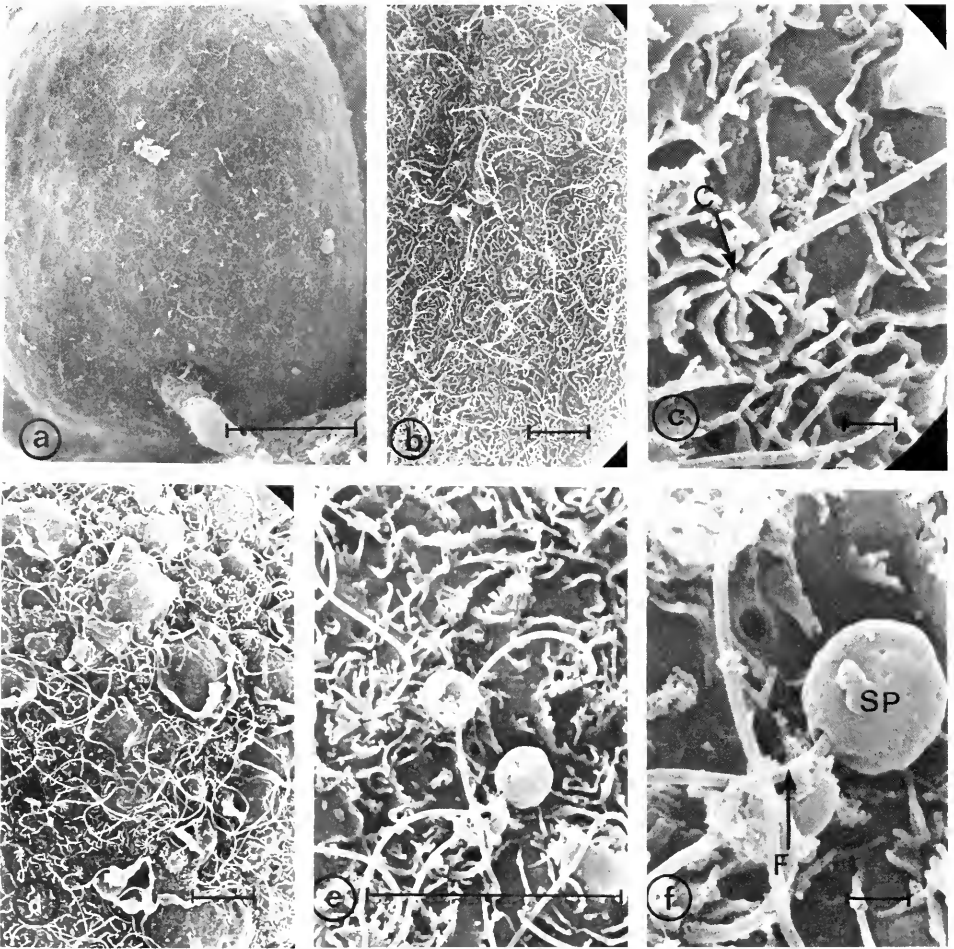

FIGURE 5. Ultrastructure of the gonadal surface of *Parerythropodium fulvum fulvum*. a: an oocyte attached with a pedicle to the mesentery. Bar = 100 μm . b: ciliary follicular endoderm of an oocyte. Bar = 10 μm . c: endodermal cilium surrounded by 8 elevated folds, cilium base (C). Bar = 10 μm . d: outer surface of a sperm sac. Bar = 10 μm . e: sperm cells on the testis. Bar = 1 μm . f: magnified sperm cell flagellum (F), sperm cell (SP). Bar = 1 μm .

examination reveals that the outer surface of the sperm sacs is elevated into hillocks and fold-like crests (Fig. 5d). In addition, microvilli and cilia are located among them (Fig. 5d, e). Immature sperm cells are found attached to the surface of the testes. They probably burst the spermary wall during fixation (Fig. 5e, f). The diameter of their rounded head is 2 μm , while their tail exceeds a length of 12 μm .

Spawning, fertilization, and embryogenesis

After spawning, all the eggs of *P. f. fulvum* remain on the surface of the female colonies, where they develop into planula larvae (Fig. 6a). The lemon-yellow color of the eggs make them very apparent even from a distance of several meters. The eggs are suspended in transparent, gelatinous material secreted by the corals. This

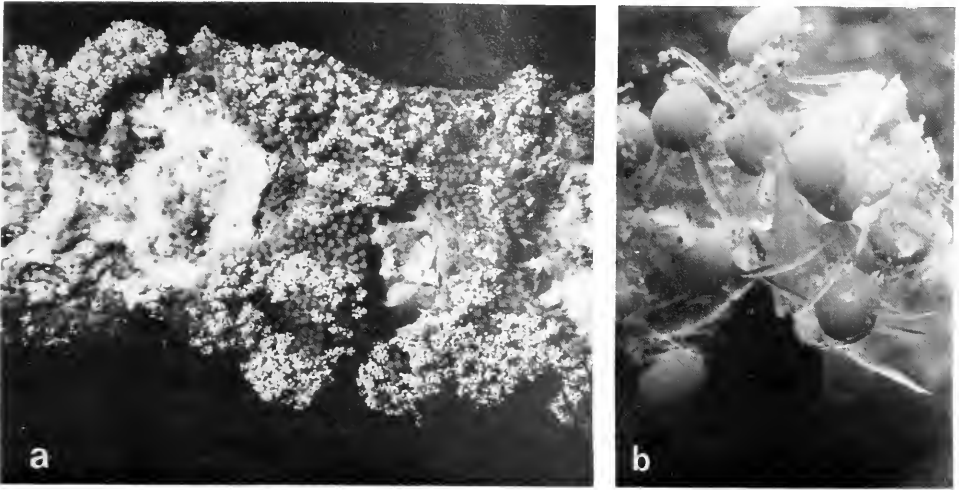

FIGURE 6. Spawning of *Parerythropodium fulvum fulvum* a: colony covered by spawned eggs embedded in mucus. b: eggs and sclerites entangled in mucus ($\times 10$).

mucus cover also contains many sclerites which are torn from the polyps during egg expulsion (Fig. 6b). Various organic and inorganic particles adhere to the mucus. The mucus flocks remain on the surface of the colonies for a week, and during this period cleavage takes place within the mucus.

Successive observations suggest that shortly before spawning the eggs of *P. f. fulvum* are fertilized within the polyp cavities. Thus, some female colonies that were kept in aquaria during the breeding season failed to spawn. Nevertheless, cleavage occurred inside their polyps. Additional evidence supporting internal fertilization was detected by SEM observations. Fixation of female colonies a few hours after egg expulsion revealed clusters of mature spermatozoa along the mesenterial filaments.

The eggs of *P. f. fulvum* are of the telolecithal type. Normally, cleavage occurs on the surface of the female colonies. The fertilized eggs lack a follicular layer, which is most probably detached before fertilization (Fig. 7a). Cleavage of the eggs begins within 3–5 h after fertilization. The first two divisions are meridional and equatorial (Fig. 7b). Throughout cleavage highly irregular, lobed structures are formed (Fig. 7c). The holoblastic, unequal cleavage produces a morula with large cells at the vegetal pole and smaller cells at the animal pole (Fig. 7d). Further divisions 24 h after fertilization lead to the formation of a round blastula (Fig. 7e). Histological sections indicate that this is a steroblastula, lacking a blastocoel. The thin external cell layer forms a cortex, while the inner cells are filled with yolk platelets.

The surface of the blastula (Fig. 8a) is characterized by folds and microvilli 1–2 μm long. Numerous microvilli are located between the neighboring cells (Fig. 8b). Ciliated ectodermal cells are recognized at a later stage on the young developing planula (Fig. 8c). During the third day after fertilization the diameter of the embryo is 350 μm (Fig. 7f). After four days a gastrula develops with a length of 600 μm (Fig. 7g). A young planula bearing an oral opening is found one day later (Fig. 7h). The young planula is rounded and gradually changes to an egg-like and then a pear-like shape (Fig. 7i). At this stage the young larvae are motionless, still embedded in the mucus. By the 6th day the planulae elongate; their aboral end is tapered while the oral side is rounded.

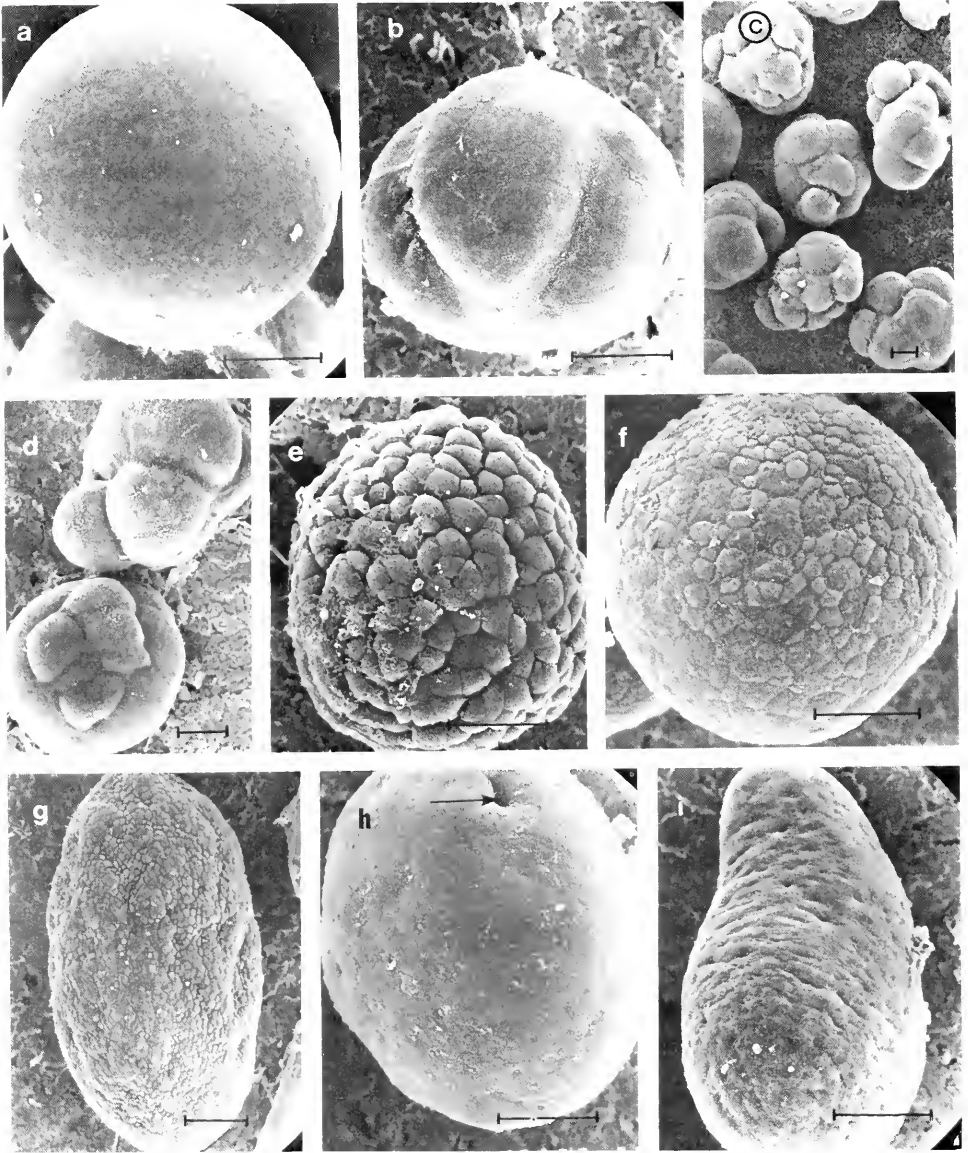

FIGURE 7. Embryogenesis of the planula larva of *Parerythropodium fulvum fulvum*. Bar = 100 μm . a: an egg without follicular layer. b: first two divisions of the egg. c: young embryos. d: irregular embryos. e: 24 h blastula. f: 48–72 h blastula. g: gastrula, 4 days after fertilization. h: young planula, arrow points to mouth opening. i: mature planula.

Planulae structure and behavior

Seven days after fertilization the mucus with the mature planulae in it starts to detach from the surface of the colonies and sink near the “mother colony” (Fig. 8d). The mucoid substance starts to degrade, and the larvae begin to move with their cilia. Figure 8e presents a fractured mature planula, where dense ciliary ec-

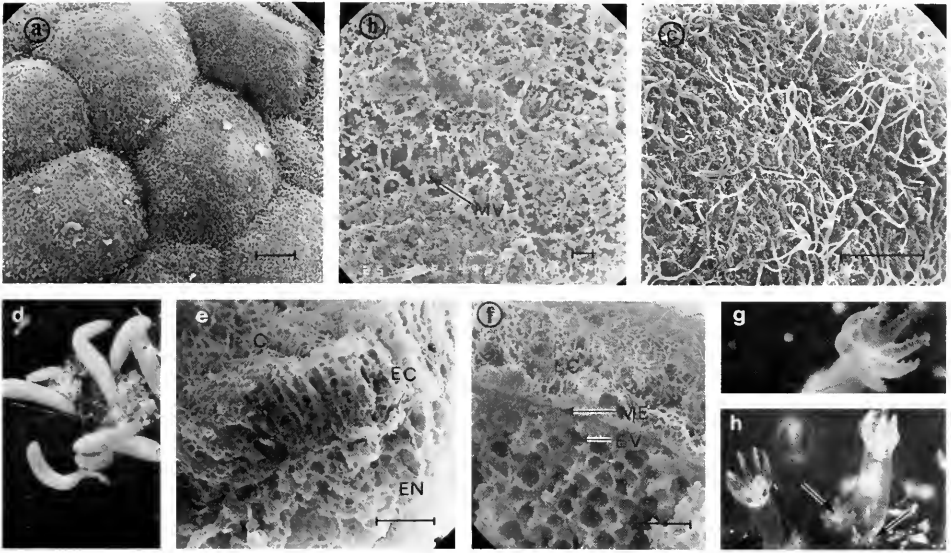

FIGURE 8. Planula structure and post larval development of *Parerythropodium fulvum fulvum*. a: blastula cells. Bar = 10 μm . b: microvilli (MV) on the surface of 24 h blastula cells. bar = 1 μm . c: ciliated blastula cells. Bar = 10 μm . d: mature planula ($\times 18$). e: fracture of mature planula, cilia (C), ectoderm (EC), endoderm (EN) Bar = 10 μm . f: fractured mature planula, ectoderm (EC), mesoglea (ME), endodermic vacuole (EV). Bar = 10 μm . g: 12–16 day old polyp ($\times 8$). h: young colony, arrows indicate buds of young polyps.

toderm and endodermal cells can be seen. The mesoglea of the planula is very thin, bounded by vacuolated endodermal cells (Fig. 8f), which probably serve for yolk storage. The cilia are uniformly scattered on the ectodermis, however due to the larval contractions, they might be hidden among the body folds. The planula larvae are elongated, barrel-shaped and recognized by their typical lemon-yellow color. When fully extended their maximal length reaches 2.4–3.2 mm. During the first days after maturation the planulae tend to change their shape by body contractions, from elongated to rounded and *vice versa*. Most of the time the larvae are attached to the substrate on their oral side by mucus secretion. Occasionally swimming is observed, typified by a corkscrew rotation along the oral-aboral axis. The larvae also tend to crawl over the substrate for short distances of a few cm.

Post-larval development and formation of a young colony

Laboratory and underwater experiments dealing with substrate selection by the planulae (Benayahu and Loya, in prep.) have enabled us to follow the morphological changes occurring during planulae metamorphosis. Development within the planulae population is not synchronized; differences in the developmental stages in the same age group may vary by as much as 3 to 5 days. During the first 3–7 days after planulae maturation they attach to the substrate and develop into young cone-shaped polyps, surrounded by 8 tentacular buds. During days 7–10 the tentacles elongate, and 8 septa are observed inside the polyp cavity. The development of the first pair of tentacular pinnules occurs during days 11–12. In days 12–16 an additional 4–7 pairs of pinnules develop on each tentacle (Fig. 8g). Within the next

month 2–3 secondary polyps develop in the young colony, and sclerites are seen within the polyp body (Fig. 8h).

Rhythmicity of spawning

Table II presents the timing of egg expulsion in the population of *P. f. fulvum*. The dates in the table represent the first day of each spawning (which may last 2–3 days). Successive underwater observations indicate that spawning starts around the middle of June and lasts for approximately two months. The process begins at dusk, and corresponds to a lunar periodicity, lasting from a few days after the new moon to a few days preceding its last quarter.

Although egg expulsion is synchronized, it does not occur simultaneously within the population. A sample of 130 colonies was examined underwater at the beginning of the breeding season in June 1978, a few days after first spawning was observed. The majority of the colonies from both sexes had not yet spawned, and only a minor number had shed part of their gametes.

Figure 9 represents the reproductive state of the shallow water population of *P. f. fulvum* sampled during summer 1980 at Muqebal'. The colonies are divided into 4 groups: males with sperm sacs, females with oocytes in the polyp cavities, females with eggs on their surface (brooding females), and colonies without any genital products. The first two dates represent the population reproductive structure before the breeding season. The majority of the colonies still contain gametes in their polyp cavities. The histograms from 21 and 22 June (Fig. 9) indicated the reproductive state a few days after gamete expulsion, which took place on 18 June (Table II). These results show a decrease in the percentage of male colonies with testes, hence, an increase in the number of colonies without any genital products. During these days, only a minor proportion of the population brood their larvae. Seven to ten days after spawning, in 26 and 28 June, no brooding females could be found. Similar reproductive structure was found at the two following dates. After the 15 July spawning (Table II), the population consisted of brooding females and colonies without gonads (17 July, Fig. 9). Underwater observations over large areas at various reef localities indicated that only a negligible percentage of corals spawned on 2 July 1980.

Figure 10 presents the reproductive structure of the population along a depth gradient at the M.B.L. reef during the breeding season of 1980. The upper part of the figure illustrates the results obtained on 18–20 July, and the lower part that of 2–4 August. The massive spawning of July (Table II) occurred along all the depth range studied. A few days after spawning, brooding females were observed, especially at a depth of 5–20 m. Consequently, a marked decrease of females with oocytes was noted. At reef zones deeper than 5 m, the percent of male corals with sperm

TABLE II

Timing of egg expulsion in the population of Parerythropodium fulvum fulvum

Date	Moon phase	Depth m
25 June 1978	Full moon—Last quarter	1–4
27 June 1979	New moon—First quarter	1–6
18 June 1980	New moon—First quarter	1–3
2 July 1980	Full moon—Last quarter	1–18
15 July 1980	New moon—First quarter	15–25
30 July 1980	Full moon—Last quarter	30–35
4 July 1981	Full moon—Last quarter	1–5

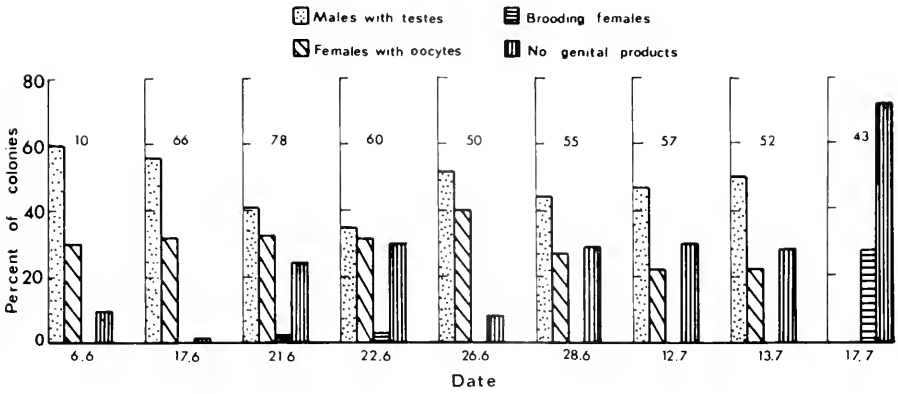

FIGURE 9. The reproductive state of shallow water population of *Parerythropodium fulvum fulvum* at Muqebla' during the breeding season of 1980. The numbers within each sampling date represent the sample size.

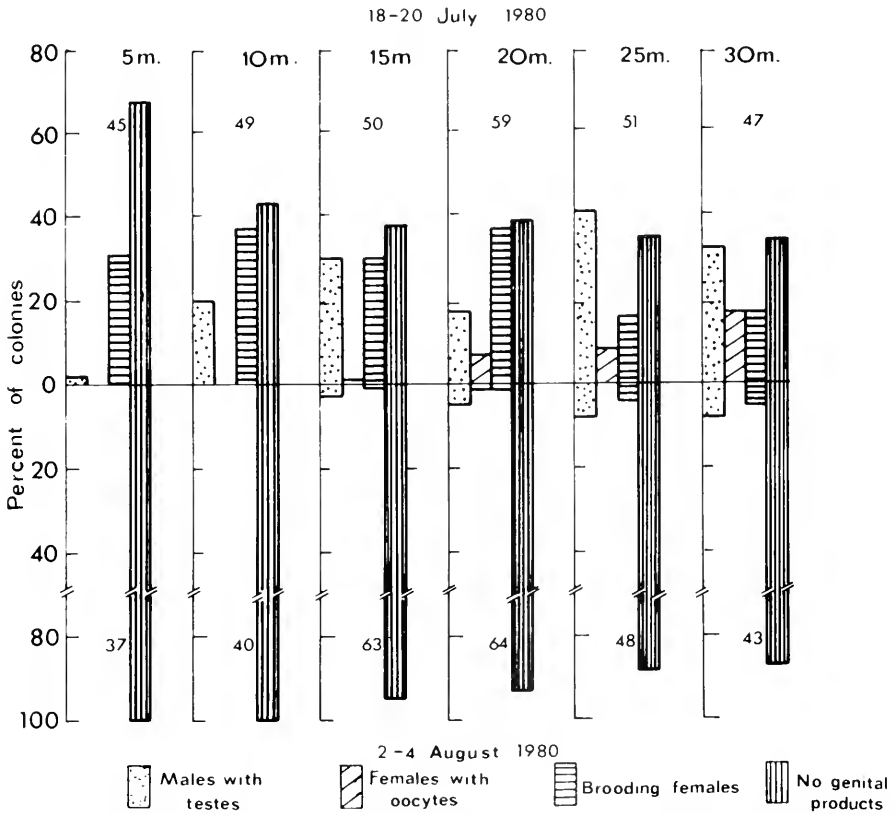

FIGURE 10. The reproductive structure of *Parerythropodium fulvum fulvum* along a depth gradient during the breeding season of 1980.

sacs still remained high. The spawning of 30 July (Table II) was recorded below 5 m depth. However, brooding colonies were observed only at 20–30 m depth. The lower part of Figure 10 indicates that after this spawning almost the whole population remained without genital products, except for a small number of males at a depth below 15 m. Figures 9 and 10 point out that the shallow water population breeds before the deeper one, and the whole reproductive period takes place during approximately two months.

DISCUSSION

During the last several years much interest has been focused on the life history of scleractinian corals (Harrigan 1972; Stimson, 1978; Rinkevich and Loya, 1979a, b; Szmant-Froelich *et al.*, 1980; Kojis and Quinn, 1981, Fadlallah and Pearse, 1982a, b). Although the significance of alcyonacean corals within the coral reef environment is well recognized, only scant surveys were conducted on their life history. The present study elucidates for the first time various aspects of the reproductive dynamics of the common Red Sea soft coral *P. f. fulvum*.

The general morphological features of the gonads of *P. f. fulvum* resemble those of *Alcyonium digitatum* (Hickson, 1895; Hill and Oxon, 1905) and *Heteroxenia fuscescens* (Gohar and Roushdy, 1961). Field experiments dealing with the colonization capacity of *P. f. fulvum* (Benayahu, 1982) indicate that all colonies above the age of 3–4 years old develop gonads. Small sized colonies mostly contain male gonads, while females become sexually mature at an older age. These results fit well with the common pattern found in other corals (Harrigan, 1972; Hartnoll, 1977; Grigg, 1977; Rinkevich and Loya, 1979b).

Sex ratios of *P. f. fulvum* differed between the shallow water and the deep reef populations. This may be due to local aggregations of the species (Benayahu, 1975). Such uneven distribution of individuals can cause local clumps of one sex. Additionally, asexual reproduction of *P. f. fulvum* formed by fragmentation (Benayahu, 1982), may cause deviation from a 1:1 sex ratio.

Fecundity of gorgonian octocorals has been determined as the number of planulae produced per polyp (Grigg, 1977). Thus, the alcyonaceans *Heteroxenia fuscescens* (Gohar, 1940a) and *Alcyonium digitatum* (Hartnoll, 1975) with long polyp cavities are characterized by high egg production. However, in *P. f. fulvum*, which has an encrusting growth form and short polyp cavities, fecundity is low (18–24 eggs per polyp).

Several studies reported lunar periodicity in the reproduction of stony corals (Harrigan, 1972; Stimson, 1978; Rinkevich and Loya, 1979b). This study documents a distinct lunar rhythmicity in the breeding of an alcyonacean coral. Lobel (1978) suggests that such spawning may act as a cue synchronizing simultaneous reproductive readiness within a species. We further speculate that this mechanism is critically important within colonies like *P. f. fulvum*, which breed only a few days per year. It should be noted that the time lag in spawning at greater depths (Fig. 10) is probably due to differences in time of the peak water temperature along depth gradient, as suggested by Grigg (1977) in his study on gorgonians.

Among the anthozoans, *P. f. fulvum* exhibits a unique mode of sexual reproduction and planulae development. This coral is oviparous, yet cleavage of the eggs takes place on the surface of the female colonies within a mucoid suspension. We term this peculiar mode of planula development as surface brooding. Brooding in marine invertebrates was defined by Dunn (1975) as "the retention of offspring by

parent through embryonic stages usually passed in the plankton," hence, *P. f. fulvum* is an external brooder. External brooding in anthozoans is uncommon. The group which is best known are actinians of the genus *Epiactis* (Chia, 1976), especially *E. prolifera* which broods its young on its lower column (Dunn, 1975). In this species the embryos are enveloped by the parent, and the ectoderm of the two are closely apposed. The intimate connection between the offspring and the parent is obligatory and essential for their development. Dunn further suggests that this might serve a nutritional function.

External brooding has also been recorded in the octocoral species from the order Stolonifera: *Clavularia crassa* (Kowalewsky and Marion, 1883), *Cornularia komaii*, and *C. saganiansis* (Suzuki, 1971). In these species the fertilized eggs developed into planulae in an external brooding cavity formed by the tentacles. The eggs of the scleractian coral *Goniastrea australensis* are expelled as masses embedded in mucus (Kojis and Quinn, 1981). They remain on the colony and after spawning is terminated, the eggs sink down to the bottom where planular development takes place. The results of the present work indicate that the brooding behavior of *P. f. fulvum* differs from that of other anthozoans with external brooding. Although no cellular connection exists between the embryos and the colonies, cleavage occurs on the external surface of the females. Thus, the embryos are protected from mechanical damage such as the erosive activity of sediment or wave action.

Membranaceous growth form is rare among the octocorals. The encrusting colonies of *P. f. fulvum* are characterized by a thin coenenchyme and short polyp cavities. Most eggs of soft corals are large in diameter (500–700 μm : Benayahu, 1982). It is therefore presumed, that if embryogenesis had been internal, the number of eggs per polyp would have been reduced even below the number of 18–24 oocytes due to small polyp size. We suggest that surface brooding maximizes fecundity and is an adaptation to the encrusting growth form. Egg production in *P. f. fulvum* is rather low, but this is compensated for by surface brooding which protects the offspring through embryogenesis. It is interesting to note that the three aforementioned external brooding Stolonifera species are also encrusting corals. Hence, the same reproductive strategy has been adopted by two different octocoral groups.

ACKNOWLEDGMENTS

We are indebted to the late Prof. C. Lewinsohn (Tel Aviv University) for his advice during this study. We are grateful to Dr. W. M. Goldberg (Florida International University) for critical comments on the manuscript. We thank the M.B.L. staff at Eilat for their hospitality and facilities. We would like to thank L. Maman and A. Shoob for taking the photographs. Y.B. is indebted to D. Benayahu for her endless help.

LITERATURE CITED

- BAYER, F. M. 1973. Colonial organization in octocorals. Pp. 69–93 in *Animal Colonies Development and Function Through Time*, R. S. Boardman, A. H. Cheetham, and W. A. Oliver Jr., eds. Dowden, Hutchinson and Ross, Inc. Stroudsburg, Pennsylvania.
- BENAYAHU, Y. 1975. Quantitative characteristics of community structure of stony corals, soft corals and algae in the northern Gulf of Eilat (Red Sea). M.Sc. Thesis, Tel Aviv Univ. 132 pp. (In Hebrew, with English summary).
- BENAYAHU, Y. 1982. Population dynamics of soft corals (Octocorallia, Alcyonacea) at the coral reefs of the Gulf of Eilat. Ph.D. Thesis, Tel Aviv Univ. 214 pp. (in Hebrew, with English summary).

- BENAYAHU, Y., AND Y. LOYA. 1977. Space partitioning by stony corals, soft corals and benthic algae on the coral reefs of the northern Gulf of Eilat (Red Sea). *Helgol. Wiss. Meeresunters.* **30**: 362-382.
- BENAYAHU, Y., AND Y. LOYA. 1981. Competition for space among coral-reef sessile organisms at Eilat, Red Sea. *Bull. Mar. Sci.* **31**: 514-522.
- CARY, L. R. 1931. Studies on the coral reefs of Tutuila, American Samoa, with especial reference to the Alcyonaria. *Pap. Tortugas Lab. Carnegie Inst. Wash.* **27**: 53-98.
- CHIA, F. S. 1976. Sea anemone reproduction: Patterns and adaptive radiation. Pp. 261-270 in *Coelenterate Ecology and Behavior*, G. O. Mackie, ed. Plenum Publishing Corporation, New York.
- DUNN, D. F. 1975. Reproduction of the external brooding sea anemone *Epiactis prolifera* Verrill, 1869. *Biol. Bull.* **148**: 199-218.
- FADLALLAH, Y. H., AND J. S. PEARSE. 1982a. Sexual reproduction in solitary corals: Overlapping oogenic and brooding cycles, and benthic planulas in *Balanophyllia elegans*. *Mar. Biol.* **71**: 223-231.
- FADLALLAH, Y. H., AND J. S. PEARSE. 1982b. Sexual reproduction in solitary corals: Synchronous gametogenesis and broadcast spawning in *Paracyathus stearnsii*. *Mar. Biol.* **71**: 233-239.
- FISHELSON, L. 1970. Littoral fauna of the Red Sea: The population of non scleractinian anthozoans of shallow waters of the Red Sea (Eilat) *Mar. Biol.* **6**: 106-116.
- FISHELSON, L. 1973. Ecological and biological phenomena influencing coral-species composition on the reef tables at Eilat. *Mar. Biol.* **19**: 183-196.
- GOHAR, H. A. F. 1940a. Studies on the Xenidiidae of the Red Sea. *Publ. Mar. Biol. Stn. Al Ghardaqa* **2**: 27-118.
- GOHAR, H. A. F. 1940b. The development of some Xenidiidae (Alcyonaria). *Publ. Mar. Biol. Stn. Al Ghardaqa* **3**: 27-76.
- GOHAR, H. A. F., AND H. M. ROUSHDY. 1961. On the embryology of the Xenidiidae (Alcyonaria) (with notes on the extrusion of the larvae). *Publ. Mar. Biol. Stn. Al Ghardaqa* **11**: 45-70.
- GRIGG, R. W. 1977. Population dynamics of two gorgonian corals. *Ecology* **58**: 278-290.
- HARRIGAN, J. 1972. The planula and larva of *Polcillopora damicornis*: Lunar periodicity of swarming and substratum selection behavior. Ph.D. Thesis Univ. of Hawaii. 213 pp.
- HARTNOLL, R. G. 1975. The annual cycle of *Alcyonium digitatum*. *Estuarine Coastal Mar. Sci.* **3**: 71-78.
- HARTNOLL, R. G. 1977. Reproductive strategy in two British species of *Alcyonium*. Pp. 321-328 in *Biology of Benthic Organisms*, P. O. Ceidigh and P. J. S. Boaden, eds. Pergamon Press, New York.
- HICKSON, S. J. 1895. The anatomy of *Alcyonium digitatum*. *Q. J. Microsc. Sci.* **37**: 343-388.
- HILL, M. D., AND M. A. OXON. 1905. Notes on the maturation of the ovum of *Alcyonium digitatum*. *Q. J. Microsc. Sci.* **49**: 493-505.
- KOJIS, B. L., AND N. J. QUINN. 1981. Aspects of sexual reproduction and larval development in the shallow water hermatypic coral *Goniastrea australensis* (Edwards and Haime, 1857) *Bull. Mar. Sci.* **31**: 558-573.
- KOWALEWSKY, A. O., AND A. F. MARION. 1883. Documents pour l'histoire embryogénique des Alcyonnaires. *Ann. Mus. Hist. Nat. Marseille* **1**: 6-50.
- LACAZE-DUTHIERS, H. 1865. Histoire naturelle du corail. Organisation, reproduction, peche ne Algérie, industrie et commerce. J. B. Bailliere et fils, Paris, Pp. 371.
- LOBEL, P. S. 1978. Diel, lunar and seasonal periodicity in the reproductive behavior of the pomacanthid fish, *Centropyge potteri* and some other reef fishes in Hawaii. *Pac. Sci.* **32**: 193-207.
- LOYA, Y., AND L. B. SLOBODKIN. 1971. The coral reefs of Eilat (Gulf of Eilat Red Sea). *Symp. Zool. Soc. Lond.* **28**: 117-139.
- MARAGOS, J. E. 1974. Coral communities on a seaward reef slope, Fanning Island. *Pac. Sci.* **28**: 257-278.
- MARISCAL, R., AND C. H. BIGGER. 1976. A comparison of putative sensory receptors associated with nematocysts in an anthozoan and a scyphozoan. Pp. 559-568 in *Coelenterate Ecology and Behavior*, G. O. Mackie, ed. Plenum Publishing Corporation, New York.
- MATTHEWS, A. 1917. The development of *Alcyonium digitatum* with some notes on the early colony formation. *Q. J. Microsc. Sci.* **62**: 43-94.
- PEARSON, R. G. 1981. Recovery and recolonization of coral reefs. *Mar. Ecol. Prog. Ser.* **4**: 105-122.
- RINKEVICH, B., AND Y. LOYA. 1979a. The reproduction of the Red Sea coral *Stylophora pistillata*. I. Gonads and planulae. *Mar. Ecol. Prog. Ser.* **1**: 133-144.
- RINKEVICH, B., AND Y. LOYA. 1979b. The reproduction of the Red Sea coral *Stylophora pistillata*. II. Synchronization in breeding and seasonality of planulae shedding. *Mar. Ecol. Prog. Ser.* **1**: 145-152.
- SCHUHMACHER, H. 1975. Die Rolle der weichkorallen (Alcyonacea, Octocorallia) innerhalb der riffbio-

- zönosen des roten meeres und des australischen grossen barrieriffs. *Verh. Zool. Ges.* **67**: 380-384.
- STIMSON, J. S. 1978. Mode and timing of reproduction of colonies in some common hermatypic corals of Hawaii and Enewetak. *Mar. Biol.* **48**: 173-184.
- SZMANT-FROELICH, A, P. YEVICH, AND M. E. Q. PILSON. 1980. Gametogenesis and early development of the temperate coral: *Astrangia danae* (Anthozoa:Scleractinia). *Biol. Bull.* **158**: 257-269.
- SUZUKI, H. 1971. Notes on *Cornularia* (Stolonifera, Alcyonacea) found in the vicinity of Manazuru marine biological laboratory. *Sci. Rep. Yokohama Nat. Univ. Sec. II.* **18**: 1-6.
- VERON, J. E. N., R. A. HOW, T. J. DONE, L. D. ZELL, M. J. DODKIN, AND A. F. O. FARRELL. 1974. Corals of the Solitary Islands, Central New South Wales. *Aust. J. Mar. Freshwater Res.* **25**: 193-208.
- VERSEVELDT, J. 1969. Octocorallia from North western Madagascar (Part I) *Zool. Verh. (Leiden)* **106**: 1-38.
- YAMAZATO, K., AND M. SATO. 1981. Reproductive biology of an alcyonarian coral, *Lobophytum crassum* Marenzeller. Pp. 74-75, abstract in *Proc. 4th Inter. Coral Reef Symp.* Manila.

SEXUAL DIMORPHISM AND REPRODUCTIVE BEHAVIOR IN
ALMYRACUMA PROXIMOCULI (CRUSTACEA:
CUMACEA): THE EFFECT OF HABITAT

THOMAS K. DUNCAN*

Boston University Marine Program, Marine Biological Laboratory, Woods Hole, Massachusetts 02543

ABSTRACT

Individuals of *Almyracuma proximoculi* are the least sexually dimorphic cumaceans known, because the males are progenetic, *i.e.*, they are precociously sexually mature at a morphologically immature state. This species lives in dense aggregations in the upper intertidal zone and has eliminated the morphologically complex, apparently pheromone-sensitive, and highly motile terminal male stage found in other cumacean species. The sexually dimorphic characters that are present are predominantly ones that facilitate the rapid removal of the female's exuviae by the male during her fertilization molt. The removal rate is critical, because the partially detached exuviae blocks access to the female's ventrum. With the exception of the rudimentary penes found in two genera, male cumaceans do not possess an intromittent organ and apparently must deposit one or more spermatophores on the female's ventrum before the developing oostegites completely enclose this area.

INTRODUCTION

Cumaceans belong to the superorder Peracarida, which also includes amphipods, isopods, tanaidaceans, and mysidaceans, among others. The Cumacea are infaunal peracarid crustaceans that are primarily marine and are found world-wide from the intertidal zone to abyssal depths (Jones, 1976). Sexually immature males and females have very similar external morphologies and ornamentation, and most of the sexually dimorphic characters are acquired in the last few molts (Zimmer, 1941).

Like most Peracarida, cumaceans brood their young in a ventral marsupium, and the most striking change in female morphology is the rapid and complete development of the oostegites in only two molts. The external development of the male is typically a more gradual process and involves the sexually dimorphic development of a variety of body parts (Forsman, 1938; Granger *et al.*, 1979; Bishop, 1982). Commonly this differential development of the male includes, but is not limited to, the following: an increased number and greater development of natatory thoracic exopodites; the presence of up to five pairs of natatory pleopods which, with the exception of one species, are never present in females; a less spinose carapace that generally has a lower profile than that of the conspecific female; and the flattening and broadening of various appendages and projections such as the epimeral plates of the thoracic and abdominal somites. No one species possesses all of these adaptations in their most developed forms, but typically a male cumacean will exhibit a combination of several of them, as in *Diastylis cornuta* (Fig. 1).

In addition to the above changes, the greatest differential development occurs in the male's second antennae. The second antennae of mature male cumaceans

Received 28 March 1983; accepted 18 July 1983.

* Present address: Department of Environmental Science, Nichols College, Dudley, Massachusetts 01570.

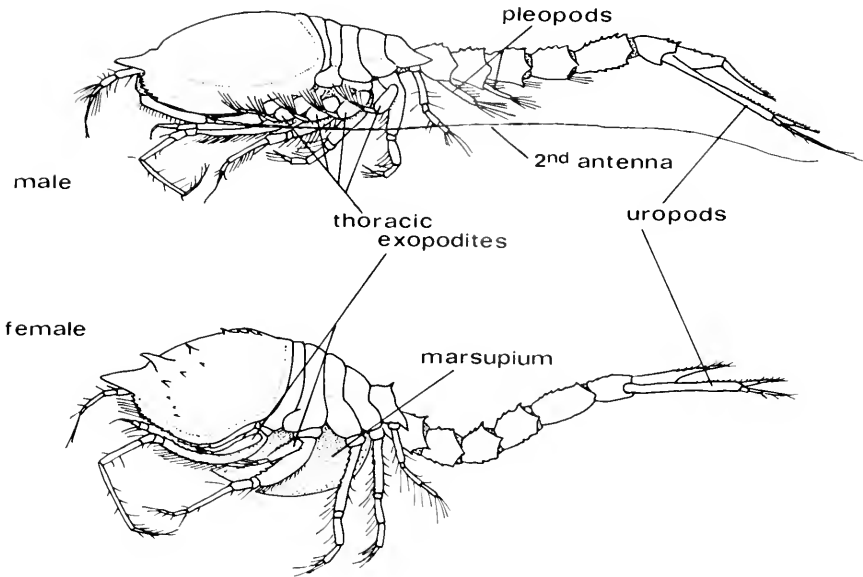

FIGURE 1. Copulatory male and marsupial female of *Diastylis cornuta* (after Sars, 1900).

are always well developed, with the exception of one species, while those of females are always rudimentary (Jones, 1963). In many species they equal or exceed the male's total body length (Sars, 1900). The development of these enormous antennae only in sexually mature male instars suggests that they are probably chemosensory, serving as the receptors for pheromones released by females before their fertilization molts, as has been demonstrated in the Amphipoda (Dahl *et al.*, 1970; Lyes, 1979). These two modes of differential development produce a motile, chemically sensitive male which is able to swim up into the water column and seek out potential mates.

The cumacean *Almyracuma proximoculi* Jones and Burbanck, 1959, is a small crustacean, with sexually mature individuals ranging from about 2.3 to 4.3 mm in length (Duncan, 1981). It has been collected in low numbers in estuarine areas from Currituck Sound, North Carolina, to Cape Cod, Massachusetts (Jones and Burbanck, 1959; Sanders *et al.*, 1965; Boesch and Diaz, 1974; Crandall, 1977; Ristich *et al.*, 1977; Menzie, 1980; T. E. Bowman, Smithsonian Institution, pers. comm.), but its optimal habitat appears to be thermally moderated areas in the immediate vicinity of freshwater springs in the upper intertidal zone of Long Island, New York, and southern New England. It inhabits these areas year-round, typical densities within a few meters of these groundwater discharges range from 3000–4500 m⁻², and extrapolated densities as high as 31,000 m⁻² have been recorded in these areas (Duncan, 1981). This species is essentially restricted to these disjunct, intertidal aggregations with high within-habitat densities and proportionately large distances between aggregations.

MATERIALS AND METHODS

Random samples of ten preparatory females and ten copulatory males from an intertidal freshwater spring in West Falmouth Harbor, Massachusetts, were measured with an ocular micrometer (± 0.0196 mm). All dimensions are from the left

sides of individuals, with the exception of the cross-sectional area of the fifth abdominal somite.

Laboratory observations were made on over 600 clasping pairs of individuals (copulatory male and preparatory or marsupial female). These individuals were collected from intertidal freshwater springs at the following localities on Cape Cod, Massachusetts: West Falmouth Harbor, Waquoit Bay, and Pocasset. Most of the individuals were maintained as isolated pairs in multicompartmented, transparent, plastic trays for up to four months. In addition to the animals, each compartment contained 20 ml of water and a small amount of sand from a collection site. Additional observations were made on groups of individuals maintained in glass finger bowls with varying amounts of water and substrate. Specimens for scanning electron microscopy were fixed in 5% glutaraldehyde for 10 min at room temperature, transferred to 95% ethanol, and air-dried on double-sided adhesive tape.

RESULTS

Morphology

The external morphology of the copulatory male of *A. proximoculi* is very simple (Fig. 2) and provides a sharp contrast to typical copulatory male cumaceans (Fig. 1). Neither sex has pleopods. Both sexes have a moderate and equivalent development of the thoracic exopodites, show similar profiles and smoothness of the carapace, and lack pronounced flattening and broadening of appendages or body parts. The male's second antenna is rudimentary and comparable to that of the female (Jones and Burbanck, 1959). With the exception of the developing oostegites of the female and the consequent greater width of her thorax, there are few other obvious morphological differences between the sexes.

The limited sexual dimorphism that is present in *A. proximoculi* is expressed mainly in the disproportionate development of the copulatory male's third maxillipeds and first pereopods (Fig. 2) and of most of the post-thoracic region of his body (Fig. 2, Table I). On average, the abdomens of copulatory males are 31% longer and have a 55% greater cross-sectional area when compared to those of preparatory females of similar carapace lengths. Additionally, the uropodal peduncles of these males are 65% longer and 25% wider than those of the females (Table I; Fig. 3A, B). In contrast, the male uropodal endopods are only 7% longer than the female ones, equivalent to the average difference in carapace lengths between the two groups.

Although there are no other major differences between the sexes in the general shape, sculpturing, or ornamentation of the integument, the medial surfaces of the male's uropodal peduncles and endopods are armed with two distinct types of spines which are arranged in single rows. Those found on the endopods are simple, cone-shaped projections which are more numerous on the male than on the female (usually six *versus* two, Fig. 3A, B, D). The second type is a complex, pinnate form (Fig. 3C) which is absent on female or less mature male stages. There are usually six to ten of these on each uropodal peduncle of a copulatory male. The same margin of female and earlier male instars carries only a few simple setae (Fig. 3A). The other margins of the uropodal appendages of both sexes are either bare or carry simple setae only (Fig. 3A, B).

Behavior

In late winter, throughout the spring, and during summer mature males will clasp preparatory females. During precopula the female is clasped and manipulated

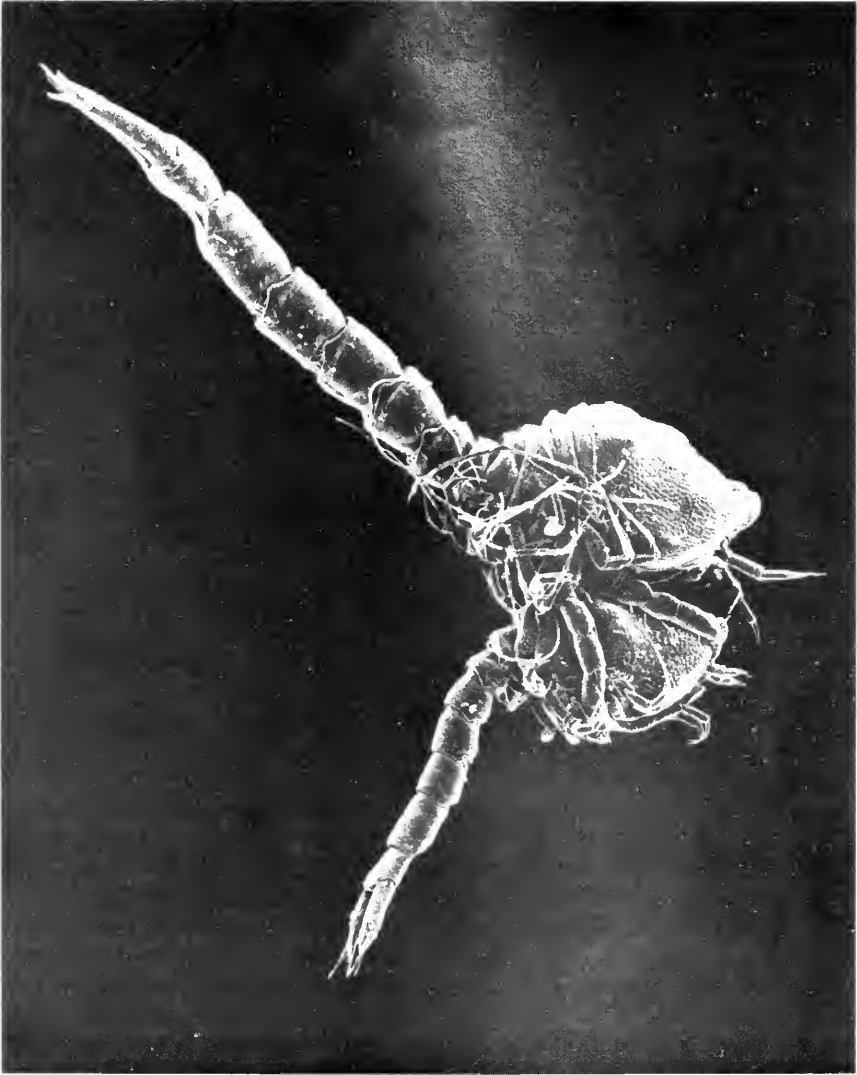

FIGURE 2. Scanning electron micrograph of a precopulatory clasp pair of *Amyracuma proximoculi*. The preparatory female is being held by the male's third maxillipeds and first pereopods.

with the male's oversized third maxillipeds and first pereopods (Fig. 2). She is usually carried in the same posterior-anterior alignment as the male with her dorsum adjacent to the male's ventral surface (2951 of 2962 observations). Unless disturbed, clasp pairs generally lie on their sides on the bottom of the observation dish, or if enough sediment is present, they remain buried. When disturbed they often swim up into the water, using the thoracic exopodites of the male and occasionally those of the female for locomotion. Males were never observed feeding while clasping females, but clasped females continue to feed normally by grasping sand grains and rotating them against their mouthparts. It is unknown how long pairs will remain in a clasped position in the field, but in laboratory conditions males have clasped

TABLE I

Mean dimensions and their standard errors of Almyracuma proximoculi

	Carapace length	Abdomen length	Cross-sectional area of fifth abdominal somite ($\times 10^3$)	Uropodal peduncle length	Uropodal peduncle width	Uropodal endopod length
preparatory female	851 \pm 12.3	1494 \pm 24.0	37.9 \pm 1.01	282 \pm 9.8	98 \pm 1.4	255 \pm 5.1
copulatory male	894 \pm 15.8	1952 \pm 30.4	58.9 \pm 1.89	465 \pm 8.8	123 \pm 7.3	272 \pm 3.5
increase in male	5.05%	30.7%	55.4%	64.9%	25.5%	6.67%

All dimensions are in micrometers, except for cross-sectional areas in square micrometers, and are from random samples of ten individuals of each sex.

females for as long as four months when the fertilization molt was experimentally delayed by lowering ambient temperatures.

Normally, the male's abdomen is straight or slightly flexed, but occasionally he flexes it enough to grasp the female's abdomen immediately behind the thorax with his uropods. The male then straightens his abdomen rapidly, raking the medial surfaces of his uropods along her abdomen. If copulatory males are present that are not already clasping females, they will approach a clasping pair and attempt to dislodge the male. During these events and while trying to hold onto the female in any way possible, either male uses his oversized abdomen and uropods in two ways. He attempts to force his uropods between the other male and the female and pry them apart and/or he grabs the other male's abdomen with his uropods and attempts to pull him off the female.

The fertilization molt is initiated by the splitting of the female's exuviae on the dorsal midline of the five exposed thoracic somites. Immediately after this the male moves his first pereopods under the loose thoracic segments of the exuviae and forces his third maxillipeds under the posterior margin of the exuvial carapace. The carapace then comes off in one piece. The five exuvial thoracic segments remain attached ventrally to each other and to the exuvial carapace and abdomen. Consequently, the detached portions of the exuviae hang beneath the female. The male then arches his abdomen, grasps the female's abdomen immediately behind the thorax with his uropods, and rakes the entire length of her abdomen with their inner surfaces (Fig. 4). This vigorous raking, involving considerable effort by the male, continues until the exuviae is pulled completely free from her abdomen. The male immediately turns the female over, reverses her anterior-posterior position, and briefly clasps her with their ventral surfaces opposed. Shortly thereafter ova can be seen within the marsupium. Females with fully developed marsupia very seldom elicit a response from males; but as soon as the young are released, and females molt back into a preparatory instar ("interbrood" stage, *sensu* Duncan, in prep.), mature males will clasp them.

DISCUSSION

The rudimentary state of the copulatory male's second antennae in *A. proximoculi* is unique among the approximately 1000 known species of Cumacea (Jones and Burbanck, 1959). The copulatory males of this species are progenetic (Duncan,

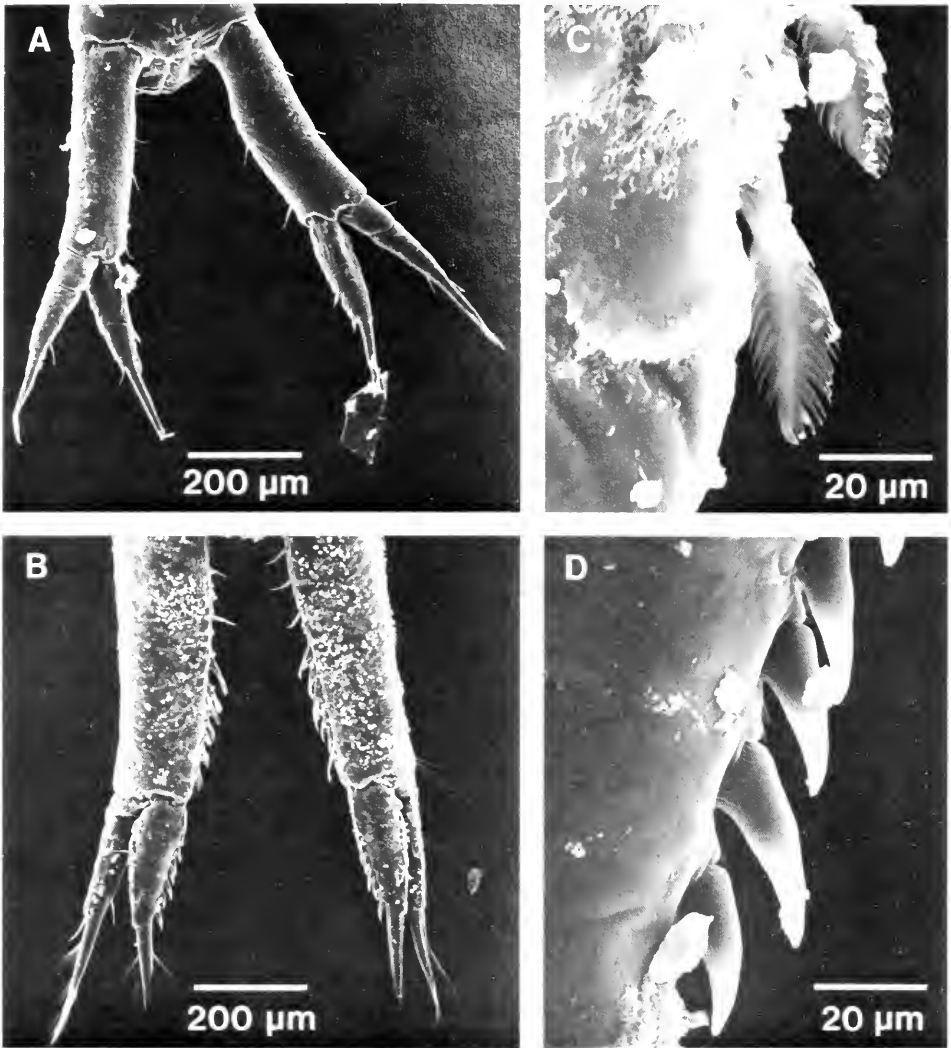

FIGURE 3. Scanning electron micrograph of the uropods of mature *Amyracuma proximoculi*: A) dorsal view of preparatory female; B) same view of copulatory male; C) dorsal view of two most distal spines on left peduncle in (B); D) dorsal view of middle spines on left endopod in (B).

1981), *i.e.*, they are precociously sexually mature at a morphologically immature state. I suggest that the typical distribution of this species in disjunct, dense, intertidal aggregations has eliminated the need for a pheromone-sensitive, highly motile, copulatory male. This distribution has apparently permitted this species to eliminate a morphologically complex instar that would normally be the final male stage and possibly reduces intraspecific competition for food resources that would otherwise be needed for the elaboration of body parts seen in the males of other species. In *Pseudocuma longicornis*, another cumacean species, "young males" clasp females, and "fully adult" males, although present, have never been observed in mating pairs (Foxon, 1936; Corey, 1969). This species is most common in low intertidal and

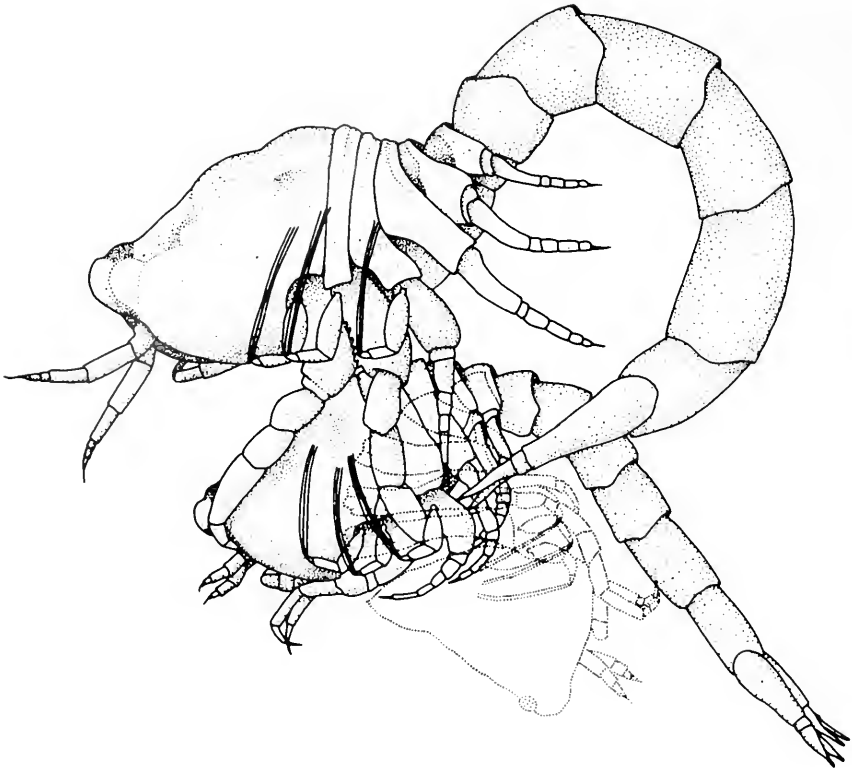

FIGURE 4. Precopulatory clasping pair of *Almyracuma proximoculi*, consisting of a copulatory male (top), a mature female (middle), and a partially detached exuvia (dotted outline at bottom).

shallow intertidal zones (Corey, 1970) and appears to be another example of pro-genetic development of copulatory males in a shallow water cumacean species.

The comparatively greater size and spination of the uropods of male cumaceans has been known for many years (Sars, 1900; Zimmer, 1941), and it has been suggested that these are adaptations for cleaning adhering material from the mouthparts and other appendages (Dixon, 1944). This function alone can not explain the striking sexual and ontogenetic differences seen in the uropods and abdomen of *A. proximoculi* and other species, since both sexes and the various instars of a particular species generally occur in the same substrate and can be expected to have the same cleaning requirements. Additionally, there is a distinct shift of morphological emphasis in the males of *A. proximoculi* from the enhancement of natatory functions to improving the males' ability to clasp and manipulate females.

The precopulatory clasping posture utilized by *A. proximoculi* (female dorsum clasped to male ventrum with both individuals in the same anterior-posterior alignment) is the same as has been noted in other Cumacea (Zimmer, 1941), with the exception of *Mancocuma stellifera* (Gnewuch and Croker, 1973) and *Spilocuma salomani* (Saloman, 1981). Saloman, citing Jones and Burbanck (1959), stated that male *A. proximoculi* grasp female abdomens with their second antennae. Apparently he misread the latter paper. The rudimentary development of these antennae (Jones and Burbanck, 1959; personal observation) makes such behavior impossible. Due to the position of the female's body and the use of the male's appendages for clasping, this posture probably precludes feeding by the males of most species during this period.

However, this may be unimportant, since the copulatory stage is usually a terminal one for male cumaceans, and most males die soon after mating. A similar nonfeeding pattern occurs in the copulatory males of several species of Tanaidacea, where the mouthparts are reduced and the anus is fused shut (Gardiner, 1975). Conversely, the elaborate natatory and sensory appendages seen in typical copulatory male cumaceans are maladaptive for the infaunal, burrowing lifestyle of young males and do not develop fully until the terminal instar.

Preparatory females and other developmental stages, including all of the immature male instars, molt successfully without aid in the laboratory. Therefore, it appears that the male's differential development and behavior serve only to accelerate the female's fertilization ecdysis. With the exception of the rudimentary penes found in two genera, *Archeocuma* (Băcescu, 1972) and *Campylaspenis* (Băcescu and Muradian, 1974), intromittent organs are unknown in the Cumacea, and sperm are extruded from two pores on the ventrum of the fifth thoracic somite. The partially detached exuviae blocks access to the female's thoracic ventrum, and shortly after molting the fully developed oostegites overlap each other considerably, completely enclosing this area. Thus the removal rate is critical, if the male is to gain access to this area and deposit a spermatophore successfully.

The unusual habitat of *A. proximoculi* has influenced both the morphology and the behavior of this species. High levels of chemosensitivity and swimming ability may not be particularly advantageous in a species, such as this one, that has a distributional pattern of high local densities in an intertidal area and relatively large distances between aggregations. Instead, the ability to rapidly remove a female's exuviae once molting has started and to deposit a spermatophore before the ventrum is enclosed by the marsupium or interruption and/or displacement by a competing male occurs appears to have influenced the morphology of the male of this species. *Almyracuma proximoculi* represents one end of the spectrum of morphological complexity and swimming ability found in male cumaceans that may be controlled, ultimately, by the densities of potential mates and competing males.

ACKNOWLEDGMENTS

I am very grateful to Masahiro Dojiri, Arthur Humes, Howard Sanders, and two anonymous reviewers, all of whom provided constructive criticism of earlier drafts of this paper. A substantial part of this paper has been extracted from a thesis submitted to Boston University in partial fulfillment of the requirements for the Ph.D. degree, and I am grateful for the support provided by this university.

LITERATURE CITED

- BĂCESCU, M. 1972. *Archeocuma* and *Schizocuma*, new genera of Cumacea from the American tropical waters. *Rev. Roum. Biol. Sér. Zool.* **17**: 241-250.
- BĂCESCU, M., AND Z. MURADIAN. 1974. *Campylaspenis*, *Styloptocuma*, *Atlantacuma*, new genera of Cumacea from the deep waters of the Atlantic. *Rev. Roum. Biol. Sér. Zool.* **19**: 71-78.
- BISHOP, J. D. D. 1982. The growth, development and reproduction of a deep sea cumacean (Crustacea: Peracarida). *Zool. J. Linn. Soc.* **74**: 359-280.
- BOESCH, D., AND R. DIAZ. 1974. New records of peracarid crustaceans from oligohaline waters of the Chesapeake Bay. *Chesapeake Sci.* **15**: 56-59.
- COREY, S. 1969. The comparative life histories of three Cumacea (Crustacea): *Cumopsis goodsiri* (van Beneden), *Iphinoe trispinosa* (Goodsir), and *Pseudocuma longicornis* (Bate). *Can. J. Zool.* **47**: 695-704.
- COREY, S. 1970. The quantitative distribution of three Cumacea. *Can. J. Zool.* **48**: 925-930.
- CRANDALL, M. E. 1977. Epibenthic invertebrates of Croton Bay in the Hudson River. *N. Y. Fish Game J.* **24**: 178-186.
- DAHL, E., H. EMANUELSSON, AND C. VON MECKLENBURG. 1970. Pheromone reception in the males of the amphipod *Gammarus duebeni* Lilljeborg. *Oikos* **21**: 42-47.

- DIXON, A. Y. 1944. Notes on certain aspects of the biology of *Cumopsis goodsiri* (van Beneden) and some other cumaceans in relation to their environment. *J. Mar. Biol. Assoc. U. K.* **26**: 61-71.
- DUNCAN, T. K. 1981. *Life history and ecology of Almyracuma proximoculi Jones and Burbanck, 1959 (Crustacea: Cumacea)*. Ph.D. Thesis, Boston University.
- DUNCAN, T. K. (in prep.). Life history of *Almyracuma proximoculi* Jones and Burbanck, 1959, (Crustacea: Cumacea) from intertidal freshwater springs on Cape Cod, Massachusetts. Submitted to *J. Crust. Biol.*
- FORSMAN, B. 1938. Untersuchungen über die Cumaceen des Skageraks. *Zool. Bidr. Upps.* **18**: 1-162.
- FOXON, G. E. H. 1936. Notes on the natural history of certain sand-dwelling Cumacea. *Ann. Mag. Nat. Hist. (Ser. 10)* **17**: 377-393.
- GARDINER, L. F. 1975. The systematics, postmarsupial development, and ecology of the deep-sea family Neotanaide (Crustacea: Tanaidacea). *Smithson. Contrib. Zool.* **170**: 1-265.
- GNEWUCH, W. T., AND R. A. CROKER. 1973. Macroinfauna of northern New England marine sand. I. The biology of *Mancocuma stellifera* Zimmer, 1943. (Crustacea: Cumacea). *Can. J. Zool.* **51**: 1011-1020.
- GRANGER, D., P. BRUNEL, AND D. MESSIER. 1979. Cycle de développement de *Leucon nasica* (Crustacea, Cumacea) dans la nappe glaciale circalittorale de la baie des Chaleurs, golfe du Saint-Laurent, en 1968 et 1969. *Can. J. Zool.* **57**: 96-106.
- JONES, N. S. 1963. The marine fauna of New Zealand: crustaceans of the order Cumacea. *Bull. N. Z. Dep. Scient. Ind. Res.* **152**(Mem. No. 23, N. Z. Oceanogr. Inst.): 9-78.
- JONES, N. S. 1976. *British Cumaceans*. Academic Press, New York.
- JONES, N. S., AND W. D. BURBANCK. 1959. *Almyracuma proximoculi*, gen. et spec. nov. (Crustacea, Cumacea) from brackish water of Cape Cod, Massachusetts. *Biol. Bull.* **116**: 115-124.
- LYES, M. C. 1979. The reproductive behavior of *Gammarus duebeni* (Lilljeborg), and the inhibitory effect of a surface active agent. *Mar. Behav. Physiol.* **6**: 47-55.
- MENZIE, C. A. 1980. The chironomid (Insecta: Diptera) and other fauna of a *Myriophyllum spicatum*. L. plant bed in the lower Hudson River. *Estuaries* **3**: 38-54.
- RISTICH, S. S., M. CRANDALL, AND J. FORTIER. 1977. Benthic and epibenthic macroinvertebrates of the Hudson River. I. Distribution, natural history, and community structure. *Estuar. Coast. Mar. Sci.* **5**: 255-266.
- SALOMAN, C. H. 1981. Aspects of the biology of *Spilocuma Salomani* (Cumacea: Boditriidae) [sic]. *Northeast Gulf Sci.* **4**: 99-104.
- SANDERS, H. L., P. C. MANGELSDORF, JR., AND G. R. HAMPSON. 1965. Salinity and faunal distribution in the Pocasset River, Massachusetts. *Limnol. Oceanogr.* **10**(suppl.): R216-R229.
- SARS, G. O. 1900. *An Account of the Crustacea of Norway with Short Descriptions and Figures of All of the Species. 3. Cumacea*. Bergen Museum, Bergen.
- ZIMMER, C. 1941. Cumacea. In *Bronn's Kl. Ordn. Tierreichs* **5**(1): 1-222.

ULTRASTRUCTURAL DIFFERENCES IN THE EGGS AND OVARIAN FOLLICLE CELLS OF *CAPITELLA* (POLYCHAETA) SIBLING SPECIES

KEVIN J. ECKELBARGER¹ AND JUDITH P. GRASSLE²

¹Functional Reproductive Biology Program, Harbor Branch Foundation, R.R. 1, Box 196, Fort Pierce, Florida 33450, and ²Marine Biological Laboratory, Woods Hole, Massachusetts 02543

ABSTRACT

Ultrastructural studies of ovarian follicle cells and mature eggs in four sibling species in the polychaete genus *Capitella* have revealed distinct and consistent morphological differences that parallel in some respects the differences between the species in egg size, and embryonic and larval development. *Capitella* spp. I and II are extremely similar in all respects: the follicle cells lack lipid and contain a modest amount of glycogen; the mature eggs are rich in lipid and glycogen and contain very similar proteid yolk granules. In both species mature eggs have a characteristic electron-dense band and a zone of mitochondria in the cortical ooplasm. These sympatric species have eggs that are similar in size and lecithotrophic larvae that are planktonic for only a short time. *Capitella* sp. III (*Capitella jonesi*) has ovarian follicle cells containing a small amount of lipid and no glycogen, while the mature eggs have a small amount of lipid, abundant glycogen, and large proteid yolk granules. These small eggs show no evidence of an electron-dense band or any concentration of mitochondria in the cortical ooplasm. This species has planktotrophic larvae that remain in the plankton for many weeks. *Capitella* sp. IIIa has ovarian follicle cells rich in both lipid and glycogen. The large mature eggs are rich in lipid, have relatively little glycogen, and have abundant proteid yolk granules. The cortical ooplasm contains electron-dense material similar to that observed in the eggs of species I and II but it is distributed in a discontinuous band. This species has direct development, and juvenile worms emerge from the parental brood tube after metamorphosis. The egg envelopes and microvilli of the eggs of all four sibling species undergo substantial morphological changes following release from the ovary into the coelom.

The significance of these morphological and biochemical differences between the species is not known, but the lack of intraspecific variation in these characters suggests that their presence or absence reflects specific differences in the processes of yolk formation and utilization.

INTRODUCTION

Comparative studies of metazoan sperm structure have demonstrated considerable interspecific variation unprecedented in other cell types. Since one of the events in speciation is the creation of barriers to crosses between new species and the parental forms, it is generally thought that the modifications in sperm morphology and their properties may contribute to the establishment of such a barrier. Baccetti and Afzelius (1976) point out that species specificity not only resides in the genetic material bound in the nucleus of the spermatozoan but is also imprinted in the morphology of the cell itself. Thus in some nereid polychaetes, for example,

we observe markedly different sperm types in morphologically similar species (Hauenschild, 1951; Durchon, 1955). Comparative studies of egg morphology are rare however, because at the light microscope level at least, female germ cells show far less structural variation. Aside from differences in volume, color, general shape, or perhaps features of the egg envelope, there are fewer morphological parameters available for cytological comparisons than in sperm. However, comparative light microscope observations on egg morphology in closely related polychaete species have been reported in orbinids (Anderson, 1961) spionids, (Blake, 1969) and cirratulids (Gibbs, 1971).

It seems reasonable to assume that in some cases, barriers to cross fertilization between incipient species might be reflected by morphological changes in the eggs as they are in sperm. Recent comparative ultrastructural studies of oogenesis in four species of the sibling complex of *Capitella* have revealed distinct and consistent morphological differences in the ovarian follicle cells and mature eggs among members of this group. The differences include variation in the relative quantities of nutritive materials stored in the mature egg which in turn may reflect differences in the energetic requirements of the larvae. These findings are the first to our knowledge, to describe ultrastructural differences in the female germ cells of closely related invertebrate species.

Capitella capitata (Fabricius), formerly regarded as an opportunistic, cosmopolitan polychaete species characteristically present in dense populations in highly disturbed environments (Grassle and Grassle, 1974; Pearson and Rosenberg, 1978), recently has been shown to be a complex of more than ten sibling species (Grassle and Grassle, 1976; Grassle, 1980). Although the morphologies of the adults are very similar, the species show striking differences in life history features including reproductive mode, breeding season, egg size, and dispersal capability of the larvae. Marked differences are also observed in the electrophoretic mobilities of allozymes at selected enzyme loci, indicating that genetic distances between species are great. In addition, individuals of the various sibling species do not hybridize in the laboratory or in the field (Grassle and Grassle, 1976; Grassle, 1980). The *Capitella* species complex is particularly interesting because it represents a wide range of reproductive variation from species I, which has large eggs (260 μm), small broods (30–400 eggs), and a lecithotrophic larval dispersal phase of only a few hours to species III (*Capitella jonesi*) which has small eggs (50 μm), large broods (200–1000 eggs), and a planktotrophic larval phase of five weeks or more. The length of oogenesis also varies from 5–7 days in species I to 40–50 days in species IIIa. Breeding seasons range from a short period in winter or early spring (species Ia and III) to those which breed throughout the year (species I and II).

MATERIALS AND METHODS

Animals used in this study belong to four genetically distinct sympatric *Capitella* species collected from the field in the vicinity of Woods Hole, Massachusetts. The material from *Capitella* spp. I, II, and IIIa was obtained from laboratory strains. *Capitella jonesi* (*Capitella* sp. III, Grassle and Grassle, 1976) individuals were collected in the field and maintained in the laboratory. Worms were kept in filtered, standing sea water at 15°C and were provided with azoic mud as food and substrate. Food and water were changed at bi-weekly intervals. For electron microscopy, genital segments from females and hermaphrodite individuals at various stages of sexual maturity were cut into small pieces. Tissue fixation and preparation were according to procedures previously outlined in Eckelbarger (1979). Sections of embedded tissue

were cut on a Porter-Blum MT-2B ultramicrotome with a diamond knife, stained with aqueous saturated uranyl acetate followed by lead citrate, and examined with a Zeiss EM-9S2 electron microscope.

RESULTS

The ovaries of all members of the *Capitella* sibling species complex examined are paired, sac-like organs, suspended by mesenteries in the ventral coelomic cavity throughout the mid-body segments. Each ovary consists of a sac (or follicle) formed by somatic follicle cells in which the oocytes complete vitellogenesis. The follicle cells are modified coelomic peritoneal cells which become hypertrophic prior to vitellogenesis and undergo marked cytological changes including the development of extensive arrays of rough endoplasmic reticulum (RER) and numerous Golgi complexes (Fig. 1). In the medial region of the ovary, developing oocytes remain in intimate contact with the layer of follicle cells but gradually lose the association as they reach their maximum size and expand into the lateral region of the ovary where they cease growth and await ovulation. When release from the ovary occurs, possibly resulting from the active migration of follicle cells from the surface of the eggs (Eckelbarger and Grassle, 1982), the eggs enter the coelom where they float freely for a variable period before being spawned by the female. Laboratory observations indicate that the period of coelomic egg storage in the female is minimal when a sexually mature male is present in the culture. Most ultrastructural features of the eggs in the lateral region of the ovary are indistinguishable from those floating freely in the coelom, although the egg envelopes of all four sibling species and the cortical ooplasm in the egg of species IIIa undergo additional differentiation following ovulation. All ovulated eggs have a prominent germinal vesicle and there is no indication that further maturation occurs before spawning. Numerous ovarian follicle cells, ovarian eggs, and ovulated eggs from many individuals were carefully examined ultrastructurally in all stages of vitellogenesis in the four sibling species of *Capitella*. No intraspecific variation in follicle cell and mature egg morphology was apparent.

Follicle cells

The ovarian follicle cells of these four members of the *Capitella* sibling species complex have many similar ultrastructural features. These include the presence of large nuclei each with a prominent nucleolus, extensive RER, Golgi complexes, a variety of membrane-bound, heteromorphic electron-dense bodies resembling lysosomes, bundles of fibrils measuring 5–7 nm, mitochondria, and often a pair of centrioles (Fig. 2). However, there are consistent differences in the relative number of glycogen granules and lipid droplets found in these cells throughout the life history of each species (Table I). Species I and II follicle cells are similar in not possessing lipid droplets at any stage of oogenesis (Figs. 2, 4) whereas species IIIa cells have an abundant quantity (Fig. 3). The follicle cells of species III have a small number of lipid droplets. Except for species III, the follicle cells of each of the species contain glycogen (Figs. 3, 4). These differences are readily apparent after observing semi-serial sections from numerous ovaries in many individuals in different stages of sexual maturity. Since quantitative methods of comparison between the follicle cells of various siblings would be difficult, we have made qualitative, ultrastructural comparisons based on the absence of lipid or glycogen or its presence in small, moderate, or abundant quantities (Table I).

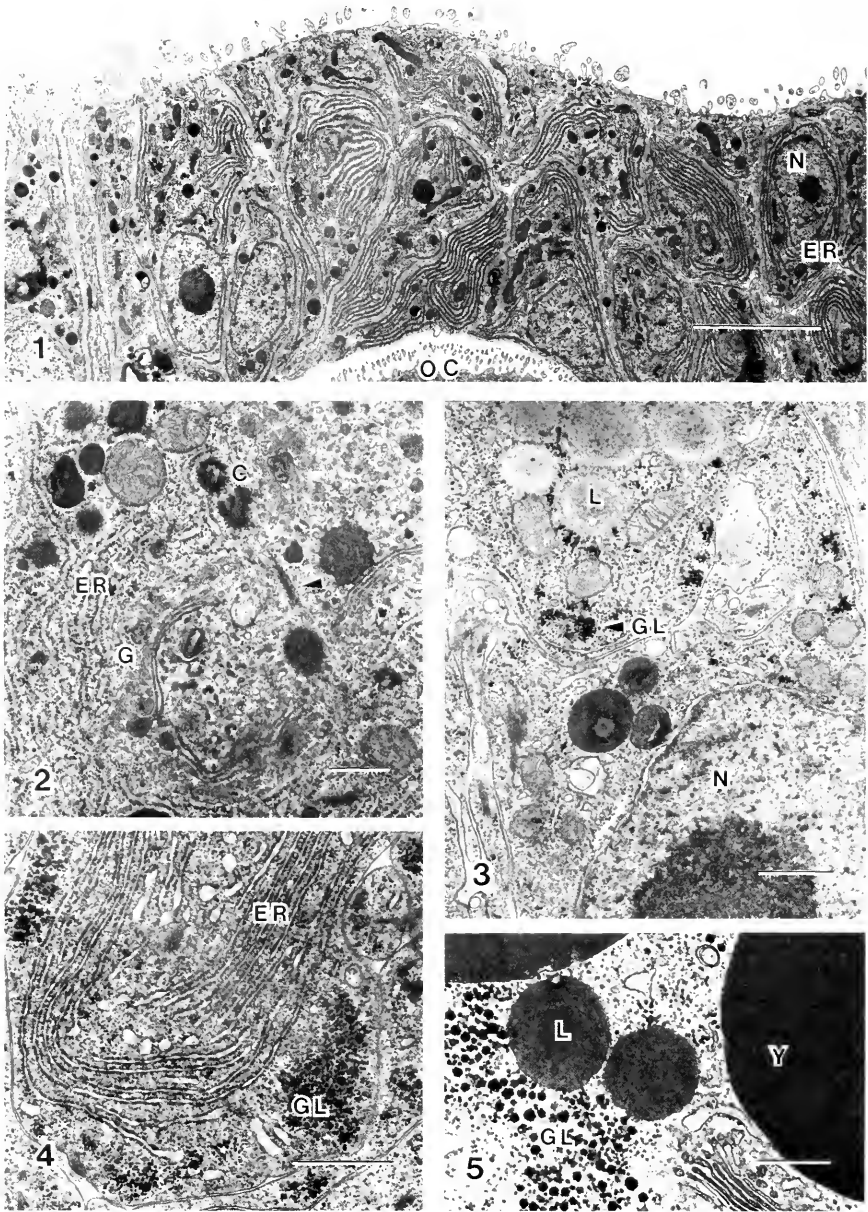

FIGURE 1. Stratified layer of follicle cells composing the wall of the ovary in *Capitella* species III. N, nucleus; ER, rough endoplasmic reticulum; OC, vitellogenic oocyte. Bar = 5 μ m.

FIGURE 2. Follicle cell from ovary of *Capitella* species I showing centrioles (C), Golgi complex (G), fibrils (arrowhead) and rough ER. Bar = 0.6 μ m.

FIGURE 3. Lipid (L) droplets in follicle cell of *Capitella* IIIa ovary. N, nucleus; GL, glycogen. Bar = 1.5 μ m.

FIGURE 4. Rough ER and electron-dense glycogen granules (GL) in the follicle cells of *Capitella* species II. Bar = 2 μ m.

FIGURE 5. Large membrane-bound proteid yolk (Y), small lipid droplets (L) and glycogen granules (GL) in the mature egg of *Capitella* species III. Bar = 1.5 μ m.

TABLE I

Ultrastructural features of eggs and follicle cells of Capitella sibling species

	Egg diameter (μm)	Larvae in plankton	Follicle cells	Egg	Yolk granule diameter (μm)*	Egg envelope (coelomic eggs)	Cortical ooplasm (coelomic eggs)
SPECIES I	260 by 180	Several hours	Lipid ⁻ Glycogen ⁺⁺	Lipid ⁺⁺ Glycogen ⁺⁺⁺	3.1	Envelope 1.2 μm thick Slender microvilli with smooth surfaces	Electron-dense band Mitochondria concentrated in band
SPECIES II	190	Several days	Lipid ⁻ Glycogen ⁺	Lipid ⁺⁺ Glycogen ⁺⁺⁺	3.1	Envelope 0.8 μm thick Smooth microvilli	Electron-dense band Mitochondria concentrated in band
SPECIES III	50	Approx. 5 weeks	Lipid ⁺ Glycogen ⁻	Lipid ⁺ Glycogen ⁺⁺⁺	4.75	Envelope 0.75 μm thick Microvilli granulated on lateral surfaces	No electron-dense material or mitochondrial band Random distribution of organelles
SPECIES IIIA	250	None	Lipid ⁺⁺⁺ Glycogen ⁺⁺	Lipid ⁺⁺⁺ Glycogen ⁺	3.7	Envelope 0.6 μm thick Short, stubby microvilli with granular tips	Intermittent band of electron-dense material Random distribution of organelles.

- none

+ rare

++ moderate

+++ abundant

* based on the average of 100 of the largest yolk granules

Eggs

The mature eggs of all four sibling species are creamy-white to pale yellow in color. As many as three types of nutritive material or yolk are recognizable in the eggs including large, membrane-bound, spherical, proteid yolk bodies, small unbound lipid droplets, and electron-dense glycogen granules (Fig. 5). The formation of these yolk materials has been described in a previous publication (Eckelbarger and Grassle, 1982). The proteid yolk granules are usually spherical in shape and vary in size within the same egg. This variation probably results, in part, from a sectioning artifact in which only a portion of some granules are visible in any one section. The maximum diameter of yolk granules does show considerable interspecific variation (based on measurement of 100 of the largest yolk granules per egg). The smallest (averaging $3.1 \mu\text{m}$) is found in species I and II, and the largest (averaging $4.75 \mu\text{m}$) in species III. Those of species IIIa are intermediate in size, averaging $3.7 \mu\text{m}$. Qualitative observations suggest that the number of these granules per unit area is approximately the same in the ovulated egg of all four sibling species (Figs. 6–9) with the exception of species IIIa which appears to have many more (Fig. 9).

In addition to differences in species-specific egg diameter and yolk granule diameter, there are also differences in the arrangement and location of cortical organelles in the eggs. These differences are first observed in the early to middle stages of vitellogenesis and persist in some species even after release from the ovary. The cortical regions of the eggs of species I and II are free of all organelles except for a distinct band of mitochondria (Figs. 10, 11). Apart from their concentration in a cortical monolayer, these mitochondria are indistinguishable from those present in the remainder of the ooplasm. There is also a thin (100–120 nm) layer of amorphous electron-dense material parallel to the oolemma (Figs. 10, 12, 15, 16, 19). This circumferentially arrayed band sometimes appears, in favorable sections, to consist of densely packed but randomly oriented filaments which extend into the adjacent microvilli in some instances. This band appears during early vitellogenesis (Fig. 12) while the mitochondrial band appears during the middle stages of yolk formation. The eggs of species III and IIIa lack the monolayer of mitochondria. The electron-dense band is absent from the cortical ooplasm of species III eggs but is present as a discontinuous band in the eggs of species IIIa. The cortical region of the egg of species III contains the same random mixture of yolk granules and mitochondria as the remainder of the egg (Fig. 13) at all stages of development while that of species IIIa possesses a unique organelle-free cortical zone up to $2.6 \mu\text{m}$ wide (Fig. 14) which persists until ovulation. Following release from the ovary, the organelle-free zone disappears and the ooplasmic components become evenly distributed (Fig. 18). The post-ovulatory arrangement of ooplasmic organelles remains unchanged in the eggs of species I, II, and III (Figs. 15–17).

Prior to release of the eggs into the coelom, the egg envelopes of all four species are similar in thickness and in having short, branching microvilli and a simple electron-dense layer extending from the oolemma to near the tips of the microvilli (Figs. 19–22). Following ovulation, however, substantial changes are observed in the egg envelope and the morphology of the egg microvilli (Figs. 23–26). The envelope varies in thickness from $1.2 \mu\text{m}$ in species I to $0.6 \mu\text{m}$ in species IIIa. The microvilli covering the eggs of species I, II, and III have flattened, swollen, or branching tips (Figs. 23–25), while those of species IIIa are short with constricted tips bearing small granules (Fig. 26). The lateral surfaces of the microvilli in species I, II, and IIIa are relatively smooth while those of species III have a granulated appearance (Fig. 25). Table I summarizes the ultrastructural differences between the coelomic eggs and ovarian follicle cells of the four sibling species.

DISCUSSION

The occurrence of sibling species in polychaetes in which members of natural populations are morphologically similar or identical yet reproductively isolated has been revealed through the analysis of morphological data, reproductive processes,

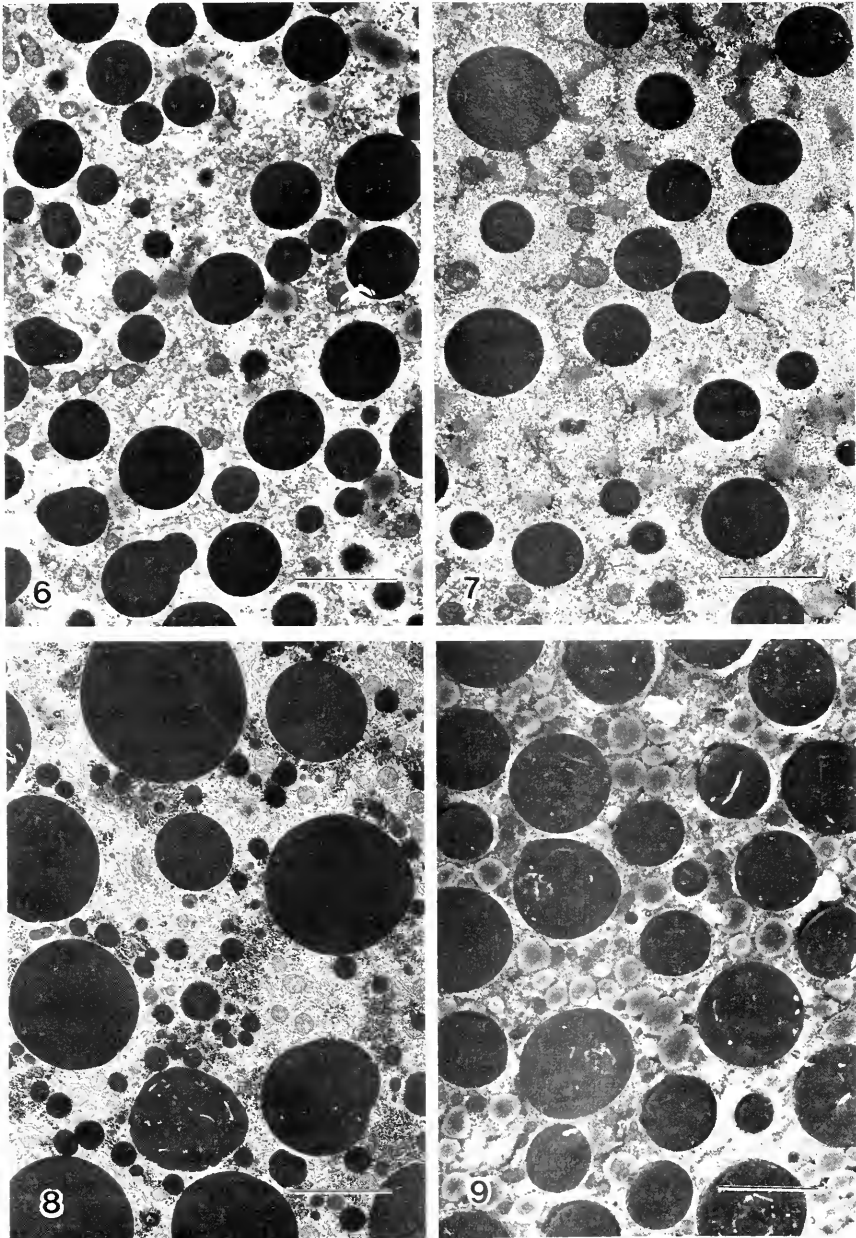

FIGURES 6-9. Yolk bodies from mature (coelomic) eggs of *Capitella* sibling species. Figure 6, species I; Figure 7, species II; Figure 8, species III; Figure 9, species IIIa. Bars = 3.0 μm .

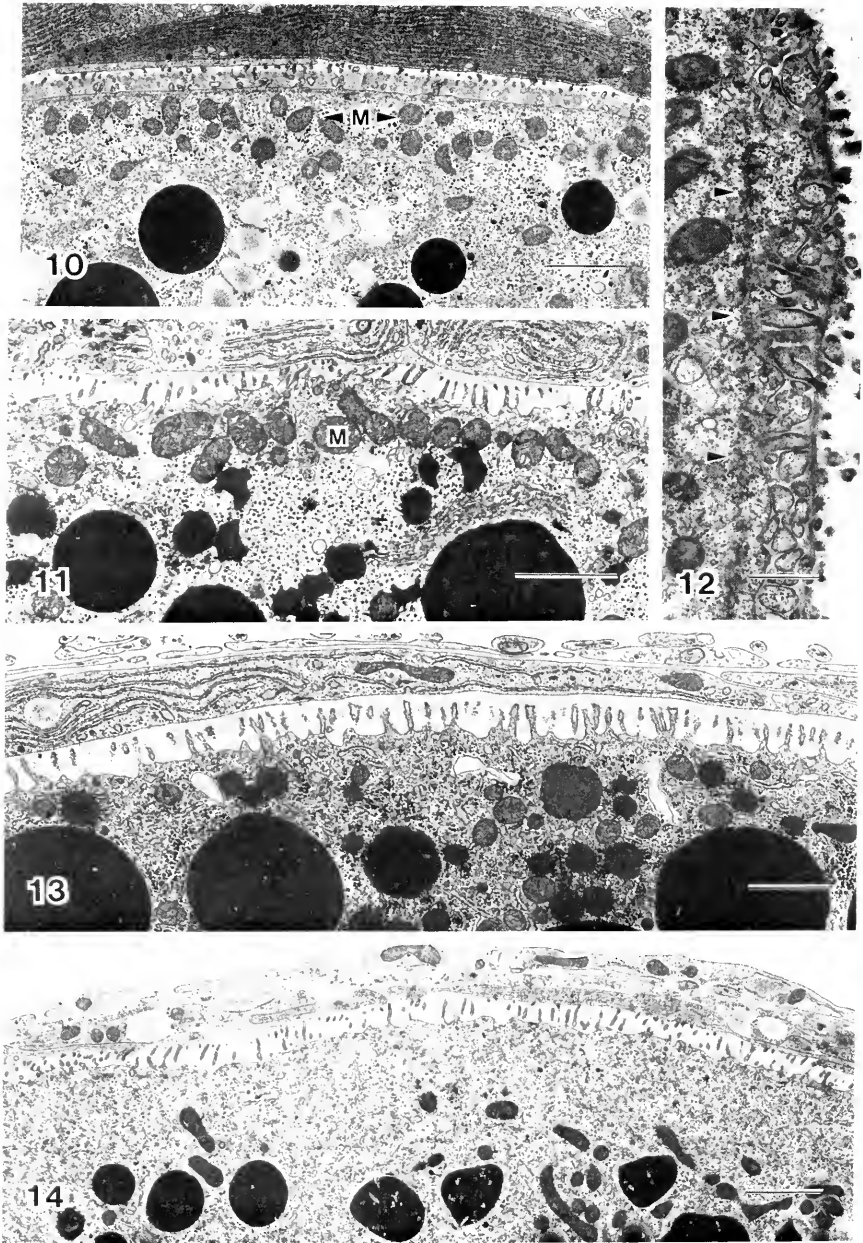

FIGURES 10, 11, 13, 14. Cortical ooplasm of eggs in lateral region of ovary. Eggs have completed growth and vitellogenesis.

FIGURE 10. Cortical ooplasm of *Capitella* species I showing band of mitochondria (M). Bar = 2 μm .

FIGURE 11. Cortical ooplasm of *Capitella* species II showing band of mitochondria (M). The thin layer of amorphous electron-dense material parallel to the oolemma is seen to the right of the mitochondria in this section.

FIGURE 12. Band of amorphous material (arrowheads) adjacent to newly forming microvilli in cortical ooplasm of early vitellogenic oocyte of *Capitella* species I. Bar = 0.53 μm .

FIGURE 13. Cortical ooplasm of *Capitella* species III egg. Bar = 1.3 μm .

FIGURE 14. Cortical ooplasm of *Capitella* species IIIa showing organelle-free zone. Bar = 1.8 μm .

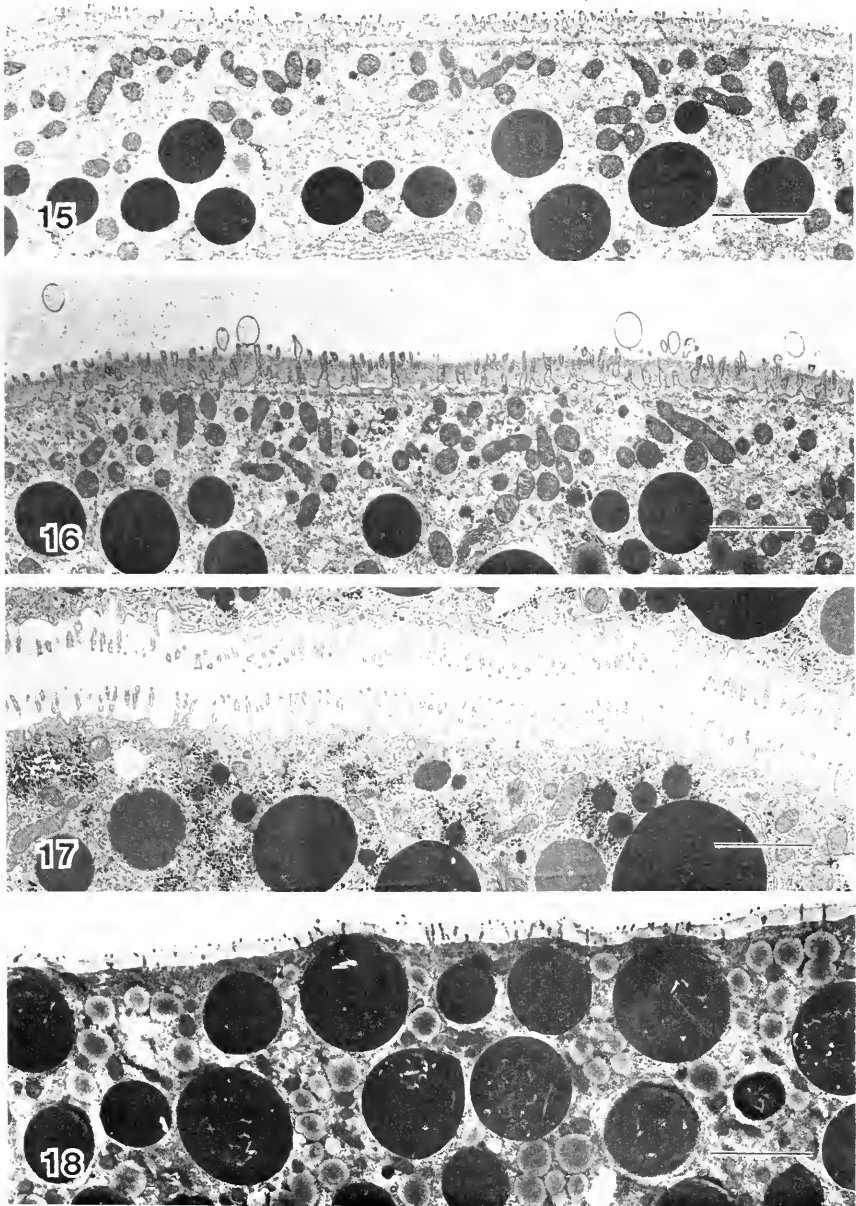

FIGURES 15-18. Cortical ooplasm of coelomic eggs of *Capitella* sibling species. Figure 15, species I; Figure 16, species II; Figure 17, species III; Figure 18, species IIIa. Bars = 3.0 μm .

physiological responses, and electrophoretic patterns of related enzymes (see review by Rice and Simon, 1980). The present paper is the first to our knowledge to describe interspecific differences in the eggs and follicle cells of sibling species in any invertebrate. These findings are especially interesting in that not only is interspecific

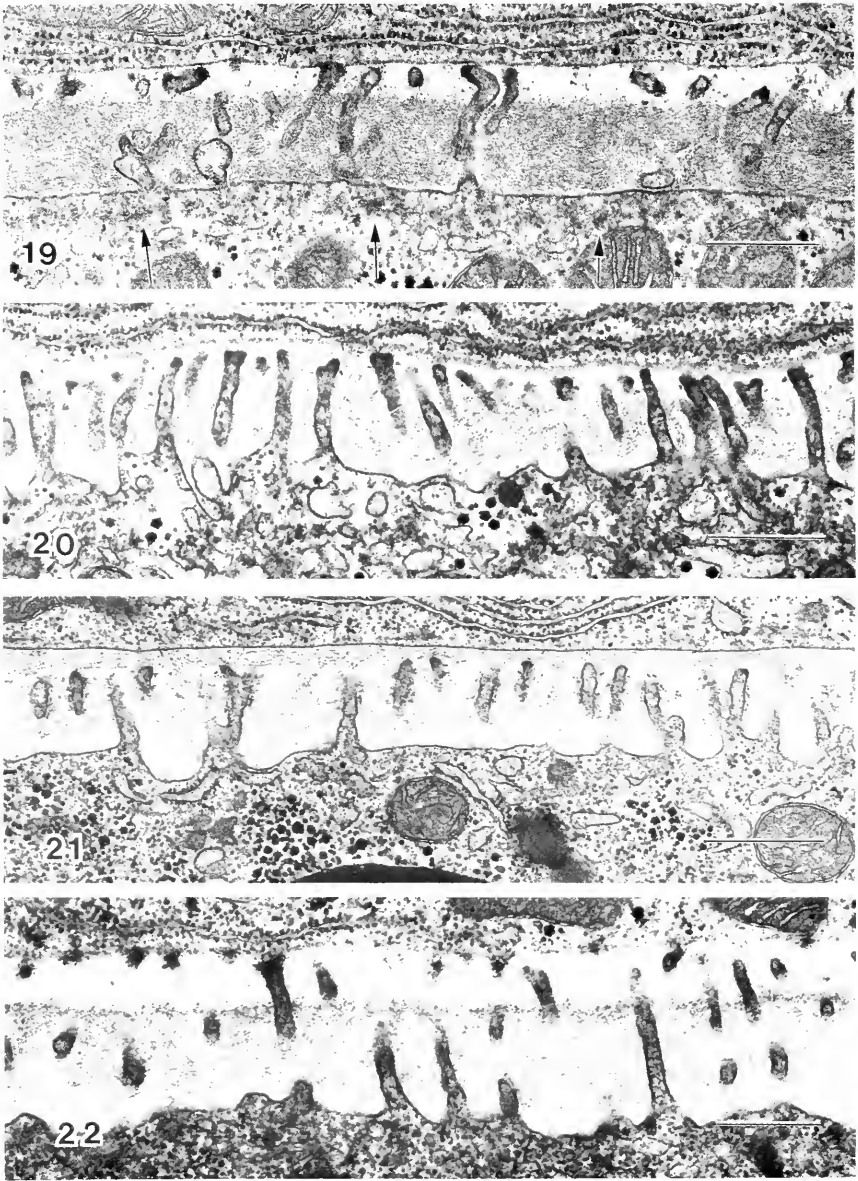

FIGURES 19-22. Egg envelopes of ovarian eggs of *Capitella* sibling species. Figure 19, species I; Figure 20, species II; Figure 21, species III; Figure 22, species IIIa. Note the amorphous material (arrows) parallel to the oolemma in Figure 19. Bars = 0.63 μm .

variation on the ultrastructural level demonstrated but also that the variation occurs in the female gamete which generally shows little gross morphological variation. The significance of differences in cortical organelle distribution or type of nutrient material in the eggs of *Capitella* sibling species is not readily apparent but it does not appear to bear any obvious relationship to egg size, cleavage pattern, or type of larval development.

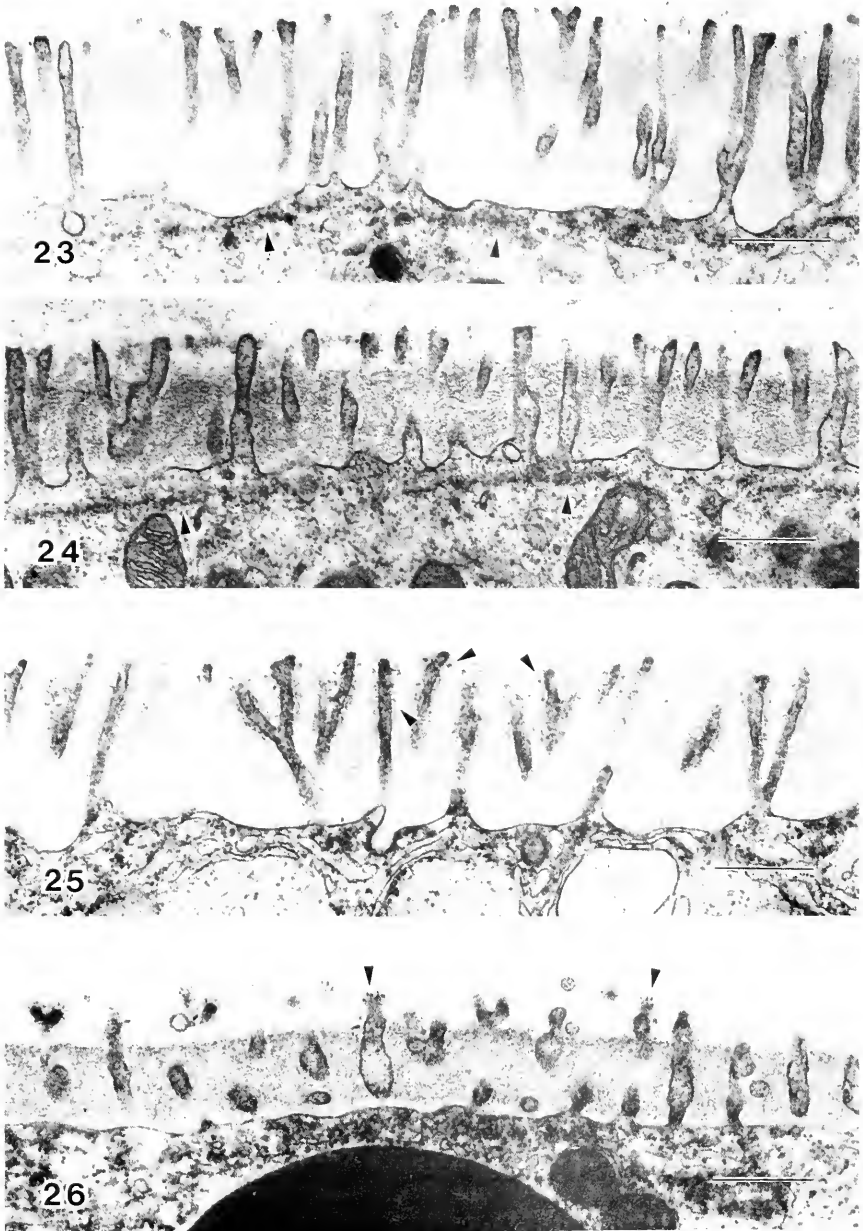

FIGURES 23-26. Egg envelopes of coelomic eggs of *Capitella* sibling species. Figure 23, species I; Figure 24, species II; Figure 25, species III; Figure 26, species IIIa. Note the band of amorphous material (arrowheads) adjacent to the oolemma in Figures 23 and 24. Note also the granules attached to the lateral surfaces of the microvilli in Figure 25 and to the microvillar tips in Figure 26. Bars = 0.6 μ m.

The use of ultrastructural characters in phylogeny and systematics is gradually gaining support (see review by Tyler, 1979). With regard to *Capitella*, some of the ultrastructural differences observed in the eggs of the four sibling species are further

evidence of morphological divergence in this taxonomically difficult species group and may have systematic applications. Some features of the eggs such as the cortical mitochondria in species I and II are not strictly ultrastructural characters since they are discernible with careful light microscopy. However, the cortical band of amorphous material observed in the eggs of species I, II, and IIIa, is only visible with electron microscopy. These additional morphological features may be of systematic importance when combined with the abundant information already available on adult morphology, genetics, and reproductive and life history characteristics (Grassle and Grassle, 1976; Grassle, 1980). Interspecific differences in the relative size, number, and morphological features of the large proteid yolk granules also appear to exist, although it is difficult to establish homology between them. Although they appear to have similar origins (Eckelbarger and Grassle, 1982), it is likely they have very different chemical composition despite their morphological similarity. The use of various morphological features of yolk granules as systematic characters has been proposed in some invertebrate oocytes (Gremigni, 1979) although this approach has been strongly criticized (Tyler, 1981).

The concentration of mitochondria in the cortical ooplasm in the eggs of *Capitella* species I and II is unusual for a polychaete but not uncommon for other animal oocytes (Raven, 1961; Arnold, 1971; Boyer 1972). Localization or stratification of ooplasmic components was termed "ooplasmic segregation" by Costello (1948) and quite often is restricted to the animal pole or polar lobe of the egg (Allen, 1961; Raven, 1961; Anderson and Huebner, 1968; Huebner and Anderson, 1976). In *Diopatra cuprea*, for example, Anderson and Huebner (1968) found yolk granules to be vegetally located and lipid and mitochondria were found in the animal pole. This localized stratification was even retained during early cleavage. Costello (1945, 1948) reported ooplasmic segregation in *Nereis limbata* only following fertilization. Recently, Eckberg (1981), using electron microscopy to study the eggs of *Chaetopterus pergamentaceus*, reported that cytoplasmic components are localized in different regions of the egg and that this localization is maintained as the embryo undergoes cleavage and differentiation. Hess (1971) noted that ooplasmic organelles such as yolk bodies, mitochondria, and endoplasmic reticulum, as well as cellular products such as various types of RNA and metabolites, are unevenly distributed during ooplasmic segregation but are later evenly distributed to the blastomeres during the process of cleavage. The presence of a cortical, organelle-free zone in the egg of species IIIa prior to ovulation, and its disappearance following release from the ovary, is a developmental event previously unreported in an annelid egg. Its significance is unknown.

The functional importance of mitochondrial segregation in *Capitella* eggs is unknown. It is clearly tempting to try to relate ooplasmic segregation to mosaic egg development. However, it has been demonstrated that displacement of cell organelles by reverse centrifugation of some mosaic eggs does nothing to alter development (Clement, 1968). Huebner and Anderson (1976) suggested that a similar distribution of cortical mitochondria in the egg of the hemipteran *Rhodnius prolixus* might reflect the need for an energy source for pinocytosis by the oolemma. Although this is possible in some eggs, it seems unlikely for *Capitella* eggs since only the eggs of species I and II have this mitochondrial layer even though the level of endocytotic activity appears to be the same in the eggs of all the sibling species examined.

The significance of the amorphous electron-dense band in the cortical ooplasm of the eggs of species I, II, and IIIa is obscure. Some micrographs suggest that this layer is composed of fine filaments although this is uncommon in oocytes. Anderson (1969) described a prominent layer of filaments parallel to the oolemma in the

developing oocytes of the amphineurans *Mopalia mucosa* and *Chaetopleura apiculata* but did not speculate as to their possible significance. The amorphous substance observed in the eggs of *Capitella* might represent a less organized, non-filamentous form of microfilament similar to that described in the sperm duct epithelium of the ascidian *Ciona intestinalis* by Woollacott and Porter (1977). If the material in *Capitella* eggs indeed represents a microfilament reserve, the precise role of the putative organelles is problematical. They could serve a structural function, or be involved in morphogenetic movements, the fertilization reaction, or perhaps in the movement of mitochondria into the cortical ooplasm.

Wide variation in egg envelope morphology has been reported in different genera of polychaetes within the same family (Eckelbarger, in press) but never among closely related species of the same genus. This variation may be related to differences in the types of yolk precursors and metabolites being absorbed by the eggs during vitellogenesis or to the development of cross fertilization barriers. The morphological changes observed in the egg microvilli before and after ovulation in *Capitella* have not been previously described in polychaetes. This demonstrates that additional differentiation of the egg can occur following separation from the investing follicle cells which appear to be crucial to yolk synthesis.

Follicle cells are often associated with developing oocytes in polychaetes (Eckelbarger, in press) but extensive deposits of lipid and glycogen, as reported here in some *Capitella* ovaries, are uncommon. Eckelbarger (1979) reported some lipid and extensive deposits of glycogen in the follicle cells associated with the ovary in *Phragmatopoma lapidosa*. These deposits were believed to be utilized by the developing oocytes during vitellogenesis. Heacox and Schroeder (1981) observed lipid in the follicle cells associated with the gonial cell clusters in *Typosyllis pulchra* which they suggested might serve as nutrient material for the oocytes during development. In many polychaetes, the coelomic peritoneum often stores lipid and glycogen which are believed to serve a nutritive function during vitellogenesis, particularly in species undergoing extraovarian oogenesis (Eckelbarger, 1983). The ovarian follicle cells of *Capitella* are derived from the peritoneum, and the lipid and glycogen stores are believed to be destined for the developing oocytes (Eckelbarger and Grassle, 1982).

The differences reported here in the relative quantities of lipid and glycogen in the ovarian follicle cells of *Capitella* sibling species, presumably reflect the ultimate differences in types and quantities of yolk materials stored in the eggs. This in turn probably has a significant effect on embryogenesis and larval development particularly when egg size and subsequent developmental pattern (*i.e.*, planktotrophy versus lecithotrophy) vary so widely between the *Capitella* species under discussion. There are apparent differences in the general types of nutritive materials stored in the eggs of *Capitella* but unfortunately nothing is known of their chemical nature. It is tempting to use egg size as a unit of adult energy expenditure since it has been widely used in theoretical considerations of life history patterns (see Stearns, 1976) but it can be a misleading parameter which ignores organic composition (Turner and Lawrence, 1979). Indeed, in a study of the eggs of several invertebrate groups including polychaetes, Strathmann and Vedder (1977) reported that although organic matter per egg increases with egg diameter or volume, it is not directly proportional to egg volume because small eggs have more concentrated organic matter than larger eggs. It will be of interest to quantify the various organic components stored in the mature eggs of these *Capitella* sibling species (*i.e.*, proteid yolk, lipid, glycogen), to see how these materials might be utilized during embryogenesis and early larval development. This should help us better understand the developmental and ecological implications of the disparate distribution of nutrient material in the

follicle cells and eggs of *Capitella*. Laboratory studies of inbred strains of the lecitotrophic *Capitella* spp. I and II indicate that there is marked variation between lines in the capacity of the larvae to delay settlement in the absence of suitable substrate without suffering post-settling mortality (Grassle, unpub.). We expect these differences to be reflected in between-line differences in the amounts and/or types of nutritive materials incorporated into the eggs.

ACKNOWLEDGMENTS

The authors wish to acknowledge the technical assistance of C. Gelfman, P. A. Linley, S. W. Mills, and K. G. Panker. This paper is contribution No. 347 of the Harbor Branch Foundation.

LITERATURE CITED

- ALLEN, M. J. 1961. A cytochemical study of the developing oocytes and attached nurse cells of the polychaetous annelid *Diopatra cuprea* (Bosc). *Acta Embryol. Morphol. Exp.* **4**: 219-238.
- ANDERSON, D. T. 1961. The development of the polychaete *Haploscoloplos fragilis*. *Q. J. Microsc.* **102**: 257-272.
- ANDERSON, E. 1969. Oocyte-follicle cell differentiation in two species of amphineurans (Mollusca), *Mopalia mucosa* and *Chaetopleura apiculata*. *J. Morphol.* **129**: 89-126.
- ANDERSON, E., AND E. HUEBNER. 1968. Development of the oocyte and its accessory cells of the polychaete *Diopatra cuprea* (Bosc). *J. Morphol.* **126**: 163-198.
- ARNOLD, J. M. 1971. Cephalopods. Pp. 265-310 in *Experimental Embryology of Marine and Freshwater Invertebrates*, G. Reverberi, ed. American Elsevier Publishing Co., New York.
- BACCETTI, B., AND B. A. AFZELIUS. 1976. *The Biology of the Sperm Cell*. S. Karger Publishing, Basel. 254 pp.
- BLAKE, J. A. 1969. Reproduction and larval development of *Polydora* from northern New England. (Polychaeta: Spionidae). *Ophelia* **7**: 1-63.
- BOYER, B. C. 1972. Ultrastructural studies of differentiation in the oocyte of the polyclad turbellarian, *Prostheceraeus floridanus*. *J. Morphol.* **136**: 273-296.
- CLEMENT, A. C. 1968. Development of the vegetal half of the *Ilyanassa* egg after removal of most of the yolk by centrifugal force, compared with the development of animal halves of similar visible composition. *Dev. Biol.* **17**: 165-186.
- COSTELLO, D. P. 1945. Segregation of ooplasmic constituents. *J. Elisha Mitchell Sci. Soc.* **61**: 277-289.
- COSTELLO, D. P. 1948. Ooplasmic segregation in relation to differentiation. *Ann. N.Y. Acad. Sci.* **49**: 663-683.
- DURCHON, M. 1955. Sur le polymorphisme présenté par quelques néréidiens (annélides polychètes) au moment de la reproduction. *Bull. Soc. Hist. Nat. Afr. Nord.* **46**: 180-193.
- ECKBERG, W. R. 1981. An ultrastructural analysis of cytoplasmic localization in *Chaetopterus pergamentaceus*. *Biol. Bull.* **160**: 228-239.
- ECKELBARGER, K. J. 1979. Ultrastructural evidence for both autosynthetic and heterosynthetic yolk formation in the oocytes of an annelid. (*Phragmatopoma lapidosa*: Polychaeta). *Tissue Cell* **11**: 425-443.
- ECKELBARGER, K. J. In Press. Comparative aspects of oogenesis in polychaetes. In *Polychaete Reproduction: Progress in Comparative Reproductive Biology*, A. Fischer and H.-D. Pfannenstiel, eds. Proc. of Symposium, Helgoland, West Germany, April 1982. Fortschritte der Zoologie, (M. Lindauer, ed.), Wurzburg.
- ECKELBARGER, K. J. 1983. Evolutionary radiation in polychaete ovaries and vitellogenic mechanisms: Their possible role in life history patterns. *Can. J. Zool.* **61**: 487-504.
- GIBBS, P. E. 1971. A comparative study of reproductive cycles in four polychaete species belonging to the family Cirratulidae. *J. Mar. Biol. Assoc. U.K.* **51**: 745-769.
- GRASSLE, J. F., AND J. P. GRASSLE. 1974. Opportunistic life histories and genetic systems in marine benthic polychaetes. *J. Mar. Res.* **32**: 253-284.
- GRASSLE, J. P., AND J. F. GRASSLE. 1976. Sibling species in the marine pollution indicator *Capitella* (Polychaeta). *Science* **192**: 567-569.
- GRASSLE, J. P. 1980. Polychaete sibling species. Pp. 25-32 in *Aquatic Oligochaete Biology*, R. O. Brinkhurst and D. G. Cook, eds. Plenum Publishing Corp., New York.
- GREMIGNI, V. 1979. An ultrastructural approach to planarian taxonomy. *Syst. Zool.* **28**: 345-355.

- HAUENSCHILD, C. 1951. Nachweis der sogenannten atoken Geschlechtsform des Polychaeten *Platynereis dumerilii* Aud. et. M.-Edw. als eigene Art auf Grund von Suchtversuchen. *Zool. Jahrb. Abt. Allg. Zool. Physiol. Tiere.* **63**: 107-128.
- HEACOX, A. E., AND P. C. SCHROEDER. 1981. A light and electron microscopic investigation of gametogenesis. *Cell Tissue Res.* **218**: 641-658.
- HESS, O. 1971. Fresh water gastropods. Pp. 215-247 in *Experimental Embryology of Marine and Fresh-water Invertebrates*, G. Reverberi, ed. American Elsevier Publishing Co., New York.
- HUEBNER, E., AND E. ANDERSON. 1976. Comparative spiralian oogenesis—structural aspects: An overview. *Am. Zool.* **16**: 315-343.
- PEARSON, T. H., AND R. ROSENBERG. 1978. Macrobenthic succession in relation to organic enrichment and pollution of the marine environment. *Oceanogr. Mar. Biol. Assoc. Rev.* **16**: 229-311.
- RAVEN, C. 1961. *Oogenesis: The Storage of Developmental Information*. Pergamon Press, New York. 247 pp.
- RICE, S. A., AND J. L. SIMON. 1980. Intraspecific variation in the pollution indicator polychaete *Polydora ligni* (Spionidae). *Ophelia* **19**: 79-115.
- STEARNS, S. C. 1976. Life history tactics: A review of the ideas. *Q. Rev. Biol.* **51**: 3-47.
- STRATHMANN, R. R., AND K. VEDDER. 1977. Size and organic content of eggs of echinoderms and other invertebrates as related to developmental strategies and egg eating. *Mar. Biol.* **39**: 305-309.
- TURNER, R. L., AND J. M. LAWRENCE. 1979. Volume and composition of echinoderm eggs: implications for the use of egg size in life-history models. Pp. 25-40 in *Reproductive Ecology of Marine Invertebrates*, S. E. Stancyk, ed. Univ. South Carolina Press, Columbia.
- TYLER, S. 1979. Contributions of electron microscopy to systematics and phylogeny: introduction to the symposium. *Am. Zool.* **19**: 541-543.
- TYLER, S. 1981. Ultrastructural characters in planarian taxonomy: another point of view. *Am. Zool.* **30**(1): 71-73.
- WOOLLACOTT, R. M., AND M. E. PORTER. 1977. A synchronized multicellular movement initiated by light and mediated by microfilaments. *Dev. Biol.* **61**: 41-57.

ULTRASTRUCTURE OF EARLY EMBRYONIC SHELL FORMATION IN THE OPISTHOBRANCH GASTROPOD *AEOLIDIA PAPILLOSA*^a

LINDA S. EYSTER

Marine Science and Maritime Studies Center, Northeastern University, Nahant, Massachusetts 01908

ABSTRACT

Early shell formation was examined in embryos of the opisthobranch gastropod *Aeolidia papillosa*. Secretion of the first organic shell material occurs prior to closure of the shell gland lumen, contrary to reports for other molluscan embryos. This difference suggests that in externally shelled gastropods and bivalves initiation of shell secretion may be coincident with narrowing of the shell gland pore rather than with closure of the lumen. The shell growth region was examined ultrastructurally. As no shell material is seen in the shell gland lumen, the shell gland seems not to be actively involved in shell secretion. Initial shell material is secreted only by cells surrounding the shell gland pore. Shell material seems to be added, not in a gap between cells as previously described, but over the apical surface of cells at the growing edge. The growing edge of the shell and the growing edge cells are covered by cytoplasmic extensions arising from the neighboring cells distal to the shell gland. No infoldings of the growing edge cell membranes are seen. The first organic shell material is 20 nm thick, consists of two electron dense layers separated by an electron lucent layer, and is secreted at least 33 hours (5°C) before shell mineralization, as detected by polarizing microscopy.

INTRODUCTION

Most molluscs secrete external calcareous shells. Although this secretion begins during early embryogenesis, most of our knowledge of shell formation is derived from studies of post-embryonic molluscs (*e.g.*, Wilbur and Jodrey, 1952; Bevelander and Nakahara, 1969; Wilbur, 1972; Saleuddin, 1974; Weiner and Hood, 1975; Young *et al.*, 1977a, b; Wheeler *et al.*, 1981.). Kniprath (1981) summarized the literature on the development, morphology, and function of the embryonic shell gland and shell field in molluscs; little is known about how, when, and where embryonic shell material is secreted. To date, the only molluscs in which embryonic shell formation has been studied ultrastructurally are the marine bivalves *Mytilus galloprovincialis* and *M. edulis* (Humphreys, 1969; Kniprath, 1980b), the freshwater pulmonate *Lymnaea stagnalis* (Kniprath, 1977), the terrestrial pulmonate *Helix aspersa* (Kniprath, 1980a), the freshwater prosobranch *Marisa cornuarietis* (Kniprath, 1979), and the chitons *Lepidochitona cinera* and *Ischnochiton rissoa* (Haas *et al.*, 1979; Kniprath, 1980c).

The region of ectodermal cells responsible for embryonic shell secretion is called the shell field. Preceding embryonic shell formation in all gastropod and bivalve molluscs, a region of the dorsal shell field invaginates to form the "shell gland"

Received 28 March 1983; accepted 20 July 1983.

^a Contribution No. 113 of the Marine Science and Maritime Studies Center Northeastern University, Nahant, MA.

(Pelseneer, 1906; chitons lack a true shell gland, see Kniprath, 1981). It is because this invagination always forms in externally shelled species, that it has been assumed to have an active function in shell formation. The invaginated region has been referred to as the shell gland since 1873 (see Kniprath, 1979) although its actual role in shell formation has been little studied and remains unclear. After the shell gland invaginates, its lumen "closes" (narrows to a canal open to the outside through a pore; see Kniprath, 1979, Figs. 2a, b; 1980, Fig. 1e). The shell gland later evaginates or spreads back to a non-invaginated shell field.

In 1979 Kniprath outlined three aspects of early shell formation that were in a state of confusion and that warranted further examination: 1.) At what developmental stage of the shell gland is the first shell material secreted? 2.) Which cells secrete the first shell material? and 3.) How does evagination of the shell gland proceed. Although several authors have addressed the first two problems (*e.g.*, Humphreys, 1969; Kniprath, 1980a, b), conflicting results have been presented and a clear description of the cells at the leading or growing edge of the embryonic shell is lacking. Also absent are precise date on the shape of the shell gland at the time of secretion of the first organic shell material.

The present work provides the first ultrastructural description of embryonic shell formation in a marine gastropod. In this paper I describe when and where the first organic shell material is observed in embryos of the nudibranch *Aeolidia papillosa*. The fine structure of the first shell material and of the cells at the early growing edge of the shell are also examined.

MATERIALS AND METHODS

Reproductively active specimens of *Aeolidia papillosa* were collected subtidally near Nahant, MA using SCUBA and were placed in a flow-through sea water aquarium. Adults and young were thus exposed to natural temperature (5°C) and salinity (30‰) conditions. Egg masses laid on the aquarium walls soon after incarceration of the adults were allowed to harden for a few days before they were carefully removed and placed in wide-mesh baskets suspended in the aquarium.

Capsules containing embryos were removed mechanically from the egg masses and examined under a compound microscope to confirm synchrony, normality, and stage of embryonic development. Polarizing microscopy (pieces of polarizing film set at maximum extinction) was used to ascertain initiation of shell formation since the initial shell material is not detectable with standard light microscopy. Birefringence in the shell field observed with polarizing microscopy indicates shell mineralization rather than presence of the organic portion of the shell since treatment of embryos with the calcium chelator EGTA (10 mM ethylene-glycol-bis-N,N'-tetraacetic acid) resulted in loss of the birefringence. Since secretion of organic shell material precedes shell mineralization, by the time birefringence was detectable I knew that the first organic shell material had already been secreted. Because of the functional relationship between the organic materials and inorganic mineralization, timing of the various developmental stages is given in hours preceding detectable birefringence (Fig. 19).

Once gastrulation had begun and until calcareous shell material was detectable with polarizing microscopy, embryos within their egg capsules were removed periodically from the egg masses and fixed. Embryos were held in fixative in a refrigerator up to 3 days, until the last sample was fixed. A variety of primary fixatives were tried; the best results were obtained with 3% glutaraldehyde, 1% formaldehyde with paraformaldehyde (Karnovsky, 1965), 3% NaCl, 4.5% sucrose in 0.1 M phos-

phate buffer, with dimethylsulfoxide added to aid penetration of the fixative (pH 7.4). Embryos were washed at room temperature in 0.1 *M* phosphate buffer with 8% sucrose and post-fixed in 2% OsO₄ in 0.2 *M* phosphate buffer for 1 h. The tissue was dehydrated in a graded series of ethanol to 100% and was infiltrated with and embedded in Spurr low viscosity embedding medium (Spurr, 1969).

Embryos were sectioned at random orientation since they could not be oriented. For light microscopy, from 10–72 embryos at each stage were serially sectioned (0.5–1.0 μm). Sections were cut using glass knives, mounted onto glass slides, and stained with Richardson's stain (Richardson *et al.*, 1960). For transmission electron microscopy (TEM), thin sections were cut on a Sorvall MT-2B ultramicrotome using glass or diamond knives, mounted onto copper grids, and stained 15 minutes in saturated aqueous uranyl acetate followed by lead citrate. For TEM localization of periodate-reactive carbohydrates, thin sections were mounted onto gold grids and exposed sequentially to periodic acid (PA), thiosemicarbazide (TSC), and silver proteinate (SP); appropriate controls were run simultaneously (Thiéry, 1967; Porter and Rivera, 1979). Thin sections were examined and photographed on an RCA EMU-4 transmission electron microscope.

RESULTS

Initiation of shell secretion

The shell gland invagination is present by 2 days (5°) prior to first detectable birefringence in embryos of *Aeolidia papillosa* (Figs. 1, 2). At this stage embryonic ciliation is just visible with a compound microscope; the embryos move slightly inside their capsules but do not spin actively. Based on the large size of the shell gland pore (about 17 μm) and irregular outline of the shell gland lumen, the shell gland seems to be still forming. No secreted shell material is evident at this stage with transmission electron microscopy although the dense granules believed to be involved in shell formation (see Fig. 10) are already present. At all stages of development, the shell gland lumen is lined with scattered microvilli.

In embryos fixed three hours later, at 43 hours before birefringence is observed, the shell gland lumen is more circular in section and up to 26 μm wide and 30 μm deep (Fig. 3). Also the shell gland pore has become smaller. The smallness of the pore and the fact that the embryos are insufficiently differentiated to be oriented prior to sectioning makes it difficult to obtain sections passing through both the pore and the lumen of the shell gland at this and all later stages. No secreted shell material is observable with transmission electron microscopy in embryos at this stage (Fig. 4).

In embryos fixed 33 hours before the first birefringence, the shell gland has changed to a more oval shape with a shell gland neck that is narrower than the rest of the shell gland lumen (Figs. 5, 6). It is at this stage that the first organic shell material is observed. The shell material covers the opening of the shell gland pore. Additions of new organic material are made at the growing edge, away from the shell gland (Fig. 6).

Two areas of shell growth are seen in each section. The cells directly beneath the zone of shell growth are referred to as "GE cells" because of their proximity to the growing edge (GE). The cells adjacent to the GE cells but distal to the shell gland are referred to as "MV cells" because of their characteristic abundance of microvilli (see Figs. 20, 21).

At 23 hours prior to the first detectable shell mineralization, the shell gland has closed to a narrow canal but is still open to the outside through a small pore (Figs.

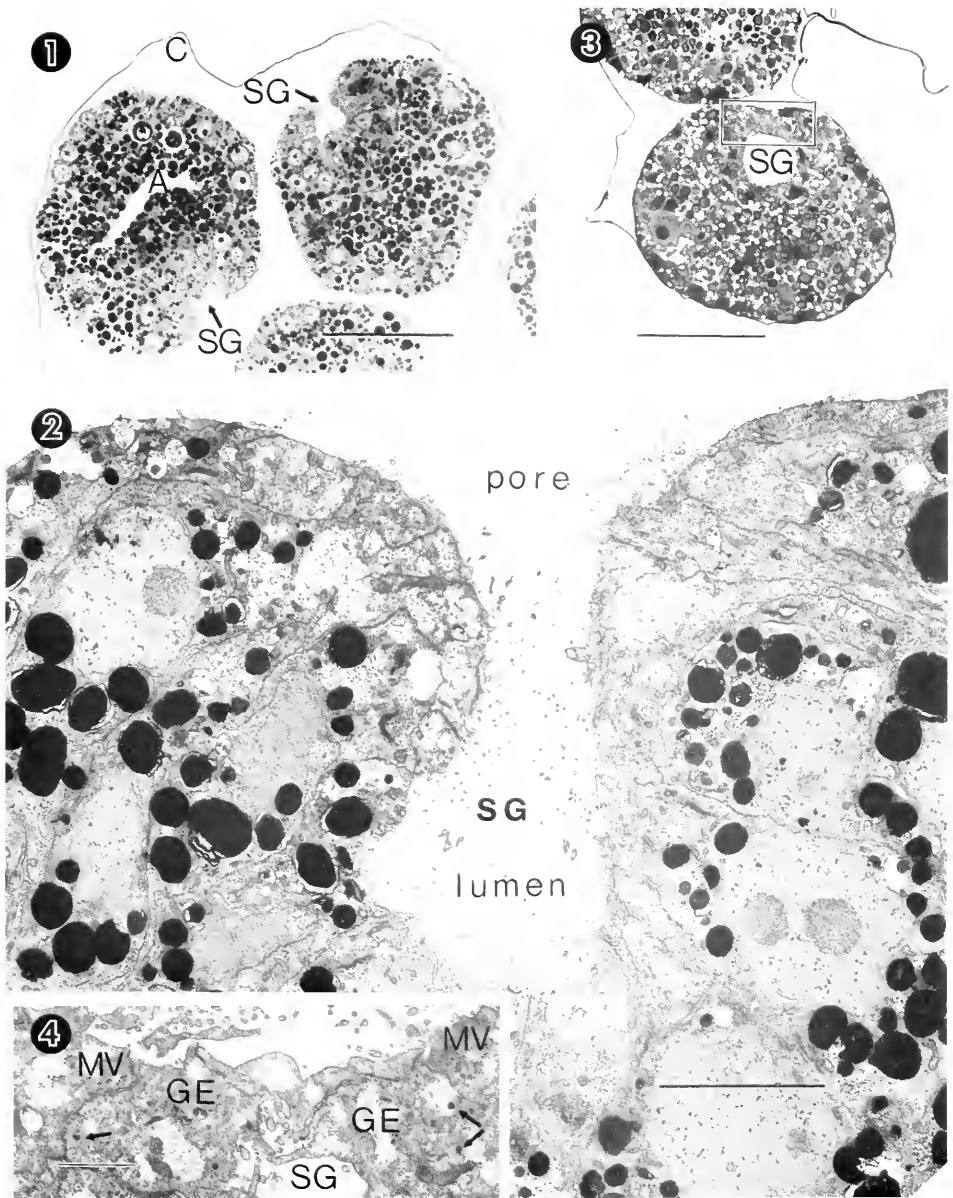

FIGURES 1, 2. Micrographs of sections through *Aeorlidia papillosa* embryos fixed 46 h prior to shell mineralization (5°C). FIGURE 1. Light micrograph. Embryos are within egg capsule (C) and show shell gland (SG) and archenteric (A) invaginations. Bar = 50 μ m. FIGURE 2. Transmission electron micrograph (TEM) showing pore and lumen of shell gland (SG) prior to shell secretion. Bar = 5 μ m.

FIGURES 3, 4. Micrographs of sections through embryos 43 h prior to shell mineralization. The shell gland (SG) is open to outside through a pore, not visible here or in Figure 5 due to sectioning angle. FIGURE 3. Light micrograph. Bar = 50 μ m. FIGURE 4. TEM of region similar to box in Figure 3, showing growing edge cells (GE) with electron dense granules (arrows), and microvilli-bearing cells (MV). Bar = 1 μ m.



FIGURES 5, 6. Micrographs of sections through embryos fixed 33 h prior to shell mineralization. FIGURE 5. Light micrograph. Bar = 50 μ m. FIGURE 6. TEM of newly secreted shell material (arrows) lying over the pore of the shell gland (SG), the proximal cells (P), and growing edge cells (GE). Also shown are microvilli-bearing cells (MV), distal cells (D), and one cluster of vesicles present in proximal cells (circle). Bar = 5 μ m.

FIGURE 7. Light micrograph of section through embryos fixed 23 h prior to shell mineralization. The shell gland (SG) has "closed" to a narrow canal. Bar = 50 μ m.

7, 19). The lumen of the shell gland canal is still lined with scattered microvilli but the number of microvilli seen in any section is greater after narrowing of the shell gland lumen. This apparent increase in abundance of microvilli may reflect decreased distance between cells lining the lumen rather than an actual increase in number of microvilli. Although Figures 8 and 11–18 are all from embryos fixed 23 h prior to mineralization, at this stage MV cells, GE cells, and the shell itself have the same morphological characteristics observed in embryos fixed 10 hours earlier. The morphology of these cells and of the secreted shell material are described below.

Morphology of the shell growth region

The zone of shell growth is near the apical surface of the GE cells. The GE cells are columnar, have rough endoplasmic reticulum associated with sub-basal nuclei, and have fields of periodic acid–thiosemicarbazide–silver proteinate (PA-TSC-SP) positive material, presumed to be glycogen. These cells are readily identified by the presence of numerous membrane-bound granules (Figs. 8, 9). In section the granules are either circular or oblong and have a maximum length of 200 nm (Fig. 10). The granules are frequently seen in association with Golgi apparatus just apical to the nucleus (Fig. 11); often near the cell apices (Fig. 8); occasionally within apical cytoplasmic extensions (Fig. 9); but never outside of the cell.

Electron cytochemistry is currently being utilized to determine if the granules contain potential organic or inorganic shell components. The major organic shell component in molluscs is protein (Wilbur, 1972), but no stains are specific for protein (Hayat, 1970). Because polysaccharides are also present in molluscan shells (Wilbur, 1972), the PA-TSC-SP procedure was used. Preliminary tests with the PA-TSC-SP procedure indicate that the granules do not contain carbohydrates oxidizable with periodic acid. The granules are electron lucent in glutaraldehyde-osmium fixed sections, but are very electron dense after sequential staining with uranyl acetate and lead citrate. No distinct substructure was observed in stained or unstained granules at a magnification of 500,000 \times .

At all stages prior to mineralization, the shell consists of two electron dense layers separated by an electron lucent layer or gap (Fig. 12). In embryos fixed 33 hours prior to detectable mineralization, the shell material seen in section was up to 10 μ m long (following all contours) and 22 nm thick. Clusters of small vesicles, most about 15–60 nm in diameter, are associated with the outer surface of the shell (Figs. 13, 14). These clusters appear to be randomly scattered.

The growing edge of the shell either abruptly terminates (Figs. 9, 16) or consists of small electron dense particles (Figs. 8, 18, 20). Regardless of its exact morphology, the edge of the newly formed shell material is always located on the apices of the GE cells and never between the lateral plasma membranes of the GE cells and the neighboring MV cells. No secretory infoldings of the lateral plasma membranes of the GE cells were observed.

The proximal cells, those cells adjacent to the GE cells and proximal to the shell gland, occasionally have infolded apical plasma membranes (Fig. 17). These cells also occasionally contain electron dense granules as described in the GE cells. One consistent feature of these cells is their association with apical-lateral intercellular spaces lined with microvilli. A space was consistently observed between the GE cells and proximal cells (Figs. 16–18, 20). The shell extending over this intercellular space is almost entirely separated from it by cytoplasmic extensions arising from the cells lining the space (Figs. 16, 18). These cytoplasmic extensions are in intimate contact with the inner surface of the shell (Figs. 16, 18). Groups of small uncoated vesicles

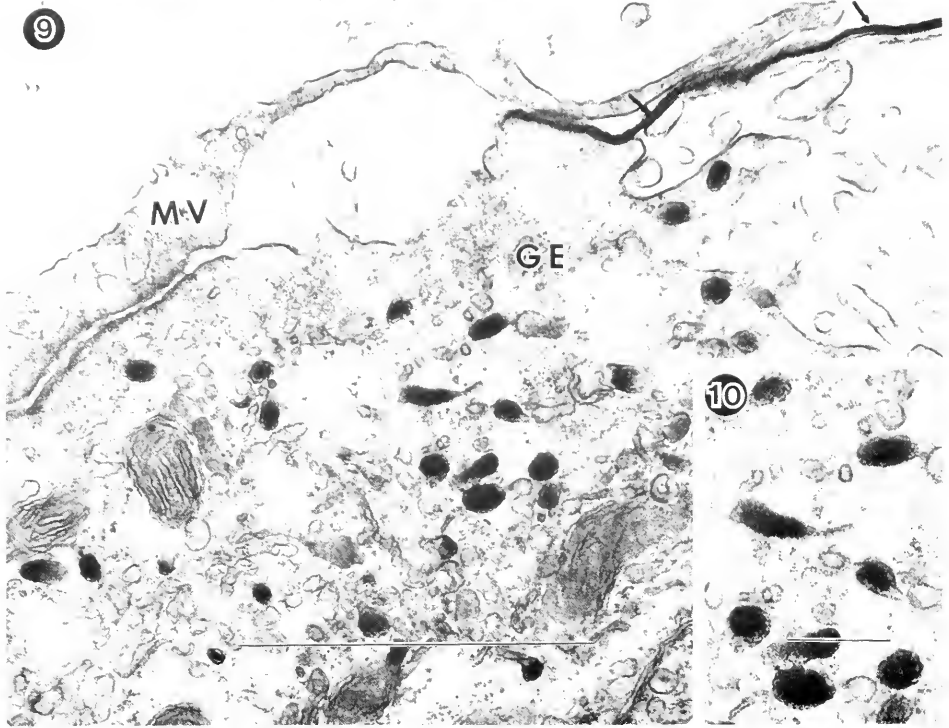
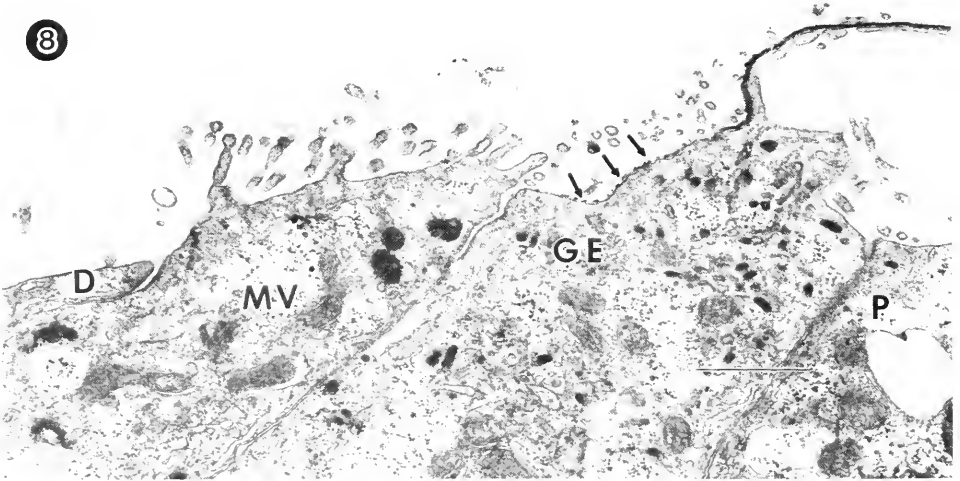

FIGURE 8. Transmission electron micrograph of apices of: cell distal to shell gland (D), microvilli-bearing cell (MV), growing edge cell (GE), and proximal cell (P). The growing edge of the shell lies over the GE cell and here consists of small electron dense particles (arrows). Bar = 1 μ m.

FIGURE 9. Apex of growing edge cell (GE), characterized by electron dense granules; from embryo fixed 33 h prior to mineralization. A cytoplasmic extension of the microvilli-bearing cell (MV) lies over the growing edge of the shell (arrows). Bar = 1 μ m.

FIGURE 10. Electron dense granules in GE cell, from Figure 9. Bar = 200 nm.

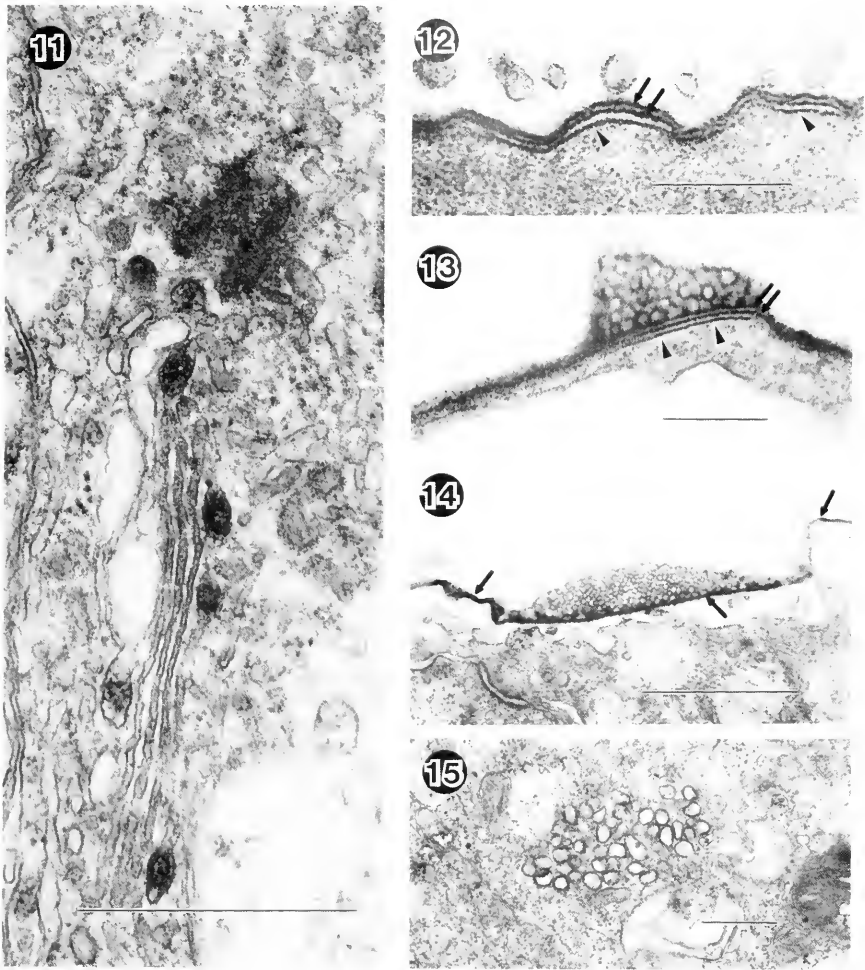

FIGURE 11. Electron dense material associated with Golgi complex. Bar = 500 nm.

FIGURE 12. Section showing two electron dense layers of shell (arrows) lying close to plasma membrane (arrowheads) of shell field cell. Sections through microvilli are shown at top. Bar = 200 nm.

FIGURES 13, 14. Clusters of small vesicles associated with outer surface of shell (arrows). FIGURE 13. The dense layer below the shell is the plasma membrane (arrowheads). Bar = 200 nm. FIGURE 14. Bar = 1 μ m.

FIGURE 15. Small vesicles seen in proximal cells. Bar = 500 nm.

circular to pear-shaped in profile and about 100 nm in diameter are present in the proximal cells (Figs. 6, 15). These vesicles have lucent cores but are larger and have a much denser border than the vesicles present on the outer surface of the shell.

Only one MV cell with numerous microvilli is observed in section at each growing edge (Figs. 6, 16). In comparison, the distal cells (cells adjacent to MV cells but distal to shell gland), never have more than a few scattered microvilli (Figs. 6, 8, 17, 21). The MV cells do not contain the electron dense granules typical of the GE cells but both the MV cells and GE cells have numerous mitochondria apically. The MV cells are joined apically to the GE cells by zonulae adhaerens and septate

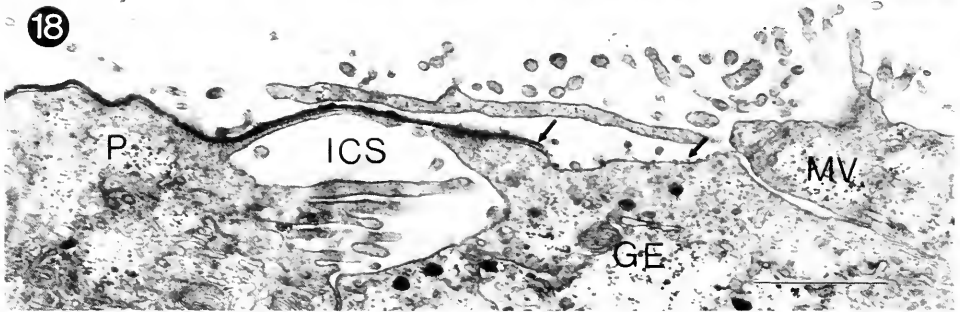
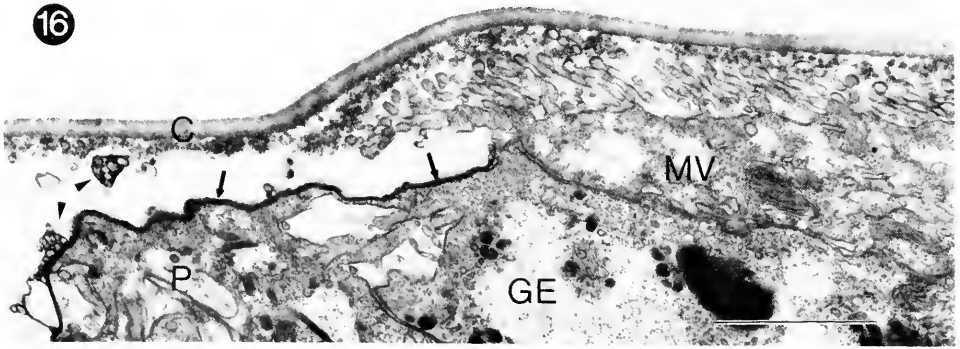

FIGURE 16. The microvilli of the MV cell lean over the growing edge cell (GE) and over the growing edge of the shell. Two clusters of vesicles are shown (arrowheads); rarely were clusters seen not in contact with the outer shell surface (arrows). P = proximal cell; C = capsule. Bar = 1 μ m.

FIGURE 17. Infoldings (arrowheads) of the apical plasma membranes of the proximal cells (P) were observed rarely; no infoldings of other shell fields cells were observed. The growing edge of the shell is covered by abundant microvilli of the microvilli-bearing cell (MV). The distal cell (D) has only sparse microvilli. Arrows = shell. Bar = 1 μ m.

FIGURE 18. An intercellular space (ICS) occurs between the proximal cells (P) and growing edge cells (GE). Some sections show long cytoplasmic extensions from the microvilli-bearing cells (MV) covering the growing edge of the shell (arrows). Bar = 1 μ m.

desmosomes. The microvilli of the MV cells tend to lean over the GE cells and the growing edge of the shell (Figs. 16, 17). Long cytoplasmic extensions that arise from the inner edges of the MV cells also reach over the growing edge of the shell and may completely cover the apical surfaces of the GE cells (Figs. 9, 18).

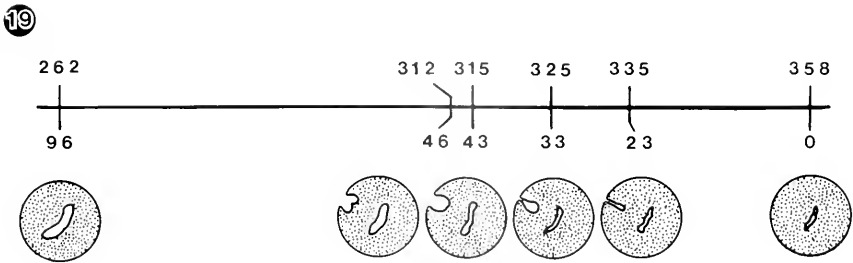

FIGURE 19. Schematic diagram of changes in shell gland morphology related to time (hours) after oviposition (top scale) and time prior to detection of shell mineralization (bottom scale), 5°C. Drawings represent sections through embryos at gastrulation and as in Figures 1, 3, 5, and 7. Not to scale.

DISCUSSION

Timing of first shell secretion

The first shell material in embryonic molluscs is secreted sometime during the existence of the shell gland (Cather, 1967; Demian and Yousif, 1973; Kniprath,

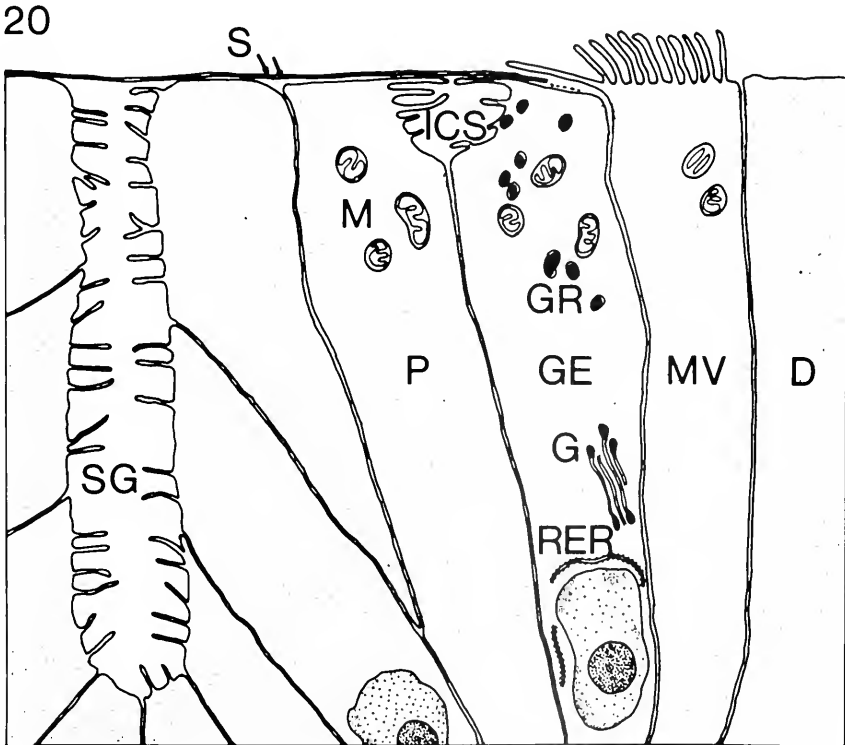

FIGURE 20. Schematic diagram showing arrangement of shell and early shell field cells, at about 30 h prior to detection of shell mineralization. The shell (S) consists of two electron dense layers (arrows). At its growing edge, the shell consists of small electron dense particles lying on the apical surface of the growing edge cell (GE) and is covered by cytoplasmic extensions arising from the microvilli-bearing cell (MV). Also shown are proximal (P) and distal (D) shell field cells, named in terms of their proximity to the shell gland (SG). M = mitochondria. GR = granules. G = Golgi complex. RER = rough endoplasmic reticulum. ICS = intercellular space. Not to scale.

21

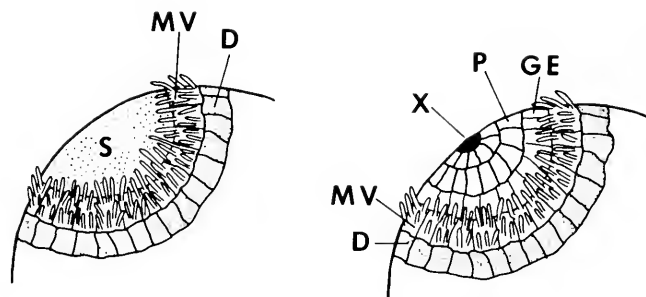

FIGURE 21. Schematic diagram of hypothetical arrangement of shell and early shell field cells, in surface view. At the left the shell (S) covers the underlying cells and extends to the microvilli-bearing cells (MV). The same region is redrawn (right) with the secreted shell material removed to reveal underlying cells and pore of the shell gland (X). P = proximal cells. GE = growing edge cells. D = distal cells. Not to scale.

1977). However, the shell gland of developing embryos is present for hours and goes through several morphologically distinct stages or shape changes. Only Kniprath (1977, 1979, 1980b) has specifically examined the morphological stage of the shell gland at which shell secretion begins.

In *Aeolidia papillosa* the first organic shell material is secreted at least 10 hours before the shell gland "closure" stage (see Fig. 19) and at least 33 hours prior to detection of shell mineralization. The electron dense granules believed to contain components of organic shell material were present at least 13 hours prior to observation of first secreted shell material and 23 hours prior to shell gland closure. This is in contrast to the findings of Kniprath (1981) who stated that in the species he examined the cells of the shell field "do not synthesize anything for secretion before the closure stage". It is uncertain whether the cells lining the shell gland lumen ever become tightly apposed in *Aeolidia papillosa*.

In contrast, in the snails *Lymnaea stagnalis* (Kniprath, 1977) and *Marisa cornuarietis* (Kniprath, 1979), the shell gland lumen closes to a canal prior to shell secretion. In the mussel *Mytilus galloprovincialis* (Kniprath, 1980b) the walls of the shell gland seem to close so tightly that not even a narrow canal is detectable with transmission electron microscopy. In that species, the shell gland lumen is apparently completely gone prior to shell secretion. Thus closure of the shell gland lumen precedes shell secretion in all three of these species, but not in *Aeolidia papillosa*.

Secretion of the first shell material while the shell gland is still open in *Aeolidia papillosa* demonstrates that closure of the shell gland lumen is not requisite to initiation of shell secretion. Instead, the size of the pore of the shell gland may be the important factor, especially if the shell material is first secreted over the pore rather than along the lining of the shell gland lumen. In all of the above species the shell gland pore becomes smaller prior to shell secretion. Presumably a small pore would be easier to seal over with shell material than would a large pore.

Identification of shell secreting cells

The embryonic shell of molluscs is often said to be secreted by the "shell gland" (Fretter and Graham, 1962; Raven, 1966; Jablonski and Lutz, 1980), a term which has different meanings to different authors. In many cases, general statements about the "shell gland" are in fact references to the entire shell-secreting epithelium, (*i.e.*,

the shell field) regardless of its morphology. Originally the term was applied by Ray Lankester just to the invagination (Pelseneer, 1906), not to the entire shell field. The term has more recently also been defined as the calcifying invagination of the ectoderm (Waller, 1978). As used in the present work the term shell gland strictly refers to the invaginated region of the shell field without reference to function. Thus the shell gland is the center of the early shell field. After shell gland evagination or spreading, the cells that once lined the shell gland lumen are still shell field cells (Kniprath, 1979, 1981).

The present ultrastructural evidence demonstrates that in *Aeolidia papillosa* the first organic portion of the shell is secreted only by the non-invaginated shell field cells around the shell gland pore. No substances resembling shell material were ever observed within the lumen of the shell gland. Thus, it is clear that the shell gland *sensu stricto* does not secrete the embryonic shell in *Aeolidia papillosa*.

These results support the electron microscopic work of Kniprath (1977, 1979, 1980a, 1980b) on *Lymnaea stagnalis*, *Marisa cornuarietis*, *Helix aspersa*, and *Mytilus galloprovincialis*. Kniprath reported that the first shell material is secreted solely by a ring of cells surrounding the shell gland pore while the invaginated cells of the shell gland remain nonsecretory until calcium secretion begins. Possibly the invagination of these cells while they are nonsecretory serves to prevent a large hole from forming in the center of the shell, an idea suggested previously by several workers (see Haas *et al.*, 1979; Kniprath, 1979).

It should be noted that earlier work based on light microscopy (*e.g.*, Cather, 1967, on *Ilyanassa obsoleta*; Demian and Yousif, 1973, on *Marisa cornuarietis*; Raven, 1975, on *Lymnaea stagnalis*) produced results conflicting with later studies utilizing TEM (*e.g.* Kniprath, 1977, on *Lymnaea stagnalis*; Kniprath, 1979, on *Marisa cornuarietis*; present study on *Aeolidia papillosa*). These conflicting results probably do not reflect biological differences. With light microscopy the shell material was observed extending into the shell gland lumen and therefore was believed to have been secreted there. With transmission electron microscopy the first shell material is seen only outside the shell gland (lying over the shell gland pore). These differences may reflect several factors. First, earlier authors may have been unable to detect the very first shell material with light microscopy. The initial shell material, because of its thinness, may not be detectable with light microscopy until it separates from the underlying epithelium. After separation the shell material might then fold down into the lumen, giving the impression that it was secreted there. Second is the possibility that the earliest shell material might be dislodged from excapsulated or non-encapsulated embryos during handling for fixation and dehydration. If the very early shell material can be dislodged by handling then the shell would not be detected when it is initially secreted. In the present study all embryos of *Aeolidia papillosa* were fixed and dehydrated within their capsules. A third factor that might have led to these different conclusions concerning the timing and location of initial shell secretion is sampling (fixation) frequency. In some species studied the frequency of sampling may have been low relative to rate of shell development, so that the earliest stages of shell formation may have been missed. Sampling more frequently relative to developmental rate should help resolve some or all of these issues.

It is not clear whether the various cell types seen in the early shell field maintain their respective functions throughout evagination or spreading of the shell gland. In *Aeolidia papillosa* the cells at the growing edge are seen further and further from the shell gland lumen as evagination proceeds, suggesting that these cells are merely migrating. Whether or not the cells change function following evagination as the shell field grows into a distinct mantle is yet to be documented.

Certainly, further studies of other molluscan species are required to determine the range of shell gland morphologies and to elucidate the role of the shell gland cells *versus* that of other cells of the shell field. If such studies demonstrate that the invaginated cells have no role in secretion of either organic or inorganic shell components, what is now called the shell gland might be better referred to as the shell field invagination.

Site of early shell secretion

It is well known that regions where biomineralization proceeds are sealed off from chemical influences of the surrounding environment (Wilbur, 1972; Clark, 1976). Clark (1976) reviewed three main approaches to marginal calcification in post-larval invertebrates, two of which deserve further mention here. First, in some invertebrates such as scleractinian corals, a marginal fold of tissue drapes over the growing margin, isolating it from sea water. Secondly, in many molluscs and brachiopods, periostracum is secreted in a marginal fold and isolates the underlying region of shell mineralization. Also, the shell material in molluscs may be securely anchored to the apices of the secreting cells (Chétail and Krampitz, 1982), thus isolating the inner surface of the shell from the external medium. In molluscan embryos the location of the growing edge and method(s) of sealing it off have not been established.

Few authors have examined the location of the early growing edge in molluscan embryos on an ultrastructural level. Humphreys (1969) briefly described embryonic shell formation in the mussel *Mytilus edulis*, stating that the growing edge of the shell was intracellular. He suggested that it undercut the cilia and microvilli of the cell apices, all of which were subsequently sloughed off. However, Kniprath (1980b) has determined that the first and outermost shell material of *Mytilus galloprovincialis* is laid down extracellularly and seems to be protected from the surrounding medium by a thick glycocalyx and by microvilli of the adjacent cells. He also reported that the growing edge in *M. galloprovincialis* lies in an intercellular gap, sometimes down to the desmosome, and that infoldings of the lateral plasma membranes in this region seem to secrete materials that thicken the shell pellicle. This intercellular gap may also serve to seal off the growing edge.

Ultrastructural observations on *Aeolidia papillosa* confirm that the shell is laid down extracellularly. However, instead of forming in a lateral intercellular gap, the embryonic shell of *A. papillosa* seems to be produced on the apical surface of the GE cells. No infolding of the lateral plasma membranes was seen in this area, and no shell material in addition to the two dense lamellae was observed in regions of the shell distant from the growing edge. Thus additions to the shell in this species seem to occur solely over the cell apices, where the growing edge is potentially exposed to the surrounding environment.

Two factors may be involved in sealing off the shell edge of *Aeolidia papillosa*. First, the shell in this region is closely applied to the underlying cells and seems to be secured to the cell apices (Figs. 16, 18), while in regions away from the growing edge the shell is often separated from the underlying cells by a gap. Secondly, the MV cells may have a role in sealing off the growing edge. The microvilli of these cells are angled towards the GE cells (Fig. 16), and long cytoplasmic extensions arising from the proximal edges of the MV cells lie over the growing edge of the shell (Figs. 9, 18). Haas (1976), Haas *et al.* (1979), and Kniprath (1980c) have observed a similar situation and reached a similar conclusion for shell plate formation in chitons. Haas (1976) suggests that the microvilli may form "a barrier which

controls the growth of the tegmental crystals". Kniprath (1980c) provided support for this idea by his observation that the first trace of mineral detectable under polarizing microscopy was seen at exactly the stage of development where the large flat villi from the distal edges of neighboring cells overlapped and closed off the crystallization space. Although the MV cells may serve other functions (transport?) than isolation of the growing edge of the shell in *Aeolidia papillosa*, it is doubtful that they secrete the organic shell material since they lack the dense granules presumed to contain organic shell components and since the growing edge of the shell lies over a different cell type.

Preliminary studies (Eyster, unpubl.) on the development of several other opisthobranch species show that the growing edge of the shell of these species also lies over the apical surfaces of the GE cells and that it is covered by cytoplasmic extensions arising from the MV cells. Possibly, presence of the growing edge on the potentially exposed cell apices of developing opisthobranch embryos reflects protection from the surrounding medium afforded by the embryonic capsules. Attempts to mechanically remove the capsules surrounding young embryos failed although the same procedures worked on embryos ready to hatch; embryos removed from the egg mass but left within their capsules developed normal shells. Preliminary attempts to examine the early growing edge in *A. papillosa* with scanning electron microscopy have proved unproductive due to the obscuring of the embryonic surface with precipitated components of the fluid held inside the capsule. Further studies are required to determine whether these reported differences in early shell development between opisthobranch gastropods and other taxa have phylogenetic significance.

ACKNOWLEDGMENTS

Specimens were kindly collected by T. K. Van Wey and Dr. K. P. Sebens. I express my gratitude to K. Porter and Dr. E. R. Rivera for demonstrating the PA-TSC-SP stain technique, to E. Cole for typing the final drafts, to C. B. Calloway and Drs. M. P. Morse, J. A. Pechenik, and R. D. Turner for critically reviewing the manuscript, and to Drs. V. Fretter and N. Watabe for unknowingly sparking my interest in molluscan shell formation more than six years ago.

LITERATURE CITED

- BEVELANDER, G., AND H. NAKAHARA. 1969. An electron microscope study of the formation of the nacreous layer in the shell of certain bivalve molluscs. *Calcif. Tiss. Res.* **3**: 84-92.
- CATHER, J. N. 1967. Cellular interactions in the development of the shell gland of the gastropod, *Ilyanassa*. *J. Exp. Zool.* **166**: 205-224.
- CHÉTAIL, M., AND G. KRAMPITZ. 1982. Calcium and skeletal structures in molluscs: concluding remarks. Proc. Seventh International Malacological Congress. *Malacologia* **22**(1-2): 337-339.
- CLARK, G. R., II. 1976. Shell growth in the marine environment: Approaches to the problem of marginal calcification. *Am. Zool.* **16**: 617-626.
- DEMIAN, E. S., AND F. YOUSIF. 1973. Embryonic development and organogenesis in the snail *Marisa cornuarietis*. (Mesogastropoda: Ampullariidae). IV. Development of the shell gland, mantle and respiratory organs. *Malacologia* **12**(2): 195-211.
- FRETTER, V., AND A. GRAHAM. 1962. *British Prosobranch Molluscs. Their Functional Anatomy and Ecology*. Bartholomew Press, Dorking, Great Britain. 755 pp.
- HAAS, W. 1976. Observations on the shell and mantle of the Placophora. Pp. 389-402 in *The Mechanisms of Mineralization in the Invertebrates and Plants*, N. Watabe, and K. M. Wilbur, eds. Belle W. Baruch Library in Marine Science, 5. Univ. South Carolina Press, Columbia, 461 pp.
- HAAS, W., K. KRIESTEN, AND N. WATABE. 1979. Notes on the shell formation in the larvae of the Placophora (Mollusca). *Biom mineralization* **10**: 1-8.
- HAYAT, M. A. 1970. *Principles and Techniques of Electron Microscopy. Biological Applications, I*. Van Nostrand Reinhold, Co., New York. 412 pp.

- HUMPHREYS, W. J. 1969. Initiation of shell formation in the bivalve, *Mytilus edulis*. *Proc. Electr. Microsc. Soc. Am.*, Twenty-seventh Ann. Meeting: 272-273.
- JABLONSKI, D., AND R. A. LUTZ. 1980. Molluscan larval shell morphology. Ecological and paleontological applications. Pp. 323-377 in *Skeletal Growth of Aquatic Organisms*, D. C. Rhoads and R. A. Lutz, eds. Plenum Pub. Co., New York. 750 pp.
- KARNOVSKY, M. J. 1965. A formaldehyde-glutaraldehyde fixative of high osmolarity for use in electron microscopy. *J. Cell. Biol.* **27**: 137 A.
- KNIPRATH, E. 1977. Zur Ontogenese des Schalenfeldes von *Lymnaea stagnalis*. *Wilhelm Roux's Arch.* **181**: 11-30.
- KNIPRATH, E. 1979. The functional morphology of the embryonic shell-gland in the conchiferous molluscs. *Malacologia* **18**: 549-552.
- KNIPRATH, E. 1980a. Sur la glande coquilliere de *Helix aspersa* (Gastropoda). *Arch. Zool. Exp. Gén* **121**: 207-212.
- KNIPRATH, E. 1980b. Larval development of the shell and the shell gland in *Mytilus* (Bivalvia). *Wilhelm Roux's Arch.* **188**: 201-204.
- KNIPRATH, E. 1980c. Ontogenetic plate and plate field development in two chitons, *Middendorffia* and *Ischnochiton*. *Wilhelm Roux's Arch.* **189**: 97-106.
- KNIPRATH, E. 1981. Ontogeny of the molluscan shell field: a review. *Zool. Scri.* **10**: 61-79.
- PELSENEER, P. 1906. Part V. Mollusca. In: 1906. *A Treatise on Zoology*, Edwin Ray Lankester, ed. Adam and Charles Black, London. 355 pp.
- PORTER, K. J., AND E. R. RIVERA. 1979. An ultrastructural cytochemical analysis of mucoid secretory granules in nudibranch epidermis. *Proc. Electron Microsc. Soc. Am.*, 37th Ann. Meeting: 302-303.
- RAVEN, C. P. 1966. *Morphogenesis: The Analysis of Molluscan Development*. Pergamon Press, New York. 366 pp.
- RAVEN, C. P. 1975. Development. Pp. 367-400 in *Pulmonates I. Functional Anatomy and Physiology*, V. Fretter and J. Peake, eds. Academic Press, New York. 417 pp.
- RICHARDSON, K. C., L. JARRETT, AND E. H. FINKE. 1960. Embedding in epoxy resin for ultrathin sectioning in electron microscopy. *Stain Technol.* **35**: 313-323.
- SALEUDDIN, A. S. M. 1974. Ultrastructural studies on the structure and formation of the periostracum in *Helisoma* (Mollusca). Pp. 309-337 in *The Mechanisms of Mineralization in the Invertebrates and Plants*, N. Watabe, and K. M. Wilbur, eds. Belle W. Baruch Library in Marine Science, S. Univ. South Carolina Press, Columbia. 461 pp.
- SPURR, A. R. 1969. A low-viscosity epoxy resin embedding medium for electron microscopy. *J. Ultrastruct. Res.* **26**: 31-43.
- THIÉRY, J. P. 1967. Mise en évidence des polysaccharides sur coupes fines en microscopie électronique. *J. Microsc.* **6**: 987-1018.
- WALLER, T. R. 1978. Formation of a posterodorsal notch in larval oyster shells and the prodissoconch—I/II boundary in the Bivalvia. *Bull. Am. Malacol. Union, Inc.*, 1978: 55-56.
- WEINER, S., AND L. HOOD. 1975. Soluble protein of the organic matrix of mollusk shells: a potential template for shell formation. *Science* **190**: 987-989.
- WHEELER, A. P., J. W. GEORGE, AND C. A. EVANS. 1981. Control of calcium carbonate nucleation and crystal growth by soluble matrix of oyster shell. *Science* **212**: 1397-1398.
- WILBUR, K. M. 1972. Shell formation in mollusks. Pp. 103-145 in *Chemical Zoology*, 7, M. Florkin, and B. T. Scheer, eds. Academic Press, London. 567 pp.
- WILBUR, K. M., AND L. H. JODREY. 1952. Studies on shell formation I. Measurement of the rate of shell formation using Ca^{45} . *Biol. Bull.* **103**: 269-276.
- YOUNG, S. D., M. A. CRENSHAW, AND D. B. KING. 1977a. Mantle protein excretion and calcification in the hardshell clam *Mercenaria mercenaria*. I. Protein excretion in the intact clam. *Mar. Biol.* **41**: 253-257.
- YOUNG, S. D., M. A. CRENSHAW, AND D. B. KING. 1977b. Mantle protein excretion and calcification in the hardshell clam *Mercenaria mercenaria*. II. Protein synthesis and excretion by the isolated mantle. *Mar. Biol.* **41**: 259-262.

POSTLARVAL GROWTH IN JUVENILE *RHITHROpanopeus harrisii*

JOHN A. FREEMAN¹, TERRY L. WEST², AND JOHN D. COSTLOW³

¹Department of Biology, University of South Alabama, Mobile, Alabama 36688, ²Institute of Coastal Marine Resources, East Carolina University, Greenville, North Carolina 27834, and ³Duke University Marine Laboratory, Beaufort, North Carolina 28516

ABSTRACT

Eyestalk removal accelerated the molt cycles of megalopal and juvenile (first through fifth crab instars) *Rhithropanopeus harrisii*. Eyestalkless crabs also demonstrated a greater increase in size at each ecdysis. The growth rate of eyestalkless crabs was approximately twice the rate measured in control crabs. Epidermal cell density measurements showed that the cell density was the same in intermolt fifth instar control and eyestalkless crabs. The results demonstrate that growth in juvenile crabs is under the influence of eyestalk neurosecretory centers and that growth is a result of epidermal cell proliferation and not cell enlargement.

INTRODUCTION

The growth rate of crustaceans is a function of both the molting rate and the increase in size obtained at each molt. In adults, these aspects of growth are thought to be regulated by hormones (see Passano, 1960; Kleinholz and Keller, 1979; Skinner, 1983 for review). The molting rate may be controlled by molt-inhibiting hormone (MIH) which is secreted by neuro-endocrine cells in the eyestalk. The eyestalk may also contain a factor that restricts the uptake of water at ecdysis and, consequently, the expansion of the new cuticle. The accelerated molting rate and the greater incremental increase in size observed in eyestalkless animals is believed to be a consequence of the absence of these two factors.

The action of endocrine factors in crustacean larvae and postlarvae, however, is not clearly defined. In early studies it was found that eyestalk removal did not result in a more rapid molting rate until the third post-larval instar in *Callinectes sapidus* (Costlow, 1963) or the fourth post-larval instar in *Rhithropanopeus harrisii* (Costlow, 1966). However, recent work in which the larvae were observed several times a day, revealed that eyestalk removal did elicit a faster molting rate in *R. harrisii* larvae (Freeman and Costlow, 1980).

In the present study, the effect of eyestalk removal during larval stages on molting rate, incremental size increase, and epidermal cell density in early juvenile *R. harrisii* is examined.

MATERIALS AND METHODS

Larval rearing

The larval development of *R. harrisii* consists of four zoeal instars and one megalopal instar. Zoeae were hatched and mass reared in 25‰ sea water maintained at 20–21°C. The water was changed and freshly hatched *Artemia* were added daily.

Upon reaching the megalopal instar the larvae were maintained individually in compartmentalized plastic boxes.

Eyestalk removal

Fourth instar zoeae were placed on a small glass disc (4 cm diameter) in a volume of water that was sufficient to keep them moist (50–100 μ l), but small enough to restrict their movement. An iris scapel was used to sever the eyestalk at the articulating membrane. The larva was returned to 25‰ sea water immediately after the operation. Sixty percent of the eyestalkless larvae lived to molt to the megalopal instar. Of the larvae that molted to the megalopal instar, twenty five percent (9 of 36) lived to the sixth crab instar. Thirty nine percent (14 of 36) of the control crabs lived to the sixth crab instar. No abnormal megalopae, or supernumerary larvae were observed in either the intact or eyestalkless crabs.

Determination of molting and growth rates

Intact (control) and eyestalkless animals were observed twice daily for indications of ecdysis (presence of shed exoskeletons), and/or for apolysis (retraction of the epidermis from the cuticle). Apolysis indicates the initiation of the premolt phase (D_0) of the molt cycle (Drach and Tchernigovtzeff, 1967). Apolysis was determined through microscopic observation of the integument in the leg, rostrum, antennules, and antennae. Due to the opacity of the cuticle in third through fifth crab instars, apolysis was not followed in these crabs. The incremental growth at each instar was determined by measuring the differences in carapace width (CW) between the shed exoskeletons of that instar and the previous instar. The number of crabs observed for each measurement is indicated in the figures. Analysis of variance was done using the F-test. Significant difference between means was done with the *t*-test.

Measurement of epidermal cell density

Cell density measurements were done on whole mounts of hepatic or branchial sections (see McLaughlin, 1980) of dorsal carapaces removed from both intact (control) or eyestalkless fifth instar crabs. The specimens were fixed in Bouin's fluid, stained by the Feulgen method and mounted *in toto*. Cell counts were made from photographs of the stained whole mounts and are reported in the Results section as # nuclei/100 μ m². Differences in cell density in control and eyestalkless crabs was determined with the *t*-test after analysis of variance.

RESULTS

Eyestalk ablation during the late zoeal period accelerated the molt cycles of subsequent megalopal and juvenile instars (Fig. 1). The period from ecdysis to premolt (stage D_0) in eyestalkless crabs was significantly shorter ($P < .05$) than those of intact animals. The duration of the molt cycle (ecdysis to ecdysis) was also significantly reduced in eyestalkless crabs. These findings suggest that the eyestalks of the juvenile *R. harrisii* contain a factor that inhibits molting. The degree to which eyestalk removal shortened the molt cycle, however, varied from instar to instar. The molt cycles of the megalopal instar and fourth and fifth instar crabs underwent a greater reduction in duration, compared to control crabs, than did the molt cycles of the first, second, or third instar crabs.

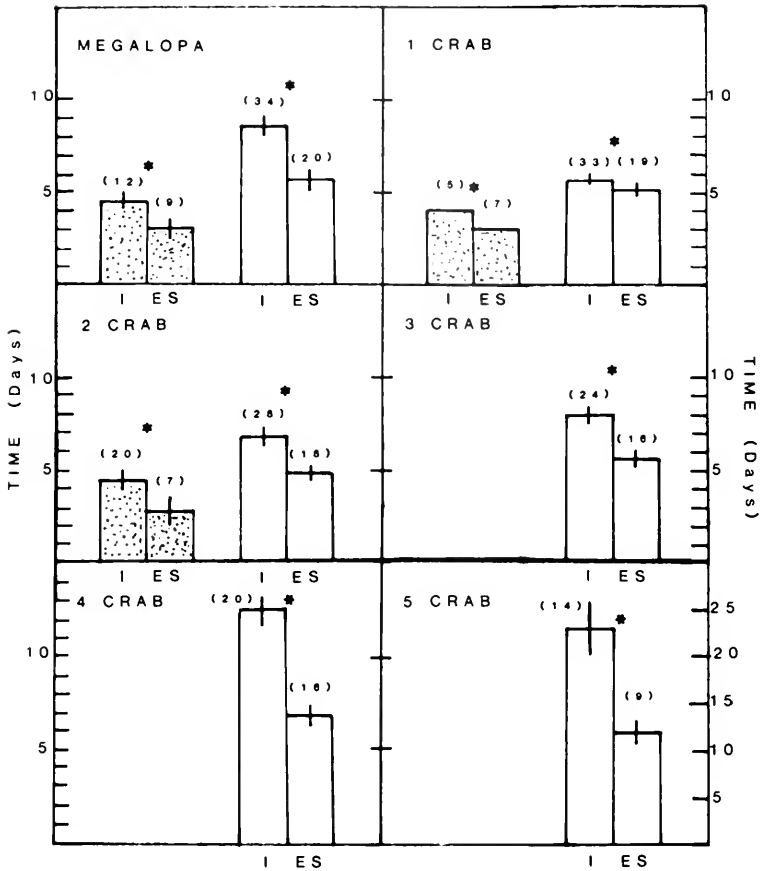

FIGURE 1. Duration (days) from ecdysis to premolt (D_0 , stippled bars) and to the next ecdysis (open bars) in intact (I) and eyestalkless (ES) *Rhithropanopeus harrisi* megalopae and first through fifth crab (designated 1, 2, 3, 4, 5 crab, respectively) instars. Each bar represents mean \pm 1 standard deviation. Bars without S.D. lines indicate no variation. Sample size for each measurement indicated in parentheses above the bar. Asterisk indicates significant differences ($P < .05$) between intact and eyestalkless groups.

Carapace widths of eyestalkless animals were always significantly larger ($P < .05$) than those of controls (Fig. 2). The actual difference in carapace widths between control and eyestalkless crabs was small during the megalopal and first two crab molt cycles. The differences increased, however, in the third, fourth, and fifth crab molt cycles. These data indicate that eyestalk removal affects the mechanism that regulates size increases at each ecdysis.

While it may be suspected that a crab would have more potential for growth if the molt cycle was longer, the results reported here show that just the opposite occurred in eyestalkless crabs. When data from Figures 1 and 2 are combined to yield a growth rate (mm carapace width/time, Table I) it can be seen that, even though the eyestalkless crabs reached the fifth crab in roughly two-thirds the time required by the control crabs, their growth was over twice that of control animals. To find if the growth rate varied in different instars, the increase in carapace width/instar was calculated (Table II). With the exception of the first crab, the eyestalkless

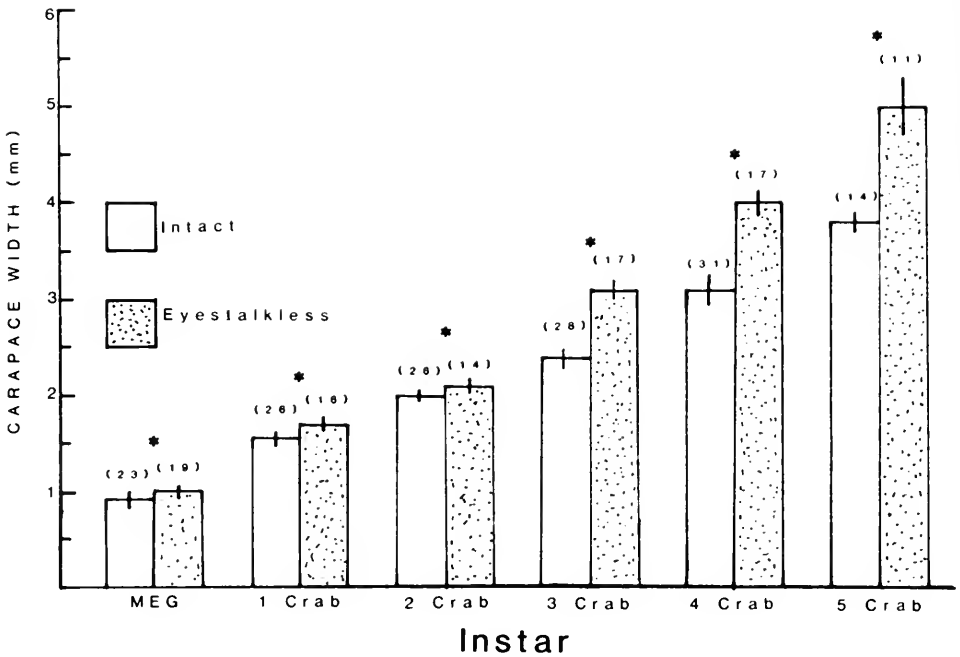

FIGURE 2. Carapace widths of intact and eyestalkless megalopae and first through fifth instar crabs (designated 1, 2, 3, 4, 5 crab, respectively) *R. harrisii*. Each bar represents mean \pm 1 standard deviation. Width measurements were taken at end of instar by measuring shed exoskeleton. Sample size for each measurement indicated in parentheses above the bar. Asterisk indicates significant difference ($P < .05$) between intact and eyestalkless groups.

crabs demonstrated more growth per instar than did control crabs. Since the control and eyestalkless groups differed in molt cycle length at each molt cycle, the growth rates were calculated in terms of carapace width increase/day/instar (Table II). These calculations demonstrate that, in each of the molt cycles examined, there was a greater growth rate in the eyestalkless crabs.

If the greater incremental size increase of eyestalkless animals was strictly a function of excessive cuticular stretching caused by unrestricted intake of water at ecdysis, then the epidermal cell density of eyestalkless animals should be less than that of intact animals. When epidermal cell density determinations were made on

TABLE I

Growth in Rhithropanopeus harrisii juveniles

	Total time (days) from megalopa to fifth instar crab	Growth of carapace during period from megalopa to fifth instar crab (mm/day)
control	55.7*	.052**
eyestalkless	34.1	.117

* From Figure 1: Sum of mean durations for first-fourth crab molt cycles.

** From Figures 1 and 2: mean CW fifth crab minus mean CW megalopa/sum mean durations of first-fifth crab molt cycles.

TABLE II

Growth rates for juvenile Rhithropanopeus harrisi

Instar	Carapace width increase (mm/instar)*		Carapace width increase (mm/day/instar)**	
	Control	Eyestalkless	Control	Eyestalkless
Megalopa	.65	.70	.076	.125
First instar crab	.45	.45	.080	.089
Second instar crab	.40	1.00	.059	.204
Third instar crab	.70	.90	.090	.172
Fourth instar crab	.70	1.00	.056	.145

* From Figure 2, mean CW of instar n + 1 minus mean CW of instar n.

** From Figures 1 and 2, CW instar n + 1 - CW instar n/mean number of days per instar.

regions of the dorsal carapace, there was no significant difference in cell density between the control and eyestalkless crabs (Table III), even though the mean carapace widths of the two groups differed by nearly 25%. These findings suggest that the observed size differences between the control and eyestalkless crabs were not due to differences in cell size, but rather to enhanced cell proliferation in the eyestalkless crabs.

DISCUSSION

Our results show that eyestalkless juvenile crabs molt at a more rapid rate than intact crabs demonstrating that the eyestalks of juvenile crabs are involved in regulation of the molt and growth rates. This is in keeping with earlier findings (Freeman and Costlow, 1980) which showed that MIH is produced during the larval period.

The extent to which the molt cycle is accelerated in eyestalkless crabs varied during the megalopa and juvenile period. This suggests that the eyestalks may produce a molt-inhibiting hormone (MIH) in differing quantities during each of the zoeal, megalopal, and juvenile phases of the life cycle. It is possible that alterations in the molting frequency may be an adaptation to the different environments experienced by the three phases. Molt-inhibiting hormone is apparently present in reduced amounts during the zoeal period (Freeman and Costlow, 1980), thus allowing the larvae to grow and complete postembryonic development in the shortest period of time. While the plankton contains optimal amounts of food for zoeal growth, the longer the larva resides in the plankton, the greater the chance that it will be consumed by larger larvae or fish (see Morgan, 1981). Conversely, increased levels of MIH during the megalopal instar would lengthen the molt cycle, allowing the crab more time to take up a benthic existence and find a suitable habitat. Then,

TABLE III

Mean cell density of carapace from control and eyestalkless fifth instar crabs Rhithropanopeus harrisi

	Nuclei/100 μm^2
control	1.22 \pm .27* (n = 16)
eyestalkless	1.10 \pm .16 (n = 5)

* Mean \pm 1 standard deviation.

during the early juvenile phase, minimal production of MIH would again permit rapid molting, providing a mechanism for rapid growth and onset of reproductive maturity, which occurs in the fifth crab instar (Payen *et al.*, 1969).

The results of the present study differ from those of earlier reports on molting in juvenile *Callinectes sapidus* (Costlow, 1963) and *R. harrisii* (Costlow, 1966). The discrepancy may be explained by two important differences in the experimental protocols. First, in this study, the animals were reared at 21°C while, in the earlier studies, the crabs were reared at 25°C. The lower temperature shows the molt cycle, thus making subtle differences between the intact and eyestalkless animals more evident. Second, both apolysis (stage D₀) and ecdysis were followed in the present study, while only ecdysis was noted in the earlier work. The observation schedule used here has been shown to be a more accurate means of assessing the rate at which an animal passes through the molt cycle stages (Freeman and Costlow, 1980).

Eyestalk removal also resulted in large increases in carapace width at each ecdysis, in keeping with earlier findings on larval crabs (Costlow, 1966) and shrimp (Little, 1969). Similar findings have been presented for adult *Uca pugnator* (Abramowitz and Abramowitz, 1940), *Cambarus* (Scudamore, 1947), *Carcinus* (Carlisle, 1955), *Homarus americanus* (Mauviot and Castell, 1976), and other crustaceans (see Passano, 1960). Enhanced growth in eyestalkless animals has been attributed to loss of a neurosecretory factor that regulates, in some manner, the rate of water influx at ecdysis (see Passano, 1960). Water uptake at ecdysis is a normal physiological event which serves to increase hemolymph hydrostatic pressure, thereby causing the rupture of the weakened old exoskeleton and unfolding of the epidermis from a plicated to a planar form (Drach, 1939; Passano, 1960). An abnormal increase in the influx could result in an actual stretching of the integument. Direct proof for a mechanism involving neurosecretory-controlled increase in water uptake, however, has not been forthcoming. Alternatively, as pointed out by Passano (1960), the increased extensibility may be due to a thinner exoskeleton at the time of ecdysis. This would occur if ecdysis took place earlier than normal during the premolt period when fewer lamellae would have been secreted in the new exoskeleton.

Initially, enhanced integumental stretch would result in each epidermal cell having an increased apical area. Findings obtained in this study show, however, that the epidermal cell density is the same in intermolt crabs from both the control and eyestalkless groups. For the cell density to be similar, while the growth rate was greater, there would have to be more cell proliferation in the integument of the eyestalkless crabs. It is, therefore, possible that the epidermis of eyestalkless animals responded to the stretch by increasing the amount of cell proliferation, thereby restoring the apical region of the epidermal cell to the normal area. At the present time, it is unclear if this enhancement of epidermal cell proliferation has an endocrine basis or if it is a result of the stimulation of metabolic processes that characteristically follow eyestalk removal (Kleinholz and Keller, 1979).

In the present study, we were able to maintain eyestalkless *R. harrisii* through one megalopal instar and five consecutive crab instars. In contrast, eyestalk removal in adult crabs often results in death after one molt. Seldom are several consecutive molts obtained. Although we can not explain this difference from the results reported here, it is possible that the relatively brief molt cycle duration of the juvenile *R. harrisii* (4–12 days) may allow them to molt several times before the detrimental effects of eyestalk loss become severe. Larger crabs often have molt cycle durations that are much longer than several days. In fact, the molt cycles of mature adult *R. harrisii* can last for two months (Freeman, unpublished observations), almost twice the total time for the larvae to pass through the first five crab instars (see Table I).

ACKNOWLEDGMENTS

The authors wish to thank Ms. Anita Walker for technical assistance, and anonymous reviewers for their helpful comments on the manuscript. This work was supported by contract No. NR-104-194 between the Office of Naval Research and Duke University.

LITERATURE CITED

- ABRAMOWITZ, R. K., AND A. A. ABRAMOWITZ. 1940. Moulting, growth and survival after eyestalk removal in *Uca pugilator*. *Biol. Bull.* **78**: 179-188.
- CARLISLE, D. B. 1955. On the hormonal control of water balance in *Carcinus*. *Publ. Staz. Zool. Napoli* **27**: 227-231.
- COSTLOW, J. D. 1963. The effect of eyestalk extirpation on metamorphosis of megalops of the blue crabs. *Callinectes sapidus* Rathbun. *Gen. Comp. Endocrinol.* **3**: 120-130.
- COSTLOW, J. D. 1966. The effect of eyestalk extirpation on larval development of the mud crab, *Rhithropanopeus harrisi* (Gould). *Gen. Comp. Endocrinol.* **7**: 255-274.
- DRACH, P. 1939. Mue et cycle d'intermue chez les Crustacés Décapodes. *Ann. Inst. Oceanogr.* **19**: 103-391.
- DRACH, P., AND C. TCHERNIGOVITZEFF. 1967. Sur la méthode de détermination des stades d'intermue et son application générale aux crustacés. *Vie Milieu Ser. A* **18**: 595-610.
- FREEMAN, J. A., AND J. D. COSTLOW. 1980. The molt cycle and its hormonal control in *Rhithropanopeus harrisi* larvae. *Dev. Biol.* **74**: 479-485.
- KLEINHOLZ, L. H., AND R. KELLER. 1979. Endocrine regulation in crustacea. Pp. 159-213 in *Hormones and Evolution*, E. J. W. Barrington, ed. Academic Press, New York.
- LITTLE, G. 1969. The larval development of the shrimp *Palaemon macrodactylus* Rathbun, reared in the laboratory, and the effect of eyestalk extirpation on development. *Crustaceana* **17**: 69-87.
- MAUVIOT, J., AND J. D. CASTELL. 1976. Molt- and growth-enhancing effects of bilateral eyestalk ablation on juvenile and adult American lobster (*Homarus americanus*). *J. Fish. Res. Board Can.* **33**: 1922-1929.
- MCLAUGHLIN, P. A. 1980. *Comparative Morphology of Recent Crustacea*. Pp. 177. W. H. Freeman, San Francisco.
- MORGAN, S. C. 1981. Larval spines as an anti-predator device in *Rhithropanopeus harrisi* (Decapoda, Xanthidae). *Am. Zool.* **21**: 518.
- PASSANO, L. M. 1960. Molting and its control. Pp. 473-576 in *The Physiology of Crustacea*, Vol. 1, T. H. Waterman, ed. Academic Press, New York.
- PAYEN, G., J. D. COSTLOW, AND H. CHARNIAUX-COTTON. 1969. Mise en évidence expérimentale de l'indépendance de la réalisation de sexe chez le Crabe *Rhithropanopeus harrisi* (Gould) à l'égard du complexe neurosécréteur organe de Hanstrom-glande du sinus. *C. R. Acad. Sci. Paris* **269**: 1878-1881.
- SCUDAMORE, H. H. 1947. The influence of the sinus glands upon molting and associated changes in the crayfish. *Physiol. Zool.* **20**: 187-208.
- SKINNER, D. M. 1983. Regeneration and Molting. In *The Biology of Crustacea*, Vol. 9, D. E. Bliss and L. H. Mantel, eds. Academic Press, New York.

INTRASEXUAL AGGRESSION IN *METRIDIUM SENILE*

SAUL W. KAPLAN

Institute of Animal Behavior, Rutgers University, 101 Warren Street, Newark, New Jersey 07102

ABSTRACT

The dioecious anemone *Metridium senile* reproduces both sexually (in summer) and asexually (year round). Asexual reproduction yields genetically identical clones via longitudinal fission or pedal laceration. Clonemates may form large aggregates, ranked together in close order, and become aggressive against neighboring clones. Interclonal aggression is frequently carried out with the use of hypertrophied tentacles referred to as catch tentacles. The present study indicates that catch tentacles do not maintain clonal segregation, and do not serve as aggressive appendages against all nonclonemates. Laboratory pairings of nonclonemates and observations of their movements in the field indicate that interclonal aggression in this species is mediated by sex. Nonclonemates will become aggressive only against same sexed individuals, males fighting males and females fighting females, while nonclonemates of opposite sex may exhibit nonaggressive interaction, with or without the use of catch tentacles. Interclonal/intrasexual aggression in this species may function to increase the probability of successful fertilization during sexual reproduction by increasing the proximity of males to females and *vice versa*.

INTRODUCTION

Metridium senile is a dioecious cold water anemone common on both the east and west coasts of the United States. *Metridium* reproduces both sexually (in summer) and asexually (year round) by pedal laceration and longitudinal fission (Stephenson, 1935). Asexual reproduction commonly produces clones ranging from a few to many hundreds of genetically identical individuals. Color variation among clones makes it possible to distinguish easily between clonemates and nonclonemates in the field (Hoffman, 1976).

Most populations include individuals bearing large opaque tentacles surrounding the mouth which are structurally and functionally distinct from feeding tentacles (Purcell, 1977). Prior studies have shown that these tentacles, referred to as "catch tentacles" may be used in aggressive encounters between nonclonemates. These appendages, derived from feeding tentacles though not themselves used in feeding, had originally been reported to function in the maintenance of interclonal boundaries, in much the same way as acrorhagi maintain interclonal segregation in *Anthopleura elegantissima* (Francis, 1973). Intermingling of clones among *Metridium* is not uncommon, and individuals of clearly distinct appearance, bearing catch tentacles, are frequently found adjacent and in contact in the field (Purcell and Kiting, 1982), with no sign of aggressive interaction.

Interclonal aggression may be initiated when an individual spontaneously extends catch tentacles and contacts a nonclonemate, or when movement within or between clones bring two nonclonemates within feeding tentacle range. When extended, catch tentacles are longer than feeding tentacles, and may be as much as four times longer than the diameter of the oral disc (Purcell and Kiting, 1982),

extending the effective territory of the anemone by a factor of eight. When a catch tentacle finds a nonclonemate and nematocyst discharge occurs, the tentacle tip may adhere, while the tentacle retracts, so that the tip breaks off and remains attached to the victim, continuing to sting after the aggressor has withdrawn. Following one or more bouts of aggressive interaction, one anemone will usually retract its tentacles within its column, and bend or move across the substrate, out of range of further attack. Interclonal contact without aggressive interaction may also involve catch tentacle extension. Nonclonemates may contact one another with catch tentacles, draw closer, make contact with feeding tentacles, and remain in close proximity with no aggression or withdrawal, sometimes for days.

The present study tests the hypothesis that catch tentacles are used in aggressive interaction exclusively between nonclonemates of like sex, and that nonclonemates of opposite sex not only tolerate one another's presence but may engage in non-aggressive interaction.

MATERIALS AND METHODS

Seventeen anemones from five clones with catch tentacles (two male and three female clones) were collected from Monterey Harbor and the Elkhorn Slough, and allowed to settle on individually marked glass discs in flowing sea water aquaria. Each subject was anesthetised in an isotonic magnesium chloride solution to facilitate examination of the contents of the gastrovascular cavity. A glass pipette was introduced into the oral opening, and its contents withdrawn. In some cases the wall of the gastrovascular cavity was pierced and cellular material withdrawn from within. All subjects contained either live sperm or well developed eggs. In this manner it was possible to determine the sex of the individual without resorting to the more conventional sectioning and staining techniques which make subsequent behavioral testing difficult.

Two individuals from different clones were placed in contact with one another in sea water-filled glass observation bowls. Trials lasted up to twelve hours. Aggressive contact was clearly distinguishable from nonaggressive interaction as it was quickly followed by marked, sharp withdrawal as if in response to pain. In some cases aggressive interaction began immediately upon contact. In others it appeared only after hours of intermittent contact and withdrawal. Aggressive behavior, *i.e.*, first catch tentacle erection, number of catch tentacles erect, and elapsed time until separation, were recorded. Eighteen of forty-two pairings elicited catch tentacle expansion. Eleven of these were aggressive encounters.

Following forty-two laboratory pairings all subjects were allowed to settle on a Plexiglas panel which was then suspended in Monterey Harbor, so that the anemones could move freely, contacting clonemates and nonclonemates of both sexes on the basis of "preference." The position and movement of each anemone was checked and recorded daily for an eighteen day period.

RESULTS

Forty-two trials were conducted, in which twelve individuals showed aggressive behavior. All instances of aggressive behavior were confined to trials between individuals of the same sex (Table I). In no case did a male attack a female or *vice versa*. The probability of this occurring on the basis of chance alone, and not due to the sex of the animals being tested is equivalent to one half to the twelfth, or .00024. Observation of the suspended panel corroborated the findings of the laboratory pairings. In eighteen days of free movement the seventeen subjects showed no tendency to reaggregate as clones, but in four instances individuals paired off in

TABLE I

Interclonal aggressive encounters

	Clone	#1	#2	#3	#4	#5
Female	#5	0	0	2	3	
Female	#4	0	0	2		
Female	#3	0	0			
Male	#2	5				
Male	#1					

direct tentacle to tentacle contact with nonclonemates of the opposite sex for the duration of the eighteen day period. Nonclonemates of the same sex were never found in contact.

DISCUSSION

Metridium senile, unlike *Anthopleura elegantissima*, does not spawn synchronously throughout a colony (Abbot, Hopkins Marine Station, pers. comm., 1982). When gametes are released by individuals in an asynchronous manner into the marine environment, the problem of achieving successful fertilization may be considerable if an animal is surrounded by individuals of its own sex and its gametes are quickly dispersed. A mechanism enabling a clonal coelenterate to discover the sex of its neighbors and cause like sexed nonclonemates to move away so that opposite sexed nonclonemates can approach would greatly increase the probability of successful fertilization. Interclonal/intrasexual aggression in *Metridium senile* may be just such a mechanism. Following three active mixed sex trials, a second examination of the gastrovascular cavity of each of the three females yielded both live sperm and well developed eggs, where previously only eggs had been found. In no other case were the two found within one animal. Internal fertilization has not previously been reported to occur in this species. It is possible that catch tentacles are not only used for intrasexual aggression, but may function in "courtship" as well, enabling two anemones to release their gametes at the most propitious moment. This is the impression given by observation of the long slow catch tentacle interactions occasionally seen in mixed sex pairs of *Metridium senile*, as they touch and probe one another's oral surfaces, and draw closer and closer together.

ACKNOWLEDGMENTS

I wish to thank Dr. J. Oliver, Dr. S. Lenington, and Dr. J. Purcell. This research was submitted in partial fulfillment of the requirements for the Ph.D. This is contribution number 361 from the Institute of Animal Behavior. (Special thanks to C. Banas.)

LITERATURE CITED

- FRANCIS, L. 1973. Intraspecific aggression and its effects on the distribution of *Anthopleura elegantissima* and some related sea anemones. *Biol. Bull.* **144**: 73-92.
- HOFFMAN, R. J. 1976. Genetics and asexual reproduction of the sea anemone *Metridium senile*. *Biol. Bull.* **151**: 478-488.
- PURCELL, J. E. 1977. Aggressive function and induced development of catch tentacles in the sea anemone *Metridium senile* (Coelenterata, Actinaria). *Biol. Bull.* **153**: 355-368.
- PURCELL, J. E., AND C. L. KITING. 1982. Intraspecific aggression and population distributions of the sea anemone *Metridium senile*. *Biol. Bull.* **162**: 345-359.
- STEPHENSON, T. A. 1935. *The British Sea Anemones* 2, The Ray Society, London. p. 426.

SPERM CHEMOTAXIS IN *OIKOPLEURA DIOICA* FOL, 1872 (UROCHORDATA: LARVACEA)

RICHARD L. MILLER¹ AND KENNETH R. KING²

¹*Department of Biology, Temple University, Philadelphia, Pennsylvania 19122, and*

²*Department of Oceanography and The Friday Harbor Laboratories,
University of Washington, Seattle, Washington 98195**

ABSTRACT

An alcohol extract of unfertilized eggs of the larvacean, *Oikopleura dioica*, can attract sperm over a distance of at least 80 μm from an artificial source. The sperm, which normally swim in wide circles or straight lines, alter their path to form small loops between straight or slightly curved segments directed up the gradient. During the first loop, the velocity of sperm increases 50%. The new velocity is maintained as long as the cells are influenced by the attractant. Once sperm reach the center of the gradient, the path alters to the form of enlarging concentric circles which eventually attain the diameter of the circles made in sea water. *O. dioica* sperm and sperm attractant are species-specific in tests against attractants and sperm of sessile tunicates. It has not yet been possible to test the species-specificity against other larvaceans. We estimate that sperm chemotaxis in *O. dioica* increases the chance of sperm-egg collisions from 4 to 15 times. This is mainly due to an increase in apparent diameter of the egg and also to an increase in the velocity of attracted sperm. Rapid population increase is characteristic of *O. dioica* under appropriate conditions. An increase in the probability of fertilization produced by sperm chemotaxis may be an additional factor leading to decreased generation time for the population as a whole.

INTRODUCTION

Larvaceans are adult planktonic urochordates which resemble the tadpole larva of sessile urochordates (Tunicata). They are widely distributed in tropical and temperate oceans (*e.g.*, Forneris, 1957; Fenaux, 1967) and may be found in immense numbers under certain circumstances (Seki, 1973; Wyatt, 1973). Larvaceans may rapidly attain large population size because they take advantage of short term conditions optimal for maximum growth of the population. They possess very rapid development (Galt, 1972; Fenaux, 1976) coupled with rapid growth to sexual maturation (Fenaux, 1976; Paffenhöfer, 1976). Generation times of 10 days or less have been measured in enclosed water columns (King *et al.*, 1980; King, 1982).

In contrast to other larvaceans, *Oikopleura dioica* is dioecious. Spawning is random and may be triggered by physical means, such as turbulence or contact with another object (Galt, 1972). The completely transparent eggs are denser than sea water and sink after spawning (Bienfang and King, unpub.). Little is known about gamete interactions in these organisms. If it is advantageous to decrease development time in order to react quickly to favorable environmental conditions, then shortening

Received 16 July 1982; accepted 28 June 1983.

* Present address: Division of Biology and Living Resources, Rosenstiel School of Marine and Atmospheric Sciences, University of Miami, 4600 Rickenbacker Causeway, Miami, Florida 33149.

the interval between the spawning act and the time of fertilization may be important in situations where the presence of the opposite sex cannot be predicted. One method for ensuring fertilization and decreasing the time that the eggs remain unfertilized is sperm chemotaxis where sperm move closer to the egg from some distance away by following a gradient of a substance released by the egg (Miller, 1973). In taxa where sperm chemotaxis has been described (Miller, 1966; 1975; 1977; 1979a), it has been noted that the attractant often increases sperm velocity, further decreasing the time of sperm approach. Sperm of many planktonic hydromedusae (Miller, 1979a, b) and sessile tunicates (Miller, 1975; 1982) exhibit chemotaxis. Here we describe this phenomenon in a planktonic urochordate, and speculate on its possible impact on the population dynamics of *O. dioica*.

MATERIALS AND METHODS

Sexual specimens of *Oikopleura dioica* were gently removed from the ocean with a large bore pipette as they drifted past the dock at the Friday Harbor Laboratories. The animals were made visible using a submerged night-light (Woodland, Inc.). Ripe males could be distinguished by the swollen brilliant white testes. The ovaries of females were also swollen and white but somewhat less brilliant. Individuals were kept segregated by sex in small clean finger bowls and used immediately after collection.

Gametes were obtained by pricking the gonad surface of individuals which had been previously transferred through several changes of HA-Millipore (0.45 μm) filtered sea water to remove supernumerary sperm. Eggs were permitted to settle and the sea water removed. The damp eggs were extracted for 10–20 minutes in 95% ethanol to yield the active extract (Miller, 1979a). Aliquots of this were air-dried, diluted into an equivalent volume of sea water and injected into a suspension of actively moving sperm. The sperm suspension was placed on a standard microscope slide within a 2.4 cm^2 area previously covered with a thin layer of 1% bovine serum albumin in distilled water, to create a flat puddle a few mm deep. The egg extract was injected with an RGI micrometer syringe connected by thin polyethylene tubing to a micropipette of 30 μm tip diameter. Back pressure was controlled by filling the tubing and syringe with mineral oil. The pipette was lowered into the puddle and brought to the slide surface while under observation in dark-field illumination with a 10 \times objective.

Like other invertebrate sperm, *O. dioica* sperm become thigmotactic on non-sticky, smooth surfaces. This allows the objective to be focussed on the thigmotactic cells, which remain on the microscope slide surface indefinitely. The rationale for the use of thigmotactic sperm for observation of chemotactic behavior and the probable artifacts inherent in this approach are discussed in Miller (1973). Sperm behavior was observed and photographed at 12 fps, with 4 \times reversal film using a Bolex 16 mm camera. The developed film was analyzed with a Kodak "Analyst" projector by projecting the film onto tracing paper and plotting the path of the sperm cells by hand. Sperm velocity was determined by measuring the distance the sperm head traveled each frame.

We tested for species-specificity by confronting the sperm of *O. dioica* with egg extracts from several sessile tunicates, and the various tunicate egg extracts with the sperm of the larvaceans and tunicates. The numerical estimate of extract activity used in this work is the titer, or the number of serial half-dilutions required for complete loss of activity against homo- or heterospecific sperm (Miller, 1979a).

RESULTS

Under the standard conditions of observation, *Oikopleura dioica* sperm swimming in sea water make relatively straight (Fig. 1A) or circular paths (Fig. 1B, 2). The average velocity during these "control" trails is $75.6 \mu\text{m/s}$ (Table I). Infrequent,

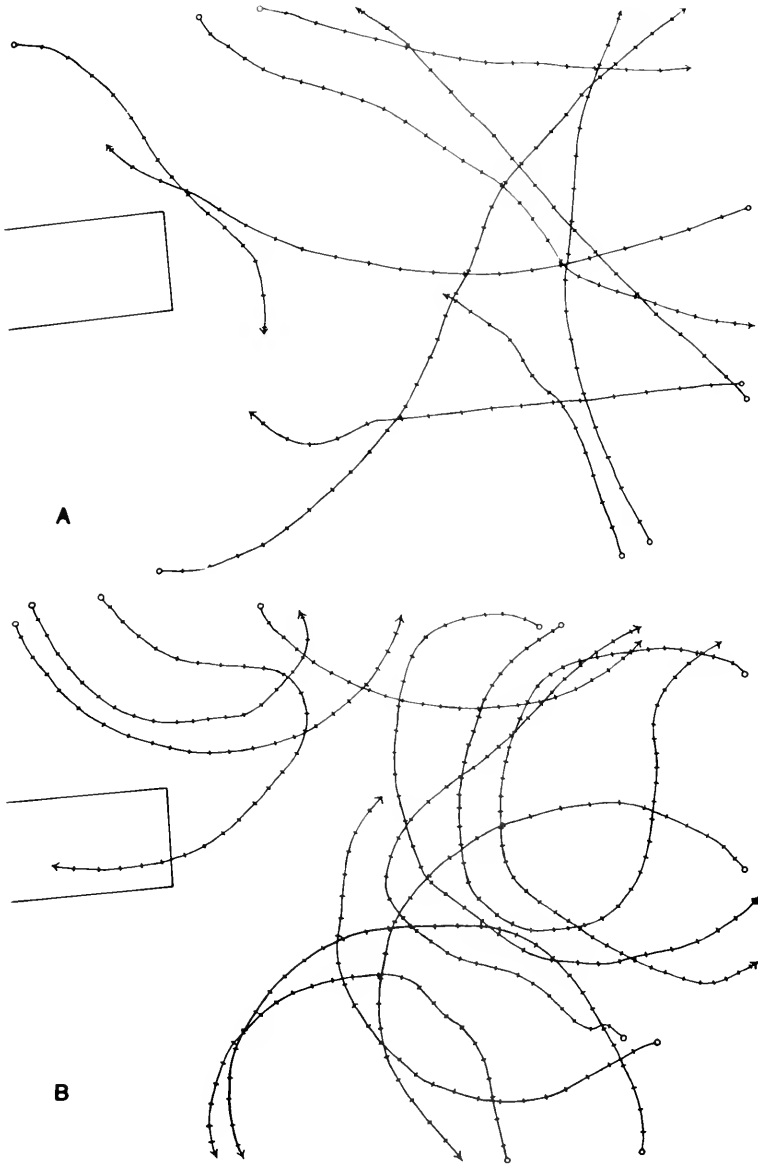

FIGURE 1. Paths of *Oikopleura dioica* sperm in the presence of a pipette injecting sea water. A. Mainly straight or slightly curved trails. B. Mainly curved trails. Pipette diameter is $30 \mu\text{m}$. Each interval on the trail represents 0.08 s.

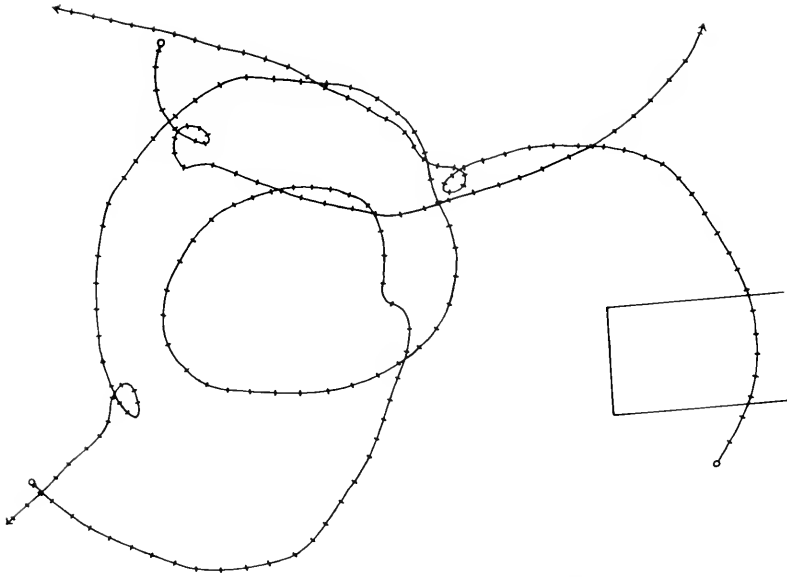

FIGURE 2. Paths of *Oikopleura dioica* sperm in the presence of a pipette injecting sea water. Curved trails with rare, random loops. Pipette diameter is 30 μm .

random turns in the form of sharp loops may occur in some trails within 4–5 frames (approximately 0.35 s) (Fig. 2). The direction taken after these loops have been completed is roughly 270° relative to the original path direction. The form of the new path is the same as the original. Injection of sea water into the sperm suspension produces no change in sperm motility or direction as long as the rate of injection is slow enough to prevent physical shifting of the sperm.

If a sea water solution of *Oikopleura* egg extract is injected (experimental trails), the sperm behave quite differently (Fig. 3). Sperm enter the field on a typical pre-attraction circular path at about average velocity (72.0 $\mu\text{m/s}$; Table I) but, about 130 μm away from the pipette tip, undergo a looping behavior which brings them closer to the pipette tip. The average velocity during these trails is 96.2 $\mu\text{m/s}$ (Table I).

TABLE I

Average velocities along Oikopleura sperm trails before and during chemotaxis

Trail type	Number of trails	Number of measurements	Mean (μs)	SD	SE	<i>P</i>
Control trails	21	852	75.61	1.896	± 0.065	<.001 ^a
Experimental trails	11	681	96.22	2.502	± 0.096	
Pre-attraction	11	148	71.97	1.565	± 0.129	<.001 ^b
Post-attraction		148	109.88	1.652	± 0.136	

Control and *Experimental* trails refer to groups of trails in sea water and exposed to a gradient of sperm attractant, respectively. *Pre-attraction* and *Post-attraction* refers to measurements made at the start of the 11 experimental trails and the same number of measurements made at the end of the same set of trails, respectively.

a. *t*-test, groups; control trails *versus* experimental trails.

b. *t*-test, pairs; pre-attraction *versus* post-attraction in experimental trails.

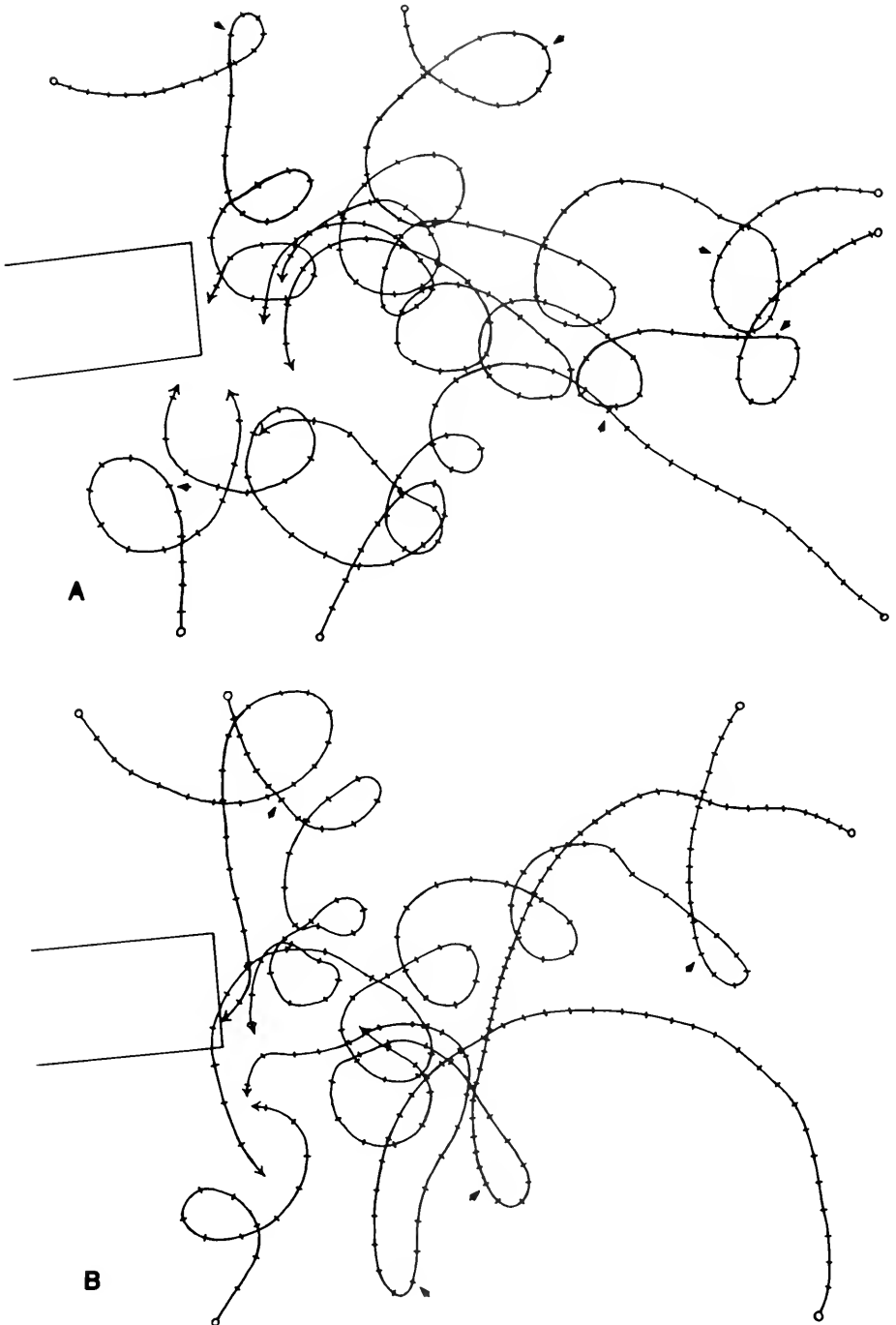

FIGURE 3. Paths of *Oikopleura dioica* sperm in the presence of a pipette injecting *O. dioica* egg extract with a titer of 9–10. Trails in A and B were obtained from an 18.7 s film sequence and trail positions have been slightly adjusted for the best demonstration of their characteristics. Arrows indicate point of acceleration of sperm in response to the attraction gradient. Pipette diameter is 30 μm .

TABLE II

Oikopleura sperm trail loop and circle characteristics before and during sperm chemotaxis

	Loops ⁰		Circles ⁰	
	Diameter (a, b)	Length (l)	Diameter (d)	Circumference (C = d)
	<i>a × b</i>			
Before	9.4 × 3.4 μm (5)*	24.7 ± 1.14 μm (5)	97.7 ± 5.8 μm (20)	306.8 ± 15.9 μm (20)
During	24.2 × 17.9 μm (25)	66.5 ± 4.4 μm (25)	42.4 ± 5.5 μm (9)	133.3 ± 17.4 μm (9)

* number of measurements.

⁰ refer to Figure 4.

Table II and Figure 4 present measurements of the loops and circles made in control and experimental trails. The average loop is 2.7 times longer and 5 times broader in the experimental (attraction) trails than during the control trails. During the first looping maneuver, the velocity of the sperm increases significantly (paired *t*-test; $P < 0.001$) (Table I) and the new speed (109.9 μm/s) is maintained for the rest of the trail.

Once the attracted sperm arrive at the pipette tip, they begin to circle around it (Fig. 5, 6A). The circles of all the sperm become more or less concentric, with an average diameter half of those made during normal swimming (Table II; compare Figs. 1A, B with Figs. 5, 6A). The concentric circular paths enlarge in diameter, resembling those seen prior to attraction (Fig. 5A, 6B). All sperm swim counterclockwise during this behavior as they did in the circles and loops made before attraction. Their velocity remains high (109.9 μm/s). The cells seem to have entered a new, stable motility configuration and behave as though the attraction gradient is no longer present. The result of this sequence of behaviors is a rapid shift of the sperm population toward the pipette tip. By the end of the film sequence, few sperm are found at the margins of the area of observation.

SPERM TRAIL LOOP AND CIRCLE PARAMETERS

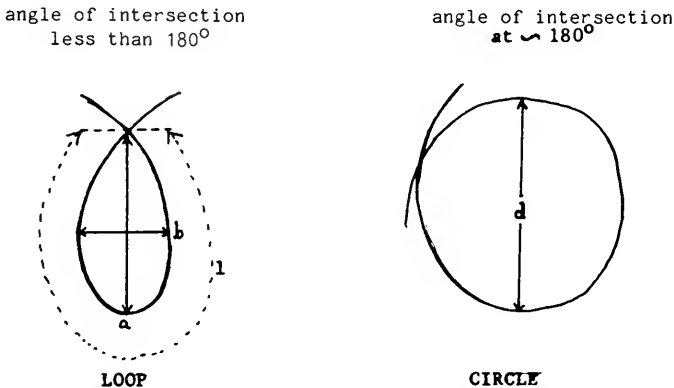

FIGURE 4. Diagrammatic representation of sperm trail loops and circles, with measurement parameters used to determine loop and circle sizes.

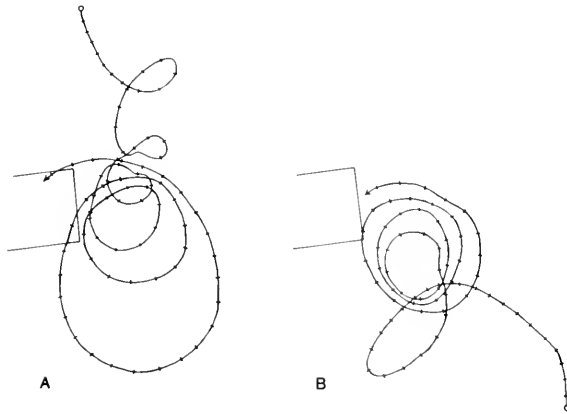

FIGURE 5. Two trails of attracted sperm showing the start of the concentric circling behavior that is the result of sperm chemotaxis. 5A shows the characteristic progressive enlargement of the circles. Pipette diameter is $30\ \mu\text{m}$.

It is evident that the sperm are directed toward the pipette tip when the *O. dioica* egg extract is released. To confirm this, the pipette was moved about $0.15\ \text{mm}$ from the outer margin of the old aggregation and a new injection made. The sperm move from the old aggregation into the new injection area, where a new swarm is formed of sperm swimming concentrically about the pipette tip. Therefore, not only is a gradient of attractant required for sperm aggregation, but the same cells can be re-attracted by the same egg extract.

In three cases we were able to follow the movement of very small particles ($\sim 1\ \mu\text{m}$ in diameter) in front of the pipette as the attractant was injected. Each of these cases differed in the force of the injection. In the first, enough force was exerted to push the particles $90\ \mu\text{m}$ away from the tip before they came to rest. Sperm were

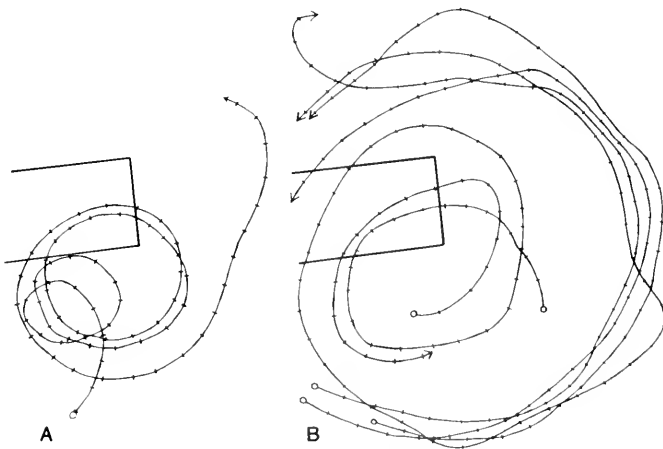

FIGURE 6. A. Another trail showing the transition to concentric circling behavior and the transition from small to large circles. B. A portion of a plot of sperm circling around the pipette tip at the end of the preparation (injection stopped). This is $5.3\ \text{s}$ of a film sequence showing this behavior only.

seen to respond 40 μm further away from the tip. In the second case, the particles came to rest 60 μm away from the pipette tip and the sperm were seen to turn a further 40 μm away. In the third case, no particle movement occurred. In this case, the sperm turned 80 μm away from the pipette tip. These three cases suggest that sperm can respond to attractant which has diffused at least 40 to 80 μm beyond the area of injection.

Tests of the effects of egg extracts from sessile tunicates on *O. dioica* sperm have yielded complete species-specificities in all cases. The active egg extracts of *Ascidia callosa* (titer = 11) and *Chelyosoma productum* (titer = 5) do not attract *O. dioica* sperm, whereas the behavior of the sperm of *Corella inflata*, *Corella willmeriana*, *Ciona intestinalis*, *Ascidia callosa*, *Chelyosoma productum*, *Styela montereyensis*, *Styela gibbsi*, and *Halocynthia igaboja* remains unaffected by the presence of a gradient of *O. dioica* egg extract (titer = 8-9).

DISCUSSION

We have demonstrated that *O. dioica* spermatozoa, when confronted with a gradient of an egg extract, are capable of sperm chemotaxis. The trails of attracted sperm strongly resemble those of chemotactic sperm of other invertebrates (Miller, 1966; 1975; 1977; 1979a). They most particularly resemble chiton sperm trails (Miller, 1977) and those of asteroid and holothuroid sperm (Miller, 1981; in prep.). Sperm chemotactic behavior is reversible and can be highly species-specific (Miller, 1979a). Recent work has shown considerable specificity at the genus level in the ascidians (Miller, 1982). Species-specificity between the larvaceans and the ascidians is therefore to be expected, and evidence for it has been presented. Interspecific comparison of sperm chemotaxis between two species of larvaceans has not been possible for lack of suitable material.

When *Oikopleura* sperm chemotactic behavior is initiated, sperm velocity increases 50% and remains at this level for the rest of the trail. Velocity increase has been observed during cnidarian sperm chemotaxis (Miller, 1966). In contrast to chiton, cnidarian, and *Oikopleura* sperm, the sperm of the sessile tunicates *Ciona* and *Styela* and those of several echinoderms show no velocity increase during chemotactic turning or subsequent movement up the gradient (Miller, 1975; 1981; 1982; in prep.). No further changes in velocity occur during subsequent reorientations of larvacean sperm, suggesting that reorientation behavior and velocity increase may be independent in *O. dioica* sperm, unlike chiton sperm, where small velocity adjustments occur during every reorientation loop (Miller, 1977). The source of the activation stimulus may be the sperm attractant itself, though it is possible that the egg extracts also contain a motility activator (Hansbrough and Garbers, 1981).

Unlike sessile tunicates, larvacean populations are not limited by availability of settling substrate for the larvae (Grosberg, 1981), but rather by food supply and predation (King, 1982). The ability of larvaceans to rapidly increase population size under certain conditions has been documented (King *et al.*, 1980; King, 1982). Quantitatively, the relative magnitude of the factors which aid in this increase are uncertain. Any factor which shortens the developmental time from spawning to sexual maturation would be of importance, particularly in this instance, where sexual aggregation may not occur prior to spawning.

Larvacean eggs have a density greater than sea water and sink at about 25 m/day (300 $\mu\text{m/s}$) (Bienfang and King, unpub.). The sperm velocity is moderate

(~ 80 – $110 \mu\text{m/s}$) and the sperm is quite small ($\sim 20 \mu\text{m}$ in length; Flood and Afzelius, 1978), though large numbers are shed by each ripe male. Spawning is cataclysmic and asynchronous in both sexes (Galt, 1972) so there should not be a uniform concentration of sperm or eggs in the water column. Both gametes have a fertilizable life of about 24 h (Galt, 1972).

Assuming the sperm are swimming in random directions relative to the egg, the chances of an egg being fertilized at a particular time depend directly on local sperm concentration, average swimming speed of sperm, the average age of the sperm and eggs, the egg surface area and its sinking rate (Rothschild and Swann, 1949; 1951). However, in larvaceans, some of these factors are not constant. Sperm velocity increases and sperm path direction is determined by the presence of eggs, once the sperm arrive within a minimum distance of $80 \mu\text{m}$ from the egg. The effect of this is to increase the chances of a nearby sperm making contact with the egg surface by enlarging the effective egg diameter from $80 \mu\text{m}$ (Delsman, 1912; Galt, 1972) to $240 \mu\text{m}$ or more.

The number of collisions of sperm with a non-sinking egg per unit time (Z) is a function of the number of sperm (n), their average velocity (c), and the square of the egg radius (r): ($Z = \pi r^2 nc$; Rothschild and Swann, 1951). Increasing velocity by 50% (from 70 to $110 \mu\text{m/s}$) will increase the number of collisions by two-thirds. Increasing radius of the egg by three (from 40 to $120 \mu\text{m}$) increases collision rate 9 times. The estimated increase in collisions due to sperm chemotaxis compared to the "standard" fertilization paradigm is approximately 15 times for *O. dioica*, assuming no increase in sperm numbers.

Unfortunately, sperm cannot swim as fast as eggs can sink. However, both sperm and eggs occur in an aqueous medium under a low Reynolds number regime where viscosity effects are dominant, flow is laminar, and nearby water tends to move with objects that are subject to an external force (Purcell, 1977; Koehl and Strickler, 1981). In such a situation the sinking egg (Reynolds number = 0.02) will have a layer of hydrodynamically constrained water (a boundary layer) associated with it. As the egg sinks, water at and beyond the boundary layer reaches a velocity, relative to the egg, equivalent to the egg sinking rate. Within the boundary layer, a velocity gradient exists such that, at $20 \mu\text{m}$ away from the surface of the egg, water velocity relative to the egg and maximum measured sperm swimming speed are equivalent (White, 1974). Assuming that sperm attractant is continually released into the boundary layer, the increase in effective egg diameter by 50% (beyond $20 \mu\text{m}$ the sperm cannot catch the sinking egg) and the concomitant increase in sperm swimming speed upon contact with attractant, yields about a four-fold increase in successful sperm egg collisions. This is probably a worst case estimate of the efficacy of sperm and sperm attractant interactions for larvaceans in the pelagial. *Oikopleura dioica* is usually most abundant in the surface mixed layer. Here, small scale turbulence in the water column may provide long term residency in the mixed layer for sperm and egg by effectively altering egg sinking rates.

ACKNOWLEDGMENTS

We wish to thank the staff of the Friday Harbor Laboratories for their hospitality during our residence. J. Rodzinski patiently hand-measured the intervals on the sperm trails. The manuscript was greatly improved by the comments of two anonymous reviewers. This research was supported by a Temple University grant-in-aid-of-research to RLM and by NSF(IDOE) grant OCE77-27224 to Karl Banse.

LITERATURE CITED

- DELSMAN, J. H. C. 1912. Beitrage zur Entwicklungsgeschichte von *Oikopleura dioica*. *Verh. Rijksinst. Onderz. Zee (Derde Deel)* 2: 3-20.
- FENAU, R. 1967. Les Appendiculaires. In *Faune de l'Europe et du Bassin Mediterranéen*. Masson et Cie, Paris.
- FENAU, R. 1976. Cycle vital d'un appendiculaire *Oikopleura dioica* Fol, 1872 description et chronologie. *Ann. Inst. Oceanogr.* 52: 89-101.
- FLOOD, P. R., AND B. A. AFZELIUS. 1978. The spermatozoon of *Oikopleura dioica* Fol (Larvacea, Tunicata). *Cell Tissue Res.* 191: 27-37.
- FORNERIS, L. 1957. The geographical distribution of the Copelata. *An. Acad. Bras. Cienc.* 29: 273-284.
- GALT, C. P. 1972. Development of *Oikopleura dioica* (Urochordata: Larvacea). Ph.D. Thesis, University of Washington, Seattle.
- GROSBURG, R. K. 1981. Competitive ability influences habitat choice by marine invertebrates. *Nature* 290: 700-702.
- HANSBROUGH, J. R., AND D. L. GARBERS. 1981. Speract: purification and characterization of a peptide associated with eggs that activates spermatozoa. *J. Biol. Chem.* 256: 1447-1452.
- KING, K. R. 1982. The population biology of the larvacean *Oikopleura dioica* in enclosed water columns. Pp. 341-351 in *Marine Mesocosms: Biological and Chemical Research in Experimental Ecosystems*, G. D. Grice and M. R. Reeve, eds. Springer-Verlag, New York.
- KING, K. R., J. T. HOLLIBAUGH, AND F. AZAM. 1980. Predator-prey interactions between the larvacean *Oikopleura dioica* and bacterioplankton in enclosed water columns. *Mar. Biol.* 56: 49-58.
- KOEHL, M. A. R., AND J. R. STRICKLER. 1981. Copepod feeding currents: food capture at low Reynolds number. *Limnol. Oceanogr.* 26: 1062-1073.
- MILLER, R. L. 1966. Chemotaxis during fertilization in the hydroid *Campanularia*. *J. Exp. Zool.* 162: 22-45.
- MILLER, R. L. 1973. Chemotaxis of animal sperm. Pp. 31-47 in *Behavior of Microorganisms*, A. Perez-Miravete, ed. Plenum Press, London.
- MILLER, R. L. 1975. Chemotaxis of the spermatozoa of *Ciona intestinalis* (Protochordata: Urochordata). *Nature* 254: 244-245.
- MILLER, R. L. 1977. Chemotactic behavior of the sperm of chitons (Mollusca: Polyplacophora). *J. Exp. Zool.* 202: 203-212.
- MILLER, R. L. 1979a. Sperm chemotaxis in the hydromedusae. I. Species and sperm behavior. *Mar. Biol.* 53: 99-114.
- MILLER, R. L. 1979b. Sperm chemotaxis in the hydromedusae. II. Some chemical properties of the sperm attractants. *Mar. Biol.* 53: 115-124.
- MILLER, R. L. 1981. Sperm chemotaxis occurs in echinoderms. *Am. Zool.* 21: 985.
- MILLER, R. L. 1982. Sperm chemotaxis in ascidians. *Am. Zool.* 22: 827-840.
- PAFFENHÖFER, G.-A. 1976. On the biology of appendicularia of the southeastern North Sea, Vol. 2, Pp. 437-455 in *Proceedings of the 10th European Symposium on Marine Biology*, G. Persoone and E. Jaspers, eds. Universa Press, Wetteren, Belgium.
- PURCELL, E. M. 1977. Life at low Reynolds number. *Am. J. Physics* 45: 3-11.
- ROTHSCHILD, L., AND M. M. SWANN. 1949. The fertilization reaction in the sea urchin egg. A propagated response to sperm attachment. *J. Exp. Biol.* 26: 164-176.
- ROTHSCHILD, L., AND M. M. SWANN. 1951. The fertilization reaction of the sea urchin. The probability of a successful sperm-egg collision. *J. Exp. Biol.* 28: 403-416.
- SEKI, H. 1973. Red tide of *Oikopleura* in Saanich Inlet. *La Mer (Bull. Franco-Japonaise Oceanogr.)* 11: 153-158.
- WHITE, E. W. 1974. *Viscous fluid flow*. McGraw-Hill Book Co., New York.
- WYATT, T. 1973. The biology of *Oikopleura dioica* and *Fritillaria borealis* in the Southern Bight. *Mar. Biol.* 22: 137-158.

LOWER MARINE FUNGUS ASSOCIATED WITH BLACK LINE DISEASE IN STAR CORALS (*MONTASTREA ANNULARIS*, E. & S.)

TALIA RAMOS-FLORES

*Department of Immunology and Infectious Diseases, The Johns Hopkins University,
School of Hygiene and Public Health, 615 North Wolfe Street, Baltimore, Maryland 21205*

ABSTRACT

A disease of corals called "black line" has become widespread in the Caribbean reefs. Although its etiology has not been determined, a lower marine fungus was found closely associated with the disease. Corals of the species *Montastrea annularis* (star coral) were collected from scattered areas of the Venezuelan reefs. Histological examinations of black line-diseased corals showed this unidentified fungus in and nearby all of the diseased tissue. The branched fungal hyphae lacked septa and ranged in size from 5 to 10 μm long and from 2.5 to 3.0 μm wide. No hyphae were found in black line disease-free areas. No fungi have been detected previously in soft coral tissue. The study of this naturally occurring infection could yield important information concerning pathological processes in corals.

INTRODUCTION

Diseases in marine animals appear to be a common feature in the aquatic environment (Kinne, 1980). However, disease processes in marine animals have been rarely studied as biological phenomena. Not much is known about pathological conditions in cnidarians, especially in "true" corals (Anthozoa: Scleractinia). In 1975, Garrett and Ducklow first reported a naturally occurring disease in the scleractinian corals of the Bermudian reefs. Personal observations of similar conditions in the Venezuelan reefs prompted my study four years ago.

Black line-diseased corals have been found in several Atlantic reefs (Fig. 1): Bermuda (Garrett and Ducklow, 1975); Barbados (Ducklow, 1977); Florida (Voss, 1973 and pers. comm. from W. Jaap, Florida Department of Natural Resources, Marine Research Laboratory, 100 Eighth Avenue, S.E., St. Petersburg, FL 33701); Saint Thomas (Coki Bay) and Saint Croix (East Point and Buck Island), U. S. Virgin Islands (pers. ob., 1976); and Venezuela. No reports of this disease have been published concerning Pacific reefs.

MATERIALS AND METHODS

A comparison of diseased tissue with normal tissue was made (Fig. 2). For this purpose, small coral heads of the species *Montastrea annularis* (Ellis and Solander), measuring about 3 cm in diameter, were collected from the Venezuelan reefs of Morrocoy National Park (10° northern latitude, 68° western longitude) and Los Roques National Park (11° northern latitude, 66° western longitude). These collection sites were chosen on the basis of field observations.

Three major collection sites were established for the study: 1) an area with a high occurrence of the disease (southern reefs of Cayo Norte, Morrocoy Park); 2)

Distribution of "Black Line" Disease in Atlantic Reefs

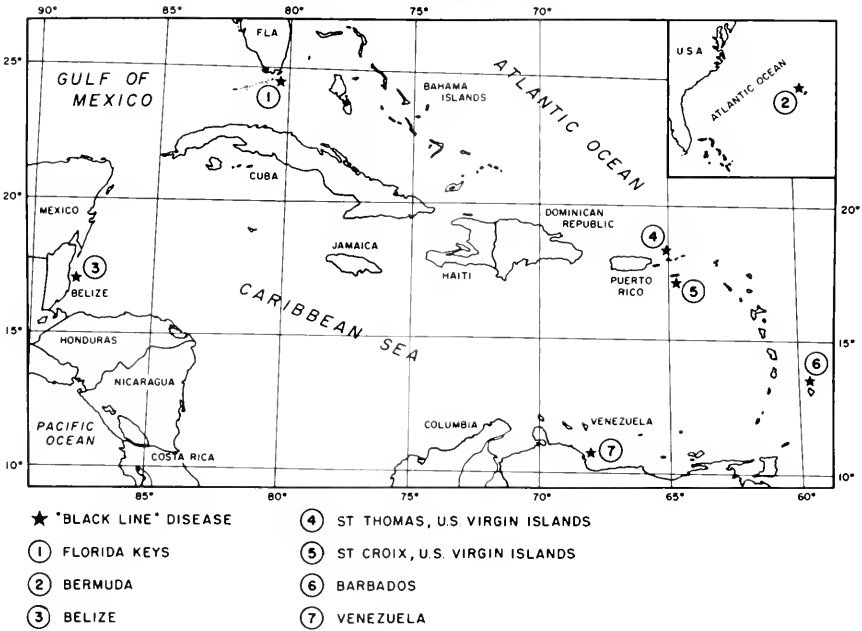

FIGURE 1. Distribution of "black line" disease in Atlantic reefs.

areas with moderate occurrences of the disease, ranging from 5 to 200 meters from the disease area (reefs west and northwest of Cayo Norte, Morrocoy Park); and 3) areas free of observable disease, ranging from 8 to 200 kilometers away from the

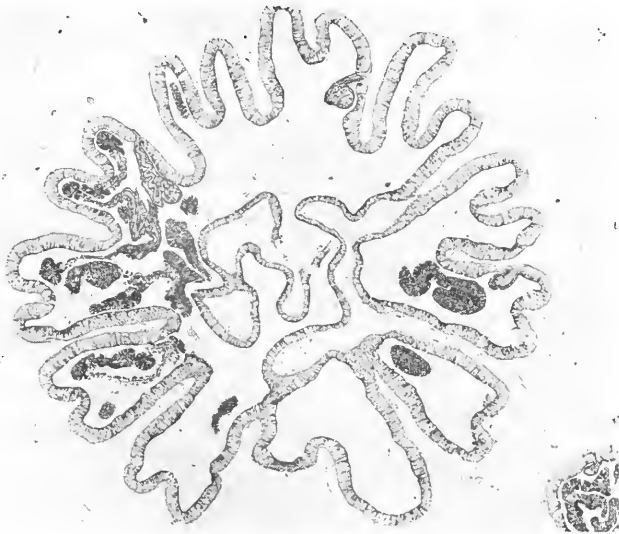

FIGURE 2. Cross section of a healthy *Montastrea annularis*, E. & S., polyp. Epidermis is free of invading organisms. Stained with toluidine blue O, methylene blue and borax. 40X.

diseased area (reefs of Cayo Sombrero in Morrocoy Park and reefs of Cayo Mosquito in Los Roques Park).

Coral heads were collected and fixed in solution for twenty-four hours. The fixative used was a modification of the formula given by McDowell and Trump (1977). The ingredients used were: 2 ml of 50% glutaraldehyde; 10 ml of 40% formaldehyde; 50 ml of filtered sea water; and 39 ml of filtered tap water. Ambient filtered sea water was used instead of the recommended buffer (sodium phosphate monobasic). The pH was adjusted to 7.4 with NaOH. The tissues were stored in alcohol until processed.

Small pieces of tissue were decalcified in Von Eber's decal (50 ml of 36% NaCl; 42 ml of distilled water and 8 ml of concentrated HCl). Small coral pieces took three days to decalcify, larger pieces took up to seven days and the decalcifying baths were changed daily. After decalcification, the tissues were washed, dehydrated in graded alcohols, and embedded in JB-4 (Polysciences), a glycol methacrylate polymer. Sections cut 1.5 microns thick were stained with toluidine blue O, methylene blue and borax dissolved in distilled water. The solution was prepared by adding 250 mg of toluidine blue O, 250 mg of methylene blue and 250 mg of borax to 100 ml of distilled water.

Other histological stains (Periodic acid Schiff, Giemsa, alcian blue and PAS at pH 1.0 and pH 2.5) were used also, as well as Grocott's method for fungi (GMS). The procedures for these stains are described in Luna (1968). After staining, the sections were mounted on plastic-coated slides, covered with a mounting medium and a cover slip, and examined under the microscope.

RESULTS

Identification of the disease in the field

The gross appearance of the disease in the field is a dark (black) line separating the dead from the living tissue in a coral head (Fig. 3). The upper coral skeleton

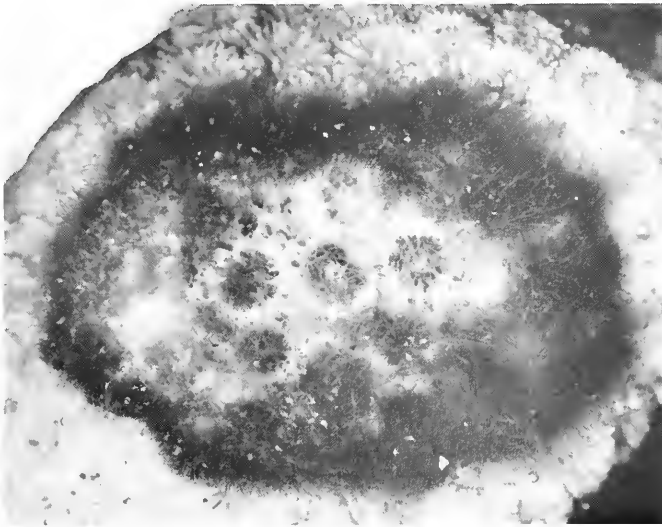

FIGURE 3. Gross appearance of star coral (*Montastrea annularis*, E. & S.) presenting "black line" disease. 4X. (Picture was taken under the laboratory dissecting microscope.)

remains mostly intact until it is overgrown by algae and other organisms. No living tissue is observable within the circumference of the black line. Well beyond the black ring, the coral appears healthy and maintains all of its zooxanthellae. Discolored patches on the coral heads are often seen in affected areas. This discoloration may indicate an early stage of the disease and may result from the loss of zooxanthellae. The most commonly affected coral genera are *Diploria* (brain coral) and *Montastrea* (star coral).

For practical purposes, a healthy coral head and polyp were defined as being free of visible lesions. Moderately affected heads and polyps showed few fungi and/or filamentous algae near the affected tissue. Infection did not occur in all cases. Heavily affected heads and polyps showed massive fungal infection and the coral tissue was destroyed for the most part. Algal invasions were present in some cases.

Histological examination in the laboratory

One hundred and fifty-nine polyps from twelve different coral heads were examined histologically (Table I). The epidermis of all individual polyps presenting the disease was penetrated by fungal hyphae (Figs. 4, 5) and in more advanced stages of the disease the gastrodermis and mesoglea also were invaded. Within a single coral head, those polyps situated directly below the black line were most affected. Polyps 1 cm away from the disease ring showed less fungal invasion and polyps 5 cm away from the diseased ring had almost no invading hyphae. The tissue appeared to be normal in these areas.

Histologic examination of the black line area in *Montastrea annularis* revealed an ellipsoidal tangle of densely packed, parallel hyphae, filamentous cyanobacteria, algal fruiting bodies, diatoms, released zooxanthellae, and rodophytes. In some instances, there were mixed fungal and algal invasions of the polyp epidermis. However, although algae were present in both disease and disease-free areas, fungal hyphae were found only in areas where the black line disease occurred. The fungal hyphae were branched and non-septate, 5 to 10 μm in length and 2.5 to 3.0 μm in width. The branching fungal filaments were stained orthochromatically with toluidine blue O and were positive for the PAS and for the GMS tests for fungal identification.

Since no sexual or asexual fruiting bodies were present, the fungus cannot be identified at this time. However, Dr. Jan Kohlmeyer (Professor, University of North Carolina, Institute of Marine Sciences, Morehead City, NC 28557) and Dr. Charles E. Bland (Professor, Department of Botany, University of North Carolina, Chapel

TABLE I

Occurrence of "black line" disease in geographically separated Venezuelan reefs: relationship to the presence of the fungus

Gross appearance of coral heads	Distance from area affected by "black line" disease	Coral heads	Coral polyps
		# diseased/ # examined	# infected with fungi/# examined
healthy	8 km; 200 km*	0/4	0/54
moderately affected	5 m; 200 m*	1/4	6/30
heavily affected	0 meters*	4/4	75/75

* See text for exact location.

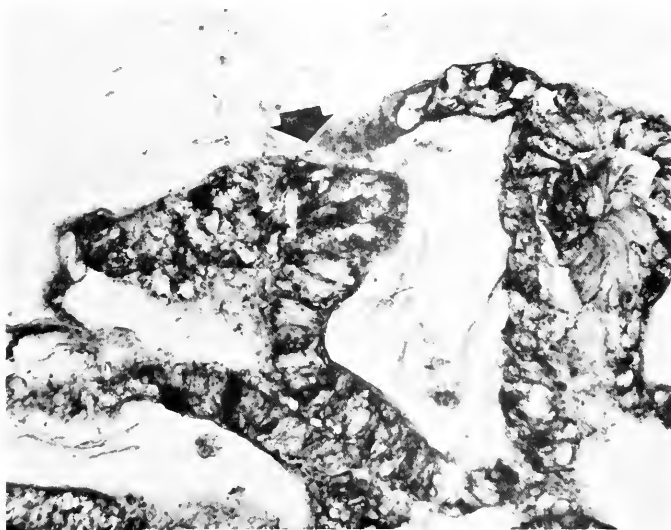

FIGURE 4. Hyphae infecting coral epidermis. Moderate infection PAS. 200 \times . Arrow points to infection site.

Hill, NC 27514) commenting on sample slides, believed the fungus probably belonged to the *lower* marine fungi.

DISCUSSION

Although fungi are very abundant in the marine environment (Kohlmeyer and Kohlmeyer, 1979) and appear to be major pathogens in some higher aquatic in-

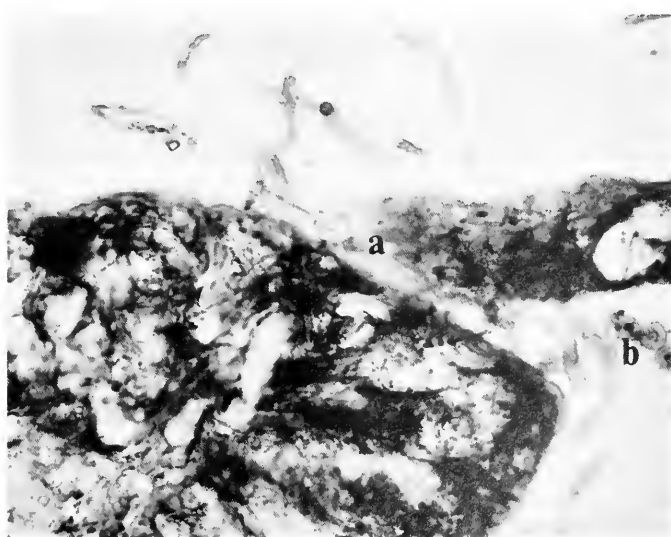

FIGURE 5. Closer view of infecting hyphae: a) hypha proliferation in the coral epithelium, and b) misplaced zooxanthellae PAS. 400 \times .

vertebrates such as crayfish and crabs (Nyhlén and Unestam, 1975; Sparks and Hibbits, 1975), very little is known about their pathogenicity in lower aquatic invertebrates. In this study, histologic examination of black line disease in corals has shown that an invasion by fungal hyphae is associated with obvious pathological changes in the tissues. The possibility that this fungus may be a boring species is indicated by the presence of hyphae growing throughout the hard parts of the corals and within the septal invaginations. It is not possible at this time to determine whether the fungus is a primary or a secondary pathogen.

Other investigators have hypothesized that this disease may be caused by bacteria. Garrett and Ducklow (1975) have suggested a gram-negative filamentous *Beggiatoa* and a sulfate-reducing anaerobic *Desulfovibrio* as plausible pathogens. Antonius (1977) has suggested a filamentous cyanophyte, *Oscillatoria submembranacea* (Ardissonne and Strafforelo) as the causative agent of the same coral condition. Nevertheless, no one has isolated the pathogen or reproduced the black line disease under controlled conditions.

The regenerative ability of some polyps may be a protective mechanism which prevents complete elimination of the reef. Nearly a century ago, Metchnikoff (1892) remarked on the amazing regenerative powers of coelenterates. The susceptibility of regenerating polyps to the disease is unknown, but some mechanism of differential susceptibility is likely since the disease does not always pursue a destructive course. Knowledge of individual polyp susceptibility to black line disease could lead to a determination of how a coral reef copes with advancing pathogens.

A large number of coral colonies on the reefs of Bermuda, Venezuela, and other Caribbean areas have dead patches. Since many of these patches may be disease related, the black line phenomenon may be an important factor in coral ecology. Knowledge of the etiology and pathogenesis of black line disease could, therefore, yield important clues to the manner in which corals defend themselves against parasites and other pathogenic agents.

ACKNOWLEDGMENTS

The field studies were made possible through the Marine Ecology Program in Morrocoy National Park sponsored by C.O.N.I.C.I.T. and the Venezuelan Institute for Scientific Research (I.V.I.C.).

I thank the late Frederik B. Bang for his direction as my advisor in the Master of Science degree program at the Johns Hopkins University School of Hygiene and Public Health; Humberto Díaz, Gilberto Rodriguez, and the staff at the Centro de Ecología/I.V.I.C.; Fundación Los Roques. Freddy Losada (Universidad Central de Venezuela) helped to locate the diseased corals in the Venezuelan reefs. I am indebted to Luis Burguillos (I.V.I.C.) and Peggy Pula (Johns Hopkins U.) for their technical advice on histological techniques. I am grateful to Hermine Bongers for her secretarial assistance and to Chester Reather for his photographic expertise. The information in this paper is also contained in a thesis submitted to and accepted by the Johns Hopkins University School of Hygiene and Public Health in partial fulfillment of the requirements for the Master of Science degree.

LITERATURE CITED

- ANTONIUS, A. 1977. Coral mortality in reefs: a problem for science and management. *Proc. Third Int. Coral Reef Symp.*, Miami, 2: 617-620.
- DUCKLOW, H. W. 1977. *Influence of Sublethal Pollutant Concentrations on the Microbial Ecology of Living Corals*. Ph.D. Dissertation, Harvard University.

- GARRETT, P., AND H. W. DUCKLOW. 1975. Coral diseases in Bermuda. *Nature* **253**: 349-350.
- KINNE, O. 1980. *Diseases of Marine Animals. I. General Aspects, Protozoa to Gastropoda*. John Wiley, Somerset, NJ. 460 pp.
- KOHLMEYER, J., AND E. KOHLMEYER. 1979. *Marine Mycology: The Higher Fungi*. Academic Press, New York. 690 pp.
- LUNA, L. G. 1968. *Manual of Histologic Staining Methods of the Armed Forces Institute of Pathology*. Third ed. McGraw-Hill, New York. 258 pp.
- MCDOWELL, E., AND B. F. TRUMP. 1977. Practical fixation techniques for light and electron microscopy. *Comp. Pathol. Bull.* **IX**: 3.
- METCHNIKOFF, E. 1892. *Lectures on the comparative pathology of inflammation*. Translated from French by F. A. Starling and E. H. Starling. Dover Publications, New York, 1968. 224 pp.
- NYHLÉN, L., AND T. UNESTAM. 1975. Ultrastructure of the penetration of the crayfish integument by fungal parasite, *Aphanomyces astaci*, Oomycetes. *J. Invert. Pathol.* **26**: 353-366.
- SPARKS, A. K., AND J. HIBBITS. 1979. Black mat syndrome: an invasive mycotic disease of the tanner crab, *Chioecetes bairdi*. *J. Invert. Pathol.* **34**: 184-191.
- VOSS, G. 1973. Sickness and death within the Florida reefs. *Nat. Hist.* **82**: 41-47.

THE DEVELOPMENTAL APPEARANCE OF PATERNAL FORMS OF LACTATE DEHYDROGENASE AND MALATE DEHYDROGENASE IN HYBRID HORSESHOE CRABS¹

HIROAKI SUGITA AND KOICHI SEKIGUCHI

Institute of Biological Sciences, University of Tsukuba, Sakura-mura, Niihari-gun, Ibaraki 305, Japan

ABSTRACT

Differences in electrophoretic mobilities of lactate dehydrogenase (LDH) and malate dehydrogenase (MDH) existed between three Asian horseshoe crabs, *Tachypleus tridentatus*, *Tachypleus gigas*, and *Carcinoscorpius rotundicauda*, used for interspecific hybridization. After electrophoresis of extracts of hybrid horseshoe crab embryos on starch gels, the paternal, maternal, and hybrid forms of the LDH and MDH were detected with specific enzyme staining. In viable hybrids the paternal form of the LDH was detected at stage 17 (immediately before the 1st embryonic molt). Similarly, evidence of gene expression for mitochondrial MDH was seen at stage 14 (stage of appearance of rudimental appendages). Gene expression for supernatant MDH was seen at stage 17 (immediately before the 1st embryonic molt). Regarding the onset of genome control in embryogenesis, it was suggested that prior to the activation of the maternal gene of the LDH, the paternal gene of the LDH was activated in horseshoe crab hybrids. Furthermore, there was evidence that the maternal effects on early embryogenesis were due to enzymes present in the egg prior to fertilization, not to continued synthesis directed by stable messenger RNA.

INTRODUCTION

Morphological studies on echinoderm, amphibian, teleost, and other species hybrids show that, in general, only maternal characters are evident until gastrular or postgastrular organogenesis. This conclusion is supported by many studies in which enzymes and other proteins of paternal type are first observed at postgastrular stages (Davidson, 1976). If two species with differences in specific enzymes form viable hybrids, and maternal- and paternal-type enzymes can be distinguished in the offspring, the paternal enzymes should not appear until after the new diploid genome is activated in the embryo. Therefore, the viable hybrids offer an opportunity for studying maternal and paternal contributions to development. To detect the paternal form of the enzyme, techniques of zone electrophoresis and specific enzyme staining have been applied to lactate dehydrogenase (LDH) in hybrids of frogs (Wright and Moyer, 1966, 1968; Wright and Subtelny, 1971) and fishes (Hitzeroth *et al.*, 1968; Goldberg *et al.*, 1969), and to malate dehydrogenase (MDH) in frog hybrids (Wright and Subtelny, 1971). In interspecific hybrids of arthropods, however, no work has been carried out to detect the paternal forms of enzymes during the development of the embryo.

In this paper we report the time of the expression of the paternal genes controlling

Received 1 April 1983; accepted 20 July 1983.

¹ Contribution No. 415 from the Shimoda Marine Research Center, University of Tsukuba. Abbreviations: LDH = lactate dehydrogenase; MDH = malate dehydrogenase.

lactate dehydrogenase and malate dehydrogenase in hybrid embryos of Asian horseshoe crabs.

MATERIALS AND METHODS

The Japanese horseshoe crab, *Tachypleus tridentatus*, was collected from Imari and Fukuoka, Japan, and the Southeast Asian horseshoe crabs, *Tachypleus gigas* and *Carcinoscorpius rotundicauda*, were collected from the vicinity of Bangsaen, Thailand, by Professor Smarn Srithunya (Zoological Museum and Marine Aquarium, Srinakharinwirot University, Thailand).

To contrast the paternal influence of three horseshoe crabs, eggs obtained from one female were divided into three groups, and each group was artificially inseminated by sperm from one of the three species and kept at 30°C. Cross-fertilizations were made in all nine combinations among three Asian horseshoe crab species. The developmental stage of the embryos was determined according to the normal plate of the Japanese horseshoe crab, *T. tridentatus*, described by Sekiguchi (1973), because fertilized eggs of *T. gigas*, *C. rotundicauda*, and the interspecific hybrids developed into swimming larvae (the first-instar larvae) through a similar morphological process to those of *T. tridentatus*.

A single embryo at each stage was homogenized in one or two drops of distilled water. Larval extracts were prepared from a single animal at the first-instar stage (just after hatching). To prepare the adult tissue extracts, the hepatopancreas was homogenized in a volume of distilled water approximately equal to the tissue volume, because all isozyme molecules of the LDH were included in horseshoe crab hepatopancreas. Sample homogenates were absorbed on a small piece of Toyo No. 50 filter paper and inserted into slits cut in the starch gel. Electrophoresis was carried out at 4°C with 11% or 12% gel horizontally for embryonic samples or vertically for larval and adult samples. Horizontal gel electrophoresis for embryonic and larval MDH was carried out using Davis' (1964) buffer system. Selander and Yang's (1969) buffer system was used during vertical gel electrophoresis for larval and adult MDH. Gel and electrode buffers for LDH isozymes were prepared according to the method of Selander and Yang (1969). A 100 ml staining mixture for the LDH consisted of 0.025 M Tris-HCl buffer (pH 7.4), 50 mg nicotinamide adenine dinucleotide, 35 mg nitro blue tetrazolium, 3 mg phenazine methosulphate, 2.0 ml 60% Na lactate, and 1.0 ml 0.5 M KCN (Shows and Ruddle, 1968). The staining mixture for the MDH was identical to the LDH but 10 ml 1.0 M Na malate, pH 7.0, was substituted for 2.0 ml 60% Na lactate.

RESULTS

Lactate dehydrogenase

Before we consider the developing enzyme patterns in hybrids, we must examine whether the enzyme variants are present in adult and larval samples. Figure 1 shows the electrophoretic patterns of the LDH from the hepatopancreas tissues and the first-instar larvae of 3 Asian horseshoe crabs. The larval LDH from 3 species showed only one enzymic band, while the LDH from the hepatopancreas tissues of *T. tridentatus* and *C. rotundicauda* occurred in 3 isozymic forms on starch gel. Furthermore, the LDH from each of interspecific hybrid larvae showed 3 enzymic bands, suggesting that 2 peptides produced from paternal and maternal genes for the LDH could form heterodimers in horseshoe crab hybrids (Fig. 1B). The adult LDH of *T. tridentatus* and *C. rotundicauda* was monomorphic and that of *T. gigas*

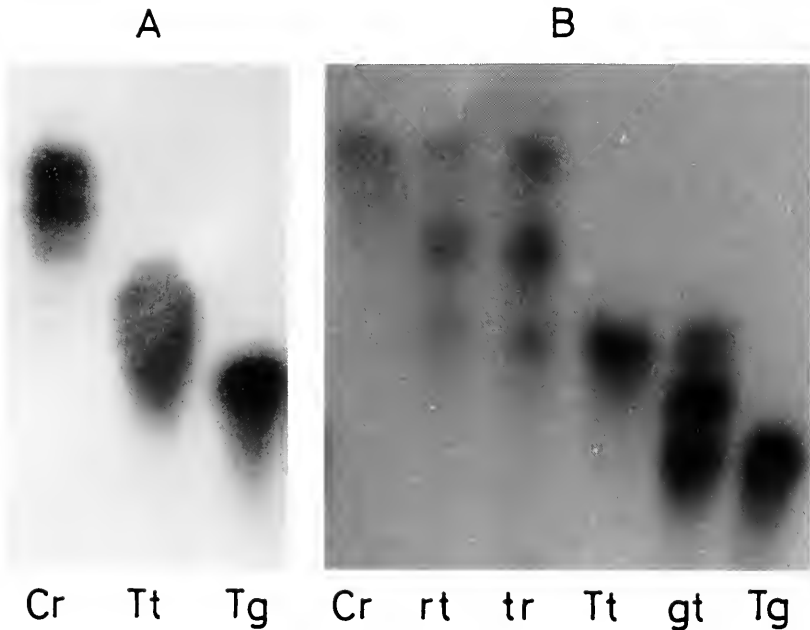

FIGURE 1. Electrophoretic patterns of horseshoe crab LDH from hepatopancreas tissues (A) and from the first-instar larvae (B). Vertical starch gel electrophoresis was carried out at 4°C with 12% gel, using the buffer system of Selander and Yang (1969). Gel buffer: 0.08 *M* Tris and 0.005 *M* citric acid, pH 8.7. Electrode buffer: 0.3 *M* boric acid and 0.06 *M* NaOH, pH 8.2). Cr = *Carcinoscorpius rotundicauda*; Tt = *Tachypleus tridentatus*; Tg = *Tachypleus gigas*; rt = hybrid between Cr ♀ and Tt ♂; tr = hybrid between Tt ♀ and Cr ♂; gt = hybrid between Tg ♀ and Tt ♂.

was polymorphic (Sugita and Sekiguchi, in prep.). Genetic variants of the LDH could not be detected in larvae developed from eggs of a single female.

In hybrid progeny obtained from the interspecific crosses of all 6 combinations among 3 species as well as in normal progeny from the control crosses, the early embryos displayed only the maternal LDH pattern which could be detected in unfertilized eggs (results not shown). The maternal LDH from these embryos had similar relative mobility to the LDH from the first-instar larvae (Fig. 1B).

In hybrid embryos between *T. tridentatus* ♀ and *C. rotundicauda* ♂, the paternal form of the LDH was first detected at stage 17 (30 days after insemination, immediately before the 1st embryonic molt) (Fig. 2A), but the paternal form of the LDH was not observed even on the 41st day after insemination (stage 19, after the 2nd embryonic molt) in hybrid embryos between *C. rotundicauda* ♀ and *T. tridentatus* ♂.

The LDH from hybrid embryo between *T. gigas* ♀ and *T. tridentatus* ♂ occurred in 3 molecular forms at stage 20 (32 days after insemination, after the 3rd embryonic molt), suggesting that the LDH of the hybrid embryo consisted of a maternal homodimer, a paternal homodimer, and a hybrid heterodimer (Fig. 2B). This paternal form of the enzyme was first observed at stage 18 (28 days after insemination, after the 1st embryonic molt) in hybrid embryo *T. gigas* ♀ × *T. tridentatus* ♂ (results not shown). On the other hand, the LDH from *T. tridentatus* ♀ × *T. gigas* ♂ hybrid embryo showed only the maternal form on the 32nd day after insemination (Fig.

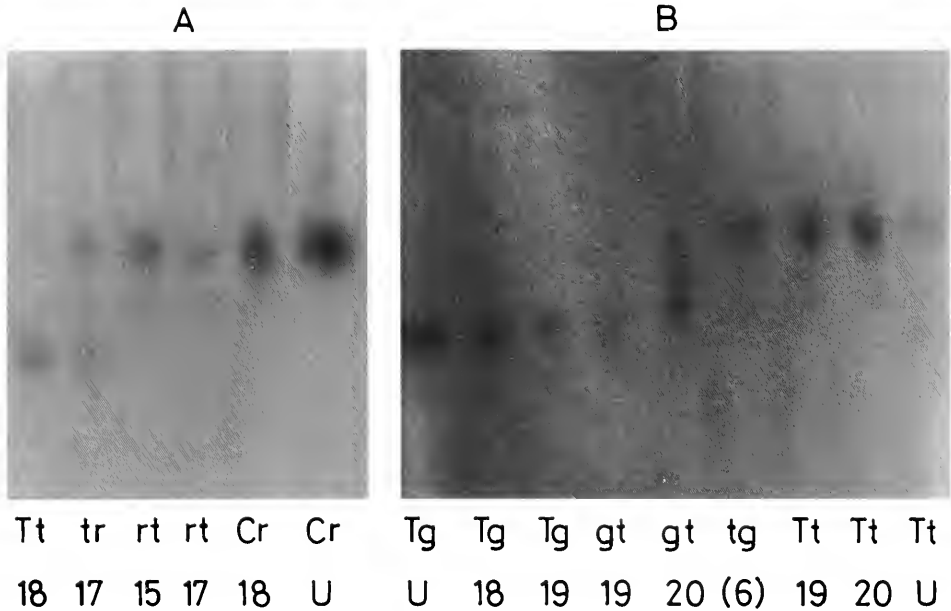

FIGURE 2. Electrophoretic patterns of the LDH in unfertilized eggs and developing embryos of 3 Asian horseshoe crabs and their hybrids. The hybridization experiments were carried out 2 times using different sets of 3 pairs (3 species) of horseshoe crabs. Electrophoretic patterns of the LDH in the 30th-day and 32nd-day embryos from the 2 experiments are shown separately in A and B, except for a column Cr U in A. Horizontal starch gel electrophoresis was carried out at 4°C with 11% gel, using the same buffer system as explained in Figure 1. Cr, Tg, Tt, gt, rt, and tr are as described in Figure 1. tg = Hybrid between Tt ♀ and Tg ♂; U = unfertilized egg. Unfertilized eggs as well as fertilized eggs were cultured in sea water at 30°C for 3 days (A) and 32 days (B). Numbers indicate the developmental stage of Sekiguchi's normal plate (Sekiguchi, 1973). The number 6 in parentheses means that hybrid embryo used was able to live on until the 32nd day after insemination, although the development had stopped at stage 6 (blastula stage).

2B). Until this day the hybrid was able to live on, although the development had stopped at blastula stage, or stage 6 (Sekiguchi and Sugita, 1980; Sugita *et al.*, 1982).

The hybridized eggs of *C. rotundicauda* ♀ × *T. gigas* ♂ and the reciprocal cross stopped their development at blastula stage (Sekiguchi and Sugita, 1980; Sugita *et al.*, 1982) and never expressed the paternal forms of the LDH (results not shown).

Malate dehydrogenase

There are 2 major electrophoretic forms of the MDH in the horseshoe crab, *Limulus polyphemus*, as well as in most animals and higher plants. These isozymes are controlled by separate genetic loci and are localized in different subcellular fractions, a mitochondrial form and a supernatant form (Selander *et al.*, 1970). On a gel run with Davis' (1964) buffer system, the larval MDH from 3 Asian horseshoe crabs showed the slower-migrating system (MDH-1), which was the mitochondrial form, and the faster-migrating system (MDH-2), or the supernatant form as Selander *et al.* (1970) reported with *Limulus* MDH using the buffer system of Selander and Yang (1969). When, in our laboratory, electrophoresis was carried out using Selander and Yang's (1969) buffer system, the mitochondrial bands were very close to the

supernatant bands on a gel. Therefore, we used Davis' (1964) buffer system to examine the developing MDH patterns in Asian horseshoe crabs and their hybrids.

There were electrophoretic variants of the MDH in 3 Asian horseshoe crabs, but genetic variants of the MDH were not detected in larvae developed from eggs of a single female (compare the MDH-1 of columns Tg, gt, and gr in Fig. 3 with that of columns Tg and gt in Fig. 4).

The early embryos displayed only the maternal forms of both MDH-1 and MDH-2 in hybrid and normal progeny and these enzyme forms were detected in unfertilized eggs of 3 species (Fig. 3). The paternal form of the MDH-1 was first detected in the *T. tridentatus* ♀ × *C. rotundicauda* ♂ embryo at stage 14 (stage of appearance of rudimentary appendages, 28 days after insemination) (Fig. 4A), while in the hybrid embryo of the reciprocal cross the paternal forms of the MDH-1 and MDH-2 were not expressed even on the 41st day after insemination (stage 19, after the 2nd embryonic molt).

The paternal form of the MDH-2 was displayed in the *T. gigas* ♀ × *T. tridentatus* ♂ embryos at stage 19 (after the 2nd embryonic molt) and stage 20 (after the 3rd embryonic molt) (Fig. 4B). This paternal form in the *T. gigas* ♀ × *T. tridentatus* ♂ embryo was first observed at stage 17 (22 days after insemination, immediately before the 1st embryonic molt, results not shown).

On the other hand, the hybrid embryos whose development was stopped at blastula stage, that is, *T. tridentatus* ♀ × *T. gigas* ♂, *T. gigas* ♀ × *C. rotundicauda*

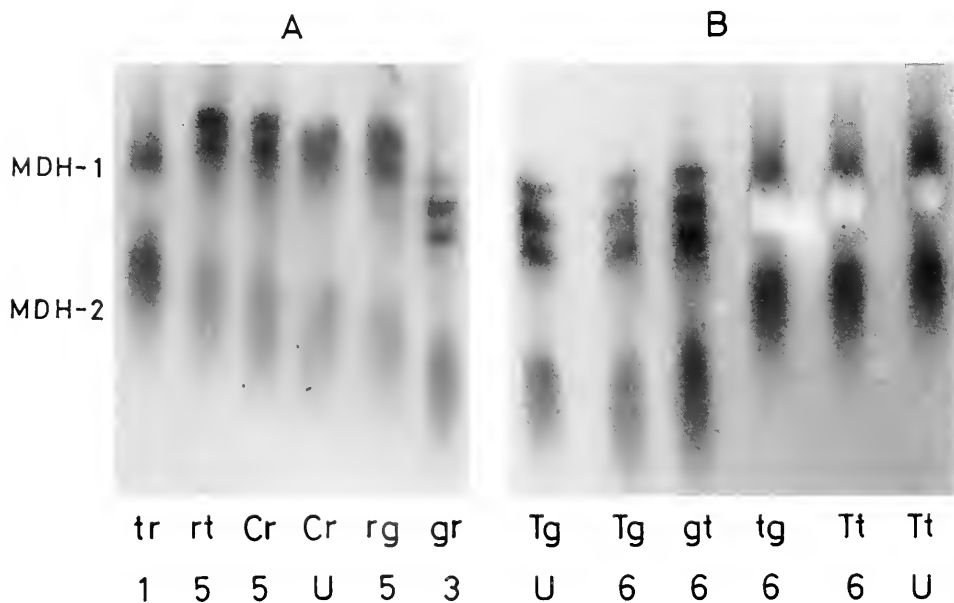

FIGURE 3. Electrophoretic patterns of the MDH in unfertilized eggs and early embryos of 3 Asian horseshoe crabs and their hybrids. The 3rd-day and 6th-day embryos from a hybridization experiment were used in A and B, respectively. Horizontal starch gel electrophoresis was carried out at 4°C with 11% gel, using the buffer system of Davis (1964). Gel buffer: 0.38 M Tris-HCl, pH 8.9. Electrode buffer: 0.005 M Tris and 0.038 M glycine, pH 8.3). Numbers indicate the developmental stage of Sekiguchi's normal plate (Sekiguchi, 1973). Symbols are explained in Figures 1 and 2, except for symbols defined below. MDH-1 = Slower-migrating system, or mitochondrial form; MDH-2 = faster-migrating system, or supernatant form; gr = hybrid between Tg ♀ and Cr ♂; rg = hybrid between Cr ♀ and Tg ♂.

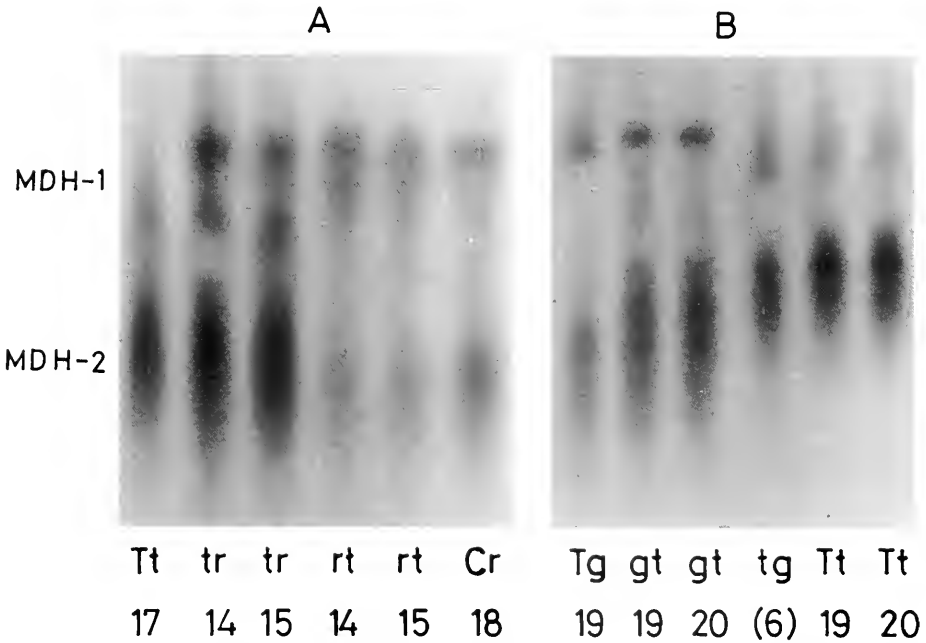

FIGURE 4. Electrophoretic patterns of the MDH from the 28th-day (A) and 32nd-day (B) embryos of 3 Asian horseshoe crabs and their hybrids. Electrophoretic patterns of the MDH in embryos obtained from different sets of 3 pairs (3 species) of horseshoe crabs are shown separately in A and B. Horizontal starch gel electrophoresis was carried out at 4°C with 11% gel using the same buffer system as in Figure 3. Numbers indicate the developmental stage of Sekiguchi's normal plate (Sekiguchi, 1973). The number 6 in parentheses means that the hybrid embryo was able to live on until the 32nd day after insemination, although the development had stopped at stage 6 (blastula stage). All symbols are explained in Figures 1, 2, and 3.

δ , and *C. rotundicauda* ♀ × *T. gigas* ♂ embryos did not express the paternal forms of the MDH-1 and MDH-2.

DISCUSSION

The LDH of horseshoe crabs is D-lactate specific and has a molecular weight of approximately 70,000 (Long and Kaplan, 1968, 1973). This D-LDH occurs in 3 dimeric forms, not in 5 tetrameric forms as does the L-LDH of vertebrates with a molecular weight of 140,000 (Selander and Yang, 1970; see columns Tt and Cr in Fig. 1A). Although each LDH from the larvae of 3 Asian horseshoe crabs shows only one dimeric form with different electrophoretic mobility from one another, the LDH from the first-instar larvae of hybrid horseshoe crabs is composed of 3 molecular forms: a maternal homodimer, a paternal homodimer, and a hybrid heterodimer (Fig. 1B). This hybrid LDH heterodimer was detected with maternal and paternal homodimers in *T. gigas* ♀ × *T. tridentatus* ♂ embryo at stage 20 (Fig. 2B). However, the paternal LDH homodimer from this cross-fertilized embryo was first observed without the hybrid heterodimer at stage 18 (results not shown). Similarly, in *T. tridentatus* ♀ × *C. rotundicauda* ♂ embryo the paternal homodimer of the LDH was first detected at stage 17 (Fig. 2A) without the hybrid heterodimer which was observed at stage 19 (41 days after insemination, results not shown).

Based on the findings that no hybrid enzymes were detected in androgenetic haploid frog hybrids, Wright and Subtelny (1971) indicated that the degradation of maternal (cytoplasmic) enzymes *in vivo* did not yield subunits capable of reaggregation with newly synthesized subunits to form active enzymes. This means that the hybrid forms of enzymes are expressed at the time when both maternal and paternal genes for the enzymes are activated together. Therefore, the findings that the paternal and maternal homodimers were detected without their hybrid heterodimer indicate that, with regard to the onset of genome control in embryogenesis, prior to the activation of the maternal gene of the LDH the paternal gene of the LDH was activated in the horseshoe crab hybrids.

The time of expression of the paternal genes controlling the mitochondrial malate dehydrogenase (MDH-1) and supernatant malate dehydrogenase (MDH-2) was examined, although they did not show clear, electrophoretic patterns. Evidence of paternal gene expression for the MDH-1 was seen in *T. tridentatus* ♀ × *C. rotundicauda* ♂ embryos at stage 14 (Fig. 4A). Expression of paternal gene for the MDH-2 was seen in *T. gigas* ♀ × *T. tridentatus* ♂ embryos at stage 17 (results not shown).

In early embryos only the maternal forms of the LDH and MDH were observed until postgastrular organogenesis (stage 13, stage of the germ-band formation). The active maternal forms of these enzymes were present in unfertilized eggs of 3 Asian horseshoe crabs (Figs. 2, 3) and the steady state activity of the maternal enzymes in unfertilized eggs did not change dramatically during the culture for 32 days at 30°C in sea water (Fig. 2B). These and other results present evidence that the maternal effects on early embryogenesis are due to enzymes present in the egg prior to fertilization, not to continued synthesis directed by stable messenger RNA (Wright and Subtelny, 1971).

ACKNOWLEDGMENTS

We thank Professor Smarn Srithunya for collecting *Tachypleus gigas* and *Carcinoscorpius rotundicauda* in Bangsaen, Thailand.

This work was supported by the grants-in-aid for scientific research from the Ministry of Education, Science and Culture of Japan.

LITERATURE CITED

- DAVIDSON, E. H. 1976. *Gene Activity in Early Development*, 2nd ed. Academic Press, New York. 452 pp.
- DAVIS, B. J. 1964. Disc electrophoresis—II. Method and application to human serum proteins. *Ann. N. Y. Acad. Sci.* **121**: 404–427.
- GOLDBERG, E., J. P. CUERRIER, AND J. C. WARD. 1969. Lactate dehydrogenase ontogeny, paternal gene activation, and tetramer assembly in embryos of brook trout, lake trout, and their hybrids. *Biochem. Genet.* **2**: 335–350.
- HITZEROTH, H., J. KLOSE, S. OHNO, AND U. WOLF. 1968. Asynchronous activation of paternal alleles at the tissue-specific gene loci observed on hybrid trout during early development. *Biochem. Genet.* **1**: 287–300.
- LONG, G. L., AND N. O. KAPLAN. 1968. D-lactate specific pyridine nucleotide lactate dehydrogenase in animals. *Science* **162**: 685–686.
- LONG, G. L., AND N. O. KAPLAN. 1973. Diphosphopyridine nucleotide-linked D-lactate dehydrogenases from the horseshoe crab, *Limulus polyphemus* and the seaworm, *Nereis virens*. I. Physical and chemical properties. *Arch. Biochem. Biophys.* **154**: 696–710.
- SEKIGUCHI, K. 1973. A normal plate of the development of the Japanese horse-shoe crab, *Tachypleus tridentatus*. *Sci. Rep. Tokyo Kyoiku Daigaku Sect. B* **15**: 153–162.
- SEKIGUCHI, K., AND H. SUGITA. 1980. Systematics and hybridization in the four living species of horseshoe crabs. *Evolution* **34**: 712–718.

- SELANDER, R. K., AND S. Y. YANG. 1969. Protein polymorphism and genic heterozygosity in a wild population of the house mouse (*Mus musculus*). *Genetics* **63**: 653-667.
- SELANDER, R. K., AND S. Y. YANG. 1970. Horseshoe crab lactate dehydrogenases: Evidence for dimeric structure. *Science* **169**: 179-181.
- SELANDER, R. K., S. Y. YANG, R. C. LEWONTIN, AND W. E. JOHNSON. 1970. Genetic variation in the horseshoe crab (*Limulus polyphemus*), a phylogenetic "relic." *Evolution* **24**: 402-414.
- SHOWS, T. B., AND F. H. RUDDLE. 1968. Function of the lactate dehydrogenase *B* gene in mouse erythrocytes: Evidence for control by a regulatory gene. *Proc. Nat. Acad. Sci. USA* **61**: 574-581.
- SUGITA, H., K. SEKIGUCHI, F. SHISHIKURA, AND Y. YAMAMICHI. 1982. An evolutionary aspect to horseshoe crabs based on developmental capacity of the interspecific hybrids (in Japanese). *Proc. Jpn. Soc. Syst. Zool. (Tokyo)* No. **22**: 1-6.
- WRIGHT, D. A., AND F. H. MOYER. 1966. Parental influences on lactate dehydrogenase in the early development of hybrid frogs in the genus *Rana*. *J. Exp. Zool.* **163**: 215-230.
- WRIGHT, D. A., AND F. H. MOYER. 1968. Inheritance of frog lactate dehydrogenase patterns and the persistence of maternal isozymes during development. *J. Exp. Zool.* **167**: 197-206.
- WRIGHT, D. A., AND S. SUBTELNY. 1971. Nuclear and cytoplasmic contributions to dehydrogenase phenotypes in hybrid frog embryos. *Dev. Biol.* **24**: 119-140.

REPETITIVE CYCLES OF BIOLUMINESCENCE AND SPAWNING IN THE POLYCHAETE, *ODONTOSYLLIS PHOSPHOREA*

FREDERICK I. TSUJI AND ELIZABETH HILL

*Marine Biology Research Division, Scripps Institution of Oceanography, University of California,
San Diego, La Jolla, California 92093, and Veterans Administration Medical Center
Brentwood, Los Angeles, California 90073*

ABSTRACT

Spawning by large numbers of the marine polychaete, *Odontosyllis phosphorea*, occurred at fortnightly intervals. The animals appeared at the surface of the water shortly after sunset and luminesced and spawned for approximately 30 minutes. The spawning was correlated with the monthly lunar and tidal cycles and lasted from June through October.

INTRODUCTION

Polychaetes of the genus *Odontosyllis* from Bermuda show spawning swarms throughout the year, with lunar periodicity: shortly after sunset, the bioluminescent worms appear at the surface, where they pair and mate, for several days immediately after full moon (Galloway and Welch, 1911; Huntsman, 1948; Markert *et al.*, 1961). Similar behavior has been reported for two other species of this genus: one from Puerto Rico (Erdman, 1965) and another, *Odontosyllis phosphorea*, from British Columbia (Potts, 1913); lunar periodicity in the latter species, however, has been questioned by others (Fraser, 1915; Berkeley, 1935). Still other species of this genus spawn only once a year (Haneda, 1971; Daly, 1975; Horii, 1982). We have observed spawning swarms in *O. phosphorea* from southern California, which are similar to those described in the Caribbean, except that the spawning peaks are strongly seasonal and occur at fortnightly intervals: *i.e.*, follow a semi-lunar rhythm rather than a lunar rhythm, as reported for other species of this genus.

MATERIALS AND METHODS

Observations were carried out from a 3 × 24 m floating dock in De Anza Cove, Mission Bay, San Diego. The dock is oriented north-south, with the east side facing the shore. Observations were made on the shore-side, which comprised a maximum area of 530 m² of water surface. The dock is connected to shore by a raised walk. The distance from the edge of the dock to the high water mark on shore was ~32 m and to the low water mark, ~10 m. The water depth on July 12, 1982, at 19:15 (low tide = 19:49) was 2.3 m at the south end of the dock and 3.0 m at the north end. Luminescing *Odontosyllis* swimming at the surface were counted by two observers walking along the edge of the dock using hand tally counters. Each observer monitored one-half of the water surface; and one observer also kept time with a stopwatch. An individual *Odontosyllis* was recognized by the greenish luminescence produced by the swimming animal. A complete count of the area could be made in one minute, even during peak activity. Records were kept of the direction and

strength of the wind, condition of the water surface, surface water temperature, phase and position of the moon (when visible), condition of the tide, and overhead cloud cover.

The times (PST) of sunset, civil twilight, moonrise, and moonset, and phase of the moon were calculated for San Diego (32.46°N) using standard tables (*Nautical Almanac for 1982*, U. S. Naval Observatory, 1980); plotted tides were predictions for San Diego (*Tide Table for 1982*, NOAA, 1981). The tidal difference between the Pacific Ocean entrance to Mission Bay and De Anza Cove is negligible. Normal probability curves and standard deviations were calculated from the observed data points (Alder and Roessler, 1968).

Specimens of *Odontosyllis* were collected with a 90 ml ladle or a fine mesh net. Each individual was immediately placed in a separate container. To determine the sex of the animal, the coelomic cavity and reproductive organ were dissected microscopically and the type of gamete was determined. The number of eggs, and, in some cases, the number of eggs already undergoing cleavage, were determined in water samples collected at the same time as the specimen. Counts were made within one hour after collection, using a dissecting microscope. Control water samples were also collected before and after each night of observation. Specimens were collected when swarming activity was at its peak.

RESULTS

The first flashes of light after sunset were usually from males. They swam in a relatively straight line while the posterior section of the body luminesced internally. A bright burst of luminous secretion was produced intermittently, forming a luminescent trail. This trail hung at the surface of the water for about a minute before dispersing. Water samples collected with such worms often contained spermatozoa. The females began flashing shortly after the males. They appeared at the surface of the water swimming in tight wiggling circles. The body as well as the secretion it discharged were brightly luminescent. Sometimes a male and a female were observed swimming together in a small circle. The water collected with such females frequently contained eggs, and the body was nearly devoid of eggs when subsequently examined.

A fully elongated adult *Odontosyllis* was 20 to 30 mm in length and was about one millimeter in width. Eggs were $\sim 15 \mu\text{m}$ in diameter. When maintained in filtered sea water at room temperature ($\sim 21^\circ\text{C}$), fertilized eggs began cleavage and reached the gastrula stage after ~ 12 hours. The ciliated gastrulae actively swam in circles near the surface of the water; they developed into early trochophores after two days and into full trochophores after four days. Each was characterized by a well developed apical tuft, prototroch, growth zone, and pygidium. The trochophores had four black eye spots and the body showed signs of segmentation. The trochophore larvae did not luminesce when tested with MgCl_2 and KCl . However, within a month they reached $40 \mu\text{m}$ in length, developed parapodia, and possessed the ability to luminesce. During peaks of swarming in July and August, 1982, egg counts ranged from 35 to 63/ml (8 counts); sex ratio (males/females) varied from 0.3 to 0.6 (3 samples).

Counts of luminescing worms on a typical high-intensity spawning date are presented in Figure 1. The worms appeared about 17 minutes after sunset, the last was seen about 32 min later, and peak abundance was about 33 min after sunset. The data show a reasonably good fit with a calculated normal probability curve. Similar curves were derived for all observation dates on which worms were seen between July and October. The centers of these spawning peaks (mean time relative

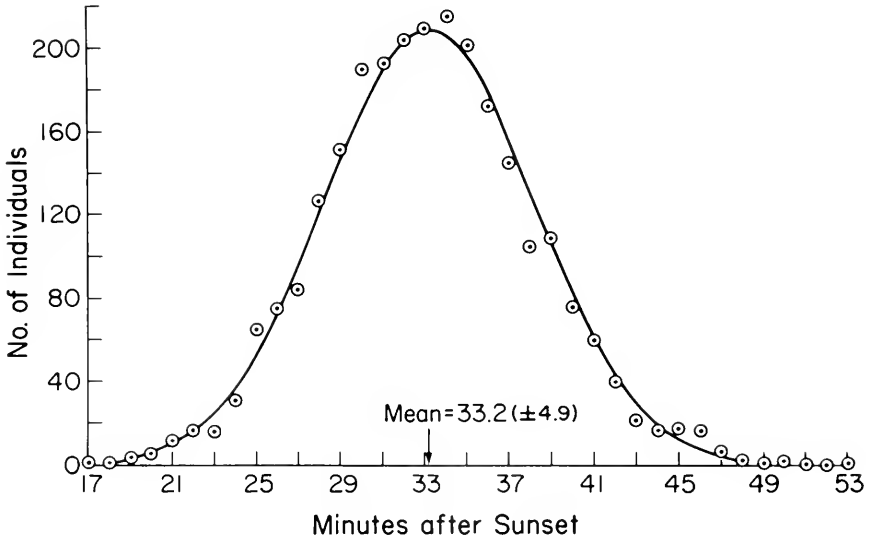

FIGURE 1. Plot of the number of *Odontosyllis* appearing after sunset on 9 August 1982. Solid line represents the normal probability curve calculated from the observed data points. Arrow indicates the mean minutes after sunset (time of peak abundance of the worms) and standard deviation.

to sunset) showed a tendency to occur progressively earlier during July, to reach a minimum in early August, and to occur progressively later thereafter, with a total seasonal range of about 30 min (Fig. 2). The days were becoming shorter (*i.e.*, sunset occurred earlier) throughout this interval. The length of twilight (~ 24 to 28 min), the time the full moon was in the sky (~ 9.5 to 11.2 hour), and weather conditions—even strong wind and overcast sky—had no apparent effect on the daily or fortnightly timing of spawning swarms.

The first sighting of *Odontosyllis* was made on 13 May (last quarter moon, 15 May) when 26 worms were counted. On 15 May, many more worms were seen, but not counted. Subsequently, worms were observed on 27 May (not counted; first quarter moon, 29 May) and on 16 June (30 counted; last quarter moon, 14 June). Thereafter, regular counts were taken. Figure 3 shows a plot of number of *Odontosyllis* observed, high and low water predictions for the tide, surface water temperature, and phases of the moon against dates of observation. The observations representing each fortnightly peak show a reasonably good fit with a calculated normal probability curve. The results show that swarming by *Odontosyllis* follows a semi-lunar cyclic pattern, with peak spawning coinciding approximately with the time of minimum variation in tidal amplitude, as well as with the first and last quarter phases of the moon. The cumulative difference between the days of peak swarming and the corresponding days of the quarter moon over the interval from late June to late October was -0.1 day; individual peaks varied from -2.9 to $+2.7$ days. The duration of bioluminescence and spawning ranged from 27.7 to 44.9 min between July and October, with a mean of 34.9 min. As surface water temperature rose in July, the *Odontosyllis* swarm populations increased to a maximum peak between 3–15 August. Thereafter, as the surface water temperature gradually fell, the peaks decreased in height, with the exception of a large peak between 6–12 October. No *Odontosyllis* were observed during regular searches, centered around times of first and last quarter of the moon, between 1 November and mid-April,

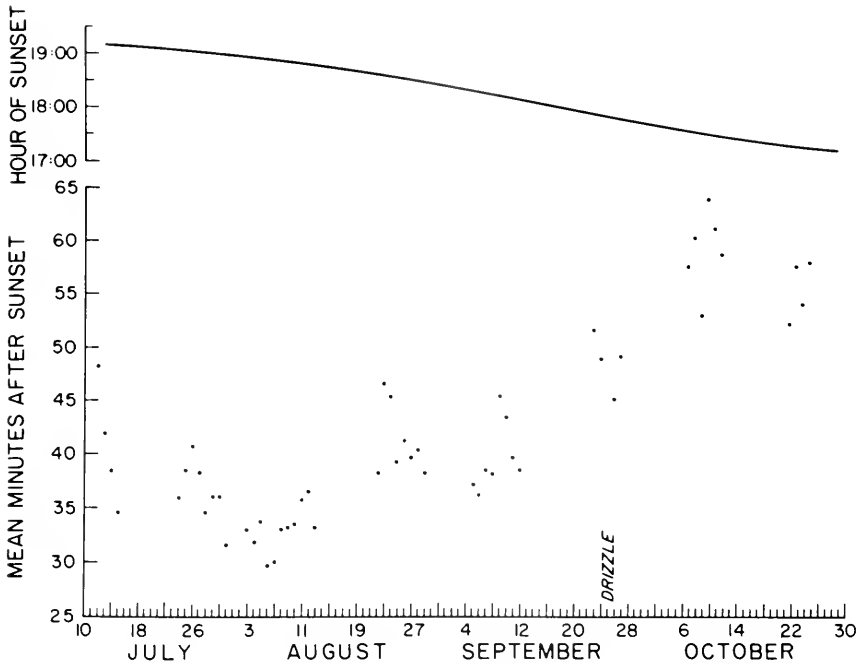

FIGURE 2. Plot of the mean minutes after sunset and time of sunset against dates of observation, July–October, 1982.

1983, as the surface water temperature reached a low of 14.0°C on 4 February. Two worms were seen on 19 April (first quarter moon) and the onset of more intensive swarming was signalled by a count of 80 worms on 3 June, by which time water temperature had risen to 22.0°C .

DISCUSSION

The data in Figures 1–3 indicate three rhythmic components in the reproductive behavior of *O. phosphorea*: a seasonal cycle, with peak spawning in the warm-water months of July to October; a fortnightly cycle, with spawning on dates corresponding roughly with first and last quarters of the moon (and hence, with neap tides); and a strong daily cycle, with spawning confined to less than an hour, beginning shortly after sunset. It is conceivable that water temperature itself influences spawning on a seasonal basis; the observations of Fraser (1915) suggest a much more seasonally restricted spawning of *O. phosphorea* in the colder waters of British Columbia. We cannot determine from the present data whether endogenous factors are involved in the fortnightly and daily rhythmicities. The semi-lunar rhythm may be directly evoked by the tidal regime, or it might represent an endogenous rhythm, perhaps synchronized by moonlight. Neumann (1976, 1978), in his laboratory studies of the reproduction of the marine midge, *Clunio marinus* (which also shows annual, semi-lunar, and daily rhythmicity), demonstrated that it is possible to induce fortnightly rhythms in the breeding by either artificial moonlight (a few days per month) or simulated tides, together with a light-dark cycle.

The fact that *O. phosphorea* shows a semi-lunar rhythm of spawning, and not a lunar rhythm, as reported for other species of this genus from the Caribbean

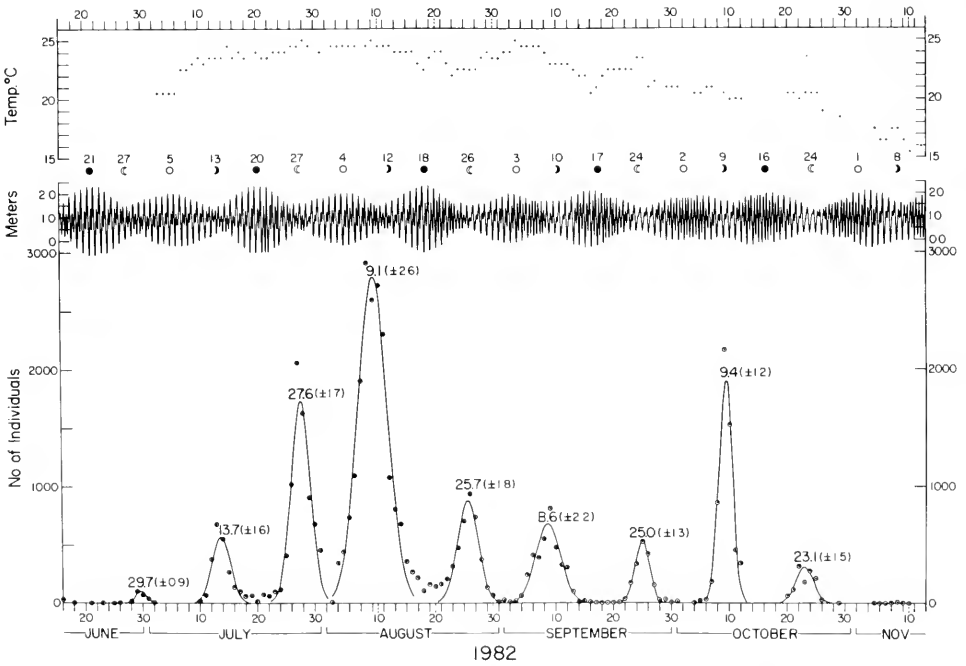

FIGURE 3. Plot of the number of *Odontosyllis* appearing, high and low water tide predictions for San Diego, surface water temperature, and phases of the moon against dates of observation, June–November, 1982. Solid line represents normal probability curves for each activity period calculated from total counts taken each evening. The values given above each peak represent the calculated mean date of peak abundance of the worms and standard deviation. The percentage of total worms (43,983), appearing in each activity period peaks, was as follows: 28 June–2 July, 0.53; 10–18 July, 5.11; 23–31 July, 16.76; 3–15 August, 40.87; 22–30 August, 9.06; 4–14 September, 8.41; 22–28 September, 3.82; 6–12 October, 12.71; and 20–26 October, 2.73.

(Markert *et al.*, 1961; Erdman, 1965) suggests that regardless of proximate factors, the behavior of the worms in Mission Bay is an adaptation to tidal conditions which recur at fortnightly intervals. In this connection, we note that during neap tides, there is minimal tidal flushing of an enclosed embayment, meaning that the progeny of spawning worms are able to complete their early larval development in near proximity to the adult habitat.

ACKNOWLEDGMENTS

We are greatly indebted to the following individuals: Dr. Kristian Fauchald, Smithsonian Institution, for identifying *O. phosphorea*; Dr. Terrance E. Meyer, University of Arizona, for assisting with some of the worm counts; and Dr. James T. Enright of our Division, S.I.O., for critically reading the manuscript. This work was supported in part by research grants PCM79-21658 and PCM82-15773 from the National Science Foundation.

LITERATURE CITED

ALDER, H. L., AND E. B. ROESSLER. 1968. *Introduction to Probability and Statistics*. W. H. Freeman and Company, San Francisco. 333 pp.

- BERKELEY, E. 1935. Swarming of *Odontosyllis phosphorea*, Moore, and of other polychaeta near Nainaimo, B. C. *Nature* **136**: 1029.
- DALY, J. M. 1975. Reversible epitoky in the life history of the polychaete *Odontosyllis polycera* (Schmarda 1861). *J. Mar. Biol. Assoc. U. K.* **55**: 327-344.
- ERDMAN, D. S. 1965. Lunar periodicity in the swarming of luminescent worms, *Odontosyllis octodentata* Treadwell (annelida) off La Parguera, P. R. *Caribb. J. Sci.* **5**: 103-107.
- FRASER, C. M. 1915. The swarming of *Odontosyllis*. *Trans. R. Soc. Can.* **9**: 43-49.
- GALLOWAY, T. W., AND P. S. WELCH. 1911. Studies on a phosphorescent Bermudan annelid, *Odontosyllis enopla* Verrill. *Trans. Am. Microsc. Soc.* **30**: 13-39.
- HANEDA, Y. 1971. Luminous swimming polychaeta from the Banda Islands. *Sci. Rep. Yokosuka City Mus.* **18**: 34-35.
- HORII, N. 1982. Observation on luminous polychaeta, *Odontosyllis undecimdonga* from Toyama Bay, Japan Sea. *Sci. Rep. Yokosuka City Mus.* **29**: 1-3.
- HUNTSMAN, A. G. 1948. *Odontosyllis* at Bermuda and lunar periodicity. *J. Fish. Res. Board Can.* **7**: 363-369.
- MARKERT, R. E., B. J. MARKERT, AND N. J. VERTREES. 1961. Lunar periodicity in spawning and luminescence in *Odontosyllis enopla*. *Ecology* **42**: 414-415.
- NEUMANN, D. 1976. Entrainment of a semilunar rhythm. Pp. 115-127 in *Biological Rhythms in the Marine Environment*, P. J. DeCoursey, ed. University of South Carolina Press, Columbia, South Carolina.
- NEUMANN, D. 1978. Entrainment of a semilunar rhythm by simulated tidal cycles of mechanical disturbance. *J. Exp. Mar. Biol. Ecol.* **35**: 73-85.
- POTTS, F. A. 1913. The swarming of *Odontosyllis*. *Proc. Camb. Phil. Soc.* **17**: 193-200.

THE KARYOLOGY OF *TEREDO UTRICULUS* (GMELIN) (MOLLUSCA, PELECYPODA)

R. VITTURI, A. MAIORCA, AND E. CATALANO

Institute of Zoology, University of Palermo, Italy

ABSTRACT

By counting spermatocyte and oocyte bivalents and mitotic metaphase chromosomes in cleaving eggs, we have determined, both the haploid ($n = 19$) and the diploid numbers ($2n = 38$) respectively, for the species *Teredo utriculus*. An XY and XO sex-determining mechanism is absent in the species under study. Chromosomes cannot be grouped into different classes according to length. It seems that, for *Teredo utriculus*, a high number of chromosomes is not necessarily accompanied by a high amount of chromosomal DNA.

INTRODUCTION

The available karyological data on the Pelecypoda (Patterson, 1969; Hinegardner, 1974; Ahmed, 1976; Rasotto *et al.*, 1981), although still very scanty, have brought to light some interesting cytological problems: 1) in many species the male bivalents break easily and aggregate in groups (Rasotto *et al.*, 1981); thus both the number and morphology of these chromosomes are quite difficult to determine; 2) the presence of sex-chromosomes has been hypothesized for two species of the family Mytilidae: *Mytilus californianus* (Ahmed and Sparks, 1970) and *Mytilus galloprovincialis* (Rasotto *et al.*, 1981).

So far as evolution within the Pelecypoda is concerned, Patterson (1969) maintains that, as in the other groups of molluscs, the "generalized" species of this class possess lower chromosome numbers; Hinegardner (1974), on the other hand, asserts that the families Ostreidae, Pectinidae, Pinnidae, Petricolidae, and Pholadidae, considered to be more evolved on the basis of their morphological characters, have a low DNA content.

To clarify these problems we thought it useful to study the chromosomes of a member of the Teredinidae. This family includes highly specialized species and belongs to the order Eulamellibranchia cytologically not extensively analyzed. In fact, only 5 of the 59 recognized families (Grassé, 1960), have been karyologically studied (Table I).

This paper reports the analysis of male and female bivalents, and of mitotic chromosomes in cleaving eggs of the species *Teredo utriculus* (Gmelin).

MATERIALS AND METHODS

For the study of spermatocyte chromosomes 30 sexually mature male specimens of *Teredo utriculus*, collected in the Gulf of Palermo, were used. The chromosome preparations were made using the well-known squashing technique (Colombera, 1970).

TABLE I

Chromosome numbers in the order Eulamellibranchia (Mollusca, Pelecypoda)

Species name	n	Authors
Family Unionidae		
<i>Unio</i> sp.	16	Ahmed, 1976
Family Cardiidae		
<i>Dinocardium robustum</i>	12	Menzel, 1968
<i>Cardium edule</i>	20	Rasotto <i>et al.</i> , 1981
<i>Cardium tuberculatum</i>	20	Rasotto <i>et al.</i> , 1981
Family Mictridae		
<i>Mactra</i> sp.	18	Kostanecki, 1904
<i>Labiosa plicatella</i>	18	Menzel, 1968
<i>Mulinia lateralis</i>	18	Menzel, 1968
Family Donacidae		
<i>Donax variabilis</i>	18	Menzel, 1968
Family Veneridae		
<i>Mercenaria mercenaria</i>	19	Menzel and Menzel, 1965
<i>Mercenaria campechiensis</i>	19	Menzel and Menzel, 1965
<i>Chione cancellata</i>	19	Menzel, 1968
<i>Saxidomus giganteus</i>	19	Ahemd and Sparks, 1967
<i>Saxidomus nuttalli</i>	19	Ahemd and Sparks, 1967
<i>Venus gallina</i>	15	Rasotto <i>et al.</i> , 1981
<i>Venus verrucosa</i>	19	Rasotto <i>et al.</i> , 1981
<i>Venerupis aurea</i>	19	Rasotto <i>et al.</i> , 1981
<i>Venerupis decussata</i>	19	Rasotto <i>et al.</i> , 1981
<i>Pitaria chione</i>	19	Rasotto <i>et al.</i> , 1981

Unfertilized eggs of 10 females, eggs immediately after fertilization, and embryos at the 4–8 blastomere stage, obtained by fertilization *in vitro*, were treated by the method used by Colombero (1969) for the chromosome study of the species *Botryllus schlosseri* (Ascidacea).

Observations and microphotographs of the chromosomes were performed with a Wild-phase contrast microscope.

The idiogram was constructed from photographic enlargements of the chromosomes in 7 late meiotic-II prophase plates, while the karyogram was prepared from 5 mitotic metaphase plates in embryos at 4–8 blastomere stage.

The mitotic chromosomes were interpreted according to the classification of Levan *et al.* (1964).

RESULTS

Meiotic chromosomes

From analyses of spermatocyte bivalents at diakinesis (Fig. 1a, b), the haploid number was $n = 19$ (Table II). The count was not difficult as broken elements were lacking.

The bivalents appeared well spaced, and intensely and homogeneously stained.

In Figure 1a, the presence of chiasmata allowed different types of bivalents to be distinguished: cross-shaped with two probable sub-terminal chiasmata, one ring-shaped element with two terminal chiasmata, and rod-shaped elements in which the presence and the position of chiasmata could not be hypothesized.

TABLE II

Number of chromosomes found in the plates observed for Teredo utriculus

	n	17	18	19	20	21
Spermatocyte bivalents	frequence	2	2	42	3	1
Oocyte bivalents	frequence	2	1	35		
Late meiotic-II prophase chromosomes	frequence		2	18		
Metaphase mitotic chromosomes in cleaving eggs	2n	36	37	38	39	40
	frequence		3	25	2	

The dimensions of these chromosomes varied from a maximum of 2.7 μm to a minimum of 1.4 μm .

At late diakinesis (Fig. 1b) the cross-shaped bivalents were still present. Owing to the higher contraction of these chromosomes, the dimensions varied from 1.8 μm to 0.9 μm .

The oocyte bivalents at metaphase-I (Fig. 2) appeared well separated on the squashing plane, thus allowing an easy count ($n = 19$) (Table II).

In addition to the numerous cross-shaped elements with two sub-terminal chiasmata, bivalents with one terminal and one sub-terminal chiasma (Fig. 2, see arrows), and apparently achiasmatic rod-shaped elements were also visible.

The dimensions of these chromosomes varied from 3.4 μm to 1.8 μm .

In fertilized but uncleaved eggs, 20 plates, interpreted as advanced prophase at the second meiotic division, were analyzed (Fig. 3). The 19 chromosomes observed in these spreads (Table II) were rod-shaped, occasionally slightly bent, elongated, and homogeneously stained. A lighter, thinner area, explained as the probable centromere position, was present in a few elements (Fig. 3, see arrows).

An average idiogram was obtained (Fig. 5) (Table III) by measuring the chromosomes of 7 plates and arranging them by length (Fig. 4, one plate is represented).

Mitotic chromosomes

Mitotic chromosomes at metaphase were observed in embryos at the 4–8 blastomere stage (Fig. 6). The chromosomes displayed different contractions in the various plates examined, and were arranged randomly on the squashing plane; from their count the diploid number resulted as $2n = 38$ (Table II). In these chromosomes the kinetochore position could be identified. In fact, in some elements the sister chromatids of each chromosome were visible, while a thinner area was present in others.

An average karyotype (Fig. 8) (Table IV) was constructed by measuring and arranging the chromosomes of 5 plates (Fig. 7, three plates are represented) according to their length and to the centromere position. From its analysis it resulted that the 38 elements could be grouped into 19 pairs of autosomes, 3 of which were meta-centric, 2 sub-telocentric, and 14 telocentric.

DISCUSSION

This study has determined the haploid number $n = 19$ and the diploid number $2n = 38$ (Table II) for the species *Teredo utriculus*. The values which vary slightly from $n = 19$ and $2n = 38$ are to be attributed to the squashing technique.

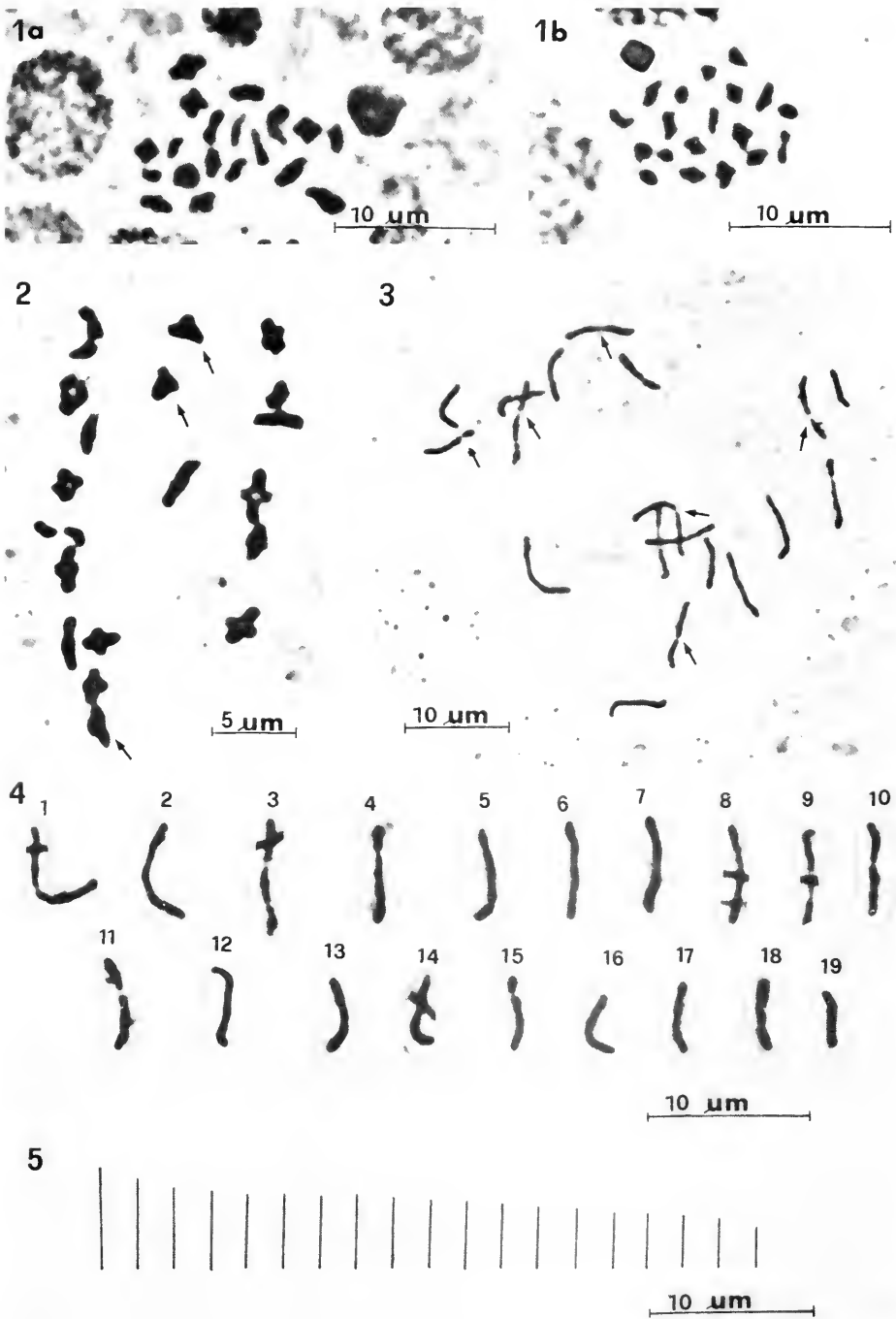

FIGURE 1a, b. Diakinetic bivalents in male gonads of *Teredo utriculus*.

FIGURE 2. Oocyte bivalents of *Teredo utriculus*.

FIGURE 3. Late prophase chromosomes at the second meiotic division of *Teredo utriculus*.

FIGURE 4. Idiogram constructed from 1 late meiotic-II prophase plate of *Teredo utriculus*.

FIGURE 5. Idiogram constructed from 7 late meiotic-II prophase plates of *Teredo utriculus*.

TABLE III

Mean length of the chromosomes and S.D. in 7 late meiotic-II prophase plates of Teredo utriculus

Chromosome	1	2	3	4	5	6	7	8	9	10	11	12	13	14	15	16	17	18	19
Mean length in microns	6.43	5.78	5.36	4.87	4.67	4.64	4.60	4.54	4.47	4.29	4.22	4.09	3.96	3.67	3.56	3.46	3.28	3.21	2.50
S.D.	1.47	1.28	1.32	1.22	1.22	1.20	1.01	1.22	1.17	1.17	1.10	1.08	1.02	1.03	0.99	0.94	0.87	0.77	0.75

The analysis of male and female bivalents showed no heterotypic element and heteromorphism is absent in every pair of chromosomes in the karyotype. We therefore think that this species does not possess an XY or XO sex-determining mechanism.

Differentiated sex chromosomes have not been observed in any of the species of Pelecypoda cytologically examined up to now (Patterson, 1969; Ahmed, 1976; Wada, 1978; Rasotto *et al.*, 1981), apart from the species *Mytilus californianus* (Ahmed and Sparks, 1970) and *Mytilus galloprovincialis* (Rasotto *et al.*, 1981); however in both cases this assertion was based on the observation of two spermatocyte bivalents which seemed to be joined together at diakinesis.

We observed chiasmata at meiosis in both sexes, but it is very unlikely that in both spermatocyte and oocyte bivalents, all the chiasmata present were counted, due to their terminalization and the overcondensation of these chromosomes.

Furthermore, comparison of the male and female bivalents revealed the greater dimensions of the latter.

The mitotic chromosomes at metaphase appear to be arranged randomly on the squashing plane, thus excluding somatic pairing of homologous chromosomes for the species under study. However, these chromosomes appear to be peculiar for their shape, which brings to mind the "colchicized" chromosomes (Ieyama and Inaba, 1974; Ieyama, 1975; Wada, 1978).

This characteristic, previously observed in mitotic chromosomes of spermatogonial metaphase of some Gastropods (Vitturi *et al.*, 1982), has not been confirmed in the Polyplacofora (Vitturi, 1982; Vitturi *et al.*, 1982).

The chromosomes in the idiogram and karyogram cannot be grouped into classes according to length since their dimensions vary gradually from the largest to the smallest (Tables III, IV).

If we consider the number of chromosomes, the haploid value $n = 19$, which characterizes the species *Teredo utriculus*, is found to be one of the highest, not only within the order Eulamellibranchia (Table I), but also within the class Pelecypoda (Rasotto *et al.*, 1981).

If, in agreement with Ahmed (1976), the basic haploid number for this class is considered to be $n = 15$, or a value close to that, then it seems probable that evolution within this group has proceeded not only with a decrease (Ahmed, 1976; Vitturi *et al.*, 1982) but also with an increase in the number of chromosomes (Patterson, 1969).

Finally, it is interesting to note that many species of the family Pectinidae possess 19 spermatocyte bivalents of greater dimensions (Rasotto *et al.*, 1981) than those of the male bivalents in the species analyzed here.

The finding of a low nuclear DNA content in these species (Hinegardner, 1974) leads to the supposition that there is a low DNA content in *Teredo utriculus* as well.

All this would indicate that specialization is, in this particular case, linked to a decrease in the chromosomal DNA content, thus supporting Hinegardner's hy-

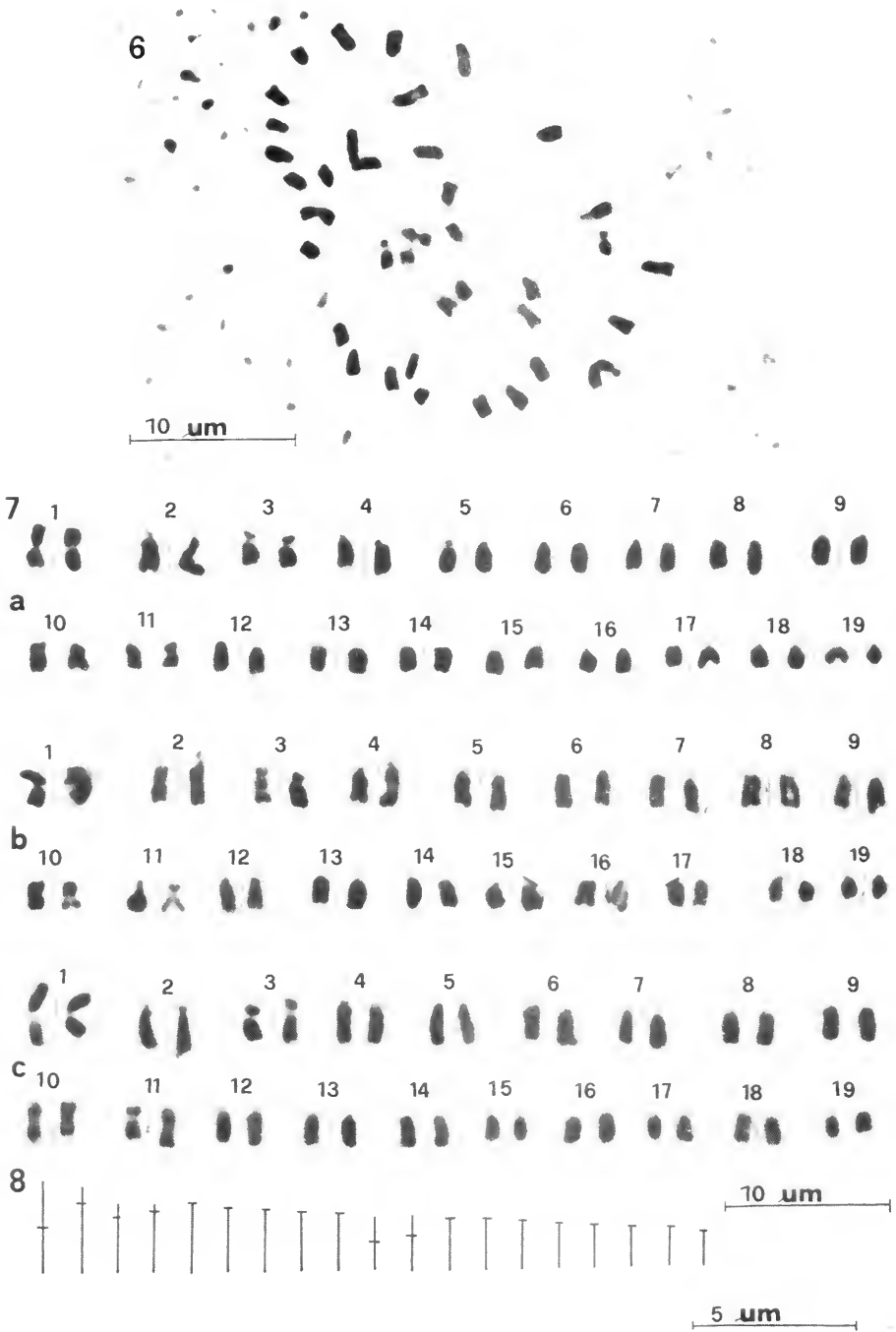

FIGURE 6. Mitotic metaphase plate in cleaving eggs of *Teredo utriculus*.

FIGURE 7. Three arrangements of mitotic metaphase chromosomes in cleaving eggs of *Teredo utriculus*.

FIGURE 8. Karyogram constructed from 5 mitotic metaphase plates in cleaving eggs of *Teredo utriculus*.

TABLE IV

Mean length and arm ratio of the chromosomes of 5 mitotic metaphase plates in cleaving eggs of *Teredo utriculus*

Chromosome pairs	Mean length in microns	S.D.	Arm ratio mean	Centromere position
1	2.86	0.53	1	M
2	2.59	0.33	5.3	ST
3	2.13	0.22	3.7	ST
4	2.09	0.28	8.2	T
5	2.09	0.28	∞	T
6	1.93	0.21	∞	T
7	1.86	0.15	∞	T
8	1.82	0.12	∞	T
9	1.82	0.12	∞	T
10	1.77	0.15	1	M
11	1.72	0.19	1.7	M
12	1.68	0.22	∞	T
13	1.66	0.18	∞	T
14	1.57	0.22	∞	T
15	1.43	0.15	∞	T
16	1.37	0.13	∞	T
17	1.29	0.15	∞	T
18	1.22	0.18	∞	T
19	1.11	0.25	∞	T

pothesis that such a mechanism is present in all classes belonging to the phylum Mollusca.

At any rate, as has already been suggested for the family Petricolidae (Pelecypoda) (Rasotto *et al.*, 1981), for the Polyplacofora (Vitturi, 1982) and for the Mesogastropoda (Mollusca, Prosobranchia) (Vitturi and Catalano, in press) it appears that, for *Teredo utriculus* as well, a high number of chromosomes is not necessarily accompanied by a high amount of chromosomal DNA.

ACKNOWLEDGMENTS

The authors are deeply indebted to Mr. G. Miceli for processing and printing the microphotographs presented here.

LITERATURE CITED

- AHMED, M. 1976. Chromosome cytology of marine Pelecypod Mollusc. *J. Sci.* (Karachi) **4**: 77-94.
- AHMED, M., AND A. K. SPARKS. 1967. *Proc. Nat. Shellfish. Assoc.* **58**: 10.
- AHMED, M., AND A. K. SPARKS. 1970. Chromosome number structure and autosomal polymorphism in the marine mussels: *Mytilus edulis* and *Mytilus californianus*. *Biol. Bull.* **138**: 1-13.
- COLOMBERA, D. 1969. The karyology of the colonial Ascidian *Botryllus schlosseri* (Pallas). *Caryologia* **22**: 339-350.
- COLOMBERA, D. 1970. A squash method for chromosomes of Ascidians (Tunicata). *Caryologia* **23**: 113-116.
- GRASSÉ, P. P. 1960. *Traité de Zoologie, Anatomie, Systematique, Biologie*. Tome V. Masson et C^o Editeurs. Paris. 2.087-2.127.
- HINEGARDNER, R. 1974. Cellular DNA content of the Mollusca. *Comp. Biochem. Physiol.* **47A**: 447-460.
- IEYAMA, H. 1975. Chromosome numbers of three species in three families of Pteriomorpha (Bivalvia). *Venus. Jpn. J. Mal.* **34**(1): 26-32.
- IEYAMA, H., AND A. INABA. 1974. Chromosome numbers of ten species in four families pf Pteriomorpha (Bivalvia). *Venus. Jpn. J. Mal.* **33**(3): 129-137.

- KOSTANECKI, K. 1904. Cytologische studien an Kunstlich parthenogenetisch entwickeluden eies von *Maetra*. *Arch. Mikroskopische Anat.* **64**: 1-98.
- LEVAN, A., K. FREDGA, AND A. A., SANDBERG. 1964. Nomenclature for centromeric position of chromosomes. *Hereditas* **52**: 201.
- MENZEL, R. W. 1968. Chromosome number in 9 families of marine Pelecypod mollusc. *Nautilus* **82**(2): 45-58.
- MENZEL, R. W., AND M. Y. MENZEL. 1965. Chromosomes of two species of quahog clams and their hybrids. *Biol. Bull.* **129**(1): 181-188.
- PATTERSON, C. M. 1969. Chromosomes of molluscs. *Proc. Symp. Moll. Mar. Biol. Assoc. India* **2**: 635-686.
- RASOTTO, M., D. ALTIERI, AND D. COLOMBERA. 1981. I cromosomi spermatocitari di 16 specie appartenenti alla classe Pelecypoda. *Comunicazione presentata al Simposio della S.M.I. (Soc. Mal. Ital.) del 9.10/5/1981*.
- VITTURI, R. 1982. The chromosomes of *Chiton olivaceus* (Spengler) (Polyplacophora) *Biol. Zbl.* **101**: 647-651.
- VITTURI, R., M. B. RASOTTO, AND N. FARINELLA-FERRUZZA. 1982. The chromosomes of 16 molluscan species. *Boll. Zool.* **49**: 61-71.
- VITTURI, R., AND E. CATALANO. Spermatocyte chromosomes in 7 species of the sub-class Prosobranchia (Mollusca, Gastropoda). *Biol. Zbl.* (in press).
- WADA, K. 1978. Chromosome karyotypes of three bivalves: the oysters, *Isognomon alatus* and *Pinctada imbricata*, and the bay scallop, *Argopecten irradians*. *Biol. Bull.* **155**: 235-245.

GAMETOGENESIS AND REPRODUCTIVE PERIODICITY OF THE SUBTIDAL SEA ANEMONE *URTICINA LOFOTENSIS* (COELENTERATA: ACTINIARIA) IN CALIFORNIA

STEVEN E. WEDI* AND DAPHNE FAUTIN DUNN**

**Department of Biology, San Francisco State University, San Francisco, California 94123, and*

***Department of Invertebrate Zoology, California Academy of Sciences, Golden Gate Park,
San Francisco, California 94118-9961*

ABSTRACT

Sexual reproduction of the actiniid sea anemone *Urticina* (= *Tealia*) *lofotensis* was studied for one year (1976–1977) in 105 specimens collected by hand monthly at 7–16 m in Carmel Bay, California. Gametogenesis, evaluated by light microscopy, is typical for an actinian. Oocyte maturation is asynchronous, even within a mesentery, whereas spermiogenesis of each male is synchronous. Each oocyte is associated with a trophonema, and eggs may exceed 1200 μm in diameter. The study population is dioecious, with a significant excess of females. Gonad indices and histological data indicate that the period of maximum female ripeness ends in December as the male maximum begins. The spawning peak appears to occur then, just as water temperature begins to fall from its annual high. Some females contain large oocytes and seem to release eggs throughout the year. Greatest reproductive quiescence is in April and May, when water temperature is at its minimum.

INTRODUCTION

Most studies of sea anemone reproduction have dealt with specimens collected intertidally; subtidal studies have relied on dredged material. Although reproductive studies on other subtidal coelenterates have been done with the aid of diving (*e.g.*, Ostarello, 1973; Rinkevich and Loya, 1979), ours is the first published study of subtidal sea anemone reproduction based on hand-collected specimens. It therefore adds a new dimension to the growing body of research on sexual reproduction of Pacific North American actinians begun two decades ago (*e.g.*, Ford, 1964; Spaulding, 1971; Siebert, 1974; Dunn, 1975; Siebert and Spaulding, 1976; Jennison, 1978, 1979; Sebens, 1981).

Urticina lofotensis (Danielssen, 1890) is a vivid crimson actiniid sea anemone with white verrucae 1–3 mm in diameter that make it appear polka-dotted or, in contraction, vertically striped (Fig. 1). Along the U. S. Pacific coast, its habitat is almost exclusively rocky subtidal. Only rare animals are exposed by minus tides, which probably accounts for the lack of biological information about the species. One of five named members of *Urticina* in the northeastern Pacific (the others are *U. columbiana*, *U. coriacea*, *U. crassicornis*, and *U. piscivora*), *U. lofotensis* ranges from Alaska to the Channel Islands (Hand, 1955; Sebens and Laakso, 1978).

In using the name *Tealia lofotensis* for this organism, Hand (1955) identified it with that which Danielssen (1890) described from Norway as *Madoniactis lofo-*

Received 29 November 1982; accepted 1 July 1983.

* Current address 1444 Laguna Avenue, Burlingame, California 94010.

**To whom reprint requests should be addressed.

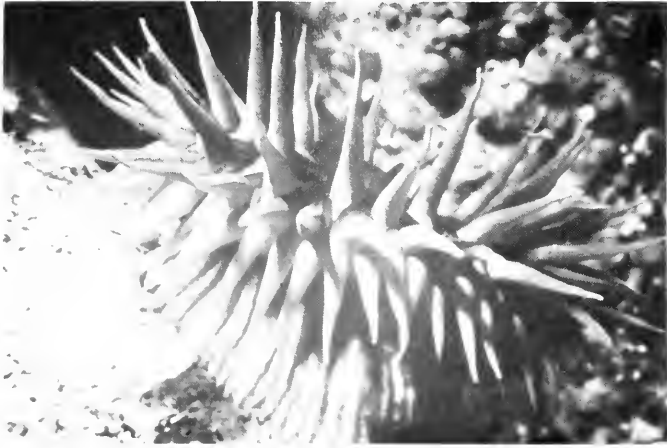

FIGURE 1. Typical posture of *Urticina lofotensis* on rock substratum. Specimen is approximately 100 mm across.

tensis. The name *Urticina* has priority over *Tealia*, which is, in turn, senior to *Madoniactis* (Williams in Manual, 1981). Manual (1981), following Stephenson (1935), synonymized the European *T. lofotensis* with *Bolocera eques* Gosse, 1860, which has been known as *T. crassicornis*, calling it *U. eques*. Manual (1981) questionably included Hand's *T. lofotensis* in the synonymy as well. It seems prudent to maintain current usage of *Urticina* species names for animals of the north Pacific pending further systematic study since anemones called *U. lofotensis* and *U. crassicornis* are easily separable on the Pacific coast of North America (Hand, 1955; Sebens and Laakso, 1978), and both seem to differ from the European *U. eques* as per Stephenson (1935) and Manual (1981).

Stephenson (1935) and Manual (1981) summarized literature on, and morphology of, European animals called *Urticina lofotensis*. Hand (1955) and Sebens and Laakso (1978) described the anatomy of northeast Pacific anemones of the same name. Data on reproduction are confined to remarks on size of gametes and distribution of gonads.

MATERIALS AND METHODS

Between 4 and 12 anemones were collected at four-week intervals from 9 November 1976, to 12 October 1977, by SCUBA diving from a boat off the rocky north end of Carmel River State Beach, California (36°32'25"N, 121°55'53"W). The bottom is characterized by rocky rubble interspersed with small sandy areas and granitic boulders, most 3–5 m in diameter, some 7 m tall and rising to within 3 m of the surface. Passages between boulders are subject to surge and scour, especially in winter, due to ocean swells coming directly from deep water offshore. The study area, approximately 200 by 100 m (Fig. 2), ranged in depth from 7 to 16 m. Anemones are scarce in water deeper than 16 m, and strong wave action and surge made collecting in water shallower than 7 m difficult or impossible during most of the year. An extension of the Carmel submarine canyon near the study area influences wave action, upwelling, and temperature fluctuation.

A different portion of the study area was sampled each month by two divers swimming along a selected compass heading, arbitrarily removing anemones from

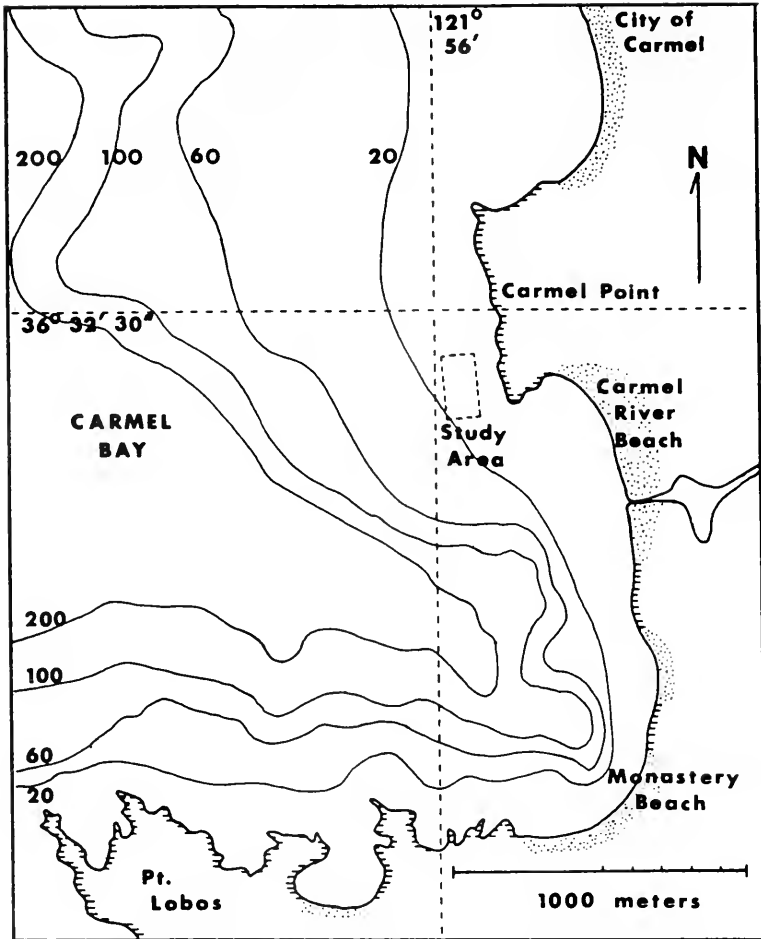

FIGURE 2. Map of southern Carmel Bay, California, indicating location of the study area. Depth contours in meters.

the substratum. Measuring pedal disc diameter prior to collecting was attempted but proved difficult in the surge, so was discontinued. Animals were carefully scraped and peeled from the rocks using a dull knife blade. To prevent contact among animals and to keep track of oocytes released after collection, each animal was placed in a separate perforated plastic jar covered by a plastic screw cap. The containers, of minimal buoyancy, could easily be transported by the diver in a nylon mesh bag. They were returned to the laboratory in a styrofoam cooler filled with sea water. Water samples from the cooler were examined microscopically after removing the jars. No eggs were found, but much undigested food expelled by the anemones during transit was always evident.

In the laboratory, the animals (in jars) were placed in running sea water. The next morning, after they had expanded fully in liter beakers of sea water, half the fluid was replaced by 100–200 ml of 10% $MgCl_2$ in sea water. Complete relaxation, until a pinch on several of the by-then flaccid tentacles elicited no response and the

oral disc was expanded and darkened, required several hours. If narcotization was slow, additional relaxant was added; this was most often necessary with specimens over 70 mm basal diameter.

Anemones were fixed in Bouin's solution (Humason, 1962) made with undiluted sea water. Despite seemingly thorough relaxation, many contracted somewhat when fixative was added. About 10% contracted violently, everting the actinopharynx, which made dissection difficult. At least a week in Bouin's was allowed for complete fixation.

Prior to dissection, pedal disc diameter was measured. The anemones were bisected across the column, 10–20 mm distal to the base. Food objects and gonadal tissue were removed with forceps under a dissecting microscope. Gonads were preserved in Bouin's solution. Mesenteries were counted in the basal section.

Each animal, minus its gonads, was dried for six days in a vacuum desiccator at 60°C, and weighed immediately upon removal. Dry weight of gonad not set aside for histological examination was determined after desiccation for 24 h. Four large blotted pieces of gonad from each anemone were weighed prior to dehydration, cleared, and embedded in paraffin. Their approximate dry weight added to that of the desiccated pieces yielded the total dry gonad weight. The relation of dried gonad weight to that of the entire animal, encompassing gonad as well as body, constituted the gonad index (GI).

Seven μm serial sections of gonad were stained with Harris' hematoxylin and eosin (Humason, 1962). Fifty oocytes from each anemone were measured in sections that included the nucleolus, which reduced the possibility of measuring the same cell more than once. The two longest perpendicular diameters were averaged in irregularly shaped oocytes. Eggs smaller than 25 μm were difficult to measure accurately, so were not included in the count.

Maturity of male gonads was scored as follows: stage 1—gonadal packets containing only spermatogonia; stage 2—packets with spermatogonia, spermatocytes, and the first noticeable tailed sperm; stage 3—fully mature packets containing predominantly sperm. Animals with follicles at a maturity level between stages 1 and 2 were placed subjectively in one or the other; those with packets between stages 2 and 3 were classified according to the relative abundance of sperm. For example, a male with packets half full of mature sperm was at stage 2½.

Surface water temperatures were obtained from the California Department of Fish and Game's Marine Culture Laboratory at Granite Canyon, south of the study area. Water temperatures taken at depth on several collecting dives during the year generally agreed with the data from Granite Canyon.

RESULTS

Sexuality and morphology

Urticina lofotensis is dioecious: 54 females, 34 males, 17 animals lacking gonads, and no hermaphrodites were collected. Sex determination was not possible externally. Even under low magnification, immature gonads of both sexes appeared similar, but at later developmental stages were distinguishable by color and form.

Male gonads were bright red, the color dulling considerably after fixation. The greatly elongated, pleated gametogenic portion along the inner mesentery edge (Fig. 3a) was easily located and removed during dissection.

Female gonadal tissue was less convoluted, the oocytes were contained within indistinct clusters along the mesentery edge. Mature clusters resembled bunches of grapes. In Bouin's fluid this tissue was generally yellow or brown, and loose eggs

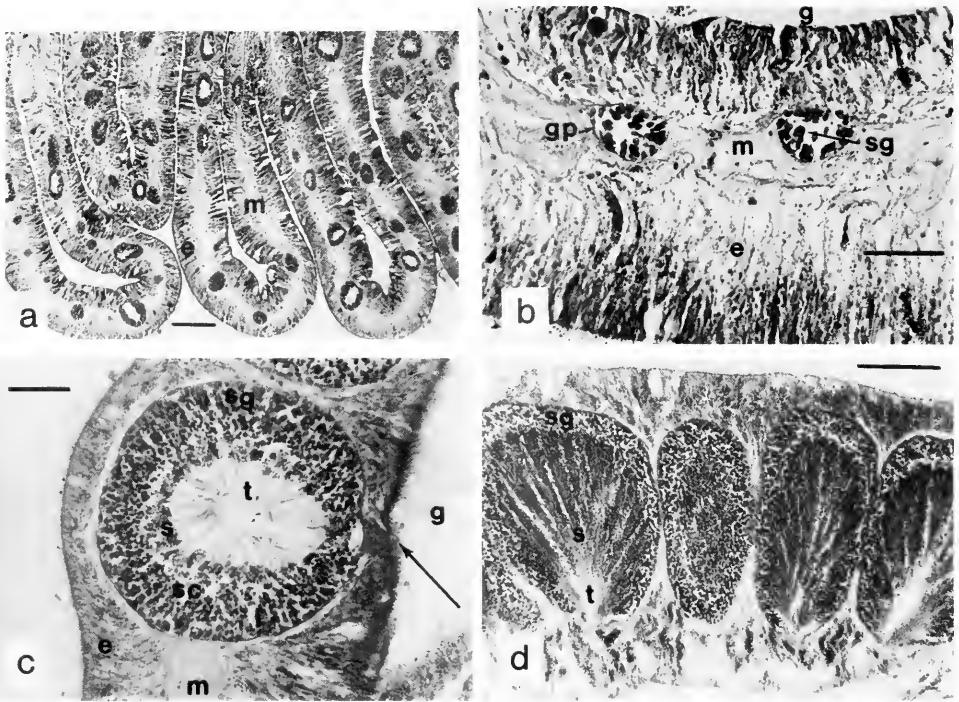

FIGURE 3. a) Section through gametogenic portion of one mesentery from male anemone. Scale bar = 100 μm . b) Section through early gonadal packets with spermatogonia (stage 1). Scale bar = 30 μm . c) Section of stage 2 gonadal packet with numerous tailed gametes. Note layering. Arrow indicates plug-like structure. Scale bar = 30 μm . d) Mature gonadal packets (stage 2 $\frac{1}{2}$) with abundant immature gametes. Scale bar = 50 μm . e = endoderm; g = gastrovascular cavity; gp = gonadal packet; m = mesoglea; s = spermatozoa; sc = spermatocytes; sg = spermatogonia; t = sperm tail.

were yellow. Sometimes oocytes/ova were expelled during fixation and several females were collected with eggs among the tentacles and adhering to the oral disc; diameter of these gametes was 700–800 μm . Spawning was never observed, and no larvae were found in or on any anemone.

The number of mesenteries in *Urticina lofotensis* corresponds to the number of tentacles and is the same distally and proximally. In 26 anemones of all sizes, it ranged from 47 to 77 pairs, and did not correlate strictly with animal size as determined by pedal disc diameter or dry weight. Generally, however, larger animals had more mesenteries. Many weighing from 12 to 15 g had just over 50 pairs, although a female with 77 pairs weighed only 8 g.

Oogenesis

The most immature germ cells observed were in the endoderm, ranged from 10 to 30 μm , and contained a nucleus about half their diameter (Fig. 4a). Large concentrations of cells occurred near the junctions of germinal and non-germinal mesentery tissue, but some were scattered in the endoderm, many near mature oocytes (Fig. 4b).

The smallest oocytes in the mesoglea were 20–50 μm in diameter. Previtellogenic cells stained a characteristic deep blue with hematoxylin and eosin; yolk platelets

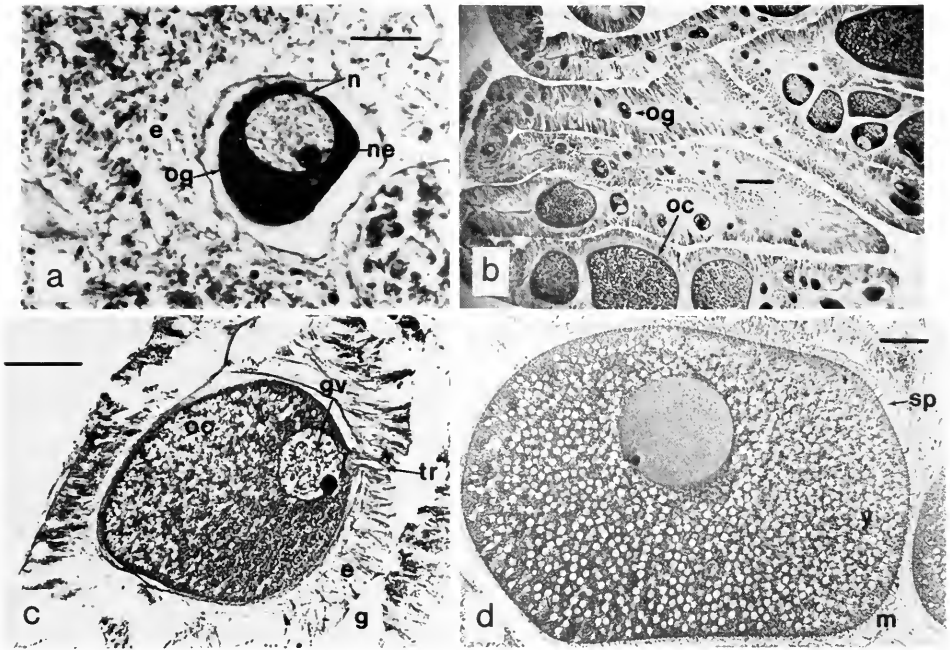

FIGURE 4. a) Section of early female gamete in the mesenterial endoderm. Scale bar = 20 μm . b) Section through a female gametogenic mesentery containing gametes in many stages of development. Scale bar = 100 μm . c) Section of an oocyte with a trophonema. Scale bar = 50 μm . d) Section through a large, yolky oocyte with spines. Scale bar = 50 μm . e = endoderm; g = gastrovascular cavity; m = mesoglea; n = nucleus, ne = nucleolus; oc = oocyte; og = immature germ cell; sp = spines; tr = trophonema; y = yolk granules.

took up eosin predominantly, giving larger cells a distinct pink color. During vitellogenesis, the oocyte nucleus (germinal vesicle) moved peripherally to either side of the cell, adjacent to the mesenterial endoderm, and did not increase appreciably in size. Nuclei of larger cells therefore appeared relatively small. Oocytes of all sizes contained one darkly stained, round nucleolus 10–20 μm in diameter.

In oocytes undergoing vitellogenesis and some previtellogenic cells, a tubular trophonema connected the cell through the mesoglea and endoderm to the gastrovascular cavity (Fig. 4c), its end flaring where it joined the oocyte. Attachment to the gamete was always in proximity to the germinal vesicle. Trophonemata were less prevalent in larger oocytes, but their remnants—small pieces of tissue adjacent to the nucleus—were common. Spines 5–15 μm long covered the surface of most larger oocytes. They were especially apparent where the mesoglea had pulled away from the oocyte during fixation (Fig. 4d). Each oocyte within the mesentery had a germinal vesicle.

Spermiogenesis

All mesenteries of an individual contained sperm follicles of uniform maturity. Spermatogonia were not identifiable in the endoderm. The smallest sperm packets in the mesoglea were round to ovoid 20–50 μm across, and contained up to 30 spermatogonia, each approximately 3–5 μm in diameter, with an indistinct nucleus half or less the diameter of the cell (Fig. 3b).

Spermatogonia lined the periphery of the growing follicle while smaller spermatocytes ($2-3\ \mu\text{m}$) occurred centrally, layering becoming pronounced with increasing numbers of cells. At a later stage, spermatids ($1\ \mu\text{m}$ diameter), in clumps of four to eight cells, occupied the packet's center. By this stage the follicle was 33–50% the width of the mesentery. Shortly thereafter the lumen of the packet opened slightly, and tailed sperm with heads approximately $1\ \mu\text{m}$ in diameter became evident (Fig. 3c).

Mature follicles expanded to nearly the full width of the mesentery (Fig. 3d). They were lined with developing gametes, spermatogonia and spermatocytes at the periphery, spermatids more centrally, and spermatozoa bundled with their tails together in the lumen. A few mature follicles occurred in spawned-out males, suggesting that all sperm are not always shed. Some spawned-out males also had immature spermatogonial packets.

Gonad Cycles

Figure 5 indicates the relative size frequencies of oocytes measured in section from the 54 female anemones collected. Although smaller oocytes were disproportionately represented due to their relatively large nuclei, changes in average gamete size through the year were evident. Cells between 50 and $150\ \mu\text{m}$ predominated in all animals, and very large oocytes ($450-600\ \mu\text{m}$) were also present all year, although in much smaller and varying quantities. Small oocytes made up a large percentage of gametes during winter (November to February), and on into spring, but represented a much smaller proportion during later spring and summer. Oocytes in the size classes of greatest frequency during winter averaged just under $100\ \mu\text{m}$. During summer (June through September), smaller oocytes decreased in frequency but had begun to increase again by October. Small quantities of large oocytes ($350-500\ \mu\text{m}$) were present in November and especially December. By January, most had disappeared.

Proportions of large (pink-staining) oocytes in the 50 measured gametes are displayed in Figure 6, which confirms their relatively high frequencies in some anemones during November and December, and their generally low prevalence in January and April. The increase from May through September is more evident in Figure 6 than in Figure 5. Animals collected during September contained the greatest

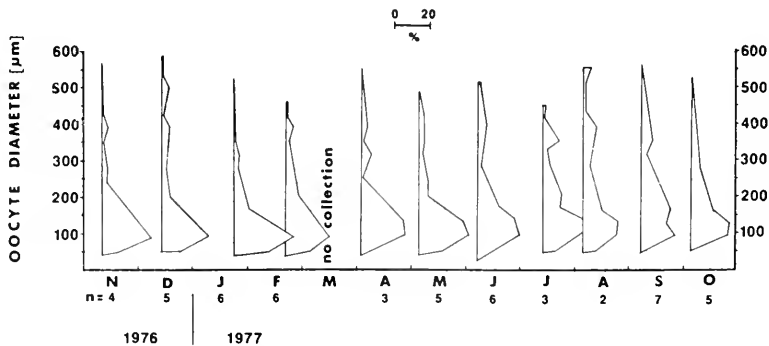

FIGURE 5. Size-frequency polygons for diameters of 50 oocytes from each female specimen of *Urticina lofotensis*. Each polygon indicates cumulative size frequencies for that month. One of the six females collected in December and one of the seven collected in January contained only loose oocytes.

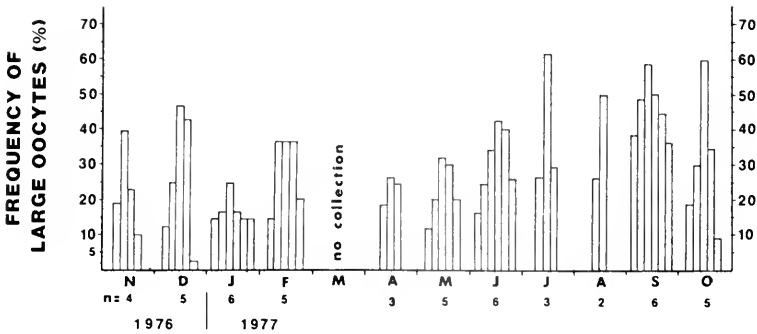

FIGURE 6. Histograms showing the proportion of large oocytes among the 50 cells measured from each female specimen of *Urticina lofotensis*. Each histogram represents an animal. One of the females collected in February and one collected in September contained only small oocytes.

proportion of large oocytes. Percentage of large cells in most females had dropped considerably by October.

Maximum female GI was 16.4% in a 10.0 g animal collected in November. The largest female, from the June collection, had a weight of 17.3 g and a GI of 15.1%; the smallest female, taken in October, weighed 4.4 g and had a GI of 3.4%. Average female GI gradually declined from November to its nadir in May, generally paralleling the pattern in males and surface water temperature (Fig. 7). Although it had just begun to increase (Fig. 6), large oocyte frequency was also low in May, when oocytes less than 200 μm in average diameter were predominant (Fig. 5).

The gonad cycle of males is shown in Figures 7 and 8. In April, when the largest male, weighing 19.3 g (GI 3.7%), was collected, and in May, when the smallest, weighing 4.1 g (GI 0.7%) was collected, gonad indices were low and males contained only spermatogonia. The first sperm had developed by June when, as with females, GI abruptly increased. From an August low (based on one male with 47 pairs of mesenteries, several residual sperm packets in its immature gonads, and a GI of 1.6%) almost equal to that of May, male GI increased through October, with a

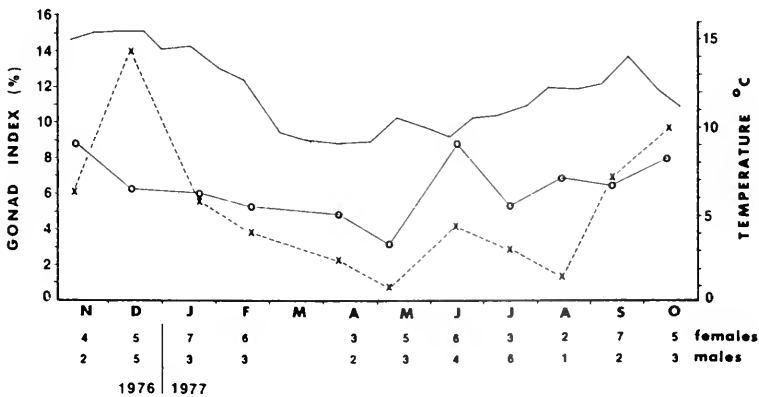

FIGURE 7. Monthly average gonad indices of female (--- O ---) and male (--- X ---) specimens of *Urticina lofotensis*, with number of specimens indicated below. Surface water temperatures (-----) are biweekly averages. No collection was made in March.

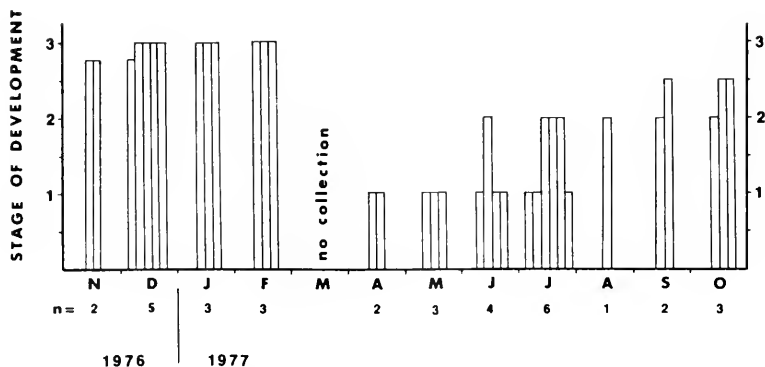

FIGURE 8. Histograms showing maturity of male specimens of *Urticina lofotensis* through the year. Each histogram represents an animal. See text for explanation.

concomitant sperm buildup. In September and October, gonadal packets were half full of sperm. Males collected in winter had follicles filled with sperm. The highest average monthly GI was in December (14.1%) when the five sea anemones had predominantly stage 3 gonadal packets. Among them was the second largest male collected (18.7 g), which had the highest individual GI, 22.7%. Although mature follicles predominated through February, average male GI decreased from December through May. GI generally increased with anemone size for both sexes (Table I).

Anemones with no gonads visible during dissection were not sectioned. All but two of these animals had dry weights less than 7.6 g (Table I), indicating that they were probably juveniles. The other two, both collected in February, were 8.0 and 13.5 g.

Natural history notes

Approximately 20% of dissected anemones contained shells, both empty and with animals, of the small (10–20 mm) gastropod *Calliostoma foliatum*. Most con-

TABLE I

Sex and gonad indices (+/- standard deviations) of *Urticina lofotensis* by weight class

Anemone dry weight (g)	Number of individuals			Average gonad index	
	Female	Male	Sterile	Female	Male
<3.9	0	0	2	—	—
4–5.9	4	3	5	3.6+/-3.0	1.4+/-1.0
6–7.9	5	6	8	4.4+/-2.1	3.5+/-3.0
8–9.9	14	5	1	5.5+/-4.4	6.9+/-5.3
10–11.9	13	13	0	7.7+/-4.9	5.7+/-5.1
12–13.9	9	3	1	5.5+/-3.2	7.3+/-2.8
14–15.9	6	2	0	9.7+/-2.5	8.8+/-1.2
16–17.9	3	0	0	11.4+/-3.4	—
18–19.9	0	2	0	—	13.2+/-13.4
	54	34	17		

Anemone dry weight includes body and gonad.

tained one shell, but a few had up to four. Other ingested objects included unidentified gastropod shells, crustacean body parts, bryozoans, pieces of algae, one 15 mm specimen of *Corynactis californica*, a 30 mm feather, a ctenophore 80 mm long, a 35 mm bat star (*Patiria miniata*), and a 100 × 50 mm flat abalone shell (*Haliotis wallalensis*) that was lodged across the actinopharynx of an anemone with basal diameter 60 mm.

Despite thorough searches of algal holdfasts, cracks, and caves with a diving light during many dives in the study area and elsewhere in Carmel Bay, no anemones less than 30 mm basal diameter were found. It is possible that very small animals were overlooked because of low numbers, being covered with debris (large animals often have material attached to their verrucae), or being hidden under algae.

DISCUSSION

Sexuality and morphology

Distribution of gametogenic mesenteries in *Urticina lofotensis* is characteristic of the genus, the first ten pairs, including the directives, being sterile (Hand, 1955). All other mesenteries may be, but are not necessarily, gametogenic. The maximum of 77 pairs correlates well with Hand's (1955) data, but Sebens and Laakso (1978) reported considerably more. The regular arrangement of mesenteries implies that asexual reproduction does not occur in this species. [J. Brumbaugh (pers. comm., 1982) observed an anemone of this species divide longitudinally in an aquarium at Sonoma State University.]

Space for gonads should increase in larger anemones, and more mesenteries should enhance fecundity. However, there was little correlation between amount of gonadal tissue and number of fertile mesenteries in an animal. In fact, large actinians with moderate numbers of mesenteries produced the greatest quantity of gonad. Several anemones lacking visible gonads had more mesenteries than some very fertile ones (a sterile 3 g individual had 54 pairs, as many or more than many fertile animals weighing up to 9 g). Anemones add mesenteries as they grow, typically to a species-specific maximum. They grow only if fed, though, and may shrink if starved (Chia and Spaulding, 1972), so size, mesentery number, and age are not necessarily interrelated. Sebens (1981) found gonad as a percentage of body volume to increase with gonad number which, in turn, increases with body size in *Anthopleura xanthogrammica* and *A. elegantissima*, the rise being more rapid in smaller than larger anemones. GI of the sea urchin *Strongylocentrotus purpuratus* increases with test diameter in small animals but not in large ones, despite internal space expanding isometrically with size. Metabolic factors seem to be responsible for this (Gonor, 1972).

Laboratory raised *Urticina crassicornis* 40 mm in diameter are 18 months old (Chia and Spaulding, 1972). Assuming a roughly comparable growth rate for *U. lofotensis* in the field, the smallest anemones observed during this study are at least a year old, and the smallest fertile ones at least a year and a half old.

Associated with an oocyte undergoing vitellogenesis is a trophonema. Recent experimental evidence (Larkman and Carter, 1982) substantiated speculation (Nyholm, 1943; Loseva, 1971; Dunn, 1975) that this tube functions in nutrient transfer from the gastrovascular cavity to the developing egg. It may also act as a channel for egg release (Carter, pers. comm.). Trophonemata have been found, although not always identified as such, in a cerianthid and many sea anemones belonging to several families, but seem to be absent in other actinians (e.g., Nyholm, 1943; Loseva,

1971; Dunn, 1975, 1982; Riemann-Zürneck, 1976; Jennison, 1979, 1981; Larkman and Carter, 1982).

At the mesentery edge, some sperm packets have a plug-like structure (Fig. 3c) that may be homologous with a trophonema. On the other hand, the convoluted gametogenic mesentery of males has a large surface area that may facilitate nutrient transfer from the gastrovascular cavity through the thin layers of endoderm and mesoglea surrounding the gametes. Gamete release is probably facilitated for both sexes by proximity to the mesentery edge.

Sex ratio of *Urticina lofotensis* is significantly different from 1:1 (chi square = 4.54; $0.025 < P < 0.05$). Although it is remotely possible that sampling error is responsible, or that most of the 17 sterile individuals were male, the preponderance of females is probably real. Such an excess is known in a variety of temperate and tropical actinians (Dunn, 1982).

Oogenesis

Oogonia originate in the endoderm of anthozoan mesenteries. Dunn (1975) and Jennison (1979) reported that after migrating into the mesentery's central mesogleal layer, secondary oogonia cease mitosis and become oocytes. However, Loseva (1971) failed to locate oogonia in *Urticina crassicornis*, and the smallest female germ cells that Larkman (1981) identified in *Actinia fragacea* endoderm were oocytes.

Eggs of *U. lofotensis* grow to 700–800 μm (preserved diameter) before being spawned. Dunn (1975) estimated that ova from *Epiactis prolifera* fixed in Bouin's solution were approximately 65% of their actual diameter. Thus, oocytes of *U. lofotensis* may actually exceed 1200 μm in diameter. Ova in other actinians range from 70 μm (*Gonactinia prolifera*; Gemmill, 1921) and 110 μm (*Bunodosoma cavernata*; Clark and Dewel, 1974), to 750–800 μm (*Stomphia didemon*; Siebert, 1973) and 1100 μm (*Bolocera tuediae*; Gemmill, 1921). Eggs of *U. coriacea* are reportedly 600 μm in diameter (Gemmill, 1921) and those of *U. crassicornis* up to 700 μm (Gemmill, 1921; Chia and Spaulding, 1972).

Germinal vesicles of *Urticina crassicornis*, *Epiactis prolifera*, and *Anthopleura elegantissima* are aligned on either side of the cell, as in *U. lofotensis* (Loseva, 1971; Dunn, 1975; Jennison, 1979). In *Actinia equina*, by contrast, those of all oocytes within each mesentery are arrayed on the same side (Chia and Rostron, 1970). The trophonema abuts an egg adjacent to its nucleus, suggesting that one may influence the position of the other. Germinal vesicles of *Peachia quinquecapitata*, which seems to lack trophonemata, are randomly oriented (Spaulding, 1974). Staining of cytoplasm in a large primary oocyte indicated protein synthesis and high concentrations of RNA around the germinal vesicle (Dybas, 1973). Presumably the subunits for these compounds reach the egg through the trophonema, as do other precursors (Larkman and Carter, 1982). Large oocytes contain evenly distributed eosinophilic yolk granules. The same is true of *U. crassicornis* (see Loseva, 1971).

In *Actinia equina*, oogenesis is synchronous within, but out of phase between mesenteries (Chia and Rostron, 1970), whereas *Urticina crassicornis*, *Peachia quinquecapitata*, and *Anthopleura elegantissima* resemble *U. lofotensis* in being asynchronous within mesenteries (Loseva, 1971; Spaulding, 1974; Jennison, 1979). As in *U. lofotensis*, male gametes of *Actinostola crassicornis* ripen synchronously within but not between individuals (Riemann-Zürneck, 1978). Gametes of both sexes in all developmental stages occur in the same mesentery of hermaphroditic individuals of *Epiactis prolifera* (see Dunn, 1975). Heterogeneity of gamete size is known in such other marine invertebrates as hydrozoans (Kessel, 1968) and echinoids (Holland, 1967; Gonor, 1973b). Spawned gonads of *A. elegantissima* contain residual oogonia and previtellogenic oocytes that Jennison (1979) suggested either are pre-

vented from maturing or comprise the first gametes of the next reproductive period. Such hypotheses probably apply as well to *U. lofotensis*.

Spines reportedly range from 10 to 25 μm long in other actinians (Chia and Spaulding, 1972; Spaulding, 1972, 1974; Siebert, 1973, 1974; Siebert and Spaulding, 1976; Jennison, 1979). Dunn (1975) suggested that surficial structures 1.5–4 μm long on oocytes of *Epiactis prolifera* may be fixation artifacts. Loseva (1971) thought that spines on *Urticina crassicornis* oocytes might function in nutrient absorption from the mesoglea, while Siebert (1973) proposed that spines prevent polyspermy.

Oocytes are apparently released with the intact germinal vesicle containing a single nucleolus, so final maturation divisions must occur during or after spawning, perhaps even after fertilization, which must be external. Eggs of *Urticina crassicornis* mature before being spawned (Chia and Spaulding, 1972).

Spermiogenesis

Development of spermatogonia, which also arise in mesenterial endoderm, is like that in other anthozoans (Chia and Rostron, 1970; Chia and Crawford, 1973; Clark and Dewel, 1974; Dunn, 1975; Jennison, 1979). Discrimination of later spermiogenic stages is facilitated by layering of the gametes. Spermatids and the first spermatozoa can hardly be identified individually. In an ultrastructural study of the sea anemone *Bunodosoma cavernata*, Dewel and Clark (1972) reported that spermatocytes already possess a flagellum, making it difficult to distinguish between the latter stages of spermiogenesis, a problem Jennison (1979) also had in a light microscopic study of *Anthopleura elegantissima*. The germinal portion of the mesentery is resorbed after spawning of *A. elegantissima*, destroying the primary germ cells that had occupied the mature follicle's periphery (Jennison, 1979). The same may happen in *Urticina lofotensis*.

The 1 μm sperm heads of fixed *Urticina lofotensis* are similar in size to those of many other actinians (e.g., Chia and Rostron, 1970; Dunn, 1975; Jennison, 1979, 1981), but smaller than some (Frank and Bleakney, 1976). Live spermatozoa of *U. crassicornis* have heads $1.5 \times 2.0 \mu\text{m}$ (Chia and Spaulding, 1972), while those of *Peachia quinquecapitata* are $5.5 \times 6.5 \mu\text{m}$ (Spaulding, 1972) and those of two species of *Anthopleura* are about $2 \times 2\text{--}3 \mu\text{m}$ (Siebert, 1974).

Gonad Cycles

Gonad indices have been used to assess reproductive cycles of many marine invertebrates (e.g., Pearse, 1970, 1978; Gonor, 1972, 1973a, b; Rutherford, 1973), but seldom sea anemones [Ford (1964) is an exception, and Sebens (1981) used a modified volumetric index]. Actinian gonadal tissue, not being concentrated in discrete organs, is not easily quantified. In addition, wet body weight is difficult to assess, which is why dry weights were used in this study. Histological observations acted as a check on GI (Giese and Pearse, 1974).

Data for *Urticina lofotensis* during 1976–1977 (Figs. 5–8) suggest an annual reproductive cycle with prolonged gamete release. Male and female gonad indices reached minimum values in May, when gametes of both sexes were immature and water temperature was at its minimum. Male GI attained its maximum in December; males were ripest December–February. Female GI had a high value in June and a slightly lower one in November; the highest proportion of ripe eggs was July–October.

Mesenteries of spawned-out female *Anthopleura elegantissima* were extensively ruptured (Jennison, 1979). This was never apparent in *Urticina lofotensis*. Large eggs of *A. elegantissima* disappeared after spawning, and several months later a new

cohort began to grow (Ford, 1964). Most female *U. lofotensis* studied contained histologically normal oocytes 600 μm or more in diameter throughout the year. These data explain the lower amplitude of female than male GI, and suggest that *U. lofotensis* may release ova intermittently rather than massively. This is supported by loose eggs in the enterons of many females. For example, such cells occurred in three of five females collected during October; four of them contained proportionately fewer large oocytes than any female taken the previous month. In contrast to prior months, no loose eggs were found in females during May, when large oocyte quantity was at a minimum.

The drop in male GI between December and January, just as water temperature began to fall from its annual high, suggests a massive spawning, with continued slower release until March, at the latest. A simultaneous decline in large oocytes supports this as the main spawning period. Ripe spermatozoa during winter may have been left after the major spawn. Residual sperm packets in *Anthopleura elegantissima* can be maintained up to four months after spawning, but eventually are resorbed (Jennison, 1979; Sebens, 1981). The actinian *Halcapa duodecimcirrata* contains motile sperm both before and after female spawning (Nyholm, 1949). On the other hand, except for April and May, some males always contained stage 2 and riper sperm. Some sperm of *Urticina crassicornis* are released immature, with excess cytoplasm around the head; their fertilization capability is unknown (Chia and Spaulding, 1972). If further research determined that 1) this occurs in *U. lofotensis*, and 2) the sperm can mature following release, a strategy for fertilization of the eggs that seem to be continually dribbled out would be provided.

High GI did not always coincide with gamete ripeness. The abrupt increase in indices during June may have been due to abundant food. The largest number of *Calliostoma foliatum* shells were recovered from anemones collected then, when three out of six females had loose oocytes in their coelenterons. For males, with only immature sperm follicles, the increase was in gonad quantity but not maturity. Sebens (1981) offered the same explanation for briefly increased volume of immature gonads in *Anthopleura elegantissima*.

Low GI may indicate recent spawning, but handling might induce premature gamete release, and individuals just developing gonads would presumably have a low GI. [Animals lacking gonads were assumed to have either recently spawned (several loose oocytes were found in two of them) or been sexually immature.] Perhaps an anemone attains sexual maturity at a particular size, gradually coming into phase with the rest of the population, as Gonor (1972) found in *Strongylocentrotus purpuratus*. Were this true, small samples containing animals of all sizes would emphasize asynchrony of reproductive cycles. However, gonad indices varied even among anemones of similar sizes collected at the same time. Sterile animals were taken throughout the year.

Speculations on larval development and settlement patterns

Based on published reports and his own findings, Spaulding (1974) ventured that internal brooding is facultative in *Urticina crassicornis*. Stephenson (1928) noted that rather large, unwieldy planulae rich in yolk, such as those of *U. lofotensis* in Europe, are rare except in viviparous forms. Whether he meant to imply that *U. lofotensis* broods is unclear; no reference has been made to this habit by others. There is no evidence that it does so in Carmel Bay.

In the study area, specimens of *Urticina lofotensis* occur more densely in shallow, horizontal depressions of large boulders than on open substrata. Perhaps larvae or adults are carried there by gravity or in eddies. If so, chances of survival should be enhanced because food would be similarly concentrated and the depressions would

provide protection from surge and scour. Alternatively, larval or adult anemones might actively seek depressions [adults can creep on their pedal discs as can many other anemones (Stephenson, 1928; Dunn, 1977)] for the shelter and abundant food they provide.

ACKNOWLEDGMENTS

This paper is adapted from a thesis submitted to San Francisco State University by S.E.W. in partial fulfillment of the requirements for the M.A. degree. S.E.W. thanks Dr. Albert Towle for help during both research and writing phases of this project, and Dr. Thomas Niesen for helpful editorial comments.

Collections for this study were frequently made under adverse conditions, and would have been impossible except for the diving assistance of David Klise and Ben Tetzner, both of whom must often have wondered what they had let themselves in for. S.E.W.'s wife, Becky, was a valuable field assistant on many collections, often made under less than ideal conditions, and was very understanding and supportive during this research.

LITERATURE CITED

- CHIA, F.-S., AND B. CRAWFORD. 1973. Some observations on gametogenesis, larval development and substratum selection of the sea pen *Ptilosarcus guernevi*. *Mar. Biol.* **23**(1): 73-82.
- CHIA, F.-S., AND M. A. ROSTRON. 1970. Some aspects of the reproductive biology of *Actinia equina* [Cnidaria: Anthozoa]. *J. Mar. Biol. Assoc. U. K.* **50**: 253-264.
- CHIA, F.-S., AND J. G. SPAULDING. 1972. Development and juvenile growth of the sea anemone, *Tealia crassicornis*. *Biol. Bull.* **142**: 206-218.
- CLARK, W. H., JR., AND W. C. DEWEL. 1974. The structure of the gonads, gametogenesis, and sperm-egg interactions in the Anthozoa. *Am. Zool.* **14**(2): 495-510.
- DANIELSSEN, D. C. 1890. Actinida. *Norw. North-Atl. Exp. 1876-1878* **19**: 1-184.
- DEWEL, W. C., AND W. H. CLARK, JR. 1972. An ultrastructural investigation of spermiogenesis and the mature sperm in the anthozoan *Bunodosoma cavernata* (Cnidaria). *J. Ultrastr. Res.* **40**(3/4): 417-431.
- DUNN, D. F. 1975. Reproduction of the externally brooding sea anemone *Epiactis prolifera* Verrill, 1869. *Biol. Bull.* **148**(2): 199-218.
- DUNN, D. F. 1982. Sexual reproduction of two intertidal sea anemones (Coelenterata: Actiniaria) in Malaysia. *Biotropica* **14**(4): 262-271.
- DYBAS, L. C. 1973. A histochemical and ultrastructural study of the coelomic cells of *Phascolosoma agassizii* Keferstein, with particular reference to correlating structure and function. *M. A. thesis, San Francisco State University*. 175 pp.
- FORD, C. E., JR. 1964. Reproduction in the aggregating sea anemone, *Anthopleura elegantissima*. *Pac. Sci.* **18**: 138-145.
- FRANK, P., AND J. S. BLEAKNEY. 1976. Histology and sexual reproduction of the anemone *Nematostella vectensis* Stephenson 1935. *J. Nat. Hist.* **10**: 441-449.
- GEMMILL, J. F. 1921. The development of the sea anemone *Bolocera tuediae* (Johnst.). *Q. J. Microsc. Sci.* **65**: 577-587.
- GIESE, A. C., AND J. S. PEARSE. 1974. Introduction: general principles. Pp. 1-49 in *Reproduction of Marine Invertebrates*, A. C. Giese and J. S. Pearse, eds. Academic Press, New York and London.
- GONOR, J. J. 1972. Gonad growth in the sea urchin, *Strongylocentrotus purpuratus* (Stimpson) (Echinodermata: Echinoidea) and the assumptions of gonad index methods. *J. Exp. Mar. Biol. Ecol.* **10**: 89-103.
- GONOR, J. J. 1973a. Reproductive cycles in Oregon populations of the echinoid, *Strongylocentrotus purpuratus* (Stimpson). I. Annual gonad growth and ovarian gametogenic cycles. *J. Exp. Mar. Biol. Ecol.* **12**(1): 45-64.
- GONOR, J. J. 1973b. Reproductive cycles in Oregon populations of the echinoid, *Strongylocentrotus purpuratus* (Stimpson). II. Seasonal changes in oocyte growth and in abundance of gametogenic stages in the ovary. *J. Exp. Mar. Biol. Ecol.* **12**(1): 65-78.
- GOSSE, P. H. 1860. *Actinologia Britannica: A History of the British Sea-anemones and Corals*. Van Voorst, London. 362 pp.
- HAND, C. 1955. The sea anemones of central California. Part II. The endomyarian and mesomyarian anemones. *Wasmann J. Biol.* **13**(1): 37-99.

- HOLLAND, N. D. 1967. Gametogenesis during the annual reproductive cycle in a cidaroid sea urchin (*Stylocidaris affinis*). *Biol. Bull.* **133**: 578-590.
- HUMASON, G. L. 1962. *Animal Tissue Techniques*. W. H. Freeman and Co., San Francisco and London. 468 pp.
- JENNISON, B. L. 1978. Effects of thermal effluents on reproduction in a sea anemone. Pp. 470-483 in *Energy and Environmental Stress in Aquatic Systems*, J. H. Thorp and J. W. Gibbons, eds. U. S. Dept. Energy Conf. 771114.
- JENNISON, B. L. 1979. Gametogenesis and reproductive cycles in the sea anemone *Anthopleura elegantissima* (Brandt, 1835). *Can. J. Zool.* **57**(2): 403-411.
- JENNISON, B. L. 1981. Reproduction in three species of sea anemones from Key West, Florida. *Can. J. Zool.* **59**(9): 1708-1719.
- KESSEL, R. G. 1968. Electron microscope studies on developing oocytes of a coelenterate medusa with special reference to vitellogenesis. *J. Morphol.* **126**(2): 211-248.
- LARKMAN, A. U. 1981. An ultrastructural investigation of the early stages of oocyte differentiation in *Actinia fragacea* (Cnidaria; Anthozoa). *Int. J. Invert. Repro.* **4**: 147-167.
- LARKMAN, A. U., AND M. A. CARTER. 1982. Preliminary ultrastructural and autoradiographic evidence that the trophonema of the sea anemone *Actinia fragacea* has a nutritive function. *Int. J. Invert. Repro.* **4**: 375-379.
- LOSEVA, L. M. 1971. Observations on oogenesis of actinians. II. Oogenesis in *Tealia crassicornis* (Muell.), *Metridium senile* (L.) and *Protanthea simplex* (Carlg.). [in Russian] *Vestn. Leningr. Univ. Biol.* **9**: 22-29.
- MANUAL, R. L. 1981. *British Anthozoa*. Synopses of the British Fauna No. 18. Academic Press, London. 241 pp.
- NYHOLM, K.-G. 1943. Zur Entwicklung und Entwicklungsbiologie der Ceriantharien und Aktinien. *Zool. Bidr. Uppsala* **22**: 87-248.
- NYHOLM, K.-G. 1949. On the development and dispersal of athenaria actinia with special reference to *Halcampa duodecimcirrata*, M. Sars. *Zool. Bidr. Uppsala* **27**: 465-506.
- OSTARELLO, G. L. 1973. Natural history of the hydrocoral *Allopora californica* Verrill (1866). *Biol. Bull.* **145**: 548-564.
- PEARSE, J. S. 1970. Reproductive periodicities of Indo-Pacific invertebrates in the Gulf of Suez. III. The echinoid *Diadema setosum* (Leske). *Bull. Mar. Sci.* **20**(3): 697-720.
- PEARSE, J. S. 1978. Reproductive periodicities of Indo-Pacific invertebrates in the Gulf of Suez. IV. The chitons *Acanthopleura haddoni* Winckworth and *Onithochiton lyelli* (Sowerby), and the abalone *Haliotis pustulata* Reeve. *Bull. Mar. Sci.* **28**(1): 92-101.
- RIEMANN-ZÜRNECK, K. 1976. Reproductive biology, oogenesis and early development in the brood-caring sea anemone *Actinostola spetsbergensis* (Anthozoa: Actiniaria). *Helgol. Wiss. Meeresunters.* **28**: 239-249.
- RIEMANN-ZÜRNECK, K. 1978. Actinaria des Südwestatlantik IV. *Actinostola crassicornis* (Hertwig, 1882) mit einer Diskussion verwandter Arten. *Veröff. Inst. Meeresforsch. Bremerhaven* **17**: 65-85.
- RINKEVICH, B. AND Y. LOYA. 1979. The reproduction of the Red Sea coral *Stylophora pistillata*. I. Gonads and planulae. *Mar. Ecol. Prog. Ser.* **1**: 133-144.
- RUTHERFORD, J. C. 1973. Reproduction, growth and mortality of the holothurian *Cucumaria pseudo-curata*. *Mar. Biol.* **22**: 167-176.
- SEBENS, K. P. 1981. Reproductive ecology of the intertidal sea anemones *Anthopleura xanthogrammica* (Brandt) and *A. elegantissima* (Brandt): body size, habitat, and sexual reproduction. *J. Exp. Mar. Biol. Ecol.* **54**(3): 225-250.
- SEBENS, K. P., AND G. LAAKSO. 1978. The genus *Tealia* (Anthozoa: Actiniaria) in the waters of the San Juan Archipelago and the Olympic Peninsula. *Wasmann J. Biol.* (for 1977) **35**(2): 152-168.
- SIEBERT, A. E., JR. 1973. A description of the sea anemone *Stomphia didemon* sp. nov. and its development. *Pac. Sci.* **27**(4): 363-376.
- SIEBERT, A. E., JR. 1974. A description of the embryology, larval development, and feeding of the sea anemones *Anthopleura elegantissima* and *A. xanthogrammica*. *Can. J. Zool.* **52**(11): 1383-1388.
- SIEBERT, A. E., AND J. G. SPAULDING. 1976. The taxonomy, development and brooding behavior of the anemones, *Cribrinopsis fernaldi* sp. nov. *Biol. Bull.* **150**: 128-138.
- SPAULDING, J. G. 1971. The development and brooding behavior of the anemone *Cribrinopsis williamsi* Carlgren. (Abstr.) *Am. Zool.* **11**(4): 701.
- SPAULDING, J. G. 1972. The life cycle of *Peachia quinquecapitata*, an anemone parasitic on medusae during its larval development. *Biol. Bull.* **143**(2): 440-453.
- SPAULDING, J. G. 1974. Embryonic and larval development in sea anemones (Anthozoa: Actiniaria). *Am. Zool.* **14**(2): 511-520.
- STEPHENSON, T. A. 1928. *The British Sea Anemones*, Vol. I. Ray Society, London. 148 pp.
- STEPHENSON, T. A. 1935. *The British Sea Anemones*, Vol. II. Ray Society, London. 426 pp.

ECHINODERM IMMUNOLOGY: BACTERIAL CLEARANCE BY THE SEA URCHIN *STRONGYLOCENTROTUS PURPURATUS*

MARY A. YUI AND CHRISTOPHER J. BAYNE

Department of Zoology, Oregon State University, Corvallis, Oregon 97331

ABSTRACT

Characteristics of bacterial clearance were investigated in the purple sea urchin, *Strongylocentrotus purpuratus* (Echinodermata: Echinoidea). Primary clearance kinetics were determined for three bacteria, a marine Gram negative motile rod, a marine Gram positive non-motile rod, and a Gram negative freshwater fish pathogen, *Aeromonas salmonicida*. Clearance kinetics differed for each of the three bacteria. Secondary clearance rates were not significantly different from primary clearance rates for any of the three bacteria, regardless of the time interval between inoculations (9-21 days), implying a probable absence of immunologic memory. During primary clearance, total coelomocyte counts declined 93% by 90 min post injection. All four coelomocyte types declined, however the relative proportions of each type changed during the six-hour sampling period. In cell-free coelomic fluid, viable counts of marine bacteria declined, with different kinetics for the two species. Viable counts in sea water controls did not change. Declines in viable counts may be due to bactericidal activity and/or agglutination, although bacterial agglutination was not observed.

INTRODUCTION

Despite recent advances (reviewed by Cooper, 1976; Manning and Turner, 1976; Marchalonis, 1977; Hildemann *et al.*, 1981), the phylogeny of immunity remains obscure. In particular, the mechanisms of invertebrate immunity are diverse, and many are poorly understood. The phylogenetic position of echinoderms makes them pivotal to the understanding of the phylogeny of immunity and the evolution of vertebrate immunity.

Allogeneic transplantation studies have shown that memory and specificity, two important characteristics of vertebrate immune responses, are possessed by echinoderms (Karp and Hildemann, 1976; Coffaro and Hinegardner, 1977; Coffaro, 1980), as well as by members of other invertebrate phyla (sponges, Hildemann *et al.*, 1979; cnidarians, Hildemann *et al.*, 1977; annelids, Cooper, 1970). Any role of memory and specificity in invertebrate internal defenses to potentially infectious agents has yet to be identified.

In this study, we sought to determine whether the echinoderm, *Strongylocentrotus purpuratus*, exhibits memory or altered reactivity on secondary contact with biologically relevant antigens, namely bacteria. Additionally, because the coelomic fluid of healthy echinoderms is generally aseptic (Bang and Lemma, 1962; Unkles, 1977; Kaneshiro and Karp, 1980), and few studies have been made on the characteristics and mechanisms of bacterial clearance in echinoderms (Johnson, 1969a, b; Johnson *et al.*, 1970; Johnson and Chapman, 1971; Wardlaw and Unkles, 1978),

we also studied some of the *in vivo* and *in vitro* primary interactions between echinoderm coelomocytes and cell-free coelomic fluid and bacteria.

MATERIALS AND METHODS

Collection and maintenance of animals

Strongylocentrotus purpuratus (80–150 g) were hand collected from intertidal surge channels at Yaquina Head, Newport, Oregon where the species is abundant. Care was taken to avoid damaging the urchins during collection and transportation to the 22,700 liter recirculating sea water system at Oregon State University in Corvallis, 70 km away. Water temperatures were 12–15°C, comparable to coastal temperatures. Urchins were fed macroalgae *ad libitum*.

Isolation and culture of bacteria

One Gram negative motile rod and one Gram positive non-motile rod were isolated from the coelomic fluid (CF) of moribund sea urchins. Selection was based on growth characteristics (rate of growth, colony color and morphology). All bacteria were grown in marine broth 2216E (Difco Laboratories), enriched with peptone (5 g l⁻¹) and yeast extract (3 g l⁻¹). Nutrient agar (1%) in marine broth was used for pour plate viable counts. For each experiment, bacteria were inoculated into fresh, enriched broth in triple baffle, side-arm flasks and grown at room temperature (20–23°C) on a rotary table (100 rpm). The bacteria were harvested during log phase, centrifuged for 10 min at 300 g, and resuspended in cold (10°C) sterile sea water to appropriate concentrations. Bacterial suspensions used for injections were serially diluted and plated to determine actual inoculation doses.

Because the urchins may previously have encountered the marine bacteria, a freshwater bacterium, *Aeromonas salmonicida*, was also used for some experiments. *A. salmonicida* is a salmonid fish pathogen, a Gram negative non-motile rod generally not present in the marine environment (although it has rarely been found in marine fish, Evelyn, 1971). These bacteria were grown in tryptic soy broth using methods already described.

Coelomic fluid volume estimates

Estimation of CF volumes was required for determining the quantity of bacteria to be injected for a specific concentration in the perivisceral coelom. The weight, test diameter, test height, and peristomium diameter were measured for 28 urchins. The CF was then drained through a cut in the peristomium and the volume measured. Each external parameter was regressed on the CF volume. Weight was found to be the best indicator of CF volume ($R^2 = 0.96$). The following equation defined the relationship and was used in all experiments:

$$\text{Coelomic fluid volume (ml)} = 0.35 \times \text{weight (g)} - 4.2.$$

Clearance experiments

Urchins were weighed, CF volumes estimated, and the dose of bacteria calculated for a given final concentration of bacteria in the CF. During experiments, urchins were kept in 20 liter plastic aquaria filled with aerated sea water at 10°C.

Before injections and sampling, the peristomium was washed several times with cold sterile sea water. Care was taken to avoid tearing tube feet during handling. The bacterial suspension (0.4–0.6 ml) was injected through the peristomial mem-

brane with a 26 gauge, 0.5-inch needle and 1 ml tuberculin syringe. Preliminary experiments showed that 40–90 min were required for even dispersal of bacteria. Because we wanted to sample within that time, half of the inoculum was injected, with the other half injected 180° from the initial injection site. Coelomic fluid samples (0.2–0.3 ml) were removed with a sterile 26 g, 0.5-inch needle and 1 ml syringe. Samples taken before the injection of bacteria were directly plated for sterility checks. Samples taken after injection of bacteria were serially diluted in sterile sea water and plated by pour plate methods for viable counts. Distinctive colony morphologies, colors, and growth rates were used to help ascertain that these bacteria were those previously injected.

Total and differential coelomocyte cell counts

At various times after urchins were injected with the marine Gram negative bacteria, or with an equal volume of sterile sea water, CF was removed with a 20 g, 1.5-inch needle into an equal volume of cold anticoagulant (30 mM EDTA in 0.3 M Hepes buffered sea water, after Bertheussen and Seljelid, 1978). Two differential counts were made and averaged using a Brightline hemacytometer. The four major coelomocyte types found in *Strongylocentrotus* spp. (Johnson, 1969a; Bertheussen and Seljelid, 1978), phagocytes (leukocytes), vibratile cells, and red and colorless spherule (morula) cells, were counted. Total counts were determined by adding the counts for the four cell types.

Humoral factors: In vitro effects of cell-free coelomic fluid on viable counts of bacteria

Coelomic fluid was removed with a 20 g, 1.5-inch needle or drained out through a cut in the peristomium into a sterile, cold beaker. The CF was immediately filtered by gentle passage through two Millipore prefilters then sterilized using a 0.22 μm Millipore filter. Since clotting of CF (30 min, 10°C) before filtration does not seem to affect its bactericidal activity (Wardlaw and Unkles, 1978; Yui, 1982), we routinely filtered before clot formation.

Two ml of cell-free CF were placed in sterile glass vials. Sterile-filtered artificial sea water (Instant Ocean) or Hepes sea water medium (Bertheussen and Seljelid, 1978) was used as control fluid. Twenty μl aliquots of the bacterial suspension were added to each vial, which was then held at 10°C. Samples (10 and 100 μl) were removed and plated by pour plate methods for viable counts.

Humoral factors: Bacterial agglutinins

The CF (5–10 ml) was collected through a cut in the peristomium, filtered, added to the first well of a microtiter plate and serially diluted by one-half with 10°C artificial sea water (Instant Ocean). The last well was a sea water-only control. An equal volume of bacterial suspension in sea water was added to each well, then the plates were covered and placed on a rotary table (60 rpm) at 10°C. After 30 min to 20 h plates were inspected for agglutination.

RESULTS

Primary clearance

Gram negative bacteria. Six urchins injected with 3.3×10^7 marine Gram negative bacteria ml^{-1} of CF rapidly reduced viable counts (v.c.) of bacteria in the CF

in the first hour post-injection (p.i.) by 95.7%, followed by a period of slower clearance (Fig. 1). Clearance continued after 6 h (Fig. 2), and bacteria were not detected 4–8 days p.i. To further characterize the initial 90 min of clearance, four or five samples were removed from each of nine urchins previously injected with 10^5 – 10^7 bacteria ml^{-1} of CF. Clearance was exponential. Lines were fitted to the log-transformed data using linear regression by calculating independent slopes for each urchin and obtaining a mean and standard error for those slopes. The slopes are equivalent to the “Phagocytic Index” or K value as defined by Biozzi *et al.* (1953) for particle clearance kinetics in mammals, and Renwrantz and Mohr (1978) for particle clearance in a land snail, *Helix*. For the first 90 min of clearance, a K value of $-0.0179 \pm 0.0016 \log_{10}$ bacteria min^{-1} was obtained for the Gram negative ($R^2 = 0.963$). The slope was not strongly dose dependent (Yui, 1982).

Because of individual differences, primary and secondary clearance rates were determined for the same individual urchins. Injection doses of 10^6 – 10^7 bacteria ml^{-1} of CF were selected for further experiments because, at those doses, bacteria were:

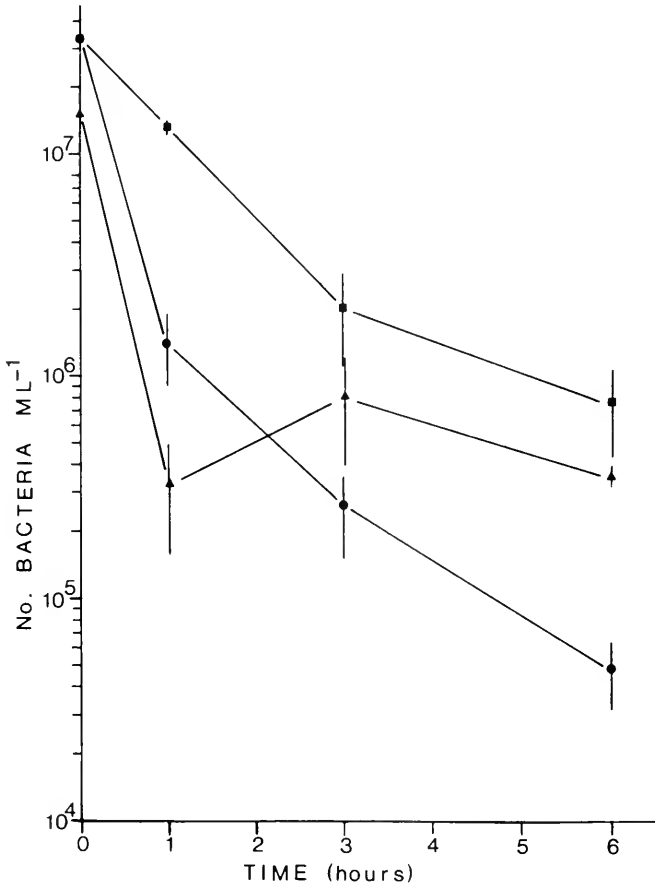

FIGURE 1. Primary clearance of the Gram negative and Gram positive marine bacteria, and *Aeromonas salmonicida*, sampled at 1, 3, and 6 hours post-injection (mean \pm standard error). ● Gram negative ($n = 6$), ▲ Gram positive ($n = 3$), ■ *Aeromonas salmonicida* ($n = 3$).

(a) cleared without mortality or obvious trauma, (b) detectable at high enough levels at 6 and 24 h p.i. that a decline upon secondary injection was still quantifiable even with small CF sample volumes, and (c) persistent in the CF for a period of 4–8 days. This persistence of viable bacteria in the CF was considered advantageous because sensitization and induction of memory may require a long period of exposure, as with graft rejection. Furthermore, the need for booster injections was precluded.

Gram positive bacteria. A rapid decline (97.7%) in v.c. also occurred within 1 h after injection of Gram positive bacteria (Fig. 1). However, unlike the results with the Gram negative bacteria, v.c. were slightly higher at 3 h with declines continuing to 6 and 24 h p.i. (Fig. 2). Bacteria were not detected 8–12 days p.i. The K value for the first 90 min was -0.0195 ± 0.0037 ($n = 3$), not significantly different from K for the Gram negative bacteria.

Aeromonas salmonicida. At 1 h p.i., v.c. dropped only 61.5%, a much lower initial rate of clearance than that of the marine bacteria (Fig. 1). Clearance continued at the same rate to 3 h and more slowly thereafter.

Primary versus secondary clearance

Because the first and second inoculation doses could not be made identical, the slopes of the lines were calculated from \log_{10} -transformed v.c. at time = 0 to 6 and

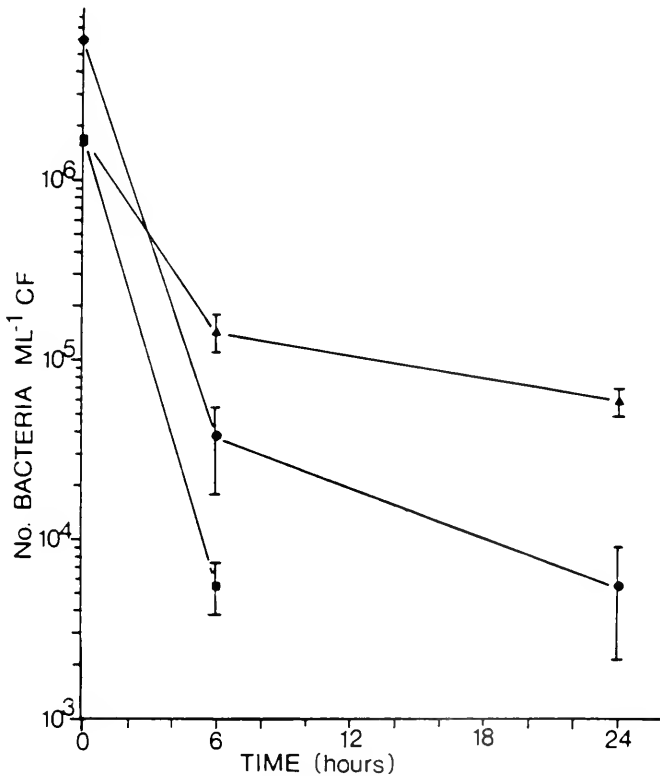

FIGURE 2. Primary clearance of the Gram negative and Gram positive marine bacteria, sampled at 6 and 24 hours post-injection, and *Aeromonas salmonicida*, sampled at 6 hours post-injection (mean \pm standard error). ● Gram negative ($n = 11$), ▲ Gram positive ($n = 12$), ■ *Aeromonas salmonicida* ($n = 6$).

24 h. The difference in slope between primary and secondary clearance for each urchin was then calculated and compared to zero (Table I).

Urchins injected with approximately 10^7 bacteria ml^{-1} of CF were challenged with a similar dose of the same bacteria 9, 14, and 21 days after the first injection of the two marine bacteria, and after 19 days with *Aeromonas salmonicida*. In no case was the mean difference in slope between primary and secondary clearance significantly different from zero. Even when data from the three injection times were pooled, the mean difference in slope was not significantly different from zero.

Total and differential counts of coelomocytes

The average number of coelomocytes ml^{-1} counted from uninjected urchins collected in August and September was $1.0 \pm 0.2 \times 10^7$ ($n = 6$). The majority of cells were phagocytes ($67.8 \pm 4.4\%$), followed by vibratiles ($16.8 \pm 3.8\%$), red spherules ($10.5 \pm 3.1\%$), and colorless spherules ($5.0 \pm 1.3\%$). These values are similar to those reported for *S. droebachiensis* (Bertheussen and Seljelid, 1978). In October and November, coelomocyte counts were lower, due predominantly to fewer phagocytes (Yui, 1982).

Sea water injected control urchins exhibited a sharp, brief decline in cell numbers during the first hour p.i., followed by rapid recovery to pre-injection values (Fig. 3). After injection of Gram negative bacteria, a sharp decline was seen during the first 1.5 h. Declines continued, more slowly, to about 5 h. The overall drop was from 8.8×10^6 to 6×10^5 coelomocytes ml^{-1} , a 93% decline.

After injection, all cell types declined (Fig. 3), with a change in the relative proportion of each cell type (Fig. 4). The percentages of phagocytes and red spherule

TABLE I

Mean difference in slope between clearance of primary (1°) and secondary (2°) injections of Gram negative and positive marine bacteria and *Aeromonas salmonicida**

$1^\circ-2^\circ$ Interval (days)	Sample time (hours)	Mean difference in slope (1° minus 2°) $\bar{x} \pm \text{SD}$ (n)**		
		Gram negative	Gram positive	<i>Aeromonas salmonicida</i>
9	6	0.083 ± 0.106 (4)	-0.027 ± 0.108 (4)	—
	24	0.006 ± 0.018 (4)	0.011 ± 0.011 (4)	—
14	6	0.038 ± 0.190 (4)	0.027 ± 0.078 (4)	—
	24	-0.030 ± 0.051 (3)	-0.008 ± 0.016 (4)	—
21	6	0.032 ± 0.182 (4)	-0.063 ± 0.061 (4)	—
	24	0.013 ± 0.024 (4)	-0.020 ± 0.025 (4)	—
19	6	—	—	0.067 ± 0.090 (4)

* Approximately 1×10^7 bacteria ml^{-1} of coelomic fluid were injected for each clearance rate determination.

** A negative value indicates a more rapid 2° rate of clearance, a positive value, a less rapid 2° rate of clearance. None of these values were significantly different from zero using a Student's *t*-test.

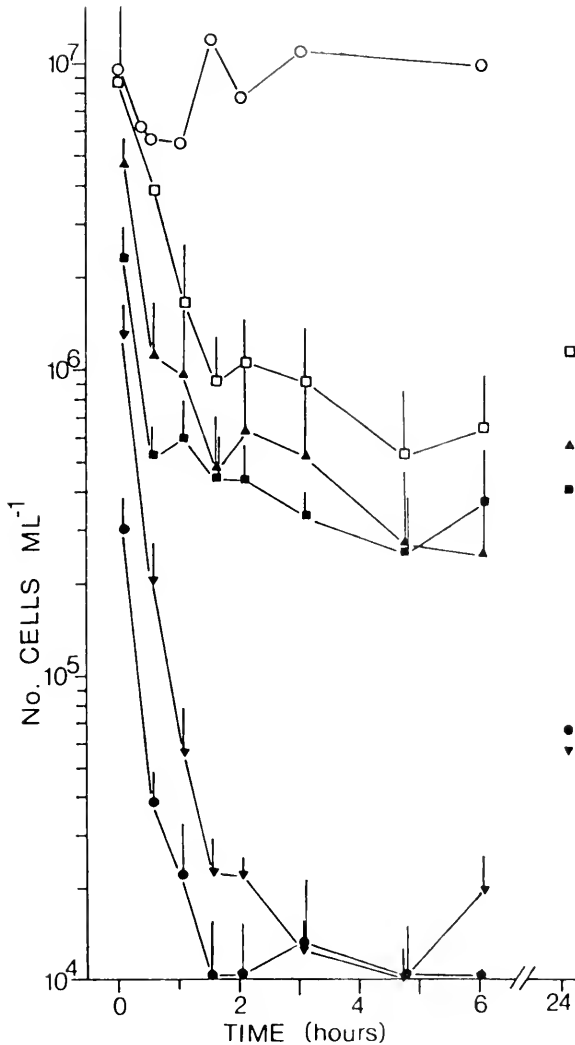

FIGURE 3. Total and differential coelomocyte counts (mean \pm standard error) after injection with 10^8 Gram negative bacteria ml^{-1} of coelomic fluid ($n = 3$). The 24-hour sample was from the only urchin sampled at that time. Also included are the total coelomocyte counts for the sea water-injected control ($n = 1$). Total coelomocyte counts: \circ sea water injected, \square bacteria injected; differential coelomocyte counts: \blacktriangle phagocytes, \blacksquare vibratiles, \blacktriangledown red spherules, \bullet colorless spherules.

cells declined while the percentage of vibratiles increased. The percentage of colorless spherule cells did not change appreciably, although the values were at very low levels throughout. In the one animal sampled at 24 h p.i., cell counts (Fig. 3) and relative proportions (Fig. 4) were approaching pre-injection values.

Humoral factors: In vitro effects of cell-free coelomic fluid on viable counts of bacteria

Gram negative bacteria. Coelomic fluids from six urchins, three injected 3 days earlier and three uninjected, were tested for their effects on viability of the marine

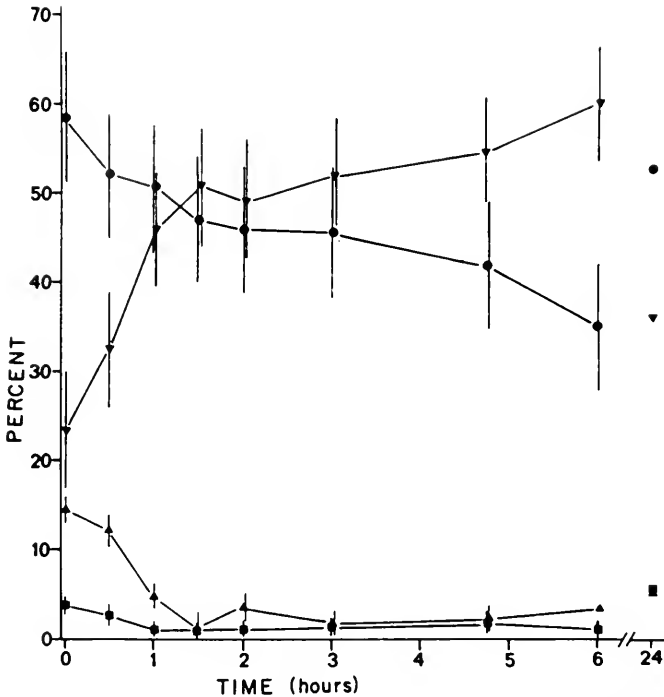

FIGURE 4. Relative proportions (mean % \pm standard error) of the four coelomocyte types after injection of 10^7 bacteria ml^{-1} of coelomic fluid ($n = 3$). The 24-hour sample was from only one of the three urchins. ● phagocytes, ▼ vibratiles, ▲ red spherules, ■ colorless spherules.

Gram negative bacteria. Sea water served as a control. No significant differences were noted between any of the three treatments at 15 and 45 min post-inoculation (one-sided Student's *t*-test) (Fig. 5). Although v.c. were lower in CF from preinjected than in uninjected urchins at 90 min or 5 h, the differences were not significant. V.c. were significantly lower in the CF from the six urchins than in sea water at 90 min ($P < 0.005$) and 5 h ($P < 0.01$).

Gram positive bacteria. The change in v.c. of Gram positive bacteria in CF differed from that of the Gram negative (Fig. 6). V.c. had declined 2.5 orders of magnitude below those of the initial inoculum and the sea water control at 2 h post-inoculation. Test fluids from each of five urchins exhibited this large decline in v.c. at 2 h while none of the three controls exhibited a similar response. This result cannot reflect bactericidal activity since counts returned to values not significantly different from sea water controls by 5 h. At 20 h, v.c. in CF were lower than those in sea water ($P = 0.05$). Viable counts in CF were quite variable relative to sea water controls. This variability probably reflects differences in amount(s) of humoral factor(s) present in the CF rather than differences due to sampling methods.

Bacterial agglutinins

Cell-free CF samples from eight urchins were mixed with the Gram negative bacteria and CF samples from four urchins were tested with the Gram positive bacteria, in suspensions ranging from 5×10^4 to 5×10^8 bacteria ml^{-1} . Samples

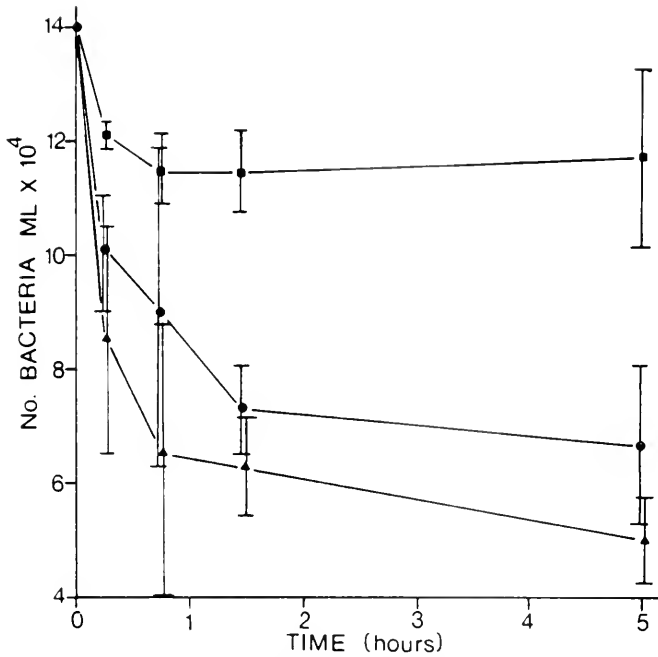

FIGURE 5. Viable counts (mean \pm standard error) for the Gram negative bacteria in sea water and cell-free coelomic fluid from injected and uninjected urchins. ■ sea water ($n = 3$), ● uninjected ($n = 3$), ▲ injected ($n = 3$).

were checked at various times from 30 min to 20 h. Neither of the two bacteria were agglutinated.

DISCUSSION

Primary clearance

Clearance from echinoderm coelomic fluid has been reported after the injection of bacteria (Wardlaw and Unkles, 1978; Kaneshiro and Karp, 1980; Bertheussen, 1981), bacteriophage T₄ (Coffaro, 1978), red blood cells, latex beads and yeast cells (Bertheussen, 1981), xenogeneic cells and carborundum (Reinisch and Bang, 1971), and bovine and human serum albumin (Hilgard and Phillips, 1968). However, the kinetics of particle clearance have not been followed, and the fates of these particles in echinoderms remain unknown.

Strongylocentrotus purpuratus efficiently cleared all three bacteria from its coelomic fluid. Viable counts were reduced 90–99% in 3–6 h after injection of doses of approximately 10^6 – 10^7 bacteria ml^{-1} of CF. Clearance occurred in at least two phases, with the rate of clearance of one of the bacteria different from that of the others during each phase. Clearance was approximately exponential for the first 1.5 h p.i. for the Gram negative bacteria. Both marine bacteria were cleared at similar rates over the first 1.5 h while the initial rate of clearance of *A. salmonicida* was slower than that of the marine bacteria.

The second phase of clearance was slower. However, by 6 h p.i., *A. salmonicida* had been cleared almost as well as the marine Gram negative bacteria despite the slower initial rate, suggesting a higher rate of clearance after 1 h compared to the

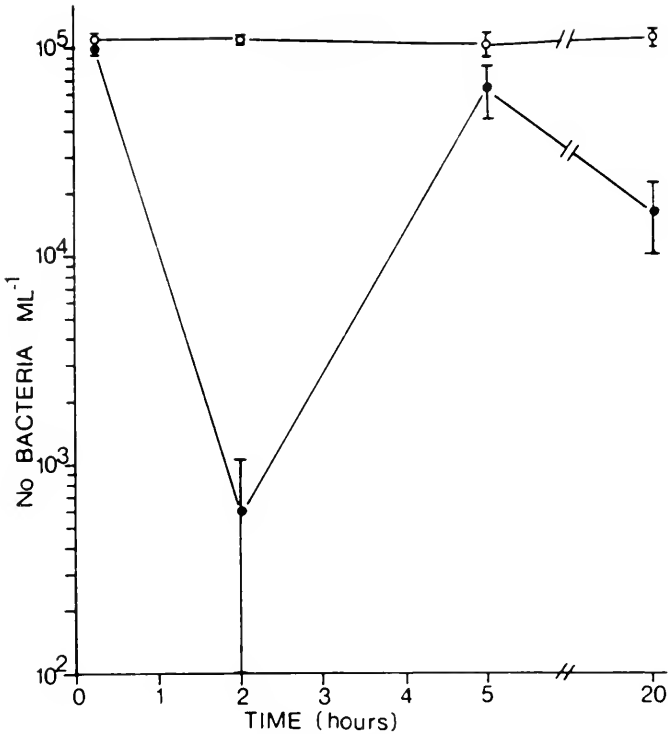

FIGURE 6. Viable counts for the Gram positive bacteria in sea water and cell-free coelomic fluid (mean \pm standard error). \circ sea water ($n = 3$), \bullet cell-free coelomic fluid ($n = 5$).

other bacteria. The marine Gram positive, on the other hand, had a significantly lower reduction in v.c. at 6 h p.i. compared with the marine Gram negative bacteria and *A. salmonicida*. At 24 h the overall percent reduction of Gram positive bacteria was still lower than that of the Gram negative.

The clearance we observed resembles the equivalent process in other invertebrates and in mammals. Generally, the first phase of clearance in mammals is rapid and exponential, with 90–99.9% reduction in circulating bacteria (Rogers, 1960). This phase is relatively independent of the nature of the microbe, the animal under study, and the subsequent outcome of injection. During the second phase the microbe either persists at lower concentrations or is slowly removed over several hours or days. This phase differs considerably with different bacteria.

Similarly, four mollusc species (Bayne and Kime, 1970; Pauley *et al.*, 1971; Bayne, 1973; van der Knaap *et al.*, 1981) and a crustacean (Smith and Ratcliffe, 1980) cleared 90–99% of injected bacteria (10^6 – 10^9 bacteria per animal) in the first 2–3 h p.i., with slower subsequent declines after 3 h. In some species Gram positive and Gram negative bacteria may be cleared equally well (Smith and Ratcliffe, 1980), while in others, Gram positives may be cleared more rapidly than Gram negatives (van der Knaap *et al.*, 1981). Gram negative and Gram positive bacteria may be recognized by different coelomocyte subpopulations in the marine annelid, *Arenicola marina* (Fitzgerald and Ratcliffe, 1982). In *Strongylocentrotus* spp., Johnson (1969b) noted more active phagocytosis of Gram positive than Gram negative bacteria, in

contrast with this study. This difference may be due to the different bacteria used or because phagocytosis alone does not determine the overall rate of bacterial clearance.

Total and differential cell counts indicated a 93% reduction in numbers of all four coelomocyte types accompanying primary clearance of Gram negative bacteria. Similar declines in circulating hemocyte numbers have also been observed in crustaceans (Cornick and Stewart, 1968; Smith and Ratcliffe, 1980), insects (Wittig, 1965; Gagen and Ratcliffe, 1976), molluscs (Bayne and Kime, 1970; Pauley *et al.*, 1971; van der Knapp *et al.*, 1981; Renwantz *et al.*, 1981), and in leukocyte numbers in mammals (Rogers, 1960).

Clotting, due to aggregation of phagocytes (Johnson, 1969a), no doubt contributes to some of the observed decline in numbers of cells and bacteria. Cellular clots were often observed in coelomic fluid samples which were taken after injection of bacteria. Bertheussen (1981) noted clot formation in *S. droebachiensis* only after injection of bacteria and not after injection of other particles (red blood cells, yeast, latex). Cellular aggregation and/or attachment to epithelia may enhance phagocytosis by providing a substrate for trapping bacteria. Vertebrate leukocytes trap and phagocytose encapsulated bacteria more easily when attached to substrates (Wood, 1960).

Cellular clotting may also explain the observation that red spherule cells declined proportionately with phagocytes while vibratile cells increased proportionately. Red spherules are relatively non-motile and they may therefore be passively caught with aggregating phagocytes as observed in hanging drops (Johnson, 1969a). Although the percentage of non-motile colorless spherules did not appear to change, actual cell counts were very low so changes were difficult to detect. Vibratiles, being highly motile, may extricate themselves from the clots or may be recruited more rapidly from elsewhere, causing the observed increase in relative abundance.

Cell-free coelomic fluid contains one or more humoral factor(s) active against both Gram negative and Gram positive bacteria. To the contrary, Wardlaw and Unkles (1978) found that coelomocytes were required for bactericidal activity. Because the quantity of humoral factor(s) would be limited and not renewable in a cell-free *in vitro* system, the number of bacteria per given volume of coelomic fluid would be critical in the detection of activity. In addition, observable activity may depend upon the species of bacteria used and the species of echinoderm from which test fluids are obtained.

Declines of 6 to 9×10^4 v.c. ml^{-1} of CF from 6 urchins were observed *in vitro* by 2 h after inoculation with Gram negative bacteria, enough to account for at least some of the decline observed *in vivo*. It is possible that the decrease in v.c. was due to agglutination rather than bacterial killing, although agglutination was not detected in this study. Prior injection with bacteria did not accelerate the decline.

Results obtained with Gram positive bacteria in cell-free CF are difficult to explain since agglutinins were not found. Large declines in v.c. were noted in the 2 h samples from the CF from all 5 urchins tested. These declines could not be explained by bacterial killing because v.c. returned to control levels by 5 h p.i. and these bacteria do not grow that quickly at 10°C . These results, however, do correspond with the lower v.c. noted at 1 h than at 3 h in *in vivo* clearance of the Gram positive. Although v.c. in cell-free CF *in vitro* were not significantly lower than in sea water at 5 h, v.c. at 20 h were considerably lower than the sea water controls and the initial inoculation dose.

Although bacterial agglutination was not observed, these experiments do not rule out the possibility that agglutinins function in clearance of bacteria. In fact, the

results of the bactericidal test using the Gram positive suggest that agglutination may occur temporarily at 2 h p.i. Relative proportions of bacteria to concentration of active molecules in the CF may have been inappropriate for the observation of agglutination.

Differences in the rates of clearance of the three bacteria may depend on (1) differences in specific or non-specific cellular recognition and response, (2) the quantity, rate of release and effectiveness of humoral bactericidal substances, agglutinins, and/or opsonins, and (3) the rate of bacterial reproduction. Based on our studies of *in vivo* and *in vitro* primary clearance, it appears that both cellular and humoral factors are involved in bacterial clearance. Clotting and the overall decline of coelomocytes paralleled bacterial clearance. Bacteria were observed in the cellular clots, and within phagocytes after injection (Yui, 1982). Different quantities of CF factor(s) or numbers of responding cells may cause the large individual variation observed between urchins.

The two stages of bacterial clearance in *S. purpuratus* are probably the result of a decline in active cells and/or molecules in the first few hours with further clearance being dependent on the level of cell recruitment or activation and/or release of active molecules.

Primary versus secondary clearance

Our failure to find accelerated secondary clearance of bacteria is consistent with the few other attempts to induce elevated responses in echinoderms to foreign materials, other than grafts. Coffaro (1978) was unable to elicit accelerated clearance of the bacteriophage T₄ in *Lytechinus pictus*. No increase in the rate of foreign protein uptake was detected in *S. purpuratus* after injection of four doses of protein at 18 h, 3 days, 7 days, and 2 months after primary injection (Hilgard and Phillips, 1968). *Asterias vulgaris* was inoculated with 5×10^5 *Arbacia* cells six times, with no change in the rate of cell disappearance (Reinisch and Bang, 1971).

Secondary responses to bacteria have been elevated in other phyla, including both deuterostomes (*e.g.*, vertebrates) and protostomes, in which molluscs (see Bayne *et al.*, 1980 for review; Bayne, 1980; van der Knapp, 1980), sipunculids (Evans *et al.*, 1969), crustaceans (Evans *et al.*, 1968; Acton *et al.*, 1969; McKay and Jenkin, 1969; Stewart and Zwicker, 1974) and insects (Boman *et al.*, 1972; Boman *et al.*, 1974) have yielded positive results. However, in the invertebrate examples, either enhancement has been non-specific or the extent of specificity has not been thoroughly tested, and mechanisms of enhancement are seldom known.

The lack of accelerated secondary clearance in this study can be explained in the following ways:

- (1) There is no memory component to bacterial clearance, although memory does appear to exist in responses to grafts and may exist in response to other infectious organisms.
- (2) Memory does exist but was undetected due to:
 - (a) previous exposure to the same or similar bacteria sharing certain surface characteristics or molecules critical for recognition and response, or
 - (b) lack of sensitivity in detection of memory or sub-optimal enhancement of secondary responses.

Despite such considerations, there is a need to conduct experiments to identify the conditions under which echinoderms will respond optimally to immunologic

challenge. Without such studies, the mechanisms of echinoderm internal defenses and the evolutionary history of immune responsiveness will remain elusive.

ACKNOWLEDGMENTS

We thank E. S. Loker and C. A. Boswell for suggestions on the manuscript, and J. A. Longmate for assistance collecting urchins. The research was supported by grants from the Oregon State University Zoology Department Research Fund.

LITERATURE CITED

- ACTON, R. T., P. F. WEINHEIMER, AND E. E. EVANS. 1969. A bactericidal system in the lobster *Homarus americanus*. *J. Invert. Pathol.* **13**: 463-464.
- BANG, F. B., AND A. LEMMA. 1962. Bacterial infection and reaction to injury in some echinoderms. *J. Insect Pathol.* **4**: 401-414.
- BAYNE, C. J. 1973. Internal defense mechanisms of *Octopus dofleini*. *Malacol. Rev.* **6**: 13-17.
- BAYNE, C. J. 1980. Molluscan immunity: Induction of elevated immunity in the land snail (*Helix*) by injections of bacteria (*Pseudomonas aeruginosa*). *Dev. Comp. Immunol.* **4**: 43-54.
- BAYNE, C. J., AND J. B. KIME. 1970. *In vivo* removal of bacteria from the hemolymph of the land snail *Helix pomatia* (Pulmonata: Stylommatophora). *Malacol. Rev.* **3**: 103-113.
- BAYNE, C. J., T. SMINIA, AND W. P. W. VAN DER KNAAP. 1980. Immunological memory: Status of molluscan studies. Pp. 57-64 in *Phylogeny of Immunological Memory*, M. J. Manning, ed. Elsevier/North Holland, Amsterdam.
- BERTHEUSSEN, K. 1981. Endocytosis by echinoid phagocytes *in vitro*. I. Recognition of foreign matter. *Dev. Comp. Immunol.* **5**: 241-250.
- BERTHEUSSEN, K., AND R. SELJELID. 1978. Echinoid phagocytes *in vitro*. *Exp. Cell Res.* **111**: 401-412.
- BIOZZI, G., B. BENACERRAF, AND B. N. HALPERN. 1953. Quantitative study of the reticuloendothelial system. II. A study of the kinetics of the granulopoietic activity of the RES in relation to the dose of carbon injected. *Br. J. Exp. Pathol.* **34**: 441-457.
- BOMAN, H. G., I. NILSSON, AND B. RASMUSON. 1972. Inducible antibacterial defence system in *Drosophila*. *Nature* **237**: 232-235.
- BOMAN, H. G., I. NILSSON-FAYE, K. PAUL, AND T. RASMUSON. 1974. Insect immunity I. Characteristics of an inducible cell-free antibacterial reaction in hemolymph of *Samia cynthia* pupae. *Infect. Immunol.* **10**: 136-145.
- COFFARO, K. 1978. Clearance of bacteriophage T₄ in the sea urchin *Lytechinus pictus*. *J. Invert. Pathol.* **32**: 384-385.
- COFFARO, K. A. 1980. Memory and specificity in the sea urchin, *Lytechinus pictus*. Pp. 77-80 in *Phylogeny of Immunological Memory*, M. J. Manning, ed. Elsevier/North Holland, Amsterdam.
- COFFARO, K. A., AND R. T. HINEGARDNER. 1977. Immune response in the sea urchin *Lytechinus pictus*. *Science* **197**: 1389-1390.
- COOPER, E. L. 1970. Transplantation immunity in helminths and annelids. *Transplant. Proc.* **2**: 216-221.
- COOPER, E. L. 1976. *Comparative Immunology*. Prentice Hall, Inc. 338 pp.
- CORNICK, J. W., AND J. E. STEWART. 1968. Interaction of the pathogen *Gaffkya homari* with natural defense mechanisms of *Homarus americanus*. *J. Fish. Res. Board Can.* **25**: 695-709.
- EVANS, E. E., B. PAINTER, M. L. EVANS, P. WEINHEIMER, AND R. T. ACTON. 1968. An induced bactericidin in the spiny lobster, *Panulirus argus*. *Proc. Soc. Exp. Biol. Med.* **128**: 394-398.
- EVANS, E. E., P. F. WEINHEIMER, R. T. ACTON, AND J. E. CUSHING. 1969. Induced bactericidal response in a sipunculid worm. *Nature* **223**: 695.
- EVELYN, T. P. T. 1971. An aberrant strain of the bacterial fish pathogen *Aeromonas salmonicida* isolated from a marine host, the sablefish (*Anoplopoma fimbria*), and from two species of cultured Pacific salmon. *J. Fish. Res. Board Can.* **28**: 1629-1634.
- FITZGERALD, S. W., AND N. A. RATCLIFFE. 1982. Evidence for the presence of subpopulations of *Arenicola marina* coelomocytes identified by their selective response toward Gram + ve and Gram - ve bacteria. *Dev. Comp. Immunol.* **6**: 23-34.
- GAGEN, S. J., AND N. A. RATCLIFFE. 1976. Studies on the *in vivo* cellular reactions and fate of injected bacteria in *Galleria mellonella* and *Pieris brassicae* larvae. *J. Invert. Pathol.* **28**: 17-24.
- HILDEMAN, W. H., R. L. RAISON, G. CHEUNG, C. J. HULL, L. AKAKA, AND J. OKAMOTO. 1977. Immunologic specificity and memory in a scleractinian coral. *Nature* **270**: 219-223.
- HILDEMAN, W. H., I. S. JOHNSON, AND P. L. JOKIEL. 1979. Immunocompetence in the lowest metazoan phylum: transplantation immunity in sponges. *Science* **204**: 420-422.

- HILDEMAN, W. H., E. A. CLARK, AND R. L. RAISON. 1981. *Comprehensive Immunogenetics*. Elsevier/North Holland, Amsterdam. 368 pp.
- HILGARD, H. R., AND J. H. PHILLIPS. 1968. Sea urchin response to foreign substances. *Science* **161**: 1243-1245.
- JOHNSON, P. T. 1969a. The coelomic elements of sea urchins (*Strongylocentrotus*) I. The normal coelomocytes; their morphology and dynamics in hanging drops. *J. Invert. Pathol.* **13**: 25-41.
- JOHNSON, P. T. 1969b. The coelomic elements of sea urchins (*Strongylocentrotus*). III. *In vitro* reaction to bacteria. *J. Invert. Pathol.* **13**: 42-62.
- JOHNSON, P. T., P. K. CHIEN, AND F. A. CHAPMAN. 1970. The coelomic elements of sea urchins (*Strongylocentrotus*) V. Ultrastructure of leukocytes exposed to bacteria. *J. Invert. Pathol.* **16**: 466-469.
- JOHNSON, P. T., AND F. A. CHAPMAN. 1971. Comparative studies on the *in vitro* response of bacteria to invertebrate body fluids. III. *Stichopus tremulus* (sea cucumber) and *Dendraster excentricus* (sand dollar). *J. Invert. Pathol.* **17**: 94-106.
- KANESHIRO, E. S., AND R. D. KARP. 1980. The ultrastructure of coelomocytes of the sea star *Dermasterias imbricata*. *Biol. Bull.* **159**: 295-310.
- KARP, R. D., AND W. H. HILDEMAN. 1976. Specific allograft reactivity in *Dermasterias imbricata*. *Transplantation* **22**: 434-439.
- MANNING, M. J., AND R. J. TURNER. 1976. *Comparative Immunobiology*. Wiley and Sons. 184 pp.
- MARCHALONIS, J. J. 1977. *Immunity in Evolution*. Harvard University Press. 316 pp.
- McKAY, D., AND C. R. JENKIN. 1969. Immunity in invertebrates. II. Adaptive immunity in the crayfish (*Parachaeraps bicarinatus*). *Immunology* **17**: 127-137.
- PAULEY, G. B., S. M. KRASSNER, AND F. A. CHAPMAN. 1971. Bacterial clearance in the California seahare *Aplysia californica*. *J. Invert. Pathol.* **18**: 227-239.
- REINISCH, C. L., AND F. B. BANG. 1971. Cell recognition: Reactions of the seastar (*Asterias vulgaris*) to the injection of amoebocytes of sea urchin (*Arbacia punctulata*). *Cell. Immunol.* **2**: 496-503.
- RENWRANTZ, L., AND W. MOHR. 1978. Opsonizing effect of serum and albumin gland extracts on the elimination of human erythrocytes from the circulation of *Helix pomatia*. *J. Invert. Pathol.* **31**: 164-170.
- RENWRANTZ, L., W. SCHANCKE, H. HARM, H. ERL, H. LIEBSCH, AND J. GERCKEN. 1981. Discriminative ability and function of the immunobiological recognition system of the snail *Helix pomatia*. *J. Comp. Physiol.* **141**: 477-488.
- ROGERS, D. E. 1960. Host mechanisms which act to remove bacteria from the blood stream. *Bacteriol. Rev.* **24**: 50-66.
- SMITH, V. J., AND N. A. RATCLIFFE. 1980. Host defense reactions of the shore crab, *Carcinus maenas* (L): Clearance and distribution of injected test particles. *J. Mar. Biol. Assoc. U. K.* **60**: 89-102.
- STEWART, J. E., AND B. M. ZWICKER. 1974. Induction of internal defense mechanisms in the lobster *Homarus americanus*. Pp. 233-239 in *Contemporary Topics in Immunobiology*, Vol. 4, E. L. Cooper, ed. Plenum Press.
- UNKLES, S. E. 1977. Bacterial flora of the sea urchin *Echinus esculentus*. *Appl. Environ. Microbiol.* **34**: 347-350.
- VAN DER KNAAP, W. P. W. 1980. Recognition of foreignness in the internal defense system of the freshwater gastropod *Lymnaea stagnalis*. Pp. 91-97 in *Aspects of Developmental and Comparative Immunology-I*, J. B. Solomon, ed. Pergamon Press, Oxford.
- VAN DER KNAAP, W. P. W., T. SMINIA, F. G. M. KROESE, AND R. DIKKEBOOM. 1981. Elimination of bacteria from the circulation of the pond snail *Lymnaea stagnalis*. *Dev. Comp. Immunol.* **5**: 21-32.
- WARDLAW, A. C., AND S. E. UNKLES. 1978. Bactericidal activity of coelomic fluid from the sea urchin *Echinus esculentus*. *J. Invert. Pathol.* **32**: 25-34.
- WITTIG, G. 1965. Phagocytosis of blood cells in healthy and diseased caterpillars. I. Phagocytosis of *Bacillus thuringiensis* in *Pseudaletia unipuncta*. *J. Invert. Pathol.* **7**: 474-488.
- WOOD, W. B. 1960. Phagocytosis, with particular reference to encapsulated bacteria. *Bacteriol. Rev.* **24**: 41-49.
- YUI, M. A. 1982. Bacterial clearance in the sea urchin, *Strongylocentrotus purpuratus*. M.S. Thesis. Oregon State University, Corvallis.

ABSTRACTS OF PAPERS PRESENTED AT THE GENERAL
SCIENTIFIC MEETINGS OF THE MARINE BIOLOGICAL
LABORATORY AUGUST 16-19, 1983

Abstracts are arranged alphabetically by first author within the following categories: cellular and molecular biology, cell structure; developmental biology; ecology, evolution, and plant sciences; gametes and fertilization; microbiology; neurobiology, learning, and behavior; parasitology, pathology, and aging; and photoreceptors, vision, and rhythms. Author and subject references will be found in the regular volume index in the December issue.

Ernest Everett Just (1883-1941): A Dedication. WILLIAM R. JEFFERY (University of Texas at Austin).

This session of the General Meetings of the Marine Biological Laboratory (MBL) is dedicated to the centenary of Ernest Everett Just, a distinguished Professor of Zoology at Howard University and prominent investigator at the MBL and various European scientific institutes. The contributions of E. E. Just, who received his Ph.D. under the direction of Frank R. Lillie at the University of Chicago, are many and varied. His dissertation involved an experimental analysis of the generation of polarity in the egg of the marine annelid *Nereis*, which he showed was determined by the relationship between the position of the polar bodies and the point of sperm entry. After pursuing independent research at the MBL on the nature of fertilization in *Nereis* and sand dollar eggs, he was among the first to recognize and characterize the so-called fertilization wave, now known to be caused by a calcium-mediated exocytosis of the cortical vesicles. Although E. E. Just is often remembered at Woods Hole for his genius in the design of experiments and the handling of marine eggs, he has left an almost-forgotten legacy to the modern field of cell biology. He correctly predicted that the cell surface was not simply a static limiting membrane, but instead a dynamic, compound structure composed not only of the plasma membrane but also of an underlying motile cortex which he called the ectoplasm.

E. E. Just's philosophy of these General Meetings, were he to preside over them this week, might best be expressed by a quote from his last book *The Biology of the Cell Surface* published in 1939.

"Although we may deal with particulars, we return finally to the whole pattern woven out of these. So in our studies of the animal egg; though we resolve it into its constituent parts the better to understand it, we hold it as an integrated thing, as a unified system; in it life resides and in its moving surface life manifests itself".

The aspirations of the present generation of MBL scientists, especially those of us who study the isolated parts of cells or organisms, might well profit by carefully considering this thought of their long-deceased colleague, Ernest Everett Just.

CELLULAR AND MOLECULAR BIOLOGY; CELL STRUCTURE

Studies of the isolation and calcium-induced fusion of fusogenic wild carrot protoplasts. NINA STRÖMGREN ALLEN (Dartmouth College) AND WENDY F. BOSS.

Wild carrot suspension culture cells with the potential to undergo somatic cell embryogenesis have been grown; these cells yield protoplasts which are fusogenic (Boss and Grimes 1983, submitted to *Protoplasma*). Morphological changes occurring during protoplast formation as well as during the fusion process were studied using videoenhanced microscopy (Allen and Allen 1983, *J. Microsc.* 129: 3-17).

Fusion of the protoplasts is calcium dependent and is inhibited by EGTA. The fusion process is rapid, and is complete within 1 to 20 minutes after initial contact. When calcium is added, the fusogenic, but not the nonfusogenic protoplasts, crenate. The fusion occurs as follows. First, there is contact recognition, then adhesion followed by fusion at the points of adhesion. The complete expansion of the cytoplasmic connection and the mixing of the cell contents generally occurred in 20 minutes, but could be enhanced by exposing the protoplasts to a hypotonic solution. Electron Spin Resonance studies of fusogenic and nonfusogenic cells suggest that the glycerol backbone region of the membrane was less fluid in nonfusogenic cells than in fusogenic cells.

These filamentous extensions (0.1 μm or less in diameter) were found on fusogenic protoplasts in 0.4 molal sorbitol or after digestion on 0.4 molal sorbitol and 2% driselase. These membranous extensions (Hechtian threads) connected adjacent cells during wall digestion and as the cells broke apart, the threads often terminated in knob-like structures. Such filamentous threads were not seen on nonfusogenic protoplasts. Larger, more readily visible extensions were seen when cells were osmotically stressed with 0.8 molal sorbitol. A videotape (available from N. S. Allen) demonstrates the fusion, plasmolysis, and digestion events.

Fusogenic carrot cultures provide an ideal system for the study of membrane fusion. Cell-to-cell fusion has potential use in the study of membranes and membrane fusion as well as for genetic engineering.

Supported by grants from Monsanto Co. (N.S.A.), Pioneer Hi-Bred International, Inc. and North Carolina Agricultural Research Services (W.F.B.) and the generous loan of equipment from Carl Zeiss, Inc., R. D. Allen, and Hamamatsu, Inc.

A proteinase inhibitor released from the Limulus ameobocyte during exocytosis.

PETER B. ARMSTRONG (Department of Zoology, University of California, Davis),
JAMES P. QUIGLEY, AND JACK LEVIN.

The blood cell (ameobocyte) of the horseshoe crab, *Limulus*, is packed with large oval granules that can be stimulated to release their contents by exocytosis. Among the materials released are a system of proteolytic enzymes involved in the clotting reaction (Levin 1979, *Prog. Clin. Biol. Res.* 29: 131). We have identified, in addition, a potent proteinase inhibitory activity that is also released. In the standard preparation, a uniform suspension of washed ameobocytes is suspended in 10 ml of 0.5 M NaCl + 10 mM CaCl₂. Exocytosis is initiated by adding the ionophore A23187 (10 mM) and the preparation is incubated at room temperature for 10–60 min. One ml of packed cells releases enough inhibitor to half-inactivate 4 mg of bovine pancreatic trypsin (9100 BEAE units/mg). During the release reaction, cell lysis is negligible, as can be ascertained by: (1) direct microscopic examination of amoebocytes adherent to microscope coverglasses and (2) the absence of lactate dehydrogenase in the fluid phase recovered from a preparation of cells after exposure to ionophore. (One ml of packed cells releases 30 units of LDH if lysed in distilled water but releases none under the conditions of ionophore-induced exocytosis.) No inhibitory activity is released from living cells that have not been stimulated to undergo exocytosis. The inhibitor preparation suppresses activity against both high (casein) and low (BAPNA) molecular weight substrates, is relatively stable at low pH (half inactivation occurs at pH 2.9, 1 h, room temp.), and high temperature (half inactivation occurs at 100°C, 2 min), and both native and acid-treated releasate are active against trypsin, chymotrypsin, and thermolysin. The inhibitor is also active against the clotting enzyme (a serine proteinase) that clots the coagulogen in the *Limulus* ameobocyte lysate reaction.

Supported by NSF Grant No. PCM80-24181.

Isolation and characterization of tubulin clones from Dictyostelium discoideum. MONICA CARSON AND REX L. CHISHOLM (MIT).

The α - and β -tubulin genes have been found in three types of genomic organization. In most higher eukaryotes, the α - and β -tubulin genes exist as unlinked elements dispersed throughout the genome. In *Leishmania enriettii*, the α -tubulin genes are tandemly repeated but unlinked to the β -tubulins which are also tandemly repeated. Finally, in *Trypanosoma brucei*, the α - and β -tubulin genes are linked and this α - and β -tubulin unit is tandemly repeated. These three types of genomic organization may be necessary for differential transcriptional regulation.

Dictyostelium discoideum possesses distinct developmental stages capable of directed cell movement. Cellular movement at each stage probably involves cytoskeletal elements. To investigate the structure of the *Dictyostelium* tubulin genes and as a prerequisite to studies of their expression, a *Dictyostelium* genomic library was constructed and screened using either a *Chlamydomonas reihardii* α - or β -tubulin probe. Five recombinant phage which hybridized to the *Chlamydomonas* α -tubulin probe and eight recombinant phage which hybridized to the *Chlamydomonas* β -tubulin probe were plaque purified.

Initial restriction mapping of each of the *Dictyostelium* α - and β -tubulin clones suggests that both the α - and β -tubulin clones contain overlapping segments of DNA from the same or similar regions of the *Dictyostelium* genome. Furthermore, both the *Chlamydomonas* α - and β -tubulin probes hybridize to the identical 4 Kb Eco RI fragment of the Eco RI digested *Dictyostelium* tubulin clones. The 4 Kb fragment from both a *Dictyostelium* α - and β -tubulin clone was purified and used to probe a genomic Southern of *Dictyostelium* DNA. The 4 Kb fragment from both the *Dictyostelium* α - and β -tubulin clones hybridized to the same fragments of *Dictyostelium* DNA. Therefore the *Dictyostelium* α - and β -tubulin genes appear linked to each other as observed in *Trypanosoma*. However, the *Dictyostelium* and *Chlamydomonas* probes hybridize to genomic fragments which co-migrate with the predicted mobilities of

ribosomal DNA. The *Dictyostelium* probes also appear to hybridize to both ribosomal RNA and to RNA which migrates at the α - and β -tubulin position. These results suggest that in addition to the α - and β -tubulin gene linkage, these genes also may be linked to the ribosomal RNA gene cluster. Alternately, the observed hybridization could result from fortuitous cross hybridizations. Further experiments to distinguish between these possibilities are in progress.

This work was supported by NIH Training Grant GM-31136-05.

Immunofluorescence of Allogromia reticulopodia. V. E. CENTONZE (Dartmouth College) AND J. L. TRAVIS.

Allogromia laticollaris, a marine foraminifera, extends a radial reticulopodial network upon settling on a solid substratum. Bidirectional streaming and saltatory particle movements are evident in the spreading network. Previous studies (Travis and Allen 1981, *J. Cell Biol.* **90**: 211-221) of *Allogromia* on both the optical and electron microscope levels show that particle movement coincides with the position of microtubule bundles which are the major cytoskeletal elements of the reticulopodial extensions.

To determine tubulin antigenic crossreactivity, we probed glutaraldehyde fixed networks with antibodies prepared against tubulin from widely divergent organisms. A polyclonal antibody prepared by Miles against chicken brain tubulin produces an intense staining of the microtubule bundles. When comparing phase and fluorescence light micrographs it becomes apparent that individual microtubule bundles may be resolved, especially in flattened lamellipodial regions. A monoclonal antibody probe, 34 #10, prepared against yeast tubulin produced a similar staining pattern identifying only the fibrous bundles. Another monoclonal antibody YL1/2, specific to the carboxy terminal end of tyrosylated α -tubulin, also stained the microtubule bundles. Fluorescence staining produced by this antibody was similar though less intense. Therefore, due to this monoclonal's specificity we propose the tyrosylated form of tubulin is a subset of *Allogromia* tubulin.

We would like to specially thank Dr. John Kilmartin for providing both of the monoclonal antibodies. We would also like to thank J. Rosenbaum, E. Stromboli, and the entire Marine Biological Laboratory Physiology Course. Support for this work was NIH Training Grant GM-31136-05.

Marginal band function in the dogfish erythrocyte. WILLIAM D. COHEN AND JACQUELYN JOSEPH-SILVERSTEIN (Hunter College, NY).

Marginal bands (MBs) of microtubules in mature erythrocytes of all non-mammalian vertebrates are believed to function universally in cellular morphogenesis (transformation from sphere to flattened ellipse) but not in cell shape maintenance (Behnke 1970, *J. Ultrastruct. Res.* **31**: 61-75; Barrett and Dawson 1974, *Dev. Biol.* **36**: 72-81). The primary supporting evidence is that, in mature erythrocytes of certain species (e.g., chicken), the MB disassembles at 0°C while native cell shape is retained. Although the same observation can be made with erythrocytes of the smooth dogfish (*M. canis*), we believe the interpretation to be incorrect. Two methods were used to produce dogfish erythrocytes containing or lacking MBs under otherwise similar conditions: (a) stabilization of the MB at 0°C by taxol, and (b) inhibition of MB reassembly at room temperature by nocodazole or colchicine. Cells with or without MBs had normal shape. Anucleate ghosts were prepared by osmotic lysis and shearing of cells at 0°C. Ghosts containing MBs generally retained a flattened elliptical shape, while those without MBs buckled. Living cells contained MBs at 0°C and when subjected to mechanical stress (fluxing in glass capillary tubes) similarly maintained normal shape, whereas those lacking MBs did not. The same result was obtained using fluxed cells + and -MBs at room temperature. How might the MB maintain cell shape under such conditions? If normal dogfish erythrocytes are incubated at room temperature for long periods (approx. 5-24 h), abnormal pointed cells containing pointed MBs appear. However, we found that cells lacking MBs do not form points, demonstrating that MB shape determines cell shape. We propose that erythrocyte shape coincides with the shape of the cell surface-associated cytoskeleton (SAC), within which the MB acts as a flexible frame. We conclude that MBs may function to maintain erythrocyte shape in non-mammalian vertebrates, resisting deformation and/or rapidly returning deformed cells to an efficient shape in the circulation.

Supported by Professional Staff Congress-City University of New York grant #13567 and #6-63177, and by NSF #PCM-8107195.

Actin microfilaments are a major cytoskeletal component in squid axoplasm. KARL R. FATH (Case Western Reserve University) AND RAYMOND J. LASEK.

The axoplasm of the squid (*Loligo pealei*) giant axon can be extruded from its sheath leaving a 10 μ m thick cortical rim of axoplasm with the discarded plasma membrane. The extruded cylinder of

axoplasm contains 1.4 mg/ml actin—60% of which is assembled into actin microfilaments (MF) (Morris, in press, *J. Cell Biol.*) principally as a polymer approximately 0.5 μm in length.

Two to three μl of axoplasm was extruded into 200–300 μl buffer (designed to simulate the solution conditions in the axon, Morris 1982, *J. Cell Biol.* **92**: 192–198) containing 10 μM phalloidin which binds to and stabilizes polymeric actin. Potassium iodide (0.6 M) was then added to disperse the axoplasm by denaturing neurofilaments and microtubules, but leaving the phalloidin-stabilized MF intact. The dispersed axoplasm was reacted on a grid with the myosin subfragment one (S-1) and negatively stained for transmission electron microscopy.

Measurements of a total of 500 S-1 decorated MF from four different axons revealed a distribution of lengths with a mode at 0.45 μm (40% were between 0.3–0.6 μm) and a range from 0.2 to 3 μm . Control preparations without phalloidin contained MF of similar lengths suggesting that actin polymerization was not induced by drug treatment. Purified skeletal muscle actin when polymerized in our buffer and processed in an identical manner were much longer than axoplasmic MF indicating that MF were not sheared in our preparations.

Other studies have shown that intact MF are necessary for transport of membranous vesicles in the squid giant axon. We feel that the relatively modest lengths of axoplasmic MF reported above may limit the types of models we can build regarding a role of actin in motile mechanisms.

Characterization of Trypanosoma brucei tubulin genes. A. FLISSER, A. S. FAIRFIELD, AND D. WIRTH (Harvard School of Public Health).

Microtubules are associated with many eukaryotic cell functions. Alpha (α) and beta (β) tubulins are the main proteins of microtubules. Tubulin genes have been identified in organisms such as *Chlamydomonas*, *Drosophila*, and man, where they appear as distinct gene families which exist in dispersed multiple copies. Recently, α and β tubulin genes have been identified in *Trypanosoma brucei* and *Leishmania enriettii*; unlike other eukaryotes, however, the genes are arranged as tandem repeats. Several hypotheses to explain a tandem gene arrangement have been proposed, of which the most likely explanation is that tubulin is a major biosynthetic product (up to 10% of total cell protein) of the organism.

In the work reported here, the alpha and beta tubulin genes from *T. brucei* were identified by Southern blot using heterologous α and β tubulin probes from *Leishmania enriettii*. Restriction cut (Pst 1) *T. brucei* DNA was cloned into the bacterial plasmid pBR322, and of the resulting genomic library 93% of the clones contained inserts. The library was screened by colony hybridization and four positive clones were identified with the tubulin probes. Two of these clones were isolated, the plasmid purified and analyzed by restriction mapping.

A strategy to differentiate mutants affecting voltage-sensitive sodium channels in Drosophila. LINDA M. HALL (Albert Einstein College of Medicine).

A goal of this laboratory is to identify the genes involved in the production and regulation of voltage-sensitive sodium channels found in excitable cells. We are interested in developing pharmacological procedures which will allow us to distinguish between different classes of mutants affecting this ion channel. Two general mutant classes of interest would be: (1) those which increase channel activity and (2) those which decrease channel activity. The first class of mutants would include those which affect channel regulation causing overproduction and those which affect the activation and inactivation processes. These would have agonist-like effects. The second class would be antagonist-like and would include those which block channel function as well as those which reduce the number of channels produced without affecting function. We predict that mutants which increase channel activity should show increased sensitivity to agonists such as veratridine and decreased sensitivity to antagonists such as tetrodotoxin. In contrast, mutants which decrease channel activity should show decreased sensitivity to agonists and increased sensitivity to antagonists. To test this hypothesis we have used the temperature-sensitive paralytic mutant *nap*⁵ which has a reduced number of sodium channels as revealed by ³H-saxitoxin binding studies (Hall *et al.* 1982, *Ciba Found. Symp.* **88**: 207–220). Flies were fed either the agonist veratridine or the antagonist tetrodotoxin and the lethality at specific doses was compared with that of wild-type flies. As predicted by our hypothesis, the *nap* mutant was resistant to veratridine and sensitive to tetrodotoxin. Thus, by screening for tetrodotoxin-resistant mutants and then identifying that subclass which show increased sensitivity to veratridine, it should be possible to identify new classes of sodium channel mutants with increased channel activity. It will be of interest to determine whether these mutants identify new genes or coincide with those already identified on the basis of temperature-induced paralysis and alterations in ³H-saxitoxin binding activity.

This work was supported by NIH grant 16204.

Structure of the isolated and in situ giant smooth muscle fibers of Mnemiopsis leydii (ctenophora). MARI-LUZ HERNANDEZ-NICAISE AND GHISLAIN NICAISE (Université Claude Bernard, Villeurbanne, France).

The first example of a giant smooth muscle cell has been reported in the mediterranean ctenophore *Beroe ovata* (Hernandez-Nicaise *et al.* 1980, *J. Gen. Physiol.* **75**: 79–105). These cells have been successfully isolated in a functional state (Hernandez-Nicaise *et al.* 1982, *Proc. Natl. Acad. Sci.* **79**: 1884–1888). The limited availability of beroids prompted us to seek another suitable species. The lobate ctenophore *Mnemiopsis leydii*—which is common during the summer in Woods Hole—possesses such giant fibers, grouped in 2 saggittal bundles. Functional isolated cells were obtained after a sequential digestion of mesoglea in 0.3% hyaluronidase (type III Sigma) for 75–90 min, followed by 0.3% hyaluronidase + 0.05% trypsin (type III Sigma) for 20–30 min, at 30°C, in Ca-free artificial sea water.

Each bundle is made of 30 to 50 multinucleated cylindrical cells which may reach 35 μm in diameter and 2 cm in length. The nuclei and non-contractile organelles (mitochondria, golgi, granular endoplasmic reticulum) are contained in a discontinuous axial core, surrounded by a thick sheath of myofilaments. Thin (actin) filaments, 5.9 nm in diameter, form irregular rosettes around the thick (myosin) filaments, 16.1 nm in diameter. An actin:myosin filament ratio of 7.2 and a myosin density of 249 filaments per μm^2 were found in cross-sections of relaxed *in situ* cells. No dense bodies or attachment plates were observed. From the coiled shape of contracted single cells and from the rearrangement of organelles in such coiled cells, we propose that myofilaments are organized in thin long myofibrils attached upon the cell membrane at both ends, and that the attachment sites follow two (sets of) enantiomorphic helices. The sarcoplasmic reticulum builds up a longitudinally oriented 3-dimensional network of narrow tubules among the myofilaments. Its relative volume, estimated from cross-sections, amounts to 0.9% of the contractile cytoplasm. No peripheral couplings have been observed, nor any tubular or vesicular invagination of the sarcolemma.

Supported by NATO grant #251-81, and the CNRS (L.A. 040244).

Opposite end assembly-disassembly of single microtubules. H. HOTANI AND J. L. TRAVIS (Yale University, Dept. Biology).

Tubulin assembles onto both ends of a microtubule filament and the microtubule grows quickly at its plus end and more slowly at the minus end. The critical concentration for the assembly of tubulin is higher at the minus end than the plus end. Analysis of tritiated GTP incorporation into microtubules at *steady state* has suggested that treadmilling of tubulin subunits through the microtubule occurs. There is therefore a net addition of tubulin subunits at the plus end and a net loss from the minus end, yet the microtubule remains the same length. If this treadmilling occurred in the living cell, it might cause the microtubule to change position relative to a fixed structure. This could have great importance for the mechanism by which microtubules function in mitosis, particle movement, and other microtubule-based processes. We visualized the treadmilling in single microtubules by dark-field light microscopy and dynein decoration.

Purified brain microtubule protein was assembled into microtubules, the microtubules were sonicated to break them into small pieces, and the pieces were then decorated with purified *Tetrahymena* dynein ATPase. When the microtubules are decorated with dynein they can easily be distinguished from undecorated ones in the dark-field microscope because the decorated ones appear fat, and the undecorated ones quite thin. The small pieces of decorated microtubules were then incubated with brain tubulin at a concentration that permitted elongation to occur at both ends of the microtubules; the system was allowed to come close to equilibrium, (little change in microtubule length) and then a video recording was made of the changes in lengths of the undecorated segments which had elongated from both the plus and the minus ends of the dynein decorated piece of microtubule. The length of the undecorated microtubule at the plus end increased (4 $\mu\text{m}/\text{h}$) and that at the minus end decreased (3 $\mu\text{m}/\text{h}$), while the decorated portion did not change in length. Moreover, since the decorated microtubule section was attached to the coverslip, we observed that the microtubule changed position relative to other fixed structures in the field due to its head to tail assembly.

We would like to thank Dr. J. Rosenbaum and the entire Marine Biological Laboratory Physiology Course.

Fully automated image analysis can be used to study intramembranous particle (IMP) behavior during development in Tetrahymena. LINDA A. HUFNAGEL (University of Rhode Island).

The cell surface of *Tetrahymena* is covered by three membranes, the plasma membrane (PM), and outer and inner alveolar membranes (OAM and IAM). The OAM and PM are closely associated via frequent,

10 nm long, cross-linking fibers, and thus assembly of these membranes must be coordinated. Nevertheless, freeze-fracture studies reveal that these membranes have unique structures, which respond differently to reduced temperatures (*c.f.* Hufnagel 1981, *J. Protozool.* **28**: 192-203). Comparison of morphological changes in these two membranes during membrane growth accompanying refeeding of starved cells would be of considerable interest. Membrane structure can be described in terms of size, frequency, orientation, and locations of IMPs, considered to represent transmembrane proteins. To hasten such an analysis, the Zeiss IBAS analysis system, attached to a video camera and light box, is being used to record, process, digitize, and measure IMPs, starting with EM negatives. Suitability of this fully automated system for IMP analysis was previously reported (Hufnagel 1983, *Proc. EMSA 41st Ann. Meeting*, pp. 637-639). Cells starved overnight in 10 mM Tris buffer, and starved cells refed for several hours (thus in early stages of cytokinesis) were compared. Based on measurements of several thousand IMPs, particle frequency increased from 2324 ± 377 IMPs/nm² in starved cells to 5138 ± 108 IMPs/nm² in fed cells. Area and diameter distributions of IMPs were also obtained. Differences were detected in the relative increase in frequency of different size classes of particles in starved *versus* fed cells. Visual inspection of digitized images revealed differences in spatial arrangements of IMPs, in starved and fed cells. Analysis of distribution of asymmetric IMPs relative to angular orientation suggests that particle asymmetry results partly from shadowing direction, but that classes of similarly oriented IMPs may exist in the PM. These preliminary observations suggest that membrane structural changes during development can be characterized quite effectively and efficiently by fully automated image analysis of freeze fracture replicas.

Visualizing extremely low contrast images by digital enhancement of selected portions of the image grey scale. SHINYA INOUÉ (Marine Biological Laboratory), THEODORE D. INOUÉ, AND GORDON W. ELLIS.

Image contrast in the light microscope has been substantially improved over the past 50 years. However, one could detect and measure smaller retardations, absorbances, fluorescence, etc., and uncover finer structural details of the specimen, if contrast could be improved further. Two years ago, we (Inoué *J. Cell Biol.* **89**: 346-356) and Allen *et al.* (*Cell Motility* **1**: 275-289, 291-302) reported the use of video to enhance microscope image contrast. This summer, we developed an interactive digital image processing system that enhances selected regions of the image grey scale. The system works with video cameras providing standard video signals, is simple to use, and less expensive than other digitized image enhancing systems with comparable potentials. We can average out statistical image noise, subtract noise-averaged background, select the image grey level to be enhanced and the degree of contrast enhancement, display the enhanced regions in pseudo-color with the unenhanced regions in natural grey scale or pseudo-color, sharpen edges, generate differential contrast, detect motion, etc., all in real time, and provide image convolutions in fractional seconds. The computer hardware, including three $512 \times 512 \times 8$ bit frame buffers, an analog processor, and an arithmetic logic unit, were acquired from Imaging Technology Inc. of Woburn, Massachusetts. The computer program for interactive image manipulation was developed primarily by Ted Inoué. Performance of the new system, which requires little experience with computers, and which should be applicable to electron microscopy, radiography, astronomy, surveillance, and industrial applications, in addition to light microscopy, was demonstrated at the Meetings. The system attached to the microscope was demonstrated the same evening.

Grant support: NIH 5R01 GM 31617-02, NSF PCM 8216301.

Composition and function of the cytoskeleton in "blood clam" erythrocytes. JACQUELYN JOSEPH-SILVERSTEIN (Hunter College, NY) AND WILLIAM D. COHEN.

Erythrocytes of *Noetia ponderosa* and related species contain a marginal band (MB) of microtubules and a cell surface-associated cytoskeleton (SAC). The MB is cold labile, disassembling at 0°C and reassembling upon rewarming. When nucleated cytoskeletons are prepared from room temperature cells by Triton lysis in microtubule-stabilizing medium and analyzed by SDS-PAGE, the major protein components are tubulin and two proteins which comigrate with human erythrocyte α -spectrin and actin. Disassembly of the MB at 0°C allows one to localize proteins to the MB. When protein components of cytoskeletons lacking MBs (cells at 0°C) are compared to those from cytoskeletons with MBs (cells at room temperature), a diminution of the tubulin doublet and a decrease in two minor proteins (~80K, ~105K) is observed. No change is apparent in those proteins comigrating with human erythrocyte α -spectrin and actin, suggesting that they are in the SAC. The possibility that the ~80K and ~105K components are MB microtubule-associated proteins (MAPs) was examined further. Cells at room temp. were prepared with and without MBs by inhibiting MB reassembly with nocodazole or colchicine. Nucleated cytoskeletons with and without reassembled MBs were compared for protein content by SDS-

PAGE. Cytoskeletons from cells with reassembled MBs were enriched for the ~80K and ~105K proteins as well as for tubulin. The results suggest that the ~80K and ~105K proteins are MAPs which cycle with the MB. The ability to produce erythrocytes with and without MBs at room temperature allowed us to examine the role of the MB in cell shape maintenance under conditions in which cells are subjected to mechanical stress. When erythrocytes with and without MBs were fluxed in 10 μ l capillary tubes, those with MBs were still flattened and elliptical (98%), while many of those without MBs were deformed (20–45%). The MB may thus play a role in cell shape maintenance, effecting the rapid recovery of erythrocyte shape following deformation.

Supported by PSC-CUNY grant #13567 and #6-63177, and by NSF #PCM-8107195.

Two-dimensional gel analysis of sea urchin ciliary tubulins. THOMAS KELLY, JOEL L. ROSENBAUM, AND TIM HUNT.

We isolated cilia from *Arbacia punctulata* embryos according to the method of Stephens (1977, *Dev. Biol.* **61**: 311–329). Samples were analyzed by two-dimensional gel electrophoresis. α and β tubulins migrated as single discrete spots on coomassie blue stained gels. In a separate experiment, developing embryos were labeled for 20 minutes with 35 S-methionine five and nine hours post-fertilization. Whole embryos were analyzed by two-dimensional gel electrophoresis. The resulting fluorograms showed that α and β tubulins migrated as discrete spots in the same positions as the tubulins from mature detached cilia. Thus, in contrast to flagellar α tubulin of *Chlamydomonas reinhardtii* (L'Hernault and Rosenbaum 1983, *J. Cell Biol.* **97**: 258–263) and α tubulin from cilia of *Polytomella agilis* (McKeithan and Rosenbaum 1981, *J. Cell Biol.* **91**: 352–360), there is no evidence for a posttranslational modification of α or β tubulin which would change the isoelectric point or molecular weight of ciliary tubulins relative to cytoplasmic tubulins in sea urchins.

This work was supported by N.I.H. training grant GM-31136-05. The authors thank Emilio Stromboli for stimulating discussions.

Enhancement of the appearance of lateral projections on negatively stained microtubules after glutaraldehyde—tannic acid fixation. GEORGE M. LANGFORD (University of North Carolina, Chapel Hill, NC).

Methods for enhancing the visualization of microtubule-associated proteins (MAPs) on the surfaces of reassembled neuronal microtubules (MTs) by negative staining were investigated. A drop of MTs, diluted 10–20 fold, was placed on a carbon-formvar coated grid for 8–10 s. The grid was rinsed with 1–2 drops of buffer, stained with 8–10 drops of 1% uranyl acetate (UA), air dried, and examined in the electron microscope. This staining procedure yielded light and dark staining populations of MTs. The dark staining MTs had short, globular projections on their surfaces while the surfaces of the light staining ones appeared smooth. The two populations of MTs resulted from differences in the staining reaction of MTs suspended in a droplet of buffer on the grid and those MTs adsorbed to the surface of the grid. Microtubules that were adsorbed to the grid surface were flattened and their MAPs were attached to the carbon-formvar film in an extended configuration. The MAPs in this configuration were difficult to visualize by the UA stain and only an indistinct band, 40–50 nm in width, of fine, filamentous material was seen along the sides of the MTs. Microtubules that were in suspension were “fixed” by the UA stain and their MAPs coiled into short globular projections, 7–10 nm in length; UA had altered the length and configuration of the MAPs. To enhance the visualization of the MAPs, MTs were fixed in 1% glutaraldehyde–0.2% tannic acid before staining. This method of fixation increased the diameter of the projecting MAPs, thereby enhancing their contrast, but causing them to shorten to 20–25 nm; a length which is shorter than the expected extended length of the MAPs. These data demonstrate that glutaraldehyde-tannic acid fixation is a very useful method for enhancing the contrast of MAPs on reassembled MTs.

Supported by NIH grant GM28107.

Structure and expression of tubulin genes in the protozoan parasite Leishmania enriettii. SCOTT LANDFEAR (Harvard University).

In the gut of the insect vector, protozoan parasites of the genus *Leishmania* exist as highly motile, flagellated, extracellular organisms called promastigotes. When promastigotes are injected into the mammalian host by a bite of the sandfly vector, the parasites are phagocytized by host macrophages and develop into intracellular non-motile forms, called amastigotes, which possess only a residual flagellum. Amastigotes synthesize low levels of tubulin proteins, but the biosynthesis of both α - and β -tubulin is greatly increased during the transformation of amastigotes to promastigotes.

Previously, we have used a genomic α -tubulin clone from *Leishmania enriettii* to show that the chromosomal copies of the α -tubulin genes are arranged in a precise tandem repeat containing about 15 copies of the 2 kilobase repeat unit. We have now cloned a copy of the β -tubulin gene. This 4 kilobase fragment of genomic DNA contains single sites for the restriction enzymes Bam HI, Xho I, and Hind III. If genomic DNA is cut with these restriction enzymes, run on a Southern blot, and probed with the β -tubulin clone, a single 4 kilobase fragment hybridizes in all three digestions. This result shows that each restriction site within the β -tubulin gene is bounded, in the chromosomal DNA, by another such site 4 kilobases away. The β -tubulin genes must therefore be arranged in a tandem repeat consisting of 4 kilobase repeat units.

Equal amounts of total RNA from amastigotes and promastigotes have been run on Northern blots and probed with the α - or β -tubulin clones. The hybridization of either α - or β -tubulin mRNA is about 5 to 10 fold higher in RNA from promastigotes compared to RNA from amastigotes. This result demonstrates that tubulin gene expression is controlled at the level of mRNA accumulation during the *Leishmania* life cycle.

Voltage clamp studies of dispersed toadfish pancreatic islet cells. D. R. MATTESON
(Dept. of Physiol., Univ. of Pennsylvania).

Pancreatic islet cells isolated from toadfish were voltage clamped using the whole cell variation of the patch clamp technique. The cells were dispersed by treating islets with 2 mg/ml of trypsin and 1 mg/ml of collagenase for 20 min at room temperature. Giga seals were readily obtained on isolated single cells, 10–12 μ m in diameter, with 3 to 5 Mohm patch electrodes. By measuring capacitive currents, total cell capacitance was estimated to be 3.5 ± 1.4 pF (6 cells). In the presence of 130 mM Na + 10 mM Ca externally and 130 mM K + 10 mM Cs internally (130 Na 10 Ca//130 K 10 Cs), the voltage dependent ionic current at 0 mV consisted of a rapidly activating inward current, followed by a more slowly activating phase of outward current. The reversal potential of the fast, early current is close to the calculated Na equilibrium potential, and the current is blocked by tetrodotoxin (TTX), indicating that it is generated by Na channels. The outward currents were blocked when patch electrodes were filled with Cs⁺, indicating that K channels carry this current component. In 130 Na 10 Ca//140 Cs, two patterns of inward current were frequently seen. (1) In some cells, the Na current appeared to only partially inactivate to a maintained level of inward current. After TTX block of the Na channels in these cells, the remaining inward current activated more slowly, did not inactivate in 7 ms, and was larger in the presence of Ba⁺⁺ than in Ca⁺⁺. This TTX insensitive inward current is most likely carried by Ca channels. (2) In the other type of cell, the Na current inactivated completely revealing no maintained inward current.

High molecular weight (380Kd) ATPase in axoplasm of squid giant axon. M. M. PRATT (Univ. of Miami School of Medicine).

Vesicle and organelle transport in axoplasm is a dramatic example of microtubule-associated motility, however, the mechanism by which this movement is generated is unknown. The force for microtubule-mediated movements in ciliary and flagellar axonemes is provided by dynein, a Mg⁺⁺-ATPase with unique enzymatic properties, and a protein composition which includes polypeptides of 300–400 Kd. Since a cytoplasmic dynein can be isolated from unfertilized sea urchin eggs by calmodulin (CaM) affinity chromatography, this technique was used in the study to examine squid axoplasm for the possible presence of a high molecular weight ATPase which associated with microtubules.

When a soluble extract of axoplasm was fractionated on a CaM affinity column, a portion of the total ATPase bound to the column in the presence of CaCl₂, and could be eluted with EGTA, a calcium chelator. SDS-polyacrylamide gel electrophoresis showed that the EGTA-eluted ATPase activity was associated with a polypeptide of 380 Kd, along with minor bands at approximately 80 Kd, 70 Kd, and 60 Kd. To examine the association of the 380 Kd protein and of ATPase activity with microtubules, a soluble cytoplasmic extract was prepared in tubulin isolation buffer. Stable microtubules were polymerized from this fraction (using 10 μ M taxol and 1 mM GTP) and 85% of the ATPase cosedimented with the microtubules, along with nearly all of the 380 Kd polypeptide. When these microtubules were extracted with 0.35 M NaCl, both the 380 Kd polypeptide and about 90% of the ATPase activity were solubilized. The ATPase activity in the NaCl extract was activated equally by Mg⁺⁺ or Ca⁺⁺. When assayed in 0.5 M KCl and 2 mM EDTA, the enzyme exhibited less than half of the Mg⁺⁺ activated activity, suggesting that it is *not* myosin-like. The Mg⁺⁺-ATPase activity was inhibited 50% by 0.1 mM Na₃VO₄, an inhibitor of dynein ATPase, and only 20% by NaF, an inhibitor of non-specific phosphatase.

These results suggest that axoplasm contains an ATPase of 380 Kd which can be partially purified by CaM affinity chromatography in a manner similar to cytoplasmic dynein. Cosedimentation experi-

ments further demonstrate that both the 380 Kd polypeptide and Mg^{++} -ATPase activity associate with repolymerized axoplasmic microtubules.

This study was supported by a Steps Toward Independence Fellowship from the Marine Biological Laboratory, and by NSF grant PCM 81-19156.

Characterization and isolation of a homologue of alpha-2-macroglobulin from the plasma of the horseshoe crab, Limulus. JAMES P. QUIGLEY (Marine Biological Laboratory) AND PETER B. ARMSTRONG.

A proteinase inhibitor detected in the plasma of the horseshoe crab, *Limulus*, displays the following features diagnostic for α_2 macroglobulin: (1) the inhibitor is active against a variety of endopeptidases of differing catalytic mechanisms (trypsin, chymotrypsin, plasmin, elastase, subtilisin, thermolysin, and papain), (2) it suppresses activity against high—but not low—molecular weight substrates, (3) it protects the active site of trypsin against macromolecular active site inhibitors such as soybean trypsin inhibitor, and (4) its activity is destroyed by methylamine and low pH treatment. The inhibitor has been isolated from the cell-free, hemocyanin-free plasma by polyethylene glycol precipitation (5.5–12% cut), followed by two passages over a Sephacryl S-300 column. The inhibitor elutes from the column corresponding to a molecular weight of 520×10^3 d. On the same column, human α_2 macroglobulin elutes at the expected molecular weight of 720×10^3 d. Electrophoresis of the isolated *Limulus* inhibitor on 6% polyacrylamide gels under non-reducing conditions yields a single band at approximately 500×10^3 d, using unreduced plasma fibronectin (440×10^3 d) as the molecular weight standard. Under reducing conditions, a single major band is present at approximately 180×10^3 d, close to the position of the human α_2 macroglobulin subunit. These data are consistent with the possibility that *Limulus* α_2 macroglobulin is a trimer of a 180×10^3 d subunit, in contrast to the tetrameric structure of mammalian and the dimeric structure of fish α_2 macroglobulin.

Supported by NSF Grant No. PCM 80-24181.

Inhibition of mitotic anaphase and cytokinesis and reduction of spindle birefringence following microinjection of anti-calcium transport enzyme IgGs into Echinarracnius parma blastomeres. ROBERT B. SILVER (Department of Biological Chemistry, Univ. of Health Sciences, North Chicago, IL).

Monospecific antibodies to the calcium transport enzyme (α -Ca-pump) inhibit mitosis when microinjected into sand dollar (*E. parma*) blastomeres. Immunoglobulin Gs (IgGs) were raised against the calcium transport enzyme (Ca-pump) of sarcoplasmic reticulum from both rat skeletal muscle and guinea pig ileum smooth muscle. Specific IgGs were further purified from whole IgG preparations by immunoaffinity chromatography, using the electrophoretically purified SR-Ca-pump as the immobilized ligand. ELISA demonstrated that common epitopes are shared by SR, SR-Ca-pumps from rat skeletal and guinea pig smooth muscle, and isolated membrane containing, "native" mitotic apparatus (MA) from first cleavage *Strongylocentrotus purpuratus* embryos. Preimmune sera gave negative results in identical control assays. Triton X-100 extraction of MA removes the SR-Ca-pump antigens. These α -SR-Ca-pump IgGs inhibit ATP dependent ^{45}Ca -sequestration by purified calcium sequestering MA membranes (Silver *et al.* 1980, *Cell* **19**: 505–516) in a concentration dependent fashion. Indirect immunofluorescence light microscopy of isolated native MA demonstrated coincident localization of the MA-Ca-pump, sequestered calcium (Ca-7-chlorotetracycline chelates), and membrane vesicles (differential interference contrast). Fluorescent foci were non-uniformly distributed throughout the volumes of the asters and spindle. The majority of the MA-Ca-pump and sequestered calcium was found in aspherical zone from 3 to 8 micrometers from the mitotic poles. The mitotic poles were devoid of fluorescence, and thus do not have the MA-Ca-pump or sequestered calcium. Microinjection of the α -Ca-pump IgGs into one of the two sister blastomeres, at second metaphase, resulted in mitotic arrest of the injected cell, accompanied by a rapid loss of spindle birefringence. Karyomeres formed and fused to form nuclei at the site occupied by the chromosomes at the time of injection of the IgGs. The cleavage furrow did not develop in cells injected at metaphase. The cleavage furrow arrested, then relaxed in cell injected in anaphase or beyond. Noninjected sister cells, and neighboring blastomeres continue normal mitotic cycling. Routine control injections of bioned immune IgG, pre-immune IgG, Wesson oil, buffer, or goat-anti-rabbit-IgG did not affect mitosis. Br of the MA, or cleavage furrow activity. From these data it is clear that the MA-Ca-pump plays a key part in the functioning of the MA and in mitosis.

This work was supported by a grant from the American Cancer Society (#CD-128) and a Steps Towards Independence Fellowship from the Marine Biological Laboratory, Woods Hole, Massachusetts.

Lactoperoxidase-tubulin interaction in ciliary membranes. R. E. STEPHENS (Marine Biological Laboratory).

Roussett and Wolff (1980, *J. Biol. Chem.* **255**: 2514) recently demonstrated that lactoperoxidase (LPO) binds to both brain microtubules and tubulin at ratios of 0.2–0.3 and 2 moles LPO per tubulin dimer, respectively, with a binding constant of $2 \times 10^6 M^{-1}$. Based on their work, I am using LPO binding to study the disposition of membrane tubulin in molluscan (scallop) gill ciliary membranes and in membrane vesicles reconstituted by detergent removal/freeze-thaw (Stephens 1983, *J. Cell Biol.* **96**: 68–75). LPO interaction with intact cilia results in vesiculation and partial membrane protein solubilization but in only minimal LPO binding to the remaining membrane. In the case of reconstituted vesicles, however, the binding approaches one mole of LPO per mole of membrane tubulin dimer, resulting in a monodisperse vesicle population of uniformly increased density. Half-maximal binding occurs in the micromolar range, implying an apparent binding constant of $>10^6 M^{-1}$. Judged both by direct sedimentation analysis and by a shift in the Soret spectrum of the LPO heme group (characteristic of LPO-tubulin binding), the interaction is relatively slow, going to completion in about 30 minutes at 25°C. The interaction is slowed further by salt but is not inhibited by colchicine at 1 mM. Similar observations were made by Roussett and Wolff for LPO-brain tubulin interaction. When either whole cilia or ciliary membrane vesicles are labeled with LPO and fixed with glutaraldehyde/tannic acid/osmium, no obvious surface labeling is evident; subjectively, the LPO-labeled membranes simply appear more granular. Two conclusions can be drawn from these results: 1) LPO interacts with ciliary membrane tubulin in the same manner as with brain tubulin; and 2) membrane tubulin in intact cilia is less accessible to direct LPO interaction than in reconstituted vesicles, implying either inside-out vesicles or random insertion of membrane tubulin. These results also suggest that labeled LPO could serve as a useful probe for membrane tubulin localization.

Supported by NIH Grants GM 20,644 and GM 29,503.

Calcium activated channels in the mechanically sensitive abfrontal ciliated cells of Mytilus gill. ELIJAH W. STOMMEL (Marine Biological Laboratory).

Mechanical stimulation of the cilia of abfrontal gill epithelial cells elicits depolarizing generator potentials which in turn can elicit regenerative potentials of up to 40 mV (Stommel 1983, *Biophys. J.* **41**: 90a). Both the mechanically sensitive and the voltage sensitive channels appear to be selective for Ca^{++} . Perfusion with Co^{++} sea water or Ca^{++} -free sea water eliminates any depolarizing response to mechanical stimulation. Depolarization with injected current towards the E_{Ca} at least in part diminishes the depolarizing response. Use of high resistance electrodes does not permit accurate bridge recordings for depolarizations greater than +20 mV. Na^+ -free sea water (TMA or Tris substituted) has no effect on the depolarizing response or the occasional spontaneous regenerative potentials. Substitution of Ba^{++} for Ca^{++} causes a long lasting depolarization upon mechanical stimulation. Substitution of nitrate for chloride often causes sustained depolarization, suggesting a role for chloride in repolarization. K^+ blockers (TEA or 4 AP) have no obvious effect on the repolarization. Iontophoretic injection of EGTA into cells before mechanical stimulation causes steady depolarizations that return to the original resting potential in discrete steps. These steps might reflect the repolarization of electrically coupled cells occurring at different times as a result of unequal amounts of calcium loading. The levels of the steps are similar from one stimulus to the next. Depolarizing the cells away from the driving force for the repolarizing current, should produce an undershoot. However, none occurs. It has not been possible to elicit regenerative responses by depolarizing the cells. If one assumes that the excitable membrane resides in the cilia alone, then any current injected might be shunted through low resistance cell bodies, where the resistance is $35 \pm 11 M\Omega$ ohms ($n = 15$). The conductance/area ratio is 5.6 m mhos/cm². Because of the high core resistance of the cilia, they would offer an unlikely current path.

Supported by NIH Grant GM 29,503.

Studies of cytotoxic free radicals produced by some methoxy-quinones plus ascorbate in the presence of Ehrlich ascites cells. ALBERT SZENT-GYORGYI, PETER GASCOYNE, RONALD PETHIG, AND JANE MCLAUGHLIN (Marine Biological Laboratory).

Previous reports from this laboratory by Gascoyne *et al.* (1982, *Biol. Bull.* **163**: 399) and Pethig *et al.* (1983, *Proc. Natl. Acad. Sci. USA* **80**: 129–132) demonstrated that direct correlations exist between the electrochemical potentials, generated semiquinone and ascorbate free radical lifetimes, and cytotoxic action in Ehrlich ascites bearing mice of various methoxy-substituted p-quinones in the presence of ascorbic acid. Spectroscopic measurements and electrochemical titrations support the concept that the

observed cytotoxic properties of the 2,5- and 2,6-dimethoxy quinones were related to the production of long lived free radicals as a result of one- rather than two-electron reductions by ascorbic acid.

We have extended the electrochemical studies to include 2,3,5-trimethoxy- and tetra-methoxy-p-quinone and the redox potentials obtained (at pH 7.4 and 25°C) were 72 mV and 99 mV, respectively. *In vivo* studies of the cytotoxic properties of these quinones in the presence of ascorbic acid against Ehrlich ascites are currently in progress.

The semiquinone and ascorbate free radical lifetimes in ascitic fluid have been determined as a function of the Ehrlich ascites cell concentration. Evidence has been obtained to show that the rate of disappearance of the generated free radicals is directly proportional to the concentration of *viable* ascites cells. Blocking of cell surface sulfhydryl groups by N-ethylmaleimide has indicated that -SH groups are responsible for the free radical depletion. The cell surface -SH groups are found to be of the order 20 times more efficient as radical scavengers than an equivalent aqueous concentration of glutathione.

The quinones were prepared in the laboratory of Professor Gabor Fodor, and the work is supported by the National Foundation for Cancer Research.

ATP-reactivated models of ctenophore comb plates. SIDNEY L. TAMM AND SHOGO NAKAMURA (Boston University Marine Program).

Comb plate cilia of cydippid larvae of *Pleurobrachia* and *Mnemiopsis* undergo a Ca^{2+} -dependent reversal in beat direction, causing larvae to swim backwards (Tamm and Tamm 1981, *J. Cell Biol.* **89**: 495-509). We now find that $5 \mu M$ A23187 + $10 mM$ Ca^{2+} in Ca^{2+} - Mg^{2+} -free artificial sea water (ASW) also causes backward swimming, confirming the role of Ca^{2+} in regulation of ciliary beat direction in ctenophores.

Mnemiopsis larvae placed in $150 mM$ KCl, $1 mM$ EGTA, $30 mM$ PIPES, 2% polyethylene glycol, pH 7.0 for 10 min dissociate into single living comb plate cells which beat in the normal direction and "swim" in circular paths. When transferred by Ca^{2+} - Mg^{2+} -free ASW containing $5 \mu M$ A23187 + $10 mM$ Ca^{2+} , these solitary comb plate cells, free of nervous tissue, beat in the reverse direction and "swim" backwards in circles (high-speed video recordings). Thus, Ca^{2+} directly activates the ciliary reversal mechanism, and may be required for synaptic triggering of reversal, since comb plate cells in intact larvae are innervated by the nervous system (Tamm and Tamm 1981).

ATP-reactivated models of comb plates were obtained by extracting larvae in 0.005% Triton-X 100, 10% glycerol, 2% polyethylene glycol, $2.5 mM$ $MgCl_2$, $150 mM$ KCl, $1 mM$ EGTA, $30 mM$ PIPES, pH 6.9 (ES) for 3 min at room temperature. When placed in $2 mM$ ATP, $2.5 mM$ $MgCl_2$, 2% polyethylene glycol, $150 mM$ KCl, $1 mM$ EGTA, $30 mM$ PIPES, $1 mM$ DTT, pH 6.95 (RS), comb plates beat in a direction similar to that of living ones. The beat frequency and extent of reactivation depend on the Mg^{2+} -ATP concentration, and reactivation is inhibited by $30 \mu M$ vanadate. No beating occurs in the absence of ATP. $10^{-6} M$ Ca^{2+} in RS causes reversal in beat direction, so that each beat cycle starts with an aborally-directed recovery stroke, followed by an effective stroke toward the mouth (high-speed video recordings). In RS containing trypsin, initial beating is followed by ATP-induced sliding disintegration of the axonemes, resulting in extrusion and looping out of doublet microtubules.

Taking advantage of the unique untrastructural markers for specific doublet microtubules in ctenophore cilia, we plan to determine the effects of Ca^{2+} on the pattern of microtubule sliding during ciliary reversal.

Supported by NIH Grant GM 27903.

Intracellular fusion between reticulopodial networks in Allogromia laticollaris. J. L. TRAVIS (University of West Virginia) AND V. E. CENTONZE.

Membrane fusion plays an important role in the formation and activity of foraminiferal reticulopodial networks. This fusion is most noticeable during the anastomosis and fusion of pseudopodia forming the interconnected reticulopodial network. Membrane fusion may also occur between experimentally (or accidentally) excised networks and an intact portion. The excised or "satellite" portions show normal bidirectional streaming at first, but this gradually becomes less vigorous. In addition, the cytoplasm of the satellites withdraws radially to form a droplet that becomes quiescent (Jahn and Rinaldi 1959, *Biol. Bull.* **117**: 100). Satellites may be "rescued" (Allen 1964, *Primitive Motile Systems in Cell Biology*, Academic Press) by fusing with an intact portion of the reticulopodial network which results in the reincorporation of the satellite into the original network. While confirming these earlier studies, we have determined that *Allogromia laticollaris* can fuse with satellites excised from other organisms forming hybrid reticulopodia. These results differ from Schwab's (Schwab and Schwab-Stay 1980, *Protoplasma* **102**: 141) which suggested that fusion cannot occur between reticulopodia of different organisms.

We thank J. Rosenbaum, E. Stromboli, and the entire Marine Biological Laboratory Physiology Course. This work was supported by NIH Training Grant GM-31136-05.

Marine molluscan genomes contain sequences homologous to the octopine synthase gene of Agrobacterium tumefaciens. ERIC R. WARD AND WAYNE M. BARNES (Washington University, St. Louis).

Octopine, a conjugate of pyruvate and arginine, has been characterized as an anaerobic metabolite in a wide variety of marine molluscs. Its synthesis is catalyzed by a monomeric 40 Kd NADH-dependent oxidoreductase called octopine dehydrogenase. Octopine is also found in crown galls, which are neoplastic growths incited in dicotyledonous plants by the soil-borne *Agrobacterium tumefaciens*. A large (~120 Md) tumor-inducing (Ti) plasmid mediates virulence in this bacterium. During infection of a plant by *Agrobacterium*, a portion of the Ti plasmid containing various oncogenic functions (the T-DNA) becomes covalently joined to the chromosomal DNA of the host plant. Within the T-DNA lies the gene encoding octopine synthase, an NADPH-dependent oxidoreductase similar to octopine dehydrogenase. The regulatory signals of the octopine synthase gene closely resemble those of most eukaryotic structural genes and its expression depends on incorporation of the T-DNA into the plant chromosome. These two apparently unrelated systems have previously been assumed to share their unique ability to synthesize octopine as a result of convergent evolution. Should the *Agrobacterium* and marine molluscan genomes display homology, a putative evolutionary relationship could be inferred. We examined this question by digesting genomic DNA from the squid *Loligo pealii* and the clam *Spisula solidissima* with restriction endonucleases, electrophoretically separating the resulting fragments, denaturing and binding the fragments to nitrocellulose filter, and hybridizing to the filter a radioactively labeled cloned DNA fragment of the A6 Ti plasmid containing the octopine synthase gene. Genomes of both molluscs selectively hybridized to the labeled probe sequence under conditions permitting approximately 10% sequence divergence. The homologous sequence occurs in approximately single copy per haploid genome in both molluscs. DNA from *Escherichia coli*, the sea urchin *Strongylocentrotus purpuratus*, and the slime mold *Dictyostelium discoideum* did not hybridize to the probe sequence.

E.R.W. acknowledges the encouragement of the staff and students of the 1983 Physiology course, especially Drs. R. Chisholm, P. Lefebvre, and C. Silflow. This work was carried out under the generous support of the James S. Mountain Memorial Fund.

Mitochondrial and spherosomal movement along a filamentous network in the marine slime mold Gymnophrydium marinum. STANLEY W. WATSON (Woods Hole Oceanographic Institution), BRUCE J. SCHNAPP, AND ROBERT V. RICE.

Over 60 years ago investigators became aware of a rapid transport of optically detectable organelles in eucaryotic cells. Why and how these organelles move still awaits experimental verification. Electron microscopic studies strongly suggest that some organelle transport is associated with microtubules or microfilaments, and bidirectional movement of submicroscopic particles along linear structures in axons has been elegantly demonstrated by Allen *et al.* (1982, *Biol. Bull.* **163**: 379).

Present studies concern the multidirectional movement of mitochondria, spherosomes, and other unidentified particles along a cytoplasmic filamentous, undulating network (100–200 nm in diameter) at velocities of 1–2 $\mu\text{m s}^{-1}$ in the marine slime mold *Gymnophrydium marinum*. Movement along this cytoplasmic network is observed with both phase-contrast and differential interference contrast (DIC) microscopy but the DIC image is greatly improved employing video and computer enhancement.

The biochemical nature of these filaments has not been identified but it seems unlikely that they represent bundles of microtubules since the network is not disrupted nor does the transport of cytoplasmic particles cease or appear effected in 10^{-3} M concentrations of colchicine. Cytoplasmic particles move along the filaments in this branching network and are most clearly observed in the flat lobopodia (less than a μm thick). Similar filaments are observed in the narrow dense rhizopodia, but in these pseudopodia extensive branching of the filaments is not observed. The undulating nature of these filaments suggest that they may be composed of contractile proteins which in an unknown manner interact with organelle membranes resulting in a rapid transport of such particles.

Rise of free intracellular Ca^{2+} in mouse macrophage associated with $\gamma 2\text{b}/\gamma 1$ Fc receptor-ligand interaction. JOHN DING-E YOUNG (The Rockefeller University, New York, NY 10021).

Binding of the mouse macrophage $\gamma 2\text{b}/\gamma 1$ Fc receptor (FcR) by immune complexes triggers a number of dramatic responses, which include secretion of inflammatory metabolites and phagocytosis. Previous work has shown that FcR behaves as a ligand-dependent ion channel.

A rise of free cytosolic Ca^{2+} concentration $[\text{Ca}^{2+}]_i$ is a key regulator of cell surface-activated responses. We now report on $[\text{Ca}^{2+}]_i$ changes associated with FcR-ligand interaction. We used quin-2A/M to measure $[\text{Ca}^{2+}]_i$. J774 macrophages grown in spinner cultures showed a loading efficiency of 15–20% (or [quin-2], of 0.11–0.13 mM) with 20 μM of quin-2A/M. The maximum signal-to-noise ratio was 3.5–4.0. The resting $[\text{Ca}^{2+}]_i$ was 87 nM (± 15 SE; $n = 9$) which could be lowered to 29 nM (± 9 SE; $n = 6$) after a 30 min incubation in Ca^{2+} -free medium. Addition of A23187 (10 nM) raised $[\text{Ca}^{2+}]_i$ to $> 1 \mu\text{M}$. Addition of the monoclonal antibody 2.4G2 IgG (5×10^{-7} M), which binds to a functional site of FcR, raised $[\text{Ca}^{2+}]_i$ to ~ 400 nM within seconds. This response was transient (lasting 5–10 min) and showed dose-dependence. The monovalent ligand 2.4G2 Fab (10^{-6} M) gave only a small response (~ 120 nM) and was capable of blocking cell response to subsequent addition of 2.4G2 IgG. Ligands of higher valence (soluble and precipitable immune complexes) were more effective in raising $[\text{Ca}^{2+}]_i$, at much lower concentrations. Incubation of macrophages with antibody-coated erythrocytes raised $[\text{Ca}^{2+}]_i$ to μM levels. $[\text{Ca}^{2+}]_i$ changes were only partially inhibited by the absence of external Ca^{2+} or following incubation with valinomycin or FCCP (10 μM , 30 min). Depolarizing cells with 50 mM KCl raised $[\text{Ca}^{2+}]_i$ to ~ 180 nM. Preliminary experiments show that buffering $[\text{Ca}^{2+}]_i$ with 100 μM quin-2A/M in the absence of external Ca^{2+} inhibited phagocytosis of antibody-coated erythrocytes by macrophages. Together, these data suggest a rise of $[\text{Ca}^{2+}]_i$ following binding to FcR that is due to influx of external Ca^{2+} and release of Ca^{2+} from internal stores. These Ca^{2+} stores are not limited to mitochondria. The Ca^{2+} response is associated with receptor cross-linking and aggregation by ligands and cannot be explained solely by a membrane depolarization effect induced by ligands.

This work was supported by a fellowship from the Grass Foundation. Suggestions and advice from Dr. Joel Brown are heartily acknowledged.

Ocular lens aging in the skate. SEYMOUR ZIGMAN, TERESA PAXHIA, BLEND A ANTONELLIS, AND WILLIAM WALDRON (University of Rochester School of Medicine and Dentistry, Rochester, NY 14642).

Skate lenses were used to study age related changes in gross and microscopic morphology and in protein state (degree of aggregation). Lens weight of fresh *Raja erenacea* and *Raja eglanteria* was plotted against body weight. Lens weights increased colinearly until plateaus began at 110 mg (*R. erenacea*) and 160 mg (*R. eglanteria*). Lens weight increase relative to body length or wing span were less definite.

After capsule removal, skate lenses were homogenized whole or after separation into concentric layers (outer cortex, inner cortex, outer nucleus, nuclear core) in PO_4 buffer (pH 7.4). Soluble and insoluble fractions were separated by centrifugation (100,000 $\times g$ for 30 min). Insoluble proteins were extracted successively with 8M urea, 1% SDS, and SDS + 50 mM DTT. Extracts were examined by Lowry analyses and SDS polyacrylamide gel electrophoresis (PAGE), and soluble proteins were subjected to high pressure liquid chromatography (HPLC). Insoluble protein levels became equivalent with soluble proteins in lenses weighing 125 mg to 145 mg. In lenses weighing 400 mg, insoluble levels were 33% in excess. Such high ratios of insoluble to soluble proteins would cause opacities, so that the high urea level of the skate lens may prevent them.

HPLC indicated a predominance of lens soluble crystallins of 20,000 d molecular weight exclusively in their cores, and additional heavier crystallins in their outer layers. SDS-PAGE revealed soluble crystallins with molecular weights between 18,000 and 22,000 d. Extracts solubilized only by SDS plus DTT contained 26,000 and 22,000 d plus traces of 45,000 d chains. SDS and urea extracted noncovalently-linked chains similar in size to the soluble crystallins, leaving only intrinsic proteins. Insoluble protein in the cores was 50% greater than in outer layers of the lens; 67% of the insoluble protein of outer layers, but only 50% of the cores, were urea and SDS soluble.

Skate lenses are thus useful in assessing both morphological and biochemical features of aging.
Support: National Eye Institute and Research to Prevent Blindness.

DEVELOPMENTAL BIOLOGY

Developmental studies of a major maternal mRNA in Arbacia punctulata. SARAH BRAY (University of Cambridge, England) AND TIM HUNT.

Synthesis of a maternal mRNA which encodes a 41K protein is initiated at fertilization in *Arbacia punctulata* (Evans *et al.* 1983, *Cell* 33: 389–396). This mRNA is present at the same levels in both unfertilized eggs and early embryos, so the onset of synthesis must reflect a change in the ability of the embryo to translate this RNA. We have isolated a cDNA clone to this RNA by hybrid selection and are using it to study the message and its fate during development.

When Northern blots of total RNA are probed using this cloned sequence, it hybridizes to a single RNA species of approximately 3Kb. This is considerably larger than would be predicted for an RNA encoding a 41K protein. However we were unable to detect any processing of this RNA at fertilization or at later stages in development. The RNA persists throughout development as late as pluteus; however at later stages it is a much less abundant component of the RNA population.

We fractionated the RNA from eggs and 4-cell embryos using oligo-dT chromatography and found that this RNA is present in the poly-A containing fraction in both.

Southern blots of genomic DNA from sperm of an individual *Arbacia* cut with different restriction enzymes show two bands of equal intensity hybridizing to the cloned sequence suggesting at least two copies per genome. The clone also cross-reacts with *Strongylocentrotus purpuratus* DNA and RNA.

The protein encoded by the RNA binds quantitatively to an anti-yeast-tubulin affinity column (Kilmartin *et al.* 1982, *J. Cell Biol.* 93: 576-582). We hope ultimately to elucidate how the RNA is regulated and the role of the protein it encodes.

Supported by NIH grant no. GM-31136-05 and the Science and Engineering Research Council of Great Britain.

Induction of heat shock proteins in early embryos of Arbacia punctulata. SARAH HOWLETT, JOHN MILLER, AND GILBERT SCHULTZ (University of Calgary).

We have re-examined the ability of early sea urchin embryos to synthesise heat shock proteins (hsps). By raising the culture from 20-22°C to 31°C, a discrete set of new proteins are induced, the major species being 70,000 d (70K) in molecular weight. The hsp 70 was detectable within 25 minutes following heat shock, together with several minor polypeptides (118, 60K). Little, if any, reduction in total protein synthesis was observed.

We have confirmed that synthesis of hsp 70 is not inducible in unfertilized eggs or early embryos. The first time at which hsp 70 is inducible appears to be at about the 64 to 128 cell stage, and the response remains through hatching blastula and gastrula stages. With the possible exception of 2 and 4 cell embryos, most (greater than 75%) heat shocked embryos continued to develop to form normal hatched blastulae following an hour long heat shock.

Heat shock in the presence of 20 µg/ml actinomycin D to inhibit mRNA synthesis confirmed the heat shock response to be dependent upon novel transcription. Indeed, *in vitro* translation in a reticulocyte lysate cell free system of RNA extracted from heat shocked hatched blastulae showed an abundance of this hsp 70. Further, a *Drosophila* genomic DNA fragment complementary to the coding region of a hsp 70 gene hybridised to polyadenylated RNA from mid-cleavage (32-128 cells) and gastrula stages after heat shock but not to mRNA from control or heat shocked embryos up to the 16 cell stage. Further experimentation is aimed at determining the exact cell cycle at which the switch to an inducible state occurs.

This work was supported (in part) by NIH Training Grant 5-T35-HD07098 awarded to the Embryology Course, Marine Biological Laboratory, Woods Hole, MA.

Changes in histone synthesis during Arbacia development. P. E. KUWABARA, K. GREER, S. MAEKAWA, AND E. S. WEINBERG (University of Pennsylvania).

Histone protein in early developmental stages of *Arbacia punctulata* was studied using *in vivo* labeling of eggs and embryos. Embryos were pulse labeled with ³H-leucine and ³H-lysine after aliquots were removed at five different times after fertilization. Total cell histones were extracted with H₂SO₄ and run on either an 18% polyacrylamide-SDS gel or a Triton X-acid-urea gel. The H1 synthesized in the first 30 min after fertilization co-migrates in the SDS gel with the cleavage stage H1 of *Strongylocentrotus purpuratus*. In the next 30 min, after nuclear membrane breakdown, the synthesis of an H1 protein which co-migrates with *S. purpuratus* α-H1 is seen. A similar shift is observed among the subtypes of the H2A histones resolved on a Triton X gel. Accumulation of newly synthesized histones after fertilization and in unfertilized eggs was demonstrated by continuous labeling with ³H-leucine. Samples were removed at 10 min intervals and prepared for analysis on SDS-polyacrylamide gels by trichloroacetic acid precipitation followed by an acetone wash. Synthesis of histone proteins is detectable at twenty min after fertilization and is also seen in the unfertilized egg. This indicates that some histone message is available for translation before nuclear envelope breakdown and even before fertilization. Continuous labeling was also done in the presence of 5 µg/ml of aphidocholin. In treated embryos, the synthesis of the histone proteins occurs during the first 30 min after fertilization but further increase is inhibited. This effect could be related to the inhibition of DNA synthesis by aphidocholin or to the prevention of nuclear membrane breakdown and consequent prevention of histone mRNA release. Aphidocholin also prevented the normal

disappearance at first cleavage of a protein believed to be α -cyclin. Other proteins, including β -cyclin, are synthesized as in the control embryos.

Supported by NIH grant GM-31136-05 to the Physiology Course.

Accumulation of late H2b histone mRNA in sea urchin embryogenesis. GARY LYONS (University of Pennsylvania School of Medicine), SUSAN HALSELL, AND ROB MAXSON.

Three distinct histone protein subtypes appear during embryogenesis of the sea urchin *Strongylocentrotus purpuratus*. The switches in histone synthesis occur as a result of changes in the activity of different histone gene sets. As a first step toward characterizing the kinetics of this system, the levels of transcripts at successive stages of development were measured.

A 183 nucleotide cloned late H2b histone gene probe was used in these experiments. This probe hybridizes to other members of the late H2b gene family but not to early H2b genes under appropriately stringent conditions. RNA gel blots and RNA dot hybridizations were hybridized with nick-translated probe DNA to determine the relative amounts of histone mRNA at various developmental stages. The absolute amount of mRNA present at a given stage was measured by hybridizing the probe to increasing amounts of RNA. Total RNA of 72 hour pluteus larvae was titrated with single stranded DNA probe synthesized on an M13 phage DNA template containing the late H2b fragment. The specific activity of the probe was 1) calculated from the known specific activity of the ^{32}P -ATP and the known sequence of the probe and 2) measured by titrating the probe with increasing amounts of cold DNA. The two estimates were in close agreement and a value of approximately 2×10^8 cpm/ μg was obtained. From the RNA titration curve the probe was determined to be 75% hybridizable. The level of late H2b mRNA was determined to be 4.7×10^5 RNA molecules/embryo. From this information and from the relative amounts of mRNAs determined by scanning the Northern blots and dot hybridizations, it was possible to determine the number of mRNA molecules present at each stage. It was found that late H2b mRNA levels increase rapidly between 14 and 16 hours, reach a peak of 6.2×10^5 RNA molecules/embryo at 22.5 hours, and start to decrease at the pluteus stage.

The probe was also used to assay adult tissues for late histone mRNA. RNA was isolated from gonad, coelomocyte, intestine, and tube foot tissue by guanidine thiocyanate or phenol extraction. After fractionation on a gel and transfer to nitrocellulose, the RNA was allowed to hybridize the radiolabeled probe. The results show that molecules of the late H2b class are present in all adult tissues, though in smaller amounts than in the embryo.

This work was supported (in part) by NIH Training Grant 5-T35-HD07098 awarded to the Embryology Course, Marine Biological Laboratory, Woods Hole, MA.

A video time lapse study of cell behavior during notochord morphogenesis in ascidian embryos. DAVID M. MIYAMOTO (Seton Hall University).

Ascidians are attractive organisms to study how cells form structures in living embryos. Video time lapse recordings of notochord cell behavior during gastrulation and tail formation in dechorionated embryos of *Ciona intestinalis* were made using a perfusion chamber that maintained temperature at 18–19°C and permitted the use of oil immersion Nomarski microscopy. The eight central notochord cells become flask-shaped as they turn inwards to form the anterior lip of the blastopore. As the lip moves posteriorly, these cells divide parallel to the embryonic axis, away from the lip. Internalized cells divide out of synchrony with those that remain part of the lip. Lip cells lose their attachment to the blastopore only as it becomes smaller and enclosed within the forming posterior neural tube. No distinctive surface activity such as blebbing was evident in these cells during gastrulation.

After gastrulation the notochord is a mass of spindle and wedge-shaped cells that show rhythmic back and forth movements as they interdigitate to form a strand of disc-shaped cells lined up end to end (early tailbud, 9 h). These cells decrease in diameter as they increase in length as the tail elongates at a rate of 1.3 $\mu\text{m}/\text{min}$. Basal surfaces adjacent to surrounding tissues begin to bleb actively, probably an indication of the formation of the extracellular sheath described by others. Intracellular vacuoles appearing at this time show dynamic behavior, extending and retracting bulges in various directions, as they increase in size. Separating partitions disappear at about 16 h as these intracellular vacuoles fuse to form the intercellular vacuoles described by others. Blebbing activity begins to decline in intensity at this point and at the time of normal hatching (18 h), cell surfaces are quiescent. Cytoplasm and nuclei shift toward the periphery and intercellular vacuoles combine to form the internal matrix core as previously described by other workers.

The author gratefully acknowledges the assistance of Dr. J. R. Whittaker and Robert Crowther (Boston University Marine Program) in this work. The work was supported by a University Research Council Grant from Seton Hall University and NSF Research Instrumentation Grant, RII-821021.

Rates of 5S RNA and tRNA synthesis in sea urchin embryos animalized by Evans Blue. ANNE F. O'MELIA (Department of Biology, George Mason University, Fairfax, VA 22030).

The application of certain chemicals to whole sea urchin embryos between early cleavage and the blastula stage interferes with normal cell associations and interactions producing characteristic malformations in germ layer formation, termed animalization (ectodermalization) and vegetalization (endomesodermalization). Animalization of *Arbacia punctulata* embryos was induced by culturing embryos in Evans Blue continuously from the 2-cell stage. Previous research showed that the accumulation of the newly synthesized nucleolar ribosomal RNAs (26S, 18S rRNAs) is strongly inhibited in Evans Blue-animalized embryos (O'Melia 1983, *Dev. Growth Differ.* 25: 171-180). The present study determined the effect of this animalizing agent on the synthesis of the third rRNA, 5S RNA, and of transfer RNA (tRNA). Cultures of mesenchyme blastulae, plutei and corresponding animalized embryos each were labeled for 3 h with [8-³H]-guanosine. Total RNA was extracted using the cold (4°C)-phenol-SDS method and purified (NaCl-soluble) RNA preparations were fractionated by electrophoresis on 10% polyacrylamide gels. Rates of accumulation of newly synthesized 5S RNA and of tRNA in control and in animalized embryos were calculated from the radioactivity coincident with the 5S RNA and with the tRNA absorbance peaks (A_{260nm}) on each gel, from the known GMP composition of sea urchin 5S RNA and tRNA, and from the average specific radioactivity of the GTP precursor pool during the 3 h labeling period. The results showed that the rates of accumulation of newly made 5S RNA and tRNA per embryo and per cell are similar in control and in Evans Blue-animalized embryos at each stage. Therefore, the alterations in cell associations, interactions, and germ layer formation induced by Evans Blue did not affect the synthesis of 5S RNA and of tRNA in sea urchin embryos.

Support: Office for Research and Advanced Studies, George Mason University.

Reproduction in Haploplana and Stylochus: developmental and cytoskeletal research possibilities. PAUL P. PALASZEWSKI AND BARBARA C. BOYER (Union College).

An unusual cytoplasmic blebbing coinciding with polar body formation in the determinative eggs of *Hoploplana inquilina* and *Stylochus zebra* make these hermaphroditic polyclad turbellarians valuable research animals for developmental studies. *H. inquilina*, obtained from the mantle cavity of *Buyscon* sp., and *S. zebra*, collected from *Pagurus* shells, were maintained in finger bowls of sea water and remained reproductively active for 8 weeks. Artificial fertilization, by manually releasing gametes, provided eggs free from the impermeable membrane normally surrounding them.

Both blebbing and cleavage were inhibited by colchicine and taxol at approximate concentrations of 10 µg/ml and 1 µg/ml respectively. *H. inquilina* was slightly more sensitive than *S. zebra*. *H. inquilina* eggs in 0.25 µg/ml taxol displayed normal bleb formation but their characteristic resorption was incomplete and the cleavages were abnormal. In both species blebbing and cleavage were unaffected by cytochalasin B concentrations as high as 20 µg/ml. These results suggest a microtubule associated cytoskeletal mechanism for this blebbing, which may function in cytoplasmic localization and other early organizational events of development.

Comparisons of gonad development as a function of body length indicate that testes and ovaries develop concurrently in *H. inquilina*. However, 20% of the *S. zebra* specimens collected were male, averaging 1.2 cm in length; the remainder were hermaphroditic and averaged 1.9 cm in length. Additionally, since testes appeared to mature before ovaries a protandric transition in *S. zebra* is hypothesized.

In culture, *H. inquilina* produced an average $0.20 \pm .03$ egg masses-animal⁻¹-day⁻¹. Peak laying activity followed a consistent 3 day cycle and productivity decreased linearly as a function of time in captivity.

This work was supported by a Research Corporation Grant to B. Boyer.

Cell-cell recognition and adhesion during embryogenesis in the sea urchin. E. GAYLE SCHNEIDER (University of Nebraska Medical Center).

The object of the current study was to investigate species-specific recognition and adhesion between dissociated embryonic cells of hatched blastulae of *Arbacia punctulata*, *Lytechinus variegatus*, and *Strongylocentrotus purpuratus* using a quantitative reaggregation assay. The assay used is a modification of one previously developed by McClay and Hausman (1975, *Dev. Biol.* 47: 454-460) and involves collection

of labeled single cells to preformed collecting aggregates. The aggregates are prepared by dissociation of blastulae in calcium and magnesium-free sea water. The dissociated cells are allowed to reaggregate in stationary culture; the aggregates are collected by centrifugation and washed. The labeled probe cells are prepared by incubation of blastulae in [^3H]leucine and dissociation of these as above. The assay consists of mixing labeled probe cells ($0.15\text{--}0.8 \times 10^6$ cells/ml) with various concentrations of aggregates in a total volume of 2 ml for 2 h in suspension culture. The aggregates and adhered probe cells are separated from unadhered probe cells by gentle centrifugation, and the percent reaggregation of probe cells to the aggregates is determined. The results indicate no significant adhesion to aggregates for probe cells fixed by glutaraldehyde or formaldehyde or disrupted by sonication. In addition, fixation of aggregates by glutaraldehyde greatly diminished binding of probe cells. Finally, adhesion of probe cells to homospecific aggregates was significantly greater than that to heterospecific aggregates. The results demonstrate reciprocal species-specific adhesion between *Arbacia punctulata* versus *Strongylocentrotus purpuratus* and *Arbacia punctulata* versus *Lytechinus variegatus*. The results extend previous work with other species and suggest that species-specific recognition is a universal phenomenon in the sea urchin. In addition, this recognition, as measured by the present assay, requires living cells.

This work has been supported by a 1982-83 Steps Toward Independence Fellowship from the Marine Biological Laboratory and by a grant from the National Science Foundation (#PCM-8118503).

Leukotriene B₄ promotes the calcium-dependent aggregation of marine sponge cells.

GERALD WEISSMANN, CATHLEEN ANDERSON, LESLIE B. VOSSHALL, ABBY M. RICH, KATHLEEN A. HAINES, TOM HUMPHREYS, AND PHILIP DUNHAM (Marine Biological Laboratory).

We have previously reported that aggregation of dissociated *Microciona prolifera* cells induced by Ca, Ca-ionophores such as A 23187, and specific aggregation factor (MAF) resembles the active, stimulus-response coupling of human neutrophils (Dunham *et al.* 1983, *Proc. Natl. Acad. Sci.* **80**: 4756-4760). We now report that sponge cells, stimulated by >5 mM Ca added to Ca-free media take up ^{45}Ca from the medium. Uptake was saturable ($K_{1/2}$ approx. 10 mM) and was not reversible by excess La or EDTA. MAF-induced aggregation was accompanied by 40 percent enhancement of ^{45}Ca influx. Cells pre-loaded with chlorotetracycline (CTC) underwent prompt decrements in CTC fluorescence upon addition of Ca, indirect evidence for mobilization of endogenous membrane-associated Ca. Aggregation, ^{45}Ca influx, and decrements in CTC fluorescence were inhibited by non-steroidal antiinflammatory agents (indomethacin, ibuprofen, piroxicam; 50-100 μM), usually considered to act by inhibiting arachidonate oxidation *via* the cyclooxygenase pathway to stable prostaglandins. Yet *Microciona* cells were neither aggregated, nor prevented from aggregating in response to MAF or ionophore, by cyclooxygenase products (PGE₁, PGF_{1 α} , PGF_{2 α} , PGE₂, PGI₂, PGE₁, PGB₁, PGD₂; 5 μM — 1 mM \pm theophylline). In contrast, the 5-lipoxygenase product leukotriene B₄, an aggregant of neutrophils, provoked Ca-dependent aggregation (<1 μM), and nordihydroguaretic acid, a lipoxygenase inhibitor, inhibited MAF- and ionophore-induced aggregation. Other lipoxygenase products (5-, 12-, 15-HETE; *trans* isomers or *omega* metabolites of LTB₄; 14,15-diHETE; 2 μM) failed to influence sponge cell aggregation. Colchicine (1 mM, 20 min), which specifically inhibits LTB₄ synthesis of ionophore-stimulated neutrophils, inhibited sponge cell aggregation induced by MAF or ionophore, but had no effect on ^{45}Ca influx. The data suggest not only that sponge cells utilize leukotriene B₄, or a similar product, as part of a Ca-dependent, stimulus-response coupling sequence, but that non-steroidal antiinflammatory agents cannot exert all of their biological effects by simply inhibiting extracellular release of stable prostaglandins.

Evidence for regulation of protein synthesis at the level of translational machinery in the sea urchin egg. MATTHEW WINKLER AND BREWER SHETTLES (Department of Zoology, University of Texas, Austin, TX 78712).

Fertilization of the sea urchin egg results in a 20-40 fold increase in the rate of protein synthesis. This increase is mediated by the mobilization of stored maternal mRNA into polysomes. It is not known if this process is regulated at the level of mRNA availability (masked message hypothesis) or at the level of the translational machinery. We have used a novel *in vivo* assay to try to distinguish between these two possibilities.

Unfertilized *Arbacia punctulata* eggs were incubated for 45 minutes in 10^{-4} M emetine, a potent protein synthesis elongation inhibitor. These eggs and untreated controls were fertilized and, at various time intervals aliquots, were removed and processed for sedimentation on high salt sucrose gradients. Before sedimentation samples were treated with ribonuclease A. Under these conditions polysomes are converted into 80S monomers which are resistant to high salt. Free 80S ribosomes will be dissociated into 40 and 60S subunits. This procedure allows one to easily determine the percent of ribosomes in

polysomes. Stored mRNAs in emetine treated eggs would be expected to bind a single ribosome as they move into polysomes. If mRNAs are being activated then there should be 1/(average number of ribosomes per polysome) amount of high salt resistant 80S ribosomes. If some component of the translational machinery were being activated, then emetine treated eggs and the controls should have equal amounts of high salt resistant 80S ribosomes. We find that emetine treated eggs have from 50–80% of the control value of high salt resistant 80S ribosomes. This value is significantly larger than the 15–20% expected if mRNA availability limited protein synthesis. This result indicates that protein synthesis is regulated at the level of the translational machinery at fertilization, possibly by activation of ribosomes.

This work was supported in part by NIH training grant 5-T35-HD07098 awarded to the Embryology Course, Marine Biological Laboratory, Woods Hole, MA and NIH grant HD 17722-01 awarded to M.W.

ECOLOGY, EVOLUTION, AND PLANT SCIENCES

Current flow around Zostera marina plants and flowers: implications for submarine pollination. JOSEF D. ACKERMAN (SUNY, Stony Brook, NY).

Zostera marina L. (eelgrass) is a marine angiosperm possessing a unique flowering morphology, which suggests a singular adaptation to submarine pollination. The physical aspects of this process were examined on both a macro and micro scale, in an eelgrass bed in Great Harbor, Woods Hole, MA, and in a flume (flow channel) in the laboratory. Dyes and Sephadex particles were used to mark the flow. Flow rates ($1-2 \text{ cm s}^{-1}$) observed in the eelgrass canopy were simulated in the flume. Current flow patterns were photographed and videotaped using a Zeiss stereomicroscope. Individual particle trajectories were tracked on the frame advance mode for videotaped sequences.

Flow velocity was reduced in the eelgrass bed by 10-fold compared to that observed outside the bed. Vertical stratification of velocity within the canopy was noted, with flow decreasing towards the sea floor. The rhipidia (flowering branches) were found in the top two-thirds of the canopy. The overlap of inflorescences on a rhipidium further reduced current velocity 5-fold. The most marked change in current velocity and flow occurred within 3 mm of a female flower, with velocity being reduced from 1.5 to 0.1 cm s^{-1} , and flow directed towards a focal zone downstream from the stigmata. There is an upward movement of water from the blade towards the stigmata, and a net downward draw of water along the length of an inflorescence. These changes in flow result from a 12-fold increase in the area of water influenced by a female flower.

Density of mature female flowers was established, and combined with current flow measurements, provided an encounter frequency of water particles with flowers. From these calculations, it has been determined that under moderate flow conditions, any particle within a m^2 will encounter a mature stigmata within 5–20 minutes. From these observations it is concluded that the search time for pollen must be short. This corresponds to the short exposure time for female flowers (4–6 h). Submarine pollination in *Zostera marina* is a process mediated by floral morphology as it influences current flow.

Special thanks to Phillip H. Presley for providing Zeiss instruments.

Population ecology of the Caribbean bivalve Asaphis deflorata (Linné, 1758). PHILIP ALATALO AND CARL J. BERG, JR. (Marine Biological Laboratory).

Field studies of the Caribbean bivalve *Asaphis deflorata* were conducted at Gold Rock Creek, Grand Bahama Island, to establish life history parameters. *Asaphis deflorata* lives intertidally among coarse rock gravel, 5–15 cm below the surface. It feeds on phytoplankton and organic detritus using long, extendible siphons. Population densities average 34 clams/ 25 m^2 , but may reach 87 clams/ 25 m^2 .

The total of all monthly size distribution samples were fit to the von Bertalanffy growth curve using the ELEFAN I computer program and predicted curves were corroborated with probit analysis of individual monthly samples. Mean sizes of 19, 33, 43, 52, and 58 mm were calculated for animals 1 year through 5 years old respectively.

Seasonal analysis of body parameters revealed an increase in dry meat weight for all size animals from January to June. Individuals greater than 40 mm shell length failed to gain dry tissue weight through September, suggesting summer spawnings for these larger animals.

Asaphis deflorata is dioecious and becomes sexually mature at shell lengths greater than 25 mm. Based on histological analysis of gonads, it appears that natural spawnings occur between July and September at water temperatures above 25°C . Eggs spawned in the laboratory range in size from 60–65 μm diameter. Larvae are planktotrophic and exhibit a brief pediveliger stage 10–12 days after spawning

at 25–29°C. Metamorphosis occurs at a size of 161–205 μm shell length. No specific substrate is required for metamorphosis. Growth rates in the laboratory were slower than those predicted from population samples.

Supported by funds from the Wallace Groves Aquaculture Foundation, Freeport, Bahamas.

Genetic variation in the queen conch, Strombus gigas, across its geographic range.

Preliminary results. CARL J. BERG, JR., KATHERINE S. ORR, AND JEFFRY B. MITTON (Marine Biological Laboratory).

The queen conch, *Strombus gigas*, is an economically important gastropod mollusk distributed throughout the Caribbean Basin, the Bahamas, and in Bermuda. It has pelagic larvae that remain in the water column a minimum of 21 days, so the potential exists for long distance dispersal in this species. Little is known, however, about the actual distances that larvae travel before abandoning the planktonic stage of the life cycle and becoming benthic juveniles. Therefore a study of geographic variation of protein polymorphisms was conducted to determine the degree and pattern of genetic differentiation. Population samples were collected from four keys in the Turks and Caicos Islands; Carriacou in the Grenadines; Ambergris Cay in Belize; and from Bermuda. Starch gel electrophoresis was conducted upon proteins in the digestive gland of the conch.

Preliminary analysis of four polymorphisms (malate dehydrogenase 1 and 2, phosphoglucosmutase, and aminopeptidase) revealed statistically significant differentiation in two of the four polymorphisms among the different geographic areas. Similar analyses among the four keys within the Turks and Caicos Islands did not reveal any significant differentiation. These preliminary results suggest that there is not sufficient dispersal between these widely spread island groups to prevent genetic differentiation.

Supported by the World Wildlife Fund-U. S.

The acquisition of a collection of western north Atlantic fishes (Pisces) by the Gray Reference Collection, Marine Biological Laboratory, Woods Hole, MA. ALAN H. BORNBUSCH (Department of Zoology, Duke University, NC.).

During the summer of 1983, the George M. Gray Reference Collection, a synoptic collection of the flora and fauna of the United States Atlantic coast from the Gulf of Maine to Cape Fear, SC, received approximately 1200 specimens of western north Atlantic fishes (Pisces). Included are representatives of 74 families and 126 species, collected between 1929 and 1973 by the Woods Hole Laboratory of the National Marine Fisheries Service (NMFS) and previously kept in storage. Prior to accessioning into the Gray Collection, all identifications were checked and unidentified lots were identified by A. Bornbusch. Several specimens were found to be of interest, two of which are briefly mentioned here: a single specimen of *Eumicrotremus spinosus* (Müller) (Cyclopteridae) was collected in the area of 42° 43'N, 70° 20'W; and a specimen of *Caristius*, Gill & Smith (Caristiidae) was trawled 40 miles east of Nantucket, MA at a depth of 70 to 82 fathoms. The latter specimen is of a standard length of 17.0 cm.

With the addition of the NMFS material, 110 families and 317 species of Atlantic fishes are now represented in the Gray Collection, thereby forming an important regional reference collection of western north Atlantic fishes.

This project was made possible by a National Science Foundation Predoctoral Fellowship and a grant from the Stephen H. Tyng Foundation of Williams College to A. Bornbusch. The help and advice of Dr. Louise Bush, Curator and C. Diane Boretos, Assistant at the Gray Collection, and Roger Theroux (NMFS) are gratefully acknowledged.

Anaerobic chitin degradation as a carbon and hydrogen source for sulfate reduction and methanogenesis in salt marsh bacteria. JOSEPH N. BOYER (Virginia Institute of Marine Science) AND RALPH S. WOLFE.

The anaerobic pathway of chitin decomposition was studied with an emphasis on product coupling to other bacteria present in the marsh. Sediment samples were taken from Great Sippiwissett Marsh and plated onto selective media for the isolation of chitin degraders, sulfate reducers, and methanogens. Inoculations were performed under strict anoxic conditions using modified Hungate technique. Chitin degraders were characterized as forming a zone of clearing around colonies on chitin agar. Black colonies formed by the precipitation of ferrous sulfide were indicative of sulfate reducers. Methanogens produced methane when grown under hydrogen-carbon dioxide atmosphere. Isolates transferred to chitin broth medium were assayed for degradation products. Gas chromatographic analysis of headspace and medium after incubation at 30°C for five days indicated the presence of acetate, hydrogen, and carbon dioxide.

Neither sulfate reducers nor methanogens grew on chitin as sole carbon source. When chitin degraders were combined with methanogens in chitin medium, 20 mmoles of methane and 50 mmoles of acetate per 100 mmoles chitin were produced anaerobically. Cocultures of chitin degraders and sulfate reducers resulted in 35 mmoles of acetate with positive sulfide production. The combination of all three metabolic types in a single tube resulted in the production of 37 mmoles acetate, 5 mmoles methane, and positive sulfate reduction. It is interesting to note that the acetate levels in cultures containing sulfate reducers were significantly lower than those without. This is consistent with the fact that some sulfate reducers can use acetate as primary substrate. It seems clear that chitin degrades anaerobically and that the products are coupled via interspecies transfer to both sulfate reduction and methanogenesis.

Speciation in the brine shrimp Artemia: cross-breeding between sexual Mediterranean populations. ROBERT BROWNE (Wake Forest University).

Due to implications with regard to studies on partitioning the environmental and genetic components of life history traits (Brown *et al.* in press, *Ecology*) and on the biogeographic distribution of brine shrimp populations (Browne and MacDonald 1982, *J. Biogeogr.* 9: 331-338), three sexual Mediterranean populations of *Artemia* were tested for cross-breeding potential. Virgin adults from Tunis Tunisia (TUN), Lanarca Lake Cyprus (CYP), and Santa Pola Spain (SP), were reciprocally test crossed using the following format and number of test pairs: TUN-TUN (3), CYP-CYP (7), SP-SP (6), TUN-CYP (8), TUN-SP (6), and CYP-SP (7). All offspring produced were cysts, with the ratio of cysts hatched/total cysts produced as follows: TUN-TUN 19/49, CYP-CYP 12/186, SP-SP 18/121, TUN-CYP 66/366, TUN-SP 22/142, and CYP-SP 1/13. Although hatch rates are low in some crosses, subsequent hydrations may increase yields, as has been found in past studies. Crossing experiments are to some extent complicated by a small number (approximately 5%) of parthenogenetic females in the SP population. However, for each of the three population crosses, viable cyst(s) were obtained from an SP male sire. F₁ progeny from all crosses have been successfully reared to 18 days of age. Low cyst production in CYP-SP crosses is attributed primarily to abbreviated adult lifespan in that group. Although F₁ crosses need to be conducted to check for hybrid infertility, it is suggested that the three populations be grouped within the *A. tunisiana* designation.

Supported by an Archie Fellowship and a Research and Publication Fund grant from Wake Forest University and travel funds from the Southern Regional Education Board.

Iron and phosphorus cycling in a permanently stratified coastal pond. NINA CARACO (Boston University Marine Program, Marine Biological Laboratory) AND IVAN VALIELA.

Although uptake by algae is generally assumed to be the only important phosphate removal mechanism in aquatic ecosystems, chemical reactions may remove phosphate from solution before it reaches the biota. Iron oxides, which form at oxic/anoxic interfaces (oxyclines), are known to rapidly remove phosphate from solution. Such chemical scavenging in aquatic systems can be important in regulating the supply of phosphate from anoxic bottom waters to algae in the photic zone. We examined this process in Siders Pond.

Siders Pond is a salt-stratified, meromictic coastal pond. The bottom waters are anoxic and during 1982-83 the depth of the oxycline varied between 2.5 and 7 m. Growth of phytoplankton is limited by the supply of phosphate to the euphotic surface waters. The permanently anoxic bottom waters are extremely high in dissolved P (up to 80 μM). Vertical mixing in Siders Pond could, therefore, supply large quantities of phosphate to surface waters and stimulate phytoplankton growth.

To determine if scavenging of phosphate by iron oxides at the oxycline occurred, we analyzed suspended particulates from the surface of the pond to 15 m (maximum depth) throughout the year. Particulate iron and phosphorus profiles showed peaks at the oxycline during most samplings, indicating the phosphorus was being scavenged by iron oxides. In addition, these peaks in iron and phosphorus were not usually associated with peaks in particulate organic carbon (POC) indicating the particulate phosphorus at the oxycline was not all bound to organics. Both above and below the oxycline the POC:P ratios in the pond were 100 to 200, whereas, the ratio at the chemocline ranged from 30 to 100.

To help quantify the importance of iron oxides in removing phosphate from the water column, the downward flux of particulates was measured using sediment traps suspended at the bottom of the euphotic zone, at the oxycline, and at 13 m. We found that phosphorus flux was usually highest in the trap at the oxycline. This peak in phosphorus flux was associated with a peak in Fe flux. As with the suspended particulates, sediment trap material had lowest POC:P values at the oxycline. We estimate that about half of the phosphate fluxing through the oxycline is associated with iron oxides. Chemical scavenging by iron oxides is, therefore, significant in controlling the supply of phosphate to the photic zone in Siders Pond.

Interactions of harpacticoid copepods and photosynthetic microbes in the salt marsh

ALAN W. DECHO (Louisiana State University) AND RICHARD W. CASTENHOLZ.

A sandy drainage channel at Great Sippewissett Marsh, West Falmouth, was investigated during early July with respect to its photosynthetic microbial flora and meiobenthic harpacticoid copepods. The channel exhibited three zones, based on the color patterns of the sediments generated by the resident microbial populations. A diatom zone, located near the center of the channel, was composed primarily of naviculoid diatoms (densities = $4.44 \pm 0.49 \times 10^6 = \bar{x} \pm \text{SD} \cdot \text{cm}^{-3}$). A purple zone, adjacent to the diatom zone, was composed of the purple sulfur bacteria tentatively identified as *Thiocapsa* sp. A clear zone, at the periphery of the channel, showed no apparent microbial coloration. Spectrophotometric pigment analysis of sediments in the diatom zone, using absolute methanol extraction, showed chlorophyll-a concentrations of $695.2 \pm 78.4 \mu\text{g} \cdot \text{cm}^{-3}$ sediment. This was primarily due to the diatoms and partly to the cyanobacterium *Oscillatoria*. A concentration of bacteriochlorophyll-a of $126.9 \pm 57.2 \mu\text{g}$ was the result of *Thiocapsa*. In the purple zone the chlorophyll-a ($206.4 \pm 71.3 \mu\text{g}$) was less, but bacteriochlorophyll-a ($525.7 \pm 98.6 \mu\text{g}$), a result of *Thiocapsa*, was quite high. In the clear zone chlorophyll-a ($341.3 \pm 126.2 \mu\text{g}$) was generated by several cyanobacteria (*Microcoleus*, *Lyngbya*, *Spirulina*) which encroach from a nearby microbial mat. Bchl-a ($234.5 \pm 116.7 \mu\text{g}$) was again from *Thiocapsa*.

For meiobenthic analyses, fifteen replicate samples were taken from the surface (0–0.5 cm depth) sediments of each zone. Preliminary sampling indicated almost no copepods below this depth. Seven species of harpacticoid copepods were found. Distributional data of three species showed significantly different abundances depending on the zone ($P < 0.001$). *Stenocaris* c.f. *pristina* was found in very high densities ($1032 \pm 125.9 = \text{no} \cdot \text{cm}^{-3}$) in the diatom zone and relatively low densities in the purple (18.8 ± 8.3) and clear zones. *Pseudomesochra* c.f. *divaricata* showed high densities in the purple (367.8 ± 78.4) and clear (631 ± 118.8) zones and low densities (127 ± 68.7) in the diatom zone. *Harpacticus nipponicus* exhibited a similar distributional pattern. The distribution of these species was strongly related to high densities of photosynthetic microbes in their respective zones.

Growth responses of Zostera marina (eelgrass) to in situ manipulations of sediment nitrogen availability. W. C. DENNISON AND R. S. ALBERTE (University of Chicago).

Sediment nitrogen availability to rooted aquatic angiosperms could be an important factor controlling growth and biomass of these plants in coastal marine habitats. Therefore we examined this parameter in relation to growth of the temperate seagrass, *Zostera marina* (eelgrass). *In situ* manipulations of nitrogen availability were conducted with plexiglass chambers containing eelgrass roots, rhizomes, sediments, and a diffusion exchange reservoir for pore water. Plants from shallow (1.3 m) and deep (5.5 m) stations in an eelgrass bed in Great Harbor, Woods Hole, MA, were placed into replicate rhizosphere chambers and grown at the shallow and deep stations for 30 days in June and July, 1983. Nitrogen availability was increased by additions of ammonia (NH_3) to the pore water reservoirs ($>5 \text{ mM NH}_3$) and decreased by periodic flushing of the reservoirs. In control chambers, NH_3 was initially added to the reservoirs to approximate concentrations in the pore water (0.2 mM NH_3) without further manipulations.

At the shallow station, leaf production rates were increased by 70% with additional nitrogen and decreased by 4% with reduced nitrogen availability with respect to the control. Rhizome production rates were increased (+11%) by nitrogen addition and decreased (–8%) by nitrogen reduction. Shoot density increases were higher than controls in the added nitrogen treatment with little change in the reduced nitrogen treatment. At the deep station, leaf and rhizome production rates and shoot densities were unaffected by manipulations of sediment nitrogen availability. These results provide evidence for nitrogen limitation of growth in shallow growing eelgrass while deep station plants do not appear to be nitrogen limited. Previous findings demonstrated light limitation of eelgrass growth at depth. Therefore, two different limiting environmental factors, daily light period and nitrogen availability, can function in determining the growth and depth distribution of *Zostera marina* within a single community.

Research supported by NSF Grants DEB 8210322 and OCE 8214914.

The sensitivity of freshwaters of Cape Cod, Massachusetts to acid precipitation.

JENNIFER DUNGAN (Marine Biological Laboratory), BRUCE PETERSON, AND SALLY MARQUIS.

The annual mean pH of rain on Cape Cod is approximately 4.1. Have these acid inputs decreased the pH of Cape Cod ponds and lakes? Are these surface freshwaters susceptible to a decrease in pH in the future as they receive additional inputs of acid precipitation? The limited data available can only provide a conclusive answer to the second question. The only two relatively complete surveys of Cape Cod ponds and lakes include a 1975 study by the Environmental Management Institute (EMI), which

reported pH, conductivity, and chemical composition; and another begun in 1983, the Acid Rain Monitoring survey (ARM), which is reporting pH and alkalinity. The EMI study showed that the mean pH of surface waters was 5.08 and that approximately 20% of the ponds had a pH lower than 5. The preliminary results of the ARM study confirm the high acidity of many ponds, and further show that the alkalinity of most are in the critical to highly sensitive range.

A model devised by Norwegian scientist Arne Henriksen may be useful in predicting the degree of acidification of Cape Cod ponds. The premise of this model is that non-marine calcium and magnesium are balanced by a nearly equivalent amount of bicarbonate in unacidified waters. Although bicarbonate may be consumed and replaced by sulfate ion during acidification, thereby lowering the alkalinity, calcium and magnesium should still represent unacidified alkalinity. Calcium makes up the major portion of cations that originate from weathering, and may well be adequate for the purpose of the model. A graph of pH versus excess calcium constructed by Henriksen showed a well defined dividing line between the unacidified waters of southern Sweden and the acidified waters of western and central Sweden. The EMI Cape Cod data plotted on a similar graph shows that most of the ponds are in the "acidified" portion.

The Henriksen calcium-pH model suggests but does not conclusively prove that Cape Cod pond chemistry has been changed by acid precipitation. The data do show that Cape ponds have low alkalinity and are likely to be sensitive to acidification.

Growth and photosynthetic responses to temperature of two populations of Zostera marina. ANN S. EVANS (Virginia Institute of Marine Science, College of William and Mary).

The growth and photosynthetic responses to temperature of two disjunct populations of the seagrass *Zostera marina* were investigated during July 1983. Plants were collected in sediment cores from a 24–27°C coastal lagoon, Bourne Pond (Falmouth, MA), and a 20–22°C open coastal environment, Great Harbor (Woods Hole, MA) for growth in aquaria at 15 and 25°C, and for growth in their natural habitats (*in situ* plants). After 2 weeks, photosynthetic characteristics were determined at 15 and 25°C for all growth conditions, and after 4 weeks growth was measured.

The *in situ* Great Harbor plants had greater shoot length and biomass, specific leaf weight, and total production than *in situ* Bourne Pond plants. These growth differences were maintained when plants from both populations were grown at 15°C. The 25°C growth condition resulted in complete mortality of both populations. *In situ* and aquaria plants from both populations had higher maximal rates of photosynthesis (P_{max}) at 25 than 15°C. P_{max} , in $\mu\text{mol O}_2 \text{ mg chl}^{-1} \text{ min}^{-1}$, for plants grown in aquaria and measured at their growth temperature, was 0.43 ± 0.10 at 15°C and 0.49 ± 0.09 at 25°C for Bourne Pond, and 0.18 ± 0.03 at 15°C, and 0.59 ± 0.11 at 25°C for Great Harbor. Similar patterns for P_{max} were observed for *in situ* plants. The Bourne Pond plants grown at 25°C had a P_{max} of 0.15 ± 0.02 when measured at 15°C, which was 31% lower than that at 25°C. The Great Harbor population, when examined under identical conditions, showed a decrease of 36% in P_{max} . In contrast, plants grown at 15°C and measured at 25°C showed 61% and 51% increases for Bourne Pond and Great Harbor plants, respectively.

The fact that both populations had higher P_{max} s at the temperature (25°C) at which mortality occurred indicates that photosynthetic performance does not necessarily predict ecological success. The data further indicate that the Bourne Pond population is phenotypically more plastic than the Great Harbor population to growth temperature. That growth differences were maintained under identical conditions at 15°C suggests the two populations may be ecotypically distinct.

Photosynthetic activity of Zostera marina L. epiphytes in relation to light regime and substratum. L. MAZZELLA (Stazione Zoologica di Napoli, Italy), W. C. DENNISON, AND R. S. ALBERTE.

The epiphytic algae colonizing the leaves of submerged angiosperms such as seagrasses can contribute significantly to the productivity and biomass of these ecosystems. We sought to assess the photosynthetic activity, biomass, and productivity of *Zostera marina* epiphytes in relation to light regime and substratum. Plants were marked *in situ* and collected 15 days later during July 1983, at two stations (1.3 m and 5.5 m) in an eelgrass bed in Great Harbor, Woods Hole, MA. Light regime was manipulated with underwater lamps and shade screens. In addition, artificial eelgrass (polyamide blades) were planted at the control site of both stations and collected after 15 days.

At the shallow station, light saturated photosynthetic activity ($\mu\text{mol O}_2 \text{ dm}^{-2} \text{ min}^{-1}$) of *Zostera* epiphytes was 0.12, 0.06, and 0.01 for increased, control, and decreased light treatments, respectively. A similar trend was found in epiphyte biomass; 25.7, 18.9, and 5.6 mg dm^{-2} at the increased light, control, and decreased light treatments, respectively. At the deep station, epiphyte photosynthetic activity was 0.06, 0.10, and 0.0 $\mu\text{mol O}_2 \text{ dm}^{-2} \text{ min}^{-1}$ at the increased light, control, and decreased light treatments,

respectively. A parallel trend was observed in epiphyte biomass for the three light treatments (22.2, 20.0, and 0.00 mg dm⁻²). Experiments with artificial eelgrass leaves showed a higher photosynthetic rate (0.35 compared to 0.21 $\mu\text{mol O}_2 \text{ dm}^{-2} \text{ min}^{-1}$) and biomass (111.3 compared to 84.5 mg dm⁻²) at the shallow station than at the deep station.

Epiphyte photosynthetic activity, biomass, and productivity accounted for 7%, 4% and 8%, respectively, of eelgrass at the shallow station, and 12%, 5%, and 7%, respectively, at the deep station. Light regime manipulations strongly affected *Z. marina* epiphyte photosynthetic activity, biomass, and productivity. The potential for epiphyte growth, as demonstrated by the rapid colonization of artificial substratum, is greatest at the shallow station however, epiphyte biomass on *Zostera* leaves does not differ with depth. Therefore, we conclude that epiphyte colonization and growth of *Zostera marina* is controlled by leaf characteristics and by light regime.

Sulfate reduction following marsh grass die-back. SUSAN M. MERKEL (Ecosystems Center, MBL), JEAN M. HARTMAN, AND ROBERT W. HOWARTH.

Sulfate reduction rates were measured following *Spartina alterniflora* die-back in an effort to understand better decomposition in salt marsh soils. Marsh sediments below the top centimeter are anoxic, and the major decomposition occurs through sulfate reduction and related fermentations. Sulfate reduction is fueled by simple organic compounds which are metabolic products of fermentation. The source of these compounds could be rapidly used labile organics or more slowly decomposed refractory root material. Die-back was induced in two short *Spartina* sites in Great Sippewissett Marsh (Cape Cod, MA). One site was covered with a board for 12 months, the other was covered with *Spartina* rack for 6 months and uncovered for 20 months. Four months after coverage, the board site showed sulfate reduction rates 40% higher than the control site. After this initial rise, the ratio of sulfate reduction rates at the dieback site *versus* controls decreased to .85 after 6 months, .75 after 13 months, and .45 after 26 months. *Spartina* did not recolonize the rack site, even after 20 months. Hydrogen sulfide concentrations (0.2 mM) were an order of magnitude below that found to cause living grass to die.

We suggest that "leakage" from live roots maintains a certain level of SO₄⁼ reduction. Following die-back, a pulse of labile organic compounds is released which fuels high SO₄⁼ reduction rates. As these labile compounds are used up, SO₄⁼ reduction rates decrease. Refractory root material is slowly decomposed by fermentative bacteria whose products support low levels of SO₄⁼ reduction.

Diel vertical movements of bacteria in intertidal streams of Sippewissett Marsh. KENNETH M. NOLL (Dept. of Microbiology, University of Illinois) AND RICHARD W. CASTENHOLZ.

Bacteria living in the intertidal streams of the Sippewissett Salt Marsh move vertically within the sediment in response to daily changes in environmental conditions. Light intensity plays a major role in these movements. Both field and laboratory experiments demonstrated that a species of cyanobacterium, *Oscillatoria*, migrates to the surface of the sand under low light conditions. At night *Oscillatoria* is distributed between 3 and 5 mm below the surface. This *Oscillatoria* also migrates toward sources of reduced sulfur suggesting a role for sulfide in its daily movements. Sulfur-containing filaments of the sulfide-oxidizing bacterium *Beggiatoa* come to the surface at night and migrate down during the daytime. The appearance of colorless filaments lacking sulfur granules during the day at 4 mm below the surface suggested the *Beggiatoa* may use the stored sulfur during the day. Gliding green sulfur bacteria of the genus *Chloroherpeton* apparently migrate upward at dusk. A gliding, filamentous, phototrophic bacterium (*Chloroflexus*-like) was found in these sediments and may also migrate upward at dusk. Preliminary studies involving *in vivo* pigment analyses allowed more sensitive determinations of the vertical distribution of species than did microscopic observations.

Vertical movements of the hard clam, Mercenaria mercenaria, in response to changes in barometric pressure. EUGENE C. REVELAS (Marine Sciences Research Center, State University of New York, Stony Brook, NY 11794).

The hard clam or quahog, *Mercenaria mercenaria* is a commercially important bivalve species common along the east coast of the United States. Due to its economic value, *Mercenaria* has been well studied, yet little is known about the clam's burrowing behavior. Commercial clambers contend that hard clams move up and down in the substrate aperiodically. Also, there are scattered reports in the literature of clams found at unusual depths in the sediment (two to three times their normal life position of one to five cm).

To investigate the burrowing behavior of *Mercenaria*, a method was devised (involving the attachment of nylon string to clams) by which vertical movements of clams within natural sediments could be determined. The movements of 15 clams placed in sand-filled aquaria in a running sea water system were monitored from 16 June to 18 August 1983. Simultaneously, water temperature and barometric pressure were recorded. During this period, vertical movements of clams were correlated with changes in barometric pressure (Kendall's rank test for association, $P < .05$). That is, relatively large decreases in pressure ($>.40$ "Hg) coincided with downward movement (~ 1 cm) of clams. Clams did not move during periods of steady or slightly changing pressure. To further test this response, clams were placed in a sealed aquarium in which air pressure could be manipulated. Preliminary results from this system also indicate that *Mercenaria* burrows deeper as pressure drops.

Mercenaria's response to barometric pressure may be the result of strong selective pressure to remain within the sediment, thereby avoiding predators. Decreasing barometric pressure is often associated with increased wind and wave action; therefore clams may move deeper to avoid disinterment by sediment scour. How *Mercenaria* detects changes in pressure is unknown. However, the mechanism may be tied to an internal clock which enables the clam to filter out larger, but predictable wave- and tide-induced hydrostatic pressure changes.

Effect of age and quality of detritus on growth of the salt marsh snail, Melampus bidentatus. CAROL S. RIETSMA (State University of New York at New Paltz).

Quality (nitrogen content) of *Spartina alterniflora* detritus as a food source for detritivores can be altered by chronic fertilization. Fertilization increases its nitrogen content.

Newly formed detritus has high nitrogen and ferulic acid contents. As detritus ages, available nitrogen is rapidly lost. Ferulic acid, an abundant phenolic acid, is lost more slowly.

Quality and age of detritus can affect its palatability to detritivores such as salt marsh snails, *Melampus bidentatus*. Detritus that is newly formed and from fertilized plots is more palatable. However, high ferulic acid reduces palatability (Valiela *et al.* 1979, *Nature* **280**: 55-57). This inhibitory effect can be decreased or eliminated by artificially increasing nitrogen content (Rietsma 1981, *Biol. Bull.* **161**: 330).

This study tested the effect of detritus quality and age on growth of snails.

Snails were reared on *Spartina alterniflora* detritus in four treatments: detritus aged for two weeks or for eight months from both control and fertilized salt marsh plots. Shell lengths and wet weights of snails were measured at two week intervals for eight weeks. Each treatment was replicated five times with a total of 50 snails in each treatment. Detritus was analyzed for carbon, nitrogen, total soluble phenolic acids, ash, fiber, and soluble carbohydrates.

Snails fed 8-month-old detritus from control plots grew faster than in all other treatments. This detritus had a higher carbon:nitrogen ratio considered unfavorable for growth. However, it had the lowest phenolic acid, highest ash, and lowest fiber contents. Snails fed 2-week-old detritus from control and fertilized plots grew slowest. Growth differences seemed to be related to the phenolic acid content of detritus. It appears that the phenolic acid content of detritus overrides the importance of nitrogen content in snail growth.

Supported by a SUNY Research Fellowship and Grant-in-Aid.

The design and construction of a benchtop reactor to model an anaerobic/oxic wastewater treatment system. GEORGE J. SKLADANY (Clemson University), BRIAN A. WRENN, AND ROBERT R. HALL.

Exposing sludge to an initial anaerobic treatment in a zone wherein influent and recycled sludge are initially contacted followed by an aerobic treatment results in efficient removal of phosphate from the water and produces a sludge with excellent settling qualities (M. Timmerman *Dev. Ind. Microbiol.* 1979, **20**: 285-298.) To understand the biological phenomena we have designed a plug-flow reactor able to model the anaerobic/oxic treatment process.

The reactor is constructed of interlocking circular plastic Tupperware hamburger freezing containers, 2 cm deep and 10.5 cm wide. Passages were cut in the plastic allowing gas and liquid to flow through the system. Nitrogen gas or compressed air introduced into the bottom of each chamber mixed the contents and maintained anaerobic or aerobic conditions. Sampling ports made from bulkhead fittings modified to hold a rubber septum allowed liquids to be added or removed from any chamber with a syringe. A clarifier, constructed of similar plastic sections was added to the final stage of the reactor to provide for settling and recycling of the biomass. Clarified effluent passed out of the reactor through a wier cut in the wall of the clarifier. Settled sludge was removed from the clarifier through glass tubes attached to bulkhead fittings in place at the top of the clarifier, with open ends extending down into the

sludge. Flow rates were controlled with a peristaltic pump. The device was clamped between two rectangular pieces of plastic for support. The reactor allows flexibility in experimental design and can accommodate experiments not possible at a wastewater treatment plant.

This work was supported by funds to the Microbial Ecology course from Air Products and Chemicals, Inc.

Deforestation in the Amazon Basin measured by satellite: a release of CO₂ to the atmosphere. T. A. STONE, R. A. HOUGHTON, J. M. MELILLO, AND G. M. WOODWELL (Ecosystems Center, Marine Biological Laboratory).

Deforestation is contributing to the build-up of CO₂ in the atmosphere, yet there exists a six-fold difference in the estimated rates of deforestation in the tropics. Many countries do not know the rates at which their forests are being converted to other uses, and their estimates may be biased by political or economic objectives. Use of satellite data allows complete and repeated coverage of the land surface and the opportunity for an unbiased approach.

A change detection method using LANDSAT data has been applied to an area of 185 × 185 km in the Brazilian state of Rondonia on the southwestern edge of the Amazon Basin. Rondonia has been rapidly deforested by extensive colonization since 1970. A time series of 0.0045 km² resolution LANDSAT data was analyzed and showed rates of deforestation of 26,900 ha/yr from 1976 to 1978 and 55,200 ha/yr from 1978 to 1981. These data, combined with data from the literature on above and below-ground biomass were used with a model to calculate that between 3.7 × 10¹² g C and 5.5 × 10¹² g C was released to the atmosphere in 1981 from the area of the LANDSAT scene.

To examine the entire Amazon Basin would require use of about 400 LANDSAT scenes unless a sampling strategy is adopted. An alternative method would be to use the NOAA7 satellite with an image swath of 2400 km and a resolution of 1 km², to determine areas of intense deforestation which can then be examined in detail with the LANDSAT satellite data.

This research was supported by the Department of Energy grant P8000014.

Age of first reproduction in Melampus bidentatus: the effects of overwintering degrowth and repair. JAY SHIRO TASHIRO, MARK WILTSHIRE, AND CHARLES POHL (Kenyon College, Gambier, OH 43022).

Theories of life-cycle evolution lack substantive data bases quantifying relationships between a particular reproductive effort and future reproductive potential. Such relationships involve trade-offs in physiological allocation of resources to repair of somatic tissues or into reproductive products. Biological repair of integral structures sustains the life of an organism, but there is selection for balances between increasing probability of survival (repair) and diverting resources to fecundity.

Overwintering maintenance and emergency repair were assessed in the salt-marsh pulmonate gastropod species *Melampus bidentatus*. Maintenance repair was examined in specimens of *Melampus* from a population in Little Sippewisset salt marsh, just north of Woods Hole, Massachusetts. The life cycle and early life-history of specimens from this population had been reported in an elegant study (Russell-Hunter *et al.* 1972, *Biol. Bull.* 143: 623–656). Collections from the summer of 1983 had the same age and size structure as that reported for this population a decade ago. Snails were placed in a diapause state in the winter of 1981. Experimentally induced diapause (10°C) was maintained for four weeks, at which time tissue protein, carbohydrates, and dry weight were analyzed for 2- and 3-year-old animals. Only the younger snails showed significant changes in biomass constituents (protein loss relative to prediapause controls).

Emergency repair was assessed in the winter of 1982 using diapausing specimens of *Melampus* from a population near Weymouth, Massachusetts (maintained under conditions identical to those used for the Little Sippewisset population). The right tentacle for 2- and 3-year-old animals was ablated after four weeks in diapause, followed by injection of ³H-thymidine. Nine days later, regrowth and repair were quantified (morphometric measurements and autoradiographic techniques). The data suggest that younger snails had higher rates of emergency repair during diapause.

Maintenance repair is manifest as protein degrowth in overwintering specimens of *Melampus*, but degrowth is age-specific. Emergency repair during diapause is also age-specific. Repair can enhance survivorship and residual reproductive capacity, but degrowth in younger snails could delimit age of first reproduction by precluding partitioning of resources into reproductive efforts.

This work was supported by a Theodore Roosevelt Memorial Grant from the American Museum of Natural History.

The role of freshwater wetlands in the ontogeny of a New England saltmarsh. JOSEF P. TREGGOR (Central Connecticut State University, New Britain, CT 06050).

Previous ontological investigation of the Great Sippewissett Marsh (Falmouth, MA) indicated that freshwater wetlands preceded the upland development of the saltmarsh. This conclusion was based on the presence of *Phragmites communis* roots and rhizomes in salt marsh core horizons. While *P. communis* can be found in freshwater systems, its window of salinity tolerance is far too great for it to be a reliable indicator. Therefore a method of freshwater horizon identification subject to less error was necessary.

Cores were taken in contemporary freshwater systems. Parameters yielding positive correlations with the "freshwater" horizons were: root/rhizome dry weight, water and organic content, and direct comparison of root/rhizome samples. These parameters provide sufficient evidence for identification of freshwater horizons in salt marsh cores.

Cores were taken directly in the salt marsh to qualify the type of wetland, to determine any successional patterns, and to estimate the extent of coverage. The deep cores provided well-defined horizons of *Spartina alterniflora*, short form (high marsh cord grass), *S. patens* (salt hay), *Chamaecyparis thuyoides* (atlantic white cedar), *Typha* sp. (cattail), and *Quercus* sp. (scrub oak). *P. communis* was found throughout the core but never in distinct horizons. The *C. thuyoides* was oriented longitudinally in the tube indicating the presence of standing trunks. Depths of salt marsh peat overlaying the freshwater horizons were <1 m while in the adjacent marsh exhibiting no freshwater constituents, peat depths exceeded 2 m.

The results of these analyses provide a successional history of the freshwater wetlands: a. wet uplands, b. freshwater marsh, c. cedar swamp, and finally d. direct colonization of the high salt marsh. These areas were of substantial proportion and resulted in the considerable delay of the upland expansion of the marsh. The presence of *P. communis* as stated suggests that it was transitional between periods of systemic change.

Microbial selection in an artificial ecosystem. W. S. VINCENT (University of Delaware) AND ROBERT M. HALL.

Commercial waste water treatment plants form an artificial ecosystem in which waste water contributes nutrients in very dilute concentrations. These nutrients are then converted into bacterial biomass which is removed or recycled through the system as sludge. The effluent, essentially nutrient-free, is then discharged into streams, lakes, and ground water.

As sludge is concentrated by gravitational settling, only those bacterial cells which can form clumps will remain in the system. As 20% to 50% of the sludge is recycled with each complete flow through of the system, there is a powerful selection process for cells which cause clumping, as well as those which can be clumped.

Twenty-one different bacterial isolates from many sources were tested for their ability to be clumped by a clumping strain (CH-1) isolated from a sludge sample. Only 3 strains, all *Acinetobacter*-like, isolated from sludge, were competent to be clumped. Four strains of *Acinetobacter lwoffii* isolated from soil were not competent.

Several aspects of the clumping process have been determined. The CH-1 strain is hydrophobic; the competent strains are not. The competent strains do not form clumps in the absence of CH-1. Competent strains adhere to a small clump of CH-1, and then are able to cause other cells to adhere. Neither CH-1 cell-free growth media nor heat killed CH-1 cells will cause clumping.

Thus, the water treatment system acts as a highly selecting ecosystem which favors the retention of oligotrophic, clumping bacteria. As clumping is a procedure by which oligotrophic bacteria increase their ability to take advantage of scarce nutrients, the recycled sludge process conserves those cells which clump. Others will be lost from the system.

This work was supported in part by a grant from Air Products and Chemicals, Inc. to the Microbial Ecology Course.

GAMETES AND FERTILIZATION

Is there specificity in the induction of polyspermy in sea urchins by protease inhibitors? M. C. ALLIEGRO AND H. SCHUEL (Dept. Anat. Sci., SUNY at Buffalo).

Sea urchin eggs contain a trypsin-like proteolytic activity that is activated and secreted during fertilization. Results obtained in several laboratories have implicated this activity in the cortical reaction, elevation of the fertilization envelope, and the establishment of the block to polyspermy. These conclu-

sions are supported in part by studies using several trypsin inhibitors (reviewed by: Schuel 1978, *Gamete Res.* 1: 299.). However, this interpretation has been challenged, and past results with inhibitors were attributed to a non-specific protein effect (Dunham *et al.* 1982, *Biol. Bull.* 163: 420.). This hypothesis was tested by comparing the potency of enzymatic inhibitors of the sea urchin egg protease—soybean trypsin inhibitor (SBTI), ovomucoid, limabean trypsin inhibitor, antipain (AP), leupeptin (LP), and tosyl lysine chloromethyl ketone (TLCK)—with their ability to promote polyspermy. Proteolytic activity was isolated from unfertilized *Strongylocentrotus purpuratus* eggs by SBTI-affinity chromatography (Fodor *et al.* 1975, *Biochemistry* 14: 4923.) in the presence of benzamidine to reduce autodigestion (Baginski *et al.* 1982, *Gamete Res.* 6: 39.). The ability of the protease inhibitors to promote polyspermy in *Arbacia punctulata* eggs coincides with their potency as inhibitors of the purified *Strongylocentrotus* egg protease. According to Spearman's rank correlation, r_s equals 0.93 ($P < 0.01$). Since AP, LP, and TLCK are not proteins, it is unlikely that their action on eggs is due to a non-specific protein effect. Furthermore, inactivation of SBTI by treatment with acid or alkali (Kunitz 1947, *J. Gen. Physiol.* 30: 291.) abolished its ability to inhibit the egg protease or to cause polyspermy. We conclude that induction of polyspermy in sea urchin eggs by protease inhibitors is indeed due to inhibition of the egg protease.

Supported by NSF grant #PCM-82-01561 to H.S.

Superoxide dismutase biomimetic compounds prevent fertilization in Arbacia punctulata eggs. FREDRIC BLUM, MARGARET NACHTIGALL*, AND WALTER TROLL. (N.Y.U. Medical Center, New York, NY).

Superoxide dismutase (SOD) is the major catalyst for the formation of hydrogen peroxide (H_2O_2) from superoxide (O_2^-). Fertilized sea urchin eggs excrete H_2O_2 promptly after fertilization thus inactivating other sperms about to enter the eggs. Entrance of more than one active sperm disturbs normal development and causes polyspermic fertilization. Destruction of H_2O_2 by catalase also results in polyspermy. However SOD, which we expected to cause a burst of H_2O_2 production, did not disturb fertilization (Colburn *et al.* 1981, *Dev. Biol.* 84: 235). A possible reason for SOD's lack of activity is that it does not cross cell membranes and the egg does not excrete O_2^- . Thus enzyme and substrate may never meet. SOD-biomimetic compounds (SODB) that are ether soluble and can cross cell membranes have recently been described (Kensler *et al.* 1983, *Science* 221: 75). We noted that application of a SODB, *e.g.*, Cu(II)-diisopropyl salicylate, resulted in inhibition of fertilization presumably due to a burst of H_2O_2 . Addition of catalase, which converts H_2O_2 to O_2 , at a concentration of SODB where fertilization is completely blocked resulted in 100% fertilization. This supports the proposed role of H_2O_2 in the inhibition of fertilization. Sperms treated with SODB were not damaged. An unexpected finding was that addition of SODB 30 s after fertilization caused polyspermy. This was significantly reduced by catalase and suggests that sperms attempting to enter fertilized eggs 30 s after fertilization are prevented by a mechanism, perhaps a physical membrane, vulnerable to H_2O_2 .

Supported by NIH-CA-16060 to W.T. and N.Y.U. Honors Program to F.B.

* Princeton University.

What makes cyclin cycle? RICHARD CORNALL, ELAYNE BORNSLAEGER, AND TIM HUNT (Department of Biochemistry, University of Cambridge, England).

Cyclin is a 55,000 M.W. protein which is synthesized at a high rate after fertilization of *Arbacia punctulata* eggs. It is destroyed at a certain point in the cell cycle (Evans *et al.* 1983, *Cell* 33: 389-396); because its synthesis is continuous its level oscillates in a saw-tooth pattern. We wished to determine the exact point of cyclin disappearance, and to investigate the effects of various inhibitors of the cell cycle on its behavior in order to understand its role in early development.

^{35}S -methionine was added to suspensions of fertilized eggs at 20°C. Samples were removed at intervals and analyzed by autoradiography of SDS polyacrylamide gels. Parallel samples were fixed to determine cleavage index, or orcein stained to visualize chromosomes. The precise point of cyclin breakdown was most clearly defined when 10^{-4} M emetine was added to the suspensions 50 minutes after fertilization to prevent further cyclin synthesis during the period of rapid degradation. When added at this time, emetine does not inhibit cleavage, and abrupt degradation of cyclin occurred at a time corresponding to the metaphase-anaphase transition. Early addition of emetine (20 minutes post-fertilization), however, prevented both cleavage and cyclin degradation. Parthenogenetic activation of protein synthesis by 10 mM NH_4Cl also precluded cleavage and cyclin breakdown, as did the DNA synthesis inhibitor aphidicolin (5 $\mu g/ml$), provided that it was added before completion of DNA synthesis. The motility inhibitors colchicine (100 μM), taxol (10 $\mu g/ml$), and cytochalasin D (2 $\mu g/ml$) prevent cleavage

but do not block cyclin breakdown. However, they delay the onset and reduce the rate of cyclin degradation.

Our results strongly suggest, but by no means prove, that cyclin has a role in mitosis and cell division, and that its disappearance is necessary for normal completion of the process.

We acknowledge the support of NIH training grant GM-31136-05.

Isolation of cytoskeletons from Chaetopterus eggs. WILLIAM R. ECKBERG (Howard University) AND GEORGE M. LANGFORD.

On cytological and experimental evidence, we indicated that 1) ooplasmic components in *Chaetopterus* are embedded in a cytoskeletal matrix and that 2) this matrix is responsible for ooplasmic reorganization in development and differentiation without cleavage. We report the initial results on isolation and characterization of that matrix.

To visualize the surface structure of the cytoskeletons, we developed a procedure for rapid quantitative vitelline layer removal. We added an equal volume of 0.5 M sucrose in 0.125 M EDTA, pH 8, to a 50% egg suspension in MFSW, and centrifuged eggs out by hand after 20–30 seconds. Eggs treated in this way could be fertilized, developed a rapid partial block to polyspermy, and developed to trochophore larvae.

Cytoskeletons were isolated by suspending vitelline layerless oocytes in 10–20 vol of 10 mM PIPES, pH 6.8; 300 mM sucrose; 100 mM KCl; 5 mM MgCl₂; 1 mM EGTA; 100 μM PMSF and 1% NP-40. Oocytes were suspended for 30 min during which they cleared, beginning at the surface and moving inward. Cytoskeletons were centrifuged by hand, washed with the above buffer minus NP-40, and re-centrifuged.

Cytoskeletons contained 20–30% of the total cellular protein. SDS-polyacrylamide gel electrophoresis indicated that the polypeptide composition of isolated cytoskeletons was qualitatively similar to that of whole vitelline layerless eggs. However, several polypeptides were quantitatively reduced in isolated cytoskeletons and others were quantitatively increased. These latter polypeptides had apparent molecular weights of 45K, 54K, 63K and 85K.

Cytoskeletons were fixed and processed for scanning electron microscopy which revealed that 1) cytoskeletons isolated by this procedure were entirely cortical and subcortical and 2) the inner surface of the cytoskeleton showed granules of various sizes embedded in a filamentous network. These results greatly extend and confirm our previous observations.

S. Johnson and D. Rogers provided technical assistance and were supported by the Rockefeller Foundation/Howard University/MBL Careers in Science Program.

Calcium transients during fertilization in single sea urchin eggs. A. EISEN (Children's Hospital, Philadelphia), G. T. REYNOLDS, S. WIELAND, AND D. P. KIEHART.

Two events associated with a putative transient increase in cytoplasmic free calcium include: activation of the starfish oocyte with the maturation hormone 1-methyl adenine (1-MA), and fertilization of the starfish egg with sperm. These events were investigated in single oocytes and eggs by the detection of calcium specific luminescence from single cells injected with an acetylated form of the photoprotein aequorin (10 mg/ml in 10 mM HEPES, 0.2 mM EGTA, pH 7.0 to 3% of cell volume). Using a microscopophotomultiplier and a microscope-image intensifier-SIT vidicon detector sensitive to $<10^{-7} M Ca^{++}$ we found: 1) a barely detectable ($\leq 10^{-7} M$) change in free calcium from oocytes in response to 1-MA (final concentration ca. 150 μM), and 2) a large (ca. 10^{-6}) increase from eggs fertilized with sperm 15 minutes after application of 1-MA and 5 minutes after general vesicle breakdown (17°). The calcium-aequorin luminescence increases as it propagates over 30–40 s and decays uniformly over 200–300 s. The absence of a calcium transient in the *Asterias forbesi* differs significantly from the large (ca. $10^{-6} M$) transient reported in the *M. glacialis* oocyte and is suggested as being a common feature of starfish oocyte activation. The calcium transient at fertilization in *Asterias* eggs is similar to that described in several species of sea urchin (*A. punctulata* and *L. variegatus*) although the propagation time is much longer in the starfish egg.

We thank Dr. O. Shimomura for the gift of acetylated aequorin. We thank Dr. A. J. Walton for the use of his microscope objectives and assistance in the experiments. This work was supported by DOE Contract EY-76-S-02-3120 to G.T.R.

Calcium transients during fertilization in single sea urchin eggs. A. EISEN (Children's Hospital, Philadelphia), G. T. REYNOLDS, S. WIELAND, AND D. P. KIEHART.

A transient increase in cytoplasmic free calcium occurs in the eggs of the sea urchins *Arbacia punctulata* and *Lytechinus variegatus* at fertilization. This transient has been detected from the lumi-

nescence originating within single eggs injected with the calcium specific photoprotein aequorin. We used the native protein and an acetylated form (10 mg/ml in 10 mM HEPES, 0.2 mM EGTA, pH 7.0, injected to 3% cell volume), in conjunction with a microscope-image intensifier-SIT vidicon, or a microscope-photomultiplier to determine the spatial distribution and time course of the calcium transient. In the *Arbacia* egg the transient begins 26 ± 4 s after membrane depolarization. The Ca-aequorin luminescence increases over 6–12 s, persists behind the advancing wave front, remains at its peak for *ca.* 25 s, and decays uniformly over 100–120 s. The onset and peak of the luminescence occurs long before the onset of fertilization membrane elevation, which occurs 54 ± 9 s after membrane depolarization. Observations of the centrifugally organelle-stratified *Arbacia* egg indicate a possible biphasic release of Ca^{++} from two sources, with the majority of the Calcium coming from a mitochondria associated source and going into the mitochondria.

Similarly, in the *L. variegatus* egg, a Ca^{++} wave quickly traverses the egg, persisting behind the advancing front, and decaying uniformly.

We thank Dr. O. Shimomura for the gift of native and acetylated aequorin. We thank Dr. A. J. Walton for the use of his microscope objectives. This work was supported by DOE Contract EY-76-S-02-3120 to G.T.R.

A major maternally encoded 41K protein in both Spisula and Arbacia binds to an anti-tubulin affinity column. ELIZABETH L. GEORGE, SARAH BRAY, ERIC T. ROSENTHAL, AND TIM HUNT (Department of Biochemistry, University of Cambridge, England).

The pattern of protein synthesis changes at fertilization in both *Spisula solidissima* and *Arbacia punctulata* (Rosenthal *et al.* 1980, *Cell* 20: 487; Evans *et al.* 1983, *Cell* 33: 389). This rapid and specific control of translation after fertilization suggests that the set of proteins activated in these organisms may play a role in cell division during early development. Protein C in *Spisula* and protein B in *Arbacia* both have a molecular weight of 41,000 and accumulate during early development rather than cycle with each cell division. Both proteins also bind specifically to an anti-tubulin affinity column (rat monoclonal anti-yeast alpha tubulin, provided by John Kilmartin). We wished to determine whether protein C in *Spisula* bound directly to the tubulin antibody, or whether its binding was indirect *via* endogenous tubulin which was present in the cell extract. Oocytes were activated by KCl and newly synthesized proteins were labeled with ^{35}S -methionine. The post-ribosomal supernatant of the cell homogenate was then treated with Taxol ($40\mu\text{M}$) in order to remove endogenous tubulin. Protein C did not precipitate with the stabilized microtubules, but remained in the supernatant. This supernatant was then passed over the anti-tubulin column, and protein C was still qualitatively retained in the bound fraction as judged by SDS-polyacrylamide gel electrophoresis. This suggests that protein C in *Spisula* shares an antigenic determinant with tubulin, rather than having affinity for tubulin itself. The anti-tubulin affinity column system is a specific method of purification of protein C, and preliminary evidence suggests that a coomassie-stained protein corresponds to the labeled band. This should permit raising antibodies against protein C, which would be a powerful tool in elucidating its cellular role.

This work was supported by NIH Training Grant GM-36116-05.

An organelle complex responsible for mRNA localization in the cortex of Chaetopterus eggs. WILLIAM R. JEFFERY (University of Texas at Austin).

The mechanism of cortical mRNA localization in the egg of *Chaetopterus pergamentaceus* was examined by a combination of *in situ* hybridization, centrifugation, and electron microscopy. The egg contains three cytoplasmic regions; the hyaloplasm, the endoplasm, and the cortical ectoplasm. The hyaloplasm consists of clear cytoplasm derived from the germinal vesicle (GV), the endoplasm contains lipid and yolk particles, and the ectoplasm is composed of very electron-dense particles embedded in a granular-fibrillar matrix. *In situ* hybridization with poly(U), actin DNA, and histone DNA probes showed that more than 95% of the poly(A)⁺RNA, actin mRNA, and histone mRNA was localized in the ectoplasm of the mature egg, although this region represents less than 25% of the total egg volume. The mRNA appeared to co-distribute with the ectoplasmic organelle complex (EOC) during early development. Both entities were present in the cortex of mature eggs and zygotes, entered the endoplasm just prior to the first cleavage, and returned to the cortex as the astral rays elongated during early cleavage. The ectoplasmic mRNA localization and the EOC were divided into animal and vegetal fields shortly before the first cleavage. The animal field entered the AB and CD blastomeres while the vegetal field was localized in the polar lobe of trefoil embryos and was shunted primarily to the CD cell. *In situ* hybridization was conducted on eggs centrifuged through Ficoll step gradients to determine whether the ectoplasmic mRNA is associated with the EOC. Centrifugation at $500 \times g$ for 5 min at 18°C caused the EOC to be displaced to the centrifugal pole of the egg. Centrifugation also caused quantitative displacement of the poly(A)⁺RNA, actin mRNA, and histone mRNA to the

centrifugal pole of the egg. These results suggest that maternal mRNA may be localized in the egg cortex and differentially segregated to the AB and CD blastomeres by an association with the EOC.

This work was supported by NIH Training Grant 5-T35-HD07098 awarded to the Embryology Course, Marine Biological Laboratory, Woods Hole.

The fertilization potential of eggs of the nemertean, Cerebratulus. DOUGLAS KLINE (Univ. of California, Davis, CA) AND LAURINDA A. JAFFE.

Some electrical properties of the egg of the nemertean, *Cerebratulus lacteus* were studied before, during, and after fertilization using intracellular microelectrodes. The membrane potential of the unfertilized egg in sea water is -67 ± 15 mV (SD, $n = 10$). A long-lasting action potential can be elicited by a depolarizing current injection. A peak amplitude of $+43 \pm 6$ mV ($n = 6$) is reached within one second; then the membrane potential reaches a plateau of about +20 mV and gradually returns to a negative resting potential. The duration of the positive phase of the action potential is 8 minutes. At fertilization the membrane depolarizes to $+43 \pm 9$ mV ($n = 10$) and reaches a plateau potential of $+21 \pm 6$ mV ($n = 10$) during the first 30 minutes following fertilization. The potential stays positive for 74 ± 22 minutes ($n = 10$). Development of 7 of these eggs was followed through first cleavage, and cleavage was normal.

When the sodium concentration of sea water is reduced to one-tenth of the normal (500 to 50 mM, choline substituted) the amplitude of both the fertilization potential and the action potential is reduced, indicating that a large part of the potential changes may be due to sodium flux. The average potential in 1/10 Na⁺ sea water for the first 30 minutes following fertilization is -30 ± 22 mV ($n = 4$). Eggs inseminated in 1/10 Na⁺ sea water become polyspermic. Eggs also become polyspermic when transferred from normal sea water to 1/10 Na⁺ sea water as long as 15 minutes after insemination. This suggests that the long positive phase of the fertilization potential is important in preventing entry of supernumerary sperm until a permanent block to polyspermy is established.

This work was, in part, supported by an NIH training grant (5-T35-HD07098) awarded to the Embryology Course, Marine Biological Laboratory, Woods Hole.

FPL-55712, a leukotriene antagonist, promotes polyspermy in sea urchins. R. MOSS, R. SCHUEL, AND H. SCHUEL (Dept. Anat. Sci., SUNY at Buffalo).

Sea urchin eggs release H₂O₂ during the cortical reaction at fertilization to inactivate excess sperm at their surfaces thereby helping to prevent polyspermy (Boldt *et al.* 1981, *Gamete Res.* 4: 365.). This process resembles the peroxidatic killing of bacteria by phagocytic leukocytes during inflammation. Associated with these reactions in leukocytes, arachidonic acid can be oxidized via the cyclooxygenase pathway to produce prostaglandins or via the lipoxygenase pathway to produce leukotrienes. Cyclooxygenase products have been implicated in the prevention of polyspermy in sea urchins (Schuel *et al.* 1982, *Biol. Bull.* 163: 377.). We now report that FPL-55712, a well known antagonist for leukotrienes C₄ and D₄, causes a dose (1-10 μM) and sperm density dependent induction of polyspermy in *Arbacia punctulata* if added before the eggs complete the cortical reaction (elevation of the fertilization envelope). The dose at which 50% of the eggs become polyspermic upon insemination with excess sperm ($4.0 \pm 2.2 \times 10^7$ /ml) is 2.5 ± 0.8 μM. To determine which gamete is affected by the drug, eggs and sperm were pretreated with 50 μM FPL-55712 which was removed by dilution at fertilization. Eggs pretreated with FPL-55712 become polyspermic upon insemination with control sperm. Sperm pretreated with the drug do not cause polyspermy. These results suggest that: (1) leukotrienes may have a role in preventing polyspermy in sea urchins; (2) leukotrienes may modulate the egg's receptivity to sperm during the cortical reaction; and (3) both cyclooxygenase and lipoxygenase products derived from the arachidonic acid cascade may help assure monospermic fertilization in sea urchins.

Supported by NSF (#PCM-82-01561) and NIH (#HD-17087) grants to H.S.

Binding of ¹⁴C-gossypol by Arbacia sperm. EIMEI SATO (The Population Council), N. MATSUO, M. H. BURGOS, S. S. KOIDE, AND S. J. SEGAL.

Gossypol, a phenolic aldehyde, inhibits sperm motility. This action has been attributed to suppression of synthesis and utilization of ATP, possibly by blocking the activities of mitochondrial enzymes (Mg²⁺-dependent ATPase, Na⁺,K⁺-dependent ATPase, pyruvate dehydrogenase) [Adeyemo *et al.* 1982, *Arch. Androl.* 9: 343] and dynein ATPase [Mohri *et al.* 1982, *Biol. Bull.* 163: 374].

In the present study, binding of ¹⁴C-gossypol by *Arbacia* sperm was studied. The gossypol, radiolabeled on the aldehyde group with sp. act. of 3.33×10^5 dpm/micromole, was prepared by Dr. K. Watanabe and Dr. Y. F. Ren of Sloan Kettering Institute.

Uptake of ^{14}C -gossypol by *Arbacia* sperm reached saturation rapidly. Within one min of exposure to $10\ \mu\text{M}$ radiolabeled gossypol ($t = 22^\circ\text{C}$), 1 ml of sperm suspensions at densities of $7 \times 10^7/\text{ml}$ and $7 \times 10^8/\text{ml}$ incorporated 58% and 74% of the labeled gossypol, respectively. Immobile sperm prepared by heating at 60°C for 10 min or by suspending in Ca^{2+} , Mg^{2+} -free ASW incorporated the same amount of radiolabeled gossypol as motile sperm. The incorporated ^{14}C -gossypol resisted extraction by repeated washing with ASW or with $7\ \text{M}$ guanidine \cdot HCl. It was not hydrolyzed under acidic or alkaline conditions and was not displaced by unlabeled gossypol.

The amount of ^{14}C -gossypol bound to *Arbacia* sperm and eggs was 28.2 and 16.3 nmoles/mg (dry wt.), respectively. Uptake of ^{14}C -gossypol at 5 min was greater at 22°C than at 4°C . Binding was slightly higher under acidic conditions. Addition of unlabeled gossypol prevented competitively the binding of ^{14}C -gossypol. Specific binding sites for gossypol per individual spermatozoan or eggs were calculated to be about 8×10^8 and 6×10^{11} , respectively. The ^{14}C -gossypol-protein complexes were solubilized by incubating radiolabeled sperm in three different media: 0.1% Triton X-100; 1 mM urea, 5 mM EDTA; and 20% sodium dodecyl sulfate, 0.1 M 2-mercaptoethanol. The amount extracted was 15, 23, and 74%, respectively. The sp. act. of the extracted complexes were 3.7×10^3 , 4.4×10^3 , and 0.5×10^3 per mg protein.

The results suggest that there are specific binding sites for gossypol on the sperm surface and in the cytoplasm. The interaction of gossypol with sperm proteins is strong, indicating covalent linkage.

E. Sato is a post-doctoral fellow of the Rockefeller Foundation.

Fertilization-induced ion conductances in frog eggs. LYANNE C. SCHLICHTER AND LAURINDA A. JAFFE (Physiology Dept., Univ. of Connecticut Health Center, Farmington, CT 06032).

Fertilization of the frog egg (*Rana pipiens*) elicits a membrane depolarization (fertilization potential, FP) that lasts many minutes and functions as a fast block to polyspermy (Cross and Elinson 1980, *Dev. Biol.* 75: 187-198). The FP is caused in part by opening Cl channels. We explored two main questions. 1) What are the ion conductances underlying the FP and how do they change with time? 2) Do the ion channels pre-exist in the plasma membrane or are they inserted during cortical vesicle exocytosis?

We used the voltage-clamp technique to measure ion currents and conductances (g) before and during fertilization or artificial activation. Before fertilization a voltage-sensitive g_{Na} is present (Schlichter 1983a, b, *Dev. Biol.* 98: 47-59 and 60-69). On fertilization two new conductances (g_{K} and g_{Cl}) appear, reach a maximum in 1-2 min, then decrease more slowly. After fertilization g_{Na} disappears. The time course of the conductance changes is not affected by voltage clamping. g_{K} and g_{Cl} were separated by blocking g_{K} with external tetraethylammonium. g_{Cl} is voltage dependent. The same conductance changes are elicited by monospermy or by polyspermy or by artificial activation; therefore, the opening of fertilization channels is an all-or-none event.

Simultaneous measurements of changes in membrane potential, conductance, and surface area (by the AC capacitance method) were made during fertilization or activation. At fertilization the surface area increases $1\frac{1}{2}$ to 2 fold because of cortical vesicle exocytosis. A significant increase in conductance precedes the increase in surface area; therefore, cortical vesicle exocytosis is not the initial source of new ion channels. Membrane area subsequently decreases, which might contribute to the loss of channels after fertilization.

Supported by an NSERC postdoctoral fellowship to L.C.S., NIH grant 5 RO1 HD14939 to L.A.J., and NIH training grant 2 T35 HD07098 to the Embryology Course at the Marine Biological Laboratory, Woods Hole.

Ultrastructural changes characteristic of Arbacia sperm exposed to gossypol. S. J. SEGAL (Rockefeller Foundation), M. BURGOS, AND S. S. KOIDE.

Gossypol, a yellow pigment extracted from the cotton seed, inhibits motility of *Arbacia* sperm. The mechanism of this effect is not clearly understood, although inhibition of a series of mitochondrial enzymes involved in ATP synthesis and utilization has been demonstrated.

Scanning electron microscopy reveals that the first change observed after sea urchin sperm are exposed to gossypol ($25\ \mu\text{M}$) is a separation of the cell membrane in the region of the sperm head and mid-piece. This appears to be due to an accumulation of fluid, possibly due to an alteration of cell membrane permeability. Study of the cell membrane by freeze-fracture replicas reveals that after gossypol exposure ($25\ \mu\text{M}/10\ \text{min}$) there is a condensation of the small particles, normally distributed at random, in the region of the head and mid-piece. Concurrently, small blebs, free of particles, appear in the P face, leaving corresponding depressions in the E face. The particle-free blebs appear to coalesce so that large regions of the cell surface can be affected. When these regions rupture, as is observed frequently, the

nuclear material can be seen below. The cell membrane overlying the tail appears to be most resistant to these changes.

The most evident alterations observed by transmission electron microscopy are those affecting the mitochondria. These structures lose their normal appearance and display a clear, watery matrix and swelling of the cristae. An accumulation of round, dense bodies can be observed around the inner mitochondrial membrane and also between the cell membrane and the mitochondria. These are interpreted as lipid droplets.

We conclude that gossypol selectively affects the cell membrane of sperm and that the substance concentrates in the mitochondrial region.

In vitro transcription of histone genes in isolated nuclei from *S. Purpuratus*. KATHLEEN SHUPE AND ERIC WEINBERG (Univ. of Pennsylvania).

Nuclei were isolated at various times (9, 13, 15, 17, and 20 hours) after fertilization and utilized in a cell-free transcription system. Transcription per nucleus increased with time of development. The average rate of incorporation was 30 pm UMP/ 10^8 nuclei/60 min in 9 hour nuclei, 45 pm/ 10^8 nuclei/60 min in 15 hour nuclei and 75 pm/ 10^8 nuclei/60 min in 20 hour nuclei. RNA labeled during *in vitro* transcription was isolated and the transcriptional products analyzed using dot blot hybridization. *In vivo* labeled early histone H3 message was gel purified and used in all hybridizations as an internal control and all ^{32}P counts corrected for % homologous hybridization. Early histone transcription represented approximately 11% of total transcription at 9 hours falling to 2% by 13 hours and rising again to 6% at 17 and 20 hours. This sharp fall in early histone mRNAs going from morula to blastula confirms *in vivo* results, however early histone mRNAs are not seen to accumulate *in vivo* despite the observation that transcription continues *in vitro* suggesting that in addition to strong transcriptional regulation there is also a decrease in early message stability. Late histone gene transcription appears to begin at low levels (0.1%) at 13 hours rising to 1.0% by 20 hours demonstrating that the late histone genes are also under transcriptional regulation.

The *in vitro* system was demonstrated to faithfully transcribe from the plus strand only. Analysis of count hybridized before and after RNase treatment suggest that for each of the early genes a percentage of the transcripts are terminating within the coding region. Initial experiments using γ -labeled nucleotides plus/minus initiation inhibitors suggest no initiation is occurring *in vitro* although further work is warranted.

Is there a developmental significance for mRNA localized in the cortex of Chaetopterus eggs? BILLIE J. SWALLA (University of Iowa), RANDALL T. MOON, AND WILLIAM R. JEFFERY.

An organelle complex containing the maternal complement of mRNA is localized in the cortex of eggs and early embryos of *Chaetopterus pergamentaceus*. The organelle complex and its associated mRNA molecules are quantitatively displaced to the centrifugal pole region of the egg by centrifugation. We have employed a combination of egg fragmentation, *in situ* hybridization, and embryo culture methods to investigate whether the cortical mRNA molecules are required for normal embryonic development. Centrifugation of unfertilized eggs through sucrose step gradients results in their equatorial splitting and separation into light and heavy fragments. The heavy fragments contain yolk particles, mitochondria, the cortical organelle complexes, and all of the poly(A)⁺RNA that is detectible by *in situ* hybridization with a poly(U) probe. The light fragments contain lipid droplets, mitochondria, hyaloplasm, and the female pronucleus, but no detectible poly(A)⁺RNA. Using this technique eggs are separated into nucleate fragments without mRNA and anucleate fragments with mRNA. To test their developmental capacity, the egg fragments were washed in sea water, fertilized, and cultured. About 60% of the mRNA-containing heavy fragments were able to cleave and form swimming larvae (presumably haploid). In contrast, about 90% of the mRNA-lacking light fragments arrested after the first or second cleavage and did not form swimming larvae. These results show that egg fragments deprived of poly(A)⁺RNA develop abnormally and are consistent with the possibility that maternal mRNA molecules are necessary for normal embryonic development.

This work was supported by NIH Training Grant 5-T35-HD07098 awarded to the Embryology Course, Marine Biological Laboratory, Woods Hole, MA.

Maturation of sea urchin and Chaetopterus oocytes results in a change in the pattern of protein synthesis. ALBRECHT VON BRUNN (Albert-Ludwigs-Universität Freiburg, W. Germany), RONALD A. CONLON, AND M. M. WINKLER.

We find that there are changes in the pattern of protein synthesis associated with oocyte maturation in sea urchins and in the marine annelid *Chaetopterus pergamentaceus*. Recently changes in the pattern of protein synthesis have been described in the surf clam *Spisula solidissima* and the starfish *Asterias forbesi*. The similar changes in patterns of protein synthesis in such distantly related species suggest that this phenomenon is a very general one and may indicate that a different set of specific translation products are required for maintenance of the immature oocyte and the transition to a developing embryo.

Ovaries of *Lytechinus pictus* and *Arbacia punctulata* were dissected and oocytes were picked out individually by mouth pipetting and washed with pasteurised MFSW. Only oocytes which were about the same size as mature eggs were used. Immature *Chaetopterus* oocytes were collected by washing the animal in Ca-free sea water (SW). Germinal vesicle breakdown (GVBD) was induced by transfer into MFSW. Sea urchin oocytes could not be matured artificially by hypertonic, Ca/Mg-free SW, the ionophore A23187, NH₄Cl, serotonin, or human chorionic gonadotropin. ³⁵S-methionine was used as radiolabel at levels of 50–250 Ci/ml for qualitative and 70–75 Ci/ml for quantitative incorporation experiments. Label was applied 5 minutes postfertilization for 60 minutes (18°C). Protein synthesis was analyzed by 1D SDS-PAGE. Several bands are prominent before GVBD; their rate of synthesis decreases in mature eggs and their synthesis is not detectable in fertilized eggs. Some bands appear only in immature oocytes. Others are present only in mature and fertilized eggs. In uptake and incorporation experiments 3 to 10 times more label enters the immature sea urchin oocytes as compared to mature eggs and 2 to 20 fold more label is incorporated into TCA-precipitable proteins. In *Chaetopterus* the rate of incorporation does not seem to increase significantly at GVBD or fertilization.

This work was supported in part by NIH Training Grant 5-T35-HD07098 awarded to the Embryology Course, Marine Biological Laboratory, Woods Hole, MA and NIH grant HD 17722-01 awarded to M.W.

Preliminary evidence indicating the existence of intermediate filament-like proteins in unfertilized eggs of the surf clam, Spisula solidissima. KAREN M. YOKOO, ANNE E. GOLDMAN, AND ROBERT D. GOLDMAN (Northwestern University Medical School, Chicago).

Intermediate filaments (IF) are major cytoskeletal components of animal cells, but their existence in oocytes has not been demonstrated conclusively. Unlike the other two major, highly conserved cytoskeletal components, microtubules and microfilaments, IF have subunit compositions which differ significantly among various cell types. To explore the developmentally regulated basis for this IF diversity, we attempted to determine whether IF are present in unfertilized *Spisula* eggs. Eggs were lysed in an IF isolation/stabilization solution containing Triton X-100 which was developed for cultured baby hamster kidney (BHK-21) cells (Zackroff and Goldman 1979, *P.N.A.S.* 76: 6226). Sodium dodecyl sulfate polyacrylamide gel electrophoresis (SDS-PAGE) revealed several proteins in the 40–70,000 molecular weight (K) range with a major component at ~55K, which comigrated with the 54–55K subunits of cultured BHK-21 cell IF. As in other IF systems, this *Spisula* preparation could be solubilized (disassembled) in 8 M urea, 5 mM Tris-HCl, 0.1% B-mercaptoethanol (BME), 0.1 mM phenylmethylsulfonyl fluoride (PMSF) (pH 7.4). Following ultracentrifugation at 55,000 rpm (Beckman 65 rotor) the supernatant was dialyzed against assembly buffer (5 mM sodium phosphate, 0.1 mM PMSF, 0.1% BME, pH 6.6). This cycle of disassembly followed by reassembly was repeated, and the resulting pellets were examined by electron microscopy and SDS-PAGE. The latter analysis revealed great enrichment for a ~55K protein, as well as several proteins in the 40–50K range and the >55K–70K range. By electron microscopy, ~10 nm diameter filamentous networks were observed. Peptide mapping by limited proteolysis revealed that the 55K proteins of *Spisula* and BHK-21 differ significantly. However, immunoblotting analyses showed that the major 55K band from *Spisula* reacted with BHK-21 IF antiserum. In addition, mouse skin keratin antisera reacted with proteins in the >55K–70K range and the 40–50K range present in both freshly isolated and reassembled *Spisula* IF preparations. These studies support the presence of both mesenchymal and epithelial-like IF systems in unfertilized *Spisula* eggs.

Supported by NIH and NSF.

Hyperosmotic treatment inhibits cortical granule exocytosis in the sea urchin Lytechinus pictus. JOSHUA ZIMMERBERG (NIH, Bethesda, MD 20205).

An osmotic hypothesis of exocytosis (Zimmerberg *et al.* 1980, *Science* **210**: 901) was tested. If osmotic swelling of exocytotic vesicles is an absolute requirement for fusion, hyperosmotic treatment of secretory cells and the subsequent shrinkage of exocytotic vesicles should inhibit secretion. This is indeed the case. Ninety-seven \pm 1.9% of sea urchin eggs treated with 40 μ M calcium ionophore A23187 raised fertilization envelopes. If eggs were first placed for three minutes in sea water containing added sucrose to a final osmolality of 2.42 Osm/kg (2.42 Osm SW) they shrank significantly. When ionophore (40 μ M) was added to this mixture, only $6.3 \pm 3.8\%$ of the eggs formed fertilization envelopes. Use of 1.59 and 2 Osm SW in the above experiment led to 83% and 57% fertilization envelope elevation, respectively. The inhibited eggs still had a full complement of intact cortical vesicles, as ascertained by direct microscopic examination after fixing and clearing. The prevention of secretion was reversible. Seventy-one \pm 2% of eggs placed in 2.42 Osm SW for three minutes, then returned to sea water for one or ten minutes, and finally treated with 40 μ M ionophore in sea water raised fertilization envelopes. Sucrose did not pharmacologically interfere with exocytosis, as 85% of eggs treated with 40 μ M ionophore in 1 M sucrose 5 mM CaCl₂ formed normal-looking fertilization envelopes.

Thus external hyperosmotic media reversibly inhibit exocytosis. These results are consistent with the osmotic theory of exocytosis. It is known that the fertilization envelope elevation is due to increased colloid osmotic pressure within the perivitelline space. This colloid is presumably contained within the cortical granules in an inactive form. I propose that the sperm-induced rise in intracellular calcium triggers an osmotic activation of previously inert cortical granule contents. These activated substances induce water flow into the cortical granules, resulting in cortical granule swelling and fusion. The contents are thereby secreted into the perivitelline space. They continue to induce water flow into the perivitelline space causing fertilization envelope elevation.

This work was supported in part by NIH training grant 5-T35-HD07098 awarded to the embryology course, Marine Biological Laboratory, Woods Hole, MA and in part by NIH NRSA 3-F32 GM09078-01 to J.Z.

MICROBIOLOGY

Mutants of Escherichia coli affected in "inducer exclusion." E. B. ACKERMAN (Department of Soil Science and Biometeorology, Utah State University, Logan, Utah) AND H. L. KORNBERG.

Glucose, and non-catabolizable analogs such as 3-deoxy 3-fluoroglucose (DFG), inhibit the induction of the lactose operon of *Escherichia coli* by preventing the initial entry of lactose into the cells; this phenomenon is known as "inducer exclusion." Mutants altered in this property were selected by plating samples of the K 12 strain HK 743 (*ptsM umgC arg thr leu rpsL*), pre-grown on glucose, on agar plates that contained the required amino acids, salts, and 5 mM lactose as sole carbon source; in addition, several drops of 0.1 M-DFG were placed in the center. Growth of the organisms occurred initially only at the periphery of the plates but, after 2-3 days' incubation at 41°C, a number of mutants appeared within the zone of growth inhibition. These mutants were screened for their continued ability to grow on glucose and to take up [¹⁴C]glucose and methyl- α -D-[¹⁴C]glucoside; this showed that they had lost neither the Enzyme II for glucose uptake that is specified by *ptsG*⁺ nor the factor III^{glc} that is associated with it. All the mutants tested also remained inducible for lactose utilization.

Like the *iex* mutants described by Parra *et al.* (1983, *J. Gen. Microbiol.* **129**: 337-348) our mutants readily induced the lactose operon when glucose-grown cells were allowed to grow further in media containing 2.5 mM lactose and either 5 mM glucose or 5 mM N-acetylglucosamine (NAG); the parent strain did not do so. But, unlike the *iex* mutants previously reported, our mutants had simultaneously lost "catabolite inhibition:" neither glucose nor NAG was used in preference to other sugars taken up via the PEP-phosphotransferase system, such as fructose. In contrast, glucose 6-phosphate, which is taken up as such by *E. coli*, excluded lactose and was used preferentially to fructose in our mutants just as it was in the parent organisms.

Studies on manganese oxidizing, spore forming bacteria. H. O. HALVORSON (Brandeis University, Waltham, MA), A. KEYNAN, AND T. TIERNAN.

Manganese oxidizing spore forming bacteria were isolated from the Sippewissett Marsh by plating heated (80°C for 30 min) marsh samples on Zobell sea water medium. Eight strains were selected by

their ability to oxidize manganese verified by the Leucoberberlin reaction (Kumbein and Altmann 1973, *Helgol. Wiss. Meeresunter.* 25: 347.) Strain Mn 8 was selected for further studies. Spores of this strain were prepared as described previously (Wier *et al.* 1982, *Biol. Bull.* 163: 370). When examined by flame photometry the spores of this species were found to have a significantly higher concentration of Mn^{+} and Fe^{++} (68.5×10^{-8} and 32×10^{-8} moles/mg dry wt.) than any of several well known soil or marine spore forming bacteria. Further, sporulating cells concentrate Ca^{++} in a high Mg^{++} environment. Spores of Mn 8 had a higher specific density than other marine spore formers investigated; they centrifuged through 62.5–65% renographin, while most other spores pellet through 50–55% renographin. No significant germination occurred in Zobell or other nutrient media, with or without sea water. Over 80% germination occurred when spores were incubated at 30°C for 80 min in medium containing 12.2 mM glucose, 17 mM NaCl, 18.7 mM NH_4Cl , 0.4 mM L-alanine, 0.4 mM adenosine, 1% Tween-80 and 0.01 M HEPES buffer pH 8.2; chloramphenicol (50 µg/ml) was included to prevent outgrowth. Germination did not require heat activation. During germination loss of refractility is accompanied by swelling with a substantial increase in volume. No parallel decrease in optical density of the suspension was observed. Although the germination requirements of strain Mn 8 seem to be more complex, they are similar to those of a previously described marine spore former (Wier *et al.*) in their requirement for NH_4^{+} , Na^{+} , and relative high pH.

Numbers of symbiotic bacteria in the gill tissue of the bivalve Solemya velum Say.
TRICIA A. MITCHELL AND COLLEEN M. CAVANAUGH (Harvard University).

Symbiotic, sulfur-oxidizing, chemoautotrophic bacteria occur in *Solemya velum* Say, an Atlantic coast bivalve found in reducing, muddy sediments (Cavanaugh 1983, *Nature* 302: 58–61). In this study we investigated the effect of varying environmental conditions on the numbers of these symbionts.

Animals were collected from eelgrass beds at Hadley Harbor near Woods Hole, MA. Bacteria (rod-shaped fluorescent cells) were enumerated using epifluorescent microscopy in tissue homogenates (from formalin-fixed gills) after staining with acridine orange. All of the cell counts are reported as number of cells per gram wet weight gill tissue; mean \pm 1 S.D.

Animals, collected 2 June 1983, were kept for 10 days in MBL sea water tables at ambient temperature (15°C) in mud from the collection site with running sea water and in running sea water alone. During the course of the experiment, half of the sea water animals died whereas all of the animals in mud survived. Direct counts of bacteria indicated that there were $2.56 \pm 0.11 \times 10^9$ ($n = 3$) in the freshly collected animals, $1.63 \pm 0.36 \times 10^9$ ($n = 3$) in those animals maintained in mud, and $0.54 \pm 0.25 \times 10^9$ ($n = 3$) in the animals held in sea water. Bacterial numbers were significantly lower in those animals kept in running sea water but not in those kept in mud.

In a subsequent experiment, animals collected 10 August 1983 were maintained under four different treatments, all at ambient temperature (22°C): as above in mud or in running sea water, or in aerated, filtered (0.45 µm) sea water supplemented or unsupplemented with 0.4 mM thiosulfate. There was no significant difference between bacterial numbers in animals harvested after 4 days from any of the treatments (average cell count from all four treatments = $1.33 \pm 0.63 \times 10^9$; $n = 15$) and in freshly collected animals ($1.23 \pm 0.4 \times 10^9$; $n = 3$). This data suggests that the number of symbionts are resistant to short term fluctuations in environmental conditions.

Qualitative observations indicate that the bacterial cells are larger in freshly collected animals and in animals kept in mud, suggesting that biomass estimates, as well as CO_2 fixation activity measurements, will provide a more accurate assessment than cell counts of the effects of varying environmental conditions on the symbiotic bacteria in *S. velum*.

This research was supported by NSF grant DEB-8104701. We thank John Helfrich for helpful advice and discussion and John E. Hobbie for the use of his epifluorescent microscope.

Sheath pigment formation in a blue-green alga, Lyngbya aestuarii, as an adaptation to high light. LISA MUEHLSTEIN (Wright State University) AND RICHARD W. CASTENHOLZ.

Lyngbya aestuarii is a predominant blue-green alga found in the top layer of the intertidal microbial mats in the Great Sippewissett marsh. These mats are subjected to long exposures of high light intensities which potentially cause photodynamic damage to the microorganisms exposed. *L. aestuarii* with heavily pigmented sheaths is often found in these exposed areas. The pigment is yellowish brown and has been called scytonemine. In order to study the sheath pigment further, axenic cultures were used. The cultures were grown in high light outside, lower light outside, and fluorescent light inside. Sheath pigments were formed only in the cultures grown in the high outside light. Methanol was used to extract the cell pigments for spectrophotometric analysis. Dimethyl sulfoxide successfully extracted the sheath pigments which remained after the methanol extraction. The absorbance of the sheath pigment is highest in the near

ultraviolet range (360–400 nm), which is thought to be the most damaging part of the spectrum normally reaching the earth's surface. There is also heavy absorbance through the violet, blue, and blue-green regions with a prominent secondary maximum at 495 nm. The absorbance is low at wavelengths greater than ~540 nm. The sheath pigments have a much higher absorbance overall than cell pigments from the same amount of culture material grown in the outside light, indicating that sheath pigment may convey significant protection. Cell pigment regulation is another way that many photosynthetic organisms protect themselves from photooxidative damage. In *L. aestuarii* the chlorophyll content of the cells also appears to be regulated, decreasing as light intensity increases. The carotenoid to chlorophyll absorbance ratio also decreases from high to low light. *L. aestuarii* appears to adapt to high light intensities inherent to its environment, by regulating chlorophyll and carotenoids in the cells, as well as by the formation of pigmented sheaths.

Factors affecting growth inhibition of enteric bacteria by methyl α -D-glucoside.

D. F. SUTHERLAND (Department of Biology, Creighton University, Omaha, NE 68178) AND H. L. KORNBERG.

It was reported previously (Schnell *et al.*, 1982, *Biol. Bull.* 163: 403) that the growth of some enteric bacteria in media of low phosphate content is inhibited by methyl α -glucoside but that, after 2–4 h., the organisms "escape" from inhibition; their subsequent growth is not affected by this and other glucose analogs. Working with a number of strains of *Escherichia coli* and with *Vibrio harveyi* 392, we have shown that:

(1) growth inhibition and "escape" occur also when cultures grow in media of high (50 mM) phosphate content, even when the *phoA* gene is deleted: alkaline phosphatase therefore plays no major part in this phenomenon;

(2) the extent of growth inhibition depends on the amounts of methyl α -glucoside (phosphate) accumulated inside the cells and retained by them. There was a loss of over 90% of the ^{14}C taken up by *V. harveyi*, whose growth on 10 mM-mannose had been inhibited by 2 mM methyl α -[^{14}C] glucoside, prior to "escape." Moreover, strains of *E. coli* that form the uptake system for glucose and methyl α -glucoside constitutively (*umgC*) do not "escape" from inhibition;

(3) this "escape" from growth inhibition, by *V. harveyi* as by *V. parahaemolyticus* (Schnell *et al.* 1982), is associated with the appearance of a system that causes methyl α -glucoside taken up by cells to be rapidly lost from them. Since the elaboration of this system is prevented by chloramphenicol (100 $\mu\text{g} \cdot \text{ml}^{-1}$), it probably involves *de novo* synthesis of protein; and

(4) the growth of cells subsequent to their "escape" is accompanied by repression of the Enzyme II specified by *ptsG*⁺ irrespective of the presence of the glucose analog in the medium.

Mechanical stimulation of bioluminescence in dilute suspensions of dinoflagellates.

G. T. REYNOLDS (Department of Physics, Princeton University) AND ALAN J. WALTON.

Mechanical stimulation of individual dinoflagellates by means of a piezoelectric cylinder incorporated in a suction pipette has been reported (Reynolds, 1970, *Biophys. Soc. Ann. Meet. Abstr.* 10: 132A). In this method the organism responds to a shock wave transmitted to the tip of the pipette, and the stimulus may be pressure or membrane distortion. Following a suggestion and initial experiments by James F. Case we have stimulated dilute suspensions of *Gonyaulax polyedra* and *Pyrocystis lunula* (ca. 1000/ml) by means of moving objects through the suspension. The container measured 10 \times 10 \times 30 cm³. A cone 2 cm high, 2.5 cm diameter, with a 1.5 cm. high, 2.5 cm. diameter cylinder attached, was moved through the medium at velocities 5 cm/s. to 30 cm/s. The resulting patterns of bioluminescence were recorded through a high gain image intensifier-SIT vidicon detector and stored on magnetic tape for analysis.

Luminescence was observed at the top and sides of the advancing cone, and the side and trailing edge of the cylinder. The Reynolds numbers in these experiments were low, but the sharp trailing edges of the moving objects caused eddies. Bright luminescence was associated with the thread by which the object was raised through the medium. Assuming the dinoflagellates attached to the thread while it was at rest prior to upward motion, this indicated a response to shear as the thread moved through the medium.

We thank Elijah Swift, Celia Chen, Donald Anderson, and David Kulis for preparation of the cultures used in this work. The work was supported by DOE Contract EY-76-S-02-3120 and ONR Contract N0014-83-C-0234.

NEUROBIOLOGY, LEARNING, AND BEHAVIOR

Pseudostereoscopy allows direct visualization of the velocity distribution of particles undergoing fast axonal transport. W. J. ADELMAN, JR. AND ALAN J. HODGE (Laboratory of Biophysics, NINCDS, NIH, MBL)

The movement of particles undergoing fast axonal transport can be readily detected and their velocity (speed) distribution visualized by a simple pseudostereoscopic viewing procedure utilizing pairs of images derived from a videotape or other record, and separated by an appropriate time lapse. When such pairs are examined stereoscopically, the parallax arising from particle motion results in the images of particles being raised or lowered relative to an immobile background plane in proportion to their speed and direction. In effect, the binocular optic axis serves as a velocity axis under these conditions.

The method is particularly useful when observing the simultaneous motion of large numbers or swarms of particles and for the detection of small numbers of slowly moving particles. The technique is generally applicable to a variety of situations, and can be made quantitative using standard photogrammetric procedures. It can also be readily adapted for on-line analysis, particularly in video imaging systems where frame buffers can be utilized.

Transport of vesicles along filaments dissociated from squid axoplasm. ROBERT D. ALLEN, DOUGLAS T. BROWN, SUSAN P. GILBERT, AND HIDESHI FUJIWAKE (Dartmouth College).

It has been previously reported that fast axonal transport of vesicles could be observed in squid axoplasm by Allen video enhanced contrast-differential interference contrast (AVEC-DIC) videomicroscopy (Allen *et al.* 1982, *Science* **218**: 1127-1129). Axoplasm extruded from axons displays similar transport even when mechanically disrupted by stirring with a needle, so that its constituent linear elements have been randomized in direction and shape (Brady *et al.* 1982, *Science* **218**: 1129-1131).

We now report that squid axoplasm dissociated by gentle shear while diluted up to 1:5 in buffer X containing 1 mM of ATP (Morris and Lasek 1982, *J. Cell Biol.* **92**: 192-198) breaks up into linear elements or filaments, some of which display unidirectional or bidirectional transport of vesicles. These vesicles are in rapid Brownian motion in the vicinity of the filaments but adhere when they collide with a filament, then move along the filament to one of its ends and are discharged into the medium. The observations so far are consistent with the expectation that dissociated linear elements might comprise neurofilaments (singly or in bundles) showing no motility and microtubules, either single or in bundles showing unidirectional or bidirectional transport. Filamentous actin might be present in these filaments, but would not be detected. The filaments themselves move about due certainly to Brownian bombardment and possibly to motility as well. Different filaments display different degrees of Brownian deformation consistent with the belief that they contain different numbers and/or types of cytoskeletal elements.

The observations provide evidence that the fundamental process in fast axonal transport can persist in dispersed filaments and vesicles. They also suggest that reconstitution experiments involving biochemically defined, interactive filaments and vesicles may shed some light on the mechanisms of fast axonal transport.

Presynaptic action of baclofen, a GABA analog, at the crayfish neuromuscular junction. SUSAN R. BARRY (Dept. of Neurology, Univ. of Michigan).

The action of baclofen, a GABA analog, was studied at the neuromuscular junction (NMJ) of the crayfish *Procambarus clarkii*. Baclofen (Lioresal) is used clinically to treat spasticity. In the vertebrate nervous system, the drug may bind to GABA receptors on presynaptic nerve terminals and produce a decrease in transmitter release.

GABA mediates presynaptic and postsynaptic inhibition at the NMJ of the crayfish opener muscle. The muscle is innervated by an excitatory and inhibitory axon. The inhibitory axon, whose transmitter is GABA, also synapses on the excitatory nerve terminal. GABA acts postsynaptically by increasing chloride conductance of the muscle and acts presynaptically by depressing transmitter release from the excitatory nerve terminal (Dudel and Kuffler 1961, *J. Physiol.* **155**: 543-562). These two effects are mediated by pharmacologically different receptors (Dudel 1965, *Pflugers Archiv.* **283**: 104-118).

Baclofen was tested on the opener muscle junction to determine whether the drug mimicked GABA's presynaptic or postsynaptic actions. 10^{-4} M Baclofen produced a 25% decrease in excitatory junction

potential (ejp) amplitude, but had no effect on the muscle input resistance. 10^{-4} M Baclofen also reduced the frequency of spontaneous miniature excitatory junction potentials (mejp's) by 30% but did not alter the size distribution of mejp's. Since baclofen reduced ejp amplitude and mejp frequency without affecting muscle input resistance, it may act by depressing transmitter release from the excitatory nerve. Since the size of the mejp's was not changed, baclofen probably did not alter the muscle's response to the excitatory transmitter.

Thus, baclofen may mediate presynaptic but not postsynaptic inhibition at the crayfish NMJ. The drug may bind selectively to presynaptic GABA receptors. Baclofen's action at the crayfish NMJ may parallel its effect in the vertebrate nervous system.

I thank the Grass Foundation for their support and generosity and Dr.'s C. K. Govind, M. Goy, J. Brown, and L. Rubin for technical assistance.

Slow rearrangements of membrane bound, halogenated fluoresceins produce altered K^+ currents in squid axon. RICHARD J. BOOKMAN (Dept. of Physiology, Univ. of Pennsylvania).

The interaction of dyes with excitable membranes can be exploited for a variety of purposes. In such studies it is important to distinguish between the actions of the dyes in the presence and absence of light. In these experiments, halogenated fluoresceins (e.g., Rose Bengal (RB), Eosin Y, Erythrosin, & Phloxine B) have been shown to be specific and potent modulators of outward K^+ current when applied to the inside of the internally perfused, voltage clamped squid giant axon. This reaction, with $1 \mu M$ RB inside, reaches completion very slowly (i.e., minutes), modifies about 75% of the channels and is only partially reversible. In the absence of light, K^+ currents from such a stained axon exhibit a number of interesting features: as measured at 7 or 35 ms after the application of a voltage clamp step to a positive membrane potential, I_K is diminished and has not reached a steady state. Long voltage clamp steps show that these currents are still increasing after more than 100.0 ms. The ON kinetics are thus slowed by more than an order of magnitude. However, once the K^+ channels are open and conducting, they seem to close with approximately normal kinetics upon returning to the holding potential of -70.0 mV. This result is best demonstrated by using a double pulse procedure which also illustrates that recently closed channels reopen with more nearly normal kinetics and that the full extent of the slowly opening behavior is only re-established after many seconds. Repeatedly pulsing the axon to $+80$ mV leads to a frequency dependent increase and speeding of the current—the recent history of the membrane can shift channels into the rapidly opening state. The illumination of a previously stained axon specifically destroys K^+ channels with bound dye. The decrease in I_K proceeds exponentially and the remaining current has almost normal kinetics.

These results show that halogenated fluoresceins are a new family of highly potent K^+ blockers. The nature of this block is similar to that which has been described for the aminopyridines (Yeh *et al.* 1976, *J. Gen. Physiol.*, **68**: 519–535) and therefore suggests that squid K^+ channels may have a site or sites whose occupancy by either of these molecules can regulate channel function.

Supported by a Grass Foundation Fellowship.

Structure of the squid axon membrane as seen after freeze-fracture. DONALD C. CHANG (Baylor College of Medicine, Houston, TX 77030), ICHIKI TASAKI, AND TOM S. REESE.

A classical excitable membrane is the axolemma of the squid axon. We used freeze-fracture technique to examine the morphology of this membrane to try to identify the membrane protein structures which are thought to be conductance pathways for ions ("channels"). Many large pieces of membrane were seen in the replicas of the intact fixed axon but fractures did not occur through the axolemma. Since there are many layers of Schwann cells, most fracture planes tend to go through the Schwann cell membrane rather than the axolemma. When the Schwann cells are removed, the axolemma is easily recognized at the boundary between the external ice and the axoplasm. However, very little membrane was seen in these replicas of desheathed axons because the axolemma was usually cross-fractured without splitting it over any significant distance. The best results were obtained using axons with Schwann cells chemically detached from the axon but not mechanically removed. In one particularly clear example the fracture plane cut through a stack of Schwann cells and then exposed a large extent of axolemma.

Our first impression of the P-face of the axon membrane is that, unlike the Schwann cell membrane or the membrane of myelinated nerve fibers, the squid axon membrane is marked by many small particles (3 to 4 nm in diameter). It is also clear that there are large P-face particles distributed randomly in the axon membrane. Judging from their size (between 10 and 18 nm) and density (1203 ± 416 per μm^2), some of these large particles are likely candidates for the intramembrane component of the "sodium

channels." A peculiar structure was observed in one sample where a particularly large extent of axonal membrane was exposed. Hemispherical blebs having a diameter ranging from 40 to 58 nm were distributed randomly at the axon surface at a density of roughly 80 per μm^2 , and the surface of these blebs lacked intramembrane particles. These blebs are tentatively interpreted as contacts, presumably artifactual, between the axolemma and numerous underlying small vesicles.

Work supported partially by ONR Contract N00014-76-C-0100.

Fine structure of synapses and synaptosomes of the squid (Loligo pealei) optic lobe.

ROCHELLE S. COHEN, NASRIN HAGHIGHAT, AND GEORGE D. PAPPAS (Marine Biological Laboratory).

Cephalopod optic lobes are a rich source of cholinergic endings (Dowdall and Whittaker 1973, *J. Neurochem.* **20**: 921-935). As a prelude to subsequent morphological and biochemical analyses of cholinergic transmission in the central nervous system (CNS), we describe the ultrastructure of synaptic endings of the optic lobe of the squid and categorize them into distinct morphological types recognizable in the squid optic lobe synaptosome fraction. Toluidine blue staining of epon-embedded thick sections showed an outer cortex (consisting of four main layers) where the incoming nerve fibers meet the tangential dendrites of second order visual neurons (Young 1974, *Phil. Trans. B.* **245**: 263-302), and an inner medulla, composed partly of radial columns and islands of different types of neurons. Photoreceptor endings were seen within the plexiform layer of the cortex. Electron microscopy revealed that both chemical and electrotonic synapses were present, the former being predominant and showing two basic forms. One was an invaginated synapse between photoreceptor endings and spines; the second was a typical chemical synapse, found in almost all layers except the upper portion of the first radial layer. Most of the synapses in the medulla were of the second type although a few photoreceptor endings extend to this region. Gap junctions were found where photoreceptor processes contact each other. Synapses were categorized into five distinct types which corresponded to five types of synaptosomes recognized in a synaptosome fraction derived from these lobes. E-PTA staining of synapses revealed a much thinner layer of postsynaptic material than found at typical mammalian cortex synapses as postsynaptic densities. Because of its high content of cholinergic endings and distinct synaptic types, the squid optic lobe may provide an interesting model for the isolation of cholinergic synaptosomes and synaptosomal plasma membranes from the CNS.

This work was supported by NIH (grants NS 15889 and NS 16610) and NSF.

Pathway tracing in the squid nervous system. SUSAN C. FELDMAN AND GEORGE D. PAPPAS (Marine Biological Laboratory).

When germ agglutinin (WGA), a lectin which binds to sialic acid and N-acetyl-glucosamine residues, has been shown to be axonally transported in the vertebrate visual system. In this study we demonstrate the labeling of cells and fibers in the squid nervous system following injection of the lectin into the eye and stellate ganglion. Squid received 2-5 μl of a 30% solution of WGA or WGA conjugated to HRP (HRP-WGA) into one eye or both stellate ganglia. Animals were allowed to survive up to 48 h in sea water (11-16°C). WGA was localized immunocytochemically on 10 μM paraffin sections; HRP-WGA was visualized using CoCl_2 intensified DAB.

Injection of WGA into one eye resulted in a narrow patch of cells and fibers in the ipsilateral optic lobe. With the more sensitive immunocyto-chemical procedure both labeled cells and fibers were seen in the central ganglia and fibers were demonstrable in the contralateral optic lobe (30 h survival time). Injection of WGA into the stellate ganglion resulted in labeling in the giant axons, in fibers within the ganglion, and in a few small to medium-sized cells. No labeling was seen in the second-order fibers or in or around the large ganglion neurons. In the giant axons the staining was restricted to parallel longitudinally arranged arrays with occasional labeled strands between them.

Ultrastructural studies are in progress to resolve the identity of the elements to which the lectin is bound. The results of the present study demonstrate the potential usefulness of WGA, and other lectins, as markers of specific pathways and in transport studies.

Supported in part by NIMH grant MH 38485 to S.C.F. and NS grant 16610 to G.D.P.

*An infrared macrophotographic technique for quantifying the behavioral response to rotation of the gastropod *Hermisenda crassicornis*.* SERGE GART, IZJA LEDERHENDLER, AND DANIEL ALKON (Marine Biological Laboratory).

Positive phototaxis in *Hermisenda* is modified by repeatedly pairing light and rotation. Further understanding of this associative learning depends on defining an unconditioned response to rotation. We

have developed infrared photographic methods to measure the foot muscle during rotation. This light, to which *Hermisenda* is unresponsive can also provide high resolution negatives of these semi-translucent animals, and clear negatives, without blur, of the subjects at high rpm.

The animals were placed in sea water filled tubes below a motor-driven Nikon FM 2 35 mm camera with a 55 mm Micro-Nikkor lens, fitted with a Schott RG-630 and Tiffen polarizing and dichroic filters. Four Vivitar 283 flash units with VP-1 varipower modules and two Tensor high-intensity contrast lights, all fitted with Schott RG-665 and Tiffen polarizing and dichroic filters, were used to illuminate the subject. The camera and flash units were attached to a modified motorized X-Y plotter in order to track the moving animal. Shutter release was triggered manually or by a photoelectric cell linked to an electronic delay device. We used Kodak Recording 2475 or High Speed Infrared 2481 film. Pictures were taken at the rate of one per second, four prior to rotation, and up to 20 during rotation. The negatives were projected onto an L-W Photooptical Digitizer for direct scaled measurements of the foot muscle.

The length of the foot decreased in all 20 animals tested. Average decreases were 14.8% one second into rotation (N = 20), 13.1% after 3 s (N = 20), 11.1% after 6 s (N = 4), 3.7% after 9 s (N = 4), and 2.9% after 20 s (N = 4).

Thus foot shortening is greatest immediately after rotation starts and subsequently begins to recover. Preliminary analysis indicates that area and width of the foot also change. The response to rotation may thus involve several component elements in the foot muscle. Foot shortening is thus a reliable quantifiable unconditioned response for use in conditioning studies.

Messenger RNA in squid axoplasm. ANTONIO GIUDITTA (Institute of General Physiology, Via Mezzocannone 8, Naples, Italy), TIM HUNT, AND LUIGIA SANTELLA.

The axoplasm of the squid giant axon contains sizable amounts of tRNA (Black and Lasek 1977, *J. Neurobiol.* 8: 229-237), while minor amounts of rRNA have been detected in the axoplasm of the squid *Loligo vulgaris* (Giuditta *et al.* 1980, *J. Neurochem.* 34: 1757-1760). Furthermore, the axoplasm of the latter species contains all soluble factors required for protein synthesis (Giuditta *et al.* 1977, *J. Neurochem.* 28: 1393-1395). In the further search for additional components of the protein synthetic machinery we have examined for mRNA in squid axoplasm. Our method of analysis was based on the ability of the rabbit reticulocyte lysate to synthesize radioactive proteins using ³⁵S-methionine in the presence of exogenous mRNA. RNA was purified by phenol extraction from the axoplasm of the giant axon, from the extruded stellate nerve, and from the giant fiber lobe of the squid *Loligo paelii*. A marked stimulation of protein synthesis was obtained with all RNA preparations, including axoplasmic RNA. In addition, radioactive translation products were separated by electrophoresis on SDS-polyacrylamide gels and visualized by fluorography. Up to 50 different protein bands were found labeled when axoplasmic RNA was used as template. Some of the bands were intensely radioactive. The overall pattern of labeling was similar to that obtained with RNA extracted from the giant fiber lobe or from the extruded stellate nerve, but several consistent differences were detected. Those present between axoplasm and extruded stellate nerve appeared to exclude the possibility of contamination of axoplasmic mRNA by nerve material intruding during the extrusion step. To examine the possibility that axoplasmic mRNA was originating from mitochondria, several subcellular fractions were obtained from squid optic lobes, including a purified fraction of synaptosomal mitochondria. RNA extracted from the latter fraction was essentially inactive in the translation assay, at variance with the RNAs extracted from the other subcellular fractions. This result suggests the extramitochondrial origin of axoplasmic mRNA. The functional role of axoplasmic mRNA, *i.e.*, its presence in an inactive or in an active form, remains to be established.

Supported by NATO grant no. 18781.

Phospholipid synthesis in the injected squid giant axon. ROBERT M. GOULD (Institute for Basic Research in Developmental Disabilities), MARTHA JACKSON, AND ICHIIJI TASAKI.

Axoplasm extruded from the squid giant axon incorporates a variety of precursors into phospholipids. In order to relate the giant axon's lipid metabolism with its excitable properties we injected small volumes of labeled precursor in solution into giant axons and stimulated them for a variety of time courses. The following precursors were used, ³²P-inorganic phosphate, γ -³²P-adenosine triphosphate, ³H-acetate, ³H-choline, ³H-glycerol, and ³H methionine. After injection the axons were incubated in sea water for 30 min to 2 h. Some axons were stimulated at high frequency (50-100 Hz). The others were taken as control. Following incubation and extrusion of axoplasm homogenates of axoplasm and sheath (containing cortical axoplasm, axolemma, and glial cell layers) were extracted with acidified chloroform-methanol. With each precursor, labeled lipids were found in both axoplasm and sheath. Excepting glycerol, the amount of

recovered lipid was higher in the axoplasm than the sheath. Based on recoveries expressed in terms of total lipid and aqueous (upper phase), radioactivity (total lipid formation) in axoplasm sheath was not significantly altered by the stimulation. We will conclude with examination of the labeled lipids after separation on TLC plates. Subsequent autoradiography and counting of specific lipids will reveal exact distribution of the lipids formed and if the distribution is altered by stimulation.

This study was supported by a grant from the NIH NS-13980.

Physiological activity of efferent vestibular neurons and their action on primary afferents in the toadfish. STEPHEN M. HIGHSTEIN AND ROBERT BAKER (Marine Biological Laboratory).

The efferent and afferent innervation of the vestibular semicircular canals in the toadfish (*Opsanus tau*) are anatomically distinct both centrally and peripherally. This arrangement permits glass microelectrodes to be inserted into visually identified axons of efferent and afferent neurons. In order to study the activity of efferent neurons and their physiological effect upon afferents, toadfish were spinalized, held in a plastic tank, and perfused through the mouth with running sea water. Following stable axon penetrations depolarizing pulses of 0.1–1 nA and 10–100 ms duration were passed through the microelectrode to evoke action potentials. Efferent neurons characteristically responded with a single action potential while all primary afferents generated a train of impulses equal to the duration of membrane depolarization. Efferent neurons were spontaneously active (1–5 impulses/s) while afferents displayed the same spectrum of regular and irregular activity seen in other vertebrate labyrinths.

When light punctate tactile stimulation was applied to particularly sensitive areas around the nose, lips, and eyes all efferent vestibular neurons increased their level of spontaneous activity. Continuous tactile contact—especially with moving stimuli—produced an “alerting response” characterized by eye retraction, cessation of gilling, fin erection, and fanning. This behavioral arousal frequently culminated in swimming. Since eye retraction was a sensitive measure of the onset and progress of the above behavioral sequence it was employed to evaluate timing of neural activity. During all stages of the alerting response there was an increase in activity of both efferent and afferent neurons. The increase in discharge frequency seemed to be positively correlated with the level of arousal and the changes were especially clear during swimming. As expected, peripheral section of the efferent bundle abolished the behaviorally observed activation of afferents. Electric pulse stimulation of either severed or intact efferent axons evoked presumably monosynaptic (latency 1–1.5 ms) EPSPs and action potentials in primary afferents. These data suggest that the efferent vestibular system in the toadfish may terminate directly on primary afferents with an excitatory action. In view of the neuronal correlates to behavior, we conclude that the physiological role of the efferent vestibular system may be to enhance the sensitivity of afferents to motion both prior to and during movement.

Supported by NS 21518.

Fast axonal transport is not affected by dimethyl sulfoxide (DMSO) used to facilitate glycerination and/or glutaraldehyde fixation of squid axons. ALAN J. HODGE AND W. J. ADELMAN, JR. (Laboratory of Biophysics, NINCDS, NIH, MBL).

Squid giant axons and smaller axons in fin and stellate nerves were examined under video-enhanced differential interference contrast conditions during the application of DMSO-containing solutions designed to facilitate (a) the formation of a glycerinated model axon system, and (b) rapid fixation using glutaraldehyde as the cross-linking agent. Freshly dissected preparations were maintained in oxygenated filtered sea water to establish the presence of vigorous fast axonal transport (FAT). Irrigation with sea water containing 15% DMSO caused no change in the rate or character of the FAT over periods of several hours. However, application of a glutaraldehyde fixative (Hodge and Adelman 1980, *J. Ultrastr. Res.* 70: 220–241) containing 15% DMSO resulted in fairly rapid fixation as judged by cessation of transport even deep in the axoplasm of giant axons within about a minute, and with no discernible change in optical properties. Electron microscopy showed good preservation of axoplasmic structure, including microtubules, comparable with that obtained by cannulation/irrigation fixation (Hodge and Adelman 1980). Irrigation with a neutral buffered solution containing 15% of both DMSO and glycerol caused quite severe blebbing and vacuolization within a few minutes, but with no apparent effect on FAT. The blebbing receded and disappeared within a total time of about ten minutes. The axons now were scarcely distinguishable from their original appearance, and continued FAT unabated. These preliminary results support the notion that a model axon system suitable for the study of FAT may be soon attainable.

The pH dependence of the tetrodotoxin-blockade of sodium channels. S. L. HU AND C. Y. KAO (Department of Pharmacology, State University of New York Downstate Medical Center, Brooklyn, NY 11203).

Tetrodotoxin (TTX) and saxitoxin (STX) are important neurobiological tools because of their selective and stoichiometric blockade of the sodium channel. Recently, some stereospecific, similar functional groups have been identified in these different molecules, and a surface receptor is proposed as the common site of their interactions with excitable membranes (see Kao 1983, *Toxicol. Suppl.* 3: 211-219). Among these similarities are a cationic guanidinium moiety and a pair of adjacent -OH groups. In STX, the -OH's are on C-12; in TTX, they are on C-9 and C-10. In STX, the C-12 -OH's are essential for hydrogen-bonding to membrane components.

In TTX, the C-10 -OH deprotonates with a pK_a of 8.8, thereby permitting some manipulations of its chemical form within physiological ranges of pH. Previous investigations on the pH dependence of TTX-action relied on single, approximately equipotent doses of TTX at different pH's. Although lacking in quantitative consistency, the earlier results show that TTX was more active in the cationic form at neutral pH than in the zwitterionic form at alkaline pH.

We have reinvestigated the pH dependence of the TTX-blockade on the internally perfused squid giant axon under voltage-clamped conditions. Dose-response relations have been obtained for the maximum I_{Na} at pH 8.80 and 7.80, at which the proportion of the protonated form of C-10 -OH is 0.5 and 0.9 respectively. Were the activity of TTX determined solely by the electric charge(s) of the whole molecule, the relative potencies at these pH's should be close to 1.8 (0.9/0.5). We found an ED_{50} of 5.2 nM at pH 7.80 and 14.2 nM at 8.80. The potency ratio of 2.7 suggests that an important effect of alkaline pH on the TTX-blockade is the loss of a hydrogen-bonding site, and not merely the abundance of a zwitterionic form.

This work is supported in part by an NIH grant, NS 14551. S.L.H. is a Grass Fellow in Neurophysiology.

Hermisenda crassicornis: a disease complex. I. The normal animal. ALAN M. KUZIRIAN (NINCCDS-NIH, Marine Biological Laboratory, Woods Hole, MA 02543), LOUIS LEIBOVITZ, AND DANIEL L. ALKON.

The nudibranch mollusc, *Hermisenda crassicornis*, has been used for over a decade for neurobiological research with the aim of developing a model system for the study of associative learning. This animal, endemic to the Pacific Coast of North America, is shipped to this laboratory weekly and is then maintained under laboratory conditions consistent with short- and long-term animal husbandry. Normally, healthy animals have been cultured through three generations, and field collected adults have been maintained in the laboratory for up to three months (Harrigan and Alkon 1978, *Biol. Bull.* 154: 430-439). During the spring of 1983, the mean survival rate dropped precipitously to between 10 to 12 days, with no change in the routine maintenance conditions. The nudibranchs also exhibited progressive morphological changes consistent with some form of debilitating disease and infectious organism(s). The onset of this problem coincided with naturally-occurring environmental perturbations experienced before the animals were collected and sent to Woods Hole.

Due to the obvious pathology exhibited by the infected animals, a program of investigation was implemented between the Section on Neural Systems, Laboratory of Biophysics, NIH, and the Marine Animal Health Laboratory, to isolate and identify the causative agents infecting the nudibranchs. Concurrently, a histological study of the non-neural organ systems of normal, non-infected *Hermisenda* was also instituted to provide baseline data for comparison with the pathological material. Light, scanning, and transmission electron microscopic observations of the oral tentacles, rhinophores, and cerata revealed in normal individuals a similar ciliated epithelium with putative mechano- and chemoreceptors being especially prevalent on the oral tentacles and rhinophores. There is an underlying, subepidermal complex of mucous glands and nerve, muscle, and connective tissue fibers. The cerata contain hepatic tissue of several cell types and the cnidosac with encapsulated nematocysts.

Associative learning in Hermisenda crassicornis (Gastropoda): evidence that light (the CS) takes on characteristics of rotation (the UCS). I. IZJA LEDERHENDLER (NIH Lab of Biophysics, Marine Biological Laboratory), SERGE GART, AND DANIEL L. ALKON.

Associative learning in *Hermisenda* satisfies a host of criteria traditionally applied to vertebrate learning. Reductions of positive phototaxis are produced by repeatedly pairing light and rotation stimuli. A variety of such studies have shown that an associative change in behavior has been learned. The nature

of the learned association between stimulus and response remained obscure however, because the response(s) to rotation (the unconditioned response, UCR) had not been specified.

Recent advances (see Gart *et al.*, 1983 *Biol. Bull.* 165) allowed a precise description and quantification of the UCR. During rotation in the dark, all *Hermisenda* shorten the foot muscle. Presentation of light alone causes an increase in foot length (68% of cases). After associative training, in 83.3% of cases, paired animals shortened the foot in response to light. Control groups did not change.

We measured difference scores for each individual comparing length 3 s after light onset with length in the dark. The mean score of the paired group ($N = 6$) was significantly reduced ($P < .05$). Neither the random ($N = 4$) or the naive ($N = 4$) control groups were statistically different from pre-training values or from each other. The pre-training minus post-training scores between paired and pooled control groups were significantly different ($P < .01$).

An historic hallmark of classical conditioning (a special form of associative learning) is that the CS take on some functional character of the UCS. Our data demonstrate that light, which originally evokes foot-lengthening produces an opposite and, therefore, new response as the result of associative conditioning. This new conditioned response resembles the unconditioned response to rotation.

Propagating calcium spikes in identified cells in the supraesophageal ganglion of the giant barnacle, Balanus nubilus. LISA A. LEWENSTEIN (New York Medical College, Valhalla, NY).

Reported here is a cell having sufficient TTX-insensitive calcium channels to generate a propagating action potential, without the use of TEA to block voltage-sensitive potassium channels.

The cell is located on the posterior-medial margin of the ventral surface in each hemiganglion of the supraesophageal ganglion of the barnacle. Its axon extends across the commissure to the contralateral hemiganglion where it branches into a synaptic field and continues out the contralateral antennular nerve. Only one such cell exists on each side.

Intracellular recordings were made from the soma using a 10–20 mesohm KCl microelectrode. A suction electrode was placed on the contralateral antennular nerve for recording extracellularly and stimulating antidromically. Anatomical information was obtained by iontophoresis of Lucifer yellow into the soma and cobalt backfills of the antennular nerve. Optical experiments were done by injecting Arsenazo III, a calcium sensitive dye, into the cell and detecting absorbance changes at 660 nm in different regions of the cell when the soma was stimulated.

In normal saline, the cell produced action potentials with an average amplitude of 80 mV, a 4 ms duration at half-height and a 60 ms undershoot. Fifteen minutes after application of 3×10^{-7} M TTX, action potentials could be elicited orthodromically and antidromically, while the extracellular recording was devoid of other activity. Superfusion with saline in which all the sodium was replaced with choline produced similar results.

Saline in which the normal 20 mM Ca was replaced with 2 mM Ca, 18 mM Co, or mM Ca, 30 mM Mg allowed an action potential to propagate as well.

Finally, the addition of 3×10^{-7} M TTX to 2 mM Ca, 18 mM Co saline silenced all intracellular regenerative activity as well as all extracellularly recorded activity. Activity returned after washing in normal saline.

Optical experiments have confirmed calcium entry into the soma, along the length of the axon across the commissure and through the contralateral hemiganglion when a propagating action potential was stimulated.

In summary, here is a cell capable of producing a propagating calcium action potential along the length of its axon, as well as its soma, for which either calcium or sodium is sufficient and neither calcium nor sodium is necessary.

Visualization of depolarization-evoked presynaptic calcium entry and voltage dependence of transmitter release in squid giant synapse. R. LLINAS (N. Y. U. Medical Center), M. SUGIMORI, AND J. M. BOWER.

Data obtained using voltage clamp techniques in the squid giant synapse have suggested that pre-membrane potential determines not only the amount of calcium that enters the preterminal during depolarization, but also directly influences calcium-evoked release of transmitter (Llinas 1981, *Biophys. J.* 33: 323–352; Simon 1983, *Biophys. J.* 41: 136). A further demonstration of this voltage sensitivity has been performed utilizing direct intracellular pressure injections of calcium which induce large-amplitude (10–20 mV) long-duration (10s of seconds) excitatory postsynaptic potentials (EPSPs). We have found that following a calcium injection, a voltage change induced by current injection in the preterminal results in an immediate and reversible increase in the amplitude of the injection-evoked release. This increase is

present even when entry of additional calcium through voltage-sensitive calcium or sodium channels is blocked by cadmium and TTX or in low extracellular calcium medium (10^{-6} M).

We have also studied the spatial distribution of calcium entry during a presynaptic depolarization. Using a double microchannel plate (ITT-Aerospace Optical Div.) coupled to an image-intensifying video camera (Dage, MTI), we have achieved nearly single photon sensitivity and thus have been able to visualize directly the spatial distribution of the light response of the photoprotein aequorin (Llinas 1975, *Proc. Natl. Acad. Sci. USA* 72: 187-190) to increase in intracellular calcium concentration. Our results indicate that calcium entry, even during prolonged (3 s) and large (50 mV) depolarizations of the preterminal, is restricted to the region of synaptic contact of the preterminal, where morphological evidence suggests that calcium channels are located and transmitter liberated (Pumplin 1981, *Proc. Natl. Acad. Sci. USA* 78: 7210-7213). This calcium-evoked aequorin response is spatially restricted even though aequorin has diffused throughout the presynaptic fiber.

Supported by NS 14014 from NINCDS.

Ordered assemblies of neurofilament proteins isolated from squid giant axon. J. METUZALS, D. F. CLAPIN (Faculty of Health Sciences, University of Ottawa, Ottawa K1H 8M5, Ontario, Canada), P. A. M. EAGLES, AND G. J. FENNELLY.

An investigation of the three-dimensional structure of the neurofilament network proteins and their periodic supramolecular aggregates may enable us to model and understand the structure of the crystalline arrays of filaments seen in brains of Alzheimer's patients. These preparations lend themselves to image processing techniques through which the signal-to-noise ratio of the structural detail can be maximized.

A preparation of neurofilament proteins, obtained by extraction of extruded axoplasm, was solubilized and reconstituted essentially according to the same procedure as that used for the crystallization of tropomyosin (see Metzuzals *et al.* 1982, *Biol. Bull.* 163: 387). The crystallization product was pelleted by centrifugation at $10,000 \times g$ for 10 min and was fixed and embedded according to standard procedures. Analysis of the extracted axoplasm by SDS-PAGE showed that it consisted of 82% neurofilament proteins, 14% tubulin, and a small amount of actin. The pellet obtained following the crystallization procedure had a similar composition.

Light microscopy of the precipitate showed a network of highly birefringent coiled strands and numerous small birefringent crystals. Electron micrographs of thin sections of embedded pellets showed sheets of intercoiled filaments 4-5 nm in diameter. The sheets are curved into tubes and rolled up to form cylindrical scrolls. Densely packed, layered assemblies of filaments were also observed. The samples of the pellets, stained negatively with 1% uranyl acetate, contain tubular networks and crystalline sheets. The crystalline sheets consist of 2-3 nm wide filaments in a near orthogonal lattice with intercosils 4.6 nm \times 5.9 nm. The filaments have a wavy or kinked appearance suggesting a helically intercoiled organization. Preliminary analysis of the arrangement of units in the sheets and of the computed diffraction pattern of the tubes showed that the basic lattice is similar in the two structures.

The observed regular assemblies appear to be different motifs of assembly of neurofilament proteins which may aid in the elucidation of the functional role of neurofilament proteins under normal and pathological conditions.

This investigation was supported by grant MA-1247 from the Medical Research Council of Canada.

Optical recording of action potentials from mammalian nerve terminals in situ.

A. L. OBAID, H. GAINER, AND B. M. SALZBERG (University of Pennsylvania and N.I.H.).

A detailed understanding of the physiology of synaptic transmission in the vertebrates has been delayed by our inability to monitor the action potential in nerve terminals because the small size of the nerve terminal prevents a direct measurement of the presynaptic potential change. The vertebrate hypothalamo-neurohypophysial system represents an excellent model for the study of excitation-secretion coupling, but here also, the neurosecretory terminals are too small for microelectrode recording of the electrophysiological events that affect release.

We report here the use of optical methods that employ voltage sensitive dyes to record action potentials from populations of nerve terminals in the intact neurohypophysis of the CD-1 mouse, and the manipulation of the shape of the action potential by extracellular calcium and other agents known to affect the release of neurohormones and neurotransmitters. A PDP 11/34 based system for Multiple Site Optical Recording of Transmembrane Voltage (MSORTV) was used to record the absorption changes from 124 regions of the posterior pituitary gland, stained with the potentiometric probe NK2367, and stimulated with 0.5 ms electrical pulses to the infundibulum.

We find that at 24°C, the action potential has a width at half height of 3–4 ms. This duration is significantly increased in the presence of 4-aminopyridine at a concentration (50 μM) known to promote exocytosis. Elevated Ca^{++} , increased frequency of stimulation, and 4-aminopyridine enhance a slow component of the optical response having a wavelength dependence characteristic of light scattering. This signal appears in the absence of stain, does not reverse with wavelength, is present in white light, and is blocked by 1 mM Cd^{++} . These results strongly suggest that the light scattering signal monitors secretion and should be useful for resolving the kinetics of release.

We expect that direct optical measurement of transmembrane potential changes from the nerve terminals of the mammalian neurohypophysis, when correlated with the light scattering changes that appear to be associated with secretion of neurohypophysial peptides, will provide new insight into the electrophysiology of transmitter and hormone release.

We are grateful to D. Langer for help during some of these experiments. Supported by U. S. Public Health Service grant NS 16824 and a Steps Fellowship to A.L.O.

A relatively stable 100K_d protein is derived from the Ca²⁺-dependent proteolysis of neurofilament proteins in the squid axoplasm. HARISH C. PANT, PAUL E. GALLANT, ROCHELLE S. COHEN, AND HAROLD GAINER (Laboratory of Preclinical Studies, National Institute on Alcohol Abuse and Alcoholism, ADAMHA, Rockville, MD 20852).

Previous studies on the kinetics of degradation of neurofilament proteins in squid axoplasm by an endogenous calcium activated neutral protease (CANP) suggested a relatively stable 100K_d protein intermediate (Pant and Gainer 1980, *J. Neurobiol.* **11**: 1–12). Further analysis using SDS-PAGE and gel scanning of stained proteins on gradient slab gels confirmed these observations. These studies also indicated that the neurofilament proteins which were found in the 100,000 $\times g$ supernatant and pellet from axoplasm differed. The supernatant contained relatively more 200K_d neurofilament protein, whereas pellet contained relatively more larger forms (>400K_d). Both forms were degraded by endogenous CANP, but with different kinetics and peptide products. This was more clearly visualized by first phosphorylating the neurofilament proteins using [γ -³²P]ATP and endogenous kinase, and then subjecting the labeled proteins to CANP degradation. The labeled 200K_d proteins in both supernatant and pellet were degraded to a major 100K_d protein product and several smaller (*ca.* 95K_d) protein products. The labeled >400K_d forms in both fractions did not produce these intermediates upon CANP degradation, but rather larger (>250K_d) and smaller (*ca.* 37K_d) protein products. This suggests that >400K_d neurofilament protein is not a simple oligomer of 200K_d protein, but may represent a separate gene product or a highly cross linked form of the 200K_d protein.

Some morphological observations on the giant synapse of immature squid, Loligo pealei. D. W. PUMPLIN (Univ. of Maryland Schl. of Med.) AND J. HARRIGAN.

Immature *L. pealei* (dorsal mantle lengths 3.5–20 mm) were captured in ongoing ecological studies by trawling in the upper 30 m of the water column. As soon as possible after capture, specimens were fixed with glutaraldehyde in phosphate buffer containing sucrose. Stellate ganglia were postfixated in osmium, dehydrated, and embedded by standard methods. Thin sections were taken at 30-micron intervals transverse to the most distal giant fiber, proceeding from the center of the neuropil into the giant fiber lobe. In squid with mantle lengths of 3.5–5.5 mm, pre- and post-synaptic giant fibers were identified by their differential staining and electron density.

In immature ganglia, pre- and post-giant axons lay adjacent to each other separated by a thin glial layer. The pre-axon was about 5 microns in diameter, comparable to or somewhat larger than the post-axon. One pre-axon generally lay adjacent to two or more as-yet-unfused portions of the post-axon. In one such case, a projection from one post-axon passed through the glial layer to appose the pre-axon directly. This apposition was somewhat small (300 nm in length), but had the characteristic features of active zones of the giant synapse in older squid. Thus at least some active zones develop prior to complete fusion of elements of the post-axon.

Profiles of fibers contributing to the post-axon became more numerous and smaller in sections closer to the distal part of the giant fiber lobe, but were always in a discrete bundle. Intercellular junctions were found between some fibers. Junctions with widely-spaced (200 Å) parallel membranes and intervening electron density appear to be desmosomes; those with closely-spaced membranes (less than 100 Å) suggest invertebrate gap junctions, although both types should be characterized more fully.

D.W.P. is supported by grants from the NIH, Muscular Dystrophy Assoc., and the Bressler Fund of the Univ. of Maryland. J.H. is supported by the NINCDS, NIH. We thank M. Volkman, C. Tyndale, and the MBL EM lab for assistance.

Flight fuel utilization and flight energetics in the migratory milkweed bug, Oncopeltus fasciatus. MARY ANN RANKIN AND LAURA L. MORROW (University of Texas, Austin).

In order to identify the primary fuel for long distance flight in the migratory milkweed bug, *Oncopeltus fasciatus* (Lygaeidae: Hemiptera), total body lipid and carbohydrate were measured in animals flown to exhaustion, animals stopped after 30 min of flight (regarded as potential migrants), and animals that did not make a long flight. Total body lipid showed a significant decrease in long fliers compared to short fliers, while carbohydrate was not significantly different in any of the groups tested.

Measurements were made of ^{14}C CO₂ expelled during flight by animals injected prior to testing with potential flight fuels. Injected ^{14}C -palmitic acid was metabolized significantly above resting levels throughout the flight period, while ^{14}C -glucose was not oxidized by fliers to any greater extent than by non-fliers. ^{14}C -proline was utilized significantly above resting levels during approximately the first 90 min of flight. ^{14}C -glutamic acid was utilized only during the first 15 min of flight, while ^{14}C -glutamine was not oxidized by fliers to any greater extent than by non-fliers.

Evidence from CO₂ evolution and oxygen consumption during flight indicated that short flight or the first hour of long-duration flight is energetically more expensive than subsequent hours of long duration flight. Wingbeat frequency measurements by stroboscope showed a change from 67.8 ± 1.5 beats per second to 63.6 ± 0.2 beats per second during the first 30 min of flight. However, it is doubtful whether this drop is sufficient to account for the sevenfold decrease in energy demand which occurs during the first hour of flight. Measurements of thoracic temperature during flight are planned. It is concluded that proline may be important as an energy source for metabolically expensive short or the initial period of long-duration flight, while lipid is the primary fuel for long-distance flight in this species.

This work was supported by NSF grant # PCM-8110568.

Calcium transients in voltage clamped presynaptic terminals. STEPHEN J. SMITH, GEORGE J. AUGUSTINE, AND MILTON P. CHARLTON (University of Toronto).

We have used the indicator dye Arsenazo III to measure Ca transients in the giant presynaptic terminal of *Loligo pealei*. A 2-microelectrode voltage clamp configuration was used to control the presynaptic membrane potential, while a third electrode was inserted into the postsynaptic axon to measure transmitter release. Preparations were treated with tetrodotoxin (10^{-6} M) and injected with 3,4-diaminopyridine and tetraethylammonium to block Na and K currents. Arsenazo III was injected to a final concentration of 0.1 to 1 mM. Optical signals were acquired with a single optical fiber (20–60 μm diameter) placed over the presynaptic terminal and were detected with a multiwavelength microspectrophotometer.

Depolarizing voltage steps produced transient changes in dye absorbance spectra consistent with a change in intracellular Ca. Intracellular Ca rose linearly during 20–40 ms depolarizing pulses at a rate dependent on the amplitude of the presynaptic depolarization. Transients could be detected for pulses as short as 4 ms. Signals declined over several seconds following repolarization.

The Ca-Arsenazo signal had a bell-shaped voltage dependence, as expected from the Ca current-voltage relationship. However, the precise form of the voltage dependence varied with the position of the light pipe along the presynaptic terminal. Signals recorded from the distal portion of the terminal were largest at command potentials of -10 to 0 mV and disappeared at depolarizations of $+60$ or $+70$ mV. This relationship agrees with voltage clamp measurements of presynaptic Ca currents. Arsenazo signals from more proximal portions of the terminal were skewed, with peaks at $+10$ to $+20$ mV and suppression at potentials more positive than $+80$ mV. This suggests that the potential at the proximal portion is different from the rest of the terminal, perhaps due to voltage decrement within the long presynaptic axon. We tested this possibility by recording membrane potential at several points along voltage clamped terminals and found that, during large depolarizations, the proximal portion could be 20–30 mV less depolarized than the distal portion. We conclude that Arsenazo III can be used to measure Ca transients in voltage clamped presynaptic terminals, but that Ca entry is influenced by presynaptic voltage gradients.

Supported by NIH grant NS-16671 to S. Smith, NRSA Fellowship to G. Augustine, and Whitehall Foundation and MRC (Canada) grants to M. Charlton.

Single amino acids stimulate lobster (Homarus americanus) behavior against ambient and modified amino acid backgrounds. MARILYN SPALDING AND JELLE ATEMA (Boston University Marine Program, Marine Biological Laboratory, Woods Hole, MA 02543).

Raw sea water contains free amino acid concentrations in the pico-to-nanomolar range; ammonia occurs in micromolar quantities. This is the normal noise background for lobster chemoreception. Lob-

sters have prominent populations of receptor cells which are narrowly tuned for single amino acids and ammonia. Such cells are found both in smell and in taste organs. One might expect, therefore, that elevating the normal background for one amino acid should raise its detection threshold to this new level, but should not interfere with the reception of another.

We used eight one-year-old lobsters of about 13 mm carapace length in 50 ml centrifuge tubes. We counted antennular-flicking rate to measure their responses to 2 ml stimuli injected into the sea water background flow of $0.6 \text{ ml} \cdot \text{s}^{-1}$. We obtained dose-response curves for L-proline, L-glutamine, and ammonia from 10^{-12} M to 10^{-3} M in single log steps.

In normal sea water the proline and glutamine curves emerged from control levels at 10^{-9} M , the ammonia curve at 10^{-5} M , *i.e.*, just above the ambient sea water background for these three compounds. With elevated sea water backgrounds of 10^{-8} M and 10^{-6} M proline, the proline threshold shifted up to the new background levels, but the entire curve also dropped, indicating that even at high stimulus concentrations responses were suppressed in elevated backgrounds. This was seen also for glutamine; ammonia was not tested.

Similarly and unexpectedly, the glutamine and ammonia curves dropped in elevated proline backgrounds; also, the proline response at 10^{-6} M was completely suppressed by a 10^{-6} M glutamine background. We conclude that the peripheral receptor cells converge centrally such that their narrow tuning is not used behaviorally.

In elevated backgrounds lobsters responded to both higher and lower stimulus concentrations indicating that sudden temporary dilution of only one amino acid in the whole background mixture cannot only be detected but constitutes a behaviorally significant stimulus.

Depolarizing and desensitizing actions of glutaminergic and cholinergic agonists at the squid giant synapse. E. F. STANLEY (Johns Hopkins Med. Sch.).

Studies on the squid stellate ganglion giant synapse have resulted in a detailed understanding of the physiology of synaptic transmission. However, relatively little is known about the pharmacology of this synapse, primarily because of the formidable diffusion barrier for drugs entering from the bathing medium. This study used a technique of infusing substances through the arterial blood supply as described in Stanley and Adelman (1982, *Biol. Bull.* **163**: 403), to circumvent this barrier in order to examine the actions of glutaminergic and cholinergic agonists at this synapse.

Abruptly switching the infusion solution from sea water to L-glutamate results in an immediate (3 to 8 seconds delay for dead space in the cannula and artery), dose dependent (0.1 to 10 mM) depolarization (maximum 13.5 mV) followed at higher concentrations of glutamate by a gradual repolarization, presumably due to desensitization. Sterically restricted glutamate agonists also depolarized the postsynaptic axon in a decreasing order (measured as maximum rate of initial depolarization) of: L-glutamate, kainate, quisqualate, L-aspartate = D-aspartate, ibotenate, N-methyl-D-L-aspartate. The amino acids taurine and glycine had no effect, whereas serine was a weak agonist.

Acetylcholine and its agonist carbamylcholine also depolarized the synapse in a dose-dependent manner and with maintained infusion at a high concentration (10 mM) desensitized to both themselves and each other. The cholinergic receptor appeared to be distinct from the glutaminergic receptor since desensitization by glutamate did not eliminate the carbachol response nor *vice versa*.

Glutaminergic agonists also desensitized the synapse to the endogenous transmitter as evidenced by a gradual reduction and eventual disappearance of the EPSP evoked by stimulating the pre-nerve, whereas the cholinergic agonists did not. This is consistent with the endogenous transmitter being a glutamate agonist. Carbachol also reduced the EPSP but this effect was transient and the EPSP recovered during carbachol desensitization. Since no change was detected in the intracellularly recorded pre-synaptic resting potential these results suggest that the carbachol-induced reduction in the EPSP is a post synaptic phenomenon, due perhaps to a fall in the input resistance. Such an effect, a depolarization combined with a decrease in input resistance, is explained if carbachol activated a chloride channel, though this hypothesis requires further study.

Functional and chemical characterization of squid neurofilament polypeptides.

R. V. ZACKROFF (Department of Cell Biology and Anatomy, Northwestern University Medical School, Chicago, IL), W. D. HILL, M. TYTELL, AND R. D. GOLDMAN.

Neurofilaments isolated from the optic lobe of the squid (*Loligo pealei*) by two cycles of *in vitro* assembly-disassembly are composed of four polypeptides, with molecular weights 60K, 74K, 100K, and 220K (Zackroff and Goldman 1980, *Science* **208**: 1152-1155). Densitometric scans of sodium dodecyl sulfate (SDS) gels indicate that >70% of neurofilament protein is represented in the 60K band, while 5-10% of the protein is represented in each of the 74K, 100K, and 220K bands. When neurofilaments are

isolated by assembly-disassembly from the stellate ganglion, an additional protein of 65K is obtained. We have investigated the ability of each of these proteins to form homopolymer intermediate filaments (IF) *in vitro* after purification by SDS polyacrylamide gel electrophoresis followed by removal of the SDS. We find that the 60K and 74K proteins can form homopolymer IF, while the 65K, 100K, and 220K proteins do not. Peptide mapping of each of these proteins after digestion with *S. aureus* protease (Cleveland *et al.* 1977, *J. Biol. Chem.* **252**: 1102) results in a virtually identical pattern for each of the four optic lobe proteins, while the 65K stellate ganglion protein exhibits a different peptide map. Since the higher molecular weight (220K and 100K) proteins exhibit structural similarity to the 60K and 74K proteins, these results suggest that all four of these proteins are IF structural polypeptides. It appears likely that the 60K and/or 74K proteins are precursors which become covalently linked to form the 100 and/or 220K proteins, or, conversely, that the higher molecular weight proteins may be cleaved to form the lower molecular weight (74K and 60K) IF forming proteins. The properties of the 65K protein suggest that it may be a neurofilament associated protein which is specifically localized in the neuronal cell body and/or axonal hillock region.

Supported by NIH and NSF.

PARASITOLOGY, PATHOLOGY, AND AGING

Phagocytosis and intralysosomal killing of Leishmania mexicana by *Entamoeba histolytica*. L. F. ANAYA-VELAZQUEZ AND K.-P. CHANG (Experimental Pathology Section, Center for Research and Advanced Studies of the National Polytechnical Institute P. O. 14-740, Mexico D. F., 07000 Mexico).

The protozoa *Entamoeba histolytica* is one type of professional phagocytes, which can ingest and digest other cells by unknown mechanisms. *Leishmania* spp. are unicellular protozoa, which normally live in the lysosomes of the macrophages. Cellular interactions between these two organisms are, therefore, of interest for investigations.

10^6 trophozoites and 2×10^7 leishmanial promastigotes were incubated in the amoeba culture medium containing heat-inactivated fetal bovine serum at 35°C in a stirring vial with or without cytochalasin B (10 µg/ml). Samples were taken at different times points for microscopic examinations and for cultivation to check the viability of the promastigotes. In the absence of cytochalasin B, there was a rapid uptake and degradation of promastigotes by the amoeba. The rate of uptake reached a maximum of about 350 promastigotes/100 amoeba in 20 minutes. The rate of intracellular degradation of promastigotes reached 90% by 40 minutes. In the presence of cytochalasin B, there was neither uptake nor degradation of the promastigotes by the amoeba.

We also prelabeled amoeba with FITC-Dextran overnight and then infected them with leishmanias. UV microscopy revealed fluorescence in the leishmania-containing vacuoles, indicating lysosome-phagosome fusion. Fluorescent intensity in these vacuoles was measured by using a photomultiplier at excitation wavelengths of 350–450 nm and 450–495 nm, the emission wavelength being 550 nm. The intravacuolar pHs were calculated from the ratio of 450–495 nm/350–450 nm against a standard plot of fluorescein solutions at different pHs. The leishmania-containing vacuoles in amoeba were determined to have a low pH of 4.5–5.0 consistent with that of the lysosomal compartment. Since *E. histolytica* does not utilize oxygen for microbicidal action, its lysosomal killing of leishmanias must be based on a non-oxidative mechanism.

IgE monoclonal antibodies produced from mice immunized with irradiated cercariae of Schistosoma mansoni. G. EKAPANYAKUL, A. FLISSER, A. KO, AND D. HARN (Harvard School of Medicine).

IgE antibodies have been implicated in the host immune response to several helminth infections including schistosomiasis. The exact role that IgE antibodies play in these parasitic infections is not understood. To help elucidate the functions in which IgE antibodies might be involved we generated parasite specific IgE antibodies using hybridoma technology.

To generate parasite specific IgE antibodies mice were primed and boosted with irradiated cercariae of *Schistosoma mansoni*. Spleens of immunized mice were used for fusions on days 4, 5, and 6 after the final boost. Spleen cells were fused with NS-1 cells using polyethylene glycol.

Prior to spleen removal, immunized mice were bled and the sera were tested for IgE antibodies to parasite antigens. IgE antibodies were detected by enzyme linked immunosorbent assay (ELISA) using a purified rabbit anti-mouse IgE (epsilon specific) antibody or by passive cutaneous anaphylaxis in rats.

Hybridomas were initially screened for IgE secretion and/or antibodies to parasite antigens by ELISA. The frequency of IgE positive hybridomas ranged from 4 to 20 times that found in normal spleen cell populations.

Putative IgE secreting hybridomas were also tested for surface binding to living schistosomula and/or cercarial tails by indirect immunofluorescence. Several of the IgE antibodies were surface membrane binding.

Ten IgE and parasite specific hybridomas were cloned by limiting dilution. Assay of the cloned hybridomas allowed us to select and begin expansion of five clones which were still secreting IgE antibodies as determined by ELISA.

Characterization of the major surface antigen of Plasmodium falciparum merozoites. A. S. FAIRFIELD, D. A. E. DOBBELAERE, AND M. PERKINS (Rockefeller U.).

Invasion of erythrocytes by the merozoite stage of *Plasmodium falciparum*, a human malaria parasite, requires specific recognition between the host cell and the parasite. The receptor in the red cell has been identified as glycophorin, but the corresponding receptor on the merozoite is unknown. To date, the only merozoite surface protein identified in *P. falciparum* by monoclonal antibody is a protein of MW 200 kd. Our project was concerned with the characterization of this protein with a view of understanding its role in merozoite invasion.

Initially we were successful in purifying the 200 kd antigen using Affigel crosslinked to the monoclonal antibody. By labeling *in vitro* cultures of *P. falciparum* with ^3H -glucosamine it was possible to show that the protein is a glycoprotein.

Pulse-chase experiments show that during maturation and release of merozoites the 200 kd protein is processed into two soluble (MW 130 and 150 kd) and two membrane-bound (50 and 80 kd) polypeptides. To determine at which parasite stage the protease is present, ^3H -proline-labeled substrate was incubated with lysates of different stages of the parasite. Contrary to expectations, none of the parasite stages were able to process the protein. However, schizonts solubilized with triton X-100 did permit proteolysis to occur. It appears, therefore, that the protease is membrane-bound and closely associated with the 200 kd protein to be effective. An identical experiment using red blood cells showed that they were not an active factor in this process.

The possibility that this proteolysis was an artifact of parasite isolation also warranted investigation. ^3H -glucosamine-labeled schizonts were allowed to mature and re-invade red cells in unlabeled medium. Surprisingly, many of the major proteins, including the 200 kd protein, were conserved well into the parasite ring stages.

In summary it appears that a major 200 kd surface protein of the mature stages of *P. falciparum* is a glycoprotein based on ^3H -glucosamine labeling and purification by monoclonal antibody. A putative parasite protease cleaving the 200 kd antigen is produced as early as the schizont stage, is membrane-bound, and is probably closely situated to its 200 kd substrate. The possibility that proteolysis of the 200 kd protein is a result of experimental manipulations was also raised.

An epizootic disease-complex of wild and laboratory-maintained Hermisenda crassicornis. LOUIS LEBOVITZ (Laboratory for Marine Animal Health, Marine Biological Laboratory, Woods Hole, MA 02543), ALAN KUZIRIAN, JUNE HARRIGAN, EDWARD F. SCHOTT, IZJA LEDERHENDLER, AND DANIEL L. ALKON.

Hermisenda crassicornis is an eolid marine nudibranch utilized in comparative developmental, behavioral, and neurobiological laboratory studies. A highly fatal epizootic disease-complex in wild and laboratory-maintained *H. crassicornis* is reported. Early signs of the disease are reduced photosensitivity, decreased motility, and erosion and deformity (kinks) of the oral tentacles. More advanced gross signs are pericardial clouding, cardiac arrest, increased cardiac eminence (hunchback), loss of cerata and oral tentacles, and desquamation of the surface epithelium. Terminal signs are generalized body deformity and depigmentation, rupture of the body wall, visceral prolapse, and death.

Histological and microbiological examinations revealed fungal infections of the surface epithelium in early stages; generalized bacterial invasion in later stages. A ciliate, *Licnophora* sp., was found in increasing numbers on surface appendages (tentacles and cerata) as the disease progressed. Work is in progress to further characterize the disease and to develop methods of prevention, control, and eradication.

We wish to thank Dr. Jean Maguire, Ms. Catherine Tamse, and Dr. Eugene Copeland for their assistance. This study was supported in part by a grant (No. 1-40-PR01333-03) from the Division of Research Resources, National Institute of Health.

Trematode infection in Ilyanassa obsoleta: dependence on size and sex of the host, and effect on chemotaxis. MATTHEW LIEBMAN (State University of New York at Stony Brook).

Life cycles of trematodes parasitizing the common mud snail, *Ilyanassa obsoleta*, are well described, but little is known about their effect on the population biology and behavior of host snails. I determined infection rates of snail populations at Great Sippewissett salt marsh and Barnstable harbor in July and August 1983 and tested the effect of parasitism on the alarm response to crushed conspecifics. Parasitism was determined by dissection in most cases, or by release of cercariae.

Incidence of parasitism exhibited temporal and spatial variability. In an aggregation from the salt marsh, the infection rate decreased from 71.6% on 3 July (n = 204), to 4.5% on 11 July (n = 200), to 3.1% on 16 July (n = 162), and then increased to 10.9% on 8 August (n = 110). On 3 July, *Zoogonus rubellus* dominated the trematode community. On 8 August, *Austrobilharzia variglandis* was the dominant parasite. On 3 July, an aggregation located fifty meters away showed 0% (cercarial release) infection (n = 100). At Barnstable, an immobile aggregation of 100 snails showed 75.3% infection whereas only 2.7% (cercarial release, n = 110) of the main migratory population was infected. The dominant parasites were *Lepocreadium setiferoides* and *Himastha quissetensis*.

Female snails (mode = 24 mm) were larger than males (mode = 22 mm) and comprised 68% of the population (n = 645) at Sippewissett. The incidence of parasitism was similar for males (27.1%) and females (23.1%) and increased exponentially with size-class. Infection rates indicate snail age since infections are permanent and older snails have been exposed to parasites longer. The largest size classes of male and female snails had comparable infection rates, but the larger sizes of females indicate a faster growth rate.

The effect of parasitism on the alarm response of snails from Barnstable was tested in a flowing sea water aquarium. Snails were kept at the sediment surface, and then exposed to crushed conspecifics. No significant differences in burrowing was observed between parasitized and non-parasitized snails.

These results indicate that incidence of parasitism 1) is spatially and temporally variable, 2) increases with snail age, and 3) does not affect the alarm response.

Thanks to H. Stunkard, G. Brenchley, E. Shott, B. Crowther, and L. Leibovitz. Research supported by a Founders Scholarship, MBL.

Mitogenic activity of extracts and supernates from Plasmodium falciparum. A. PERCY (University of California, Los Angeles) AND M. PERKINS.

The malaria parasite *Plasmodium falciparum* has been shown to produce a mitogen which acts on lymphocytes (Gabrielson and Jensen 1982, *Am. J. Trop. Med. Hyg.* 31: 441-448). The polyclonal activation of lymphocytes is important in the disease, resulting in hypergammaglobulinemia and the presence of anti-self antibodies. As a first step in the characterization of this mitogen, we have examined freeze-thaw extracts from various stages of the parasite for mitogenic activity.

Parasite extracts were prepared by the procedure of Gabrielson and Jensen from synchronous cultures of *P. falciparum*. Dilutions of these extracts were incubated in microtiter plates for five days with 10^5 human peripheral blood lymphocytes. Parasites were maintained in erythrocytes from the lymphocyte donor. After 116 hours of culture, five microcuries of tritiated thymidine was added to each culture, incubated for four hours, and the cells were harvested. All experiments were performed in duplicate. The human B cell mitogen, pokeweed mitogen, was used as a positive control, extracts from autologous erythrocytes as a negative control, and extracts from heterologous erythrocytes and from another parasite (*Leishmania enriettii*) as controls for antigen-specific stimulation.

Mitogenic activity (stimulation as strong as that seen with the mitogen control) was seen with 1:10, but not 1:100 dilutions of extracts from ring forms, schizonts, and merozoites. However, both 1:10 and 1:100 dilutions of supernates from two hour cultures of schizonts and of merozoites showed high activity, equivalent to that of the mitogen control. Pulse labeling experiments with tritiated proline have shown that only two proteins synthesized by the parasite are released into the supernate, one of 130,000, the other of 150,000 daltons.

Thus the *Plasmodium* mitogen is present in all stages of the parasite, but the highest activity is obtained in the supernate of parasite cultures.

Intracellular vacuolar pH of Leishmania mexicana infected macrophages. L. RIVAS AND K.-P. CHANG (Department of Microbiology, UHS/Chicago Medical School, North Chicago, IL 60064).

Leishmania organisms are parasitic protozoa and agents of human leishmaniasis. They have developed an extraordinary mechanism of survival inside the macrophage lysosomes. One possibility pro-

posed (Coombs 1982, *Parasitology* **84**: 149) is that they may increase the lysosomal pH, thereby inactivating the microbicidal function. We were unable to confirm this theory by quantitative fluorescence measurement of individual vacuoles, labeled with FITC-dextran, with or without parasites.

The macrophages were infected at a ratio of 10 parasites per macrophage, as previously described (Chang 1980, *Science* **209**: 1240) in FITC-dextran at 1 mg/ml. The fluorescence was measured in sequence with 2 excitation filters (350–450 nm and 450–490 nm). The emission filter was 550 nm. The ratio, 450–490 nm/350–450 nm, was plotted against different pH standard solutions with FITC-dextran.

According to these data, in the early times of infection with either amastigotes or promastigotes (1–3 h), a considerable proportion (30–40%) of the parasitophorous or nonparasitized vacuoles were found in a weak acidic environment; later (24–48 h) after infection, they appeared in more acidic compartments of pH 4.5–5.5, very similar to the value previously reported for the lysosomes.

In other experiments, we have detected serine- and metallo-proteinases released by promastigotes into the culture medium, as assayed by using ^{125}I -casein at pH 6.5. The physiological role of these enzymes in the survival of parasites in macrophages is not known.

We thank M. Bibee and P. Presley of Zeiss Co. and P. Olwell of Leitz Co. for their help with fluorescent microscopy.

Detection of Leishmania Kinetoplast DNA using biotinylated DNA probes. GUILERMO ROMERO (Universidad Cayetano Heredia, Lima, Peru), YARA CSEKO, AND DYANN WIRTH.

Recently, a method for the rapid identification of human pathogenic *Leishmania* was developed (Wirth and Pratt 1982, *PNAS* **79**: 6999). The method uses ^{32}P labeled Kinetoplast DNA (K-DNA) probes hybridized to tissue blots and detected by autoradiography. To develop a more suitable technique to work in endemic areas, we have examined the sensitivity of biotinylated K-DNA probes in the detection of promastigotes and K-DNA of *L. enriettii*.

L. enriettii K-DNA isolated from cultured promastigotes was nick-translated with biotinylated dUTP (Enzo Biochemicals) and alpha- ^{32}P dATP. *L. enriettii* promastigotes and purified K-DNA were blotted in nitrocellulose paper. The K-DNA probe (10 ng/ml) was hybridized as described (Wirth and Pratt 1982). The hybridized probe was detected by autoradiography and a variety of procedures based on the recognition of biotin by streptavidin.

Two hundred promastigotes or 30 pg of K-DNA could be detected by autoradiography. A streptavidin-horseradish peroxidase complex (Enzo Biochemicals) could resolve 10^5 promastigotes (15 ng of K-DNA). Biotinyl-N-Hydroxysuccinimide ester was synthesized and used to biotinylate crosslinked alkaline phosphatase. The biotinylated enzyme allowed visualization of 10^4 promastigotes or 1.5 ng of K-DNA (see Leary *et al.* 1983, *PNAS* **80**: 4045). A fluorescence assay was also tested. Poly-L-lysine (M.W. 200,000 daltons) was consecutively biotinylated and labeled with excess fluorescein isothiocyanate (FITC). The labeled protein was incubated at a 5 fold molar excess with streptavidin and the complex formed was used to develop the blots. The biotinylated FITC labeled polylysine allowed the visualization of 1000 promastigotes (150 pg of K-DNA) with the aid of a hand held UV light. Extensive washing with 4 M NaCl was used to eliminate nonspecific binding of the polylysine to DNA. Salmon sperm DNA was used to verify the washing procedure.

The sensitivity of the procedures tested compares very well with other previously published reports. The direct fluorescence assay may be useful in the field diagnosis of tegumentary leishmaniasis.

Antigens on both mechanical and lung stage schistosomula of Schistosoma mansoni are masked by host molecules. L. D. SIBLEY, J. KRAKOW, A. FLISSER, AND D. HARN (Harvard Medical School).

The acquisition of host antigens (Ag) by mechanical somula (MS) was studied using a monoclonal antibody (Ab) to worm surface Ag and chronic mouse serum (CMS). Monoclonal 1C4 binds to the surface of MS up to 96 h of culture in media containing FCS; culture of MS in normal mouse serum (NMS) from CBA mice (H-2K^b) for 24 h results in elimination of 1C4 binding by immunofluorescence assay (IFA). We conclude that host molecules present in serum mask worm surface Ag, and it was shown by IFA with specific monoclonal Ab that these molecules are not H-2K^b or Ia^b. We have also shown that IgG-depleted NMS eliminates 1C4 binding after 24 h in culture.

When lung stage schistosomula were examined by Sher *et al.* (*J. Exp. Med.* 1978, **148**: 46–57) and Gitter and Damian (*Par. Imm.* 1982, **4**: 383–393), MHC Ag were detected on freshly harvested worms. We confirmed the presence of H-2K^b and Ia^b on worms recovered from CBA mice at 6 h post-harvest. However, presence of MHC by IFA on lung worms placed in culture diminished at 48 h indicating shedding of these host Ag. This correlates with failure of CMS to bind freshly harvested worms, whereas worms cultured 36 h showed strong binding of CMS.

To examine acquisition of MHC Ag, we cultured lung worms 72 h to allow shedding of original host MHC molecules, and verified this by IFA. We then cultured MS or lung somula with washed peritoneal exudate cells in FCS. While no transfer of MHC Ag was detectable up to 48 h, somula cultured with CBA cells acquire H-2K^k and Ia^k after 72 h. Somula cultured with CD1 cells, shown to be negative for H-2K^k and Ia^k, remain negative for these host Ag.

Inhibition of a surface binding monoclonal antibody to schistosomula of Schistosoma mansoni by lectins. LINDA SWISTON, ALBERT KO, AND DON HARN (Harvard School of Medicine).

Developing mechanical and lung somula of *Schistosoma mansoni* were analyzed for surface membrane carbohydrates by a direct fluorescence assay using rhodamine conjugated (R) lectins. Lectins which bound to the surface membrane of the schistosomula were also tested for their ability to inhibit binding of a surface membrane specific monoclonal antibody. Our studies of lectin binding to mechanical somula at various time points agree with those of Simpson *et al.* (1983, *Mol. Biochem. Parasitol.* **8**: 191-205) in that all lectins used [concanavalin A (Con A), lentil, peanut agglutinin (PNA), wheat germ agglutinin (WGA), soybean agglutinin, and *Ricinus communis* agglutinin] showed a decrease in binding ability related to an increase in time of culture. Our data on lectin binding to lung worms varies in two aspects from the published data. We found no ability of RWGA, and only a slight ability of RPNA to bind to our fresh and twenty-four hour cultured lung worms, whereas the findings of Simpson *et al.* and others show binding of both RWGA and RPNA. However, these other studies did not examine cultured lung worms.

Lectin inhibition of monoclonal antibody IC4, developed by D. Harn and known to bind to the surface of mechanical somula, was also studied. Worms were incubated with different lectins prior to the addition of the monoclonal antibody. The parasites were then tested for rhodamine and fluorescein fluorescence. Our results show that RPNA inhibits IC4 binding up to ten hour post-transformation. RConA showed a slight inhibition of IC4 binding at a two hour post-transformation, but it seemed to lose this quality quite rapidly. The other lectins showed no inhibition. Whether this inhibition was caused by steric hindrance or direct binding of the lectin to the antigenic epitope was not addressed in this study. Additional experiments involving inhibition with the respective sugars which will reveal the specificity need to be carried out.

Host specificity of intestinal gregarines (Protozoa, Apicomplexa) in two sympatric species of Capitella (Polychaeta). GARY E. WAGENBACH (Department of Biology, Carleton College, Northfield, MN), JUDITH P. GRASSLE, AND SUSAN W. MILLS.

Capitella species I and II were surveyed for parasites using field-collected and laboratory-reared worms. Field-collected *Capitella* species I were from Wild Harbor (MA) and inbred laboratory-reared strains originated from animals collected from Falmouth Harbor, from a culture maintained at the Skidaway Institute of Oceanography, and from coastal California. Field-collected *Capitella* species II were from New Bedford Harbor (MA) and laboratory strains originated from Woods Hole sewer outfall animals. All laboratory strains were maintained under identical conditions: 15°C static culture in filtered sea water using Sippewissett Marsh mud that had been freeze-thawed twice as substrate and food. Worms were anesthetized in chloretone-sea water and mounted in 50:50 glycerol:ethanol for examination.

Gregarines were the most abundant parasites observed (field-collected *Capitella* occasionally had trematode metacercaria and a possible coccidian). Notably all the *Capitella* species I samples had an apparently identical unidentified gregarine, while both samples of *Capitella* species II contained a gregarine of the genus *Ancora*. We propose that each *Capitella* hosts a unique gregarine even when the two *Capitella* species are kept under identical conditions in the laboratory.

Highest densities of gregarines were found in the host gut between setigers 13 and 20-28 just posterior to the stomach. Infection rates in the six samples varied from 27% to 100%. Five samples had a mean gregarine population of <118 while one *Capitella* species I strain was 100% infected with a mean of 1645 gregarines/worm. The number of gregarines per individual in *Capitella* species I did not differ between males and females. Heavily (mean = 1645 gregarines/worm) and lightly (mean = 9 gregarines/worm) infected *Capitella* species I showed no difference in fecundity (number of eggs/individual in the first brood). *Capitella* fecundity is strongly affected by genetic and environmental factors. We need to determine the probable effects of the gregarines on the population dynamics of these two sympatric *Capitella* species.

The assistance of Dr. N. Levine is gratefully acknowledged.

Structure of tubulin RNA from Leishmania enriettii. CLAIRE WYMAN (Johns Hopkins University School of Hygiene and Public Health) AND SCOTT LANDFEAR.

Protozoan parasites of the species *Leishmania* exist in two morphologic forms. The flagellated motile promastigote lives extracellularly in the sandfly gut. Inside their mammalian host promastigotes are ingested by macrophages and transform into nonmotile amastigotes. Tubulin expression during transformation is a developmentally regulated process: promastigotes contain more tubulin mRNA and synthesize more tubulin protein than amastigotes.

The α - and β -tubulin genes of *Leishmania enriettii* are arranged as tandem repeats. The α gene repeat contains approximately 15 copies of a 2 kilobase repeat unit. β -tubulin genes are arranged in 4 kilobase repeating units. Given this array the tubulin genes could be transcribed from a single upstream promoter to produce a very long (e.g., 30 kilobase) precursor that is processed down to the mature message. Alternatively transcription could occur from promoters at the beginning of each repeat. The 4 kilobase β -tubulin repeat unit also contains twice as much DNA as is needed to encode the mature message. This extra sequence could either be a non-transcribed intergenic spacer or part of an initial transcript that is cut out to form the mature message. The purpose of our experiments was to attempt to detect precursors to mature α - or β -tubulin mRNA.

RNA was obtained from promastigotes by both phenol and guanidium thiocyanate extraction. Northern blot analysis was used to look for RNA precursors. Blots were probed with α - and β -tubulin clones and a fragment of the β clone containing sequence probably not present in the mature message. Blots probed for α -tubulin RNA show several faint bands above the 2 kilobase message. Blots probed for β -tubulin RNA show three distinct bands other than the 2 kilobase message; one slightly above 2 kilobases, one slightly below, and one at about 4 kilobases. The two bands above and the one band below 2 kilobases also hybridize to the β fragment probe, but the 2 kilobase message itself does not hybridize to this probe. These experiments provide preliminary evidence for longer length precursors for α - and β -tubulin mRNA, and suggest that at least part of the additional DNA in the β -tubulin gene is initially transcribed.

If the temperature of promastigote cultures is shifted from 27°C to 35°C the cells resorb their flagella and begin to look like amastigotes. RNA was obtained from rapidly growing promastigotes and temperature transformed pseudoamastigotes by guanidinium thiocyanate extraction. Northern blot analysis shows that the promastigotes contain much more tubulin RNA than the pseudoamastigotes. Thus temperature shifting may be a useful model for studying promastigote to amastigote transformation with respect to tubulin gene expression.

PHOTORECEPTORS, VISION, AND RHYTHMS

Vision in Limulus mating behavior: tests for detection and form discrimination.

ROBERT B. BARLOW, JR., LEONARD KASS, VIVIAN MANCINI, AND JANICE L. PELLETIER (Syracuse University).

Vision plays a role in *Limulus* mating behavior. During the mating season, these horseshoe crabs move in from deep water, pair off, and build nests near the water's edge at high tide. Painted cement castings of the female carapace and other forms placed in the nesting area attract males; the degree of attraction depends in part on the visual contrast of the castings (Barlow *et al.* 1982, *Nature* 296: 65-66).

We tested the animal's ability to detect dark objects by observing male behavior in the vicinity of a submerged black cement hemisphere (29 cm diameter). The hemisphere, which is about the size of an adult female, was located 5 m below the high water line on the South side of Mashnee Dike, Cape Cod, MA. Sixty-four percent of males ($n = 285$) moving within 1.2 m of the hemisphere oriented toward the cement form and contacted it. No such behavior was observed for animals at distances greater than 1.2 m. It is interesting to note that at this distance the hemisphere can be seen by no more than four visual receptors in the central portion of the lateral eye.

We also tested the animal's ability to discriminate among submerged objects of different form. Black silhouettes of an adult female carapace (38 cm length), a hemisphere (29 cm diameter), and a square (18 cm/edge), all having equal surface area, were placed 1.1 m in front of the opening of a submerged holding pen. The three silhouettes were located at 45°, 90°, and 135° with respect to the pen opening. Seventy-seven percent of males ($n = 349$) leaving the pen approached and contacted one of the three silhouettes without preference for form.

In sum, during the day and at night, male *Limuli* visually detected dark submerged objects at distances of up to 1.2 m but did not discriminate small changes in the form of the objects.

We thank Heidi Howard, Maureen K. Powers, and George H. Renninger for their assistance. Supported in part by NIH grants EY-00667 and EY-05443 and NSF grant BNS 8104669.

Detection of membrane signals correlated with sensory excitation of phototactic Halobacterium halobium. BARBARA E. EHRLICH, CATHY R. SCHEN, AND JOHN L. SPUDICH (Albert Einstein College of Medicine, New York).

H. halobium, a bacterial species which lives in saturated brine, demonstrates both chemotactic and phototactic behavior. While much is known about the molecular mechanism for sensory adaptation of taxis, little is known about sensory excitation. The retinal-dependent phototaxis of halobacteria provides a model system to look for signals related to sensory excitation. Wild type halobacteria have three known retinal-containing pigments: bacteriorhodopsin (bR), halorhodopsin (hR), and s-rhodopsin (sR). The first two hyperpolarize the cell membrane by electrogenic transport of H^+ and Cl^- respectively. The third pigment, sR, may be a photosensory receptor because mutants lacking bR and hR retain phototactic behavior. To examine the effects of photoexcitation on cells and membrane vesicles, we monitored light-induced changes in fluorescence of the voltage-sensitive dye, diOC₆(3). We were able to detect four types of signals from cells and membrane vesicles. Red light-induced potential changes generated by bR were seen only in wild type cells and were similar to signals described previously by Renthall and Lanyi (1976, *Biochem.* **15**: 2136). In cells lacking bR, signals generated by hR could be identified using four criteria: wavelength dependence, Cl^- dependence, shunting by valinomycin and K^+ , and the absence of these signals in hR-deficient mutants. In mutants lacking bR and hR, two additional signals were measured: blue light caused a decrease and red light an increase in dye fluorescence. Both signals are retinal dependent. These signals may represent localized potential changes (*e.g.*, changes in surface charge due to sR photocycling) rather than transmembrane potentials because the signal could not be shunted by valinomycin and K^+ . The behavioral response in cells and the fluorescent changes we detect in cells and vesicles share two important characteristics: 1) the opposing effects of blue and red light and, 2) retinal dependence. This correlation strongly suggests that these signals are generated during sensory excitation.

Supported by NY Heart Association and NIH GM 27750. B.E.E. is a NY Heart Association Young Investigator.

Current clamp of photoreceptors and pacemaker neurons in eye of Bulla. JON W. JACKLET (SUNY Albany, NY 12222).

In addition to photoreceptors, the eyes of certain gastropods such as *Aplysia* and *Bulla* contain neurons that are circadian pacemakers. They are active, even in darkness, during the projected day, but silent during the projected night, of a circadian cycle sending circadian information to central neurons via optic nerve compound action potentials. A study of the *Bulla* eye (Jacklet and Colquhoun 1983, *J. Neurocytology* **12**: 373-396) shows *ca.* 1000 large photoreceptors ($30 \times 100 \mu m$) but only *ca.* 100 neurons ($15-25 \mu m$) tightly packed at the eye base. Both types have axons in the optic nerve. Gap junctions occur between neuronal processes in the neuropil but not between juxtaposed somata. Current clamp with a Dagan single electrode system shows membranes of large depolarizing photoreceptors have 30-80 ms time constants and 50-100 m Ω input resistances. Resistance decreases abruptly at *ca.* -35 mV indicative of voltage dependent changes and decremented action potentials invading the soma of some cells. Brief voltage and time dependent hyperpolarization follows release from hyperpolarizing pulses, indicative of IA current. Initial voltage clamp shows a prominent IA current. Serotonin, known to phase shift the circadian rhythm, hyperpolarizes photoreceptors and reduces their resistance, suggesting increased potassium conductance. Neurons fire action potentials 1:1 with optic nerve compound action potentials. Injected depolarizing current evokes decremented potentials and regenerative action potentials and also optic nerve compound action potentials, suggesting neurons are electrically coupled. Neurons have several time constants, a 12-20 ms time constant and a much longer one. Voltage and time dependent hyperpolarization follows hyperpolarizing pulses. Thus both neurons and photoreceptors have time and voltage dependent conductances including IA addition to expected light-evoked conductances.

Supported by NSF BNS 06245.

cAMP: a possible intracellular transmitter of circadian rhythms in Limulus photoreceptors. LEONARD KASS, JANICE L. PELLETIER, GEORGE H. RENNINGER, AND ROBERT B. BARLOW, JR. (Syracuse University).

At night a circadian clock in the *Limulus* brain transmits neural activity to the lateral eyes via efferent optic nerve fibers (Barlow *et al.* 1977, *Science* **197**: 86-89). The efferent input induces anatomical and physiological changes that combine to increase retinal sensitivity (Barlow *et al.* 1980, *Science* **210**:

1037–1039). Octopamine has been identified as a putative transmitter of the clock's action and exogenous octopamine increases cAMP levels in the lateral eye (Battelle *et al.* 1982, *Science* **216**: 1250–1252). In this study, we investigated the possible role of cAMP as an intracellular transmitter.

Photoreceptor potentials were recorded from slices of retina maintained in an organ culture medium (Bayer and Barlow 1978, *J. Gen. Physiol.* **72**: 539–563). The intracellular records were characteristic of those recorded *in situ* during the day in the absence of efferent input (Barlow and Kaplan 1977, *J. Gen. Physiol.* **69**: 203–220): they exhibit large spontaneous and light-evoked potential fluctuations (quantal bumps up to 50 mV in amplitude), large resting potentials (~60 mV), and a plateau in the midrange of the intensity-response function. Adding 8-bromo-cAMP (250 μ M), a putative adenylate cyclase activator (forskolin at 250 μ M), or a potent octopamine agonist (naphazoline at 25 μ M) to the bathing medium induced physiological changes characteristic of those recorded *in situ* during the night (Kaplan and Barlow 1980, *Nature* **286**: 393–395): namely, spontaneous quantal bumps were reduced in frequency, and the slope (gain) of the intensity-response function was increased. These were the most striking effects but occasionally decreases in threshold were also observed.

In sum, our results are consistent with the following scheme: activity of a circadian clock in the brain releases octopamine from terminals of efferent optic nerve fibers in the retina. The octopamine increases cAMP levels in photoreceptors thereby changing their physiology, anatomy, and morphology.

Supported by NIH grants EY-00667 and EY-05443, NSF grant BNS 8104669, and a grant from NSERC Canada.

Photoreceptors add at the anterior edge of Limulus lateral eye. JENNIFER J. MARLER, ROBERT B. BARLOW, JR., LESLIE EISELE, AND LEONARD KASS (Marine Biological Laboratory).

The lateral eye of *Limulus polyphemus* provides an interesting preparation for studying the development of the visual system, by virtue of the continued addition of ommatidia to the eye during the postembryonic growth of this animal. Given the recent description of a retinotopic map in *Limulus* (Chamberlain and Barlow 1982, *J. Neurophysiol.* **48**: 505–520), one may address the issue of how newly-added units become organized in the optic nerves and make appropriate functional connections in the optic ganglia. An important preliminary question, examined in this study, concerns where new ommatidia are added to the eyes.

Sixth stage juvenile animals were collected, 2–3 retinal scars (each of which destroyed 5–10 ommatidia) were made over their eyes in an array around the anterior edges, and the eyes were photographed. The anterior margins of the eyes were chosen as scarring sites due to the observations that (a) the facet diameters of anterior ommatidia are qualitatively smaller than more posterior ones in juveniles, (b) fault lines exist in the hexagonal packing of ommatidia near the anterior edges, and (c) rows of small ommatidia can occasionally be discerned beneath the carapaces of pre-molt juveniles. The animals were left to molt, after which their eyes were rephotographed.

Comparison of pre- and post-molt eyes yielded the following results: (1) ommatidia are added, in vertical strips, to the anterior edges of the growing lateral eyes of these juveniles, (2) the sizes of units added show dorso/ventral differences (larger units are added ventrally), (3) diameters of existing ommatidia increase during growth, and (4) the rate of ommatidial addition may vary between the two eyes of a single individual. One consequence of this pattern of retinal growth is that the retinotopic organization of the visual system changes as the animal grows. That is, the receptors seeing the anterior portion of the visual field as juveniles will view the medial portion as adults.

Supported in part by NIH grants EY 00667 and EY 05443 and NSF grant BNS 8104669.

The effects of intracellular calcium/EGTA on the photoactivation of Limulus ventral photoreceptors. RICHARD PAYNE AND ALAN FEIN (Marine Biological Laboratory).

Limulus ventral photoreceptors were impaled with two micropipettes, one containing 2.5 M KCl, the other 0.1 M K₂EGTA [Ethylene-glycol-bis-(β -aminoethyl ether) N,N,N',N'—tetraacetic acid] and sufficient Ca(OH)₂ to create buffered free calcium concentrations between 0.1 and 10 μ M at pH 7.0. Ten to 100 pl of the latter solution were pressure-injected into cells. Currents generated by 10 ms flashes were recorded under voltage clamp at the resting potential. Each flash was estimated to produce approximately 200 discrete waves.

After injections of EGTA solutions containing 0.1 μ M free calcium, the responses of 8 cells became slower, with less abrupt rising edges, but the area under the responses was undiminished. After injection, the responses could be modelled as the output of 7 cascaded, exponential stages of delay, having 6 time constants, T_a, of 39 \pm 11 ms and one, T_b, of 534 \pm 128 ms. Injection of EGTA solutions containing

10 μM free calcium into 8 other cells resulted in a 100-fold reduction in response area. A 7-stage model again described the time-course of the response, but with faster time constants, $T_a = 10 \pm 1$ ms and $T_b = 89 \pm 4$ ms. Despite the reduction in peak amplitude, the average initial response after injection of 10 μM calcium exceeded that after injection of 0.1 μM calcium. Calcium therefore increases both the rate of production and the rate of decay of the photocurrent.

A considerable problem remains in relating the kinetics of the responses recorded before EGTA injection to those recorded after. Dark-adapted responses recorded before injection of EGTA, or after control injections of aspartate, exhibit too abrupt a rising edge to be modelled with 6–7 stages of delay. One possible explanation is that EGTA buffers an early, local release of calcium which would normally accelerate the initial generation of photocurrent.

Localization of calcium transients in the presynaptic terminals of a barnacle photoreceptor detected using Arsenazo III. WILLIAM N. ROSS AND N. STOCKBRIDGE (New York Medical College, Valhalla, NY 10595).

The median photoreceptor of a giant barnacle, *Balanus nubilus*, with well separated cell body, axon, and presynaptic terminal is a good preparation for studying calcium control of transmitter release at a tonic synapse.

The supraesophageal ganglion, its connectives, and the median ocellus were dissected and mounted on the stage of a Zeiss compound microscope. The preparation was imaged onto a 100-element photodiode array with a 40 \times water immersion objective. With this lens, each element detected light from an area of $25 \times 25 \mu\text{m}$ in the plane of the preparation. The calcium-binding dye, Arsenazo III, was iontophoresed into the distal axon of 1 cm long photoreceptors about 100–200 μm from the end of the axon and allowed to diffuse into the terminal arborization of the cell.

Absorbance changes were observed when the photoreceptor was depolarized electrically or by light. These changes were consistent with those expected from calcium entering from outside the cell: increase maximal at 660 nm, decrease maximal at 530 nm, and an isosbestic point at approximately 570 nm. When calcium action potentials were elicited in 20–50 mM TEA, absorbance changes were much larger than in normal saline. The absorbance changes were eliminated in saline in which cobalt replaced 90% of the calcium.

Although dye was most clearly visible near the site of injection, absorbance changes were restricted to the region of terminal arborization, about 50 μm . Smaller signals recorded over the surrounding 50 μm area were consistent with scattering of light during passage through the tissue. The absorbance change over the terminal was at least 50 times larger than that detected over the axon.

The afterhyperpolarization in the photoreceptor was TEA-insensitive and has a reversal potential dependent on the extracellular potassium concentration (Edgington, unpub.). Its recovery time course was well matched by the time course for calcium removal, suggesting that this hyperpolarization was due to calcium-activated potassium channels. Since calcium enters only at the terminal, this conductance must also be confined to the terminal region.

Continued from Cover Two

secutive Arabic numbers, on a separate sheet at the end of the paper. Footnotes should be limited to authors' current addresses, acknowledgments or contribution numbers, and explanation of unusual abbreviations. All such footnotes should appear on the title page. Footnotes are not normally permitted in the body of the text.

4. **A condensed title** or running head of no more than 35 letters and spaces should appear at the top of the title page.

5. **Literature cited.** In the text, literature should be cited by the Harvard system, with papers by more than two authors cited as Jones *et al.*, 1980. Personal communications and material in preparation or in press should be cited in the text only, with author's initials and institutions, unless the material has been formally accepted and a volume number can be supplied. The list of references following the text should be headed LITERATURE CITED, and must be typed double spaced on separate pages, conforming in punctuation and arrangement to the style of recent issues of *The Biological Bulletin*. Citations should include complete titles and inclusive pagination. Journal abbreviations should normally follow those of the U. S. A. Standards Institute (USASI), as adopted by BIOLOGICAL ABSTRACTS and CHEMICAL ABSTRACTS, with the minor differences set out below. The most generally useful list of biological journal titles is that published each year by BIOLOGICAL ABSTRACTS (BIOSIS List of Serials; the most recent issue). Foreign authors, and others who are accustomed to using THE WORLD LIST OF SCIENTIFIC PERIODICALS, may find a booklet published by the Biological Council of the U.K. (obtainable from the Institute of Biology, 41 Queen's Gate, London, S.W.7, England, U.K.) useful, since it sets out the WORLD LIST abbreviations for most biological journals with notes of the USASI abbreviations where these differ. CHEMICAL ABSTRACTS publishes quarterly supplements of additional abbreviations. The following points of reference style for THE BIOLOGICAL BULLETIN differ from USASI (or modified WORLD LIST) usage:

- A. Journal abbreviations, and book titles, all underlined (for *italics*)
- B. All components of abbreviations with initial capitals (not as European usage in WORLD LIST e.g. *J. Cell. Comp. Physiol. NOT J. cell. comp. Physiol.*)
- C. All abbreviated components must be followed by a period, whole word components *must not* (i.e. *J. Cancer Res.*)
- D. Space between all components (e.g. *J. Cell. Comp. Physiol.*, not *J.Cell.Comp.Physiol.*)
- E. Unusual words in journal titles should be spelled out in full, rather than employing new abbreviations invented by the author. For example, use *Rit Visindafjélags Íslendinga* without abbreviation.
- F. All single word journal titles in full (e.g. *Veliger, Ecology, Brain*).
- G. The order of abbreviated components should be the same as the word order of the complete title (i.e. *Proc. and Trans.* placed where they appear, not transposed as in some BIOLOGICAL ABSTRACTS listings).
- H. A few well-known international journals in their preferred forms rather than WORLD LIST or USASI usage (e.g. *Nature, Science, Evolution* NOT *Nature, Lond., Science, N.Y.; Evolution; Lancaster, Pa.*)

6. **Reprints, charges.** *The Biological Bulletin* has no page charges. However, authors will be requested to help pay printing charges of manuscripts that are unusually costly due to length or numbers of tables, figures, or formulae. Reprints may be ordered at time of publication and normally will be delivered about two to three months after the issue date. Authors (or delegates or foreign authors) will receive page proofs of articles shortly before publication. They will be charged the current cost of printers' time for corrections to these (other than corrections of printers' or editors' errors).

CONTENTS

<p>AYLING, AVRIL L. Growth and regeneration rates in thinly encrusting demospongiae from temperate waters</p>	343
<p>BENAYAHU, Y., AND Y. LOYA Surface brooding in the Red Sea soft coral <i>Parerythropodium fulvum fulvum</i> (Forskål, 1775)</p>	353
<p>DUNCAN, THOMAS K. Sexual dimorphism and reproductive behavior in <i>Almyracuma proximoculi</i> (Crustacea: Cumacea): the effect of habitat</p>	370
<p>ECKELBARGER, KEVIN J., AND JUDITH P. GRASSLE Ultrastructural differences in the eggs and ovarian follicle cells of <i>Capitella</i> (Polychaeta) sibling species</p>	379
<p>EYSTER, LINDA S. Ultrastructure of early embryonic shell formation in the opisthobranch gastropod <i>Aeolidia papillosa</i></p>	394
<p>FREEMAN, JOHN A., TERRY L. WEST, AND JOHN D. COSTLOW Postlarval growth in juvenile <i>Rhithropanopeus harrisi</i></p>	409
<p>KAPLAN, SAUL W. Intrasexual aggression in <i>Metridium senile</i></p>	416
<p>MILLER, RICHARD L., AND KENNETH R. KING Sperm chemotaxis in <i>Oikopleura dioica</i> Fol, 1872 (Urochordata: Larvacea)</p>	419
<p>RAMOS-FLORES, TALIA Lower marine fungus associated with black line disease in star corals (<i>Montastrea annularis</i>, E. & S.)</p>	429
<p>SUGITA, HIROAKI, AND KOICHI SEKIGUCHI The developmental appearance of paternal forms of lactate dehydrogenase and malate dehydrogenase in hybrid horseshoe crabs</p>	436
<p>TSUJI, FREDERICK I., AND ELIZABETH HILL Repetitive cycles of bioluminescence and spawning in the polychaete, <i>Odontosyllis phosphorea</i></p>	444
<p>VITTURI, R., A. MAIORCA, AND E. CATALANO The karyology of <i>Teredo utriculus</i> (Gmelin) (Mollusca, Pelecypoda)</p>	450
<p>WEDI, STEVEN E., AND DAPHNE FAUTIN DUNN Gametogenesis and reproductive periodicity of the subtidal sea anemone <i>Urticina lofotensis</i> (Coelenterata: Actiniaria) in California ...</p>	458
<p>YUI, MARY A., AND CHRISTOPHER J. BAYNE Echinoderm immunology: bacterial clearance by the sea urchin <i>Strongylocentrotus purpuratus</i></p>	473
<p>ABSTRACTS OF PAPERS PRESENTED AT THE GENERAL SCIENTIFIC MEETINGS OF THE MARINE BIOLOGICAL LABORATORY</p>	
Cellular, molecular biology, etc.	487
Developmental biology	499
Ecology, evolution, plant sciences	504
Gametes and fertilization	512
Microbiology	520
Neurobiology, learning, behavior	523
Parasitology, pathology, aging	534
Photoreceptors, vision, rhythms	539

Volume 165

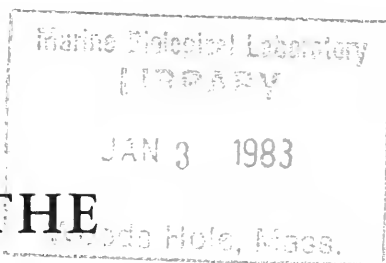

Number 3

THE BIOLOGICAL BULLETIN

PUBLISHED BY
THE MARINE BIOLOGICAL LABORATORY

Editorial Board

- | | |
|--|--|
| DANIEL L. ALKON, National Institutes of Health and
Marine Biological Laboratory | MICHAEL G. O'RAND, Laboratories for Cell Biology,
University of North Carolina at Chapel Hill |
| ROBERT B. BARLOW, JR., Syracuse University | RALPH S. QUATRANO, Oregon State University at
Corvallis |
| WALLIS H. CLARK, JR., University of California at
Davis | LIONEL I. REBHUN, University of Virginia |
| DAVID H. EVANS, University of Florida | JOEL L. ROSENBAUM, Yale University |
| HARLYN O. HALVORSON, Brandeis University | DOROTHY M. SKINNER, Oak Ridge National
Laboratory |
| RONALD R. HOY, Cornell University | JOHN D. STRANDBERG, Johns Hopkins University |
| SAMUEL S. KOIDE, The Population Council,
Rockefeller University | JOHN M. TEAL, Woods Hole Oceanographic
Institution |
| FRANK J. LONGO, University of Iowa | J. RICHARD WHITTAKER, Boston University
Marine Program and Marine Biological Laboratory |
| CHARLOTTE P. MANGUM, The College of
William and Mary | GEORGE M. WOODWELL, Ecosystems Center, Marine
Biological Laboratory |

Editor: CHARLES B. METZ, University of Miami

DECEMBER, 1983

Printed and Issued by
LANCASTER PRESS, Inc.
PRINCE & LEMON STS.
LANCASTER, PA.

THE BIOLOGICAL BULLETIN

THE BIOLOGICAL BULLETIN is published six times a year by the Marine Biological Laboratory, MBL Street, Woods Hole, Massachusetts 02543.

Subscriptions and similar matter should be addressed to THE BIOLOGICAL BULLETIN, Marine Biological Laboratory, Woods Hole, Massachusetts. Single numbers, \$13.00. Subscription per volume (three issues), \$32.50 (this is \$65.00 per year for six issues).

Communications relative to manuscripts should be sent to Dr. Charles B. Metz, Editor, or Pamela Clapp, Assistant Editor, at the Marine Biological Laboratory, Woods Hole, Massachusetts 02543 between May 1 and October 1, and at the Institute For Molecular and Cellular Evolution, University of Miami, 521 Anastasia, Coral Gables, Florida 33134 during the remainder of the year.

Copyright © 1983, by the Marine Biological Laboratory

Second-class postage paid at Woods Hole, Mass., and additional mailing offices.

ISSN 0006-3185

INSTRUCTIONS TO AUTHORS

The Biological Bulletin accepts outstanding original research reports of general interest to biologists throughout the world. Papers are usually of intermediate length (10–40 manuscript pages). Very short papers (less than 10 manuscript pages including tables, figures, and bibliography) will be published in a separate section entitled "Short Reports." A limited number of solicited review papers may be accepted after formal review. A paper will usually appear within four months after its acceptance.

The Editorial Board requests that manuscripts conform to the requirements set below; those manuscripts which do not conform will be returned to authors for correction before review.

1. **Manuscripts.** Manuscripts, including figures, should be submitted in triplicate. (Xerox copies of photographs are not acceptable for review purposes.) The original manuscript must be typed in double spacing (including figure legends, footnotes, bibliography, etc.) on one side of 16- or 20-lb. bond paper, 8½ by 11 inches. Manuscripts should be proofread carefully and errors corrected legibly in black ink. Pages should be numbered consecutively. Margins on all sides should be at least 1 inch (2.5 cm). Manuscripts should conform to the *Council of Biology Editors Style Manual*, 4th Edition (Council of Biology Editors, 1978) and to American spelling. Unusual abbreviations should be kept to a minimum and should be spelled out on first reference as well as defined in a footnote on the title page. Manuscripts should be divided into the following components: Title page, Abstract (of no more than 200 words), Introduction, Materials and Methods, Results, Discussion, Acknowledgments, Literature Cited, Tables, and Figure Legends. In addition, authors should supply a list of words and phrases under which the article should be indexed.

2. **Figures.** Figures should be no larger than 8½ by 11 inches. The dimensions of the printed page, 5 by 7¾ inches, should be kept in mind in preparing figures for publication. We recommend that figures be about 1½ times the linear dimensions of the final printing desired, and that the ratio of the largest to the smallest letter or number and of the thickest to the thinnest line not exceed 1:1.5. Explanatory matter generally should be included in legends, although axes should always be identified on the illustration itself. Figures should be prepared for reproduction as either line cuts or halftones. Figures to be reproduced as line cuts should be unmounted glossy photographic reproductions or drawn in black ink on white paper, good-quality tracing cloth or plastic, or blue-lined coordinate paper. Those to be reproduced as halftones should be mounted on board, with both designating numbers or letters and scale bars affixed directly to the figures. All figures should be numbered in consecutive order, with no distinction between text and plate figures. The author's name and an arrow indicating orientation should appear on the reverse side of all figures.

3. **Tables, footnotes, figure legends, etc.** Authors should follow the style in a recent issue of *The Biological Bulletin* in preparing table headings, figure legends, and the like. Because of the high cost of setting tabular material in type, authors are asked to limit such material as much as possible. Tables, with their headings and footnotes, should be typed on separate sheets, numbered with consecutive Roman numerals, and placed after the Literature Cited. Figure legends should contain enough information to make the figure intelligible separate from the text. Legends should be typed double spaced, with consecutive Arabic numbers, on a separate sheet at the end of the paper. Footnotes should be limited to authors'

Continued on Cover Three

COMPETITIVE DISPLACEMENT OF NATIVE MUD SNAILS BY INTRODUCED PERIWINKLES IN THE NEW ENGLAND INTERTIDAL ZONE

G. A. BRENCHLEY¹ AND J. T. CARLTON²

¹*Department of Ecology and Evolutionary Biology, University of California, Irvine, California 92717 and Marine Biological Laboratory, Woods Hole, Massachusetts 02543;* ²*Department of Biology, Woods Hole Oceanographic Institution, Woods Hole, Massachusetts 02543 and*
**Williams College Program, Mystic Seaport, Connecticut 06355*

ABSTRACT

During the nineteenth century the mud snail *Ilyanassa obsoleta* was abundant on sand and mud flats, wood works, sea walls, salt marshes, eel grass beds, and cobble beaches in New England. With the exception of sand and mud flats, these habitats are now largely occupied by the introduced periwinkle, *Littorina littorea*. To determine whether *Littorina* competitively displaces *Ilyanassa*, an experimental study was conducted at a site in Barnstable Harbor, Massachusetts where the observed distributions overlapped by 3% by Morisita's index.

Mark-recapture studies suggested that the distribution of *Littorina* was limited by an abiotic factor, currents, through which this species realized its fundamental niche. In contrast, density manipulations demonstrated that *Ilyanassa* emigrated from areas where *Littorina* exceeded densities of 2 to 5 per 0.25 m². *Littorina* limited the upper and lower distribution of *Ilyanassa* and affected its microhabitat distribution in the mid intertidal zone. Habitat displacement was 70% for *Ilyanassa*, calculated as the difference between *Ilyanassa*'s observed distribution and its distribution during littorinid removal experiments. The two species display reciprocal niche overlap with each possessing an exclusive region from which the other is physically restricted. The results suggest that the historical change in the distribution of *Ilyanassa* was due to competitive exclusion by introduced *Littorina*.

INTRODUCTION

Introduced species are numerically dominant members of many marine and estuarine communities in North America, having arrived as fouling organisms on ships and with commercial oysters and by other means since the mid-eighteenth century (Hanna, 1966; Carlton, 1979; Scheltema and Carlton, 1983). Introduced species have been viewed traditionally from an economic perspective with most discussion oriented towards their roles as pests and predators or for mariculture potential (e.g., Elton, 1958; Mann, 1979; Simberloff, 1981). Recently, studies on community structure in marine systems have shown that invading species often competitively displace native species (Farnham, 1980; Carlton, *et al.*, 1982; Race, 1982). Displacement usually involves resource partitioning whereby native species relinquish portions of their habitats or microhabitats to introduced species. In most cases of introduced species in marine systems, however, there are too few descriptions of the earlier community to allow one to assess the degree of competitive displacement.

Received 25 April 1983; accepted 26 September 1983.

* Address for correspondence.

In this paper we report the results of experiments which demonstrate competitive displacement of the mud snail *Ilyanassa obsoleta* (= *Nassarius obsoletus*), native to New England, by the introduced periwinkle *Littorina littorea*. These species are the most abundant, large intertidal gastropods of New England. Prior to the arrival of *Littorina*, *Ilyanassa* was described by many naturalists (Say, 1822; Adams, 1839; Gould, 1841; Stimpson, 1865; Perkins, 1869; Verrill and Smith, 1873; Rathbun, 1881). In a comprehensive survey of the Cape Cod region Verrill and Smith (1873) ranked *Ilyanassa* "dominant" on marine and estuarine sand and mud flats, wood works, sea walls, salt marshes, and eel grass beds; "common" on protected rocks, cobble beaches, and pilings of wharves; and "present" in oyster beds. The habitat of *Ilyanassa* has changed markedly since the arrival of *Littorina* although its geographical range along the East Coast (Nova Scotia to northern Florida) has remained unchanged.

History of co-occurrence

Despite the presence of rare subfossil and fossil shells of *Littorina littorea* in Newfoundland and Nova Scotia (Clarke, 1971; Wagner, 1977), the periwinkle was absent from American shores south of Nova Scotia prior to 1860 (Morse, 1880; Ganong, 1886; Kraeuter, 1976; Carlton, 1982) and was probably absent in modern times from all of North America prior to about 1800 (Carlton, in prep.). First recorded in the Bay of Fundy in 1861, *Littorina* reached the north shore of Cape Cod by 1870. It appeared south of Cape Cod at Woods Hole in 1875, in the New York region by 1879, and at Cape May, New Jersey by 1890 (Carlton, 1982; in prep.). To the south, *Littorina* now occurs on isolated rock jetties in Delaware, Maryland, and Virginia, but no populations are established south of about 38° north latitude. *Littorina*, although usually associated with the rocky shore (e.g., Lubchenco, 1978; Carlton *et al.*, 1982), is a predominant organism in marshes and eel grass beds that border soft bottoms, and is also common on such "hard" substrates as wood, algae, rocks, and worm tubes of soft bottom habitats (Rathbun, 1881; Pearse, 1914; Stauffer, 1937; Spooner and Moore, 1940; Dexter, 1945, 1947; Bradley, 1957; Wharfe, 1977; Jüch and Boekschoten, 1980).

The historical progression of *Littorina* west and south along the Atlantic coast is one of the best documented cases of the dispersal of a non-native marine species; this, combined with the superb record-keeping of early naturalists, makes *Ilyanassa* and *Littorina* an exceptional example in which the history of habitat overlap can be reconstructed. North of Cape Cod, *Littorina* was reported to co-occur with *Ilyanassa* on mudflats by Grabau in 1898 (near Boston, MA), on and among eel grass in 1912 by Pearse (1913, 1914; Nahant, MA), and in mud channels by Batchelder in 1915 (New Hampshire). Rathbun (1881), reporting upon observations made at Provincetown, MA in 1879, recorded *Ilyanassa* present on "the inner beaches, and extending up to high tide level," and *Littorina* present "on the shore, on piles of wharves, and . . . on the eel-grass in countless numbers," but did not specifically indicate direct co-occurrence. South of Cape Cod, Balch reported *Littorina* to co-occur with *Ilyanassa* along marsh edges and on mudflats in 1899 (Cold Spring Harbor, NY). Balch (1899), noting the relatively recent arrival of *Littorina* on the New York shore, stated that although it "does not appear as yet seriously to threaten *Nassa obsoleta*, the native competitor for the mudflats," *Ilyanassa* was nonetheless "begin[ning] to yield room." Recognizing differences in diet but without postulating a mechanism, Dimon (1905) predicted that *Littorina* would displace *Ilyanassa* except "on the mud flats, from which it is not likely to be crowded [out] by the newcomer." By 1923 *Ilyanassa* could no longer be found in the Woods Hole region in two of the habitats, cobble and

wood pilings, in which it had been numerically dominant about 1871 (Verrill and Smith, 1873; Allee, 1923). By 1930 Clench was able to report that, all along the shores of bays and inlets of New England, *Littorina* "can be found everywhere between the tide marks crawling over mud and on the blades and among the roots of *Zostera*." Although juveniles are still found around marshes in New England (Brenchley, 1984b), the adult *Ilyanassa*, as Dimon predicted, are generally confined to the soft sand and mud flats (Burbanck, *et al.*, 1956; Dippolito, *et al.*, 1975), the remaining firmer habitats generally being occupied by *Littorina* (Allee, 1923; Dexter, 1945; Burbank, *et al.*, 1956; Dippolito, *et al.*, 1975).

Life habit

The historical account strongly implies the displacement of *Ilyanassa* by *Littorina* but the mechanisms of this displacement have not been previously known. Whether competition for food exists among adult snails, although thought unlikely by Dimon (1905) and by Dippolito *et al.* (1975), is not known. *Littorina littorea* is a facultative omnivorous grazer, consuming both macroalgae and microalgae (Hylleberg and Christensen, 1978; Lubchenco, 1978; Petraitis, 1983), invertebrate eggs (Brenchley, 1982), marsh detritus (Pourreau, 1979), barnacle cyprids in large numbers (Carlton, pers. obs.), and a wide variety of other small encrusting or benthic animals (Blegvad, 1915; Hayes, 1929; Hylleberg and Christensen, 1978; Carlton, pers. obs.). Similarly, *Ilyanassa obsoleta*'s diet encompasses most of these types and other prey as well. *Ilyanassa* has been described as a facultative herbivore/carnivore (Brown, 1969), as an obligate omnivore (Curtis and Hurd, 1979), and as a grazer, deposit-feeder, and detritivore (Connor and Edgar, 1982), ingesting sediment and a wide selection of living and dead animal and plant material (Dimon, 1905; Gurin and Carr, 1971; Atema and Burd, 1975; Haines and Montague, 1979; Abbott and Haderlie, 1980; Curtis and Hurd, 1981; Connor and Edgar, 1982; Race, 1982; Brenchley, pers. obs.).

Dippolito *et al.* (1975) suggested that competition for space is also unlikely, *Littorina* preferring solid substrates and *Ilyanassa* the softer substrata. During the reproductive season, however, *Ilyanassa* move onto solid substrates to lay their egg capsules (Scheltema, 1962; Pechenik, 1978). *Littorina* occupy these substrates and graze attached egg capsules (Brenchley, 1982). Laboratory studies demonstrate that during this process *Littorina* physically interferes with *Ilyanassa*'s egg laying behaviors (Brenchley, 1980, 1984a).

Alternatively, the change in *Ilyanassa*'s distribution may be coincidentally rather than causally related to *Littorina*'s arrival. Chew (1981) has demonstrated that local extinction and displacement of a native pierid butterfly in New England, believed to be due to competitive exclusion by an introduced pierid, is actually the result of shifts in land use and resultant changes in the flora. Alternative hypotheses that would explain the observed shift in *Ilyanassa*'s habitat utilization would therefore include other possible physical or biological changes in the mud snail's environment in the past century. We know of no physical (or chemical) change within *Ilyanassa*'s former or present habitat regime that could cause such shifts nor, in particular, any changes that would affect *Ilyanassa* but no other species. Biologically, at least one other species affecting *Ilyanassa* has also arrived recently in New England: the green crab *Carcinus maenas* (reviewed by Vermeij, 1982a,b) which preys heavily upon *Ilyanassa*'s egg capsules (Brenchley, 1982). Juvenile and adult *Ilyanassa* are prey for a variety of species including birds (Recher, 1966), other snails (Atema and Burd, 1975), crabs (Stenzler and Atema, 1977; Brenchley, unpub. data) and sea stars (Peterson, 1979), but the mud snail is believed to be a generally minor food item. *Ilyanassa* would

not be expected to respond dramatically to manipulations in the density of *Littorina* if predation by other species or other factors were primarily responsible for the change in *Ilyanassa*'s distribution.

The present study was conducted on a sand flat located between a marsh and eel grass bed, one of the few habitats where the two species still coexist. Through mark-recapture experiments, factors controlling the distribution of *Littorina* were studied. Density manipulations of *Littorina* were used to study its effect on distributions of *Ilyanassa*. Elsewhere the behavioral components of the interactions (Brenchley, 1984a) as well as juvenile distributions (Brenchley, 1984b) are detailed; here we focus on patterns and factors controlling adult distributions.

MATERIALS AND METHODS

Patterns of distribution

The study was conducted in Barnstable Harbor, Massachusetts (41°43'N, 70°20'W) between June and September 1980, and between May and November 1981 on a sandy intertidal flat between Indian Trail and Bone Hill Road. A census of adult *Ilyanassa* and *Littorina* was conducted each month along three permanent transects that extended through the intertidal zone from the marsh edge or high intertidal zone, across a sand flat to an eel grass bed at the low intertidal zone, a distance of 150 to 250 m. Individuals on hard surfaces, on the sand, and buried 2 to 3 cm within the sand were counted in 0.25 m² quadrats (n = 4 to 8) every 5 to 10 m along the transects. Additional transects 50 to 100 m in length and paralleling the edges of the marsh and eel grass bed were also censused periodically.

Natural movements of individuals were studied by mark-recapture (Table I). Snails were brought into the laboratory, kept in running sea water, marked, and returned to the field within 3 days of collection. *Ilyanassa* shells were cleaned with a wire brush and the apex was marked with a durable paint (Mark-Tex Corp., NJ). Each shell was numbered with India ink. *Littorina* shells were marked *in situ* or in the laboratory. During June 1981, marked snails were returned to their respective habitats: *Ilyanassa* to the mid-intertidal sand flat, and *Littorina* to the eel grass bed, rocks on

TABLE I

Summary of research protocol, Barnstable Harbor, Massachusetts

Zones	Habitats	Mark-recapture ¹	Manipulations	Fundamental ² niche	Realized niche
Low	Eel grass bed	1502 <i>Littorina</i>	None	August census	July census
Mid	Solid substrata Sand	76 <i>Littorina</i> 781 <i>Ilyanassa</i>	Tide pools: littorine removals, littorine additions, controls	Littorine-removal pools ³	Littorine-control pools ³
High	Marsh sediment Marsh shoots	202 <i>Littorina</i>	Marsh edge: littorine removal plots, control plots	Littorine-removal plots ⁴	Littorine-control plots ⁵

¹ Numbers of marked snails released in June 1981.

² Calculated for *Ilyanassa* only.

³ Mean density on day 7.

⁴ Mean of peak density in each plot.

⁵ Mean of daily means in each plot.

the sand flat, and the marsh edge. Marked individuals were returned to the laboratory for measurement every 6 weeks through November.

Experimental procedures

To determine their effect on the upper limit of *Ilyanassa's* distribution, all *Littorina* were removed daily between 29 June and 7 July, 1980 from three replicate plots, each 2 m long and extending 1.5 m into the marsh (Table I). Two unmanipulated plots, each 1.5 m long and lying between test areas, served as control areas. Numbers of both species were counted daily in 0.25 m² quadrats in all areas; these were approached from the marsh and comparably disturbed by the censuses. On the 4th day of the experiment about 100 *Ilyanassa* were collected from both the marsh and adjacent sand flat at low tide and measured (± 0.1 mm).

Densities of *Littorina* were manipulated in the tide pools to determine their effect on the distribution of *Ilyanassa* in the mid intertidal zone (see Table I). In June 1981 all littorines were collected from one pool (4 to 6 m² area) and added to the center of an adjacent pool that was similar in size and appearance. A third pool was left undisturbed to serve as a control area. Densities of both species were counted prior to these manipulations and also twice during the following week in 8 to 10 replicate quadrats (each 0.25 m²) placed in the center of each pool. This experiment was repeated three times in three weeks in different sets of tide pools. Treatments in 2 pools were reversed after one week by collecting all littorines in an addition-pool and releasing them in a pool from which littorines previously had been removed (Experiments A1, A2).

Censuses of snail distributions in the intertidal zone were used to calculate Morisita's (1959) index of niche overlap. Despite modifications and alternatives to this original index, it remains the least biased when sample sizes are small (Smith and Zaret, 1982) and was appropriate for this study where five habitats were recognized (see Table I). Because the eel grass lay limply at low tide, it was combined with sand into a single habitat. Resource utilization for each species at each monthly census was calculated from the mean density of individuals on each resource summed over the three tidal zones ($n \geq 16$ quadrats per zone, see Table II).

Indices of niche overlap were similarly calculated to determine the extent of habitat displacement (Table I). The "realized niche" (*sensu* Hutchinson, 1957) of *Ilyanassa* and *Littorina* were derived from mean densities in experimental controls and the July census of the eel grass bed when littorines were present. The "fundamental niche" (*sensu* Hutchinson, 1957) of *Ilyanassa* was derived from densities resulting in littorinid removal plots and the August census of the eel grass bed when littorines were absent. Mark-recapture studies indicated that the fundamental niche was the realized niche for *Littorina*; no additional calculations were made for this species.

RESULTS

Littorina distribution

Littorina littorea was most abundant in the upper intertidal zone in the marsh at Barnstable Harbor (Table II) (as is typical of its distribution on soft sediments of Europe and New England). Except during a period between late July and September its distribution extended through the mid intertidal zone, where it was locally abundant on most firm substrates (wood, peat, pebbles, worm tubes, algae), and into the low intertidal eel grass bed where it crawled across sand and blades of grass at low tide.

Mark-recapture studies in the low intertidal zone demonstrated the transient

TABLE II

Mean densities per 0.25 m² of *Littorina littorea* on substrates in three intertidal zones in Barnstable Harbor, Massachusetts, in monthly census in 1981

	May	June	July	Aug.	Sept.	Oct.	Nov.
Upper Zone ¹							
Marsh sediments	48.3	39.7	41.4	89.9	64.8	62.9	31.1
Marsh shoots	21.7	16.3	20.9	30.4	69.2	33.7	8.0
N	32	32	64	64	16	16	32
Mid Zone							
Sand ²	0.9	0.5	0.2	<0.1	0.4	0.1	0.7
Firm objects	3.8	2.3	2.1	0.8	2.3	3.6	3.9
N	32	64	64	64	60	16	16
Low Zone							
Eel grass bed	9.8	9.4	9.4	0.1	0.1	5.3	6.7
N	32	16	16	16	32	16	32

¹ "Sediment" includes bases of stalks; "shoots" refers to snails on blades of cord grass.

² Combined areas with and without *Ilyanassa*; differences not significant ($P > 0.05$) by one-way Analysis of Variance on pooled monthly data.

N, numbers of quadrats counted at low tide.

nature of *Littorina*. *Littorina* were dislodged from "softer" surfaces (e.g., worm tubes, sand, filamentous and "spongy" algae, eel grass) and were often seen rolling along the bottom during incoming tides. These individuals crawled along the sand and often followed mucous trails of conspecifics until a solid object was encountered. Of 1502 marked snails released in the eel grass bed in June 1981, only 40 were recovered there after 1 week and only 3 were recovered after 1 month, all along the marsh edge. Several lines of evidence indicated that widespread transport rather than mass mortality was responsible for this low recovery rate. We also inspected thousands of empty shells in the eel grass and marsh without finding any marked shells; most had been bored by naticid gastropods.

Transport in the mid intertidal zone was documented in August 1980 when approximately 100 unmarked periwinkles were released on each of four occasions in sandy areas where solid substrates were rare and other littorines absent. After 3–4 days on each occasion less than 8 snails were found within a 20 × 20 m area (and these were found on marking-stakes). This dispersion was a result of transport by currents and not active movement, since littorines move only about 60 cm per day on rocky shores (Dexter, 1943) and 20 to 25 m during the autumn on soft substrata (Batchelder, 1915).

In higher intertidal areas where mucous dried during low tide, *Littorina* clung to rocks and marsh grasses. A few individuals marked on rocks and in the marsh in June were still present after 3 months. However, these individuals were also transient as evidenced by rates of colonization. All periwinkles were removed from two rocks and from a log in the mid intertidal zone every 3 to 4 days for a period of 4 weeks in June 1981. Recolonization after 3–4 days ranged from 0 to 14 individuals per ca. 0.10 m², the unmanipulated density, with no change in numbers through time. Daily colonization rates along the marsh edge were obtained from censuses of the littorinid removal experiment, and ranged from 0 to 109 individuals per 0.25 m² per day. In this case colonization rates decreased steadily over the course of the experiment, indicating local rather than widespread transport of individuals.

Ilyanassa distribution

The population of *Ilyanassa obsoleta* in the study area was estimated to contain millions of snails. The population was dominated by adult-sized individuals (Fig. 1A; see Scheltema, 1964) with sparse recruitment in 1979, 1980, and 1981. Beginning in May, as the water warmed, they moved onto solid objects of the mid intertidal zone (Table III) to lay egg capsules, preferring isolated eel grass plants, drift algae, and small islands of marsh peat and avoiding both the eel grass bed and marsh where periwinkles were numerous.

The adult population moved about the 1 km stretch of shoreline of the study site in the mid intertidal zone from March to November. Although Jenner (1956) reports that mud snails in the Harbor aggregate after reproduction ceases, the study population remained in dense aggregations throughout the year, foraging upon their own shells (illustrated by Morse, 1921) and on each other's shell epiflora. Isolated individuals were always rare although individuals moved freely between the aggregations (see also Borowsky, 1979) of which there were usually two or three. General patterns of movement were directed toward the marsh during spring tides from April through July, and toward the eel grass during spring tides occurring in the summer and fall.

In a nursery area near the marsh there was a small group (2–5 thousand individuals) comprised of fast growing, immature snails (<17 mm) which separated from the adults in June and roamed about near the marsh until late August or September when they rejoined the adult aggregations.

During winter months the population of *Ilyanassa* hibernated 5 cm in the sediment in the mid intertidal zone. With littorines present in the low intertidal eel grass bed, the mud snails did not migrate to the subtidal zone as has been reported for populations in other areas (e.g., Batchelder, 1915; Sindermann, 1960; Scheltema, 1964; Stambaugh and McDermott, 1969; Murphy, 1979).

Recapture rates of marked *Ilyanassa* were relatively high: of 781 snails released in June 1981, 419 (53.6%) were recovered in September and 109 (13.9%) in August

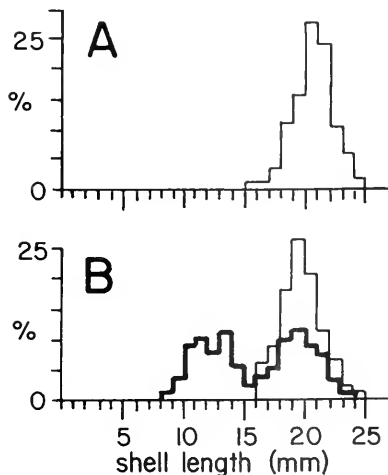

FIGURE 1. Size frequency distributions of *Ilyanassa obsoleta* on the study site in Barnstable Harbor, Massachusetts. A: Sizes of individuals in roving aggregations on the sand flat in July 1981 ($n = 500$). B: Sizes of individuals migrating into the marsh in littorinid removal plots (thin lines) and on the adjacent sand flat (heavy lines) on 3 July 1981 ($n = 100$ each).

TABLE III

Mean densities per 0.25 m² of adult *Ilyanassa obsoleta* in three intertidal zones in Barnstable Harbor, Massachusetts in 1981

	May	June	July	Aug.	Sept.	Oct.	Nov.
Upper Zone ¹							
Marsh sediments	<1	<1	<1	<1	<1	0	0
Mid Zone							
Sand flat ²	89.3	81.6	93.5	61.1	82.6	67.6	81.8
Firm objects ³	1.7	2.6	<1	<1	<1	<1	<1
Low Zone							
Eel grass beds	0	<1	<1	12.0	1.1	0	0

¹ Densities on marsh shoots always zero.

² Densities in areas where aggregations of mud snails were present.

³ Excluding *Ilyanassa* shells.

Numbers of quadrats as in Table I.

1982. Of 200 new snails released in November 1981, 99 (49.5%) were recovered the following August. Observations on recovered snails indicated that the decline in the return rate was largely due to the mark, lost by snail grazing and overgrown by a thick diatom layer; empty shells were always rare during the summers of this study.

Evidence of displacement of *Ilyanassa*

The roving groups of adult *Ilyanassa* rarely entered either the marsh or eel grass bed during the summer migration (see Table III). As evidenced by density relationships, the boundaries between mud snails and littorines were extremely abrupt and rarely did the two species co-occur within a 0.25 m² quadrat (Fig. 2).

Within 24 to 48 h after the removal of *Littorina* from the marsh edge, upwardly migrating *Ilyanassa* moved into test areas of the marsh but they did not enter the control areas (Fig. 3). Maximum densities of *Ilyanassa* were recorded 4 days (plot "E"), 5 days ("A") and 6 days ("C") after the initial removal of littorines. This experiment was performed during *Ilyanassa's* first advance toward the marsh in 1980 and prior to the separation of the immatures and adults. Samples collected on the 4th day showed that all *Ilyanassa* in the marsh were of adult size (Fig. 1B). Adults moved from the edge (lower 0.5 m band) into the marsh (upper 0.5 m band) (Fig. 3). As the neap tide approached, both adult and immature *Ilyanassa* retreated from the general vicinity of the marsh. Observations made underwater at later dates revealed that adult *Ilyanassa* occurred along the bases of marsh shoots but never up on the grass blades as do immature *Ilyanassa* (Dimon, 1905; Brenchley, 1984b).

Use of microhabitats differed where the snails occurred in the mid intertidal zone: *Littorina* were more common on solid objects (Table II) and *Ilyanassa* on sand (Table III). Manipulative experiments demonstrated that *Littorina* had three density-related impacts on the microhabitat distribution of reproductively active *Ilyanassa* within the mid intertidal zone (Table IV). (1) Densities of mud snails did not change following the initial removal of littorines from tide pools, but (2) microhabitat distribution changed within 3 days, and by the seventh day significantly more natives were found on solid objects than in either the pre-manipulated, unmanipulated, or littorinid-addition pools. (3) When numbers of periwinkles were doubled, densities of mud snails had decreased by the third day and were significantly smaller than in control

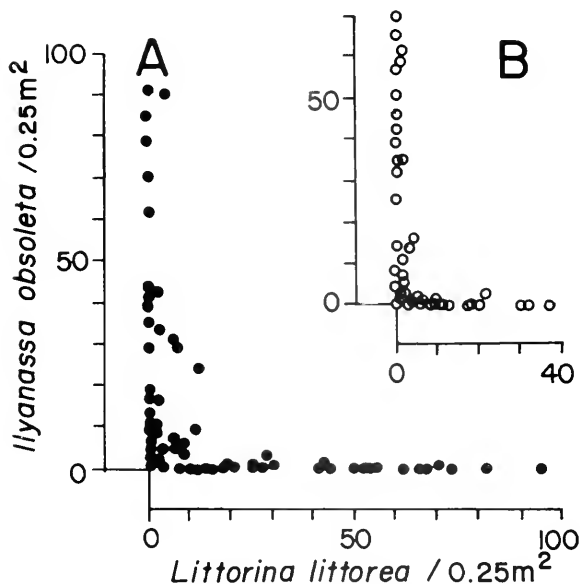

FIGURE 2. Densities of adult *Ilyanassa* as a function of *Littorina* densities in 0.25 m² quadrats in Barnstable Harbor, Massachusetts, June-August 1981: A, upper intertidal marsh edge; B, lower intertidal eel grass bed. Each point represents one quadrat.

pools by day 7. When experimental conditions were reversed in Experiment A2, *Ilyanassa* immigrated into the pool from which they had previously emigrated, and migrated from the new littorinid addition pool (Table IV). This result demonstrates unequivocally that adult *Ilyanassa* avoided *Littorina*. Densities in unmanipulated pools did not change significantly during any experiment.

The overlap in observed distributions of *Ilyanassa* and *Littorina* over the course of the summer ranged from 2 to 5% and averaged 3% (Table V). The experimental studies indicate that, had *Ilyanassa* not avoided *Littorina*, their distributions would have overlapped 71%. The value is not 100% for three reasons: (1) in the absence of *Littorina*, adult *Ilyanassa* did not move onto shoots in the marsh as did *Littorina* (Fig. 3); (2) only a minority of mud snails on the sand flat moved onto solid substrates to reproduce in the absence of *Littorina* (Table IV); and (3) densities of *Littorina* on sand never matched those of *Ilyanassa* (Tables II and III).

DISCUSSION

Results of experimental manipulations of *Littorina littorea* demonstrate density relationships that generally explain observed distributional patterns of *Ilyanassa obsoleta* in the study site. The results show the emigration of *Ilyanassa* from mid intertidal areas when densities of littorines are manipulated (*i.e.*, doubled) to match the conditions found in the marsh and during most of the year in the eel grass beds. Following manipulations to remove littorines from the marsh, *Ilyanassa* expands its distribution upshore; a similar result occurs on cobble beaches in Rhode Island (M. Bertness, pers. comm.) In the one local marsh (Salem, MA) found to contain no *Littorina*, *Ilyanassa* extended throughout to a retaining wall. The results further show that at densities below about 5 individuals per 0.25 m², *Littorina* alters the microhabitat

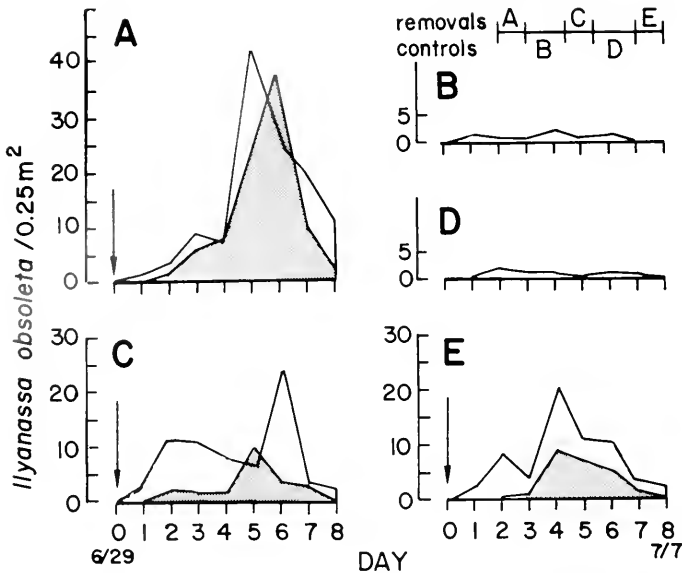

FIGURE 3. Movement of *Ilyanassa* into the marsh in *Littorina*-removal plots (A, C, E) and control plots (B, D) in Barnstable Harbor, Massachusetts in 1980. Position of plots illustrated in upper right corner. Numbers of *Ilyanassa* per 0.25 m² are shown for two 0.5 m wide bands: open figure, lower edge; closed figure, marsh side. Values are means of 4 (removals) or 5 (control) counts per day per area.

distribution of *Ilyanassa*. By excluding the indigenous species from firm substrata, *Littorina* significantly affects the reproductive activity of *Ilyanassa* (Brenchley, 1981, 1984a). In the tide pool experiments, for example, *Ilyanassa* laid significantly more egg capsules in the littorinid removal pools than in littorinid addition pools (Brenchley, 1981, 1984a).

Brenchley (1982) finds that *Littorina littorea* is a major predator on egg capsules of *Ilyanassa obsoleta* in this harbor. Race (1982) documents a similar interaction in San Francisco Bay between a native mud snail (*Cerithidea californica*) and *Ilyanassa obsoleta*, introduced about 1905 (Carlton, 1979). In both cases reproducing individuals are more likely to contribute to the next generation if they avoid habitats occupied by egg predators. If avoidance behaviors of this kind are genetic then only among *Cerithidea* with nonplanktonic larvae are such traits inheritable within local populations. The larvae of *Ilyanassa*, by contrast, have broad dispersal capability (Scheltema, 1962; Gooch *et al.*, 1972). Mechanisms responsible for generating the patterns observed in this study are not likely to have a genetic basis.

Studies of conditioning in *Aplysia californica* by Carew *et al.* (1983) and others have shown that snails can learn to discriminate between tactile stimuli even in a single trial, and can demonstrate the response after several hours. *Littorina* provides tactile stimuli by grazing on shell epiflora of *Ilyanassa*, a behavior which interferes with foraging, locomotory, and reproductive activities of the native species (Brenchley, 1980, 1984a, in prep.). When either *L. littorea* or a native littorinid species (*L. saxatilis*) is on its shell, *Ilyanassa* responds by twisting, a behavior which probably is inherited (see McKillup, 1983, for the polytypic species *Nassarius pauperatus*) since lead weights also elicit the response. Although twisting seldom removes the littorine on the shell, it provides *Ilyanassa* with the opportunity to learn the littorinid scent, or to reinforce prior learning given that the mud snail lives 8 or more years (Jenner

TABLE IV

Densities of *Ilyanassa obsoleta* per 0.25 m² (mean \pm one standard deviation) in tide pools at Barnstable Harbor, Massachusetts, having *Littorina littorea* removed, added, or unchanged in June 1981, compared by one-way Analysis of Variance

Experiment:	A1 (Week 1)	A2 (Week 2)	B (Week 2)	C (Week 3)
<i>Littorina</i> removals				
Overall density				
Initial	26.8 \pm 14.9	2.4 \pm 4.1	42.8 \pm 29.0	43.0 \pm 22.3
Final	28.2 \pm 29.8	31.2 \pm 9.2	35.7 \pm 24.6	27.0 \pm 19.0
F _{1,14}	0.014	57.83***	0.245	3.091
On solid substrata				
Initial	1.2	<0.1	0.9	1.0
Final	3.8	3.1	2.9	3.5
F _{1,14}	16.21***	48.22***	11.51**	29.98***
<i>Littorina</i> addition				
Overall density				
Initial	23.7 \pm 13.2	28.2 \pm 29.8	48.5 \pm 32.4	92.4 \pm 27.9
Final	2.4 \pm 4.1	7.1 \pm 8.0	5.9 \pm 3.9	8.8 \pm 7.4
F _{1,14}	16.66***	3.28	11.93**	58.39***
Unmanipulated controls				
Overall density				
Initial	39.5 \pm 19.6	see B	40.2 \pm 20.9	76.6 \pm 31.5
Final	43.4 \pm 20.4		45.6 \pm 27.6	83.0 \pm 36.6
F _{1,14}	2.911		1.433	2.614

Each n = 8. Conditions of experimental pools in A1 were reversed in A2.

** $P \leq 0.005$; *** $P \leq 0.001$.

and Jenner, 1977). Adult *Ilyanassa* responds to chemical cues, to carrion for example, by extending its proboscis (e.g., Carr, 1967; Brown, 1969). This behavior is observed when adult *Ilyanassa* responds to the littorinid species: after attempting to shake off littorines by twisting, adult *Ilyanassa* will attack the littorine's foot with its proboscis and radula (Brenchley, in prep.). Following sensitization to lead weights, a higher proportion of immature mud snails show this behavior—evidence of a learned response; but adults are slower to probe with their proboscis—evidence that the behavior can be reconditioned.

TABLE V

Index of microhabitat overlap (Morisita, 1959) for *Littorina littorea* and *Ilyanassa obsoleta* at Barnstable Harbor, Massachusetts, during the summer of 1981

Niche	Method	Index
Realized	Seasonal ¹	0.031
Realized	Experimental Controls ²	0.021
Fundamental	Experimental Treatments ²	0.711

¹ Mean of six monthly censuses.

² See Table I.

The proximity of the two species in space depends on the frequency with which *Ilyanassa* encounter *Littorina* on their shells. This frequency depends on two main factors: mobility of littorines, which is largely a function of substrata; and the epiflora on the mud snail shells, which varies both with habitat and snail age. In habitats where littorines are mobile, such as exists throughout the main study site, the critical density is between 12 and 20 littorines per square meter; at higher densities encounters are too frequent and mud snails emigrate. The critical density can be higher on cobble beaches, for example, where *Littorina* are generally less mobile. Types of mud snail shell epiflora correlate with habitat. In sand habitats the epiflora is thickest (up to 2 mm) with strands of *Enteromorpha* common in some regions of the harbor. Thus in muddy habitats *Ilyanassa* can be found in the immediate vicinity of *Littorina* on rocks; this situation rarely occurs in sandier habitats because *Littorina* will move from rock edges to shells of passing mud snails to graze on shell epiflora. We have observed the complete removal of *Enteromorpha* by *Littorina* from shells of a large aggregation of mud snails during a 48 h migration across a rocky area. Finally, *Littorina* rarely grazes on the shells of immature *Ilyanassa* in muddy or sandy regions of the harbor (Brenchley, 1984b). In comparison to adults, juveniles of *Ilyanassa* and *Littorina* have similar foraging behaviors, grazing on microflora on sand and marsh plants. Immature *Ilyanassa* show no evidence of avoiding *Littorina* even when resources are limiting. The change from exploitation to interference competition as the snails age, which coincides with a change from inclusive to reciprocal niche overlap (see Cowell and Fuentes, 1975), is a result of behavioral interactions discussed above.

Unlike the effects of pests and predators (Elton, 1958; Simberloff, 1981), competition leading to displacement or niche partitioning in most cases is subtle. Competition between *Ilyanassa* and *Littorina*, for example, becomes evident through density manipulations but not by comparing the two species' habitat preferences, physiological tolerances, or patterns of distribution (Dippolito *et al.*, 1975). We can estimate from previous faunal descriptions the extent of habitat displacement of *Ilyanassa* by *Littorina*, although we cannot as yet determine the extent to which the abundance of *Ilyanassa* has been affected.

Our studies confirm Dimon's (1905) prediction that the "struggle between [*Littorina* and *Ilyanassa*] may result in a modification of the range" of *Ilyanassa*. Since Dimon's observations in 1905, noting that *Ilyanassa* "act as scavengers for the coast," numerous workers have attempted to elucidate, by observation and experimentation, the precise nature of *Ilyanassa*'s role in the economy of soft sediment shores (Grant, 1965; Mills, 1967; Sibert, 1968; Nichols and Robertson, 1979; Pace *et al.*, 1979; Hunt, 1981; Connor and Edgar, 1982; Connor *et al.*, 1982; Levinton and Stewart, 1982). These studies have demonstrated that *Ilyanassa* exerts significant effects upon community structure, indirectly modifying resources (trophic, spatial, temporal, or otherwise) required by other species, and directly by consuming or displacing potential members of the community. Curtis and Hurd (1981) have speculated in particular upon the full suite of potential impacts by *Ilyanassa* on community structure. We extend Curtis and Hurd's rationale here. We suggest that *Littorina*'s displacement of *Ilyanassa*, while significant to the mud snail, is secondary to the effects that this displacement has had on the benthic community, released from mud snail perturbations. We suggest that there have been major indirect effects in habitats where *Ilyanassa* has been displaced by *Littorina*, whose sediment disturbance (=bioturbation) abilities are minor compared to those of mud snails (Brenchley, pers. obs.); we predict that in habitats from which *Ilyanassa* has been displaced the faunal and floral communities will be similar to experimental manipulative studies that have removed *Ilyanassa* artificially. The introduction of an exotic species has altered community structure not simply

by the modification of distributional patterns of a native species but more profoundly by secondarily modifying the community interactions of the native species as well. As one example, our predictions suggest that polychaete population explosions in mud flats, whose rarity was linked by Levinton and Stewart (1982) to persistent snail populations, would be more common in areas where *Ilyanassa's* local distribution has been contracted by competition. Furthermore, suspecting that the contraction in *Ilyanassa's* distribution due to *Littorina* is associated with the aggregatory behavior of *Ilyanassa* in our study site (Brenchley, 1980), we predict that the establishment and subsequent destruction of dense beds of tubicolous amphipods by aggregations of mud snails (Mills, 1967) will coincide with the abundance of *Littorina* in New England. We conclude that the interpretation of factors controlling the structure of many modern-day marine communities in North America must consider the dynamic interactions of both ecological processes and historical impacts of introduced species.

ACKNOWLEDGMENTS

This research began while we were supported as Postdoctoral Scholars at the Woods Hole Oceanographic Institution. Subsequent research was funded (for G.A.B.) by Marine Biological Laboratory STEPS fellowships and faculty grants from the University of California at Irvine and (for J.T.C.) by a National Science Foundation National Needs Postdoctoral Fellowship. We thank Merryl Alber for field assistance and Gayle Gray for preparing the manuscript. Lynn Carpenter, Mark Hixon, Sarah Woodin, and an anonymous reviewer provided many useful comments on the manuscript.

LITERATURE CITED

- ABBOTT, D. P., AND E. C. HADERLIE. 1980. Prosobranchia: marine snails. Pp. 230-307 in *Intertidal Invertebrates of California*, R. H. Morris, D. P. Abbott and E. C. Haderlie, eds. Stanford University Press, Stanford.
- ADAMS, C. B. 1839. Observations on some species of the marine shells of Massachusetts, with descriptions of five new species. *Boston J. Nat. Hist.* 2: 262-288.
- ALLEE, W. C. 1923. Studies in marine ecology. I. The distribution of common littoral invertebrates of the Woods Hole region. *Biol. Bull.* 44: 167-191.
- ATEMA, J., AND G. D. BURD. A field study of chemotactic responses of the marine mud snail, *Nassarius obsoletus*. *J. Chem. Ecol.* 1: 243-251.
- BALCH, F. N. 1899. List of marine Mollusca of Coldspring Harbor, Long Island, with descriptions of one new genus and two new species of nudibranchs. *Proc. Boston Soc. Nat. His.* 29: 133-162.
- BATCHELDER, C. H. 1915. Migration of *Ilyanassa obsoleta*, *Littorina litorea* and *Littorina rudis*. *Nautilus* 29: 43-46.
- BLEGVAD, H. 1915. Food and conditions of nourishment among the communities of invertebrate animals found on or in the sea bottom in Danish waters. *Rep. Danish Biol. Sta.* 22: 41-78.
- BOROWSKY, B. 1979. The nature of aggregations of *Nassarius obsoletus* in the intertidal zone before the fall offshore migration. *Malacologia* 12: 89-90.
- BRADLEY, W. H. 1957. Physical and ecologic features of the Sagadahoc Bay tidal flat, Georgetown, Maine. *Mem. Geol. Soc. Am.* 67(Part 2): 641-682.
- BRENCHLEY, G. A. 1980. Distribution and migratory behavior of *Ilyanassa obsoleta* in Barnstable Harbor. *Biol. Bull.* 159: 456-457.
- BRENCHLEY, G. A. 1981. Limiting resources and the limits to reproduction in the "mud" snail *Ilyanassa obsoleta* in Barnstable Harbor, Massachusetts. *Biol. Bull.* 161: 323.
- BRENCHLEY, G. A. 1982. Predation on encapsulated larvae by adults: effects of introduced species on the gastropod *Ilyanassa obsoleta*. *Mar. Ecol. Prog. Ser.* 9: 255-262.
- BRENCHLEY, G. A. 1984a. Substrate selection for reproduction in *Ilyanassa obsoleta*: avoidance of objects used by introduced *Littorina litorea*. (In review.)
- BRENCHLEY, G. A. 1984b. Competition between native and introduced marine snails: juveniles exploit resources. (In review.)

- BROWN, S. C. 1969. The structure and function of the digestive system of the mud snail, *Nassarius obsoletus* (Say). *Malacologia* **9**: 447-500.
- BURBANCK, W. D., M. E. PIERCE, AND G. C. WHITELEY, JR. 1956. A study of bottom fauna of Rand's Harbor, Massachusetts: an application of the ecotone concept. *Ecol. Monogr.* **26**: 213-243.
- CAREW, T. J., R. D. HAWKINS, AND E. R. KANDEL. 1983. Differential classical conditioning of a defensive withdrawal reflex in *Aplysia californica*. *Science* **219**: 397-400.
- CARLTON, J. T. 1979. History, biogeography, and ecology of the introduced marine and estuarine invertebrates of the Pacific coast of North America. Ph.D. Dissertation, Univ. California, Davis.
- CARLTON, J. T. 1982. The historical biogeography of *Littorina littorea* on the Atlantic coast of North America, and implications for the interpretation of the structure of New England intertidal communities. *Malacol. Rev.* **15**: 146.
- CARLTON, J. T., D. P. CHENEY, AND G. J. VERMEIJ, eds. 1982. Abstracts of a Symposium on the ecological effects and biogeography of an introduced species: the periwinkle *Littorina littorea*. *Malacol. Rev.* **15**: 143-150.
- CARR, W. E. S. 1967. Chemoreception in the mud snail, *Nassarius obsoletus*. I. Properties of stimulatory substances extracted from shrimp. *Biol. Bull.* **133**: 90-105.
- CHEW, F. S. 1981. Coexistence and local extinction in two pierid butterflies. *Am. Nat.* **118**: 655-672.
- CLARKE, A. H. 1971. *Littorina littorea*, native or introduced? *The Biologist* **53**: 160-162.
- CLENCH, W. J. 1930. *Littorina littorea* Linn. *Nautilus* **43**: 105.
- CONNOR, M. S., AND R. K. EDGAR. 1982. Selective grazing by the mud snail *Ilyanassa obsoleta*. *Oecologia (Berl.)* **53**: 271-275.
- CONNOR, M. S., J. M. TEAL, AND I. VALIELA. 1982. The effect of feeding by mud snails, *Ilyanassa obsoleta* (Say), on the structure and metabolism of a laboratory benthic algal community. *J. Exp. Mar. Biol. Ecol.* **65**: 29-45.
- COWELL, R. K., AND E. R. FUENTES. 1975. Experimental studies of the niche. *Ann. Rev. Ecol. Syst.* **6**: 281-310.
- CURTIS, L. A., AND L. E. HURD. 1979. On the broad nutritional requirements of the mud snail *Ilyanassa (Nassarius) obsoleta* (Say), and its polytypic role in the food web. *J. Exp. Mar. Biol. Ecol.* **41**: 289-297.
- CURTIS, L. A., AND L. E. HURD. 1981. Nutrient procurement strategy of a deposit-feeding estuarine neogastropod, *Ilyanassa obsoleta*. *Estuarine Coastal Shelf Sci.* **13**: 277-285.
- DEXTER, R. W. 1943. Observations on the local movements of *Littorina littorea* (L.) and *Thais lapillus* (L.). *Nautilus* **57**: 6-8.
- DEXTER, R. W. 1945. Zonation of the intertidal marine mollusks at Cape Ann, Massachusetts. *Nautilus* **58**: 135-142.
- DEXTER, R. W. 1947. The marine communities of a tidal inlet at Cape Ann, Massachusetts: a study in bio-ecology. *Ecol. Monogr.* **17**: 261-294.
- DIMON, A. C. 1905. The mud snail: *Nassa obsoleta*. *Cold Spring Harbor Monogr.* **5**: 50 pp.
- DIPPOLITO, A. F., J. SIENKO, AND B. S. SMITH. 1975. Relationship between mud snail and periwinkle. *Proc. Malacol. Soc. Lond.* **41**: 529-532.
- ELTON, C. S. 1958. *The Ecology of Invasions by Plants and Animals*. Methuen Co., London. 181 pp.
- FARNHAM, W. F. 1980. Studies on aliens in the marine flora of southern England. Pp. 875-914 in *The Shore Environment*, vol. 2, J. H. Price, D. E. G. Irvine and W. F. Farnham, eds. Academic Press, New York.
- GANONG, W. F. 1886. Is *Littorina littorea* introduced or indigenous? *Am. Nat.* **20**: 931-940.
- GOOCH, J. L., B. S. SMITH, AND D. KNUPP. 1972. Regional survey of gene frequencies in the mud snail, *Nassarius obsoletus*. *Biol. Bull.* **142**: 36-48.
- GOULD, A. A. 1841. *Report on the Invertebrata of Massachusetts comprising the Mollusca, Crustacea, Annelida, and Radiata*. Folstom, Wells and Thurston, Cambridge.
- GRABAU, A. W. 1898. Zoology: marine invertebrates. Pp. 67-96 in *Guide to Localities Illustrating the Geology, Marine Zoology, and Botany of the Vicinity of Boston*, A. W. Grabau, and J. E. Woodman, eds. *Am. Assoc. Adv. Sci.*, 50th Anniv. Meeting, Boston, August 1898. vi + 100 pp.
- GRANT, D. C. 1965. Specific diversity in the infauna of an intertidal sand community. Ph.D. dissertation, Yale University, New Haven.
- GURIN, S., AND W. E. CARR. 1971. Chemoreception in *Nassarius obsoletus*: the role of specific stimulatory proteins. *Science* **174**: 293-295.
- HAINES, E. B., AND C. L. MONTAGUE. 1979. Food sources of estuarine invertebrates analyzed using $^{13}\text{C}/^{12}\text{C}$ ratios. *Ecology* **60**: 48-56.
- HANNA, G. D. 1966. Introduced mollusks of western North America. *Occas. Pap. Calif. Acad. Sci.* **48**: 108 pp.
- HAYES, F. R. 1929. Contributions to the study of marine gastropods. III. Development, growth and behaviour of *Littorina*. *Contrib. Can. Biol.* **4**: 413-430.

- HUNT, J. H. 1981. The importance of adult-larval interactions in determining abundance patterns of soft-sediment infauna. M.S. thesis, University of North Carolina, Chapel Hill.
- HUTCHINSON, G. E. 1957. Concluding remarks. *Cold Spring Harbor Symp. Quant. Biol.* **22**: 415-427.
- HYLLEBERG, J., AND J. T. CHRISTENSEN. 1978. Factors affecting the intraspecific competition and size distribution of the periwinkle *Littorina littorea* (L.). *Natura Jutlandica* **20**: 193-202.
- JENNER, C. E. 1956. A striking behavioral change leading to the formation of extensive aggregations in a population of *Nassarius obsoletus*. *Biol. Bull.* **111**: 291.
- JENNER, C. E., AND M. G. JENNER. 1977. Experimental displacement of an *Ilyanassa obsoleta* (Mollusca: Gastropoda) aggregation. *J. Elisha Mitchell Sci. Soc.* **93**: 103.
- JÜCH, P. J. W., AND G. J. BOEKSCHOTEN. 1980. Trace fossils and grazing traces produced by *Littorina* and *Lepidochitona*, Dutch Wadden Sea. *Geol. Mijnbouw* **59**: 33-42.
- KRAEUTER, J. N. 1976. Offshore currents, larval transport, and establishment of southern populations of *Littorina littorea* Linne along the U. S. Atlantic coast. *Thalassia Jugosl.* **10**: 159-170.
- LEVINTON, J. S., AND S. STEWART. 1982. Marine succession: the effect of two deposit feeding gastropod species on the population growth of *Paranais littoralis* Müller 1784 (Oligochaeta). *J. Exp. Mar. Biol. Ecol.* **59**: 231-241.
- LUBCHENCO, J. 1978. Plant species diversity in a marine intertidal community: importance of herbivore food preference and algal competitive abilities. *Am. Nat.* **112**: 23-39.
- MANN, R., ed. 1979. *Exotic Species in Mariculture*. MIT Press, Cambridge. 363 pp.
- MCKILLUP, S. C. 1983. A behavioural polymorphism in the marine snail *Nassarius pauperatus*: geographic variation correlated with food availability, and differences in competitive ability between morphs. *Oecologia (Berl.)* **56**: 58-66.
- MILLS, E. L. 1967. The biology of an ampeliscid amphipod crustacean sibling species pair. *J. Fish. Res. Board Can.* **24**: 305-355.
- MORISITA, M. 1959. Measuring of interspecific association and similarity between communities. *Mem. Fac. Sci. Kyushu Univ., Ser. E Biol.* **3**: 65-80.
- MORSE, E. S. 1880. The gradual dispersion of certain mollusks in New England. *Bull. Essex Inst.* **12**: 171-176.
- MORSE, E. S. 1921. *Observations on Living Gasteropods of New England*. Peabody Museum, Salem. Nichols Press, Lynn, Massachusetts. 29 pp.
- MURPHY, D. J. 1979. A comparative study of the freezing tolerances of the marine snails *Littorina littorea* (L.) and *Nassarius obsoletus* (Say). *Physiol. Zool.* **52**: 219-230.
- NICHOLS, J. A., AND J. R. ROBERTSON. 1979. Field evidence that the eastern mud snail, *Ilyanassa obsoleta*, influences nematode community structure. *Nautilus* **93**: 44-46.
- PACE, M. L., S. SHIMMEL, AND W. M. DARLEY. 1979. The effect of grazing by a gastropod, *Nassarius obsoletus*, on the benthic microbial community of a salt marsh. *Estuarine Coastal Mar. Sci.* **9**: 121-134.
- PEARSE, A. S. 1913. Observations on the fauna of the rock beaches at Nahant, Massachusetts. *Bull. Wisconsin Nat. Hist. Soc.* **11**: 8-34.
- PEARSE, A. S. 1914. Observations on the fauna of the rock beaches at Nahant, Massachusetts (continued). *Bull. Wisconsin Nat. Hist. Soc.* **12**: 72-80.
- PECHENIK, J. A. 1978. Adaptations to intertidal development: studies on *Nassarius obsoletus*. *Biol. Bull.* **154**: 282-291.
- PERKINS, G. H. 1869. Molluscan fauna of New Haven. *Proc. Boston Soc. Nat. Hist.* **13**: 109-163.
- PETERSON, C. H. 1979. The importance of predation and competition in organizing the intertidal epifaunal communities of Barnegat Inlet, New Jersey. *Oecologia* **39**: 1-24.
- PETRAITIS, P. S. 1983. Grazing patterns of the periwinkle and their effect on sessile intertidal organisms. *Ecology* **64**: 522-533.
- POURREAU, C. N. 1979. Succession of five common salt marsh detritivores on *Spartina alterniflora* detritus of decreasing particle size and increasing age. *Biol. Bull.* **157**: 390.
- RACE, M. S. 1982. Competitive displacement and predation between introduced and native mud snails. *Oecologia (Berl.)* **54**: 337-347.
- RATHBUN, R. 1881. The littoral marine fauna of Provincetown, Cape Cod, Massachusetts. *Proc. U. S. Nat. Mus.* **3**: 116-133.
- RECHER, H. F. 1966. Some aspects of the ecology of migrant shorebirds. *Ecology* **47**: 393-407.
- SAY, T. 1822. An account of some of the marine shells of the United States. *J. Phil. Acad. Nat. Sci.* **2**: 221-248.
- SCHELTEMA, R. S. 1962. Pelagic larvae of New England intertidal gastropods. I. *Nassarius obsoletus* Say and *Nassarius vibex* Say. *Trans. Am. Microsc. Soc.* **81**: 1-11.
- SCHELTEMA, R. S. 1964. Feeding habits and growth in the mud-snail *Nassarius obsoletus*. *Chesapeake Sci.* **5**: 161-166.
- SCHELTEMA, R. S., AND J. T. CARLTON. 1983. Methods of dispersal among fouling organisms and possible

- consequences for range extension and geographical variation. In *Proc. Symp. Mar. Biodeterioration*, Bethesda, MD. Office of Naval Research, U. S. Naval Institute, Washington, DC. In press.
- SIBERT, J. 1968. Interactions between detritus, microorganisms, and the mud-snail, *Nassarius obsoletus* (Say). Ph.D. dissertation, Columbia University, New York.
- SIMBERLOFF, D. 1981. Community effects of introduced species. Pp. 53-81 in *Biotic Crises in Ecological and Evolutionary Time*, M. H. Nitecki, ed. Academic Press, New York.
- SINDERMANN, C. J. 1960. Ecological studies of marine dermatitis-producing schistosome larvae in northern New England. *Ecology* **41**: 670-684.
- SMITH, E. P., AND T. M. ZARET. 1982. Bias in estimating niche overlap. *Ecology* **63**: 1248-1253.
- SPOONER, G. M., AND H. B. MOORE. 1940. The ecology of the Tamar Estuary. VI. An account of the macrofauna of the intertidal muds. *J. Mar. Biol. Assoc. U. K.* **24**: 283-330.
- STAMBAUGH, J. E., AND J. J. McDERMOTT. 1969. The effects of trematode larvae on the locomotion of naturally infected *Nassarius obsoletus* (Gastropoda). *Penn. Acad. Sci.* **43**: 226-231.
- STAUFFER, R. C. 1937. Changes in the invertebrate community of a lagoon after disappearance of the eel grass. *Ecology* **18**: 427-431.
- STENZLER, D., AND J. ATEMA. 1977. Alarm response of the marine mud snail, *Nassarius obsoletus*: specificity and behavioral priority. *J. Chem. Ecol.* **3**: 159-171.
- STIMPSON, W. 1865. On certain genera and families of zoophagous gasteropods. *Am. J. Conchol.* **1**: 55-64.
- VERMEIJ, G. J. 1982a. Environmental change and the evolutionary history of the periwinkle (*Littorina littorea*) in North America. *Evolution* **36**: 561-580.
- VERMEIJ, G. J. 1982b. Phenotypic evolution in a poorly dispersing snail after arrival of a predator. *Nature* **299**: 349-350.
- VERRILL, A. E., AND S. I. SMITH. 1873. Report upon the invertebrate animals of Vineyard Sound and the adjacent waters. *Rept. U. S. Comm. Fish. and Fisheries for 1871-1872*, pp. 295-537.
- WAGNER, F. J. E. 1977. Palaeoecology of marine Pleistocene Mollusca, Nova Scotia. *Can. J. Earth Sci.* **14**: 1305-1323.
- WHARFE, J. R. 1977. An ecological survey of the benthic invertebrate macrofauna of the lower Medway estuary, Kent. *J. Anim. Ecol.* **46**: 93-113.

THE BIOLOGY OF *FISSURELLA MAXIMA* SOWERBY (MOLLUSCA:
ARCHAEOGASTROPODA) IN NORTHERN CHILE. 2. NOTES
ON ITS REPRODUCTION

MARTA BRETOS¹, ITALO TESORIERI, AND LUIS ALVAREZ

Centro de Investigaciones Marinas, Universidad Del Norte Sede Iquique.

ABSTRACT

For 14 months, monthly samples were collected to study reproduction in *Fissurella maxima* at Huayquique. Results indicate that *F. maxima* is a dioecious species; no sign of hermaphroditism has been observed. The sex ratio is 1:1 in the different size classes analyzed. Ovaries are green and testis are median brown to yellowish white. Eggs in the ovary measure from 120–280 μ without envelopes. The gonads are parasitized by adult digenea trematods of the genus *Proctoeces*. Some effects of parasitism are discussed.

Variations in mean monthly gonadosomatic index suggest that there is a main spawning period in late November–December (late spring-early summer) and a secondary period in July–August (winter). Fluctuations in mean gonad index show a close correlation with sea water temperature variations.

The youngest mature specimens detected were about 5 cm in shell length (over two years old), but the majority of mature animals were over 6.5 cm.

INTRODUCTION

Fissurella maxima Sowerby, 1835, is the most conspicuous of the Chilean *Fissurella* species, reaching sizes of about 12 cm in shell length at the Iquique region (20°14'S, 70°10'W) and 14 cm at Los Vilos (31°55'S, 71°32'W). It lives throughout the low intertidal and high subtidal levels, under *Lessonia* sp. leaves on exposed rocky shores. *F. maxima* is a species with a life span of about 7–10 years (Bretos, 1982), and like *F. crassa* it seems to form two shell growth rings per year (Bretos, 1980). Typical commercial sizes vary from 60–85 mm in shell length at Iquique; these animals are usually between 2 and 4 years old.

Although keyhole limpets of the genus *Fissurella* are abundant on Chilean coasts, little information is available on their biology and there appears to be no published studies on their reproduction. Some data has been found on reproduction of *Fissurella* from other regions. The breeding cycle of a small sized Caribbean species, *F. barbadensis* Gmelin has been described by Ward (1966). This research was based on collections, made at bimonthly intervals, analyzed by using histological study of the gonads. Two principal spawning periods were recorded: from September to November and from March to June. Spawning specimens were present in all but two samples throughout the collecting period (early January and early April). The results of this study indicate that there is no resting phase in *F. barbadensis* along the coasts of Barbados.

Received 8 July 1983; accepted 29 August 1983.

¹ Present address: Departamento de Ciencias Básicas, Universidad de La Frontera, Casilla 54-D, Temuco, Chile.

Concerning European species, Boutan (1885) reported that *F. reticulata* spawns from May to early July at Port Vendres. In *F. (Cremides) nubecula* (L.) spawning occurs in May at Naples Port (Bacci, 1947).

The present study was undertaken as the first step in the analysis of reproduction of *F. maxima* in Northern Chile.

MATERIALS AND METHODS

F. maxima samples were collected at Huayquique (20°17'S, 70°08'W), in northern Chile. Sampling took place at approximately monthly intervals, from July 1979 to August 1980. The animals were collected by diving in shallow waters, from 0–2 m below low-water mark, and intertidally. The sampling area was a rocky shore, open coast habitat.

In the laboratory, each animal was weighed (wet weight) and removed from its shell. Wet weight of gonad and soft parts were also determined by using a digital Sauter balance to the nearest 0.1 g. Shell length was measured by using vernier calipers to the nearest 0.1 mm. Sampling covered the available size range. Size of the specimens was not selected in order to determine the size at which *F. maxima* attains first sexual maturity.

The sex of the animal was determined when the gonad was exposed by gross dissection. Gonads were observed under a stereo-microscope and notes were made on their appearance. Egg diameters in the ovary were measured by using micrometric eye lens.

Data were grouped in size classes of 5 or 10 mm. The general reproductive condition of each sample was assessed by calculating the gonadosomatic index (GSI). This was calculated by expressing the ratio of gonad wet weight to total wet body weight as a percentage. Sexually undetermined animals were numerous in size classes up to 60 mm in shell length. For this reason, data were analyzed mainly in animals whose shell length was greater than 60.0 mm. Separate monthly GSI means were calculated for each sex in animals over 60.0 mm in shell length.

Sexual maturity of each animal was estimated by considering its GSI, and the size and appearance of the gonad. Sexual maturity of animals in each sample was estimated.

Trematods were present in the gonadas of *F. maxima*. The percentage of infection was analyzed in sexually undetermined specimens.

Variations in monthly GSI means were related to sea surface temperature. It was measured daily at 9:00 hours at the sampling locality.

RESULTS

A total of 1602 animals were examined whose sizes ranged from 21.5 to 98.6 mm in shell length (Table I). Only 24 animals were captured in May 1980 because of strong seas.

The gonads

F. maxima is a dioecious species; no hermaphrodites were detected among the animals studied. The sexes cannot be distinguished externally.

Animals classified as sexually undetermined had inconspicuous or no discernible gonads, whitish or transparent, sometimes pinkish colored. The pinkish color was due to parasites in the gonad. These parasites were identified as adult specimens of the digenetic trematods *Proctoeces* Odhner, 1911 (Bretos and Jirón, 1980). Many

TABLE I

Material of F. maxima collected at Huayquique

Date	Total N	Sexed animals				Sexually undet. animals
		Females		Males		
		N	%	N	%	
4-7-79	136	69	52.3	63	47.7	4
27-8-79	139	72	57.1	54	42.9	13
25-9-79	150	61	44.9	75	55.1	14
22-10-79	137	50	46.3	58	53.7	29
19-11-79	130	35	44.3	44	55.7	51
20-12-79	116	34	44.7	42	55.3	40
2-1-80	105	21	39.6	32	60.4	52
11-2-80	70	30	46.9	34	53.1	6
10-3-80	78	38	50.0	38	50.0	2
14-4-80	138	60	44.8	74	55.2	4
29-5-80	24	13	54.2	11	45.8	0
9-6-80	105	48	48.0	52	52.0	5
29-7-80	148	72	51.4	68	48.6	8
26-8-80	126	68	57.6	50	42.4	8
Total	1.602	671		695		236

Percentages of females and males are given for sexed animals.

young specimens of sexually undetermined *F. maxima* (73.7%) had as many as 17 adult trematods in their gonads (Table II).

The gonad is single. When developed or mature, the female gonad is green and the male gonad varies from median brown to yellowish white.

In young specimens the small gonad is found next to the digestive gland; its weight was under 0.1 g. The smallest female with a detectable gonad was 27.3 mm

TABLE II

Numbers of sexually undetermined specimens of F. maxima from Huayquique, and quantity of parasites in their gonads

Shell length (mm)	Infected specimens	Intensity		Not infected specimens	Total specimens examined
		Mean \pm SD	Range		
20.1-25.0	1	2	2	0	1
25.1-30.0	1	1	1	0	1
30.1-35.0	1	2	2	4	5
35.1-40.0	8	4.0 \pm 3.0	1-10	10	18
40.1-45.0	25	3.6 \pm 2.4	1-9	10	35
45.1-50.0	45	4.4 \pm 2.9	1-17	17	62
50.1-55.0	63	4.1 \pm 2.2	1-11	17	80
55.1-60.0	25	4.9 \pm 3.4	1-16	2	27
60.1-65.0	3	5.0 \pm 2.7	3-8	1	4
65.1-70.0	2	4.5	4-5	0	2
70.1-75.0	0	—	—	1	1
Total	174			62	236
%	73.73			26.27	100.00

long, the smallest male 30.7 mm. Both sizes correspond to one-year-old animals (Bretos, 1982).

As the gonad grows, it remains attached to the digestive gland by the connective tissue envelope sheet. When the gonad is separated from the digestive gland by dissection, the gonad sac opens. Both gonads consist of a sac with a large lumen. Trabeculae occur within the gonads. At mature stage, the gonads are filled with the gametes. Eggs found in the lumen of the ovary measured from 120–280 μ in diameter without envelopes. At least two sheets of a gelatinous matrix have been detected around the eggs at observation under the microscope.

The mature gonad can attain a wet weight of 30.6 g in females and 17.4 g in the reproductive season (November). The gonad is turgent and gametes can easily emerge when the gonad is dissected. The sex cells are discharged into the sea water through the right nephridiopore. It has been observed in males placed in aquaria, that the sperms are liberated through the apical hole as a white jet.

Sex ratio

Sex ratio was calculated as a percentage in size classes without considering sexually undetermined individuals (Fig. 1). Sexes were similarly represented in classes over 60 mm. Among sexed animals, 49.12% corresponds to females and 50.88% to males (Table III).

Sexually undetermined specimens are abundant in size classes up to 60 mm in shell length (two year old animals). Among 236 undetermined animals examined, only 7 were longer than 60.0 mm (Table II).

Most of the sexually undetermined animals occurred in samples from October to January (Table I). The lowest mean shell lengths (Table IV) were observed during this period because many small animals were found in these months.

Estimated maturity

Some gonad characteristics and the gonadosomatic index were used as criteria to classify sexed animals as mature or immature.

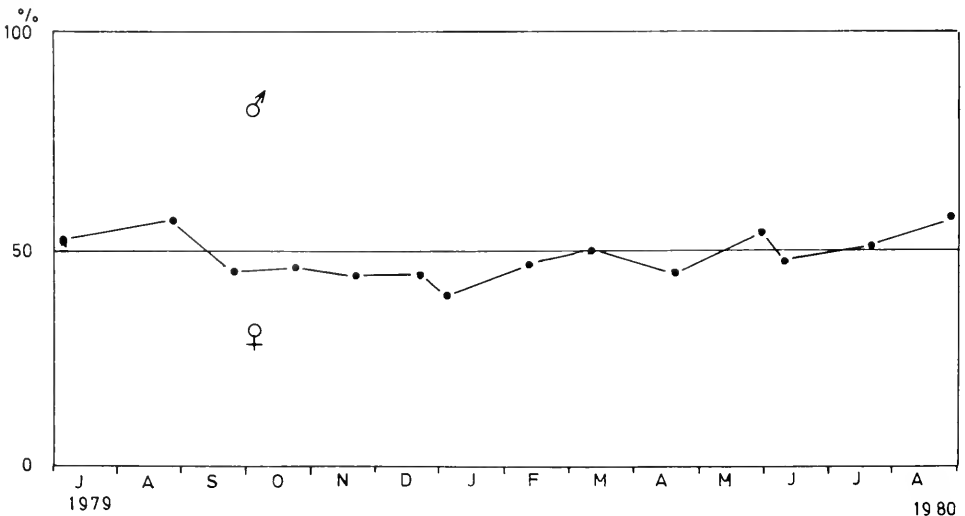

FIGURE 1. Sex ratio in *F. maxima* from Huayquique.

TABLE III

Sex distribution of F. maxima in size classes from all samples

Shell length (mm)	Sexed animals				Females + males	Sexually undet.	Total
	Females		Males				
	N	%	N	%			
20.1-30.0	1	—	0	—	1	2	3
30.1-40.0	1	—	2	—	3	23	26
40.1-50.0	25	48.1	27	51.9	52	97	149
50.1-60.0	110	50.9	106	49.1	216	107	323
60.1-70.0	177	48.9	185	51.1	362	6	368
70.1-80.0	228	48.7	240	51.3	468	1	469
80.1-90.0	114	48.5	121	51.5	235	0	235
90.1-100.0	15	51.7	14	48.3	29	0	29
Total	671		695		1366	236	1602
% in total		49.1		50.9	100		

Two aspects were studied in male gonads: the color variation and the relative abundance of ripe spermatozoa. An attempt was made to find a correlation between the color and the maturity stage in male gonads. Testis with high GSI were creamy or light olive green, but there was no clear color graduation nor a constant relationship between the color and the GSI. In addition, male gonads were classified as milky, semi-milky, or not-milky, according to the quantity of semen observed among the testis trabeculae after dissection. Milky and semi-milky testis were usually present in specimens with high or medium GSI values.

No color differences were observed in female gonads of animals with different GSI values. Only very small ovaries had a lighter green color. Female specimens with

TABLE IV

Size of F. maxima

Samples	N	Shell length (mm)	
		Mean \pm S.D.	Range
Jul 79	136	74.9 \pm 9.2	35.2-96.5
Aug 79	139	74.2 \pm 13.1	35.5-98.6
Sep 79	150	72.7 \pm 13.8	27.3-96.1
Oct 79	137	61.7 \pm 10.7	34.3-86.3
Nov 79	130	60.9 \pm 13.0	36.8-90.3
Dec 79	116	61.2 \pm 9.4	41.4-89.9
Jan 80	105	56.3 \pm 11.1	21.5-87.2
Feb 80	70	63.0 \pm 11.6	30.7-95.7
Mar 80	78	72.5 \pm 12.7	37.2-94.2
Apr 80	138	68.3 \pm 11.2	37.4-98.5
May 80	24	78.7 \pm 7.8	61.5-92.9
Jun 80	107	67.0 \pm 12.5	25.9-97.9
Jul 80	148	66.0 \pm 11.3	39.5-90.9
Aug 80	126	67.0 \pm 12.2	32.2-91.6

Collected at Huayquique. N = number of specimens. S.D. = standard deviation.

high or medium GSI values had ovaries of friable consistency and in which eggs detached easily from the trabeculae at the time of dissection.

Assuming that an increase in GSI may be interpreted as a buildup of gametogenic cells and gametes, while a decrease indicates spawning, GSI was used to estimate the reproductive activity in both sexes in the present study.

After analyzing the data obtained, we concluded that the GSI was the most reliable method for classifying *F. maxima* animals as "mature" or "immature".

Animals with spent and recovering gonads were grouped together as "immature" specimens. Only fully mature animals, with high GSI were considered "mature".

Sexual maturity estimations are summarized in Table V. The highest number of mature animals was detected in late July, 1980. Many mature specimens were also found in October and November, 1979. Mature animals were present throughout the year, although they were scarce in some months (Table V).

The onset of sexual maturity

The size at which *F. maxima* may first spawn is considered as the minimum size at which estimated mature animals have been found.

The youngest mature female detected measured 49.8 mm and the youngest mature male 47.7 mm in shell length (1.5-year-old animals). Nevertheless, numerous mature specimens were usually observed in size classes over 65 mm (animals two or more years old) (Bretos, 1982).

The highest GSI, meaning fully developed gonads, were detected in animals ranging from 70 to 90 mm in shell length, with GSI values from 21.3 (males) to 32.2 (females).

Spawning

Mean GSI were calculated separately per month for females and males over 60.0 mm shell length (Fig. 3). Mean GSI values exhibit the same tendencies in both sexes although the highest values were observed in females in November.

TABLE V

Estimated maturity of F. maxima over 60.0 mm in shell length, at Huayquique.

Date	Females		Total	Males		Total
	Mature	Immature		Mature	Immature	
Jul 79	13	52	65	27	34	61
Aug 79	25	39	64	25	27	52
Sep 79	1	54	55	13	52	65
Oct 79	13*	13	26	23*	22	45
Nov 79	14*	8	22	19*	14	33
Dec 79	1	27	28	3	26	29
Jan 80	0	16	16	1	21	22
Feb 80	6	16	22	8	15	23
Mar 80	10	24	34	5	27	32
Apr 80	21	32	53	28	33	61
May 80	0	13	13	2	9	11
Jun 80	6	29	35	21*	18	39
Jul 80	39*	12	51	40*	8	48
Aug 80	17	33	50	23*	16	39

* Mature animals are equal or more numerous than immature animals.

Two noticeable peaks appeared in November, 1979 and late July, 1980. The peak of early July, 1979 is less conspicuous.

The lowest mean GSI value was observed in early January; only one male was estimated as sexually mature in this sample (Table V). These facts strongly support the idea that a massive spawning period is complete in December. Mean GSI also decreased in August-September suggesting the occurrence of a winter spawning. Mean GSI also decreased in May, but the sample obtained included few animals, indicating that it may not be a representative sample of the population.

According to the GSI fluctuations, we assume that there are two spawning seasons per year in the *F. maxima* population under study: a main reproductive period occurring in late spring-early summer (November-December) and a secondary period occurring in winter (July-August).

A close relationship appears to exist between the GSI cycle and the sea temperature cycle (Fig. 2).

Surface sea water temperature at Huayquique exhibits two rises each year (see Fig. 2, and Bretos, 1978). A little peak is found in winter; temperatures may reach more than 17°C. The long and conspicuous rise of temperature begins in October-November, *i.e.*, in spring, and its highest values are observed in January-February (summer). Sea water temperatures are particularly high, up to 25°C, in years in which El Niño current descends to northern Chile from Peru, as observed in the summer of 1977 (Bretos, 1978).

DISCUSSION

According to Bacci (1947) there is "a certain degree of hermaphroditism" in *F. nubecula* from the Gulf of Naples, detectable by statistical methods. This means that sex reversal of the protandric type would occur in about 12% in this species of limpet. On the contrary, other papers concerning the anatomy of reproductive organs in *Fissurella* have described normal ovaries and testis and no signs of hermaphroditism (Boutan, 1885; Ziegenhorn and Thiem, 1925). Ward (1966) reported that there was no indication of hermaphroditism nor of change of sex at any shell length in *F. barbadensis*. The results of the present study indicate that *F. maxima* is a dioecious species in which sex reversal has not been detected. No significant differences were found in size classes over 60 mm in shell length (Table III). Personal unpublished observations on the gonads of the eight other *Fissurella* species from northern Chile (Bretos, 1976) supports this.

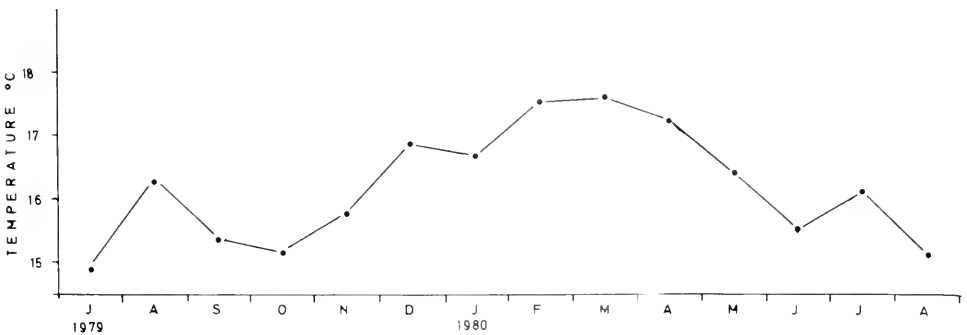

FIGURE 2. Mean sea surface temperatures at Huayquique.

Not all of the individuals of the same species or population develop their gonads at the same time, age, or shell length, since growth is variable from one animal to another, and growth rate depends partly on endogenous factors (Wilbur and Owen, 1964; Bretos, 1978). Nevertheless, it is surprising to find sexually undetermined *F. maxima* animals measuring as much as 72 mm in shell length (Table II). These are juveniles in which development of the gonad has not yet, or only partially, begun. Considering that it is possible to identify clearly ovaries and testis in small *F. maxima* individuals (27.3 mm and 30.7 mm in shell length respectively), it may be assumed that exogenous factors could be acting to retard gonad development. The main exogenous factor is the high incidence of trematod parasites in the gonad, attaining an infection rate of up to 73.73% in sexually undetermined animals (Table II). Gastropods

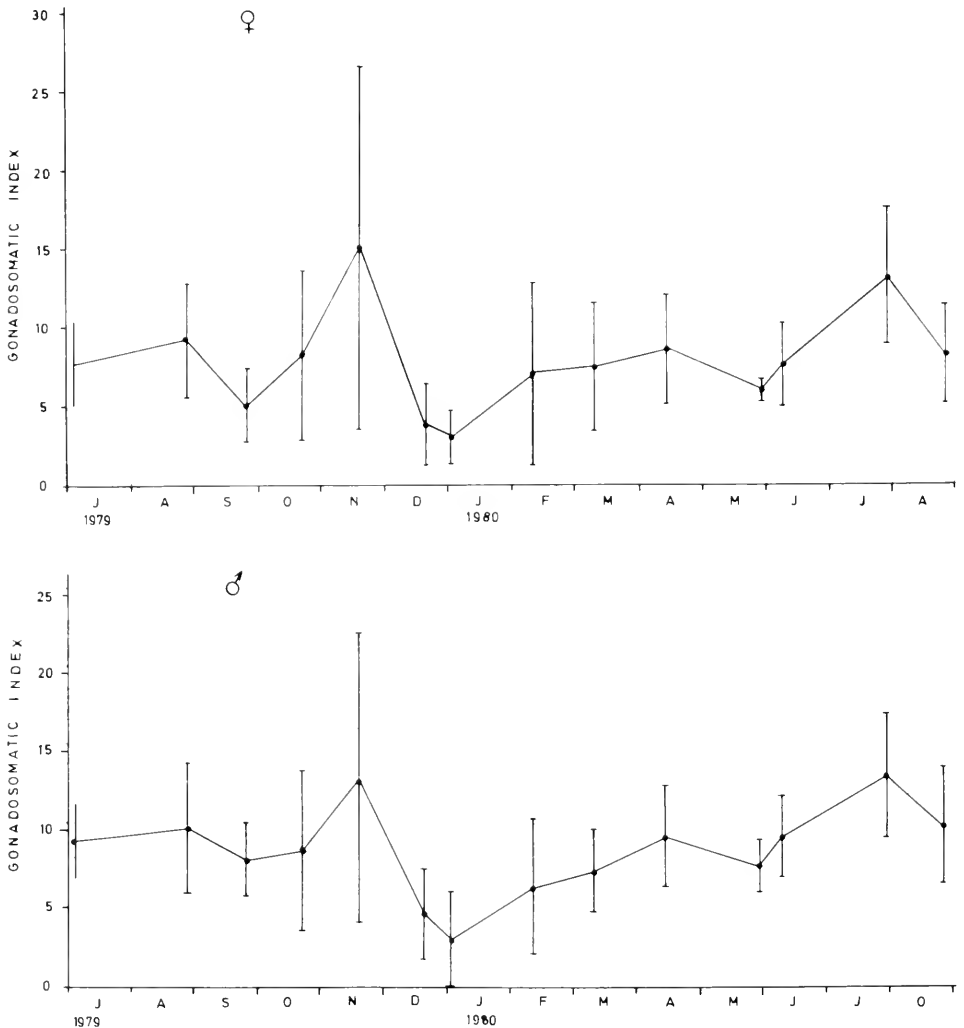

FIGURE 3. Monthly changes in gonadosomatic index in females and males. Mean values and standard deviation.

are often part of parasitic life cycles, particularly those of digenetic trematodes. The gametogenic activity of the mollusc is either curtailed or even completely suppressed by parasitism (Webber, 1977), or the invaded gonad may be destroyed (McArthur and Featherston, 1976), causing parasitic castration. It should be noted that the gonads or other organs of molluscs are usually invaded by trematode cercaria, *i.e.*, by trematode larval forms. In *F. maxima* the digenetic trematodes that parasitize the gonads are adult specimens (Bretos and Jirón, 1980), not larval stages which may cause considerable damage. Gametogenetic activity does not seem to be suppressed in *F. maxima* nor is the gonad destroyed by adult *Proctoeces* trematods.

F. maxima eggs are much larger (0.12–0.28 mm without envelopes) than those of *F. reticulata* that measure 0.1 mm (Boutan, 1885) or those of *F. barbadensis* [0.08–0.18 mm including the gelatinous coat (Ward, 1966)]. This may be related to the size that each species attains: *F. barbadensis* can measure up to 3.3 cm in shell length and *F. reticulata* is also small, but *F. maxima* can reach a shell length of 12 or more centimeters.

The data obtained suggest that reproduction occurs rhythmically in the *F. maxima* study population, showing a semiannual pattern of breeding. According to the GSI calculated, two spawning periods per year were detected: one in winter and the other in late spring-early summer (Fig. 3). A similar reproductive pattern is found in *F. barbadensis* (Ward, 1966), which has two breeding seasons.

Semiannual breeding seasons occur in a number of tropical and temperate species. One of the major environmental parameters affecting or influencing the reproductive state of a population is temperature. Seasonally changing sea temperatures may influence reproductive activities and may serve to promote and synchronize spawning (Webber, 1977). Mean sea surface temperature shows a bimodal cycle at Huayquique (Fig. 2), presenting the main peak in summer and a little one in winter. There appears to be a close correlation between sea temperature fluctuations and *F. maxima* gonadosomatic index variations (Fig. 3), thus, its reproductive activity. *F. maxima* seems to be one of the mollusc species whose spawning is influenced by sea temperature changes.

F. gibba individuals at Banyuls, and *F. reticulata* individuals at Port-Vendres seemed to be more numerous during the breeding season (Boutan, 1885). The samples of *F. maxima* obtained in winter and summer seem to be more numerous (Table I), but this may be a coincidence. Nevertheless, more females than males were detected in July-August (winter months). This period coincides with the secondary spawning season of *F. maxima* at Huayquique. During the main spawning period (November-December) however, males were more numerous than females (Table I), but there was also a large number of sexually undetermined specimens which altered the real sex ratio in these samples.

The youngest sexually mature specimens measured about 50 mm in shell length, but the majority of the *F. maxima* population were mature at shell lengths of over 65 mm. On the other hand, a good number of sexually undetermined individuals were observed up to 60 mm in shell length. It is therefore not advisable to catch *F. maxima* animals smaller than 65 mm in shell length for commercial or industrial purposes.

ACKNOWLEDGMENTS

These investigations were supported by SERPLAC I Región (Regional Development Funds) and by the General Research Management of the Universidad del Norte. We are also indebted to Mr. José Ignacio Moraga for making the figures.

LITERATURE CITED

- BACCI, G. 1947. Osservazioni sulla sessualità degli Archaeogastropoda. *Arch. Zool. Ital.* **32**: 329-341.
- BOUTAN, L. 1885. Recherches sur l'anatomie et le développement de la fissurelle. *Arch. Zool. Exp. Gen.* **3 Bis**: 1-173.
- BRETOS, M. 1976. Keyhole limpet of the genus *Fissurella* from northern Chile. *Resúmenes de Comunic. y Simp., XIX Annual Meeting of the Biology Soc. of Chile*, pp. 8.
- BRETOS, M. 1978. Growth in the keyhole limpet *Fissurella crassa* Lamarck (Mollusca: Archaeogastropoda) in Northern Chile. *Veliger* **21**: 268-273.
- BRETOS, M. 1980. Age determination in the keyhole limpet *Fissurella crassa* Lamarck (Archaeogastropoda: Fissurellidae), based on shell growth rings. *Biol. Bull.* **159**: 606-612.
- BRETOS, M. 1982. Biología de *Fissurella maxima* Sowerby (Mollusca: Archaeogastropoda) en el Norte de Chile. 1.—Caracteres generales, edad y crecimiento. *Cahiers Biol. Mar.* **23**: 159-170.
- BRETOS, M., AND C. JIRÓN. 1980. Trematods in Chilean Fissurellid molluscs. *Veliger* **22**: 293.
- MCARTHUR, C. P., AND D. W. FEATHERSTON. 1976. Suppression of egg production in *Potamopyrgus antipodarum* (Gastropoda: Hydrobiidae) by larval trematods. *N. Z. J. Zool.* **3**: 35-38.
- WARD, I. 1966. The breeding cycle of the keyhole limpet *Fissurella barbadensis* Gmelin. *Bull. Mar. Sci. Gulf Caribb.* **16**: 685-695.
- WEBBER, H. H. 1977. Gastropoda: Prosobranchia. Pp. 1-98 in *Reproduction of Marine Invertebrates*. Vol. IV, A. C. Giese and J. S. Pearse, eds. Academic Press, New York.
- WILBUR, K. M., AND G. OWEN. 1964. Growth. Pp. 211-242 in *Physiology of Mollusca*. Vol. I, K. M. Wilbur and C. M. Younge, eds. Academic Press, New York.
- ZIEGENHORN, A., AND H. THIEM. 1925. Beitrage zur Systematik und Anatomie der Fissurellen. *Jena Z. Naturwiss.* **55**: 1-78.

INDUCED DEVELOPMENT OF SWEEPER TENTACLES ON THE REEF CORAL *AGARICIA AGARICITES*: A RESPONSE TO DIRECT COMPETITION

ELIZABETH A. CHORNESKY

Division of Biological Sciences, The University of Texas, Austin, Texas 78712

ABSTRACT

The scleractinian coral *Agaricia agaricites* often has elongate sweeper tentacles on colony margins close to other sessile animals. Sweeper tentacles can damage tissues of opponents and are probably used in direct competition for substrate space. Furthermore, contact with tissues or mesenterial filaments of other corals, or with tissues of the gorgonian *Erythropodium caribaeorum* or the zooanthid *Palythoa caribbea* can stimulate the development of sweeper tentacles by *A. agaricites*. Depending on both the particular competitor species involved and the distance separating it from *A. agaricites*, events leading to the development of sweeper tentacles may or may not include tissue loss by *A. agaricites*. On average the development of sweeper tentacles takes thirty days, and is localized exclusively on tissues close to the region in contact with competitors. Sweeper tentacles do not develop in response to artificial stimuli simulating tactile contact or damage such as occur in natural interactions with other corals. Thus, recognition of competitor tissues appears to be a necessary stimulus for sweeper formation.

INTRODUCTION

Sessile colonial animals, particularly scleractinian corals, crowd many tropical reefs where space for growth often becomes limited (*e.g.*, Porter, 1972, 1974; Glynn, 1973; Connell, 1976, 1978; Sheppard, 1979, 1982). Although upright or branching corals may partially escape this problem by growing up and over adjacent animals (Porter, 1974; Connell, 1976; Glynn, 1976; Jackson, 1979; Wellington, 1980), many corals growing along reef surfaces frequently encounter other sessile animals. Thus, competition for substrate space is considered one of the processes structuring coral reef communities and selecting for life history characteristics and other attributes of sessile reef inhabitants (Connell, 1973, 1976; Glynn, 1973; Lang, 1973; Porter, 1974, 1976; Jackson, 1977, 1979; Potts, 1977; Bak and Engel, 1979; Sheppard, 1982).

When stony corals grow close together, they often directly damage one another by using mesenterial filaments or sweeper tentacles (Lang, 1971, 1973; Richardson *et al.*, 1979; Sheppard, 1979; Wellington, 1980; Bak *et al.*, 1982). If corals of different species are placed in direct contact, many can extend their mesenterial filaments within hours and use them to digest tissues on the opposing coral (Lang, 1971, 1973; Glynn, 1976; Sheppard, 1979). The consequences of such interactions are generally predictable; certain "digestively dominant" species, particularly of the suborder Faviina, are consistently able to use mesenterial filaments to damage others (Lang, 1973; Sheppard, 1979). The additional use of sweeper tentacles in natural interactions by some corals, however, may alter the long term outcomes of these otherwise predictable

encounters (Richardson *et al.*, 1979; Wellington, 1980; Bak *et al.*, 1982; Sheppard, 1982). Sweeper tentacles are longer than normal (Lewis and Price, 1975; Bak and Elgershuizen, 1976) and armed with specialized cnidae (den Hartog, 1977; Wellington, 1980). When expanded, these tentacles increase the volume within reach of live coral tissues and may deter other corals from growing too closely (Richardson *et al.*, 1979) or may actively damage competitor tissues (Wellington, 1980; Bak *et al.*, 1982).

All coral polyps have mesenterial filaments. In contrast, the distribution of sweeper tentacles is erratic, and the determinants of their presence are poorly understood. For species which can form sweeper tentacles, neither every colony in a population, nor every polyp on a colony necessarily possesses sweepers. On *Montastraea cavernosa* (Linnaeus), these tentacles, which are present on most colonies, are thought to extend in response to water currents and are most abundant around colony perimeters (Price, 1973 in den Hartog, 1977; den Hartog, 1977; Richardson *et al.*, 1979). On *Pocillopora* sp. (Wellington, 1980) and *Madracis mirabilis* (Duchassaing and Michelotti) (Bak *et al.*, 1982) sweepers develop on polyps next to wounds caused by the mesenterial filaments of adjacent corals.

Since the stimulus for sweeper development determines their location on a colony, it also determines whether they are used in competitive interactions. Thus, the consequences of direct encounters involving corals depend not only on the relative effects of mesenterial filaments and sweeper tentacles, but also on the factors which initiate sweeper formation. Many of the responses of other cnidarians to direct competition are thought to be stimulated by contact and recognition of opponent tissues (Theodor, 1970; Ivker, 1972; Francis, 1973; Purcell, 1977; Ottaway, 1978; Brace *et al.*, 1979; Bigger, 1980; Watson and Mariscal, 1983).

This paper explores the conditions under which sweeper tentacles form on the Caribbean reef coral *Agaricia agaricites* (Linnaeus). This species has short mesenterial filaments which extend only a few mm away from the corallum (Bak *et al.*, 1982), and can use them to digest only a few other species of coral (Lang, 1973). *A. agaricites*' polyps are flat and normally have short tentacles (approximately two mm long, Lewis and Price, 1975). In contrast, sweeper tentacles on *A. agaricites* may be over a cm in length (Bak and Elgershuizen, 1976; pers. obs.; Fig. 1A). The occurrence of these special tentacles only on portions of colonies of *A. agaricites* adjacent to other species of sessile animals (pers. obs.) strongly suggests that they develop specifically in response to direct competitive interactions.

Here I examine the potential function of sweeper tentacles on *A. agaricites* and the stimulus for their development. The role of sweeper tentacles on *A. agaricites* in determining the long term consequences of competitive encounters will be discussed elsewhere.

GENERAL MATERIALS AND METHODS

This study has two components: I) determination of the potential function of sweeper tentacles on *A. agaricites* and observation of their development under natural and experimental conditions; and II) experimental determination of the nature of stimuli which induce sweeper formation. The specific protocol and results for each section follow this general discussion of information pertaining to the entire study.

All collections of animals, observations, and *in situ* experiments were accomplished using SCUBA at a depth of -10 meters on the west forereef at Discovery Bay, Jamaica. Aquaria with running, unfiltered sea water for laboratory experiments concerning sweeper function were provided by the Discovery Bay Marine Laboratory of the University of the West Indies. Since the sweeper tentacles of *A. agaricites* expand

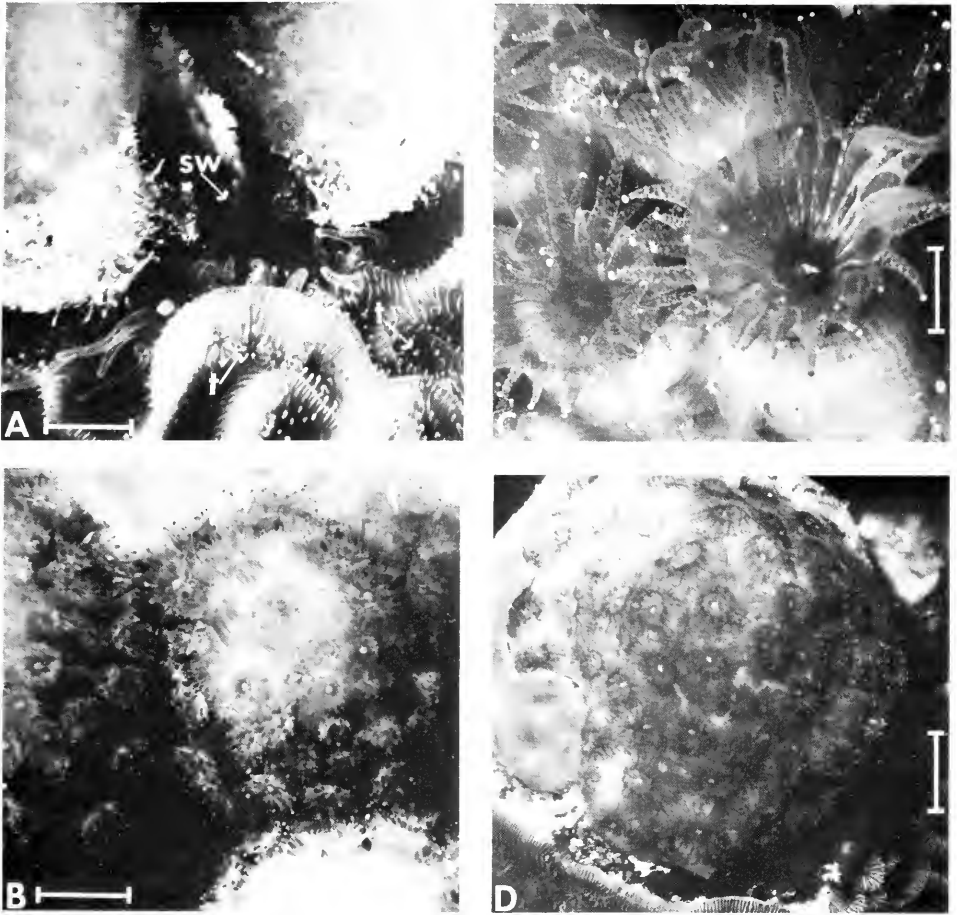

FIGURE 1. Coral polyps expanded at night. Corals are: A) *Agaricia agaricites*, B) *Madracis decactis*, C) *Montastraea cavernosa*, and D) *Montastraea annularis*. Arrows indicate sweeper tentacles (sw) and regular tentacles (t), and scale bars equal approximately 5 mm. In (A) compare length of regular and sweeper tentacles on *A. agaricites*, here shown next to a damaged colony of *Madracis decactis*. Photographs were taken *in situ* using a Nikonas camera, one to two framer, extension tube, and strobe.

maximally at night (Chornesky, unpub. data), all behavioral observations were made after sunset between 2000 and 2400 hours. This study took place between March 1981 and September 1982.

Observations and experiments involved *A. agaricites* and various sessile animals spanning a range of competitive strategies and including four corals, a zooanthid, and a gorgonian (Table I). Among the stony corals used, *A. agaricites* can digest two species (*Madracis decactis* [Lyman] and *Porites astreoides* Lesueur) and can be digested by the two other species (*Montastraea annularis* [Ellis and Solander] and *Montastraea cavernosa*) (Lang, 1973). Within each pair of digestively dominant or subordinate corals, one can sometimes possess sweeper tentacles (*Madracis decactis*, pers. obs.; *M. cavernosa*, Lewis and Price 1975) while the other does not (*P. astreoides* and *M. annularis*) (Table I). The zooanthid *Palythoa caribbea* Duchassaing and the gorgonian *Erythropodium caribaeorum* Duchassaing and Michelotti sometimes overgrow *A.*

TABLE I

*Characteristics of competitor species used in observations and experiments**

Order: Species:	Scleractinia				Zooanthidae	Gorgonaceae
	P.a.	M.d.	M.a.	M.c.	P.c.	E.c.
A.a. can digest	(+)	(+)	(-)	(-)	—	—
Can digest A.a.	(-)	(-)	(+)	(+)	—	—
May have sweepers	(-)	(+)	(-)	(+)	—	—
Other	—	—	—	—	cytotoxins overgrowth	overgrowth
Length polyps	med.	long	short	long	med.	long
Length tentacles	short	long	short	long	short	long

* Abbreviations and symbols used in table are: A.a. = *Agaricia agaricites*, P.a. = *Porites astreoides*, M.d. = *Madracis decactis*, M.a. = *Montastraea annularis*, M.c. = *Montastraea cavernosa*, P.c. = *Palythoa caribbea*, E.c. = *Erythropodium caribaeorum*, (+) = species has characteristic, (-) = species does not have characteristic.

agaricites (Karlson, 1980). *P. caribbea* contains secondary chemicals which might be used against competing animals (Cieresko and Karns, 1973).

Unless stated otherwise, all colonies of *A. agaricites* and *Madracis decactis* used in these experiments lacked sweeper tentacles prior to treatment. Colonies of *A. agaricites* used were of the formae *A. agaricites* f. *purpurea* or *A. agaricites* f. *carinata* as described by Wells (1973). Where appropriate, data were analyzed using Chi-square and Mann-Whitney tests for statistical significance.

I. FUNCTION AND DEVELOPMENT OF SWEEPER TENTACLES ON *A. AGARICITES*

MATERIALS AND METHODS

Function

Lewis and Price (1975) originally described the sweeper tentacles of *A. agaricites* as appendages for feeding. Nevertheless, in hundreds of separate observations I have never seen *A. agaricites* use sweepers to capture visible particulate food, although specifically searching for this behavior. This failure to observe feeding, combined with my consistent observations that sweeper tentacles on *A. agaricites* only occur on colony margins close to other animals, implied that on this species sweeper tentacles might play a role in competitive interactions.

Experiments were conducted in sea water aquaria to determine the potential function of sweeper tentacles on *A. agaricites* in spatial competition. Colonies of *A. agaricites* already possessing sweeper tentacles, along with colonies of several competitor species, were collected on the forereef and transferred to the aquaria. The *A. agaricites* were then observed on several nights after expansion. After determining the location of sweepers on these colonies, during the day, colonies of *Madracis decactis* (n = 5), *P. astreoides* (n = 7), and *M. annularis* (n = 8) were placed within "sweeper length" of the *A. agaricites*. These artificially arranged interactions were then observed on several (3 to 5) nights for the behavior and condition of both corals in each pair. Opponent species used in these experiments were selected because they all seem to maintain normal behavior and health in a running sea water system.

Development: natural interactions

To determine the frequency with which sweeper tentacles occur on portions of *A. agaricites* involved in competitive interactions, I labeled a series of natural encounters where colonies of *A. agaricites* were already within one cm of competitors. These interactions were visited repeatedly at night and scored for the presence or absence of sweeper tentacles on the *A. agaricites*. Interactions observed were with: *P. astreoides* (n = 28), *Madracis decactis* (n = 17), *M. annularis* (n = 15), *P. caribbea* (n = 14), and *E. caribaeorum* (n = 9).

To examine moreover, whether sweeper tentacles develop over time as competitive interactions progress, the labeled encounters between *A. agaricites* and *P. astreoides*, *Madracis decactis*, and *M. annularis* were subsequently scored for the presence or absence of sweeper tentacles during four observation periods throughout the following ten months.

Within each observation period, labeled interactions were visited on at least three nights to minimize the chance that sweepers were contracted due to incidental activity of other nocturnally active animals or other unpredictable events.

Development: experimentally induced

The following experiments tested whether sweeper tentacles form specifically as a consequence of contact between *A. agaricites* and adjacent animals. Encounters among reef corals generally result from gradual growth, and the first contact between adjacent animals may often involve intermittently expanded tentacles and polyps. Such intermittent contact may stimulate a different response from that of close tissue and skeletal contact which presumably occur in natural encounters as the animals grow closer and any interaction proceeds (see: Lang, 1973; Potts, 1977; Sheppard, 1979; Wellington, 1980; Bak *et al.*, 1982). Two kinds of experiments were conducted *in situ* in which: 1) animals were placed in very close tissue and skeletal contact; and 2) animals were fixed a small and consistent distance apart, simulating initial interactions resulting from gradual growth.

1) *Close contact.* Colonies of *A. agaricites* were dislodged using a chisel and placed in direct contact with the corals *P. astreoides* (n = 6), *Madracis decactis* (n = 5), and *M. annularis* (n = 11), the zooanthid *P. caribbea* (n = 5), and the encrusting gorgonian *E. caribaeorum* (n = 6). Paired colonies touched even when both polyps and tissues were contracted, ensuring constant contact independent of patterns of tissue and tentacle expansion. Presence of sweeper tentacles on *A. agaricites* was assessed nocturnally at weekly intervals for a period of up to fifty days.

2) *Controlled distance.* To more accurately simulate the initial contact between competitors as it occurs in natural interactions, colonies of *A. agaricites* were cemented by basal portions of bare skeleton onto cinder blocks (Fig. 2A) or onto stationary asbestos tiles at a small distance from colonies of *M. cavernosa* (n = 10), *Madracis decactis* (n = 18), and *M. annularis* (n = 34). The underwater epoxy-putty used to fix corals in place was never in contact with live coral tissues and appears to be non-toxic (Birkeland, 1976). Specimens of *Madracis decactis* and *M. cavernosa* (both of which have long polyps and tentacles; Figs. 1B, 1C, Table I) were positioned so that contact occurred only between tentacle tips of these species and tissues of the *A. agaricites* when corals were fully expanded at night. Approximate distances between contracted corals were 3 mm with *Madracis decactis* and 2 cm with *M. cavernosa*. Colonies of *A. agaricites* next to *M. annularis* (which has short polyps and tentacles; Fig. 1D, Table I) were positioned so that their polyps were separated by a 1–2 mm gap even when both animals were fully expanded at night (distance between contracted

corals of 2–3 mm). In four of these interactions, tissues of *A. agaricites* and *M. annularis* were in contact when expanded because colonies slipped into closer proximity before the epoxy-putty hardened. Interactions were observed frequently during the day and a minimum of once a week at night for a period of eighty days.

RESULTS

Function

Under laboratory conditions, without exception, tissues of competitor corals placed close to the sweeper tentacles of *A. agaricites* were damaged. The behavior of sweeper tentacles is similar to that of the catch tentacles of anemones (Purcell, 1977). Extended sweepers brush against and sometimes adhere to opponents, creating patches of sloughing necrotic tissues within their reach. Such lesions are easily distinguished from the regions of clean bare skeleton resulting from digestion by mesenterial filaments.

Development: natural interactions

In natural interactions sweeper tentacles were initially present on between forty-seven and fifty-seven percent of *A. agaricites* colonies, depending on the competitor species (Table IIA). In contrast to these initial frequencies, the cumulative frequency of colonies having sweepers sometime during the ten months was between sixty-five and eighty percent. This suggests that, over time, proximity to other corals stimulates the development of sweeper tentacles on colonies of *A. agaricites*. Therefore, the duration of observations may greatly influence the interpretation of the frequency of sweeper occurrence in natural interactions.

Development: experimental induction

1) *Close contact*. Sweeper tentacles developed on *A. agaricites* in response to close contact with all opponent species (Table IIB). Their development was restricted to tissues within approximately 5 mm of the competitor. The sequence of events

TABLE II

Development of sweeper tentacles (sw) on *Agaricia agaricites* in natural (A) and experimental (B, C) interactions

Competitor	A. Natural interactions			B. Direct contact		C. Controlled distance	
	N	% Colonies with Sw		N	% Develop Sw	N	% Develop Sw
		Initial	Cumulative				
<i>Porites astreoides</i>	28	57	71	6	50	—	—
<i>Madracis decactis</i>	17	47	65	5	80	18	83
<i>Montastraea annularis</i>	15	47	80	11	64	34	56*
<i>Montastraea cavernosa</i>	—	—	—	—	—	10	90
<i>Palythoa caribbea</i>	14	56	—	5	40	—	—
<i>Erythropodium caribaeorum</i>	9	57	—	6	50	—	—

* A total of 26 colonies of *A. agaricites* were digested by *M. annularis*. 76% of these colonies developed sweeper tentacles.

varied with opponent species. For example, on colonies next to *Madracis decactis* and *P. astreoides*, sweepers developed after the digestive filaments of *A. agaricites* damaged tissues of the *Madracis* and the *Porites*. In contrast, on colonies adjacent to *M. annularis*, sweepers developed around wounds caused by digestion of *A. agaricites* by mesenterial filaments of *M. annularis*. Thus, direct contact with other animals can stimulate development of sweeper tentacles on *A. agaricites*, and this response is localized around the zone of contact.

2) *Controlled distance*. Although sweeper tentacles also developed on colonies of *A. agaricites* at a fixed distance from opponents, the sequence of events differed in perhaps important ways from that occurring when corals were in closer contact.

Most colonies of *A. agaricites* (90%) placed within reach of *M. cavernosa* tentacle tips developed sweeper tentacles (Table IIC). No *M. cavernosa* ever digested tissues of *A. agaricites*, nor did they develop sweeper tentacles in interactions prior to the *A. agaricites* (although *M. cavernosa* can itself develop sweepers during competitive interactions, Chornesky and Williams, 1983).

Fifteen of eighteen colonies (83%) of *A. agaricites* placed within tentacle reach of *Madracis decactis* developed sweeper tentacles (Table IIC). There was no evidence that the *A. agaricites* ever damaged tissues of *Madracis decactis* with mesenterial filaments. Thirteen of the eighteen colonies of *Madracis decactis* also developed sweeper tentacles. Interestingly, the three *A. agaricites* which did not form sweepers during the experiment were adjacent to colonies of *Madracis* which had developed sweeper tentacles first and then used them to create extensive wounds on the *A. agaricites*. Sweepers developed around one of these wounds on *A. agaricites* at the end of the study. In many of the interactions where sweeper tentacles did develop first on the *A. agaricites*, nearby tissues of the *Madracis decactis* were damaged, confirming laboratory predictions of sweeper function (test for association between development of sweeper tentacles by *A. agaricites* and damage to *Madracis decactis* tissues: $\chi^2 = 8.08$, d.f. = 1, $P < .005$).

When paired with *M. annularis* sweepers developed on over half (56%) of the colonies of *A. agaricites* placed adjacent to, but out of reach of opponents' polyps and tentacles. Development occurred after the *M. annularis* digested *A. agaricites* tissues (test for association between digestion and sweeper development: $\chi^2 = 7.99$, d.f. = 1, $P < .005$) (Table IIC). Sweeper tentacles which developed in these interactions seemed to function both to damage nearby *M. annularis* tissues and to prevent further digestion by *M. annularis*. In forty-three percent of the interactions where sweeper tentacles developed on the *A. agaricites*, wounds appeared on adjacent colonies of *M. annularis* which could be attributed to the action of sweeper tentacles. In only a total of five interactions (19%) were colonies of *A. agaricites* digested a second time by the *M. annularis*. In four of these cases, sweeper tentacles had not yet developed on the *A. agaricites*; the one colony redigested despite having developed sweeper tentacles had previously been severely injured by the predaceous gastropod *Corallophila abbreviata* (Lamarck).

The rate at which sweeper tentacles develop on *A. agaricites* is best reflected in data from experiments with *Madracis decactis* and *M. annularis*. Mean development time of sweepers on colonies of *A. agaricites* adjacent to *Madracis decactis* was 30.2 days after corals were cemented close together (standard deviation of 16 days). For colonies adjacent to *M. annularis*, the mean development time after digestion by *M. annularis* was 31.6 days (standard deviation of 18.5 days). There is no significant difference between rates of sweeper formation in experiments with *Madracis decactis* and *M. annularis* (Mann-Whitney U = 132, $n_1 = 18$, $n_2 = 15$, $P > .1$).

In a few cases, unexpected factors affected sweeper tentacle development. Shortly

after corals were cemented in place, seventeen of the thirty-four pairs of *A. agaricites* and *M. annularis* were temporarily invaded by small crabs (identified tentatively as *Domecia acanthophora* f. *acanthophora* [Desbonne and Schramm], Austin Williams pers. comm.). A single crab was usually seen in the crevice formed between adjacent corals (Fig. 2B). In hundreds of observations, during the day and at night, I have never seen these crabs in natural interactions among corals. Comparison of interactions with and without resident crabs shows that crabs decreased the likelihood that colonies of *A. agaricites* already digested by *M. annularis* would develop sweeper tentacles (test for association between presence of crabs and inability to develop sweepers: $\chi^2 = 3.87$, d.f. = 1, $P < .05$). However, on those colonies which did develop sweepers after crabs appeared, the crabs had no significant effect on the amount of time between digestion by *M. annularis* and the appearance of sweeper tentacles (Mann-Whitney $U = 28$, $n_1 = 12$, $n_2 = 6$, $P > .1$). Other factors inhibiting sweeper formation after digestion by *M. annularis* included enlargement of the wound by the predaceous gastropod *Coralliophila* (1 of the 26 digested) and redigestion by *M. annularis* resulting in destruction of tissues surrounding the initial wound (3 of the 26). Bak *et al.* (1982) note the ability of *Domecia* and *Coralliophila* to damage coral tissues close to the site of competitive interactions.

In summary, development of sweeper tentacles can occur prior to close tissue and skeletal contact between adjacent corals. The distance at which the interaction begins is a function of the length of competitor species' polyps, tentacles, and mesenterial filaments, and their readiness to evert mesenterial filaments. In addition, development of sweeper tentacles or repeated use of mesenterial filaments by competitors may delay sweeper formation by *A. agaricites*. Sweeper development may also be inhibited by activity of epifauna such as crabs and gastropods. After development, the sweeper tentacles of *A. agaricites* sometimes injure tissues of competitors and may help prevent further damage by the mesenterial filaments of opponents.

II. STIMULUS FOR SWEEPER TENTACLE DEVELOPMENT

MATERIALS AND METHODS

The preceding experiments demonstrate that contact with various competitors can stimulate development of sweeper tentacles on *A. agaricites*. Although differing

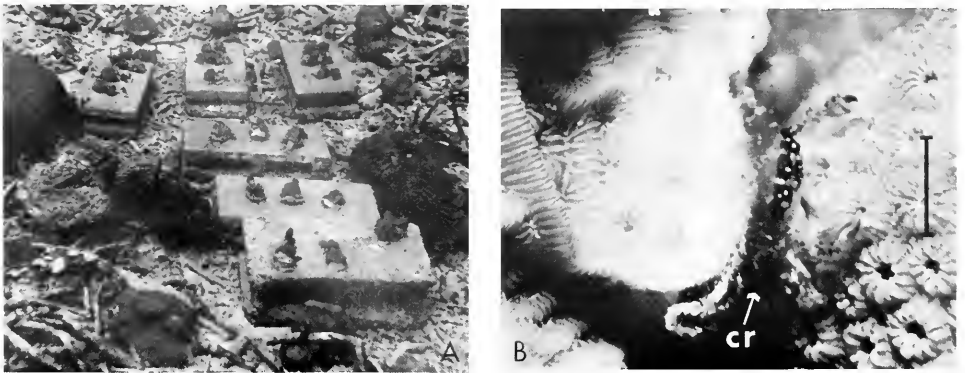

FIGURE 2. A) Corals cemented onto cinder blocks in controlled distance experiments. B) Photograph taken at night of a small crab (cr) in the crevice formed between colonies of *A. agaricites* and *M. annularis* in controlled distance experiments. Bar = ~ 5 mm.

in specific form among competitors, this contact generally involves three components which occur simultaneously: 1) tactile contact; 2) damage, for example by tentacular nematocysts or by the digestive enzymes or nematocysts of mesenterial filaments; or 3) chemical recognition of competitor tissues. The following experiments were designed to separate the role of these factors in stimulating the formation of sweeper tentacles. Corals were exposed to one of the following five stimuli: A) inanimate tactile contact; B) inanimate damage; C) inanimate contact plus damage; D) animate damage; and E) inanimate plus animate damage (see Fig. 3). After application of each treatment *in situ*, corals were observed for development of sweeper tentacles approximately once a week at night for a minimum of forty days.

To test whether inanimate tactile contact alone can induce sweepers, tufts of artificial tentacles made of nylon monofilament line were nailed above colonies of *A. agaricites* ($n = 5$; Fig. 3A). Tips of these artificial tentacles swayed slightly in the surge and were constantly in contact with a portion of the *A. agaricites*.

To determine whether inanimate damage alone can induce sweeper tentacles, portions of live tissues on colonies of *A. agaricites* were destroyed to mimic digestion by mesenterial filaments ($n = 5$; Fig. 3B). Small amounts of concentrated hydrochloric acid were applied to live tissues using a glass hypodermic syringe. Because the viscosity and specific gravity of concentrated acid are greater than sea water, it remained where applied and killed only a discrete patch of tissues. There was no apparent damage to surrounding tissues. The acid left the skeleton denuded of coral tissues, resembling lesions from digestion by other corals.

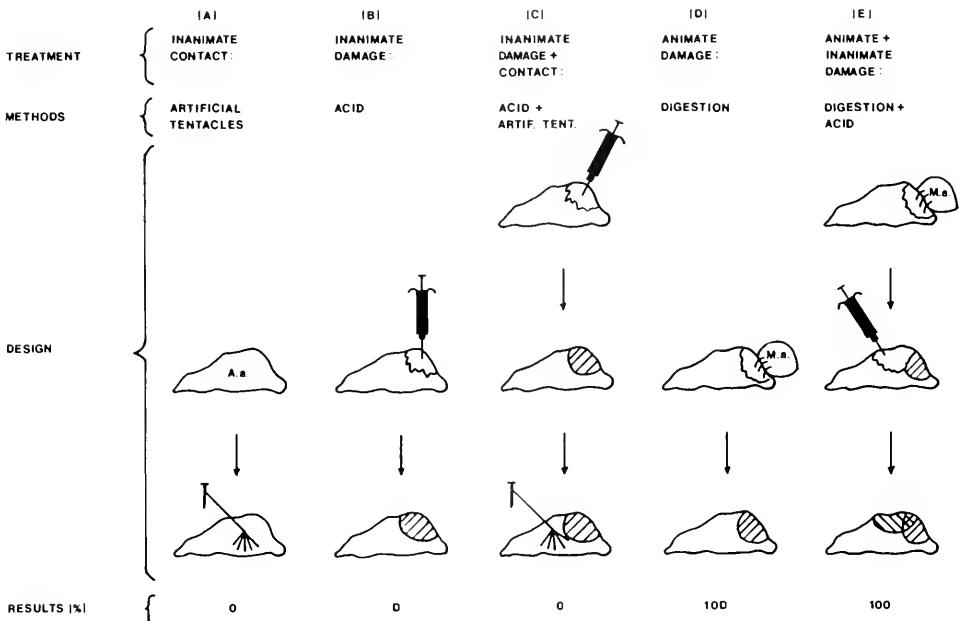

FIGURE 3. Experimental determination of stimulus for sweeper tentacle development. Corals were treated with various combinations of artificial tentacles, artificial wounds created with HCl, and wounds caused by mesenterial filaments of *M. annularis*. Results are presented as percent of colonies which developed sweeper tentacles. In treatment E, sweeper development occurred only around wounds caused by mesenterial filaments of *M. annularis*.

To simulate both the damage and tactile components of natural interactions, HCl and artificial tentacles were applied to a series of *A. agaricites* ($n = 5$; Fig. 3C). Here, artificial tentacles were positioned over live coral tissues next to the wound created with HCl.

When coral tissues are destroyed by mesenterial filaments, damage is accompanied by the potential for chemical recognition of competitors. In this treatment (animate damage), corals were damaged by mesenterial filaments in a way which allows comparison with the inanimate damage treatment described above. Colonies of *A. agaricites* were allowed to be digested overnight by *M. annularis* ($n = 6$; Fig. 3D), and the corals were separated the next day and then kept separate for the duration of the experiment.

When a colony of *A. agaricites* is stimulated by a competitor, development of sweeper tentacles is localized around the affected region. This final treatment was designed to test the extent to which recognition of a competitor affects other tissues within a colony by artificially creating a second inanimate wound on colonies already digested by *M. annularis*. Colonies of *A. agaricites* were allowed to be digested by *M. annularis*, after which the corals were separated. One day later, a second wound which overlapped the first wound slightly on one side was artificially created using HCl ($n = 5$; Fig. 3E). Development of sweepers around the artificial wound would reflect the degree to which surrounding tissues were also affected by digestion of other tissues within the colony. This treatment also controlled for whether the use of concentrated HCl was appropriate to simulate damage in natural interactions, since application of HCl might conceivably disrupt normal physiological processes and thereby inhibit sweeper tentacle formation. This would be apparent if sweepers did not develop next to the *M. annularis* wound close to where the two wounds overlapped.

RESULTS

Sweeper tentacles did not form on colonies of *A. agaricites* in response to any of the inanimate treatments—artificial tentacles, HCl lesions, or a combination of the two (Fig. 3A–C). Sweepers did form, however, on all *A. agaricites* with lesions from *M. annularis* mesenterial filaments (Fig. 3D). These sweeper tentacles appeared within eighteen days, were smaller than usual, and regressed within three weeks of development. In nature, I have occasionally seen sweeper tentacles regress as the regenerating edges of wounds caused by mesenterial filaments begin to advance. Sweeper tentacles also formed on all colonies of *A. agaricites* with both *M. annularis* and HCl lesions (Fig. 3E), but only adjacent to the *M. annularis* wound. Similarly, these sweepers were smaller than usual and regressed within three weeks. There was no evidence that HCl inhibited development of sweeper tentacles anywhere near the first wound. There are two alternative explanations for why sweepers developed only adjacent to the *M. annularis* wound on these colonies: 1) the response to recognition of another animal within *A. agaricites* colonies may be quite localized, here occurring only adjacent to the *M. annularis* wound; or 2) if recognition is colony-wide, tactile contact may also be required to stimulate sweeper tentacle development.

DISCUSSION

Cnidarians display a notable array of responses to competitors, including: agonistic behavior (Lang, 1971, 1973; Francis, 1973; Bigger, 1977, 1980; Ottaway, 1978; Brace *et al.*, 1979; Sheppard, 1979; Purcell and Kitting, 1982), development and use of elongate tentacles (Purcell, 1977; Wellington, 1980; Bak *et al.*, 1982; Watson and Mariscal, 1983), directed growth (Ivker, 1972; Potts, 1977; Wahle, 1980), or an “immune response” (Theodor, 1970; Hildeman *et al.*, 1975; Rinkevich and Loya, 1983). Most of these processes operate between animals within taxonomic orders, either

intraspecifically (Theodor, 1970; Ivker, 1972; Francis, 1973; Hildeman *et al.*, 1975; Potts, 1977; Purcell, 1977; Ottaway, 1978; Brace *et al.*, 1979; Rinkevich and Loya, 1983; Watson and Mariscal, 1983) or interspecifically (Lang, 1971, 1973; Purcell, 1977; Sheppard, 1979; Bigger, 1980; Wellington, 1980), with a few exceptions (Bigger, 1977; Wahle, 1980; Sammarco *et al.*, 1983). The scleractinian coral *Agaricia agaricites* develops sweeper tentacles in response to encounters with a range of other animals, including various corals, a gorgonian, and a zooanthid.

Interactions among sessile reef animals usually result from gradual growth. Particularly for a species like *A. agaricites*, having flat polyps, short tentacles, and short mesenterial filaments, the nature of direct competitive encounters will vary with characteristics of its opponents. The morphology of competitor polyps, tentacles, and mesenterial filaments, as well as their readiness to evert mesenterial filaments, determine how they first contact *A. agaricites*.

Regardless of the specific mode of contact between *A. agaricites* and various anthozoan competitors, all such contact stimulates *A. agaricites* to develop sweeper tentacles. For example, when *A. agaricites* grows close to corals having long tentacles, the first contact will be with their tentacle tips. In experiments simulating such encounters, corals which are digestively dominant when in close contact (*M. cavernosa* and *A. agaricites*) did not evert mesenterial filaments onto opposing corals (*A. agaricites* and *Madracis decactis*, respectively). Contact with only tentacle tips of opponents stimulated development of sweepers on nearby *A. agaricites* tissues. This differs from controlled distance experiments with *M. annularis*, a digestively dominant coral having short polyps and tentacles and long mesenterial filaments. Here, the first contact between corals was digestion of *A. agaricites*, and sweeper tentacles developed around the resulting wounds. The distance between interacting corals did not affect the behavior of *M. annularis*, as seen by Wellington (1980) for *Pavona*.

It is interesting that in these experiments the distance separating competitors affected the readiness to evert mesenterial filaments of some corals (*i.e.*, *M. cavernosa*) and not of others (*i.e.*, *M. annularis*). This, combined with evidence from controlled distance experiments that contact was not necessarily required to stimulate eversion of mesenterial filaments by *M. annularis*, suggests that controls over the use of mesenterial filaments in competitive interactions may be quite complex.

The development of sweeper tentacles on *A. agaricites* apparently occurs only after recognition of competitor tissues. Tactile contact and tissue damage also may be involved in initiating this process, although neither alone nor the two combined is sufficient. In natural interactions however, contact, damage, and recognition are probably inseparable. Corals being digested by mesenterial filaments surely have the potential to recognize competitor tissues. Likewise, those in contact with tentacle tips of adjacent corals may incur small scale damage from the tentacular nematocysts. However, if chemical recognition is sufficient to induce sweeper tentacle formation, the stimulus is probably not a diffusible substance (*sensu* Bigger, 1977). *A. agaricites* colonies separated by only 1–2 mm from tissues of *M. annularis* did not develop sweeper tentacles until after digestion by *M. annularis*.

Sweeper tentacles develop only within a zone of approximately 5 mm surrounding tissues stimulated by another animal. For example, on colonies with wounds resulting from both digestion by *M. annularis* and HCl, sweepers formed only around the wound inflicted by *M. annularis*. Moreover, disturbance by crabs or predaceous gastropods to tissues immediately surrounding stimulated regions prevented a few *A. agaricites* from developing sweeper tentacles at wounds caused by *M. annularis*. Development of sweeper tentacles on *A. agaricites* was also inhibited or delayed by the formation of sweeper tentacles on opposing colonies of *Madracis decactis* or by redigestion by *M. annularis*. These various disturbances all damaged the small region

of "responsive" tissues where sweepers would have formed, thereby preventing their development. This suggests that recognition of competitors stimulates a localized and not a colony-wide response within colonies of *A. agaricites*.

In contrast to mesenterial filaments, sweeper tentacles are not generally present on *A. agaricites*, but develop specifically as a response to competitive encounters with other sessile animals. These sweepers have the potential to damage tissues of competitors and may affect the long term outcome of competitive interactions (Chornesky, in prep.). The exact sequence of events leading to formation of sweeper tentacles depends upon characteristics of the opponent species and the distance at which encounters occur. These two factors will therefore determine the extent of damage to *A. agaricites* before it develops sweeper tentacles. Understanding the dynamics of such complex processes may be important for interpretation of the mechanism and consequences of natural and experimental encounters among many reef corals.

ACKNOWLEDGMENTS

I am grateful to the many people who contributed to this work, especially Judith Lang for her enthusiasm and for many generous and stimulating exchanges of ideas, Charles Wahle for encouragement and assistance, and George and Mary Chornesky for support throughout. I wish to thank: C. Brunet, J. C. Lang, C. M. Wahle, and G. M. Wellington for useful comments on earlier drafts of this manuscript; J. Cripps for assistance with photographic techniques; F. Chace and A. Williams for identification of *Domecia acanthophora*; countless dive buddies including C. Brunet, G. Eberhart, and R. Ramsay for assistance in the field; the West Indies Laboratory for supporting preliminary stages of this research; and the Discovery Bay Marine Laboratory for providing surface facilities. I gratefully acknowledge financial support from the Lerner-Gray Fund of the American Museum of Natural History, the National Science Foundation (DEB 8105172), and Sigma Xi. This paper is a partial fulfillment of the requirements for a doctoral degree at The University of Texas at Austin. This is contribution number 294 of the Discovery Bay Marine Laboratory of the University of the West Indies.

LITERATURE CITED

- BAK, R. P. M., AND B. W. ELGERSHUIZEN. 1976. Patterns of oil-sediment rejection in corals. *Mar. Biol.* 37: 105-113.
- BAK, R. P. M., AND M. S. ENGEL. 1979. Distribution, abundance and survival of juvenile hermatypic corals (Scleractinia) and the importance of life history strategies in the parent coral community. *Mar. Biol.* 54: 341-352.
- BAK, R. P. M., R. M. TERMAAT, AND R. DEKKER. 1982. Complexity of coral interactions: influence of time, location of interaction and epifauna. *Mar. Biol.* 69: 215-222.
- BIGGER, C. H. 1977. The acrorhagial response in *Anthopleura krebsi*: intraspecific and interspecific recognition. Pp. 127-136 in *Coelenterate Ecology and Behavior*, G. O. Mackie, ed. Plenum Press, New York.
- BIGGER, C. H. 1980. Interspecific and intraspecific acrorhagial aggressive behavior among sea anemones: a recognition of self and not-self. *Biol. Bull.* 159: 117-134.
- BIRKELAND, C. 1976. An experimental method of studying corals during early stages of growth. *Micronesica* 12: 319-322.
- BRACE, R. C., J. PAVEY, AND D. L. J. QUICKE. 1979. Intraspecific aggression in the color morphs of the anemone *Actinia equina*: the convention governing dominance ranking. *Anim. Behav.* 27: 553-561.
- CIERESZKO, L. S., AND K. B. KARNS. 1973. Comparative biochemistry of coral reef coelenterates. Pp. 183-203 in *Biology and Geology of Coral Reefs*, vol. II, O. A. Jones and R. Endean, eds. Academic Press, New York.
- CHORNESKY, E. A., AND S. L. WILLIAMS. 1983. Distribution of sweeper tentacles on *Montastrea cavernosa*. In press in *The Ecology of Deep and Shallow Coral Reefs*, M. L. Reaka, ed. Symposium Series on Undersea Research, Natl. Office of Undersea Research, NOAA, Rockville, Maryland.
- CONNELL, J. H. 1973. Population ecology of reef-building corals. Pp. 205-245 in *Biology and Geology of Coral Reefs*, vol. II, O. A. Jones and R. Endean, eds. Academic Press, New York.

- CONNELL, J. H. 1976. Competitive interactions and the species diversity of corals. Pp. 51-68 in *Coelenterate Ecology and Behavior*, G. O. Mackie, ed. Plenum Press, New York.
- CONNELL, J. H. 1978. Diversity in tropical rain forests and coral reefs. *Science* **199**: 1302-1310.
- DEN HARTOG, J. C. 1977. The marginal tentacles of *Rhodactis sanctithomae* (Corallimorpharia) and the sweeper tentacles of *Montastrea cavernosa* (Scleractinia); their cnidom and possible function. Pp. 463-469 in *Proc. Third Int. Coral Reef Symp.*, D. L. Taylor, ed. Univ. of Miami Press, Coral Gables.
- FRANCIS, L. 1973. Interspecific aggression and its effects on the distribution of *Anthopleura elegantissima* and some related sea anemones. *Biol. Bull.* **144**: 73-92.
- GLYNN, P. W. 1973. Aspects of the ecology of coral reefs in the western Atlantic region. Pp. 271-324 in *Biology and Geology of Coral Reefs*, vol. II, O. A. Jones and R. Endean, eds. Academic Press, New York.
- GLYNN, P. W. 1976. Some physical and biological determinants of coral community structure in the eastern Pacific. *Ecol. Monogr.* **46**: 431-456.
- HILDEMANN, W. H., D. S. LINTHICUM, AND D. C. VANN. 1975. Transplantation and immunoincompatibility reactions among reef-building corals. *Immunogenetic* **2**: 269-284.
- IVKER, F. B. 1972. A hierarchy of histo-incompatibility in *Hydractinia echinata*. *Biol. Bull.* **143**: 162-174.
- JACKSON, J. B. C. 1977. Competition on marine hard substrata: the adaptive significance of solitary and colonial strategies. *Am. Nat.* **111**: 743-767.
- JACKSON, J. B. C. 1979. Morphological strategies of sessile animals. Pp. 499-555 in *Biology and Systematics of Colonial Organisms*, G. Larwood and B. R. Rosen, eds. Academic Press, New York.
- KARLSON, R. H. 1980. Alternative competitive strategies in a periodically disturbed habitat. *Bull. Mar. Sci.* **30**: 894-900.
- LANG, J. C. 1971. Interspecific aggression by scleractinian corals I. the rediscovery of *Scolymia cubensis* (Milne Edwards and Haime). *Bull. Mar. Sci.* **21**: 952-959.
- LANG, J. C. 1973. Interspecific aggression by scleractinian corals II. why the race is not always to the swift. *Bull. Mar. Sci.* **23**: 260-279.
- LEWIS, J. G., AND W. S. PRICE. 1975. Feeding mechanisms and feeding strategies of Atlantic reef corals. *J. Zool. Lond.* **176**: 527-544.
- OTTAWAY, J. R. 1978. Population ecology of the intertidal anemone *Actinia tenebrosa* I. pedal locomotion and intraspecific aggression. *J. Mar. Freshwater Res.* **29**: 787-802.
- PORTER, J. W. 1972. Patterns of species diversity in Caribbean reef corals. *Ecology* **53**: 744-748.
- PORTER, J. W. 1974. Community structure of coral reefs on opposite sides of the isthmus of Panama. *Science* **186**: 543-545.
- PORTER, J. W. 1976. Autotrophy, heterotrophy, and resource partitioning in Caribbean reef-building corals. *Am. Nat.* **110**: 731-742.
- POTTS, D. C. 1977. Growth interactions among morphological variants of the coral *Acropora palifera*. Pp. 79-88 in *Coelenterate Ecology and Behavior*, G. O. Mackie, ed. Plenum Press, New York.
- PURCELL, J. E. 1977. Aggressive function and induced development of catch tentacles in the sea anemone *Metridium senile* (Coelenterata, Actiniaria). *Biol. Bull.* **153**: 355-368.
- PURCELL, J. E., AND C. L. KITTING. 1982. Intraspecific aggression and population distribution of the sea anemone *Metridium senile*. *Biol. Bull.* **162**: 345-359.
- RICHARDSON, C. A., P. DUSTAN AND J. C. LANG. 1979. Maintenance of living space by sweeper tentacles of *Montastrea cavernosa*. *Mar. Biol.* **55**: 181-186.
- RINKEVICH, B., AND Y. LOYA. 1983. Intraspecific competitive networks in the Red Sea Coral *Stylophora pistillata*. *Coral Reefs* **1**: 161-172.
- SAMMARCO, P. W., J. C. COLL, S. LA BARRE, AND B. WILLIS. 1983. Competitive strategies of soft corals (Coelenterata: Octocorallia): allelopathic effects on selected scleractinian corals. *Coral Reefs* **1**: 173-178.
- SHEPPARD, C. R. C. 1979. Interspecific aggression between reef corals with reference to their distribution. *Mar. Ecol. Prog. Ser.* **1**: 237-247.
- SHEPPARD, C. R. C. 1982. Coral populations on reef slopes and their major controls. *Mar. Ecol. Prog. Ser.* **7**: 83-115.
- THEODOR, J. L. 1970. Distinction between "self" and "not-self" in lower invertebrates. *Nature* **227**: 690-692.
- WAHLE, C. M. 1980. Detection, pursuit and overgrowth of tropical gorgonians by milleporid hydrocorals: Perseus and Medusa revisited. *Science* **209**: 689-691.
- WATSON, G. M., AND R. N. MARISCAL. 1983. The development of a sea anemone tentacle specialized for aggression: morphogenesis and regression of the catch tentacle of *Haliplanella luciae* (Cnidaria, Anthozoa). *Biol. Bull.* **164**: 506-517.
- WELLINGTON, G. M. 1980. Reversal of digestive interactions between Pacific reef corals: mediation by sweeper tentacles. *Oecologia* **47**: 340-343.
- WELLS, J. W. 1973. New and old scleractinian corals from Jamaica. *Bull. Mar. Sci.* **23**, 16-58.

ANALYSIS OF HEMOLYMPH OXYGEN LEVELS AND ACID-BASE STATUS DURING EMERSION 'IN SITU' IN THE RED ROCK CRAB, *CANCER PRODUCTUS*¹

PETER L. DEFUR², BRIAN R. MCMAHON, AND CHARLES E. BOOTH

Department of Biology, University of Calgary, Calgary, Alberta, Canada T2N 1N4

ABSTRACT

Hemolymph samples were taken from small (<100 g) individuals of *Cancer productus* following ca. 3 h air exposure (emersion) on the beach, 'in situ', at Friday Harbor, Washington. Compared with crabs of similar size in sea water in the laboratory, these crabs emersed 'in situ' had lower P_{aO_2} , and P_{vO_2} , but no significant change in pH and a small, not significant, internal hypercapnia. Total CO_2 (C_{CO_2}) content of the hemolymph was elevated by 70% (15.2 versus 9.0 mM), possibly as compensation for input of acid into the hemolymph. These responses are qualitatively similar to those resulting from similar treatment in the laboratory, but differ in the reduced magnitude of the internal hypercapnia and acidosis of the hemolymph. It is suggested that the particular conditions of emersion 'in situ' permit some gas exchange with interstitial sea water. Interstitial sea water was found to be hypoxic ($P_{O_2} = 20\text{--}40$ torr), which would limit oxygen supply yet permit CO_2 excretion to continue, in agreement with the data.

INTRODUCTION

Intertidal decapod crustaceans may face exposure to air and hence the transition from aquatic to aerial respiration on a daily or more frequent basis, depending on tide cycles and amplitudes. Reasonably complete patterns of respiratory responses during short term air exposure (emersion) have been described for two marine crabs, *Carcinus maenas* (Truchot, 1975; Taylor and Butler, 1978) and *Cancer productus* (deFur and McMahon, 1984a, b) and also for freshwater crayfish, *Austropotamobius pallipes* (Taylor and Wheatly, 1980). Less complete patterns of response to emersion have also been described for several other marine crabs (McDonald, 1977; O'Mahoney, 1977; Batterton and Cameron, 1978). These laboratory studies indicate that short term emersion is associated with an acidosis, which may be respiratory, as in *Carcinus maenas* (Truchot, 1975; Taylor and Butler, 1978) or mixed respiratory and metabolic as in *Austropotamobius pallipes* (Taylor and Wheatly, 1980) and *Cancer productus* (deFur and McMahon, 1984b). Compensation for the acidosis in all species studied occurs largely via a rise of hemolymph bicarbonate, although the process is still incomplete in 3–4 h. Gas exchange during emersion is probably diffusion limited in all species studied and may also be perfusion limited in some species (deFur and McMahon, 1984a). All of these studies, however, have been conducted in the laboratory

Received 17 March 1983; accepted 21 September 1983.

¹ Supported by NSERC grant A5762.

² Supported by Province of Alberta Graduate Fellowship.

Present address of P. L. deFur: Department of Biology, George Mason University, Fairfax, Virginia 22030.

and it is not known how closely these 'laboratory' responses mimic those occurring 'in situ' under natural conditions.

The present study, therefore, describes hemolymph acid-base conditions and oxygen levels in the crab, *Cancer productus* Randall during 'in situ' emersion at low tide on the beach. These hemolymph samples provide respiratory data obtained from crabs air exposed in their natural habitat and unaffected by previous laboratory manipulations.

MATERIALS AND METHODS

This study was undertaken at the Friday Harbor Laboratories of the University of Washington on San Juan Island, Washington. Hemolymph was sampled while animals were air exposed on the beach 'in situ' at low tide. Animals from the same vicinity were also collected and maintained in flowing natural sea water at the Friday Harbor Laboratories to provide comparative data from immersed crabs. All crabs held in the laboratory were kept at ambient sea water temperature (9–10°C) in darkened aquaria provided with 5–10 cm of fine sand and gravel substrate. These crabs were fed 2–3 times weekly except within 24 h of experiments.

Initially, an intertidal area where individuals were routinely emersed at low tide was located, the time of exposure noted, and approximately 3 h later, hemolymph samples were taken. Crabs were usually buried in the substrate beneath rocks or kelp; hence it was necessary first to lift the kelp or a rock, locate a crab, and then rapidly take the hemolymph samples. All hemolymph samples were withdrawn into iced, 1 ml glass syringes, which were immediately sealed and replaced on ice. Postbranchial (arterial) samples were taken by carefully puncturing the dorsal carapace, anteriolateral to the heart using the syringe needle, and then withdrawing 0.2–0.4 ml of hemolymph. Prebranchial (venous) samples were taken from the base of the fifth walking leg by gently restraining the crab and lifting the posterior end partially out of the substrate. The iced samples were then returned to the laboratory for analysis. Burnett and Bridges (1981) report that sealed, ice hemolymph samples may be kept for at least 1 h with no significant changes in acid-base or O_2 variables. This conclusion was tested and verified using three samples in the present study.

Postbranchial samples could be obtained quickly and with a minimum of disturbance to the animals because the crabs remained motionless in the substrate. However, partial removal from the substrate, as was necessary during prebranchial sampling, or repeated prodding always provoked evasive behavior. Thus, if a prebranchial sample could not be obtained swiftly on the first attempt, the sample was discarded. Both postbranchial and prebranchial samples were obtained sequentially from 8 crabs fully emersed 'in situ', and these were treated statistically as paired samples.

Hemolymph samples were analyzed for pH, total CO_2 (C_{CO_2}), CO_2 tension (P_{CO_2}), and O_2 tension (P_{O_2}), although small sample volume frequently prohibited making all measurements on each sample. Hemolymph pH was measured with a Radiometer capillary electrode (G299A) thermostatted to 9–10°C and connected to an acid-base analyzer (Radiometer PHM 71). C_{CO_2} was determined on 40 μ l of hemolymph using the method of Cameron (1971) with each sample measurement preceded and followed by 15 μ l standard injections of 30 mM $NaHCO_3$. Hemolymph P_{CO_2} was measured using a Radiometer electrode (E 5036-0) thermostatted to 9–10°C and the signal displayed on an acid-base analyzer (Radiometer PHM 71) set to 10 \times sensitivity. The electrode was calibrated with humidified gases of known P_{CO_2} delivered via a Wosthoff pump. Measures of P_{O_2} were made with a Radiometer

electrode (E 5047), thermostatted to 10°C, and an acid-base analyzer (Radiometer PHM 71).

Statistical analyses

Statistical analyses were performed using Student's *t*-test for either grouped or paired variates and the 0.05 level was used as the criterion of significance. Regressions were performed via the least squares estimation. Mean values (\bar{x}) in the text are given \pm one standard error (S.E.).

RESULTS

General observations

Individuals of *Cancer productus* were abundant in shallow water (<1.5 m) in the vicinity of the Friday Harbor Laboratories during November, 1979, but large numbers of crabs were found air exposed at low tide only in Beaverton Cove. This particular area was protected, permitting the growth of a large kelp bed which covered the lower intertidal zone during low tides. The substrate was predominantly coarse sand mixed with fine gravel and restricted areas of loose, fine gravel. During low tide, *C. productus* were most often found buried in the substrate beneath rocks or kelp with only the most anterior-dorsal aspect of the shell protruding above the sand. Crabs were observed emerged on top of the substrate only once and all but one of these were beneath thick layer of kelp. On several occasions, crabs were found buried in fine substrate which still held noticeable amounts of interstitial sea water. Postbranchial hemolymph samples were obtained from 7 of these crabs and 4 samples of the interstitial water were also obtained for measurement of P_{O_2} .

The mean weight of 30 crabs, which were not sampled but collected and returned to the laboratory was 29.63 ± 2.40 g. Data from these animals were used to describe the relationship between wet weight and carapace width (Fig. 1), from which the mean wet weight of crabs sampled 'in situ' was estimated to be 21.02 ± 2.16 g. It is interesting to note that there is a semilogarithmic relationship between carapace width and wet weight. Tides which were sufficiently low to result in emersion of *C. productus*

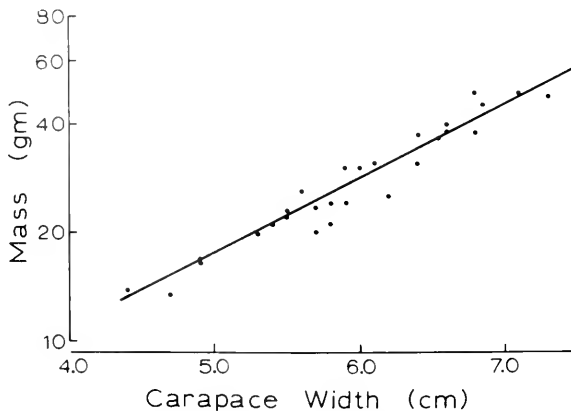

FIGURE 1. Semilogarithmic relationship between body mass and carapace width in *C. productus*, used to calculate wet weight of crabs sampled *in situ*. $r = 0.99$.

occurred after dark, therefore air temperatures during sampling did not differ significantly from the sea water temperatures of 9–10°C.

Crabs immersed in the laboratory

Mean values of P_{O_2} , pH, C_{CO_2} , and P_{CO_2} in pre- and postbranchial hemolymph of immersed crabs held in the laboratory for 3–10 days are given in Table I. P_{aO_2} and P_{vO_2} were typical of values reported previously for small *C. productus* exhibiting primarily unilateral ventilation (deFur and McMahon, 1984a). The acid-base system of immersed crabs in the laboratory was characterized by a high pH, low P_{CO_2} , and low C_{CO_2} (Table I). These values and P_{O_2} levels of crabs immersed in the laboratory were used as a baseline with which to compare emersed crabs *in situ*.

Hemolymph samples were obtained from 22 small *C. productus* which had been emersed on the beach, *in situ* for approximately 3 h. P_{aO_2} and P_{vO_2} were significantly lower in crabs emersed *in situ* than in immersed crabs, yet there remained a significant difference between P_{aO_2} and P_{vO_2} of 6.85 torr (Table I). This difference was the same regardless of whether the data were analyzed as grouped or as paired data, *i.e.*, using samples taken sequentially from the same crabs (Table I). Hemolymph O_2 content was not measured in the present study, yet the amount of oxygen delivered to the tissues in crabs emersed *in situ* can be estimated using oxygen equilibrium curves determined by deFur and McMahon (1984a) for hemolymph from crabs of similar size at 10°C, 34‰ (Fig. 2). In spite of the low *in vivo* P_{O_2} 's measured during *in situ* emersion, hemocyanin was more than 70% oxygen saturated in transit through the gills, and only 12% oxygen saturated in hemolymph returning from the tissues (Fig. 2). At a mean hemolymph oxygen carrying capacity of 0.466 mM (deFur and McMahon, 1984a), this represents 0.141 mmol O_2 per liter of hemolymph delivered to the tissues. Unloading of oxygen from hemocyanin at the tissues was enhanced by approximately 20% via a normal Bohr shift (see below).

TABLE I

Hemolymph oxygen tensions and acid base status of C. productus during emersion in situ and in interstitial water

	P_{O_2} (torr)	pH	C_{CO_2} (mM)	P_{CO_2} (torr)
Emersed <i>in situ</i>				
postbranchial	12.38 ± 1.35 (16)	7.948 ± 0.023 (16)	15.23 ± 0.67 (15)	2.50 ± 0.22 (12)
prebranchial	5.85 ± 1.05 (6)	7.906 ± 0.031 (13)	15.96 ± 0.92 (13)	2.82 ± 0.29 (5)
pre-postbranchial (paired) ⁽¹⁾	6.3 ± 1.9 (6)	0.072 ± 0.020 (8)	1.78 ± 0.47 (8)	0.267 ± 0.09 (5)
Interstitial				
<i>In situ</i>	16.86 ± 2.32 (7)	7.899 ± 0.055 (7)	15.89 ± 0.74 (7)	2.29 ± 0.21 (6)
Immersed in laboratory				
postbranchial	58.85 ± 10.7 (13)	7.960 ± 0.03 (12)	8.95 ± 0.75 (7)	1.97 ± 0.31* (7)
prebranchial	19.04 ± 3.0 (14)	7.921 ± 0.033 (13)	—	—

Mean ± S.E. (N).

⁽¹⁾ Paired samples were taken sequentially and the data analyzed as paired variates.

* Calculated using the method of Wilkes *et al.* (1980).

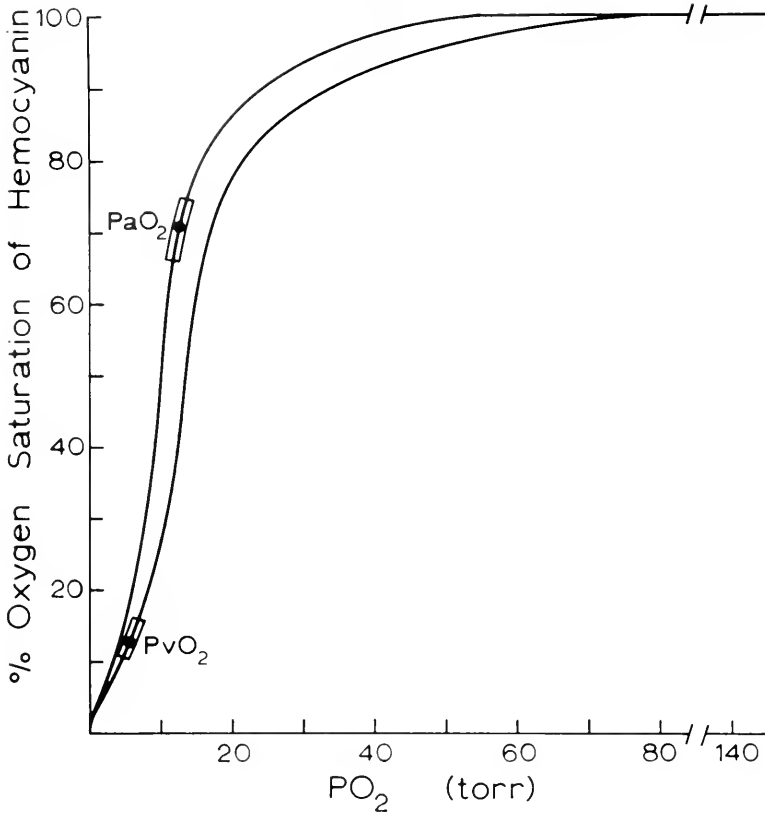

FIGURE 2. Oxygen binding curves for hemocyanin of small *C. productus* at $\text{pH}_a = 7.98$ and $\text{pH}_v = 7.90$ using data from deFur and McMahon (1984a) and deFur (1980).

Although hemolymph pH during *in situ* emersion was not significantly different from corresponding values in immersed crabs (Table I) other variables in the acid-base system of hemolymph in crabs emersed *in situ* were nonetheless dissimilar. Pa_{CO_2} was slightly (not significantly) higher in emersed crabs *in situ*, but Ca_{CO_2} was significantly (70%) higher ($P < .05$) (Table I), indicating a large base excess. Sequential samples of pre- and postbranchial hemolymph from these naturally emersed crabs exhibited significant differences between the mean values of all three acid-base variables (paired observations). Pv_{CO_2} and Cv_{CO_2} were higher and pH_v lower than the corresponding values for postbranchial hemolymph, indicating that branchial excretion of CO_2 continued during emersion (deFur and McMahon, 1984b).

Postbranchial hemolymph samples were also taken from seven crabs emersed *in situ* but buried in substrate containing obvious interstitial sea water. These crabs were clearly able to circulate some of this water through the branchial chambers since water could often be seen flowing from the exhalant branchial apertures. Acid-base conditions of hemolymph in these animals were, however, not significantly different from crabs emersed in adjacent but drier areas, although Pa_{CO_2} was slightly ($P > .05$) lower. Mean Pa_{O_2} of the crabs obviously utilizing interstitial sea water was only 4.5 torr higher ($P > .05$) than in those from drier areas, but was significantly reduced from that of immersed crabs. This low mean Pa_{O_2} was likely a consequence of the hypoxic nature of the interstitial water ($\text{P}_{\text{O}_2} = 27 \pm 4.5$ torr; $n = 4$).

The responses of small *C. productus* to emersion in substrate containing interstitial water was further investigated in the laboratory. Ambient P_{O_2} fell from 150 torr to 51 torr in the first hour and decreased further to 31 torr by 4 h. Hemolymph Pa_{O_2} fell rapidly during initial exposure (Fig. 3), and continued to decline slowly; mean Pa_{O_2} over the 0.75–4.0 h period was only 14.3 ± 1.5 torr. Mean Pa_{O_2} of samples taken from these crabs was not significantly different from mean Pa_{O_2} of either group of crabs sampled *in situ* on the beach. Hemolymph pHa of crabs in interstitial water in the laboratory was quite variable (Fig. 3) and the mean was not significantly different from that of any of the groups of crabs sampled on the beach. Hemolymph Ca_{CO_2} of crabs exposed to interstitial water in the laboratory increased linearly during 4 h (Fig. 3), reaching levels similar to those in crabs emersed *in situ*.

DISCUSSION

The data obtained at Friday Harbor for crabs immersed in flowing natural sea water, at sea level, in the laboratory at 9–10°C and 34‰ salinity, compare well with those obtained at similar temperature and salinity in a recirculating sea water system at an altitude of 1050 m in Calgary (Table II). Pa_{O_2} , Pa_{CO_2} , and Ca_{CO_2} were slightly

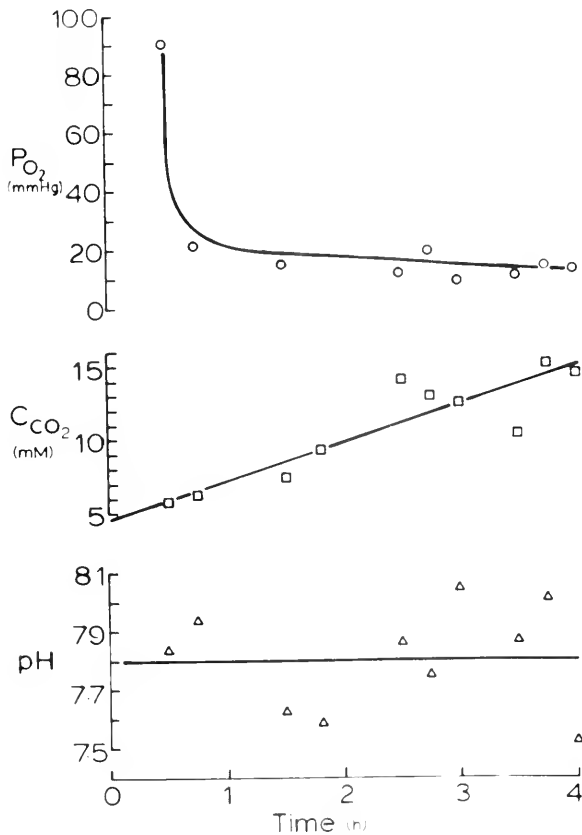

FIGURE 3. Postbranchial hemolymph P_{O_2} , C_{CO_2} , and pH in individual small *C. productus* emersed for 4 h in substrate containing interstitial sea water in the laboratory. Line fitted by eye for P_{O_2} , by least squares estimation for C_{CO_2} ($r = 0.99$), and through \bar{x} for pH. Symbols represent individual values.

TABLE II

Hemolymph P_{O_2} and acid-base status of small *C. productus* immersed in sea water (10°C , 32–35‰ salinity) and the changes resulting from 3–4 h emersion in the laboratory and in situ

Location	Immersed crabs					
	P_{aO_2} (torr)	pHa	C_{aCO_2} (mM)	P_{aCO_2} (torr)		
Calgary ¹	50.7 ± 8.0 (8)	8.017 ± 0.02 (10)	7.31 ± 0.44 (7)	1.33 ± 0.05 (7)		
Friday Harbor ²	58.9 ± 11 (11)	7.960 ± 0.03 (12)	8.95 ± 0.75 (7)	$1.97 \pm 0.31^*$ (7)		
Changes during emersion						
	ΔP_{aO_2} (torr)	ΔP_{vO_2} (torr)	$\Delta p\text{Ha}$	ΔP_{aCO_2} (torr)	ΔC_{CO_2} (mM)	pHa–pHv
<i>In situ</i> ² (3–4 h) (Friday Harbor)	–46.5	–13.2	–0.012	+0.53	+6.28	0.072
Laboratory ¹ (4 h) (Calgary)	–37.2	–10.7	–0.147	+2.27	+8.72	0.034

¹ deFur and McMahon, 1984b.

² Table I.

* Calculated using the method of Wilkes *et al.* (1980).

Data are $\bar{x} + 1$ S.E. (n).

higher and pHa slightly lower in Friday Harbor than in Calgary as might be expected from the change in altitude, but none of these differences was significant. deFur and McMahon (1984a) also observed similar respiratory behavior patterns in immersed *C. productus* regardless of location. These observations indicate that the respiratory status of *C. productus* is affected little by the differences between experimental conditions in Calgary and those more similar to the natural habitat.

The present data are the first hemolymph acid-base status or oxygen tensions reported for decapods *in situ* during air exposure. A greater degree of variability than usually occurs in laboratory studies was noted in some variables, perhaps because factors such as nutritional state and molting stage are not controlled, as under laboratory conditions. An important aspect of the present study is the qualitative similarity between the responses of small *C. productus* to emersion on the beach in Friday Harbor and in the laboratory in Calgary (Table II); under both experimental regimes P_{O_2} and pH decreased, and C_{CO_2} and P_{CO_2} increased. The decreases in both P_{aO_2} and P_{vO_2} were greater under natural conditions than in the laboratory, but these differences between responses *in situ* and in the laboratory are not significantly different. Additionally, under both conditions, hemocyanin is well oxygenated at the gill and most of the O_2 is removed in passage through the tissues (Fig. 2 and deFur and McMahon, 1984a).

Crabs emersed under laboratory conditions (deFur and McMahon, 1984b) exhibited a marked acidosis due in part to a significant increase in P_{CO_2} . In contrast, crabs emersed '*in situ*' showed neither a significant acidosis nor increase in P_{CO_2} . The small decrease in pH in these crabs (Table I) was less, however, than would be expected on the basis of the *in vitro* buffering properties (deFur and McMahon, 1984b), suggesting that more effective compensation occurred '*in situ*'. The more than 6 mM increase of C_{CO_2} implies that there is some net input of acid which is compensated by elevation of HCO_3^- . The relative contribution of other acids, especially metabolic ones such

as lactic acid, to the acid-base status of crabs emersed 'in situ' is not known. Thus, the present study cannot identify with certainty the compensatory mechanisms involved. However, the greater $\text{pH}_a\text{-pH}_v$ difference and lower Pa_{CO_2} measured in crabs emersed 'in situ' suggest that CO_2 excretion may be more effective under these conditions.

Maintenance of branchial CO_2 excretion implies maintained ventilation and perfusion of the gills during emersion. deFur and McMahon (1984a) measured maintained sub-ambient branchial pressures in small *C. productus* during emersion in the laboratory, and reasoned that interstitial sea water could be aspirated into the branchial chamber. This water could allow CO_2 excretion to continue during emersion but seems to have no effect on O_2 uptake since Pa_{O_2} is depressed (Table I). This situation is not paradoxical since a) CO_2 diffuses more effectively in aqueous systems, and b) interstitial sea water samples, though more highly oxygenated than finer sediments, were still hypoxic. Thus, irrigation of the gills with interstitial sea water could allow CO_2 excretion with little effective oxygenation. Under the laboratory conditions used by deFur and McMahon (1984a, b), care was taken to remove as much sea water, including interstitial, as possible, precluding its use for branchial functions.

The observed acid-base changes during emersion *in situ* show a discrepancy between measured and calculated P_{CO_2} similar to that observed in the laboratory (deFur, Wilkes and McMahon, 1980). This discrepancy is clearly apparent on a "Davenport diagram" (Fig. 4) and precludes use of such a diagram for analysis of the acid-base system. A discrepancy occurs only during emersion and was associated with large, rapid elevations of hemolymph C_{CO_2} , indicating dynamic rather than steady-state conditions. As noted by deFur *et al.* (1980), data from crabs immersed in sea water are described perfectly on the Davenport diagram.

In a similar study, Toulmond (1973) described the responses of the intertidal polychaete *Arenicola marina* during 4 h emersion 'in situ'. *Arenicola* also experienced a decrease of $\text{P}_{\text{V}_{\text{O}_2}}$, nearly exhausting the otherwise substantial venous oxygen reserve.

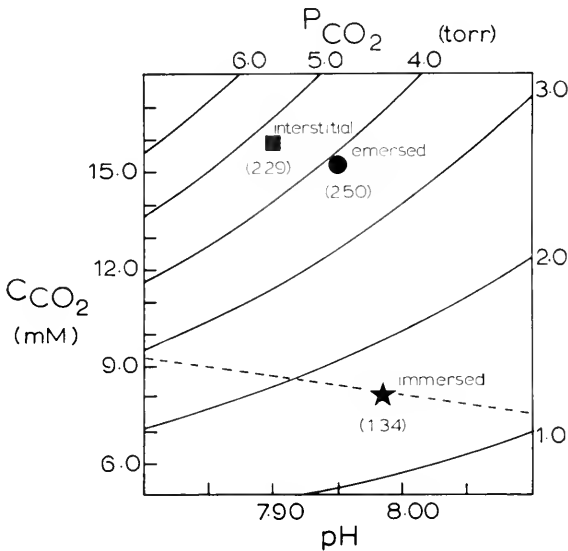

FIGURE 4 "Davenport diagram" relating C_{CO_2} , pH, and P_{CO_2} in the hemolymph of *C. productus* according to the method of Wilkes *et al.* (1980). The diagonal line (---) represents the *in vitro* buffer capacity. Points depict mean *in vivo* values from Table I with measured P_{CO_2} given in (□) beneath the symbol.

Simultaneously, there was an internal hypercapnia with a subsequent acidosis (respiratory) and rise of blood bicarbonate (Toulmond, 1973). This author concludes that gas exchange is impaired under these conditions and anaerobiosis occurs, contributing a metabolic component to the acidosis. The responses of small *C. productus* under similar conditions (Table I) are qualitatively similar to those of *Arenicola*, but are quantitatively quite different. The decrease in P_{O_2} and pH and the increase in P_{CO_2} are less in small *C. productus*. These differences are likely due to some air breathing capability of the crabs, and availability and utilization of sea water during emersion. *Arenicola marina* ceases all ventilation, normally accomplished by body movements forcing water through the burrow. Small *C. productus*, however, are able to utilize the hypoxic interstitial sea water, permitting CO_2 excretion but limiting oxygen supply.

Small *C. productus* occupy a restricted habitat within the intertidal zone and during air exposure remain buried in the substrate in locations where sea water drains from the substrate relatively slowly. In this condition, the small crabs can maintain acid-base balance for the few hours of emersion, yet must endure a reduction in oxygen supply. Thus, these small crabs which have access to interstitial water may not be able to maintain oxygen uptake in air, but do not have the problem of carbon dioxide excretion which is the major respiratory problem of truly intertidal crabs and true air breathers.

ACKNOWLEDGMENTS

The authors wish to thank the Director and staff of the Friday Harbor Laboratories of the University of Washington for their cooperation and assistance. The fine technical assistance of Alan W. Pinder is gratefully acknowledged.

LITERATURE CITED

- BATTERTON, C. V., AND J. N. CAMERON. 1978. Characteristics of resting ventilation and response to hypoxia, hypercapnia, and emersion in the blue crab, *Callinectes sapidus* (Rathbun). *J. Exp. Zool.* **203**: 403-418.
- BURNETT, L. E., AND C. R. BRIDGES. 1981. The physiological properties and function of ventilatory pauses in the crab, *Cancer pagurus*. *J. Comp. Physiol.* **145B**: 81-88.
- CAMERON, J. N. 1971. Rapid method for determination of total carbon dioxide in small blood samples. *J. Appl. Physiol.* **31**: 632-634.
- DEFUR, P. L., AND B. R. MCMAHON. 1984a. Physiological compensation to short term air exposure in Red Rock crabs, *Cancer productus* Randall, from littoral and sublittoral habitats. I. Oxygen uptake and transport. *Physiol. Zool.* accepted.
- DEFUR, P. L., AND B. R. MCMAHON. 1984b. Physiological compensation to short term air exposure in Red Rock crabs, *Cancer productus* Randall, from littoral and sublittoral habitats. II. Acid-base balance. *Physiol. Zool.* accepted.
- DEFUR, P. L., P. R. H. WILKES, AND B. R. MCMAHON. 1980. Non-equilibrium acid-base status in *C. productus*: role of exoskeletal carbonate buffers. *Respir. Physiol.* **42**: 247-261.
- MCDONALD, D. G. 1977. *Respiratory Physiology of the Crab*. Cancer magister. Ph.D. Thesis, Department of Biology, University of Calgary, Calgary, Alberta, T2N 1N4, Canada.
- O'MAHONEY, P. M. 1977. *Respiratory and Acid-base Balance in Brachyuran Decapod Crustaceans: the Transition From Water to Land*. Ph.D. Thesis, State University of New York, Buffalo, New York.
- TAYLOR, E. W., AND M. G. WHEATLY. 1980. Ventilation, heart rate and respiratory gas exchange in the crayfish *Austropotamobius pallipes* (Lereboullet) submerged in normoxic water and following 3 h exposure to air at 15°C. *J. Comp. Physiol.* **138B**: 67-78.
- TAYLOR, E. W., AND P. J. BUTLER. 1978. Aquatic and aerial respiration in the *Carcinus maenas* (L.), acclimated to 15°C. *J. Comp. Physiol.* **127B**: 315-323.
- TRUCHOT, J. P. 1975. Blood acid-base changes during experimental emersion and reimmersion of the intertidal crab *Carcinus maenas* (L.) *Respir. Physiol.* **23**: 351-360.
- TOULMOND, A. 1973. Tide-related changes of blood respiratory variables in the lugworm *Arenicola marina* (L.). *Respir. Physiol.* **19**: 130-144.
- WILKES, P. R. H., P. L. DEFUR, AND B. R. MCMAHON. 1980. A new operational approach to P_{CO_2} determination in crustacean hemolymph. *Respir. Physiol.* **12**: 17-28.

EXPERIMENTAL STUDIES ON EMBRYOGENESIS IN HYDROZOANS (TRACHYLINA AND SIPHONOPHORA) WITH DIRECT DEVELOPMENT

GARY FREEMAN

*Friday Harbor Laboratories, University of Washington and the Department of Zoology,
University of Texas, Austin, Texas 78712¹*

ABSTRACT

The normal embryology of the trachymedusa *Aglantha digitale* and the siphonophores *Nanomia cara* and *Muggiaea atlantica* is described. Marking experiments on these embryos indicate that the site of first cleavage initiation corresponds to the oral pole of the oral-aboral axis. In *Muggiaea* the plane of the first cleavage corresponds to the plane of bilateral symmetry. Experiments in which presumptive aboral and oral regions are isolated from these embryos at different stages of development indicate that there is an early determination of different regions along this axis. Only the oral region of the *Muggiaea* embryo has the ability to regulate. These eggs have a pronounced centrolecithal organization. As a consequence of cleavage, the outer ectoplasmic layer of the egg ends up in the cells that form the ectoderm, while the inner or endoplasmic region of the egg ends up in the cells that form the endoderm. Experimentally created fragments of fertilized eggs that contain only ectoplasm differentiate to form an unorganized ectodermal cell mass, indicating that endoplasm is necessary in order to differentiate endoderm.

The process of embryogenesis in these animals and the developmental mechanisms they use are very different from those used by hydrozoans with indirect development. These embryos use a suite of developmental mechanisms which are very similar to those used by ctenophores. The significance of this similarity is discussed.

INTRODUCTION

From a developmental standpoint, the class Hydrozoa in the phylum Cnidaria appears to be quite diverse (Tardent, 1978). All of the experimental studies that have tried to define the mechanisms that underlie early embryogenesis in this group have been done on one order, the Hydroida. (Table I presents the taxonomic classification of the class Hydrozoa used in this paper.) On the basis of this experimental work a list of the mechanisms that mediate early embryogenesis in this group has emerged (see Discussion). One consequence of these mechanisms is that these embryos have a remarkable ability to regulate (Teissier, 1931, Freeman, 1981).

Most of the species in the order Hydroida have a complex polymorphic life cycle. In one major phase of the life cycle these animals are attached to a substrate and in the other major phase they are free swimming animals which function in a pelagic environment. The life cycle begins when an egg undergoes embryogenesis to generate a planula larva which undergoes metamorphosis to form a sessile polyp. Typically the polyp forms a colony that buds free swimming medusae. The medusae grow in size and develop gonads which form the gametes that are the basis for the next generation.

TABLE I

Classification of the class Hydrozoa to a sub order level

order Hydroida	order Trachylina
Anthomedusae	Trachymedusae
Leptomedusae	Narcomedusae
Limnomedusae	Pteromedusae
order Milleporina	order Siphonophora
order Stylasterina	Cystonectae
	Physonectae
	Calycophorae
	order Actinulida

Not all orders of the class Hydrozoa have this kind of life cycle. In the order Trachylina the egg develops via a planula directly into a medusa; the polyp stage is absent or rudimentary. In the order Siphonophora the egg develops via a planula into a larva with both medusoid and polypoid characteristics that forms a colony composed of members of both types. The process of embryogenesis has been described for a number of species from these two direct developing orders (see Metschnikoff, 1874, 1886; Brooks, 1886 for the Trachylina; Metschnikoff, 1874, Russell, 1938, Carré, 1967, 1969 for the Siphonophora). Very little experimental work has been done on embryogenesis in the Trachylina and Siphonophora (however, see Zoja, 1895; Maas, 1908; Carré, 1969). These two orders are normally found in deep water in the open ocean; their life cycle occurs exclusively in a pelagic environment.

The present paper examines the process of embryogenesis in the trachymedusa *Aglantha digitale* and the siphonophores *Nanomia cara* (Physonectae) and *Muggiaea atlantica* (Calycophorae) from an experimental point of view. The results of these experiments indicate that these animals share only a few developmental mechanisms with the Hydroida. In each of these species there is a precocious segregation of developmental potential and the embryos have only a limited ability to regulate.

The Trachylina and Siphonophora are not the only cnidarian orders that develop directly. Some scyphozoan orders have a similar life cycle. Unfortunately no experimental work has been done on early embryogenesis in these animals. However, in the related radiate phylum Ctenophora, development is also direct. In these animals the product of embryogenesis is a larva, but in most species no major polymorphic change in the anatomy of the larva occurs as it grows into an adult. The embryology of these animals has been studied in some detail from an experimental viewpoint (see Reverberi, 1971 for a review). In this group there is also a precocious segregation of developmental potential. The life cycle of most ctenophores occurs exclusively in a pelagic environment. In the discussion section of this paper the developmental mechanisms used by the Hydroida and the Ctenophora will be compared. The significance of the demonstration that Trachylina and Siphonophora embryos have a suite of developmental mechanisms that are similar to those of the Ctenophora will then be discussed.

MATERIALS AND METHODS

Animals

Aglantha and *Nanomia* were collected from the Friday Harbor laboratory dock with a beaker attached to the end of a pole. These two species are not common in

the surface waters at Friday Harbor during the spring and summer seasons. Their distribution is patchy; during some years *Aglantha* appears to be much more abundant than during other years. *Aglantha* is always more common than *Nanomia*. *Muggiæa* eudoxids were collected by doing plankton tows 3–4 meters below the surface and half way up East Sound on Orcas Island. Eudoxids are present there in the last half of June, July, and August. Kozloff (1974) was used for identifying the species employed in this study. All of these species descriptions are based on animals found in the Atlantic Ocean. While these animals resemble those found in the Atlantic, there are some differences; it is not clear that these animals are identical to the Atlantic species.

Eggs were obtained through natural spawnings. It is difficult to predict the time of spawning for these species. Bowls containing the animals were checked at 30 minute to 2 hour intervals throughout the day for spawning. *Aglantha* tends to spawn between 0200–0400 and 1000–1200 hours. *Nanomia* tends to spawn one hour after it is brought into the light. In the siphonophores the testes tend to become opaque 2–3 hours prior to spawning. In *Aglantha* and in *Muggiæa* eudoxids the sexes are separate. In these species 2–4 sexually mature females were maintained in a bowl. When eggs were found they were collected and a culture was set up by adding sea water containing sperm from a bowl of males. A sexually mature *Nanomia* has both female and male gonads. In this work eggs were fertilized by the sperm from the same individual as they were spawned. The initiation of first cleavage was regarded as T_0 for the purpose of timing development.

The embryos were raised at 11–12°C. They were reared in millipore filtered pasteurized sea water in wells (0.5–1.5 ml vol.) of spot plates. In many of the experiments involving *Aglantha* blastomere isolates, 100 units/ml of penicillin was added to the sea water; this significantly improved viability. The siphonophore embryos frequently get caught at the air-water interface and are destroyed by surface tension forces. In some experiments polyethylene oxide was added to the sea water (0.1 g/10 ml) to increase its viscosity. The embryo develops normally in this medium, but moves very little; as a consequence it is much less likely to get caught at the air-water interface.

Experimental manipulations

Embryos were operated on in wells with a 2% agar bottom. Glass needles were used as knives to cut the embryos into parts.

Early cleavage stage embryos were marked with chalk particles (chalk was used because the vital dyes that were tried tended to diffuse throughout the early embryo). A suspension of small chalk particles was produced by placing a drop of sea water on a frosted glass slide and rubbing the tip of a stick of chalk in it. A small amount of this suspension was placed in one corner on the agar surface of an operating dish which was then filled with sea water. The part of the embryo surface to be marked was placed in contact with one or more chalk particles and gently pressed against the chalk with a blunt glass needle attached to a micromanipulator. This procedure firmly attaches the chalk to the embryo's surface. Embryos at later stages were marked with the stain Nile blue; a 1% solution of the dye was prepared in distilled water. One or more points on the surface of the embryo were marked by using a micromanipulator to bring the open end of a fine capillary tube filled with 2% agar containing the dye in contact with the surface of the embryo for a few minutes. Novikoff (1938) gives directions for preparing these capillary tubes. The embryos tend to lose stain and there is a diffusion of the stain into the endoplasmic region; however, the dyed spot can usually be followed for 2–3 days. Since the embryos are translucent the dye spots

on the surface can be observed even when they are very light by viewing the embryo with a compound microscope under conditions of critical illumination. Frequently embryos were first marked with chalk and subsequently remarked by staining. Too much stain has a deleterious effect on the development of these embryos.

Eggs were centrifuged to create ectoplasmic and endoplasmic fragments. Centrifugation stratifies the contents of the egg. In these species the yolky endoplasm takes up a centripetal position and the ectoplasmic zone takes up a centrifugal position. Following stratification the eggs elongate and may split into endoplasmic and ectoplasmic fragments. If they do not separate into fragments they can be easily cut into fragments following centrifugation. *Aglantha* eggs were centrifuged in a mixture of 2 parts 1 molal sucrose and 1 part sea water for 15 minutes at 9500 rpm ($10,800 \times g$). *Nanomia* eggs were centrifuged in a mixture of 1 part 1 molal sucrose and 1 part sea water for 10 minutes at 9500 rpm. The diameter of the fragments was measured with a screw micrometer eye piece.

Histological procedures

Embryos and larvae were fixed in 1% osmium in cold sea water for one hour, washed, dehydrated, and embedded in Epon. Sections were cut at $2 \mu\text{m}$ and stained with methylene blue and azure II (Richardson *et al.*, 1960).

RESULTS

Normal development of Aglantha digitale

The normal development of *Aglantha* has not been described; however, Metschnikoff (1886) described the development of a related species, *Aglaura hemistoma* from the Mediterranean. Figure 1 presents a series of photographs which outline the development of *Aglantha*. The uncleaved egg has an average diameter of $139 \mu\text{m}$ (range $125\text{--}153 \mu\text{m}$, sample size 24). There is a membrane around the egg which is closely applied to it; the embryo hatches out of the membrane during development (Fig. 1f). Polar bodies are not visible. Sections through fixed uncleaved eggs (Fig. 2a) show a central zone containing large endoplasmic granules and a peripheral region where these granules are absent. Cleavage is unipolar. The first two cleavages generate four equal blastomeres. A number of embryos were marked at either the site of origin of the first cleavage furrow (18 cases) or directly opposite this site (5 cases). These marking studies showed that the second cleavage is always initiated at the same site at the first cleavage. The third is unequal. Four micromeres are produced that are largely devoid of endoplasmic granules (Figs. 1b, 2b). The embryos with the chalk marks showed that the micromeres are given off opposite the site of first cleavage initiation. During the fourth cleavage (Fig. 1c) the four macromeres divide equatorially to form two tiers of macromeres along the axis specified by the first two cleavage furrows. It is hard to follow cleavage beyond this point.

Gastrulation takes place during the next 3–4 hours. During this period the cells that make up the micromere cap flatten and spread as a coherent layer over the macromeres to create an ectodermal cell layer which surrounds the yolky macromeres (Fig. 2c). The spreading movement can be followed by observing appropriately oriented embryos at 10–15 minute intervals using Nomarski optics. It is not clear that epibolic movement is the only mechanism of gastrulation; endoplasm free ectodermal cells may also be generated by a cytokinesis which occurs tangentially to the external cell membrane in some of the macromeres. As gastrulation takes place the embryo elongates

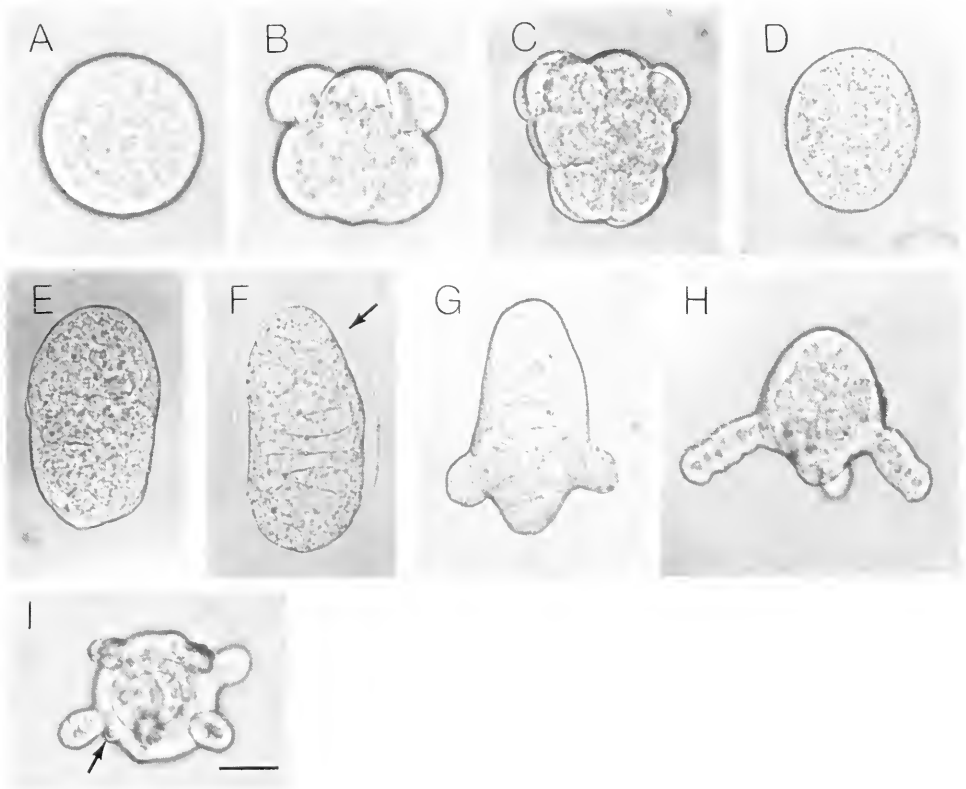

FIGURE 1. Normal development of *Aglantha*. A) Uncleaved egg. B) Eight cell stage. C) 16 cell stage. D) Five hour embryo. E) Eight hour embryo. F) 24 hour embryo. The arrow indicates the membrane that surrounds the egg out of which the embryo is hatching. G) 40 hour embryo. Note the tentacle rudiments. H) 54 hour embryo. I) Oral view of three day old embryo. The tentacles are contracted. The arrow indicates a marginal sense organ. All photographs are at the same magnification. The bar indicates 50 μm .

(Fig. 1d). The marking experiments show that the direction in which the embryo elongates corresponds to the axis of the first two planes of cleavage.

After gastrulation is completed, the ectodermal cells begin to form cilia. Over the next 12 hour period the embryo hatches out of its membrane and begins to swim. The planula rotates around its long axis as it moves forward; it does not reverse its direction of movement. Experiments in which the chalk marks were replaced by dye marks at 8–10 hours of development (8 cases) show that the site where cleavage is initiated corresponds to the posterior or oral end of the planula.

Between 24 and 48 hours of development two tentacles begin to form opposite each other in the oral region of the planula (Fig. 1g). At this point the planula begins to transform into an actinula. Within a few hours after these two tentacles begin to form, two more tentacles start to appear opposite each other between the first pair of tentacles. During the next few days additional tentacles form. A tentacle is composed of both ectodermal and endodermal cells; the ectoderm contains both nematoblasts and nematocysts. The tentacles of an actinula are relatively rigid but they can contract and change positions. Ciliary tracts that run the length of the tentacle serve as the main locomotory organ of the actinula. The tentacles of the medusa have similar ciliary tracts which beat in a coordinated manner. After four days of development

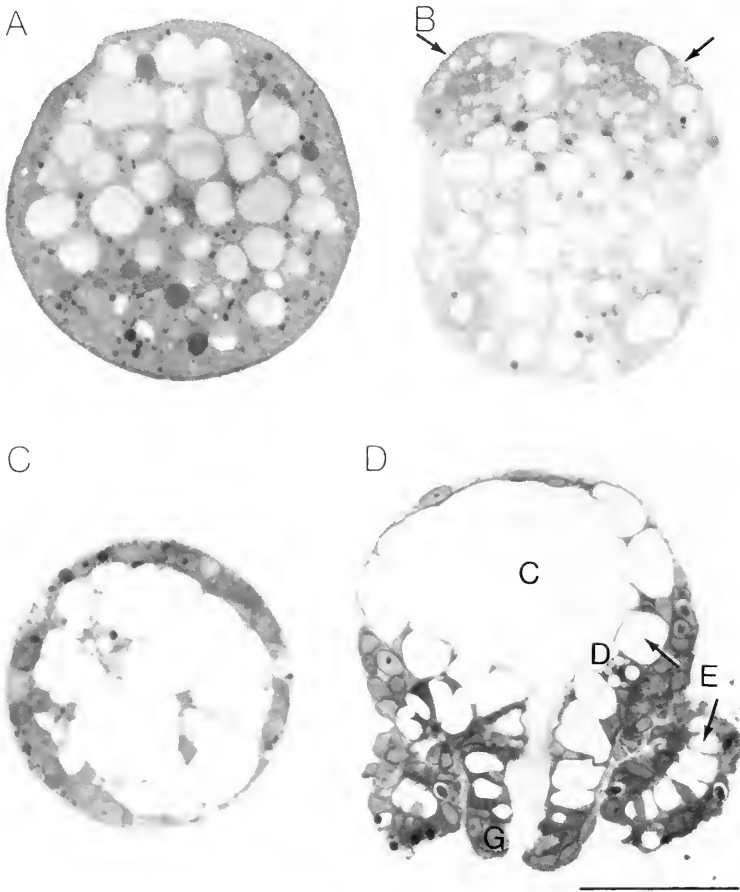

FIGURE 2. Normal embryology of *Aglantha*. A) Section through an egg. Note the endoplasmic granules. B) Section through an eight cell stage embryo. The arrows indicate the micromeres. Note the relative paucity of endoplasmic granules in the micromeres. C) Section through seven hour embryo. Note the ectoplasm containing ectodermal cells and the endoplasm containing endodermal cells. The ectodermal nuclei have nucleoli. Note the change in the morphology of the endoplasmic granules between the onset of cleavage and gastrulation. D) Section through a five day old larva. Note the gastrovascular cavity, C; the gland cells associated with the mouth G; the digestive gland cells, D; and the endodermal cells which line the gastrovascular cavity and make up the core of the tentacles, E. The bar indicates 50 μm .

marginal sense organs form between some of the tentacles. At the same time the tentacles start to form, the manubrium begins to differentiate at the oral end of the planula. At this site a heavily ciliated mouth forms between days two and three of development. Between 3 and 4 days of development manubrial gland cells form adjacent to the mouth. The endoderm, which is composed of highly vacuolated cells, organizes itself into an epithelium and a space which is continuous with the manubrium forms in the center of the larva. As these events occur a basement membrane forms between the ectodermal and endodermal cell layers. By five days of development gland cells with small vacuoles begin to appear between the large vacuolated endodermal cells in the oral region of the larva (Fig. 2d).

Experimental work on Aglantha

The ability of parts of embryos that normally form different germ layers or different regions of the actinula larva, to differentiate these structures when isolated was studied by doing the following experiments.

1) At the eight cell stage the micromeres and macromeres were isolated (Fig. 3a). Since the micromeres form ectoderm and the macromeres form both ectoderm and endoderm in the intact embryo, this experiment asks whether or not there is a segregation of germ layer specific developmental potential at the eight cell stage. Nineteen micromere and 25 macromere halves were raised for six days; four cases of each type were sectioned. All of the micromere isolates formed a compact sphere (Figs. 4a, 5a). The surface cells were ciliated but there was no indication of swimming polarity. In every case nematocysts were present. There was no indication of a basement membrane separating the external from the internal cells of the sphere. The development of the macromere isolates was more variable (Figs. 4b, 5b). The isolates were spherical to oblong in shape. All of them formed both ectoderm and endoderm; however, endodermal gland cells did not differentiate. In all of the cases the ectodermal cells appeared to be very thin in places or did not completely cover the endoderm. The ectodermal cells were ciliated; in 13 cases the isolates showed swimming polarity. Nematocysts were present in the ectoderm in 15 cases. Two of the isolates formed a stubby tentacle and one of these cases formed a manubrium.

2) At the 16 cell stage the embryo was cut into two parts in such a way that one isolate consisted of four oral macromeres and the other consisted of the micromeres and their adjacent macromeres (Fig. 3b). This experiment was done to find out if an embryo which lacks the endodermal cells that are normally present at the oral end of the embryo still has the ability to form tentacles and a manubrium. Twenty-two micromere and aboral macromere isolates were raised for six days; six of these cases were sectioned. Fifteen of these isolates formed normal actinula larvae (Fig. 4c); three cases formed a manubrium but no tentacles and one case formed tentacles but no manubrium. The three remaining isolates formed ectoderm containing nematocysts and endoderm, all of them showed swimming polarity. Sixteen oral macromere isolates were raised for six days; three of these cases were sectioned. These cases resembled the eight cell stage macromere isolates (Fig. 4d); however, they did not form nematocysts and no case showed swimming polarity.

3) At eight hours of development (Fig. 1e) (5 hours after the 16 cell stage), the embryo was cut into an oral and an aboral half (Fig. 3c). In order to identify each half, these cases were marked at the site of origin of the first cleavage furrow. At eight

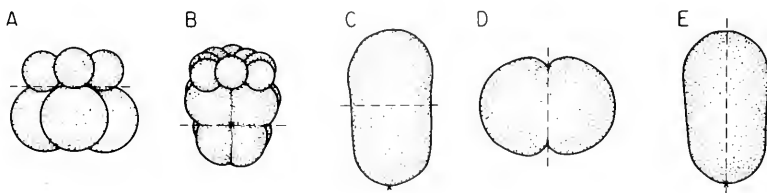

FIGURE 3. Operations performed to isolate parts of the *Aglantha* embryo at different stages of development. A) Eight cell stage; isolation of micromeres and macromeres. B) 16 cell stage; isolation of micromeres with aboral macromeres and oral macromeres. C) Eight hour embryo; isolation of oral and aboral halves. D) Two cell stage; isolation of individual blastomeres. E) Eight hour embryo; isolation of lateral halves. x, chalk mark placed at the site of origin of the first cleavage indicating the oral end of the embryo. The dashed line indicates how the embryo was cut.

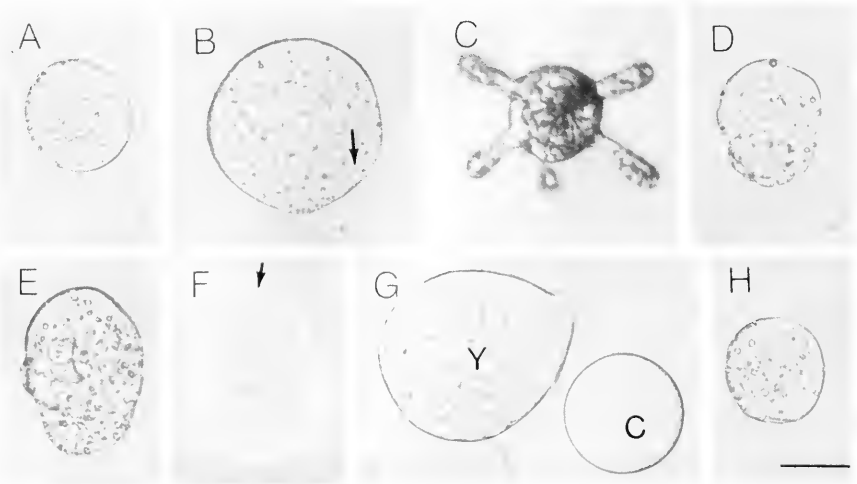

FIGURE 4. The development of isolates from *Aglantha* embryos. A) Five day old micromere isolate from eight cell stage embryo. Note the lack of endoderm. B) Five day old macromere isolate from eight cell stage embryo. The arrow indicates the boundary between the ectoderm and endoderm. C) Five day old micromere and middle macromere isolate from a 16 cell stage embryo. D) Five day old oral macromere isolate from 16 cell stage embryo. E) Five day old aboral half isolated from eight hour old embryo. F) Three day old isolate from two cell stage embryo. The arrow indicates the ectodermal cap. G) Y, yolk fragment and C, clear cytoplasmic fragment from a centrifuged egg. Note the nucleus in the clear cytoplasmic fragment. H) Four day old embryo from clear cytoplasmic fragment. Note the lack of endoderm. All photographs are at the same magnification. The bar indicates 50 μm .

hours of development both regions of the embryo have ectodermal and endodermal cell layers; a number of hours will elapse before there is an obvious indication of organogenesis. This experiment was done to find out if the aboral half of the embryo can regulate to form the tentacles and manubrium which are normally formed in the oral half of the embryo. Twenty-one aboral halves were raised for six days; eight of these cases were sectioned. All of the aboral halves developed swimming polarity. Eighteen cases showed no indication of tentacle or manubrium formation (Fig. 4e). Fourteen of these cases formed nematocysts at their oral end; the six embryos in this category that were sectioned had small vacuole endodermal gland cells. Three cases formed one or two stubby tentacles at their oral end, in all three cases nematocysts were present. None of these cases showed any indication of forming a manubrium, this point was checked by sectioning two of these cases. Sixteen oral halves were raised for six days. All of these cases formed a normal larva with tentacles and a manubrium.

4) Two kinds of control operations were performed. At the two cell stages each blastomere was isolated (Fig. 3d) and at the eight hour stage the embryo was cut into two lateral halves (Fig. 3e). These isolates contain both oral and aboral regions and ectodermal and endodermal germ layers or have the potential to form these germ layers. Twenty-eight two cell stage isolates were raised for six days; three of these cases were sectioned. All of these cases formed both ectodermal and endodermal germ layers. Eighteen of the isolates formed a ball of endodermal cells with a cap of ectoderm covering primarily one end of the endoderm (Figs. 4f, 5c). Nematocysts were frequently present in the ectodermal cell layer. Many of these isolates (14) showed swimming polarity. The ectodermal cap was always at the aboral end of the swimming isolate. (Eight isolates had a mark indicating where the first cleavage was

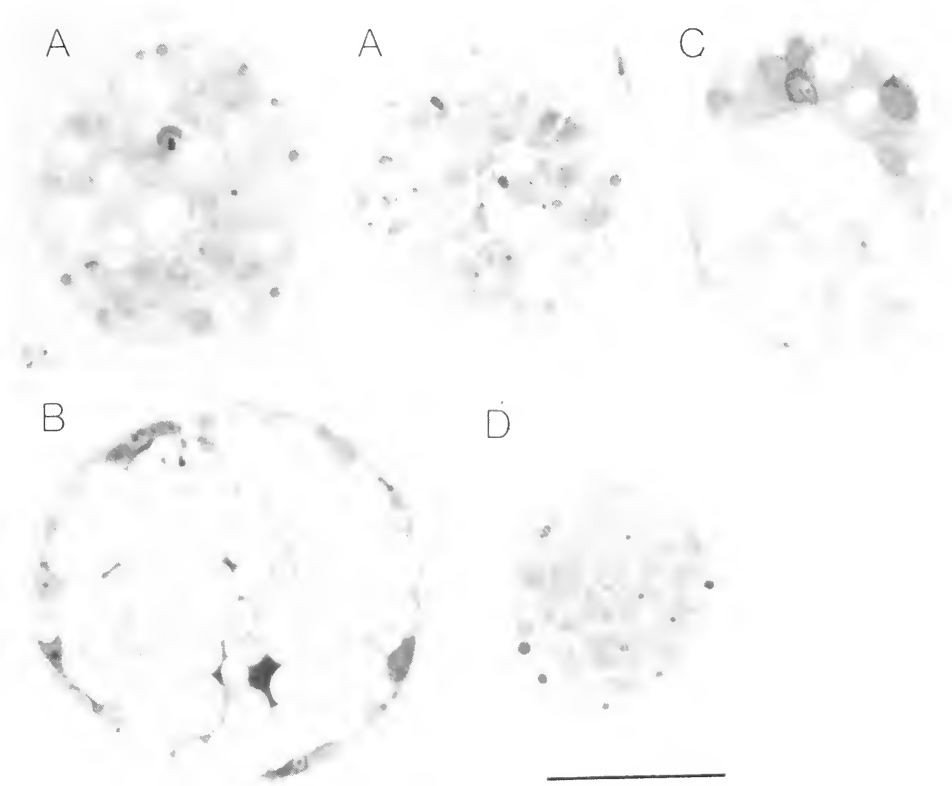

FIGURE 5. The histology of sectioned isolates from *Aglantha* embryos. A) Two five day micromere isolate from eight cell stage embryo. Note the lack of endoderm. B) Five day macromere isolate from eight cell stage embryo. Note the places where the ectoderm does not completely surround the endoderm. C) Five day isolate from two cell stage embryo. The endoderm is surrounded by ectoderm and there is an ectodermal cap at one end of the embryo. D) Four day embryo from clear cytoplasmic fragment. Note the lack of endoderm. All photographs are at the same magnification. The bar indicates 50 μm .

initiated; the cap was opposite the mark.) These cases probably failed to gastrulate properly. The remaining cases (10) formed more or less normal actinula larvae with one or more tentacles and a manubrium. Fifteen, eight hour lateral half isolates were raised for six days. Twelve of these cases formed actinula larvae with one or more tentacles and manubrium. These experiments show that the patterns of development seen in experiments 1–3 cannot be ascribed to the operative procedures used, but must reflect a program of differentiation inherent in the various regions of the embryo at the time these regions were isolated.

5) The last experiment investigated the effect of the yolky endoplasm on development. Nucleated egg fragments that lacked endoplasm were produced by centrifuging fertilized eggs and examining the ability of the resulting fragments to develop. Figure 4g shows the ectoplasmic and endoplasmic fragments produced by centrifugation. The average diameter of the ectoplasmic fragments was 90 μm (range 81–95 μm , sample size 35), while the average diameter of the endoplasmic fragments was 126 μm (range 109–156 μm , sample size 28). The ectoplasmic fragments contained approximately 27% of the egg volume. Five ectoplasmic fragments were sectioned; they

contained the nucleus and all of the visible egg constituents except the larger endoplasmic yolk granules. None of the endoplasmic fragments that were produced cleaved (115 cases). Sixty-two (38%) of the ectoplasmic fragments cleaved compared with approximately 70% for the untreated control eggs from the same batches. The first two cleavages of the ectoplasmic fragments are normal; however, at the third cleavage micromeres are not formed. There was no indication of gastrulation. After 24 hours of development a solid ciliated ball of small cells formed. Most of these isolates disintegrated between the second and third day of development. It was possible to raise 13 cases for five days (Figs. 4h, 5d); four of these cases were sectioned. They resembled eight cell stage micromere isolates, but they lacked nematocysts. They showed no swimming polarity; they lacked endoderm and showed no indication of manubrium or tentacle formation. This experiment shows that in the absence of endoplasm, endoderm will not differentiate.

Normal development of Nanomia cara and Muggiaea atlantica

The normal development of a Mediterranean species of *Nanomia* (Metschnikoff, 1874; Carré, 1969) and *M. atlantica* and a related Mediterranean species of *Muggiaea* (Metschnikoff, 1874; Russell, 1938) have been described. Figures 6 and 7 present a



FIGURE 6. Normal development of *Nanomia*. A) First cleavage. Note the unipolar furrow. B) Eight cell stage. C) Six hour embryo. D) 12 hour embryo. E) 18 hour embryo. F) 44 hour embryo. Vacuolated cells have begun to form in the anterior region of the planula (arrow). Anterior and lateral endodermal thickenings are present. G) 57 hour embryo. The arrow indicates the tentacle rudiment. H) Four-and-a-half day old siphonula. Note the pneumatophore rudiment P, the tentacle with cnidobands at its base T, the oral pigment O, and the first indications of gastric cavity formation. I) Seven day old functional siphonula. Note the cnidobands on the tentacle. All photographs are at the same magnification. The bar indicates 50 μm .

series of photographs that outline the development of *Nanomia* and *Muggiæa*, respectively. The uncleaved *Nanomia* egg has an average diameter of 274 μm (range 252–292 μm , sample size 13), while the *Muggiæa* egg has an average diameter of 319 μm (range 307–331 μm , sample size 17). The *Muggiæa* egg is less dense than sea water. There are no membranes around these eggs. In *Muggiæa* the polar bodies are associated with an extracellular structure, the cupule (Carré and Sardet, 1981) that tends to fall off the egg shortly after fertilization. Sections through uncleaved eggs show a central zone containing large endoplasmic granules and a peripheral region where these granules are absent (Fig. 8a). The distinction between the ectoplasmic zone and the endoplasm is much sharper in these eggs than it is in the *Aglantha* egg. Cleavage is unipolar; the first two cleavages generate four equal blastomeres. In both species the site of origin of the second cleavage furrow was established by marking the site of origin of the first cleavage furrow or the point directly opposite this site. The second cleavage furrow occurred at the site of origin of the first cleavage furrow in 64% of the cases (sample size 22) for *Nanomia* and in 84% of the cases (sample size 18) for *Muggiæa*. In the remaining cases the second cleavage was initiated at the equator. The variable origin of the second cleavage furrow has been noted in *Nanomia* by Carré (1969), it has also been observed in other hydrozoans (Teissier, 1931; Freeman, 1981). The third cleavage is always perpendicular to the preceding cleavage and gives rise to two tiers of blastomeres with four equal sized cells in each tier (Figs. 6b, 7b).

Gastrulation begins following the 64 cell stage. Prior to gastrulation each blastomere contains part of the initial surface of the egg. The cell nucleus and the ectoplasmic region of the egg are found here. Gastrulation occurs when a tangential cell division gives an external daughter cell that contains the ectoplasmic region and an internal daughter cell that contains the endoplasm (Fig. 8b–d). Gastrulation is completed by six to seven hours of development in both species.

The *Nanomia* embryo begins to elongate between 12 and 18 hours of development; cilia develop and the embryo begins to show swimming polarity. The embryo has now transformed into a planula. Experiments in which the site of origin of the first cleavage furrow was marked show that this region corresponds to the posterior end of the planula (16 cases). During the next six hour period (18–24 hours of development) the embryo continues to elongate and an endodermal thickening begins to develop at the anterior end and along one side of the planula. At the same time the anterior ectodermal cells begin to enlarge (Fig. 6f). Between 42 and 54 hours of development the ectoderm at the anterior end of the planula invaginates and begins to form the pneumatophore, while a tentacle begins to grow out from the side of the planula where the endoderm has thickened. At this point the planula begins to transform into a siphonula larva. By seven days a feeding siphonula has developed. During this period the pneumatophore begins to secrete gas. Red pigment cells form at the posterior end of most larvae and a mouth with associated muscle and gland cells forms at this site. The large endodermal cells that filled the interior of the larva disappear and a gastric cavity forms in their place. Cnidobands form at the base of the tentacle and take up positions on the tentacle.

The *Muggiæa* embryo begins to form cilia between six and eight hours of development. By 12–15 hours the embryo shows swimming polarity and an endodermal thickening forms along one side of the planula; during this period the embryo also begins to elongate. At about 24 hours of development an invagination begins to form in the anterior part of the lateral endodermal thickening, this is the first indication of nectophore development; in the lateral band just below the invagination a bulge forms, this is the first indication of tentacle formation. Experiments in which the site

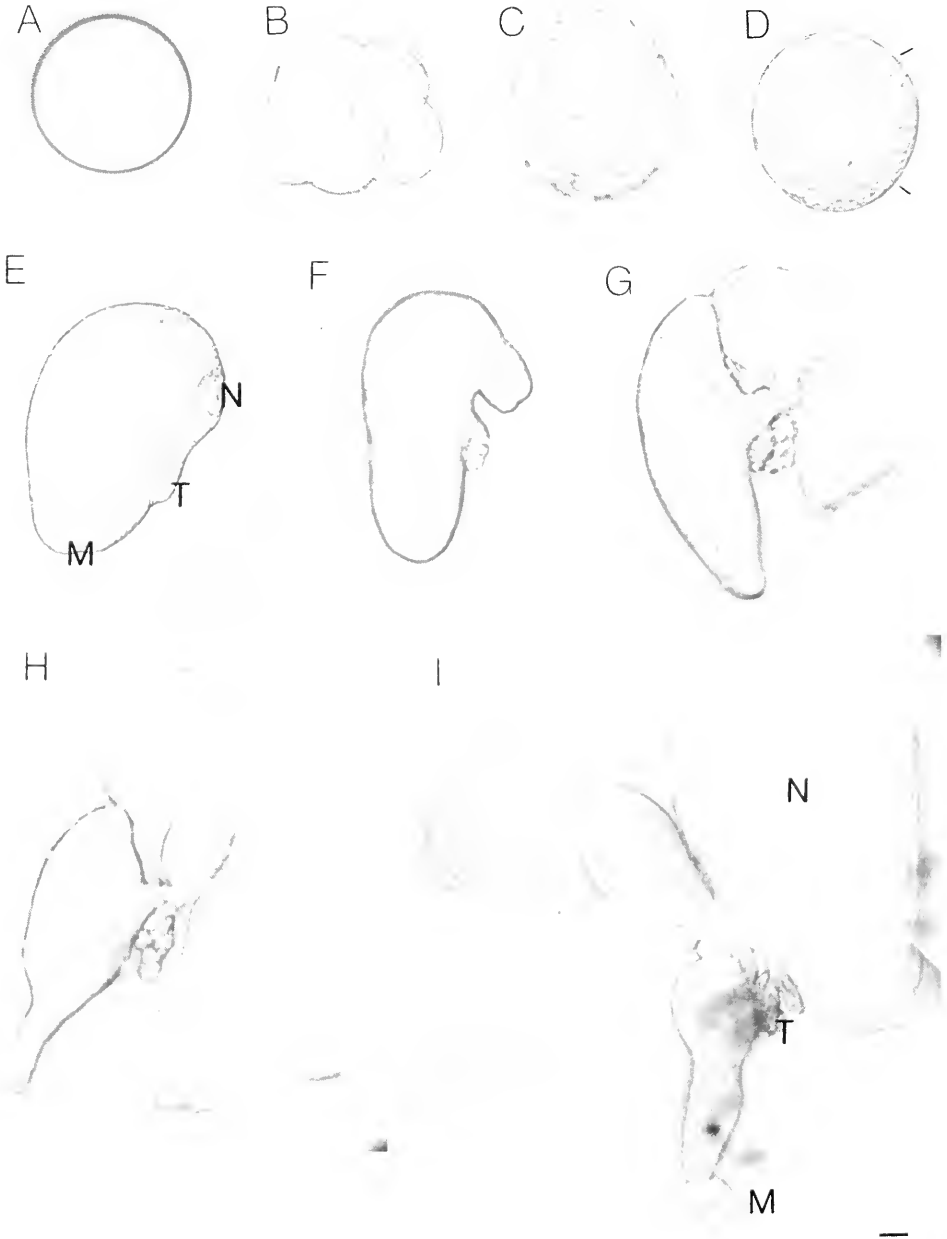

FIGURE 7. Normal development of *Muggiaca*. A) Uncleaved egg. B) Eight cell stage. C) Six hour embryo. D) 15 hour embryo. The brackets indicate the lateral endodermal thickening. E) 28 hour embryo. The nectophore and tentacle rudiments are beginning to form. F) 43 hour embryo. G) Two-and-a-half day old larvae. The nectophore is functional. H) Three-and-a-half day old larvae. The mouth is forming. I) Four-and-a-half day old larvae. Cnidobands are present on the tentacle. N, nectophore or rudiment; T, tentacle or rudiment; M, mouth or rudiment. All photographs are the same magnification. The bar indicates 50 μm .

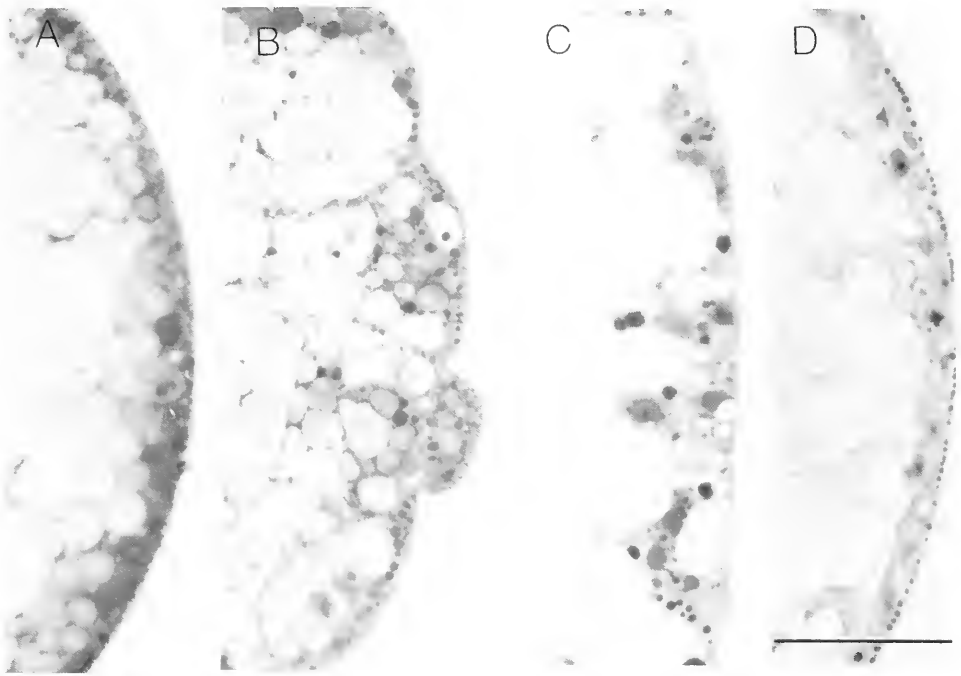

FIGURE 8. Normal embryology of *Nanomia* and *Muggiaea*. A) Section through part of a *Nanomia* egg. Note the large endoplasmic granules and the sharp transition between the ectoplasm and the endoplasm. B) Section through the peripheral region of a six hour *Nanomia* embryo. C) Section through the peripheral region of an 18 hour *Muggiaea* embryo. C) and D) are similar. Note the ectoplasm containing ectoderm cells. *Muggiaea* has cortical granules under the outer ectodermal cell membrane; these were initially just under the egg membrane. The nuclei of these cells have nucleoli. The primary endoderm is made up of large endoplasm containing cells. The bar indicates 50 μ m.

of origin of the first cleavage furrow was marked show that this region corresponds to the posterior end of these larvae (17 cases).

In both *Muggiaea* and *Nanomia* the formation of the lateral endodermal thickening and organogenesis in this region give the larva a bilateral character. In *Muggiaea* the relationship between the plane of the first cleavage and the plane of bilateral symmetry was studied by placing a series of chalk marks around the egg on the first cleavage furrow and examining the positions of the chalk marks in the 24 hour larva. Over 30 cases were marked, but only six cases were suitable for analysis because in most cases the chalk tends to get displaced from the surface of the planula when it begins to swim. In each of these six cases one side of the circle of chalk marks was coincident with the lateral endodermal thickening. An attempt to do this experiment in *Nanomia* failed because a much longer period elapses before an unambiguous lateral thickening develops and too many of the chalk granules were lost.

Between days one and four of *Muggiaea* development the nectophore rudiment grows rapidly and transforms into a functional locomotory organ. During this same period the somatocyst forms, the tentacle rudiment transforms into a functional tentacle and cnidobands form and take up positions on the tentacle. A mouth forms at the posterior end of the larva and the large endodermal cells that filled the interior of the planula disappear and a gastric cavity forms in their place.

Experimental work on Nanomia and Muggiaea

1) The first set of experiments on the siphonophore embryos were done to determine when the various regions along the oral-aboral axis, which will become the mouth, tentacle, and pneumatophore or nectophore, are specified to form these structures. The embryos were cut into oral and aboral halves at various times from the eight cell stage on and these halves were raised to see how they differentiated. Figure 9 indicates how these operations were done. When these operations were done at early stages of development (prior to 20 hours), the site of origin of the first cleavage furrow was marked so that the oral end of the embryo could be unambiguously identified. After an operation at the eight cell stage, gastrulation appeared to take place in both pieces at the normal time. When the operation was done after gastrulation, the ectodermal covering spread over the yolkly endoderm cells within an hour. During this period the isolate sometimes lost one or two large endodermal cells. If cell loss was excessive the case was discarded. The results of these experiments are summarized in Tables II and III.

The results indicate that in *Nanomia* the specification of the mouth, tentacle, and pneumatophore forming regions along the oral-aboral axis has already occurred by the eight-cell stage of development. Aboral halves produced at this stage and later stages correspond to the anterior third of the siphonula (Fig. 10a). Most of the surface of these isolates is covered with large vacuolated cells. There is frequently a pneumatophore at the anterior end of these isolates and a rudimentary tentacle at the posterior end; frequently pigment cells are found at the posterior end but a mouth does not form. This point was checked by sectioning three of these cases. The muscle and gland cells that are characteristic of the mouth were not present. Oral isolates produced at the eight cell stage and later corresponded to the posterior two thirds of the siphonula (Fig. 10b). In most cases they have a tentacle at their anterior end (there may also be a few large vacuolated cells in this region) and a mouth and

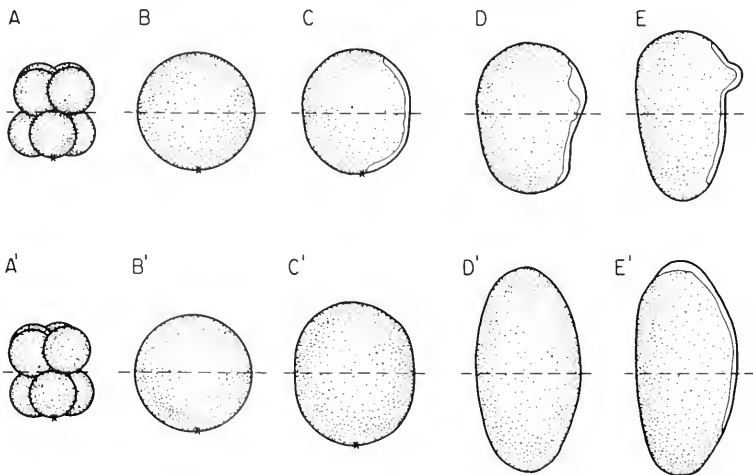

FIGURE 9. Operations performed to isolate oral and aboral halves of *Muggiaea* and *Nanomia* embryos at different stages of development. A-E, *Muggiaea*. A'-E', *Nanomia*. A) Eight cell stage. B) Six to seven hour embryo. C) 15-17 hour embryo. D) 22-24 hour embryo. E) 30-36 hour embryo. A') Eight cell stage. B') Six to seven hour embryo. C') 12-13 hour embryo. D') 18-19 hour embryo. E') 31-41 hour embryo. x, chalk mark placed at the site of origin of the first cleavage indicating the oral end of the embryo. The dashed line indicates how the embryo was cut.

TABLE II

The differentiation of Muggiaca embryo halves isolated at different times during development

Isolate type	Time of isolation	Number of cases	Corresponding member of pair	Kind of differentiation		
				Nectophore ¹	Tentacle ²	Mouth
Oral	8-cell st.	4	2	4 (2)	4 (2)	4
	6-7 h	6	4	6 (3)	5 (3)	6
	15-17 h	4	2	4 (2)	4 (3)	4
	22-24 h	4	4	1 (0)	4 (3)	4
	30-36 h	3	2	0	3 (3)	3
Aboral	8-cell st.	2		2 (2)	0	0
	6-7 h	4		4 (3)	0	0
	15-17 h	3		3 (3)	0	0
	22-24 h	5		5 (5)	0	0
	30-36 h	4		4 (4)	0	0
Lateral	2-cell st.	22	9	22 (22)	21 (20)	22
	8-cell st.	1	0	1 (1)	1 (1)	1
	6-7 h	4	1	4 (3)	3 (2)	4
	22-24 h	2	1	2 (1)	2 (1)	2
	30-36 h	5	2	5 (4)	5 (4)	5
Dorso-ventral	6-7 h	10	4	10 (8)	10 (8)	10
Dorsal	15-17 h	5	3	4 (2)	4 (1)	5
	22-24 h	5	3	3 (1)	4 (0)	5
	30-36 h	1	1	0	1 (0)	1
Ventral	15-17 h	7		7 (6)	7 (6)	7
	22-24 h	7		7 (6)	6 (4)	7
	30-36 h	1		1 (1)	1 (1)	1

¹ The parenthesis indicates the number of cases that formed functional nectophores.² The parenthesis indicates the number of cases that formed tentacles with nematoband brackets.

pigment cells at their posterior end. The *Nanomia* data can also be analyzed by examining the 24 examples of pairs of aboral and oral isolates from the same embryo. The tentacle forming region is found in the zone between the oral and aboral halves. Usually the tentacle is better developed in the oral isolate than it is in the aboral isolate. In those cases (3) where the tentacle is well developed in the aboral isolate it is rudimentary in the oral isolate. There is no indication that both halves develop more complete tentacles when they are isolated at an early stage *versus* a later stage. However, there is a tendency for oral isolates to differentiate large vacuolated cells more frequently when they are isolated at early stages rather than later stages. This suggests that the region which will differentiate large vacuolated cells may not have been definitively positioned along the oral-aboral axis of the embryo by the eight cell stage. The only feature which regulates its position along the oral-aboral axis is the pigment cells. These regularly form at the most posterior end of aboral halves regardless of the time at which these halves were isolated.

The results of the isolation experiments involving oral and aboral halves of the *Muggiaca* embryo are more complex. Aboral halves produced at the eight cell stage and later differentiated only the nectophore (Fig. 10c); these nectophores attain the size of nectophores from an intact embryo. This result suggests that the aboral half

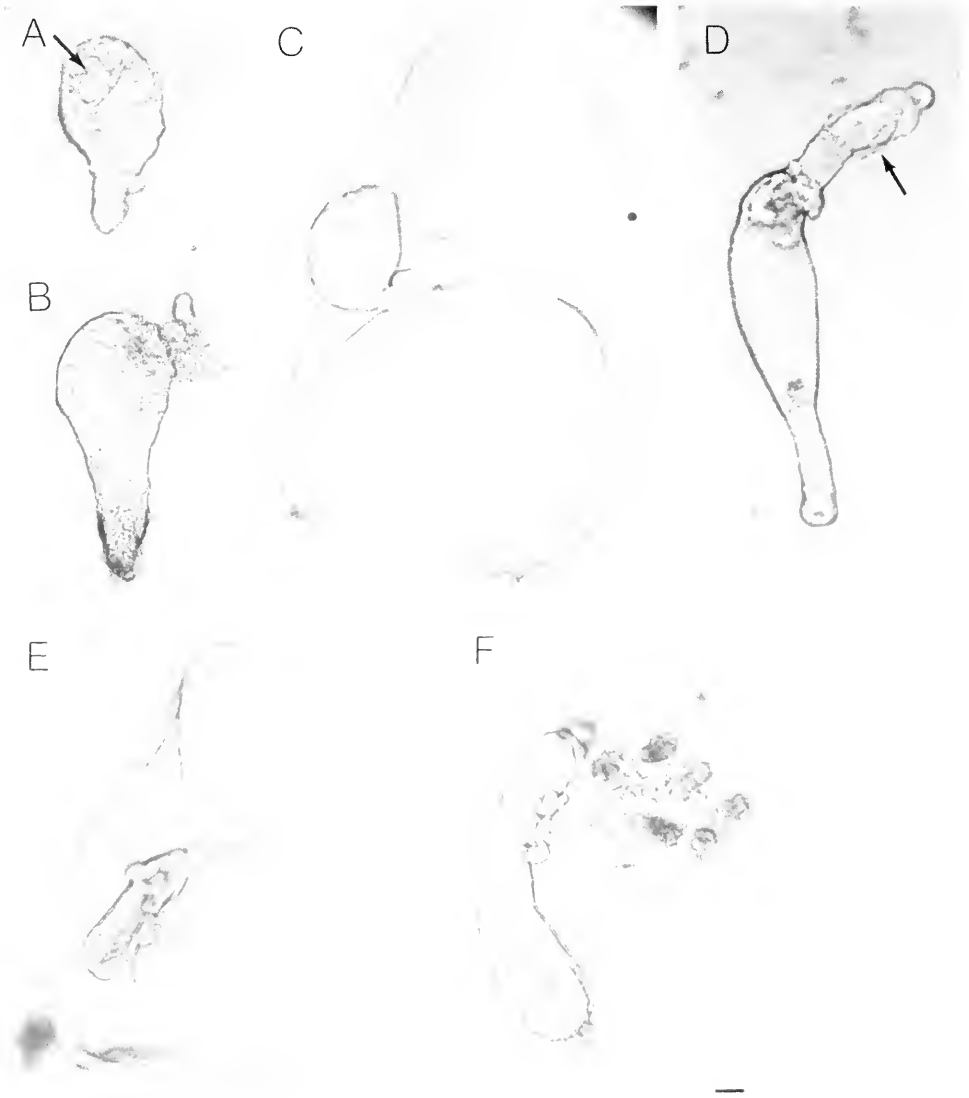

FIGURE 10. The development of aboral and oral isolates from *Nanomia* (A-B) and *Muggiaca* (C-F) embryos. All isolates are seven days old. A) Aboral half from eight cell stage embryo. Note the anterior pneumatophore rudiment (arrow). B) Oral half from same eight cell stage embryo as (A). Note the anterior tentacle with a cnidoband and the posterior mouth and pigment cells. C) Aboral half from eight cell stage embryo. Note the lack of a mouth and tentacle. D) Oral half from 15 hour embryo. The embryo has a mouth and a tentacle rudiment. The arrow points to an abnormal nectophore rudiment. E) Oral half from the same eight cell stage embryo as (C). Note the mouth and tentacle. F) Oral half from 22 hour embryo. The embryo has an anterior protrusion, a tentacle with a position along the body which is more anterior than normal and a posterior mouth. All photographs are at the same magnification. The bar indicates 50 μm .

of the embryo is specified to form the nectophore some time prior to the eight cell stage. Oral isolates produced at early developmental stages can form a normal larva with a nectophore, tentacle, and mouth. While the larva is smaller than normal, the

parts show the correct proportions (Fig. 10e). However, in half of these cases the nectophore was smaller than normal and nonfunctional or rudimentary (Fig. 10d). Since many of these oral isolates with a nectophore have a corresponding aboral isolate from the same embryo that has also formed a nectophore, the oral isolate must have formed a nectophore as a consequence of a regulatory adjustment that occurred as a result of the operation. Between 15 and 22 hours of development there is a marked decrease in the ability of the oral halves to differentiate a nectophore. These cases form a tentacle at their anterior end and a posterior mouth (Fig. 10f).

These experiments show that in both the *Muggiaea* and *Nanomia* embryos there is an early specification of the ways in which the different regions will differentiate along the oral-aboral axis of the future larva. However, in *Muggiaea* differentiation of part of the oral region of the embryo can be respecified until just before the first indications of organogenesis.

2) Since the different regions along the oral-aboral axis of the *Nanomia* embryo appear to be specified some time before the eight cell stage, an attempt was made to bracket the time period when specification occurs. Eggs which were undergoing their first cleavage (14 cases) and two cell stage embryos that were marked at the site of first cleavage initiation (5 cases) were cut into oral and aboral halves (Fig. 11). In each case only the oral half contained the nuclei, and thus it was the only half that developed. When an operation was done the diameter of each fragment was measured to calculate the relative volume of the oral isolate.

The results of these experiments are presented in Table III. Unlike the oral isolates produced at the eight-cell stage and at later stages, a substantial proportion of these cases formed large vacuolated cells and a pneumatophore. These cases can be further categorized by examining the kinds of structures that differentiate and the proportions of the larvae. Six cases formed miniature larvae of normal proportions (Fig. 12a). Ten cases formed the components of a normal larva but the anterior region was abnormally small (Fig. 12b). About half of these cases looked like the eight cell stage oral isolate that had a few large vacuolated cells at its anterior end. The anterior end of the other isolates was better developed. There were also three cases that did not form large vacuolated cells or a pneumatophore (Fig. 12c). There did not appear to be a correlation between the time of the operation or where the cut was placed with reference to the cleavage furrow and the kind of larva that differentiated. However, larger isolates tended to form more normal larvae than smaller oral isolates (Fig. 13). This experiment suggests that the specification of different regions along the oral-aboral axis of the *Nanomia* embryo is either taking place during the first cleavage and the two cell stage, or that it has occurred prior to this time, but the oral region

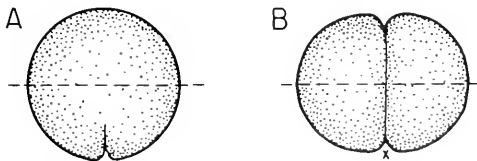

FIGURE 11. Operations performed to isolate oral portions of first cleavage and two cell stage *Nanomia* embryos. A) First cleavage. B) Two cell stage. In both operations the plane of the cut was perpendicular to the oral-aboral axis of the embryo; however, the position of the plane along the oral-aboral axis varied from case to case giving oral isolates of varying size. When operations were done on embryos that were undergoing their first cleavage in some cases the cut was made through the first cleavage furrow, in other cases the cut was made before the furrow reached that point. x, chalk mark placed at the site of the origin of the first cleavage indicating the oral end of the embryo. The dashed line indicates how the embryo was cut.

TABLE III

The differentiation of Nanomia embryo halves isolated at different times during development

Isolate type	Time of isolation	Number of cases	Corresponding member of pair	Pneumatophore	Kind of differentiation			Posterior pigment
					Vacuolated cells	Tentacle ¹	Mouth	
Oral	8-cell st.	9	8	0	3	4 (1)	9	7
	6-7 h	5	5	0	1	4 (1)	4	2
	12-13 h	7	7	0	1	7 (2)	7	6
	18-19 h	7	2	0	1	7 (2)	7	5
	31-41 h	2	2	0	0	2 (2)	2	2
Aboral	8-cell st.	9		7	9	4 (0)	0	4
	6-7 h	7		3	7	3 (0)	0	0
	12-13 h	7		6	7	5 (0)	0	1
	18-19 h	3		1	3	3 (0)	0	3
	31-41 h	6		5	6	6 (1)	0	5
Lateral	2-cell st.	16	4	7	16	16 (4)	16	12
	8-cell st.	8	4	5	7	7 (0)	7	4
	6-7 h	6	3	0	5	4 (0)	5	2
	12-13 h	6	3	4	6	6 (2)	6	4
Oral	1st cleavage-2 cell	19		9	16	18 (4)	19	17

¹ The parenthesis indicates the number of cases that formed tentacles with nematoband brackets.

of the *Nanomia* embryo can regulate in much the same way that the oral region of the *Muggiaea* embryo regulates at later developmental stages.

3) As a control experiment embryos were cut into lateral halves at the two cell

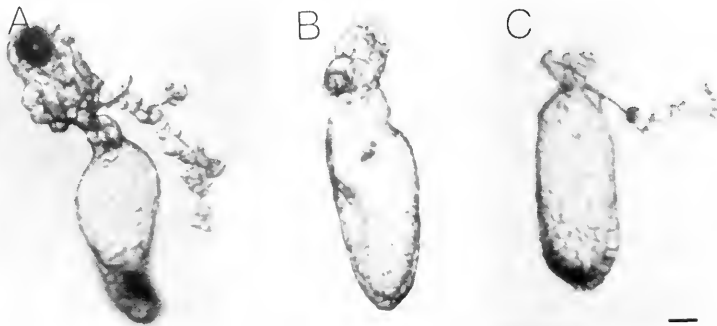

FIGURE 12. The development of oral isolates from *Nanomia* eggs undergoing their first cleavage. All isolates are seven days old. A) Normal larvae. The pneumatophore has secreted a gas bubble. This case developed from an egg fragment with 53% of the volume of a normal egg. B) Larvae with a reduced aboral end; a pneumatophore rudiment is present. This case developed from an egg fragment with 49% of the volume of a normal egg. C) Larva which lacks an aboral end. This case developed from an egg fragment with 50% of the volume of a normal egg. All of these cases developed from eggs that were cut through a non-furrow region when the furrow was a third of the way across the egg. All photographs are at the same magnification. The bar indicates 50 μ m.

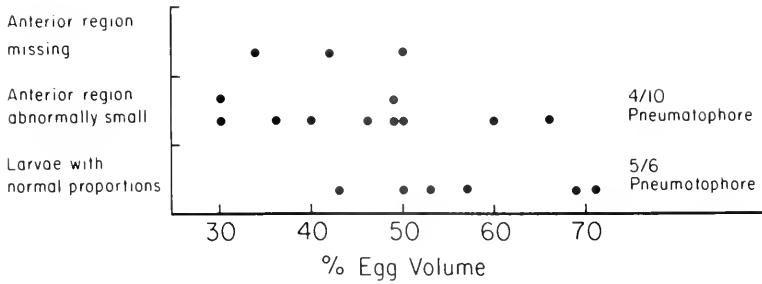

FIGURE 13. Graph relating the development of oral isolates from first cleavage and two cell stage *Nanomia* embryos to the size of the isolate.

stage and later developmental stages (Fig. 14). All of the operations on *Nanomia* embryos were performed before the development of the lateral thickening. Since the point where the lateral thickening will develop in these embryos is not known, it is more accurate to say that these embryos were cut along their oral-aboral axis. The *Muggiaea* embryos were cut into lateral halves. Since the first cleavage furrow defines the plane of bilateral symmetry the blastomere isolation experiments at the two cell stage produces lateral halves. The experiments at the eight cell stage and at six to seven hours of development were performed on embryos in which the first cleavage furrow was marked. At later stages the lateral thickening was obvious. Virtually all of these cases developed into normal larvae regardless of the stage when the operation was performed (Table II). Each pair of lateral halves from the same embryo always form the same structures. This experiment shows that the results obtained when these embryos are cut into oral and aboral halves cannot be ascribed to the operation *per se*.

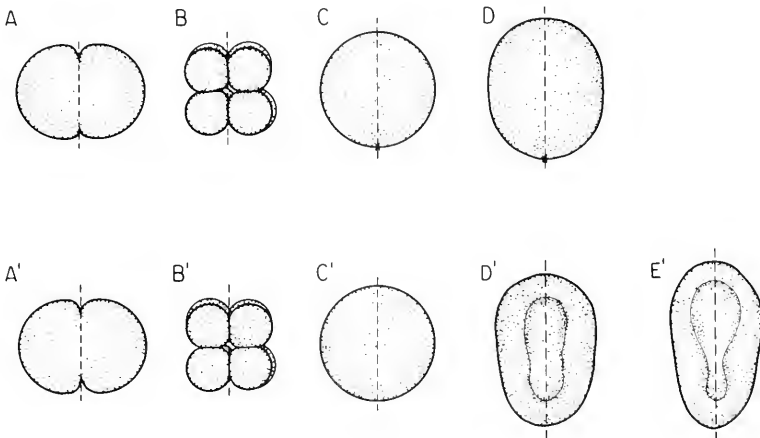

FIGURE 14. Operations performed to isolate lateral halves of *Nanomia* and *Muggiaea* embryos at different stages of development. A-D, *Nanomia*. A'-E', *Muggiaea*. A) Two cell stage. B) Eight cell stage. C) Six to seven hour embryo. D) 12-13 hour embryo. A') Two cell stage. B') Eight cell stage. C') Six to seven hour embryo. D') 22-24 hour embryo. E') 30-36 hour embryo. x, chalk mark placed at the site of origin of the first cleavage indicating the oral end of the embryo. The dashed line indicates how the embryo was cut. Embryos B' and C' were cut along a set of chalk marks that indicate the plane of the first cleavage. The ventral thickening was used to orient embryos D' and E'.

4) The region along the oral-aboral axis where the lateral thickening forms is referred to as the ventral side of the embryo. The differentiation of the dorsal and ventral sides of the *Muggiaea* embryo was studied by cutting these embryos into halves along their frontal plane at various time periods during development (Fig. 15). The earliest stage when this operation was done was at six to seven hours of development on embryos in which the first cleavage furrow was marked. At this stage it is not possible to distinguish between a dorsal and a ventral side. All of these cases developed into normal larvae (Table II). In two pairs of isolates from the same embryo the chalk marks stayed on until the ventral thickening had formed. In both cases both members of each pair formed their ventral thickening under the same chalk mark, indicating that the outer surface of either side of the embryo is capable of becoming the ventral side. The other operations were performed after the ventral thickening had formed (15–36 h) (Table II). At all time periods when the operation was done the ventral halves formed normal larvae (Fig. 16a). The behavior of the dorsal halves depended upon when the operation was performed. When dorsal halves were produced at 15–17 hours of development a ventral thickening quickly formed opposite the cut and in most cases a nectophore and tentacle formed. When dorsal halves were produced at 22–24 and at 30–36 hours of development the ventral thickening took much longer to form and there was a marked decline in the ability of these halves to form a nectophore even though they formed a rudimentary tentacle (Fig. 16b). These experiments show that both of the regions defined by the plane of bilateral symmetry as potential dorsal or ventral sides of the embryo have the capacity to become the ventral side of the embryo. Even after the ventral side of the embryo has begun to differentiate, the dorsal side which is morphogenetically quiescent can differentiate as a ventral side. One of the embryos that was to be used for these operations at 22 hours of development illustrates this point in a different way. The glass needle that was used broke during the operation and only the aboral end of this embryo was cut along the frontal plane. The cut was rather jagged, however it healed over. Subsequently an endodermal thickening developed on the dorsal side of the embryo opposite the region where the nectophore would form on the ventral side. The embryo went on to form two nectophores (Fig. 16c).

Experiments have not been done that address the issue of dorsal ventral specification in *Nanomia*, however a few of the embryos operated on in experiment 3 must have been cut along or close to the presumptive frontal plane. Since both halves developed normally in all cases one can tentatively conclude that at the time the operations were performed the presumptive dorsal side (if it exists) can still regulate.

5) The last experiment investigated the effect of the yolky endoplasm of the

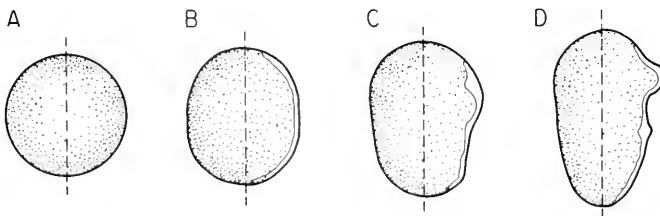

FIGURE 15. Operations performed to isolate dorsal and ventral halves of *Muggiaea* embryos at different stages of development. A) Six to seven hour embryo. This embryo was cut along the oral-aboral axis in a plane perpendicular to a set of chalk marks that indicate the plane of the first cleavage. B) 15–17 hours of development. C) 22–24 hours of development. D) 30–36 hours of development. The ventral thickening was used to orient embryos B–D. The dashed line indicates how the embryo was cut.

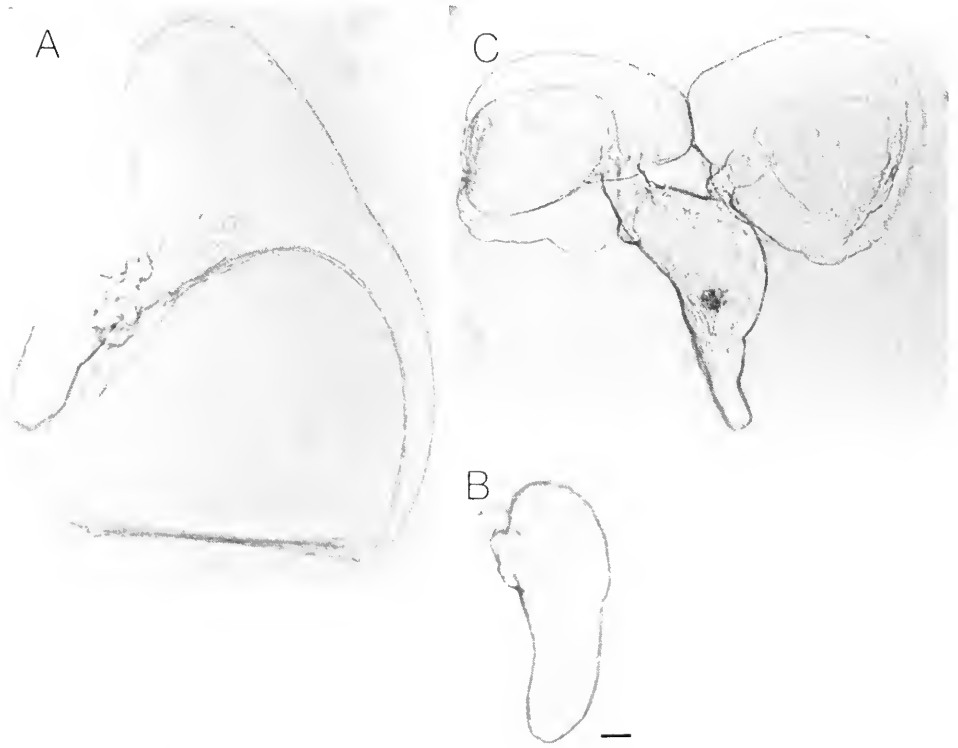

FIGURE 16. *Muggiaca* larvae from operated embryos. A) Six day old ventral isolate from 22 hour embryo. B) Six day old dorsal isolate from 22 hour embryo. Note the tentacle rudiment. The dorsal half is from the same embryo as (A). C) Five day old larva with two nectophores. All photographs are at the same magnification. The bar indicates 50 μ m.

siphonophore egg in development. Eggs were centrifuged to produce ectoplasmic and endoplasmic fragments. These experiments were only done on *Nanomia*. The endoplasmic fragments that were produced moved to the air water interface either during centrifugation or shortly after centrifugation and were destroyed. Figure 17a shows

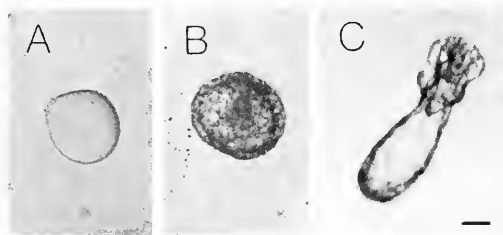

FIGURE 17. The development of ectoplasmic fragments and older *Nanomia* embryos that have lost their endoplasm. A) Ectoplasmic fragment from centrifuged egg. B) Five day ciliate sphere from ectoplasmic fragment. C) Seven day larva from embryo which lost its endoplasm at 16 hours of development. The embryo has a pneumatophore rudiment, vacuolated anterior cells, a tentacle rudiment and a mouth. It is much smaller than a normal larva. Compare this figure with 61. All photographs are at the same magnification. The bar indicates 50 μ m.

an ectoplasmic fragment. The average diameter of these fragments was 131 μm (range 107–142 μm , sample size 12). An ectoplasmic fragment contains about 10% of the egg volume. Only about a fourth of the eggs that were centrifuged produced ectoplasmic fragments. Most (88%) of the ectoplasmic fragments cleaved. The early cleavages were normal. Cilia developed by 15 hours, however, the embryos did not elongate and there was no indication of swimming polarity. Twenty embryos were raised for five days. Ten of these cases were sectioned. There was no indication of organogenesis (Fig. 17b). This experiment suggests that the endodermal plasm is necessary for normal development.

This conclusion is supported by observations on post gastrula *Nanomia* embryos that get caught on the air-water interface. When this happens most or all of the endodermal cells are lost and one is left with an ectodermal hull. Unfortunately this procedure for removing the endoderm of the embryo is not exactly well controlled. When an embryo is de-endodermized between 6 and 12 hours of development (5 cases) the ectoderm that remains forms a ciliated ball and no organogenesis occurs. If even a small amount of endoderm remains the embryo will show swimming polarity and a mouth and/or a few large vacuolated cells will form (12 cases). If an embryo is de-endodermized after it has begun to elongate it will differentiate most structures even though the larva will be very small (8 cases) (Fig. 17c). This suggests that the yolk endoderm is only necessary for the early stages of development.

DISCUSSION

The generality of the findings

Trachylina. There are a number of descriptive studies on early development of other species in the order Trachylina. Most of this literature dates from the last century; a great deal of it is summarized in Metschnikoff's (1886) monograph on the embryology of medusae. This monograph describes the egg and/or early developmental stages of seven species in the order Trachylina; it also provides comparative data on a number of species in the order Hydroida. All of the species in the order Trachylina appear to have eggs with large endoplasmic granules; these granules are much smaller in the eggs and early developmental stages of species in the order Hydroida. Within the order Trachylina there appears to be some variation in the size of these granules and their packing in different species.

In all of the species in the order Trachylina there appears to be an early establishment of ectodermal and endodermal cell layers. In *Aglantha* this process begins at the eight cell stage; I suspect that this may also occur at this stage in two of the species Metschnikoff studied, *Aglaura* and *Polyxenina*. Prior to the work on *Aglantha* described here, gastrulation was considered to be the time when ectodermal and endodermal cell layers formed. Gastrulation can occur in several ways in cnidarians; several schemes describe the ways in which this process can occur (Tardent, 1978). Different species in the Trachylina have been placed in different slots in these schemes. However in every case gastrulation involves a delamination in which a cell division takes place in such a way that an inner larger cell inherits primarily the granular endoplasm and a smaller outer daughter cell inherits primarily the cortical cytoplasm. This type of gastrulation is not too different from the formation of an endoplasm-poor micromere at the eight cell stage. In every case these gastrulation events occur at an early stage of development before a great deal of cell division has taken place. The kinds of cnidarian gastrulation that are associated with later cleavage stages, such as ingression and secondary delamination, do not occur in these embryos.

The process of embryogenesis in *Aglantha* is very similar to the process of em-

bryogenesis in *Aglaura* which Metschnikoff (1886) has studied. Metschnikoff considered the possibility that epiboly might occur in *Aglaura* but rejected it because he had no evidence that smaller blastomeres were moving over the larger blastomeres; however, I have seen epiboly occur in *Aglantha*. The fact that two cell stage blastomere isolates sometimes have an ectodermal cap at their aboral end supports this view—these cases would be generated when epiboly does not occur.

At this point no experiments have been done on the embryos of other species in the order Trachylina that elucidate the issues considered here. Both Maas (1908) and Zoja (1895) separated and reared blastomeres from early cleavage stage embryos of the narcomedusae *Liriope* and *Geryonia*. Single blastomeres isolated from two and four cell stage embryos form medusae or medusa larvae.

Siphonophora. The early development of only a few species of siphonophores has been studied. Carré's papers (1967, 1969) contain the best histological descriptions of early development. All species of siphonophores appear to have relatively large eggs. In every case where the egg has been examined, it contains relatively large endoplasmic granules and there is a sharp boundary between the endoplasm and the cortical layer of the egg. In every case where gastrulation has been described, it appears to take place early in development by delamination.

The only experimental work on early embryogenesis in siphonophores has been done by Carré (1969) on *Nanomia bijuga*. This work addresses the issue of whether regulation can occur along the oral-aboral axis of the embryo and the effect of developmental age on regulatory ability. The results she obtained contradict the results presented here. Because her work is only briefly described, many crucial details that would aid in interpreting the experiments are not given. One set of experiments involved the isolation of blastomeres at the 2, 4, 8, and 16 cell stages. In a crucial experiment an eight cell stage embryo was separated into eight blastomeres; seven of these isolates formed a pneumatophore bud and a tentacle. Another set of experiments divided gastrulae, young planulae, and planulae with a pneumatophore bud into two halves. In the experiment on the planulae with a pneumatophore bud, and presumably, in the young planulae, the cut created oral and aboral halves, but when gastrulae were cut into halves the cut was not oriented because marked embryos would have to be used. Carré reports that when gastrulae or young planulae were cut in half regulation occurred in all cases. The only developmental stage where regulation did not occur was the planula with the pneumatophore bud. At this stage the aboral half developed into a small siphonula without a gastrozoid and the oral half formed a gastrozoid but did not differentiate a pneumatophore. Carré concluded that regulation is total in young planulae and disappears when organogenesis begins.

It is hard to believe that two species belonging to the same genus should behave in such different ways. At present on the basis of my experiments on *Nanomia cara* and *Muggiaea* I would argue that there is probably an early specification of different regions along the oral-aboral axis of all siphonophore embryos. However Carré's report suggests that the situation may be more complex. It is conceivable that some species in this Order may show an early specification of different regions along the oral-aboral axis of the embryo and that these same species may differ in their ability to regulate. In other species the ability of different regions along the oral-aboral axis to regulate may be so extensive that it may be difficult to define when a particular region along this axis is specified.

The comparative embryology of the Hydroida and Ctenophora

Hydrozoans with both direct and indirect development and ctenophores share a number of developmental traits. Both of these groups have a centrolecithal egg with

a central yolky endoplasmic region that is surrounded by a peripheral layer of cortical cytoplasm. In both groups cleavage is unipolar. The oral-aboral axes of the embryos are established at the time of first cleavage under conditions where the oral pole of the axis corresponds to the site of first cleavage initiation (Freeman, 1977, 1980). In the order Hydroida this region corresponds to the posterior end of the planula which becomes the mouth of the polyp after metamorphosis.

When the basic features of development in the order Hydroida are compared with a similar set of features in the Ctenophora, several major differences between these two groups that involve the structure of the egg, the process of embryogenesis and the mechanisms that underlie this process become apparent. Each of these differences will now be examined.

Egg organization. While the Hydroida and Ctenophora have centrolecithal eggs, these two groups differ in the way this organization is expressed. The endoplasmic granules of ctenophore eggs are larger and more closely packed than those of Hydroida eggs, as a consequence the transition between the ectoplasmic and endoplasmic regions is much sharper in ctenophore eggs (see Fig. 30 in Freeman and Reynolds, 1973 for a section through a typical ctenophore egg and Fig. 1 in Freeman and Miller, 1982, for sections through Hydroida eggs.). In the ctenophore egg both of these cytoplasmic layers behave to a large extent like immiscible fluids (Spek, 1926). This kind of cytoplasmic behavior appears to be absent or much less pronounced in the Hydroida.

The *Aglantha* egg is similar to a ctenophore egg in that it has large endoplasmic granules; however these granules are not closely packed. Nevertheless the ectoplasmic region of the *Aglantha* egg appears to be more distinct than it is in Hydroida eggs. Both siphonophore eggs have large closely packed endoplasmic granules (see Fig. 1 in Carré and Sardet, 1981, for sections through the egg of a related species of *Muggiaea*) and a distinct ectoplasmic region. These eggs closely resemble ctenophore eggs.

Cleavage pattern. In the Hydroida it is difficult to talk about cleavage patterns during early embryogenesis. After the first cleavage there is generally not a set orientation for subsequent cleavage furrows, even though certain cleavage planes are more probable than others. There is no evidence that ectoplasm and endoplasm are differentially distributed to different blastomeres during early cleavage (Tardent, 1978). In ctenophores early cleavage occurs according to a stereotypic pattern. The first three cleavages take place along the oral-aboral axis of the embryo generating eight macromeres. Ctenophores are biradially symmetrical; there is a one-to-one relationship between the planes of the first cleavages and the sagittal and tentacular planes of these embryos. At the fourth cleavage each macromere gives off a micromere at the aboral pole of the embryo. During this division there is a differential distribution of cytoplasm so that the micromeres inherit very little endoplasm. During the next few divisions additional yolk-free micromeres are given off at the aboral pole of the embryo. These micromeres will become the ectodermal covering of the embryo; gastrulation occurs by epiboly (Reverberi, 1971).

In *Aglantha* the initial cleavage divisions also generate a stereotypic pattern. This embryo closely resembles the ctenophore embryo in that micromeres which are largely yolk-free are generated at the aboral end of the embryo. These micromeres will also form at least part of the ectodermal covering of the embryo. Gastrulation takes place in the same way in both forms. The two siphonophores do not generate a stereotypic cleavage pattern, in this sense they are Hydroida-like. However, in *Muggiaea* the plane of the first cleavage corresponds to the plane of bilateral symmetry of the embryo. Thus there is a relationship between the plane of cleavage and a symmetry property of the embryo as there is in ctenophores. Both siphonophore embryos undergo differential divisions at early stages of development that generate endoplasm and

ectoplasm free cells. These divisions which constitute gastrulation produce the external ectoplasm containing cells that form the ectoderm of the embryo; although this differential division does not occur in the same way it does in the ctenophore embryo, it has the same effect.

The establishment of embryonic regions with different developmental potentials. During the early cleavage stages of embryogenesis in ctenophores several cell divisions have been identified that give rise to daughter cells with different developmental potentials (Reverberi, 1971; Freeman and Reynolds, 1973). The first of these divisions occurs at the third cleavage. If a blastomere is isolated at the four cell stage it will continue to cleave and subsequently differentiate comb plate cilia cells and light producing cells. When the four cell stage blastomere divides, it produces E and M daughter cells. If the E blastomere is isolated it will subsequently differentiate comb plate cilia cells, but not light producing cells, while the isolated M macromere will differentiate light producing cells but not comb plate cilia cells. In these embryos cleavage does not passively divide up special cytoplasmic regions of the egg that have been in place for some time. The factors that specify these two cell types are gradually localized in the future E and M macromere forming regions of the embryo during the two cleavages which precede this division (Freeman, 1976). These embryos behave like a mosaic of parts which have been largely specified during early cleavage stages.

In the Hydroida that gastrulate by unipolar ingression it is possible to map the position of the presumptive ectodermal and endodermal cells prior to gastrulation. The ectodermal cells are found at the presumptive anterior end while the endodermal cells are found at the presumptive posterior end of the embryo. At any time prior to gastrulation it is possible to isolate each of these presumptive regions and both kinds of isolates will form a normal planula larva with both ectodermal and endodermal cell layers (Freeman, 1981). When an isolated region regulates to form a normal planula it always conserves its polarity properties (Teissier, 1931). During gastrulation the presumptive ectodermal cells lose their capacity to form endodermal cells; this is the first point during development where there is a restriction of developmental potential (Freeman, 1981). Following gastrulation the embryo differentiates into a planula larva. If a post gastrula embryo or planula is cut up into regions with different presumptive fates, each part will regulate to form a normal planula, as long as both ectodermal and endodermal cell layers are present (Müller *et al.*, 1977; Freeman, 1981, however, see Lesh-Laurie, 1976). These embryos behave like developmental fields (Wolpert, 1969). The way a given cell differentiates in these embryos ultimately depends upon its position with respect to its neighbors.

In *Aglantha* and the two siphonophores there is an early specification of different embryonic regions. In *Aglantha* the micromeres that are produced at the eight cell stage differentiate only ectoderm while the macromeres differentiate both ectoderm and endoderm. In ctenophores the micromeres and macromeres produced at the 16 cell stage differentiate in the same way. This is quite different from the Hydroida where ectoderm and endoderm are not specified until gastrulation. Gastrulation in the hydroida is not an early event as it is in *Aglantha*, but a relatively late event, at least in those forms which gastrulate by ingression. After gastrulation the aboral half of the *Aglantha* embryo cannot regulate to form a mouth and tentacles; it behaves differently from the aboral half of the Hydroida embryo which can regulate. Unfortunately this experiment has not been done on ctenophore embryos.

In *Nanomia* there is a specification of different regions along the oral-aboral axis of the embryo by the eight cell stage; this specification occurs before ectodermal cells have formed as it does in the ctenophore embryo. In *Muggiaea* the situation is more complicated, while the aboral region of the embryo is specified by the eight cell stage,

the oral part of the embryo is capable of regulation until just before organogenesis begins; the same is true of the presumptive dorsal half of the embryo. In this embryo the timing of determinative events appears to be a mix which has some of the elements of the ctenophore situation and some of the elements of the Hydroida situation.

The role of ectoplasm and endoplasm in cell specification. In both the Ctenophora and the Hydroida, experiments have been done to create egg fragments that lack endoplasm (see Beckwith, 1914; Freeman and Miller, 1982, for the Hydroida, and LaSpina, 1963; Freeman and Reynolds, 1973 for the Ctenophora). This experiment is done by centrifuging fertilized uncleaved eggs to stratify the egg contents and then increasing the centrifugal force or cutting the egg to give a nucleated ectoplasmic fragment. When this experiment is done on ctenophores the initial cleavages are normal. However there is not a normal segregation of developmental potential, both the E and M macromeres differentiate comb plate cilia. These embryos fail to differentiate certain cell types such as light producing cells and they develop into a poorly organized ectodermal mass (see Fig. 35 in Freeman and Reynolds, 1973 for a cross section through one of these "embryos"). In the Hydroida ectoplasmic fragments form normal planulae. This comparison indicates that endoplasm is necessary for normal embryogenesis in the Ctenophora, but not in the Hydroida.

Ectoplasmic fragments of both *Aglantha* and *Nanomia* differentiate ectodermal masses that are similar to the ectodermal mass produced under similar conditions by the ectoplasmic fragments of Ctenophore eggs. The behavior of the ectoplasmic fragments reflects the marked distinction between the ectoplasm and the endoplasm in the eggs and embryos and the inheritance of the ectoplasm by the ectodermal cells in these three groups of animals. The lack of morphogenesis in these ectodermal masses probably reflects the lack of endoderm. Hydroida embryos which lack endoderm are capable of undergoing metamorphosis but cannot form a polyp (Freeman, 1981).

This comparison of development in the Ctenophora, the Hydroida, the Trachylina, and the Siphonophora shows that the Trachylina and the Siphonophora each have an egg organization, a mode of early development, and a set of mechanisms for specifying embryonic regions that is very similar to those found in Ctenophores.

The bases for developmental parallelism

The Cnidaria and the Ctenophora are thought to be closely related (Hyman, 1940). It is possible that the development parallelism between the Trachylina, the Siphonophora, and the Ctenophores could be explained on the basis of common descent. At present there is no agreement about how the classes and orders in the phylum Cnidaria are related. It is not even clear what the most primitive members of the phylum looked like. Some students of this group have argued that the first Cnidarians were polyps (Werner, 1973) while others have argued that the first Cnidarians were medusae (Brooks, 1886, Rees, 1966). It is also not clear how the phylum Ctenophora is related to the Cnidaria. However, a number of speculative phylogenies have been developed that have the status of educated guesses. Hyman (1940) has argued that the Trachylina and the Ctenophora are closely related. No one has suggested the Siphonophora are closely related to either the Ctenophora or Trachylina. The speculations concerning the origin of the Siphonophora derive this order from the Hydroida (Totton, 1965).

This parallelism may also reflect the fact that these embryos develop directly. During embryogenesis a set of structures are going to develop which are more elaborate than those of a planula larva. This reflects the fact that these animals have to function in a pelagic environment. It will take a certain amount of time to generate these

structures. Because the egg is a closed system, only so much time is available for building these structures before the embryo's nutrient reserves are depleted. These two considerations could place a premium on the way time is allocated during embryogenesis.

Before a structure develops a decision has to be made about its placement. An embryonic field is one mechanism for specifying structure placement and is used by the Hydrozoa. This mechanism relies on physiological machinery which assigns each cell an address with respect to its neighbors. In order for this mechanism to function, its physiological machinery has to be created and it must function for a period of time. This means that this could be a relatively costly mechanism in terms of time utilization. However, if the differentiation of a structure depends on the inheritance of localized cytoplasmic regions, as it appears to be in the direct developers, the time needed to decide where a given structure will be placed is reduced substantially.

The process of embryogenesis in Cnidarians also depends upon interactions between ectodermal and endodermal cell layers. This means that these cell layers have to exist before structure formation can begin. When the specification of these cell layers depends upon the position of a given cell with respect to its neighbors, as it does in the Hydrozoa with indirect development, this process is going to take much longer than it will in direct developing embryos where the parcelling out of ectoplasm and endoplasm at cleavage accomplishes the same end.

Embryonic field mechanisms and cytoplasmic localization mechanisms are frequently regarded as separate and distinct ways of specifying the developmental potential of different parts of embryos. The experiments described here suggest that during the course of evolutionary diversification within a group of animals, a transition from one mechanism to the other can occur relatively easily (see Freeman, 1982, for a general discussion of this mode of evolutionary change).

The developmental similarities that the Trachylina, the Siphonophora, and the Ctenophora share is impressive. If one assumes that all three groups evolved independently from a Hydrozoa like stock, one would have to argue that while there are no constraints which prevent the transition from a field to a cytoplasmic localization mechanism of embryonic determination, the way one undergoes the transition is highly constrained. For example, in all three groups the axial relationships are similar, and when cleavage is related to symmetry, the same relationship holds in different groups. This kind of constraint provides a basis for explaining the developmental similarities within these groups.

ACKNOWLEDGMENTS

The impetus for this work was a Dahlem workshop on Evolution and Development held in Berlin in May, 1981. I want to thank Professor A. O. D. Willows, the director of the Friday Harbor Laboratories for facilitating my work there. I am especially grateful to R. Emler, G. Mackie, R. Miller, C. Mills, S. Smiley, R. Satterlie, and A. Spencer for collecting siphonophores. This work was supported by grant GM 20024 from the National Institute of Health.

LITERATURE CITED

- BECKWITH, C. 1914. The genesis of the plasma-structure in the egg of *Hydractinia echinata*. *J. Morphol.* 25: 189-251.
- BROOKS, W. 1886. The life history of the hydromedusae: a discussion of the origin of the medusae and of the significance of metagenesis. *Mem. Boston Soc. Nat. Hist.* 3: 359-430.
- CARRÉ, D. 1967. Étude du développement larvaire de deux Siphonophores: *Lensia conoidea* (Calyptophore) et *Forskalia edwardsi* (Physonecte). *Cah. Biol. Mar.* 8: 233-251.

- CARRÉ, D. 1969. Étude histologique du développement de *Nanomia bijuga* (Chiaja, 1841) Siphonophore, physonecete, aglamidae. *Cah. Biol. Mar.* **10**: 325-341.
- CARRÉ, D., AND C. SARDET. 1981. Sperm chemotaxis in siphonophores. *Biol. Cell.* **40**: 119-128.
- FREEMAN, G. 1976. The role of cleavage in the localization of developmental potential in the Ctenophore *Mnemiopsis leidyi*. *Dev. Biol.* **49**: 142-177.
- FREEMAN, G. 1977. The establishment of the oral-aboral axis in the Ctenophore embryo. *J. Emb. Exp. Morphol.* **42**: 237-260.
- FREEMAN, G. 1980. The role of cleavage in the establishment of the anterior-posterior axis of the hydrozoan embryo. Pp. 97-108 in *Developmental and Cellular Biology of Coelenterates*, P. and R. Tardent, eds. Elsevier/North Holland, Amsterdam.
- FREEMAN, G. 1981. The role of polarity in the development of the hydrozoan planula larva. *Wilhelm Roux's Arch.* **190**: 168-184.
- FREEMAN, G. 1982. What does the comparative study of development tell us about evolution? Pp. 155-167 in *Evolution and Development*, J. Bonner, ed. Springer-Verlag, Berlin.
- FREEMAN, G., AND R. MILLER. 1982. Hydrozoan eggs can only be fertilized at the site of polar body formation. *Dev. Biol.* **94**: 142-152.
- FREEMAN, G., AND G. REYNOLDS. 1973. The development of bioluminescence in the Ctenophore *Mnemiopsis leidyi*. *Dev. Biol.* **31**: 61-100.
- HYMAN, L. 1940. *The Invertebrates: Protozoa through Ctenophora*. McGraw-Hill, New York. 726 pp.
- KOZLOFF, E. 1974. *Keys to the Marine Invertebrates of Puget Sound, the San Juan Archipelago and Adjacent Regions*. University of Washington Press, Seattle. 226 pp.
- LASPINA, R. 1963. Development of fragments of the fertilized egg of ctenophores and their ability to form ciliated plates. *Acta. Embryol. Morphol. Exp.* **6**: 204-211.
- LESH-LAURIE, G. 1976. Stolon vs. hydranth determination in *Pennaria tiarella* planulae: a role for DNA synthesis. Pp. 365-375 in *Coelenterate Ecology and Behavior*, G. Mackie, ed. Plenum, New York.
- MAAS, O. 1908. Über der Bau des Meduseneis. *Verh. Deutsch. Zool. Ges. Leipzig.* 114-129.
- METSCHNIKOFF, E. 1874. Studien über die Entwicklung der Medusen and Siphonophoren. *Z. Wiss. Zool.* **24**: 15-80.
- METSCHNIKOFF, E. 1886. *Embryologische Studien an Medusen: Ein Beitrag zur Genealogie der Primitivorgane*. and Atlas, Alfred Hölder, Vienna. 159 pp.
- MÜLLER, W., A. MITZ, J. WICKHORST, AND H. MEIER-MENGE. 1977. Polar morphogenesis in early hydroid development: action of Caesium, of neurotransmitters and of an intrinsic head activator on pattern formation. *Wilhelm Roux's Arch.* **182**: 311-328.
- NOVIKOFF, A. 1938. Embryonic determination in the annelid *Sabellaria vulgaris*. II. Transplantation of polar lobes and blastomeres as a test of their inducing capacities. *Biol. Bull.* **74**: 211-234.
- REES, W. 1966. The evolution of the hydrozoa. Pp. 199-221 in *The Cnidaria and their Evolution*, W. Rees, ed. Academic Press, London.
- RICHARDSON, K., L. JARRET, AND E. FINKE. 1960. Embedding in epoxy resins for ultrathin sectioning in electron microscopy. *Stain Technol.* **35**: 313-325.
- REVERBERI, G. 1971. Ctenophores. Pp. 85-103 in *Experimental Embryology of Marine and Freshwater Invertebrates*, G. Reverberi, ed. North Holland, Amsterdam.
- RUSSELL, F. 1938. On the development of *Muggiaca atlantica* Cunningham. *J. Mar. Biol. Assoc. U. K.* **22**: 440-446.
- SPEK, J. 1926. Über gesetzmässige substanzverteilung bei der Furchung des Ctenophoreneis und ihre Beziehung zu den Determinations-problem. *Wilhelm Roux's Arch.* **107**: 54-73.
- TARDENT, P. 1978. Pp. 67-415 in *Morphogenese der Tiere Coelenterata, Cnidaria 1*, Al F. Seidel, ed. Gustave Fischer, Jena.
- TEISSIER, G. 1931. Etude expérimentale du développement de quelques hydraires. *Ann. Sci. Nat. Ser. Bot. Zool.* **14**: 5-60.
- TOTTON, A. 1965. *A Synopsis of the Siphonophora*. British Museum (Natural History) London. 230 pp.
- WERNER, B. 1973. New investigations on systematics and evolution of the class scyphozoa and the phylum cnidaria. *Publ. Seto Mar. Biol. Lab.* **20**: 35-61.
- WOLPERT, L. 1969. Positional information and the spatial pattern of cellular differentiation. *J. Theoret. Biol.* **25**: 1-47.
- ZOJA, R. 1895. Sullo sviluppo dei blastomeri isolati di alcuni medusae (e di altr organismi). *Wilhelm Roux's Arch.* **1**: 578-595, **2**: 1-37.

CIRCULATION OF FLUIDS IN THE GASTROVASCULAR SYSTEM OF THE REEF CORAL *ACROPORA CERVICORNIS*

ELIZABETH H. GLADFELTER

West Indies Laboratory, Teague Bay, Christiansted, St. Croix. USVI 00820, and Department of Biology, University of California, Los Angeles, California 90024

ABSTRACT

Circulation of fluids in the gastrovascular system of *A. cervicornis* was determined by observing the movement of fluorescein dye injected via a lateral polyp and viewed in the dark under ultra-violet light. Scanning electron microscopy and petrographic thin sections were used to describe the general morphology of the gastrovascular system. This consists of two functional units: an axial unit composed of the coelenteron of the axial polyps and a peripheral unit composed of tubes oriented axially ramifying through the skeleton lying just beneath the outer ectoderm. These units are connected by radially oriented tubes including the coelenterons of the lateral polyps. The entire gastrovascular system is lined by flagellated endoderm cells.

Flow in the axial unit is always proximal. Flow in the peripheral unit is both distal and proximal and the velocity is always less than the flow in the axial unit. Light does not appear to change the rate of flow. Rates of flow in the peripheral unit show a diel cycle, with increased flow rates occurring between 2100 and 0600.

INTRODUCTION

Reef corals are symbioses between colonial cnidarians (Anthozoa: Scleractinia) and intracellular dinoflagellates (=zooxanthellae). The animal colony consists of polyps connected by coenosarc through which extensions of the gastrovascular system ramify (Wells, 1956). Thus, there exists the potential for transport of materials (*e.g.*, dissolved or particulate organic matter) from one site in the colony to another.

Gastrovascular transport systems in Cnidaria have been investigated in hydro-medusae (Roosen-Runge, 1967); hydroids (Rees *et al.*, 1970); pennatulids (Musgrave, 1909; Parker, 1920; Brafield, 1969); and gorgonians (Murdock, 1978a, b). To date, work on transport in scleractinian corals is limited to a few studies in which materials introduced at one site in the colony have been detected at another site (Pearse and Muscatine, 1971; Taylor, 1977).

The reef coral *Acropora cervicornis* is a branching form consisting of a relatively large axial corallite and polyp at the terminus of each branch, and many smaller lateral calices with polyps along the length of the branch. The distal portion of the axial corallite is a site of rapid skeletal development (*e.g.*, Goreau and Goreau, 1959; Pearse and Muscatine, 1971; Gladfelter, 1982, 1983) and cell division (Gladfelter, 1983); both processes occur in a characteristic diel pattern (Gladfelter, 1983). When soluble organic molecules and $^{45}\text{Ca}^{++}$ have been introduced at a distance from the tip of a branch, they have been detected later in the tissues of the axial polyp and its skeleton at the extreme distal portion of the branch; it has been inferred that these molecules and ions have been transported in some way to the tip (Pearse and Muscatine,

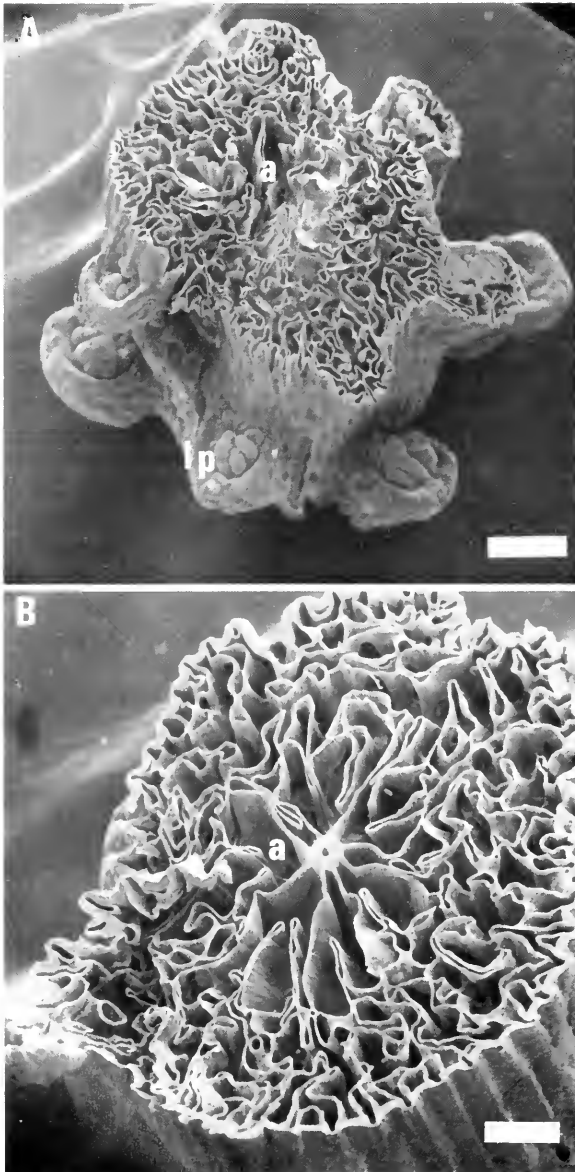

FIGURE 1. Several SEMs of decalcified axial polyps, showing the axial unit of the fluid transport system. a. Cross-section of an axial polyp *ca.* 10 mm from the tip, exposing the axial unit (a) of the fluid transport system, the canal formed by the coelenteron of the axial polyp lying within the calyx of the skeleton. A number of lateral polyps (lp) can be seen. Scale bar = 500 μm . b. Cross-section of the axial polyp *ca.* 20 mm from the tip, showing the now partly occluded axial canal (a). Scale bar = 250 μm . c. View of the membrane surface of the endodermal cells lining the axial canal. Note that each flagellum is surrounded by a circlet of raised projections of the cell membrane. Scale bar = 5 μm .

1971; Taylor, 1977). To date, however, neither the morphological basis of this transport nor the patterns of flow in this hypothesized transport system have been described. The present study was undertaken with these goals in mind.

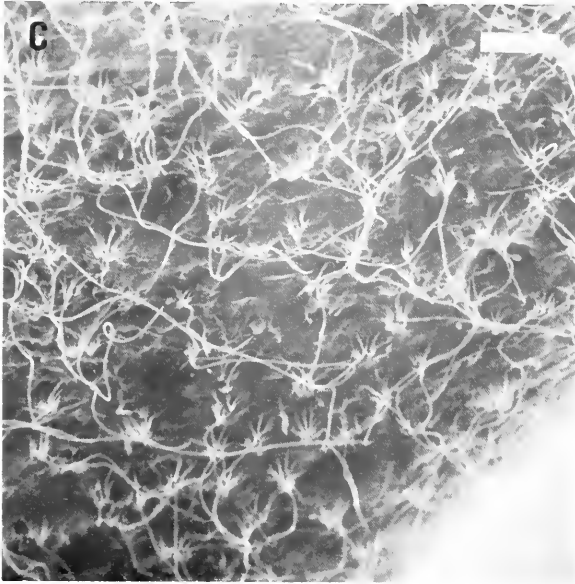

FIGURE 1. (Continued)

MATERIALS AND METHODS

Morphology of the gastrovascular system

Scanning electron microscopy (SEM) was used to describe the general morphology of the gastrovascular system of *A. cervicornis*. Specimens examined by SEM were prepared as described by Gladfelter (1982, 1983). Measurements of the volume occupied by certain parts of the gastrovascular system were made from petrographic thin cross-sections of the skeleton (made along the branch length) as described by Gladfelter (1982); spaces void of skeleton are occupied by the coelenteron of the gastrovascular system (Gladfelter, 1982). The total cross-sectional area of the axial corallite (calyx and theca) and the area of secondary radial growth was determined by direct measurement of 10 colonies (with 2–3 branches per colony).

Patterns and rates of fluid transport

Collection and maintenance of specimens. *Acropora cervicornis* was collected from a depth of 10–12 m in Buck Island Channel, adjacent to Teague Bay forereef, St. Croix, U. S. Virgin Islands. Straight branches, ca. 20 cm long, with a single axial corallite were removed from the colonies. Within 20 min of collection, the branches were transported submerged in a plastic tub filled with sea water to the West Indies Laboratory. The coral branches were placed in shaded outdoor aquaria supplied with fresh continuously flowing sea water. Corals were routinely allowed to acclimate for 24 h before measuring rates of fluid transport.

Detection of fluid transport. The fluorescent dye, fluorescein, was used to detect transport of fluids along the axis of a branch of *A. cervicornis*. For each experiment, 10–12 branches were brought into a darkened laboratory and allowed to acclimate in running sea water for 1 h prior to measurement. The temperature during all the measurements of rates of fluid movement was the same as that of the natural en-

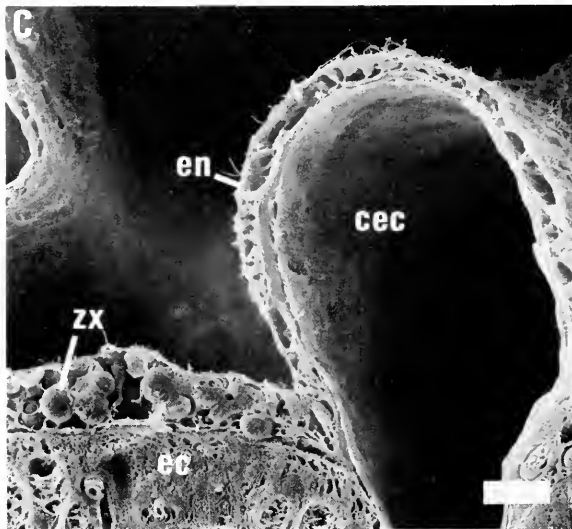
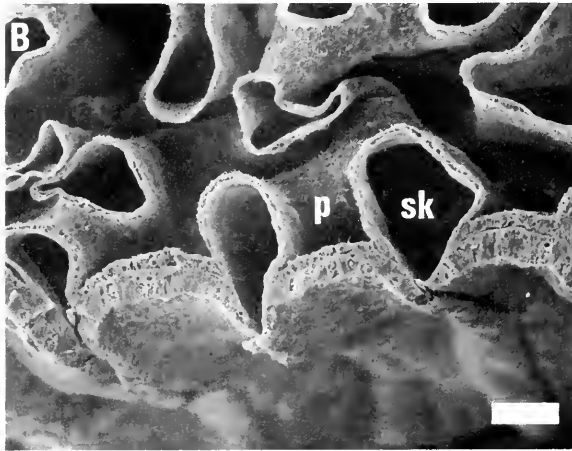
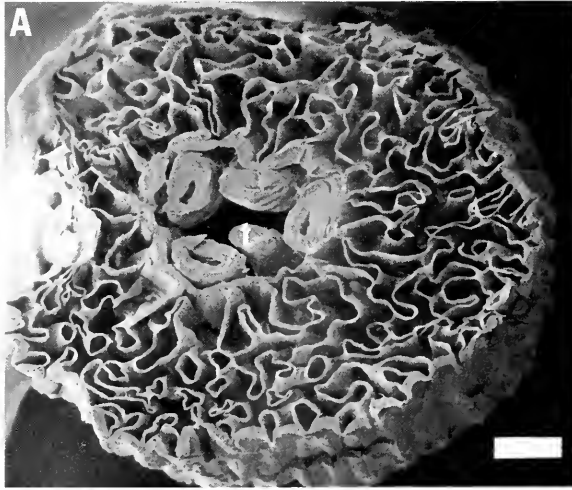

vironment, $27^{\circ} \pm 1^{\circ}\text{C}$. A single branch was placed horizontally in a plastic tub (90 cm \times 45 cm \times 23 cm) filled with sea water. A hypodermic syringe with a #26 needle was used to inject 0.05 ml of a saturated solution of fluorescein dye in sea water into a lateral polyp. The distance traveled by the moving dye front was measured each minute after the initial injection by observing the branch in the dark with an ultraviolet light. As a control, 3 coral branches were fixed in 10% buffered formalin, injected with fluorescein, and observed as described above. On some coral branches either the distal portion of the axial polyp or the proximal portion of the axial polyp was injected with fluorescein dye, and observed as described above.

RESULTS

Morphology of the gastrovascular system

Canals. The gastrovascular system of a branch of *Acropora cervicornis* is a series of interconnected large (ca. 1000 μm in cross-section) and small (ca. 100 μm in cross-section) canals. The largest canal in each branch is the portion of the coelenteron of the axial polyp within the calyx of the axial corallite (Fig. 1a, b); this is referred to as the axial canal. Slightly smaller are the somewhat radially oriented canals formed by the coelenterons of the lateral polyps within the lateral corallites. The smallest canals ramify through the porous skeleton (Figs. 2, 3a, b); the canals oriented axially and lying just beneath the outer ectoderm are referred to as peripheral canals. In the distal 5 mm of the branch, the canals within the wall of the axial corallite are the peripheral canals, but as the branch increases in diameter the canals just below the outer ectoderm, between the pseudocostae of the skeleton, serve in this capacity (Fig. 3). Petrographic thin cross-sections of the skeleton were used to determine the cross-sectional areas of component parts of the gastrovascular system. As the branch increases in girth by radial accretion of skeleton, the resulting secondary growth of skeleton contains both the coelenterons of the lateral polyps as well as small canals connecting the axially oriented canals (both peripheral and axial). The total cross-sectional area of the calyx (containing the axial canal) does not decrease significantly until ca. 30 cm from the tip, while the cross-sectional area of the combined peripheral canals increases several fold (Table I). The cross-sectional areas of the canals oriented radially, in the secondary radial growth of the skeleton increases from 0 cm^2 at the tip of the branch (where there is no radial growth) to a large cross-sectional area 30 cm from the tip (Table I).

Endodermal cells. The entire gastrovascular system is lined by flagellated endodermal cells (Figs. 1c, 2c, 4, 5). The flagella are ca. 200 nm wide and ca. 10–15 μm long; they are surrounded by a cirlet of ca. 10 membrane ridges (Fig. 4a, c) about 1 μm long and up to 200 nm above the surface of the membrane. Each endodermal cell appears to have 1 flagellum (Fig. 5). Zooxanthellae are located primarily in those endodermal cells which lie beneath the outer ectoderm (Figs. 1b, 2c, 5b) although

FIGURE 2. SEMs of a decalcified axial polyp, exposing a cross-section ca. 1 mm from the tip of a branch. a. Low magnification showing the entire axial polyp. The tentacles (t) are withdrawn into space left in the calyx of the corallite. The porous wall (*i.e.*, theca) of the corallite contains the ramifying canals of the peripheral unit of the fluid transport system. Lower edge is magnified in 2b. c. Scale bar = 250 μm . b. The ramifying canals of the peripheral unit (p) are located within the porous skeleton (sk), seen in this view as empty space after the removal of the mineral. Scale bar = 50 μm . c. Enlargement of 2b showing the tissue layers at the edge of the axial polyp: outer ectoderm (ec), calciblastic ectoderm (cec) and endoderm (en) which contains zooxanthellae (zx). Scale bar = 12.5 μm .

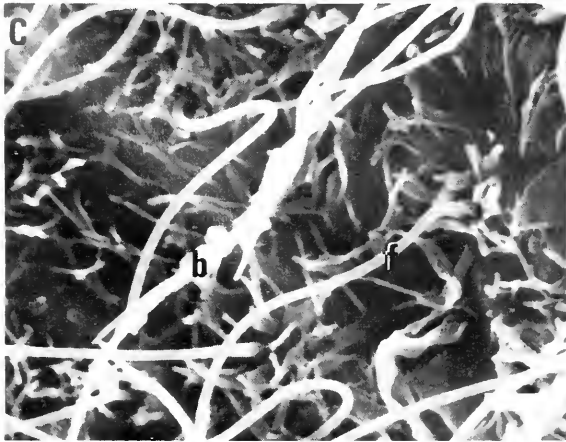
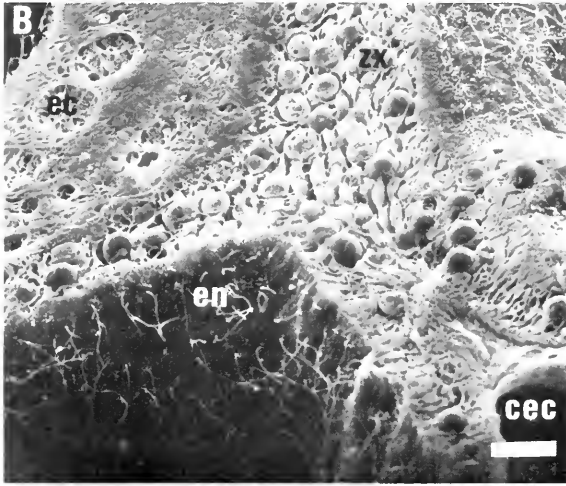
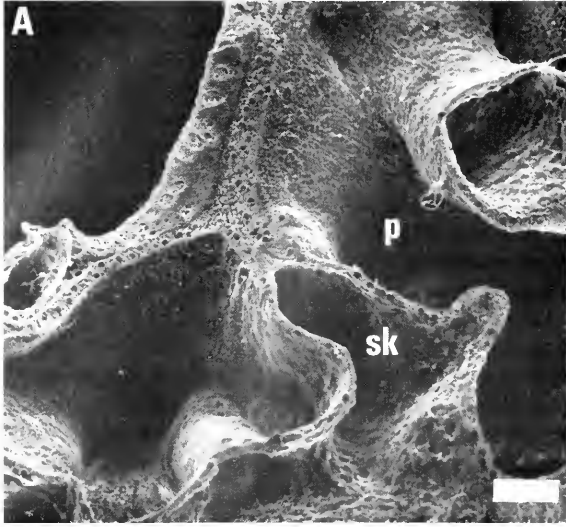

TABLE I

Cross-sectional area (cm²) of the components of the fluid transport system at different distances from the branch tip

Distance from tip (cm)	Axial unit-axial canal	Peripheral unit peripheral canals	Radial unit lateral canals
0	.020	.028	—
10	.016	.074	.30
20	.015	.105	.50
30	.008	.135	.90

occasionally they are found deeper within the colony. There appears to be one zooxanthella per cell (Fig. 5b).

The surface of the endodermal cells facing the coelenteron may have relatively few membrane projections (Fig. 4a) between flagella. However, there may be numerous folds projecting above the surface of the membrane, particularly in those cells containing zooxanthellae and lying adjacent to the outer ectoderm (Figs. 1c, 4c) or endodermal cells in the gastrovascular pockets of the distal portion of the axial polyp in the specimens fixed at night (*i.e.*, either 2400 or 0500; Fig. 4b). The surfaces of cell membranes in specimens fixed during the day (*i.e.*, 1100 and 1800) have fewer projections (Fig. 4a).

Endodermal cells at different sites in the gastrovascular system have different shapes. Cells at the distal tip of the axial corallite, at the distal end of the peripheral canals are columnar, *ca.* 12 μm tall and *ca.* 1 μm in diameter (Fig. 6a). Proximal to the tip, the shape of the endodermal cells becomes squamous (Fig. 6b), only a few μm tall, and *ca.* 10 μm in diameter; by 200 μm below the distal tip, most of the endodermal cells lining the canals of the gastrovascular system have this shape. The exceptions are cells containing zooxanthellae; these cells, lying beneath the outer ectoderm and lining the peripheral canals (Figs. 2c, 3b) are tall (*ca.* 12 μm) and broad (*ca.* 10 μm). There is a large subepidermal space in the endoderm (Fig. 5a, b); it is more noticeable where cells are not occupied by zooxanthellae.

The distal end of a peripheral canal has a high density of flagella. This is due to the columnar shape of the cells, with a correspondingly small membrane surface (containing one flagellum per cell) facing the coelenteron (Fig. 7).

In this study the digestive role of the gastrovascular system was not investigated; nevertheless, certain observations can be made from SEMs. As noted above, numerous projections, microvilli, often vastly increase the surface area of the endodermal cell membrane. Foreign particles were found in contact with these microvilli (Fig. 4b, c). In several SEM preparations, particulate matter was present in the canals of the gastrovascular system. In one case the particulate matter was a mass of unidentifiable smaller particles (perhaps partially decomposed food) entangled by flagella (Fig. 7a,

FIGURE 3. SEMs of the outer edge of a decalcified branch, exposing a tangential section located 45 cm from the tip. a. View of peripheral canals (p) between pockets left after the dissolution of the pseudocostae of the skeleton (sk). Scale bar = 50 μm . b. Higher magnification of 3a, showing the configuration of the tissue layers at the edge of the branch, labeled as in Figure 2. The label, en, is located in the approximate region magnified in 3c. Scale bar = 12.5 μm . c. View of the membrane surface of endodermal cells lining the coelenteron. Note the flagella (f) and numerous small projections of the membrane surface. Small particles, possibly bacteria (b) are also seen on the surface. Scale bar = 1.3 μm .

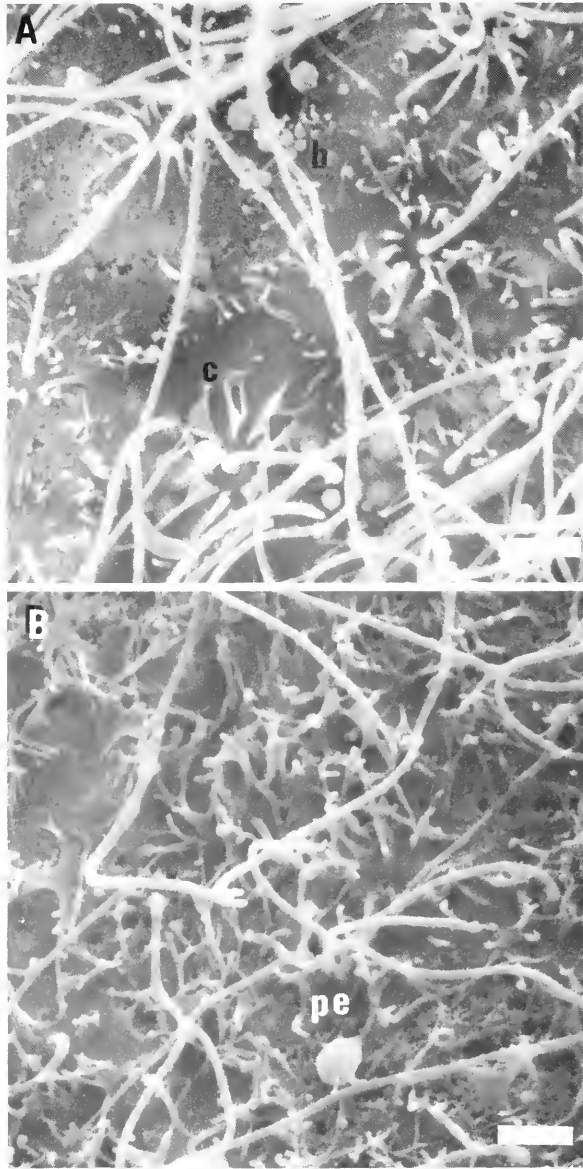

FIGURE 4. SEMs of endodermal cells, showing the surfaces of the membranes which face the coelenteron. Scale bar = 1.3 μ m. a. Endoderm located in a gastrovascular pocket at the tip of the axial polyp; specimen fixed at 1500. Note circlet (e) of projections surrounding each flagellum and foreign particles, possibly bacteria (b) on the surface. b. Endoderm located in a gastrovascular pocket at the tip of the axial polyp; specimen fixed at 0500. Note the possible phagocytic event (pe). c. Endoderm located beneath outer ectoderm, 30 mm from branch tip. These cells contain zooxanthellae. Note the possible phagocytic event (pe).

b). In another case a mass of zooxanthellae plus some smaller objects (perhaps bacteria) were attached to the wall of a canal. In freshly collected coral tips, viewed with a 50 \times dissecting microscope, free zooxanthellae were observed in the peripheral canals at the tip of the branch.

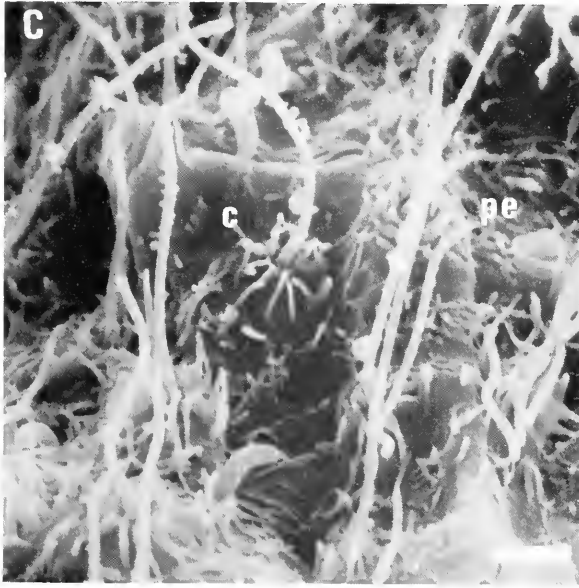

FIGURE 4. (Continued)

Patterns and rates of fluid transport

To detect the pattern and rate of flow in the gastrovascular system, fluorescein dye was injected into the system via a lateral polyp. Initially, just after the injection ($t = 0$), dye extended 0.7 cm proximally and 0.3 cm distally from the injected polyp. Usually the dye moved in both directions from the point of injection; distance traveled was measured each minute. The rate of movement was determined from the slope of a linear regression, plotting distance *versus* time; the coordinates at $t = 0$ were 0.7 cm for the proximal rate and 0.3 cm for the distal rate. In 75% of the trials the initial dye movement was in a right hand helical direction. The dye front moving proximally appeared fainter than that moving distally.

To determine if rate or pattern of flow was affected by distance from the branch tip, corals were injected at either 3 cm, 7 cm, or 10 cm proximal to the tip. To determine the effect of light on transport of fluids, some corals were maintained under daylight fluorescent light (750 ft candles), except during the $10 \text{ s} \cdot \text{min}^{-1}$ when the room was darkened to observe the position of the fluorescein visible under ultraviolet light. All determinations of the rate of transport as affected by distance from tip or by light were made between 1000 and 1500. The results of these experiments are shown in Tables II and III. The rate of flow was greater in the proximal direction than in the distal direction in 83% of the branches measured (Table II). This proportion is significantly different than expected if there were no difference in the rates in the two directions ($P < 0.005$, $\chi^2 = 92.1$). Table II also shows that neither light nor distance from tip affected pattern of flow, *i.e.*, proximal was greater than the distal rate.

Table III shows that rate of both proximal and distal flow was not significantly altered (as determined by *t*-tests between the means) by either distance from the tip or by the presence of light; *i.e.*, for each direction (*e.g.*, proximal) and each distance from the tip (*e.g.*, 3 cm) the dark value for rate ($2.11 \text{ cm} \cdot \text{min}^{-1}$) is virtually the same

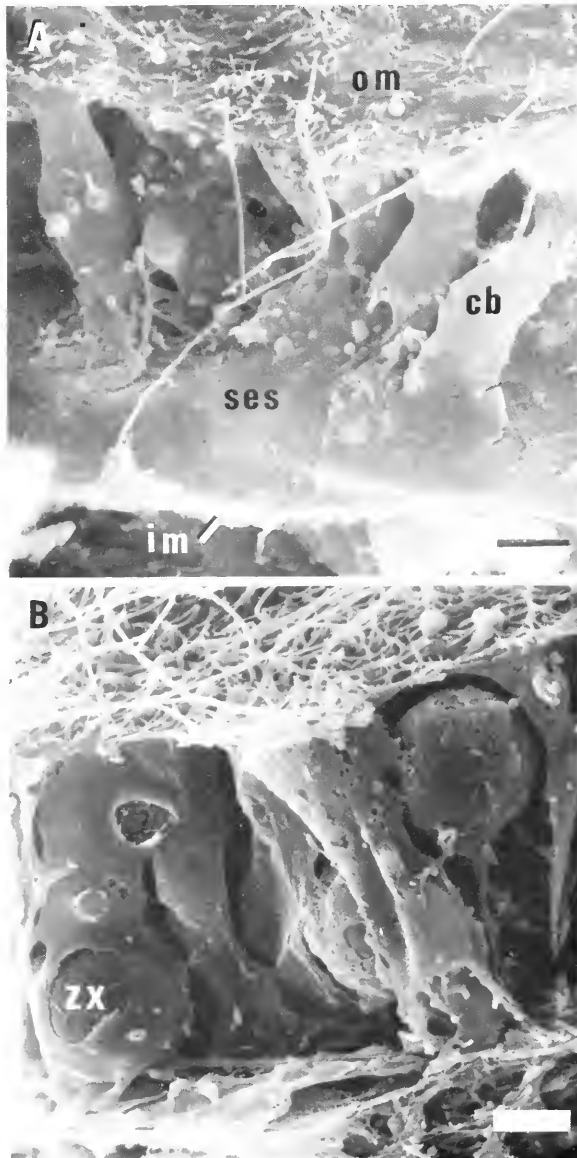

FIGURE 5. SEMs of endoderm: cross-section through the tissue layer exposing flagellated outer membrane surface (om) facing the coelenteron, body of the endodermal cells (cb), subepithelial space (ses), and inner membrane (im) adjacent to the mesoglea. Scale bar = $2.5 \mu\text{m}$. a. Endoderm located in gastrovascular pockets near the tip of the axial polyp. The cells do not contain zooxanthellae. There is one flagellum per cell. b. Endoderm located adjacent to outer ectoderm 10 mm from the tip of the axial polyp. These cells do contain zooxanthellae (zx).

as the light value ($2.10 \text{ cm} \cdot \text{min}^{-1}$) and the range of values in the proximal direction (1.72–2.14) found in the three distances from the tip are not statistically different. However, the mean rate of flow is significantly greater in the proximal than in the

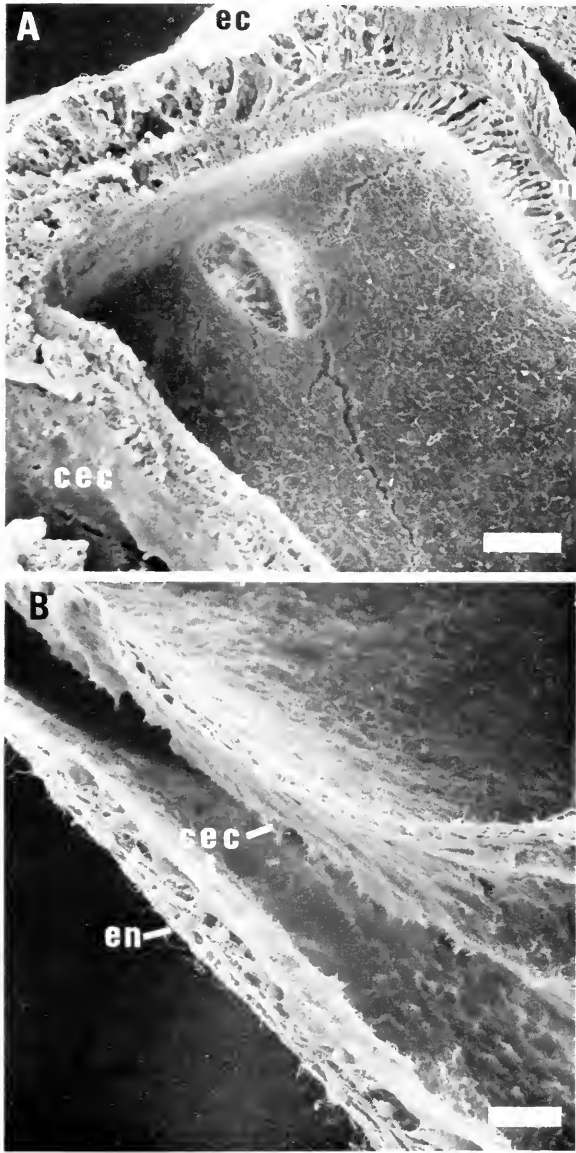

FIGURE 6. SEMs of longitudinal sections through a decalcified axial polyp, showing differences in morphology of endodermal cells from different locations. a. Gastrovascular pocket is located near the tip of the axial polyp with an opening to an adjacent pocket. Outer ectoderm (ec) covers the distal tip and is separated by mesoglea (m) from the calicoblastic ectoderm (cec) and endoderm (en). b. View *ca.* 300 μm from the tip showing the change in the shape of cells of the endoderm (en) and the calicoblastic ectoderm (cec) from columnar (see 7a) to squamous.

distal direction ($P < 0.001$, $F = 43.51$, ANOVA) under all conditions tested (Table III).

About 1 h after the termination of a series of measurements, the coral branches had expelled the fluorescein dye from all portions of the colony. The dye remained

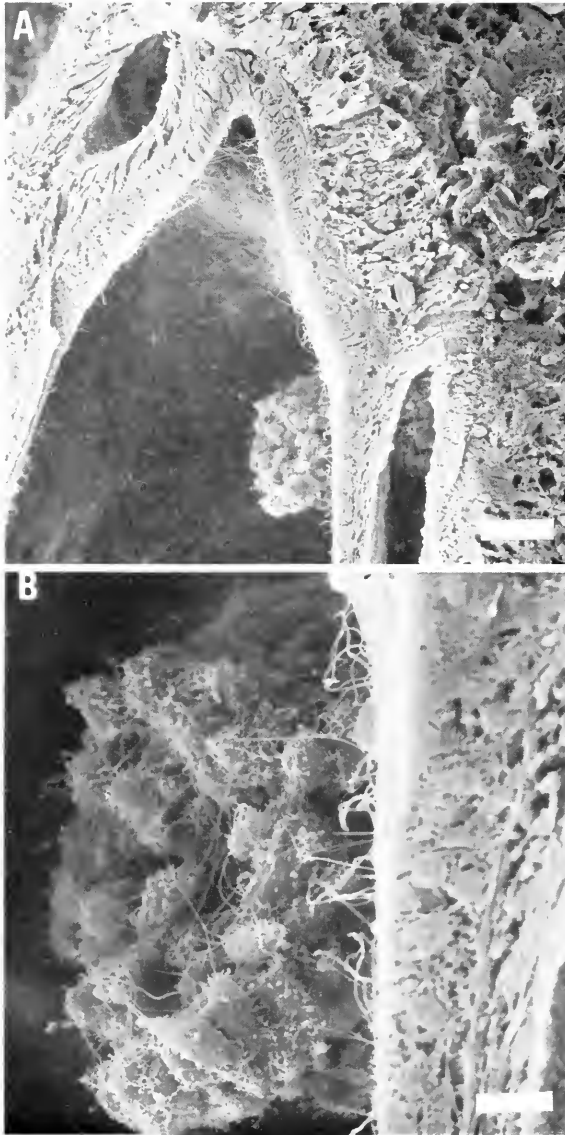

FIGURE 7. SEM of a decalcified axial polyp. a. A gastrovascular pocket located at the tip of the polyp. Note higher density of flagella towards the tip of the pocket. Also note the bolus of foreign material in the canal of the peripheral unit. Scale bar = 25 μm . b. Higher magnification of bolus in 7 a. Scale bar = 6 μm .

as a "cocoon" in the coral mucus surrounding each branch until the branches were rinsed and replaced in an aquarium with fresh flowing sea water.

To determine if rates or pattern of flow varied with time of day, one set of coral branches were monitored every 3 h, from 1200 on one day up to and including 1200 on the following day. A second set of corals were monitored *ca.* every 3 h from 1000 to the following 0130. The results are presented in Figure 8. The rate of fluid flow

TABLE II

Summary of the direction of fluid movement in the peripheral unit of individual branches¹

Distance from tip (cm)	Dark (D) or Light (L)	No. of trials	Pr > Di		Pr = Di		Pr < Di	
			#	%	#	%	#	%
3	D	31	25	81	2	7	4	13
	L	13	10	77	2	15	1	8
7	D	21	17	82	1	5	3	14
	L	5	5	100	0	0	0	0
10	D	5	4	80	1	20	0	0
	L	26	22	85	3	12	1	4
Total no. trials		101	83		9		9	
% of total trials				83		9		9

¹ Data presented are the number of trials in which the rate of movement of the dye front was greater in a preferred direction (*i.e.*, distal, Di or proximal Pr) or equal in both directions (within 0.1 cm · min⁻¹).

in the proximal direction was always greater than that in the distal direction, confirming the results presented above. There was, however, a diel pattern in the rate of fluid transport. Highest rates occurred between 2400 and 0900, with a rapid decline in the rate of flow at mid-morning to the low between 1000–1200 until about 1800 when the flow rates began a gradual increase to the early morning peak.

No movement of fluid occurred in the control branches which had been fixed in formalin.

All measurements of fluid transport described above refer to observations of dye moving in an axial orientation (either proximal or distal) just beneath the surface of the outer ectoderm of the colony. To determine the rate and direction of fluid movement in the axial core of a branch, several approaches were taken. The first was to observe the time at which dye injected into a lateral polyp was first observed in the proximal portion of the axial polyp exposed on the open portion of a branch. The second approach involved directly injecting the axial polyp and noting the time at which the dye reached the proximal end of the axial polyp. Finally the distal tip (*ca.* 2 cm) of a coral branch injected either via a lateral polyp or via the proximal end

TABLE III

Rate of fluid movement (cm/min) in peripheral canals in the proximal (Pr) and distal (Di) direction as affected by distance from branch tip and illumination (L, light; D, dark)

Distance from tip (cm)	Dark (D) or Light (L)	Proximal			Distal		
		\bar{x}	S.D.	n	\bar{x}	S.D.	n
3	D	2.11	0.64	30	1.35	0.54	31
	L	2.10	0.78	14	1.58	0.74	13
7	D	1.72	0.82	21	1.02	0.44	20
	L	1.90	0.80	5	1.05	0.21	5
10	D	2.14	0.56	5	1.28	0.40	5
	L	2.08	0.71	26	1.37	0.33	26

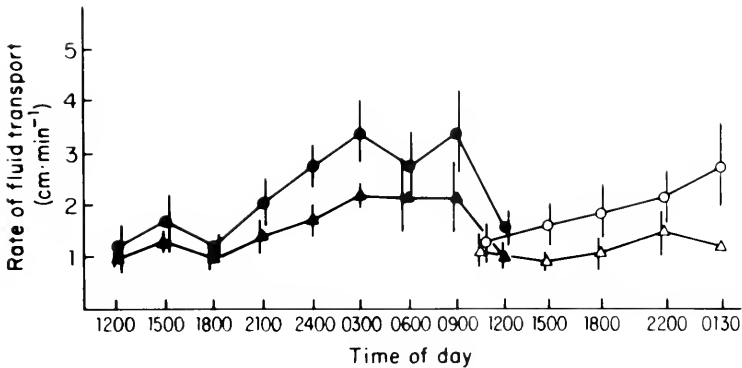

FIGURE 8. Diel patterns of the rate of fluid movement in the peripheral unit of the gastrovascular system. Each point represents data from 12 coral branches; closed points are from the second set. Values plotted are the mean of 12 measurements and the 95% confidence limits. Proximal flow is indicated by circles; distal flow is indicated by triangles.

of the axial polyp was broken so that dye moving distally in the axial polyp could be detected. The results of these investigations are summarized in Table IV. Dye injected into either the axial polyp or a lateral polyp was first observed at the center of the broken proximal end of the branch (in the axis) and later at the edges (*i.e.*, circumference) of the proximal end of the branch. Fluid transport in the distal direction in the axial canal was never observed. Rate of fluid conduction in the axial canal was always 2–3 times greater than the rate of fluid transport just beneath the outer ectoderm. Dye was never seen in the area between the periphery and the axis, indicating that the canals in this area served mainly for radial conduction of fluids. Some of the dye injected into a lateral polyp is transported to the axial polyp, and some of the dye injected into the axial polyp is transported to the periphery.

TABLE IV

Summary of rate and direction of fluid movement in the axial canal

n	Position of injection	Position of dye after transport	Rate (cm · min ⁻¹)	
			\bar{x}	S.D.
5	axial polyp (distal)	axial canal-proximal end	11.4	10.7
		peripheral canal-proximal end	rate not measured, but dye present	
5	axial canal (proximal)	axial canal-distal end	NEVER observed	
		peripheral canals	1.9	0.6
17 tips*	lateral polyp, 5 cm from tip	axial canal-distal end	NEVER observed	
		axial canal-proximal end	6.5	2.2
		peripheral canals	range (3.4–9.9)	
			see Figure 8	
			range (1–3)	

* 74 trials.

DISCUSSION

The fluid transport system of *Acropora cervicornis* consists of the canals of the gastrovascular system. These canals conduct fluids axially along a branch and radially between the periphery and axis of the branch. Two units, peripheral (P) and axial (A) are responsible for conduction along the axis of a branch. The peripheral unit consists of small peripheral canals. It conducts fluid proximally and distally. The axial unit consists of the large axial canal. It differs in two respects from the peripheral unit: 1) flow is always in the proximal direction and 2) the rate of flow is 2–3 times greater. The peripheral and axial units are connected by a radially conducting unit consisting of the canals of the lateral polyps and smaller short canals within the radial secondary growth of the skeleton. This radial unit can conduct fluids both towards and away from the branch axis. Fluid moving from the outside medium into the gastrovascular system was never directly observed. The “cocoon” of mucus with expelled dye which surrounds the entire coral branch *ca.* 1 h after the injection of the dye suggests that exchange of gastrovascular fluid with the outside medium occurs via all the lateral polyps and perhaps the axial polyp as well.

The mechanism of fluid propulsion is probably flagellar action. Musgrave (1909) described a ciliated canal system in a pennatulid, and suggested that it functioned in intracolony transport of fluids. Parker (1920) observed that circulation in *Renilla* followed a specific route. Thus, the idea of a circulatory system in colonial cnidarians, with fluid propelled by cilia has been in the literature for a number of years. In *A. cervicornis* the flagella are short (10–15 μm) like cilia, but since there is only one per cell, the conventional terminology employed by Robson (1957) will be used in this discussion. In references to past literature, when the term “ciliated canals” is used, I will refer to the tubules in that form.

The fluid transport system operates under low Reynolds numbers; the Reynolds number of the axial transport unit (A) and the peripheral unit (P; and p, for one canal in the unit) can be calculated (Alexander, 1968):

$$\text{Re} = \rho ua / \eta$$

where

ρ = density of fluid

u = velocity of fluid

a = radius of canal

η = viscosity of fluid; and

$\eta/\rho = \nu$ = kinematic viscosity = $10^{-2} \text{ cm}^2 \cdot \text{s}^{-1}$

$u_A = 10^{-1} \text{ cm} \cdot \text{s}^{-1}$; $u_P = 3 \times 10^{-2} \text{ cm} \cdot \text{s}^{-1}$

$a_A = 5 \times 10^{-2} \text{ cm}$; $a_P = 5 \times 10^{-3} \text{ cm}$

so that

$$\text{Re}_A = 5 \times 10^{-1} \text{ and } \text{Re}_P = 1.5 \times 10^{-2}.$$

Since a Reynolds number of >2000 is necessary to produce turbulent flow (Vogel, 1981), the fluids in the gastrovascular system of *A. cervicornis* have a laminar flow.

Roosen-Runge (1967) described a very similar system in the circulation of fluids in the canals of a small hydromedusa, *Phialidium* sp. He observed rates of flow *ca.* $100 \mu\text{m} \cdot \text{s}^{-1}$ in canals with radii of $25 \mu\text{m}$. Using these values and the Poiseuille equation he concluded that the circulatory system of the medusa was operating at pressures of .12 mm-Hg. Unfortunately, Poiseuille's equation cannot be applied in a

situation in which fluid is propelled by flagella because Poiseuille's equation depends on a pressure differential and assumes that "the fluid velocity at the edge of the tube is zero" (Feigl, 1974). In ciliated tubes the "pump" is located all along the length of the tube and the flow velocity profile is reversed from that seen in Poiseuille flow (Vogel, 1981). A fluid flow profile normal to a ciliated wall shows a maximum velocity *ca.* 2 cilia lengths from the ciliated wall with a decrease in velocity to zero at 10 cilia lengths from the ciliated surface (Cheung and Winet, 1975). In a tube lined with cilia, each of whose length is 20% of the radius of the tube, the flow velocity profile is almost flat due to the combined effect on water particles from cilia located on opposite sides of the tube (Gray, 1928). A peripheral canal of *Acropora cervicornis* presents such a situation. The length of a flagellum is *ca.* 25% of the radius of the canal. In fluid flow along this type of canal, the most important force is tangential, the wall shear stress (Brennan and Winet, 1977). Descriptions of fluid flow in ciliated tubes have largely been confined to mucociliary systems. Even in these accounts there are not enough sufficient observations or quantitative information to adequately describe the hydrodynamics of flow (Brennan and Winet, 1977). Perhaps the two dimensional model, Couette flow (R. Kelly, pers. comm.), describing a wall moving in relation to a fluid in which tangential force is the most important component affecting the velocity profile, is most applicable.

In the axial canal of *A. cervicornis*, flow induced by flagellar beating would produce a flow velocity profile decreasing from a maximum velocity 2 flagellar lengths from the wall to a velocity of zero at 10 flagellar lengths from the wall. If flagella are the only propulsive force, then fluid in the center of the axial canal would be stationary, since 10 flagellar lengths is equal to about 130 μm from the wall while the radius of the axial canal is 500 μm . Whether the central fluid is stationary or whether some other force moves this fluid cannot be ascertained from this study.

In the canals of the medusa, *Phialidium* sp. (Roosen-Runge, 1967), muscular action could affect the direction, and sometimes the rate of flow, but the flagella were the main driving force. Brafield (1969) concluded that in the pennatulid, *Pteroides* sp., the peristaltic muscular contractions were the most important driving force in the circulation of fluids throughout that colony. In *Acropora cervicornis*, muscular action probably plays no role because the canals of the gastrovascular system are set at a fixed size due to their position, embedded in a rigid skeleton.

In Roosen-Runge's study (1967) he observed the actual movements of particles within the canals and he was able to discern that flow could proceed in opposite directions in the same canal. This might provide an explanation for the observation that the peripheral unit of *A. cervicornis* can carry fluids in two directions at the same time. In an analysis of a stationary protozoan, Cheung and Winet (1975) found flow velocity profiles showing a backflow of fluid between a ciliated wall and up to 0.5 cilia lengths from the wall, with the maximum forward velocity occurring at 2 cilia lengths from the wall. If this pattern occurs in a peripheral canal of *A. cervicornis*, it could be the mechanism by which flow could proceed in the opposite direction in the same tube. In systems operating under low Reynolds numbers, such as cnidarian circulatory systems, the fluids act very viscous. Consequently, very little mixing of adjacent streams need take place (Vogel, 1981). In these peripheral canals, a large surface area relative to that of the axial canal, presents a site for exchange of dissolved and particulate matter. The cell membranes of the endodermal cells lining the peripheral canals are often highly folded, and phagocytic events can be observed in SEMs.

Pearse and Muscatine (1971) and Taylor (1977) demonstrated that soluble organic molecules and inorganic ions are transported distally to the growing tip of *Acropora*

cervicornis. Other investigators found that only after a short time (30 min) can radioactive food fed to a colonial cnidarian polyp be detected in adjacent polyps (Rees *et al.*, 1970; Murdock, 1978a, b). Furthermore, Rees *et al.* state that in a growing hydroid colony, "radioactive food fed to the terminal hydranth seemed to be preferentially utilized by the growing regions." Thus, it is not surprising that the growing tip of *A. cervicornis* (ca. $300 \mu\text{m} \cdot \text{day}^{-1}$; Gladfelter, 1982) serves as a "sink" for soluble organic material and Ca^{++} , required for the development of the axial polyp and the skeleton (Pearse and Muscatine, 1971; Taylor, 1977). The role of the gastrovascular system in removing materials from the growing tip has not been investigated. Several hypotheses to explain light enhancement of calcification depend on the removal of substances from the sites of crystal deposition (*e.g.*, Goreau, 1959; Simkiss, 1964; Gladfelter, 1983); the role of the fluid transport system in effecting removal of materials is unknown.

To resolve some of the questions concerning calcification it would be useful to know the chemical properties of the fluid in the gastrovascular system. Obviously, most useful would be data on the chemical composition of fluids outside the calciblastic ectoderm, *i.e.*, just adjacent to the developing skeleton, but these data are extremely difficult to obtain, even in relatively large volume reservoirs such as the extrapallial fluids of molluscs (Simkiss, 1982). Additionally, it would be useful to know the rate of exchange of fluids between the gastrovascular system and the external medium. On one hand, if the gastrovascular system serves to distribute soluble organic matter throughout the colony to sites which can use it as an energy source or as precursor molecules, it would be disadvantageous to rapidly exchange the gastrovascular fluid for sea water. The zooxanthellae can serve to clean the system of metabolic wastes, as they effectively remove ammonia (Muscatine, 1980) and probably other materials as well. However, at some point, the fluid in the gastrovascular system would become depleted of such things as calcium ions, which the colony needs for extension of its skeleton as well as increasing the strength of the skeleton by subsequent infilling of pores (Gladfelter, 1982).

To summarize, the gastrovascular system of *Acropora cervicornis* serves as a circulatory system, characterized by: (1) two units (axial and peripheral) conducting fluids by means of flagella along the axis of the branch; (2) a low Reynolds number, leading to laminar flow; (3) a predictable diel pattern in the rate of flow in the peripheral unit; and (4) no change in the rate of flow due to light.

ACKNOWLEDGMENTS

I would like to thank W. B. Gladfelter for helpful field assistance and suggestions during the course of this study, L. Muscatine for encouragement and editorial comments, and N. Merrell for initially developing the technique used to observe fluid flow. R. Trench, P. Nobel, and R. Kelly provided valuable suggestions to improve the discussion.

This study was partially funded by a Biomedical Research Support Grant (NIH) to UCLA and the Chancellor's Patent Fund of UCLA. I wish to thank the West Indies Laboratory of Fairleigh Dickinson University, particularly the past and present directors, R. F. Dill and J. C. Ogden, for the use of its facilities. I also wish to thank S. Bedlyar and J. Berliner for the use of the SEM facility in the School of Medicine at UCLA. Support during the final year of this study was provided through the Meta McBride Haupt Dissertation Fellowship from the American Association of University Women.

This paper is West Indies Laboratory Contribution #99.

LITERATURE CITED

- ALEXANDER, R. M. 1968. *Animal Mechanics*. University of Washington Press, Seattle. 346 pp.
- BRAFIELD, A. E. 1969. Water movements in the pennatulid coelenterate *Pteroides griseum*. *J. Zool., Lond.* **158**: 317-325.
- BRENNEN, C., AND H. WINET. 1977. Fluid mechanics of propulsion by cilia and flagella. *Ann. Rev. Fluid Mech.* **9**: 339-398.
- CHEUNG, A. T. W., AND H. WINET. 1975. Flow velocity profile over a ciliated surface. Pp. 223-234 in *Swimming and Flying in Nature*. T. Y-T. Wu, C. J. Brokaw, and C. Brennen, eds. Plenum Press, New York.
- FEIGL, E. O. 1974. Physics of the cardiovascular system. Pp. 10-22 in *Physiology and Biophysics II*, T. C. Ruch and H. D. Patton, eds. W. B. Saunders, Co., Philadelphia.
- GLADFELTER, E. H. 1982. Skeletal development in *Acropora cervicornis*: I. Patterns of calcium carbonate accretion in the axial corallite. *Coral Reefs* **1**: 45-51.
- GLADFELTER, E. H. 1983. *Skeletal development and related aspects of the reef coral Acropora cervicornis*. Ph.D. dissertation, University of California, Los Angeles.
- GOREAU, T. F. 1959. The physiology of skeleton formation in corals. I. A method for measuring the rate of calcium deposition by corals under different conditions. *Biol. Bull.* **116**: 59-75.
- GOREAU, T. F., AND N. I. GOREAU. 1959. The physiology of skeleton formation in corals. II. Calcium deposition by hermatypic corals under various conditions in the reef. *Biol. Bull.* **117**: 239-250.
- GRAY, J. 1928. *Ciliary Movement*. The University Press, Cambridge. 162 pp.
- MURDOCK, G. R. 1978a. Digestion, assimilation, and transport of food in the gastrovascular cavity of a gorgonian octocoral (Cnidaria: Anthozoa). *Bull. Mar. Sci.* **28**(2): 354-362.
- MURDOCK, G. R. 1978b. Circulation and digestion of food in the gastrovascular system of gorgonian octocorals (Cnidaria: Anthozoa). *Bull. Mar. Sci.* **28**(2): 363-370.
- MUSCATINE, L. 1980. Uptake, retention and release of dissolved inorganic nutrients by marine alga-invertebrate associations. Pp. 229-244 in *Cellular Interactions in Symbiosis and Parasitism*, C. B. Cook, P. W. Pappas, and E. D. Randolph, eds. Ohio State University Press, Columbus.
- MUSGRAVE, E. M. 1909. Experimental observations on the organs of circulation and powers of locomotion in pennatulids. *Q. J. Microsc. Sci.* **54**: 443-482.
- PARKER, G. H. 1920. Activities of colonial animals. I. Circulation of water in *Renilla*. *J. Exp. Zool.* **31**: 342-367.
- PEARSE, V. B., AND L. MUSCATINE. 1971. Role of symbiotic algae (zooxanthellae) in coral calcification. *Biol. Bull.* **141**: 350-363.
- REES, J., L. V. DAVIS, AND H. M. LENHOFF. 1970. Paths and rates of food distribution in the colonial hydroid *Pennaria*. *Comp. Biochem. Physiol.* **34**: 309-316.
- ROBSON, E. A. 1957. The structure and hydrodynamics of the musculo-epithelium in *Metridium*. *Q. J. Microsc. Sci.* **98**(2): 265-278.
- ROOSEN-RUNGE, E. C. 1967. Gastrovascular system of small hydromedusae: Mechanisms of circulation. *Science* **156**(3771): 74-76.
- SIMKISS, K. 1964. Phosphates as crystal poisons. *Biol. Rev.* **39**: 487-505.
- SIMKISS, K. 1982. Mechanisms of mineralization (normal). Pp. 351-366 in *Biological Mineralization and Demineralization*, G. H. Nancollas, ed. Springer-Verlag, New York.
- TAYLOR, D. L. 1977. Intra-colonial transport of organic compounds and calcium in some Atlantic reef corals. *Proc. 3rd Int'l Coral Reef Symp.* **1**: 431-436.
- VOGEL, S. 1981. *Life in Moving Fluids*. Willard Grant Press, Boston. 352 pp.
- WELLS, J. W. 1956. Scleractinia. Pp. 328-444 in *Treatise in Invertebrate Paleontology*, R. C. Moore, ed. Geol. Soc. of Am. and University of Kansas Press.

SURVIVAL, GROWTH, AND BEHAVIOR OF THE LOLIGINID SQUIDS
LOLIGO PLEI, *LOLIGO PEALEI*, AND *LOLLIGUNCULA BREVIS*
(MOLLUSCA: CEPHALOPODA) IN CLOSED SEA WATER SYSTEMS

ROGER T. HANLON, RAYMOND F. HIXON, AND WILLIAM H. HULET

*The Marine Biomedical Institute, The University of Texas Medical Branch,
200 University Boulevard, Galveston, Texas 77550-2772*

ABSTRACT

Over 1200 squids were captured by night lighting, trawling, or seining in the northern Gulf of Mexico for laboratory maintenance. Two types of recirculating sea water systems were designed and evaluated: a 2 m circular tank (1500 liter capacity) and a 10 m long raceway (10,000 liters). Mean laboratory survival was: *Loligo plei* (12 to 252 mm mantle length, ML) 11 days, maximum 84 days; *Loligo pealei* (109 to 285 mm ML) 28 days, maximum 71 days; *Lolliguncula brevis* (27 to 99 mm ML) 19 days, maximum 125 days. Smaller squids showed significantly poorer survival than larger ones. All squids fed well on a variety of live estuarine fishes and shrimps. Growth rates depended upon stage of maturity. The highest rates were *Loligo plei* 59 mm/month (23.8 g/mo), *Loligo pealei* 77 mm/mo (67.3 g/mo), and *Lolliguncula brevis* 31 mm/mo (17.2 g/mo). General aspects of behavior and body patterning were species-specific and were useful indices of the squids' condition. Key factors for laboratory survival were (1) prevention of skin damage, (2) tank systems with sufficiently large horizontal dimensions, (3) high quality water, (4) ample food supply, (5) no crowding, (6) maintaining squids of similar size to reduce aggression and cannibalism, and (7) segregating sexes to reduce aggression associated with courtship, mating, and egg laying.

INTRODUCTION

Pelagic, schooling squids of the Order Teuthoidea are powerful swimmers that forage over great distances in coastal and open-ocean waters. These dynamic predators, with their highly developed organ systems, are of great interest and use to the scientific community, mainly because they have a network of giant axons that mediates a simultaneous contraction of the mantle for jet-propulsed swimming from predators. Historically, researchers have experienced difficulty in collecting and maintaining these animals alive in captivity, due primarily to damage of the delicate squid skin during capture, transport, and maintenance. Over the past ten years, considerable progress has been made in identifying and resolving problems associated with keeping squids alive under laboratory conditions. Since 1975 we have reviewed, tested, and refined many techniques for the capture and maintenance of squids, with the ultimate goal of supplying neuroscience investigators at The University of Texas Medical Branch with live squids. We present here our capture, transport, and maintenance methodology, the design of our closed sea water systems, and we describe the survival, growth, and general aspects of behavior of squids maintained in these systems.

Three loliginid squid species (Suborder Myopsida, Family Loliginidae) are commonly found on the continental shelf in the northern Gulf of Mexico near Galveston: the tropical arrow squid *Loligo (Doryteuthis) plei* Blainville, 1823, the common long-finned squid *Loligo pealei* Lesueur, 1821, and the bay or brief squid *Lolliguncula brevis* (Blainville, 1823). Aspects of the areal and bathymetric distribution of these species are described by Rathjen *et al.* (1979), Hixon (1980a) and Hixon *et al.* (1980). *Loligo plei* and *L. pealei* in the Gulf of Mexico attain maximal reported sizes of 297 mm and 285 mm mantle length (ML), respectively (Rathjen *et al.*, 1979; Hixon, 1980a; Hixon *et al.*, 1980), and they are well-established experimental models, primarily for studies of the giant fiber system (*cf.*, Rosenberg, 1973; Arnold *et al.*, 1974; DiPolo, 1976; Tasaki, 1982). *Lolliguncula brevis* is a smaller species, maximal 107 mm ML, that has potential for a variety of scientific applications (Hulet *et al.*, 1980; Hendrix *et al.*, 1981).

MATERIALS AND METHODS

Capture

Field collections were made from two University of Texas research vessels, the 16 m stern trawler R/V ERIN LEDDY-JONES and the 12 m R/V VIRGINIA BLOCKER. The R/V ERIN LEDDY-JONES was equipped for bottom trawling and for night lighting with three quartz iodide lamps controlled by rheostats (Fig. 1). One 1000-watt lamp was mounted on the stern A-frame, and two 500-watt lamps were located on either side of the rigging amidships. The R/V VIRGINIA BLOCKER was used for night lighting only. It deployed two portable 500-watt lamps astern or a 500-watt underwater mercury vapor lamp.

Great emphasis was placed on obtaining squids by methods that imparted little or no skin damage, particularly to the fins (Hulet *et al.*, 1979). Both species of *Loligo* were captured alive by attracting them to bright lights at night and dipnetting them onboard. Squid jigs were often used at night-light stations to lure squids to the surface where they were more easily dipnetted. The dipnets were 3 or 5 m-long aluminum poles attached to a 46 cm-diameter stainless steel hoop with a shallow net made of soft 1.3 cm ($\frac{1}{2}$ inch) knotless nylon mesh. Every effort was made to handle the squids briefly and gently. After dipnetting, squids were immediately immersed into a shipboard sea water transport tank so that their water-to-air-to-water transfer lasted only several seconds.

Lolliguncula brevis was captured by bottom trawling and beach seining. Trawl durations were very short (5 to 15 minutes) and in shallow water (3 to 10 m) in and around Galveston Bay, so that residence time in the net was short and squids were not tightly compressed in the codend for long periods. Forward speed of the vessel was reduced during trawl retrieval and only the codend was swung onboard, placed in water, and the squids quickly placed by hand into transport tanks. Several trawl nets were used, including a 9.1 m-wide (length of foot rope) semi-balloon trawl, a 3.0 m-wide shrimp try net, and 3.0 m-, 6.4 m- or 9.1 m-wide box trawls constructed by Marinovich Trawl Co. (Biloxi, Mississippi). The semi-balloon trawl and the try net were made of 3.8 cm stretch mesh nylon netting with a codend inner liner of 1.3 cm mesh knotless nylon netting. The box trawls were constructed entirely with knotless nylon netting (1.9 and 1.3 cm mesh) and were fitted with stainless steel hoops in the codend. Beach seining for *Lolliguncula brevis* took place at night in summer on the bay side of Galveston Island. Short tows (5 minutes) were made with a 30.5 m-long by 2 m-wide bag seine constructed of 1.3 cm knotless nylon mesh. Squids were transported to the laboratory within one hour of capture.

Shipboard transport and laboratory transfer

Squids were always immediately segregated from other captured organisms (e.g., fishes and other invertebrates) and transported in one of three types of shipboard tanks (Fig. 1). The first type consisted of simple, vertically oriented Nalgene cylinders of 200 or 380 l capacity (VT, vertical tank), with no flow-through of sea water. The second consisted of fiberglass cylinders of 380 or 550 l capacity mounted horizontally on skids (HCT, horizontal cylindrical tank) and fitted with a rectangular, hinged opening along the length of the upper surface. These horizontal cylinders substantially reduced sloshing, thereby decreasing haphazard contact between the squids and tank wall. The third type was a 1020 l fiberglass rectangular horizontal tank (RHT) with rounded corners. This tank was separated into two layers that doubled the transport capacity over other designs. In the latter two systems, fresh running sea water was pumped into the top and flowed out the bottom. These systems were switched to a recirculating mode and 100 percent oxygen was bubbled into the water when *Loligo* spp. were being transported from offshore and water quality deteriorated nearshore. Most tanks were covered with polystyrene on the outside for insulation.

For transfer from shipboard to the laboratory, the squids were caught with small dipnets and placed by hand into clear plastic bags (38 cm × 80 cm), with care being taken not to startle the squids and cause inking. One to three squids and approximately 4 l of sea water were put in each bag, which was then pumped full with 100 percent oxygen and tied off. Several bags were placed horizontally in an insulated container, the top was closed, and they were taken by truck several hundred meters to laboratory tank systems with similar temperature and salinity. The bags were floated in the tanks for 15 to 30 minutes until temperatures equilibrated. Each bag was then opened and the squids were released directly into the tank without handling.

Throughout this paper we report our results as mean and median values, but only median values were compared statistically because we used non-parametric tests (see Gibbons, 1976). The shipboard transport, laboratory transfer, and 24 hour acclimation mortality data were analyzed statistically to test for (1) differences in mortality among the three species, (2) differences in the performance of the three tank designs, and (3) differences in mortality associated with squid size. The first comparison (Kruskal-Wallis test) was carried out among all three species, using only the HCT data. The performance of the tank systems was evaluated (Kruskal-Wallis test) using the data of *Loligo plei* because it was the only species transported in all three tanks. Finally, the third comparison (Mann-Whitney U test) was made between the sizes of *L. plei* that died *versus* those that survived in the VT and HCT transport tanks; similar data were not available for the other two species.

Closed sea water systems

A major objective was to develop a large-volume, inexpensive, easily reproducible sea water system that could be modified to test different techniques for maintaining and growing squids. Two basic systems were developed, both being closed systems that recirculated and filtered their own set volume of sea water.

The 2 m circular tank (CT) system (Fig. 2) is a simple and readily modified design that we developed in 1975 and continues to be our standard system for maintenance and experimentation (Hanlon *et al.*, 1978). Its capacity is approximately 1500 l of sea water. Biological filtration, which includes mineralization, nitrification, and dissimilation of nitrogenous compounds (*cf.*, Spotte, 1979a, b), is carried out principally in the filter bed. This layer is 6 cm deep and consists exclusively of crushed oyster shell (approximate particle size 10 × 5 × 2 mm; total weight approximately 160 kg)



FIGURE 1. Capture and transport. A. R/V ERIN LEDDY-JONES nightlighting for *Loligo plei* off the coast of Galveston, Texas in 17 m of water. Note the 1000-watt quartz-iodide lamp on the A-frame and two 500-watt quartz-iodide lamps amidships that are used to attract squids. Squids are dipnetted on board (left) and placed in a transport container (arrow). B. Three types of transport containers: VT is the vertical tank; HCT is the horizontal cylindrical tank; RHT is the rectangular horizontal tank. The tanks and squids are all drawn to the same scale. The squids equal the approximate size of 200 mm mantle length. Water flow is indicated by arrows. In the RHT, (A) is the removable partition that is replaced when approximately 15 adult *Loligo* spp. are put in the tank. The tank top (B) is then secured with stainless steel bolts (C) that force a rubber gasket (D) against the top edge of the tank, producing a water-tight seal. Another 15 squids are placed in the upper compartment through the chimney (E). When water quality is good, sea water is continually pumped into the base of the tank through (F) and allowed to overflow from the chimney. When water quality deteriorates near shore, the tank water is circulated by a submersible pump (G) that pushes the water through an exterior filter (H) and back into the tank. Pure oxygen or air may be added through a valve (I).

on which bacteria attach and grow. Newly constructed systems are “conditioned” for several weeks to allow bacterial populations to equilibrate. Toxic ammonia, directly excreted by tank animals or produced indirectly through mineralization of organic products, is oxidized by nitrifying bacteria in the filter bed to nitrite and then to less toxic nitrate. Nitrate is either assimilated by green algae growing in the algal tank under continuous illumination, removed through partial water changes, or removed through dissimilation by bacteria into a completely reduced state in which inorganic nitrogen is released from the water into the atmosphere (Painter, 1970).

Mechanical filtration reduces water turbidity by separating and concentrating particulate organic carbon (*i.e.*, particles, aggregates, detritus, free floating algae, and bacteria) in the filter bed and in two layers of polyester fiber within an auxiliary filter (Fig. 2). Physical adsorption of dissolved organic carbon is accomplished with granular activated carbon in the auxiliary filter or with the periodic use of a foam fractionator

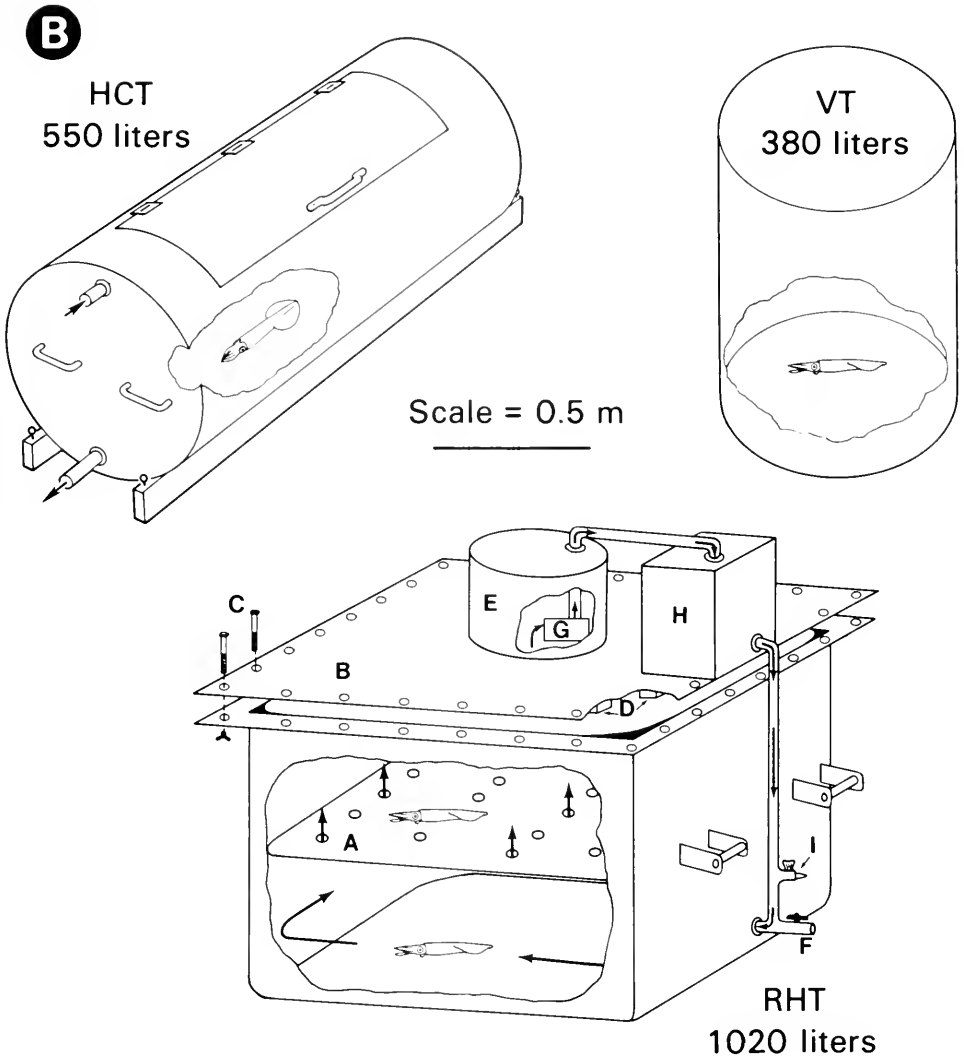
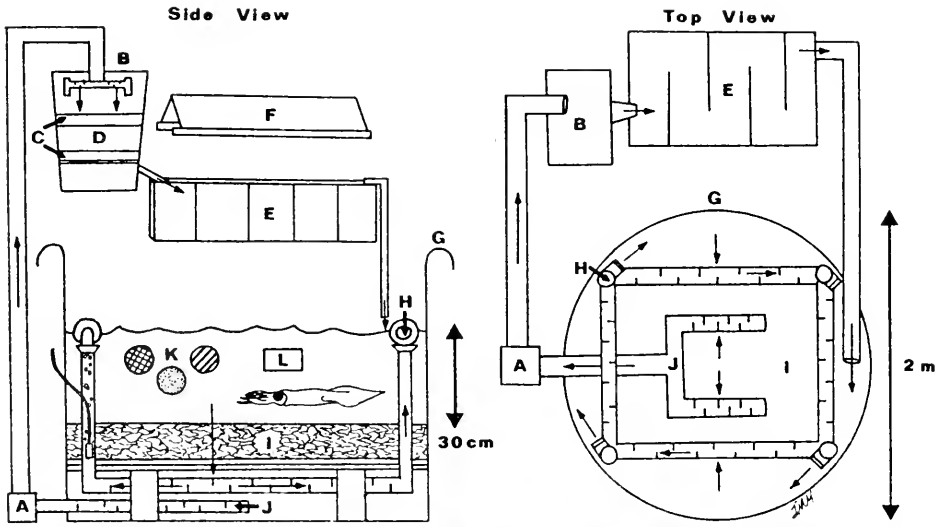

FIGURE 1. (Continued)

or "protein skimmer" that physically binds surface-active organic material to the air-water interface of bubbles and chemically binds non-surface-active compounds with surface-active material (Rubin *et al.*, 1963). This is necessary when the tank is loaded to high capacity and partially eaten food accumulates in the system. Flow rate through the system is approximately 16 l per minute.

All fabrication materials are fiberglass, polyvinyl chloride (PVC), or some other inert synthetic product. The only metal components are in the pumps and they do not come in contact with sea water. Tank walls are painted with various patterns made with an inert black paint (Thioxchlor, Napko Paint Co., Houston, Texas) to increase contrast and make the walls more visible to squids. Partitions that divided the tank into two or four segments were used occasionally and were constructed of



a PVC frame with soft knotless nylon netting. Several CT systems constructed since 1978 have been used without the algal tank.

Our second design is a 10,000 l raceway (RW) system based upon a design for the intensive closed-system culture of penaeid shrimps (Mock *et al.*, 1977). Our original raceway (Fig. 3) was 10 m long, 2 m wide, and had rounded ends. The raceway framework consisted of aluminum struts that supported walls made of plywood panels, and rounded ends made of curved aluminum sheeting. A watertight rubberized liner was placed inside the framework, and a corrugated fiberglass partition was suspended lengthwise inside the raceway. Air-lift pumps attached to the central partition provided aeration and water circulation. A CT system (similar in design to Fig. 2) was connected to the raceway to provide water filtration. The algal tank consisted of eight rotating polystyrene "biodiscs" that provided a larger surface area for algal and bacterial growth (Antonie, 1976).

Newer raceways now in operation consist of a single long fiberglass sheet that is curved upward on the sides by supporting struts and closed at each end by a rounded fiberglass half-circle. They may be ordered in a variety of lengths and widths (Ewald Mfg., Karnes City, Texas). The central partition can be omitted to provide greater horizontal space. In this case, water is pumped through auxiliary filters (similar to those shown in Fig. 2, part B) and re-enters the raceway to provide aeration and directional water flow.

When necessary, water is chilled by cooling units (Model D1-100, Frigid Units, Inc., Toledo, Ohio). A deionized water unit provides water for mixing artificial sea water and for replacing water lost through evaporation. Polystyrene panels are fitted over the tops of the raceway and the CT system. These covers reduce evaporation, provide some temperature insulation, and prevent outside activity from disturbing experimental animals.

Both natural and artificial sea water (Instant Ocean Brand, Aquarium Systems Inc., Eastlake, Ohio) have been used in our tanks. Water quality was monitored frequently. Temperature, salinity, and pH were recorded every one to three days. Estimates of inorganic nitrogen buildup were made biweekly with field test kits (Hach Chemical Co., Ames, Iowa) and precise measurements were made periodically for ammonia (Solórzano, 1969), nitrite (Strickland and Parsons, 1972) and nitrate (Rand *et al.*, 1976). No tolerance levels for these ions have been established for cephalopods, but a partial water change was made when the concentrations exceeded those recommended for most marine animals (Spotte, 1973, 1979a, b). At approximately monthly intervals, a trace element mix (Wimex Trace Elements, Hawaiian Marine Imports, Houston, Texas) was added to each system to replenish those trace elements lost through algal metabolism. Dissolved oxygen measurements were made infrequently, but were always near saturation. Activated carbon in the auxiliary filters was changed every four to ten weeks, depending upon the animal load in the system. The foam fractionators and UV sterilizers were used continuously. Lighting was from indirect natural sunlight and from overhead fluorescent lights regulated to provide a natural light/dark photoperiod.

FIGURE 2. The 2 m circular tank (CT). This closed sea water system is shown with 11 female *Loligo plei*. A pump (A) pushes water to an auxiliary filter (B), where it then flows by gravity through two layers of polyester fiber (C) and granular activated carbon (D) into an algal tank (E) that is under continuous illumination (F) and back into the squid holding tank (G). Water circulation in G moves in a clockwise direction that is caused primarily by the flow from air-lift pumps (H). Water is drawn through the filter bed (I) into the perforated subsurface pipes of the air-lift pumps (H). Water is also drawn into another set of subsurface pipes (J) by the pump (A). Various painted patterns (K) make the wall more visible to the squids. Viewing ports (L, and arrows in photograph) are used for underwater observations.

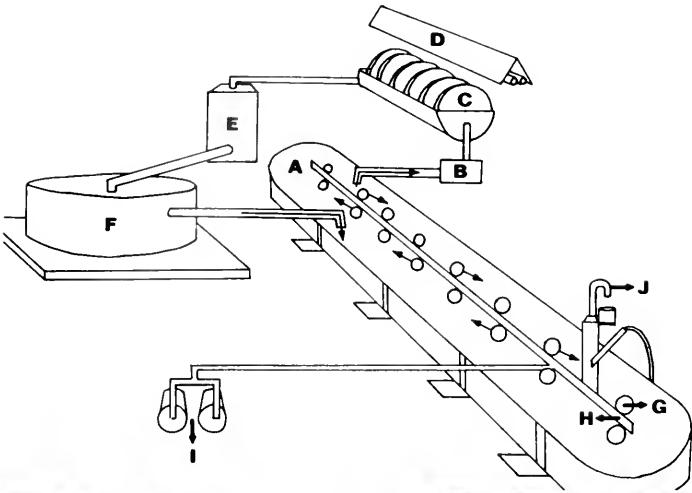

Recapturing, handling, and anaesthetizing live squids

Squids could be dipnetted from both tank systems due to the narrow dimensions of each. It was usually possible to slowly herd the schools into particular sections of the tank and then isolate individuals for netting (Fig. 3). Dipnetted animals were handheld and gently immersed into a solution of 1.0 to 1.5 percent ethanol in sea water for one to three minutes until respiratory movements slowed or stopped. Squids occasionally inked in the ethanol solution, and the ink was immediately dipnetted out with a fine-mesh net. The anaesthetized animals could be examined, weighed, or measured for a period of five to ten minutes. Thereafter, each squid was placed by hand into sea water and rocked to and fro for 30 to 180 seconds until it regained alertness and body control and swam off. Squids released directly into the tank before full recovery were often attacked by other squids.

Survival, growth, and mortality analyses

When squids were maintained, daily records were kept for each laboratory tank system. When each squid died, the date of death, number of days since capture, sex, mantle length, stage of sexual development, and probable cause of mortality were recorded. Data on mantle length, sex, and sexual development were unavailable when squids died from cannibalism or when squid remains were eaten by food organisms in the tank. Small-sized, usually immature, squids less than 40 mm ML in *Lolliguncula brevis* and less than 50 mm ML in *Loligo plei* were termed "juveniles." The analysis of variance procedure by ranks (Conover and Iman, 1976) was used to detect differences in laboratory survival time observed among (1) the three species and (2) males, females, and juveniles within each species.

For determinations of growth of laboratory animals, squids were maintained in the CT systems. Individuals that were in good condition after one week in captivity were measured at intervals of 7 to 21 days. After being anaesthetized, each squid was (1) held head-down for several seconds to allow the mantle cavity to drain, (2) gently blotted on absorbent paper towels, (3) sexed, (4) weighed to the nearest gram, and (5) measured (dorsal mantle length) to the nearest mm. No attempts were made to mark squids for identification, but notes were taken of recognizable differences in individuals (*e.g.*, scars, damaged chromatophores) and this was sufficient to identify squids in subsequent examinations. Throughout the growth observations, palaemonid shrimps and various small cyprinodont fishes were fed to the squids at least twice daily. There was an excess of live food in the tanks at all times. Male and female squids were segregated in the *Loligo* spp. observations but not in those of *Lolliguncula brevis*.

Increases or decreases in mantle length or wet weight over the duration of the growth observation were expressed in two ways: (1) as the change in mantle length or wet weight per month (30 days; abbreviated mo), and (2) as an instantaneous

FIGURE 3. The 10,000 l raceway (RW), a closed sea water system. Seventeen *Loligo plei*, mostly males, are seen swimming over a white fiberglass sheet (put in for the photograph only). The air-lift pumps are turned off for the photograph. Water leaves the raceway (A) via a siphon to a pump (B) that pushes the water to a rotating biodisc tank (C) that is under continuous illumination (D). The water flows by gravity first into the auxiliary filter (E) then through the main filter (F, a CT system) and then back to the raceway. Water within the raceway is circulated in a clockwise direction by the discharge from the main filter and by the air-lift pumps. Two air blowers (I) drive the air-lift pumps. A foam fractionator (J) is mounted in the raceway. Note the accessibility of the squids for recapture.

relative growth rate expressed as the percent gain in length or weight per day (Winberg, 1960). Statistical analyses were conducted only with *Lolliguncula brevis*, and using only monthly changes in mantle length and wet weight; no statistical comparisons were made with *Loligo* spp. due to the small sample size. Tests were made on *Lolliguncula brevis* to compare the monthly growth rates of males and females (Mann-Whitney U test), and to detect size-dependent differences in growth rate within each sex (Kruskal-Wallis test).

Two six-day observations were conducted with six *Loligo plei* to collect preliminary data on gross growth efficiency (or food conversion efficiency). This was measured as the ratio $G/I \times 100$, where G was wet weight increase of the squid and I was total wet weight of food ingested. Only fishes were used as food. All fishes were weighed before entry into the tank (twice per day) and their remains removed and weighed daily. The ingested wet weight of fish was calculated simply by subtracting the total weight of food remains from the total weight of fishes.

Feeding

Daily feeding consisted of small live estuarine fishes and shrimps. Principal food organisms included the sheepshead minnow *Cyprinidon variegatus*, the longnose killifish *Fundulus similis*, the diamond killifish *Adinia xenica*, the sandtrout *Leiostomus xanthurus*, the sailfin molly *Poecilia latipinna*, the tidewater silverside *Menidia beryllina*, juvenile mullet *Mugil* spp., juvenile menhaden *Brevoortia* spp., juvenile and adult penaeid shrimp *Penaeus* spp., and the palaemonid shrimp *Palaemonetes pugio*. These species were all readily seined throughout the year in nearby salt marsh areas, estuarine bay waters, and low-energy beachfronts. These organisms are part of the natural diet of *Lolliguncula brevis*, but not of *Loligo plei* or *L. pealei*, which come from offshore. In most cases food was dropped into the tank two or three times per day in quantities that allowed feeding *ad libitum* throughout the day and night. Most prey organisms were equal to or slightly greater than the length of the squids' arms, but on some occasions mid-sized squids attacked and ate prey organisms nearly their own length. Food remains were netted or siphoned out of the tanks daily.

Behavioral observations

In the laboratory, squids were observed carefully and often from above the tanks or, more commonly, through the windows in the tank walls. In order to determine possible direct and indirect causes of mortality, particular attention was paid to chromatophore patterning, postures, and general aspects of behavior associated with temperature or salinity shock, fin damage, feeding, and intraspecific interactions.

In the field, *Loligo* spp. were observed occasionally by skin or SCUBA diving near the boat during night lighting stations offshore from Galveston and throughout the western Gulf of Mexico. More extensive night diving observations were made on *Loligo plei* in St. Croix in 1978 (Hanlon *et al.*, 1980) and at Grand Cayman Island in 1980 (Hanlon and Hixon, 1981).

RESULTS

Capture

For the analyses of shipboard transport and laboratory maintenance, a total of 700 *Loligo plei* and 89 *Loligo pealei* were captured by night lighting and dipnetting,

and approximately 425 *Lolliguncula brevis* were captured by bottom trawling. Many more squids were obtained during these collections between 1976 and 1982, but they were preserved for other studies. A wide size range of animals was collected in the northern Gulf of Mexico for these analyses: *Loligo plei* 12 to 252 mm ML; *Loligo pealei* 109 to 285 mm ML; and *Lolliguncula brevis* 27 to 99 mm ML.

Capture results for each species varied with season, year, and collection site. The areal and bathymetric distributions of the three species near Galveston have been outlined previously (Rathjen *et al.*, 1979; Hixon *et al.*, 1980), and Hixon (1980a, b) has described aspects of the seasonal movements and abundance of each species. At present, we estimate the seasonal availability of each species as follows. *Loligo pealei* is generally present on the edge of the continental shelf (40 to 250 m deep), but this species is more abundant in fall, winter, and spring and less abundant in summer. *Loligo plei* is present closer to shore in depths between 20 and 75 m. Large adults are most abundant in spring and summer. Small and mid-sized *L. plei* are found farther offshore during fall and winter, but large adults disappear from the northwestern Gulf in early fall and do not reappear until spring. *Lolliguncula brevis* is present year-round. It is usually abundant in Galveston Bay (1 to 20 m deep) between early spring and late fall. When bay temperatures drop in winter, this species moves out of the bay to nearshore waters less than 40 m deep along the Texas coast.

Both species of *Loligo* came to night lights, but *Loligo plei* did so more readily and consistently than *Loligo pealei*. We conducted 164 night light stations for these species totaling 301 hours of observations. Capture rates by dipnet were low for both species: 5.0 squids/h for *L. plei* and 0.9 squids/h for *L. pealei*. Occasionally there were highly productive nights in which hundreds of squids could be easily dipnetted; on these nights capture was terminated quickly when onboard tanks were filled, so the capture rates are conservative. Other contributing factors to the low numerical catch rate were that: (1) squids were often present, but out of dipnet range, (2) very small squids were often not collected, and (3) there were seasonal and yearly decreases in squid abundance and many of these observations were taken during year-round exploratory fishing.

The quartz-iodide lamps deployed above water generally attracted more squids than the underwater mercury vapor lamp, but our attempts to quantify this observation have failed (*e.g.*, Hanlon *et al.*, 1980; Hanlon and Hixon, 1981). Changing the light intensity to draw in squids seen on the periphery of the lighted area did not work consistently. Some squids were caught with squid jigs, but usually jigs attracted squids near the boat for dipnetting. Thus far, no particular style of jig has been effective for consistently capturing these species of *Loligo*, although a wide variety of jigs from Japan and South America has been used (*cf.*, Rathjen *et al.*, 1979, Fig. 4).

Trawling and seining have been reasonably successful capture methods for *Lolliguncula brevis*. The slow-moving nets were effective because this species lives in nearshore waters of high turbidity, thus reducing net avoidance. We believe that the large trawls (6.4 and 9.1 m) caught higher numbers of *Lolliguncula brevis* than the small trawls (3.0 m), but comparisons could not be made because of the wide variability in the seasonal and yearly use of the nets and differences in the abundance of the animals.

Various injuries were sustained by the squids during capture, and these affected their subsequent survival during transport and later in the laboratory maintenance tanks. *Loligo plei* and *Loligo pealei* caught with dipnets were practically unharmed when placed in the onboard transport tanks. Squids caught with jigs had small puncture wounds in the arms, tentacles, and funnel, but no permanent damage was done to the skin on the mantle and fins. In comparison, most of the squids caught by the

trawls sustained skin abrasion caused by the net or other captured animals. The use of nets such as box trawls or beach seines, which are constructed entirely of knotless nylon netting, may reduce skin abrasion caused by the knots in conventional nets. Survival in the trawls was poor when squids were caught with stinging jellyfishes or organisms with hard or pointed exoskeletons such as crabs. Squids generally survived capture better when caught with moderately large numbers of small schooling fishes such as anchovies or menhaden.

Shipboard transport and laboratory transfer

Success in shipboard transport varied greatly depending upon the species caught, the squids' size, and physical condition after capture, time in transport, sea and weather conditions, and type of shipboard transport tank (Tables I, II, and III). Mortality associated with shipboard transport and laboratory transfer included squids that died any time from capture through their first 24 hours of acclimation in the laboratory tank systems. Average mortality was 35 percent for *Loligo plei* during a mean transport time of 7 hours (standard error of the mean, \bar{S}_x , 1.1 hours). Average mortality was 48 percent for *Loligo pealei* during a mean transport time of 15 hours ($\bar{S}_x = 3.2$ hours). Average mortality was 27 percent for 324 *Lolliguncula brevis* during a mean transport time of 1 hour ($\bar{S}_x = 0.4$ hours). However, no statistically significant differences were found in median mortality (*L. plei*, 17.5 percent; *L. pealei*, 33 percent; *Lolliguncula brevis*, 29 percent) among the three species when transported in the HCT. Most mortality in *Loligo plei* occurred in small squids less than 50 mm ML, some of it due to cannibalism by larger squids. High mortality in *Loligo pealei* was attributable to the long transport times and the relatively small horizontal tanks (380 and 550 l HCT) in which this large species was transported. In contrast, *Lolliguncula brevis* had the shortest transport time and low mortality; a contributing factor was that mortality rates associated with beach seining (Table III, Observations 9, 10, 11, and 12) were between only 0 and 13 percent.

Mortality in the vertically oriented cylinders (VT) was high compared to the horizontal cylindrical tank (HCT) or the rectangular horizontal tank (RHT). When mortality of all squids of all three species was compared by type of transport tank, overall pooled mortality in the vertical tanks was 47 percent *versus* 28 and 24 percent in the other tank designs. For *Loligo plei*, transport in the vertical tanks resulted in 53 percent overall pooled mortality *versus* 20 and 24 percent in the HCT and RHT tanks, respectively (Table I). However, for this species no statistically significant differences in median mortality (VT, 33 percent; HCT, 17.5 percent; RHT, 16 percent) were found among transport containers (Kruskal-Wallis test, $.05 < P < .10$). Nevertheless, we found the vertical tanks unacceptable because of the lack of flowing sea water and because their narrow horizontal dimensions led to crowding, uncontrolled water sloshing, and fin and skin damage due to collisions with the tank wall.

The horizontally oriented cylinders and the rectangular tank functioned better than the vertical tanks. The closed tops in both designs substantially reduced sloshing, thereby decreasing haphazard contact between the squids and the tank walls. When sea conditions were good, squids swam in the middle of the water column or slightly nearer the bottom; in general, the upper half of the water column was unused by the squids. The 1020 l rectangular horizontal tank successfully utilized this upper part of the water column by insertion of a horizontal divider after a number of squids had already distributed themselves across the bottom of the tank. The next batch of squids was then collected and placed in the upper level.

Small-sized squids did not withstand capture and transport as well as larger con-

specifics. For example, *Loligo plei* that survived transport in the HCT were significantly (Mann-Whitney U test, $P < .001$) larger (median ML 113 mm) than squids that died during transport (median ML 53.5 mm). Similar, but not statistically significant, results were found in *L. plei* transported in the VT. Smaller squids were generally more damaged during capture, they incurred more skin damage from wall contact during transport, and adult *Loligo* often cannibalized smaller squids in the same transport tank.

Transferring squids in plastic bags to the laboratory was successful. Although somewhat time consuming, it insured that each squid had adequate sea water, oxygen, and space during this critical period. There was also little sloshing, and when there was sloshing the rounded sides of the horizontally oriented bags reduced fin abrasion. The squids transferred well in the darkness of the closed container. This served to cut off their view of all external commotion, to which they reacted poorly. It was important not to jar the squids during this process. All movements were gentle including driving, closing truck doors, and carrying the squids into the laboratory; otherwise the squids were startled and would ink in the bag.

Healthy, undamaged squids of all three species were able to survive substantial temperature and salinity changes between capture and release into the laboratory tanks. During transport, temperature and salinity usually changed slightly from conditions at the capture sites. When the squids were transferred to the laboratory maintenance tanks in plastic bags, temperature equilibration usually took place within 30 minutes, whereas salinity changes occurred abruptly when the squids were released into the tanks. These changes in temperature and salinity are listed for each species in Tables I, II, and III.

Lolliguncula brevis (Table III) was subjected to the largest temperature and salinity changes. The largest temperature changes were $+11$ or -9°C (average change was approximately $\pm 6^{\circ}\text{C}$), and the largest salinity shocks were $+12$ or -8 ppt (average shock was slightly less than ± 5 ppt). The combination of most extreme change was in Observation 1, with a salinity decrease of 8 ppt combined with a temperature decrease of 9°C . As expected, this estuarine nearshore species tolerated salinity and temperature changes quite well. Hendrix *et al.* (1981) have recently analyzed salinity tolerance in this squid and shown that this species is an osmoconformer that readily moves within salinities between 17 and 36 ppt.

Loligo plei and *Loligo pealei* tolerated surprisingly large changes with little or no apparent harm to their subsequent laboratory survival. In *L. plei* (Table I), the largest temperature changes were $+8$ or -11°C (average change approximately $\pm 5^{\circ}\text{C}$), and the largest salinity shocks were $+9$ or -8 ppt (average shock was about ± 3.5 ppt). The combination of most extreme change was in Observation 17, with a salinity increase of 7 ppt and a concurrent temperature decrease of 11°C . For *L. pealei* (Table II), the largest temperature changes were $+3$ or -8°C (average change approximately $\pm 5^{\circ}\text{C}$), and the largest salinity shocks were $+4$ or -5 ppt (average shock was about $+2$ ppt). The combination of most extreme change was in Observation 2, with a salinity increase of 4 ppt and a temperature decrease of 8°C . Presumably the salinity changes were dealt with by equilibrating blood osmolality through volume regulation, as found in *Lolliguncula brevis* (Hendrix *et al.*, 1981).

It was very difficult to detect any deleterious effects of these physiological stresses. Even in the extreme cases cited above, most of the undamaged animals survived well in captivity. Squids that had sustained skin trauma during capture and transport were probably most affected by the additional physiological stress of salinity and temperature shock. We believe that these squids probably accounted for most of the deaths within one to five days in captivity.

TABLE I

Loligo plei: summary of capture, transport and transfer, and laboratory maintenance

CAPTURE			SHIPBOARD TRANSPORT (TP), LABORATORY TRANSFER (TF), AND 1-DAY ACCLIMATION (AC ₁)					
Obs. No.	Date	No. Squids Collected	Transport Container	Transport Time (h)	Salinity Change (ppt)	Temp. Change (°C)	No. Dead in TP, TF, AC ₁	Percent Mortality
1	7 JUL 76	17	200 I VT	18	28-36	32-29	10	59%
2	8 AUG 76	21	200 I VT 380 I VT	5	33-32 33-25	30-27 30-24	2	10%
3	22 AUG 76	18	200 I VT	4	33-33 33-28	30-24 30-24	6	33%
4	23 SEP 76	27	200 I VT	4	30-35 30-30	27-23 27-24	2	7%
5	2 OCT 76	15	200 I VT	24	29-32	27-24	11	73%
6	11 OCT 76	29	200 I VT	3	30-32	24-22	6	21%
7	1 NOV 76	80	200 I VT	3	35-32	17-22	77	96%
8	2 NOV 76	14	200 I VT 380 I VT	3	36-32	18-22	7	50%
9	9 NOV 76	35	380 I VT	3	36-32	21-22	15	43%
10	4 DEC 76	28	380 I VT	24	35-32	18-22	25	89%
11	20 JAN 77	3	380 I HCT	11	35-37	17-21	1	33%
12	17 MAR 77	1	200 I VT	4	26-35	16-23	0	0%
13	6 APR 77	12	380 I VT	8	27-36	19-22	4	33%
14	18 APR 77	14	380 I HCT	13	34-35	22-24	0	0%
15	25 MAY 77	11	380 I HCT	6	31-34	26-21	2	18%
16	25 MAY 77	22	380 I HCT	6	31-34	26-21	2	9%
17	25 MAY 77	58	380 I HCT	1-6	30-37	32-21	10	17%
18	16 JUL 77	11	380 I HCT	3	34-34	30-21	0	0%
19	16 AUG 77	10	200 I VT	3	30-34	32-22	0	0%

TABLE I (Continued)

LABORATORY MAINTENANCE AND SURVIVAL								
Main- tenance Tank	Salinity Range (ppt)	Temp. Range (°C)	No. of Squids Main- tained	Sex	Size (mm ML) at Death		Laboratory Survival (days)	
					(\bar{x})	(Range)	(\bar{x})	(Range)
CT	34-37	24-30	3	M	182	(165-205)	17	(15-18)
			4	F	92	(82-98)	16	(14-19)
CT	25-26	24-26	10	M	129	(105-153)	6	(2-11)
CT	32-33	23-27	9	F	98	(83-118)	9	(3-18)
CT	33-35	23-25	6	M	155	(140-175)	17	(5-28)
CT	28-30	23-25	6	F	102	(100-107)	19	(5-29)
CT	30-35	22-24	4	M	103	(71-138)	4	(2-6)
			5	F	87	(74-102)	21	(15-29)
			15	J	41	(31-50)	3	(2-6)
CT	30-32	22-24	4	J	35	(30-41)	3	(2-3)
CT	31-32	22-24	11	M	63	(52-74)	7	(3-17)
			8	F	59	(52-67)	3	(3-6)
			3	J	45	(39-50)	3	(2-3)
CT	32-33	20-22	3	J	41	—	16	(2-43)
CT	33-34	21-23	3	M	59	(55-63)	4	(3-6)
CT	32-33	20-22	4	J	42	(34-48)	3	(2-6)
CT	33-34	21-23	1	M	53	—	3	—
CT	32-33	20-22	19	J	30	(21-45)	3	(2-6)
CT	35-36	20-21	3	J	37	(32-43)	4	(3-6)
CT	35-37	19-21	1	M	85	—	84	—
			1	J	43	—	22	—
CT	35-36	21-23	1	M	69	—	4	—
CT	35-35	23-23	2	M	95	—	3	(2-4)
CT	36-36	22-22	3	F	—	—	2	(2-3)
CT RW	35-36	22-25	7	M	226	(204-243)	33	(16-54)
	34-37	16-23	5	F	—	—	14	(3-21)
CT	34-37	21-22	2	M	140	—	16	(8-24)
			5	F	79	(54-95)	54	(14-52)
			2	J	43	—	4	(2-6)
CT	34-37	20-21	3	M	135	(105-160)	56	(55-57)
			17	J	40	(38-44)	7	(2-16)
RW	31-37	20-21	23	M	118	(64-223)	17	(2-49)
			21	F	76	(51-123)	18	(3-45)
			2	J	48	(47-50)	25	(22-28)
CT	34-36	20-21	4	M	139	(110-164)	10	(4-16)
			7	F	83	(65-101)	10	(5-16)
CT	34-35	21-22	10	J	19	(12-22)	3	(2-4)

TABLE I (Continued)

CAPTURE			SHIPBOARD TRANSPORT (TP), LABORATORY TRANSFER (TF), AND 1-DAY ACCLIMATION (AC ₁)					
Obs. No.	Date	No. Squids Collected	Transport Container	Transport Time (h)	Salinity Change (ppt)	Temp. Change (°C)	No. Dead in TP, TF, AC ₁	Percent Mortality
20	16 AUG 77	4	200 l VT	3	30-34	32-22	0	0%
21	18 AUG 77	7	380 l HCT	3-7	28-32	29-21	4	57%
22	15 OCT 77	14	380 l HCT	12-36	33-35	27-21	12	86%
23	30 OCT 77	13	380 l HCT	7	36-34	26-21	5	38%
24	10 MAR 78	3	380 l HCT	4	35-38	14-20	0	0%
25	26 APR 78	15	550 l HCT	3	35-35	20-28	3	20%
26	1 MAY 78	1	550 l HCT	3	34-36	22-24	0	0%
27	16 MAY 78	17	550 l HCT	6	38-32	24-23	0	0%
28	5 JUN 78	3	550 l HCT	15	34-36	27-22	3	100%
29	12 JUN 78	4	550 l HCT	2	25-31	28-22	1	25%
30	10 AUG 78	54	550 l HCT	3-5	25-32 30-32	29-21 29-22	7	13%
31	20 MAY 82	75	1020 l RHT	6	—	—	26	35%
32	8 JUL 82	37	1020 l RHT	6	—	—	6	16%
33	11 AUG 82	27	1020 l RHT	6	—	—	1	4%
$\Sigma = 700$				$\bar{x} = 7$	$\text{Max. } \Delta = \text{Max. } \Delta =$ +9, -8 +8, -11			

Abbreviations: VT, vertical tank; CT, 2 m circular tank system; HCT, horizontal cylindrical tank; RHT, rectangular horizontal tank; RW, raceway tank; J, juvenile; * artificial sea water.

In all cases it was imperative not to overload the transport tanks or transfer bags, since this promoted wall contact, general excitement among the squids, and occasionally cannibalism. Long transport times and hot summer temperatures also increased mortality. Determination of the proper number of squids to be transported per tank is a behavioral consideration, not a physiological one, because water quality is good throughout the trip. The important considerations are the relative positioning of the squids to one another (this depends on the sizes of the squids) and to the tank

TABLE I (Continued)

LABORATORY MAINTENANCE AND SURVIVAL								
Main- tenance Tank	Salinity Range (ppt)	Temp. Range (°C)	No. of Squids Main- tained	Sex	Size (mm ML) at Death		Laboratory Survival (days)	
					(\bar{x})	(Range)	(\bar{x})	(Range)
CT	34-35	20-21	2	M	106	(99-113)	3	—
			2	F	91	(82-100)	3	—
RW	32-35	20-22	1	M	—	—	23	—
			2	F	—	—	3	—
RW	36-39	18-22	1	M	70	—	2	—
			1	F	67	—	2	—
CT	34-36	20-22	1	M	53	—	2	—
			6	J	48	—	3	(2-7)
CT	34-38	20-24	3	F	64	(62-65)	20	(5-31)
CT	35-37	18-24	3	M	123	(113-133)	12	(7-19)
			8	F	102	(83-110)	14	(6-20)
CT	35-36	24-24	1	M	145	—	7	—
CT	35-37	22-23	7	M	210	(155-252)	13	(8-22)
CT*	30-32	20-22	10	F	119	(110-133)	14	(6-27)
CT*	30-32	21-24	1	M	—	—	6	—
			1	F	73	—	23	—
			1	J	—	—	3	—
RW*	32-35	21-24	26	M	173	(112-232)	10	(2-23)
CT	35-36	21-23	19	F	109	(107-139)	13	(2-29)
CT	34-34	22-23	12	M	145	(88-180)	5	(3-18)
CT*	31-32	22-23	4	F	112	(92-131)	5	(4-6)
RW*	—	—	26	M	162	(115-200)	7	(2-16)
			23	F	106	(86-124)	6	(2-12)
RW*	—	—	30	M+F+J	—	—	14	(3-36)
RW*	—	—	25	M+F+J	—	—	13	(3-30)
	(25-39)	(16-30)	$\Sigma = 453$	M	145	(52-252)	12	(2-84)
F				95	(51-139)	13	(2-52)	
J				35	(12-50)	5	(2-43)	
M+F+J				107	(12-252)	11	(2-84)	

configuration (especially the size of the horizontal dimensions of the tank) because the squid schools are generally dispersed horizontally, not vertically, in tanks. Based upon our experience in observing squids during transport and analyzing the reasons for mortality, we recommend ten full-sized *Loligo* spp. (150 to 250 mm ML) or 25 *Lolliguncula brevis* (40 to 80 mm ML) per 550 l HCT tank. For the RHT tank we recommend 15 full-sized *Loligo* spp. per level (30 total). These are conservative estimates; under ideal conditions we have successfully transported greater numbers.

TABLE II

Loligo pealei: summary of capture, transport and transfer, and laboratory maintenance

CAPTURE			SHIPBOARD TRANSPORT (TP), LABORATORY TRANSFER (TF), AND 1-DAY ACCLIMATION (AC ₁)					
Obs. No.	Date	No. Squids Collected	Transport Container	Transport Time (h)	Salinity Change (ppt)	Temp. Change (°C)	No. Dead in TP, TF, AC ₁	Percent Mortality
1	20 FEB 77	7	CT	—	35-36	16-16	2	29%
2	18 AUG 77	1	380 l HCT	7	28-32	29-21	0	0%
3	15 OCT 77	8	380 l HCT	24	35-35	27-21	2	25%
4	19 OCT 77	2	380 l HCT	28	33-35	27-21	1	50%
5	30 OCT 77	1	380 l HCT	7	36-34	26-21	0	0%
6	23 MAY 78	1	550 l HCT	10	34-36	25-22	0	0%
7	2 JUN 78	7	550 l HCT	15	34-30	27-22	6	86%
8	23 JUN 78	10	550 l HCT	10	34-32	27-22	7	70%
9	25 OCT 78	6	550 l HCT	10	35-30	26-21	4	67%
10	27 APR 79	15	550 l HCT	48	36-36	23-17	8	53%
11	10 JUN 80	22	550 l HCT	10	33-32	26-22	—	—
12	23 JUL 80	3	550 l HCT	10	35-33	28-20	1	33%
13	13 AUG 80	4	550 l HCT	10	36-36	28-22	—	—
14	1 MAR 82	2	1020 l RHT	10	36-35	18-21	—	—
		Σ = 89	$\bar{x} = 15$		Max. Δ = +4, -5	Max. Δ = +3, -8		

Abbreviations: CT, 2 m circular tank system; HCT, horizontal cylindrical tank; RHT, rectangular horizontal tank; RW, raceway tank; * artificial sea water.

Sea water systems and water quality

Both systems provided adequate filtration capability as well as space for squids. As a rule of thumb, we determined that the 2 m circular tank system could maintain the following numbers of adult squids in a healthy state for several weeks: ten to 15 *Loligo* spp. (150 to 250 mm ML) or 25 *Lolliguncula brevis* (40 to 80 mm ML). Estimates for the 10,000 l raceway were determined to be: 50 *Loligo* spp. or 100 *Lolliguncula brevis*.

The tank systems were usually kept at the same approximate temperature and salinity as each species encountered in the wild at that month of the year, although fluctuations occurred. The reported ranges that squids are found in the northern Gulf of Mexico and were subjected to during our transport and maintenance work were: *Loligo plei* 13 to 32°C and 25 to 39 ppt; *Loligo pealei* 13 to 30°C and 28 to 39 ppt; *Lolliguncula brevis* 11 to 34°C and 18 to 39 ppt (Tables I, II, III; Rathjen *et al.*, 1979; Hixon, 1980a; Hixon *et al.*, 1980).

TABLE II (Continued)

LABORATORY MAINTENANCE AND SURVIVAL								
Main- tenance Tank	Salinity Range (ppt)	Temp. Range (°C)	No. of Squids Main- tained	Sex	Size (mm ML) at Death		Laboratory Survival (days)	
					(\bar{x})	(Range)	(\bar{x})	(Range)
CT	34-36	16-23	1	M	213	—	71	—
			4	F	172	(154-200)	23	(2-67)
RW	32-35	21-22	1	F	167	—	21	—
RW	36-39	18-21	6	M	202	(158-285)	30	(15-41)
RW	36-39	18-21	1	M	183	—	5	—
CT	34-36	20-22	1	F	121	—	30	—
CT	32-37	21-23	1	M	109	—	53	—
CT*	31-32	21-22	1	F	174	—	25	—
CT*	31-32	21-22	2	M	152	(139-166)	3	(3-3)
			1	F	137	—	2	—
RW*	30-34	15-22	4	F	163	—	36	(21-60)
CT	36-36	17-18	6	M+F	—	—	17	(3-35)
RW*	32-34	21-22	4	M	190	(140-153)	44	(25-54)
CT	33-36	20-22	2	M	—	—	27	(27-27)
CT	36-36	21-22	1	F	155	—	32	—
CT*	34-36	20-22	1	F	154	—	47	—
	(30-39)	(15-23)	$\Sigma = 37$	M	184	(109-285)	31	(3-71)
				F	160	(121-200)	28	(2-71)
				M+F	174	(109-285)	28	(2-71)

Water quality remained high except in rare cases when high densities of animals (substantially greater than those mentioned above) were maintained for long periods of time. The Hach field test kits were useful only for gross estimates of nitrogenous buildup and for indicating increases, at which time detailed chemical tests were performed. The pH of each separate system was different, but the mean value for all experiments was 7.9, with a range of 7.7 to 8.5. Thirty-nine detailed water chemistry tests were performed among five CT systems during 1977 and 1978; these tests covered six different maintenance trials and all three squid species. The mean recorded level of total ammonia-nitrogen ($\text{NH}_4\text{-N}$) from detailed chemical tests was .103 mg/l, with a range of .020 to .161 mg/l ($n = 12$). Mean level of total nitrite-nitrogen ($\text{NO}_2\text{-N}$) was .003 mg/l, with a range of .002 to .007 mg/l ($n = 12$). Mean level of total nitrate-nitrogen ($\text{NO}_3\text{-N}$) was 14.65 mg/l, with a range of 9.98 mg/l to 20.73 mg/l ($n = 15$). In one separate observation, a male *Loligo plei* (124 mm ML) survived alone for 10 days in a 150 l aquarium that had approximate levels (from Hach test kits) of .185 mg/l nitrite-nitrogen and 32.50 mg/l nitrate-nitrogen on Day 7. Even assuming that

TABLE III

Lolliguncula brevis: summary of capture, transport and transfer, and laboratory maintenance

CAPTURE			SHIPBOARD TRANSPORT (TP), LABORATORY TRANSFER (TF), AND 1-DAY ACCLIMATION (AC ₁)					
Obs. No.	Date	No. Squids Collected	Transport Container	Transport Time (h)	Salinity Change (ppt)	Temp. Change (°C)	No. Dead in TP, TF, AC ₁	Percent Mortality
1	17 JUN 77	—	380 l HCT	1	29-21	30-21	—	—
2	14 SEP 77	30	380 l HCT	1	23-30	28-21	23	77%
3	30 SEP 77	32	380 l HCT	1	27-32 27-26	28-21 28-21	5	16%
4	24 OCT 77	7	380 l HCT	1	24-36	24-21	2	29%
5	1 DEC 77	20	380 l HCT	1	24-36	17-21	7	35%
6	14 DEC 77	15	380 l HCT	1	25-26	16-18	6	40%
7	26 JAN 78	9	380 l HCT	8	34-35	13-18	1	11%
8	7 MAR 78	63	380 l HCT	1	24-26	13-20	23	37%
9	20 JUN 78	7	550 l HCT	1	25-25	28-21	0	0%
10	29 JUN 78	38	200 l VT	1	24-32	29-22	5	13%
11	7 JUL 78	—	200 l VT	1	24-30	29-22	—	—
12	24 JUL 78	13	200 l VT	1	26-30	28-21	1	8%
13	14 AUG 78	36	550 l HCT	1	32-24	31-23	—	—
14	24 OCT 78	—	550 l HCT	1	27-30	23-21	—	—
15	22 JAN 79	12	550 l HCT	1	30-32	11-22	4	33%
16	5 JUL 79	42	550 l HCT	1	18-18	29-21	12	29%
17	27 FEB 80	—	550 l HCT	1	33-27	19-20	—	—
18	24 OCT 80	—	—	—	—	—	—	—

 $\Sigma \sim 425$ $\bar{x} = 1$ max. $\Delta =$
+12, -8max. $\Delta =$
+11, -9

Abbreviations: VT, vertical tank; CT, 2 m circular tank system; HCT, horizontal cylindrical tank; RW, raceway tank; J, juvenile; * artificial sea water.

TABLE III (Continued)

LABORATORY MAINTENANCE AND SURVIVAL								
Main- tenance Tank	Salinity Range (ppt)	Temp. Range (°C)	No. of Squids Main- tained	Sex	Size (mm ML) at Death		Laboratory Survival (days)	
					(\bar{x})	(Range)	(\bar{x})	(Range)
CT	22-23	21-22	8	M	56	(51-62)	13	(2-58)
			23	F	62	(44-85)	10	(2-59)
			10	J	34	(27-40)	4	(2-6)
CT	23-25	20-22	3	M	57	(41-67)	45	(8-64)
CT	29-33	21-22	2	F	82	(79-85)	40	(25-54)
			2	J	35	—	5	—
RW	34-39	18-22	15	M	51	(45-57)	23	(2-68)
CT*	26-36	20-23	11	F	73	(63-80)	33	(12-55)
CT	34-36	20-21	1	J	34	—	39	—
CT	35-38	20-23	2	M	55	(53-56)	21	(5-37)
			3	F	70	(67-72)	38	(33-44)
CT	34-36	15-21	7	M+F+J	—	—	29	(3-106)
CT*	24-27	15-24	7	M	57	(53-60)	76	(33-123)
CT	30-36	15-24	2	F	65	(59-72)	64	(58-70)
CT*	28-34	18-19	3	M	56	—	22	(15-33)
			5	F	83	—	24	(16-35)
CT	25-26	19-24	40	M+F+J	—	—	20	(2-49)
CT	22-24	21-22	3	M	59	(58-60)	46	(40-49)
			4	F	71	(62-76)	38	(33-40)
CT*	32-34	21-22	5	M	43	(41-50)	6	(4-11)
			7	F	49	(42-69)	5	(3-12)
			21	J	36	(29-40)	3	(2-5)
CT*	28-30	20-21	18	M+F+J	—	—	4	(2-8)
CT*	30-30	21-23	12	M+F+J	—	—	8	(2-12)
CT	22-24	22-24	9	M	55	(50-59)	6	(2-12)
			8	F	71	(52-99)	7	(2-17)
CT	30-32	20-21	28	M+F+J	—	—	13	(3-29)
CT	32-34	20-22	8	M+F+J	—	—	20	(3-27)
CT	18-18	20-21	30	M+F+J	—	—	12	(2-17)
CT	26-27	19-22	3	M	59	(56-60)	72	(67-74)
			3	F	68	(66-69)	67	(54-73)
CT	34-36	16-25	6	M	52	(48-56)	68	(51-115)
			2	F	63	(60-66)	120	(115-125)
			2	J	35	(32-38)	41	(28-53)
	(18-39)	(15-25)	$\Sigma = 313$	M	54	(41-67)	32	(2-123)
				F	67	(42-99)	25	(2-125)
				J	36	(27-40)	6	(2-53)
				M+F+J	55	(27-99)	19	(2-125)

there is a large source of error in the Hach test, these levels indicate that squids can tolerate concentrations at least somewhat higher than those recommended for marine animals by Spotte (1979a, b): ammonia 0.1 mg/l $\text{NH}_4\text{-N}$, nitrite 0.1 mg/l $\text{NO}_2\text{-N}$, and nitrate 20.0 mg/l $\text{NO}_3\text{-N}$.

Circular tank systems used without algal tanks since 1978 have not shown substantially increased levels of inorganic nitrogen, nor has our recent raceway tank, which does not have a biodisc but depends mostly on the bacterial population in the filter bed of the adjoining CT system for biological filtration. The biodisc filter in our early raceway system (Fig. 3) increased the capacity for biological filtration. However, a drawback of the biodisc was the lack of control over the types of organisms that grew on it, some of them undesirable in a closed system. In our new raceway without the biodisc, it is likely that this extra filtration capacity is not needed with our currently used animal loads. Certainly our attention to cleanliness contributes to this result, since food remains are carefully removed daily and nearly all maintenance procedures recommended by Spotte (1979a, b) are followed. Slight shifts in pH and corresponding increases in nitrogen levels are dealt with quickly, usually by replacing a small percentage of the water volume with fresh, clean sea water.

Some other problems are noteworthy. In uncovered tanks in bright illumination, various algae and other unknown organisms grew on the tank walls and raceway bottoms (note the black growth on the raceway bottom in Fig. 3). Growth of these types of organisms is uncontrollable and some forms can be deleterious (e.g., some blue-green algae). Bacterial buildup, especially of potentially toxic *Vibrio* spp., can also occur on these substrates as well as on biodisc filters. Therefore, we occasionally clean the bottoms or keep tops on the tanks to reduce illumination.

No conspicuous differences were noted between the performance or longevity of natural sea water and artificial sea water. Some CT systems have been in continuous use for as long as two years with no major alterations, aside from periodic ten percent water changes, occasional addition of trace metals, and occasional gentle stirring of the filter bed to siphon off excess detritus buildup that can clog the filter bed and reduce denitrification by bacteria.

General aspects of behavior

Healthy, calm squids of these three species do not bang haphazardly into aquarium walls. Squid vision is keen and they can quickly and deftly maneuver without hitting walls or other objects. Their behavior changes, however, if: (1) they are placed in small tanks, (2) they have incurred significant skin or fin damage, (3) they are engaged in intense intraspecific aggression, or (4) they are not fed. It is important to recognize normal *versus* altered behavior because it is possible to preclude or reduce circumstances that promote altered behavior, which leads to decreased survival in captivity.

Loliginid squids are social, schooling, inquisitive creatures that actively react to everything in their environment. Nearly all aspects of squid behavior are mediated through expression of the chromatophore system, as well as particular postures and movements; collectively these are referred to as body patterns (Hanlon, 1982).

Loligo plei (Fig. 4) has the widest range of body patterns and the most complex behavior. To date, 16 chromatic and six postural components of body patterning have been described and associated with specific behavior (Hanlon, 1982, and in prep.). Males grow larger than females, they are far more aggressive, and they possess seven male-only chromatic components that are used in an intraspecific aggressive context and are inextricably connected with courting and mating behavior (Hanlon, 1981, 1982). Males establish and maintain a rank order based upon size and ag-

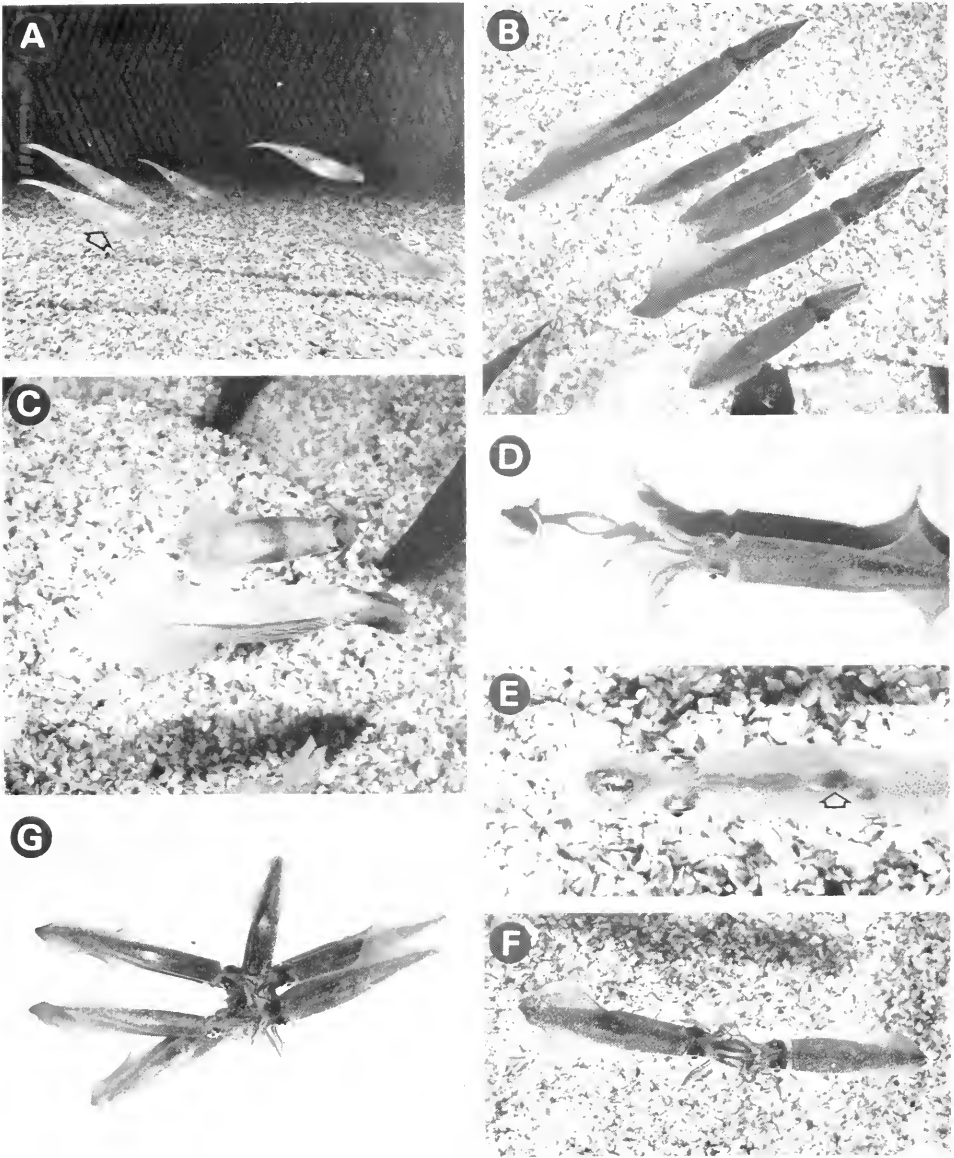

FIGURE 4. *Loligo plei*. A. Five females (74 to 102 mm ML) schooling loosely during Observation 4 (see Table I). The Clear pattern indicates calmness. Note the well-developed ovaries (white arrow) and nidamental glands (black arrow) characteristic of very mature females. In color, the red accessory nidamental glands are also visible. B. Three males (165 to 205 mm ML) and four females (82 to 98 mm ML) from Observation 1, schooling tightly in a CT system. The All Dark pattern indicates that the squids are alarmed. C. Intraspecific aggression and mate pairing during Observation 1. The large dominant male (center, 205 mm ML) is performing a "lateral display" towards the male on its right (bottom, 175 mm ML) in order to keep his female mate (93 mm ML in Ring pattern) segregated from the school. Mating and egg laying occurred the same day. D. A small live fish is seized by the extended tentacles of a male squid, 174 mm ML. Note the buckling of the tentacles (see Kier, 1982). E. A female (110 mm ML) from Observation 27 eating a small fish. Note that the fish is held vertically and that the viscera are being eaten first. The digestive gland is swollen and reddish (white arrow) and the stomach is approximately $\frac{1}{3}$ full (black arrow). F. A male (left, 113 mm ML) and female (110 mm ML) from Observation 25 in a tug-of-war over a fairly large fish. G. Cannibalism. Six males (approx. 220 mm ML) jointly eating another male that had been moribund prior to cannibalization.

gressiveness. They accomplish this mainly through visual signalling, in particular a “lateral display” in which the males position themselves in parallel and then unilaterally flash flame-like streaks of chromatophores on the lateral mantle towards one another (Fig. 4C). Up to five additional chromatic components may be expressed in this display, depending upon its intensity. In some cases the squids may also engage in “fin beating” while parallel to one another, and in extremely rare cases the dominant (and usually larger) squid may execute a forward attack and grasp or bite the other squid. In contrast, females are generally passive and docile in the laboratory (Fig. 4A, B, C) and they seldom engage in aggressive behavior except occasionally during the pursuit of prey (Fig. 4F). Mating and egg laying are common in captivity and can be artificially stimulated by placing egg strands or a facsimile in the tank in the manner described for *Loligo pealei* by Arnold (1962). Feeding and growth in captivity are good, with cannibalism (Fig. 4G) occurring rarely. *L. plei* has delicate skin and is more vulnerable to skin abrasion than the other two species (Fig. 7).

Loligo pealei (Fig. 5) has the second widest range of body patterns and its behavior

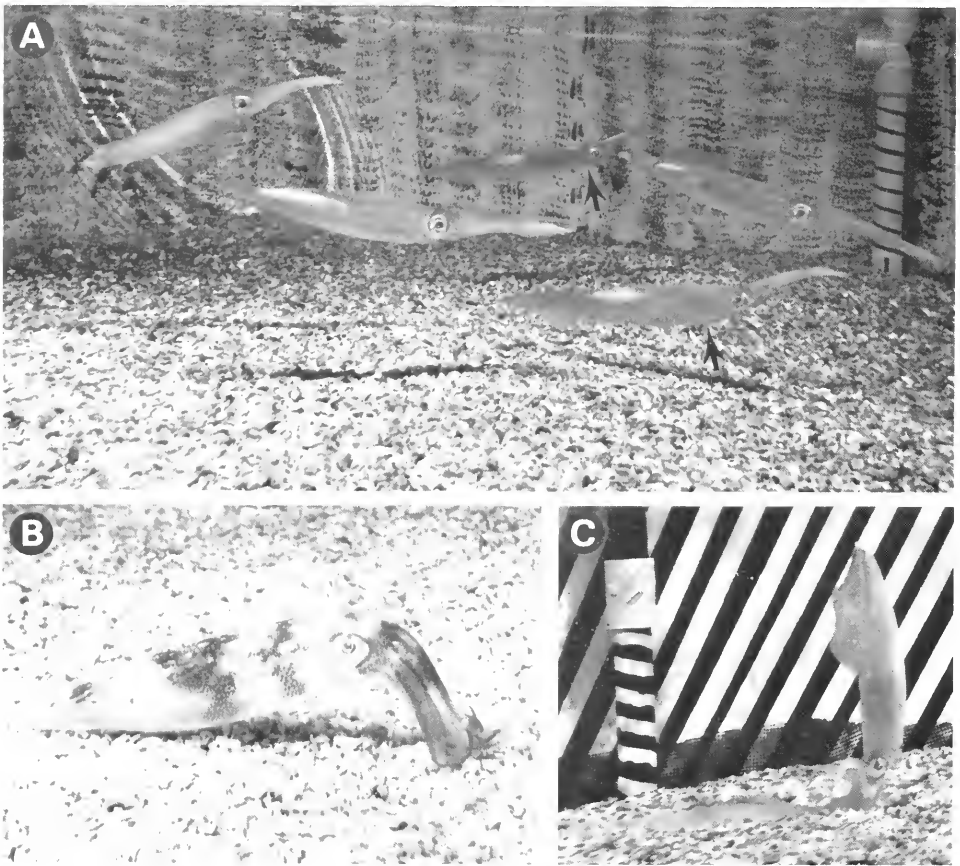

FIGURE 5. *Loligo pealei*. A. Intraspecific compatibility is obvious in this school of three *Loligo pealei* (two males, one female at far left) and two *Loligo plei* males (arrows). All squids are approximately 220 mm ML. Note the wall pattern and how squids stay near the middle of the tank. B. Female (174 mm ML) in a Ring pattern while bottom sitting. This is a normal posture for this species. C. Female (180 mm ML) actively securing an egg strand into the substrate. Note the egg strand on the left; also the bold stripes on the wall.

is similar in complexity to *L. plei*. Approximately 12 chromatic and four postural components and their associated behavior are recognizable in this species. Males and females are similar in size (Hixon *et al.*, 1981) and grow larger than *L. plei*. Males and females both display intraspecific aggression. Males are slightly more aggressive and they also establish a rank order based upon size and aggressiveness (similar to that reported by Arnold, 1962), but they do not show any obvious male-only or female-only chromatic components. Mating and egg laying are common in captivity (Fig. 5C) and can be easily stimulated (Arnold, 1962). Feeding and growth are good, as in *L. plei*, but cannibalism by large males is more common. The skin is nearly as subject to injury as in *L. plei* (Fig. 7).

Loligo pealei commonly sits on the bottom (Fig. 5B). This is a normal posture, exclusive to this species, that is assumed for long periods of time on sand or gravel substrates. Bottom sitting is conducive to laboratory survival because it conserves energy (compared to constant swimming), it maintains calmness among the tank animals, and it minimizes contact with the tank walls.

Loligo plei and *Loligo pealei* are very similar morphometrically and they are difficult to distinguish visually, especially when they are smaller than 100 mm ML. They can, however, be distinguished by their specific chromatic components (particularly *L. plei* males) and their behavior, and this is useful for the identification and segregation of animals in the laboratory.

Lolliguncula brevis (Fig. 6) is distinctly different from the two species of *Loligo*. Aside from being smaller, its behavior is less complex and only seven chromatic and four postural components of body patterning have been noted thus far. A common threat posture is illustrated in Figure 6D. Females grow markedly larger than males (Dragovich and Kelly, 1962; Hixon, 1980a). Little intraspecific aggression has been observed and there has been no evidence of rank ordering among males. Mating has been seen fairly often, and large females are often seen with conspicuous white patches of spermatophores attached to a pad on the inside of the mantle on the left side (Fig. 6A); however, egg laying in captivity is rare. Efforts to stimulate egg laying with egg strands were negative, but occasionally a temperature increase resulted in egg laying. Feeding and growth in captivity are very good (Fig. 6B, C). This species is less vulnerable to fin and skin damage than *Loligo* spp. For these reasons, males and females may be kept in the same tank at higher densities (Fig. 6A) than *Loligo* spp. and for longer periods of time.

There is some interspecific compatibility among the three species. On several occasions mid- to large-sized *Loligo pealei* and *Loligo plei* have been kept in CT systems for up to 15 days with no noticeable problems. It was important that these animals were all of a similar size (about 200 mm ML) and were put into this tank at the same time. They schooled together in a seemingly random arrangement, *i.e.*, individuals were found in different parts of the school at different times (Fig. 5A). During another observation, nine *Loligo plei* were put into a tank that held a mating pair and eggs of *Loligo pealei*. The male *Loligo pealei* continuously displayed towards and attacked the *L. plei*, which had to be removed within one day. It was difficult to tell whether this was territorial defense of the eggs, the female, or the tank, or simply the usual aggression shown by large males to define the rank order. *Lolliguncula brevis* is compatible with both species of *Loligo* if all animals are of the same size; they even school together with little interaction. But if the *Loligo* are larger they will display towards the *Lolliguncula brevis*, which in turn will often display and attack as well. It is characteristic of *Loligo plei* and *Loligo pealei* to cannibalize smaller squids or weakened squids such as those with impaired swimming due to skin damage or the effects of anaesthetic agents. Cannibalism by *Lolliguncula brevis* has been

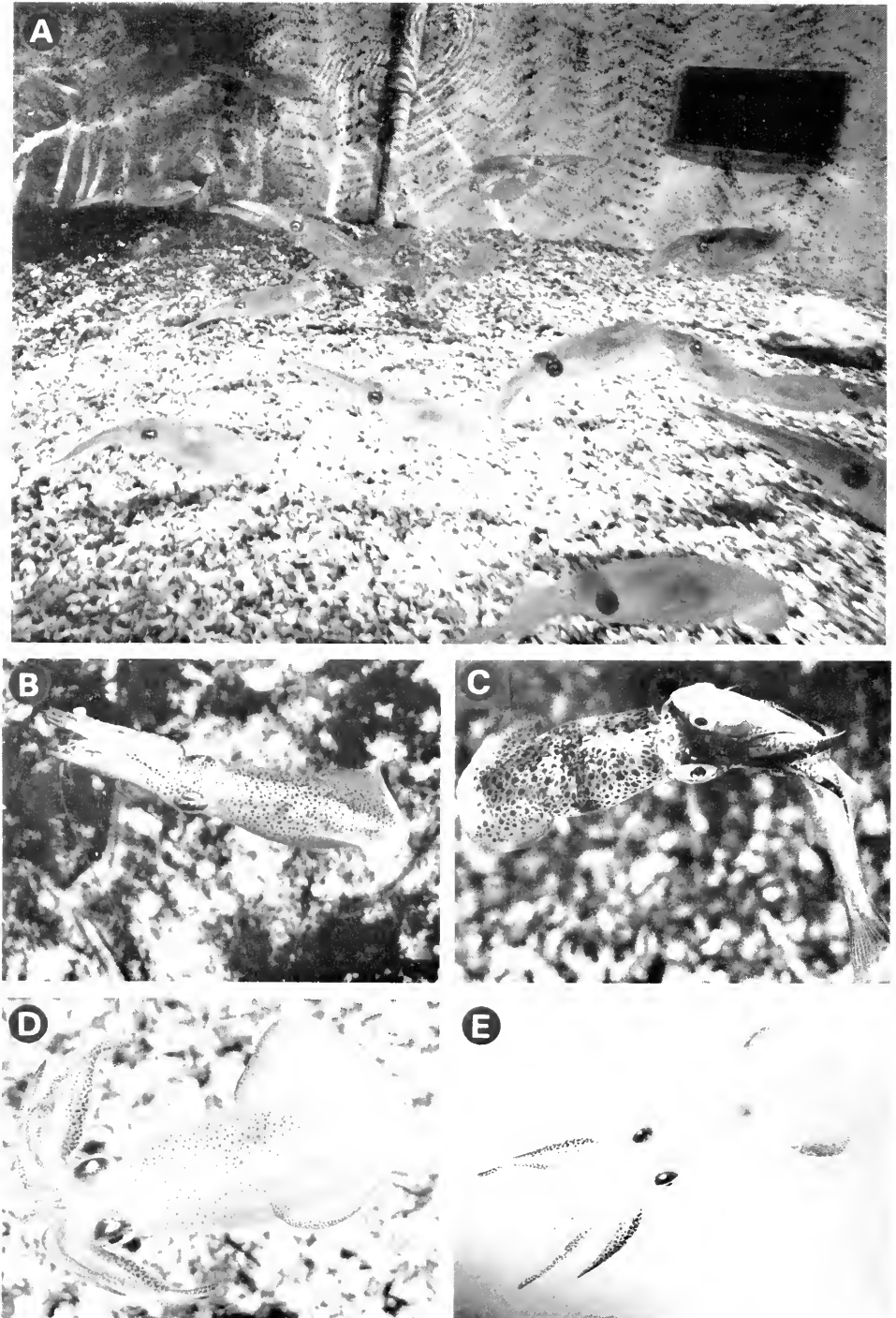

FIGURE 6. *Lolliguncula brevis*. A. Twenty-three squids in a CT system. Note the white patch of spermatophores inside the mantle on the female in the left foreground. B. Small squid feeding on a penaeid

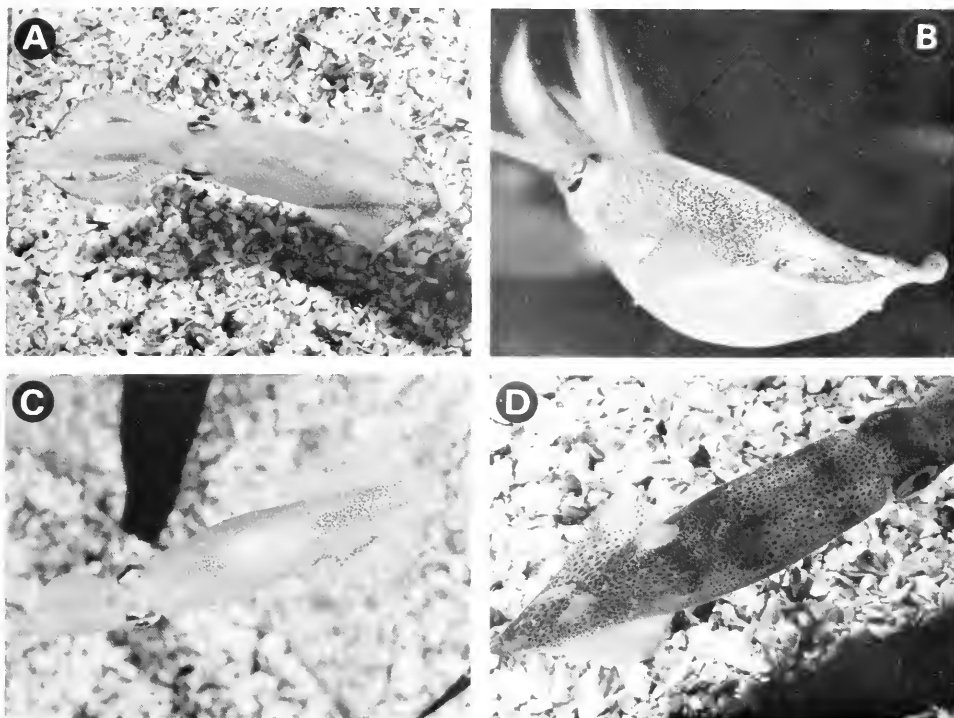

FIGURE 7. Fin damage. A. *Loligo pealei* with fairly severe fin damage incurred initially from transport. B. The same squid as in (A) showing the amount of damage on the posterior fin and the ventral mantle that resulted from hitting the transport tank walls. C. *Loligo plei* female (82 mm ML) from Observation 1 with moderate fin damage. Note the expanded chromatophores that are usually present around the periphery of damage. D. *Loligo plei* female (87 mm ML) with several round patches of damage; these are less lethal than damage to the periphery of the fin.

observed only on one rare occasion. In summary, under ideal circumstances there is interspecific compatibility among the three species, but when a size difference exists the larger individual usually dominates.

As the three species were exposed to salinity shock when first brought to the laboratory, their reactions were immediate. The first manifestation of stress was the curling of the extreme distal portions of the eight arms. The squids also showed sluggish hovering and swimming movements and usually did not school or feed immediately. In extreme cases, some squids would go to the bottom and sit, a posture very uncommon to *Lolliguncula brevis* and *Loligo plei*, but not unusual for *Loligo pealei*. Normal behavior usually resumed within one hour or less.

Field behavior was also species specific. *Loligo plei* was nearly always found in moderate- to large-sized schools both during the day and night. Around night light stations, the schools usually stayed deep and would characteristically rise *en masse* to the surface under the light, then quickly dive. They preferred the periphery of

shrimp nearly as long as the squids' mantle length. C. Small squid from Observation 16 (Table III) eating a very large silverside, *Menidia beryllina*. D. A female swimming in a typical threat posture three days after brain surgery, in which the vertical lobe was cut. E. Narcotized squid with the characteristic chromatophore pattern that is usually produced while the squid is under anaesthesia.

light. On occasion, one or several squids would leave the school to feed. Only rarely would the schools swarm for any period of time right at the surface under the lights in the manner described for the California market squid *Loligo opalescens* (Kato and Hardwick, 1975). Individual schools would seldom stay around the night light station very long, but other schools would appear later, indicating that squids were moving and actively foraging. Schools became closer knit and usually left the night light stations upon the appearance of schools of scad or jacks (Family Caranxidae), mackerel, or sharks. Schools always were comprised of squids of similar size, an observation corroborated by laboratory results that showed squid schools being incompatible when size disparities were present. In some cases it appeared that schools were not only size specific but sex specific as well [the white testis of mature males is highly conspicuous in live squids and is even used in signalling (Hanlon, 1982)]. At Grand Cayman Island, B.W.I., large schools could be attracted to night lights set on sandy patches between coral reefs at 10 m. These schools were never seen near reefs during the day, at which time they presumably moved to deeper water. Off Eleuthera Island, Bahamas, we have observed one small *Loligo* (probably *plei*) swimming on three consecutive days with a school of 12 *Sepioteuthis sepioidea*. Moynihan and Rodaniche (1982) observed this association frequently in Panama.

Loligo pealei behaved quite differently from *Loligo plei* in the field. Our only observations were at deep-water night light stations, and in most cases large adults were seen singly or in pairs. No tight, well-formed adult schools were ever observed at night light stations, although on some nights enough individuals would arrive at the lights over a period of time to form a loose aggregate of squids. In a few cases we could identify the pairs as male-female, presumably a mating pair. In contrast to adults, young juveniles were often seen in large schools under the lights, indicating that *L. pealei* becomes more solitary at night as it becomes larger. *Lolliguncula brevis* observations are scarce due to the turbid waters in which it lives.

Feeding

All three squid species fed readily on a variety of live fishes and shrimps (Figs. 4, 5, 6). The feeding response of adult squids in good physical condition has been excellent, with detection, pursuit, and capture of prey usually taking five seconds or less. Some squids fed within ten minutes of their release into the tank and nearly all fed within the first day of confinement. The feeding behavior of healthy squids is predictable and provides an indication of the animals' overall condition. Damage to the delicate fins seriously impaired the squids' ability to deftly maneuver for prey capture. Squids actively participating in intraspecific aggressive behavior often did not feed well; conversely, feeding occasionally led to aggressive behavior when two or three squids would capture the same prey organism and a vigorous tug-of-war would result (Fig. 4F).

The response of juvenile squids to the presence of food was usually slower, with feeding sometimes not beginning for a day or two and remaining sporadic thereafter. One probable cause for this was their greater susceptibility to fin damage during capture and transport to the laboratory. Another cause, in some cases, was the presence of large conspecifics that were aggressive.

Movement on the part of the prey provided an essential visual stimulus to the squids. Fishes or shrimps that made it to the bottom of the tank without detection would go uneaten for hours if they remained motionless. In the CT systems, the oyster shell substrate and the painted walls provided partial concealment because of the similarity in coloration between the substrate and prey organisms. Palaemonid

shrimps blended in especially well, and even when there were hundreds of them in the tank, only those that moved quickly or swam into the water column were attacked and eaten. In the raceway system, squids had little difficulty in sighting and capturing prey against the pale interior of new or cleaned systems, but on algae-covered bottoms (e.g., Fig. 3) small shrimps were difficult to detect. Normally, all squids ate daily at each of the two or three times food was dropped into the tanks, even though food was usually in the tanks at all times. During growth experiments, *Loligo plei* consumed 10 to 18 percent of its body weight in food per day (see *Growth* section).

Small fishes (less than about 25 mm long) were usually eaten entirely. Larger fishes were captured with the two long tentacles (Fig. 4D) and were bitten several times through the vertebrae just behind the head, after which the viscera were eaten (Fig. 4E) and all the meat on either side of the skeleton was cleanly stripped away. Shrimps were eaten completely except for some of the head and the thin exoskeleton. Hungry squids sometimes took prey nearly as long as their own mantle length (Fig. 6B, C).

It was not possible to detect any clear-cut diet preferences for different species or different growth stages. The younger stages of all three species seemed to prefer crustaceans, and the larger animals generally preferred fishes, but many individual and collective exceptions to this statement occurred. Cannibalism occurred rarely (see *Behavior* section). Growth rates were equally high on shrimp-only, fish-only, and mixed diets, and our conclusion is that estuarine food organisms are suitable for maintaining and growing loliginid squids.

Field and laboratory observations both confirmed that squids of all sizes eat prey organisms of a wide size range. Underwater observations during night lighting stations off Texas and Grand Cayman verified that adult *Loligo plei* commonly fed on very small plankton in the vicinity of the night light. The squids always seemed to be very selective about these planktonic organisms, for they would carefully orient towards, follow, and seize specific organisms even when great masses of plankton were present. Conversely, squids at the same station would inspect and sometimes attack squid jigs up to 70 mm long, objects that were many orders of magnitude larger than the planktonic organisms they had seized minutes before. Laboratory observations corroborated this behavior. We commonly saw adult squids follow and inspect small bubbles that were only several millimeters in diameter.

Survival

Loligo plei ranging in size from 12 to 252 mm ML (mean ML 107, $S\bar{x} = 3.0$) were maintained in 33 laboratory observations (Table I). The mean survival time for 455 squids was 11 days ($S\bar{x} = 0.5$, median = 7 days, Fig. 8). The longest-lived male (85 mm ML) survived 84 days, and two females (89 and 95 mm ML) survived for a maximum of 52 days. There were no significant differences in survival time between males ($n = 149$, median survival time 7 days) and females ($n = 132$, median survival time 10 days). In contrast, the survival times of 81 juveniles (less than 50 mm ML) were low. Median survival was three days, which was significantly ($P < .001$) lower than both males and females.

Loligo pealei showed best overall survival in our tank systems (Table II). Squids ($n = 37$) ranging in size from 109 to 285 mm ML (mean 173 mm ML, $S\bar{x} = 7.7$) had a mean survival time of 28 days ($S\bar{x} = 3.1$, median = 27 days, Fig. 8). The maximum survival time was 71 days for a male measuring 213 mm ML. The longest-lived female survived 67 days and measured 200 mm ML. There were no statistically significant differences in survival by sex; 17 males had a median survival time of 28

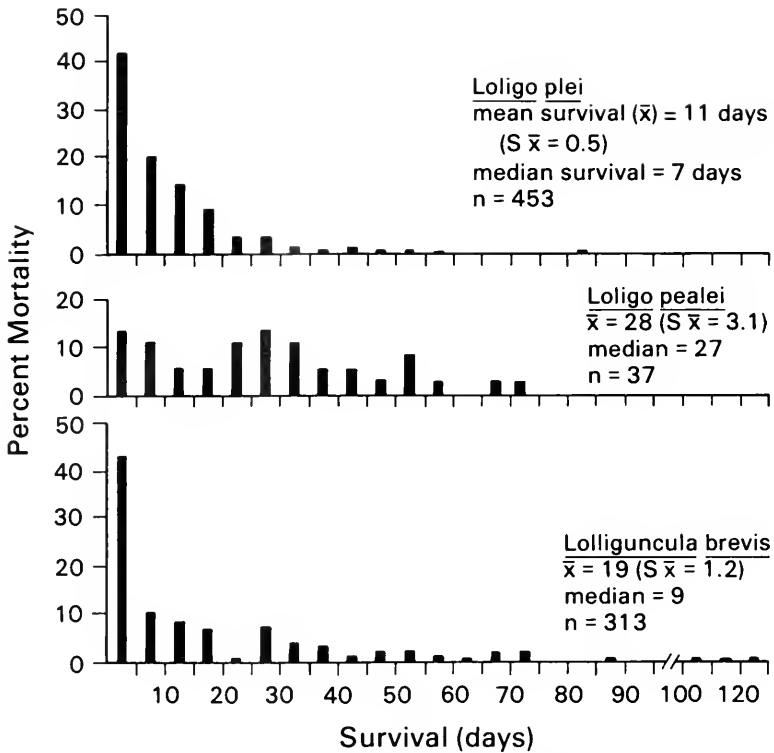

FIGURE 8. Survival summary of all squids in recirculating circular tanks and raceways.

days, and 14 females had a median survival time of 27.5 days. No small-sized juveniles of this species were maintained during the 14 laboratory observations.

A total of 313 *Lolliguncula brevis* ranging in size from 27 to 99 mm ML (mean ML 55 mm, $S\bar{x} = 1.2$) were maintained during the course of 18 laboratory observations (Table III). The mean survival time for all squids was 19 days ($S\bar{x} = 1.3$, median = 9 days, Fig. 8). Some squids commonly survived much longer; the longest-lived male (60 mm ML) survived 123 days, and the longest-lived female (also 60 mm ML) survived for 125 days. There were no statistically significant differences in survival times between 63 males (median survival 19 days) and 74 females (median survival 14 days). The median survival time of 36 juveniles (less than 40 mm ML) was only 3.5 days; this was significantly lower ($P < .001$) than that of males and females.

There were statistically significant differences in laboratory survival among the three species. *Loligo pealei* survived in the laboratory tanks significantly longer ($P < .001$) than both *Loligo plei* or *Lolliguncula brevis*, and *Lolliguncula brevis* survived significantly longer ($.001 < P < .01$) than *L. plei*.

It should be pointed out that the mean survival times for all three species shown above are conservative figures. In these estimates all squids alive in the laboratory after one day of acclimation were included, regardless of their size or physical condition after capture and transport. The inclusion in the calculations of the short-lived juveniles and sexually-mature adults near the end of their life cycle also reduced the overall mean and median values. If the effects of these factors are reduced by computing laboratory survival using only squids that lived beyond five days, instead of one, then the mean survival time for each species increases substantially. The mean survival

of *Loligo plei* becomes 15 days ($\bar{Sx} = 0.7$) compared to 11 days. Likewise, mean survival for *Loligo pealei* increases to 31 days ($\bar{Sx} = 3.1$) from 28 days, and *Lolliguncula brevis* increases to 29 days ($\bar{Sx} = 1.7$) from only 19 days.

These higher figures probably represent a more realistic approximation of how long squids survive in captivity, because they do not include squids that incurred extensive skin damage during capture, transport, and transfer. In effect, one can then begin to define the limitations to survival among these squids in terms of aspects of behavior and maturation that take place in the laboratory tank system. These are explained below (*Principal causes of mortality*).

Growth

Laboratory observations on growth were obtained from three male and three female *Loligo plei* and from seven male and one female *Loligo pealei*; temperatures ranged from 18 to 23°C (Table IV). The results suggest that adult males of both species of *Loligo* are capable of growing at high rates in both length and weight in the laboratory. Males of *L. plei* grew at a mean rate of 47 mm/mo ($\bar{Sx} = 7.6$) and 13.3 g/mo ($\bar{Sx} = 5.30$), while *L. pealei* males grew at a mean rate of 44 mm/mo ($\bar{Sx} = 10.7$) and 37.3 g/mo ($\bar{Sx} = 10.94$). In contrast, adult females grew little or not at

TABLE IV

Laboratory growth of male and female *Loligo plei* (top) and *Loligo pealei* (bottom)

Obs. No.	Temp. (°C)	Sex	Duration (days)	ML Changes (mm)	WW Changes (g)	GROWTH RATE			
						ML (mm/mo)	% Length gain/day	WW (g/mo)	% Weight gain/day
16	20-21	M	33	68-104	10.0-17.6	33	1.3	6.9	1.7
16	20-21	M	33	75-140	13.0-39.2	59	1.9	23.8	3.3
16	20-21	M	22	124-160	37.6-44.3	49	1.2	9.1	0.7
	\bar{x} :		29			47	1.5	13.3	1.9
	(\bar{Sx}):		(3.7)			(7.6)	(0.22)	(5.30)	(0.76)
15	21-22	F	10	56-54	8.0-7.5	-6	-0.4	-1.5	-0.6
15	21-22	F	33	88-93	20.5-28.2	5	0.2	7.0	1.0
15	21-22	F	12	93-87	23.4-26.0	-15	-0.6	6.5	0.9
	\bar{x} :		18			-5	-0.3	4.0	0.4
	(\bar{Sx}):		(7.4)			(5.8)	(0.24)	(2.75)	(0.52)
<i>LOLIGO PEALEI</i>									
6	21-23	M	30	86-112	27.6-49.1	26	0.9	21.5	1.9
11	21-22	M	14	130-140	54.2-60.5	21	0.5	13.5	0.8
11	21-22	M	43	132-153	70.4-78.9	15	0.3	5.9	0.3
11	21-22	M	44	135-248	55.5-133.5	77	1.4	53.2	2.0
11	21-22	M	28	149-209	72.2-130.5	64	1.2	62.5	2.1
3	18-21	M	7	262-276	216.3-232.0	60	0.7	67.3	1.0
	\bar{x} :		28			44	0.8	37.3	1.4
	(\bar{Sx}):		(6.1)			(10.7)	(0.17)	(10.94)	(0.31)
5	20-22	F	7	124-127	64.6-65.0	13	0.3	1.7	0.1

TABLE V

Laboratory growth of 28 male and 22 female *Loliguncula brevis*

Obs. No.	Temp. (°C)	Sex	Duration (days)	ML Changes (mm)	WW Changes (g)	ML (mm/mo)	% Length gain/day	WW (g/mo)	% Weight gain/day	GROWTH RATE	
										ML in mm/mo Group \bar{x} (S \bar{x}) median	WW in g/mo Group \bar{x} (S \bar{x}) median
18	16-25	M	29	29-38	1.6-4.0	9	0.9	2.5	3.2		
18	16-25	M	15	31-32	1.7-2.7	2	0.2	2.0	3.1		
18	16-25	M	43	31-56	1.8-12.3	17	1.4	7.3	4.5		
18	16-25	M	57	31-52	1.9-8.7	11	0.9	3.6	2.7		
17	19-22	M	70	34-60	2.6-14.3	11	0.8	5.0	2.4	11 (1.5)	4.3 (0.56)
17	19-22	M	47	35-58	3.5-11.0	15	1.1	4.8	2.4	//	4.4
18	16-25	M	71	36-55	3.4-10.9	8	0.6	3.2	1.6		
18	16-25	M	29	37-50	3.0-8.8	13	1.0	6.0	3.7		
9	21-22	M	49	39-59	4.8-12.0	12	0.8	4.4	1.9		
18	16-25	M	29	40-50	4.0-7.8	10	0.8	3.9	2.3		
17	19-22	M	47	41-59	4.6-12.6	11	0.8	5.1	2.1		
9	21-22	M	48	41-58	4.7-15.2	11	0.7	6.6	2.4		
6	15-24	M	87	42-53	4.7-12.2	4	0.3	2.6	1.1		
9	21-22	M	27	42-60	5.2-13.0	20	1.3	8.7	3.4	10 (1.7)	4.9 (1.10)
3	18-23	M	59	42-54	7.6-10.4	6	0.4	1.4	0.5	//	4.0
18	16-25	M	43	44-55	5.7-11.5	8	0.5	4.0	1.6		
2	20-22	M	58	44-67	5.8-18.2	12	0.7	6.4	2.0		
2	20-22	M	30	45-63	6.9-20.1	18	1.1	13.2	3.6		
3	18-23	M	59	47-53	6.4-8.4	3	0.2	1.0	0.5		
6	15-24	M	86	48-55	8.1-13.4	2	0.2	1.8	0.6		
3	18-23	M	29	50-55	7.7-10.3	5	0.3	2.7	1.0		
6	15-24	M	67	50-56	8.3-12.3	3	0.2	1.8	0.6		
6	15-24	M	123	52-60	8.5-17.9	2	0.1	2.3	0.6		
3	18-23	M	36	52-58	11.0-11.7	5	0.3	0.6	0.2	1 (1.6)	0.6 (0.82)
3	18-23	M	59	52-55	11.0-10.5	2	0.1	-0.3	-0.1	2	0.5
6	15-24	M	33	56-55	10.3-10.9	-1	-0.1	0.5	0.2		

6	15-24	M	59	60-61	13.5-16.7	1	0.0	1.6	0.4
4	20-23	M	23	63-56	12.0-8.5	-9	-0.5	-4.6	-1.5
\bar{x} :			50			8	0.5	3.5	1.7
(S \bar{x}):			(4.4)			(1.2)	(0.09)	(0.62)	(0.26)
median:			8.5					2.95	
18	16-25	F	71	34-61	2.2-16.0	11	0.8	5.8	2.8
17	19-22	F	50	35-69	3.3-22.3	20	1.4	11.4	3.8
17	19-22	F	69	37-66	3.9-23.5	13	0.8	8.5	2.6
18	16-25	F	71	40-66	3.6-16.4	11	0.7	5.4	2.1
17	19-22	F	69	40-68	4.2-28.0	12	0.8	10.3	2.8
9	21-22	F	39	42-62	5.1-18.5	15	1.0	10.3	3.3
9	21-22	F	33	43-76	6.0-23.4	30	1.7	15.8	4.1
9	21-22	F	27	46-74	5.5-18.8	31	1.8	14.8	4.6
5	15-21	F	54	49-52	7.0-11.6	2	0.1	2.6	0.9
2	20-22	F	43	51-79	9.4-26.6	20	1.0	12.0	2.4
9	21-22	F	38	52-73	8.7-30.5	17	0.9	17.2	3.3
3	18-23	F	28	54-74	9.3-20.9	21	1.1	12.4	2.9
5	15-21	F	92	55-75	10.2-25.5	7	0.3	5.0	1.0
6	15-24	F	70	55-59	9.5-14.2	2	0.1	2.0	0.6
3	18-23	F	44	59-74	11.0-26.4	10	0.5	10.5	2.0
3	18-23	F	29	68-80	19.8-33.2	12	0.6	13.9	1.8
3	18-23	F	44	69-80	17.8-30.8	7	0.3	8.9	1.2
4	20-23	F	19	71-67	18.3-15.6	-6	-0.3	-4.3	-0.8
4	20-23	F	31	74-72	21.6-21.3	-2	-0.1	-0.3	-0.1
6	15-24	F	58	74-72	21.2-23.6	-1	-0.1	1.2	0.2
3	18-23	F	36	75-82	28.0-33.5	6	0.2	4.6	0.5
3	18-23	F	36	76-81	28.3-35.1	4	0.2	5.7	0.6
\bar{x} :			48			11	0.6	7.9	1.9
(S \bar{x}):			(4.1)			(2.1)	(0.12)	(1.20)	(0.31)
median:			11			11		8.9	

Two far right-hand columns give group mean growth rates according to mantle length at the beginning of each observation. Categories for males are <39 mm, 40 to 49 mm, and >50 mm. Categories for females are <39 mm, 40 to 49 mm, 50 to 59 mm, and >60 mm.

all in these observations; negative mantle length values resulted from damage to the posterior mantle during confinement. All females were mature when captured and their oviducts were full of eggs when death occurred. Unfortunately, no growth observations on juvenile *Loligo* were made.

Growth observations were obtained on 28 male and 22 female *Lolliguncula brevis*; temperatures ranged from 15 to 25°C (Table V). Males and females survived equally well during these observations; overall mean survival was 50 days ($\bar{S}_x = 4.4$) for males and 48 days ($\bar{S}_x = 4.1$) for females. Males grew in length at an overall mean rate of 8 mm/mo ($\bar{S}_x = 1.2$) and 3.5 g/mo ($\bar{S}_x = 0.62$), while equivalent rates for females were 11 mm/mo ($\bar{S}_x = 2.1$) and 7.9 g/mo ($\bar{S}_x = 1.20$). There were no statistically significant differences in median monthly growth rates in length between the sexes (males 8.5 mm/mo, females 11 mm/mo), but males (2.95 g/mo) differed significantly from females (8.9 g/mo) in median monthly growth in weight ($.01 > P > .001$). These weight differences reflect the maturation of reproductive organs and the production of eggs in adult females.

In both sexes of *Lolliguncula brevis* there were size-dependent differences in growth rate. Small young squids grew faster than larger (and presumably older) adults. Males were divided into three categories (<39 mm ML, 40 to 49 mm ML, >50 mm ML) based on their mantle length at the beginning of the growth observation (Table V). Males >50 mm ML grew in length at a mean rate of only 0.9 mm/mo ($\bar{S}_x = 1.6$) compared to 10 mm/mo ($\bar{S}_x = 1.7$) for the 40 to 49 mm ML group and 11 mm/mo ($\bar{S}_x = 1.5$) for the <39 mm ML group. Similar differences in monthly growth rates in wet weight were measured (Table V). The median monthly growth rate in length of the >50 mm ML group (2 mm/mo) differed significantly ($P < .05$) from the median growth rates of the other two groups (both 11 mm/mo). The same statistical results among the three groups were obtained using the monthly growth in weight measurements. The reason for this reduced growth rate is that males >50 mm ML are nearing maximal size and the end of their life cycle.

Female *Lolliguncula brevis* were grouped into four categories using the same criterion: <30 mm ML, 40 to 49 mm ML, 50 to 59 mm ML and >60 mm ML (Table V). The mean monthly growth rate in length of the >60 mm ML group was only 3 mm/mo ($\bar{S}_x = 2.3$) compared to over 13 mm/mo for the other three groups. However, there was only a statistically significant difference ($.10 > P > .05$) between the median monthly growth in length of the >60 mm ML group (4 mm/mo) and the 40 to 49 mm ML group (13.5 mm/mo). Similar results were obtained using the monthly wet weight data from the four groups. The mean monthly increase in wet weight of the >60 mm ML group was low (mean 3.9 g/mo, $\bar{S}_x = 2.39$) compared to the other three groups which were all above 8.6 g/mo. However, the median monthly growth rates in weight among the four groups were not statistically different. Females showed reduced growth rates beyond 60 mm ML because they, like males, were reaching maximal size.

The growth measurements suggest that the three species generally grow in the laboratory at similar instantaneous relative growth rates (Tables IV and V); comparisons among species of differing sizes are best done using instantaneous relative growth rates (percent gain per day). Female *Loligo plei* and female *Loligo pealei* are not included due to the reasons mentioned earlier. The mean instantaneous relative growth rates in weight ranged from 1.4 %/day for *L. pealei* males to 1.9 %/day for *L. plei* males and 1.9 %/day for *Lolliguncula brevis* females; the highest measured rate was 4.6 %/day for a *Lolliguncula brevis* female. The mean instantaneous relative growth rates in length were 0.8, 0.5, and 0.6%/day for *L. pealei* males, and *Lolliguncula brevis* males and females, respectively. The mean instantaneous relative growth rate

for *L. plei* males was 1.5 %/day, but since this is based on only three squids it is difficult to make comparisons. The highest measured rate was 1.9 %/day for a *L. plei* male.

Gross growth efficiency (GGE) was estimated separately for three males and three females of *Loligo plei*. All squids had been maintained previously for 42 days in CT systems. At 21°C, the three males (107, 136, 136 mm ML) collectively gained 12.5 g over six days while ingesting 56.9 g of fish, for an estimated 22 percent GGE. However, one male was dominant and very aggressive, and he was taking the vast majority of food and accounted for 12.3 g of the weight gain. With a conservative estimate that he obtained 80 percent of the fishes, his GGE was 27 percent, and his daily food intake was 18 percent of his body weight per day. The three females (56, 89, 95 mm ML) were sexually mature and full of eggs. Collectively they gained only 1.4 g in six days while ingesting 36.1 g of fish, for an estimated 4 percent GGE. These females were eating five to 17 fishes each day, and their collective mean daily food intake was 10 percent. Apparently, either 10 percent daily food intake represents the females' required maintenance ration, or egg production utilized most of the energy that otherwise may have contributed to somatic growth.

Principal causes of mortality

The majority of deaths have been related to (1) fin damage, (2) intraspecific aggression, (3) sexual maturation, mating, and subsequent egg laying by females, and (4) crowding.

Fin damage (Fig. 7) was very critical because it impaired normal swimming and hovering and it eliminated stabilization during jet-propulsed movements, which were necessary for deftly pursuing and attacking prey and avoiding aggressive conspecifics. Details of the effects of fin damage were reported elsewhere by Leibovitz *et al.* (1977) and Hulet *et al.* (1979). Although survival during shipboard transport and laboratory transfer was fairly good, injuries incurred during shipboard transport of all species and during trawl capture of *Lolliguncula brevis* often accounted for many deaths during the first few days in captivity. Shipboard movement during heavy weather and long transports caused increased wall contact that resulted in skin abrasion to the squids, especially smaller ones.

The cumulative effects of fin damage from sporadic wall contact during long maintenance periods also contributed to mortality in all species. There were rare cases in which minor fin damage healed in some squids. Usually, however, the damage remained in a steady state or slowly spread from bacterial infection. Subsequent wall contact exacerbated existing wounds until eventually the fins became useless. The patterns painted on the walls apparently helped reduce wall contact, but they did not eliminate it.

Intraspecific aggression was one primary cause of mortality once the squids were in the laboratory. It was characteristic among *Loligo plei* males and, to a slightly lesser degree, *Loligo pealei* males; *Lolliguncula brevis* did not show obvious signs of aggression. During establishment of their rank order and during mate selection, the males vigorously made lateral displays and frontal attacks on subordinate males and sometimes females. This disrupted feeding and led to increased fin damage from wall contact when subordinate squids escaped. If *Loligo* spp. squids of a large size difference were put in the same tank, the smaller squids were nearly always badly harassed and died from fin damage and/or starvation within days, and on occasion they were cannibalized.

Sexual maturation and its manifestations were another primary cause of mortality. From the standpoint of laboratory survival, mating in *Loligo* was a fatal event because

females usually laid eggs and died within a few days. After repeated matings, males of *Loligo plei* occasionally underwent an apparent catabolic change in which the arms and fins deteriorated until the squids could not swim or capture food. Females of *Lolliguncula brevis* (42 to 99 mm ML) and *Loligo plei* (51 to 139 mm ML) often showed very rapid sexual maturation and egg development within two to three weeks in captivity. *Lolliguncula brevis* and *Loligo plei* females that were segregated from males often produced so many eggs that the mantle bulged and the internal organs were pushed forward, probably affecting digestion; they would often die without laying eggs.

Crowding caused increased intraspecific aggression, fin damage from more frequent contact with the wall, and disruption of feeding. Had crowding been allowed over long periods, it would have resulted in deterioration of water quality if the biological carrying capacity of the tank system were exceeded.

There are other factors that contributed to mortality. *Loligo plei* that inked during transfer in plastic bags died quickly in the inky water. Another similar event, which we called the "shock syndrome," occurred when *L. plei* squids were startled and began to ink. However, the ink was only ejected into the mantle and over the gills, but not forcibly enough to get it out of the mantle. Ventilatory movements ceased immediately and the squids invariably died. On rare occasions *Loligo* spp. would leap completely out of the tank during the night. As previously mentioned, cannibalism by *Loligo* spp. accounted for some mortality. A certain number of deaths were inexplicable, *i.e.*, there was no skin damage, no aggression, *etc.* It is possible that an inconspicuous pathologic condition existed, that parasites weakened the squids, or that there was a nutritional deficiency. Although these were not obvious, they deserve future attention.

A typical scenario of how fin damage, aggression, and sexual maturation affected survival in a typical summer experiment on *Loligo plei* is as follows. Out of 20 adult squids (ten male, ten female) caught at a night lighting station, 17 would survive to dockside during a seven-hour transport. Within the first five days in a CT system, four squids would die as a result of fin damage incurred during capture and transport. The other 13 squids would school together and feed well for the next two weeks except for isolated and mild aggression by the largest male as he established and maintained rank order. During this time the size of the females' ovaries and nidamental glands would swell noticeably and the accessory nidamental gland would become bright red. Pair formation would begin, with the large male herding two to three females from the school and laterally displaying towards subordinate males, who would begin to accrue fin damage from hitting the walls during escape. Two males would die within two days of this (about Day 18). Mating by several pairs would take place over several days; five females would lay eggs within one day and then die (about Day 21). Intraspecific aggression would increase, two males would die from repeated matings or fin damage, rank order would change, and several more matings with egg laying would occur by Day 25. Conditions would briefly stabilize for the remaining four squids. Then another three would die within one week—one female from having too many eggs but not laying them, and two males from aggression and fin damage—until only one large male remained alive for several more weeks (Day 50). Mean survival would be about 20 days.

DISCUSSION

Our results clearly demonstrate that successful transport and long-term maintenance of live loliginid squids are strongly dependent upon avoiding damage to the

skin and fins during capture, and upon using sufficiently large tanks during laboratory maintenance to sustain high quality sea water. These points cannot be overstressed. Key factors for laboratory survival may be summarized as follows: (1) prevention of skin abrasion during capture, transport aboard ship, and transfer to the laboratory, (2) the tank system must be sufficiently large, with opaque walls and preferably no corners, (3) water quality must be high, (4) squids must have an ample food supply, (5) they must not be crowded, (6) only squids of similar size should be in the same tank to reduce aggression and cannibalism, and (7) sexes should be segregated to reduce aggression associated with courtship, mating, and egg laying.

Capture and transport

From the outset we recognized that capturing a live, undamaged squid is difficult. Over the past five years we experimented with several capture strategies: trawls, dipnets and squid jigs with night lights, and encirclement nets such as lampara nets and purse seines. Trawling is the least satisfactory capture method because of the high percentage of dead and damaged squids due to prolonged contact with the net or other animals, and to dropping of the catch on deck, which is a common practice of fishermen. Trawling is the capture method presently used to capture squids for physiological work at Woods Hole (Summers, 1968, 1969; Summers and McMahon, 1970, 1973; Summers *et al.*, 1974), at Plymouth, England (Holme, 1974) and in the past off Ocean City, Maryland (Brinley and Mullins, 1964). Few of the squids reach shore alive because of skin damage, and those that do live stay alive briefly or for only a few days (Holme, 1974). We have tested five trawl nets, but during 226 trawl stations we had very little success in capturing live undamaged *Loligo* spp. in depths between 20 and 200 m. These nets have increased our catch of live *Lolliguncula brevis*, and for this species trawling is our primary collection method. Success with *Lolliguncula brevis* is mostly attributable to the short-duration tows in very shallow water, less than 10 m deep. From our experience and that of many others, it appears that trawl capture of large *Loligo* spp. from deep water may not ever be by a satisfactory collection technique if squids are to be kept alive more than a few days.

Less traumatic capture methods include squid jigging (day or night) or attracting squids to lights and either dipnetting them, jigging them, or encircling them with a lampara net or purse seine. Unfortunately, the mean catch rate has been low, primarily because of the inconsistent attraction of squids to lights. It is likely that there is a species-specific response to light and that a host of other factors such as hydrographic conditions, moon phase, food availability, and sexual condition can influence squid behavior in relation to artificial light. These parameters are not well defined for our species. In some other geographic areas, squids may be caught alive with these methods or with pound nets or floating fish traps, and these are certainly the preferred methods if long-term maintenance is a key objective (Tardent, 1962; Summers and McMahon, 1970; Flores *et al.*, 1976, 1977; Matsumoto, 1976; O'Dor *et al.*, 1977; Hurley, 1978; Matsumoto and Shimada, 1980). Without doubt, future work on improving light attraction and atraumatic capture methods that impart little or no skin damage should receive high priority because it affects all aspects of squid maintenance.

Factors affecting survival during shipboard transport have been discussed in Results. We believe that the configurations of the HCT and RHT tanks and their recommended stocking densities provide adequate transport survival if the squids are in good condition and water quality is not allowed to deteriorate. The larger the volume of the tanks, the better, but vessel size will limit this in most cases. For comparison, Flores *et al.* (1976, 1977) reported that fishermen transported 1000 *Todarodes pacificus* in shipboard

live wells of 4000 l capacity for about 12 hours, but they noted that the extreme crowding (1 squid/4 l) resulted in extensive fin damage to most squids. O'Dor *et al.* (1977) transported 20 *Illex illecebrosus* per container (60 × 90 × 30 cm deep, or 1 squid/8 l), but because of the short transport time of one hour, no mortalities occurred. Matsumoto (1976) transported 15 *Doryteuthis bleekeri* in a 1 × 1 × 1 m tank (1 squid/66 l) for 3 to 5 hours with no mortalities; this is more space per squid than our recommendation of ten *Loligo* spp. per 580 l HCT tank (1 squid/58 l). These results verify that squids cannot be crowded during long transport.

In many operations, a major breakdown in the successful handling of live squids takes place at dockside. Our method of placing squids in plastic bags eliminates many of the problems encountered at this stage, especially sloshing water that led to skin damage and external commotion that startled the squids. Flores *et al.* (1976) used a similar method that worked equally well. It would be desirable to reduce as much as possible the large salinity and temperature shocks that squids encounter during laboratory transfer, but this is often impractical.

Sea water systems

The performances of the 2 m circular tank systems and the 10,000 l raceways were satisfactory. Both designs provided two essential criteria: the capability to sustain high quality water, and the physical dimensions to accommodate the movements and habits of the squids. The advantages of our closed sea water systems are (1) independence from a natural sea water supply and hence, reproducibility at inland laboratories, (2) efficient filtration of recirculated water, (3) large volume and wide horizontal space for distribution of squids, (4) accessibility to and observation of live animals, (5) simple construction, and (6) low cost.

We chose a closed (recirculating) system over an open (flow through) system for several reasons. Water quality adjacent to Galveston Island is variable and often unsatisfactory. Closed systems offer better control over temperature and salinity fluctuations, disease organisms, turbidity, pollutants, and undesirable animals that compete with cultured organisms for space and nutrients (Spotte, 1979a). Moreover, once the requisite conditions for each species are identified, they can be carefully and continuously regulated. It is clear that appropriately designed closed systems are suitable for squid maintenance, since a comparison of squid maintenance work done in open *versus* closed systems showed that maintenance success with closed systems equaled or surpassed that in open systems (Boletzky and Hanlon, 1983).

Water quality is of great importance. Artificial sea water is a satisfactory substitute for natural sea water, as evidenced from our present results and our success in rearing *Loligo opalescens* from hatching to adult size over an 8-month period (Hanlon *et al.*, 1979; Yang *et al.*, 1983). Aside from its biological usefulness, we found it to be as cost effective as natural sea water because of the ship and personnel time required to obtain high salinity offshore water, and the time and space needed to filter and store it. Buildups of inorganic nitrogen (ammonia, nitrite, nitrate) were not particularly high in our systems and were not a probable cause of mortality. However, our detailed chemistry tests were few, and the subject of nitrogen tolerance is critical to closed system maintenance and culture. Since 1982, we have had detailed chemistry tests performed weekly on all systems. Preliminary results from transport experiments of *Lolliginula brevis* in plastic bags (one squid per 4 l of sea water) indicate strongly that they die primarily from decreased pH (increased hydrogen ion concentration) and secondarily from ammonia buildup. For example, if pH is maintained within ±0.2 of its original level (*e.g.*, 8.0), squids can survive up to 30 hours even when

levels of ammonia gradually increase to 10 mg/l $\text{NH}_4\text{-N}$ (or 100 times the recommended levels of Spotte, 1979a). In contrast, squids usually die if the pH is allowed to drop below about 7.0. Therefore, it seems that pH is probably the most important barometer of water quality for squids. Obviously, a great deal more work must be done to understand aspects of water quality that most affect squid survival.

Matsumoto (1976) and Matsumoto and Shimada (1980) are the only authors that give any filtration information on closed systems for squids. Matsumoto's first system (1976) utilized sand filtration. In an improved system (Matsumoto and Shimada, 1980) they added 20 kg of zeolite and 10 kg of crushed oyster shell to the filtration system. They attributed longer survival of squids to the zeolite, but the reasons are unclear. Zeolite is a naturally occurring porous material that removes selective ions by a combination of ion exchange and adsorption, but its use in marine systems is limited because of competition from other ions in sea water that quickly reduce the number of exchange sites available for binding contaminant ions such as ammonium, nitrate, and phosphate (Spotte, 1979a). Johnson and Sieburth (1974) examined the efficacy of zeolite in removing ammonium ions in salinities ranging from zero to 25 ppt. They found that, although initially it removed ammonium ions very efficiently, it lost its effectiveness after only two or three liters of sea water (25 ppt.) had passed through the ion exchange column. Furthermore, they found that the ideal size for granules was 1.00 by 0.35 mm; Matsumoto and Shimada (1980) used an average diameter of 3.00 mm. Based upon this scant information, it appears as though the use of zeolite in marine systems is limited to occasional, brief use to complement existing biological filters, but it does not seem likely that its continued use enhances filtration.

Matsumoto and Shimada (1980) did not give values for pH or nitrogenous buildup. However, it seems likely that improved survival of their squids was due partly to the buffering capacity of the added oyster shell rather than to zeolite. Our CT systems resulted in comparable survival using 360 kg of oyster shell as the only biological filtration substrate. Reports by Hirayama (1970) and Bower *et al.* (1981) show that sand filters (predominantly silica) have poor buffering capacities and that some calcareous filtrant (*e.g.*, oyster shell or coral with calcium carbonate, or dolomite with calcium carbonate and magnesium carbonate) is necessary to buffer closed sea water systems. In view of these data, it is possible that the use of zeolite is unnecessary. Rather, it is more important to have a large filtering bed area of calcareous material and a small animal load, and to monitor pH and inorganic nitrogen buildup closely to insure high quality water.

Tank size and configuration are also important to squid maintenance. Survival is generally better in tanks with wide horizontal dimensions and no corners, all other factors being equal. The narrow rectangular tanks used by Summers and McMahon (1970, 1974) and Summers *et al.* (1974) ranged in size from 0.92 m wide \times 1.83 m long \times 0.31 m deep to 1.37 m wide \times 3.66 m length \times 0.31 m deep, and mean survival was two weeks or less. Larger round tanks from 1.5 to 2.0 m wide were used by a variety of investigators to improve mean survival up to two to four weeks (*e.g.*, Neill, 1971; Matsumoto, 1976; Soichi, 1977; Hurley, 1978; Matsumoto and Shimada, 1980; the CT system in this report). Large rectangular tanks (*e.g.*, LaRoe, 1971; Mikulich and Kozak, 1971; Flores *et al.*, 1976, 1977; the raceway system in this report) produced similar mean survival of several weeks. Finally, the very large 15 m-diameter circular tank used by O'Dor *et al.* (1977) resulted in survival between 26 and 82 days.

The painted wall patterns probably reduced wall contact by the squids. However, we believe their effect was minimal on healthy, undamaged squids because they easily

avoided the walls in white walled tanks as well. Although damaged squids or those engaged in intraspecific aggressive behavior hit walls regardless of their pattern, the painted walls seemed to result in fewer collisions. These situations argue in favor of bumper systems to lessen impact, but our impression is that this is not usually worth the logistical difficulties involved. Rather, it is more practical to keep fewer squids in larger tanks, so that the decrease in wall-to-volume ratio compensates for the bumper. We used a polyethylene bumper sloping at 45° in Observation 1 for *Loligo plei* (Table I), but it did not noticeably enhance survival.

Several worthwhile comparisons may be made between our closed system 10,000 l raceway and the 580,000 l open system Aquatron used by O'Dor *et al.* (1977) to study *Illex illecebrosus*. In one sense, the Aquatron may represent the ultimate squid holding tank because its great size provides a more natural environment for aspects of normal behavior such as schooling, foraging, and reproduction. Two major drawbacks are its cost and the difficulties of recapturing squids. We believe raceway systems similar to that described herein offer a reasonable compromise. The raceways are simple in design, inexpensive, and manufactured in a variety of lengths and widths. Furthermore, squids survive well in them and are easily observed and recaptured (see Fig. 3). O'Dor *et al.* (1977) kept a maximum of 50 squids in the Aquatron at one time. By comparison, we kept 46 *Loligo plei* in a raceway for a mean survival of ~20 days and a maximum of 57 days (Observation 17, Table I). O'Dor *et al.* (1977) speculated that the tank diameter required to allow "relaxed" behavior in *Illex illecebrosus* was between 3.7 and 15 m. Our observations of loliginid squids in our 2 m diameter CT system indicate this distance is less for loliginid squids. Certainly the 10 m long × 2 m wide raceway provided sufficient room for relaxed behavior for small numbers of all three of our species, especially in later versions of the raceway in which the central partition was removed.

Behavior, survival, and growth

In the course of initially testing the prototype sea water systems, it became apparent that the behavior of the squids provided the best evaluation of the systems. This observation led to more detailed analyses of behavior that provided feedback on how to refine the methods and systems in order to accommodate the needs of the squids for long-term maintenance. The significance of this seemingly simple philosophy for providing the basic requirements of squids tends to be overlooked by many. Clearly, aspects of behavior are the true limiting factors to survival and growth of wild-caught loliginid squids in a laboratory environment. The fin and skin damage that were often cited in this report as causes of mortality were merely manifestations of either aspects of behavior, transport in small tanks, or, in *Lolliguncula brevis*, trawl capture.

By carefully observing the squids it was possible to correlate body patterns of chromatophores and postures with specific aspects of behavior such as stress, calmness, aggressiveness, and precopulatory behavior (Hanlon, 1978, 1981, 1982, and in prep.). Accordingly, these clues are now used to avoid some problems before they develop. For example, it is often difficult to segregate newly-caught animals by sex. When *Loligo plei* males begin to show lateral displays, the squids are segregated by size and by sex, with the usual result of restoring calmness and normal feeding, which in turn promotes increased survival. However, in cases such as this, the effects are relatively short-lived, on the order of several days or weeks only.

For long-term survival and growth in laboratory tanks, intraspecific aggression and sexual maturation in *Loligo* spp. are the two most restrictive factors. In *Lolliguncula brevis*, the factor most responsible appears to be sexual maturation. Feeding in all

species is clearly not the problem. In *Loligo* spp., the size relationships among squids exert a strong influence on survival. One reason is that larger squids dominate prey capture. In one 16-day growth observation period (part of Observation 16, Table IV), three males (136, 136, 107 mm ML) were kept together in a CT system with a diet of only fishes (Cyprinidontidae). One of the 136 mm ML males quickly became dominant, harassed the other two squids, and ate nearly all the fishes. During this period he grew at a rate of 51 mm ML/mo, while the other two squids grew the equivalent of 9 and -4 mm ML/mo. In contrast, the latter two males had grown at rates of 73 and 48 mm ML/mo during the 20 days previous to this observation when they were in a tank with squids of initial sizes of 68, 75, and 88 mm ML. It is noteworthy that the squids were less aggressive when they were smaller and new in the laboratory. A similar effect of intraspecific aggression on feeding was reported for fishes by Peter (1979).

A more dramatic intraspecific aggressive effect of size disparity was cannibalism by *Loligo* spp. Cannibalism was not solely a result of food deprivation because in some cases it occurred in tanks that were stocked with food organisms. Cannibalized squids were either smaller or injured. The field observation that schools of *Loligo plei* usually contained squids of similar size suggests that cannibalism is a means by which size specificity is maintained and by which weakened squids are eliminated. However, when schools of mating pairs are formed, as seen by Waller and Wicklund (1968) in the Bahamas, the smaller females are readily accepted as mates. Neither ourselves nor Waller and Wicklund (1968) observed cannibalism among mates.

Sexual maturation seemed to progress at an accelerated rate in the laboratory. Our evidence is twofold: the gonads of most squids usually grew rapidly within 1 to 4 weeks in the tanks, and wild-caught females of *Loligo plei* generally had less well-developed gonads than females of similar size that had been captured in the same geographic area but kept in the laboratory for three weeks or so. The effects of extrinsic regulators of sexual maturation such as light (intensity and cycle), temperature, and food are not understood. It is possible that the general stress of capture and maintenance, combined with constant food availability and a different light regime, was enough to accelerate sexual maturation. In any event, even the longest-lived squids of each species were always sexually mature when they died. Our recent observation that *Loligo opalescens* reared through the life cycle in the laboratory all attained sexual maturation and died within eight months indicates that the effects of maturation are, at least in part, intrinsically regulated and may be difficult to control in the laboratory.

Interspecific compatibility among the three species in the laboratory had an interesting correlate in the field. Although the three species were never observed together *in situ*, different combinations of all three species were captured together in 15-minute trawls, including all three species in the same trawl on 11 occasions (Hixon, 1980a). The results of an interspecific association analysis (Cox, 1980 based on Cole, 1949) based on 150 trawl stations showed that there was a positive coefficient of association between *Lolliguncula brevis* and *Loligo plei*, indicating that these species are found frequently in close proximity to one another. Although the other two combinations showed negative coefficients, this was a reflection of the species' areal and depth distribution as well as temperature and salinity preferences (Hixon, 1980a). These findings do not mean that these three species co-occur in the same schools, but it does indicate that species-specific schools may co-occur in the same habitat.

In Table VI are comparisons of survival among squids maintained in the laboratory by various researchers. Direct comparisons are impossible because of the highly varying conditions surrounding each worker's geographic area, the species, time of year,

TABLE VI

Comparisons of laboratory maintenance of wild-caught squids

Species	Mean survival (days)	Max. survival (days)	No. of squids evaluated	Capture method	Author, year
Suborder Myopsida					
<i>Loligo plei</i>	~7 11	38 84	25 453	night light night light	LaRoe, 1971 This report, Fig. 8
<i>Loligo pealei</i>	2 5 ~4 4 7 28	5 17 ~7 19 39 83 71	241 — ~250 468 246 ~500 37	trawl fish trap trawls & fish traps trawls trawls, seine trawls, jigs night light, jigs	Brinley and Mullins, 1964 Arnold, 1962 Summers and McMahon, 1970 Summers and McMahon, 1974 Summers <i>et al.</i> , 1974 Macy, 1980 This report, Fig. 8
<i>Lolliguncula brevis</i>	19	125	313	trawl	This report, Fig. 8
<i>Doryteuthis bleekeri</i>	~17 ~14 5 ~43	— — — 66	12 53 32 10	jigs jigs jigs jigs	Matsumoto, 1976 Matsumoto and Shimada, 1980 Matsumoto and Shimada, 1980 Matsumoto and Shimada, 1980
<i>Loligo vulgaris</i>	— ~14	60 30	— —	jigs jigs	Tardent, 1962 Neill, 1971
Suborder Oegopsida					
<i>Illex illecebrosus</i>	~30 ~30 13	41 82 24	15 35 35	floating box trap floating box trap floating box trap	O'Dor <i>et al.</i> , 1977 O'Dor <i>et al.</i> , 1977 O'Dor <i>et al.</i> , 1977
<i>Todarodes pacificus</i>	~29 ~7 ~10 ~30 ~20	35 11 25 50 45	63 7 9 10 44	cast net jigs jigs jigs jigs	Mikulich and Kozak, 1971 Flores <i>et al.</i> , 1976 Flores <i>et al.</i> , 1977 Flores <i>et al.</i> , 1977 Soitchi, 1977

number of animals evaluated, capture and transport methods, maintenance tank size, etc. In many cases, the parameters upon which survival was described were not stated or defined clearly; more significantly, information regarding selection criteria of squids that were included or deleted from survival analyses was not always provided. Nevertheless, the table provides an overview and forms a basis for discussion. Overall, the results of our work compare favorably with other research efforts.

Survival of *Loligo pealei* in the laboratory (Table VI) has been very low historically. Undoubtedly, a major reason for this is that most evaluations were made on trawl-caught squids that had substantial skin damage. All of these earlier evaluations have been on *L. pealei* from New England waters. Our results of 28 days mean survival are based on few animals ($n = 37$), but they are a considerable improvement upon past efforts. The main reason for improvement is that the squids were caught in nearly perfect condition with dipnets. The very long transport times (mean 15 hours) resulted in some degree of skin damage that affected long-term survival. Seasonality had no obvious effect on survival because squids collected throughout the year survived equally well (Table II). Survival was enhanced by the fact that no juveniles were maintained, but only mid- to full-sized adults which generally do better in captivity. Survival was strongly enhanced by the bottom sitting behavior and general calmness of this species in captivity. The fallacy that bottom sitting in *L. pealei* is abnormal behavior must be dispelled once and for all. Williams (1909), Stevenson (1934), and Macy (1982) have all reported this behavior as normal, and our observations confirm their findings. From a maintenance standpoint, it may be important to provide a substrate that is suitable to the squids for bottom sitting; the crushed oyster shell in our systems was acceptable to them.

Survival of *Loligo plei* was fairly low overall (Table VI). This resulted partly because we analyzed every squid we caught at those stations regardless of size, sex, or condition. When conditions were good (notably Observations 11, 14, 15, 16, 17, in Table I) mean survival of squids (excluding juveniles) ranged from 14 to 84 days. This maximal survival of 84 days is the longest that any squid of the genus *Loligo* has been maintained. The steep mortality slope in Figure 8 is attributable initially to skin damage during transport and generally poor survival by juveniles, and later to intraspecific aggression and sexual maturation which limited long-term survival. We expect that long-term survival would improve by selecting only mid- or large-sized squids in the best condition at capture, transporting fewer squids per tank, and segregating sexes in the laboratory.

Lolliguncula brevis survival was good. This is the only species we know of that withstands trawl capture well. As mentioned, part of the reason is the short tows in shallow water, but this species also is apparently less susceptible to skin damage than other loliginid squids. If the high early mortality (Fig. 8) attributable to capture trauma is eliminated, then mean survival for 197 squids becomes 29 days for all sizes of squids. This compares favorably with any species studied thus far. The maximal survival of 125 days is the longest that any wild-caught squid has ever been maintained in captivity. The long survival and high growth rates of this species in captivity make it a potentially useful species for long-term *in vivo* experimentation.

Loligo vulgaris (from the Mediterranean) and *Doryteuthis bleekeri* (from Japan) may be compared best to the three species mentioned above because they are all in the Family Loliginidae. Tardent (1962) and Neill (1971) demonstrated that jig-caught *Loligo vulgaris* could be kept for about 14 days in large tanks. Matsumoto (1976) and Matsumoto and Shimada (1980) showed that jig-caught *Doryteuthis bleekeri* could be maintained consistently for about 14 days (Table VI). They also reported one run in which ten squids had a mean survival of approximately 43 days. This is

an excellent result that, although not quantified, shows survival is high in jig-caught adult squids that are transported carefully and not crowded in laboratory tanks. Unfortunately, these authors give no details of squid size or sex, nor of the details of selection at the capture site. Therefore, it is difficult to make other comparisons between *Doryteuthis bleekeri* and *Loligo plei* (considered by some to belong to the genus *Doryteuthis*), which is similar in size and appearance.

Survival in captivity of the oceanic, oegopsid squids *Todarodes pacificus* and *Illex illecebrosus* has been good (Table VI). These high survival times are a result of capture and transport methods that are atraumatic, as well as the use of very large maintenance tanks and good feeding. O'Dor *et al.* (1977) found that mid- to large-sized adult *Illex illecebrosus* survived a mean of about 30 days or more, although in one group of squids mean survival was only 13 days. Mikulich and Kozak (1971), Flores *et al.* (1976, 1977), and Soichi (1977) reported mean survival up to 30 days for mid- to large-sized *Todarodes pacificus*. All of the results above are excellent examples of how squids can be kept alive for weeks if certain principals are adhered to.

To summarize the criteria necessary for good survival of squids in captivity, we once again reference the first paragraph in this discussion but also the statements by other successful researchers that reached similar conclusions (*e.g.*, Summers *et al.*, 1974; pg. 300; O'Dor *et al.*, 1977; pg. 334; Flores *et al.*, 1977). Since the squids of greatest immediate interest to neurobiologists are mainly of the genus *Loligo*, we believe that future researchers can expect mean survival of two weeks or more for loliginid squids captured, transported, and maintained by the methods outlined in this communication. Our demonstration that artificial sea water is a suitable substitute for natural sea water, and that a relatively simple, inexpensive closed system maintains squids well, will also provide alternate ways for others to keep squids alive for experimentation.

Growth comparisons may be made between our laboratory results and those of other researchers, and between our laboratory results and field estimates of growth. In general, all of our laboratory growth rates are higher than estimates from size-frequency analyses of field data. Our *Loligo pealei* mean growth rate of 44 mm/mo for males (Table IV) was higher than the 23 mm/mo reported from the laboratory studies of Macy (1980) as well as the calculated field growth rate of 15.7 mm/mo (range 6.5 to 24.5 mm/mo) based upon 618 males caught over a two-year period off the Texas coast (Hixon *et al.*, 1981). Hixon *et al.* (1981) also provided a historical comparison of field growth rate estimates, nearly all of which are under 20 mm/mo. Our single observation of 13 mm/mo in one female compares closely with the 11.7 mm/mo (range 8.6 to 14.2 mm/mo) calculated rate of 733 females caught off the Texas coast (Hixon *et al.*, 1981). The high growth rates in males are partly a reflection of ideal laboratory conditions, but they indicate that males are probably capable of very rapid growth in the field when conditions are favorable.

Loligo plei males grew in our laboratory at a mean rate of 47 mm/mo (Table IV), substantially greater than the only other laboratory estimate of 15 to 25 mm/mo given by LaRoe (1971) for comparable temperatures. Field estimates are also lower. Whitaker (1978) estimated growth rates of 5.0 to 14.3 mm/mo for 1065 squids caught off the southeastern U. S. during 1974 and 1975; the 14.3 mm/mo rate was for a period of 132 days during spring and summer, when temperatures were similar to the laboratory temperatures in our tank systems. Hixon (1980a) calculated a growth rate of 11.5 mm/mo (range 2.0 to 20.0 mm/mo) for 1819 male squids caught over a two-year period off the Texas coast. His estimate for 1887 females was 6.8 mm/mo (range 2.7 to 9.5 mm/mo); in comparison, our laboratory females did not grow (Table IV) due to sexual maturation. As in *Loligo pealei*, the high growth rates

attained by males in the laboratory indicate that this species is capable of very rapid growth during brief, ideal periods.

Lolliguncula brevis males grew at a mean rate of 8 mm/mo, and females at 11 mm/mo in our laboratory observations (Table V). No other laboratory data are available for comparison, but Hixon (1980a) estimated field growth of 1141 males at 8.6 mm/mo (range 5.7 to 11.4 mm/mo), and 1045 females at 7.9 mm/mo (range 4.3 to 12.5 mm/mo) off the Texas coast. Although the mean growth rates of males agree well, the maximal laboratory rate of 20 mm/mo is much higher than the maximal field estimate of 11.4 mm/mo. Among females, both the mean (11 mm/mo) and maximal (31 mm/mo) laboratory rates are much higher than those from field estimates (7.9 mm/mo and 12.5 mm/mo, respectively). In all cases, *Lolliguncula brevis* shows the capability of growing at rates higher than previously thought when conditions are particularly good.

Some comparisons of growth in body weight may be made also. Among the three species in this study, the instantaneous relative growth rates in weight were on the same order of magnitude: males of all three species and female *Lolliguncula brevis* grew at mean rates of 1.4, 1.7, and 1.9%/day at temperatures of 18 to 23°C (Tables IV and V). In comparison, Hirtle *et al.* (1981) reported that *Illex illecebrosus* grew at rates of 1.1 to 1.9%/day at 7 to 10°C. In the cuttlefish *Sepia officinalis*, Richard (1971) and Pascual (1978) reported growth rates of approximately 1.0 to 4.0%/day in mid-sized to adult animals at temperatures of 14 to 26°C. The only other growth rate reported in the literature is by Choe (1966), who calculated a very fast rate of 7.1%/day in mid-sized *Sepioteuthis lessoniana* at 23 to 31°C. Growth this fast is usually only attained by very young animals during their exponential growth phase, but apparently *Sepioteuthis lessoniana* is capable of continuing fast growth for a long period under ideal laboratory conditions.

The gross growth efficiency (GGE) estimate of 27 percent in a male *Loligo plei* and the estimated feeding rates of 18 and 10 percent for male and female *Loligo plei* are comparable to other squids. LaRoe (1971) reported that *Sepioteuthis sepioidea* (10 weeks old) showed GGEs of 20 to 40 percent and daily food intakes of 10 to 30 percent. Macy (1980) reported a mean daily food intake of 11 percent for adult *Loligo pealei* in the laboratory. Yang *et al.* (1983) found that laboratory-cultured *Loligo opalescens* had a mean daily food intake of 14.9 percent between Days 108 and 232 (adult size). Hirtle *et al.* (1983) reported that captive *Illex illecebrosus* showed a mean GGE of 40 percent and an average daily food intake of 10 percent. Soichi (1977) calculated that *Todarodes pacificus* had a mean daily food intake of 24.3 percent (range 10.6 to 38.9 percent).

The effects of specific diets on growth seem small. Laboratory and field studies show consistently that squids feed predominantly on crustaceans and fishes (*e.g.*, Fields, 1965; Vovk, 1974; Ennis and Collins, 1978; Vinogradov and Noskov, 1979; Macy, 1982). In the present study, squids grew equally well on fish-only, shrimp-only, or mixed diets. Hirtle *et al.* (1981) noted similar results with *Illex illecebrosus*. Previous research has indicated that smaller squids generally appear to have a slight preference for crustaceans, while fishes are preferred when the squids are larger (Hirtle *et al.*, 1981; this report). These differences are so small that, for laboratory maintenance or growth, either diet is acceptable.

The growth results given above indicate that it is feasible to grow mid-sized squids to adult size in a reasonably short time. This may be useful for *in vivo* experimentation, both short- and long-term. It might also be useful as an alternate way of providing larger axons. We have already demonstrated this on a small scale in *Lolliguncula brevis* (Table V). With growth rates of 10 mm/mo for mid-sized males and 13 mm/mo

mo for mid-sized females (Table V), squids were grown another 17 to 21 mm over 50 days to bring them to full adult size, with axons as large as 200 μm in the largest females (Hulet *et al.*, 1980). There are possibilities with *Loligo* spp. as well. For example, a mid-sized *Loligo plei* male 100 mm ML could possibly be grown to 160 mm ML in about 45 days, assuming that only the best animals were selected and that they had a sustained growth rate of 40 mm/mo. At 160 mm ML, the giant axon measures approximately 325 μm in this species, sizeable enough for many types of axon experiments. The same type of operation could apply to *Loligo pealei* which, from our experience, is a better candidate because (1) it is less aggressive than *L. plei*, (2) it sits on the bottom, (3) it is calmer, and (4) it grows larger. Since the majority of *Loligo* spp. caught by night lighting off Galveston are around 100 mm ML, testing of this concept deserves future attention.

ACKNOWLEDGMENTS

We thank John W. Forsythe, Joseph P. Hendrix, Jr., and Deirdre A. McConathy for excellent technical assistance. We also gratefully acknowledge continued support from DHHS Grant No. RR 01024, Division of Research Resources, National Institutes of Health, and the Marine Medicine General Budget of the Marine Biomedical Institute, University of Texas Medical Branch at Galveston. Portions of this work were submitted by R.T.H. and R.F.H. in partial fulfillment of the Ph.D. requirements at the Rosenstiel School of Marine and Atmospheric Science, University of Miami, Florida.

LITERATURE CITED

- ANTONIE, R. L. 1976. *Fixed Biological Surfaces—Wastewater Treatment*. CRC Press, Cleveland, Ohio. 200 pp.
- ARNOLD, J. M. 1962. Mating behavior and social structure in *Loligo pealei*. *Biol. Bull.* **123**: 53–57.
- ARNOLD, J. M., W. C. SUMMERS, D. L. GILBERT, R. S. MANALIS, N. W. DAW, AND R. J. LASEK. 1974. *A Guide To The Laboratory Use Of The Squid, Loligo pealei*. Marine Biological Laboratory, Woods Hole, Massachusetts. 74 pp.
- BOLETZKY, S.V., AND R. T. HANLON. 1983. A review of the laboratory maintenance, rearing and culture of cephalopod molluscs. *Mem. Nat. Museum Victoria* **44**: 147–187.
- BOWER, C. E., D. T. TURNER, AND S. SPOTTE. 1981. pH maintenance in closed seawater culture systems: limitations of calcareous filtrants. *Aquaculture* **23**: 211–217.
- BRINLEY, F. J., JR., AND L. J. MULLINS. 1964. The collection of squid for use at an inland laboratory. Unpublished Report to NSF (6B-1765). 6 pp.
- CHOE, S. 1966. On the growth, feeding rates and the efficiency of food conversion for cuttlefishes and squids. *Korean J. Zool.* **9**(2): 12–19. (In Korean).
- COLE, L. C. 1949. The measurement of interspecific association. *Ecology* **30**: 411–424.
- CONOVER, W. J., AND R. L. IMAN. 1976. On some alternative procedures using ranks for the analysis of experimental designs. *Communications In Statistics Series A5*: 1349–1368.
- COX, G. W. 1980. *Laboratory Manual Of General Ecology*. William C. Brown, Dubuque, Iowa. 237 pp.
- DIPOLO, R. 1976. The influence of nucleotides on calcium fluxes. *Fed. Proc.* **35**(14): 2579–2582.
- DRAGOVICH, A., AND J. A. KELLY, JR. 1962. A biological study and some economic aspects of squid in Tampa Bay, Florida. *Proc. Gulf and Caribbean Fish. Inst.* **15**: 87–103.
- ENNIS, G. P., AND P. W. COLLINS. 1978. Food and feeding of the short-finned squid (*I. illecebrosus*) during its seasonal occurrence inshore at Newfoundland and a brief review of the tropic relationships of the species. ICNAF Res. Doc. 78/II/7.
- FIELDS, W. G. 1965. The structure, development, food relations, reproduction, and life history of the squid *Loligo opalescens* Berry. *Calif. Fish & Game, Fish Bull.* **131**: 1–108.
- FLORES, E. E. C., S. IGARASHI, R. MIKAMI, AND K. KOBAYASHI. 1976. Studies on squid behavior in relation to fishing. I. On the handling of squid, *Todarodes pacificus* Steenstrup, for behavioral study. *Bull. Fac. Fish.* **27**(3–4): 145–151.
- FLORES, E. E. C., S. IGARASHI, AND T. MIKAMI. 1977. Studies on squid behavior in relation to fishing. II. On the survival of squid, *Todarodes pacificus* Steenstrup, in experimental aquarium. *Bull. Fac. Fish.* **28**(3): 137–147.

- GIBBONS, J. D. 1976. *Nonparametric Methods For Quantitative Analysis*. Holt, Rinehart and Winston, New York.
- HANLON, R. T. 1978. *Aspects of the Biology of the Squid Loligo (Doryteuthis) plei in Captivity*. Ph.D. Dissertation, University of Miami, Coral Gables, Florida.
- HANLON, R. T. 1981. Courting and mating behavior in the squid *Loligo (Doryteuthis) plei*. P. 325 (Abstract) in *Advances in Invertebrate Reproduction*, W. H. Clark, Jr., and T. S. Adams, eds. Elsevier/North-Holland, New York. 400 pp.
- HANLON, R. T. 1982. The functional organization of chromatophores and iridescent cells in the body patterning of *Loligo plei* (Cephalopoda: Myopsida). *Malacologia* **23**(1): 89-119.
- HANLON, R. T., AND R. F. HIXON. 1981. *In situ* behavioral observations of cephalopods at Grand Cayman, B.W.I. *Bull. Am. Malacol. Union*, 1980: 72. (Abstract)
- HANLON, R. T., R. F. HIXON, AND W. H. HULET. 1978. Laboratory maintenance of wild-caught loliginid squids. Pp. 20.1-20.14 in *Proceedings of the Workshop on the squid Illex illecebrosus*, Fisheries and Marine Service Technical Report, no. 833, N. Balch, T. Amaratunga, and R. K. O'Dor, eds.
- HANLON, R. T., R. F. HIXON, J. W. FORSYTHE, AND J. P. HENDRIX, JR. 1980. Cephalopods attracted to experimental night lights during a saturation dive at St. Croix, U. S. Virgin Islands. *Proc. Am. Malacol. Union*, 1979: 53-58.
- HANLON, R. T., R. F. HIXON, W. H. HULET, AND W. T. YANG. 1979. Rearing experiments on the California market squid *Loligo opalescens* Berry, 1911. *Veliger* **21**(4): 428-431.
- HENDRIX, J. P., JR., W. H. HULET, AND J. M. GREENBERG. 1981. Salinity tolerance and the responses to hyposmotic stress of the bay squid *Lolliguncula brevis*, a euryhaline cephalopod mollusc. *Comp. Biochem. Physiol.* **69A**: 641-648.
- HIRAYAMA, K. 1970. Studies on water control by filtration through sand bed in a marine aquarium with closed circulating system—VI. Acidification of aquarium water. *Bull. Jpn. Soc. Sci. Fish.* **36**(1): 26-34.
- HIRTLE, R. W. M., M. E. DEMONT, AND R. K. O'DOR. 1981. Feeding, growth, and metabolic rates in captive short-finned squid, *Illex illecebrosus*, in relation to the natural population. *J. Shell Res.* **1**(2): 187-192.
- HIXON, R. F. 1980a. *Growth, Reproductive Biology, Distribution and Abundance of Three Species of Loliginid Squid (Myopsida, Cephalopoda) in the Northwest Gulf of Mexico*. Ph.D. Dissertation, University of Miami, Coral Gables, Florida.
- HIXON, R. F. 1980b. Potential commercial squid resources of the Gulf of Mexico—an updated review. Pp. 54-73 in *Proceedings of a Workshop for Potential Fishery Resources of the Northern Gulf of Mexico*, Mississippi-Alabama Sea Grant Consortium, M. Flandorfer, and L. Skuplen, eds. Gulf Coast Research Laboratory, Ocean Springs, Mississippi. 92 pp.
- HIXON, R. F., R. T. HANLON, S. M. GILLESPIE, AND W. L. GRIFFIN. 1980. Squid fishery in Texas: biological, economic and market considerations. *Mar. Fish. Rev.* **42**(7-8): 44-50.
- HIXON, R. F., R. T. HANLON, AND W. H. HULET. 1981. Growth and maximal size of the long-finned squid *Loligo pealei* in the northwestern Gulf of Mexico. *J. Shell Res.* **1**(2): 181-185.
- HOLME, N. A. 1974. The biology of *Loligo forbesi* Steenstrup (Mollusca: Cephalopoda) in the Plymouth area. *J. Mar. Biol. Assoc. U. K.* **54**: 481-503.
- HULET, W. H., R. T. HANLON, AND R. F. HIXON. 1980. *Lolliguncula brevis*—a new squid species for the neuroscience laboratory. *Trends in Neuroscience* **3**(4): 4-5.
- HULET, W. H., M. R. VILLOCH, R. F. HIXON, AND R. T. HANLON. 1979. Fin damage in captured and reared squids. *Lab. Anim. Sci.* **29**(4): 528-533.
- HURLEY, A. C. 1978. School structure of the squid *Loligo opalescens*. *Fish. Bull.* **76**(2): 433-442.
- JOHNSON, P. W., AND J. MCN. SIEBURTH. 1974. Ammonia removal by selective ion exchange: a backup system for microbiological filters in closed-system aquaculture. *Aquaculture* **4**: 61-68.
- KATO, S., AND J. E. HARDWICK. 1975. The California squid fishery. *FAO Fish. Rep.* **170**. Suppl. 1: 107-127.
- KIER, W. M. 1982. The functional morphology of the musculature of squid (Loliginidae) arms and tentacles. *J. Morphol.* **172**: 179-192.
- LAROE, E. T. 1971. The culture and maintenance of loliginid squids *Sepioteuthis sepioidea* and *Doryteuthis plei*. *Mar. Biol.* **9**(1): 9-25.
- LEIBOVITZ, L., T. R. MEYERS, R. ELSTON, AND P. CHANLEY. 1977. Necrotic exfoliative dermatitis of captive squid (*Loligo pealei*). *J. Invert. Path.* **30**: 369-376.
- MACY, W. K., III. 1980. *The Ecology of the Common Squid Loligo pealei Lesueur, 1821 in Rhode Island Waters*. Ph.D. Dissertation, University of Rhode Island.
- MACY, W. K., III. 1982. Feeding patterns of the long-finned squid, *Loligo pealei*, in New England waters. *Biol. Bull.* **162**(1): 28-38.
- MATSUMOTO, G. 1976. Transportation and maintenance of adult squid (*Doryteuthis bleekeri*) for physiological studies. *Biol. Bull.* **150**: 279-285.

- MATSUMOTO, G., AND J. SHIMADA. 1980. Further improvement upon maintenance of adult squid (*Doroteuthis bleekeri*) in a small circular and closed-system aquarium tank. *Biol. Bull.* **159**(2): 319-324.
- MIKULICH, L. V., AND L. P. KOZAK. 1971. Experimental rearing of Pacific Ocean squid under artificial conditions. *Ėkologiya* No. 3: 94-96. (In Russian)
- MOCK, C. R., L. R. ROSS, AND B. R. SALSER. 1977. Design and preliminary evaluation of a closed system for shrimp culture. *Proc. of the 8th Annual Meeting of the World Mariculture Society*. Pp. 335-372.
- MOYNIHAN, M., AND A. F. RODANICHE. 1982. The behavior and natural history of the caribbean reef squid *Sepioteuthis sepioidea*. *Advances in Ethology* No. 25, 151 pp.
- NEILL, S. ST. J. 1971. Notes on squid and cuttlefish; keeping, handling and colour-patterns. *Pubbl. Staz. Zool. Napoli* **39**: 64-69.
- O'DOR, R. K., R. D. DURWARD, AND N. BALCH. 1977. Maintenance and maturation of squid (*Illex illecebrosus*) in a 15 meter circular pool. *Biol. Bull.* **153**: 322-335.
- PAINTER, H. A. 1970. A review of the literature on inorganic nitrogen metabolism in microorganisms. *Water Res.* **4**: 393-450.
- PASCUAL, E. 1978. Crecimiento y alimentacion de tres generaciones de *Sepia officinalis* en cultivo. *Inv. Pesq.* **42**(2): 421-442.
- PETER, R. E. 1979. The brain and feeding behavior. Pp. 121-159 in *Fish Physiology*, Vol. 8, W. S. Hoar, D. J. Randall, and J. R. Brett, eds. Academic Press, New York.
- RAND, M. C., A. E. GREENBERG, AND M. J. TARAS, eds. 1976. *Standard Methods for the Examination of Water and Wastewater*, 14th ed. American Public Health Association, Washington.
- RATHJEN, W. F., R. T. HANLON, AND R. F. HIXON. 1979. Squid fishery resources and development in the Northwest Atlantic and Gulf of Mexico. *Proc. Gulf Carribb. Fish. Inst.* **31**: 145-157.
- RICHARD, A. 1971. *Contribution a l'Étude Expérimentale de la Croissance et la Striation de la Coquille de Sepia officinalis L.* (Mollusque, Cephalopode). Thèse de Doctorat d'Etat, Univ. Lille (No. 243).
- ROSENBERG, P. 1973. The giant axon of the squid: A useful preparation for neurochemical and pharmacological studies. Pp. 97-160 in *Methods of Neurochemistry*, Vol. 4, R. Fried, ed. Marcel Dekker, Inc., New York, 322 pp.
- RUBIN, E., R. EVERETT, JR., J. J. WEINSTOCK, AND H. M. SCHOEN. 1963. Contaminant removal from sewage plant effluents by foaming. PHS Publ. no. 999-WF-5, Public Health Service, Cincinnati, Ohio. 56 pp.
- SOICHI, M., 1977. On the growth and food quantity of young common squid, *Todarodes pacificus*, in captivity. *Dosuiishi* **13**(4): 79-82. (In Japanese)
- SOLÓRZANO, L. 1969. Determination of ammonia in natural waters by the phenylhypochlorite method. *Limnol. Oceanogr.* **14**: 799-801.
- SPOTTE, S. 1973. *Marine Aquarium Keeping: The Science, Animals, and Art*. John Wiley & Sons, Inc., New York. 173 pp.
- SPOTTE, S. 1979a. *Fish and Invertebrate Culture: Water Management in Closed Systems*, 2nd Ed. John Wiley & Sons, Inc., New York. 179 pp.
- SPOTTE, S. 1979b. *Seawater Aquariums: The Captive Environment*. John Wiley & Sons, Inc., New York. 413 pp.
- STEVENSON, J. A. 1934. On the behaviour of the long-finned squid [*Loligo pealii*, (Lesueur)]. *Canadian Field-Naturalist* **XLVIII**: 4-7.
- STRICKLAND, J. D. H., AND T. R. PARSONS. 1972. *A Practical Handbook of Seawater Analysis*, 2nd Ed. *Bull. 167, Fish. Res. Board Can.*, Ottawa, 310 pp.
- SUMMERS, W. C. 1968. The growth and size distribution of current year class *Loligo pealei*. *Biol. Bull.* **135**: 366-377.
- SUMMERS, W. C. 1969. Winter population of *Loligo pealei* in the Mid-Atlantic Bight. *Biol. Bull.* **137**: 202-216.
- SUMMERS, W. C., AND J. J. MCMAHON. 1970. Survival of unfed squid, *Loligo pealei*, in an aquarium. *Biol. Bull.* **138**: 389-396.
- SUMMERS, W. C., AND J. J. MCMAHON. 1974. Studies on the maintenance of adult squid (*Loligo pealei*). I. Factorial survey. *Biol. Bull.* **146**(2): 279-290.
- SUMMERS, W. C., J. J. MCMAHON, AND G. N. P. A. RUPPERT. 1974. Studies on the maintenance of adult squid (*Loligo pealei*). II. Empirical extensions. *Biol. Bull.* **146**: 291-301.
- TARDENT, P. 1962. Keeping *Loligo vulgaris* L. in the Naples Aquarium. 1st International Congress on Aquarology. *Bull. Inst. Oceanographique, Monaco*, Special no. 1A: 41-46.
- TASAKI, I. 1982. *Physiology and Electrochemistry of Nerve Fibers*. Academic Press, New York. 343 pp.
- VINOGRADOV, V. E., AND A. S. NOSKOV. 1979. Feeding of the short-finned squid, *Illex illecebrosus*, and long-finned squid, *Loligo pealei*, off Nova Scotia and New England, 1974-75. ICNAF Sel. Papers **5**: 31-36.

- VOVK, A. N. 1974. Feeding habits of the North American squid *Loligo pealei* Les. Fisheries and Marine Service, Translation Series No. 3304. 14 pp.
- WALLER, R. A., AND R. I. WICKLUND. 1968. Observations from a research submersible—mating and spawning of the squid, *Doryteuthis plei*. *Bioscience* **18**(2): 110–111.
- WHITAKER, J. D. 1978. *A Contribution to the Biology of Loligo pealei and Loligo plei (Cephalopoda, Myopsida) off the Southeastern Coast of the United States*. Master's thesis, The College of Charleston, Charleston, North Carolina.
- WILLIAMS, L. W. 1909. *The Anatomy of the Common Squid*. The American Museum of Natural History, New York. 91 pp.
- WINBERG, G. C. 1960. *Rate of Metabolism and Food Requirements of Fishes*. Fish. Res. Board Can., Trans. Ser. No. 194, 202 pp.
- YANG, W. T., R. T. HANLON, M. E. KREJCI, R. F. HIXON, AND W. H. HULET. 1983. Laboratory rearing of *Loligo opalescens*, the market squid of California. *Aquaculture* **31**: 77–88.
- YANG, W. T., R. F. HIXON, P. E. TURK, M. E. KREJCI, R. T. HANLON, AND W. H. HULET. 1983. Culture of California market squid from hatching—completion of the rearing cycle to second generation hatchlings. *Aquabiology*. **5**(5): 328–339. (In Japanese)

THE LATITUDINAL COMPENSATION HYPOTHESIS: GROWTH DATA
AND A MODEL OF LATITUDINAL GROWTH DIFFERENTIATION
BASED UPON ENERGY BUDGETS. I. INTERSPECIFIC COMPARISON
OF *OPHRYOTROCHA* (POLYCHAETA: DORVILLEIDAE)

JEFFREY S. LEVINTON

Department of Ecology and Evolution, State University of New York, Stony Brook, New York 11794

ABSTRACT

A northern (North Carolina) sibling species of *Ophryotrocha* grew more rapidly than a southern sibling species (Florida); this presumed advantage, however, diminished to zero as temperature increased from 15 to 30°C. Survival of the northern sibling species was low at 30°C. The differential response probably had a genetic basis since both species had been reared for 2–3 generations under the same conditions. The effect lasted in laboratory populations reared for a year in the laboratory at 25°C (ca. 10 generations).

My results are consistent with a graphical model that suggests an evolutionary shift of metabolism-temperature curves and feeding efficiency curves for the two sibling species. These shifts predict a changing advantage of growth of one species relative to the other as temperature increases.

INTRODUCTION

Many studies have demonstrated physiological differences among latitudinally separated or otherwise thermally disparate populations of the same species or among closely related species. Differentiation has been recorded for metabolic rate (Mangum, 1963), temperature tolerance (Zhirmunsky, 1959), egg development time (McLaren *et al.*, 1969) and spawning temperature (Loosanoff and Nomejko, 1951). Krogh (1916) predicted that such differences should be consistent with a compensatory adaptation to maximize growth rates in a given temperature regime. Animals living in low temperature (high latitude) locales would thus be expected to "compensate" by increasing metabolic and growth rates at a given temperature, relative to animals from high temperature (low latitude) locales. This difference would be analogous to the seasonal adjustment of Q_{10} found in many marine invertebrate species. Winter-acclimated animals can sustain more activity than summer animals maintained at the same low temperature (see Kinne, 1964; Newell, 1973 for literature summaries and general discussion).

An appropriate physiological compensation for latitudinal position occurs for many, but not all, examined species. Scholander *et al.* (1953) found compensatory metabolism-temperature (M-T) adaptation in a comparison of arctic and tropical poikilotherms. Compensatory differences occur for latitudinally separated populations of a single species. Heart-beat rate, water propulsion speed, somatic growth rate, and oxygen consumption rate differ among populations of the mussel *Mytilus californianus* on the west coast of North America (*e.g.*, Rao, 1953; Dehnel, 1956; Pickens, 1965). In cases of compensation, high latitude populations show an upwards displacement

of the M-T curves relative to low latitude populations. This form of compensation is not universally observed, however (e.g., Fox, 1936; Vernberg and Vernberg, 1966).

There are two generalizations from studies on latitudinal variation in growth rates. Individuals of high latitude populations of poikilotherms often obtain larger maximum body size than conspecifics or closely related species living at low latitudes (e.g., Weymouth and McMillan, 1931; Ray, 1960). Secondly, although cold temperatures often reduce activity and constrain individuals to grow more slowly, they compensate by accelerating growth rate or larval development rate, relative to low latitude-derived individuals, when both are reared at the same temperature (Schneider, 1967; Ament, 1979; Bervan *et al.*, 1979).

Although adaptation to low temperature would probably entail a form of compensation involving relative acceleration of growth of the high latitude form at low temperature, one might expect that this shift in metabolism would result in an increased cost at higher temperature, leaving these forms at an energetic disadvantage in higher temperature environments. In other words, "latitudinal compensation" may not be compensation at all. Rather, local populations may shift their metabolic properties to maximize growth under local temperature conditions. A manifestation of this shift is a presumed acceleration of forms living in low temperatures, relative to high temperature forms reared at the same temperature. This shift would be either in the form of local evolution, or non-genetic response such as acclimation.

It is the purpose of this paper to present evidence for genetically based differences in somatic growth rates among latitudinally separated sibling species of *Ophryotrocha* (Polychaeta; Dorvilleidae). A companion paper will demonstrate differences between subspecies. I will propose a model based upon energy budgets to explain latitudinal clines in growth rate and body size in marine poikilotherms. The model assumes that all populations evolve to maximize growth rate; observations of acceleration are merely a manifestation of this selection pressure.

Evidence for genetically-based physiological compensation

Latitudinal differences in allozyme variants occur in a wide variety of invertebrates and fishes (e.g., O'Gower and Nicol, 1968; Johnson and Utter, 1973; Williams *et al.*, 1973; Koehn *et al.*, 1976). Although this clinal variation is obviously correlated with temperature change, it is not clear that the genetic differences account for the physiological differences observed in the studies cited above. In the mussel, *Mytilus edulis*, extensive latitudinal differentiation in allele frequencies occurs on the east coast of North America. By contrast, little differentiation is found in *M. californianus* along the west coast. This correlates well with the steep latitudinal thermal gradient on the east coast as opposed to the gentle gradient on the west coast (Levinton and Suchanek, 1978). Heat-stable variants of the enzyme phosphoglucosmutase are more common in more southern relative to northern populations of the east coast ribbed mussel *Geukensia demissus* (Gosling, 1979). Thus physiological differentiation may be genetically based. Adaptation at the molecular level has been shown between species living in different environments (e.g., Somero and DeVries, 1967; Hochachka and Somero, 1973; and references therein) and some evidence exists for adaptive enzyme variants within a marine invertebrate species (Burton and Feldman, 1983; Hall, 1983; Koehn *et al.*, 1980).

Latitudinal differences in whole-animal physiological parameters may or may not have a genetic basis. There are three possible components of physiological response (Kinne, 1962). (1) Labile Compensation: individuals differ physiologically due to local acclimatization. These differences are reversible after a period of laboratory

acclimation (*e.g.*, Pickens, 1965). (2) Irreversible Non-genetic Compensation: field conditions induce irreversible physiological changes that cannot be eliminated through laboratory acclimation (*e.g.*, Gibson, 1954; Zamer and Mangum, 1979). These differences are acquired independently of genotype; irreversible effects are fixed because of the environment only. An obvious example is temperature-induced sex in fishes (*e.g.*, Conover and Kynard, 1981). (3) Genetically-based Physiological Differences: this is difficult to distinguish in the field from irreversible non-genetic compensation. An irreversible physiological response could result from irreversible non-genetic, or genetically-based responses (*e.g.*, Levinton and Lassen, 1978). Unfortunately, it is not possible to distinguish between these two alternatives in most studies demonstrating differences among field-collected adults. A useful approach would be the examination of progeny of populations that have been reared in the laboratory under identical conditions, preferably for several generations (*e.g.*, Battaglia, 1957; Schneider, 1967; Ament, 1979). The examination of progeny of laboratory-reared stocks, however, may involve unrealistic laboratory conditions and ignoring field parameters that might affect gene expression. Despite these potential problems, I take the latter approach in this study.

MATERIALS AND METHODS

Three populations of two sibling species of *Ophryotrocha* (Polychaeta; Dorvilleidae) were collected. *Ophryotrocha* species are found commonly in microhabitats of fouling communities, and are readily cultured in the laboratory (*e.g.*, see Akesson, 1976, 1978; Sella, 1978). *O. costlowi* Akesson was collected from Morehead City, North Carolina, and *O. macrovifera* Akesson was collected from Tampa Bay, Florida and at St. Lucie's Inlet, Florida. Identifications were confirmed via crossing tests performed by Prof. Bertil Akesson, Goteborg University. Initial populations of approximately fifty individuals were reared on ground, par-boiled spinach, at room temperature (20°C) and 30‰ salinity. Sea water used for culture was twice glass-fiber filtered, sterilized for 24 hours at 80°C, and cooled to room temperature. Worms were cultured in glass evaporating dishes, whose curved sides permit easy examination of worms and egg cases under the dissecting microscope at 12–50× magnification.

Both species belong to the "labronica" group of *Ophryotrocha* (Akesson, 1978). Sexes are separate and the male follows the female for some time (hours to over a day) before sperm is transferred. Females construct a tubular egg mass and reside in the tube until juveniles develop directly and emerge from the egg case. The near simultaneous emergence permits experiments with large numbers of siblings of identical age to be initiated at the same time.

Somatic growth rates were measured in two ways. First, animals were collected in the field and held at *ca.* 20°C (approximately 2 degrees variation) for 2–3 generations. Approximately twenty newly emerged juveniles from the same family were placed in a dish with spinach. Individuals were transferred to constant temperature environmental chambers held at 15, 20, 25, or 30°C (variation was less than 0.5°C). Reciprocal transplants from different pairs of temperatures demonstrated no significant effect of starting the experiment from conditioned populations at 20°C. Therefore, it is unlikely that laboratory acclimation to 20°C significantly influenced the results of the growth experiments. Each day, five to ten randomly selected individuals were isolated, and the number of setigerous segments was counted. They were then returned to the bowl. I found no difference in worm length *versus* number of setigerous segments for the three populations (Fig. 1). I therefore assume that my measure is an homogeneous indicator of growth over all populations. From these data, I determined a

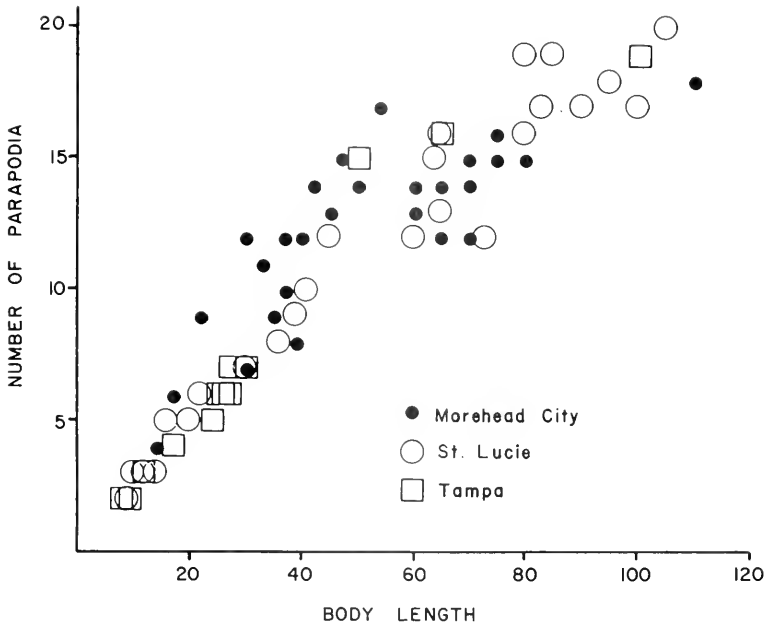

FIGURE 1. Body length (mm) versus number of setigerous segments for the two Florida populations of *O. macrovifera* (Tampa and St. Lucie Inlet) and the North Carolina population of *O. costlowi*.

somatic growth rate by regression analysis of setigers on time. Difference in growth rates within and between populations was evaluated using standard analyses of variance related to regression (Sokal and Rohlf, 1981).

Second, newly emerged juveniles were placed separately (and arranged randomly) in 1 ml wells of glass spot plates, and provided with sea water and spinach. After seven days, the number of setigerous segments was counted for each individual, which permitted comparisons between populations via nested analysis of variance. This experiment was performed at 25°C only. These experiments were designed such that several families from each sibling species were employed; this permitted an estimate of variation in growth rate among families, that is, a full-sib analysis. All experiments were done after the field-collected populations had been maintained in the laboratory at room temperature (usually *ca.* 20°C) for one year (*ca.* 10 generations), in order to eliminate physiological characteristics that may have been fixed in the field. For this comparison, I employed North Carolina *O. costlowi* and St. Lucie's Inlet, Florida *O. macrovifera*.

Egg diameter was measured with an ocular micrometer fitted to a Wild dissecting microscope (at 50×). I also recorded the time and number of setigers corresponding to the acquisition of adult jaws. Finally, the number of eggs per case was counted. Life history characteristics of two populations of *O. macrovifera* were compared. Although geographically separated, these two populations were completely interfertile.

An energy budget model of growth rate

A simple model based upon energy budgets may be used to predict genetic differences between North Carolina and Florida sibling species. Imagine the presence of cold- and warm-adapted genotypes. Figure 2 shows a hypothetical difference between

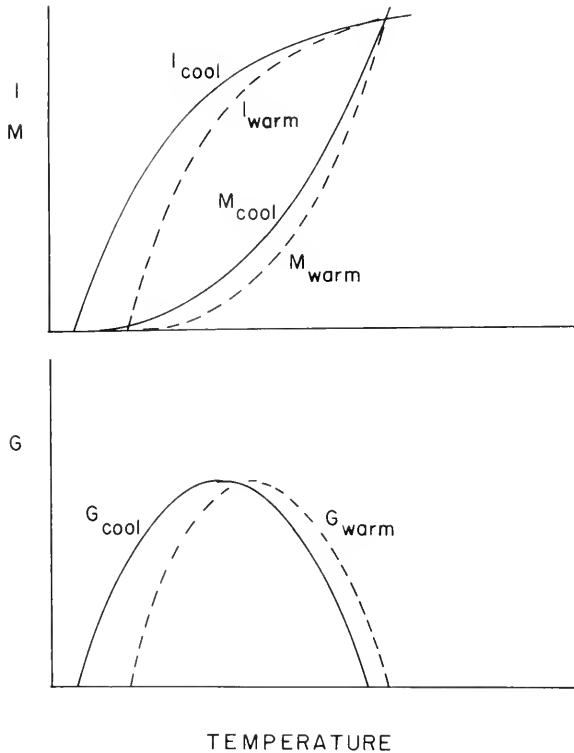

FIGURE 2. Graphical model explaining differential adaptation among latitudinally separated populations. Top diagram: Rate of ingestion, I , and metabolic cost rate, M , is illustrated for two hypothetical populations living in different thermal regimes. The regimes have similar maximum but differing minimum temperatures. Lower diagram: Difference between I and M curves yields reserves available for growth, G . The maximum growth rate of the warm-adapted form is displaced, relative to the cold-adapted form, towards higher temperature.

the two genotypes in energy acquired *versus* metabolic expenditure as a function of increasing temperature. The two hypothetical genotypes differ in that the energy intake and metabolic expenditure curves are displaced from each other such that the cold-adapted genotype enjoys a growth advantage at lower temperature (Fig. 2b).

This model predicts that at lower temperature, the cold-adapted form should grow more rapidly than the warm-adapted form. As temperature increases, this difference should diminish to a zero point, beyond which the warm-adapted genotype should enjoy the advantage. This advantage may simply involve relatively rapid growth. If the warm-adapted genotype lives in temperatures never experienced by the cold-adapted form, then the cold-evolved form might die at higher temperature, due to an excess of metabolic cost relative to rate of gained energy. Thus, the differential growth among individuals adapted to different temperatures would be seen only in the lower part of the temperature scale.

RESULTS

Temperature at the sites

Seasonal differences in temperature at the three sampling localities differ more in the distribution of temperature and winter minima than in summer maxima (Fig.

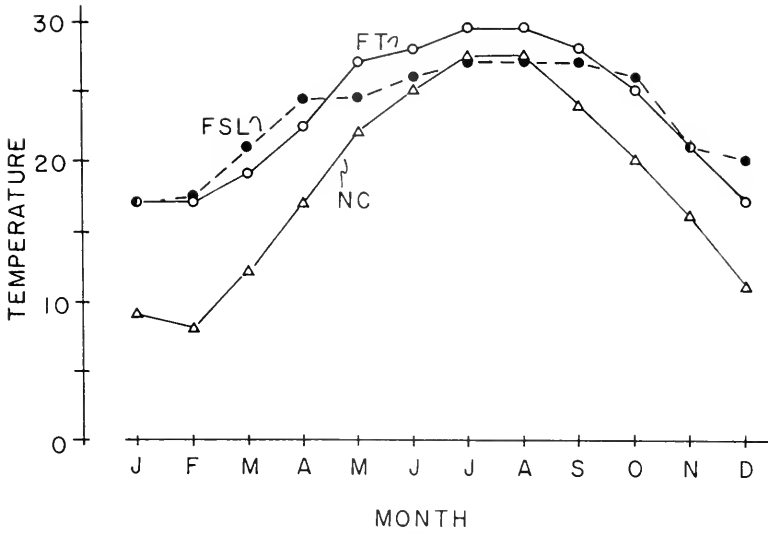

FIGURE 3. Mean monthly temperature of surface waters of the three localities: NC = Morehead City, North Carolina (actually nearby Beaufort, North Carolina); FSL = St. Lucie Inlet of Indian River, Florida; FT = Tampa Bay, Florida. Data derived from NOAA records.

3). Neither Florida locales experience mean monthly winter temperatures lower than 15°C. The North Carolina locale temperature surpasses 25°C for only two months, while both Florida sites are above 25°C for 5–6 months.

Whole family analyses

Figure 4 demonstrates the nature of the data obtained for somatic growth estimated for a given family (the complete data set is available upon request from the author). Growth rate was relatively uniform at 20, 25, and 30°C, but quite variable among individuals at 15°C.

Table I summarizes the variance analysis of the family growth regression on time, when comparing combined Florida locales with the North Carolina locale. At 15, 20, and 25°C, somatic growth rate of North Carolina animals surpasses that of Florida animals ($P < .001$). At 30°C, growth rates are approximately equal. The ratio of growth rate of North Carolina:Florida animals diminishes progressively from 15°C (1.58) to 30°C (1.02). The absolute difference in growth rate, however, is greatest at the two intermediate temperatures.

Significant differences between Florida populations were found at 15°C ($P < .001$) and 25°C ($P < .05$) (Table II). The magnitude of difference, however, is great only at 15°C, as demonstrated by the ratio of somatic growth rates at the four temperatures. At 15°C, growth differed between the two populations by a surprising factor of *ca.* 2. The variance analysis (Table III) also demonstrates that, for a given site and temperature, among-family growth rates were significantly different within sample populations from all three source localities. A more appropriate experimental design would spread members of the same family among different temperature treatments to estimate the family variance component. This approach is taken in the companion paper on intraspecific latitudinal differences (Levinton and Monahan, 1983).

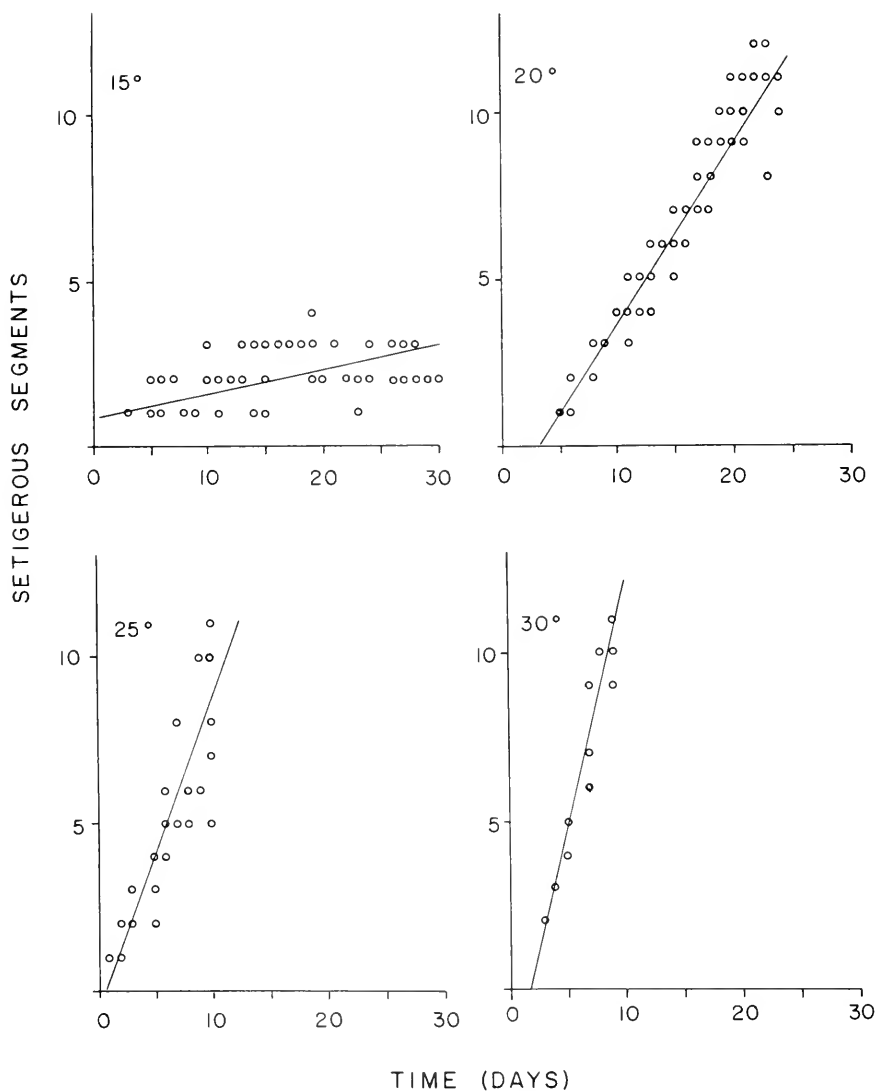

FIGURE 4. Examples of growth regressions of families of *O. costlowi* run at 15, 20, 25, and 30°C.

Survivorship of families

Eleven families each from North Carolina and the combined Florida locales were run at 30°C. The survival (defined as greater than 20 percent survival of individuals) of families from the combined Florida locales was much greater (10 out of 11) than that of the North Carolina site (1 out of 11). This difference in survival is significant ($P = .01$; 2×2 contingency table; Fisher's Exact Test). At lower temperatures survival was very high and similar between the two areas. The high mortality at 30°C in the North Carolina samples was surprising, in light of the rapid growth observed up to the day that death was observed, usually near the time of sexual maturity. Referring

TABLE I

Growth differences and variance analysis of regression statistics relating setigers to time

Experimental temperature	F _s	Degrees of freedom	Growth rate:		P	R
			Florida	North Carolina		
15	12.85	917	0.041	0.065	<.001	1.58
20	154.37	1732	0.364	0.520	<.001	1.43
25	41.99	962	0.853	0.956	<.001	1.12
30	1.58	828	1.215	1.243	NS	1.02

NS = not significant.

F statistic measures among-family *versus* between-locality variance of growth rate. Florida localities (*O. macrovifera*) are pooled for comparison with North Carolina (*O. costlowi*) locality. R = ratio of North Carolina to Florida growth rate (in setigerous segments/day).

to Figure 3, it is apparent that 30°C is greater than the mean monthly temperature experienced by all three populations. The data, however, probably underestimate the temperature achieved in the shallow microhabitats occupied by the worms. The Tampa site experiences the greatest summer maximum mean temperature.

Growth of individuals

Growth of North Carolina *O. costlowi* was found to be greater than that of Florida (St. Lucie) *O. macrovifera* (Table IV). Additionally, growth rate differed significantly among families. It is not known whether this difference can be attributed to genetic differences or to maternal effects (now under investigation). In both source populations, among-family differences were strongly significant ($P < .001$). These data indicate that among-family differences must be accounted for in physiological experimentation.

Life-history differences

Significant differences were found between the two Florida populations of *O. macrovifera*, despite complete interfertility between adults in crosses. Both egg size and number of setigerous segments at release (Table V) were larger in individuals from the Tampa population, relative to the St. Lucie population. Both eggs and larvae

TABLE II

Comparison of growth rates of O. macrovifera populations from Tampa (Gulf Coast, Florida) and St. Lucie Inlet (Atlantic Coast, Florida)

Experimental temperature	F _s	DF	Growth rate:		P	R
			Tampa	St. Lucie		
15	4.87	527	0.028	0.061	<.001	2.18
20	0.54	866	0.363	0.372	NS	1.02
25	6.31	702	0.842	0.799	<.05	0.95
30	0.19	538	1.149	1.136	NS	0.99

NS = Not Significant.

F statistic is a measure of among-family *versus* between locality variance. R = St. Lucie/Tampa growth rate.

TABLE III

Variance among families within the populations from each locality, at four temperatures

Temperature population	15°C			20°C			25°C			30°C		
	N	F	P	N	F	P	N	F	P	N	F	P
OCNC	5	5.61	<.001	11	22.32	<.001	5	6.68	<.001	7	17.86	<.001
OMT	5	32.76	<.001	5	16.76	<.001	5	9.56	<.001	5	8.71	<.001
OMSL	5	5.19	<.001	5	3.60	<.01	5	21.85	<.001	6	19.41	<.001

F statistic measures difference in variance within and among families from a given locality. (N = number of families; F = value of F statistic, P = significance level for among-family heterogeneity in somatic growth rate (setigerous segments/day)). OCNC = *O. costlowi*, North Carolina; OMT = *O. macrovifera*, Tampa; OMSL = *O. macrovifera*, St. Lucie Inlet.

of North Carolina *O. costlowi* were smaller than the eggs and larvae of Florida populations of *O. macrovifera*. The size at which the adult jaw developed was greater in *O. macrovifera* (Table V). Akesson (1978) presents similar data, except for noting intraspecific variation in *O. macrovifera*.

DISCUSSION

These results are consistent with an energy budget model that postulates a difference in adaptation of high and low latitude (*i.e.*, thermally differing) populations. The northern *O. costlowi* shows greater somatic growth rate, but this advantage decreases with increasing temperature as predicted by the model. At 30°C, the difference is nonexistent and North Carolina families show very high mortality. The rich food (spinach) used in the experiments may have tended to shift the growth differences, favoring growth of the northern populations at higher temperatures than found under field conditions with a food supply of lower nutritional content. Such an effect was documented by Bayne *et al.* (1973) in the energy budget of the mussel, *Mytilus edulis*. The rich food provided in the present experiments might explain the rapid growth observed at 30°C for all three populations. A poorer food that is available in nature might not permit a favorable energetic balance at this extreme temperature.

As illustrated by Figure 3, the thermal regimes at the three localities do not differ

TABLE IV

Analysis of variance for growth rates of individuals distributed among nine families each for *O. costlowi* from Morehead City, North Carolina and *O. macrovifera* from St. Lucie's Inlet, Florida

O. costlowi, North Carolina: Total growth = $7.48 + .37$ (95% CL)

Source of Variation	df	MS	F ₅
Among Families	8	15.08	9.40***
Within Families	72	1.60	

O. macrovifera, Florida: Total growth = $5.52 + .23$ (95% CL)

Source of Variation	df	MS	F ₅
Among Families	8	4.42	5.79***
Within Families	72	0.76	

*** $P < .001$.

Growth is measured as number of setigerous segments added in seven days after hatching.

TABLE V

Some differences in life histories between *O. costlowi* for Morehead City, North Carolina, and *O. macrovifera* from St. Lucie Inlet (Atlantic Coast of Florida) and Tampa (Gulf Coast of Florida)

Characteristic	<i>O. costlowi</i>	<i>O. macrovifera</i>	
		Tampa	St. Lucie
Egg Diameter (μm)	104.4 + 9.85 (225)	134.2 + 17.42 (128)	145.5 \pm 16.84 (80)
Setigerous Segments When Hatching	0 \pm 0 (100)	1.5 \pm 0.74 (170)	2.6 \pm 0.68
Acquisition of Adult Jaws (Males)	11.4 \pm 0.91 (39)	14.8 \pm 0.75 (12)	—
Acquisition of Adult Jaws (Females)	13.5 \pm 0.93 (44)	16.1 \pm 0.64 (18)	—

Sample size (in parentheses) and standard deviations are given.

very much in maximum summer temperature. The most important difference lies in the seasonal distribution of temperature and the winter minimum. The Florida locales have winter minima near 15°C, which is substantially greater than for North Carolina. Increasing the experimental temperature from 15 to 30°C provides an opportunity for increasing growth rate (Fig. 3). In the lower range, the high latitude population enjoys the advantage in growth efficiency. At 30°C, however, the two sibling species do not differ in growth, although North Carolina *O. costlowi* suffer high mortality. This may stem from an inability to acclimate and a predetermined pattern of investment of energy for somatic growth, despite the cost in maintenance.

At present, there are no data on reproductive output as a function of temperature. It is likely that reproductive investment will follow the patterns found for somatic growth. Akesson (1976) investigated the effect of temperature on the life cycle of *O. labronica* and demonstrated optimum intermediate temperatures for eggs per egg mass and egg output per female per day. In the sequential hermaphrodite, *Ophryotrocha puerilis*, the size at which sex change from male to female occurs is greater in a northern (Atlantic) subspecies, relative to a southern (Mediterranean) subspecies (Sella, 1978). Sella (1980) has presented evidence that the size at sex change in *O. puerilis* is genetically regulated and maintained by stabilizing selection. This suggests that thermal limitations may influence the life history patterns of sequential hermaphrodites much as spatially varying mortality patterns can (e.g., Charnov, 1978, 1979, 1981). Although the northern subspecies of *O. puerilis* switches sex at a larger number of segments, individuals grow to this size in the same number of days as individuals of the southern subspecies, implying accelerated growth for the northern form. This result is consistent with the present findings. Further work on these subspecies demonstrates intraspecific differentiation in growth rates comparable to the interspecific data presented here (Levinton and Monahan, 1983).

These results suggest that, given the strong differences in temperature along the eastern coast of North America, some compensation is possible for life at low temperature. The model and results also suggest that populations evolve locally to maximize growth rate. It is therefore incorrect to state, for example, that southern (high temperature) populations evolve slower growth rates, relative to northern populations. Rather, all populations are adapted for maximum growth rate, and they sacrifice

efficiency at temperatures rarely experienced to maximize growth efficiency at temperatures that are experienced commonly. Thus southern individuals grow more slowly at lower temperature because evolution has shifted the metabolism-temperature relationship to minimize metabolic cost at high temperature; this shift, however, restricts activity and growth at low temperature, relative to higher latitude forms. Bervan *et al.* (1978) developed a temperature-related explanation for growth differences in salamanders living at different altitudes. They described the necessary compensation of living in cold climates as "countergradient selection," implying that selection for increased growth rate works against the limiting effects of cold temperatures on poikilotherms. But animals in warm climates have their problems as well; genetic variance for a favorable metabolism-temperature response would therefore be of great advantage, given a geographic/altitudinal gradient of temperature.

Newell and Kofoed (1977) demonstrate that thermal constraints can be met with compensation via physiological acclimation. Thus the presumed genetic component we observe here must be placed aside this non-genetic response in any accounting of response to the thermal regime. The ability to acclimate is just as much an evolutionary response as the differences in growth we have discussed.

Growth experiments performed in this study were done on individuals from different populations, reared under the same laboratory conditions. Assuming laboratory conditions are reasonably related to field conditions, these results suggest that the growth differences are genetic, and confirm the expectation that populations of coastal invertebrates show strong regional differentiation in physiologically important characters (Battaglia, 1959; Gooch and Schopf, 1971; Levinton and Fundiller, 1975). These results suggest that an integrated study of energy budgets, genetics, and somatic growth rates will be useful in understanding regional differentiation within marine species. As the differences found in this study lasted (apparently) for *ca.* 10 generations of laboratory rearing (as in Battaglia, 1959), one can be reasonably certain that environmental effects can be ruled out.

ACKNOWLEDGMENTS

The initiation of this project is due to the kind provision of facilities and support by Prof. John D. Costlow, Duke University Marine Laboratories. I am also grateful to Prof. Bertil Akesson of Gothenburg University, Sweden, who performed necessary identifications and provided much-needed advice. During the course of this work I was lucky to have the assistance in the laboratory of Susan Hutchison, Reed Johnson, and Lois Mingalone. Linda Weinland provided the specimens of *Ophryotrocha macrovifera*. Rosemary Monahan edited and criticized the manuscript. This work was partially supported by U. S. National Science Foundation grants OCE-78-09057 and OCE-80-18743 (to J.S.L.), and by a grant from the Department of Energy (Contract DE-AS05-76EV04377) awarded to Duke University Marine Laboratory under the direction of J. D. Costlow. Contribution number 474 from the Graduate Studies in Ecology and Evolution, State University of New York at Stony Brook.

LITERATURE CITED

- AKESSON, B. 1976. Temperature and life cycle in *Ophryotrocha labronica* (Polychaeta, Dorvilleidae). *Ophelia* 15: 37-47.
- AKESSON, B. 1978. A new *Ophryotrocha* species of the *Labronica* group revealed in crossbreeding experiments. Pp. 573-590 in *Marine Organisms: Genetics, Ecology, and Evolution*, B. Battaglia and J. L. Beardmore, eds. Plenum Publ. Co., New York.
- AMENT, A. 1979. Geographic variation in relation to life history in three species of the marine gastropod

- genus *Crepidula*: growth rates of newly hatched larvae and juveniles. Pp. 61-76 in *Reproductive Ecology of Marine Invertebrates*. S. E. Stancyk, ed. Univ. of South Carolina Press, Columbia, SC.
- BATTAGLIA, B. 1959. Ecological differentiation and incipient intraspecific isolation in marine copepods. *Ann. Biol.* **33**: 259-268.
- BAYNE, B. L., R. J. THOMPSON, AND J. WIDDOWS. 1973. Some effects of temperature and food on the rate of oxygen consumption by *Mytilus edulis* L. Pp. 181-193 in *Effects of Temperature on Ectothermic Organisms*, W. Wieser, ed. Springer-Verlag, New York.
- BERVAN, K. A., D. E. GILL, AND S. J. SMITH-GILL. 1979. Countergradient selection in the green frog, *Rana clamitans*. *Evolution* **33**: 609-623.
- BURTON, R. S., AND M. W. FELDMAN. 1983. Physiological effects of an allozyme polymorphism: glutamate-pyruvate transaminase and response to hyperosmotic stress in the copepod *Tigriopus californicus*. *Biochem. Genet.* **21**: 239-251.
- CHARNOV, E. L. 1978. Sex ratio: adaptive response to population fluctuations in pandalid shrimp. *Science* **200**: 204-206.
- CHARNOV, E. L. 1979. Natural selection and sex change in pandalid shrimp: test of a life-history theory. *Am. Nat.* **113**: 715-734.
- CHARNOV, E. L. 1981. Sex reversal in *Pandalus borealis*: effect of a shrimp fishery. *Mar. Biol. Lett.* **2**: 53-57.
- CONOVER, D. O., AND B. E. KYNARD. 1981. Evolution of sex determination: interaction of temperature and genotype in a fish. *Science* **213**: 577-579.
- DEHNEL, P. A. 1956. Growth rates in latitudinally and vertically separated populations of *Mytilus californianus*. *Biol. Bull.* **110**: 43-53.
- FOX, H. M. 1936. The activity and metabolism of poikilothermal animals in different latitudes. *Proc. Zool. Soc. Lond.* **106**: 945-955.
- GIBSON, M. B. 1954. Upper lethal temperature relations of the guppy, *Lebistes reticulatus*. *Can. J. Zool.* **32**: 393-407.
- GOSLING, E. 1979. Hidden genetic variability in two populations of a marine mussel. *Nature* **279**: 713-715.
- GOOCH, J. L., AND T. J. M. SCHOPF. 1971. Genetic variation in the marine ectoprotect *Schizoporella errata*. *Biol. Bull.* **141**: 235-246.
- HALL, J. G. 1983. *Temperature-related Catalytic Differentiation Among Homologues of Glucosephosphate Isomerase (EC 5.3.1.9) Isolated From the Bivalves Mytilus edulis and Isognomon alatus*. PhD. Dissertation, State University of New York at Stony Brook.
- HOCHACHKA, P. W., AND G. N. SOMERO. 1973. *Strategies of Biochemical Adaptation*. W. B. Saunders, Philadelphia.
- JOHNSON, A. G., AND F. M. UTTER. 1973. Electrophoretic variants of aspartate aminotransferase of the bay mussel, *Mytilus edulis* (Linnaeus, 1758). *Comp. Biochem. Physiol.* **44B**: 317-323.
- KINNE, O. 1962. Irreversible non-genetic adaptation. *Comp. Biochem. Physiol.* **5**: 265-282.
- KINNE, O. 1964. Non-genetic adaptation to temperature and salinity. *Helgol. Wiss. Meeresunters.* **10**: 433-458.
- KOEHN, R. K., R. MILKMAN, AND J. B. MITTON. 1976. Population genetics of marine pelecypods. IV. Selection, migration and genetic differentiation in the blue mussel, *Mytilus edulis*. *Evolution* **30**: 2-32.
- KOEHN, R. K., R. I. E. NEWELL, AND F. IMMERMANN. 1980. Maintenance of an aminopeptidase allele frequency cline by natural selection. *Proc. Nat. Acad. Sci. USA* **9**: 5385-5389.
- KROGH, A. 1916. *Respiratory Exchange of Animals and Man*. Longmans Green, London.
- LEVINTON, J. S., AND D. L. FUNDILLER. 1975. An ecological and physiological approach to the study of biochemical polymorphisms. Pp. 165-178 in *Proc. 9th Europ. Mar. Biol. Symp.*, H. Barnes, ed. Aberdeen University Press, Aberdeen, Scotland.
- LEVINTON, J. S., AND H. H. LASSEN. 1978. Selection, ecology, and evolutionary adjustment within bivalve mollusc populations. *Phil. Trans. Roy. Soc. Lond. B* **284**: 403-415.
- LEVINTON, J. S., AND R. K. MONAHAN. 1983. The latitudinal compensation hypothesis: growth data and a model based upon energy budgets. II. Intraspecific comparisons between subspecies of *Ophryotrocha puerilis* (Polychaeta, Dorvilleidae). *Biol. Bull.* **165**: 699-707.
- LEVINTON, J. S., AND T. H. SUCHANEK. 1978. Geographic variation, niche breadth, and genetic differentiation at different geographic scales in the mussels *Mytilus californianus* and *Mytilus edulis*. *Mar. Biol.* **49**: 363-375.
- LOOSANOFF, V. L., AND C. A. NOMEJKO. 1951. Existence of physiologically different races of oysters, *Crassostrea virginica*. *Biol. Bull.* **101**: 151-156.
- MANGUM, C. P. 1963. Studies on speciation in maldanid polychaetes of the North American Atlantic coast. III. Intra- and interspecific divergence in oxygen consumption. *Comp. Biochem. Physiol.* **10**: 335-349.

- MCLAREN, I. A., C. J. CORKETT, AND E. J. ZILLIOUX. 1969. Temperature adaptations of copepod eggs from the arctic to the tropics. *Biol. Bull.* **137**: 486-493.
- NEWELL, R. C. 1973. Environmental factors affecting the acclimatory responses of ectotherms. Pp. 151-164 in *Effects of Temperature on Ectothermic Organisms*, W. Wieser, ed. Springer-Verlag, New York.
- NEWELL, R. C., AND L. H. KOFOED. 1977. Adjustment of the components of energy balance in the gastropod *Crepidula fornicata* in response to thermal acclimation. *Mar. Biol.* **44**: 275-286.
- O'GOWER, A. K., AND P. I. NICOL. 1968. A latitudinal cline of haemoglobins in a bivalve mollusc. *Heredity* **23**: 485-491.
- PICKENS, P. E. 1965. Heart rate of mussels as a function of latitude, intertidal height, and acclimation temperature. *Physiol. Zool.* **38**: 390-405.
- RAO, K. P. 1953. Rate of water propulsion in *Mytilus californianus* as a function of latitude. *Biol. Bull.* **104**: 171-181.
- RAY, C. 1960. The application of Bergmann's and Allen's rules to the poikilotherms. *J. Morphol.* **106**: 85-108.
- SCHNEIDER, D. E. 1967. *An Evaluation of Temperature Adaptations in Latitudinally Separated Populations of the Xanthid Crab, Rhithropanopeus harrisi (Gould), by Laboratory Rearing Experiments*. PhD. Dissertation, Duke University.
- SCHOLANDER, P. F., W. FLAGG, V. WALTERS, AND L. IRVING. 1953. Climatic adaptation in arctic and tropical poikilotherms. *Physiol. Zool.* **26**: 67-93.
- SELLA, G. 1978. Responses adaptatives a differentes temperatures chez les deux sousespeces d'*Ophryotrocha puerilis*, pendant la phase male. *Cah. Biol. Mar.* **18**: 117-125.
- SELLA, G. 1980. The genetic system controlling the body length at which sex change occurs in *Ophryotrocha puerilis* (Annelida, Polichaeta). *Atti Soc. Toscana Sci. Nat. P. V. Mem. Ser. B* **87**: 197-203.
- SOKAL, R. R., AND F. J. ROHLF. 1981. *Biometry*. W. H. Freeman and Company, San Francisco.
- SOMERO, G. N., AND A. L. DEVRIES. 1967. Temperature tolerance of some Antarctic fishes. *Science* **156**: 257-258.
- VERNBERG, W. B., AND F. J. VERNBERG. 1966. Studies on the physiological variation between tropical and temperate zone fiddler crabs of the genus *Uca* V. Effect of temperature on tissue respiration. *Comp. Biochem. Physiol.* **17**: 118-126.
- WEYMOUTH, F. W., AND H. C. MCMILLAN. 1931. The relative growth and mortality of the Pacific razor clam (*Siliqua patula* Dixon) and their bearing on the commercial fishery. *Bull. U. S. Bur. Fish.* **46**: 543-567.
- WILLIAMS, G. C., R. K. KOEHN, AND J. B. MITTON. 1973. Genetic differentiation without isolation in the American eel, *Anguilla rostrata*. *Evolution* **27**: 192-204.
- ZAMER, W. E., AND C. P. MANGUM. 1979. Irreversible non-genetic temperature adaptation of oxygen uptake in clones of the sea anemone *Haliplanella luciae* (Verrill). *Biol. Bull.* **157**: 536-547.
- ZHIRMUNSKY, A. V. 1959. The thermostability of actinias and their ciliated epithelium in natural conditions and in experimentally changed environmental temperatures. *Tsitologiya* **1**: 270-276 (In Russian).

THE LATITUDINAL COMPENSATION HYPOTHESIS: GROWTH DATA
AND A MODEL OF LATITUDINAL GROWTH DIFFERENTIATION
BASED UPON ENERGY BUDGETS. II. INTRASPECIFIC COMPARISONS
BETWEEN SUBSPECIES OF *OPHRYOTROCHA PUERILIS*
(POLYCHAETA: DORVILLEIDAE)

JEFFREY S. LEVINTON AND ROSEMARY K. MONAHAN

Department of Ecology and Evolution, State University of New York, Stony Brook, New York 11794

ABSTRACT

Individuals of two subspecies of *Ophryotrocha puerilis* (Polychaeta; Dorvilleidae) were collected from differing thermal regimes, and cultures were maintained for over a year. Despite common rearing, the two subspecies show substantial differences in somatic growth rate. At 15°C, the warm-water subspecies grew more slowly, while at 20°C growth for the two subspecies was not significantly different. At 24°C, the warm-water subspecies grew more rapidly and suffered substantially less mortality than the northern subspecies. These results conform to a model predicting genetic differentiation of metabolic efficiency, leading to differences in growth efficiency among populations adapting to thermally differentiated habitats. The problems faced by the cold-water subspecies at 24°C conforms to expectations based upon natural habitat temperatures.

INTRODUCTION

Many broadly distributed coastal marine species live in a strong thermal gradient and would be expected to be subjected to natural selection to maximize growth efficiency in the local thermal regime. If populations are sufficiently isolated, this may result in a series of genetically distinct subpopulations whose growth characteristics would differ even if reared under constant temperature conditions. In the first paper of this series, Levinton (1983) suggested that a simple model of metabolic expenditure and food (energy) intake would predict divergent temperature optima for subpopulations living under different thermal regimes. Differences among sibling species of the polychaete genus *Ophryotrocha* conform to such a model.

Here we show similar growth differences between two geographically separated subspecies. We compare somatic growth rates of Atlantic and Mediterranean subspecies of *O. puerilis* and show that, despite common rearing through several generations under identical conditions, strong differences in growth rate persist between the two populations. The differences, moreover, show an advantage that shifts from favoring the high latitude population at low temperature, to favoring the low latitude population at higher temperature. These results suggest that the thermal regime generates strong genetic differentiation along the latitudinal gradient. Our results provide more direct evidence of intraspecific latitudinal differences in temperature adaptation than do recorded differentiation in, for example, allozyme polymorphisms (*e.g.*, Levinton and Suchanek, 1978).

Received 27 May 1983; accepted 29 August 1983.

The organism

Ophryotrocha puerilis is a dorvilleid polychaete commonly collected in barely subtidal and intertidal fouling communities in European waters. The species is a protandrous hermaphrodite (sex reversal—from male to female), and occurs as two subspecies, *O. p. puerilis* from Mediterranean waters and *O. p. siberti* from the Atlantic coast of Europe (e.g., Bacci and LaGreca 1953). The two subspecies are reproductively isolated to a variable degree, depending upon the nature of the cross, but incompatibility is generally extensive (Akesson, 1975; 1977). Body size (estimated by number of setigerous segments) at time of sex change differs between the subspecies. Although size at sex change depends somewhat on temperature, *O. p. puerilis* switches at approximately 18 setigerous segments (setigers) while *O. p. siberti* changes at 20 setigers (Bacci and LaGreca, 1953; Sella, 1978). The body length at which sex change occurs is determined by a polygenic system, and selection experiments can change the size at reversal in only a few generations (Bacci and Bortesi, 1961; Sella, 1980).

We used two populations collected by Dr. Gabriella Sella of the University of Torino. The *O. p. siberti* stock was collected in 1978 at the Roscoff Marine station (Brittany, north coast of France), while the *O. p. puerilis* culture was collected in the harbor of Genoa, Italy in 1981. At Roscoff, the annual temperature range is 8.9–15°C; the range is 12.5–24.2°C in Genoa (Sella, 1978). All stocks were kept at room temperature (ca. 20°C) prior to being shipped to our laboratory in late 1981. We kept the stocks at ca. 20°C until the summer of 1982 when the experiments were performed; both stocks therefore existed for quite a long time under similar conditions. A newborn individual worm becomes a female within about three weeks at 20°C; therefore both stocks went through a number of generations in the laboratory. We doubt that any field conditioning such as local acclimation to temperature could have exerted effects on laboratory stocks over such a long period of time.

MATERIALS AND METHODS

A number of mating pairs were established for each subspecies by randomly selecting individuals (conspecifics) and placing pairs in individual glass bowls provided with 30‰ sterilized sea water and ground spinach as food (see Akesson, 1970 for instructions on the culture of *Ophryotrocha*). All mating pairs of each subspecies were kept in an incubator at 20°C, on a 12:12 light/dark cycle. Pairs were then monitored for egg case production. Juveniles of both subspecies hatched out of egg cases after approximately 11 days at 20°C.

Progeny of five pairs of *O. p. siberti* and of four pairs of *O. p. puerilis* were chosen for use in the experiment. On the day that most of the juveniles left each loose jelly egg mass, 48 from each family were isolated in individual glass bowls (30‰ sea water, spinach for food). These bowls were then placed inside plastic boxes (with distilled water on the bottom to slow evaporation). Of these 48 sibs per family, twelve progeny each were moved into incubators at 15, 20, 24, and 28°C. This design placed members of the same family under different temperature conditions, allowing an estimate of among-family difference effects that might persist despite transfer to different temperatures. The design also helps minimize the contribution of among-family differences in confounding an estimate of between-subspecies differences. If completely different families are placed in each and all dishes, then the among-family variance in growth rate cannot be distinguished from a “bowl” effect that happens to make a given family grow faster or slower, due to individual laboratory conditions. This is a problem with the sibling species data presented in Levinton (1983).

The size (number of setigers) of the progeny was then measured every seven days for four time periods. All hatched with zero setigers. Within the first week, all worms of both subspecies kept at 28°C died so this part of the experiment was abandoned. Water was changed when the worms were 21 days past hatching; food was replenished every 7 days if needed (spinach was always provided in excess).

RESULTS

Figure 1 summarizes the results for all families of *O. p. siberti* (northern subspecies) and *O. p. puerilis*. A decided shift in somatic growth rate occurs from low to high temperature. At 15°C, the northern subspecies grows most rapidly, while at 20°C growth rate is fairly similar for the two subspecies. At 24°C, however, the northern

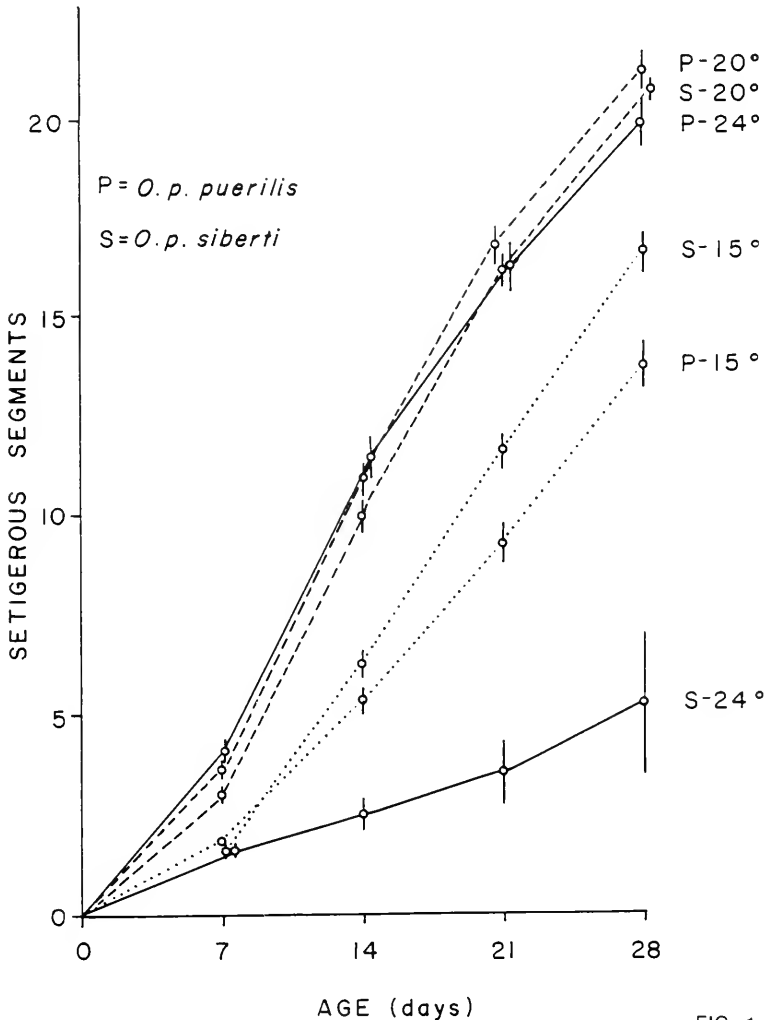

FIG. 1

FIGURE 1. Summary of growth data (means \pm 95% confidence) for individuals of all families of the two subspecies.

subspecies grows very slowly while the southern subspecies grows much more rapidly. The growth of the southern subspecies is less at 24°C than at 20°C. This indicates that even the southern subspecies is nearing its upper thermal limit at 24°C.

Growth plots for individual families show the pattern of growth differences between the two subspecies (Fig. 2). At 15°C the growth of families from the southern subspecies is less than that of the northern subspecies, with some overlap (Nested ANOVA, $F = 6.88$, $P < .05$). At 20°C the families from both subspecies overlap substantially ($F = 0.42$, Difference not significant). At 24°C, however, growth of the northern subspecies is clearly depressed relative to the southern subspecies ($F = 59.69$, $P < .001$).

The northern subspecies thus displays a growth disadvantage at higher temperature. This disadvantage is also reflected in a noticeable incidence of setiger resorption and generally poor nutritive condition. Not surprisingly, mortality in the experiment at 24°C was greater for *O. p. siberti* than for *O. p. puerilis* (Fig. 3). Most individuals that survived grew poorly; a few, however, grew at rates rather similar to those of the Mediterranean subspecies. This may represent genetic variation for the trait, but we have not followed this up.

Although there are clear intersubspecific differences, we wondered if there were significant among-family differences in growth rate, as reported in Levinton (1983). To test for this we performed a three-way analysis of variance, using temperature, family, and time as the variables. Since we had used the same families from a given subspecies in all of the temperature treatments we could estimate whether the use of different families caused an additional variance component. Table I shows the results for both subspecies. In both cases significant among-family differences in growth rate can be found when time and temperature are factored out.

In a sense, this analysis is problematical because the body size of a given individual at a given time is not independent of the previous time. Thus the relative magnitude of a family mean size may persist for more than one time period. To eliminate the problem, we performed two-way analyses of variance at a given time, using temperature and family as the variables. Table II shows the results for seven days and for 28 days. At seven days, significant and persistent among-family differences in growth occur despite rearing in several temperatures. At 28 days, however, no significant additional variance component is generated by family difference. This change may represent initial family differences that were eliminated subsequently by acclimation to new common conditions over the course of the experiment, and, possibly, mortality of more slowly-growing worms.

DISCUSSION

Our results demonstrate a shifting growth advantage consistent with the differing thermal regimes of the two subspecies. They conform to an hypothesis which predicts that local evolution should maximize metabolic efficiency and thus favor maximum growth under local thermal conditions (Levinton, 1983). Thus, despite common rearing for several generations under common conditions, the evolved differences between the populations emerge as growth differences.

The latitudinal compensation hypothesis weighs heavily on the interpretation of life-history differences among natural populations of a given species living along a thermal (e.g., latitudinal) gradient. In any study of growth, body size, and age of first reproduction, temperature may have to be considered as a primary influence on life-history traits.

Although traditional studies of latitudinal differentiation in growth and metabolism accounted for such a limitation (e.g., Weymouth and McMillan, 1931; Rao, 1953;

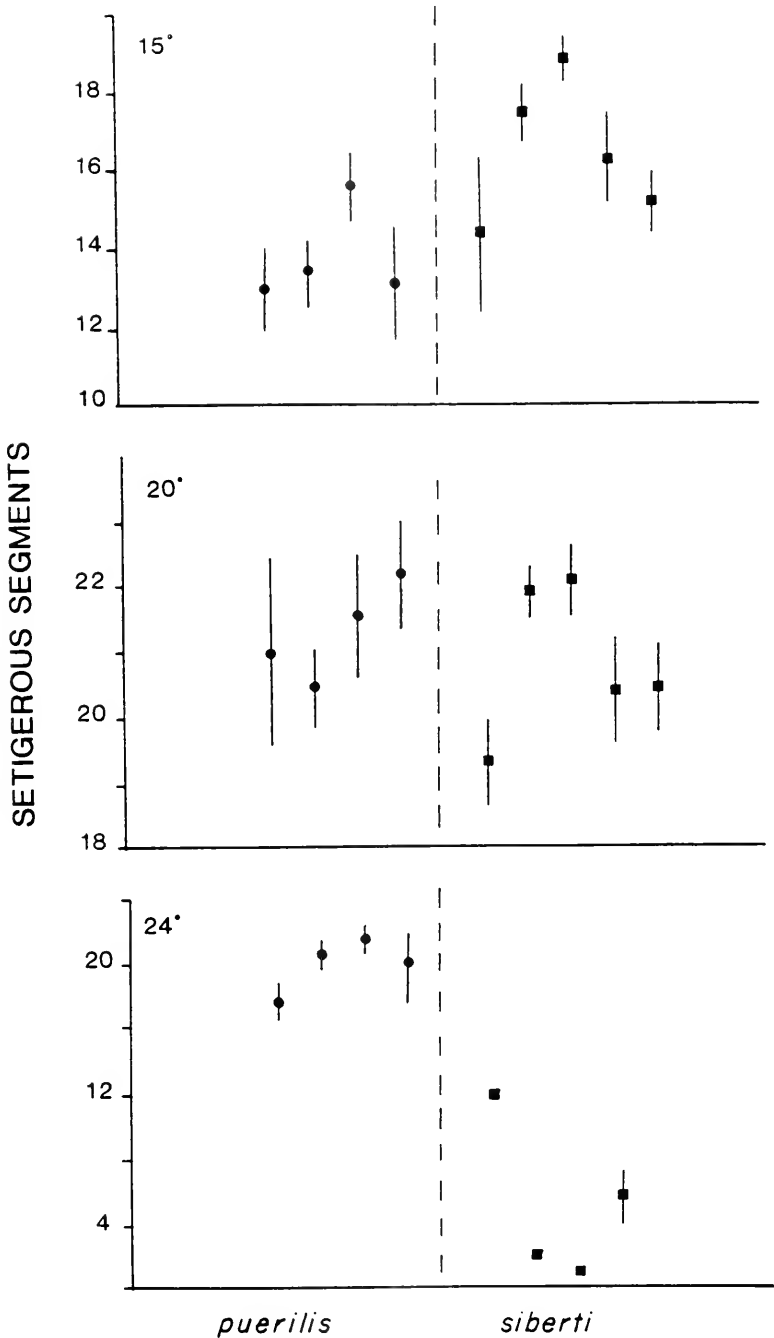

FIGURE 2. Mean individual growth (number of setigerous segments after 28 days), $\pm 95\%$ confidence, among the families of *Ophryotrocha puerilis puerilis* and *O. p. siberti* at 15, 20, and 24°C.

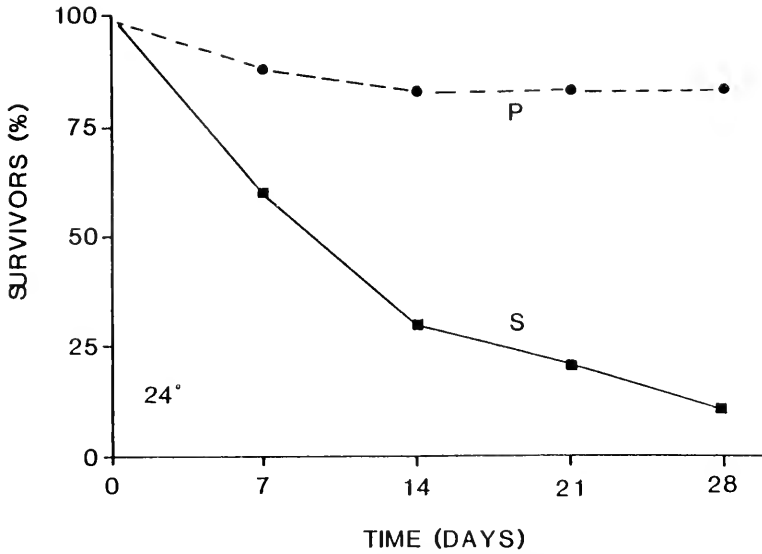

FIGURE 3. Survival of individuals of the two subspecies at 24°C.

Vernberg and Vernberg, 1966, among others), recent workers have tended to assume that latitudinal differences in life history patterns reflect differences in demography which, in turn, select for different ages of first reproduction, investment in growth

TABLE I

Three-way analysis of variance for the growth experiment, testing for differences among families, temperatures, and sampling times

<i>Ophryotrocha puerilis puerilis</i> :				
Source of Variation	DF	SS	MS	F
Temperature (T)	2	318.74	159.37	651.79***
Families (F)	3	42.29	14.10	57.64***
Sampling Week (W)	3	1544.02	514.67	2104.86***
T × F Interaction	6	15.02	2.50	10.24***
T × W Interaction	6	47.59	7.93	32.44***
F × W Interaction	9	5.51	0.61	2.51
T × F × W Interaction	18	4.40	0.25	
<i>Ophryotrocha puerilis siberti</i> :				
Source of Variation	DF	SS	MS	F
Temperature (T)	1	129.67	129.67	474.12***
Families (F)	4	53.01	13.25	48.45***
Sampling Week (W)	3	1510.14	503.38	1840.52***
T × F Interaction	4	1.00	0.25	0.91
T × W Interaction	3	16.22	5.41	19.77***
F × W Interaction	12	4.63	0.39	1.41
T × F × W Interaction	12	3.28	0.27	

*** $P < .001$.

Data for *Ophryotrocha puerilis siberti* exclude 24°C, due to low sample sizes.

TABLE II

Two-way analyses of variance considering variation in growth among temperatures and families at 7 and 28 days

Subspecies	Time (days)	Family		Temperatures	
		F	P	F	P
<i>O. p. puerilis</i>	7	5.52	<.05	15.71	<.01
<i>O. p. puerilis</i>	28	2.84	NS	69.74	<.01
<i>O. p. siberti</i>	7	11.57	<.01	17.42	<.01
<i>O. p. siberti</i>	28	0.37	NS	31.28	<.01

NS: Not Significant ($P > .05$).

versus reproduction. In a study of the turban snail *Tegula funebris*, Frank (1975) concluded that the smaller reproductive size of individuals in low-latitude habitats resulted from increased adult mortality relative to high latitudes. Such an interpretation has also been used by Boehlert and Kappenman (1980) to explain latitudinal patterns in size at reproductive maturity in a fish species. While adult mortality clearly can influence life history tactics (Stearns, 1976; Charnov, 1981), one cannot safely interpret latitudinal patterns of life history change as being due to demography alone. Our results and Levinton's (1983) model clearly show that temperature can strongly influence latitudinal variation in growth.

Some recent studies support the role of temperature in latitudinal patterns in life-history tactics. For example, Searcy (1980) shows that latitudinal body size clines in birds are best explained as an adaptation to conserve body heat. Birds living above a certain temperature need not consume energy to cool the body. Below a certain temperature for a given body volume, however, the rate of heat loss is not matched by the rate of heat production of a bird that is "thermally neutral," *i.e.*, producing enough heat to maintain typical passerine body temperature. An increase in body volume tends to reduce the rate of heat loss and therefore permits a bird to survive lower temperatures with no additional metabolic cost.

Levinton and Lonsdale (1983) have examined latitudinal patterns of growth and body size in the harpacticoid copepod *Scottolana canadensis* taken from localities from Maine to Florida. They reared populations under common conditions through several generations, and found strong differences in growth rate. These differences reflected a growth advantage of high latitude derived populations at low temperatures and the reverse at high temperature. Body size of northern-derived populations also was larger than southern-derived individuals at all temperatures despite common rearing. They suggest that both growth and body size are controlled by thermal constraints.

Several studies of latitudinal differences in growth rates have explained the acceleration of growth of high latitude (or altitude) populations, relative to low latitude (altitude) populations at low temperatures as being a form of compensation (Ament, 1979; Bervan *et al.*, 1979). The higher altitude forms grow more rapidly to compensate for the effect of lowered temperature on poikilothermic activities. Clarke (1982) suggests that slow growth in arctic forms reflects a strategy to deal with chronically low food availability.

We might speculate that the difference in size of the male-female switch in sex between subspecies may also reflect thermal limitations. The size of sex switch should be determined by the relative fecundities of males and females as a function of

increasing size. Consider the case where temperature increases. Although temperature increases metabolic demand, it also increases activity and, therefore, the rate of feeding. As long as the animal is not near its upper thermal limit the energy gain in feeding will increase disproportionately, relative to increased metabolic demand. Increasing temperature will thus increase female fecundity for a given body size. If sperm are energetically cheap to produce then there may be no difference in male fecundity with differing temperature. Increasing temperature, therefore, will increase female fecundity, relative to that of the male, at a given body size. This is sufficient to cause evolution of a decreased size of male to female switch as a response to increased temperature. Our prediction is complicated, however, by the ability of individuals of this species to undergo repeated sex changes following the initial size-specific switch. These secondary sex changes can be provoked by interactions among worms and nutritional condition (Pfannenstiel, 1975, 1977; Berruti, 1980).

We conclude that the effects of temperature probably affect all life history features of a poikilothermic organism. It therefore will be important in future studies to account for temperature in studies of life histories, along with such factors as stochastic processes of population extinction, mortality schedules, and other factors known to govern the evolution of growth and reproductive strategies.

ACKNOWLEDGMENTS

This study was supported by National Science Foundation Grant OCE 80-18743 (Biological Oceanography). Contribution number 475 from the Graduate Studies in Ecology and Evolution, State University of New York at Stony Brook.

LITERATURE CITED

- AKESSON, B. 1970. *Ophryotrocha labronica* as a test animal for the study of marine pollution. *Helgol. wiss. Meeresunters.* **20**: 293-303.
- AKESSON, B. 1975. Reproduction in the genus *Ophryotrocha* (Polychaeta, Dorvilleidae). *Publ. Staz. Zool. Napoli* **39**(suppl.): 377-398.
- AKESSON, B. 1977. Crossbreeding and geographic races: experiments with the polychaete genus *Ophryotrocha*. *Mikrofauna Meeresboden* **61**: 11-18.
- AMENT, A. 1979. Geographic variation in relation to life history in three species of the marine gastropod genus *Crepidula*: growth rates of newly hatched larvae and juveniles. Pp. 61-76 in *Reproductive Ecology of Marine Invertebrates*, S. E. Stancyk, ed. Univ. South Carolina Press, Columbia, SC.
- BACCI, G., AND O. BORTESI. 1961. Existence of multiple sex genotypes in the hermaphrodite polychaete worm *Ophryotrocha puerilis siberti*. *Nature* **190**: 838.
- BACCI, G., AND M. LAGRECA. 1953. Genetic and morphological evidence for subspecific differences between Naples and Plymouth populations of *Ophryotrocha puerilis*. *Nature* **171**: 1115.
- BERRUTI, G. 1980. The effect of starvation on the appearance of the definitive upper jaw in *Ophryotrocha puerilis* (Annelida, Polychaeta). *Boll. Zool.* **47**: 71-74.
- BERVAN, K. A., D. E. GILL, AND S. J. SMITH-GILL. 1979. Countergradient selection in the green frog, *Rana clamitans*. *Evolution* **33**: 609-623.
- BOEHLERT, G. W., AND R. F. KAPPENMAN. 1980. Variation of growth with latitude in two species of rockfish (*Sebastes pinniger* and *S. diploproa*) from the Northeast Pacific Ocean. *Mar. Ecol. Prog. Ser.* **3**: 1-10.
- CHARNOV, E. L. 1981. Sex reversal in *Pandalus borealis*: effect of a shrimp fishery. *Mar. Biol. Lett.* **2**: 53-57.
- CLARKE, A. 1982. Temperature and embryonic development in polar marine invertebrates. *Int. J. Invert. Reprod.* **5**: 71-82.
- FRANK, P. W. 1975. Latitudinal variation in the life history features of the black turban snail *Tegula funebris* (Prosobranchia: Trochidae). *Mar. Biol.* **31**: 181-192.
- LEVINTON, J. S. 1983. The latitudinal compensation hypothesis: Growth data and a model of latitudinal growth differentiation based upon energy budgets. I. Interspecific comparison of *Ophryotrocha* (Polychaeta: Dorvilleidae). *Biol. Bull.* **165**: 686-698.

- LEVINTON, J. S., AND D. J. LONSDALE. 1983. Latitudinal differentiation in copepod growth: physiological and evolutionary significance. *Proc. Nat. Acad. USA*, submitted.
- LEVINTON, J. S., AND T. H. SUCHANEK. 1978. Geographic differentiation, niche breadth, and genetic differentiation at different geographic scales in the mussels, *Mytilus californianus* and *M. edulis*. *Mar. Biol.* **49**: 363-375.
- PFANNENSTIEL, H.-D. 1975. Mutual influence on the sexual differentiation in the protandric polychaete *Ophryotrocha puerilis*. Pp. 48-56 in *Intersexuality in the Animal Kingdom*, R. Reinboth, ed. Springer-Verlag, Heidelberg.
- PFANNENSTIEL, H.-D. 1977. Experimental analysis of the 'Paarkultureffekt' in the protandric polychaete, *Ophryotrocha puerilis* Clap. *Mecz. J. Exp. Mar. Biol. Ecol.* **28**: 31-40.
- RAO, K. P. 1953. Rate of water propulsion in *Mytilus californianus* as a function of latitude. *Biol. Bull.* **104**: 171-181.
- SEARCY, W. T. 1980. Optimum body sizes at different ambient temperatures: an energetics explanation of Bergmann's rule. *J. Theor. Biol.* **83**: 579-583.
- SELLA, G. 1978. Responses adaptatives a differentes temperatures chez les deux sous-especes d'*Ophryotrocha puerilis* (Claparede et Mecznikow), au cours de la phase male. *Cah. Biol. Mar.* **19**: 117-125.
- SELLA, G. 1980. The genetic system controlling the body length at which sex change occurs in *Ophryotrocha puerilis* (Annelida, Polychaeta). *Atti. Soc. Toscana Sci. Nat. P. V. Mem. Ser. B* **87**: 197-203.
- STEARNS, S. C. 1976. Life history tactics: a review of the ideas. *Q. Rev. Biol.* **51**: 3-47.
- VERNBERG, W. B., AND F. J. VERNBERG. 1966. Studies on the physiological variation between tropical and temperate zone fiddler crabs of the genus *Uca*. V. Effect of temperature on tissue respiration. *Comp. Biochem. Physiol.* **17**: 118-126.
- WEYMOUTH, F. W., AND H. C. McMILLAN. 1931. The relative growth and mortality of the Pacific razor clam (*Siliqua patula* Dixon) and their bearing on the commercial fishery. *Bull. U. S. Bur. Fish.* **46**: 543-567.

ENERGY METABOLISM DURING AIR EXPOSURE AND RECOVERY
IN THE HIGH INTERTIDAL BIVALVE MOLLUSC *GEUKENSIA*
DEMISSA GRANOSISSIMA AND THE SUBTIDAL BIVALVE
MOLLUSC *MODIOLUS SQUAMOSUS*

C. V. NICCHITTA¹ AND W. R. ELLINGTON²

Department of Biological Science, Florida State University, Tallahassee, Florida 32306

ABSTRACT

Metabolic responses to air exposure and recovery were investigated in the adductor muscles of the high intertidal mussel *Geukensia demissa granosissima* and the subtidal mussel *Modiolus squamosus*. Exposure to air for 12 h had no significant effect on the levels of high energy phosphates (arginine phosphate, ATP) in the adductor muscles of *G. demissa granosissima*, indicating minimal metabolic stress in this species. In contrast, there was a considerable decline in arginine phosphate and ATP during air exposure in the phasic and tonic adductor muscles of *M. squamosus*. In addition, there was a substantial accumulation of alanine and succinate under these conditions. Furthermore, D-lactate accumulated in the phasic muscle of *M. squamosus* during air exposure. During recovery, there were transient accumulations of alanine/strombine in both *G. demissa granosissima* and *M. squamosus*. The differences in metabolic responses between these two species reflect adaptations to specific microhabitats. It appears that metabolism in the posterior adductor muscle of *G. demissa granosissima* is largely aerobic during air exposure. The subtidal species *M. squamosus* displays a much greater reliance on anaerobic pathways of energy production under these conditions.

INTRODUCTION

Bivalve molluscs are not structurally well adapted for aerial gas exchange (Lent, 1968). The gills show extensive modifications for filter feeding and, secondarily, for gas exchange. The role of the gills in gas exchange may be quite reduced in some species. Booth and Mangum (1978) showed that ligation of the aorta of the ribbed mussel *Modiolus demissus* (*Geukensia demissa*) resulted in only a 15% decrease in aquatic oxygen consumption. Thus, gas exchange in this species may take place primarily over the generalized body surfaces. During exposure to air at low tides, many marine bivalves appear to be capable of taking up atmospheric oxygen. Significant rates of aerial oxygen consumption have been observed in *Cerastoderma edule* (Boyden, 1972), *Mytilus edulis* (Coleman, 1973), *Modiolus modiolus* (Coleman, 1976), and *Modiolus demissus* (Booth and Mangum, 1978). Typically, rates of aerial gas exchange are lower than aquatic rates (Coleman, 1973; Bayne *et al.*, 1976; Widdows *et al.*, 1979).

The metabolic rates of bivalve molluscs exposed to air vary considerably between species and, in a temporal sense, may vary considerably within an individual. For

Received 16 May 1983; accepted 15 August 1983.

¹ Present address: Department of Biochemistry and Biophysics, University of Pennsylvania, Philadelphia, Pennsylvania 19104.

² To whom editorial correspondence and reprint requests should be sent.

instance, Pamatmat (1983) measured heat production rates during air exposure in specimens of *Geukensia demissa*. Animals tended to show regular cycles of high rates of heat production (valves presumably open, metabolism principally aerobic) followed by low rates of heat production (valves presumably closed, metabolism principally anaerobic). The period of the cycle varied from individual to individual (Pamatmat, 1983). The relative contributions of anaerobic energy yielding processes to the total metabolic rate may depend on the previous acclimation history of the individual. Shick and Widdows (1981) showed, using calorimetric techniques, that subtidally acclimated specimens of *M. edulis* relied exclusively on anaerobic metabolism during air exposure. Experiments with subtidally acclimated specimens of the cockle *Cardium edule* indicated that metabolism was exclusively aerobic during air exposure. In contrast, anaerobic heat production accounted for 62% of the total heat production in intertidally acclimated specimens of *M. edulis* exposed to air (Shick and Widdows, 1981).

Anaerobic metabolism has been studied extensively in bivalve molluscs (de Zwaan, 1977). There are a variety of metabolic options available for energy production during air exposure and anoxia. Lactate production is not common, although it is a major end product in at least one bivalve mollusc (Gäde, 1980). Typically, there is a simultaneous fermentation of glycogen and aspartate yielding succinate and alanine as end products (Collicutt and Hochachka, 1977; Ebberink *et al.*, 1979). Aspartate provides the carbon skeleton for succinate and the amino group used in alanine formation. Assuming that once aspartate levels become depleted, further alanine formation is minimal and succinate carbon is then derived exclusively from glycogen. This metabolic transition may involve a shift at the phosphoenolpyruvate (PEP) branchpoint involving increased activity of the enzyme phosphoenolpyruvate carboxykinase (PEPCK) (Ebberink *et al.*, 1979). Recently, de Zwaan *et al.* (1982) questioned the role of PEPCK in the energy metabolism of the posterior adductor muscle of *M. edulis*. During extended anoxia, the volatile fatty acid, propionate, has also been shown to be a major end product in specimens of *M. edulis* (Kluytmans *et al.*, 1975, 1978).

In addition to lactate, alanine, succinate, and propionate, an entirely new class of end products has recently been shown to accumulate during anoxia. Fields (1976) discovered a cytoplasmic dehydrogenase in oyster tissues which utilized pyruvate and an amino acid as substrates. The resulting products of the reaction were the iminodicarboxylic acids, alanopine (alanine as substrate), and strombine (glycine as substrate). Recently, it has been shown that strombine accumulates during air exposure in the posterior adductor muscles of specimens of *M. edulis* (Zurberg *et al.*, 1982; de Zwaan *et al.*, 1983).

Regardless of the qualitative nature of the end products produced during air exposure, bivalve molluscs display great similarities with respect to the overall magnitude of energy metabolism. A Pasteur effect is typically absent (de Zwaan, 1977). Thus, there is no increase in glycolytic flux during anoxia and consequentially, rates of ATP production fall. De Zwaan and Wijsman (1976) and Ebberink *et al.* (1979) showed that the energy expenditure of the adductor muscle of *M. edulis* decreases on the order of five fold during air exposure. The diminished energy demand tends to maintain energy balance despite low rates of glycolytic flux.

Investigation into the metabolic events immediately following oxygen stress has lagged far behind studies dealing with metabolism during air exposure. A variety of metabolic events occur during recovery including recharging of high energy phosphates, oxidation of end products, and resynthesis of anaerobic substrates. Typically, levels of succinate, lactate, and alanine fall while aspartate levels rise (Gäde and Meinardus,

1981; Zurburg *et al.*, 1982). The resynthesis of ATP and the phosphagen, arginine phosphate, also occurs during recovery. Most molluscs show a characteristic elevation of oxygen consumption or oxygen debt following hypoxia reflecting, to some extent, the enhanced energy demand of recovery (de Zwaan, 1977; de Vooy and de Zwaan, 1978). In addition, there may be enhanced glycolytic flux, as strombine accumulates during recovery in at least one species (Zurburg *et al.*, 1982; de Zwaan *et al.*, 1983).

In the present study, we compare metabolic responses to air exposure and recovery in two species of bivalve molluscs adapted to distinctly different micro-habitats. The ribbed mussel *Geukensia demissa granosissima* is a high intertidal species which is regularly exposed to air for hours or even days at a time. The mussel *Modiolus squamosus* is a subtidal species. Populations of *M. squamosus* are exposed to air only during exceptionally low tides. The present study shows dramatic differences in terms of the metabolic responses of the two species to experimental air exposure. Specimens of *G. demissa granosissima* appear to rely extensively on aerial gas exchange showing only trivial accumulations of anaerobic end products. In contrast, specimens of *M. squamosus* show substantial accumulations of anaerobic end products indicating a reliance on anaerobic energy production during air exposure.

MATERIALS AND METHODS

Animals

Specimens of *Geukensia demissa granosissima* were collected in salt marshes at Yent Bayou, Florida. Specimens of *Modiolus squamosus* were collected off Alligator Point, Florida. Animals were maintained in running sea water (24–28°C, 30‰) at the Florida State University Marine Laboratory, Turkey Point. Animals were used in experiments four to seven days after collection.

Materials

Biochemicals were purchased from Sigma Chemical Company (St. Louis, Missouri) and Boehringer Mannheim (Indianapolis, Indiana). All other chemicals were reagent grade quality. Octopine dehydrogenase, alanopine dehydrogenase, and D-lactate dehydrogenase were purified by affinity chromatography from the adductor muscle of the scallop *Argopecten irradians concentricus*, the adductor muscle of the oyster *Crasostrea virginica*, and muscle of the horseshoe crab *Limulus polyphemus*. These enzymes were used to assay for octopine, alanopine/strombine, and D-lactate, respectively. Succinyl Co A synthase, used in succinate assays, was a gift of Dr. William Bridger, Department of Biochemistry, University of Alberta, Edmonton, Alberta, Canada.

Profile of adductor muscle enzyme activities

Activities of key glycolytic enzymes and citrate synthase were assayed in crude, cell-free extracts of the posterior adductor muscle of *G. demissa granosissima* and the phasic and tonic portions of the posterior adductor muscles of *M. squamosus*. The following enzymes were assayed: phosphorylase (Plase), hexokinase (HK), phosphofructokinase (PFK), lactate dehydrogenase (LDH), alanopine dehydrogenase (ADH), octopine dehydrogenase (ODH), glyceraldehyde-3-phosphate dehydrogenase (G-3PDH), and citrate synthase (CS). Tissue was homogenized in nine volumes (w:v) of extraction medium using a Brinkman Polytron tissue grinder and centrifuged at

10,000 \times g for 20 min. The following extraction media were used: 50 mM triethanolamine containing 1 mM EDTA, 1 mM $MgCl_2$, and 30 mM 2-mercaptoethanol at pH 7.4 for LDH, ODH, ADH, PK, PEPCK, and HK; 70 mM Tris/HCl containing 1 mM EDTA and 5 mM $MgSO_4$ at pH 8.2 for PFK; 100 mM triethanolamine containing 7 mM 2-mercaptoethanol at pH 7.0 for Plase; and 25 mM Tris/HCl containing 1 mM EDTA at pH 7.5 for CS. Enzymes were assayed by standard procedures—Plase and G-3-PDH (de Zwaan *et al.*, 1980), PFK, HK, and PEPCK (Zammit and Newsholme, 1976), PK, LDH, ODH, and ADH (Ellington, 1981), and CS (Sugden and Newsholme, 1975). All assays were conducted in a Gilford 252-1 spectrophotometer at 25°C. Assays were initiated by the addition of substrate.

Metabolic responses to air exposure and recovery

Specimens of *G. demissa granosissima* and *M. squamosus* were collected and maintained in running sea water for four days prior to experimentation. At zero time, all animals were removed from the sea table and placed in a humidified (100%), temperature controlled (27°C) chamber. A total of 130 specimens of *G. demissa granosissima* and 144 specimens of *M. squamosus* were used in these experiments. A zero time group of animals (n = 10 for *G. demissa granosissima*, n = 12 for *M. squamosus*) was randomly selected, and the posterior adductor muscles were excised and frozen in liquid nitrogen. Phasic and tonic portions of the adductor muscle in *M. squamosus* were frozen separately. At various time intervals during air exposure (0.5, 1, 2, 4, 7, and 12 h for *G. demissa granosissima*; 0.5, 1, 4, 7, and 12 h for *M. squamosus*) subsets of either 10 animals (*G. demissa granosissima*) or 12 animals (*M. squamosus*) were removed and posterior adductor muscles frozen. At the end of 12 h of air exposure, the remaining animals were returned to the sea table and subsets of animals were removed at various time intervals (2, 4, 6, 8, 10, and 12 h) and treated as above. All tissues were stored at -80°C. Tissues were processed and analyzed within 36 h of tissue sampling.

Biochemical analyses of tissue samples

Tissue samples were fragmented using a mortar and pestle chilled in liquid nitrogen. For each analysis, approximately 1 g of tissue representing the adductor muscles of several animals was weighed and homogenized in 5 volumes (w:v) 6% perchloric acid (4°C). The homogenates were centrifuged at 10,000 \times g for 20 min and the supernatants neutralized with 5 M KOH/0.1 M $KHCO_3$. The neutralized extract was centrifuged and the supernatant stored at -80°C.

Arginine phosphate and ATP levels in the extracts were assayed within 3–5 h of extract preparation. Arginine phosphate and ATP were assayed by the spectrophotometric assays of Lowry and Passonneau (1972) except that lobster arginine phosphokinase was substituted for creatine phosphokinase. ADP and AMP were assayed according to Lowry and Passonneau (1972). Succinate was determined by the method of Williamson (1974). Octopine, alanopine/strombine and D-lactate were assayed in a reaction system consisting of 100 mM 2-amino-2-methyl-1-propanol (pH 9.2) containing 50 mM hydrazine, 4 mM NAD, and 10 mM EDTA. Assays were initiated by the addition of 5 enzyme units of the appropriate enzyme. Alanine, glycine, aspartate, and glutamate were determined using a Beckman model 120-1 automatic amino acid analyzer. Propionate levels were determined by HPLC. One (1) ml of the neutralized, perchloric acid extract was applied to a silica Sep-Pak (Waters, Inc.) pretreated with 1.0 ml ultra pure water followed by a 4.0 ml ultra pure hexane wash. The sample was then washed with 2.0 ml of ultra pure hexane and the polar fraction

eluted with 1.0 ml of ultra pure water. Treated extracts were analyzed on a Waters HPLC system using a BIO-RAD (Bio-Rad Laboratories, Richmond, California) ODS-5 reversed phase column (250 mm \times 4 mm, ID), isocratic elution (0.2 M KH_2PO_4 , pH 2.4), and UV detection (200 nm).

All metabolite data were analyzed for significance by one way ANOVA and a least significant difference test (Freyer, 1966).

RESULTS

Profile of the activities of key glycolytic enzymes and citrate synthase

Activities of key glycolytic enzymes and citrate synthase in the adductor muscle of *G. demissa granosissima* and the phasic and tonic portions of the adductor muscle of *M. squamosus* are listed in Table I. In general, enzyme activities were similar when comparing the two species. However, ADH activity in both posterior adductor muscles of *M. squamosus* was one order of magnitude greater than activity in *G. demissa granosissima*. In addition, ODH was absent in the adductor muscles of *M. squamosus*. The adductor muscles of both species had relatively low phosphorylase and hexokinase

TABLE I

Activities of key glycolytic enzymes and citrate synthase in the posterior adductor muscles of G. demissa granosissima and M. squamosus

Enzyme		Enzyme activity ¹	
		<i>M. squamosus</i>	<i>G. demissa</i>
Lactate dehydrogenase	MP	1.47 \pm 0.37	3.07 \pm 0.38
	MT	0.84 \pm 0.22	
Octopine dehydrogenase	MP	n/a	4.66 \pm 1.24
	MT	n/a	
Alanopine dehydrogenase	MP	13.56 \pm 2.04	1.02 \pm 0.04
	MT	12.06 \pm 2.76	
Pyruvate kinase	MP	2.49 \pm 0.16	1.07 \pm 0.01
	MT	2.26 \pm 0.11	
Phosphoenolpyruvate carboxykinase	MP	3.11 \pm 0.31	4.41 \pm 0.03
	MT	2.53 \pm 0.15	
Hexokinase	MP	0.02 \pm 0.00	0.30 \pm 0.03
	MT	0.02 \pm 0.01	
Citrate synthase	MP	1.16 \pm 0.08	2.34 \pm 0.20
	MT	0.96 \pm 0.09	
Glyceraldehyde-3-phosphate dehydrogenase	MP	42.75 \pm 5.41	41.05 \pm 3.42
	MT	26.15 \pm 3.12	
Phosphorylase	MP	0.87 \pm 0.02	1.24 \pm 0.18
	MT	1.38 \pm 0.15	
Phosphofruktokinase	MP	4.27 \pm 0.37	4.56 \pm 0.75
	MT	3.32 \pm 0.14	

¹ Enzyme activities are expressed as $\mu\text{moles}/(\text{min} \cdot \text{g wet wt})$ at 25°C.

Each value represents a mean \pm 1 S.D. (n = 4). MP = phasic adductor, Mt = tonic adductor, N/a = no activity.

activities implying reduced capacities for glycogen and glucose utilization. Enzyme activities in the phasic and tonic portions of the posterior adductor muscle of *M. squamosus* were virtually identical (Table I).

Metabolic responses to air exposure and recovery

Exposure to air for 12 h had no significant effect on the adenylate energy charge (Fig. 1) and the levels of arginine phosphate and ATP (Fig. 2) in the posterior adductor muscle of *G. demissa granosissima*. In contrast, adenylate energy charge and arginine

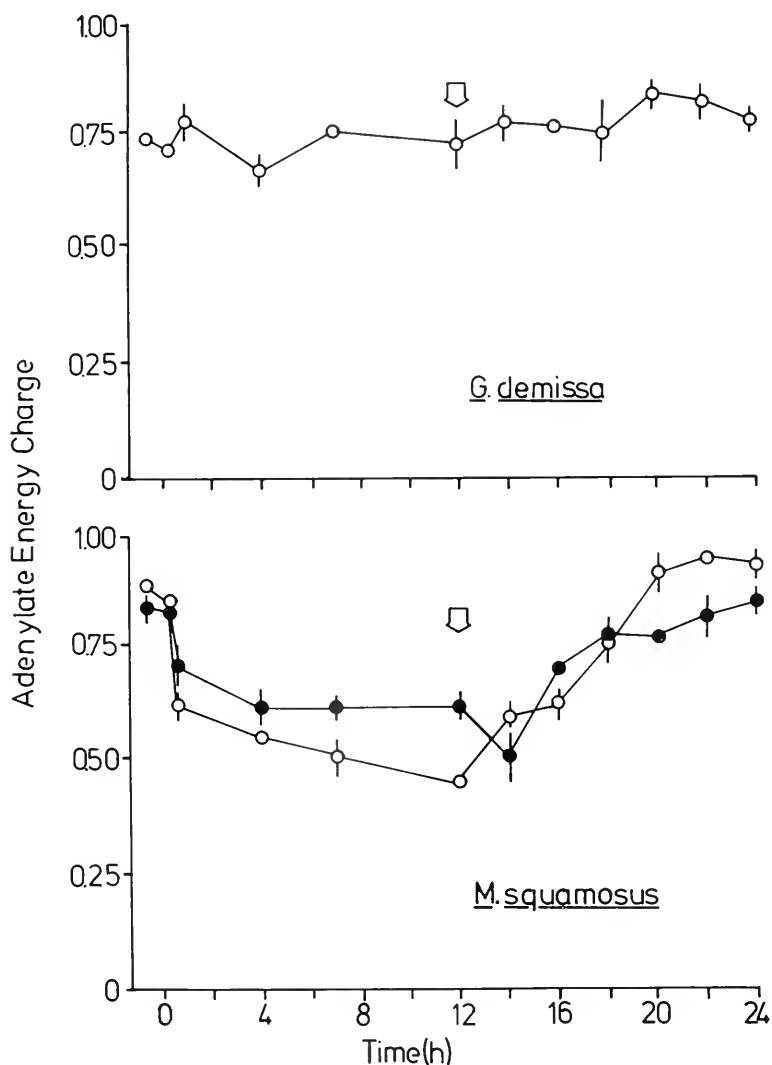

FIGURE 1. Alterations in the adenylate energy charge ($ATP + \frac{1}{2} ADP \div ATP + ADP + AMP$) in the posterior adductor muscles of *G. demissa granosissima* and *M. squamosus* during air exposure and recovery. Data for *M. squamosus* are given in terms of the phasic (solid circles) and tonic (open circles) adductor muscles. The initial time point is depicted slightly to the left of zero. The arrow indicates the onset of recovery. Each value is a mean \pm 1 S.D. (n = 4).

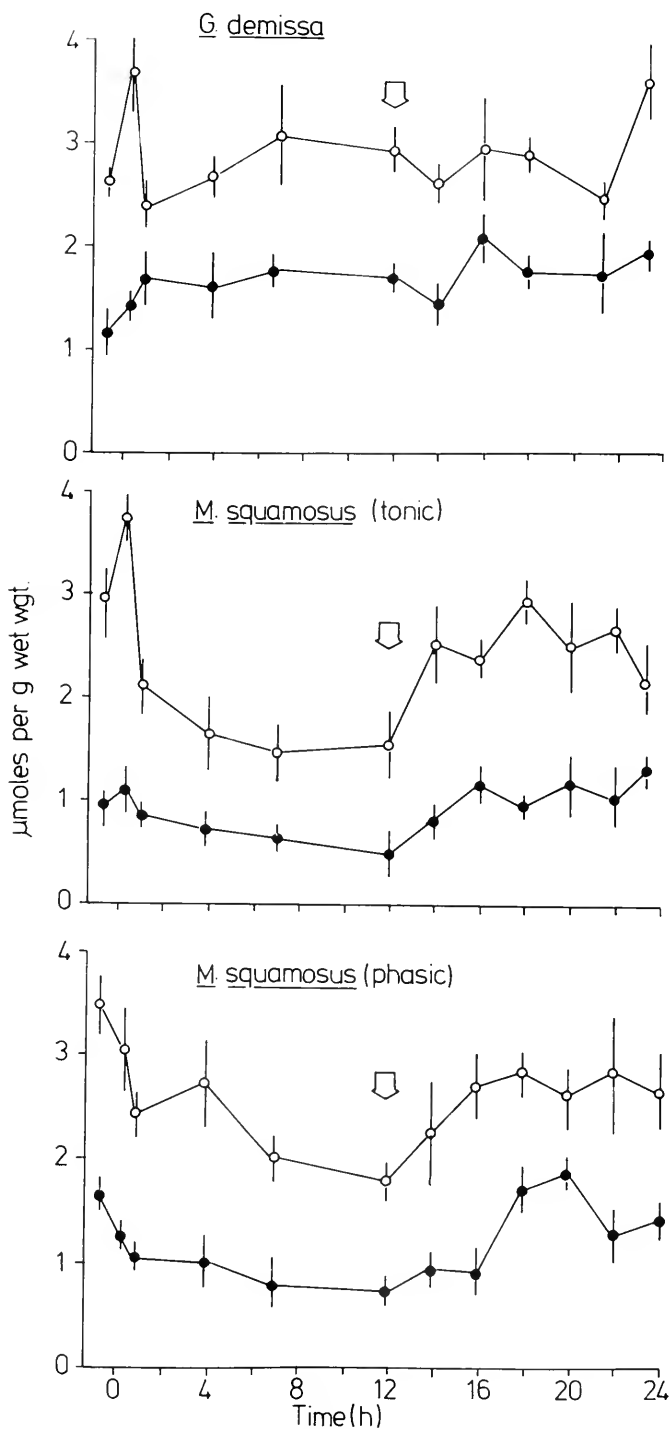

FIGURE 2. Effect of air exposure and recovery on the levels of arginine phosphate (open circles) and ATP (solid circles) in the posterior adductor muscles of *G. demissa granosissima* and *M. squamosus*. Each point is a mean \pm 1 S.D. (n = 4).

phosphate and ATP levels fell significantly in both portions of the adductor muscle of *M. squamosus* (Figs. 1, 2). The greatest changes in these parameters occurred during the first two hours of air exposure. Changes in the high energy phosphates were most pronounced in the phasic adductor muscle of *M. squamosus*. During recovery after air exposure, there continued to be no changes in high energy phosphates in specimens of *G. demissa granosissima* (Figs. 1, 2). During recovery, the adenylates returned to initial levels in the posterior adductor muscle of *M. squamosus* (Figs. 1,

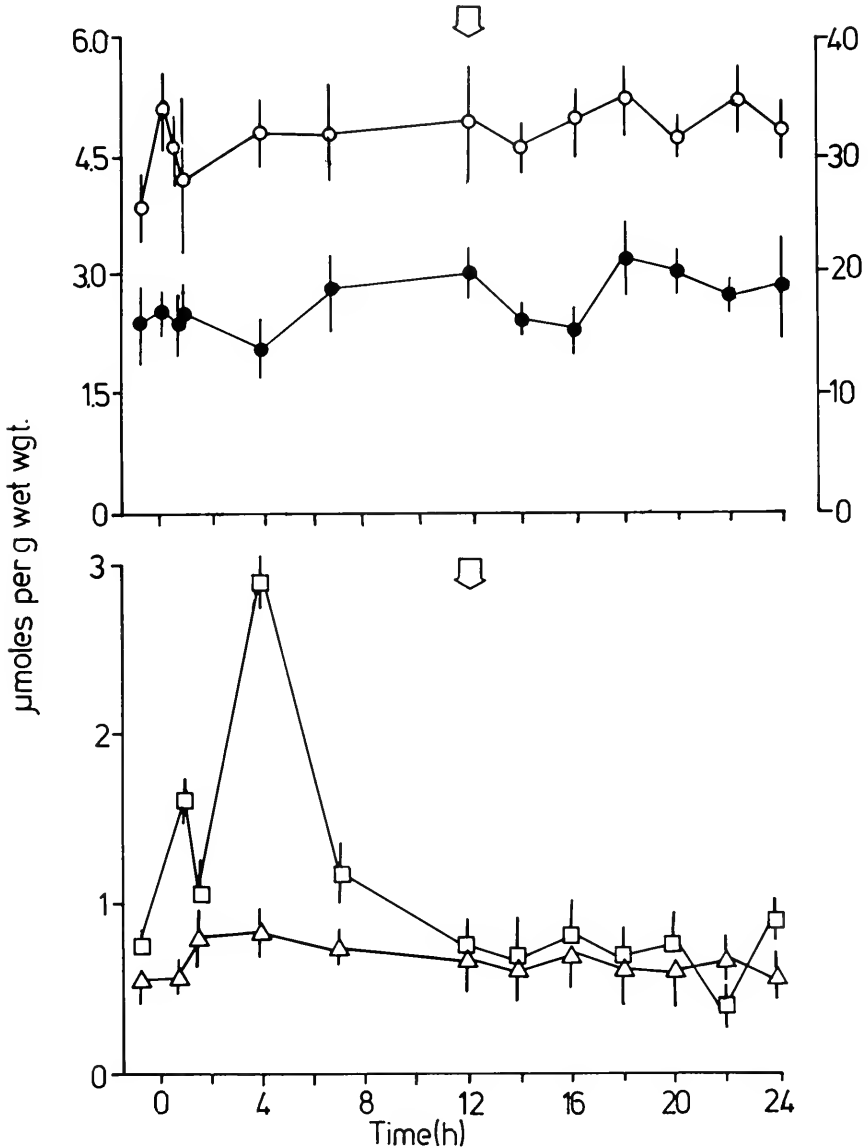

FIGURE 3. Effect of air exposure and recovery on the levels of alanine (open circles), aspartate (closed circles), succinate (squares), and D-lactate (triangles) in the posterior adductor muscle of *G. demissa granosissima*. Each value is a mean \pm 1 S.D. ($n = 4$).

2). Arginine phosphate levels rose slowly during recovery but did not reach initial levels after 12 h of recovery (Fig. 2).

There were no significant changes in the levels of alanine, aspartate, and D-lactate

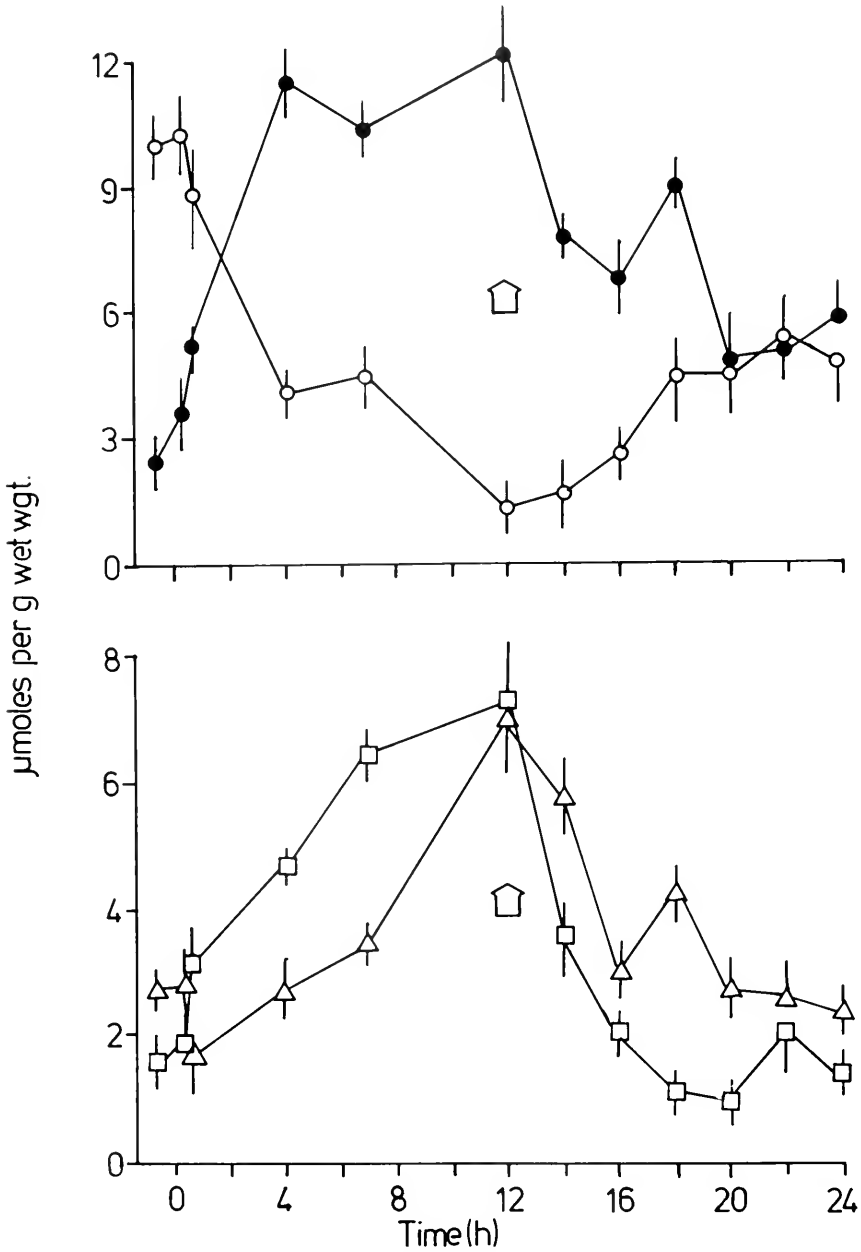

FIGURE 4. Effect of air exposure and recovery on the levels of alanine, aspartate, succinate, and D-lactate in the phasic adductor muscle of *M. squamosus*. Symbols are the same as in Figure 3. Each value is a mean \pm 1 S.D. (n = 4).

during air exposure and recovery in the posterior adductor muscle of *G. demissa granosissima* (Fig. 3). There was a transient accumulation of succinate during the early period of air exposure, but succinate levels returned to the initial levels by the end of air exposure.

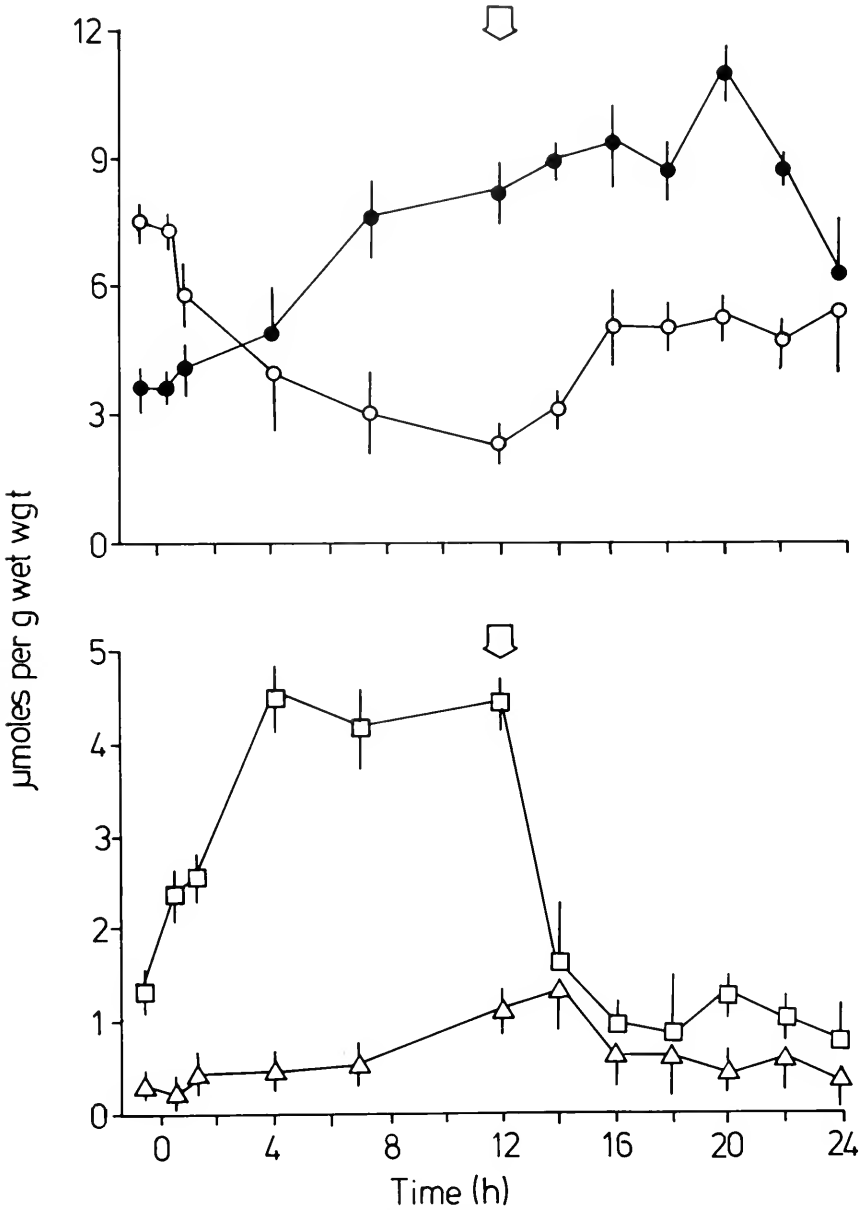
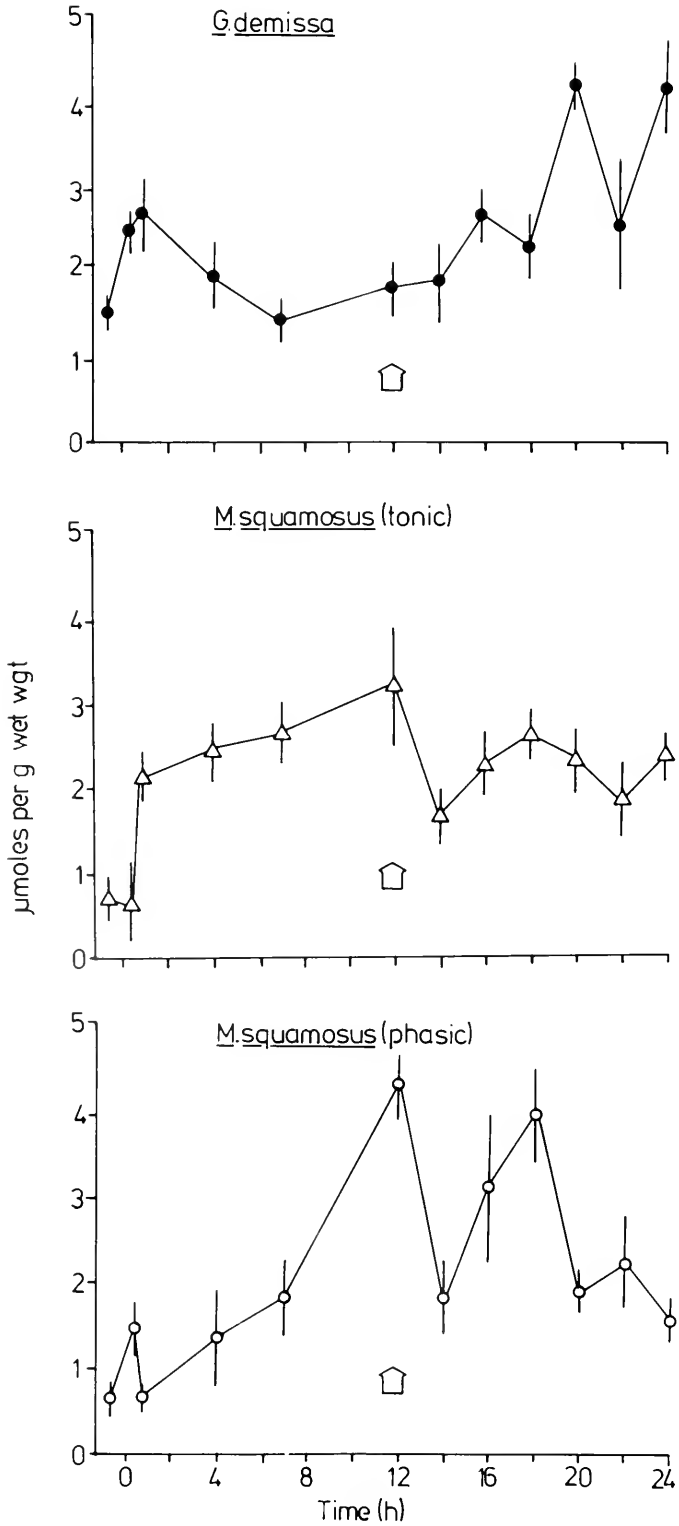

FIGURE 5. Effect of air exposure and recovery on the levels of alanine, aspartate, succinate, and D-lactate in the tonic adductor muscle of *M. squamosus*. Symbols are the same as in Figure 3. Each value is a mean \pm 1 S.D. (n = 4).



There were pronounced changes in metabolite levels in the posterior adductor muscles of *M. squamosus*. In the phasic adductor muscle, aspartate levels declined throughout air exposure and there was nearly a stoichiometric increase in alanine levels (Fig. 4). There was a linear accumulation of succinate and D-lactate in the phasic adductor muscle (Fig. 4). A similar pattern of aspartate depletion and succinate and alanine accumulation was observed in the tonic adductor muscle of *M. squamosus* (Fig. 5). In contrast to the phasic adductor, the accumulation of D-lactate was low in the tonic adductor muscle during air exposure. The general patterns of recovery were similar in the phasic and tonic adductor muscle of *M. squamosus*. Succinate was rapidly cleared with initial levels being attained after 2–4 h of recovery (Figs. 4, 5). Aspartate levels increased during recovery and there was a gradual decline in alanine. After 12 h of recovery, alanine and aspartate levels still differed considerably from pre-air exposure levels. In the case of the phasic adductor muscle of *M. squamosus*, D-lactate levels slowly declined to initial levels during recovery (Fig. 4).

Alanopine/strombine accumulated during both air exposure and recovery in the adductor muscles of *G. demissa granosissima* and *M. squamosus* (Fig. 6). In the posterior adductor muscle of *G. demissa granosissima* there was an initial increase in alanopine/strombine during air exposure followed by a gradual decline. Alanopine/strombine levels then increased two-fold during recovery. In both the phasic and tonic adductor muscles of *M. squamosus*, alanopine/strombine accumulated throughout air exposure (Fig. 6). At the onset of recovery, there was a transient decline in alanopine/strombine followed by a period of further increase during the midpoint of the recovery period.

No significant changes in the levels of glycine and glutamate were observed in the adductor muscles of *G. demissa granosissima* and *M. squamosus*. In addition, there was no accumulation of octopine in either species. Propionate levels remained low during both air exposure and recovery.

DISCUSSION

The results of this study show that there can be considerable intergeneric differences in terms of metabolic responses to air exposure in bivalve molluscs. The high intertidal mussel *Geukensia demissa granosissima* characteristically undergoes air gaping under these conditions. In contrast, the subtidal mussel *Modiolus squamosus* typically maintains tightly sealed valves during air exposure and displays air gaping only after extended periods of exposure. The consequences of these different responses to air exposure are strongly reflected in the patterns of energy metabolism in the tissues of these two species.

Air exposure for 12 h produced minimal metabolic stress on specimens of *G. demissa granosissima* as is evidenced by the lack of changes in high energy phosphates in the posterior adductor muscle. Although succinate and alanopine/strombine did accumulate during air exposure, the magnitude of the accumulation is small compared to that seen in other bivalve molluscs such as *Mytilus edulis* (de Zwaan *et al.*, 1983) and *M. squamosus* (this study). Thus, it appears that the anaerobic contribution to energy metabolism during the first 12 h of air exposure is minimal. Alanine and succinate accumulate to high levels in *G. demissa* after extended periods (>36 h) of incubation in oxygen free sea water (Ho and Zubkoff, 1982). Thus, this species has the capability of producing these end products under sufficiently stressful conditions.

FIGURE 6. Effect of air exposure and recovery on the levels of alanopine/strombine in the posterior adductor muscles of *G. demissa granosissima* and *M. squamosus*. Each value is a mean \pm 1 S.D. (n = 4).

Specimens of *G. demissa* appear to be able to maintain significant rates of oxygen uptake during air exposure (Booth and Mangum, 1978). However, aerial oxygen consumption in this species is substantially less than aquatic oxygen consumption. Since rates of aerobic energy production are reduced during air exposure and there appears to be no large-scale utilization of anaerobic energy-producing pathways, the overall rates of ATP production in *G. demissa granosissima* posterior adductor muscle must fall during air exposure. Since the high energy phosphate levels are constant during air exposure, it is evident that overall rates of energy demand in the adductor muscle fall under these conditions. Thus, the apparent metabolic responses of the mussel *G. demissa granosissima* involve aerial gas exchange coupled with an overall reduction in the rates of ATP utilization in the posterior adductor muscle.

Air exposure produced dramatic alterations in the high energy phosphate levels in the phasic and tonic adductor muscles of *M. squamosus*. These alterations in high energy phosphates were similar in magnitude to what has been observed during anoxia in the tissues of a number of molluscs including the posterior adductor muscle of *M. edulis* (Ebberink *et al.*, 1979), the foot muscle of the cockle *Cardium tuberculatum* (Gäde, 1980), and the ventricle of the whelk *Busycon contrarium* (Ellington, 1981).

The simultaneous depletion of aspartate, and accumulation of succinate and alanine in both adductor muscles, indicates that glycogen and aspartate were fermented in *M. squamosus* during air exposure. This phenomenon has been consistently observed in a variety of molluscs (Collicutt and Hochachka, 1977; Ebberink *et al.*, 1979; Ellington, 1981). Collicutt and Hochachka (1977) predicted that both succinate and alanine accumulation should occur in a 1:1 ratio with aspartate depletion. However, all previous studies have shown that the amount of alanine accumulated was substantially greater than succinate. In the present study, the alanine:succinate accumulation ratio during the first 4 h of air exposure was 2.1 in the phasic adductor muscle of *M. squamosus*. However, in the tonic adductor muscle, the accumulation ratio was less than one during the first 4 h of air exposure and approached unity only after 12 h of exposure. Recently, de Zwaan *et al.* (1983) have explained accumulation ratios greater than one by suggesting that the mitochondrial malic enzyme is involved in shunting some aspartate-derived carbon in the direction of alanine synthesis. The rather different alanine:succinate accumulation ratios between the phasic and tonic adductor muscles of *M. squamosus* reflect variations in the metabolic disposition of malate derived from aspartate. There is also the possibility that some of the succinate production is derived from glycogen by the PEPCK route.

The accumulation of D-lactate in the phasic muscle and lack of accumulation in the tonic muscle is rather surprising in that the activities of LDH are virtually identical in the tissues. However, it must be noted that the decreases in high energy phosphates were much more pronounced in the phasic adductor muscle of *M. squamosus*. In addition, absolute levels of accumulation of alanine and succinate were much higher. Thus, rates of energy demand in the phasic muscle may be greater than the tonic muscle under these conditions. The lactate accumulation reflects increased glycolytic flux in this tissue. The simultaneous accumulation of lactate and succinate has also been observed in the foot muscle of the cockle *Cardium edule* (Gäde and Meinardus, 1981).

Recovery in the posterior adductor muscles of *M. squamosus* was characterized by the rapid clearance of succinate. Lactate was also cleared rapidly in the phasic muscle. Levels of ATP were rapidly restored. Arginine phosphate and aspartate slowly increased during the 12 h of recovery. Similar phenomena have been observed during recovery in the tissues of *M. edulis* (de Zwaan *et al.*, 1983) and *C. edule* (Gäde and Meinardus, 1981). In the present study, the time courses of succinate removal and

aspartate resynthesis were distinctly different indicating that there was probably no *direct* metabolic link during recovery between the two processes.

In specimens of both *M. squamosus* and *G. demissa granosissima* there was a transient production of alanopine/strombine during recovery from air exposure. Similarly, the bulk of strombine production in *M. edulis* occurred during recovery (Zurburg *et al.*, 1982; de Zwaan *et al.*, 1983). De Zwaan *et al.* (1983) found that the PO₂ levels in the hemolymph of the adductor muscle rapidly approached normoxic values during recovery. Thus strombine, a putative end product of anaerobic metabolism, was produced under essentially aerobic conditions. De Zwaan *et al.* (1983) rationalized this paradox by suggesting that energy demands exceed the limited capacity of aerobic ATP yielding processes in the tissue. Thus, there is an increase in glycolytic flux to meet the energy demands leading to strombine formation. The production of alanopine/strombine in the posterior adductor of *M. squamosus* during recovery can be easily interpreted by this argument. The production of alanopine/strombine in this species is coincident with the period of recharging of the adenylate pool. The post air exposure production of alanopine/strombine in *G. demissa granosissima* is more difficult to explain since there were no changes in high energy phosphates. However, increased energy demands might also result from other ATP requiring processes such as the possibility of increased contractile activity of the adductor muscle during recovery. It would be of great interest to measure valve movements during recovery in *G. demissa granosissima*.

The overall results of this study show that energy metabolism during 12 h of air exposure in the posterior adductor muscle of *G. demissa granosissima* is largely aerobic. Booth and Mangum (1978) suggested that the metabolism of the adductor muscle of *G. demissa* is largely anaerobic even in normoxic sea water. However, our results show that the role of anaerobic energy metabolism is minimal even under conditions of air exposure. This suggests that aerial gas exchange is sufficient to maintain adequate rates of ATP production. Furthermore, apparent reductions in energy demand tend to maintain energy balance in this tissue. In contrast, there are substantial decreases in high energy phosphates and an extensive reliance on anaerobic energy yielding processes during air exposure in the phasic and tonic adductor muscles of *M. squamosus*. These metabolic responses are probably due to a reduced capacity for aerial gas exchange, and, perhaps, smaller reductions in energy demands during air exposure. The patterns of aspartate and glycogen fermentation are similar to what has been observed in other molluscs. The differences in metabolic responses of *G. demissa granosissima* and *M. squamosus* to air exposure reflect differences in adaptation in micro-habitats of chronic *versus* infrequent air exposure.

ACKNOWLEDGMENTS

This work was partially supported by NSF Grant #PCM-8202370 to W.R.E.

LITERATURE CITED

- BAYNE, B. L., C. J. BAYNE, T. C. CAREFOOT, AND R. J. THOMPSON. 1976. The physiological ecology of *Mytilus californianus* Conrad. 2. Adaptations to low oxygen tension and air exposure. *Oecologia* 22: 229-250.
- BOOTH, C. E., AND C. P. MANGUM. 1978. Oxygen uptake and transport in the lamellibranch mollusk *Modiolus demissus*. *Physiol. Zool.* 51: 17-32.
- BOYDEN, C. R. 1972. Aerial respiration in the cockle *Cerastoderma edule* in relation to temperature. *Comp. Biochem. Physiol.* 43A: 697-712.
- COLEMAN, N. 1973. The oxygen consumption of *Mytilus edulis* in air. *Comp. Biochem. Physiol.* 45A: 393-400.

- COLEMAN, N. 1976. The aerial respiration of *Modiolus modiolus*. *Comp. Biochem. Physiol.* **54A**: 401-406.
- COLLICUTT, J. M., AND P. W. HOCHACHKA. 1977. The anaerobic oyster heart: coupling of glucose and aspartate fermentation. *J. Comp. Physiol.* **115**: 147-157.
- EBBERINK, R. H. M., W. ZURBURG, AND D. I. ZANDEE. 1979. The energy demand of the posterior adductor muscle of *Mytilus edulis* in catch during air exposure. *Mar. Biol. Lett.* **1**: 23-31.
- ELLINGTON, W. R. 1981. Energy metabolism during hypoxia in the isolated, perfused ventricle of the whelk *Busycyon contrarium* Conrad. *J. Comp. Physiol.* **142**: 457-464.
- FIELDS, J. H. A. 1976. A dehydrogenase requiring alanine and pyruvate as substrates from oyster adductor muscle. *Fed. Proc.* **35**: 1687.
- FREYER, H. C. 1966. *Concepts and Methods of Experimental Statistics*. Allyn and Bacon, Boston, 602 pp.
- GÄDE, G. 1980. The energy metabolism of the foot muscle of the jumping cockle, *Cardium tuberculatum*: sustained anoxia versus muscular activity. *J. Comp. Physiol.* **137**: 177-182.
- GÄDE, G., AND G. MEINARDUS. 1981. Anaerobic metabolism in the common cockle *Cardium edule* V. Changes in the levels of metabolites in the foot during aerobic recovery after anoxia. *Mar. Biol.* **65**: 113-116.
- HO, M., AND P. L. ZUBKOFF. 1982. Anaerobic metabolism of the ribbed mussel *Geukensia demissa*. *Comp. Biochem. Physiol.* **73B**: 931-936.
- KLUYTMANS, J. H., P. R. VEENHOF, AND A. DE ZWAAN. 1975. Anaerobic production of fatty acids in the sea mussel *Mytilus edulis* L. *J. Comp. Physiol.* **104**: 71-78.
- KLUYTMANS, J. H., M. VANGRAFT, J. JANUS, AND H. PIETERS. 1978. Production and excretion of volatile fatty acids in the sea mussel *Mytilus edulis*. *J. Comp. Physiol.* **123**: 163-167.
- LENT, C. N. 1968. Air gaping by the ribbed mussel, *Modiolus demissus* (Dillwyn): Effects and adaptive significance. *Biol. Bull.* **134**: 60-73.
- LOWRY, O. H., AND J. V. PASSONNEAU. 1972. *A Flexible System of Enzymatic Analysis*. Academic Press, New York, 291 pp.
- PAMATMAT, M. M. 1983. Measuring aerobic and anaerobic metabolism of benthic infauna under natural conditions. *J. Exp. Zool.* (in press).
- SHICK, J. M., AND J. WIDDOWS. 1981. Direct and indirect calorimetric measurement of metabolic rate in bivalve molluscs during air exposure. *Am. Zool.* **21**: 985.
- SUGDEN, P. H., AND E. A. NEWSHOLME. 1975. Activities of citrate synthase, NAD linked and NADP linked isocitrate dehydrogenase, glutamate dehydrogenase, aspartate aminotransferase and alanine aminotransferase in nervous tissue from vertebrates and invertebrates. *Biochem. J.* **150**: 105-111.
- VOOYS, G. G. N. DE, AND A. DE ZWAAN. 1978. The rate of oxygen consumption and ammonia excretion by *Mytilus edulis* after various periods of exposure to air. *Comp. Biochem. Physiol.* **60A**: 343-347.
- WIDDOWS, J., B. L. BAYNE, D. R. LIVINGSTONE, R. E. NEWELL, AND P. DONKIN. 1979. Physiological and biochemical responses of bivalve molluscs to air. *Comp. Biochem. Physiol.* **62A**: 301-308.
- WILLIAMSON, J. R. 1974. Succinate. Pp. 1616-1621 in *Methods of Enzymatic Analysis*, Vol. 3, H. U. Bergmeyer, eds., Academic Press, New York.
- ZAMMIT, V. A., AND E. A. NEWSHOLME. 1976. The maximum activities of hexokinase, phosphorylase, phosphofructokinase, glyceral phosphate dehydrogenase, lactate dehydrogenase, octopine dehydrogenase, phosphoenolpyruvate carboxykinase, nucleoside diphosphate kinase, glutamate oxaloacetate transaminase and arginine kinase in relation to carbohydrate utilization in muscles from invertebrates. *Biochem. J.* **160**: 447-462.
- ZURBURG, W., A. M. T. DE BONT, AND A. DE ZWAAN. 1982. Recovery from exposure to air and the occurrence of strombine in different organs of the sea mussel *Mytilus edulis*. *Mol. Physiol.* **2**: 135-147.
- ZWAAN, A. DE. 1977. Anaerobic energy metabolism in bivalve molluscs. *Oceanogr. Mar. Biol. Ann. Rev.* **15**: 103-187.
- ZWAAN, A. DE, AND T. C. N. WIJSMAN. 1976. Anaerobic metabolism in bivalvia (mollusca). Characteristics of anaerobic metabolism. *Comp. Biochem. Physiol.* **54B**: 313-324.
- ZWAAN, A. DE., D. R. LIVINGSTONE, AND R. J. THOMPSON. 1980. Physiological and biochemical aspects of the valve snap and valve closure responses in the giant scallop *Placopecten magellanicus*. II. Biochemistry. *J. Comp. Physiol.* **137**: 105-114.
- ZWAAN, A. DE., A. M. T. DE BONT, AND A. VERHOEVEN. 1982. Anaerobic energy metabolism in isolated adductor muscle of the sea mussel *Mytilus edulis* L. *J. Comp. Physiol.* **149**: 137-143.
- ZWAAN, A. DE., A. M. T. DE BONT, W. ZURBURG, B. L. BAYNE, AND D. R. LIVINGSTONE. 1983. On the role of strombine formation in the energy metabolism of adductor muscle of a sessile bivalve. *J. Comp. Physiol.* **149**: 557-563.

SCANNING ELECTRON MICROSCOPY OF THE REGENERATED SHELL OF THE MARINE ARCHAEOGASTROPOD, *TEGULA*

CHARLENE REED-MILLER

Department of Geology, Florida State University, Tallahassee, FL 32306

ABSTRACT

A window was cut in the first body whorl of the marine snail, *Tegula*, to induce shell regeneration. At various intervals after the shell window was cut, the window with the regenerated material and the shell surrounding it were prepared for scanning electron microscopy. Initial crystal deposition occurred in association with an organic matrix and appeared as small, spindle-shaped crystals formed by the aggregation of needle-like subunits. The spindles were frequently aggregated into stellate clusters that coalesced to form a sheet of mineralized tissue. After about two months of regeneration, dumbbell-shaped crystal aggregates and spherulites were apparent on the surface of the regenerated shell. The regenerated shell assumed a normal structure after at least four months of regeneration.

Crystal deposition also occurred on the normal shell bordering the shell window. The crystals assumed several forms, and their orientation appeared to be determined by the microtopography of the underlying shell.

INTRODUCTION

Molluscan shell mineralization is the result of a complex and delicate association of biological, chemical, and physical processes. The result of the interaction of these factors is not always the same, even in a single animal. The degree of organic *versus* inorganic control of mineralization in the molluscan shell is an example of variability in structure determined by the interplay of these three processes. Molluscan growth surfaces show variation in organic and inorganic mechanisms of crystallization. Organic suppression of natural crystal form of the outer (distal) shell layer was much less than in the inner three shell layers of an archaeogastropod, *Cittarium pica* (Wise and Hay, 1968a, b). The same was found to be true for five species of the archaeogastropod genus, *Tegula* (Reed-Miller, 1981a). The aragonitic crystals of the nacreous shell layer are often present in tabular or diminished "c" axis form. This differs from the usual conformation of inorganically precipitated aragonite, elongate twinned prisms, and represents another example of organic control of crystal morphology.

The mineralized product formed during shell regeneration can be similar to, or quite different from the ultrastructure of the normal shell. This emphasizes again structural range of mineralized tissue (Saleuddin and Wilbur, 1969; Wilbur, 1972; Wong and Saleuddin, 1972). Earlier reports showed differences in the structure of regenerated shell compared to the normal shell of *Tegula* (Reed-Miller *et al.*, 1980; Reed-Miller, 1981a). The region of the shell involved in regeneration is considered to be another area of active calcification and mineralization. Since the area of least suppression of natural crystal form occurred at the lip, or growing edge of the shell in some archaeogastropods, including *Tegula* (see above), it was of interest to look at the crystal structure in regenerated *Tegula* shell. The initial ultrastructural changes

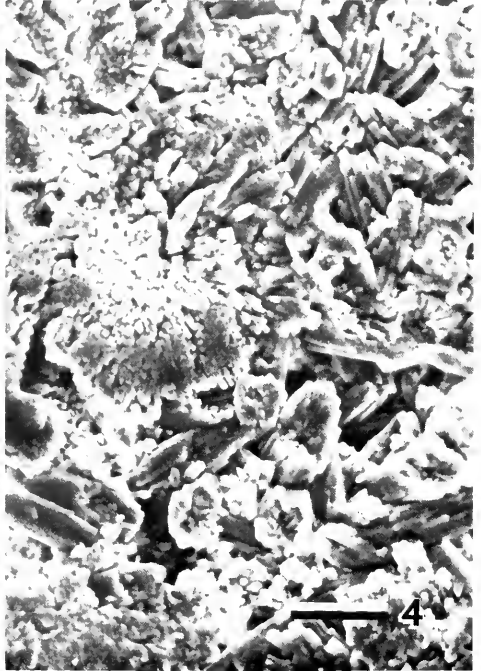
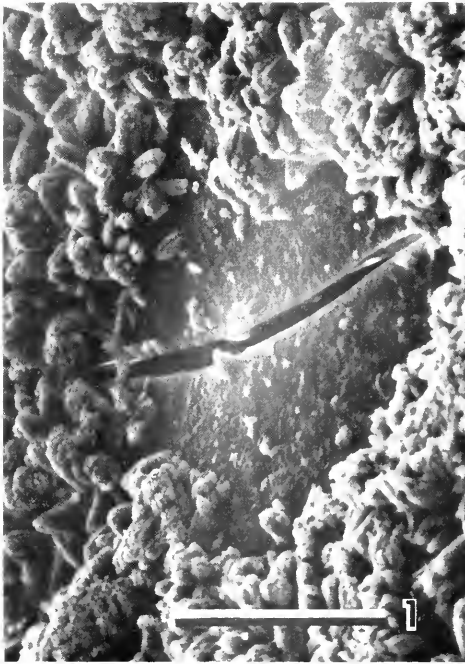

FIGURE 1. Regenerated material in the shell window, showing doubly-pointed crystallites grouped into bundles or rosettes on an organic membrane. One week of regeneration. Bar = 50 μm .

FIGURE 2. Higher magnification of spindle-shaped crystals similar to those shown in Figure 1. Note the elongated, needle-like subunits that make up the spindles. One week of regeneration. Bar = 10 μm .

FIGURE 3. Rosette-shaped assemblages of crystalline spindles. Note the underlying layer of coalesced spindles. Two weeks of regeneration. Bar = 10 μm .

FIGURE 4. A sheet of mineralized tissue formed by the coalescence of rosette-shaped crystal aggregates. Two weeks of regeneration. Bar = 20 μm .

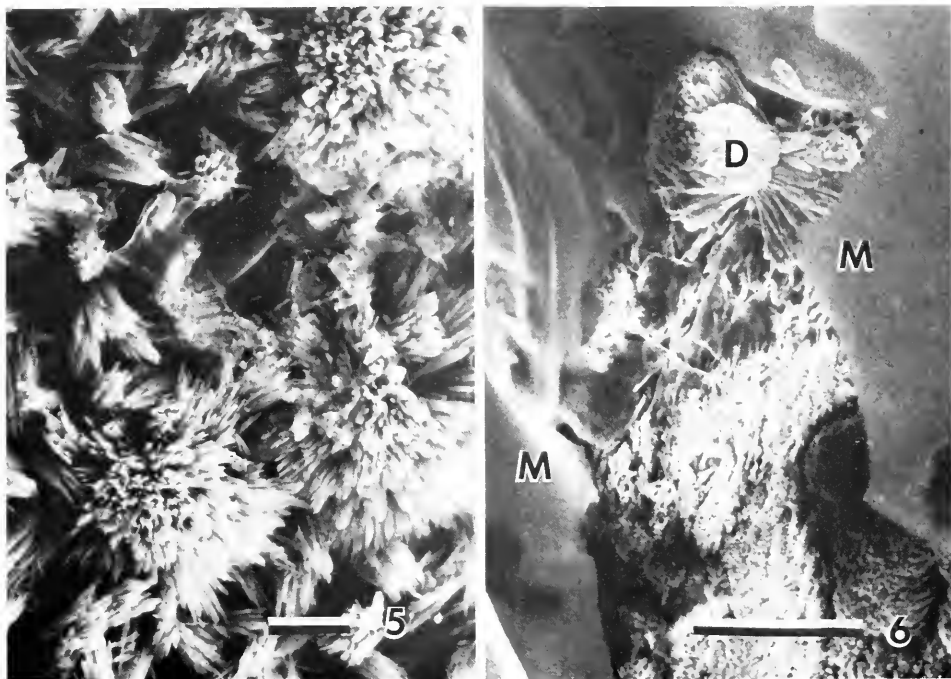

FIGURE 5. Spherulites formed of radiating clusters of needles. Three weeks of regeneration. Bar = 10 μm .

FIGURE 6. Regenerated shell with dumbbell-shaped crystal aggregates (D). Note the organic matrix (M). Two months of regeneration. Bar = 100 μm .

in the mantle, foot, and hepatopancreas during shell regeneration in this marine snail have been reported (Reed-Miller, 1983). The present study was undertaken to describe the ultrastructure of regenerated shell in *Tegula*, and to outline a possible mechanism for the crystal formation.

Preliminary accounts of this work were presented to the American Society of Zoologists (Reed-Miller, 1981b; 1982) and to the American Malacological Union.

MATERIALS AND METHODS

Tegula funebris and *Tegula eiseni* were obtained from the Pacific Biomarine Laboratories, Inc., Venice, California. They were maintained in aquaria in filtered, aerated sea water from the Gulf of Mexico (32 ppt) at 15°C. The animals were fed marine algae from a laboratory culture.

A 4 mm² section of shell was carefully removed from the first body whorl of the shell using a Dremel "Moto-tool," jeweler's saw and a triangular file. Care was taken not to injure the underlying tissue. The opening in the shell, or window, was covered with a small piece of plastic coverslip, and covered with warm dental wax, sealing the window from the external environment.

The regenerated material was removed from the animals (the procedure follows below) at intervals from 6 hours to 6 months after the shell window was cut. These were six, 12, and 18 hours; one, two, three, seven, and ten days; two weeks; and then on a weekly basis up to six months. The experiments were repeated three times with at least four experimental animals examined each time.

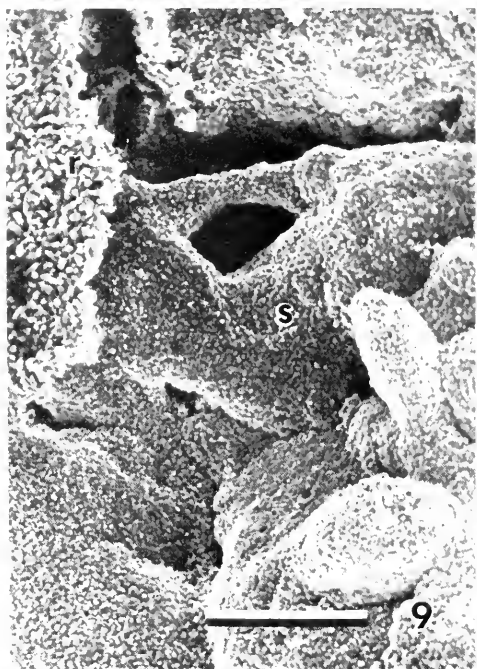
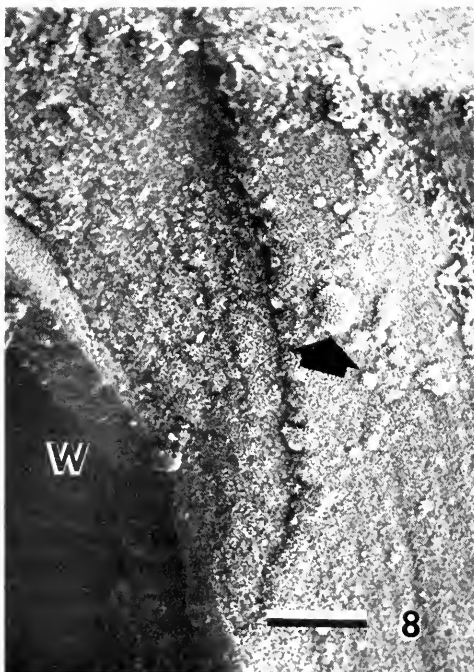

FIGURE 7. The edge of the shell window showing spindle-shaped crystals dotting the normal shell (S) and forming the regenerated shell (R). One month of regeneration. Bar = 10 μ m.

FIGURE 8. An area of the shell near the window (W) showing the clustering of spindle-shaped crystals into spherulites. Arrow points to one large spherule. The regenerated shell has been removed. Two months of regeneration. Bar = 100 μ m.

FIGURE 9. Inside of the shell at the juxtaposition of regenerated shell (R) and normal shell (S). Note movement of small crystals obscuring the normal shell. 2 1/2 months of regeneration. Bar = 100 μ m.

FIGURE 10. Edge of the shell window viewed from the inside of the shell with the regenerated material

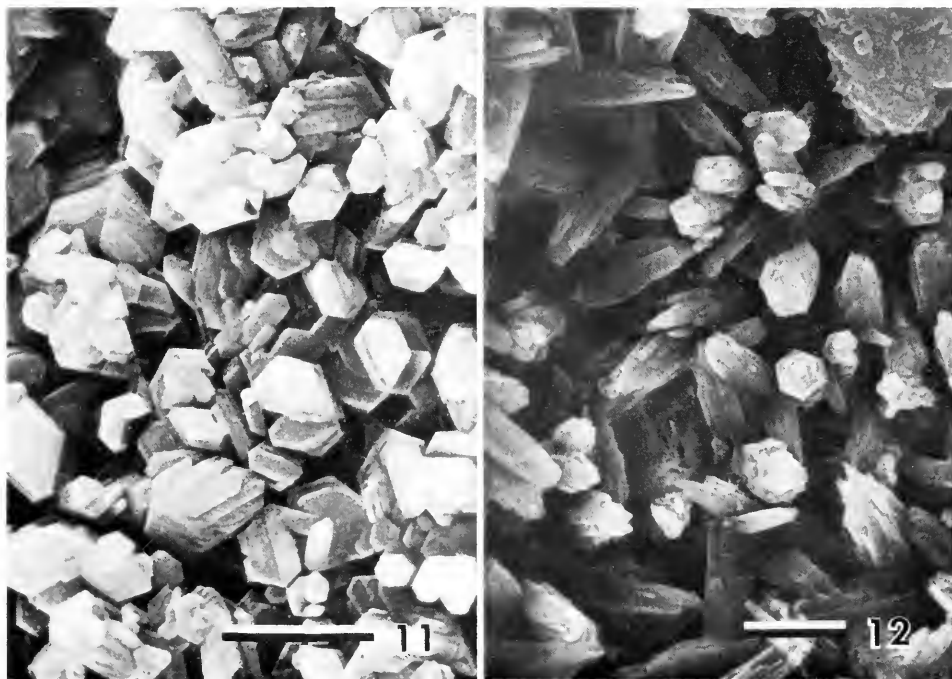

FIGURE 11. Small polygonal crystallites that were occasionally seen on the normal shell surrounding the shell window. Three months of regeneration. Bar = 4 μm .

FIGURE 12. Elongated trends of needle clusters that were seen on the normal shell bordering the window. Three months of regeneration. Bar = 5 μm .

Scanning electron microscopy

The soft parts were removed from the shell, and the shell was preserved in 70% ethanol, until it was prepared for scanning electron microscopy. The shell was then carefully cut around the window with a rotary rock saw until a small frame of shell (about 3 mm wide) surrounded the window on all sides. This frame and the shell window with the regenerated material were rinsed with distilled water and air dried. The samples were mounted on aluminum scanning electron microscopy stubs with nail polish, and coated with 100–200 \AA of gold-palladium (60:40), using an E5100 Polaron Sputter Coater. The material was observed with a Cambridge S4-10 scanning electron microscope operated at 20 kV.

RESULTS

Most of the regenerated shell of *Tegula* was built up from spindle-shaped crystals associated with an organic matrix (Fig. 1). The spindles were made up of smaller, elongated crystallites (Fig. 2). The doubly-pointed crystallites grew and formed radiating

(R) on the left. Note the large radial clusters of crystals emanating from the normal shell (S) on the right. Arrows show some of the contacts between the regenerated shell and growth from the normal shell. Organic matrix is visible overlying some of the regenerated shell in the window. Two months of regeneration. Bar = 100 μm .

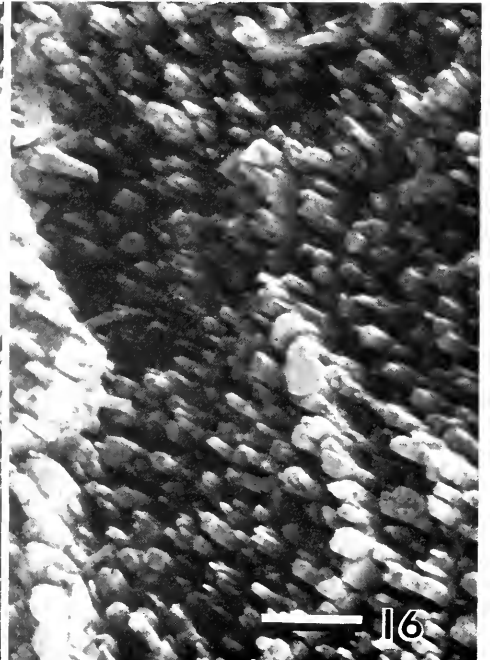
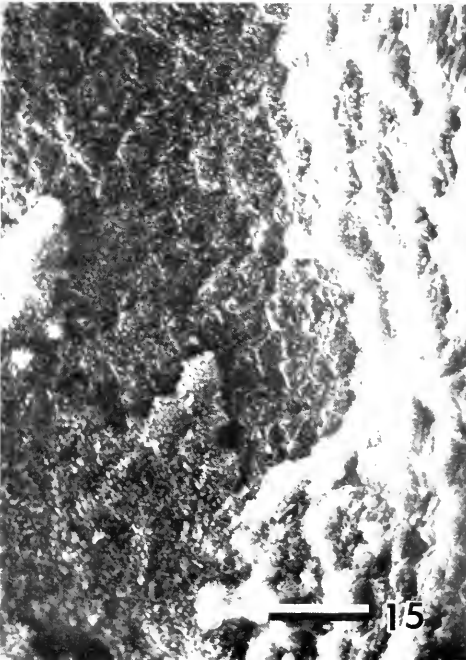
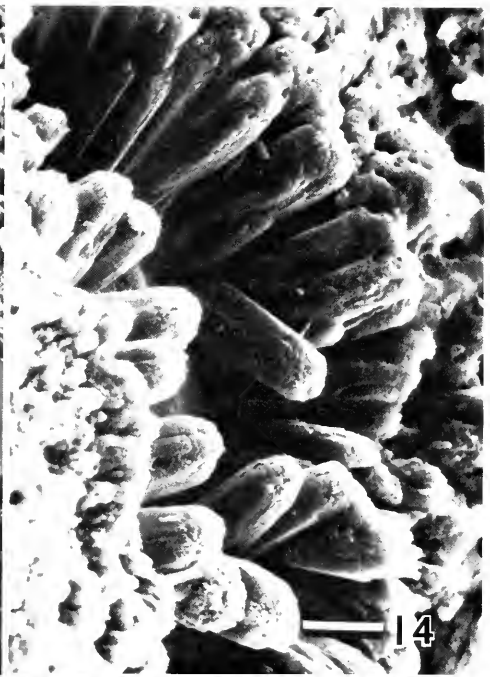

FIGURE 13. The edge of the shell window showing radiating clusters of rod-shaped crystals on the shell (S) surrounding the window. The regenerated shell (R) has separated from the normal shell in this micrograph. Four months of regeneration. Bar = 20 μ m.

FIGURE 14. Higher magnification of rod-shaped crystals similar to those shown in Figure 13. The organic matrix has collapsed over the tops of some of the crystals. Four months of regeneration. Bar = 10 μ m.

FIGURE 15. An area of shell where the nacreous layer was fractured during the removal of the shell window. Small crystallites pave the surface of the fractured shell, and the hexagonal outlines of the nacreous layer are visible underneath them. The shell window is just out of view at the top of the figure. Three months of regeneration. Bar = 20 μ m.

clusters or rosettes (Fig. 3) that eventually coalesced into a mineralized sheet (Fig. 4). Spherules formed of needle-like crystals were also observed (Fig. 5). After about two months of regeneration, dumbbell-shaped crystal aggregates and spherulites associated with an organic matrix were predominant on the surface of the regenerated material (Fig. 6).

Frequently, mineral was deposited on the normal shell surrounding the shell window. This occurred on the edges of the window both inside (next to the mantle) and outside of the shell. Typically the crystals were small and spindle-shaped (Fig. 7), and covered about one to two mm of the normal shell bordering the window (Fig. 8). The area of shell next to the mantle usually showed thicker deposition than the region on the outside of the shell (Fig. 9). After about two months of shell regeneration, crystals of regenerated shell inside the window and crystals growing from the frame around the window made contact in some places (Fig. 10).

The microstructure of the crystallites deposited on the normal shell varied somewhat from the doubly-pointed crystals described for regenerated shell. Polygonal (Fig. 11) and elongated aggregate needles (Fig. 12) were common. After four months of regeneration, the crystals on the edge of the shell window were large and rod-shaped, and were usually assembled in radiating clusters (Fig. 13). The rods were composed of smaller subunits (Fig. 14).

Figure 15 shows crystal deposition over nacreous shell. Small crystallites dot the shell, and outlines of the nacre tablets are discernable. The "c" axes of the crystallites deposited along the edges of the normal nacre tablets are slightly more elongated than those axes of the crystallites deposited on the more central regions of the tablets (Fig. 16). The regenerated shell attained a normal ultrastructural appearance after at least four months of regeneration.

DISCUSSION

There is a striking resemblance between the crystalline structures reported in this paper and structures described in other molluscan shells and for inorganically precipitated aragonite. This similarity has led to a four part hypothesis for the phases of shell regeneration in *Tegula*.

1. Aragonitic needles are precipitated from a carbonate-rich solution onto an organic matrix where they grow and form regenerated shell. The regenerated shell of *Tegula* was built up from aragonitic needle clusters that formed dual tapered crystal spindles. According to this part of the hypothesis, however, regeneration involves precipitation from a solution, and the exact area of deposition may not be limited to the shell window. This was found to be the case for *Tegula*. Crystallites were found on a small region of the nacreous shell bordering the window. The crystallites were typically smaller than the underlying nacre tablets, and in some cases, appeared to conform to or be guided by the pattern imposed by the shape of the individual nacre tablets (See Figs. 15, 16). Schroeder (1973) examined Pleistocene gastropod shells and found that apparently inorganically precipitated aragonite needles lined the interiors of the shells. The needles were oriented in two directions, determined by the underlying crossed lamellar shell structure. Meenakshi *et al.* (1974a) showed that the substrate microtopography influenced calcification patterns during shell regeneration in *Otala lactea*, a land snail. Alexandersson (1974) stated that even during inorganic

FIGURE 16. Higher magnification of Figure 15 showing elongate "c" axes of the crystallites on the edges of the nacre tablets. Three months of regeneration. Bar = 2 μ m.

precipitation, the organic matrices and matrix derivatives have some control over the form of skeletal carbonates.

The crystals described in and around the regenerated shell closely resemble the morphology of inorganically precipitated aragonite crystals (See Ginsburg and Schroeder, 1973 for a description of inorganically precipitated aragonite). In fact, Wind and Wise (1976) noted in their study of spine mineralization in the archaeogastropod *Guildifordia triumphans*, that it was virtually impossible to determine where organically precipitated aragonite ended and inorganically precipitated aragonite began. Note Figures 7, 9, and 10 in this paper which are micrographs of mineralization close to and around the edge of the shell window. It is impossible to discern whether these crystals are of an organic or an inorganic origin. Similar aragonitic crystals have been described filling in and lining gastropod shells in cup shaped algal reefs (Ginsburg *et al.*, 1971; Schroeder, 1972a, b; Ginsburg and Schroeder, 1973), forming the skeletons of one order of green algae (Marszalek, 1971), and as algal cement (Alexandersson, 1974).

2. The needles aggregate to form doubly-pointed bundles, or spindle-shaped crystals associated with an organic matrix. Spindle-shaped crystals have been described in the regenerated shell of other molluscs. For example, Blackwelder and Watabe (1977) and Meenakshi *et al.* (1974b) reported the occurrence of spindle-shaped crystals in the regenerated shells of the freshwater gastropod, *Pomacea paludosa*, and the cephalopod, *Nautilus macromphalus*. In addition, crystals morphologically similar to those described in the regenerated shells have been described in calcified byssi of the bivalve, *Anomia simplex*, and on the surface of the lithodesma of another bivalve, *Lyonsia floridana* (Prezant, 1982).

The random orientation of the crystal spindles in the regenerated shell of *Tegula* parallels the description of the formation of the growth stops and spine diaphragms in *Guildifordia triumphans* (Wind and Wise, 1976). These authors pointed out that the unpatterned disposition of the spindles indicated that they probably began forming in the extrapallial fluid, and settled at random.

3. The spindle-shaped crystals form spherules in one of two ways as outlined by Watabe (1981). First, by additional growth, the spindles become grouped into stellate- or rosette-shaped aggregates that eventually become spherules. Rosettes of spindle-shaped crystals were a prominent component of the regenerated shell in *Tegula*. They coalesced to form a mineralized sheet in the shell window. Spherulitic aggregates of crystals have been observed in other molluscs where shell is being filled in or repaired. Wind and Wise (1976) describe "elongate trends of radiating aragonite needle clusters" filling in the spine cavities of *Guildifordia triumphans*, and Watabe (1981, Fig. 5) showed spherulites of aragonite formed during early shell regeneration in the terrestrial snail, *Cepaea nemoralis*. Moreover, these aggregate crystals have been found in the normal shells of the archaeogastropod, *Cittarium pica* (Wise and Hay, 1968a, b; Erben, 1971).

The second possibility for the mechanism of spherule formation is by the addition of needles to the ends of the spindle-shaped crystals, forming a dumbbell shape. Filling in the midregion of the dumbbell with more needles would result in radial development and spherule formation. After about two months of shell regeneration, large dumbbell-shaped crystals as well as spherules were evident in the regenerated shell of *Tegula*. These crystal structures were also evident in the regenerated shell of *Mytilus edulis*, a marine bivalve, and *Pomacea paludosa*, a freshwater snail (Uozumi and Suzuki, 1979; Blackwelder and Watabe, 1977).

The results of the present study indicate that the stellate- or rosette-shaped clusters of crystal spindles occur during early shell regeneration, and the dumbbell-shaped

aggregates are present during a later stage of regeneration. This is not a definitive statement for all shell regeneration, but examples such as those of *Mytilus* and *Pomacea* show that these crystal types can occur under a wide range of conditions in regenerated shell.

4. Finally, the crystals derived from the rosette-like or the dumbbell-shaped crystal aggregates are closely apposed, and competition growth results in their coalescence and the formation of a spherulitic prismatic type of shell layer. Micrographs of the regenerated shell after at least three months of regeneration show this type of layer in *Tegula* (Reed-Miller, unpub.). This shell structure has also been seen in the regenerated shell of *Pomacea paludosa* (Blackwelder and Watabe, 1977), the shells of *Cittarium pica* (Wise and Hay, 1968a, b; Erben, 1971), *Nautilus* (Erben *et al.*, 1969; Mutvei, 1972; Meenakshi *et al.*, 1974b), and in bivalve ligaments (Mano and Watabe, 1979).

In summary, the sequence of changes throughout shell repair in *Tegula* is as follows. The initial crystal deposition occurs in association with an organic matrix and appears as small, spindle-shaped crystals formed by the aggregation of needle-like subunits. The spindles are frequently aggregated into stellate clusters that coalesce to form a sheet of mineralized tissue. After about two months, dumbbell-shaped crystal aggregates and spherulites are apparent on the surface of the regenerated shell. A normal shell structure is present after at least four months of regeneration. Crystal deposition also occurs on the normal shell surrounding the window.

A salient question arises from this study. What degree of control does an animal have over the microarchitecture of regenerated shell if at any stage the ultrastructural appearance is similar to that described for inorganically precipitated mineral?

ACKNOWLEDGMENTS

This work was supported by N.I.H. Grant #DE05491. William I. Miller, III provided excellent assistance with the scanning electron microscopy. Dennis Cassidy graciously allowed me to use the darkroom in the Antarctic Research Facility in the Department of Geology at FSU. I am grateful to Dr. S. W. Wise, Jr. for helpful discussions of the interpretation of some of the micrographs. This is contribution number 211 from the Tallahassee, Sopchoppy and Gulf Coast Marine Biological Association.

LITERATURE CITED

- ALEXANDERSSON, T. 1974. Carbonate cementation in coralline algal nodules in the Skagerak, North Sea: Biochemical precipitation in undersaturated waters. *J. Sediment. Petrol.* **44**: 7-26.
- BLACKWELDER, P. L., AND N. WATABE. 1977. Studies on shell regeneration. II. The fine structure of normal and regenerated shell of the freshwater snail, *Pomacea paludosa*. *Biom mineralization* **9**: 1-10.
- ERBEN, H. K. 1971. Anorganische und organische schalenkomponenten bei *Cittarium pica* (L.) (Archaeogastropoda). *Biom mineralization* **3**: 51-64.
- ERBEN, H. K., G. FLAJS, AND A. SIEHL. 1969. Die fruhontogenetische Entwicklung der schalenstruktur ectocohleaten Cephalopoden. *Paleontogr. Am.* **132**: 1-54.
- GINSBURG, R. N., D. S. MARSZALEK, AND N. SCHNEIDERMAN. 1971. Ultrastructure of carbonate cements in a Holocene algal reef of Bermuda. *J. Sediment. Petrol.* **41**: 472-482.
- GINSBURG, R. N., AND J. H. SCHROEDER. 1973. Growth and submarine fossilization of algal cup reefs, Bermuda. *Sedimentology* **20**: 575-614.
- MANO, K., AND N. WATABE. 1979. Scanning electron microscope observations on the calcified layers of the ligament of *Mercenaria mercenaria* (L.) and *Brachyodontes exustus* (L.). Pleycypoda. *Biom mineralization* **10**: 25-32.
- MARSZALEK, D. S. 1971. Skeletal ultrastructure of sediment producing green algae. Pp. 273-280 in *Scanning Electron Microscopy 1971* (part 1), O. Johari, ed. IIT Research Institute, Chicago.

- MEENAKSHI, V. R., G. DONNAY, P. L. BLACKWELDER, AND K. M. WILBUR. 1974a. The influence of substrata on calcification patterns in molluscan shell. *Calcif. Tissue Res.* **15**: 31-44.
- MEENAKSHI, V. R., A. W. MARTIN, AND K. M. WILBUR. 1974b. Shell repair in *Nautilus macromphalus*. *Mar. Biol.* **27**: 27-35.
- MUTVEI, H. 1972. Ultrastructural studies on cephalopod shells, Part I. The septa and siphonal tube in *Nautilus*. *Bull. Geol. Inst. Univ. Ups.* **8**: 237-261.
- PREZANT, R. S. 1982. Inorganic and biogenic deposition of calcium carbonate in molluscan accessory structures. *Am. Zool.* **22**: 982.
- REED-MILLER, C., S. W. WISE, JR., AND H. J. SIEGEL. 1980. Correlated techniques for identifying mineral phases and morphologies in regenerated archaeogastropod shell: A progress report. Pp. 73-76 in *The Mechanisms of Biomineralization in Animals and Plants*, M. Omori and N. Watabe, eds. Tokay University Press, Tokyo.
- REED-MILLER, C. 1981a. Shell structures in five species of the marine snail, *Tegula*. Pp. 243-251 in *Scanning Electron Microscopy 1981, IV*, O. Johari, ed. IIT Research Institute, Chicago.
- REED-MILLER, C. 1981b. Transmission and scanning electron microscopy of gastropod shell regeneration. *Am. Zool.* **21**: 1037.
- REED-MILLER, C. 1982. Crystalline and amorphous calcium in the tissues of shell regenerating snails. *Am. Zool.* **22**: 982.
- REED-MILLER, C. 1983. The initial calcification process in shell-regenerating *Tegula* (Archaeogastropoda). *Biol. Bull.* **165**: 265-275.
- SALEUDDIN, A. S. M., AND K. M. WILBUR. 1969. Shell regeneration in *Helix pomatia*. *Can. J. Zool.* **47**: 51-53.
- SCHROEDER, J. H. 1972a. Calcified filaments of an endolithic alga in recent Bermuda reefs. *Neus. Jb. Geol. Palaont. Mh.* **1**: 16-33.
- SCHROEDER, J. H. 1972b. Fabrics and sequences of submarine carbonate cements in Holocene Bermuda cup reefs. *Geol. Rdsch.* **61**: 708-730.
- SCHROEDER, J. H. 1973. Submarine and vadose cements in Pleistocene Bermuda reef rock. *Sediment. Geol.* **10**: 179-204.
- UOZUMI, S., AND S. SUZUKI. 1979. "Organic membrane-shell" and initial calcification in shell regeneration. *J. Fac. Sci. Hokkaido Univ. Ser. IV.* **19**: 37-74.
- WATABE, N. 1981. Crystal growth of calcium carbonate in the invertebrates. Pp. 99-147 in *Inorganic Biological Crystal Growth*, B. R. Pamplain, ed. Pergamon Press, Oxford.
- WILBUR, K. M. 1972. Shell formation in molluscs. Pp. 103-145 in *Chemical Zoology, Vol. VII, Mollusca*, M. Florkin and B. T. Scheer, eds. Academic Press, New York.
- WIND, F. H., AND S. W. WISE, JR. 1976. Organic vs. inorganic processes in archaeogastropod shell mineralization. Pp. 369-387 in *The Mechanisms of Mineralization in the Invertebrates and Plants*, N. Watabe and K. M. Wilbur, eds. Univ. South Carolina Press, Columbia.
- WISE, S. W., JR., AND W. W. HAY. 1968a. Scanning electron microscopy of molluscan shell ultrastructure. I. Techniques for polished and etched sections. *Trans. Am. Microsc. Soc.* **87**: 411-418.
- WISE, S. W., JR., AND W. W. HAY. 1968b. Scanning electron microscopy of molluscan shell ultrastructure. II. Observation of growth surfaces. *Trans. Am. Microsc. Soc.* **87**: 419-430.
- WONG, V., AND A. S. M. SALEUDDIN. 1972. Fine structure of normal and regenerated shell of *Helisoma duryi duryi*. *Can. J. Zool.* **50**: 1563-1568.

MORPHOLOGY AND GENETICS OF REJECTION REACTIONS
BETWEEN OOZOIDS FROM THE TUNICATE
BOTRYLLUS SCHLOSSERI

VIRGINIA L. SCOFIELD^{1,2} AND LAUREN S. NAGASHIMA

¹*Marine Biological Laboratory, Woods Hole, Massachusetts 02543, Hopkins Marine Station of Stanford University, Pacific Grove, California 93950, and Laboratory of Experimental Oncology, Department of Pathology, Stanford University School of Medicine, Stanford, California 94305*

ABSTRACT

Botryllus rejection reactions were followed in pairs of oozoids placed together immediately after initiation of metamorphosis. Within twelve hours, both compatible and incompatible oozoid pairs underwent tunic fusion and initiation of ampullar tip-to-side contact. Vascular fusion followed within two days between compatible pairs, while the fusion sequence was interrupted in the incompatible pairs by a rapid cytotoxic rejection response. Events occurring within and outside the ampullae in rejections were effector responses whose consequences were separation of the ampullae and isolation of the involved tissues from the bodies of the oozoids. Genetics experiments suggested that the four distinct types of rejection reflect a hierarchy of histoincompatibility in this system.

INTRODUCTION

Recent interest in colonial tunicates has centered around the phenomenon of *colony specificity*, which is the capacity for self-nonsel self distinction leading to fusion or rejection between colonies. In *Botryllus*, this histocompatibility discrimination is controlled by a single multiallelic Mendelian locus (Oka and Watanabe, 1960; Sabbadin, 1962) that resembles loci within the vertebrate major histocompatibility complex, or MHC (Scofield *et al.*, 1982a). We have undertaken studies to determine whether genes controlling allogeneic recognition in *Botryllus* are homologous to those within the MHC. To complement our molecular studies, we have examined *Botryllus* rejection responses in live preparations of rejecting oozoids, using differential interference contrast (Zeiss-Nomarski) microscopy.

Botryllus colonies are clones of individuals, or *zooids*, enclosed in a common tunic. Each zooid is parabiosed to all the others through a colonial vascular network that is terminated at the colony periphery by bulbous ampullae. Tanaka and Watanabe (1973) have shown that fusions and rejections between colonies are contact responses between their ampullae. All the individuals in a colony arise by budding from the "founder" individual, or oozoid, that is established by metamorphosis of a swimming tadpole-like larva. Oozoids possess eight microampullae, and paired oozoids undergo vascular fusions and rejections similar to those occurring between grown colonies (Scofield *et al.*, 1982a, b).

When the separated growing edges of the same *Botryllus* colony meet, the tunic (test) dissolves, and the opposite ampullae interdigitate to form tip-to-side contacts (Tanaka and Watanabe, 1973). This sequence of events is part of the morphogenetic "program" that establishes blood flow between the contacted blood vessels (Katow

Received 15 March 1983; accepted 23 September 1983.

² To whom correspondence should be addressed.

and Watanabe, 1980). Fusion also proceeds, without interruption, between colonies sharing at least one allele at the fusion locus (Oka and Watanabe, 1960). For colonies sharing no fusibility alleles, however, the fusion sequence is aborted after ampullar contact, and is followed by a cytotoxic rejection (Tanaka and Watanabe, 1973). Recently, Taneda and Watanabe (1982a, b, c) firmly established that the allorecognition elements that allow fusion, or cause rejection, are humoral and cellular elements in the blood. To outline the sequence of cellular events that follow allorecognition and lead to a completed rejection response, we followed rejections *in vitro* in paired oozoids.

In other invertebrates (Ivker, 1972), as in vertebrates (Götze, 1977), polymorphic histocompatibility gene systems show a hierarchy, manifested by differences in the timing and severity of rejection responses that depend upon particular alleles possessed by the contacted cells. To determine whether such a hierarchy exists for *Botryllus* fusibility alleles, we subjected colonies to different kinds of genetic crosses, and scored rejection "types" for the offspring.

MATERIALS AND METHODS

Colonies of *B. schlosseri* were gathered from the Eel Pond in Woods Hole, Massachusetts, and maintained with constant aeration in beakers of filtered sea water. Tadpole larvae were gathered by placing coverslips along the waterline inside the beakers, where they attached and underwent metamorphosis to form natural pairs.

For time-lapse observations, coverslips carrying oozoid pairs were inverted over a drop of sea water on a glass microscope slide. Observations were made using Zeiss-Nomarski optics. Between observations, the coverslips were cultured in their original beakers.

Genetic crosses were carried out in the same beakers that were used to culture single colonies. Three sets of experiments were done. First, colonies already carrying developing embryos ("wild-fertilized" colonies) were collected and cultured until the developing tadpoles hatched and metamorphosed to form oozoid pairs. For "defined" crosses, pairs of colonies were placed in beakers, where eggs of one colony were fertilized only by sperm from the crossing partner. For "self" crosses, colonies were isolated and self-fertilizations were allowed to proceed (Scofield *et al.*, 1982a). After each cross, colonies containing fertilized eggs were cultured in isolation until the F_1 larvae hatched.

RESULTS

The thin oozoid preparations allowed easy visualization of ampullar junctions under the microscope. Rejections and fusions occurred readily between paired oozoids within two days of hatching and metamorphosis. Within 12–24 hours of contact, blood flow was established and connecting vessels formed between fusible oozoids (Fig. 1A). Likewise, rejection reactions usually were completed by one day after initiation of ampullar contact. The characteristic feature of oozoid rejections was a bright golden-brown necrotic zone (Fig. 1B).

Figure 2A shows a normal ampulla photographed at its point of attachment to an inverted glass coverslip. The surfaces of the "tip" cells are smooth, and the surrounding tunic contains only the interconnected "test cells" (Fig. 2A). In rejecting oozoid pairs, by contrast, the ampullae and the surrounding tunic showed striking alterations. After a period of tip-to-side contact, ampullar reparation was followed rapidly by movement of blood cells through the "tipping" ampullar tip into the tunic (Fig. 2B). Closer examination of the cytotoxic mass revealed concave "holes" in the

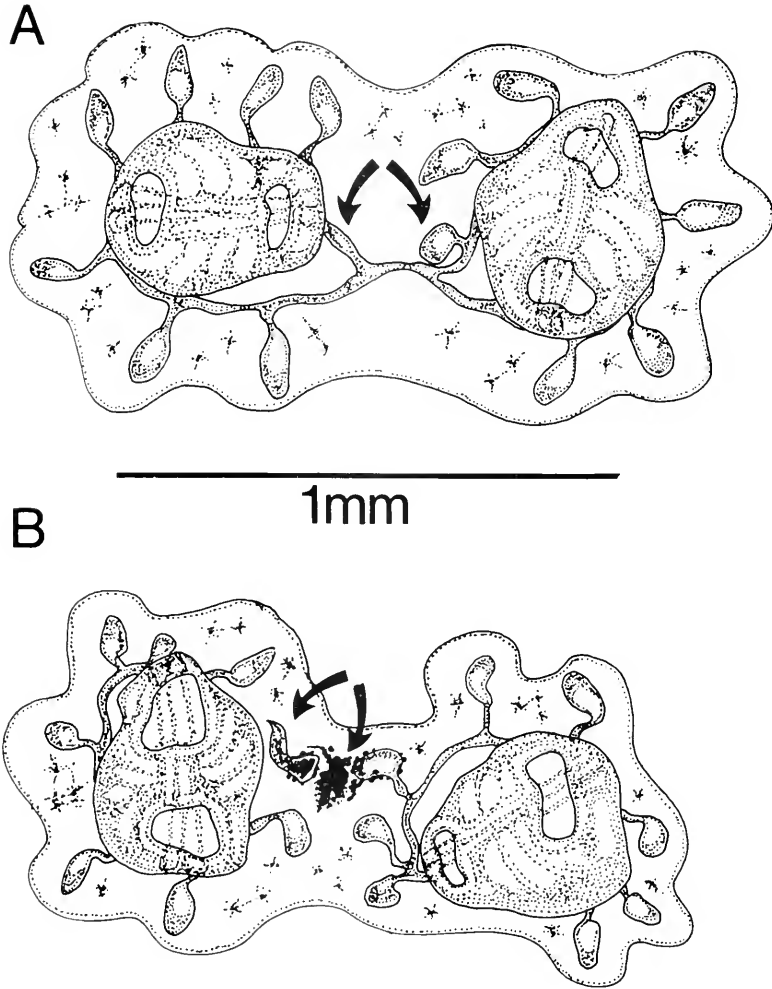
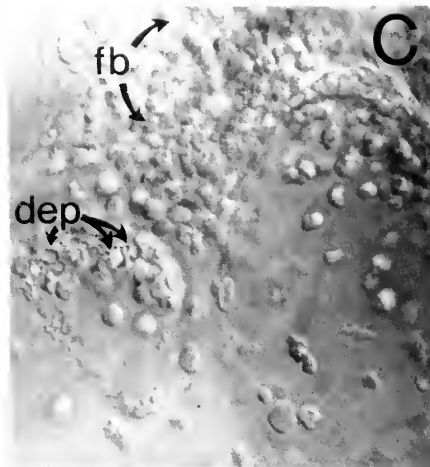
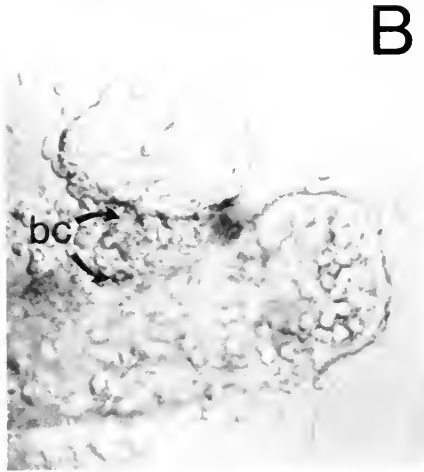
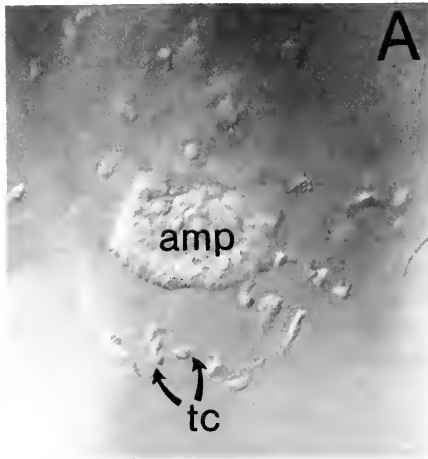

FIGURE 1. Fused and rejected *Botryllus* oozyoid pairs. A. Fused oozyoids, showing the connecting blood vessels (arrows) at the site of a prior tip-to-side contact. B. Rejected oozyoids, showing the necrotic zone and an autoamputated ampulla (arrows).

tip cells (Fig. 2C). In some pairs, blood flow inside the involved ampullae slowed to a stop. Emboli broken from these clotted masses frequently plugged the proximal end of the ampulla (Fig. 3A) at sites where amputation eventually occurred (see below). Examination of the blood cells released into the tunic revealed that the first to appear there had the distinct berry-like appearance of morula cells (Fig. 3B). Their vacuoles had turned a dark brown. After deposition into the tunic, morula cell disintegration was accompanied by condensation of fibers at the site (Fig. 2C).

Other morula cells, morula cell precursors (signet-ring and compartment cells), and granular amoebocytes were shed into the tunic as the ampullae retreated from the contact point. These, however, remained transparent by transmitted light (Fig. 2C). Some developed processes and moved away from the rejection site, while others contributed to the cytotoxic mass (Fig. 2C). It is clear from Figures 2 and 3 that



rejection reactions following allogeneic contacts in *Botryllus* are extremely destructive to surrounding tissues.

A surprising finding was that different oozoid pairs from the same hatching gave very different rejection responses. Although necrotic regions always appeared between rejected oozoids, a striking difference in timing of rejection events and gross appearance of the cytotoxic lesion became evident after examination of many pairs. The time between establishment of ampullar junctions and rejection was highly variable, ranging between about 30 minutes and approximately 12 hours. Completed rejection responses could be placed into one of four categories (1–4; Fig. 4, Table I) that were distinguished easily by reflected light. The several forms taken by oozoid rejections in this study appear in Figure 4.

"Type 1" rejections showed very slight bleeding from the "tipping" ampulla following ampullar reseparation. In most instances, careful inspection of the retreating ampullae was necessary to visualize the few golden-brown cells bled from their tips. This sometimes was accompanied by visible "sticking" of the rounded tip cells onto the "side" ampulla at the prior contact site (Fig. 4A). The "type 2" response was a more extensive bleeding of the "tipping" ampulla, again with the ampulla itself remaining sealed and generally intact. In both these types of bleeding responses, the characteristic brown color reaction was seen in the rejection lesion, but not within the ampullae.

The third type of rejection (type 3) was autoamputation (Fig. 4B), occurring with or without ampullar bleeding from the tip. For these rejections, the entire amputated ampulla, and its contents, turned brown. The rejection type "4" was ampullar disintegration, where the ampullar contents and epithelium became part of the colored rejection mass (Fig. 4C).

It appeared that these rejection types represented a continuum of responses, with the differences being a function of the extent to which the ampullae moved through the fusion sequence before it was aborted (for example, a brisk response to a rapid allorecognition might account for both the minor and more extensive bleeding responses, while more extreme ampullar reactions—amputation or disintegration—would result from more extensive mixing of allogeneic blood elements).

Because the distinct responses seemed to reflect different thresholds for "effective" allorecognition, we proposed that these differences actually reflect a nested hierarchy of histoincompatibility for the many fusibility alleles. If so, different oozoid pairs with the same combinations of fusibility haplotypes would be expected to give the same kind of rejection response. An oozoid microassay (Scofield *et al.*, 1982a) was used to test this hypothesis with different genetic crosses (Fig. 5).

Since wild colonies usually are heterozygotic at one Mendelian gene for fusion at which there are many alleles (Oka and Watanabe, 1960), any given colony can be named AB at this locus (Fig. 5, top) and the diploid progeny of that colony will be A or B with respect to the maternal fusibility allele (Scofield *et al.*, 1982a). Certain predictions can be made regarding genotypes of F_1 oozoid pairings that give rejections.

FIGURE 2. Anatomy of normal ampullae and of ampullae participating in rejection reactions. A. Normal ampullar tip (*amp*), surrounding tunic, and test cells (*tc*) in a *Botryllus* oozoid. The ampullar tip cells are columnar, vacuolated, and tightly interconnected. B. Ampullar withdrawal following a rejecting tip-to-side contact. Blood cells (*bc*) can be seen moving from the "tipping" ampulla (top) into the tunic where they undergo cytotoxic interactions and cause fiber deposition. The "side" ampulla (bottom) also is filled with clumped blood cells. C. Changes in ampullar tip cells after a rejecting tip-to-side contact. Rounded "holes" or depressions (*dep*) appear in the tip cells of the interacting ampullae. The brown fibrous barrier deposited by blood cells in the tunic (*fb*) appears at the top. A and B, $\times 500$. C, $\times 1000$.

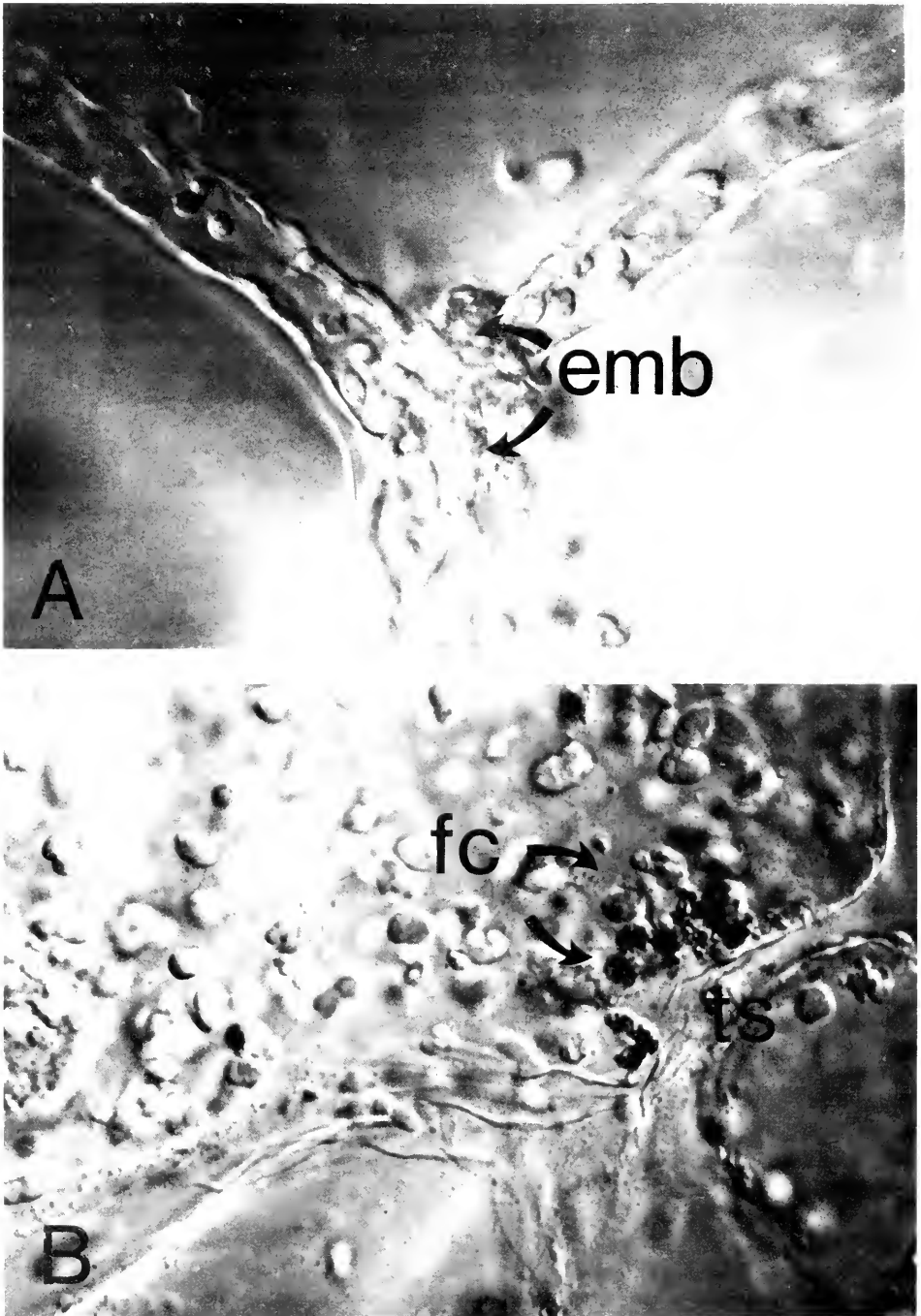

FIGURE 3. Effector responses in oozoid blood vessels and tunic after a rejection reaction. A. Embolus (*emb*) of clotted blood cells and fibers preventing backflow of blood through the proximal end of an ampulla participating in a rejection response. B. Ferrocites (*fc*), deposited into the tunic from the ampullar tip at right, have vacuoles which have turned dark red-brown. $\times 1000$.

For example, if a colony is fertilized in the natural environment by sperm from many different colonies, the randomly combined A and B oozoids yield 50% fusing and 50% rejecting pairs (the chance that any two share a paternal allele is small, Fig. 5, left). Because many different sperm fertilize in such "wild" crosses, rejections between the progeny oozoids involve many different allelic combinations (there are 50–100 fusibility alleles in natural populations—Schlumpberger and Scofield, unpub.). If rejection type depends upon fusibility alleles, then the pairs of rejected progeny from these wild crosses should show some frequency distribution of all four rejection types (Fig. 5, left).

If the same maternal AB colony is crossed by only one other colony, CD (Fig. 5, center) then only C and D sperm fertilize; the F_1 progeny are of four types, and that 25% of the progeny pairs which reject are of only two haplotypic combinations. Thus only one or two different rejection types should be represented in the paired progeny of a "defined" cross. If the AB colony is *self*-crossed, on the other hand, the rejected 12.5% of the experimental pairs are of only one allelic combination (Fig. 5, right); thus only one rejection type should be found.

Results from these experiments appear in Table I. As expected, wild-fertilized colonies yielded oozoids which, when paired, showed 50% fusions and 50% rejections (numerical data not shown; Fig. 5, left). Rejection types were distributed fairly evenly over all four categories. The defined crosses, on the other hand, hatched progeny whose pairs gave 75% fusions and 25% rejections (Fig. 5, center). The rejected pairs from these crosses generally showed only one or two rejection types; exceptions were seen only in the progeny of two crosses (defined crosses 6 and 7) where ampullar amputation in some pairs was accompanied by bleeding from the tips. Self-crossed colonies produced progeny whose pairs gave very few rejections, both because they represent only 12.5% of the total pairs (Fig. 5, right) and because inbreeding depression reduces the total number of hatched larvae (Sabbadin, 1971; Scofield *et al.*, 1982a). However, those rejections were all of one type in three experiments (Table I).

DISCUSSION

Fusions and rejections between *Botryllus* oozoids appear to be similar to those occurring between adult colonies (Tanaka and Watanabe, 1973; Katow and Watanabe, 1980). For incompatible pairs, the ampullae move into position for fusion, as they do for compatible pairs, but the process is interrupted abruptly by a cytotoxic effector cascade.

In the present study, large holes were observed in the tip cells of rejecting oozoid ampullae (Fig. 2C). Whether these were formed as part of the aborted fusion sequence (and perhaps were the means by which blood exchange leading to rejection was made) or were released endocytotic vacuoles transporting blood cells into the tunic (DeSanto, 1968) remains to be determined. In these cases, however, blood cell stasis and clumping became apparent soon after ampullar contact was established (Fig. 4A–C). This suggests that blood exchange of some kind must occur before rejection can begin, and, indeed, the first result of contact between ampullae (compatible or incompatible) appears to be tip cell alteration. Electron-microscopic examination of fusing ampullar junctions has revealed "fenestrations" in the tip cells (Katow and Watanabe, 1980). After rejections, likewise, India Ink injected into a retreating ampulla was shown to leak through the tip cells into the tunic (Taneda and Watanabe, 1982c). The results of the rejection reaction activated by mixing of allogeneic blood elements are: (1) rapid isolation of the involved structures, and (2) eventual reseparation of the allogeneic colonies.

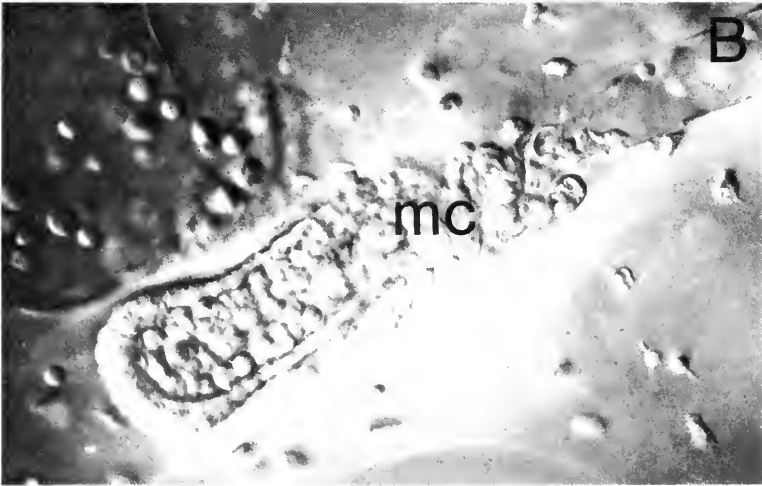
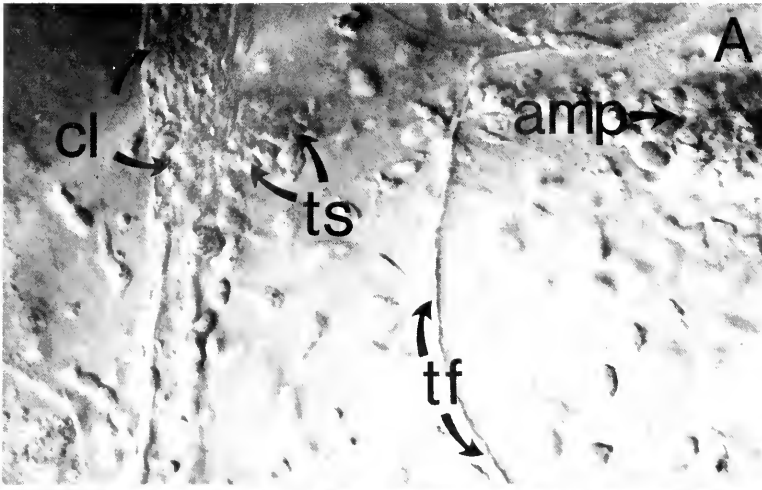

TABLE I

Percentages of each of four types of rejection (Types 1-4) in the paired F_1 progeny of colonies fertilized (1) by many different paternal colonies in the natural environment ("wild-fertilizations", Fig. 5, left), (2) by one paternal colony ("defined" crosses, Fig. 5, center) and (3) by self sperm ("self", Fig. 5, right)

Crosses ¹	n (pairs)	Rejection type			
		1	2	3	4
Wild	50	13	13	11	13
	46	13	11	9	13
	23	5	6	4	8
	50	15	14	9	12
Defined	5	1			4
	3		1		2
	8		1	7	
	11		11		
	6	6			
	16	8	5	3	
	5	1	3	1	
	5		4	1	
	9	6	3		
	6	4	2		
Self	3	3			
	2	2			
	5		5		

¹ Rejections are typed as (1) slight bleeding; (2) severe bleeding; (3) ampullar autoamputation; and (4) ampullar disintegration. For details, see text and Figure 4.

Botryllus provides one of only two known examples of genetically controlled allorecognition and response in tunicates. As shown for the solitary tunicate *Halocynthia* (Fuke, 1980; Fuke and Numakunai, 1981), allogeneic mixtures of *Botryllus* blood cells undergo rapid contact-mediated cytolysis (Scofield, in prep.). The most striking features of the *in vitro* and *in vivo* reactions between allogeneic *Botryllus* blood cells are their speed, the lack of requirement for an induction period, and the characteristic golden-brown color of the rejection lesion itself. The best clues as to cellular mechanisms for *Botryllus* alloreactivity may come from recent studies with vertebrates.

In mammals, a class of natural killer (NK) cells has been described (Herberman, 1982). Such cells have native capacities for rapid, nonimmune recognition and killing of cells of certain tumor lines, and may play a role in rejection of transplanted allogeneic blood cells (Rolstad *et al.*, 1983). Like neutrophils and monocytes, but unlike cytolytic T lymphocytes, vertebrate NK cells appear to employ reduced oxygen

FIGURE 4. Different types of cytotoxic response following a rejection reaction. A. Bleeding after partial completion of the fusion sequence. Blood cells are moving out of the "tipping" ampulla as it retreats (above right, *amp*). The site of prior tunic fusion (*tf*) and tip-to-side contact (*ts*) are marked clearly. B. Ampullar autoamputation following a rejecting tip-to-side contact. The pinching site is surrounded by morula cells (*mc*). C. Ampullar disintegration at the site of a prior tip-to-side contact (*ts*). Morula cells (*mc*) are adhered to the blood vessels of the "side" ampulla (top). $\times 1000$.

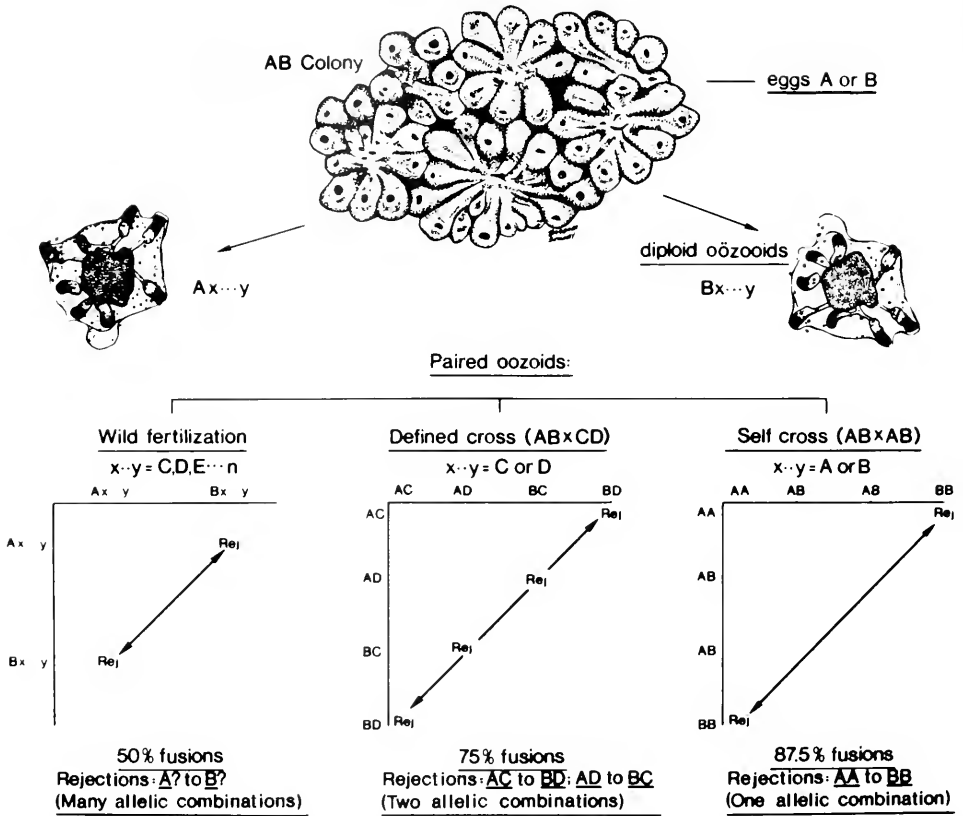

FIGURE 5. Schematic diagram showing genetic crosses performed in this study, progeny genotype ratios, and haplotypes represented in rejecting oözooid progeny pairs. Wild colonies are heterozygotic at one locus for fusibility, at which there are many alleles segregating in natural populations (50–100 in North American *Botryllus* species; Schlumberger and Scofield, unpub.). If the mother colony is designated *AB* at the fusion locus (top), and the fertilizing sperm alleles designated *x...y*, the oözooid progeny of any genetic crossing will be *Ax...y* or *Bx...y* in 1:1 proportions. *Left*: Wild fertilizations: many different fertilizing sperm (from an unknown number of paternal colonies) fertilize the *A* and *B* eggs. If rejection type is determined by fusibility haplotypes, all four rejection types should be seen in the paired offspring. *Center*: Cross-fertilizations: the maternal *AB* colony is fertilized by sperm carrying one of two fusibility alleles (*C* or *D*); rejections among the paired offspring will be *AC* to *BD* or *AD* to *BC*; therefore, one or two rejection types should be seen among the paired F_1 progeny. *Right*: Self-fertilizations: the only rejecting haplotype combination is *AA* to *BB*; thus, only one rejection type is expected.

intermediates in their cytolitic pathways (Roder *et al.*, 1982). We have found that mixed allogeneic *Botryllus* blood cells release both hydrogen peroxide and ferrous iron (Poenie and Scofield, in prep.), and that peroxidase appears in the tunic area around rejecting ampullae (Nynäs-McCoy, unpub.). Ascidian morula cells carry the transition metals vanadium, niobium, or iron (Goodbody, 1974; Rowley, 1982). In *Botryllus*, the morula cells contain reduced iron and sulfuric acid (Milanesi and Burighel, 1979). The morula cells are conspicuous participants in rejection lesions, where their transparent vacuoles turn a dark red-brown (Fig. 3B). Since this color reaction may reflect a change in the oxidation state of the contained iron, it is tempting to speculate that tunicate transition metals participate in allogeneic effector reactions by performing a catalytic function. All tunicates have large amounts of bound iodine

in the blood and tunic matrix (Barrington, 1975). It is interesting to note, therefore, that hydrogen peroxide, ferrous sulfate, and potassium iodide together can generate cytotoxic iodide ($I \cdot$) and hydroxyl ($OH \cdot$) radicals (Klebanoff, 1982). If tunicate metal ions initiate free radical-generating reactions, such intermediates could participate, as they may in vertebrates, in killing of bacteria or allogeneic cells. In *Botryllus*, for example, they might polymerize fibers from tunic or blood-borne precursors for clotting or encapsulation functions. Discovery of such a role(s) for tunicate transition metals might help to solve the long-standing mystery of their adaptive function (Goodbody, 1974).

Our observation of broad heterogeneity in rejection types in *Botryllus* is reminiscent of findings by Koyama and Watanabe (1982) with *Perophora sagamiensis*, where two distinct types of rejection were observed. Our studies suggest that colony specificity in *B. schlosseri* occurs on a continuum, where the time required for response varies for different pairs of interacting alleles. If the hierarchy of alleles in *Botryllus* reflects diverse thresholds for initiation of the rejection reaction, such differences might likewise explain interspecies variations noted by Koyama and Watanabe (1982) for different botryllid ascidians (see also Scofield, 1983).

The clear differences between the "acute" rejections described in this study and the "chronic" reactions occurring subsequent to fusion in some colony pairs (Mukai, 1967; Sabbadin and Zaniolo, 1979; Saito and Watanabe, 1982; Taneda and Watanabe, 1982c; Scofield, 1983) offer the intriguing possibility that in *Botryllus*, as in mammals, there may be two systems for cellular defense: the rapid, NK-like, native reaction described above, and a slower, induced response. Many different cell types appear to participate in *in vivo* or *in vitro* reactions between fully allogeneic blood cells (Scofield, in prep.). By contrast, the "delayed" response to semiallogeneic cells is significantly attenuated by X-irradiation of the recipient colony, a treatment that affects the numbers of lymphocyte-like cells (Taneda and Watanabe, 1982c).

It appears that both types of *Botryllus* allorecognition are controlled in some way by genes within the fusibility complex. The rapid, "acute" response serves a primary protective function against allogeneic invasion. Reactions between cells mixed after fusion, on the other hand, may prevent continued resource sharing between distantly related colonies that happen to share one fusibility allele. If the induction period for this response (about two weeks; Taneda and Watanabe, 1982c) reflects the time required for activation or expansion of clones of specific alloreactive cells, it may be significant that the genetics of these semiallogeneic reactions resemble those for vertebrate allograft rejection by cytotoxic T lymphocytes.

LITERATURE CITED

- BARRINGTON, E. J. W. 1975. Problems of iodine binding in ascidians. Pp. 129-158 in *Protochordates*, E. J. W. Barrington and R. P. S. Jefferies, eds. Academic Press, London.
- DESANTO, R. S. 1968. *The Histochemistry, Fine Structure, and Ecology of the Synthesis of the Test in Botryllus schlosseri (Pallas) Savigny*. Ph.D. Thesis, Columbia University.
- FUKE, M. T. 1980. "Contact reactions" between xenogeneic or allogeneic coelomic cells of solitary ascidians. *Biol. Bull.* **158**: 304-318.
- FUKE, M. T., AND T. NUMAKUNAL. 1981. Allogeneic cellular reactions between intraspecific types of a solitary ascidian, *Halocynthia roretzi*. *Dev. Comp. Immunol.* **6**: 253-261.
- GOODBODY, I. 1974. The physiology of ascidians. *Adv. Mar. Biol.* **12**: 1-149.
- GÖTZE, D. 1977. *The major histocompatibility complex in man and animals*. Springer-Verlag, New York.
- HERBERMAN, R. B. 1982. Overview and perspectives: natural resistance mechanisms. Pp. 799-788 in *Marcophages and Natural Killer Cells: Regulation and Function*, S. J. Normann and E. Sorkin, eds. Plenum, New York.
- IVKER, F. S. 1972. A hierarchy of histoincompatibility in *Hydractinia echinata*. *Biol. Bull.* **143**: 162-166.

- KATOW, H., AND H. WATANABE. 1980. Fine structure of fusion reaction in the compound ascidian *Botryllus primigenus* Oka. *Dev. Biol.* **76**: 1-14.
- KLEBANOFF, S. J. 1982. The iron-H₂O₂-iodide cytotoxic system. *J. Exp. Med.* **256**: 1262-1267.
- KOYAMA, H., AND H. WATANABE. 1982. Colony specificity in the ascidian *Perophora sagamiensis*. *Biol. Bull.* **162**: 171-186.
- MILANESI, C., AND P. BURIGHEL. 1979. Blood cell ultrastructure of the ascidian *Botryllus schlosseri*. I. Hemoblast, granulocytes, macrophage, morula cell and nephrocyte. *Acta Zool. (Stockholm)* **9**: 135-147.
- MUKAI, H., AND H. WATANABE. 1974. On the occurrence of colony specificity in some compound ascidians. *Biol. Bull.* **147**: 411-424.
- OKA, H., AND H. WATANABE. 1960. Problems of colony-specificity in compound ascidians. *Bull. Mar. Biol. Sta. Asamushi, Tohoku Univ.* **10**: 153-155.
- RODER, J. C., S. J. HELFAND, J. WERKMEISTER, R. MCGARRY, T. J. BEAUMONT, AND A. DUWE. 1982. Oxygen intermediates are triggered early in the cytolytic pathway of human NK cells. *Nature* **298**: 569-572.
- ROLSTAD, B., S. FOSSUM, B. TONNESEN, AND W. L. FORD. 1983. Athymic nude rats resist graft-versus-host disease because they reject allogeneic lymphocytes. *Transplant. Proc.* **XV**(2): 1656-1658.
- ROWLEY, A. F. 1982. The blood cells of *Ciona intestinalis*: an electron probe X-ray microanalytical study. *J. Mar. Biol. Assoc. U. K.* **62**: 607-620.
- SABBADIN, A. 1962. La basi genetiche della capacita di fusione fra colonie in *Botryllus schlosseri* (Ascidacea). *Rend. Accad. Lincei* **32**: 1031-1035.
- SABBADIN, A. 1971. Self and cross-fertilization in the compound ascidian *Botryllus schlosseri*. *Dev. Biol.* **24**: 379-391.
- SABBADIN, A., AND G. ZANIOLO. 1979. Sexual differentiation and germ cell transfer in the colonial ascidian *Botryllus schlosseri*. *J. Exp. Zool.* **207**: 289-304.
- SAITO, Y., AND H. WATANABE. 1982. Colony specificity in the compound ascidian, *Botryllus scalaris*. *Proc. Jpn. Acad.* **58**(Ser. B): 105-108.
- SCOFIELD, V. L., J. M. SCHLUMBERGER, L. A. WEST, AND I. L. WEISSMAN. 1982a. Protochordate allo-recognition controlled by a MHC-like gene complex. *Nature* **295**: 499-505.
- SCOFIELD, V. L., J. M. SCHLUMBERGER, AND I. L. WEISSMAN. 1982b. Colony specificity in the colonial tunicate *Botryllus* and the origins of vertebrate immunity. *Am. Zool.* **22**: 783-794.
- SCOFIELD, V. L. 1983. Control of fusibility in colonial tunicates. In *Cell Receptors and Cell Communication in Invertebrates*. A. H. Greenberg, ed. Marcel Dekker, New York. (In press.)
- TANAKA, K., AND H. WATANABE. 1973. Allogeneic inhibition in a compound ascidian, *Botryllus primigenus* Oka. I. Processes and features of "noninfusion" reaction. *Cell. Immunol.* **7**: 410-426.
- TANEDA, Y., AND H. WATANABE. 1982a. Studies on colony specificity in the compound ascidian *Botryllus primigenus* Oka. I. Initiation of "nonfusion" reaction with special reference to blood cells infiltration. *Dev. Comp. Immunol.* **6**: 253-261.
- TANEDA, Y., AND H. WATANABE. 1982b. Studies on colony specificity in the compound ascidian, *Botryllus primigenus* Oka. II. *In vivo* bioassay for analyzing the mechanism of "noninfusion" reaction. *Dev. Comp. Immunol.* **6**: 243-252.
- TANEDA, Y., AND H. WATANABE. 1982c. Effects of X-irradiation on colony specificity in the compound ascidian, *Botryllus primigenus* Oka. *Dev. Comp. Immunol.* **6**: 665-673.

FEEDING STRUCTURES, BEHAVIOR, AND MICROHABITAT OF *ECHINOCYAMUS PUSILLUS* (ECHINOIDEA: CLYPEASTEROIDA)

MALCOLM TELFORD, ANTONY S. HAROLD, AND RICH MOOI

Department of Zoology, University of Toronto, Ontario, Canada, M5S 1A1

ABSTRACT

In the Firth of Lorne, Scotland, *Echinocyamus pusillus* was found most abundantly in highly variable, poorly sorted substrates at depths of 10–20 m. It was common in areas exposed to extensive wave and tidal current activity, but absent in fine sediments in sheltered areas. In size, feeding mechanism, and behavior, the species is highly adapted for nestling in the interstices between relatively large pebbles. The feeding mechanism is atypical for clypeasteroids: substrate particles with attached organisms are selected and transported by the suckered podia. At the mouth, particles are held in place and slowly rotated by the free margin of the peristomial membrane, while the teeth strip away diatoms and organic debris. The peristomial membrane and ciliation of spines and podia are shown in scanning electron micrographs of critical point dried material. The histology of these structures is described with special reference to mucus secretion. High resolution SEM micrographs show mucus secreting pores among the epithelial microvilli of suckered and buccal podia but not in the epithelium of miliary spines. The suggestion that *E. pusillus* might represent a sand dollar ancestor is discussed. The evidence presented supports the view that it is specialized rather than primitive.

INTRODUCTION

The fibulariids are a family of very small clypeasteroids including two principal living genera, *Fibularia* and *Echinocyamus*. These genera have most often been regarded as specialized rather than primitive forms (Clark, 1914; Mortensen, 1948). The family is thought to be most closely related to the Laganidae and Rotulidae (Mortensen, 1948; Hyman, 1955; Durham and Melville, 1957, *inter alia*). That species of *Echinocyamus* are specialized has not been accepted universally. Cuénot (1941) considered *E. pusillus* to be clearly primitive and proposed that the family Fibulariidae was the evolutionary point of departure leading to the more advanced clypeasteroids. Phelan (1977) seems to support this interpretation as does the phylogenetic dendrogram shown by Durham and Melville (1957). Most recently Ghiold (1982), following a study of such external structures as spines, podia, and pedicellariae, concluded that *E. pusillus* was not a true sand dollar and suggested that it and similar forms “. . . may represent an ancestral stage of the sand dollars.”

The fundamental body forms of the Clypeasteroidea appear to be shaped by hydrodynamic forces (Telford, 1981; Telford and Harold, 1982; and Telford, in press) and by the requirements of their peculiar rocking-sieve feeding mechanism (Goodbody, 1960; Seilacher, 1979; Mooi and Telford, 1982). In assessing the status of *Echinocyamus*, correct interpretation of morphology depends in part on understanding the chosen habitat and the feeding mechanism. Neither Nichols (1959), in the most extensive study of the morphology of *Echinocyamus*, nor Ghiold (1982) were able

to make direct observations of feeding. Therefore, previous knowledge of this process has been based only on inference. The species has been reported in "shelly gravel" (Nichols, 1959). Ghiold (1982) made a laboratory study of burrowing and locomotory activity in different sized sediment particles, but no complete sieve analyses of natural substrates have been given. Wolff (1968) reported that *E. pusillus* was abundant in the North Sea in "relatively coarse sands," with a median grain size of 210–460 μm . No further details of substrate composition were provided.

We present an account of the feeding mechanism of *E. pusillus* from direct laboratory observations. Additional morphological details of the structures involved, based on scanning electron microscopy (SEM) and histological examination, are provided. Substrate analysis, SEM examination of natural substrate material and analysis of gut contents are also presented in an attempt to explain local distribution, within the Firth of Lorne, Scotland.

MATERIALS AND METHODS

Collection

Specimens of *Echinocyamus pusillus* were collected by dredge with 91.4 cm \times 30.5 cm rectangular mouth, fitted with a double layer of 6 mm string mesh, inside a protective heavy rope mesh and by Petersen grab, 36.8 \times 33.0 cm. Animals were washed from the substrate by gently swirling with water in a plastic bowl, the method was analogous to gold panning but in this case we retained the lightweight urchins. Specimens were either fixed immediately or returned live to the laboratory where they were maintained in natural substrate material washed by constant running sea water at approximately 4°C.

Live observations

To observe feeding, the methods of Mooi and Telford (1982) were used. Animals were placed in darkened glass chambers constructed from microscope slides. They were given a thin layer of natural substrate with the larger particles (>4.0 mm) removed. Observations were made using a stereomicroscope focussed on an inclined front-silvered mirror beneath the chamber. Illumination was provided by a fiber optic light. Substrate particles handled by feeding animals were measured *in situ* by ocular micrometer. Gut contents of fresh animals were examined under the light microscope and those of preserved animals by SEM.

Specimen preparation

All material used in this study was fixed for 12 hours in 2% gluteraldehyde in filtered sea water. Specimens were then briefly rinsed and stored in 2% formalin in filtered sea water. Relaxation was difficult but best results were obtained by gradually transferring specimens to 3.5% Epsom salts in distilled water. Suckered podia were also well relaxed by propylene phenoxytol-saturated sea water. For histology, specimens were decalcified in Bouin's solution for 24 to 48 h (Mooi and Telford, 1982). Paraffin sections were cut at 4 μm and stained with Milligan's trichrome and Mallory-Heidenhain rapid one-step azan for general histology. Toluidine blue and PAS were used to investigate secretory structures. All histological procedures followed the methods of Humason (1967). For SEM, whole or dissected specimens were transferred through a graded series to pure acetone, critical point dried with carbon dioxide in a SORVALL bomb, and sputter coated with gold in a SEM-PREP II (Nannotech Thin Films,

England). Substrate particles and gut contents were gently washed in distilled water to remove salts, strewn on stubs, and freeze-dried before sputter coating.

Substrate

Samples were taken from the grab and dredged material. They were dried at 80°C, weighed, and then ashed at 400°C for 30 min. After cooling and reweighing, the samples were passed through screens of mesh size 12.50, 4.00, 2.00, 1.00, 0.50, and 0.25 mm, into a collecting pan. Each fraction was weighed separately and expressed as a percentage of the total. Organic content, calculated from weight lost during ashing, was similarly expressed as a percentage of the total dry weight. Repeated ashing confirmed that organic material was fully oxidized in the initial 30 minute period. Estimates of shell (biogenic) to mineral (abiogenic) particle ratios were made by frequency from light microscope observation. Whenever possible, the generic origin of the biogenic material was noted.

RESULTS

Habitat

Echinocyamus pusillus (4–14 mm length) was collected at several sites in the Firth of Lorne (Fig. 1), at depths of 10 to 200 m. They were most abundant in shallow water, 10–20 m, and very sparse below about 50 m. We found no *E. pusillus* living in sheltered areas such as Loch Creran nor in the lee of islands but they tended to be common in locations which, according to the West Coast of Scotland Pilot (1949),

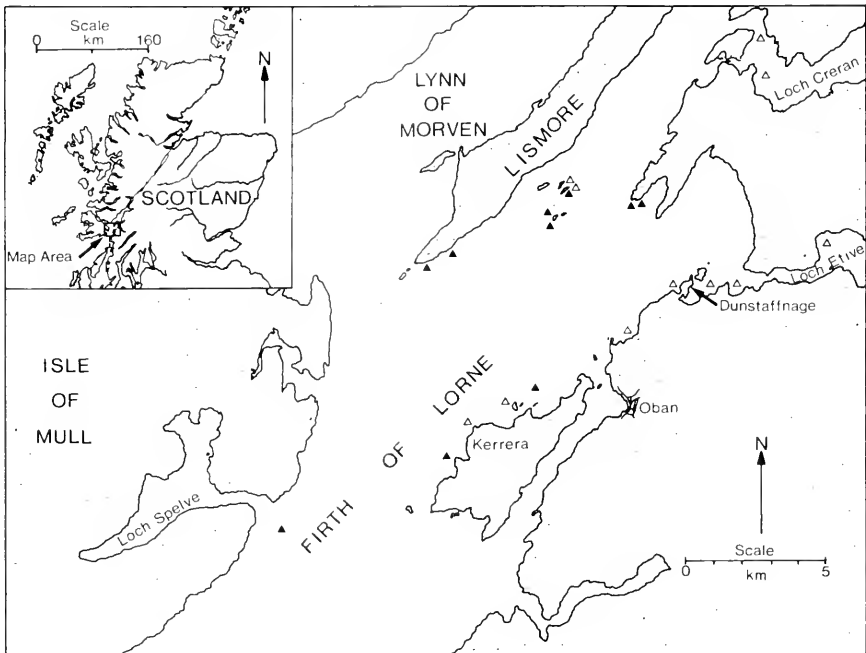

FIGURE 1. Collection sites in the Firth of Lorne, West Scotland. Solid symbols mark locations where *Echinocyamus pusillus* was obtained by dredging; open symbols indicate absence.

are exposed to strong currents. Greatest numbers (over 100 in a 10 minute dredge haul) were obtained along the exposed side of a promontory on the north side of a small bay, Camas Nathais ($56^{\circ}29'N$, $05^{\circ}28'W$). Six of seven grab samples taken from this site contained live *E. pusillus*. Analysis of particle sizes showed the substrate to be poorly sorted and highly variable (Table I). The Petersen grab tends to bias samples towards the smaller particle fractions, failing to collect the larger pebbles or rocks, sometimes returning to the surface empty. Several samples from the same location, were taken separately from the dredged material, from which unknown amounts of the finer particles had been lost during collection. A comparison of these with the grab material is shown in Table I. The fraction >12.5 mm included pebbles up to 100 mm, rarely to 200 mm. Bigger pebbles, often with attached macrophytic algae, were not included. Estimates of the ratio of shell to mineral particles, in different fractions of the samples, showed considerable variability (Table II). However, the shell component tended to be greatest around the 0.50 mm fraction. Maximum numbers of animals were found when the shell:mineral ratio in this size range was between 2:1 and 10:1, that is, about 67% to 91% shell material. Identification of organisms contributing to the shell component was possible in the larger particle fractions (Table II). Above 0.5 mm the shell comes primarily from the locally dominant pelecypods and gastropods. Below 0.5 mm, echinoderm spines and forams make significant contributions. Organic contents of the substrate were likewise rather variable, ranging from 0.8% to 2.7% by dry weight. We did not detect any correlation between organic content and the proportion of biogenic substrate particles. Substrate samples collected from several other sites in the Firth of Lorne and their characteristics were also very variable (Table III). *Echinocyamus pusillus* was not found in muddy substrates, with high proportions of fine particles (<0.25 mm).

General behavior

E. pusillus occupies the spaces between relatively large pebbles (>12.5 mm) where it either nestles (Nichols, 1959) or burrows (Ghiold, 1982) in pockets of sandy gravel. Substrate particles were moved over both the oral and aboral surfaces of exposed animals, by the action of suckered podia. Once covered, individuals retained a complete canopy of particles held firmly against the spine tips by the suckered podia, even when they were fully buried. The animals retracted their podia and gradually released particles when disturbed. During hours of daylight *E. pusillus* moved about very little but during darkness they often relocated themselves. Between the spines, water currents flow towards the peristome and from there to the periproct, as described previously (Nichols, 1959). These currents are generated by bands of cilia along the shafts of miliary spines, placed at right angles to the current flow (Fig. 2F); additional cilia are

TABLE I

Comparison of substrate samples taken by Petersen grab ($n = 7$) and dredge ($n = 9$) from the shallow bay, Camas Nathais (marked by two triangular symbols in Fig. 1)

Source	>12.5 mm	>4.0 mm	>2.0 mm	>1.0 mm	>0.5 mm	>0.25 mm	<0.25 mm
Grab	13.1 ± 18.2	10.5 ± 10.3	11.3 ± 6.9	19.7 ± 11.9	17.8 ± 10.4	13.9 ± 10.3	13.7 ± 9.8
Dredge	12.0 ± 9.1	13.7 ± 5.9	18.5 ± 6.6	25.7 ± 5.0	16.2 ± 4.6	9.8 ± 4.9	4.6 ± 2.8

Mean particle fractions (\pm S.D.) expressed as percent dry weight.

TABLE II

Shell to mineral particle ratios by number, expressed as percentages, and origin of biogenic material for substrate samples in which *Echinocyamus pusillus* was abundant

Dredge substrate samples:					
Fraction	4.0 mm	2.0 mm	1.0 mm	0.5 mm	0.25 mm
Range	15-90	30-85	50-90	30-95	25-95
Median	55	70	70	75	60
Petersen grab samples:					
Range	5-80	2-75	1-80	1-90	10-85
Median	20	55	60	75	70
Origin	Pelecypoda Gastropoda Polychaeta Echinodermata	Pelecypoda Gastropoda Echinodermata	Pelecypoda Gastropoda Echinodermata	Echinodermata Foraminifera	Foraminifera Echinodermata

Pelecypoda: *Astarte*, *Venerupis*, *Chlamys*, *Ensis*, *Cardium*.

Gastropoda: *Turritella*, *Patella*, *Calliostoma*.

Echinodermata: *Echinus*, *Psammechinus*, *Echinocyamus*, *Echinocardium*.

Median values for shell material give a good indication of the "typical" substrate.

located in relatively shorter bands on the primary spines, where they are restricted to the spine bases (Fig. 2B).

Feeding

During feeding, substrate particles were picked up and initially transported by the suckered podia which actively explored the substrate. Under the experimental conditions it was not possible to see whether podia on the aboral surface contributed equally to this process. Particles were held by the combined action of the sucker and secreted mucus: occasionally particles adhered to podia even when their suckers were fully expanded and visible. The handled particles ranged from 0.25 to 1 mm but were mostly about 0.5 mm in maximum dimension. The animals manipulated biogenic

TABLE III

Particle size fractions as percent dry weight for dredged substrate samples in which *Echinocyamus pusillus* was abundant, present, or absent

	>12.55 mm	>4.0 mm	>2.0 mm	>1.0 mm	>0.5 mm	>0.25 mm	<0.25 mm
Abundant	52.5	44.6	2.5	0.3	0.1	0.1	0.1
	13.0	21.6	29.9	26.3	8.6	0.4	0.3
	47.7	41.7	8.6	1.3	0.4	0.2	0.2
	27.2	61.5	2.0	1.9	5.8	1.4	0.2
Present	73.5	8.9	3.2	3.4	6.1	2.9	1.8
	49.2	25.3	17.6	6.0	1.1	0.5	0.4
	17.8	23.2	25.8	21.7	9.2	1.9	0.5
Absent	44.7	22.9	1.5	2.7	3.9	4.2	20.2
	53.2	8.3	4.0	5.5	7.5	7.1	14.2
	0.0	6.6	0.5	1.9	1.6	2.7	85.9

Results from single dredge hauls; samples too variable to justify calculation of means.

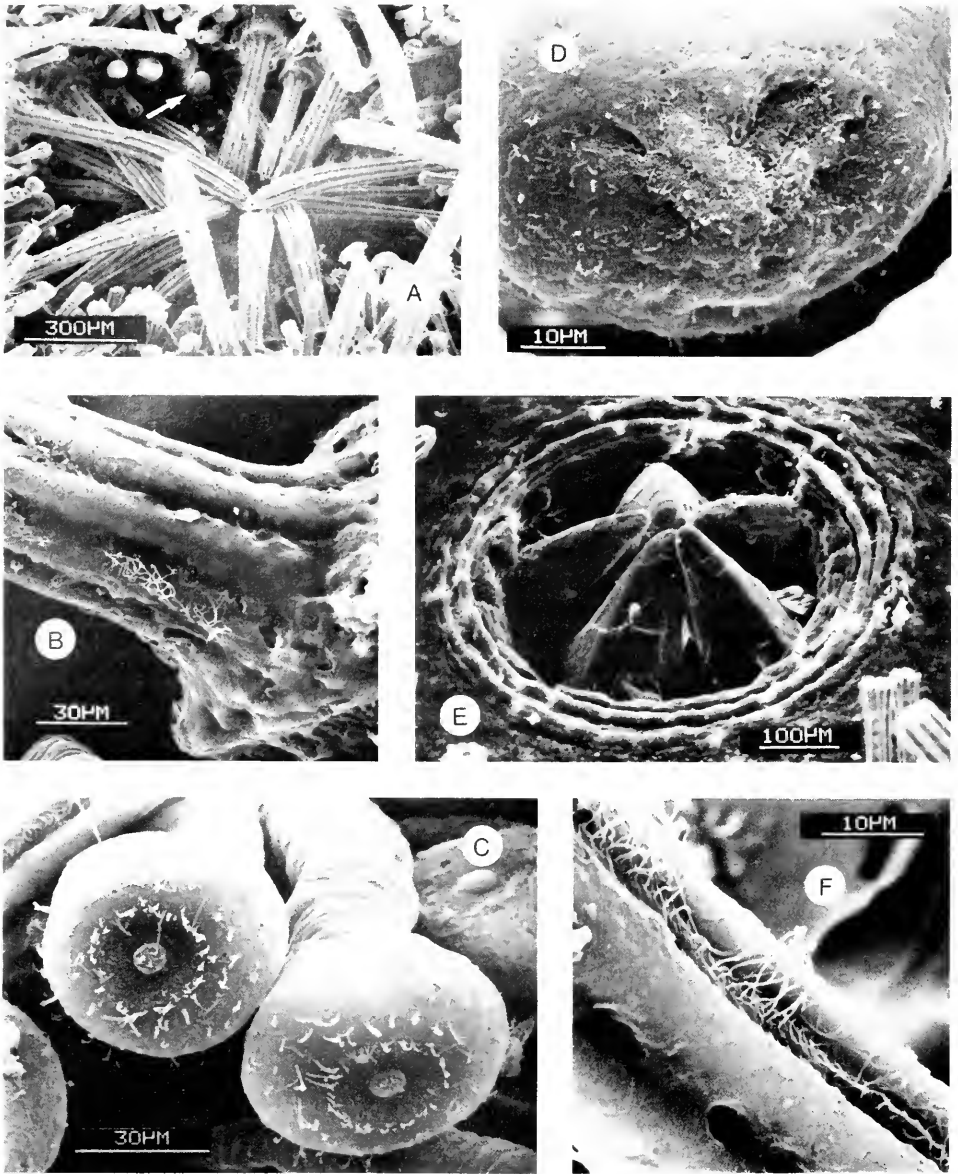

FIGURE 2. Scanning electron micrographs of *Echinocyamus pusillus*. (A) Tiered arrangement of circum-oral spines covering mouth; arrow indicates large, paired buccal podia. (B) Base of primary spine showing short band of cilia. (C) Tips of suckered podia showing cilia surrounding central nipple. (D) Sensory pad at tip of buccal podium, with scattered sensory cilia. (E) Mouth with circum-oral spines removed to show lips and protrusion of lantern teeth. (F) Distal end of miliary spine with band of cilia.

and native mineral particles in proportion to their occurrence in the substrate. Particles travelled towards the mouth area from podium to podium, until they reached the fringing circum-oral spines (Fig. 2A). These spines are arranged in two or three tiers, shorter spines near the mouth, longer ones further away, so that all of their tips can just reach the mouth itself. Five pairs of large buccal podia (Figs. 2A, D), much less

active than suckered podia but nonetheless highly extensible, surround the mouth. Fully elongated, they extend more than half way across the peristome and can readily reach into the mouth. Substrate particles arriving at the mouth region were received by the circum-oral spines and slowly manipulated into the mouth itself. During this process the particles were delicately explored by the buccal podia which collected loose organic material from the surface, or material dislodged by the action of the spines. This material was sometimes passed directly into the mouth by the podia and sometimes by the spines themselves. The greatest bulk of food, however, was obtained by the gnawing and scraping activity of the lantern teeth (Fig. 2E). Substrate particles were held against the teeth and, assisted by the circum-oral spines, they were carefully revolved by the free edge of the peristomial membrane, which functioned as a set of five mobile lips. When the particle had been stripped clean it was finally released and fell away from the mouth.

Anatomy of feeding structures

The tips of the suckered podia bear a ring of sensory cilia surrounding a central nipple (Fig. 2C) with more scattered cilia distributed outside the ring. Inside the ring of cilia there are numerous small secretory cells (10 μm in length) which stain brightly in azan (as noted by Nichols, 1959) and in Milligan's trichrome. Longer, very narrow secretory cells (15–17 μm) on the margin of the disk, outside the ring of cilia, are toluidine blue and PAS positive. These larger cells, which were not described by Nichols (1959), are difficult to detect in *E. pusillus* but are more conspicuous in other clypeasteroids (Mooi, 1983). Both types have external pores from which substances are exuded. These and other aspects of the detailed anatomy of the suckered podia have been treated by Nichols (1959) and Mooi (1983). The buccal podia (Fig. 3) also show features not observed by Nichols (1959). Many short sensory cilia are scattered over the large sensory pad (Figs. 2D, 4A). They are not confined to an outer ring, nor are they especially more numerous around the margin of the pad. The epithelium covering all surfaces of the spines and podia, including the sensory pad of the buccal podia, is densely supplied with microvilli. No cuticle is visible by SEM and the structure reported by Nichols (1959) is most probably the surface layer of microvilli. Around the sensory pad and extending towards its center there are numerous small pores (0.2–0.3 μm) among the microvilli (Figs. 4A, B) as in the suckered podia. Both PAS and triple stained sections show secretory cells wedged into the fibrous material of the sensory pad. Although the miliary spines are alleged to secrete mucus (Ghiold, 1982) we were unable to find any evidence of it. The tips of the miliary spines are covered by smooth, uninterrupted epithelium without any pores (Fig. 4C). No secretory pores could be found along the spine shafts. Histological sections show that the lumen of the miliary spines is packed with darkly staining nuclei and granular material, which is quite unlike the secretory cells found in the podia. The peristomial membrane is flexible and allows the lantern teeth to protrude slightly (Fig. 2E). It is thickened into lips (Figs. 5, 6) which grip substrate material during feeding. Histological examination shows a substantial layer of collagenous connective tissue which stains blue with azan and green with Milligan's trichrome. This layer is much more developed than in other clypeasteroids and is covered by epidermis which contains thickened areas of ciliated, secretory tissue, especially near the mouth opening. Secretions from these cells in the lips most likely assist in holding particles during feeding. As in the tips of podia, this thickened epithelium is reinforced by supporting fibers. The lips are operated by two layers of muscle, located on the inner surface of the peristomial membrane (Fig. 6). An outer layer of circumferential fibers act as sphincter muscles

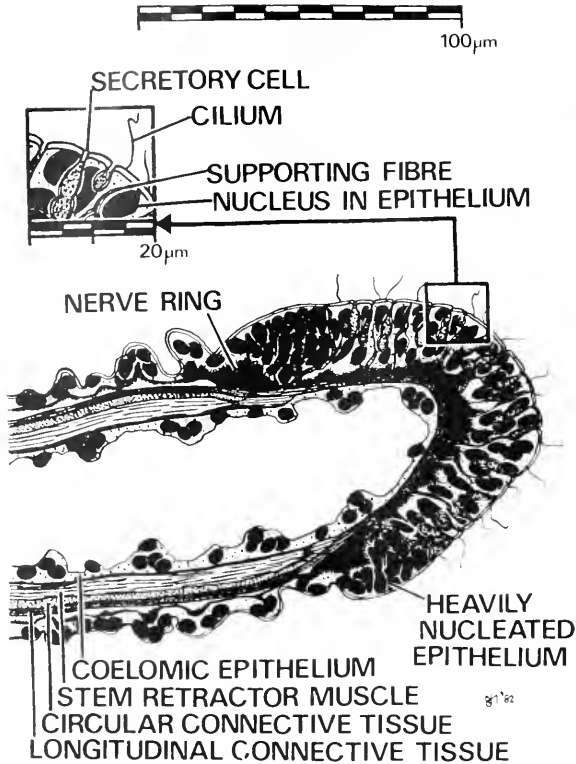

FIGURE 3. Section of buccal podium. The sensory pad consists of thickened, heavily nucleated epithelium with scattered cilia. Numerous secretory cells, squeezed between the epithelial cells (see inset), have short ducts opening among the epithelial microvilli (also see Figs. 4A, B).

to close the lips. An inner layer of radial muscles attached to the stereom of the peristome opens the lips.

Gut contents and substrate particles

Substrate particles selected by the suckered podia during feeding were often covered with organic material. Under light microscopy much of this appeared to be amorphous, flocculent stuff, but some diatoms and other algae were visible. Washed material prepared for SEM lacked most of the amorphous component but extremely numerous diatoms were found on many particles (Fig. 4D). Both light microscope and SEM examination of the gut contents of *E. pusillus* revealed fragmented and whole diatoms, small pieces of echinoderm spines, sponge spicules, forams, pieces of crustacean cuticle and setae, fragments of multicellular algae, assorted pieces of organic debris, and a few mineral fragments smaller than 0.25 mm. Diatoms made up much the greatest part of the recognizable material in the gut. Those identified included species of *Navicula*, *Nitzschia*, *Pinnularia*, *Pleurosigma*, *Fragilaria*, and *Cocconeis*. Several unidentified diatoms were also present.

DISCUSSION

The occurrence of *Echinocyamus pusillus* in shelly gravel or sand has been well documented (Mortensen, 1948; Nichols, 1959; Ghiold, 1982). Our observations in

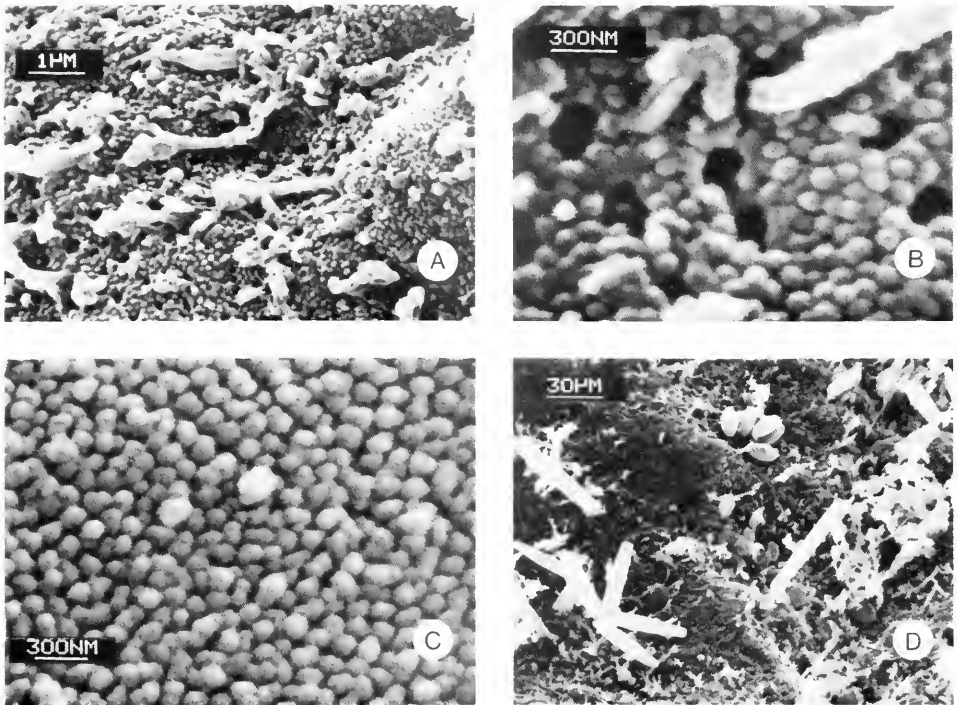

FIGURE 4. Scanning electron micrographs of *Echinocyamus pusillus*. (A) Cilia, microvilli, and secretory pores in sensory pad of buccal podium. (B) Microvilli and secretory pores (as in Fig. 4A). (C) Epithelial microvilli of military spine; no secretory pores were found anywhere on the spines. (D) Diatoms attached in shallow hollows of sand grain. Numerous mucilaginous threads mark earlier sites of attachment.

the Firth of Lorne suggest that the species occurs most commonly on substrates exposed to extensive wave and tidal current activity. These substrates may be disturbed and turned over frequently by current action and are, presumably, relatively well aerated. *Echinocyamus pusillus* was scarce or absent in fine, muddy sediments in sheltered areas (Fig. 1 and Table III) although Wolff (1968) was of the opinion that it might occur on such substrates. Other investigators (cited above) have emphasized the shell component of the substrate. The significance of this, if any, is difficult to determine. We have found *E. pusillus* to be abundant in gravelly substrates virtually free of shell debris and in substrates where shell rubble constitutes 90% or more of the particles (Table III). It seems likely that a wide range of particle sizes, including large pebbles with finer material between, and strong current exposure are the critical requirements. In the laboratory, *E. pusillus* ceased feeding when water flow, and hence oxygenation of the substrate, was low. In such active environments, shell debris may accumulate or even originate more readily from neighboring mollusc populations. We saw no evidence that the shell component was used preferentially by *E. pusillus* nor that the resident flora was greater than that on abiogenic particles. This observation is further supported by the fact that substrate organic contents were not related to the shell:mineral particle ratios. In fact, the most shelly substrates included both the lowest and highest percentages of organic material. SEM examination of substrate particles shows numerous diatoms, including many of those found in the gut of *E. pusillus*. Those shown in the SEM micrograph (Fig. 4D), are mostly attached in hollows of the grain surface, as noted by Meadows and Anderson (1968). The mi-

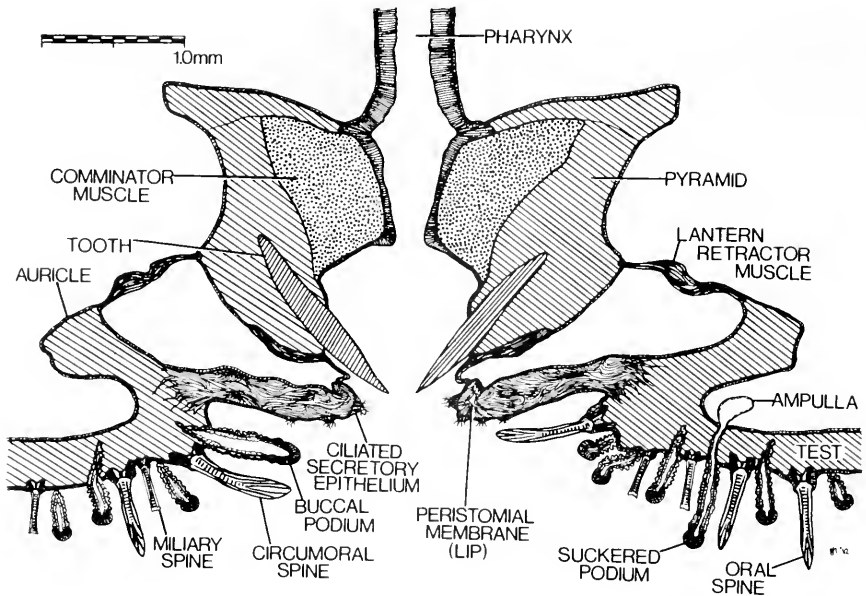

FIGURE 5. Cross section through mouth of *Echinocyamus pusillus* showing thickened peristomial membrane. The free margin of the membrane serves as a set of mobile lips which hold substrate particles in place while the lantern teeth strip away diatoms.

crograph also shows remnants of many more mucilaginous threads where diatoms were formerly attached.

The feeding mechanism of *E. pusillus* is markedly atypical of clypeasteroids, as Nichols (1959) correctly surmised. The use of the suckered podia to collect and transport food-bearing particles and, most especially, the use of the lantern teeth, is more characteristic of regular echinoids than any other group. The action of the lips at the margin of the peristomial membrane was quite unexpected and is unlike any mechanism previously described in feeding of clypeasteroids, such as sand dollars. It should, however, be noted here that sand dollars make extensive use of their accessory podia in drawing particles onto the sieving mechanism of the aboral surface (Goodbody, 1960; Bell and Frey, 1969; Mooi and Telford, 1982). Furthermore, *Clypeaster rosaceus*, another aberrant clypeasteroid, uses both the suckered podia and lantern teeth in a similar fashion.

Contrary to the opinion of Nichols (1959), the buccal podia do not seem to be solely sensory in function. Nichols did not observe secretory cells in these podia but in our sections they were present, in and around the sensory pad (Fig. 3). The pores seen among the microvilli (Fig. 4A, B) correspond in position with these cells and could be secretory outlets. These pores were never visible in areas lacking secretory cells. In addition to a major sensory function, the buccal podia are used also in collecting and transferring some of the food into the mouth. This use invites comparison with the feeding of spatangoids but the functional similarity is superficial, resting mostly on secretion of sticky substances. The simple paired buccal podia of fibulariids in no way approach the sophistication of the highly modified spatangoid feeding organs.

Ghiold (1982) reported the presence of large mucus secreting pores at the tips of miliary spines. In this study, histology did not show any evidence of secretory material

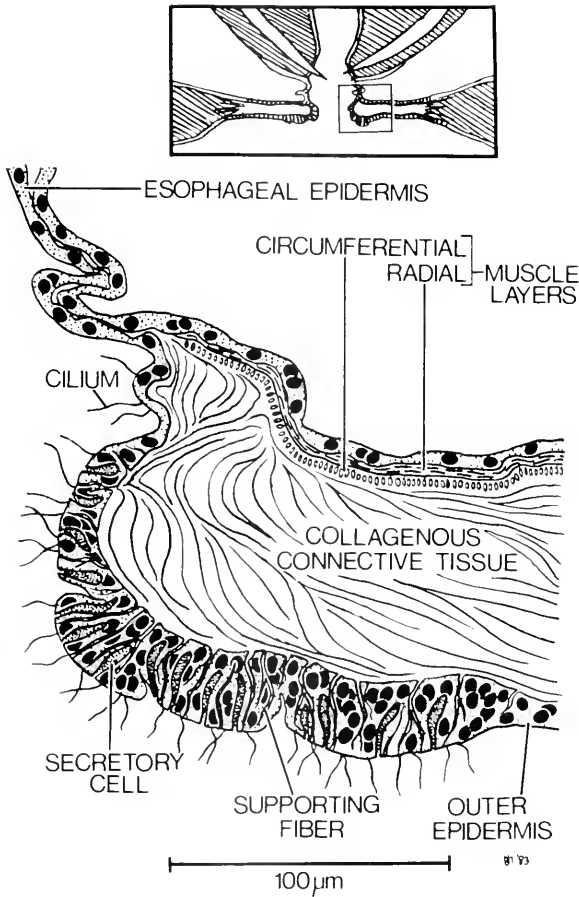

FIGURE 6. Section of edge of peristomial membrane (lip). The surface of the lip region is covered by thick secretory epithelium with scattered cilia. The lips are retracted by an inner layer of radial muscle fibers and closed by circumferential fibers.

in these spines. The lumena are filled with darkly staining nuclei and granules which do not react like secretory material with PAS or toluidine blue. Furthermore, SEM showed the total absence of pores in miliary spine epithelium (Fig. 4C). The large, terminal pores shown by Ghiold (1982) are undoubtedly artefacts due to poor specimen preparation: air-dried material is unsuitable for cellular details, such as microvilli, secretory pores, or cilia. The relatively large holes and depressions along the spine shafts (Figs. 2B, F) correspond with openings in the underlying stereom. The absence of secretory cells or granules within the spines, indicates that these openings, which might be artefacts, are not secretory pores.

Sand dollars such as *Leodia* and *Mellita* are thought to use the primary and miliary spines as a two-tiered sieve mechanism (Goodbody, 1960; Bell and Frey, 1969; Seilacher, 1979; Lane and Lawrence, 1982) which dislodges diatoms and organic debris from substrate particles. This material is then collected by ciliary currents and perhaps mucus secretion, moved to the mouth along well-defined food grooves, and there ingested. No such mechanism exists in *E. pusillus*. It is equipped with some of

the requisite structures but lacks others. There is a very clear differentiation between primary and miliary spines and the distribution of cilia on them is almost identical to that of *Echinarachnius parma* (Mooi and Telford, 1982). Ghiold (1982) has hypothesized that early clypeasteroids exploited surface cleansing currents as a new feeding system and that spine differentiation in *Echinocyamus* represents pre-adaptation in an early stage of the evolutionary development of this new mechanism. He offered no explanation of the possible adaptive significance of spine differentiation during this "pre-adaptational" stage. It is curious that the miliary spines of *E. pusillus* are more sharply differentiated and have more elaborate crowns than those of almost any other clypeasteroid. Others with highly differentiated miliary spines, although of somewhat different form, include the rotulids and mellitids, which are generally conceded to be advanced forms. Thus, according to this feature, *E. pusillus* could be regarded as advanced, not primitive. Departure from the characteristic mode of food transport in the clypeasteroids may also be considered as a secondary, specialized feature. The absence of any vestige of the food grooves or of a podial arrangement reminiscent of them, raises some interesting questions about the possible point of evolutionary divergence of the Fibulariidae. As remarked earlier, the family is generally placed close to the Laganidae, which have distinct but short food grooves, and the Rotulidae in which the grooves are much branched. Other clypeasteroids which have developed secondary feeding mechanisms, such as *Dendroaster excentricus* (Timko, 1976; O'Neill, 1978), have retained clear food grooves. This species, of course, readily feeds in the conventional mode as well as in the upright posture.

In summary, we tend to agree with the early opinion of Clark (1914) that *Echinocyamus pusillus* is a specialized, not a primitive species. Spine differentiation and ciliation are characteristics shared with all clypeasteroids, which makes it unlikely that *Echinocyamus* could in any sense represent an ancestral form of the true sand dollars. Their small size is most probably an adaptation to existence in pockets of sediment between frequently moving pebbles or stones, on substrates worked by currents. The rocking sieve mechanism described for some species, appears to work best with the relatively fine particles found in well-sorted substrates in which sand dollars most commonly occur. The small surface area of the specialized fibulariids provides insufficient spines to make an effective sieve. They rely, instead, on the collection of individual particles from which food material can be stripped by the lantern teeth.

ACKNOWLEDGMENTS

This work has been supported by the Natural Sciences and Engineering Research Council of Canada through Operating Grant #A 4696. We gratefully acknowledge support from the British Council who provided a travel grant under the ALIS program to M.T. We also wish to thank the staff of the Dunstaffnage Marine Research Laboratory, Scotland, and in particular Alan Ansell and Ian Drummond, for assistance and hospitality. We are indebted to Eric Lin, Department of Zoology, University of Toronto, for technical assistance with SEM.

LITERATURE CITED

- BELL, B. M., AND R. W. FREY. 1969. Observations on ecology and the feeding and burrowing mechanisms of *Mellita quinquesperforata* (Leske). *J. Paleontol.* **43**: 553-560.
- CLARK, H. L. 1914. Hawaiian and other Pacific Echini. The Clypeasteridae, Arachnoididae, Laganidae, Fibulariidae and Scutellidae. *Mem. Mus. Comp. Zool.*, Harvard College, XLVI No.1.
- CUÉNOT, M. L. 1941. Un paradoxe évolutif: la néoténie chez les Oursins. *Compt. Rend. de l'Acad. des Sci.* Feb. 1941.

- DURHAM, J. W., AND R. V. MELVILLE. 1957. A classification of echinoids. *J. Paleontol.* **31**: 242-272.
- GHIOLD, J. 1982. Observations on the clypeasteroid *Echinocyamus pusillus* (O. F. Muller). *J. Exp. Mar. Biol. Ecol.* **61**: 57-74.
- GOODBODY, I. 1960. The feeding mechanism in the sand dollar *Mellita sexiesperforata* (Leske). *Biol. Bull.* **119**: 80-86.
- HUMASON, G. L. 1967. *Animal Tissue Techniques*. W. H. Freeman and Co., San Francisco. 569 pp.
- HYMAN, L. 1955. *The Invertebrates 4: Echinodermata*. McGraw-Hill Co., NY. 763 pp.
- LANE, J. M., AND J. M. LAWRENCE. 1982. Food, feeding and absorption efficiencies of the sand dollar, *Mellita quinquesperforata* (Leske). *Estuarine Coastal Shelf Sci.* **14**: 421-431.
- MEADOWS, P. S., AND J. G. ANDERSON. 1968. Micro-organisms attached to marine sand grains. *J. Mar. Biol. Assoc. U.K.* **48**: 161-175.
- MOOI, R. 1983. *Morphology, Diversity and Function of Non-respiratory Podia of Clypeasteroids (Echinodermata: Echinoidea)*. M. Sc. Dissertation, University of Toronto.
- MOOI, R., AND M. TELFORD. 1982. The feeding mechanism of the sand dollar *Echinarachnius parma* (Lamarck). *Proc. Int. Echinoderms Conf.*, Tampa Bay (1981). Pp 51-57.
- MORTENSEN, Th. 1948. *A Monograph of the Echinoidea IV: 2. Clypeasteroidea*. C. A. Reitzel, Copenhagen. 471 pp.
- NICHOLS, D. 1959. The histology and activities of the tube-feet of *Echinocyamus pusillus*. *Q. J. Microsc. Sci.* **100**: 539-555.
- O'NEILL, P. L. 1978. Hydrodynamic analysis of feeding in sand dollars. *Oecologia* **34**: 157-174.
- PHELAN, T. F. 1977. Comments on the water vascular system, food grooves, and ancestry of the clypeasteroid echinoids. *Bull. Mar. Sci.* **27**: 400-422.
- SEILACHER, A. 1979. Constructional morphology of sand dollars. *Paleobiology* **5**: 191-221.
- TELFORD, M. 1981. A hydrodynamic interpretation of sand dollar morphology. *Bull. Mar. Sci.* **31**: 605-622.
- TELFORD, M. An experimental analysis of lunule function in the sand dollar *Mellita quinquesperforata* (Leske). *Mar. Biol.* (in press).
- TELFORD, M., AND A. S. HAROLD. 1982. Lift, drag and camber in the northern sand dollar, *Echinarachnius parma*. *Proc. Int. Echinoderms Conf.*, Tampa Bay (1981). Pp 235-241.
- TIMKO, P. L. 1976. Sand dollars as suspension feeders: a new description of feeding in *Dendraster excentricus*. *Biol. Bull.* **151**: 247-259.
- West Coast of Scotland Pilot*, 9th Ed. 1949. Hydrographic Dept., Admiralty, London.
- WOLFF, W. J. 1968. The Echinodermata of the estuarine region of the rivers Rhine, Meuse, and Scheldt, with a list of species occurring in the coastal waters of the Netherlands. *Neth. J. Sea Res.* **4**: 59-85.

THE ROLES OF HEMOCYTES IN TANNING DURING THE MOLTING CYCLE: A HISTOCHEMICAL STUDY OF THE FIDDLER CRAB, *UCA PUGILATOR*

LINDA L. VACCA¹ AND MILTON FINGERMAN²

¹*Department of Anatomy, The University of Kansas Medical Center, Kansas City, Kansas 66103 and*

²*Department of Biology, Tulane University, New Orleans, Louisiana 70118*

ABSTRACT

Histochemical data support the previous biochemical finding that the blood is a major site for the production of proteinaceous and diphenolic substances for tanning of the cuticle in the fiddler crab, *Uca pugilator*. Five types of hemocytes are described. Specifically in tanning, the hyaline cells (cystocytes) appear responsible for the production of diphenolic tanning agents whereas the granulocytes synthesize the proteins involved. Other types of hemocyte may be transitional forms involved in clotting (intermediate cells). Various histochemical reactions for each type of hemocyte and the cuticle are recorded throughout the molting cycle, and appear cyclic. The data suggest there is hormonal control of the cyclic events during the tanning process.

INTRODUCTION

At least in some arthropods, sclerotization consists of two major processes: (1) the biosynthesis of tanning agents (N-acetyldopamine and N-acetylnoradrenalin) from their amino acid precursors (tyrosine and phenylalanine), and (2) the subsequent incorporation of the newly formed tanning agents into the cuticle (Brunet, 1965; Koeppe, 1971; Vacca and Fingerman, 1975a, b). In the cockroach, the synthesis of the tanning agent, N-acetyldopamine, begins within the hemocytes (Whitehead, 1969). However, in crustaceans, the synthesis site of the tanning agents remains unknown. Crustaceans, like insects, maintain high metabolic pools of free amino acids within the hemolymph (Awapara, 1962; Florkin and Schoffeniels, 1965). In the hemolymph of the crab, *Carcinus maenas*, most of the free amino acid pool is concentrated within the hemocytes (Evans, 1972). The blood cells, although they provide only 1% of the total blood volume, contain 58% of the total free amino acid concentration. In this way, the blood cells maintain a steep gradient against the serum; but the purpose of this gradient remains obscure. Presumably some of the free amino acids could serve as precursors for tanning agents and their protein carriers.

Early workers regarded one type of crustacean hemocyte, the granulocyte, as a carrier of metabolites (Tait and Gunn, 1918). However, more recent evidence supports other functions also, including phagocytosis, wound agglutination, blood coagulation, parasitic encapsulation, basement membrane formation, and storage of glycoproteins (George and Nichols, 1948; Dumont *et al.*, 1966; Bang, 1967; Wood and Visentin, 1967; Strutman and Dolliver, 1968; Busselen, 1970; Wood *et al.*, 1971; Ravindranath, 1980). On the other hand, these data fail to explain why the clotting ability of the blood is minimal at ecdysis, precisely when the soft-shelled animal is most susceptible

Received 14 February 1983; accepted 16 September 1983.

Abbreviations: Az-Eo, azure-eosin; DAS, diazosulfanilic acid; DAS-AzA, diazosulfanilic acid pH 1 azure A; DOPA, dihydroxyphenylalanine; FeII, ferrous iron; FeIII, ferric iron; NQS, beta-naphthoquinone-4-sulfonate; PAS, periodic acid-Schiff; PCB, post-coupled benzylidine; RNA, ribonucleic acid.

to injury and infection (Bang, 1967; Levin, 1967; Strutman and Dolliver, 1968). Since the hemocytes do not clot well during ecdysis, they may be involved with yet another and more important function during this period, namely tanning.

Reportedly, cyclic fluctuations occur during the molting cycle in: (a) the enzymatic activity of blood phenoloxidase (Pinhey, 1930; Declair and Vercauteren, 1965; Summers, 1967); (b) the numbers of circulating hemocytes (Bruntz, 1907; Kollman, 1908; Marrec, 1944); and (c) the appearance of carrier proteins which transport tanning agents from the hemolymph into the cuticle at ecdysis (Vacca and Fingerman, 1975a, b). These cycles suggest that the hemocytes of crustaceans may have a special function which is intimately associated with the tanning process. That the hemocytes can penetrate the epithelium and synthesize protein during the secretion of the proecdysial cuticle in the crayfish *Orconectes limosus* (Keller and Adelung, 1970) further implies that they are involved in the tanning process. The present investigation explores this possibility in the fiddler crab, *Uca pugilator*, by a histochemical study of the hemocytes during the molting cycle. The histochemical reactions of the developing exoskeleton are correlated.

MATERIALS AND METHODS

All observations were made on fiddler crabs (*Uca pugilator*) during various stages of the molting cycle. Stock male and female fiddler crabs were maintained individually in finger-bowls containing enough artificial sea water (Instant Ocean, Aquarium Systems, Inc.) to cover the bottom 1 cm deep. The water was changed every 2-3 days after the animals were fed a few flakes of oatmeal. Crabs were induced into a precocious proecdysial period and eventual ecdysis as previously described (Vacca and Fingerman, 1975a, b) by removing both eyestalks (Brown and Cunningham, 1939) or by autotomizing several legs (Skinner and Graham, 1972; Fingerman and Fingerman, 1974). The intermolt crabs were intact specimens that had undergone ecdysis (induced by limb removal) and limb regeneration at least 1 month prior to use.

Stages of molt were determined according to Guyselman (1953). Proecdysial animals were selected from eyestalkless or autotomized crabs. They showed external evidence of apolysis, a bluish gray opalescence on the carapace. Forty-four specimens were selected at different stages in the molting cycle including ecdysis, various times of postecdysis (5, 10, 24 and 48 h), proecdysis, and intermolt. The crabs were fixed *in toto* either by injection of, or immersion in various fixatives including 10% neutral phosphate-buffered formalin and 6% neutral phosphate-buffered glutaraldehyde to which 6% NaCl was added; formalin-acetic acid-salt (10%:5%:5%); chloroform:methanol (2:1); and Barnett and Bourne silver fixative (Lillie, 1965).

The crabs were bisected to allow rapid entry of the fixatives, and were fixed for 24 hours. After a thorough washing, they were dehydrated in graded alcohols, and cleared in xylene. Tissues were then embedded in paraffin *in vacuo*.

Tissue sections (6-8 μm) were stained with azure-eosin (Az-Eo), pH 4.5, and examined for numbers and types of blood cells. The extinction coefficient of basic dye uptake by the hemocytes was determined with toluidine blue 0 (0.1%) at pH 1 through 3.

Other histochemical tests included: the periodic acid-Schiff (PAS) reaction for the identification of 1,2-glycols (Mowry, 1963); black Bauer and black periodic techniques for aldehyde detection (Lillie, 1965); and Sudan black B for the localization of lipids (Lillie, 1965).

In conjunction with these procedures, various blockades were used. Acetylation was accomplished after 3 hours at 60°C in a 2:3 mixture of acetic anhydride: pyridine

(Barka and Anderson, 1963), to distinguish lipid from other PAS-reactive substances. Deacetylation was performed by immersing tissue sections in ammonium hydroxide:ethanol (1:4) for 24 hours (Lillie, 1965). Incubation in saliva (1–3 h) was used to identify glycogen. To distinguish bacteria from other intra- and extracellular inclusions, ribonucleic acid (RNA) was extracted by incubating tissue sections in KOH (1% in 70% ethanol, 15–20 min.).

Several diazotized dyes were prepared for the demonstration of proteins and phenols (Lillie, 1965). These included: diazosafranin, pH 3.2 for serotonin (Lillie *et al.*, 1973a), or pH 7.8 for proteins; and diazosulfanilic acid, followed by pH 1 azure A (DAS-AzA), for norepinephrine or another primary catecholamine (Lillie *et al.*, 1973b). Lack of extraction of the colored tissue sites by acid (0.1 *N* HCl for 24 h at room temperature) verified azo-coupling.

Blocking procedures were used in conjunction with the localization of phenols. Oxidation was carried out with periodic acid (1%, 30 minutes); reduction with 5% sodium dithionite (2 or 4 two-hour incubations). Ferrous chloride (FeCl₂, 0.1 *M*, 2 h), freshly prepared by the method of Lillie *et al.* (1971), was used to block histidine staining by the DAS-AzA technique, was previously demonstrated in mammalian erythrocytes (see Lillie *et al.*, 1973b, c).

Indole derivatives were visualized by the post-coupled benzylidine (PCB) reaction (Glennner and Lillie, 1957). The beta-naphthoquinone-4-sodium sulfonate (NQS) method of Lillie *et al.* (1971) was used to demonstrate sites rich in arginine. The Morel-Sisley procedure for the demonstration of tyrosine was also applied (Lillie, 1965). The reaction for tyrosine was blocked by pretreatment (6 h at room temperature) with tetranitromethane (0.1 ml in 10 ml pyridine to which 20 ml 0.1 *N* HCl was added).

To demonstrate amino groups, slides were mordanted for two hours in FeCl₂, then stained with neutral hematoxylin, with and without prior deamination. Deamination was accomplished over a 24 hour period at 4°C in a mixture of 14% sodium nitrite in 2 *N* acetic acid.

Ferric ferricyanide was used to identify reducing sites. To distinguish phenolic sites from iron reaction, sections were reacted with acid ferri- and ferrocyanide. To differentiate between sites of reduction and oxidation respectively sections were first mordanted in FeCl₂ (0.1 *M*; 2 h), then reacted with acid ferri- and ferrocyanide.

Sections were incubated in acid silver (0.1 *M* AgNO₃ in 0.01 *M* acetate buffer, pH 5.0) in the dark (24 h at room temperature) to demonstrate further the presence of reducing substances (Lillie, 1957). Additionally, ammoniacal silver procedures were applied to the tissue sections for 10 minutes and 24 hours in the dark at room temperature (Lillie, 1965).

Several procedures were used to localize copper. These included Clara's (Mallory's neutral) hematoxylin (Lillie, 1965) and ammoniacal rubanic acid, with and without mordanting in a copper sulfate solution (2.5% in 50% alcohol for 2 h).

RESULTS

During all stages of the molting cycle, two main types of blood cells could be distinguished histochemically by the presence or absence of acidophilic cytoplasmic granules (Az-Eo; Figs. 1A, 2A): (a) large hemocytes containing numerous acidophilic (eosinophilic) granules in an abundant acidophilic cytoplasm were recognized as granulocytes and (b) smaller agranular cells exhibiting a scanty pale basophilic cytoplasm around an intensely basophilic nucleus were identified as hyaline cells (also known as cystocytes). On rare occasions, a third type of blood cell could be seen (Fig. 2) which seemed to be an "intermediate" or transitional type. It resembled the hyaline

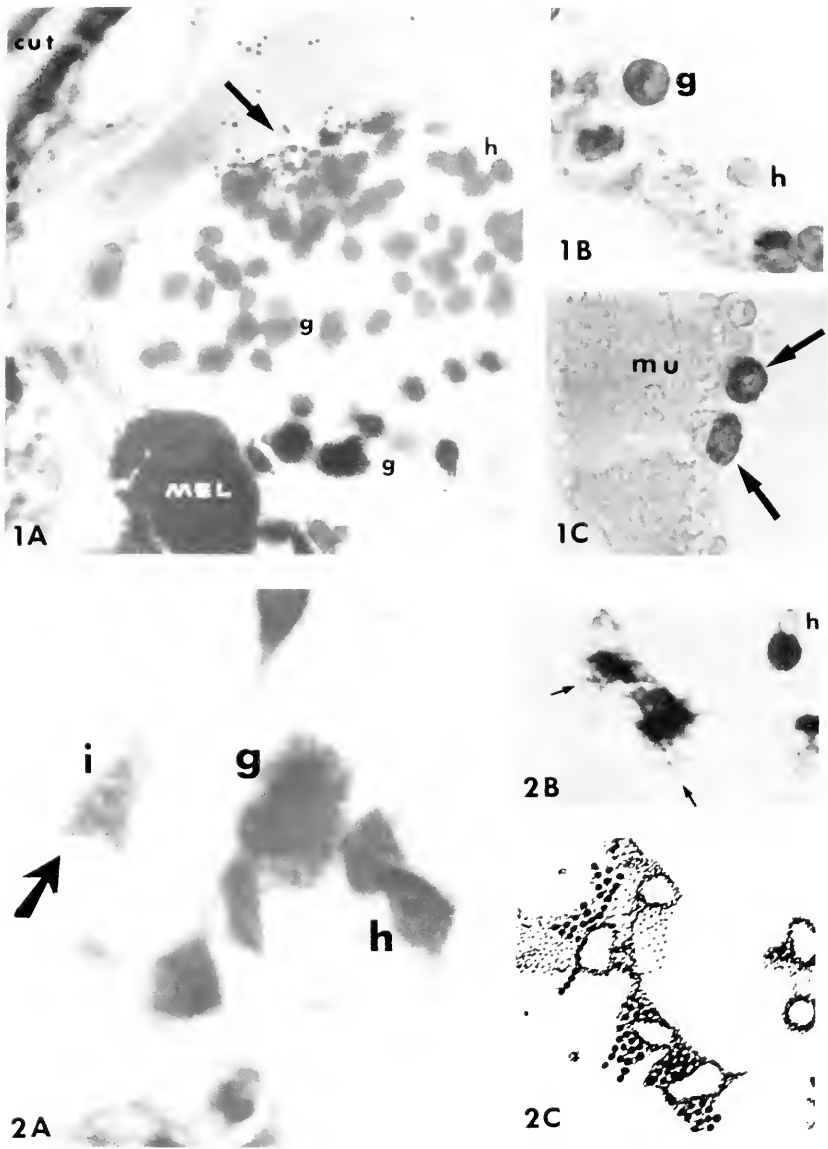

FIGURE 1. Two main types of hemocyte can be identified in the blood of *Uca*: granulocytes (g) and hyaline cells (h). In Figure 1A these hemocytes aggregate in great numbers near the epidermis and soft cuticle (cut) of a crab fixed in a buffered glutaraldehyde-salt fixative. Granulocytes and hyaline cells appear scattered within the eosinophilic serum which contains numerous granules (arrow). Certain granules exhibit basophilia; others exhibit acidophilia. Az-Eo, pH 4.5. MEL, melanophore. $\times 430$. Figure 1B shows the positive reaction for arginine in the granulocytes (g) and the negative reaction in the hyaline cells (h). NQS. $\times 600$. Figure 1C demonstrates reducing substances in small (immature?) granulocytes (arrows) found deep within the hemocoel. Ferric ferriicyanide. mu, muscle. $\times 600$.

FIGURE 2. Besides hyaline cells and granulocytes, a third type of hemocyte (intermediate or transitional type) can be seen within the hemocoel. In Figure 2A a specimen fixed in formalin:acid:salt during late intermolt, the intermediate type (transitional cystocyte) hemocyte (i, arrow) approximates the size of the hyaline cell (h) and exhibits tiny unstained granules within a less extensive cytoplasm than the granulocytes (g). Az-Eo, pH 4.5. $\times 900$. Figure 2B shows intermediate cells (arrows) releasing tiny proteinaceous granules which have azo-coupled with DAS. The hyaline cell (h) contains diphenols. The hemocytes appeared in a specimen fixed 10–15 hours postecdysis in buffered formalin-salt. $\times 600$. Figure 2C represents a diagrammatic interpretation of the intermediate cells rupturing and releasing their granules, thereby forming a cytoplasmic network which may function in clotting.

cell in size and nuclear:cytoplasmic ratio, but it contained a number of cytoplasmic granules like the granulocyte. However, the granules were smaller than those observed in the granulocyte and were refractory to staining with acid and base dyes; also they occurred within an unstained cytoplasm. Two additional types of granule-containing (transitional?) cells, large and small granular cells contained swollen granules which were discerned by other histochemical procedures (Figs. 3 and 4).

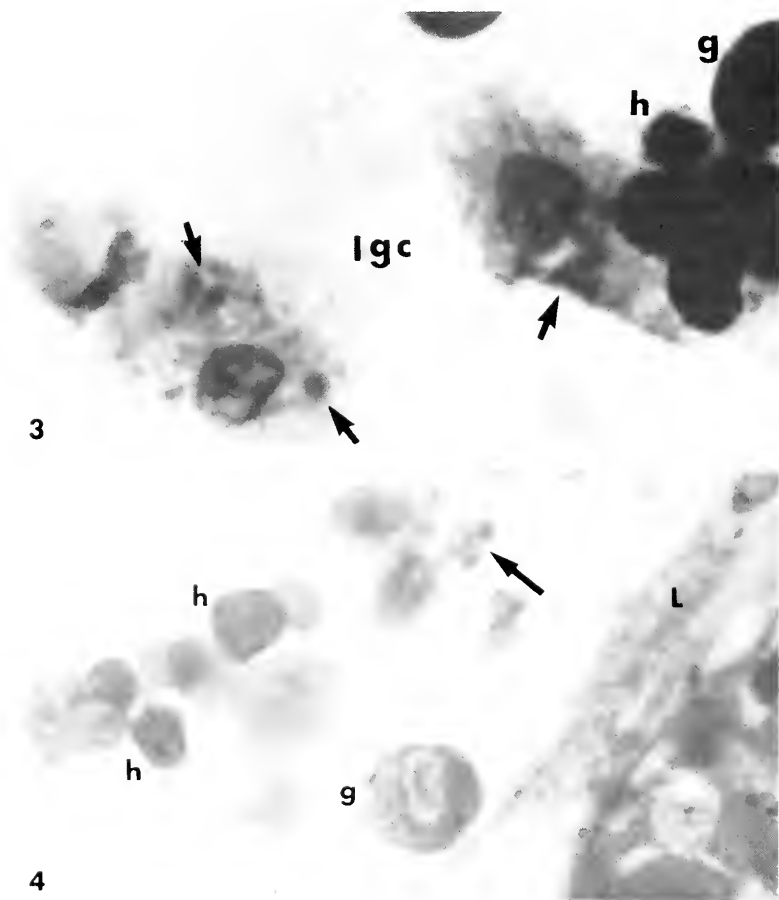

FIGURE 3. Small aggregates of hyaline cells (h) occur in the hemocoel of a crab fixed five hours postecdysis in buffered glutaraldehyde-salt. Granulocytes (g) are rare. Two large, flattened hemocytes exhibit an extensive and faintly basophilic cytoplasm which contains numerous swollen granules. Intensely eosinophilic, smaller granules surround a reticulate nucleus; peripheral granules are larger and slightly basophilic (arrows). These hemocytes have been identified as large granular cells (lgc's). Az-Eo, pH 4.5. $\times 900$.

FIGURE 4. Hyaline cells (h) and granulocytes (g) accumulate within the hemocoel beneath the epidermis underlying the newly formed cuticle of a crab fixed between 10 and 15 hours postecdysis in buffered formalin-salt. The granulocyte contains histidine in the cytoplasm and granules. The small hyaline cells possess a diphenol; a few appeared unstained as if they had released their phenolic contents. The arrow points to a small granular cell which contains swollen proteinaceous granules of undetermined function. A leucophore (L) passes across the field at right beneath the epidermis. DAS-AzA. $\times 900$.

Fluctuations in the number of hemocytes during the molting cycle

To determine whether fluctuations occurred in the number of hemocytes during the molting cycle, counts were made in the tissue sections taken from each tissue block. The sections were examined microscopically using low magnification (100×) for an area heavily populated with hemocytes. Using high magnification (450×) two counts were made of the hemocytes in that area.

The granulocytes and hyaline cells were counted; their relative numbers varied with the stages of the molting cycle. During intermolt and proecdysis, there were twice as many granulocytes as hyaline cells. At ecdysis, the numbers of both granulocytes and hyaline cells increased: two-fold and ten-fold, respectively. Thus, the proportion of granulocytes and hyaline cells (2/5) was the inverse of that in the earlier two stages. By 5–10 hours postecdysis, the hyaline cells outnumbered the granulocytes by 10:1. However, 24–48 hours postecdysis, the numbers of both types of hemocyte gradually declined. The decline was more severe among the hyaline cells, which still prevailed over granulocytes by 2:1 by 24 hours postecdysis.

During intermolt and proecdysis, the hemocytes were usually floating freely in the hemocoel. At ecdysis and throughout postecdysis, numerous hemocytes aggregated beneath the epidermal cells and penetrated the epidermal layer, approaching the newly formed cuticle (Fig. 1). In sections of crabs fixed at ecdysis and during early (5–10 h) postecdysis, numerous hyaline cells were packed together into large nodules floating near the epidermis, or occasionally freely within the hemocoel. In some specimens, small aggregates were formed near the epidermis by hyaline cells surrounding an occasional granulocyte (Fig. 3). Among the small aggregates, a fourth type of hemocyte could be identified as a large granular cell (Fig. 3). The large granular cells contained two types of swollen granules within a flattened faintly-basophilic cytoplasm; pale acidophilic granules encircled the nucleus, whereas basophilic granules populated the extensive peripheral cytoplasm. The pale basophilic nucleus had a reticulate chromatin network and contained an intensely basophilic nucleolus.

Histochemical observations—the hemocytes and the serum

Basophilia, acidophilia, glycogen, 1,2-glycols, lipids, and aldehydes. The basophilic staining of the hyaline cell cytoplasm became extinguished at pH 3 (Table I). At this pH the granules within granulocytes stained metachromatically; granule staining became abolished at pH 2 and basophilic nuclei and melanophore granules (still apparent at pH 1) could be visualized.

By PAS staining, the granulocytes contained 1,2-glycols which concentrated within the granules; the cytoplasm reacted moderately. By contrast, the hyaline cells appeared negative. The serum showed transient reactions which varied with the stages of the molting cycle: during early postecdysis the serum became filled with 1,2-glycols and numerous intensely PAS-positive granules like those in the granulocytes. Intensely PAS-positive granules also appeared within the epidermal cells and tegumental glands during this period. At the other stages of the molting cycle, the serum, epidermal cells, and glands became devoid of the presumed glycoprotein(s).

Fixation of crabs in chloroform:methanol freed the tissues of lipids, but no change occurred in the PAS reactions of the granulocytes (cytoplasm and granules) or the "serum granules." The serum exhibited reduced staining by PAS which could be ascribed to extracted lipids, but no sudanophilia could be demonstrated. Further proof that PAS stained non-lipid substances was obtained when acetylation abolished

TABLE I

Summary of histochemical reactions in the hemocytes, serum, cuticle, and melanophores of the fiddler crab*

Cell or tissue component	Histochemical reactions									Azo-Serotonin
	Basophililia	Acidophililia	Stain extinction	Glycogen	1,2-Glycols	Lipids	Induced aldehydes	Native aldehydes	Proteins	
Hyaline cell	+	-	pH 3	-	-	-	± to -	-	±	-
Granulocyte	-	+	pH 2	+	+	±	++	± to -	++ to -	-
Serum	-	+	>pH 3	±	±	±	±	-	± to - (hard) + (soft)	-
Exocuticle										
hard	+	+ (endo only)	>pH 3	-	-	-	-	-	± to ±	-
soft	-	-	>pH 3	-	±	-	-	-	±	-
Melanophore granules	±	-	pH 1	-	-	-	-	-	++	+

* Note: The words "hard" and "soft" refer roughly to the state of the cuticle during the molting cycle. "Exocuticle" was taken as representative for histochemical changes also occurring in the endocuticle (endo) during the molting cycle which often appear in parallel but at different times. Results were recorded separately when a difference in staining capacity was noted. The symbols indicate strength of the histochemical reaction: ++, intensely positive; +, positive; ±, moderately positive; ±, mildly positive; -, negative.

the reactions in the granulocytes, some of the serum granules, and reduced the PAS reaction in the serum itself; deacetylation partially restored the reactions. Digestion of glycogen from the tissue sections did not change the PAS reactions within the granulocytes. However, some of the "serum granules" showed reduced staining and therefore contained glycogen.

The induced aldehyde groups detected by black Bauer and black periodic techniques were intensely visualized within the granulocytes. In contrast, the hyaline cells reacted mildly or sometimes not at all.

Native (free) aldehydes were detectable (by direct application of Schiff reagent, 1 hour, to the tissue sections) in granulocyte cytoplasm, especially the perinuclear region, during intermolt, proecdysis and late postecdysis, but not during early postecdysis. The intracellular granules did not stain. Likewise, the hyaline cells and serum did not react.

Diazotization reactions for aromatic end-groups. The aromatic end-groups of proteins azo-coupled intensely (diazosafranin pH 7.8) within the granulocytes during most of the molting cycle (except late postecdysis) but only mildly in the hyaline cells. Interestingly at 48 hours postecdysis the granulocytes lost the ability to azo-couple as if they had released the responsible proteins. During this period, the serum showed increased reactions as if it had received the proteins released from the granulocytes. However, during proecdysis the serum must not have contained these proteins because it did not react. Subsequent extraction of the azo-coupled tissue sections in

TABLE I (Continued)

coupling		Protein End-Groups					
Catechol- amines	Histi- dine	Tryptophan	Arginine	Tyro- sine	Amino	Reducing substances	Copper
++ to -	-	± to -	-	±	±	- (hard) ± (soft)	±
-	+ to ++	+ to ±	±	++	++	- (hard) + (soft)	++ (hard) + (soft)
± to - (hard) + (soft)	±	± (hard) + to ± (soft)	-	±	± to ± (hard) ± to - (soft)	+ to -	+ to ± (hard) ± (soft)
- ++ to ±	±	- ± to -	- ± to -	- ±	- ++ to ±	± to - ++ to +	± + to ±
- (cytoplasm ++)	+	+	-	-	-	+ (hard) ++ (soft) (cytoplasm +)	-

dilute HCl failed to remove the tightly bound dye. Serotonin could not be detected using diazosafranin, pH 3.2 (Lillie *et al.*, 1973).

By azo-coupling with DAS-AzA, a primary catecholamine was demonstrated within the hyaline cells (Lillie *et al.*, 1973b, c) during most stages of the molting cycle (Fig. 4). During postecdysis, the phenolic substance gradually disappeared. Early in postecdysis, intact hyaline cells near or within the epidermal net azo-coupled mildly, as if they were losing their former contents. A phenol visualized in the serum during intermolt and proecdysis was still detectable early in postecdysis. However, by 48 hours postecdysis, the phenol in the serum became substantially reduced, and also disappeared from the hyaline cells.

Using DAS-AzA, two additional granule-containing hemocytes could be identified: small granular cells the size of hyaline cells (Fig. 4), and the large granular cells previously identified by Az-Eo (Fig. 3). The small and large granular cells contained swollen granules which exhibited intense azo-coupling (Figs. 4, 5). The large granular cells increased their numbers during early postecdysis (Fig. 5A) when two forms became apparent: cellular forms possessed a distinct cell shape and a nucleus (Fig. 5B); amorphous forms had a more extended cytoplasm and no nucleus (Fig. 5C). By 15-24 hours postecdysis, the large granular cells aligned along the epidermis (Figs. 6A, B). Morphologically they resembled melanophores, except they contained larger (swollen) granules.

Intermediate ("transitional") cells, fixed in the process of rupturing, spewed forth from their cytoplasm numerous tiny granules which azo-coupled with DAS-AzA (Fig. 2B, C). These granules approximated the size of bacteria. However, prior extraction with KOH did not remove azo-coupling capacity. Therefore, RNA was not responsible. Furthermore, no gram-positive material was demonstrable. Epidermal melanophore granules also azo-coupled intensely (Fig. 6C). Surrounding them, the cytoplasm of the melanophores azo-coupled as if it contained a phenol. The sites of azo-coupling

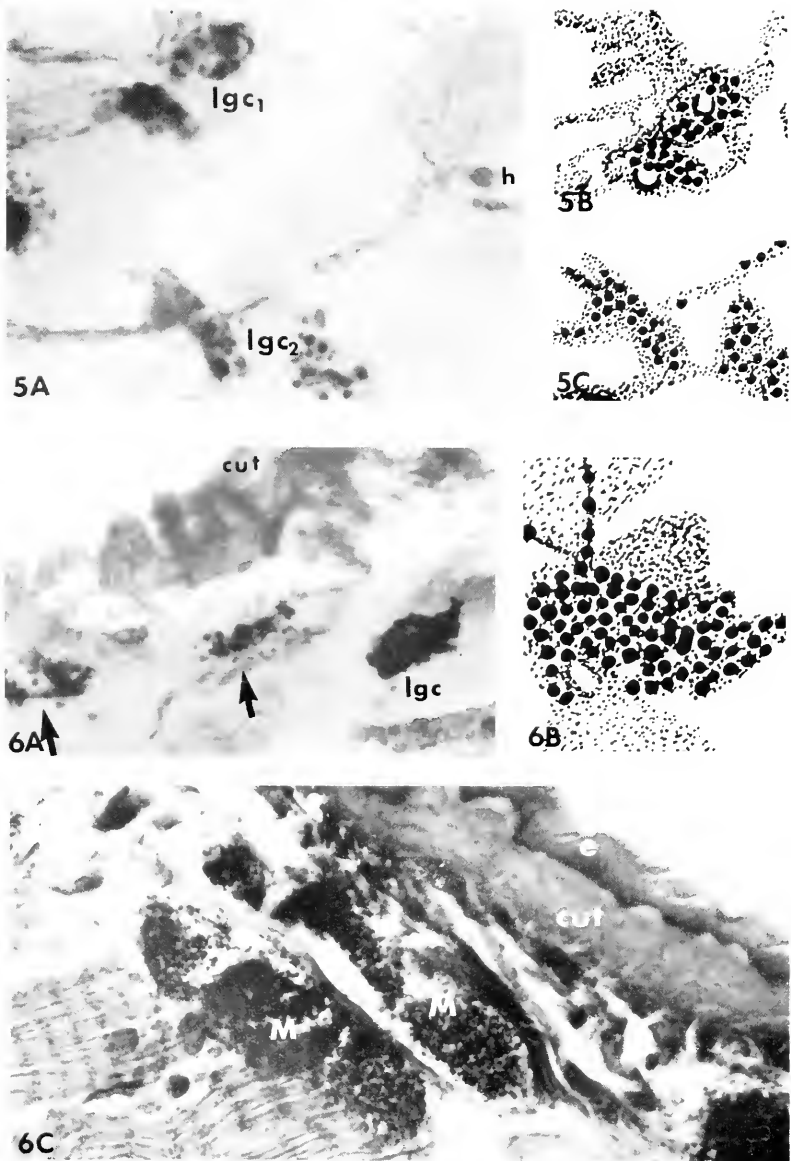

FIGURE 5. The number of large granular cells (lgc) increases in the hemocoel, especially near the epidermis, after ecdysis. The specimen was fixed 10–15 hours postecdysis in buffered formalin-salt. Figure 5A shows two types of large granular cells: type 1 (lgc_1) possesses discrete cytoplasmic boundaries and a nucleus; type 2 (lgc_2) has an amorphous cytoplasm and no nucleus can be seen. Both types contain characteristic swollen granules whose protein matrix has azo-coupled with DAS-AzA. The hyaline cell (h) is much smaller and contains diphenols. Figures 5B and 5C show diagrammatic interpretations of the two types of large granular cells shown in Figure 5A. Figure 5B shows the distinct cellular shape of an lgc_1 . Large swollen granules (dark circles) surround the nucleus (clear space). Figure 5C shows the amorphous cytoplasm of an lgc_2 which also contains swollen granules (dark circles). No nucleus can be seen perhaps indicating that these large granular cells are degenerating and releasing their contents into the serum. DAS-AzA. $\times 600$.

FIGURE 6. The relationship between the large granular hemocytes and melanophores is uncertain. Figure 6A shows three large granular cells (lgc) near the epidermis of a crab fixed 5–10 hours postecdysis

described above could not be decolorized by prolonged extraction with dilute HCl.

Verification of a diphenol: oxidation-reduction experiment. After prior oxidation, the phenols detected within the hyaline cells and serum converted into quinones and could not azo-couple with DAS-AzA. Pretreatment with dithionite reduced quinones into phenols which could then azo-couple. After brief, 4 hours, dithionite treatment, the suspected phenols in the hyaline cells and the serum curiously azo-coupled less intensely; however, prolonged dithionite (8 h) treatment rendered the staining more intense at both sites. When dithionite-reduced tissue sections were oxidized, diphenols became visualized again in the serum and hyaline cells. The intracellular granules described by DAS-AzA within the small and large granular cells, and intermediate cells remained unaffected by oxidation or reduction. Often the reducing solution extracted the granules from epidermal melanophores; the azo-coupled cytoplasm, unaffected by reduction, was rendered negative by oxidation, verifying its phenolic content.

Demonstration of histidine and amino groups. The color of the granulocytes (cytoplasm and granules) and some of the serum granules after DAS-AzA (Fig. 4) resembled that of erythrocytes containing histidine (Lillie *et al.*, 1973b, c). Pretreatment with FeCl_2 blocked the reaction, confirming the presence of histidine (Lillie *et al.*, 1971). Oxidation and reduction rendered the sites more intense. Increased histidine reactions occurred in the granulocyte and serum granules during intermolt, proecdysis, and early postecdysis. By this and other reactions (PAS, diazosafranin), some of the serum granules may be identical to (and released from) the granulocytes during the molting cycle.

Tryptophan (PCB reaction) appeared in the granulocytes during early postecdysis. However, by late postecdysis, the reaction decreased as if the cells released their proteinaceous contents. Like the granulocytes, the serum became positive during early postecdysis, but reacted less intensely 24 hours postecdysis, as well as during intermolt and proecdysis. The hyaline cells reacted mildly, or not at all, throughout the molting cycle.

Small amounts of arginine (NQS reaction, Fig. 1B) and large amounts of tyrosine could be visualized within the granulocytes during all stages of the molting cycle. In contrast the hyaline cells and serum exhibited reactions which were negative for arginine and mild for tyrosine at all times. Pretreatment of tissue sections with tetranitromethane selectively abolished the staining for tyrosine.

The presence of amino groups (with and without prior deamination) was verified by the uptake of iron (FeII) subsequently visualized by hematoxylin or by acidophilia (Az-Eo). The granulocytes stained intensely; their staining could be abolished by prior deamination. Amino groups visualized in the serum during intermolt and proecdysis were deaminated inconsistently; their presence varied during postecdysis, possibly indicating the disappearance of a protein during this time. Hyaline cells showed mild reactions at all times.

Reactions for reducing sites. The hyaline cells, granulocytes, and serum showed cyclic reactions for reducing substances during the molting cycle. Minimal at ecdysis, the reducing substances could not be visualized within hyaline cells at any other time.

in buffered formalin-salt. A type 1 large granular cell (an intact cell) with nucleus is shown at the right with the label lgc; type 2 large granular cells (amorphous without nucleus) appear at arrows to left. $\times 600$. Figure 6B diagrammatically depicts at higher magnification the type 1 large granular cell shown in Figure 6A. $\times 900$. Figure 6C shows mature melanophores (M) near epidermis and cuticle of a crab fixed 10 hours postecdysis in buffered formalin-salt. Diphenols azo-couple in the exo- (e) and endocuticle (cut), and are present in the cytoplasm of the melanophore. The melanophore granules are also proteinaceous but tiny compared with the swollen granules in the large granular cells in Figure 6A. DAS-AzA. $\times 600$.

Granulocytes remained positive between ecdysis and 5 hours postecdysis; but also became negative during the later stages of postecdysis. During late postecdysis, the serum contained reducing substances (released from the granulocytes?), but lost them cyclically during early postecdysis, intermolt, and proecdysis. The tegumental glands also reacted strongly during postecdysis. The reducing substances described above were visualized by ferricyanide, Clara's hematoxylin, and FeII acid ferrocyanide reactions.

With ferric ferricyanide, positive sites also appeared within the granules of small and large granular cells, intermediate cells, and the serum (including large swollen granules). The intracellular granules and the swollen serum granules were not affected by oxidation or reduction, and therefore they do not contain reducing groups. The serum granules having the size of those within granulocytes were affected by oxidation and reduction.

Melanophores contained numerous small granules which blackened characteristically in ammoniacal silver after 10 minutes and stained intensely with ferricyanide. The granules were contained by a positive cytoplasm. Oxidation intensified the ferricyanide (quinhydrone) reaction in the granules and masked the visualization of reducing phenols in the cytoplasm. Reduction restored the original reactions, and enabled the visualization of reducing substances (some probably phenols) within the formerly-negative hyaline cells, granulocytes, and serum. Oxidation rendered the sites negative once again.

Surprisingly, epidermal melanophore granules intensified their natural brown color by incubation in Clara's solution during postecdysis, but not during proecdysis. Reducing substances may be responsible for the transient reaction.

Copper-rich sites. Identification of copper-containing sites failed using ammoniacal rubeanic acid. Using Clara's hematoxylin, copper could be visualized mildly in the hyaline cells: more intensely in the granulocytes. In copper uptake studies, the hemocytes took up copper to a moderate degree. The reactions of the granulocytes and serum varied with the molting cycle: during postecdysis, the granulocytes stained intensely. The serum took up copper during intermolt, proecdysis, and late postecdysis. However, during early postecdysis, the serum itself showed weaker copper uptake; but intensely positive serum granules (released from the granulocytes?) could be seen.

Histochemical observations—the cuticle

Basophilia, acidophilia, glycogen, 1,2-glycols, lipids, aldehydes, and azo-coupling. Using the various histochemical procedures described above, we recorded the changes in the staining of the cuticle during the molting cycle. For the structure of the exoskeleton, Skinner's (1962) terminology was applied. An upper thin lipid epicuticle was distinguished from the procuticle below. The procuticle was divided into an upper thin exocuticle (pigmented layer) and, beneath it a thicker endocuticle (calcified layer). Epi- and exocuticle form during proecdysis; and endocuticle during postecdysis (Skinner, 1962). During late postecdysis, a deeper layer forms over the epidermis which is thin and uncalcified called the membranous (uncalcified) layer, and which does not undergo further modification by calcification or quinone tanning. In this study, the membranous layer was rarely seen.

Curiously, the exocuticle of freshly molted crabs did not stain with Az-Eo. However, by late postecdysis, the exocuticle and underlying endocuticle attained a weak basophilia. Characterizing the influx of acidic substances, this basophilia increased as the entire procuticle became wider and hardened. The new endocuticle, formed by 24 hours postecdysis, remained unstained by Az-Eo up to 48 hours postecdysis. Later,

when more fully formed and hardened, it became acidophilic, as if basic substances had penetrated.

The epicuticle which covered the fully tanned exocuticle exhibited basophilia. However, at ecdysis, the epicuticle became acidophilic. It contained aldehydes by the black Bauer and black periodic methods; sudanophilia was absent.

By PAS staining, the new exocuticle contained 1,2-glycols variably during proecdysis, ecdysis, and late postecdysis. This reaction became abolished by acetylation, but it was not restored by deacetylation. Exo- and endocuticle did not react early in postecdysis. The reaction was negative in intermolt crabs. No glycogen, aldehydes, nor lipids were detected.

Using various diazonium salts, the cyclic appearance of aromatic protein end-groups was detected within the cuticle's protein matrix. The exocuticle layer azo-coupled mildly during proecdysis and ecdysis indicating proteins exist in low concentration. The azo-coupling of the cuticle proteins intensified during early postecdysis. During late postecdysis, more aromatic end groups appeared in the outermost exocuticle than in the newer endocuticle layer. The epicuticle did not azo-couple. Subsequent extraction in weak HCl failed to change the results.

Diphenols in cuticle. The reaction of the cuticle to the DAS-AzA showed variations in the staining for phenols throughout the molting cycle. At intermolt and proecdysis, the fully-formed and hardened (quinonized) procuticle did not azo-couple. In contrast, phenols penetrated the soft exocuticle at ecdysis and azo-coupled intensely (Fig. 7A). The azo-coupling capacity of phenols in the exocuticle decreased as tanning progressed during early postecdysis; by 10 hours postecdysis only small amounts could be detected. By late postecdysis, the new endocuticle still reacted moderately for phenols. However, its azo-coupling capacity continued to decrease during late postecdysis as the width and hardening of the procuticle increased (Fig. 7B). The epicuticle showed intense reactions for phenols during the entire molting cycle (Fig. 7B).

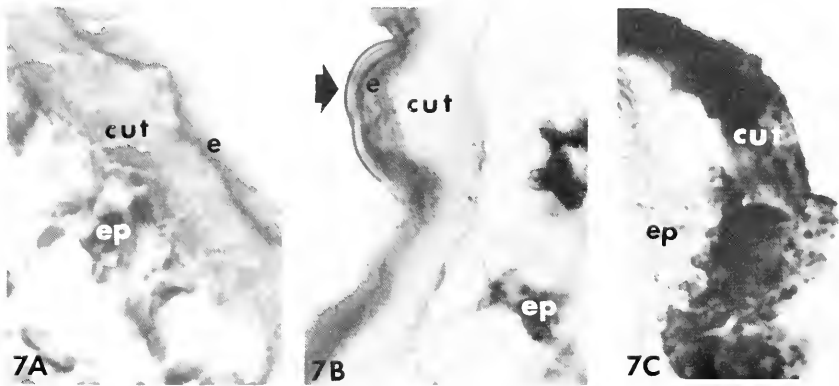

FIGURE 7. The cuticle changes its reaction for diphenols before and after tanning takes place. Figure 7A shows the intense azo-coupling of phenols in the soft exo- (e) and endocuticle (cut) of a crab fixed at ecdysis in buffered formalin-salt. Both the exo- and endocuticle react. Phenol-laden hyaline cells and histidine-rich granulocytes (not shown) occur in the hemocoel and gather close to the epidermal cells (ep) which also contain phenols during this time. Figure 7B shows the nonreactive tanned endocuticle (cut) of a crab fixed in formalin-acetic acid-salt 24-48 hours postecdysis. Exocuticle (e) reacts only mildly. Epidermal cells (ep) still react at this time. Waxy epicuticle (arrowhead) azo-couples throughout the molting cycle. DAS-AzA. Figure 7C shows the reducing capacity of the soft cuticle (cut) after fixation in Barnett-Bourne silver solution. The cuticle loses its reducing capacity as it tans. Reducing substances (non-phenolic) also appear in granulocytes; hyaline cells contain phenols which react mildly or not at all. Epidermal cells (ep) are negative. $\times 600$.

Temporally, the azo-coupling of the phenols in the endocuticle paralleled that in the older exocuticle, but occurred at later times. If the endocuticle began to form soon after ecdysis, its azo-coupling capacity coincided closely with that of the exocuticle layer (Fig. 7A). During late postecdysis, the endocuticle became non-reactive prior to the older exocuticle above it (Fig. 7B). The reactions probably depend on the extent to which phenols penetrate and become quinonized during tanning.

Oxidation and reduction procedures verified the presence of a diphenol within the cuticle. After oxidation, the diphenol in the cuticle became quinonized and no longer reacted. After reduction (4 h), tanned cuticles which did not azo-couple with DAS-AzA exhibited the presence of a diphenol.

Demonstration of histidine and amino group. Tryptophan and arginine could not be detected during proecdysis and ecdysis, although sometimes the exocuticle of newly molted crabs showed a mild reaction for arginine. Small amounts of tyrosine (selectively abolished by tetranitromethane) were detected in the exocuticle and epicuticle, but not in the endocuticle.

Prior incubation in FeCl_2 reduced the DAS-AzA reaction in the cuticle, indicating the presence of histidine. The presence of amino groups in cuticle was verified by FeII uptake stained by hematoxylin or Az-Eo, with and without prior deamination. Amino groups stained intensely but sporadically in the exocuticle between ecdysis and 10 hours postecdysis; the endocuticle reacted less intensely. The data show that histochemical changes in the cuticle occur early in postecdysis, and imply that protein(s) penetrate at this time.

Reducing substances in cuticle. Short (10 min) incubations in ammoniacal silver gave no reaction in the cuticle; after 24 hours, reducing sites (possibly phenols) became moderately visible. No reaction occurred in acid silver. Interestingly, the cuticle of crabs fixed during ecdysis and early postecdysis in Barnett-Bourne solution strongly reduced silver (Fig. 7C). Fully formed and hardened cuticle of intermolt exhibited the mild reduction of silver.

The epicuticle contained substances which reduced silver during postecdysis, but not at other times in the molting cycle. Curiously, no reducing substances were detected in the epicuticle with ferric ferricyanide.

With ferricyanide, reducing substances in the cuticle varied cyclically with the molting cycle. During intermolt and proecdysis, the hardened cuticle did not react. In contrast, reducing substances penetrated the new exocuticle at ecdysis and reacted intensely; the endocuticle reacted less intensely. The reducing substances were not detected during postecdysis. Reduction reversed the results obtained in the negative (quinonized) cuticles of specimens fixed during postecdysis and visualized reducing substances. However, no change was induced within the fully-quinonized cuticles of intermolt, proecdysis, and late postecdysis. Oxidation of reducing substances present in the cuticle at ecdysis rendered them negative.

Oxidizing substances (visualized by FeII -acid ferricyanide) were mildly or not detectable in the endocuticle and the epicuticle. The exocuticle reacted intensely.

Using Clara's hematoxylin, copper was moderately visualized in the fully-formed, hardened intermolt cuticle. During postecdysis, the visualization of copper in the exocuticle decreased continuously. Curiously, intense amounts of copper were seen in the endocuticle during late postecdysis. The epicuticle did not react.

DISCUSSION

By histochemistry and morphology, the present report identifies five types of hemocytes in the hemocoel of the fiddler crab. The two most commonly encountered types are a small agranular hyaline cell, or cystocyte, characterized by a scanty basophilic

cytoplasm encircling a densely basophilic nucleus; and a larger granulocyte containing numerous eosinophilic granules within an eosinophilic cytoplasm. The other three hemocytes were: an intermediate cell, partially resembling the hyaline cell and the granulocyte, and thus appearing to be a transitional stage in the granulocyte maturation process (Toney, 1958; Ravindranath, 1980); a small granular cell, and a large granular cell. Perhaps the latter two also represent transitional stages in the granulocyte maturation process (see Ravindranath, 1980, for review). However, their functions are unknown.

The granulocytes of several arthropod species transform their shape and degranulate on exposure to air into intermediate cells and hyaline cells (Wharton Jones, 1846; Hardy, 1892; Vranckx and Durliat, 1977). Degranulation after swelling has been associated with clotting in *Limulus* and *Homarus* (Dumont *et al.* 1966; Hearing, 1969). In vertebrates, degranulation may result from cell injury, autolysis, aging, death (Deruby, 1918; Myers and Dewolf-Glade, 1964). The present data show evidence for degranulation of intermediate cells (Figs. 2B, C), and large granular cells (Figs. 5A, C) and include indirect data for degranulation of small granular cells (personal observations) and granulocytes (histochemically by their resemblance to serum granules).

The hyaline cells and the granulocytes of *Uca pugilator* may be involved in tanning at certain points in the molting cycle. Counts of the numbers of hemocytes show cyclic events occur and verify earlier work that both granulocytes and hyaline cells increase their numbers to a peak at ecdysis (Kollman, 1908). The present report indicates the granulocytes predominate before ecdysis; the hyaline cells after ecdysis. Histochemically, these hemocytes cyclically contain protein end groups and diphenols respectively which seem to be shuttled into the serum and new exocuticle at ecdysis.

Biochemically, the blood appears to be the main site of tanning agent synthesis. Using paper chromatography, Vacca and Fingerman (1975a) identified N-acetyldopamine and N-acetylnoradrenalin as metabolites of labeled dopamine (as well as their beta-glucosides) which appear in the blood of the fiddler crab, *Uca pugilator*, during ecdysis. Subsequent incorporation into the cuticle suggests the N-acetylated dopamine metabolites attach to the glucosides and then act as tanning agents. Prior to cuticle incorporation, they become attached to two large blood proteins (>400,000 d and ~150,000 d) which transport the tanning agents into the soft cuticle. The appearance of free glucosides and attached carrier proteins in the blood is cyclic and corresponds to the incorporation of label into the cuticle during postecdysis (Vacca and Fingerman, 1975b).

Histochemically, the diphenolic substance(s) visualized in the hyaline cells at ecdysis and early postecdysis, when the hyaline cells occur in large numbers, may represent the tanning agent(s) or precursor(s). Probably a primary catecholamine, candidate tanning diphenols include norepinephrine (as demonstrated histochemically in the adrenal medulla by Lillie *et al.*, 1973a), DOPA, dopamine, N-acetyldopamine, and N-acetylnorepinephrine. Interestingly, the hyaline cells lose the diphenol during late postecdysis, as the new cuticle tans. They appear in large numbers near the epidermis, looking empty as if their contents had been released. Like the hyaline cell, the serum contains a phenol during intermolt, proecdysis, and early postecdysis. However, by 48 hours postecdysis, its presence becomes diminished. Speculatively, the diphenol in the serum originates from the hyaline cells, and enters the soft cuticle during ecdysis and early postecdysis.

During late postecdysis, the diphenol cannot be visualized in the hardened exocuticle without reduction by dithionite. Presumably, the diphenol acts as a tanning agent and cross-links with the cuticle protein matrix, transforming into the non-reactive quinone form during late postecdysis, intermolt, and proecdysis.

Vacca and Fingerman (1975b) speculated that a permeability factor enables the

rapid transfer of tanning agents from the blood (hemocytes and serum) into the cuticle during early ecdysis. Precedence for the hormonal control of tanning comes from insect studies: ecdysone and ecdysterone accelerate the formation of dopamine from precursor tyrosine within the hemocytes of tsetse fly puparia *in vitro* (Whitehead, 1971); bursicon stimulates hemocyte permeability in the initial stages of tanning agent synthesis, thereby enabling them to overcome a concentration barrier to tyrosine (Whitehead, 1970). Bursicon also stimulates lysine uptake by the cuticle (Fogal and Fraenkel, 1969). The diuretic hormone of the American cockroach enables the removal of excess liquid from the blood (*via* Malpighian tubules) during postecdysis, and also enhances the uptake of compounds such as tyrosine by the hemocytes and epidermal cells (Mills and Whitehead, 1970). Among the crustaceans, ecdysone triggers protein synthesis within the hemocytes of the crayfish *Orconectes limosus* during proecdysis (Keller and Adelung, 1970).

Various histochemical procedures visualize proteins, amino end groups, and amino acids within the granulocytes. Cyclic histochemical reactions imply that these hemocytes serve in the production of proteins during the molting cycle. Some of these groups (arginine and tyrosine, lysine and histidine) occur in the granulocytes (cytoplasm and granules) throughout the molting cycle, and can be visualized as structural elements of the protein matrix of the cuticle and the granules of the granulocytes. Other end groups appear cyclically: tryptophan (also appearing in serum) became visible in the granulocytes and serum during early postecdysis. Although detectable in the cuticle matrix throughout the molting cycle, lysine, histidine, and aromatic protein end-groups become histochemically intense and probably enter the cuticle during early postecdysis when it is still soft. Indeed, water-soluble proteins extracted from insect cuticle exhibit the free end groups of lysine; but the same groups cannot be demonstrated in sclerotized cuticle (Hackman, 1953). The visualization of additional protein end-groups in the cuticle may represent the incorporated protein carriers detected biochemically (Vacca and Fingerman, 1975a, b). The tanning protein in the hemolymph of the insect *Manduca sexta* is immunologically identical to cuticle protein (Koeppel and Gilbert, 1973). Unfortunately, the precise relationship between the cuticle protein matrix of *Uca* and the proteins carried by the granulocytes cannot be precisely determined from the present data.

The granules of the granulocytes contain basic (amino) end groups (lysine, arginine, and histidine). The reactions in serum suggest that these granule constituents are released after ecdysis as well. As the new exoskeleton forms, numerous free granules appear in the serum thereby encouraging the speculation that the granulocytes release their proteinaceous granules, as well as a cytoplasmic protein, into the serum during early postecdysis. By 48 hours postecdysis, the release process seems to be complete. Diverse serum granules were detected histochemically in *Uca* and have been reported in other arthropod hemocytes by histochemical and ultrastructural studies (see Ravindranath, 1980, for review). The different granules may represent stages in the coagulation process (Ravindranath, 1980), or may possess different functions including basement membrane formation, wound healing (Ravindranath, 1980), or tanning. The diverse functions may account for some of the staining variations of granules visualized in this report within the granulocytes, large and small granular cells, and "serum granules."

Granulocytes which contain reducing substances (probably non-phenolic) during most of the molting cycle, become unreactive at ecdysis and 5 hours later, as if their reducing substances become released. Deep within the hemocoel, small, perhaps immature, granulocytes still react intensely (Fig. 1C). The data coincide with the synthesis and release of a weakly acidic glycoprotein (perhaps a carrier which contains sulfhydryl or other reducing groups) during early postecdysis; alternatively, protein synthesis

becomes blocked or breakdown increases. Minute amounts of native aldehyde detectable within the granulocytes during intermolt, proecdysis, and late postecdysis also disappear during early postecdysis.

Surprisingly, serum (apart from its contained granules) contains few soluble reducing substances during postecdysis, when biochemically it sequesters both tanning phenols and protein carriers (Vacca and Fingerman, 1975a). Perhaps the weak histochemical reaction reflects their transient presence; alternatively these substances are not detectable because they are bound to glucosides (Vacca and Fingerman, 1975a) or to the granules released from the granulocytes.

In other arthropod species, hemolymph proteins appear cyclically during the molting cycle. *Carcinus* blood contains a glycoprotein throughout the molting cycle which disappears at ecdysis and then reappears 10 days later (Busselen, 1970), the time during which sclerotization is complete in *Uca*. Its appearance and maintenance depends upon the nutritional status of the organism. *Gecarcinus* also possesses a blood protein involved in clotting which becomes barely detectable during postecdysis (Strutman and Dolliver, 1968). The present study shows that intermediate cells rupture easily and spill their proteinaceous granules into the serum during early postecdysis. These cells may be involved in clotting. Curiously, the ability of the blood to clot is minimal during postecdysis (Strutman and Dolliver, 1968). A noteworthy speculation as to why the animal is at such a disadvantage when it is most susceptible to injury and infection might be that most of the hemocytes instead become involved in the synthesis of other substances (proteins and diphenols) to be used for sclerotization. Indeed, this function would take priority in order to reinstate the animal into its protective shell after growth.

The mechanism of hemocyte degeneration may play a significant role in supplying tanning agents to the cuticle. By late postecdysis, the serum and hyaline cells of *Uca* become exhausted of diphenols. With the loss of their diphenols, few hyaline cells remain intact and their numbers diminish severely. In addition, granulocytes release their granules and reduce in number during early postecdysis. Hypothetical tanning hormone(s) might increase hemocyte permeability to substances, thereby causing swelling and eventual lysis. This mechanism could account for the numerous granules visualized in the serum during postecdysis, and has been proposed for the numerical decrease in the hemocytes during postecdysis (Marrec, 1944). Histochemical and ultrastructural evidence exists for the disintegration and vesiculation of lipoprotein cells and nuclei with subsequent streaming-in of neighboring hemocytes during proecdysis and postecdysis in the crab *Paratelphusa* (Adiyodi and Adiyodi, 1972). Cell explosion of hyaline cells and granule release by intermediate cells and granulocytes have been postulated as mechanisms of clotting (Hardy, 1892; Tait and Gunn, 1918; Wood *et al.*, 1971; see review by Ravindranath, 1980), and tyrosinase liberation (Pinhey, 1930).

Based on his *in vitro* studies, Summers (1968) proposed that the epidermis, not the blood, is the site of tanning agent synthesis. We now present evidence that diphenols (presumably tanning agents) appear in the epidermis transiently between ecdysis and early postecdysis. These data, as well as previous biochemical evidence (Vacca and Fingerman, 1975b), suggest that the epidermis is a site of translocation rather than synthesis. Degeneration as a mechanism of tanning would cause the hemocytes to release their tyrosine-metabolizing enzymes, and would account for Summer's findings that most of the tyrosinase enzyme activity occurs in the plasma, and not the hemocytes, of the fiddler crab (Summers, 1967).

Histochemically, our study shows the hyaline cells in *Uca* take up copper, a component of hemocyte tyrosinase (Pinhey, 1930). Functionally, tyrosinase oxidizes phenols (tanning agents) to quinones which then act as strong oxidizing agents. Under

pathological conditions, quinones respond to injury and infection by forming melanin upon coagulation (Taylor, 1969). Therefore, despite a deficient clotting mechanism, perhaps the soft-shelled crab possesses the enzyme complex within the hemocytes and eventually the serum, during tanning as a ready system for defense. Indeed, the granulocytes also take up copper (especially during early postecdysis when the serum is least reactive), and contain a substance which can oxidize Clara's hematoxylin.

Koepe (1971) proposed that tyrosinase is the actual protein carrier of tanning agents in insects. Unfortunately, no oxidizing capacity could be detected histochemically in the serum, and though the exocuticle oxidizes FeII (by acid ferrocyanide reaction) at ecdysis, it resists copper uptake. Therefore, we propose another blood protein complex may be involved in the tanning process. The tegumental glands, known to possess tyrosinase, also oxidize FeII and may function in an aspect of tanning (Stevenson, 1963a, b) which histochemically relates to the epicuticle. Indeed, multiple mechanisms may exist as implied by variable basophilia or acidophilia of exo- and endocuticle.

Interestingly, reducing sites were demonstrated in the melanophore granules at ecdysis (intensified ferricyanide reaction after oxidation). Azo-coupling reactions demonstrate the presence of a protein matrix which contains amines, diphenols, and indoles. After ecdysis, these histochemical reactions changed. The data imply that amine and phenolic (tanning?) substances enter a protein-granule matrix within the melanophores during ecdysis, when tanning agents and permeability factors are available. Indeed melanin may form at the end of the tanning process as the result of a biochemical equilibrium displacement of tanning agent biosynthesis.

Histochemically, the epidermal melanophore granules resemble melanin by their argentophilia, strong basophilia, ability to take up iron, insolubility in organic solvents, and their negative PAS, acid fast, and lipid reactions. However, Noël (1982) reports that *Uca* melanophore pigment is ommochrome. Indeed the present study does not define the granules as melanin. Dithionite used for reduction extracted many melanophore granules; those which remained could not be reduced even after 8 hours.

The epidermal melanophores exhibited the presence of a cytoplasmic diphenol throughout the molting cycle. Unlike the melanophore granules, perhaps the cytoplasm maintains a separate pool of diphenols in continuous supply. It is tempting to speculate that the production of diphenolic tanning agents within the hemocytes might relate biochemically to the process of pigment formation.

Indeed certain histochemical reactions of the granules visualized in the small and large granular cells resembled those of the melanophore granules. The appearance of numerous large granular cells near the epidermis during early postecdysis suggests a relationship with melanophore formation, which has not yet been defined.

Interestingly, the large granular cells azo-couple (DAS-AzA) only during ecdysis and postecdysis. Apparently, they sequester tanning agents from the blood and deposit them on the protein matrix of the contained swollen granules. In this way, the large granular cells, like the melanophores, may function in the disposal of excess tanning agents remaining in the blood during postecdysis. This mechanism of disposal provides an alternative to glucoside formation which masks the tanning agents prior to use (Vacca and Fingerman, 1975a, b).

In conclusion, these histochemical data parallel previous biochemical findings which document the cyclic appearance of a protein-bound phenolic tanning agent in the blood of *Uca pugilator* (Vacca and Fingerman, 1975a, b). We now show that granulocytes contain protein end groups in their cytoplasm and granules which might represent portions of the protein carrier complex: the hyaline cells contain diphenols which could act as tanning agents. The reducing groups of proteins and diphenols

become demonstrable in the cuticle during the early postecdysis and cannot be visualized by 10 hours postecdysis when tanning (quinonization) takes place. Additionally, the cyclic presence of proteins and diphenols in the blood cells, serum, and cuticle indicates the existence of a tanning hormone (perhaps more than one) which enables the cyclic synthesis of the diphenolic tanning agents and protein carriers, and appropriately shuttles them from the hemocytes into the serum and cuticle during the molting cycle. Fingerman and Yamamoto (1964) provided evidence that tanning of the cuticle of the dwarf crayfish, *Cambarellus shufeldti*, is hormonally controlled. However, the tanning hormone(s) remain(s) to be identified in crustaceans.

ACKNOWLEDGMENTS

Completion of this work was partially supported by a grant from the Committee to Combat Huntington's Disease (KUMC Grant No. 9712-01) and the University of Kansas Biomedical Research Support Grant (KU SO7-RR05373) (L.L.V.). The work was initiated at Tulane University, Department of Biology, in partial fulfillment for the Ph.D. degree (L.L.V.).

LITERATURE CITED

- ADIYODI, R. G., AND K. G. ADIYODI. 1972. Histochemistry of the integumentary connective tissue of a crab in relation to the molt cycle. *J. Histochem. Cytochem.* **20**: 545.
- AWAPARA, J. 1962. Free amino acids in invertebrates: A comparative study of their distribution. In *Amino Acids Pools*, J. T. Holden, ed. Elsevier, Amsterdam.
- BANG, F. 1967. Serological responses among invertebrates other than insects. *Fed. Proc.* **26**: 1680-1684.
- BARKA, T., AND P. J. ANDERSON. 1963. *Histochemistry: theory, practice, and bibliography*. Harper and Row, New York. 660 pp.
- BROWN, F. A., JR., AND O. CUNNINGHAM. 1939. Influence of the sinus gland of crustaceans on normal viability and ecdysis. *Biol. Bull.* **77**: 104-114.
- BRUNET, P. C. J. 1965. The metabolism of aromatic compounds. Pp. 49-78 in *Aspects of Insect Biochemistry*, T. W. Goodwin, ed. Academic Press, New York.
- BRUNTZ, L. 1907. Études sur les organes lymphoïdes phagocytaires et excréteurs des Crustacés supérieurs. *Arch. Zool. Exp. Gen.* **7**: 1-67.
- BUSSELEN, P. 1970. Effects of moulting cycle and nutritional conditions on haemolymph proteins in *Carcinus maenas*. *Comp. Biochem. Physiol.* **37**: 73-83.
- DECLAIR, W., AND R. VERCAUTEREN. 1965. Activité phenoloxidase dans les leucocytes du crabe au cours du cycle d'intermue. *Cah. Biol. Mar.* **6**: 163-172.
- DERUBY, K. G. 1918. A study on autolysis of animal tissue. *J. Biol. Chem.* **35**: 179-219.
- DUMONT, J. N., E. ANDERSON, AND G. WINNER. 1966. Some cytological characteristics of the hemocytes of *Limulus* during clotting. *J. Morphol.* **119**: 181-208.
- EVANS, P. D. 1972. The free amino acid pool of the hemocytes of *Carcinus maenas* (L.). *J. Exp. Biol.* **56**: 501-507.
- FINGERMAN, M., AND S. W. FINGERMAN. 1974. The effects of limb removal on the rates of ecdysis of eyed and eyestalkless fiddler crabs, *Uca pugilator*. *Zool. Jb. Physiol.* **78**: 301-309.
- FINGERMAN, M., AND Y. YAMAMOTO. 1964. Endocrine control of tanning in the crayfish exoskeleton. *Science* **144**: 1462.
- FLOKIN, M., AND E. SCHOFFENIELS. 1965. Euryhalinity and the concept of physiological radiation. In *Studies in Comparative Biochemistry*, K. A. Munday, ed. Macmillan (Pergamon Press) Co., New York.
- FOGAL, W. H., AND G. FRAENKEL. 1969. Melanin in the puparium and adult integument of the fleshfly, *Sarcophaga bullata*. *J. Insect Physiol.* **15**: 1235-1247.
- GEORGE, W. C., AND J. NICHOLS. 1948. A study of the blood of some Crustacea. *J. Morphol.* **83**: 425-443.
- GLENNER, G. G., AND R. D. LILLIE. 1957. The histochemical demonstration of indole derivatives by the post-coupled p-dimethylaminobenzylidene reaction. *J. Histochem. Cytochem.* **5**: 279-296.
- GUYSELMAN, J. B. 1953. An analysis of the molting process in the fiddler crab, *Uca pugilator*. *Biol. Bull.* **104**: 115-137.
- HACKMAN, R. H. 1953. Chemistry of the insect cuticle. II. Hardening and darkening of the cuticle. *Biochem. J.* **54**: 367-377.

- HARDY, W. B. 1892. The blood corpuscles of the Crustacea together with a suggestion as to the origin of the Crustacean fibrin ferment. *J. Physiol.* **13**: 165-190.
- HEARING, V. G. 1969. Demonstration of acid phosphatase activity in the granules of the blood cells of the lobster, *Homarus americanus*. *Chesapeake Sci.* **10**: 24-28.
- KELLER, R., AND D. ADELUNG. 1970. Vergleichende morphologische und physiologische Untersuchungen des Integumentgewebes und des Häutungshormongehaltes beim Flusskrebs *Orconectes limosus* während eines Häutungszyklus. *Wilhelm Roux' Arch.* **164**: 209-221.
- KOEPPE, J. K. 1971. *Cuticle Sclerotization: Metabolites of Dopamine and a High Molecular Weight Carrier System of Diphenol Glucosides in the American Cockroach*. Doctoral Dissertation, Tulane University.
- KOEPPE, J. K., AND L. I. GILBERT. 1973. Immunochemical evidence for the transport of haemolymph protein into the cuticle of *Manduca sexta*. *J. Insect Physiol.* **19**: 615-624.
- KOLLMAN, M. 1908. Recherches sur les leucocytes et le tissu lymphoïde des invertébrés. *Ann. Sci. Nat. Zool.* **7**: 1-240.
- LEVIN, J. 1967. Blood coagulation and endotoxin in invertebrates. *Fed. Proc.* **26**: 1707-1712.
- LILLIE, R. D. 1957. Metal reduction reactions of the melanins: histochemical studies. *J. Histochem. Cytochem.* **5**: 325-333.
- LILLIE, R. D. 1965. *Histopathologic Technic and Practical Histochemistry*, 3rd Ed. McGraw-Hill Book Co., New York. 715 pp.
- LILLIE, R. D., P. PIZZOLATO, H. C. DESSAUER, AND P. DONALDSON. 1971. Histochemical reaction at tissue arginine sites with alkaline solutions of beta-naphthoquinone-4-sodium sulfonate and other *o*-quinones and oxidized *o*-diphenols. A possible mechanism of the Sakaguchi reaction. *J. Histochem. Cytochem.* **19**: 487-497.
- LILLIE, R. D., P. PIZZOLATO, L. L. VACCA, R. A. CATALANO, AND P. T. DONALDSON. 1973a. Use of diazosulfanilic acid, pH 1 azure A sequence of adrenal medulla and the effects of prior oxidation and reduction of the reaction in several species: man, monkey, hog, dog, cat, guinea pig, rat, mouse, gerbil, opossum. *J. Histochem. Cytochem.* **21**: 448-454.
- LILLIE, R. D., P. PIZZOLATO, L. L. VACCA, R. A. CATALANO, AND P. T. DONALDSON. 1973b. The pH range of the diazosafranin reaction of rat and other mast cells. *J. Histochem. Cytochem.* **21**: 441-447.
- LILLIE, R. D., P. PIZZOLATO, L. L. VACCA, R. A. CATALANO, AND P. T. DONALDSON. 1973c. Histochemical azo-coupling reactions: a catecholamine in enterochromaffin cells in place of or in addition to 5-hydroxytryptamine. *J. Histochem. Cytochem.* **21**: 455-463.
- MARREC, M. 1944. L'organe lymphocyto-gène des Crustacés Décapodes et son activité cyclique. *Bull. Inst. Oceanogr. Monaco* **8**: 1-4.
- MILLS, R. R., AND D. L. WHITEHEAD. 1970. Hormonal control of tanning in the American cockroach: Changes in blood cell permeability during ecdysis. *J. Insect Physiol.* **16**: 331-340.
- MOWRY, R. W. 1963. The special value of methods that color both acidic and vicinal hydroxyl groups in the histochemical study of mucins. With revised directions for colloidal iron stain, the use of Alcian Blue GBX and their combinations with the periodic acid-Schiff reactions. *Ann. New York Acad. Sci.* **106**: 402-423.
- MYERS, D. K., AND DEWOLFE-GLADE. 1964. Some effects of cationic condensing agents on rat thymocyte. *Exp. Cell Res.* **33**: 344-349.
- NOËL, P. 1982. Does melanin occur in crab's melanophores? *Fourth European Workshop on Melanin Pigmentation* (Abst.), Sept. 21-23, 1982.
- PINHEY, K. G. 1930. Tyrosinase in crustacean blood. *J. Exp. Biol.* **7**: 19-36.
- RAVINDRANATH, M. H. 1980. Haemocytes in haemolymph coagulation of arthropods. *Biol. Rev.* **55**: 139-170.
- SKINNER, D. M. 1962. The structure and metabolism of a crustacean integumentary tissue during a molting cycle. *Biol. Bull.* **123**: 635-647.
- SKINNER, D. M., AND D. E. GRAHAM. 1972. Loss of limbs as a stimulus to ecdysis in Brachyura (true crabs). *Biol. Bull.* **143**: 222-233.
- STEVENSON, J. R. 1963a. Phenols in the cuticle of the fiddler crab, *Uca pugnax* and their possible function in sclerotization. *Biol. Bull.* **125**: 392-393.
- STEVENSON, J. R. 1963b. A preliminary investigation of sclerotin precursors in crustacean cuticles. *Am. Zool.* **3**: 253.
- STRUTMAN, L. V., AND M. DOLLIVER. 1968. The mechanism of coagulation in *Gecarcinus lateralis*. *Am. Zool.* **8**: 481-489.
- SUMMERS, N. M. 1967. Cuticle sclerotization of blood phenoloxidase in the fiddler crab, *Uca pugnax*. *Comp. Biochem. Physiol.* **23**: 129-138.
- SUMMERS, N. M. 1968. The conversion of tyrosine to catecholamines and the biogenesis of N-acetyldopamine in isolated epidermis of the fiddler crab, *Uca pugnator*. *Comp. Biochem. Physiol.* **26**: 259-269.
- TAIT, J., AND J. D. GUNN. 1918. The blood of *Astacus fluviatilis*: a study in crustacean blood, with special reference to coagulation and phagocytosis. *Q. J. Exp. Physiol.* **12**: 35-80.

- TAYLOR, R. L. 1969. A suggested role for the polyphenol-phenoloxidase system in invertebrate immunity. *J. Invert. Pathol.* **14**: 427-428.
- TONEY, M. E. 1958. Morphology of the blood cells of some Crustacea. *Growth* **22**: 35-50.
- VACCA, L. L., AND M. FINGERMAN. 1975a. The mechanism of tanning in the fiddler crab, *Uca pugilator*. I. Tanning agents and protein carrier in the blood during ecdysis. *Comp. Biochem. Physiol.* **51B**: 475-481.
- VACCA, L. L., AND M. FINGERMAN. 1975b. The mechanism of tanning in the fiddler crab, *Uca pugilator*. II. The cyclic appearance of tanning agents and attached carrier proteins in the blood during the molting cycle. *Comp. Biochem. Physiol.* **51B**: 483-487.
- VRANCKX, R., AND M. DURLIAT. 1977. Etude des hémocytes circulants de Crustacés Décapodes. Corrélations entre polymorphisme et mode de prélèvement. *C. R. Acad. Sci. Paris* **285B**: 1045-1047.
- WHARTON-JONES, T. 1846. The blood corpuscle considered in its different phases of development in the animal series. Memoir II—Invertebrate. *Phil. Trans. R. Soc. Lond.* **136**: 89-101.
- WHITEHEAD, D. L. 1969. New evidence for the control mechanism of sclerotization in insects. *Nature* **224**: 721-723.
- WHITEHEAD, D. L. 1970. L-Dopa decarboxylase in the haemocytes of Diptera. *FEBS Lett.* **7**: 263-266.
- WHITEHEAD, D. L. 1971. Studies on the control of pupariation in tsetse flies. *Trans. R. Soc. Trop. Med. Hyg.* **65**: 224-225.
- WOOD, P. J., AND L. P. VISENTE. 1967. Histology and histochemical observations of the hemolymph cells in the crayfish, *Orconectes virilis*. *J. Morphol.* **123**: 559-568.
- WOOD, P. J., J. PODLEWSKI, AND T. E. SHENK. 1971. Cytochemical observations of hemolymph cells during coagulation in the crayfish, *Orconectes virilis*. *J. Morphol.* **134**: 479-489.

REGENERATION OF INJURIES AMONG JAMAICAN GORGONIANS: THE ROLES OF COLONY PHYSIOLOGY AND ENVIRONMENT

CHARLES M. WAHLE*

*Department of Earth and Planetary Sciences, The Johns
Hopkins University, Baltimore, Maryland 21218*

ABSTRACT

The consequences of injury to reef dwelling colonial animals are determined partly by rates of regeneration of lost tissues. These experiments examined two potential influences on regeneration rates of Jamaican gorgonians: 1) intrinsic physiological and energetic differences among co-occurring, conspecific colonies differing in size, reproductive phase, or injury location; and 2) differential responses among three plexaurid species to changing environmental variables across their depth range. In *Plexaura homomalla*, regeneration rate varied with the location of injury within colonies, but was unexpectedly independent of either colony size or reproductive phase. In addition, colonies of *P. homomalla*, *Eunicea mammosa*, and *Plexaurella dichotoma* differed in relative ability to regenerate equivalent injuries in different reef zones across their depth range.

“There is one fact in the life-history of corals which the study of processes of repair clearly brings out, and it is this, that all the methods of regeneration are more for the life-saving of the colony than of the individual.

Wood-Jones, 1912

INTRODUCTION

Injury is common among arborescent Caribbean gorgonians during both catastrophic (*e.g.*, hurricane) and routine conditions (Cary, 1914, 1918; Bayer, 1961; Kinzie, 1970, 1973, 1974; Birkeland 1974; Birkeland and Gregory, 1975; Kitting, 1975; Wahle, 1980; Woodley *et al.*, 1981). Moreover, injuries to Jamaican gorgonians can exhibit complex variation in both frequency and pattern among colonies living in different reef zones (Woodley *et al.*, 1981; Wahle, in prep.). Although many injuries are limited initially to a few cm of tissue (Cary, 1914; Kinzie, 1970, 1974), their effects on colonies can be subtle, delayed, and extensive. They can range from proportional reduction in the number of feeding, reproductive, and defensive polyps (*e.g.*, Jackson, 1977, 1979), to disruption of colony-wide physiological integration (Bayer, 1961, 1973; Wainwright and Dillon, 1969; Preston and Preston, 1975; Murdock, 1978a, b), and eventually to complete overgrowth by encrusting organisms (Kinzie, 1970, 1974; Wahle, 1980; and references therein). The ultimate extent and duration of the various effects of injury are determined largely by the time required to regenerate the lost tissue and cover the internal, proteinaceous axis (Kinzie, 1970, 1974; Kitting, 1975; Lang da Silveira and van't Hof, 1977; for other taxa: Glynn, 1976; Bak *et al.*, 1977; Jackson, 1977; Jackson and Palumbi, 1979; Palumbi and Jackson, 1982). Consequently, any intrinsic or extrinsic variable(s) affecting rates of

Received 18 November 1982; accepted 8 August 1983.

* Present address: Department of Zoology, The University of Texas, Austin, Texas 78712.

regeneration may indirectly but profoundly affect the survivorship, fecundity, and general ability of the colony to perform basic biological and ecological functions.

In this paper, I examine two sources of variation in the *in situ* ability of Jamaican arborescent gorgonians to regenerate injuries simulating those occurring routinely in nature (Woodley *et al.*, 1981). The first experiment considered the influence of colony physiology and energetics on the regeneration rates in the common plexaurid, *Plexaura homomalla*. Specifically, it tested the separate effects of colony size, colony reproductive phase, and location of injury on rates of regeneration of equal sized wounds placed on co-occurring colonies. The second experiment examined the relative regeneration rates of three common plexaurid species across their depth ranges. It contrasted regeneration rates of equivalent injuries among replicate colonies of *P. homomalla*, *Plexaurella dichotoma*, and *Eunicea mammosa* in three reef zones in and near Discovery Bay, Jamaica.

The two experiments differed in rationale, chronology, methods, and implication. Therefore, I first describe methods common to both, followed by separate treatments of specific methods, results, and discussion for each experiment.

MATERIALS AND METHODS

Sites

Regeneration experiments were conducted *in situ* in four reef zones in and near Discovery Bay, Jamaica during winter 1977 and summer 1978 (Fig. 1). The zones differed primarily in depth, exposure to waves, and gorgonian abundance (Kinzie, 1970, 1973; Woodley *et al.*, 1981). Many of the habitat characteristics described below, particularly the topography and structure of the benthic communities, were significantly altered by the passage of Hurricane Allen in August 1980 (Woodley *et al.*, 1981). Consequently, these descriptions apply to pre-storm conditions only.

The Mixed Zone (Fig. 1, site 1) is a shallow (7 m) hardground seaward of the reef crest containing an abundant and diverse gorgonian fauna (mean colony density of 14.6/m²; see Woodley *et al.*, 1981 for survey methods). The East Fore Reef Terrace (Fig. 1, site 2; henceforth called the Terrace) is a gently sloping plain at 15 m, characterized by thickets of *Acropora cervicornis*, scattered massive corals and sponges, and a diverse gorgonian assemblage (mean densities of 2.9 colonies/m²). The Rear Zone (Fig. 1, site 3) lies slightly west of the mouth of Discovery Bay and immediately leeward of the reef crest in depths ranging from 0.5 m to 1.5 m. Gorgonians were relatively rare, with mean colony densities of 0.3/m². The Shallow East Fore Reef (Fig. 1, site 4) lies southeast of the Terrace (site 2) and immediately east of the mouth of the bay. Although no quantitative surveys were conducted here, the site was similar to the Mixed Zone (site 1) in most respects relevant to this study.

Species

The three species chosen for these experiments span a range of polyp and colony morphologies characteristic of common, reef dwelling Caribbean plexaurids (Bayer, 1961; Kinzie, 1970). All occur as adult colonies in each zone and are frequently among the dominant members of gorgonian assemblages throughout the Caribbean and southwestern Atlantic (Bayer, 1961; Kinzie, 1970, 1973; Opresko, 1973).

Plexaura homomalla is perhaps the most studied of the Caribbean gorgonians (*e.g.* Cary, 1914, 1918; Kinzie, 1970, 1973; Bayer and Weinheimer, 1974, and papers therein; Wahle 1980). Its colonies are relatively large (roughly 1 m) with either planar or bushy branching patterns (Kinzie 1970, 1974). Colonies possess relatively thick

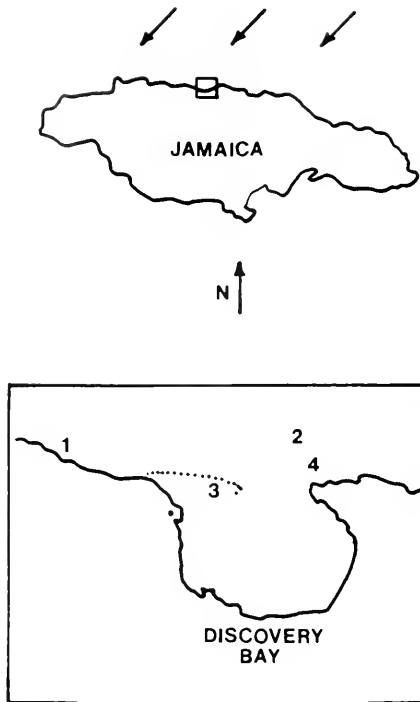

FIGURE 1. Location of experimental sites in four reef zones in and near Discovery Bay, Jamaica (inset): (1) Mixed Zone, (2) East Fore Reef Terrace, (3) Rear Zone, and (4) Shallow East Fore Reef. Dotted Line: reef crest; arrows: direction of prevailing winds and swells; asterix: D.B.M.L.

coenenchyme, and have small polyps with light spicular ornamentation on the verrucae (analogous to calyces among scleractinians; Bayer, 1961). *Plexaurella dichotoma* forms large (roughly 1.5 m), dichotomously branched colonies with thick coenenchyme, and long, unarmored polyps. *Eunicea mammosa* grows as relatively small (0.5 m), planar, candelabra-shaped colonies with thin coenenchyme and moderately long exert polyps which have heavily armored verrucae.

Techniques

Experimental injuries were placed on colonies *in situ* by carefully removing, with a scalpel, all tissue and sclerites (including the axial sheath) from around the internal, proteinaceous axis. The number, size, location, and timing of experimental injuries varied between the two experiments and are described separately below. Within each comparison of regeneration times, all injuries were equal in size (1.0 or 2.0 cm, measured by vernier calipers to within 0.1 mm) and were initiated simultaneously (within 48 hours of each other, unless otherwise specified).

The extent of tissue regrowth was recorded daily at 0700 hours. Regeneration was deemed complete when the internal axis was completely covered by gorgonian tissue and was no longer susceptible to fouling. The data, which do not satisfy the assumptions of analysis of variance (Sokal and Rohlf, 1969; Zar, 1974), were analyzed using non-parametric tests (*i.e.*, Kruskal-Wallis and Mann-Whitney).

RESULTS

Effects of colony physiology on regeneration in Plexaura homomalla

The following experiment examined the separate effects of colony size, colony reproductive phase, and injury location on regeneration rate among colonies of *Plexaura homomalla* on the Shallow East Fore Reef (Fig. 1, site 4). The experimental design (depicted schematically in Fig. 2) consisted of four paired comparisons of regeneration times (Fig. 2, bottom). A standard, simulated natural injury on 5 replicate control colonies (Fig. 2; labeled control) was compared to each of four other treatment groups differing from the controls in only one of the following variables: size, reproductive phase, or injury location (2 treatments). Controls consisted of 5 large (40–60 cm in height and width) replicate colonies, each with a single, one cm injury

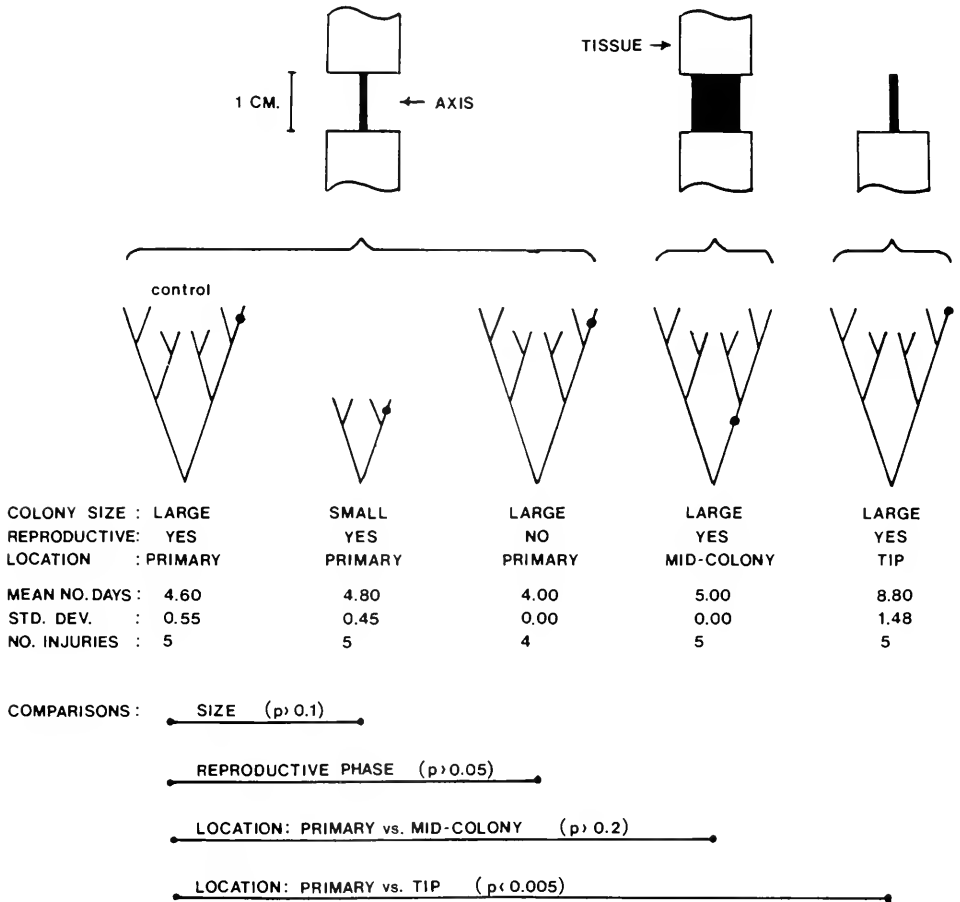

FIGURE 2. Colony physiology experiment: experimental design and results. Top: type of experimental injuries. Center: schematic of control and experimental colonies, each described below by three variables (size, reproductive phase, and injury location) and by results of regeneration experiments (mean number of days to regenerate, standard deviation, and total number of replicate injuries). Bottom: results of paired comparisons between controls and four treatment groups differing by the indicated variable (using Mann-Whitney tests).

placed mid-way down a terminal (primary) branch (Fig. 2, top and center, left). Methods and results for each of the four paired comparison are described below and in Figure 2.

With the exception of colonies in the non-reproductive treatment (described below), all experimental injuries were made in mid-July, 1978. Experimental colonies were equivalent in all obvious respects and were specifically chosen to have no external evidence of previous injury or other abnormalities. Consequently, this experiment controlled for many physiological and methodological variables potentially affecting regeneration rates within a species, including colony condition. I necessarily assumed that any other potential sources of variation affected all treatments equally or negligibly.

Colony size and regeneration. Connell (1973) and others (Fishelson 1973; Loya, 1976; Bak *et al.*, 1977) suggested that colony size might affect regeneration rates among scleractinians by limiting the availability of energy for regrowth within small colonies. Hence, assuming that energy is limiting to plexuarid gorgonians, one would predict slower regeneration rates (longer regeneration times) among small injured colonies differing from the larger controls only in colony size (10–20 cm *versus* 40–60 cm in height and width).

The results (paired comparison labeled Size, bottom of Fig. 2) showed that, while the trend in regeneration time was slightly in the predicted direction, small colonies did not regenerate significantly slower than large controls (4.80 *versus* 4.60 days; Mann-Whitney one-tailed test; $P > 0.1$). Thus, under these conditions, the presumed energetic differences between gorgonian colonies differing in size by up to 36-fold (calculated as height \times width) had no significant effect on their ability to regenerate lost tissue.

Colony reproductive phase and regeneration. It has been suggested for a variety of solitary and colonial taxa that, to the extent that energy is limiting, regeneration and sexual reproduction may compete for energy and thus may be mutually inhibitory. For example, repeated injury and regeneration may reduce subsequent sexual reproduction (bivalves: Trevaillon *et al.*, 1970; ectoprocts and sponges: Jackson, 1979; Jackson and Palumbi, 1979; zoanthids: Karlson, 1981, 1983). This experiment tested the converse hypotheses: that *P. homomalla* colonies at the peak of reproductive activity (controls) should regenerate slower than comparable but non-reproductive colonies not undergoing the simultaneous cost of gametogenesis. *P. homomalla* undergoes an annual reproductive cycle with gametogenesis peaking in late-June to mid-July (Goldberg and Hamilton, 1974; confirmed in Jamaica by *in situ* dissection and observation of gametes). Non-reproductive colonies used in this experiment were equivalent in all respects to the reproductive controls except that they were injured in December, 1977, when gametes were lacking or poorly developed (Goldberg and Hamilton 1974).

The results (paired comparison labeled Reproductive Phase in Fig. 2) show that, although the non-reproductive colonies followed the predicted trend of slightly faster regeneration rates (4.0 *versus* 4.60 days), the difference was not significant (Mann-Whitney one-tailed test; $P > 0.05$). Thus, under these conditions, the ability of *P. homomalla* to regenerate simulated, natural injuries was not significantly reduced by the presumed energetic costs of simultaneous gametogenesis.

Location of injury and regeneration. Natural injuries do not occur randomly within gorgonian colonies on northern Jamaican reefs. Rather, they tend to be concentrated on the colony periphery, and particularly on terminal or primary branches (Wahle, in prep.). This experiment compared the regeneration rates of injuries placed in three common locations on colonies of *P. homomalla*: primary branches (control), branch tips, and mid-colony (Fig. 2, top and center).

The results (Fig. 2, bottom) revealed no significant difference in regeneration rate between injuries in mid-colony and those on primary branches (5.00 *versus* 4.60 days; Mann-Whitney two-tailed test; $P > 0.2$). In contrast, injuries on branch tips regenerated significantly slower than those on primary branches of the controls (8.80 *versus* 4.60 days; Mann-Whitney one-tailed test, $P < 0.005$). Presumably, this two-fold difference in regeneration rate exists because injuries on branch tips have only one tissue front contributing to regrowth compared to two for injuries elsewhere in the colony (*sensu* Lang da Silveira and van't Hof, 1977, for *P. flexuosa*).

Among certain well-studied colonial taxa such as the ectoprocts, regenerative ability varies within colonies due to astogenetic gradients in zooid morphology and condition (Jackson and Palumbi, 1979; Palumbi and Jackson, 1982). That equivalent injuries (*i.e.*, mid-colony *versus* primary) did not vary in regeneration rate within these gorgonian colonies may reflect the apparent lack of comparable differentiation of function among polyps in the shallow water, Caribbean gorgonians (Bayer, 1961, 1973). Nevertheless, natural injuries to holdfasts and basal tissues often fail to regenerate (Cary, 1914, 1918; pers. obs. after Hurricane Allen, see Woodley *et al.*, 1981). This pattern, combined with the two-fold difference in regeneration rates between injuries on branch tips and those elsewhere on the colony, suggests that any systematic or predictable variation in the location of injury within colonies may seriously influence the ecological consequences of those injuries (particularly if on branch tips; Wahle in prep.).

Effects of species and reef zones on regeneration

Morphological and physiological differences among colonial taxa may be reflected in their ability to replace lost tissues (*e.g.*, for ectoprocts and sponges: Jackson and Palumbi, 1979). In addition, many plexaurid gorgonian species have relatively broad depth ranges across Caribbean reefs (Bayer, 1961; Kinzie 1970, 1973, 1974; Opresko, 1973). Consequently, conspecific colonies which are potentially within the same breeding population may experience very different environmental conditions, such as the availability of food or light (Kinzie, 1970) or the frequency of natural injury (Woodley *et al.*, 1981). Variation in these environmental conditions may in turn affect colony physiology, and specifically, rates of regeneration. This experiment examined regeneration rates among colonies of three common and morphologically distinct plexaurids living in three reef zones in and near Discovery Bay, Jamaica. Three related questions were addressed: 1) does a species' regenerative ability vary across its depth range; 2) do co-occurring species differ in regeneration rates within the same habitat; and 3) do the relative regeneration rates of the three species remain constant across their depth range, or are they differentially affected by changes in environmental conditions?

The species used in this experiment were *Plexaura homomalla*, *Plexaurella dichotoma*, and *Eunicea mammosa* (described in Methods). The experiments were conducted in the Mixed Zone, the East Fore Reef Terrace (Terrace), and the Rear Zone (Fig. 1, sites 1, 2, and 3 respectively), during late December, 1977. The experimental design consisted of placing two equivalent injuries on each of three replicate colonies for each of the three species in each of the three zones (Fig. 3; initial number of colonies = 27, number of injuries = 54). Final sample sizes, after loss of 2 replicate branches to storms and human disturbance, and elimination of 3 taxonomically ambiguous *Eunicea spp.* colonies, are given in Table I. Experimental injuries were made by completely removing 2 cm of tissue and sclerites mid-way down two terminal (primary) branches on each colony (Fig. 3). Paired injuries were placed on opposite

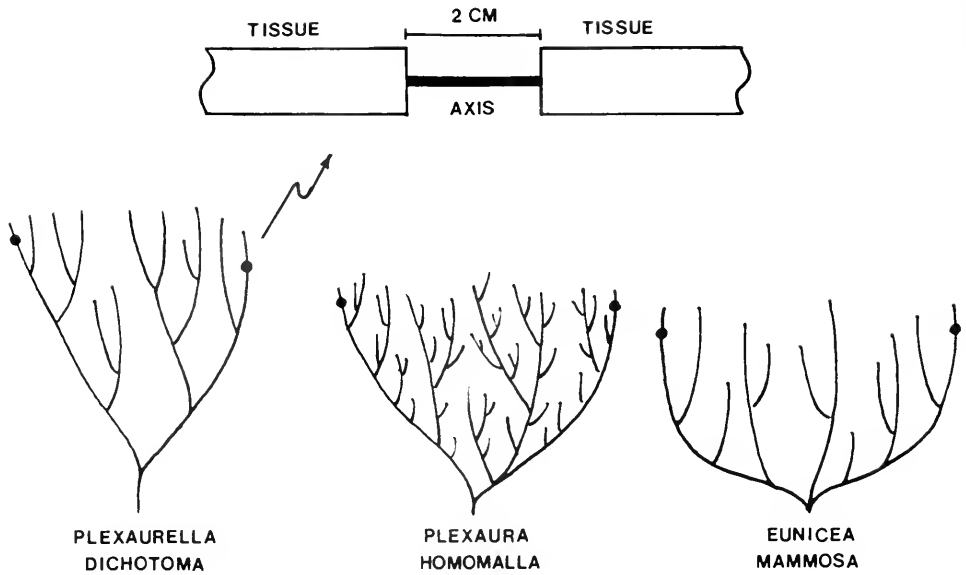

2 INJURIES x 3 COLONIES x 3 SPECIES x 3 ZONES

FIGURE 3. Species-Reef Zone experiment: experimental design showing type of injury (top), location of injuries on schematic representations of three species (center), and initial sample sizes (bottom).

sides of the colony to maximize their physiological independence and to minimize the potential for any influence of integration among regions of the colony (see Bayer, 1973; Murdock, 1978a, b). All experimental colonies were chosen for maximum size and minimum evidence of previous injury, and were thus presumed to be in optimal physiological condition within each zone.

TABLE I

Regeneration time (in days) of injuries on colonies of three species in three reef zones in and near Discovery Bay*

Species		Reef zones			Differences within species
		Mixed	Terr.	Rear	
<i>Plexaura homomalla</i>	\bar{x} :	(6.83)	(8.60)	(7.67)	$P < 0.05$
	s:	1.17	1.34	0.52	
	n:	6	5	6	
<i>Plexaurella dichotoma</i>	\bar{x} :	(6.67)	(9.00)	(10.60)	$P < 0.005$
	s:	0.52	1.55	0.89	
	n:	6	6	5	
<i>Eunicea mammosa</i>	\bar{x} :	(6.00)	(6.00)	(7.75)	$P > 0.05$
	s:	0.00	0.82	1.26	
	n:	4	4	4	
Differences within zones		$P > 0.1$	$P < 0.01$	$P < 0.01$	

* Values are: \bar{x} : mean regeneration time in days (parentheses); s: standard deviation; n: total number of injuries; P : significance levels for six Kruskal-Wallis tests of regeneration time within species or zones.

The effect of environment on specific regeneration rates. Within two of the three species examined (*Plexaura homomalla*, *Plexaurella dichotoma*), rates of regeneration differed significantly across the three reef zones (Table I; rows). The exception was seen among colonies of *Eunicea mammosa*, which showed no significant variation in regeneration rate across the reef (Kruskal-Wallis two-tailed test; $P > 0.05$). For each species (rows, Tables I and II) regeneration rates were generally fastest in the Mixed Zone, and slowest in the Rear Zone.

For each of the three reef zones, an overall, grand mean regeneration time was calculated for all co-occurring colonies, regardless of species. These three grand means were then ranked, with the zone having the fastest overall regeneration rate (least time) given primary rank (Table II, bottom row). These zone-specific regeneration ranks showed the same pattern as did the data for the individual species: increasing from Mixed to Rear Zone.

Differences in regeneration rate among co-occurring species. Within two of the three reef zones examined (Terrace and Rear Zone), regeneration rates differed significantly among the three co-occurring gorgonian species (Table I; columns). The exception was in the Mixed Zone, where regeneration rates of the three co-occurring species did not differ significantly (Kruskal-Wallis two-tailed test; $P > 0.1$). The relative regeneration rates (*i.e.*, fastest, intermediate, slowest) of the three species differed from zone to zone across the reef (Tables I and II, columns). In general however, the overall species ranking (Table II, right column) showed fastest rates of regeneration among colonies of *Eunicea mammosa*, followed by *Plexaura homomalla* and *Plexaurella dichotoma*.

DISCUSSION

Colony physiology and regeneration rates in P. homomalla

All organisms must allocate presumably limited energy to various biological functions such as growth, reproduction, regeneration and maintenance (*e.g.*, Charnov and Schaffer, 1973; Schaffer and Gadgill, 1975; Williams, 1975; Jackson, 1977; Stearns,

TABLE II

Mean regeneration rates of three species, ranked () for: conspecific colonies in different reef zones (rows); different species in the same zone (columns, parentheses); overall species rank (**); and overall zone rank (**)*

Species	Rank across	Reef zones			Overall species rank
		Mixed	Terr.	Rear	
<i>Plexaura homomalla</i>	zone:	1	3	2	2
	species:	(3)	(2)	(1)	
<i>Plexaurella dichotoma</i>	zone:	1	2	3	3
	species:	(2)	(3)	(3)	
<i>Eunicea mammosa</i>	zone:	1.5	1.5	3	1
	species:	(1)	(1)	(2)	
Overall zone rank		1	2	3	

* Ranks increase with decreasing mean regeneration rate (*i.e.*, 1, Fast; 3, slow).

** Overall ranks calculated as the ranked grand mean regeneration rate for each species across zones (right), and for each zone across species (bottom).

1977; Jackson and Palumbi, 1979; Karlson, 1981). The results of these experiments on regeneration among gorgonian colonies differing in some of the above variables (Fig. 2) suggest that energetic tradeoffs among competing biological functions may be more complex than previously thought for reef corals (Connell, 1973; Fishelson, 1973; Loya, 1976; Bak *et al.*, 1977).

For example, under the levels of injury tested in these experiments, rates of regeneration were independent of both colony size and reproductive phase (Fig. 2). These results, which contradict predictions based on simple energetic models, may have at least three possible and not necessarily mutually exclusive explanations. First, energy may seldom be limiting among reef-dwelling plexaurid gorgonians. This possibility will remain untestable until more is known about sources of nutrition and the energetic costs of growth, reproduction, and regeneration among these colonial animals. Second, the frequency and potential impact of injury on colony fitness may be sufficiently great to have selected for maintaining a permanent capacity to replace lost tissue, independent of other simultaneous energetic demands. Thus, for example, while the allocation of energy or other limited materials (*sensu* Lang da Silveira and van't Hof, 1977) may oscillate over time between growth and reproduction, gorgonians may possess a permanent and independent reserve available for future regeneration.

Third, this experiment measured rates of regeneration under normal, but relatively low levels of injury as compared to those occurring during catastrophic storms such as hurricanes (Woodley *et al.*, 1981). Moreover, experimental colonies were specifically chosen to have no evidence of previous injury or abnormalities which could potentially affect regenerative ability (*sensu* Lang da Silveira and van't Hof, 1977; Jackson and Palumbi, 1979; Palumbi and Jackson, 1982). Finally, the paired comparisons of regeneration rates consistently showed the predicted trends, but failed to differ significantly. Combined, these factors suggest that the effects on regeneration of colony size and reproductive phase (and perhaps of other aspects of colony energetics) may not become apparent until the intensity of injury (either natural or experimental) is considerably higher than that tested here. For example, gorgonians seem to be able to regenerate efficiently under low levels of natural injury (Kinzie, 1970; Birkeland and Gregory, 1975; Kitting, 1975, and references therein). However, repeated injury and regeneration among colonies of *Plexaura flexouosa* can inhibit future regeneration by depleting a critical population of rate-limiting, interstitial and transitional cells (Lang da Silveira and van't Hof, 1977). Thus, the predicted energetic constraints on regeneration may become important mainly among colonies with large, numerous, or repeated injuries. Such conditions could occur either routinely, in certain frequently disturbed reef zones, or during hurricanes (Cary, 1914, 1918; Woodley *et al.*, 1981).

Species, environment, and regeneration rates

Many common, Caribbean plexaurids extend in depth range across a variety of reef zones and environmental conditions (Bayer, 1961; Kinzie, 1970, 1973; Opresko, 1973). Among the three species examined, the influence of the environment on rates of regeneration was varied and complex (Tables I and II). Within two of the three species examined (*P. homomalla*, *P. dichotoma*), conspecific colonies differed significantly in regeneration rate across their depth range. In addition, within two of three reef zones examined (Terrace and Rear), co-occurring colonies of the three species differed significantly in regeneration rate. Moreover, the relative rankings of overall regeneration rates changed from zone to zone (Table II, across columns), and from species to species (Table II, among rows). This changing pattern suggests a potential interaction between species and environment on regeneration rate (hypothesis 3, above; Sokal and Rohlf, 1969).

Despite this degree of variation among species and reef zones, rates of regeneration were fastest and did not vary among co-occurring species in the Mixed Zone. This pattern suggests that the three species might have inherently similar regenerative capacities, but are differentially affected by changes in environment across their depth range. While the relation between environment and regeneration is undoubtedly complex, involving many variables, it may be influenced by frequencies of routine injury across the reef, and in the associated, cumulative energetic costs of repeated regeneration (*sensu* Lang da Silveira and van't Hof, 1977; Potts, 1977). For example, rates of regeneration (Tables I and II, bottom row) were fastest in the Mixed Zone, where previously surveyed natural injuries were relatively uncommon, and were slowest in the Rear Zone, where most gorgonian colonies were injured relatively heavily (Woodley *et al.*, 1981).

Injury and regeneration as ecological processes

The ability to regenerate lost tissue and skeleton is common to most of the marine invertebrate taxa which inhabit coral reefs (Mattson, 1976). Regeneration functions both as an integral part of the life history (Moment, 1951; Tardent, 1965), and as a response to injury (Wood-Jones, 1912; Cary, 1914, 1918; Kawaguti, 1937; Bayer, 1961; Mangum, 1964; Ebert, 1968; Kinzie, 1970, 1974; Trevaillon *et al.*, 1970; Connell, 1973; Fishelson, 1973; Birkeland and Gregory, 1975; Glynn, 1976; Loya, 1976; Bak *et al.*, 1977; Jackson, 1977, 1979; Lang da Silveira and van't Hof, 1977; Potts, 1977; Jackson and Palumbi, 1979; Hughes and Jackson, 1980; Karlson, 1981, 1983; Palumbi and Jackson, 1982; Hughes, 1983).

Despite its ubiquity however, the ecological role of regeneration remains relatively obscure, in part because neither injury nor regeneration immediately affect colony survivorship. Rather, their effects on colony fitness, and on the structure of sessile assemblages, may be subtle (and intimately related to colony physiology), delayed, and highly variable among different colonial taxa.

For example, regeneration of lost tissues often precludes the settlement of fouling organisms onto areas of exposed internal skeleton within the injured colony. Such fouling can have two important ecological consequences. First, settlement of competitive superiors can lead to the eventual overgrowth of the entire colony (Kinzie, 1970; Jackson and Palumbi, 1979; Palumbi and Jackson, 1982; and references therein). This potential relationship between injury, regeneration, survivorship, and abundance may have influenced patterns of gorgonian abundance in the three Jamaican reef zones examined here. Gorgonians were most common in the Mixed Zone (14.6 colonies/m²), where frequencies of natural injury were low (Woodley *et al.*, 1981) and rates of regeneration were fast (Tables I and II). Conversely, gorgonian abundances were low (0.3 colonies/m²) in the Rear Zone, where frequencies of injury were high (Woodley *et al.*, 1981) and rates of regeneration were slow (Tables I and II). Clearly however, these patterns are probably affected by many other variables as well.

The second consequence of fouling is the immediate addition of new organisms to benthic assemblages. By preventing recruitment of other organisms onto surviving colonies, regeneration may profoundly influence the structure and composition of benthic communities (Bak *et al.*, 1977; Jackson and Palumbi, 1979; Palumbi and Jackson, 1982). The impact of such fouling, however, will vary with the size, growth form, and competitive ability of the fouling taxa in relation to that of the injured colony. For example, recruitment of encrusting organisms (*e.g.*, bryozoans, foraminiferans, and crustose algae) onto similar taxa living in the relatively two-dimensional, cryptic community (Jackson, 1979) may have much greater effects on community

structure (Jackson and Palumbi, 1979; Palumbi and Jackson, 1982) than would fouling by comparable organisms onto the larger colonial animals of the open reef. Although all injuries in these experiments were fouled by various encrusting taxa (filamentous algae, athecate hydroids; with varying effects on regeneration rate) all gorgonian colonies were able to fully regenerate over these fouling organisms (see also Bak *et al.*, 1977).

Thus, among reef communities differing in scale (*e.g.*, cryptic *versus* open reef; Jackson, 1979), similar processes of injury, regeneration, and fouling may have very different ecological consequences. In the cryptic community, the major ecological effect of injury may be its influence on recruitment of comparable organisms into the community (Jackson and Palumbi, 1979; Palumbi and Jackson, 1982). On the open reef, where many fouling taxa are small relative to injured gorgonians, corals, or sponges, the primary influence of injury and regeneration may be more on colony physiology than on colony numbers. For example, in many gorgonian species, both behavior and reproduction are integrated and synchronized among most polyps within the colony (behavior: Wainwright and Dillon, 1969; Bayer, 1973; Preston and Preston, 1975; reproduction: Bayer, 1973, 1974; Goldberg and Hamiton, 1974). Injuries have the potential to temporarily or permanently disrupt these and other aspects of a colony-wide physiological integration by isolating distal regions of the colony from the main body of polyps (Wahle, 1983). Thus, a major role of regeneration among reef dwelling gorgonians, and among other open reef colonial taxa, may be to restore colony-wide integration of critical biological and ecological functions disrupted by injury.

ACKNOWLEDGMENTS

I am indebted to many people and institutions for help in this work: to D. Gerhart for tireless field assistance; to C. Cook for field work and support; to the National Science Foundation, Johns Hopkins University, and Sigma Xi for funding; to the Department of Zoology, University of Texas for facilities; to the staff of D.B.M.L.; to L. Buss, E. Chornesky, P. Gilman, T. Hughes, J. Jackson, J. Lang, S. Palumbi, P. Ringold, C. Slocum, S. Stanley, G. Wellington, S. Woodin, and an anonymous reviewer for helpful reviews; to E. Chornesky for invaluable criticism and support; and particularly to J. Jackson for stimulating and critical discussions of injury and regeneration. This is contribution number 195 of the Discovery Bay Marine Lab, University of the West Indies. This paper is in partial fulfillment of the requirements for the Ph.D. at J.H.U.

LITERATURE CITED

- BAK, R., J. BROUNS, AND F. HAYS. 1977. Regeneration and aspects of spatial competition in the scleractinian corals *Agaricia agaricites* and *Montastraea annularis*. *Proc. 3rd Int. Coral Reef Symp.* Pp. 143-148.
- BAYER, F. 1961. *The shallow water Octocorallia of the West Indian region*. Martinus Nijhoff, Netherlands. 373 pp.
- BAYER, F. 1973. Colonial organization in Octocorals. Pp. 69-94 in *Animal Colonies*, R. Boardman, A. Cheetham, and W. Oliver, eds. Hutchinson and Ross, Inc.
- BAYER, F., AND A. WEINHEIMER. 1974. *Prostaglandins from Plexuara homomalla: ecology, utilization and conservation of a major marine resource. A symposium. Studies in Tropical Oceanography*, vol. 12. Univ. of Miami Press. 165 pp.
- BIRKELAND, C. 1974. The effect of wave action on the population dynamics of *Gorgonia ventalina* Linnaeus. Pp. 115-126 in *Studies in Tropical Oceanography*, vol. 12. Univ. of Miami Press.
- BIRKELAND, C., AND B. GREGORY. 1975. Foraging behavior and rates of feeding of the gastropod *Cyphona gibbosum*. *Sci. Bull. Mus. Nat. Hist. Los Angeles County*.

- CARY, L. 1914. Observations on the growth rate and oecology of Gorgonians. *Publ. of Carnegie Inst. of Washington*. **182**: 79-90.
- CARY, L. 1918. The gorgonaceae as a factor in the formation of coral reefs. *Publ. Carnegie Inst. Washington* **213**: 343-362.
- CHARNOV, E., AND W. SCHAFFER. 1973. Life history consequences of natural selection: Cole's result revisited. *Am. Nat.* **107**: 791-793.
- CONNELL, J. 1973. Population ecology of reef building corals. Pp. 205-246 in *The Biology and Geology of Coral Reefs. Biology 1, vol. 2*, O. Jones and R. Endean, eds. Academic Press.
- EBERT, T. 1968. Growth rates of the sea urchin *Strongylocentrotus purpuratus* related to food availability and spine abrasion. *Ecology* **49**(6): 1075-1091.
- FISHELSON, L. 1973. Ecological and biological phenomena influencing coral species composition on the reef tables at Eilat (Gulf of Aquaba, Red Sea). *Mar. Biol.* **19**: 183-196.
- GLYNN, P. 1976. Some physical and biological determinants of coral community structure in the Eastern Pacific. *Ecol. Monogr.* **46**: 431-456.
- GOLDBERG, W., AND R. HAMILTON. 1974. The sexual cycle of *Plexaura homomalla*. Pp. 58-61 in *Studies in Tropical Oceanography*, vol. 12. Univ. of Miami Press.
- HUGHES, R. 1983. Evolutionary ecology of colonial reef-organisms, with particular reference to corals. *Biol. J. Linnean Soc.* **20**: 39-58.
- HUGHES, T., AND J. JACKSON. 1980. Do corals lie about their age? *Science* **209**: 713-715.
- JACKSON, J. 1977. Competition on marine hard substrata: the adaptive significance of solitary and colonial strategies. *Am. Nat.* **111**(980): 743-767.
- JACKSON, J. 1979. Morphological strategies of sessile animals. Pp. 499-555 in *Biology and Systematics of Colonial Organisms*. G. Larwood and B. Rosen, eds. Academic Press, London.
- JACKSON, J., AND S. PALUMBI. 1979. Regeneration and partial predation in cryptic coral reef environments: preliminary experiments on sponges and ectoprocts. Pp. 303-308 in *Biologie des Spongiaires*. C. Levi and N. Boury-Esnault, eds. Colloq. Int. C.N.R.S., Vol. 291.
- KARLSON, R. 1981. Reproductive patterns in *Zoanthus spp.* from Discovery Bay, Jamaica. *Proc. 4th Int. Coral Reef Symp.* **2**: 699-704.
- KARLSON, R. 1983. Disturbance and monopolization of a spatial resource by *Zoanthus sociatus* (Coelenterata, Anthozoa). *Bull. Mar. Sci.* **33**(1): 118-131.
- KAWAGUTI, S. 1937. On the physiology of reef corals III. Regeneration and phototropism in reef corals. *Palau Trop. Biol. Sta. Studies* **2**: 209-218.
- KINZIE, R. 1970. *The Ecology of the Gorgonians (Cnidaria: Octocorallia) of Discovery Bay, Jamaica*. Ph.D. Thesis, Yale University, New Haven.
- KINZIE, R. 1973. The zonation of West Indian gorgonians. *Bull. Mar. Sci.* **23**(1): 93-155.
- KINZIE, R. 1974. *Plexaura homomalla*: the biology and ecology of a harvestable marine resource. Pp. 22-38 in *Studies in Tropical Oceanography*, vol. 12 University of Miami Press.
- KITTING, C. 1975. The impact of molluscs feeding on some West Indian gorgonians. *Bull. Am. Malacol. Union* (abstract).
- LANG DA SILVEIRA, AND F. VAN'T HOF. 1977. Regeneration in the gorgonian *Plexaura flexuosa*. (Cnidaria: Octocorallia). *Bijdragen tot de Dierkunde*. **47**(1): 99-108.
- LOYA, Y. 1976. Skeletal regeneration in a Red Sea scleractinian coral population. *Nature* **261**: 5560.
- MANGUM, C. 1964. Studies on speciation in maldanid polychaetes of the North Atlantic coast. II. Distribution and competitive interactions of five sympatric species. *Limnol. Oceanogr.* **9**: 12-26.
- MATTSON, P. 1976. *Regeneration*. Bobbs Merrill Co., Inc. Indianapolis. 176 pp.
- MOMENT, G. 1951. Simultaneous anterior and posterior regeneration and other growth phenomena in Maldanid Polychaetes. *J. Exp. Zool.* **117**: 1.
- MURDOCK, G. 1978a. Digestion, assimilation, and transport of food in the gastrovascular cavity of a gorgonian octocoral (Cnidaria: Anthozoa). *Bull. Mar. Sci.* **28**: 354-362.
- MURDOCK, G. 1978b. Circulation and digestion of food in the gastrovascular system of gorgonian octocorals (Cnidaria: Anthozoa). *Bull. Mar. Sci.* **28**: 363-370.
- OPRESKO, D. 1973. Abundance and distribution of shallow-water gorgonians in the area of Miami, Florida. *Bull. Mar. Sci.* **23**(3): 535-537.
- PALUMBI, S., AND J. JACKSON. 1982. Ecology of cryptic coral reef communities. II. Recovery from small disturbance events by encrusting bryozoa: the influence of "host" species and lesion size. *J. Exp. Mar. Biol. Ecol.* **64**: 103-115.
- POTTS, D. 1977. Suppression of coral populations by filamentous algae within damselfish territories. *J. Exp. Mar. Biol. Ecol.* **28**: 207-216.
- PRESTON, E., AND J. PRESTON. 1975. Ecological structure in a West Indian gorgonian fauna. *Bull. Mar. Sci.* **25**(2): 248-258.
- SCHAFFER, W., AND M. GADGIL. 1975. Selection for optimal life histories in plants. Pp. 142-151 in *Ecology and Evolution of Communities*. M. Cody and J. Diamond, eds. Belknap Press, MA.

- SOKAL, R., AND F. RÖHLF. 1969. *Biometry*. W. H. Freeman and Co., San Francisco. 776 pp.
- STEARNS, S. 1977. The evolution of life history traits: a critique of the theory and a review of the data. *Annu. Rev. Ecol. Syst.* **8**: 145-171.
- TARDENT, P. 1965. *Regeneration in Animals and Related Problems*, V. Kiortsis and H. Trampusch, eds. North Holland Publ. Co., Amsterdam.
- TREVAILLION, A., R. EDWARDS, AND J. STEELE. 1970. Dynamics of a benthic bivalve. Pp. 285-295 in *Marine Food Chains*, J. Steele, ed. Oliver and Boyd, Edinburgh.
- WAHLE, C. 1980. Detection, pursuit, and overgrowth of tropical gorgonians by milleporid hydrocorals: Perseus and Medusa revisited. *Science* **209**: 689-691.
- WAHLE, C. 1983. The roles of age, size and injury in sexual reproduction among Jamaican gorgonians. *Am. Zool.* **23**(4).
- WAINWRIGHT, S., AND J. DILLON. 1969. On the orientation of sea fans (genus *Gorgonia*). *Biol. Bull.* **136**: 130-139.
- WILLIAMS, G. 1975. *Sex and Evolution*. Princeton Univ. Press, Princeton. 200 pp.
- WOOD-JONES, F. 1912. *Corals and Atolls*. Reeve and Co., Ltd. London.
- WOODLEY, J., E. CHORNESKY, P. CLIFFORD, J. JACKSON, L. KAUFMAN, N. KNOWLTON, J. LANG, M. PEARSON, J. PORTER, M. ROONEY, K. RYLAARSDAM, V. TUNNICLIFFE, C. WAHLE, J. WULFF, A. CURTIS, M. DALLMEYER, B. JUPP, M. KOEHL, J. NEIGEL, AND E. SIDES. 1981. Hurricane Allen's impact on Jamaican coral reefs. *Science* **214**: 749-755.
- ZAR, J. 1974. *Biostatistical Analysis*. Prentice-Hall, New Jersey. 620 pp.

MARINE BIOLUMINESCENCE SPECTRA MEASURED WITH AN OPTICAL MULTICHANNEL DETECTION SYSTEM

EDITH A. WIDDER, MICHAEL I. LATZ, AND JAMES F. CASE

Department of Biological Sciences and the Marine Sciences Institute, University of California, Santa Barbara, California 93106

ABSTRACT

The emission spectra of 70 bioluminescent marine species were measured with a computer controlled optical multichannel analyzer (OMA). A 350 nm spectral window is simultaneously measured using a linear array of 700 silicon photodiodes, coupled by fiber optics to a microchannel plate image intensifier on which a polychromator generated spectrum is focused. Collection optics include a quartz fiber optic bundle which allows spectra to be measured from single photophores. Since corrections are not required for temporal variations in emissions, it was possible to acquire spectra of transient luminescent events that would be difficult or impossible to record with conventional techniques. Use of this system at sea on freshly trawled material and in the laboratory has permitted acquisition of a large collection of bioluminescence spectra of precision rarely obtained previously with such material. Among unusual spectral features revealed were organisms capable of emitting more than one color, including: *Umbellula magniflora* and *Stachytilum superbum* (Penatulacea), *Parazoanthus lucificum* (Zoantharia), and *Cleidopus gloria-maris* (Pisces). Evidence is presented that the narrow bandwidth of the emission spectrum for *Argyrolepecus affinis* (Pisces) is due to filters in the photophores.

INTRODUCTION

Measurements of bioluminescence spectra, especially from fragile marine organisms, are complicated by the frequently dim and transient nature of their luminescence. Recently developed intensified optical multichannel detectors, capable of simultaneous measurement of an entire spectral region, are well suited to overcoming these difficulties. Here we describe the use of one such optical multichannel analyzer (OMA) system sufficiently robust for use at sea as well as in the laboratory, and present the first collection of bioluminescence spectra acquired with it. This system is adaptable to the extreme range of variables encountered in taking spectra of living systems, namely potentially broad spectral range, wide range of possible luminous intensities, erratic time-intensity characteristics of light emission, and the variable size and structure of the light emitting tissues.

MATERIALS AND METHODS

Theory of operation

The detector (Table I and Fig. 1) is an intensified silicon photodiode (ISPD) linear array placed in the image plane of a polychromator. Light focused on the entrance

Received 12 August 1983; accepted 21 September 1983.

Abbreviations: FWHM, full width at half maximum; ISPD, intensified silicon photodiode; NBS, National Bureau of Standards; OMA, optical multichannel analyzer; S.D., standard deviation; S/N, signal to noise ratio; UV, ultraviolet; λ_{max} , wavelength at peak emission.

slit of the polychromator is dispersed by the diffraction grating across the 700 intensified detector elements ($25 \mu\text{m} \times 2.5 \text{ mm}$ each) of the ISPD linear array. Photons striking the reverse-biased diodes create electron-hole pairs in the semiconductor material which discharge the equivalent capacitance of the diode. When the array is scanned, the amount of recharging required by each diode (pixel) is a measure of the number of electron-hole pairs formed. Since pixel position can be directly related to the wavelength of incident photons, the charge per pixel represents a spectrum of the light focused on the entrance slit.

Light may be directly integrated on the detector for periods ranging from 16 ms to more than 20 s. Since the entire spectral window under examination is measured simultaneously rather than sequentially, as in the conventional spectrophotometer, there is no need to correct for time dependent changes in the emission, which are common in bioluminescence. The limit of integration is determined by the dark current which is kept low by thermoelectric cooling of the detector. Computer control (Digital Equipment Corporation LSI-11) of integration time provides the sensitivity and dynamic range necessary for dealing with the wide range of luminous intensities encountered in bioluminescent organisms.

Collection optics

Because the size and structure of light emitting sources varied widely in the organisms studied, considerable flexibility was required of the polychromator collection optics. Initially, we used the convenient method of positioning the organism in front

TABLE I

Instrumentation

Detector	EG&G-PARC Model 1420 intensified silicon photodiode (ISPD) linear array, composed of 1024 diodes (each $25 \mu\text{m} \times 2.5 \text{ mm}$). The microchannel plate intensifier is fiber optically coupled to 700 of the detector elements.
Detector controller	EG&G-PARC Model 1218.
Computer console	EG&G-PARC Model 1215 and Model 1217 outboard disc drive. Allows storage and manipulation of up to 60 spectra per diskette.
Plotter	Hewlett-Packard 7045B X-Y recorder.
Polychromator	ISA Model HR-320, 0.32 m Czerny-Turner $f/4.8$ with a $58 \times 58 \text{ mm}$ 152 grooves/mm grating blazed at 250 nm. Reciprocal linear dispersion, 0.49 nm/diode.
Collection optics	Two all-quartz systems, aperture matched to the polychromator and used to focus the image of the source onto the entrance slit. Large aperture system: a 50 mm objective lens fixed at 100 mm from the 75 mm field lens. Fiber optic system: a Welch Allyn circle to line converter, 50 cm ultraviolet light pipe, with a 2mm bundle diameter terminating in a linear output $7 \text{ mm} \times 0.9 \text{ mm}$, focused with a 10 mm cylindrical lens.
Calibration system	Oriel Model 6047 low pressure mercury spectral lamp. Optronics Model 245H 45 watt quartz tungsten-halogen standard of total and spectral irradiance. Optronics Model 65 precision current source. Optronics Model UV-40 40 watt deuterium arc standard of spectral irradiance. Optronics Model 45 deuterium lamp precision current source.

of the entrance slit without input optics (Seliger *et al.*, 1964; Swift *et al.*, 1977). Since this procedure may degrade the resultant spectrum by scattering unfocused, stray light in the polychromator, two interchangeable quartz lens systems were developed to focus the luminescent source at the polychromator entrance slit. For large luminescent sources we used a 50 mm objective lens and a 75 mm field lens mounted in a fixed tube, baffled and aperture-matched to the polychromator (Fig. 1A). The input port for the tube was 1.76 cm in diameter and designed so that a luminescent source positioned in the input plane produced a focused image at the entrance slit of the polychromator. For smaller luminescent sources such as photophores (*ca.* 1 mm diameter) or other discrete luminescent regions of organisms, we used a 2 mm diameter quartz fiber optic terminated in a 7 mm \times 0.9 mm rectangular output focused on the slit by a 10 mm focal length fused silica cylindrical condenser lens. This system was also baffled and aperture matched to the polychromator (Fig. 1B).

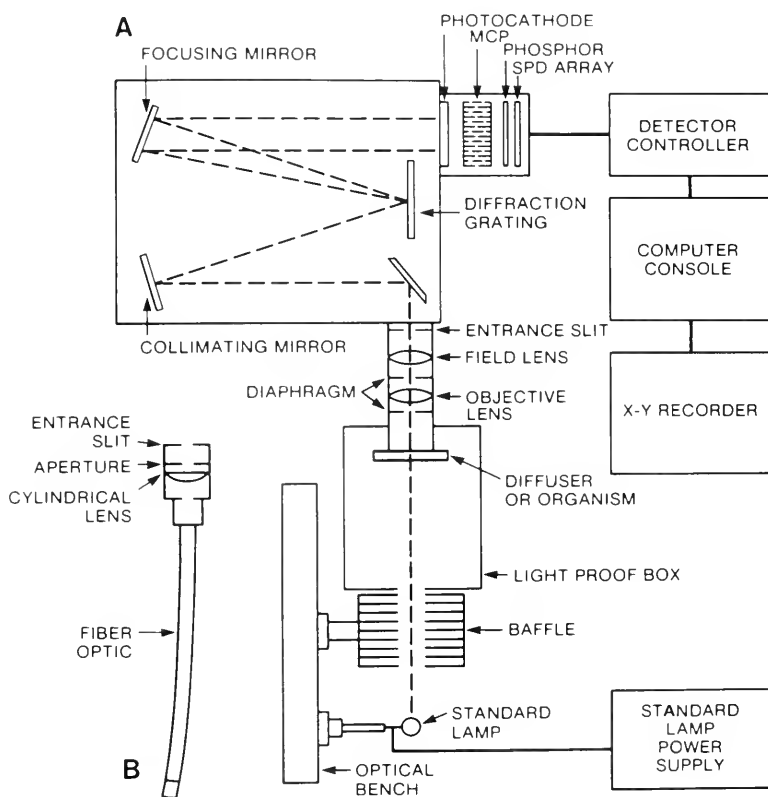

FIGURE 1. Schematic of apparatus for measuring emission spectra in calibration configuration. (A) Bioluminescence or standard lamp output is focused by the input optics on the entrance slit of the polychromator. The spectrum from the diffraction grating falls on the cathode of the detector, where it is intensified and then detected by a linear array of silicon photodiodes. The detector is operated through the detector controller under computer control. Spectral distributions are stored on floppy disk, analyzed, and then plotted on an X-Y recorder. The system is calibrated by tungsten-halogen and deuterium standard lamps and a mercury spectral lamp. The output from these calibration sources is collimated by a series of baffles and diffused by a quartz ground disc before entering the input optics to the polychromator. (B) Alternate collection optics consist of a 2 mm diameter quartz fiber optic light pipe terminating in a linear output, focused on the entrance slit by a cylindrical lens. Not drawn to scale.

Sensitivity

The combination of the microchannel plate intensifier with the long integration times attainable with the silicon photodiode array allow attainment of high sensitivity. The minimum detectable signal (signal to noise ratio = 2) for an ISPD at the normal operating temperature of 0°C is 4 photons/s/diode with an integration time of 10 s (Talmi, 1982). Insertion of the f/4.8 polychromator and collection optics between the ISPD and the source resulted in a minimum detectable signal at the input of the fiber optic of 7,150 photons/s at 475 nm with a 1 mm slit and 20 s integration time. With the double lens system, which had an input area 81 times that of the fiber optic, 45,000 photons/s at 475 nm were required.

This level of sensitivity permitted measurement of the spectrum of one flash of a single dinoflagellate, *Pyrocystis fusiformis*, and, using integration times of 10 to 20 s, it was possible to measure the spectrum of any source visible to the dark-adapted human eye.

Calibration

Since the input optics and spectral window were changed frequently while working at sea, a method of field calibration was necessary. A low-pressure mercury spectral lamp (Table I) was used for wavelength calibration. A spectral irradiance standard and precision current source (Table I) were used to correct for nonuniformities in channel-to-channel sensitivity and for detector and polychromator efficiencies. The calibration function was generated as the ratio of the measured spectrum to the true spectrum (Fig. 2A), which was determined from the NBS referenced calibration data supplied with the lamp. To be accurate, the calibration function must be generated under the same conditions as the spectrum to which it will be applied. To do this the unfocused standard lamp beam was collimated, and then diffused by a quartz ground glass of known transmission. This diffuser served as the radiant source to the polychromator and was positioned at the input of the optical system at what would be the plane of focus of the bioluminescent organism or tissue.

Stray light, often a problem in single stage polychromators, is a fraction of a percent of the total irradiance (Talmi, 1982) and is insignificant at the low intensities characteristic of bioluminescence. However, the intense red emission of the tungsten-halogen standard lamp produced stray light that was a significant percentage of the lamp's much weaker emissions below 400 nm. To insure accuracy of the correction curve in the near UV, we used an NBS referenced deuterium arc lamp to generate the correction function below 400 nm.

Data analysis

Spectra were stored on floppy disks, with automatic subtraction of the dark charge, background spectrum. Postexperiment manipulation of data primarily involved division of the emission spectrum by the correction curve stored in memory and digital smoothing of the data using a Savitzky-Golay least-square polynomial algorithm (Savitzky and Golay, 1964; Edwards and Willson, 1974) (Fig. 2B). The running least squares fit was to a second degree polynomial over a 25 channel smoothing range. This smoothing range was well below the recommended value of 70% of the narrowest spectral feature observed (Edwards and Willson, 1974) and, therefore, facilitated identification of such spectral features as λ_{\max} and FWHM without decreasing resolution. The smoothing function was applied from 1 to 10 times depending on the signal to noise ratio (S/N) of the spectrum. The signal to noise ratio of each spectrum was

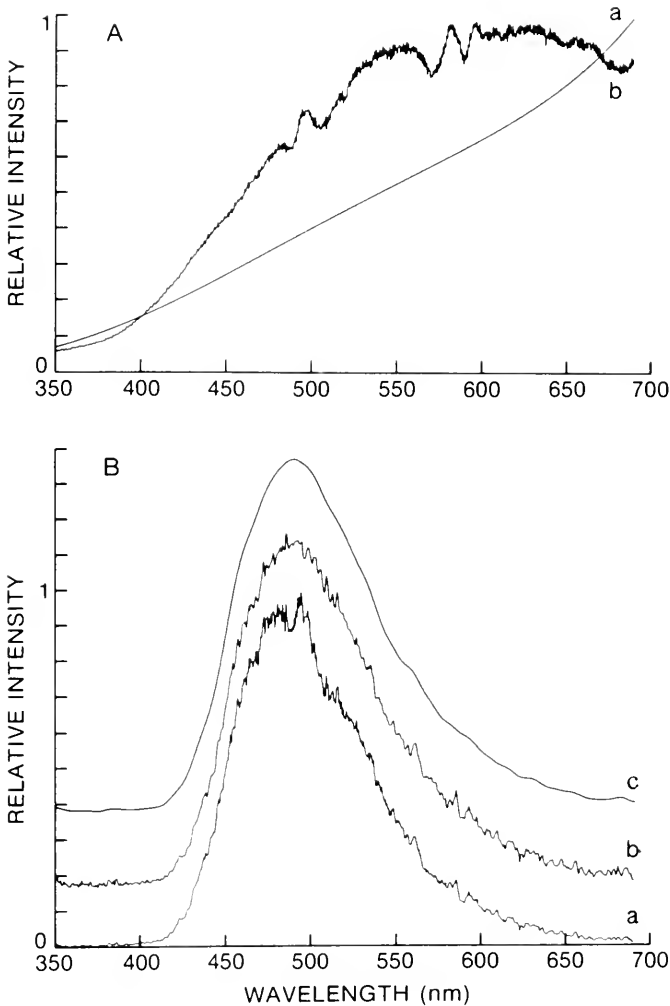

FIGURE 2. (A) Real versus ideal curves for spectral output of the tungsten-halogen standard lamp. Derived from 100 scans, each 16.6 ms in duration, using the double lens collection optics with 0.025 mm entrance slit. Relative intensity is shown as a function of wavelength. (a) Ideal curve calculated from a third degree polynomial curve fit to the data supplied with the lamp. (b) Standard lamp spectral output as measured with OMA. Fluctuations in the measured spectrum are the result of non-uniformities in the sensitivity of the system. A correction curve is generated by dividing curve (b) by curve (a). (B) Effects of data correction and analysis on emission from a colony of the tunicate, *Pyrosoma atlanticum*, using double lens optics and 1 mm slit. (a) Uncorrected spectrum. Apparent bimodality is explained by fluctuation in the real standard lamp curve (A-b), with the result that the corrected spectrum (b) is unimodal. The corrected spectrum which has been smoothed five times (c) has a $\lambda_{\max} = 491$ nm, FWHM = 96, and S/N = 99. Each curve is shown on a similar relative scale but is displaced vertically for clarity.

computed as the ratio of the signal at λ_{\max} to the root mean square noise over the whole spectral range (calculated by first subtracting the smoothed from the unsmoothed corrected spectrum). Other computer operations included calibration of channel number to wavelength value and generation of the ideal standard lamp curve using a third degree polynomial curve fit to the data supplied with the lamps.

Accuracy and resolution

Since bioluminescent emissions occur over the entire visible spectrum, it is desirable to examine as broad a spectral range as possible when examining new organisms. Consequently we have used a 152 grooves/mm plane grating which provides a spectral coverage of about 350 nm and a spectral bandwidth of 0.5 nm/diode. Geometric registration on the ISPD is excellent, ± 1 diode (Talmi and Simpson, 1980); therefore, wavelength accuracy was ± 0.5 nm with the 152 grooves/mm grating. Resolution was a function of the grating and the slit width and was empirically determined as the product of the reciprocal linear dispersion and the FWHM of one of the mercury lines (Felkel and Pardue, 1979). Experimentally determined resolution was: 2 nm using the 0.025 mm slit, 3 nm with the 0.1 mm slit, and with the 1 mm slit it was 9 nm using the fiber optic input and 20 nm using the lens system or no collection optics. Resolution and accuracy were also a function of the relative brightness of the source. In order to examine this effect, a C^{14} activated phosphor disc (λ_{\max} 524 nm) was attached to the input of the double lens system and five readings were taken with the 1 mm slit at each of several different integration times. At integration times producing signal to noise ratios of 150 and above, the average standard deviation was less than 1.5 nm for λ_{\max} and less than 0.8 nm for FWHM measurements. With signal to noise ratios between 30 and 150, the average S.D. was 6.5 nm for λ_{\max} and 0.9 nm for FWHM. At S/N ratios below 30, the S.D. of λ_{\max} and FWHM measurements were 19 and 10 nm respectively. Examples of spectra with S/N ratios within these three different ranges are shown in Figure 3A. For signal to noise ratios above 150 the smoothing function was applied only once, for ratios between 30 and 150 it was applied a maximum of 5 times, and below 30 it was applied a maximum of 10 times (Fig. 3B).

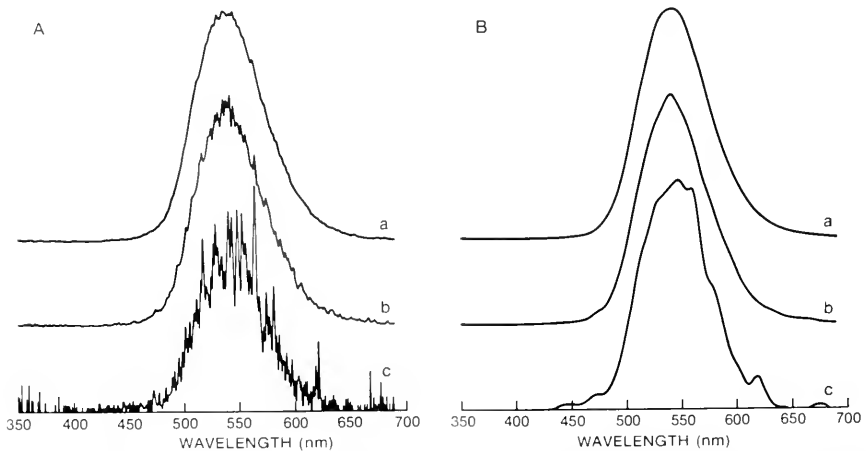

FIGURE 3. Determination of accuracy as a function of source intensity using a constant output C^{14} activated phosphor. Using the double lens optics with 1 mm slit, different integration times yielded spectra with different signal to noise ratios. (A) Corrected spectra with (a) $S/N = 229$, (b) $S/N = 71$, and (c) $S/N = 11$. With the lowest signal to noise ratio (c), noise spikes are pronounced. (B) Smoothed spectra from (A). The curve with $S/N = 229$ (a) was smoothed once, $\lambda_{\max} = 524$ nm, FWHM = 73 nm. (b) Curve with $S/N = 71$ underwent five smoothings, $\lambda_{\max} = 524$ nm, FWHM = 74 nm. (c) Curve with lowest signal to noise ratio ($S/N = 11$) was smoothed 10 times, $\lambda_{\max} = 530$ nm, FWHM = 75 nm. Note noise bumps. All six curves are plotted on a relative linear intensity scale.

Collection and handling of organisms

Deep-living organisms were collected from the Catalina, East Cortez, San Clemente, Santa Barbara, and Velero Basins off the coast of Southern California during 1982 and 1983. Benthic samples were taken with a 5 ft beam trawl and a near-bottom beam trawl with a 2×10 ft mouth opening; midwater collections were made with an opening-closing midwater Tucker trawl (10×10 ft opening) fitted with an opaque, thermally-insulated cod-end. The pelagic holothurian *Scotoanassa* was collected by the deep submersible "Alvin." Sorted animals were placed in chilled sea water (4–8°C) and maintained in light-proof coolers until use. All measurements were made within 4 h after collection. Coastal and subtidal animals were collected locally in the Santa Barbara Basin, near Santa Barbara, or near Scripps Institution of Oceanography, La Jolla, California, by trawling or SCUBA diving and maintained in the laboratory in aquaria with flow-through, sand-filtered sea water (18°C). A few specimens were obtained from laboratory cultures or a commercial aquarium. Specimens were placed for testing in quartz glassware containing sea water or held in air and positioned in front of the detector collection optics. In some cases, bioluminescence was stimulated or enhanced by 1×10^{-3} M norepinephrine, 1×10^{-4} g/ml serotonin, or 2% hydrogen peroxide. Otherwise, unstimulated or mechanically stimulated emissions were measured. Specimens were preserved in 5 or 10% buffered formalin for subsequent identification. Reference specimens have been deposited in the Invertebrate Zoology Collection, Santa Barbara Museum of Natural History.

RESULTS

Spectral data

Table II lists 70 bioluminescent species from which we have obtained spectra using the OMA. They are arranged taxonomically and the spectral features listed are the wavelength at peak emission (λ_{\max}) and the width at half the maximum value (FWHM). The signal to noise ratio (S/N) is included as a measure of relative accuracy. Whenever a given organism was available on more than one occasion, spectra were taken. Multiple spectra were averaged and the mean with standard deviation was determined. Spectra were grouped for averaging in three S/N ranges: above 150, between 150 and 30, and below 30. Readings below 30 were not listed if better measurements were available. Measurements made at different slit widths were kept separate, and in cases where different collection optics had a significant effect on the values, they were listed separately. This was most apparent when the fiber bundle collection optics were used with the 1 mm slit. The greater resolution of the fiber bundle at this slit width was due to its 0.9 mm linear output width and was most apparent for spectra with narrow bandwidths.

Over the year during which these spectra were collected an effort was made to insure accurate calibration and correction factors. One obvious independent check of the entire system is the reproducibility of the spectral data and comparison of our measurements with accurately known bioluminescence spectra from other laboratories. *Renilla* has an extremely stable emission spectrum (Wampler *et al.*, 1973) and as a result it has been suggested that it might serve as an "emission standard . . . for routine calibration checks" (Wampler, 1978). Following this advice, we measured specimens of the local species, *Renilla köllikeri*, many times throughout the year with different collection optics, slit widths, and polychromator settings (Table II). The values measured remained in good agreement and also compared well with measurements made in other laboratories (Reynolds, 1978; Wampler *et al.*, 1973).

TABLE II

Species	λ_{\max}^* (nm) $\bar{X} \pm S.D. (n)$	FWHM (nm)	S/N	Slit (mm)	Remarks
Phylum Bacteria					
<i>Photobacterium leiognathi</i>	481	79	373	1.0 ^b	
	481	77	24	0.05 ^c	
<i>Photobacterium phosphoreum</i>	483	75	385	1.0 ^b	
	481	73	241	0.025 ^b	
	481	73	43	0.025 ^c	
	492 ± 1 (2)	94 ± 0	294 ± 18	1.0 ^b	
<i>Vibrio fischeri</i>	493	95	132	0.1 ^b	
	496	94	71	0.025 ^b	
	540	81	333	1.0 ^b	20°C
<i>Vibrio fischeri</i> Y-1	495	101	72	1.0 ^b	29°C
	488	96	246	1.0 ^b	
<i>Vibrio harveyi</i>	483	93	96	0.025 ^c	
	486	73	103	1.0 ^b	
Isolates from <i>Abyssicola macrochir</i> (Pisces: Macrouridae)					
Isolates from <i>Coelorthynchus japonicus</i> (Pisces: Macrouridae)	481	77	34	1.0 ^b	
	471	35	154	1.0 ^a	
Phylum Dinophyta					
<i>Pyrocystis fusiformis</i>	472 ± 0 (2)	32 ± 3	152 ± 7	0.1 ^{a,b}	
	472	38	125	1.0 ^a	
<i>Pyrocystis lunula</i>	472 ± 0 (2)	34 ± 0	136 ± 2	0.1 ^{a,b}	

<i>Pyrocystis noctiluca</i>	472	35	180	1.0 ^a	
	472	33	170	0.1 ^b	
	474	35	53	1.0 ^a	
<i>Gonyaulax polyedra</i>	472	30	71	0.1 ^b	
Phylum Cnidaria					
<i>Maresearsia praeclara</i>	473	64	42	1.0 ^c	
<i>Periphylla periphylla</i>	463 ± 1 (3)	76 ± 4	57 ± 40	1.0 ^{a,c}	
<i>Atolla wyvillei</i>	462 ± 1 (3)	79 ± 4	88 ± 48	1.0 ^{a,c}	
<i>Renilla köllikeri</i>	509	22	199	1.0 ^a	rachis polyps
	509	25	130	1.0 ^a	
	509	23	97	1.0 ^a	
	509	25	47	1.0 ^a	
	509 ± 1 (3)	30 ± 0	276 ± 111	1.0 ^{b,c}	
	509 ± 2 (5)	30 ± 2	100 ± 27	1.0 ^{b,c}	
	508 ± 1 (5)	22 ± 1	113 ± 35	0.1 ^{a,b}	
	508	21	123	0.025 ^a	
	508 ± 1 (5)	31 ± 11	141 ± 38	1.0 ^a	
	511 ± 1 (4)	25 ± 1	84 ± 27	1.0 ^a	
<i>Acanthoptilum annulatum</i>	510 ± 1 (3)	26 ± 1	77 ± 31	1.0 ^a	
	510 ± 1 (2)	25 ± 0	162 ± 27	1.0 ^a	
<i>Stachyptilum superbum</i>	503 ± 2 (2)	29 ± 3	196 ± 21	1.0 ^a	
	505 ± 0 (2)	43 ± 4	71 ± 56	1.0 ^b	
	533	44	251	1.0 ^a	
	533	58	78	1.0 ^b	
<i>Umbellula magniflora</i>	501	30	56	1.0 ^a	bottom of stalk
	500	46	81	1.0 ^b	bottom of stalk
	499 ± 2 (2)	71 ± 25	15 ± 18	1.0 ^a	middle of stalk
	470	62	44	1.0 ^a	top of stalk
	489 ± 3 (2)	70 ± 2	8 ± 4	1.0 ^a	polyps
	498	101	14	1.0 ^b	polyps

TABLE II (Continued)

Species	λ_{max}^* (nm) $\bar{X} \pm S.D. (n)$	FWHM (nm)	S/N	Slit (mm)	Remarks
<i>Pennatula phosphorea</i> var. <i>californica</i>	500	53	45	1.0 ^a	
<i>Parazoanthus lucificum</i>	500	121	154	1.0 ^b	
	502	108	145	1.0 ^a	same colony
	574	94	56	1.0 ^a	
<i>Epizoanthus cf. induratum</i>	500	93	67	1.0 ^c	
Phylum Ctenophora					
<i>Mnemiopsis</i> sp.	480	83	47	1.0 ^b	from St. Augustine, Florida
<i>Beroë cf. cucumis</i>	484	83	45	1.0 ^c	
	483	83	23	1.0 ^c	
<i>Beroë cf. forstali</i>	482	86	89	1.0 ^a	
<i>Beroë</i> sp.	484 ± 2 (6)	80 ± 7	83 ± 29	1.0 ^c	
	484	77	21	1.0 ^a	
Phylum Artthropoda					
<i>Vargula hilgendorfi</i>	465	82	165	1.0 ^c	dried
	465	83	101	1.0 ^b	dried
	465 ± 8 (3)	84 ± 5	70 ± 8	0.1 ^{a,b,c}	dried
	469 ± 4 (2)	85 ± 1	76 ± 8	0.05 ^c	dried
<i>Vargula tsujii</i>	466 ± 0 (2)	87 ± 1	118 ± 40	1.0 ^c	dried
<i>Gausssia princeps</i>	489	77	186	1.0 ^c	secretion
	486 ± 3 (8)	75 ± 3	50 ± 18	1.0 ^{a,c}	secretion
	483	75	31	0.1 ^c	secretion
	488	74	34	0.05 ^c	secretion
<i>Gnathophausia ingens</i>	484 ± 3 (11)	83 ± 2	61 ± 32	1.0 ^{a,b,c}	secretion

<i>Scina cf. rattrayi</i>	439	70	48	1.0 ^a	antennae ¹
<i>Euphausia pacifica</i>	470 ± 2 (3)	46 ± 4	92 ± 26	1.0 ^c	
<i>Nyctiphanes simplex</i>	467	44	64	1.0 ^b	
<i>Nematocelis difficilis</i>	483	81	43	1.0 ^b	
<i>Hymenodora</i> sp.	456	70	67	1.0 ^a	secretion
<i>Parapasiphea sulcatifrons</i>	454	64	13	1.0 ^c	
<i>Sergestes similis</i>	472 ± 4 (2)	58 ± 6	12 ± 9	1.0 ^a	cephalothorax ¹
	472	63	10	1.0 ^a	post. light organ ¹
<i>Sergia phorcus</i>	472	97	4	1.0 ^c	mid-body photophores
Phylum Mollusca					
<i>Abraliopsis falco</i>	[421] 466	105	12	1.0 ^c	subocular photophores ²
<i>Cranchia scabra</i>	[480 ± 1] 510 ± 2 (2)	78 ± 2	47 ± 3	1.0 ^a	medial subocular photophores ¹
	[483] 511	77	63	1.0 ^a	lateral subocular photophores ¹
	[481] 511	83	24	1.0 ^a	subocular photophores
<i>Gaditenthis phyllura</i>	[472] 506	59	16	1.0 ^a	subocular photophores ¹
<i>Helicocranchia piefferi</i>	[476 ± 3] 502 ± 0 (2)	92 ± 0	9 ± 1	1.0 ^a	
<i>Vampiryotenthis infernalis</i>	466 ± 3 (2)	75 ± 1	21 ± 8	1.0 ^{a,c}	finbase photophore <i>in situ</i>
	461	75	136	1.0 ^a	finbase photophore <i>in situ</i> ¹
	461 ± 3 (7)	74 ± 1	70 ± 35	1.0 ^{a,c}	excised finbase photophore
	464	79	156	1.0 ^a	excised finbase photophore ¹
	464	77	44	1.0 ^a	excised finbase photophore ¹
Phylum Echinodermata					
<i>Scotoplanes globosa</i>	463 ± 1 (2)	71 ± 3	33 ± 2	1.0 ^a	
<i>Scotoanassa hollisi</i>	463 ± 0 (2)	75 ± 3	59 ± 21	1.0 ^c	

TABLE II (Continued)

Species	λ_{\max}^* (nm) $\bar{X} \pm \text{S.D. (n)}$	FWHM (nm)	S/N	Slit (mm)	Remarks
<i>Pannychia moselyi</i>	465	70	7	1.0 ^a	
<i>Ophiopholis cf. longispina</i>	[483 ± 1] 511 ± 1 [545 ± 0] (2)	98 ± 6	46 ± 6	1.0 ^a	
Phylum Chordata					
Subphylum Tunicata					
<i>Oikopleura dioica</i>	483	95	45	1.0 ^c	
<i>Pyrosoma atlanticum</i>	488 ± 1 (2) 492 ± 1 (2)	93 ± 4 98 ± 2	34 ± 2 75 ± 35	1.0 ^a 1.0 ^b	pigmented colonies
<i>Pyrosomella cf. verticillata</i>	491 ± 6 (3) 483	95 ± 2 96	89 ± 5 33	1.0 ^c 0.1 ^c	
Subphylum Vertebrata					
<i>Eurypharynx pelecanoioides</i>	472	76	13	1.0 ^a	dorsal epidermis
<i>Argyropelecus affinis</i>	482 ± 6 (3) 486 484	31 ± 8 29 53	83 ± 40 15 9	1.0 ^{a,c} 1.0 ^a 1.0 ^a	post. photophores ant. photophores; tips excised
<i>Borostomias panamensis</i>	484	68	51	1.0 ^c	post-orbital photophore
<i>Aristostomias scintillans</i>	481	59	99	1.0 ^c	post-orbital photophore ³
<i>Chauliodus macoumi</i>	478	85	11	1.0 ^a	
<i>Stomias atriventer</i>	479 ± 1 (3) 476 481 483	75 ± 1 77 71 79	104 ± 26 75 47 26	1.0 ^c 1.0 ^c 1.0 ^c 1.0 ^c	dermis; tail region dermis; dorsal mid-body region upper jaw ant. photophores
<i>Stomias sp.</i>	478 470 497	77 85 69	68 20 45	1.0 ^a 1.0 ^a 1.0 ^a	dermis; ventral caudal fin ³ ant. photophore ³ photophores ³

<i>Idiacanthus antrostomus</i>	472	82	38	1.0 ^c	posterior photophores
	471 ± 2 (2)	77 ± 1	18 ± 1	1.0 ^c	ant. photophores
<i>Triphonus mexicanus</i>	469 ± 2 (6)	62 ± 1	90 ± 55	1.0 ^{a,c}	infracaudal organ
	469	61	158	1.0 ^a	supracaudal organ
	469 ± 3 (3)	60 ± 2	105 ± 25	1.0 ^c	caudal organs
	461	91	6	1.0 ^c	photophores
<i>Lampanyctus ritteri</i>	469 ± 0 (2)	62 ± 2	86 ± 52	1.0 ^c	infracaudal organ
<i>Stenobrachius leucopsarus</i>	474	62	204	1.0 ^a	infracaudal organ
	475 ± 3 (3)	62 ± 3	94 ± 34	1.0 ^a	infracaudal organ
	473 ± 1 (2)	64 ± 1	71 ± 31	1.0 ^c	caudal organs
<i>Lampadina urophaos</i>	468 ± 1 (2)	62 ± 0	63 ± 9	1.0 ^c	caudal organs
<i>Porichthys notatus</i>	489 ± 2 507 ± 3 (4)	73 ± 3	78 ± 52	1.0 ^{a,b}	ventral photophores ³
	484 501	75	69	1.0 ^a	1 ventral photophore ³
	485 507	73	25	1.0 ^a	1 ventral photophore ³
	486 504	67	12	1.0 ^a	1 supraorbital photophore ³
	491 511	69	13	1.0 ^a	2 suborbital photophores ³
<i>Porichthys myriaster</i>	491 ± 0 512 ± 2 (2)	76 ± 0	59 ± 18	1.0 ^a	ventral photophores ³
<i>Onetrodes acanthias</i>	480	74	108	1.0 ^c	esca
<i>Onirodes</i> sp.	477	80	190	1.0 ^a	esca
<i>Cleidopus gloria-maris</i>	506	92	264	1.0 ^a	ant. region left organ; adult
	506	85	200	1.0 ^a	mid-region left organ; adult
	510	88	317	1.0 ^a	mid-region right organ; adult
	503	86	304	1.0 ^a	post. region left organ; adult
	555	120	199	1.0 ^a	ant. region right organ; juvenile
	523	120	219	1.0 ^a	mid-region right organ; juvenile
	522	122	232	1.0 ^a	mid-region left organ; juvenile
	516	101	217	1.0 ^a	post. region right organ; juvenile
<i>Anomalops katoptron</i>	493	94	53	1.0 ^a	suborbital photophore

^a Fiber bundle collection optics.^b Double lens collection optics.^c No collection optics.¹ Bioluminescence stimulated or enhanced by hydrogen peroxide.² Bioluminescence enhanced by serotonin.³ Bioluminescence stimulated or enhanced by norepinephrine.

* Secondary peaks in brackets.

Spectral range

In general, spectra were confined to the range of 400 nm to 700 nm. Occasionally spectra extended into the near UV. The greatest emission noted below 400 nm was by the squid *Abraliopsis falco* (Fig. 4E). Minor emission below 400 nm was also seen in the crustaceans *Scina* and *Sergestes* (Figs. 4A and 4C). The range of spectral maxima measured extended from 439 nm for *Scina* to 574 nm for *Parazoanthus* (Table II).

Spectral shapes

Examples of the observed variety in spectral shapes are shown in Figure 4. Most spectra were structureless and unimodal (Fig. 4A), with bandwidths ranging between 26 nm (*Argyrolepiscus affinis*, Fig. 4A) and 100 nm (*Pyrosoma atlanticum*, Fig. 2B) with an average of 75 to 80 nm. The emission spectrum for *Argyrolepiscus* was notable for its unusually narrow bandwidth. Among the other organisms measured, the narrowest bandwidths among the structureless unimodal emissions were those from the caudal organs of the myctophids (*Triphoturus mexicanus*, *Lampanyctus ritteri*, *Stenobrachius leucopsarus*, and *Lampadena urophaos*) (Table II). Emission spectra for these fish exhibited bandwidths of about 62 nm.

It is known that the photophores of *Argyrolepiscus* consist of deeply placed tissue that transmits light to the ventral surface through light-pipe-like structures which contain pigmented filters (Denton *et al.*, 1970). To determine if the filters in the ventral photophores are responsible for the unusual narrowness of the emission spectrum, a 1 mm strip was cut from the anterior photophores of one specimen. The emission spectrum from this region was measured with the fiber bundle collection optics and compared with a spectrum taken from the posterior uncut region of the same specimen. Removal of the ventral anterior strip increased the bandwidth more than 20 nm over the spectrum measured from the posterior intact photophores (Fig. 5).

Essentially unimodal spectra were observed with some structural complexity, commonly seen as a long wavelength shoulder as in all the pennatulids and dinoflagellates measured (Fig. 4B) and less commonly with a short wavelength shoulder as seen in *Sergestes*, *Parazoanthus* and the Y-1 strain of *Vibrio fischeri* (Fig. 4C).

Porichthys exhibited the only emission spectrum with bimodal peaks of approximately equal intensity (Fig. 4D). All squids measured had bimodal emission spectra with short wavelength secondary peaks and long wavelength shoulders (Fig. 4E). The only trimodal spectrum measured was that of the brittle star *Ophiopholis* which had both short and long wavelength secondary peaks (Fig. 4F).

Spectral variation within species

In several instances different emission spectra were observed from different colonies of the same species. The most notable example of this was the pennatulid, *Stachyptilum superbum* (Table II). One 60 min beam trawl at 600 m in the Santa Barbara Basin yielded hundreds of these sea pens. Visual inspection revealed that approximately 1 out of every 100 colonies had a much yellower emission than the majority. Measurements of the emission spectra demonstrated a 30 nm difference in emission maxima and a slightly broader bandwidth for the yellow emitters. No morphological differences were found to distinguish the two variants.

Another example of this phenomenon was seen in a colony of *Parazoanthus lucificum*. The emission spectrum for the colony as initially measured with the double

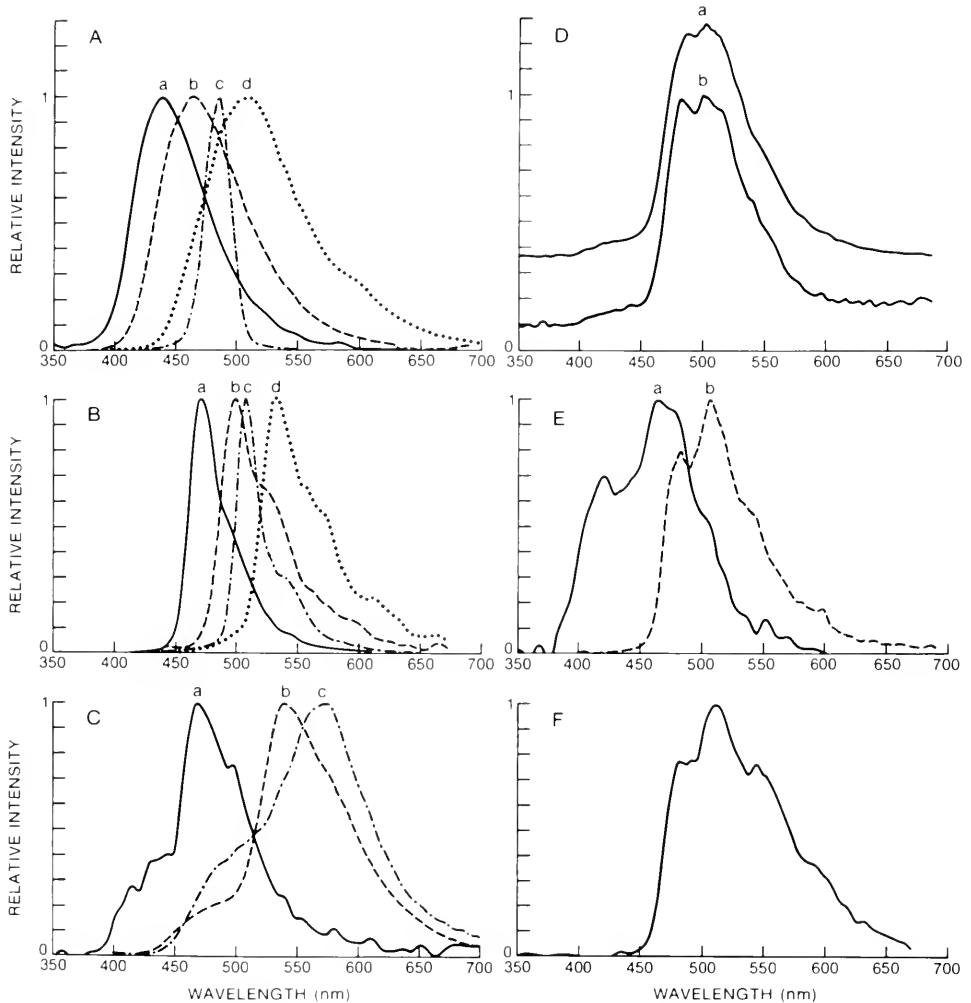

FIGURE 4. Some representative emission spectra of marine organisms. Relative intensity is shown with respect to wavelength. (A) Structureless unimodal distributions. (a) *Scina cf. rattrayi*, λ_{\max} = 439 nm, FWHM = 70 nm, S/N = 48; (b) *Vargula hilgendorffii*, λ_{\max} = 465 nm, FWHM = 83 nm, S/N = 101; (c) *Argyropelecus affinis*, λ_{\max} = 487 nm, FWHM = 26 nm, S/N = 125; (d) *Cleiodopos gloria-maris* adult, λ_{\max} = 506 nm, FWHM = 92 nm, S/N = 264. The polychromator spectral window was set for 400–750 nm for (d) and 350–700 nm for (a–c). (B) Unimodal distributions with one or more long wavelength shoulders. (a) *Pyrocystis noctiluca*, λ_{\max} = 472 nm, FWHM = 35 nm, S/N = 180; (b) *Pennatulula phosphorea*, λ_{\max} = 500 nm, FWHM = 53 nm, S/N = 45; (c) *Renilla köllikeri*, λ_{\max} = 509 nm, FWHM = 22 nm, S/N = 199; (d) *Stachytilum superbum*, λ_{\max} = 533 nm, FWHM = 58 nm, S/N = 78. (C) Unimodal distributions with short wavelength shoulder. (a) *Sergestes similis*, λ_{\max} = 469 nm, FWHM = 62 nm, S/N = 18; (b) *Vibrio fischeri* Y-1 strain at 20°C, λ_{\max} = 540 nm, FWHM = 81 nm, S/N = 333; (c) *Parazoanthus lucificum*, λ_{\max} = 574 nm, FWHM = 94 nm, S/N = 56. The bumps in (a) are due to random fluctuations (noise) which are present in all spectra but are only apparent at low signal to noise ratios. (D) Bimodal emission spectra of *Porichthys notatus*. (a) Spectrum from ventral photophores viewed by double lens optics, λ_{\max} = 488, 504 nm, FWHM = 76 nm, S/N = 130; (b) spectrum from single photophore measured with fiber optic, λ_{\max} = 484, 501 nm, FWHM = 75 nm, S/N = 64. The curves are standardized to the same scale but are vertically displaced. (E) Emission spectra of squids displaying a short wavelength secondary peak and long wavelength shoulders. (a) *Abraliopsis falco*, λ_{\max} = 421, 466 nm, FWHM = 105 nm, S/N = 12; (b) *Cranchia scabra*, λ_{\max} = 483, 511 nm, FWHM = 77 nm, S/N = 63. (F) Trimodal emission spectrum of *Ophiophilis cf. longispina*, λ_{\max} = 483, 512, 545 nm, FWHM = 102 nm, S/N = 42.

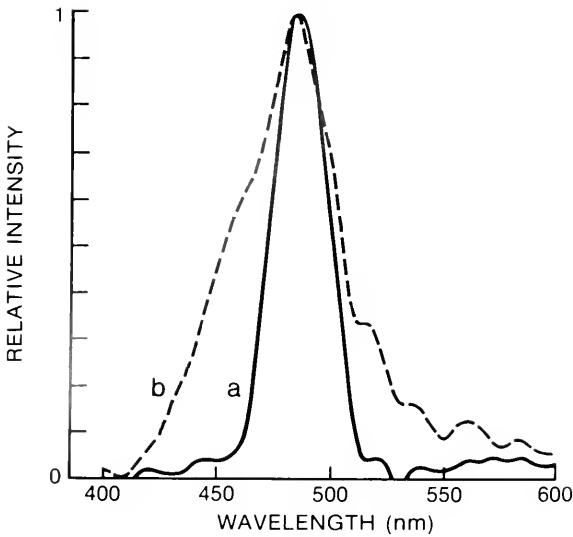

FIGURE 5. Effect of filters in the photophores of a single specimen of *Argyropelecus affinis* on emission spectra. Measured with fiber collection optics; relative intensity displayed as function of wavelength. (a) Emission of posterior photophores, $\lambda_{\max} = 486$ nm, FWHM = 29 nm, S/N = 15; (b) spectral emission of anterior photophores with ventral tip excised, $\lambda_{\max} = 484$ nm, FWHM = 53 nm, S/N = 9.

lens collection optics appeared to be bimodal (Fig. 6A). Examination with the fiber bundle collection optics showed that some polyps produced different unimodal emission spectra (Fig. 6B) with a difference in emission maxima of 70 nm. Due to its dimness, this spectral shift was much more difficult to distinguish visually than the 30 nm difference displayed by different *Stachyptilum* colonies. A different colony of the same *Parazoanthus* species had only one emission spectrum which matched the shorter wavelength spectrum of the two color colony.

In the pinecone fish *Cleidopus gloria-maris* there is a visible color difference between the bacterial light organ of juveniles as compared to adults. Comparison of the emission spectra confirmed a 15 nm short wavelength shift in the adults. The fiber bundle collection optics demonstrated the presence of a pronounced emission gradient across the juvenile light organ that was essentially absent in the adult (Table II). Light from the anterior region of the juvenile light organ had a λ_{\max} of 555 nm compared to a λ_{\max} of 523 nm measured from the mid region and 516 nm in the posterior region. In the adult, measurements from equivalent regions across a single organ were 506 nm, 506 nm, and 503 nm from anterior to posterior. These emission spectra of both juvenile and adult are very different from the spectrum measured from *Vibrio fischeri* (λ_{\max} 492 nm, Table II), the bacterium isolated from light organs of this species (Fitzgerald, 1977).

A similar color gradient was seen in the sea pen *Umbellula* (Table II). Luminescence at the base of the stalk was bright green ($\lambda_{\max} = 500$ nm) with the narrow bandwidth and long wavelength shoulder typical of *in vivo* pennatulid emissions (Morin and Hastings, 1971b; Wampler *et al.*, 1973). Proceeding up the stalk the emission became broader, bluer, and dimmer until at the top of the stalk it had a broad, structureless spectrum with a λ_{\max} of 470 nm.

The Y-1 strain of *Vibrio fischeri* is also capable of more than one emission color (Ruby and Neilson, 1977). At 20°C or below, emission is unimodal with a short wavelength shoulder and a λ_{\max} of 540 nm. However, upon heating the emission

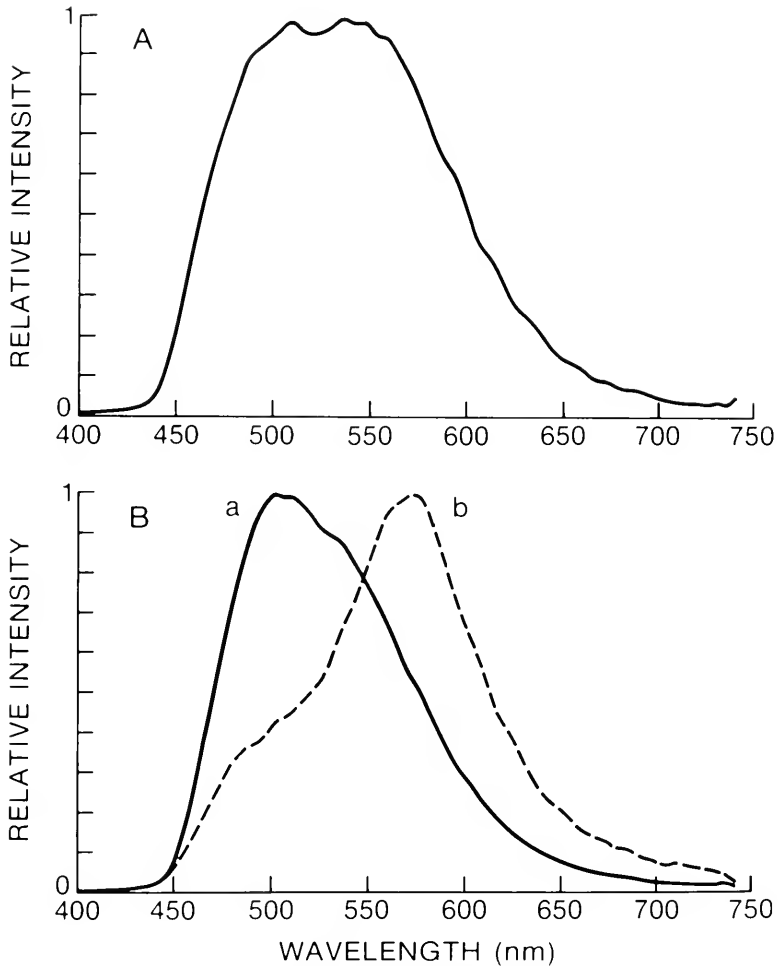

FIGURE 6. Emission spectra of a colony of *Parazoanthus lucificum*. Relative intensity is shown with respect to wavelength. (A) Apparent bimodal spectral distribution from entire colony, measured with double lens collection optics, $\lambda_{\max} = 509.537$ nm, FWHM = 140 nm, S/N = 96. (B) Emissions from individuals of colony measured with fiber collection optics. In this colony, two different unimodal distributions were produced, (a) $\lambda_{\max} = 502$ nm, FWHM = 108 nm, S/N = 145; (b) $\lambda_{\max} = 574$ nm, FWHM = 94 nm, S/N = 56.

gradually shifts until at 28°C and above the emission is structureless with a λ_{\max} of 495 nm.

DISCUSSION

The number of published bioluminescence emission spectra is a small percentage of the total number of luminescent marine species known to exist and the number of accurately determined spectra is probably even smaller. This is largely due to the difficulty of measuring bioluminescence by conventional spectrophotometric techniques. The fragility of marine luminescent organisms demands that the instrumentation be brought to them and the nature of the instrumentation thus far in common use makes this difficult.

The earliest practical spectrophotometric systems used in bioluminescence work were designed for high sensitivity at the expense of resolution. Nicol (*e.g.*, 1958, 1960), using paired photomultipliers, one to correct for total energy variation and the other measuring spectral regions through a series of colored filters, was able to measure dim, relatively long time-course sources such as myctophid photophores, but resolution was limited to approximately 25 nm. Morin and Hastings (1971a, b) utilized a grating monochromator with calibrated photomultiplier to give a calculated bandwidth of 6.6 nm with 4 mm slits. Using a similar system with 2 mm slits, Swift *et al.* (1977) were able to resolve emission peaks 3.5 nm apart. Even though scanning time across the spectrum with the latter system was as short as 3.1 s (Biggley *et al.*, 1981), there was variability in consecutive measurements due to modulations in emission intensity. Other high resolution systems currently in use include Reynolds' (1978) photographic spectroscopy-intensifier system and Wampler's spectrofluorometer on-line computer system (Wampler and DeSa, 1971).^{*} The Reynolds system allows simultaneous registration of a wide spectral range (400–600 nm) but in its present configuration it is not amenable to ship-board use and data reduction is time-consuming. The spectrofluorometer system of Wampler utilizes computer software to facilitate data collection, storage, and analysis, but requires scan times of 8 s or longer (Wampler *et al.*, 1971, 1973). For this reason, techniques such as quick freezing and subsequent thawing have been employed to generate steady bioluminescence over the scanning period.

The OMA system, as we have employed it, has three properties essential for determining the emission spectra of living specimens: high sensitivity, high resolution, and simultaneous light collection. It, therefore, represents a practical solution to many problems which have plagued bioluminescence emission spectroscopy, especially with regards to extreme temporal variations of the emissions. For example, luminescent flashes with very fast kinetics such as those produced by myctophid caudal organs (as contrasted with photophores) were easily measured with the OMA in the present study. No published spectra exist for these bright luminescent organs, presumably because irregular flashes of such short duration (60–80 ms, Barnes and Case, 1974) have been impossible to measure with a scanning spectrophotometer.

This system also has the advantage of being able to measure spectra from very localized sources owing to the collection optics employed. The fiber collection optics provide a spatial resolution that has not been previously available. The combination of high sensitivity and spatial resolution allowed convenient measurement of the spectrum of a single photophore (Fig. 4D) and makes the system ideally suited for studying organisms capable of multichromatic emissions. The bichromatic *Parazoanthus lucificum* colony is a dramatic example of the need for this kind of resolving power. Bioluminescence from the colony produced a bimodal spectrum that localized measurements from single polyps resolved into two unimodal peaks. The highest degree of spacial resolution was attained with the pinecone fish, *Cleidopus gloriamaris*, where a gradient of emission was clearly resolved in a light organ measuring only 4×2 mm (Haneda, 1966).

In some organisms the chemistry of the luminescent system is responsible for the different colors of emissions. For example, in *Umbellula* the difference in emission between the base and the top of the stalk may be accounted for by different ratios of the two emitters responsible for pennatulid bioluminescence (Wampler *et al.*, 1971, 1973). The emission patterns present in *Umbellula* could involve an increasing con-

^{*} Note: Herring (in press) describes results obtained with a paired scanning photomultiplier system (Collier *et al.*, 1979). This device has a scan time of 30s and a stated accuracy of ± 4 nm.

centration of the green fluorescent protein emitter from stalk tip to base that gradually masks the dim blue luciferin emission. The 533 nm emission spectrum from some colonies of the pennatulid *Stachyptilum* is not readily explainable on the basis of the known luciferin and green fluorescent protein emitters responsible for pennatulid luminescence. This emission could be due to a different, undescribed emitter.

Optical filtering may also alter the color of some emissions. In *Argyroleucus* filters narrow the bandwidth of the bioluminescence emission. This may facilitate counterillumination since the maximum and bandwidth of the filtered emission are very similar to that measured for oceanic downwelling irradiance (Young *et al.*, 1980). Filtering may also be responsible for the color of the bacterial light organ of the pinecone fish, *Cleidopus gloria-maris*. The use of filters in the light organ accounts for the difference between the blue-green emission from the intact light organ and the blue luminescence of the bacterial isolates from such organs (Haneda, 1966). The presence of a gradient of emission across the juvenile light organ that is absent in the adults also seems to be due to optical filtering.

The primary value of accumulating a large library of corrected spectra is to classify emitter types. Evidence exists that similar spectra may be due to a common emitter (Wampler *et al.*, 1973). It remains to be seen what chemical relationships exist between organisms that share a common spectral fine structure but emit at different wavelengths, such as the pennatulids already discussed (Fig. 4B) or the squids of Figure 4E. It is also possible that similar spectra in unrelated species may reveal dietary dependencies, although so far where such dependencies have been demonstrated the spectra of predator and prey have been markedly dissimilar (Tsuji *et al.*, 1975; Frank, Widder, Latz and Case, in press).

ACKNOWLEDGMENTS

The authors are indebted to Mark Lowenstine who assisted with installation of the OMA, provided advice on data processing, and has since maintained the system in working order. We also thank Dr. Jeremy Lerner of Instruments SA for suggesting the design of the collection optics. For assistance with animal collection we thank Dr. Peter Anderson, Shane Anderson, Dr. Alissa Arp, Dr. James Childress, John Favuzzi, Tamara Frank, Bill Lowell, and the captains and crews of the "R/V VELERO IV" and "R/V NEW HORIZON." Dr. B. M. Sweeney provided unialgal cultures of all the dinoflagellates and the bacterial isolates of *Abyssicola macrochir* and *Coelohynchus japonicus*; Dr. Kenneth Neilson generously allowed us to work in his laboratory and provided the remainder of the bacterial cultures. We are grateful to him and to Sea World, San Diego, for providing specimens of *Anomalops* and *Cleidopus* from their displays and to Scripps Aquarium for providing the *Parazoanthus* colonies. Specimens of *Oikopleura* were kindly provided by Dr. Charles Galt. Specimens were identified with the assistance of Dr. F. G. Hochberg, Jr. and Paul Scott of the Santa Barbara Museum of Natural History, Dr. Lawrence Madin of Woods Hole Oceanographic Institution, Dr. Robert Carney of Moss Landing Marine Laboratory, and Dr. Andrew Lisner. This work was supported by a grant from the Office of Naval Research (ONR contract number N00014-75-C-0242), the FBN fund, and faculty research funds from the University of California, Santa Barbara. Work at sea was supported by a grant from the National Science Foundation (OCE 81-10154) to J. J. Childress.

LITERATURE CITED

- BARNES, A. T., AND J. F. CASE. 1974. The luminescence of lanternfish (Myctophidae): Spontaneous activity and responses to mechanical, electrical, and chemical stimulation. *J. Exp. Mar. Biol. Ecol.* **15**: 203-221.

- BIGGLEY, W. H., T. A. NAPORA, AND E. SWIFT. 1981. The color of bioluminescent secretions from decapod prawns in the genera *Oplophorus* and *Systemaspis* (Caridea). Pp. 66–71 in *Bioluminescence Current Perspectives*, K. H. Neelson, ed. Burgess Publishing Co., Minneapolis.
- COLLIER, A. F., R. J. P. BURNHAM, AND P. J. HERRING. 1979. A system for the collection of comparative emission spectra suitable for shipboard use. *J. Mar. Biol. Assoc. U.K.* **59**: 489–495.
- DENTON, E. J., J. B. GILPIN-BROWN, AND P. G. WRIGHT. 1970. On the “filters” in the photophores of mesopelagic fish and on a fish emitting red light and especially sensitive to red light. *J. Physiol.* **208**: 72P–73P.
- EDWARDS, T. H., AND P. D. WILLSON. 1974. Digital least squares smoothing of spectra. *Appl. Spectrosc.* **28**: 541–545.
- FELKEL, H. L., JR., AND H. L. PARDUE. 1979. Simultaneous multielement determinations by atomic absorption and atomic emission with a computerized echelle spectrometer/imaging detector system. Pp. 59–96 in *Multichannel Image Detectors*, Y. Talmi, ed. *Am. Chem. Soc. Symp. Ser.* Washington, DC.
- FITZGERALD, J. M. 1977. Classification of luminescent bacteria from the light organ of the Australian pinecone fish, *Cleidopus gloria-maris*. *Arch. Microbiol.* **112**: 153–156.
- FRANK, T. M., E. A. WIDDER, M. I. LATZ, AND J. F. CASE. Dietary maintenance of bioluminescence in a deep-sea mysid. *J. Exp. Biol.* (in press).
- HANEDA, Y. 1966. On a luminous organ of the Australian pine-cone fish, *Cleidopus gloria-maris* De Vis. Pp. 547–555 in *Bioluminescence in Progress*, F. H. Johnson and Y. Haneda, eds. Princeton University Press, Princeton.
- HERRING, P. J. The spectral characteristics of luminous marine organisms. *Proc. R. Soc. Lond. B.* (in press).
- MORIN, J. G., AND J. W. HASTINGS. 1971a. Biochemistry of the bioluminescence of colonial hydroids and other coelenterates. *J. Cell Physiol.* **77**: 305–311.
- MORIN, J. G., AND J. W. HASTINGS. 1971b. Energy transfer in a bioluminescent system. *J. Cell Physiol.* **77**: 313–318.
- NICOL, J. A. C. 1958. Observations on luminescence in pelagic animals. *J. Mar. Biol. Assoc. U. K.* **37**: 705–752.
- NICOL, J. A. C. 1960. Spectral composition of the light of the lantern fish *Myctophum punctatum*. *J. Mar. Biol. Assoc. U. K.* **39**: 27–32.
- REYNOLDS, G. T. 1978. Application of photosensitive devices to bioluminescence studies. *Photochem. Photobiol.* **27**: 405–421.
- RUBY, E. G., AND K. H. NEALSON. 1977. A luminous bacterium that emits yellow light. *Science* **196**: 432–434.
- SAVITZKY, A., AND M. J. E. GOLAY. 1964. Smoothing and differentiation of data by simplified least squares procedures. *Anal. Chem.* **36**: 1627–1639.
- SELIGER, H. H., J. B. BUCK, W. G. FASTIE, AND W. D. MCELROY. 1964. The spectral distribution of firefly light. *J. Gen. Physiol.* **48**: 95–104.
- SWIFT, E., W. H. BIGGLEY, AND T. A. NAPORA. 1977. The bioluminescence emission spectra of *Pyrosoma atlanticum*, *P. spinosum* (Tunicata), *Euphausia tenera* (Crustacea) and *Gonostoma* sp. (Pisces). *J. Mar. Biol. Assoc. U. K.* **57**: 817–823.
- TALMI, Y. 1982. Spectrophotometry and spectrofluorometry with the self-scanned photodiode array. *Appl. Spectrosc.* **36**: 1–18.
- TALMI, Y., AND R. W. SIMPSON. 1980. Self-scanned photodiode array: a multichannel spectrometric detector. *Appl. Opt.* **19**: 1401–1414.
- TSUJI, F. I., B. G. NAFPAKITIS, T. GOTO, M. J. CORMIER, J. E. WAMPLER, AND J. M. ANDERSON. 1975. Spectral characteristics of the bioluminescence induced in the marine fish, *Porichthys notatus*, by *Cypridina* (Ostracod) luciferin. *Mol. Cell. Biochem.* **9**: 3–8.
- WAMPLER, J. E. 1978. Measurements and physical characteristics of luminescence. Pp. 1–48 in *Bioluminescence in Action*, P. J. Herring, ed. Academic Press, London.
- WAMPLER, J. E., AND R. DESA. 1971. An on-line spectrofluorimeter system for rapid collection of absolute luminescence spectra. *Appl. Spectrosc.* **25**(6): 623–627.
- WAMPLER, J. E., K. HORI, J. W. LEE, AND M. J. CORMIER. 1971. Structured bioluminescence. Two emitters during both the *in vitro* and the *in vivo* bioluminescence of the sea pansy, *Renilla*. *Biochemistry* **10**: 2903–2909.
- WAMPLER, J. E., Y. D. KARKHANIS, J. G. MORIN, AND M. J. CORMIER. 1973. Similarities in the bioluminescence from the Pennatulacea. *Biochim. Biophys. Acta* **314**: 104–109.
- YOUNG, R. E., E. M. KAMPA, S. D. MAYNARD, F. M. MENCHER, AND C. F. E. ROPER. 1980. Counter-illumination and the upper depth limits of midwater animals. *Deep-Sea Res.* **27A**: 671–691.

SPATIAL AND TEMPORAL PATTERNS OF MITOSIS IN THE CELLS
OF THE AXIAL POLYP OF THE REEF CORAL
ACROPORA CERVICORNIS

ELIZABETH H. GLADFELTER

*West Indies Laboratory, Teague Bay, Christiansted, St. Croix, USVI, and Department of Biology,
University of California, Los Angeles, California 90024*

ABSTRACT

The fluorescent stain DAPI was used to observe mitoses in the endoderm and the calicoblastic ectoderm of the axial polyp of the reef coral *Acropora cervicornis*. A diel periodicity in the mitotic index (defined as the percentage of cells in some stage of mitosis) of each tissue occurred with a maximum of about 2% at midnight and a minimum of 0.5% at midday. Dividing cells were located from the tip of the column (when the polyp was contracted into the calyx) to 10 mm proximal to this point suggesting that there is no narrow zone of proliferating cells. The magnitude of the mitotic indices of these tissues suggests that it may account for the observed daily growth rate of *ca.* 300 μm in the axial polyp.

INTRODUCTION

Coral growth has been the focus of numerous studies (*e.g.*, Buddemeier and Kinzie, 1976; Highsmith, 1979; Gladfelter 1982, 1983; Wellington and Glynn, 1983); most investigators have measured some parameter of skeletal growth. Rates of tissue production have been inferred from linear increases in the skeleton (Lewis, 1982), but direct measurements have not been made. In acroporid corals, for example, an increase in the length of an axial polyp as the skeleton extends could initially involve only a change in the shape of the cells, *i.e.*, elongation. Eventually, however, the production of new tissue must involve cell division and subsequent growth.

Site and frequency of cell division have been investigated in other cnidarians, *e.g.*, *Hydra* spp. (David and Campbell, 1972; Neckelmann, 1982); colonial hydroids (Hale, 1964; Campbell, 1968); anemones (Singer, 1971; Minasian 1980); and scleractinian corals (Cheney 1973). Some authors reported that cell proliferation occurs only or at least primarily in the ectoderm (Hale, 1964; Singer, 1971; Cheney, 1973) while others stated that cell division occurs in both the endoderm and the ectoderm (Campbell, 1968; David and Campbell, 1972; Minasian, 1980). Whether this discrepancy in the site of cell proliferation is due to species specific differences or to incorrect interpretation of data has not yet been resolved (Davis, 1971).

In this study, the site and diel periodicity of mitoses in the endoderm and the calicoblastic ectoderm of the axial polyp of the reef coral *Acropora cervicornis* were determined.

MATERIALS AND METHODS

Coral tips were collected at 0600, 0900, 1200, 1500, 1800, 2100, 2400, and 0200 from a depth of 11 m in Buck Island Channel, St. Croix, U. S. Virgin Islands. The tips were transferred immediately to the West Indies Laboratory. Within 30 min of

collection, the specimens were fixed in 10% formalin and stored. The corals tips were decalcified in 10% EDTA in 0.03 M NaOH for a day. Each tip was trimmed to a 1 cm length. Tips were dehydrated in a graded series of ethyl alcohol, cleared in toluene, and embedded in Paraplast (m.p. 57–59°C); each step required 15 min.

Longitudinal sections, 10 μm thick were cut from prepared tissue blocks with a microtome. Sections through the midsection of the polyp were saved and placed on glass slides coated with 1% gelatin. The tissue on the slides was rehydrated (2 min per step); after 4 min in distilled water, a drop of DAPI (4'-6-Diamidino-2-Phenylindole; 1 $\mu\text{g} \cdot \text{ml}^{-1}$ distilled water; Russell *et al.*, 1975) was placed on the tissue and a coverslip placed on the slide.

The slide was examined within minutes by epifluorescence microscopy as described by Neckelmann (1982). The nuclei of all cells appear fluorescent with mitotic figures staining brightly. Zooxanthellae fluoresce red. The slide was first surveyed using the 25 \times objective. Fields viewed with the 63 \times objective were sampled from the distal tip of the polyp to 2 mm below the tip. The percentage of cells in some phase of mitosis (*i.e.*, late prophase, metaphase, anaphase, and telophase) was determined for the endoderm and the calicoblastic ectoderm for each field sampled. Enough fields were counted on each tip until *ca.* 1000 endodermal cells and *ca.* 750 calicoblastic ectodermal cells were examined. Two tips were thus examined for each time of collection and an average value determined.

RESULTS

The tissues at the tip of the axial polyp of *Acropora cervicornis* are clearly outlined by the fluorescence of their nuclei when stained with DAPI. In these longitudinal sections, the outer ectoderm had the highest density of cells; the positions of the nematocysts and spirocysts are also clearly visible. The nuclei of the cells of the outer ectoderm overlapped so frequently that an accurate determination of cells in some phase of mitosis in this tissue layer was not feasible; some mitotic figures were observed, however.

The calicoblastic ectoderm and the endoderm appear to have a high density of cells covering the distal tip of the skeleton; as the conformation of these cells changes with distance from tip, from columnar to squamous (Gladfelter, 1983) the nuclei become spaced further apart.

Most of the nuclei in all the tissues at all times of day were in interphase (*i.e.*, some stage of the cell cycle other than mitosis). The nuclei in this condition stained brightly, but diffusely when compared to nuclei where mitotic figures were present. Occasionally, dividing zooxanthellae were also seen.

Mitosis occurs in both the endoderm and the calicoblastic ectoderm. To determine the frequency of mitosis in each tissue layer, I calculated a mitotic index (M.I.) for each tissue at each time of day. The mitotic index is the percentage of total cells in some stage of mitosis. The results, expressed as an average and a range (Fig. 1) show that the diel pattern of mitotic division in the cell populations is moderately synchronous. The M.I. of the endoderm is high (>1%) from 1800 through 0600, peaking at 2% at 2400, and low (<0.7%) from 0900 through 1500. The M.I. of the calicoblastic ectoderm also shows a peak of *ca.* 2% at 2400, but the range of values is much greater, and the peak much sharper than seen in the endoderm. All values (with the exception of almost overlapping values at 0900) are higher in the endoderm than the calicoblastic ectoderm.

Frequency of division as a function of distance from tip was not quantified. Observations indicate that dividing cells occur not only right at the tip (among the

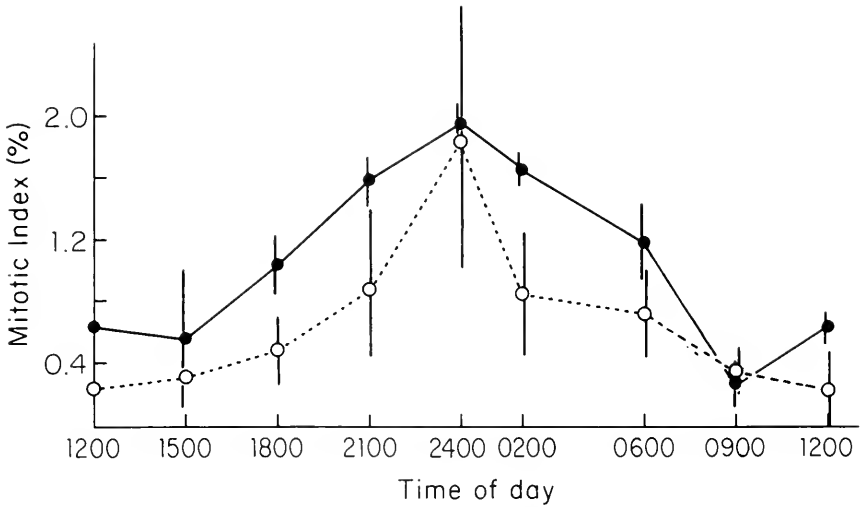

FIGURE 1. Diel pattern of percentage division (M.I.) of cells from the endoderm (solid circles) and cells from the calicoblastic ectoderm (open circles). Each point is the average of two determinations from each time period; the vertical bars indicate the range of the two values. Note that the two values for the calicoblastic ectoderm at 1500 were the same, hence no range bar.

columnar cells) but also 2 mm from the tip (the extent of the region surveyed for the determination of mitotic indices) and up to 10 mm from the tip as well. No narrow zone of cell proliferation is apparent; cells divide at random points throughout the column.

DISCUSSION

The axial polyp of *Acropora cervicornis* contains dividing cells from the tip to at least 10 mm proximal to the tip in both the endoderm and the calicoblastic ectoderm. These results are similar to those found by David and Campbell (1972) for the hydrozoan polyp *Hydra attenuata* and by Minasian (1980) for the anthozoan (actinarian) polyp *Haliplanella luciae*. Both studies described proliferating cells among all epithelial layers. In addition, David and Campbell (1972) showed that the number of divisions observed in the endodermal and ectodermal tissue were enough to account for the observed growth of those cell populations; migration of cells from one epithelial layer to another probably did not occur. Until more is known about the cell cycle kinetics of *A. cervicornis*, it cannot be stated with certainty that the mitotic indices observed in this study would result in a sufficient increase in cell population to account for the observed growth rate of the polyp. However, the magnitude of the mitotic indices in the endoderm and the calicoblastic ectoderm of *A. cervicornis* is the same as that seen in *Hydra attenuata* (David and Campbell, 1972) and *H. viridis* (Neckelmann, 1982) suggesting that if the cell cycle kinetics are similar to those described for *H. attenuata* (David and Campbell, 1972), which result in a cell population doubling time of 3 days, then these observed mitotic events are probably enough to account for the rapid axial growth of *A. cervicornis*.

Campbell (1968) found that cell division occurred in both the ectoderm and the endoderm of the extending stolons of *Probosciodactyla*, a colonial hydroid. The rate of elongation along a growth axis in this situation is comparable to that seen in *A.*

cervicornis. However Hale (1964), described cell division primarily among the ectodermal cells in the stolons of another hydroid, *Clytia*. Cheney (1973) used tritiated thymidine to label proliferating cells and found labeled cells primarily among cells of the column epidermis (ectoderm) and of the polyps and coenosarc of the reef coral *Pocillopora damicornis*. The internal tissues incorporated little, if any, label. This might reflect a label uptake problem rather than a true picture of the sites of cell proliferation in coral tissues. The internal tissues probably take up label from the fluid in the coelenteron; under experimental conditions this fluid might not exchange rapidly with the external medium.

The frequency of mitosis in the endoderm and the calicoblastic ectoderm of *Acropora cervicornis* has a diel periodicity, with a peak at midnight. David and Campbell (1972) found a diel periodicity in the mitotic index of ectodermal and endodermal cells of *Hydra attenuata*; they correlated the midnight peak with a daily feeding regime at 1000 each morning. Neckelmann (1982) also found a diel periodicity in the mitotic index of endodermal cells in *H. viridis*. The peak occurred *ca.* 10–12 h after feeding; no peak occurred in starved controls. The *A. cervicornis* in the present study were collected from field populations. Normal feeding in these coral colonies probably occurs on a diel cycle set by food availability. Demersal plankton, an important food source for corals (Porter, 1974; Aldredge and King, 1977) is thought to be most abundant, *i.e.*, available for consumption, at dusk and especially at dawn (Glynn, 1973). Johannes and Tepley (1974) found that the peak feeding activity of *Porites lobata* (another reef coral with small polyps as in *A. cervicornis*) occurs at dawn. Thus the diel cycle in mitotic index of cells in the axial polyp of *A. cervicornis* might be set by a naturally occurring cycle in feeding behavior. It could also be related to the diel periodicity of a reef coral's other carbon source, *i.e.*, photosynthate transferred from the zooxanthellae (Muscatine *et al.*, 1981).

In another system in which the growth of the organism is dependent primarily on increase in cell number, *i.e.*, freshwater planarians, Baguna (1974) demonstrated a rapid increase in mitotic activity following feeding. He hypothesized that the cell population of a planarian contains a number of cells in the G2 state of the cell cycle. These cells are awaiting the proper stimulus (*e.g.*, food) to divide; the precise mechanism of how food stimulates cell division is unclear. Presumably, reef corals receiving a daily pulse of organic carbon (from zooplankton or zooxanthellae) might have a daily peak of cell division; those deprived of this normal nutritional regime should show decreased mitotic activity.

In this study, a diel cycle in mitosis was revealed. It suggests a periodicity in polyp elongation; daily extension is 300 μm . Skeletal growth in *A. cervicornis* has a diel pattern (Gladfelter, 1983). Extension in another branching acroporid is at least as rapid during the night as in the day (Barnes and Crossland, 1980). The factors which set these diel cycles in both tissue and skeletal growth are unknown.

To summarize, endodermal and calicoblastic ectodermal cells are in stages of mitosis in the column of the axial polyp of *Acropora cervicornis*. The magnitude of the mitotic indices of these cell populations are on the order of 0.5%–2% and vary in a diel pattern. Cell division in each tissue layer is probably enough for the observed rate of growth of these cell populations, resulting in a daily elongation rate of 300 μm .

ACKNOWLEDGMENTS

I would like to thank W. B. Gladfelter and many West Indies Laboratory undergraduate students for assistance in collection of samples and L. Muscatine for

reviewing the manuscript. T. James, N. Neckelmann, G. M. Parker, and F. Wilkerson contributed valuable suggestions about using DAPI to observe dividing cells. Support during the final part of this study was provided through the Meta McBride Haupt Dissertation Fellowship of the American Association of University Women.

This is West Indies Laboratory Contribution No. 98.

LITERATURE CITED

- ALLDREDGE, A. L., AND J. M. KING. 1977. Distribution, abundance and substrate preferences of demersal reef zooplankton at Lizard Island Lagoon, Great Barrier Reef. *Mar. Biol.* **41**: 317-333.
- BAGUNA, J. 1974. Dramatic mitotic response in planarians after feeding, and a hypothesis for the control mechanism. *J. Exp. Zool.* **190**: 117-122.
- BARNES, D. J., AND C. J. CROSSLAND. 1980. Diurnal and seasonal variations in the growth of a staghorn coral measured by time-lapse photography. *Limnol. Oceanogr.* **25**: 113-117.
- BUDDEMEIER, R. W., AND R. A. KINZIE. 1976. Coral growth. *Oceanogr. Mar. Biol. Ann. Rev.* **14**: 183-225.
- CAMPBELL, R. D. 1968. Colony growth and pattern in the two-tentacled hydroid, *Proboscidadactyla flavicirrata*. *Biol. Bull.* **135**: 96-104.
- CHENEY, D. P. 1973. Cell proliferation as an index of growth in corals: incorporation of ^3H -thymidine. *Publ. Seto Mar. Biol. Lab.* **20**: 285-297.
- DAVID, C. N., AND R. D. CAMPBELL. 1972. Cell cycle kinetics and development of *Hydra attenuata*. I. Epithelial cells. *J. Cell Sci.* **11**: 557-568.
- DAVIS, L. V. 1971. Growth and development of colonial hydroids. Pp. 16-36 in *Experimental Coelenterate Biology*, H. M. Lenhoff, L. Muscatine, and L. V. Davis, eds. University of Hawaii Press, Honolulu.
- GLADFELTER, E. H. 1982. Skeletal development in *Acropora cervicornis*. I. Patterns of calcium carbonate deposition in the axial corallite. *Coral Reefs* **1**: 45-51.
- GLADFELTER, E. H. 1983. *Skeletal Development and Related Aspects of the Reef Coral Acropora cervicornis*. Ph.D. Dissertation, University of California, Los Angeles.
- GLYNN, P. W. 1973. Ecology of a Caribbean coral reef. The *Porites* reef-flat biotype. Pt. II. Plankton community with evidence for depletion. *Mar. Biol.* **22**: 1-22.
- HALE, L. J. 1964. Cell movements, cell division and growth in the hydroid *Clytia johnstoni*. *J. Embryol. Exp. Morph.* **12**: 517-538.
- HIGHSMITH, R. C. 1979. Coral rates and environmental control of density banding. *J. Exp. Mar. Biol. Ecol.* **37**: 105-125.
- JOHANNES, R. E., AND L. TEPLEY. 1974. Examination of feeding of the reef coral *Porites lobata* in situ using time-lapse photography. *Proc. 2nd Int'l Coral Reef Symp.* **1**: 127-131.
- LEWIS, J. B. 1982. Estimates of secondary production of reef corals. *Proc. 4th Int'l Coral Reef Symp.* **2**: 369-374.
- MINASIAN, JR. L. L. 1980. The distribution of proliferating cells in an anthozoan polyp, *Haliplanella luciae* (Actiniaria: Acontiaria), as indicated by ^3H -thymidine incorporation. Pp. 415-420 in *Developmental and Cellular Biology of Coelenterates*, P. Tardent and R. Tardent, eds. Elsevier/North-Holland Biomedical Press, Holland.
- MUSCATINE, L., L. R. McCLOSKEY, AND R. E. MARIAN. 1981. Estimating the daily contribution of carbon from zooxanthellae to animal respiration. *Limnol. Oceanogr.* **26**(4): 601-611.
- NECKELMANN, N. S. 1982. *Regulation of Numbers of Symbiotic Algae in the Digestive Cell of Hydra viridis*. Ph.D. Dissertation. University of California, Los Angeles.
- PORTER, J. W. 1974. Zooplankton feeding by the Caribbean reef-building coral *Montastrea annularis*. *Proc. 2nd Int'l Coral Reef Symp.* **1**: 111-125.
- RUSSELL, W. C., C. NEWMAN, AND D. H. WILLIAMSON. 1975. A simple cytochemical technique for demonstration of DNA in cells infected with mycoplasmas and viruses. *Nature* **253**: 461-462.
- SINGER, I. I. 1971. Tentacular and oral-disc regeneration in the sea anemone *Aiptasia diaphana* III. Autoradiographic analysis of patterns of tritiated thymidine uptake. *J. Embryol. Exp. Morphol.* **26**: 253-270.
- WELLINGTON, G. M., AND P. W. GLYNN. 1983. Environmental influence on skeletal banding in Eastern Pacific (Panama) corals. *Coral Reefs* **1**(4): 215-222.

INDEX

A

- Accumulation of late H2b histone mRNA in sea urchin embryogenesis, 501
- Acid-base balance, 582
- Acid phosphatase, 241
- Acid precipitation, 507
- ACKERMAN, E. B., AND H. L. KORNBERG, Mutants of *Escherichia coli* affected in "inducer exclusion," 520
- ACKERMAN, JOSEF, Current flow around *Zostera marina* plants and flowers: implications for submarine pollination, 504
- Acquisition of a collection of western north Atlantic fishes (Pisces) by the Gray Reference Collection, Marine Biological Laboratory, Woods Hole, MA, The, 505
- Acritarchs, 241
- Acropora cervicornis*, 619
- Actin microfilaments are a major cytoskeletal component in squid axoplasm, 489
- ADELMAN, W. J., JR., AND ALAN J. HODGE, Pseudostereoscopy allows direct visualization of the velocity distribution of particles undergoing fast axonal transport, 523
- ADELMAN, W. J., JR., see Alan J. Hodge, 527
- Adhesion, 502
- Aeolidia papillosa*, 394
- Aequorin, 529
- Afferent neurons, 527
- Age of first reproduction in *Melampus bidentatus*: the effects of overwintering degrowth and repair, 511
- Aging, skate ocular lens, 499
- Aggression, intrasexual in *Metridium*, 416
- AGUDELO, MARIA I., KENNETH KUSTIN, GUY C. MCLEOD, WILLIAM E. ROBINSON, AND ROBERT T. WANG, Iron accumulation in tunicate blood cells. I. Distribution and oxidation state of iron in the blood of *Botenia ovifera*, *Styela clava*, and *Molgula manhattensis*, 100
- Air exposure, 582, 708
- ALATALO, PHILIP, AND CARL J. BERG, JR., Population ecology of the Caribbean bivalve *Asaphis deflorata* (Linné, 1758), 504
- ALBERTE, R. S., see W. C. Dennison, 507, and L. Mazzella, 508
- Alcyonium siderium* Verrill, 286
- Algal mats, 509
- ALKON, DANIEL L., see Alan M. Kuzirian, 528, Izja Lenderhendler, 528, Louis Leibovitz, 535, and Serge Gart, 525
- ALLEN, NINA STRÖMGREN, AND WENDY F. BOSS, Studies of the isolation and calcium-induced fusion of fusogenic wild carrot protoplasts, 487
- ALLEN, ROBERT, D., DOUGLAS T. BROWN, SUSAN P. GILBERT, AND HIDESHI FUJIWAKE, Transport of vesicles along filaments dissociated from squid axoplasm, 523
- ALLIEGRO, M. C., AND H. SCHUEL, Is there specificity in the induction of polyspermy in sea urchins by protease inhibitors? 512
- Allogromia*, 489, 497
- Almyracuma proximoculi*, 370
- Alpha and Beta tubulin gene linkage, 488
- Alpha-2-macroglobulin, 495
- ALVAREZ, LUIS, see Marta Bretos, 559
- Alzheimer's disease, 530
- Amino acid, 532
- Amoebomastigote, 241
- cAMP: a possible intracellular transmitter of circadian rhythms in *Limulus* photoreceptors, 540
- Anaerobic chitin degradation as a carbon and hydrogen source for sulfate reduction and methanogenesis in salt marsh bacteria, 505
- Anaerobic metabolism, 708
- Analysis of hemolymph oxygen levels and acid-base status during emersion 'in situ' in the red rock crab, *Cancer productus*, 582
- ANAYA-VALAZQUEZ, L. F., AND K.-P. CHANG, Phagocytosis and intralysosomal killing of *Leishmania mexicana* by *Entamoeba histolytica*, 534
- ANDERSON, CATHLEEN, see Gerald Weissmann, 503
- ANDERSON, WINSTON A., AND WILLIAM R. ECKBERG, A Cytological analysis of fertilization in *Chaetopterus pergamentaceus*, 110
- Animal husbandry, 528
- Animalization, 502
- Anthozoan, 569
- Antigen masking, 537
- Antigens on both mechanical and lung stage schistosomula of *Schistosoma mansoni* are masked by host molecules, 537
- Anti-tubulin, 515
- ANTONELLIS, BLENDIA, see Seymour Zigman, 499
- Arbacia punctulata*, 499, 500, 513, 516, 517
- ARMSTRONG, PETER B., JAMES P. QUIGLEY, AND JACK LEVIN, A proteinase inhibitor released from the *Limulus* amoebocyte during exocytosis, 488
- ARMSTRONG, PETER B., see James P. Quigley, 495
- Arsenazo III, 529, 542
- Artemia tunisiana*, 506
- Ascidian embryos, 501
- Ascidian-*Prochloron* symbiosis: the role of larval photoadaptations in midday larval release and settlement, 221
- Ascidians
- coordination by epithelial conduction, 209
 - symbiosis with *Prochloron*, 221
- Associative learning in *Hermisenda crassicornis* (Gastropoda): evidence that light (the CS) takes on characteristics of rotation (the UCS), 528

- ATEMA, JELLA, see Marilyn Spalding, 532
 Atlantic, 505
 ATPase, 494
 ATP-reactivated models of ctenophore comb plates, 497
 AUGUSTINE, GEORGE J., see Stephen J. Smith, 532
 Axon, 529
 Axonal protein synthesis, 526
 Axoplasm, 489
 AYLING, AVRIL L., Growth and regeneration rates in thinly encrusting demospongiae from temperate waters, 343

B

- Baclofen, 523
 Bacteria
 enteric, 522
 manganese oxidizing, 520
 photosynthetic, 509
 spore forming, 520
 symbiotic, 521
 Bacterial clearance in urchins, 473
 Bacterial taxis, 509
 Baja California, 241
 BAKER, ROBERT, see Stephen M. Highstein, 527
Balanus, 330
 BARLOW, ROBERT B., JR., LEONARD KASS, VIVIAN MANCINI, AND JANICE L. PELLETIER, Vision in *Limulus* mating behavior: tests for detection and form discrimination, 539
 BARLOW, ROBERT B., JR., see Leonard Kass, 540, and Jennifer Marler, 541
 BARNES, WAYNE M., see Eric R. Ward, 498
 Barometric pressure, 509
 BARRY, SUSAN, R., Presynaptic action of baclofen, a GABA analog, at the crayfish neuromuscular junction, 523
 Bathypelagic, 182
 BAYNE, CHRISTOPHER, J., see Mary A. Yui, 473
 Behavior, 539, 745
 squid, 637
 BENAYAHU, Y., AND Y. LOYA, Surface brooding in the Red Sea soft coral *Parerythropodium fulvum fulvum* (Forskål, 1775), 353
 BERG, CARL J. JR., KATHERINE S. ORR, AND JEFFREY B. MITTON, Genetic variation in the queen conch, *Strombus gigas*, across its geographic range. Preliminary results, 504
 BERG, CARL J. JR., see Philip Alatalo, 504
 BICKELL, LOUISE R., AND STEPHEN C. KEMPF, Larval and metamorphic morphogenesis in the nudibranch *Melibe Leonina* (Mollusca: Opisthobranchia), 119
 Binding of ¹⁴C-gossypol by *Arbacia* sperm, 516
 Biology of *Fissurella maxima* Sowerby (Mollusca: Archaeogastropoda) in northern Chile. 2. Notes on its reproduction, The, 559
 Bioluminescence, 444, 522
 Bioluminescence spectra, 791
 Biomineralization, 723
 Biotinylated DNA probes, 537

- Bivalves, 504, 521, 708
 Black line disease, 429
 Blebbing, 502
 Blood cells of tunicates, 100
 BLUM, FREDERIC, MARGARET NACHTIGALL, AND WALTER TROLL, Superoxide dismutase biomimetic compounds prevent fertilization in *Arbacia punctulata* eggs, 513
Boltenia ovifera, see tunicates
 BOOKMAN, RICHARD J., Slow rearrangements of membrane bound, halogenated fluoresceins produce altered K⁺ currents in squid axon, 524
 BOOTH, CHARLES E., see Peter L. deFur, 582
 BORNBUSCH, ALAN H., The acquisition of a collection of western north Atlantic fishes (Pisces) by the Gray Reference Collection, Marine Biological Laboratory, Woods Hole, MA, 505
 BORNSLAEGER, ELAYNE, see Richard Cornell, 513
 BOSS, WENDY F., see Nina Strömrgren Allen, 487
Botryllus rejection reactions, 733
 BOWER, J. M., see R. Llinas, 529
 BOYER, BARBARA C., see Paul P. Palaszewski, 502
 BOYER, JOSEPH N., AND RALPH S. WOLFE, Anaerobic chitin degradation as a carbon and hydrogen source for sulfate reduction and methanogenesis in salt marsh bacteria, 505
 BRAY, SARAH, AND TIM HUNT, Developmental studies of a major mRNA in *Arbacia punctulata*, 499
 BRAY, SARAH, see Elizabeth L. George, 515
 BRECHLEY, G. A., AND J. T. CARLTON, Competitive displacement of native mud snails by introduced periwinkles in the New England intertidal zone, 543
 BRETOS, MARTA, ITALO TESORIERI, AND LUIS ALVAREZ, The biology of *Fissurella maxima* Sowerby (Mollusca: Archaeogastropoda) in northern Chile. 2. Notes on its reproduction, 559
 BROWN, DOUGLAS T., see Robert D. Allen, 523
 BROWNE, ROBERT, Speciation in the brine shrimp *Artemia*: cross-breeding between sexual Mediterranean populations, 506
 BURGOS, M. H., see Eimei Sato, 516, and S. J. Segal, 517
 Burrowing response, 509

C

- CaCO₃, 723
 Calcification in *Tegula*, 265
 Calcium, 503, 542
 action potential, 529
 -activated protease, 531
 buffer, 541
 changes, 498
 regulation in mitosis, 495
 transport enzyme, 495
 Calcium activated channels in the mechanically sensitive abfrontal ciliated cells of *Mytilus* gill, 496
 Calcium transients during early development in single starfish (*Asterias forbesi*) oocytes and eggs, 514

- Calcium transients during fertilization in single sea urchin eggs, 514
- Calcium transients in voltage clamped presynaptic terminals, 532
- Callinectes sapidus*, 321
- Capitella* sibling species, 538
- Capitella* spp. eggs and follicle cells, 379
- CARACO, NINA, AND IVAN VALIELA, Iron and phosphorus cycling in a permanently stratified coastal pond, 506
- Carbohydrate transport, 520
- Carbon dioxide, 511
- Carcinoscorpius rotundicauda*, see horseshoe crabs Caribbean, 504
- CARLTON, J. T., see G. A. Brenchley, 543
- CARSON, MONICA, AND REX L. CHISHOLM, Isolation and characterization of tubulin clones from *Dictyostelium discoideum*, 488
- Caryology, see karyology
- CASE, JAMES F., see Edith A. Widder, 791
- CASTENHOLZ, RICHARD W., see Alan W. Decho, 507, Lisa Muehlstein, 521, and Kenneth M. Noll, 509
- CATALANO, E., see R. Vitturi, 450
- CAVANAUGH, COLLEEN M., see Tricia A. Mitchell, 521
- Cell
 cycle, 513
 shape maintenance, 489
- Cell division in axial polyp of *Acropora*, 811
- Cell-cell recognition and adhesion during embryogenesis in the sea urchin, 502
- CENTONZE, V. E., AND J. L. TRAVIS, Immunofluorescence of *Allogromia reticulopodia*, 489
- CENTONZE, V. E., see J. L. Travis, 497
- Cerebratulus*, 516
- Chaetopterus*, 110, 514, 515, 518
- CHANG, DONALD C., ICHIIJI TASAKI, AND TOM S. REESE, Structure of the squid axon membrane as seen after freeze-fracture, 524
- CHANG, K.-P., see L. F. Anaya-Valazquez, 534, and L. Rivas, 536
- Changes in histone synthesis during *Arbacia* development, 500
- Characterization and isolation of a homologue of alpha-2-macroglobulin from the plasma of the horseshoe crab *Limulus*, 495
- Characterization of the major surface antigen of *Plasmodium falciparum* merozoites, 535
- Characterization of *Trypanosoma brucei* tubulin genes, 490
- CHARLTON, MILTON P., see Stephen J. Smith, 532
- Chemical communication in *Rhithropanopeus*, 154
- Chemical scavenging, 506
- Chemoreception, 532
- Chemotaxis, 419
- CHILDRESS, JAMES J., see Page Hiller-Adams, 182
- Chionoicetes bairdi*, see tanner crab
- CHISHOLM, REX L., see Monica Carson, 488
- Chitin, 505
- Cholinergic agonists at the giant synapse, 533
- CHERNESKY, ELIZABETH A., Induced development of sweeper tentacles on the reef coral *Agaricia agaricites*: a response to direct competition, 569
- Chthamalus*, 330
- Ciliary
 movement, 496
 reversal, 497
- Circadian pacemaker neurons, 540
- Circadian rhythms, 540
- Circulation of fluids in the gastrovascular system of the reef coral *Acropora cervicornis*, 619
- CLAPIN, D. F., see J. Metzuzals, 530
- Classical conditioning, 528
- Closed systems, 637
- Clumping organisms, 512
- Cnidarian, 569, 778
- Coelomic fluid, 473
- Coelomocytes, 473
- COHEN, ROCHELLE S., NASRIN HAGHIGHAT, AND GEORGE D. PAPPAS, Fine structure of synapses and synaptosomes of the squid (*Loligo pealei*) optic lobe, 525
- COHEN, ROCHELLE S., see Harish C. Pant, 531
- COHEN, WILLIAM D., AND JACQUELYN JOSEPH-SILVERSTEIN, Marginal band function in the dogfish erythrocyte, 489
- COHEN, WILLIAM D., see Jacqueline Joseph-Silverstein, 492
- Colony size, 778
- Comparative immunology, 473
- Competition, 569
- Competitive displacement of native mud snails by introduced periwinkles in the New England intertidal zone, 543
- Composition and function of the cytoskeleton in "blood clam" erythrocytes, 492
- CONLON, RONALD A., see Albrecht Von Brunn, 519
- Constraint surface, 305
- Control of egg hatching in the crab *Rhithropanopeus harrisi* (Gould), 154
- Coordination of compound ascidians by epithelial conduction in the colonial blood vessels, 209
- Coral
 disease, 429
 larval settlement, 286
 reef, 569, 619
 sweeper tentacle development, 569
- CORNALL, RICHARD, ELAYNE BORNISLAEGER, AND TIM HUNT, What makes cyclin cycle? 513
- COSTLOW, JOHN D., see John A. Freeman, 409
- Crabs, *Rhithropanopeus*, 139, 154
- CRONIN, THOMAS W., AND RICHARD B. FORWARD, JR., Vertical migration rhythms of newly hatched larvae of the estuarine crab, *Rhithropanopeus harrisi*, 139
- Crustacea, 409, 582
- Crustacean reproductive biology, behavior, 370
- CSEKO, YARA, see Guillermo Romero, 537
- Ctenophore, 491, 497
- Cumacean dimorphism and behavior, 370
- Current clamp of photoreceptors and pacemaker neurons in eye of *Bulla*, 540
- Current flow around *Zostera marina* plants and

flowers: implications for submarine pollination, 504
 Cysts, 241
 Cytological analysis of fertilization in *Chaetopterus pergamentaceus*, A, 110
 Cytoskeleton, 489, 492, 514

D

DAPI, 811
 Dark-field microscopy, 491
 DECHO, ALAN W., AND RICHARD W. CASTENHOLZ, Interactions of harpacticoid copepods and photosynthetic microbes in the salt marsh, 507
 Decomposition, 509
 Decapoda, 582
 Deep-sea, 167, 182
 Deforestation in the Amazon Basin measured by satellite: a release of CO₂ to the atmosphere, 511
 DEFUR, PETER L., BRIAN R. MCMAHON, AND CHARLES E. BOOTH, Analysis of hemolymph oxygen levels and acid-base status during emersion 'in situ' in the red rock crab, *Cancer productus*, 582
 DENNISON, W. C., AND R. S. ALBERTE, Growth responses of *Zostera marina* (eelgrass) to *in situ* manipulations of sediment nitrogen availability, 507
 DENNISON, W. C., see L. Mazzella, 508
 Depolarizing and desensitizing actions of glutamnergic and cholinergic agonists at the squid giant synapse, 533
 Desiccation of tolerance, 241
 Design and construction of a benchtop reactor to model an anaerobic/oxic wastewater treatment system, The, 510
 Detection of *Leishmania* kinetoplast DNA using biotinylated DNA probes, 537
 Detection of membrane signals correlated with sensory excitation of phototactic *Halobacterium halobium*, 540
 Detritus, quality and age, 510
 Deuterostome immunology, 473
 Development, 491, 518
 Developmental regulation, 500
 Developmental studies of a major maternal mRNA in *Arbacia punctulata*, 499
 Diapause, 511
Dictyostelium discoideum, 488
 Diel patterns of coral cell division, 811
 Diel vertical movements of bacteria in intertidal streams of Sippewissett Marsh, 509
 Direct development, 591
 Disease, in *Hermisenda*, 535
 DMSO facilitation, 527
 cDNA clone, 499
 DOBBELAERE, D. A. E., see A. S. Fairfield, 535
 Dogfish erythrocyte, 489
 Dopamine, 758
Drosophila melanogaster, 490
 DUNCAN, THOMAS K., Sexual dimorphism and re-

productive behavior in *Almyracuma proximoculi* (Crustacea: Cumacea): the effect of habitat, 370

DUNGAN, JENNIFER, BRUCE PETERSON, AND SALLY MARQUIS, The sensitivity of freshwaters of Cape Cod, Massachusetts to acid precipitation, 507
 DUNHAM, PHILIP, see Gerald Weissmann, 503
 DUNN, DAPHNE FAUTIN, see Steven E. Wedi, 458
 DUNN, KENNETH, see L. B. Slobodkin, 305

E

EAGLES, P. A. M., see J. Metzuzals, 530
 Ecdysis, 758
 Ecdysteroid titers during the molt cycle of the blue crab resemble those of other Crustacea, 321
Echinocyamus pusillus, 745
 Echinoderm immunology: bacterial clearance by the sea urchin *Strongylocentrotus purpuratus*, 473
 ECKBERG, WILLIAM R., AND GEORGE M. LANGFORD, Isolation of cytoskeletons from *Chaetopterus* eggs, 514
 ECKBERG, WILLIAM R., see Winston A. Anderson, 110
 ECKELBARGER, KEVIN J., AND JUDITH P. GRASSLE, Ultrastructural differences in the eggs and ovarian follicle cells of *Capitella* (Polychaeta) Sibling species, 379
 Ecology of coral reefs, 569
 Effect of age and quality of detritus on growth of the salt marsh snail, *Melampus bidentatus*, 510
 Effects of feeding, feeding history, and food deprivation on respiration and excretion rates of the bathypelagic mysid *Gnathopausia ingens*, 182
 Effects of intracellular calcium/EGTA on the photoactivation of *Limulus* ventral photoreceptors, The, 541
 Efferent neurons, 527
 Egg, 514
 Egg hatching in *Rhithropanopeus*, 154
 Ehrlich ascites tumor cells, 496
 EHRlich, BARBARA E., CATHY R. SCHEN, AND JOHN L. SPUDICH, Detection of membrane signals correlated with sensory excitation of phototactic *Halobacterium halobium*, 540
 EISELE LESLIE, see Jennifer J. Marler, 541
 EISEN, A., G. T. REYNOLDS, S. WIELAND, AND D. P. KIEHART, Calcium transients during fertilization in single sea urchin eggs, 514
 EISEN, A., G. T. REYNOLDS, S. WIELAND, AND D. P. KIEHART, Calcium transients during fertilization in single sea urchin eggs, 514
 EKAPANYAKUL, G., A. FLISSER, A. KO, AND D. HARN, IgE monoclonal antibodies produced from mice immunized with irradiated cercariae of *Schistosoma mansoni*, 534
 Electrochemical potential, 496
 Electron microscopy
 of calcification process, 265
 of protein crystals, 530
 ELLINGTON, W. R., see C. V. Nicchitta, 708
 ELLIS, GORDON W., see Shinya Inoué, 492

- Embryology, hydrozoan, 591
 Embryonic shell formation, 394
 Emersion, 582
 Emission spectra, 791
 Energetics, 197, 532, 778
 Enhancement of the appearance of lateral projections on negatively stained microtubules after glutaraldehyde—tannic acid fixation, 493
 Energy budgets, 686, 699
 Energy metabolism during air exposure and recovery in the high intertidal bivalve mollusc *Geukensia demissa granosissima* and the subtidal bivalve mollusc *Modiolus squamosus*, 708
 Energy metabolism pathways of hydrothermal vent animals: Adaptations to a food-rich and sulfide-rich deep-sea environment, 167
Entamoeba, 534
 Enteric bacteria, 522
 Environment, 778
 Enzyme activity levels, deep-living marine animals, 167
 Epiphytes, 508
 Epithelial conduction in colonial blood vessels, 209
 Epizootic disease-complex of wild and laboratory-maintained *Hermisenda crassicornis*, An. 535
 Ernest Everett Just (1883–1941): a dedication, 487
Escherichia coli, 520
 Estuarine crabs, see *Rhithropanopeus*
 EVANS, ANN S., Growth and photosynthetic responses to temperature of two populations of *Zostera marina*, 508
 Evidence for regulation of protein synthesis at the level of translational machinery in the sea urchin egg, 503
 Evolutionary constraint, 305
 Excretion in bathypelagic mysid, 182
 Exocytosis, 488, 520
 Experimental studies on embryogenesis in hydrozoans (Trachylina and Siphonophora) with direct development, 591
 Eyestalk removal, 409
 EYSTER, LINDA S., Ultrastructure of early embryonic shell formation in the opisthobranch gastropod *Acolidia papillosa*, 394
- F**
- Factors affecting growth inhibition of enteric bacteria by methyl α -D-glucoside, 522
 FAIRFIELD, A. S., D. A. E. DOBBELAERE, AND M. PERKINS, Characterization of the major surface antigen of *Plasmodium falciparum* merozoites, 535
 FAIRFIELD, A. S., see A. Flisser, 490
 Fast axonal transport, 523, 527
 Fast axonal transport is not affected by dimethyl sulfoxide (DMSO) used to facilitate glycerination and/or glutaraldehyde fixation of squid axons, 527
 FATH, KARL R., AND RAYMOND J. LASEK, Actin microfilaments are a major cytoskeletal component in squid axoplasm, 489
 Fc receptor, 498
 Feeding
 and energetics of crab larvae, 197
 in bathypelagic mysid, 182
 squid, 637
 Feeding structures, behavior, and microhabitat of *Echinocyamus pusillus* (Echinoidea: Clypeasteroidea), 745
 FEIN, ALAN, see Richard Payne, 541
 FELDMAN, SUSAN C., AND GEORGE D. PAPPAS, Pathway tracing in the squid nervous system, 525
 FENNELY, G. J., see J. Metzuzals, 530
 Fertilization, 503, 514
 block, 513
 currents, 517
 in *Chaetopterus*, 110
 Fertilization-induced ion conductances in frogs eggs, 517
 Fertilization potential of eggs of the nemertean, *Cerebratulus*, The, 516
 Fiddler crab, 758
 Fine structure of synapses and synaptosomes of the squid (*Loligo pealei*) optic lobe, 525
 FINGERMAN, MILTON, see Linda L. Vacca, 758
 Fishes (Pisces), 505
Fissurella maxima, reproduction, 559
 Flagellates, 241
 Flight fuel utilization and flight energetics in the migratory milkweed bug, *Oncopeltus fasciatus*, 532
 FLISSER, A., A. S. FAIRFIELD, AND D. WIRTH, Characterization of *Trypanosoma brucei* tubulin genes, 490
 FLISSER, A., see G. Ekapanyakul, 534, and L. D. Sibley, 537
 Fluoresceins, 524
 Fluorescence emission maxima, 241
 FORWARD, RICHARD B., JR., AND KENNETH J. LOHMANN, Control of egg hatching in the crab *Rhithropanopeus harrisi* (Gould), 154
 FORWARD, RICHARD B., JR., see Thomas W. Cronin, 139
 FPL-55712, a leukotriene antagonist, promotes polyspermy in sea urchins, 516
 FREEMAN, GARY, Experimental studies on embryogenesis in hydrozoans (Trachylina and Siphonophora) with direct development, 591
 FREEMAN, JOHN A., TERRY L. WEST, AND JOHN D. COSTLOW, Postlarval growth in juvenile *Rhithropanopeus harrisi*, 409
 Free radical kinetics, 496
 Freeze-fracture, 517, 524
 Freshwater, Cape Cod, 507
 Frog egg fertilization, 517
 FUJIWAKE HIDESHI, see Robert D. Allen, 523
 Fully automated image analysis can be used to study intramembranous particle (IMP) behavior during development in *Tetrahymena*, 491
 Fungus, lower marine, 429
 Fusogenic protoplasts, 487
 Functional and chemical characterization of squid neurofilament polypeptides, 533

G

- GABA receptors, presynaptic, 523
 GAINER, HAROLD, see A. L. Obaid, 530, and Harish C. Pant, 531
 GALLANT, PAUL E., see Harish C. Pant, 531
 Gametogenesis and reproductive periodicity of the subtidal sea anemone *Urticina lofotensis* (Coelenterata: Actiniaria) in California, 458
 GART, SERGE, IZJA LEDERHENDLER, AND DANIEL ALKON, An infrared macrophotographic technique for quantifying the behavioral response to rotation of the gastropod *Hermisenda crassicornis*, 525
 GART, SERGE, see Izja Lederhendler, 528
 GASCOYNE, PETER, see Albert Szent-Györgyi, 496
 Gastropods, 394, 543, 723
 Gastrovascular cavity, 619
 Genetics, 686, 699, 733
 Genetic variation in the queen conch, *Strombus gigas*, across its geographic range. Preliminary results, 504
 Geographic limits, 330
 Geographic limits and local zonation: the barnacles *Semibalanus (Balanus)* and *Chthamalus* in New England, 330
 GEORGE, ELIZABETH L., SARAH BRAY, ERIC T. ROSENTHAL, AND TIM HUNT, A major maternally encoded 41K protein in both *Spisula* and *Arbacia* binds to an anti-tubulin affinity column, 515
 Giant smooth muscle cell, 491
 Giant synapse pharmacology, 533
 GILBERT, SUSAN P., see Robert D. Allen, 523
 GLADFELTER, ELIZABETH H., Circulation of fluids in the gastrovascular system of the reef coral *Acropora cervicornis*, 619
 GLADFELTER, ELIZABETH H., Spatial and temporal patterns of mitosis in the cells of the axial polyp of the reef coral *Acropora cervicornis*, 811
 Glutamnergic agonists at the giant synapse, 533
 Glutaraldehyde fixation, 527
 Glycerinated axons, 527
Gnathopausia ingens, see mysid
 GOLDMAN, ANNE E., see Karen M. Yokoo, 519
 GOLDMAN, ROBERT D., see Karen M. Yokoo, 519, and R. V. Zackroff, 533
 Gorgonian regeneration, 778
 Gossypol, 516, 517
 GOULD, ROBERT M., MARTHA JACKSON, AND ICHUJI TASAKI, Phospholipid synthesis in the injected squid giant axon, 526
 GRASSLE, JUDITH P., see Kevin J. Eckelbarger, 379 and Gary E. Wagenbach, 538
 Gray Reference Collection, 505
 Grazing and predation as related to energy needs of stage I zoeae of the tanner crab *Chionoecetes bairdi* (Brachyura, Majidae), 197
 GREER, K., see P. E. Kuwabara, 500
 Growth, 507, 508
 and latitude, 686
 in corals, 811

- in squid, 637
 postlarval in crabs, 409
 Growth and photosynthetic responses to temperature of two populations of *Zostera marina*, 508
 Growth and regeneration rates in thinly encrusting demospongiae from temperate waters, 343
 Growth responses of *Zostera marina* (eelgrass) to *in situ* manipulations of sediment nitrogen availability, 507
 GUIDITTA, ANTONIO, TIM HUNT, AND LUIGIA SANTILLA, Messenger RNA in squid axoplasm, 526

H

- HAGHIGHAT, NASRIN, see Rochelle S. Cohen, 525
 HAINES, KATHLEEN A., see Gerald Weissmann, 503
 HALL, LINDA M., A strategy to differentiate mutants affecting voltage-sensitive sodium channels in *Drosophila*, 490
 HALL, ROBERT R., see George J. Skladany, 510, and W. S. Vincent, 512
 Halobacteria, 540
 HALSELL, SUSAN, see Gary Lyons, 501
 HALVORSON, H. O., A. KEYNAN, AND T. TIERNAN, Studies on manganese oxidizing, spore forming bacteria, 520
 HAND, STEVEN C., AND GEORGE N. SOMERO, Energy metabolism pathways of hydrothermal vent animals: adaptations to a food-rich and sulfide-rich deep-sea environment, 167
 HANLON, ROGER T., RAYMOND F. HIXON, AND WILLIAM H. HULET, Survival, growth, and behavior of the loliginid squids *Loligo plei*, *Loligo pealei*, and *Lolliguncula brevis* (Mollusca: Cephalopoda) in closed sea water systems, 637
 HARN, DON, see G. Ekapanyakul, 534, L. D. Sibley, 537, and Linda Swiston, 538
 HAROLD, ANTONY S., see Malcolm Telford, 745
 Harpacticoid copepods, 507
 HARRIGAN, JUNE, see Louis Leibovitz, 535, and D. W. Pumphlin, 531
 HARTMAN, JEAN M., see Susan M. Merkel, 509
 Heat shock proteins, 500
 Hemocytes and tanning, 758
 Hemolymph acidosis, 582
 Henriksen model, 507
 Hermaphroditism in nudibranch, 276
Hermisenda crassicornis, 276, 525, 528, 535
Hermisenda crassicornis: a disease complex. I. The normal animal, 528
 HERNANDEZ-NICAISE, MARI-LUZ, AND GHISLAIN NICAISE, Structure of the isolated and *in situ* giant smooth muscle fibers of *Mnemiopsis leidyi*, 491
 High molecular weight (380Kd) ATPase in axoplasm of squid giant axon, 494
 HIGHSTEIN, STEPHEN M., AND ROBERT BAKER, Physiological activity of efferent vestibular neurons and their action on primary afferents in the toadfish, 527
 HILL, ELIZABETH, see Frederick I. Tsuji, 444
 HILL, W. D., see R. V. Zackroff, 533

- HILLER-ADAMS, PAGE, AND JAMES J. CHILDRESS, Effects of feeding, feeding history, and food deprivation on respiration and excretion rates of the bathypelagic mysid *Gnathopausia ingens*, 182
- Histochemistry, 758
- Histone
genes, 501
mRNAs, 518
synthesis, 500
- HIXON, RAYMOND F., see Roger T. Hanlon, 637
- HODGE, ALAN J., AND W. J. ADELMAN, JR., Fast axonal transport is not affected by dimethyl sulfoxide (DMSO) used to facilitate glycerination and/or glutaraldehyde fixation of squid axons, 527
- HODGE, ALAN J., see W. J. Adelman, Jr., 523
- Horseshoe crabs, 436
- Host specificity of intestinal gregarines (Protozoa, Apicomplexa) in two sympatric species of *Capitella* (Polychaeta), 538
- HOTANI, H., AND J. L. TRAVIS, Opposite end assembly-disassembly of single microtubules, 491
- HOUGHTON, R. A., see T. A. Stone, 511
- HOWARTH, ROBERT W., see Susan M. Merkel, 509
- HOWLETT, SARAH, JOHN MILLER, AND GILBERT SCHULTZ, Induction of heat shock proteins in early embryos of *Arbacia punctulata*, 500
- HU, S. L., AND C. Y. KAO, The pH dependence of the tetrodotoxin-blockade of sodium channels, 528
- HUFNAGEL, LINDA A., Fully automated image analysis can be used to study intramembranous particle (IMP) behavior during development in *Tetrahymena*, 491
- HULET, WILLIAM H., see Roger T. Hanlon, 637
- HUMPHREYS, TOM, see Gerald Weissmann, 503
- HUNT, TIM, see Sarah Bray, 499, Richard Cornall, 513, Elizabeth L. George, 515, Antonio Giuditta, 526, and Thomas Kelly, 493
- Hybrid horseshoe crab LDH and MDH, 436
- Hybridoma, 534
- Hydra, 305
- Hydrogen sulfide, influence on metabolism, 167
- Hydrothermal vent animals, energy metabolism, 167
- Hydrozoan experimental embryology, 591
- Hyperosmotic treatment inhibits cortical granule exocytosis in the sea urchin *Lytechinus pictus*, 520
- I**
- Identified neurons, 531
- IgE monoclonal antibodies produced from mice immunized with irradiated cercariae of *Schistosoma mansoni*, 534
- Ilyanassa obsoleta*, 536, 543
- Image
analysis, 491
contrast, 492
intensification, 514, 522
- Immunofluorescence of *Allogromia reticulopodia*, 489
- Immunology, echinoderm, 473
- INCZE, LEWIS S., AND A. J. PAUL, Grazing and predation as related to energy needs of stage I zoeae of the tanner crab *Chionoecetes bairdi* (Brachyura, Majidae), 197
- Induced development of sweeper tentacles on the reef coral *Agaricia agaricites*: a response to direct competition, 569
- Inducer exclusion, 520
- Induction of heat shock proteins in early embryos of *Arbacia punctulata*, 500
- Infrared macrophotographic technique for quantifying the behavioral response to rotation of the gastropod *Hermisenda crassicornis*, An, 525
- Inhibition of a surface binding monoclonal antibody to schistosomula of *Schistosoma mansoni* by lectins, 538
- Inhibition of mitotic anaphase and cytokinesis and reduction of spindle birefringence following microinjection of anti-calcium transport enzyme IgGs into *Echinaraeus parma* blastomeres, 495
- Injury, 778
- Initial calcification process in shell-regenerating *Tegula* (Archaeogastropoda), The, 265
- INOUE, SHINYA, THEODORE D. INOUE, AND GORDON W. ELLIS, Visualizing extremely low contrast images by digital enhancement of selected portions of the image grey scale, 492
- INOUE, THEODORE, see Shinya Inoue, 492
- In situ*
emersion of *C. productus*, 582
hybridization, 515
- Interactions of harpacticoid copepods and photosynthetic microbes in the salt marsh, 507
- Intermediate filaments, 519, 533
- Intertidal snails, 543
- Intracellular fusion between reticulopodial networks in *Allogromia laticollaris*, 497
- Intramembranous particles, 491
- Intraparasitophorous vacuolar pH of *Leishmania mexicana* infected macrophages, 536
- Intrasexual aggression in *Metridium senile*, 416
- Introduced species, 543
- Invertebrate
ecology, 221
immunology, 473
pathology, 429, 528
- In vitro* transcription of histone genes in isolated nuclei from *S. purpuratus*, 518
- Ion conductances—fertilization, 517
- Iron accumulation in tunicate blood cells. I. Distribution and oxidation state of iron in the blood of *Boltenia ovifera*, *Styela clava*, and *Molgula mahnattensis*, 100
- Iron and phosphorus cycling in a permanently stratified coastal pond, 506
- Isoenzymes, 241
- Isolation and characterization of tubulin clones from *Dictyostelium discoideum*, 488

- Isolation of cytoskeletons from *Chaetopterus* eggs, 514
 Is there a developmental significance for mRNA localized in the cortex of *Chaetopterus* eggs? 518
 Is there specificity in the induction of polyspermy in sea urchins by protease inhibitors? 512

J

- JACKLET, JON W., Current clamp of photoreceptors and pacemaker neurons in eye of *Bulla*, 540
 JACKSON, MARTHA, see Robert M. Gould, 526
 JAFFE, LAURINDA A., see Douglas Kline, 516 and Lyanne C. Schlichter, 517
 JEFFERY, WILLIAM R., An organelle complex responsible for mRNA localization in the cortex of *Chaetopterus* eggs, 515
 JEFFERY, WILLIAM R., Ernest Everett Just (1883-1941): a dedication, 487
 JEFFERY, WILLIAM R., see Billie J. Swalla, 518
 JOSEPH-SILVERSTEIN, JACQUELYN, AND WILLIAM D. COHEN, Composition and function of the cytoskeleton in "blood clam" erythrocytes, 492
 JOSEPH-SILVERSTEIN, JACQUELYN, see William D. Cohen, 489

K

- KAO, C. Y., see S. L. Hu, 528
 KAPLAN, SAUL W., Intrasexual aggression in *Mertridium senile*, 416
 Karyology of *Teredo utriculus* (Gmelin) (Mollusca, Pelecypoda), The, 450
 KASS, LEONARD, JANICE, L. PELLETIER, GEORGE H. RENNINGER, AND ROBERT B. BARLOW, JR., cAMP: a possible intracellular transmitter of circadian rhythms in *Limulus* photoreceptors, 540
 KASS, LEONARD, see Robert B. Barlow, Jr., 539, and Jennifer J. Marler, 541
 K⁺ channels, 524
 KELLY, THOMAS, JOEL L. ROSENBAUM, AND TIM HUNT, Two-dimensional gel analysis of sea urchin ciliary tubulins, 493
 KEMPF, STEPHEN C., see Louise R. Bickell, 119
 KEYNAN, A., see H. O. Halvorson, 520
 KIEHART, D. P., see A. Eisen, 514
 Kinetoplast DNA, 537
 KING, KENNETH R., see Richard L. Miller, 419
 KLINE, DOUGLAS, AND LAURINDA A. JAFFE, The fertilization potential of eggs of the nemertean, *Cerebratulus*, 516
 KO, A., see G. Ekapanyakul, 534, and Linda Swiston, 538
 KOIDE, S. S., see Eimei Sato, 516, and S. J. Segal, 517
 KORNBERG, H. L., see E. B. Ackerman, 520, and D. F. Sutherland, 522
 KRAKOW, J., see L. D. Sibley, 537
 KUSTIN, KENNETH, see Maria I. Agudelo, 100
 KUWABARA, P. E., K. GREER, S. MAEKAWA, AND

- E. S. WEINBERG, Changes in histone synthesis during *Arbacia* development, 500
 KUZIRIAN, ALAN M., LOUIS LEIBOVITZ, AND DANIEL L. ALKON, *Hermisenda crassicornis*: a disease complex. I. The normal animal, 528
 KUZIRIAN, ALAN, see Louis Leibovitz, 535

L

- Laboratory maintenance, 637
 Lactate dehydrogenase of hybrid horseshoe crab embryos, 436
 Lactoperoxidase-tubulin interaction in ciliary membranes, 496
 Laguna Figueroa, 241
 LANDFEAR, SCOTT, see Claire Wyman, 539
 LANDFEAR, SCOTT, Structure and expression of tubulin genes in the protozoan parasite *Leishmania enriettii*, 493
 LANGFORD, GEORGE M., Enhancement of the appearance of lateral projections on negatively stained microtubules after glutaraldehyde-tannic acid fixation, 493
 LANGFORD, GEORGE M., see William R. Eckberg, 514
 Larvaceans, 419
 Larval and metamorphic morphogenesis in the nudibranch *Melibe leonina* (Mollusca: Opisthobranchia), 119
 Larval crabs, 139
 Larval ecology, 221
 Larval settlement and metamorphosis of *Alcyonium*, 286
 LASEK, RAYMOND J., see Karl R. Fath, 489
 Lateral eye, 541
 Latitude, 686, 699
 Latitude and intraspecific growth, 699
 Latitudinal compensation hypothesis: growth data and a model of latitudinal growth differentiation based upon energy budgets. I. Interspecific comparison of *Ophryotrocha* (Polychaeta: Dorvilleidae), The, 686
 Latitudinal compensation hypothesis: growth data and a model of latitudinal growth differentiation based upon energy budgets. II. Intraspecific comparisons between subspecies of *Ophryotrocha puerilis* (Polychaeta: Dorvilleidae), The, 699
 LATZ, MICHAEL I., see Edith A. Widder, 791
 Lectin, 525, 538
 LEIBOVITZ, LOUIS, ALAN KUZIRIAN, JUNE HARRIGAN, EDWARD F. SCHOTT, IZJA LEDERHENDLER, AND DANIEL L. ALKON, An epizootic disease-complex of wild and laboratory-maintained *Hermisenda crassicornis*, 535
 LEIBOVITZ, LOUIS, see Alan M. Kuzirian, 528
Leishmania, 534, 536, 539
 identification, 537
 tubulin genes, 493
 LENDERHENDLER, IZJA, see Serge Gart, 525
 LENDERHENDLER, IZJA, SERGE GART, AND DANIEL L. ALKON, Associative learning in *Hermisenda crassicornis* (Gastropoda): evidence that light

- (the CS) takes on characteristics of rotation (the UCS), 528
- Lens, 499
- Leucine aminopeptidase, 241
- Leukotriene, 503, 516
- Leukotriene B₄ promotes the calcium-dependent aggregation of marine sponge cells, 503
- LEVIN, JACK, see Peter B. Armstrong, 488
- LEVINTON, JEFFERY S., AND ROSEMARY K. MONAHAN, The latitudinal compensation hypothesis: growth data and a model of latitudinal growth differentiation based upon energy budgets. II. Intraspecific comparisons between subspecies of *Ophryotrocha puerilis* (Polychaeta: Dorvilleidae), 699
- LEVINTON, JEFFREY S., The latitudinal compensation hypothesis: growth data and a model of latitudinal growth differentiation based upon energy budgets. I. Interspecific comparison of *Ophryotrocha* (Polychaeta: Dorvilleidae), 686
- LEWENSTEIN, LISA A., Propagating calcium spikes in identified cells in the supraesophageal ganglion of the giant barnacle, *Balanus nubius*, 529
- LIEBMAN, MATTHEW, Trematode infection in *Ilyanassa obsoleta*: dependence on size and sex of the host and effect on chemotaxis, 536
- Life history, Octocorallia, 353
- Limulus*, 488, 495, 539
photoreceptors, 540, 541
- Littorina littorea*, 543
- LLINAS, R., M. SUGIMORI, AND J. M. BOWER, Visualization of depolarization-evoked presynaptic calcium entry and voltage dependence of transmitter release in squid giant synapse, 529
- Loabster, 532
- Localization of calcium transients in the presynaptic terminals of a barnacle photoreceptor detected using Arsenazo III, 542
- LOHMANN, KENNETH J., see Richard B. Forward, Jr., 154
- Loligo*, 637
- Lower marine fungus associated with black line disease in star corals (*Montastrea annularis*, E. & S.), 429
- LOYA, Y., see Y. Benayahu, 353
- Lymphocyte mitogen, 536
- Lyngbya aestuarii*, 521
- LYONS, GARY, SUSAN HALSELL, AND ROB MAXSON, Accumulation of late H2b histone mRNA in sea urchin embryogenesis, 501
- Lysosome, 534
- Lysosomal pH, 536
- M**
- MACKIE, G. O., AND C. L. SINGLA, Coordination of compound ascidians by epithelial conduction in the colonial blood vessels, 209
- Macrophage, 536
- MAEKAWA, S., see P. E. Kuwabara, 500
- MAIORCA, A., see R. Vitturi, 450
- Major maternally encoded 41 K protein in both *Spisula* and *Arbacia* binds to an anti-tubulin affinity column, A, 515
- Malaria, 536
- Malate dehydrogenase of hybrid horseshoe crab embryos, 436
- Mammalian nerve terminals, 530
- MANCINI, VIVIAN, see Robert B. Barlow, Jr., 539
- Manganece-oxidizing bacteria, 241
- MAPS (microtubule-associated proteins), 492
- Marginal band function, 492
- Marginal band function in the dogfish erythrocyte, 489
- MARGULIS, LYNN, see Laurie K. Read, 241
- Marine bioluminescence spectra measured with an optical multichannel detection system, 791
- Marine molluscan genomes contain sequences homologous to the octopine synthase gene of *Agrobacterium tumefaciens*, 498
- MARQUIS, SALLY, see Jennifer Dungan, 507
- MARLER, JENNIFER J., ROBERT B. BARLOW, JR., LESLIE EISELE, AND LEONARD KASS, Photoreceptors add at the anterior edge of *Limulus* lateral eye, 541
- Maternal mRNA, 499
- Mating and egg mass production in the aeolid nudibranch *Hermisenda crassicornis* (Gastropoda: Opisthobranchia), 276
- MATSUO, N., see Eimei Sato, 516
- MATTESON, D. R., Voltage clamp studies of dispersed toadfish pancreatic islet cells, 494
- Maturation of sea urchin and *Chaetopterus* oocytes results in a change in the pattern of protein synthesis, 519
- MAXSON, ROB, see Gary Lyons, 501
- MAZZELLA, L., W. C. DENNISON, AND R. S. ALBERTE, Photosynthetic activity of *Zostera marina* L. epiphytes in relation to light regime and substratum, 508
- MCLAUGHLIN, JANE, see Albert Szent-Györgyi, 496
- MCLEOD, GUY C., see Maria I. Agudelo, 100
- MCMAHON, BRIAN R., see Peter L. deFur, 582
- Mechanical stimulation of bioluminescence in dilute suspensions of dinoflagellates, 522
- Mechanosensitivity, 496
- Meiobenthos, 507
- Melanopus bidentatus*, 510, 511
- Melanin, 758
- Melibe leonina*, 119
- MELILLO, J. M., see T. A. Stone, 511
- Memory, 473
- Membrane potential, 540
- Membranes, 496
- Mercenaria mercenaria*, 509
- MERKEL, SUSAN M., JEAN M. HARTMAN, AND ROBERT W. HOWARTH, Sulfate reduction following marsh grass die-back, 509
- Merozoite surface glycoprotein, 535
- Messenger RNA in squid axoplasm, 526
- Metabolism of a bathypelagic mysid, 182
- Metamorphosis
of *Melibe*, 119
of soft-coral larvae, 286

Methanogenesis, 505
Metridium, intrasexual aggression, 416
 METUZALS, J., D. F. CLAPIN, P. A. M. EAGLES, AND G. J. FENNELY, Ordered assemblies of neurofilament proteins isolated from squid giant axon, 530
 Microbial selection in an artificial ecosystem, 512
 Microhabitat of *Echinocyamus*, 745
 Microscope, 492
 Microtubule, 491, 493, 494
 MILLER, JOHN, see Sarah Howlett, 500
 MILLER, RICHARD L., AND KENNETH R. KING, Sperm chemotaxis in *Oikopleura dioica* Fol, 1872 (Urochordata: Larvacea), 419
 MILLS, SUSAN W., see Gary E. Wagenbach, 538
 MITCHELL, TRICIA A., AND COLLEEN M. CAVANAUGH, Numbers of symbiotic bacteria in the gill tissue of the bivalve *Solemya velum* Say, 521
 Mitochondrial and spherosomal movement along a filamentous network in the marine slime mold *Gymnophrydium marinum*, 498
 Mitogenic activity of extracts and supernates from *Plasmodium falciparum*, 536
 Mitosis, 495, 811
 Mitotic index in coral tissues, 811
 MITTON, JEFFRY, B., see Carl J. Berg, Jr., 504
 MIYAMOTO, DAVID M., A video time lapse study of cell behavior during notochord morphogenesis in ascidian embryos, 501
 Model system, 510
Molgula manhattensis, see tunicates
 Mollusc reproduction, 559
 Molting cycle, 409, 758
 Molting in Crustacea, 321
 Monoclonal antibody, 535, 538
 MOOI, RICH, see Malcolm Telford, 745
 MOON, RANDALL T., see Billie J. Swalla, 518
 Morphogenesis in a nudibranch (*Melibe*), 119
 Morphology and genetics of rejection reactions between oozoids from the tunicate *Botryllus schlosseri*, 733
 MORROW, LAURA L., see Mary Ann Rankin, 532
 MOSS, R., R. SCHUEL, AND H. SCHUEL, FPL-55712, a leukotriene antagonist, promotes polyspermy in sea urchins, 516
 Motility, 523
 MUEHLSTEIN, LISA, AND RICHARD W. CASTENHOLZ, Sheath pigment formation in a blue-green alga, *Lyngbya aestuarii*, as an adaptation to high light, 521
 Multiple fission, 241
 Mutants of *Escherichia coli* affected in "inducer exclusion," 520
 Mysid, bathypelagic, 182

N

NACHTIGALL, MARGARET, see Frederic Blum, 513
 NAGASHIMA, LAUREN S., see Virginia L. Scofield, 733

NAKAMURA, SHOGO, see Sidney L. Tamm, 497
 Nerve conduction, 526
 Neurofilament, 530, 531, 533
 Neurogenesis in *Melibe*, 119
 Neuronal cytoskeleton, 533
 Neurotubules, 493
 New strain of *Paratetramitus jugosus* from Laguna Figueroa, Baja California, Mexico, A, 241
 NICAISE, GHISLAIN, see Mari-Luz Hernandez-Nicaise, 491
 NICCHITTA, C. V., AND W. R. ELLINGTON, Energy metabolism during air exposure and recovery in the high intertidal bivalve mollusc *Geukensia demissa granosissima* and the subtidal bivalve mollusc *Modiolus squamosus*, 708
 Noradrenalin, 758
 NOLL, KENNETH M., AND RICHARD W. CASTENHOLZ, Diel vertical movements of bacteria in intertidal streams of Sippewissett Marsh, 509
 Notochord, 501
 Nudibranchia, 119, 276, 528, 535
 Numbers of symbiotic bacteria in the gill tissue of the bivalve *Solemya velum* Say, 521

O

OBAB, A. L., H. GAINER, AND B. M. SALZBERG, Optical recording of action potentials from mammalian nerve terminals *in situ*, 530
 OBAR, ROBERT, see Laurie K. Read, 241
 Octocoral, 353, 778
 Octopine synthase, 498
 Ocular lens aging in the skate, 499
Odontosyllis, 444
Oikopleura, 419
 OLSON, RICHARD RANDOLPH, Ascidian-*Prochloron* symbiosis: the role of larval photoadaptations in midday larval release and settlement, 221
 O'MELIA, ANNE F., Rates of 5S RNA and tRNA synthesis in sea urchin embryos animalized by Evans Blue, 502
 Ommatidia, 541
Oncopeltus fasciatus, 532
 On the evolutionary constraint surface of hydra, 305
 Oocytes, 379
 Oogenesis, 379
 Ooplasmic segregation, 379
 Opposite end assembly-disassembly of single microtubules, 491
 Opisthobranchia, 119
 Optical recording of action potentials from mammalian nerve terminals *in situ*, 530
 Optic lobe, 525
 Ordered assemblies of neurofilament proteins isolated from squid giant axon, 530
 Organelle complex responsible for mRNA localization in the cortex of *Chaetopterus* eggs, An, 515
 Organelle transport, 498
 ORR, KATHERINE S., see Carl J. Berg, Jr., 504
 Osmotic, 520

- Ovarian
 ecdysteroids, 321
 follicle cells, 379
- P**
- PALASZEWSKI, PAUL P., AND BARBARA C. BOYER,
 Reproduction in *Haploplana* and *Stylochus*:
 developmental and cytoskeletal research pos-
 sibilities, 502
- Pancreatic islet cells, 494
- PANT, HARISH C., PAUL E. GALLANT, ROCHELLE
 S. COHEN, AND HAROLD GAINER, A relatively
 stable 100K_d protein is derived from the Ca²⁺-
 dependent proteolysis of neurofilament proteins
 in the squid axoplasm, 531
- PAPPAS, GEORGE D., see Rochelle S. Cohen, 525,
 and Susan C. Feldman, 525
- Parasite antigens, 537
- Parasites, 538
- Parasitism, 536
- Paratetramitus jugosus*, 241
- Paternal forms of LDH and MDH, 436
- Particle velocity distribution, 523
- Pathway tracing in the squid nervous system, 525
- PAUL, A. J., see Lewis S. Incze, 197
- PAXHIA, TERESA, see Seymour Zigman, 499
- PAYNE, RICHARD, AND ALAN FEIN, The effects of
 intracellular calcium/EGTA on the photoac-
 tivation of *Limulus* ventral photoreceptors, 541
- PELLETIER, JANICE L., see Robert B. Barlow, Jr.,
 539, and Leonard Kass, 540
- PEP-phosphotransferase system, 522
- PERCY, A., Mitogenic activity of extracts and su-
 pernatants from *Plasmodium falciparum*, 536
- PERKINS M., see A. S. Fairfield, 535
- PETERSON, BRUCE, see Jennifer Dungan, 507
- PETHIG, RONALD, see Albert Szent-Györgyi, 496
- Phagocytosis and intralysosomal killing of *Leish-
 mania mexicana* by *Entamoeba histolytica*, 534
- pH dependence of the tetrodotoxin-blockade of so-
 dium channels, The, 528
- Phenolic acid, 510
- Phosphate removal, 510
- Phospholipid synthesis in the injected squid giant
 axon, 526
- Phosphorous cycling, 506
- Photoactivation kinetics, 541
- Photoadaptation, 221
- Photographic (infrared analysis), 525
- Photophore, 791
- Photoreceptors, 540, 542
- Photoreceptors add at the anterior edge of *Limulus*
 lateral eye, 541
- Photosensory excitation, 540
- Photosynthesis, 508
- Photosynthetic activity of *Zostera marina* L. epi-
 phytes in relation to light regime and substratum,
 508
- Photosynthetic microbes, 507
- Physiological activity of efferent vestibular neurons
 and their action on primary afferents in the
 toadfish, 527
- Pigment, 521
- Plasmodium falciparum*, 535
- Plasmodium* mitogen, 536
- POHL, CHARLES, see Jay Shiro Tashiro, 511
- Pollination, submarine, 504
- Polychaeta, 379, 686, 699
- Polyclads, 502
- Polyspermic fertilization, 513
- Polyspermy, 512, 516
- Population crosses, 506
- Population dynamics, 538
- Population ecology of the Caribbean bivalve *Asaphis
 deflorata* (Linné, 1758), 504
- Postlarval growth in juvenile *Rhithropanopeus har-
 risii*, 409
- Posttranslational modification, 493
- PRATT, M. M., High molecular weight (380Kd)
 ATPase in axoplasm of squid giant axon, 494
- Preliminary evidence indicating the existence of in-
 termediate filament-like proteins in unfertilized
 eggs of the surf clam, *Spisula solidissima*, 519
- Presynaptic action of baclofen, a GABA analog, at
 the crayfish neuromuscular junction, 523
- Prochloron*, symbiosis with Ascidian, 221
- Promitosis, 241
- Propagating calcium spikes in identified cells in the
 suprasophageal ganglion of the giant barnacle,
Balanus nubilus, 529
- Propionyl esterase, 241
- Protease inhibitors, 512
- Protein
 microtubule-associated, 493
 synthesis, 503, 513, 519
- Proteinase inhibitor, 488, 495
- Proteinase inhibitor released from the *Limulus* ame-
 bocyte during exocytosis, A, 488
- Pseudostereoscopy allows direct visualization of the
 velocity distribution of particles undergoing fast
 axonal transport, 523
- PUMPLIN, D. W., AND J. HARRIGAN, Some mor-
 phological observations on the giant synapse of
 immature squid, 531
- Q**
- QUIGLEY, JAMES P. AND PETER B. ARMSTRONG,
 Characterization and isolation of a homologue
 of alpha-2-macroglobulin from the plasma of
 the horseshoe crab *Limulus*, 495
- QUIGLEY, JAMES P., see Peter B. Armstrong, 488
- R**
- RAMOS-FLORES, TALIA, Lower marine fungus as-
 sociated with black line disease in star corals
 (*Montastrea annularis*, E. & S.), 429
- RANKIN, MARY ANN, AND LAURA L. MORROW,
 Flight fuel utilization and flight energetics in

- the migratory milkweed bug, *Oncopeltus fasciatus*, 532
- Rates of 5S RNA and tRNA synthesis in sea urchin embryos animalized by Evans Blue, 502
- READ, LAURIE K., LYNN MARGULIS, JOHN STOLZ, ROBERT OBAR, AND THOMAS K. SAWYER, A new strain of *Paratetramitus jugosus* from Laguna Figueroa, Baja California, Mexico, 241
- Receptor aggregation, 498
- Recognition, 502, 569
- Red Sea, soft coral, 353
- Reef coral, 619
- REED-MILLER, CHARLENE, The initial calcification process in shell-regenerating *Tegula* (Archaeogastropoda), 265
- REED-MILLER, CHARLENE, Scanning electron microscopy of the regenerated shell of the marine archaeogastropod, *Tegula*, 723
- REESE, TOM S., see Donald C. Chang, 524
- Regenerated *Tegula* shell, 723
- Regeneration of injuries among Jamaican gorgonians: the roles of colony physiology and environment, 778
- Regeneration, sponge, 343
- Rejection reaction, 733
- Relatively stable 100K_d protein is derived from the Ca²⁺-dependent proteolysis of neurofilament proteins in the squid axoplasm, A, 531
- Remote sensing, 511
- RENNINGER, GEORGE H., see Leonard Kass, 540
- Repetitive cycles of bioluminescence and spawning in the polychaete, *Odontosyllis phosphorea*, 444
- Reproduction, 458, 502, 559
- Reproduction in *Haploplana* and *Stylochus*: developmental and cytoskeletal research possibilities, 502
- Reproductive behavior in nudibranch, 276
- Reproductive periodicity, 458
- Reproductive phase, 778
- Respiration in bathypelagic mysid, 182
- Restriction mapping, 490
- Reticulopodial network, 497
- Retinal growth, 541
- REVELAS, EUGENE C., Vertical movements of the hard clam, *Mercenaria mercenaria*, in response to changes in barometric pressure, 509
- REYNOLDS, G. T., AND ALAN J. WALTON, Mechanical stimulation of bioluminescence in dilute suspensions of dinoflagellates, 522
- REYNOLDS, G. T., see A. Eisen, 514
- Rhithropanopeus*, 139, 154, 409
- Rhythms in *Rhithropanopeus*, 139, 154
- RICE, ROBERT V., see Stanley W. Watson, 498
- RICH, ABBY M., see Gerald Weissmann, 503
- RIETSMAN, CAROL S., Effect of age and quality of detritus on growth of the salt marsh snail, *Melampus bidentatus*, 510
- Rise of free intracellular Ca²⁺ in mouse macrophage associated with $\gamma 2b/\gamma 1$ Fc receptor-ligand interaction, 498
- RIVAS, L., AND K.-P. CHANG, Intraparasitophorous vacuolar pH of *Leishmania mexicana* infected macrophages, 536
- RNA
 accumulation, 501
 mRNA, 515, 518
 rRNA gene cluster, 488
- ROBINSON, WILLIAM E., see Maria I. Agudelo, 100
- Rock intertidal, 330
- Role of freshwater wetlands in the ontogeny of a New England saltmarsh, The, 512
- Roles of hemocytes in tanning during the molting cycle: a histochemical study of the fiddler crab, *Uca pugnator*, The, 758
- ROMERO, GIULLERMO, YARA CSEKO, AND DYANN WIRTH, Detection of *Leishmania* kinetoplast DNA using biotinylated DNA probes, 537
- ROSENBAUM, JOEL L., see Thomas Kelly, 493
- ROSENTHAL, ERIC T., see Elizabeth L. George, 515
- ROSS, WILLIAM N., AND N. STOCKBRIDGE, Localization of calcium transients in the presynaptic terminals of a barnacle photoreceptor detected using Arsenazo III, 542
- RUTOWSKI, RONALD L., Mating and egg mass production in the aeolid nudibranch *Hermisenda crassicornis* (Gastropoda: Opisthobranchia), 276

S

- Salt marsh, 512, 543
- Salt-tolerant amoebae, 241
- SALZBERG, B. M., see A. L. Obaid, 530
- SANELLA, LUIGIA, see Antonio Giuditta, 526
- Satellite fusion, 497
- SATO, EIMEI, N. MATSUI, M. H. BURGOS, S. S. KOIDE, AND S. J. SEGAL, Binding of ¹⁴C-gosypol by *Arbacia* sperm, 516
- SAWYER, THOMAS K., see Laurie K. Read, 241
- Scanning electron microscopy of the regenerated shell of the marine archaeogastropod, *Tegula*, 723
- SCHEN, CATHY R., see Barbara E. Ehrlich, 540
- Schistosoma mansoni*, 534, 537, 538
- SCHOTT, EDWARD F., see Louis Leibovitz, 535
- SCHLICHTER, LYANNE C., AND LAURINDA A. JAFFE, Fertilization-induced ion conductances in frog eggs, 517
- SCHNAPP, BRUCE J., see Stanley W. Watson, 498
- SCHNEIDER, E. GAYLE, Cell-cell recognition and adhesion during embryogenesis in the sea urchin, 502
- SCHUEL, H., see M. C. Alliegro, 512, and R. Moss, 516
- SCHUEL, R., see R. Moss, 516
- SCHULTZ, GILBERT, see Sarah Howlett, 500
- Scleractinian corals, 569
- SCOFIELD, VIRGINIA L., AND LAUREN S. NAGASHIMA, Morphology and genetics of rejection reactions between oozoids from the tunicate *Botryllus schlosseri*, 733
- Sea anemone, see *urticina*
- Sea urchin, 502, 519
 ciliary tubulin, 493

- eggs, 503, 520
 embryo, 502
 fertilization, 512, 516
- SEBENS, KENNETH, P., Settlement and metamorphosis of a temperate soft-coral larva (*Alcyonium siderium* Verrill): induction by crustose algae, 286
- Sediment nitrogen availability, 507
- SEGAL, S. J., M. BURGOS, AND S. S. KOIDE, Ultrastructural changes characteristic of *Arbacia* sperm exposed to gossypol, 517
- SEGAL, S. J., see Eimei Sato, 516
- SEKIGUCHI, KIOCHI, see Hiroaki Sugita, 436
- Semibalanus*, 330
- Sensitivity of freshwaters of Cape Cod, Massachusetts to acid precipitation, The, 507
- Settlement and metamorphosis of a temperate soft-coral larva (*Alcyonium siderium* Verrill): induction by crustose algae, 286
- Sexual dimorphism and reproductive behavior in *Almyracuma proximolculi* (Crustacea: Cumacea): the effect of habitat, 370
- Sheath pigment formation in a blue-green alga, *Lyngbya aestuarii*, as an adaptation to high light, 521
- Shell gland, 394
- Shell regeneration in *Tegula*, 265
- Shell ultrastructure, 723
- SHETTLES, BREWER, see Matthew Winkler, 503
- SHUPE, KATHLEEN, AND ERIC WEINBERG, *In vitro* transcription of histone genes in isolated nuclei from *S. purpuratus*, 518
- SIBLEY, L. D., J. KRAKOW, A. FLISSER, AND D. HARN, Antigens on both mechanical and lung stage schistosomula of *Schistosoma mansoni* are masked by host molecules, 537
- Sibling species, *Capitella*, 379
- SILVER, ROBERT B., Inhibition of mitotic anaphase and cytokinesis and reduction of spindle birefringence following microinjection of anti-calcium transport enzyme IgGs into *Echinarracnius parma* blastomeres, 495
- SINGLA, C. L., see G. O. Mackie, 209
- Single amino acids stimulate lobster (*Homarus americanus*) behavior against ambient and modified amino acid backgrounds, 532
- Siphonophora, 591
- Skate, 499
- SKINNER, DOROTHY M., see Cynthia Soumoff, 321
- SKLADANY, GEORGE J., BRIAN A. WRENN, AND ROBERT R. HALL, The design and construction of a benchtop reactor to model and anaerobic/oxic wastewater treatment system, 510
- Slime mold, 498
- SLOBODKIN, L. B., AND KENNETH DUNN, On the evolutionary constraint surface of hydra, 305
- Slow rearrangements of membrane bound, halogenated fluoresceins produce altered K^+ currents in squid axon, 524
- SMITH, STEPHEN J., GEORGE J. AUGUSTINE, AND MILTON P. CHARLTON, Calcium transients in voltage clamped presynaptic terminals, 532
- Snails, see *Tegula*
- Sodium channel, 490, 528
- Some morphological observations on the giant synapse of immature squid, 531
- SOMERO, GEORGE N., see Steven C. Hand, 167
- SOUMOFF, CYNTHIA, AND DOROTHY M. SKINNER, Ecdysteroid titers during the molt cycle of the blue crab resemble those of other Crustacea, 321
- SPALDING, MARILYN, AND JELLA ATEMA, Single amino acids stimulate lobster (*Homarus americanus*) behavior against ambient and modified amino acid backgrounds, 532
- Spartina alterniflora*, 509
- Spatial and temporal patterns of mitosis in the cells of the axial polyp of the reef coral *Acropora cervicornis*, 811
- Spawning cycles in *Odontosyllis*, 444
- Spectra, 791
- Speciation in the brine shrimp *Artemia*: cross-breeding between sexual Mediterranean populations, 506
- Spectroscopy, 791
- Sperm chemotaxis in *Oikopleura dioica* Fol, 1872 (Urochordata: Larvacea), 419
- Sperm motility, 516
- Spisula*
 early development, 515
 oocyte, 519
- Sponge cell aggregation, 503
- Sponge growth and regeneration, 343
- SPUDICH, JOHN L., see Barbara E. Ehrlich, 540
- Squid
 axon, 523, 524, 526
 axoplasm, 494, 526, 531
 behavior, 637
 development, 531
 growth, 637
 maintenance, 637
 nervous system, 525
 synapse, 529
- 5S RNA and tRNA synthesis, 502
- STANLEY, E. F., Depolarizing and desensitizing actions of glutaminergic and cholinergic agonists at the squid giant synapse, 533
- Starvation, effects of in bathypelagic mysid, 182
- Stellate ganglion, 531
- STEPHENS, R. E., Lactoperoxidase-tubulin interaction in ciliary membranes, 496
- STOCKBRIDGE, N., see William N. Ross, 542
- STOLZ, JOHN, see Laurie K. Read, 241
- STOMMEL, ELIJAH W., Calcium activated channels in the mechanically sensitive abfrontal ciliated cells of *Mytilus* gill, 496
- STONE, T. A., R. A. HOUGHTON, J. M. MELILLO, AND G. M. WOODWELL, Deforestation in the Amazon Basin measured by satellite: a release of CO_2 to the atmosphere, 511

Strategy to differentiate mutants affecting voltage-sensitive sodium channels in *Drosophila*, A, 490

Strombus gigas, 504

Strongylocentrotus purpuratus, 473, 501, 518

Structure and expression of tubulin genes in the protozoan parasite *Leishmania enriettii*, 493

Structure of the isolated and *in situ* giant smooth muscle fibers of *Mnemiopsis leydyi*, 491

Structure of the squid axon membrane as seen after freeze-fracture, 524

Structure of tubulin RNA from *Leishmania enriettii*, 539

Studies of cytotoxic free radicals produced by some methoxy-quinones plus ascorbate in the presence of Ehrlich ascites cells, 496

Studies on manganese oxidizing, spore forming bacteria, 520

Studies of the isolation and calcium-induced fusion of fusogenic wild carrot protoplasts, 487

Styela clava, see tunicates

Subtidal sponge growth, 343

SUGITA, HIROAKI, AND KOICHI SEKIGUCHI, The developmental appearance of paternal forms of lactate dehydrogenase and malate dehydrogenase in hybrid horseshoe crabs, 436

SUGIMORI, M., see R. Llinas, 529

Sulfate reduction, 505, 509

Sulfate reduction following marsh grass die-back, 509

Sulfur-oxidizing chemoautotrophic bacteria, 521

Superoxide dismutase biomimetic compounds prevent fertilization in *Arbacia punctulata* eggs, 513

Surface brooding in the Red Sea soft coral *Parerythropodium fulvum fulvum* (Forskål, 1775), 353

Survival, growth, and behavior of the loliginid squids *Loligo plei*, *Loligo pealei*, and *Lolliguncula brevis* (Mollusca: Cephalopoda) in closed sea water systems, 637

SUTHERLAND, D. F., AND H. L. KORNBERG, Factors affecting growth inhibition of enteric bacteria by methyl α -D-glucoside, 522

SWALLA, BILLIE J., RANDALL T. MOON, AND WILLIAM R. JEFFERY, Is there a developmental significance for mRNA localized in the cortex of *Chaetopterus* eggs? 518

Swarming in polychaetes, 444

Sweeper tentacle, 569

SWISTON, LINDA, ALBERT KO, AND DON HARN, Inhibition of a surface binding monoclonal antibody to schistosomula of *Schistosoma mansoni* by lectins, 538

Symbiosis, Ascidian-*Prochloron*, 221

Synapses, 525

Synaptic transmission, 532

Synaptosomes, 525

SZENT-GYÖRGYI, ALBERT, PETER GASCOYNE, RONALD PETHIG, AND JANE MCLAUGHLIN, Studies of cytotoxic free radicals produced by some methoxy-quinones plus ascorbate in the presence of Ehrlich ascites cells, 496

T

Tachypleus, see horseshoe crabs

TAMM, SIDNEY L., AND SHOGO NAKAMURA, ATP-reactivated models of ctenophore comb plates, 497

Tanner crab, energy needs of zoeae, 197

Tanning, hormone, 758

TASAKI, ICHJI, see Donald C. Chang, 524 and Robert M. Gould, 526

TASHIRO, JAY SHIRO, MARK WILTSHIRE, AND CHARLES POHL, Age of first reproduction in *Melampus bidentatus*: the effects of overwintering degrowth and repair, 511

Tegula, 265, 723

TELFORD, MALCOLM, ANTONY S. HAROLD, AND RICH MOOL, Feeding structures, behavior, and microhabitat of *Echinocyamus pusillus* (Echinozoidea: Clypeasteroidea), 745

Temperature, 508

Teredo, karyology, 450

Terminal anecdyosis, 321

TESORIERI, ITALO, see Marta Bretos, 559

Tetrahymena, 491

Tetrodotoxin, 490, 528

TIERNAN, T., see H. O. Halvorson, 520

Ti plasmid, 498

Toadfish, 494

Trachylina, 591

Transcriptional regulation, 518

Translational control, 515

Transport of vesicles along filaments dissociated from squid axoplasm, 523

TRAVIS, J. L., AND V. E. CENTONZE, Intracellular fusion between reticulopodial networks in *Allogromia laticollaris*, 497

TRAVIS, J. L., see V. E. Centonze, 489 and H. Hotani, 491

Treadmill, 491

TREGGOR, JOSEF P., The role of freshwater wetlands in the ontogeny of a New England saltmarsh, 512

Trematode infection in *Ilyanassa obsoleta*: dependence on size and sex of the host and effect on chemotaxis, 536

TROLL, WALTER, see Frederic Blum, 513

Tropical deforestation, 511

Trypanosoma brucei, 490

TSUJI, FREDERICK I., AND ELIZABETH HILL, Repetitive cycles of bioluminescence and spawning in the polychaete *Odontosyllis phosphorea*, 444

Tubulin, 489, 496

genes, 490, 493

RNA, 539

Tunicates, 100, 733, see ascidians

Two-dimensional gel analysis of sea urchin ciliary tubulins, 493

TYTELL, M., see R. V. Zackroff, 533

U

- Uca pugilator*, 758
 Ultrastructural changes characteristic of *Arbacia* sperm exposed to gossypol, 517
 Ultrastructure, 491
 Unconditioned behavioral response to learning, 525
 Undulipodia, 241
Urticina lofotensis, 458
 Urochordata, 419
 Ultrastructural differences in the eggs and ovarian follicle cells of *Capitella* (Polychaeta) sibling species, 379
 Ultrastructure of early embryonic shell formation in the opisthobranch gastropod *Aeolidia papillosa*, 394

V

- VACCA, LINDA L., AND MILTON FINGERMAN, The roles of hemocytes in tanning during the molting cycle: a histochemical study of the fiddler crab, *Uca pugilator*, 758
 Vahlkampfid amoebae, 241
 VALIELA, IVAN, see Nina Caraco, 506
 Vascular system of ascidians, 209
 Veratridine, 490
 Vertical migration rhythms of newly hatched larvae of the estuarine crab, *Rhithropanopeus harrisi*, 139
 Vertical movements of the hard clam, *Mercenaria mercenaria*, in response to changes in barometric pressure, 509
 Vestibular system, 527
 Video, 492
 Video time lapse study of cell behavior during notochord morphogenesis in ascidian embryos, A, 501
 VINCENT, W. S., AND ROBERT M. HALL, Microbial selection in an artificial ecosystem, 512
 Vision in *Limulus* mating behavior: tests for detection and form discrimination, 539
 Visualization of depolarization-evoked presynaptic calcium entry and voltage dependence of transmitter release in squid giant synapse, 529
 Visualizing extremely low contrast images by digital enhancement of selected portions of the image grey scale, 492
 VITTURI, R., A. MAIORCA, AND E. CATALANO, The karyology of *Teredo utriculus* (Gmelin) (Mollusca, Pelecypoda), 450
 Voltage clamp, 532
 dependence, 529
 sensitive dyes, 530
 Voltage clamp studies of dispersed toadfish pancreatic islet cells, 494
 VON BRUNN, ALBRECHT, RONALD A. CONLON, AND M. M. WINKLER, Maturation of sea urchin and

Chaetopterus oocytes results in a change in the pattern of protein synthesis, 519
 VOSSHALL, LESLIE B., see Gerald Weissmann, 503

W

- WAGENBACH, GARY E., JUDITH P. GRASSLE, AND SUSAN W. MILLS, Host specificity of intestinal gregarines (Protozoa, Apicomplexa) in two sympatric species of *Capitella* (Polychaeta), 538
 WAHLE, CHARLES M., Regeneration of injuries among Jamaican gorgonians: the roles of colony physiology and environment, 778
 WALTON, ALAN J., see G. T. Reynolds, 522
 WALDRON, WILLIAM, see Seymour Zigman, 499
 WANG, ROBERT T., see Maria I. Agudelo, 100
 WARD ERIC R., AND WAYNE M. BARNES, Marine molluscan genomes contain sequences homologous to the octopine synthase gene of *Agrobacterium tumefaciens*, 498
 Wastewater treatment, 510, 512
 WATSON, STANLEY W., BRUCE J. SCHNAPP, AND ROBERT V. RICE, Mitochondrial and spherosomal movement along a filamentous network in the marine slime mold *Gymnophrydium marinum*, 498
 WEDI, STEVEN E., AND DAPHNE FAUTIN DUNN, Gametogenesis and reproductive periodicity of the subtidal sea anemone *Urticina lofotensis* (Coelenterata: Actiniaria) in California, 458
 WEINBERG, ERIC, see Kathleen Shupe, 518
 WEINBERG, E. S., see P. E. Kuwabara, 500
 WEISSMANN, GERALD, CATHLEEN ANDERSON, LESLIE B. VOSSHALL, ABBY M. RICH, KATHLEEN A. HAINES, TOM HUMPHREYS, AND PHILIP DUNHAM, Leukotriene B₄ promotes the calcium-dependent aggregation of marine sponge cells, 503
 WEST, TERRY L., see John A. Freeman, 409
 WETHEY, DAVID S., Geographic limits and local zonation: the barnacles *Semibalanus* (*Balanus*) and *Chthamalus* in New England, 330
 What makes cyclin cycle? 513
 Wheat germ agglutinin, 525
 WIDDER, EDITH A., MICHAEL I. LATZ, AND JAMES F. CASE, Marine bioluminescence spectra measured with an optical multichannel detection system, 791
 WIELAND, S., see A. Eisen, 514
 WILTSHIRE, MARK, see Jay Shiro Tashiro, 511
 WINKLER, MATTHEW, AND BREWER SHETTLES, Evidence for regulation of protein synthesis at the level of translational machinery in the sea urchin egg, 503
 WINKLER, M. M., see Albrecht Von Brunn, 519
 WIRTH, D., see A. Flisser, 490, and Guillermo Romero, 537
 WOLFE, RALPH S., see Joseph N. Boyer, 505
 WOODWELL, G. M., see T. A. Stone, 511
 WRENN, BRIAN A., see George J. Skladany, 510

WYMAN, CLAIRE, AND SCOTT LANDFEAR, Structure of tubulin RNA from *Leishmania enriettii*, 539

Y

YOKOO, KAREN M., ANNE E. GOLDMAN, AND ROBERT D. GOLDMAN, Preliminary evidence indicating the existence of intermediate filament-like proteins in unfertilized eggs of the surf clam, *Spisula solidissima*, 519

YOUNG, JOHN DING-E, Rise of free intracellular Ca^{2+} in mouse macrophage associated with $\gamma 2b/\gamma 1$ Fc receptor-ligand interaction, 498

YUI, MARY A., AND CHRISTOPHER J. BAYNE, Echi-

noderm immunology: bacterial clearance by the sea urchin *Strongylocentrotus purpuratus*, 473

Z

ZACKROFF, R. V., W. D. HILL, M. TYTELL, AND R. D. GOLDMAN, Functional and chemical characterization of squid neurofilament polypeptides, 533

ZIGMAN, SEYMOUR, TERESA PAXHIA, BLEND ANTONELLIS, AND WILLIAM WALDRON, Ocular lens aging in the skate, 499

ZIMMERBERG, JOSHUA, Hyperosmotic treatment inhibits cortical granule exocytosis in the sea urchin *Lytechinus pictus*, 520

Zostera marina, 504, 507, 508

Continued from Cover Two

current addresses, acknowledgments or contribution numbers, and explanation of unusual abbreviations. All such footnotes should appear on the title page. Footnotes are not normally permitted in the body of the text.

4. **A condensed title** or running head of no more than 35 letters and spaces should appear at the top of the title page.

5. **Literature cited.** In the text, literature should be cited by the Harvard system, with papers by more than two authors cited as Jones *et al.*, 1980. Personal communications and material in preparation or in press should be cited in the text only, with author's initials and institutions, unless the material has been formally accepted and a volume number can be supplied. The list of references following the text should be headed LITERATURE CITED, and must be typed double spaced on separate pages, conforming in punctuation and arrangement to the style of recent issues of *The Biological Bulletin*. Citations should include complete titles and inclusive pagination. Journal abbreviations should normally follow those of the U. S. A. Standards Institute (USASI), as adopted by BIOLOGICAL ABSTRACTS and CHEMICAL ABSTRACTS, with the minor differences set out below. The most generally useful list of biological journal titles is that published each year by BIOLOGICAL ABSTRACTS (BIOSIS List of Serials; the most recent issue). Foreign authors, and others who are accustomed to using THE WORLD LIST OF SCIENTIFIC PERIODICALS, may find a booklet published by the Biological Council of the U.K. (obtainable from the Institute of Biology, 41 Queen's Gate, London, S.W.7, England, U.K.) useful, since it sets out the WORLD LIST abbreviations for most biological journals with notes of the USASI abbreviations where these differ. CHEMICAL ABSTRACTS publishes quarterly supplements of additional abbreviations. The following points of reference style for THE BIOLOGICAL BULLETIN differ from USASI (or modified WORLD LIST) usage:

- A. Journal abbreviations, and book titles, all underlined (for italics)
- B. All components of abbreviations with initial capitals (not as European usage in WORLD LIST e.g. *J. Cell. Comp. Physiol.* NOT *J. cell. comp. Physiol.*)
- C. All abbreviated components must be followed by a period, whole word components *must not* (i.e. *J. Cancer Res.*)
- D. Space between all components (e.g. *J. Cell. Comp. Physiol.*, not *J.Cell.Comp.Physiol.*)
- E. Unusual words in journal titles should be spelled out in full, rather than employing new abbreviations invented by the author. For example, use *Rit Viðindafjélagi Íslendinga* without abbreviation.
- F. All single word journal titles in full (e.g. *Veliger, Ecology, Brain*).
- G. The order of abbreviated components should be the same as the word order of the complete title (i.e. *Proc.* and *Trans.* placed where they appear, not transposed as in some BIOLOGICAL ABSTRACTS listings).
- H. A few well-known international journals in their preferred forms rather than WORLD LIST or USASI usage (e.g. *Nature, Science, Evolution* NOT *Nature, Lond., Science, N.Y.; Evolution, Lancaster, Pa.*)

6. **Reprints, charges.** *The Biological Bulletin* has no page charges. However, authors will be requested to help pay printing charges of manuscripts that are unusually costly due to length or numbers of tables, figures, or formulae. Reprints may be ordered at time of publication and normally will be delivered about two to three months after the issue date. Authors (or delegates or foreign authors) will receive page proofs of articles shortly before publication. They will be charged the current cost of printers' time for corrections to these (other than corrections of printers' or editors' errors).

CONTENTS

BRECHLEY, G. A., AND J. T. CARLTON	Competitive displacement of native mud snails by introduced periwinkles in the New England intertidal zone	543
BRETOS, MARTA, ITALO TESORIERI, AND LUIS ALVAREZ	The biology of <i>Fissurella maxima</i> Sowerby (Mollusca: Archaeogastropoda) in northern Chile. 2. Notes on its reproduction	559
CHORNESKY, ELIZABETH A.	Induced development of sweeper tentacles on the reef coral <i>Agaricia agaricites</i> : a response to direct competition	569
DEFUR, PETER L., BRIAN R. MCMAHON, AND CHARLES E. BOOTH	Analysis of hemolymph oxygen levels and acid-base status during emersion 'in situ' in the red rock crab, <i>Cancer productus</i>	582
FREEMAN, GARY	Experimental studies on embryogenesis in hydrozoans (Trachylina and Siphonophora) with direct development	591
GLADFELTER, ELIZABETH H.	Circulation of fluids in the gastrovascular system of the reef coral <i>Acropora cervicornis</i>	619
HANLON, ROGER T., RAYMOND F. HIXON, AND WILLIAM H. HULET	Survival, growth, and behavior of the loliginid squids <i>Loligo plei</i> , <i>Loligo pealei</i> , and <i>Lolliguncula brevis</i> (Mollusca: Cephalopoda) in closed sea water systems	637
LEVINTON, JEFFREY S.	The latitudinal compensation hypothesis: growth data and a model of latitudinal growth differentiation based upon energy budgets. I. Inter-specific comparison of <i>Ophryotrocha</i> (Polychaeta: Dorvilleidae)	686
LEVINTON, JEFFREY S., AND ROSEMARY K. MONAHAN	The latitudinal compensation hypothesis: growth data and a model of latitudinal growth differentiation based upon energy budgets. II. Intra-specific comparisons between subspecies of <i>Ophryotrocha puerilis</i> (Polychaeta: Dorvilleidae)	699
NICCHITTA, C. V., AND W. R. ELLINGTON	Energy metabolism during air exposure and recovery in the high intertidal bivalve mollusc <i>Geukensia demissa granosissima</i> and the subtidal bivalve mollusc <i>Modiolus squamosus</i>	708
REED-MILLER, CHARLENE	Scanning electron microscopy of the regenerated shell of the marine archaeogastropod, <i>Tegula</i>	723
SCOFIELD, VIRGINIA L., AND LAUREN S. NAGASHIMA	Morphology and genetics of rejection reactions between oozoids from the tunicate <i>Botryllus schlosseri</i>	733
TELFORD, MALCOLM, ANTHONY S. HAROLD, AND RICH MOOI	Feeding structures, behavior, and microhabitat of <i>Echinocyamus pusillus</i> (Echinoidea: Clypeasteroidea)	745
VACCA, LINDA L., AND MILTON FINGERMAN	The roles of hemocytes in tanning during the molting cycle: a histochemical study of the fiddler crab, <i>Uca pugilator</i>	758
WAHLE, CHARLES M.	Regeneration of injuries among Jamaican gorgonians: the roles of colony physiology and environment	778
WIDDER, EDITH A., MICHAEL I. LATZ, AND JAMES F. CASE	Marine bioluminescence spectra measured with an optical multichannel detection system	791
<i>Short Report</i>		
GLADFELTER, ELIZABETH H.	Spatial and temporal patterns of mitosis in the cells of the axial polyp of the reef coral <i>Acropora cervicornis</i>	811
INDEX TO VOLUME 165		816

ACME
BOOK CO., INC.

FEB 29 1984

100 M. = 300 FEET
CHARLESTOWN, MASS.

MBL WHOI LIBRARY



WH 1B24 0

