

BIOLOGICAL BULLETIN

OF THE

Marine Biological Laboratory

WOODS HOLE, MASS.

VOL. LVI

JANUARY, 1929

No. 1

CONTENTS

TURNER, C. L.	<i>Studies on the Secondary Sexual Characters of Crayfishes, IX. Females of Cambarus with Aberrant Female Characters</i>	1
MACKEY, MARGARET E.	<i>The Digestive System of the Eel-Pout (Zoarces Anguillaris)</i>	8
MACKEY, MARGARET E.	<i>Note on the Bile in Different Fishes</i>	24
RICHARDS, OSCAR W.	<i>The Effect of Neurophil Drugs on the Fiddler Crab, Uca pugnax</i>	28
RICHARDS, OSCAR W.	<i>The Conduction of the Nervous Impulse through the Pedal Ganglion of Mytilus</i> ..	32
CRABB, EDWARD D.	<i>Growth of a Pond Snail, Lymnaea stagnalis appressa, as Indicated by Increase in Shell Size</i>	41
MORITA, YUN-ICHI, AND CHAMBERS, ROBERT.	<i>Permeability Differences between Nuclear and Cytoplasmic Surfaces in Amæba dubia</i> ...	64
HOPKINS, D. L., AND JOHNSON, PERCY L.	<i>The Culture of Amæba proteus in a Known Salt Solution</i>	68

PUBLISHED MONTHLY BY THE
MARINE BIOLOGICAL LABORATORY

PRINTED AND ISSUED BY
LANCASTER PRESS, INC.
LANCASTER, PA.

AGENT FOR GREAT BRITAIN
WHELDON & WESLEY, LIMITED
2, 3 and 4 Arthur Street, New Oxford Street, London, W. C. 2

Single Numbers, \$1.00. Per Volume (6 numbers), \$4.50

Editorial Staff

GARY N. CALKINS—*Columbia University.*

E. G. CONKLIN—*Princeton University.*

M. H. JACOBS—*University of Pennsylvania.*

FRANK R. LILLIE—*University of Chicago.*

GEORGE T. MOORE—*The Missouri Botanic Garden.*

T. H. MORGAN—*Columbia University.*

W. M. WHEELER—*Harvard University.*

E. B. WILSON—*Columbia University.*

Managing Editor

C. R. MOORE—*The University of Chicago.*

All communications and manuscripts should be sent to the Managing Editor, the University of Chicago. Subscriptions and other matter should be addressed to the Biological Bulletin, Prince and Lemon Streets, Lancaster, Pa.

BIOLOGICAL BULLETIN

STUDIES ON THE SECONDARY SEXUAL CHARACTERS OF CRAYFISHES.

IX. FEMALES OF *Cambarus* WITH ABERRANT FEMALE CHARACTERS.

C. L. TURNER,

ZOÖLOGICAL LABORATORY, NORTHWESTERN UNIVERSITY.

In the various genera of crayfishes the external apertures of the oviducts are placed at the bases of the third walking legs.

Desmarest in 1848 described a specimen of *Astacus fluviatilis* having supernumerary oviducal pores at the bases of the fourth walking legs. Upon dissection it was found that a normal pair of oviducts emerged from the sides of the ovary but that each oviduct bifurcated. The divided oviducts were attached at their distal ends to both normal and supernumerary apertures.

Benham, in 1891, described an unusual case of supernumerary oviducal pores in *Astacus fluviatilis*. Normal openings occurred at the bases of the third walking legs, but in addition to these a pair of oviducal pores appeared at the bases of the fifth walking legs. The oviducts divided after continuing for the greater part of their length as single tubes, one branch going to each oviducal opening.

Bateson, in 1894, after reviewing the described cases, offered fifteen new cases in *Astacus fluviatilis* in which females bore aberrant female characters. Four of these were specimens with only one oviducal pore at the base of a third walking leg instead of the usual pair. One of the specimens when dissected was found to have a normal oviduct on the side with the opening, but a blind and abortive tube on the other side. Seven specimens were described which had a single supernumerary pore on the right fourth leg. One was described in which supernumerary

pores were present in third, fourth, and fifth walking legs. In most of the cases the oviduct was divided on the side with the supernumerary pores, but in one or two cases the supernumerary pore occurred with no branch of the oviduct to connect with it. In the specimen having three pairs of oviducal pores, a pair of bifurcated oviducts extended to the pores on the third and fourth legs, but the pores on the fifth legs were blind.

Bateson was interested primarily in determining the proportion of specimens that were abnormal and in ascertaining whether the supernumerary pores formed a continuous or a discontinuous succession with the normal pores. His conclusions may be summarized as follows:

1. The cases with supernumerary pores are over 3 per cent. of the total number of *Astacus fluviatilis* examined.
2. The supernumerary pores are more likely to be unilateral than bilateral.
3. There is a clear succession between the legs with normal oviducal pores and those with supernumerary pores, the supernumerary pores always being smaller, although large enough in some cases to permit the passing of eggs.
4. The series may be an interrupted one, as shown by the case in which there are normal pores on the third legs and supernumerary pores on the fifth legs.

The matter of abnormal oviducal openings has been given little attention in the genus *Cambarus*. Undoubtedly cases like those to be described have been observed, but few if any have been described, and no attempt has been made to study the condition in *Cambarus* as Bateson has done in *Astacus fluviatilis*. The writer has been collecting and studying crayfishes with aberrant sexual characters for the past eight years, and among the thousands of specimens examined there have appeared twenty-one cases in females of *Cambarus virilis* and *Cambarus propinquus* which had aberrant conditions in the oviducal pores. In the region from which most of these specimens came (central and southeastern Wisconsin, northern Illinois, parts of Michigan, and northeastern Ohio) one of these two species has been the most abundant crayfish of the region, and attention has been confined almost entirely to these two. What the condition may

be in other species is not known, and not enough aberrant specimens have been collected to justify an opinion. The attempt has been made to study the relative proportion of aberrant and normal specimens in single localities in order to discover whether the aberrant cases are widely and uniformly distributed or whether they are concentrated in single localities.

DESCRIPTION OF CASES.

Case number one, a specimen of *Cambarus propinquus*, 52 mm. long, was collected from a small tributary of Turtle Creek at Carvers Rock, Wisconsin, on July 16, 1922. Normal genital apertures occur at the bases of the third walking legs, and in addition a fully developed genital aperture is found at the base of the left second walking leg. Upon dissection it appears that a normal oviduct occurs upon the right side but that two oviducts

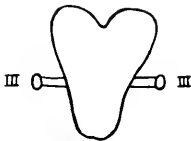

Fig. 1

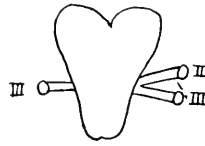

Fig. 2

occur on the left side (Fig. 2). The latter are joined together at the point of their union with the ovary and are attached to the oviducal pores at their distal ends. Figure one is a diagrammatic illustration of the relations of the ovary, oviducts, and oviducal pores in a normal female viewed from the ventral aspect. The Roman numerals indicate the walking legs.

Specimen number two, also one of *Cambarus propinquus*, 49 mm. long, was collected from South Kinnikinnic Creek, Illinois, a tributary of the Rock River, on June 30, 1924. Like specimen number one it is abnormal only in possessing an extra genital aperture. In this case the extra aperture is located at the base of the right second walking leg. The oviduct on the left side of the body is normal in every respect, but the one on the right side bifurcates at a point about one third of its length from the ovary, and the two branches become attached to the genital pores located in the second and third walking legs (Fig. 3).

A third abnormal specimen of *Cambarus propinquus*, 57 mm.

in length, was taken from Turtle Creek, Wisconsin, on July 5, 1924. A single normal oviducal pore is to be found on the left side of the body. There is no trace of the oviducal pore which is normally to be expected at the base of the third walking leg upon the right side of the body. The oviduct is entirely normal upon the left side, but a normal oviduct after leaving the ovary at the usual point and after proceeding for about four fifths of its normal length ends blindly, and the free end is attached to the exoskeleton of the leg by a few thin strands of connective tissue (Fig. 4).

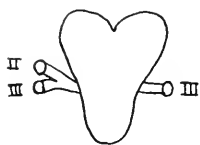

Fig. 3

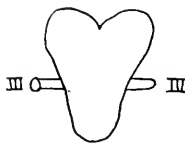

Fig. 4



Fig. 5

A fourth specimen of *Cambarus propinquus*, 42 mm. in length, from White River near Lake Geneva, Wisconsin, has a supernumerary oviducal pore at the base of the left second walking leg. The specimen was collected on July 2, 1924. Unfortunately the preservation is poor and the internal structure cannot be made out.

The fifth case was discovered in a collection from Pike River near Racine, Wisconsin. The specimen is 33 mm. in length and was taken on July 9, 1924. Beside the usual oviducal pores at the bases of the third walking legs, supernumerary oviducal pores are found on the bases of the second walking legs. The left oviduct is normal at its base but divides into two branches, the ends of which are attached to the normal and the supernumerary oviducal pores. On the right side there are two oviducts which arise from the ovary practically together and become attached at their distal ends to the normal and the supernumerary oviducal pores (Fig. 5).

A sixth specimen of *Cambarus propinquus*, 38 mm. in length, came from Turtle Creek near Beloit, Wisconsin, and was collected on July 5, 1925. The abnormality in this case consists of a well-developed supernumerary oviducal pore located on the base of the right second walking leg. Normal oviducts extend from

the ovary to the oviducal pores at the bases of the third legs, but the supernumerary oviducal pore is isolated with no duct of any kind attached to it (Fig. 6).

The seventh specimen has already been described in an earlier paper as a female bearing male secondary sex characters in the form of male first and second abdominal appendages and male genital pores at the bases of the fifth leg. In addition to the male characters, however, there is also a supernumerary female character in the form of a small oviducal pore upon the base of the left fourth walking leg. This supernumerary pore is much smaller than the normal one, but it is distinct and its character is unmistakable. In spite of the array of male and supernumerary female structures, the specimen proved to be a functional female, and was bearing embryos attached to the swimmerets when taken (May, 1923) (Fig. 7).

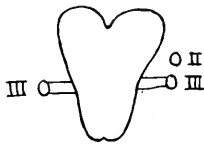

Fig. 6

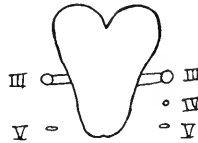

Fig. 7

Three other cases were discovered in *Cambarus virilis* which were much like some of those described for *Cambarus propinquus*. One of them from a small tributary of the Wisconsin River near Middleton, Wisconsin, had supernumerary oviducal pores upon both second walking legs and the arrangement of the oviducts was much like that figured in Fig. 5. The other, collected on July 11, 1923, from the outlet of Muskego Lake, Wisconsin, had a supernumerary oviducal pore upon the right second walking leg but, the internal organs being in a very bad state of preservation, nothing could be made out as to the arrangement of the oviducts.

A collection of 356 female specimens of *Cambarus virilis* from the Wisconsin River between Rhinelander and Wisconsin Rapids, collected July, 1926, contained seven which had an unusual arrangement of the oviducal pores. Two had supernumerary pores upon the left second walking legs, two had supernumerary pores upon the right second legs, while the other three had supernumerary pores upon both the second walking legs.

A female specimen of *Cambarus virilis* from the Rock River (collected by David Thompson of the Illinois State Laboratory of Natural History, August, 1926) near Rockford, Illinois, had an oviducal pore only upon the left third walking leg.

A specimen of *Cambarus propinquus* collected in 1924 from School Section Creek near Grayling, Michigan, by Hankinson and Langlan had small supernumerary oviducal pores upon the second walking legs.

A medium-sized specimen of *Cambarus virilis* from Browns Lake, Michigan, collected July 2, 1907, by Baker, showed the usual oviducal pore upon the left third leg but failed to have one upon the right leg.

The last specimen was a small *Cambarus propinquus* female from Third Creek, Flint, Michigan (Kaufman collector) which had a full-sized oviducal pore upon the right second walking leg in addition to the usual pair upon the third legs.

DISCUSSION.

Bateson apparently did not study any considerable number of specimens of *Astacus* from a single locality to determine the proportion of aberrant to normal specimens for a single crayfish population. He leaves the impression, however, that a fair proportion of all the females are aberrant (over 3 per cent.). In *Cambarus* the proportion of aberrant to normal females is much less, at least in *Cambarus virilis* and *Cambarus propinquus*. Only an approximate record has been kept of the total number examined by the writer in these two species, but the total would be well over 15,000 females, and the twenty recorded here represent all of the females with unusual female characters. It should be emphasized that all were examined with attention focused upon the secondary sexual characters. Some facts are available as to whether these abnormalities represent a random scattering or a concentration in particular localities. In case number two, forty-seven females constituted the entire collection in which this one abnormality was found. Case four occurred in a collection of fifteen females, case three in a collection of 150 females, case five in a collection of 82 females, case eight in a collection of 110 females, case nine in a collection of 27 females,

case seventeen in a collection of 90 females, and in cases ten to sixteen a collection of 356 females yielded seven aberrant specimens. Except in the last instance, there does not seem to be any concentration in a particular locality. The data furnished in the descriptions makes it evident also that *Cambarus propinquus* is as likely to produce these aberrant females as *Cambarus virilis*.

When there are supernumerary oviducal pores in *Cambarus*, they are located usually upon the second walking legs. This is in marked contrast to the condition in *Astacus* where the supernumerary pores occur upon the fourth walking leg or more rarely upon the fifth. Apparently there are basic reasons for this persistent difference.

It should be noted in passing that true oviducal pores in *Cambarus* do not occur upon any other leg than the third unless the third also bears pores. When males of *Cambarus* bear oviducal pores, it is always upon the third leg also. It may be considered that, in *Astacus*, the third, fourth, and fifth walking legs are potential bearers of oviducal pores, and in *Cambarus* the second and third, but in both that the third leg is greatly emphasized in this respect.

In normal specimens a fully developed oviduct is attached to each oviducal pore. It is obvious that this relationship need not be definitely fixed and that they are not mutually interdependent in their embryology for guidance in direction of differentiation. If an oviduct required for its normal development that it be attached to an oviducal pore or a pore for its development upon an adjacent oviduct, then the cases represented in Figs. 4, 6, and 7 would be impossible. Here we have oviducal pores without oviducal tubes and tubes without pores.

LITERATURE.

Bateson, Wm.

'94 Materials for the Study of Variation.

Benham, W. B.

'91 Ann. Mag. Nat. Hist., 1891, Series 6, VII., p. 256.

Desmarest, E.

'48 Ann. Soc. Ent. France, Series 2, VI., p. 479.

THE DIGESTIVE SYSTEM OF THE EEL-POUT
(*ZOARCES ANGUILLARIS*).

MARGARET E. MacKAY.

(From the Atlantic Experimental Station, St. Andrews, N. B.)

A systematic examination of the digestive system and its function in fishes, at different levels on the evolutionary scale, may greatly aid in the understanding of the digestive processes in higher animals, and in addition may shed some light on the relation between certain fish and other marine forms: a problem interesting from a theoretical as well as a practical point of view.

In the present study an attempt has been made to investigate the functions of the digestive system of the eel-pout (*Zoarces Anguillaris*) found in the Bay of Fundy. As no description of the alimentary tract and its appendages could be found in the literature available, a few macroscopical dissections were made in order to show the anatomical relations existing in the eel-pout. The drawings presented in this paper are all done from a single specimen, which measured 425 mms. from the snout to tip of the caudal fin.

The alimentary canal in the eel-pout is comparatively short and presents an œsophagus, stomach and intestine, of which the latter may be separated into a duodenum and small intestine. On opening the abdomen the ventral surfaces of the viscera are seen *in situ* (Fig. 1). The stomach, partially obscured by the liver, lies on the left side; during fasting this viscus is rather small, but in fed animals it may become tremendously distended. Pyloric cæca are absent, but there is a well-marked sphincter separating the stomach from the pear-shaped duodenum. The latter structure occupies a mid-ventral position from whence it curves posteriorly and to the right, gradually tapering into the small intestine. The intestine is bent upon itself to form three limbs—an ascending, transverse and descending—which latter limb passes posteriorly to the rectum. In Fig. 2 the empty ali-

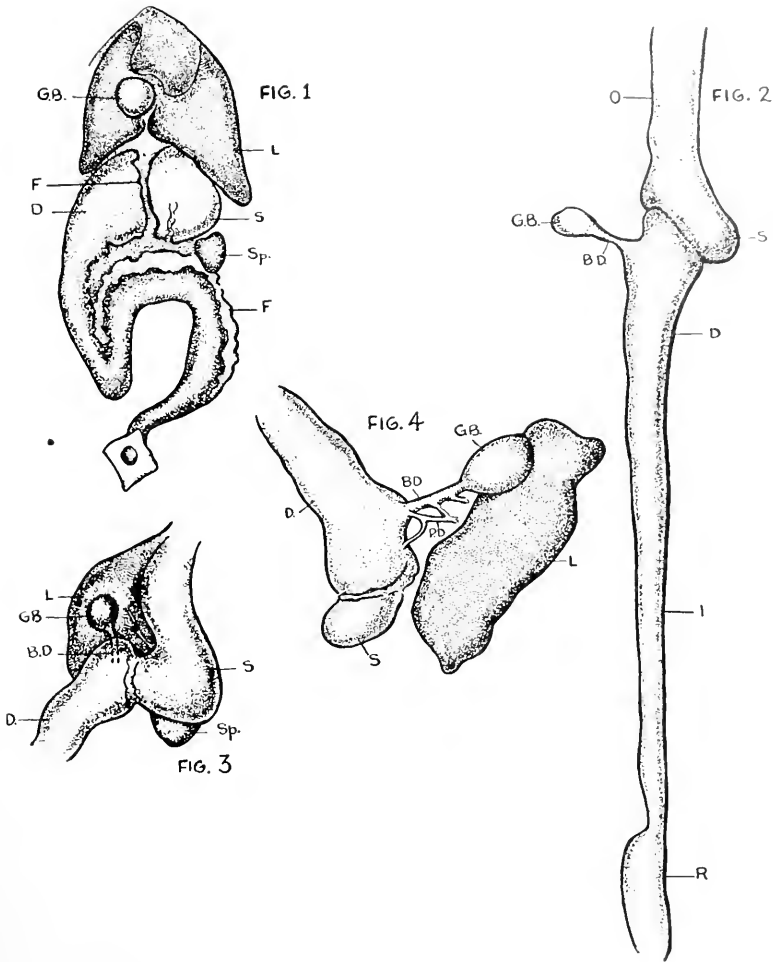

FIG. 1. Diagram of the alimentary tract *in situ*.

FIG. 2. Scheme of the alimentary tract, dissected free from surrounding structures.

FIG. 3. Shows the entrance of the bile duct into the duodenum.

FIG. 4. Diagram to show the pancreatic duct entering the duodenum in close relation to the bile duct. *L.* Liver; *G.B.* Gall bladder; *B.D.* Bile duct; *P.D.* Pancreatic duct; *Sp.* Spleen; *F.* Fat; *O.* Œsophagus; *S.* Stomach; *D.* Duodenum; *I.* Intestine; *R.* Rectum.

mentary canal dissected free from surrounding structures is stretched out to show the length of the various portions and their relation to each other.

The liver is a large three-lobed organ which occupies an anterior ventral position in the abdomen, the left lobe obscuring the œsophagus and part of the stomach, while the tip of the right lies behind the duodenum. Between these lobes is situated the large gall bladder, which in the specimen examined had a body length of 14 mms. by 10 mms. and was drained by a duct of 8 mms. (Figs. 4 and 1). This duct pierced the duodenum on its anterior dorsal surface a few mms. below the pyloric sphincter (Figs. 2 and 3). No special microscopic examination was made for pancreatic tissue, but it appears that the pancreatic duct joins the bile duct or enters the duodenum close to it (Fig. 4).

According to Krüger (1), in a closely related species *Zoarces viviparus*, the pancreas is diffused amongst the fatty tissue situated in the loops of the small intestine and forms pancreatic threads which lie in the groove between the stomach and the duodenum, and also cover the short bile duct. The opening from the pancreatic gland, in this species, is combined with the bile duct, but does not empty into it.

METHODS.

The reaction of the stomach, duodenum and bile in the eel-pout and other fishes was measured by the "spot" method described by Felton (2). This method was very satisfactory for the purpose, as it required only a few drops of fluid for a determination. The values obtained from it, however, can only be considered as approximate, as a protein and salt error was frequently introduced by the presence of mucus or partially digested food in the sample under investigation.

To study the digestive enzymes in the eel-pout, extracts were made of different parts of the alimentary tract. The method of making these extracts was as follows: The mucous membrane was washed in running water, scraped off from the muscular layers and made into a brew consisting of 50 per cent. tissue, 50 per cent. extracting substance and toluene. The mixture was allowed to stand for two days at room temperature, after which it was filtered before adding to the substrate. Saline, 30 per cent. alcohol, and glycerol were all used for extracting substances, but were not all equally effective, the alcoholic extract yielding

the most active amylase and lipase, while glycerol only extracted a protease. The latter enzyme was rather weak and difficult to obtain under any of the observed conditions.

In the experiments to test the presence of an amylase, 2-4 drops of the filtered enzyme extract were added to 2 cc. 5 per cent. soluble starch, the P_H adjusted between 6.6 and 7.0 and the whole incubated at $37^\circ C$. During the incubation, the mixture was tested occasionally with iodine to ascertain how the digestion was proceeding, and at the end of two days a quantitative sugar determination was carried out by the Folin-Wu method (3) for blood sugar.

For lipase determinations the method of Anrep Lush and Palmer (4) was used. Three drops of the enzyme extract were added to a solution of glycerol triacetate buffered at a P_H 8.0. The time was taken which was required for the enzyme to turn the solution to a P_H 7.0 at room temperature. Changes in reaction were observed by noting the color changes in an indicator which had been added, at the beginning, to the mixture.

Both the amylase and lipase experiments were controlled by comparing with similar experiments in which the extracts had been previously boiled for 10 minutes.

A quantitative method was not used for the estimation of a protease. The presence of this enzyme was determined by the digestive action of the extract on protein. For this purpose fibrin was obtained from fresh blood and kept in glycerol, being thoroughly washed, and dried between filter paper, before using. Small shreds were then placed in three tubes, each containing some of the extract to be tested, and their reaction adjusted to a P_H 2.0, P_H 6.8 and P_H 8.0 respectively. These mixtures were incubated at $37^\circ C$. and the time noted which was taken to digest the fibrin.

Experimental data

The Reaction in the Alimentary Tract of the Eel-Pout under Different Conditions.—Investigations to determine the reaction of the stomach and duodenum were carried out on a large number of eel-pouts. These determinations were made, either immediately after the fish had been hooked on the trawl or after they had been kept in a tank or cage for several days without food.

Thus, it was possible to study the reaction in the alimentary canal under different conditions in both fasting and fed animals. In the Bay of Fundy the eel-pouts live chiefly on mytilus, periwinkles, scallops, barnacles, sea urchins and occasionally fish; they will, however, bite herring as readily as clam bait.

To obtain a sample for a P_H determination, the abdomen was first opened by a mid-line incision, the alimentary tract removed intact, and a ligature placed between the stomach and duodenum to prevent the passage of fluid from one to the other during the manipulations. A few drops of the contents were then sucked out by a pipette and were diluted 2-4 times before measuring the P_H . If the fish under examination was in a starving condition and the alimentary tract empty, the mucous membrane was washed with a few drops of distilled water on which the P_H was subsequently determined.

The following table shows the reaction of the stomach, duodenum and bile under different conditions.

TABLE I.

REACTION OF THE STOMACH, DUODENUM AND BILE IN THE EEL-POUT.

A. Stomach Empty.

Fish Number.	Stomach.		Duodenum.		Bile.	
	Contents.	P_H .	Contents.	P_H .	Color.	P_H .
10	Empty	7.0	Empty	8.0	Greenish yellow	5.8
13	Empty	5.8	Yellow mucus	6.8-8.4	Greenish yellow	5.6
14	Empty	7.0	Empty	6.4	Greenish yellow	5.4
19	Empty	8.6	Fluid and mucus	7.0	Greenish yellow	5.8
27	Empty	6.5	Empty	8.4	Light greenish yellow	5.4

B. Stomach, Fluid Contents Only.

9	Yellow fluid	7.4	Clear fluid	7.7	Greenish yellow	5.8
25	Yellow fluid	8.2	Yellow fluid	8.2	Dark greenish yellow	5.8
26	Colorless fluid	8.4	Fluid, hermit crab	8.0	Dark greenish yellow	5.6

C. Stomach Full.

2	Clam bait	8.0	Small shell fish	8.3	Dark green	5.4
15	Clam bait	6.6	Brown fluid, shell fish, lower in intest.	{ 7.4 8.2 lower in intest. 6.8	—	—
1	Fish	7.1	—		—	—
5	Herring bait	6.4	Empty	7.4	Dark green	5.4
8	Herring, hermit crab	6.6	Snails, hermit crab	{ 7.2 7.6 lower in intest. 7.0	—	—
3	Fish and snails	7.6	Empty		Light greenish yellow	4.7
4	Small clams, scallops and ascidians partially digested	8.4	Small shell fish partially digested		8.2	Light greenish yellow

Reaction in the Alimentary Tract of Living Eel-Pout with and without Forced Feeding.—To investigate further the reaction of the stomach a series of experiments was performed on living eel-pouts during periods of fasting and after forced feeding. In order to obtain a sample from the stomach without killing the fish, a long glass tube was inserted through the œsophagus and some of the contents sucked out. As this process involved considerable manipulation, causing a certain amount of injury to the animal, these experiments did not give the expected results. They confirmed, however, the findings on recently killed fish.

As it was thought possible that the reaction in the stomach might, to a certain extent, be determined by the food ingested, various substances such as clam, flounder and sea urchin were given in the forced feedings. The reactions of these foods differ somewhat, flounder flesh having a P_H of 6.8, clam P_H about 6.8 and ground-up sea urchin (including the shell) a P_H of 8.2.

The experiments of Tables I. and II. show that the reaction in the stomach of starved fishes as well as in fed animals is, as a rule, near the neutral point. It may, however, range slightly on either side of this point, the alkaline reaction even reaching a P_H of 8.5.

Two tentative explanations may be offered for this phenomenon. It is possible that the alkalinity of the gastric contents may be

due to the alkalinity of the food (shell fish), or it may be the result of the regurgitation of alkaline duodenal juices into the stomach. There is evidence for the latter suggestion, because in two instances the stomach contents showed a positive test for bile, this indicating the presence of duodenal juices.

The most striking fact, however, in all these experiments is that none of the food stuffs or even such a strong gastric stimulant as alcohol produced a high acidity in the stomach.

TABLE II.

P_H OF SAMPLES TAKEN FROM THE STOMACH OF LIVING EEL-POUTS.

A. Without Feeding.

No. Fish.	Date.	Interval between Samples.	P _H .	Description of Sample.
7	July 29	0 hrs.	7.0	Clear watery.
		3 hrs.	7.0	Clear watery.
	July 30	18 hrs.	8.2	Mucus, slightly opaque.
		4 hrs.	7.4	Mucus, slightly opaque.
		18 hrs.	7.2	
17	Aug. 16	0 hrs.	8.5	Reddish brown fluid, sea urchin shell.
18	Aug. 16	0 hrs.	8.3	Reddish brown fluid.

B. Sea Urchin Fed.

23	Aug. 19	0 hrs.	7.2	Clear mucus.
		2 hrs.	Sea urchin fed P _H 8.2.	
		7 hrs.	8.0	Reddish fluid cont. sea urchin.
	Aug. 20	16 hrs.	7.0	Mucus.

C. Clam Fed.

6	July 27	0 hrs.	8.4	—	
		17 hrs.	7.4	—	
		7 hrs.	8.4	—	
		17 hrs.	6.8	Mucus.	
		4 hrs. later	Clam fed P _H 6.8.	5.8	Mucus.
		3 hrs.		7.6	—
12	Aug. 3	0 hrs.	7.0	Clear watery.	
		24 hrs.	4.4	Gray mucus.	
		3 hrs.	Clam fed P _H 6.6.	6.6	—
		16 hrs.		4.7	—
		5 hrs.		6.6	Died.

TABLE II. (*Continued*).*D. Flounder and Alcohol Fed.*

No. Fish.	Date.	Interval between Samples.	PH.	Description of Sample.	
20	Aug. 20	0 hrs.	8.6	Clear fluid.	
		1 hr.	Flounder fed PH 6.8.	8.0	Clear, contained pieces flounder.
	Aug. 21	8 hrs.	7.6	Clear.	
		16 hrs.	6.2	Clear.	
	Aug. 22	48 hrs.	6.6	Clear.	
		48 hrs.	10 cc. 10 per cent. alcohol fed PH 6.6.	6.6	—
	Aug. 24	48 hrs.	6.6	—	
		3 hrs.	6.6	—	
21	Aug. 19	0 hrs.	6.4	—	
		1 hr.	Flounder fed PH 6.8.	6.6	—
		8 hrs.	4.4	—	
	Aug. 20	16 hrs.	6.4	—	
		48 hrs.	6.5	—	
	Aug. 22	48 hrs.	10 cc. 10 per cent. alcohol PH 6.6.	7.4	—
		48 hrs.	7.4	—	
	Aug. 24	1 hr.	10 cc. 10 per cent. alcohol PH 6.6.	7.2	—
		1 hr.	6.4	—	
		1 hr.	6.4	—	
		3 hrs.	6.4	—	

E. Alcohol Fed.

24	Aug. 19	0 hrs.	6.2	—	
		2 hrs.	Fed sea urchin PH 7.6.	7.6	—
		7 hrs.	6.4	Mucus clear.	
	Aug. 20	16 hrs.	5.4	Mucus clear.	
		24 hrs.	7.8	Mucus clear.	
	Aug. 22	24 hrs.	Gave alcohol 10 cc. 10 per cent. PH 6.8.	8.0	—
		1 hr. 30 min.	Gave alcohol 10 cc. 10 per cent. PH 6.8.	6.8	—
		35 mins.	6.8	—	
		3 hrs.	8.6	—	
27	Aug.	0 hrs.	8.2	Yellowish fluid.	
			Gave 10 cc. 10 per cent. alcohol PH 6.8.	7.2	—
		20 mins.	8.0	—	
		4 hrs.	8.0	—	

Reaction in the Alimentary Tract of Other Fishes.—The reaction of the stomach and duodenum of various fishes was investigated so that they could be compared with the eel-pouts. All the examined fishes, except fundulus, had a neutral or slightly acid reaction in the stomach during fasting, and a very high acidity during digestion, as is shown in the following table.

TABLE III.

REACTION OF THE STOMACH, DUODENUM AND BILE IN VARIOUS FISHES.

A. *Stomach Empty.*

Fish Specimen.	Stomach.		Duodenum.		Bile.
	Contents.	P _{H.}	Contents.	P _{H.}	P _{H.}
Skate (Barn-door).....	Empty	1.5 Cardiac 3.7 Pyloric	Empty	6.3 Duoden. 7.2 Intest.	—
(a) Fundulus	No stomach	—	Empty	7.1	7.0
(b)	No stomach	—	Empty	7.2	6.8
(c)	No stomach	—	Empty	7.4	7.0
(a) Flounder.	Empty	6.8	Empty	8.4	—
(b)	Empty	6.4	Empty	8.0	6.6
Haddock.....	Empty	6.2	Full small shell fish	6.7	6.4
Herring.....	Empty	6.8	Empty	7.0	5.8
Lump fish....	Empty	4.0	Empty	8.6	—
Sculpin.....	Empty	7.4	Empty	—	5.8

B. *Stomach Full.*

Skate.....	Full herring bait (beginning of digestion)	5.2 Cardiac 5.5 Pyloric	Full herring bait	6.3 Duoden. 7.2 Intest.	5.6
Skate.....	Full herring (partially digested)	2.8	Fluid	4.6	5.8
Lump fish....	Digesting food	2.8	Digesting food	8.2	—
Sculpin.....	Full fish (digesting)	2.2	Fluid	8.4	5.4
Sculpin.....	Full herring bait (digesting)	2.8	Digesting food	7.4 Duoden. 8.2 Intest.	5.6

It will be seen, on comparison of the above table with Tables I. and II., that the gastric digestion of the eel-pout presents certain peculiarities, being different from the usual type of acid gastric digestion in fishes. Since there are fishes deprived of a stomach (*e.g.*, the family of Cyprinidæ, *Fundulus*, etc.) the question arises as to whether the eel-pout possesses an organ which is capable of secreting pepsin-hydrochloric acid. From an anatomical point of view, there is no doubt that the eel-pout possesses a structure corresponding to a stomach. Although this diverticulum is rather small, it cannot be considered as part of duodenum, for it is separated from it by a sphincter. Further evidence for this lies in the fact that the common bile and pancreatic duct enters the duodenum just below this sphincter.

As no histological examination could be made of the microscopic structure of the glands in the mucous membrane of the stomach, further investigation was restricted to a study of the digestive enzymes in the gastric and duodenal contents, and in extracts made from different parts of the alimentary canal.

Digestive Enzymes in Extracts of the Stomach, Duodenum and Liver of the Eel-Pout.—In Table IV., three typical experiments are quoted to show the amylolytic, lipolytic and proteolytic action of differently prepared extracts of the gastric and duodenal mucous membrane and of the liver. A number of other experiments gave analogous results.

As may be seen from Table IV., the presence of a lipase was demonstrated in the extracts of the liver and in the mucous membrane of the stomach and duodenum of the eel-pout. The activity of this enzyme was most pronounced in the alcoholic liver extracts, which were frequently strong enough to produce a P_H change from 8.0 to 7.0 in 1 hour and 30 minutes; compared with this, its action in the stomach is somewhat weaker, 4 hours being the average time taken to produce the desired change in reaction. The lipolytic enzyme of the duodenum is the weakest of the three, since it is usually one or more hours slower in its action than that of the stomach.

The strongest amylase was found in the extracts of the mucous membrane of the duodenum, which gave values as high as .6 per cent. with the Folin-Wu method. On the other hand extracts of the stomach had a very weak, if any, amylolytic action, .12 per cent. being the highest figure obtained. As the liver extract itself was found to contain glucose, the high values procured in the sugar determination are useless. There is, however, some slight evidence for the presence of an amylase in the liver because in several of the experiments there is an indication of a color change in the starch following the addition of iodine.

The range of the Folin-Wu method is from .07-.4 per cent. In the cases where the values obtained are higher than .4 the solution had been previously diluted so as to come in the correct range. The value obtained was then multiplied by the dilution. Controls done on soluble starch without extracts gave an average value of .076 per cent.

TABLE IV.
ENZYMES IN EXTRACTS OF THE MUCOUS MEMBRANE OF THE STOMACH, DUODENUM AND LIVER.

Date.	No. Fish.	Part Dig. Tract Used for Extracts.	Amylase.	Lipase.	Protease.
Aug. 5	13	Stomach, alcohol ext.	2 cc. starch + 4 drops ext. 1 dy. iodine reac.—blue. 2 dys. iodine reac.—blue. 2 dys. sugar deter. .091% —. Boiled control = .069% —.	3 drops ext. + buffer at P _H 8.0. Went to P _H 7.0 +. Control P _H 8.0 —.	1. fib. + 15 drops ext. at P _H 1.6 —. 2. fib., 15 drops ext. at P _H 6.0 —. 3. fib., 15 drops ext. at P _H 8.0 —. 3 days no digestion.
		Duodenum, alcohol ext.	2 cc. starch + 4 drops ext. 1 dy. iodine reac.—light blue. 2 dys. iodine reac.—light blue. 2 dys. sugar deter. = .60% +.	3 drops ext. + buffer at P _H 8.0. 7 hrs. went to P _H 7.0 +. 7 hrs. control P _H 8.0 —.	1. same as above, P _H 1.6 +. 2. same as above 15, P _H 6.0 —. 3. same as above 15, P _H 8.0 —. 3 dys. Nos. 2 and 3, no diges. 3 dys. No. 1 digested.
		Liver, alcohol ext.	2 cc. starch + 2 drops ext. 2 dys. iodine reac.—blue. Sugar deter. useless, as liver ext. cont. sugar.	3 drops ext. + buffer at P _H 8.0. 7 hrs. went to P _H 7.0 +. 7 hrs. control P _H 8.0 —.	1. same as above, P _H 1.6 —. 2. same as above, P _H 6.0 —. 3. same as above, P _H 8.0 —. 3 dys., no digestion.
8	14	Stomach, glycerol ext.	2 cc. starch + 2 drops ext. 1 dy. iodine reac.—blue. 2 dys. iodine reac.—blue. 2 dys. sugar deter. = .08% —. Boiled control = .03% —.	3 drops ext. + buffer at P _H 7.0. 3 dys. went to P _H 7.0. (Glycerol ext. not good for lipase).	1. fib., 5 drops ext. 20 drops H ₂ O, P _H 1.6 +. 2. fib. and same, P _H 6.0 —. 3. fib. and same, P _H 8.0 —. 1 dy. Nos. 2 and 3, no diges. 1 dy. No. 1, digested.
		Duodenum, glycerol ext.	2 cc. starch + 2 drops ext. 1 dy. iodine reac.—blue. 2 dys. iodine reac.—light blue. 2 dys. sugar deter. = .20% —. Boiled control = .04% —.	3 drops ext. + buffer at P _H 8.0. 3 dys. went to P _H 7.0.	1. same as above, P _H 1.6 —. 2. same as above, P _H 6.0 —. 3. same as above, P _H 8.0 —. 3 dys., no digestion.

TABLE IV. (Continued).

Date.	No. Fish.	Part Dig. Tract Used for Extracts.	Amylase.	Lipase.	Protease.
18	19	Stomach, HCl ext. Duodenum, alcohol ext. Liver, alcohol ext.	No amylase in HCl ext. 2 cc. starch + 4 drops ext. 1 dy. iodine reac.—blue. 2 dys. iodine reac.—very pale. 2 dys. sugar deter. = .23% +. 2 dys. boiled control = .08% —. 2 cc. starch + 4 drops ext. 2 dys. iodine reac.—blue. Sugar deter. useless.	No lipase in HCl ext. 3 drops ext. + buffer at P _H 8.0. 3 hrs. went to P _H 7.0 +. 3 hrs. control P _H 8.0 —. 3 drops ext. + buffer at P _H 8.0. 1½ hrs. went to P _H 7.0 +. 1½ hrs. control P _H 8.0 —.	1. fib. + 10 drops ext., 10 drops H ₂ O, P _H 2.0 —. 2. fib. same boiled. 10 drops H ₂ O, P _H 2.0 —. 3 dys., no digestion. 1. fib. + 15 drops ext., 10 drops H ₂ O, 2.0 —. 2. fib. same, P _H 6.0 —. 3. fib. same, P _H 8.0 —. 3 dys., no digestion. 1. fib. + 15 drops ext., 15 drops H ₂ O, P _H 2 —. 2. fib. same, P _H 6.0 —. 3. fib. same, P _H 8.0 —. 3 dys., no digestion.

+ at end of line means digestion.
— at end of line means no digestion.

There is no proteolytic enzyme in the extracts of the liver or of the duodenum, but occasionally such a one was found in the extracts of the stomach. This enzyme could be extracted with glycerol only, and acted slowly, in a very acid medium P_H 1.6–2.0. Since there is no difficulty whatever in obtaining pepsin from the mucous membrane of fishes possessing an acid gastric digestion, by means of such extracting substances as glycerol, .36 per cent. to .4 per cent. HCl or even distilled water (Kenyon) (5), the results quoted in this investigation are worthy of attention. The conclusion must be drawn that the acid-peptic digestion does not play an important part in the alimentary canal of the eel-pout. Even if an acid gastric juice is secreted its pepsin has very little chance to act either in the stomach or the duodenum. This is clear from the fact that the usual range of P_H in the stomach of the eel-pout is from 6.4 to 8.2; in a few instances only, it was found to be as low as 4.0 to 4.4 (Table II). The reaction in the duodenum is always on the alkaline side.

Further experiments dealing with the estimation of digestive enzymes in the juices taken from the stomach and intestine of various eel-pouts lend a strong support to the above view.

One may see from Table V. that in the juice taken from the stomach of a number of animals a very strong proteolytic enzyme was found which digested fibrin at a P_H 6.4 to 8.2. This enzyme could not be extracted either from the gastric or duodenal mucous membranes. A possible explanation of this phenomenon is the assumption that the pancreatic juice regurgitates from the duodenum and continues its action in the stomach.

DISCUSSION.

The gastric digestion in the eel-pout presents marked peculiarities. Although a protein-digesting enzyme could be extracted from the gastric mucous membrane, it appears that it cannot play a great part in gastric digestion. The evidence for this is as follows: This proteolytic enzyme is not easily extracted by the usual methods, which is an indication that the mucous membrane is not rich in its contents. It seems, however, to be a true digestive enzyme, because it is active at a P_H 1.6 to

TABLE V.
DIGESTIVE ENZYMES IN THE JUICE TAKEN FROM THE STOMACH AND INTESTINE OF THE EEL-POUT.

Fish No.	Juice Taken from	Amylase.	Lipase.	Protease.
15	Stomach	2 cc. 5% starch, 5 drops juice. 1 dy. iod. test—pale lavender.	3 drops ext. buffer at P _H 8.0. night passed P _H 7.0 +++.	Juice and fibrin. 5 hrs. all digested, P _H 6.4 +++.
	Duodenum	1 dy. sugar deter. .66% ++. 2 cc. 5% starch, 5 drops juice. 1 dy. iod. test—colorless. 1 dy. sugar deter. .83% +++.	3 drops ext. buffer at P _H 8.0. night went to P _H 7.0 +.	Juice and fibrin. 5 hrs. all digested, P _H 6.4 +++.
17	Stomach	—	—	Juice and fibrin (P _H 8.5). 4½ hrs. all digested (P _H 7.2) +++.
18	Stomach	—	—	Juice and fibrin (P _H juice 8.3). 4 hrs. all digested (P _H 6.6) +++.
25	Duodenum	—	—	Juice and fibrin (P _H juice 8.2). 2 hrs. all digested (P _H at 8.2) +++.
26	Stomach	4 cc. 5% starch, 12 drops gastric juice. 1 dy. sugar deter. .15% +.	3 drops ext. buffer at P _H 8.0. 18 hrs. went to P _H 7.0 +.	Juice and fibrin (P _H juice 8.4). 1½ hr. all digested (P _H at 7.4) +++.
	Intestine (below duod.)	4 cc. 5% starch, 12 drops juice. 1 dy. sugar deter. .40% +.	3 drops ext. buffer at P _H 8.0 24 hrs. still at P _H 8.0 —.	Juice and fibrin (P _H juice 8.0). 12 hrs. all digested +.

Remark.—Glycerol extracts were made of the stomach and duodenum of fish No. 15; no proteolytic enzyme was present in the duodenal extract and in the extract of the stomach fibrin was digested only at a P_H 2.0, and not at a P_H 6.0 or 8.0, though the juice from the stomach readily digested fibrin at P_H 6.4.

2.0, while the autolytic enzyme of a type of pepsin is destroyed at a P_H of 2.6 (Bradley) (6). Moreover, the action of this enzyme on such an easily digestible substrate as fibrin is rather weak.

Further evidence that the proteolytic enzyme is not important in gastric digestion lies in the fact that only occasionally was the reaction of the stomach found to be acid enough (P_H 4.0-5.8) to allow a pepsin-like enzyme to act. According to McFarlane (7) the range of activity for pepsin is from a P_H of 0.5 to 6.5.

These facts show that if peptic digestion takes place in the stomach of the eel-pout it plays a subordinate or secondary part. The protein substances in the food of this animal are digested chiefly by the trypsin of the pancreatic juice, which probably regurgitates into the stomach.

It would be highly interesting to perform a histological examination of the gastric mucous membrane of the eel-pout to determine whether the peptic glands are fully developed as to both number and structure.

SUMMARY.

1. The eel-pout has a true anatomical stomach. The common bile and pancreatic duct opens into the duodenum below the pyloric sphincter.
2. The reaction of the stomach in both fasting and fed animals is near the neutral point, ranging from a P_H of 6.5 to 8.4. The reaction in the duodenum is slightly alkaline.
3. The extracts of the stomach possess a strong lipase, a very weak amylase and a pepsin-like enzyme, digesting at a P_H of 1.2. The duodenal extracts, on the other hand, have a strong amylase, a lipase and no protease. Liver extracts had a marked lipolytic action, but contained no protease.
4. Digestive juices removed from both the stomach and duodenum of eel-pouts had a lipase, amylase and a very strong proteolytic enzyme, digesting at a P_H near the neutral point.

My thanks are due to Dr. B. Babkin, who directed this work, to the Biological Board of Canada for the permission to use the facilities of the Atlantic Biological Station, St. Andrews, N. B., and to Dr. A. G. Huntsman and his staff for valuable assistance received in the course of the study.

BIBLIOGRAPHY.

1. **Krüger, A.**
'05 Wissenschaftliche Meeruntersuchungen Abt. Kiel, N.F., Vol. 8, p. 57.
2. **Felton, L. D.**
'21 Jour. Biol. Chem., Vol. 46, p. 229.
3. **Folin, I., and Wu, H.**
'20 Jour. Biol. Chem., Vol. 41, p. 367.
4. **Anrep, Lush and Palmer.**
'25 Jour. Physiol., Vol. 59, p. 436.
5. **Kenyon, W. R.**
'25 U. S. Bull. Bureau of Fisheries, Vol. 41, p. 181.
6. **Bradley, H. C.**
'22 Jour. Biol. Chem., Vol. 52, p. 467.
7. **McFarlane, J., et al.**
'27 Jour. Gen. Physiol., Vol. 10, p. 437.

NOTE ON THE BILE IN DIFFERENT FISHES.

MARGARET E. MACKEY.

(From the Atlantic Biological Station, St. Andrews, N. B.)

The results of investigations on two problems concerning the bile of different fishes of the northeast Atlantic coast will be presented in this note: (1) A series of determinations were carried out on the reaction of gall-bladder bile in various fishes; (2) The content of enzymes in the gall-bladder bile of *Fundulus Heteroclitus* was studied.

THE REACTION OF GALL-BLADDER BILE.

There is a definite difference between the reaction of the gall-bladder and hepatic bile in warm-blooded animals, the first being less alkaline than the second. In most of the animals observed (ox, pig, sheep, rabbit and guinea-pig), Neilson and Meyer (1), and Tschopp (2), found the reaction of gall-bladder bile to be slightly on the alkaline side of neutrality, the average P_H range being 7.0-7.5. Okada (3) has shown that in the dog the reaction of the gall-bladder bile is on the acid side (P_H 6.39-6.74), while that of hepatic bile is decidedly more alkaline (P_H 7.89-8.10). Brugsch and Horster (4) found a P_H of 7.4-7.89 for bile received from a dog with a permanent fistula of the gall bladder. In this animal the bile could not remain long in the gall bladder and it is interesting to note that its reaction is only a little less alkaline than that found by Okada for hepatic bile.

In contrast to the neutral or slightly alkaline bile of warm-blooded animals, it was found that in the fishes investigated the bile though sometimes neutral was usually on the acid side. The degree of acidity varied considerably in different species but was fairly constant in a given species.

The colorimetric "spot" method elaborated by Felton was used for determining P_H . For this method it was first necessary to dilute the bile from three to eight times, depending on the depth of its color. As bile is a buffered solution this dilution would not cause any appreciable error in the determination.

The following table shows the P_{H} of the bile in all the fishes examined. In some cases where the bile was very dark in color, it was difficult to make a comparison even after diluting eight times.

TABLE I.

THE P_{H} OF THE GALL-BLADDER BILE IN DIFFERENT FISHES.

Fish.	Color of Bile.	Reaction.
Fundulus (<i>Fundulus Heteroclitus</i>).....	Emerald green	7.0
Fundulus (<i>Fundulus Heteroclitus</i>).....	Emerald green	6.8
Fundulus (<i>Fundulus Heteroclitus</i>).....	Emerald green	7.0
Fundulus (<i>Fundulus Heteroclitus</i>).....	Emerald green	6.9
Eel-Pout (<i>Zoarces Anguillaris</i>).....	Greenish yellow	5.4
Eel-Pout (<i>Zoarces Anguillaris</i>).....	Greenish yellow	5.4
Eel-Pout (<i>Zoarces Anguillaris</i>).....	Greenish yellow	5.8
Eel-Pout (<i>Zoarces Anguillaris</i>).....	Greenish yellow	6.2
Eel-Pout (<i>Zoarces Anguillaris</i>).....	Dark greenish yellow	5.4
Eel-Pout (<i>Zoarces Anguillaris</i>).....	Dark greenish yellow	5.4
Eel-Pout (<i>Zoarces Anguillaris</i>).....	Light greenish yellow	5.6
Eel-Pout (<i>Zoarces Anguillaris</i>).....	Dark greenish yellow	5.4
Eel-Pout (<i>Zoarces Anguillaris</i>).....	Light greenish yellow	5.4
Eel-Pout (<i>Zoarces Anguillaris</i>).....	Light greenish yellow	5.8
Eel-Pout (<i>Zoarces Anguillaris</i>).....	Light greenish yellow	5.8
Eel-Pout (<i>Zoarces Anguillaris</i>).....	Light greenish yellow	5.6
Eel-Pout (<i>Zoarces Anguillaris</i>).....	Light greenish yellow	5.4
Skate (<i>Raja erinacea</i>).....	Greenish yellow	7.6
Skate (<i>Raja erinacea</i>).....	Dark green	6.4
Skate (<i>Raja erinacea</i>).....	Greenish yellow	6.7
Skate (<i>Raja erinacea</i>).....	Light greenish yellow	5.4
Skate (<i>Raja erinacea</i>).....	Dark green	5.8
Skate (<i>Raja erinacea</i>).....	Dark green	5.6
Skate (<i>Raja erinacea</i>).....	Greenish yellow	6.8
Sculpin (<i>Cottus grænlandicus</i>).....	Colorless	5.8
Sculpin (<i>Cottus grænlandicus</i>).....	Pale green	5.4
Sculpin (<i>Cottus grænlandicus</i>).....	Pale green	5.8
Haddock (<i>Melanogrammus</i>).....	Dark green	6.4
Herring (<i>Clupea Harengus</i>).....	Emerald green	5.8
Flounder (<i>Paralichthys dentatus</i>).....	Dark green	6.6
Flounder (<i>Paralichthys dentatus</i>).....	Dark green	7.0

A STUDY OF THE SOURCE OF THE ENZYMES IN THE BILE OF *FUNDULUS HETEROCLITUS*.

Babkin and Bowie (5) found proteolytic, amylolytic and lipolytic enzymes in the bile of *Fundulus*. This bile was collected by squeezing the gall bladder and it was possible that the enzymes contained in it came from a layer of pancreatic tissue which they later found surrounding this viscus. Therefore to investigate the source of these enzymes it was necessary to use a method for emptying the gall bladder which would prevent the bile coming in contact with the outer pancreatic cells.

The first method used was as follows: The bile duct was

ligated and the gall bladder removed and dipped in warm melted wax. When this had hardened slightly, a hot needle was used to puncture the viscus and the bile forced out by slight pressure.

This method was unsatisfactory as the bile still contained both amylolytic and proteolytic enzymes.

Another method was therefore devised for emptying the gall bladder. The viscus was first removed, as previously described, and placed for one minute in a solution of Bouin's fluid containing picric acid, acetic acid and formalin. The purpose of this treatment was to kill the surrounding layer of pancreatic cells. The bladder was next washed a number of times in distilled water; it was then punctured with a hot needle and its contents squeezed out.

It was found that bile collected in this way had no enzymes. The results of two experiments are quoted below.

TABLE II.

Date.	No. of Fish Used.	Amylase.	Lipase.	Protease.
Aug. 13. . .	Bile from 6 fish.	2 cc. 5% starch. 2 drops bile. 2 days iod. test. blue—no sugar.	3 drops bile buffer at P _H 8.0. 2 days—no change in P _H .	
Aug. 23. . .	Bile from 10 fish.	2 cc. 5% starch. 2 drops bile. 2 days—no sugar.	3 drops bile buffer at P _H 8.0. 2 days—no change in P _H .	10 drops bile, duod. extract, fibrin. 2 days—no digestion.

The method for lipase is that of Anrep, Lush and Palmer.

An objection could be made to these results on the grounds that Bouin's fluid may have penetrated the wall of the gall bladder and killed any enzymes which were present in the bile. This, however, is rather unlikely; it is more probable that in Babkin and Bowie's experiments the pancreatic enzymes were mixed with the sterile bile during its collection from the gall bladder. Therefore, their conclusion is valid that the pancreatic gland of fundulus produces trypsin, amylase and lipase.

My thanks are due to Dr. Babkin who directed this work and to Dr. Huntsman and the Biological Board of Canada for use of the facilities of the Atlantic Biological Station.

BIBLIOGRAPHY.

1. **Neilson and Meyer.**
'21 Journ. of Infect. Dis., Vol. 28, p. 510.
2. **Tschopp.**
'25 Zentralblatt f. Allg. Pathol. u. pathol. Anat., Vol. 36, S. 123.
3. **Okada.**
'15-'16 Journ. of Physiol., Vol. 50, p. 114.
4. **Brugsch and Horster.**
'24 Med. Klinik, No. 20.
5. **Babkin and Bowie.**
'28 BIOL. BULL., Vol. 54, p. 254.

THE EFFECT OF NEUROPHIL DRUGS ON THE FIDDLER CRAB, *UCA PUGNAX*.

OSCAR W. RICHARDS.

(From the Department of Biology, Clark University, Worcester, and Marine
Biological Laboratory, Woods Hole.)

These experiments were made to determine if the fiddler crab, *Uca pugnax* S. I. Smith, could be forced to move in only one direction, rather than sidewise, forward and backward, by means of the effect of a suitable drug. If this could be accomplished it would simplify the study of the phototropism of this animal. A drug that causes the legs on the opposite sides to pull against each other, such as nicotine, phenol, or veratrine, leads inevitably to movement backward, because the second pair of legs slopes backward at an angle of about 35° , the third pair also slopes backward at an angle of about 65° , the fourth pair remains almost vertical and the fifth pair of legs slopes forward at an angle of about 70° . This movement resulting from the more effectively braced second and third pair of legs opposing the fifth pair of legs is too irregular to produce a dynamic orientation.

The responses of the fiddler crabs to the neurophil drugs used may be compared with the results with other animals obtained by other investigators. The solutions were made by dissolving the alkaloid in 200 cc. of sea water in a finger bowl, which amount was sufficient to cover the animals. The control animals were placed in the same amount of sea water. Two animals were placed in each solution and from 2 to 5 separate experiments were performed on different days. Unless otherwise specified the solutions were all of 1 : 1,000 strength. During the time of observation the animal was placed in a large crystallizing dish containing an even layer of moist sand, after which it was returned to the solution.

Atropine SO_4 (1 : 500 to 1 : 10,000), apomorphine (sat. sol.), morphine SO_4 , caffeine, codeine and digitonin were without any visible effect on the animals during 40 hours' exposure. .

When an object is brought near a control *Uca* placed in the observation dish, the animal raises its large cheliped above its head, toward the stimulating object, and backs away from it. This response is inhibited after 5 min. immersion in picrotoxin (sat. sol.), 10 min. in strychnine SO₄, 15 min. in phenol or pilocarpine HCl and somewhat later in nicotine. Even when vigorously stimulated the animal cannot raise the chela. Conversely this response is greatly exaggerated after 3-4 minutes in camphor; the animal now does not back away but will grab a pencil or other object in its big claw and will hold it more firmly, and for a longer time than the control animal can be induced to do after the control animal has been "cornered" at the edge of the dish.

Picrotoxin, phenol, and veratrine (sat. sol. alkaloid) reverse the usual activity of the legs so that the legs on the opposite sides of the body pull against each other rather than moving together, as has been mentioned. An analysis at the locus of this effect might perhaps be made with the aid of a galvanic current as has been done with *Lineus*.¹

All of the legs except the chelipeds are drawn upward and toward the body by contraction of the dorsal musculature of the legs (opisthotonic) after 1/2 hour's immersion in strychnine SO₄, phenol or camphor. The strychninized animal's body rests in the sand when the legs are drawn up but the animal can move on stimulation in any direction. This would seem to result from a partial paralysis of parts of the neuromuscular system rather than a specific effect on synapses. Nicotine, veratrine and pilocarpine HCl cause the legs to be extended. In nicotine and in picrotoxin the legs are first extended and later those of the opposite sides are drawn together, so that the animal instead of being held only a few millimeters from the sand is raised up 8/10 mm. above the substratum. After several hours in phenol the legs are drawn together toward the center of the body but the distal segments of the legs are not extended.

Very little asymmetric behavior of the unequal chelipeds of the animals was observed. The male crabs after veratrinization tend to move sidewise in the direction of the large chela. The

¹ See Crozier⁷; cf. also Kropp, B., and W. J. Crozier, 1928. Jour. Gen. Physiol., 12: 111-22.

legs were drawn more closely toward the body on the side opposite the large chela as this phase of the picrotoxin effect appeared. The chief difference noticed was that when this large chela was prevented from being drawn close to the body the animals were unable to right themselves after falling on their backs.

Camphor and to a lesser extent nicotine seem to lower the threshold of excitation and the animals are more active than the control animals. The same drugs also affect the chromatophores, so that the animals become lighter in color and after an hour are a light blue. This coloration persists for some time after apparent death.

The reversal of the response of the large claw by strychnine in *Uca* resembles a similar reversal of the response of the prolegs of caterpillars found by Crozier² to result from the injection of atropine. Camphor excites the fiddler crab but inhibits in the grasshopper.³ The specific effect of camphor in determining the backward swimming of *Crangon*⁴ is not parallel with *Uca*. Backward movements of the crayfish are impeded by strychnine,² but this drug has no such effect on the fiddler crab. The effect of strychnine and nicotine on the legs of the fiddler crab is comparable to the effect of these drugs reported by Moore,⁵ who found that strychnine causes the arms of *Asterias* to bend dorsally while nicotine forces the arms to bend ventrally.

The responses of *Uca* to strychnine, picrotoxin, nicotine, camphor, and phenol, but not to atropine or caffeine, indicate that the crab neuromuscular system is more like that of the insects than like that of the worms.^{6, 7} An isopod, *Asellus*, is unaffected by strychnine, caffeine, atropine, and nicotine⁸. The greater alkalinity of sea water may be more favorable to a combination of the alkaloids with the tissue proteins, as has been suggested by the experiments of the Petrunkins,⁹ and may

² Crozier, W. J., 1922. BIOL. BULL., 43: 239-45.

³ Crozier, W. J., and G. F. Pilze, 1924. Amer. Jour. Physiol., 69: 41-2.

⁴ Moore, A. R., 1917. Proc. Nat. Acad. Sci., 3: 598-602.

⁵ Moore, A. R., 1920. Jour. Gen. Physiol., 2: 201-4.

⁶ Moore, A. R., 1921. Jour. Gen. Physiol., 4: 29-31.

⁷ Crozier, W. J., 1927. Jour. Gen. Physiol., 10: 395-406.

⁸ Fries, E. F. B., 1928. Jour. Gen. Physiol., 11: 507-13.

⁹ Petrunkin, A., and M. Petrunkin, 1927. Jour. Gen. Physiol., 11: 101-10. Cf. also Crozier².

account for the different effects on the fresh water and marine arthropods. Since the crab is not affected by caffeine it may have a less differentiated nervous system than the squid.⁶

SUMMARY.

A reversal of the usual motor responses of the legs of the male fiddler crab, *Uca pugnax*, has been observed when the animals have been in solutions of picrotoxin, strychnine, phenol, philocarpine, or veratrine in sea water. Camphor increases the irritability of the animals. Atropine, apomorphine, morphine, codeine, caffeine, and digitonin are without effect on the crabs. The results of these experiments are discussed in relation to those made with other arthropods.

THE CONDUCTION OF THE NERVOUS IMPULSE THROUGH THE PEDAL GANGLION OF MYTILUS.

OSCAR W. RICHARDS.

(From the Department of Biology, Clark University, Worcester.)

The object of these experiments was to determine the change in the rate and nature of nervous conduction through the pedal ganglion of *Mytilus*. The large Pacific Coast mussel, *M. californianus* Conrad, was used in the early experiments which were made at the Hopkins Marine Station of Stanford University during the summer of 1926. The latter experiments were made at the Marine Biological Laboratory during the summer of 1928, using *M. edulis* L. The mussel was used rather than *Ensis* (cf. Drew, 1908) because the former permitted an independent nerve muscle preparation of the foot while the cerebral ganglia must be included in a similar preparation of the latter in order to obtain a reflex response. Nerve conduction through the ganglion was much slower with both species of animals than the conduction in the pedal nerve. This difference was greatly reduced after a solution of strychnine was placed on the ganglion. Camphor also removed the inhibiting effect of the ganglion, and atropine caused a reversal of the contractions of the longitudinal and circular muscles of the foot.

I.

The foot of *M. californianus* obtained by severing it from the animal makes an excellent nerve-muscle preparation. It quickly relaxes from the stimulation of the cut and may be pinned firmly to a wax-bottomed dish by two pins placed about 8 mm. from its distal end. The pedal nerve and ganglion may be easily exposed by a cut through the dermis the length of the foot. After the position of the nerve is familiar it is not necessary to make cuts other than at the points of stimulation.

In the following experiments the nerve was not exposed further

than by carefully pushing the points of the platinum electrodes through the skin, so as not to injure the nerve, until the records were completed. After that the ganglion was exposed to make certain that the points of stimuli were properly located with respect to the ganglion. This procedure permits several determinations with little injury to the animal.

The tip of the foot of the preparation was connected to a light writing lever by means of thread. It was necessary to reduce the speed of the slide myograph by substituting a weight to draw the carriage for the spring that comes with the instrument. The key switch on the instrument made the stimulus and the rate of movement of the paper carriage was shown by recording a 100 d.v. tuning fork. The precautions indicated by Jenkins and Carlson (1903) and Maxwell (1907*b*) for avoiding experimental difficulties were followed in these experiments. The rates of nervous conduction were calculated from measurements of the times of the latent periods.

The average rate of nervous conduction of 64.2 cm. per second was obtained from 16 determinations made with 4 different preparations. The room temperature varied from 18–20° C. The animals were large, about 200 mm. long (*cf.* Richards, 1928), so that the average nerve length was about 25 mm. This length and the small probable error of ± 1.8 cm. per second indicate the reliability of the determinations.

However, if the rate of conduction through the ganglion be determined it is found to be 22 per cent. ± 2 per cent. slower than conduction along the nerve trunk distal to the ganglion. This strongly suggests the possibility that Fick¹ may have stimulated through a ganglion when in 1863 he found for the "nerve conduction" of *Anodon* the surprisingly low rate of 1 cm. per second. This rate is much slower than the rates for other molluscs are reported to be (*cf.* Jenkins and Carlson, 1903, and Rogers, 1927).

II.

The smaller size of the Eastern mussel, *M. edulis*, necessitated some modification of the technique. The shell was carefully opened by cutting the posterior retractor muscle and the pedal

¹ Quoted by Jenkins and Carlson (1903).

ganglion exposed by breaking through the tissue along the anterior retractor muscles of the foot. The small pedal ganglion is bright orange (Field, 1922), which aids in finding it. The animal was held in a small dish and then the tip of the foot was connected with a writing lever. By using the animal in the shell in this manner a less injured preparation is obtained. As the foot was too small to anchor near its tip, the rates had to be calculated from the latent periods of the reflex time from stimulating the foot distally and close to the body. As the contraction always occurs first at the base of the foot these times may be directly compared. A few determinations with the isolated foot gave essentially the same conduction rates, with a greater variability which was due to the technical difficulties involved with so small a preparation.

The average rate of conduction was found to be 92.9 cm. per second, from 12 determinations with 8 animals. Because the animals were smaller, the difference between the points of stimulation averaging about 18 mm., the probable error is greater, being 3.3 cm. per second. The room temperature averaged 24° C. and when this higher temperature is taken into consideration we see the rate in the two species of mussels is about the same.

The slowing of the conduction rate through the ganglion was determined by stimulating the nerves entering the ganglion, and the pedal nerve, stimulating in both cases close to the ganglion, and noting the differences in the latent periods of the responses. The distance between the points of stimulation averaged about 3 mm. The average time of conduction through the ganglion was 0.0087 sec. from 9 determinations with 7 different animals. This is about 2.7 times slower than the conduction along a nerve trunk would be, and further supports the suggestion of the possible cause of the slow rate found by Fick mentioned in the last section.

III.

If this delay in the rate of conduction through the ganglion is due to a synaptic resistance, it might be expected to be reduced when the ganglion is treated with strychnine. This proved to be the case, as five minutes after applying 1 : 500 strychnine SO_4

in sea water to the outside of the ganglion the difference dropped to an average of 0.003 second. This average was obtained with 6 tests with 4 animals. Before strychninization the average delay for the same animals was 0.008 second.

Strychnine does not "open the synapses" in the same way as with vertebrates, because unless the animal is stimulated the foot shows no contraction when its actions are recorded on a kymograph (Fig. 1). The threshold of excitation of skin, nerve

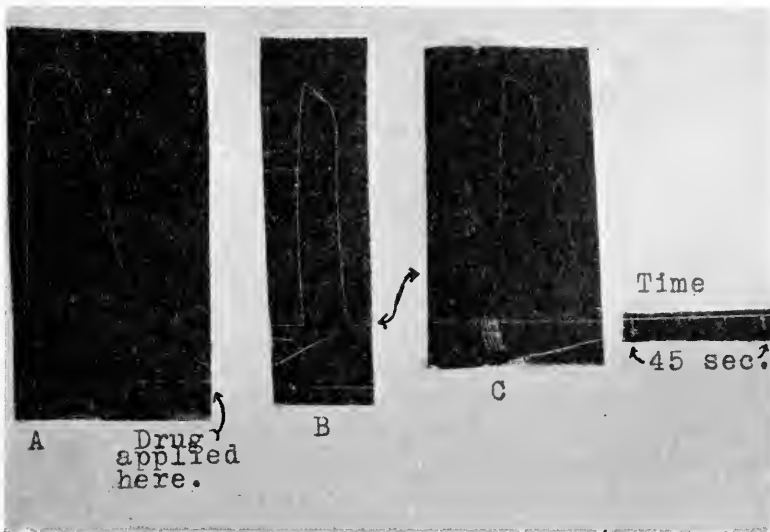

FIG. 1. The effect of applying strychnine to the pedal ganglion of *Mytilus*, as seen in the contraction of the foot. A, contraction before using the drug; B, contraction 6 minutes later; C, contraction 12 minutes later, which shows decreased irritability of the preparation.

and ganglion is greatly increased. Ten minutes after applying the drug the skin is barely sensitive to touch. If the foot is free to move and not attached to the recording apparatus, writhing movements are seen as soon as the drug is applied to the ganglion. These soon cease and the foot remains partly contracted. The circular muscles are contracted proportionally more than the longitudinal muscles. After an hour the foot becomes normally relaxed and quickly responds to stimuli.

Picrotoxin and philocarpine HCl (1 : 200) seem to have no

effect on the ganglion. Phenol 1 : 200 keeps the foot about half contracted, but its irritability remains the same as that of the control animal whose ganglion was washed with sea water. After the application of creatin 1 : 200 to the ganglion the circular muscles at the base of the foot remained contracted and prevented the foot from completely shortening when it was stimulated. The preparation seemed about as irritable as the controls. Thirty minutes after the application of caffeine 1 : 200 the foot became contracted to about one fourth of its normal size and exhibited rapid spontaneous movements. This may be due to some other and secondary effect rather than to the drug itself (*cf.* Maxwell, 1907*a*). Nicotine 1 : 200 may have reduced the sensitivity of the preparation slightly, but this was barely apparent.

Immediate squirming of the foot is seen when 1 : 200 atropine SO_4 is placed on the pedal ganglion. Two minutes later the foot is sensitive to stimuli but it can only contract half-way as the circular muscles at the base of the foot are tightly contracted and the tip of the foot remains flabby and relaxed. The foot becomes hypersensitive to stimuli, partially contracts and relaxes quickly, then a control foot seven minutes after the drug was applied. When it is relaxed the base is narrow from the contraction of the circular muscles, but the rest is greatly elongated as if the longitudinal muscles were forcibly relaxed. This seems to be a reversal of reciprocally acting muscles and somewhat resembles the "reversal" observed after atropine is injected into the body of caterpillars (Crozier, 1922). The effect of atropine on the mussel is similar to the effect of strychnine on the foot of *Chromodoris* (Crozier & Arey, 1919). It is very difficult to record the effect of atropine graphically as the increasing relaxation of the foot necessitates frequent readjustment of the base line and the slight pull on the foot of the writing lever initiates frequent movements of the foot. Such movements were rarely observed with the control preparations.

When a few drops of saturated solution of camphor in sea water were dropped on the pedal ganglion the foot immediately contracted and quickly relaxed. Within two minutes the threshold is so lowered that a jar of the table initiates a spasmodic con-

traction of the foot and adjacent musculature. Soon spasmodic movements of the foot are observed without any apparent stimuli. Six minutes later mantle spasms are observed. The foot becomes so irritable that it immediately contracts when it relaxes enough to barely touch the mantle or a gill. These twitchings are illustrated in Fig. 2. If the ganglion be isolated



FIG. 2. The effect of applying camphor to the pedal ganglion of *Mytilus*. (Cf. Fig. 3.)

by cutting the collaterals which connect it with the rest of the nervous system, the foot relaxes and remains relaxed unless stimulated (Fig. 3). Twenty minutes after camphor is applied, the foot is fully contracted to about one quarter of its usual size. Both the circular and longitudinal muscles are then tightly contracted. This effect of camphor resembles the effect of strychnine in lessening synaptic resistance in certain other animals.

The slower rate of conduction of the nervous impulse through the pedal ganglion of the mussel is abolished five minutes after the ganglion is bathed with strychnine, and the irritability of the foot neuromuscular mechanism is reduced. Atropine causes a reverse of the reciprocally acting muscles of the foot. Camphor seems to open the pathways so that an almost continuous discharge of nervous impulses keeps the foot in active movement until the foot is so contracted that it can hardly move. That this is not due to a stimulation of the ganglion cells is shown by

the relaxation and inactivity of the foot when the pedal ganglion is isolated from the rest of the nervous system.

The supra-oesophageal, pedal, and (in cephalopods) the stellate ganglia respond specifically to the application of strychnine or phenol (*cf.* Baglioni, 1905, Frölich, 1910, Moore, 1917). The injection of strychnine into *Limax* suppresses the phototropic

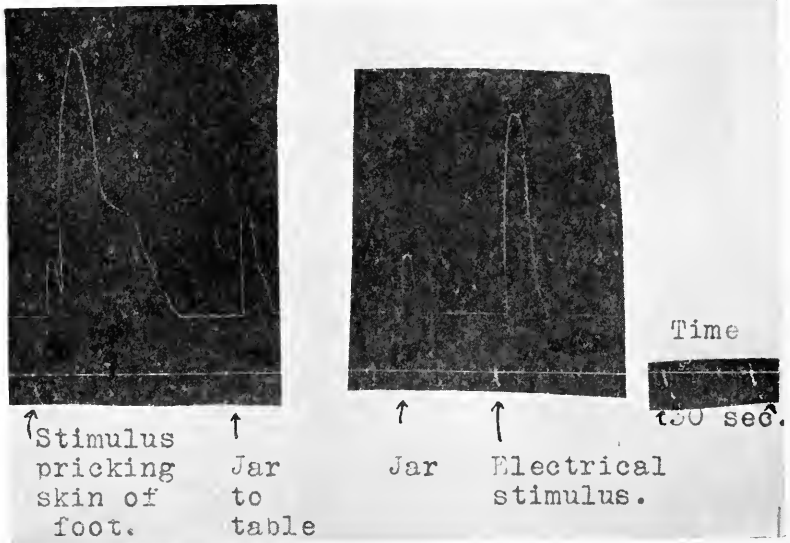

FIG. 3. The effect of camphor on the pedal ganglion of *Mytilus*, as seen in the contraction of the foot. The foot shows contraction only after direct stimulation of the preparation, when the cerebro-pedal connectives have been severed to isolate the pedal ganglion and nerve from the rest of the nervous system. (*Cf.* Fig. 2.)

circus movements of the animal without affecting the activity of the foot. Crozier and Federighi (1924) consider that this result is due to central "competition" between impulses, resulting in the release of pedal waves and in the maintenance of a turning posture.

Strychnine and atropine seem to affect different parts of the organization of the pedal ganglion of *Mytilus* and camphor seems to affect most of the neurones in the ganglion. Strychnine may do the same, but the effect may be masked by some direct or secondary anæsthetic action. These observations intimate caution in the interpretation of the possible locus of the strychnine

effect as synaptic. The chemical differences among the drugs used in this study imply chemical differences in the combination of the drugs with the nervous elements, but enough information is not yet available for a classification of the differences. The cephalopod is sensitive to caffeine, atropine and camphor (Moore, 1917). *Mytilus* is poisoned readily by atropine and camphor and less so by caffeine. The effect of strychnine is less pronounced on *Mytilus* than on *Chromodoris* (Crozier and Arey, 1919). The effect of drugs would place the mussel between the nudibranchs and the cephalopods, which is in agreement with taxonomy.

SUMMARY.

The rate of nervous conduction in *Mytilus californianus* was found to be 64.2 ± 1.8 cm. per second at $18-22^{\circ}$ C. and that of *M. edulis* was found to be 92.9 ± 3.3 cm. per second at 24° C. The rate of conduction through the pedal ganglion was much slower in both animals. Treatment of the ganglion by bathing it with strychnine abolished this delay. Applying camphor to the ganglion results in the foot exhibiting almost continuous movement with no apparent source of stimulation. These movements stop if the pedal ganglion is isolated by cutting the connectives just anterior to the ganglion. The longitudinal muscles of the foot are greatly relaxed and the circular muscles, especially at the base of the foot, contract when the foot is stimulated after applying atropine to the ganglion. This is just the reverse of the response of the foot of the control animal to stimulation. These observations are discussed with respect to the drug effects with other animals and to the use of strychnine as a test for the function of the synapse.

BIBLIOGRAPHY.

- Baglioni, S.
'05 Z. allg. Physiol., 5: 43.
- Carlson, A. J.
'05 Am. Jour. Physiol., 13: 351.
'11 Am. Jour. Physiol., 27: 323-30.
- Crozier, W. J.
'22 BIOL. BULL., 43: 239-45.
- Crozier, W. J., and L. B. Arey.
'19 Jour. Exp. Zool., 32: 261-310.
- Crozier, W. J., and H. Federighi.

- '24 Jour. Gen. Physiol., 7: 221-4.
Drew, G. A.
'08 Jour. Exp. Zoöl., 5: 311-26.
Field, I. A.
'22 Bull. U. S. Bureau Fisheries, 38: 127-259.
Frölich, F. W.
'10 Z. allg. Physiol., 11: 269.
Jenkins, O. P., and A. J. Carlson.
'03 Am. Jour. Physiol., 8: 251-69.
Maxwell, S. S.
'07*a* Jour. Biol. Chem., 3: 21-4.
'07*b* Jour. Biol. Chem., 3: 359-85.
Moore, A. R.
'17 Proc. Nat. Acad. Sci., 3: 598-602.
'21 Jour. Gen. Physiol., 4: 29-31.
Richards, O. W.
'28 The Nautilus, 41: 99-101.
Rogers, C. G.
'27 Textbook of Comparative Physiology, New York, 537 pp.

GROWTH OF A POND SNAIL, *LYMNÆA STAGNALIS*
APPRESSA, AS INDICATED BY INCREASE
IN SHELL-SIZE.

EDWARD D. CRABB,

ZOOLOGICAL LABORATORY, UNIVERSITY OF PENNSYLVANIA.

This paper is a result of attempts to develop a method of rearing pond snails in the laboratory for experimental purposes in which early development of healthy animals that lay a quantity of normal viable eggs at all seasons of the year was of prime importance. After this point had been attained various conditions of food and media were tried to see whether the results would confirm those of other workers who have investigated growth in fresh-water pulmonates or help to explain their conclusion. Since practically no literature on growth in *L. s. appressa* is available, it is necessary to turn to the work on the old world species for comparison. After comparing shells of my stock and of wild individuals from the same lake (in Michigan) which afforded the progenitors of my experimental animals with specimens of *Lymnæa stagnalis* of the P. Hesse and other collections in The Academy of Natural Sciences of Philadelphia, which were collected in many parts of Europe, I am satisfied that there is no constant difference between the American *L. stagnalis appressa* and the European *L. stagnalis* with regard to shell-form and size. British shells of *L. stagnalis* measure 47×21 mm. (Hogg, 1854, Fig. 7) and $34-50 \times 18-28$ mm. (Ellis, 1926), but the radula differs somewhat in American and in European snails (F. C. Baker, 1911). Thus it follows that the age and growth relation of the shell in *L. s. appressa* Say should be very similar to that of the European species, *Lymnæa stagnalis* Lin.

An idea which prevails among some of the conchologists is that in nature the volume of the medium largely determines the maximum size attained by the snails so that individuals of the same species grow larger in large bodies of water than in small, and this differential growth is offered as a means of explaining

the origin of races, or subspecies. Others attribute differences in shell-size to transient, imposed conditions which play no part in the origin of races. The genetics of pond snails has been considered in a previous publication (Crabb, 1927a). Semper (1883) indicates that Hogg, Blanchard, and he were probably the first investigators to demonstrate by laboratory experiments that variation in shell-size in *Lymnaea stagnalis* is dependent upon the size of the body of water in which the snail lives. Hogg (1854: 103) was confident that he had arrested growth in *L. stagnalis* by keeping the snails in small vessels, and Semper (1874, 1883) maintains that increase in growth is directly related to the volume of medium up to 4-5 liters per snail, but that additional increase in volume has no further effect on growth. Apparently he was confident of evolutionary significance of his results, for he stated (1883: 163) that every *Lymnaea* which failed to attain a length of 20 mm. during the first year of its life under unfavorable conditions produces a dwarf race if the conditions which have retarded its growth be repeated during the following years. He explains the relation of growth to volume (1883: 166) by postulating the theory that there is present in water a minute quantity of an unknown substance which is probably absorbed through the skin, the amount of which that can be absorbed "in a given time depends upon the volume of the water and increases or diminishes with it," Shells of the third and fourth generations of *Lymnaea megasoma* reared in the laboratory had more slender spires and differed materially in other ways from the wild Vermont parent and led Whitefield (1882) to suppose that he had created a new form, presumably by rearing individuals in a smaller volume of water than their parents were accustomed to in nature. *Lymnaea traskii* living in a large glacier-fed lake in the Canadian Rockies averaged $27\frac{1}{2}$ - $60\frac{1}{2}$ per cent. smaller than those living in a near-by pond having a higher maximum temperature and more abundant food supply (Mozely, 1928).

Most aquarists and investigators who have reared fresh water pulmonates agree that these snails do best in a relatively large volume (about a liter or more to the snail) of water (Whitefield, 1882; Semper, 1874-1883; de Varigny, 1894; Willem, 1896;

Legendre, 1907, 1908; F. C. Baker, 1911; Colton, 1912, and Popovici-Bazosanu, 1921, with *Lymnæa*). It has been shown in other aquatic forms that reduced volume, including crowding, reduces the growth rate of the animals, a part of the body, or the rate of division in one-celled organisms (Kulagin, 1899; Woodruff, 1911, 1913; Robertson, 1923, and Greenleaf, 1926, on Infusoria; Vernon, 1895, 1899, 1903, plutei; Warren, 1900, Daphnia, and Young, 1885, tadpoles). Most of these workers appear to believe that this retardation of growth is the result of foul media and, or, insufficient food, but none of them has shown conclusively just what the cause is. Robertson (1923: 139) maintains that in Infusoria, although growth (as indicated by multiplication) is retarded by old culture media, "the origin of the retardation . . . may readily be shown to reside neither in exhaustion of available foodstuffs nor in the accumulation of toxic products within the medium." To me the results of his experiments indicate a "specificity of toxicity" which is Woodruff's (1913) explanation of the results of his experiments in which Infusoria grew readily in old Hypotricha media, but were markedly retarded when cultured in old Infusoria media. A similar "specific fouling injury" was found to exist in Daphnia cultures (Vernon, 1899, 1903). However, he shows that old cultures are more favorable to hatching and growth in a different than in the same species of Echinoid.

Besides Semper's novel explanation of the cause of stunted growth there are others that pertain to fresh-water snails. Willem (1896) put from 1 to 10 *Lymnæa ovata* and 1 to 5 *Planorbis corneus* in equal volumes of media with food, light, temperature, etc., the same and by aërating "to saturation" he got a maximum of 37.32 per cent. increase in growth in six snails over an equal number which were not aërated. He concludes that oxygen is the factor which determines growth and states "that in the basommatophores cutaneous respiration is more important than pulmonary respiration and that it alone is sufficient for the animal" (p. 562). De Varigny (1894) thinks that growth in *Lymnæa* is directly related to increased surface area, even though the volume is reduced, by permitting the snail to take an increased amount of exercise, for dwarfing from crowding is not

due so much to the actual numbers in the vessel as to the "moral influence of numbers which inhibit exercising, just as a man does not like to take a walk on a crowded street. . . ." Popovici-

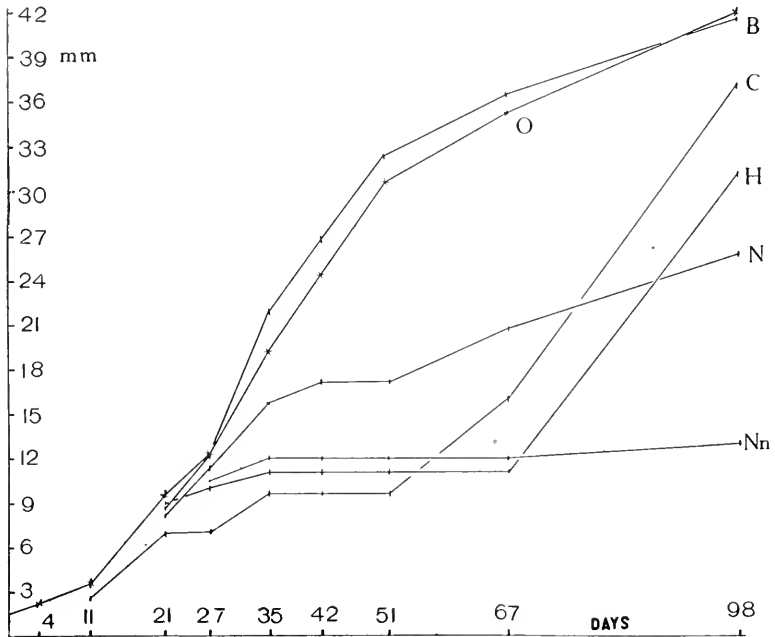

FIG. 1 shows the effect of foul medium on growth of the shell. The individuals are all from the same mass of eggs and were isolated in tap water at or before hatching. All conditions, light, temperature, etc., except media, were kept the same in each case. Food: leaf lettuce, boiled wheat and filter paper every two or three days. *B*, mean length of 15 snails; medium was poured out and fresh supplied every 7 days. The deviation from the mean is -4 at age of 51 days. *C*, length of the smallest individual in the *O* group. *H*, length of the smallest individual of the *B* group (not included in *B*). *N*, mean length of 14 snails, except that three died before the last measurement; therefore only 11 are represented in it. Excrement never removed but allowed to decay; fresh tap water added to maintain the standard volume. The probable error of the mean at the age of 51 days was ± 1.18 ; at age 98, ± 1.12 mm. *Nn*, length of the smallest individual of the *N* group. *O*, control (elsewhere designated as "Master Control") mean length of 15 snails; tap water; excrement siphoned off 3 times each week, all the water poured off as often as it became foul and fresh added. The probable error of the mean length at the age of 51 days was ± 0.635 ; at age of 98, ± 0.711 .

Bazosanu (1921) holds that food is the most important factor in producing growth in pond snails, and that the effect of excrement is not as important as Legendre thinks. However, Legendre

(1907, 1908) found that clean cultures favor the growth of both snails and water plants, while excrement, "especially the liquid or soluble kind," retards growth. He (1907) records five experiments with *Lymnaea stagnalis* in which volume, temperature, light, surface and food were the same and in which the water on the controls was changed every two days while that on the experimental animals was not changed, only fresh water added to maintain the volume. By this treatment he obtained a maximum length in control animals of 25 mm. at the age of 97 days. Further analysis of his results shows that his differences in the mass cultures are insignificant (maximum 1.8 mm.) when the relative numbers in each experiment and in the control are considered and that the maximum growth-rate of his controls, 8.4 mm. in about 74 days (relatively less than half that of my experimental animals (Fig. 1, N), indicates that these snails, as well as the experimental animals, were suffering from severe inanition. For the same reason the maximum adult length obtained by Popovici-Bazosanu (1921: 52) in his control *Lymnaea stagnalis* was 26 mm. in 143 days. That the snails in this experiment were started out properly is shown by their length at the age of 29 days, 19 mm., which compares favorably with my best results (Fig. 1, B, O). Hoffmann (1927), citing Kunkel, 1916, gives the size of a *Lymnaea stagnalis* as 20×9 mm. at nine months old and at the age of 20 months, 47×23 mm. Legendre (1907), using 1,300 ml. of water to each control culture of ten *L. stagnalis*, obtained maximum lengths of 18-22 mm. in about eleven months. In comparison with this and other work done on the effects of crowding may be mentioned one of my cultures in which eight snails were hatched and reared in a 100 ml. wide-mouthed bottle (ca. 12.5 ml. to each snail), and at the age of 151 days the three smallest averaged 26 mm. in length. Similar results obtained by various investigators rearing fresh-water mussels in crates and observed by them in nature have been attributed to crowding and to insufficient food supply (Coker, Shira, Clark and Howard, 1922; Iseley, 1914). Abnormally low growth rates for control animals is a criticism which is applicable to the work on *Lymnaea stagnalis* by the investigators cited in this paper. Most of these investigators

apparently depended upon Lemna, Algæ, Chara, Elodea and other water plants to furnish the major part of the food for their snails. Popovici-Bazosanu (1921) speaks favorably of lettuce for snail food, but adds that "of all foods microflora is the most important."

In general my growth curves are the sigmoid type and agree with Semper's (1883: 163), and Roberts' (1923) curves and his

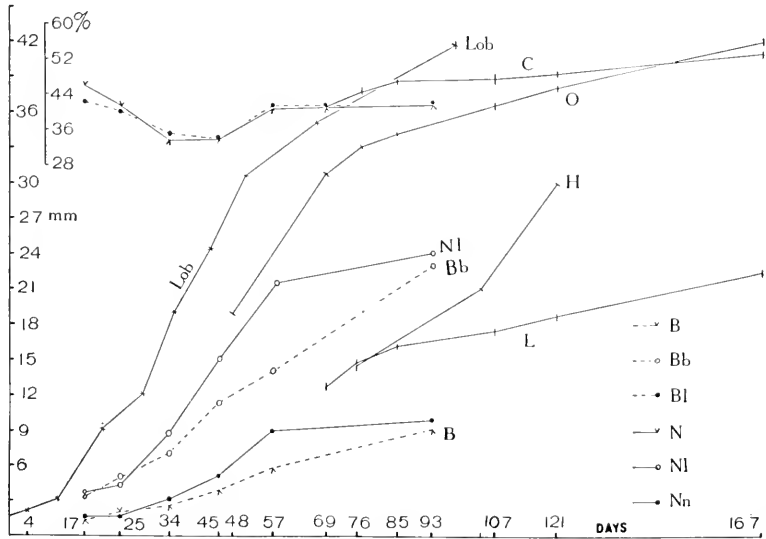

FIG. 2 shows effects of food, medium and crowding. Each individual, except group *H*, was reared in isolation in tap water under the same temperature and light conditions. *B*, mean width; *Bb*, mean length; *Bl*, mean index of stature of 7 individuals which were fed lettuce, hard-boiled eggs and filter paper until 57 days old; then fed leaf lettuce only; excrement removed once every 7 days. A mixed culture of microorganisms was included in the food the first two times the snails were fed. *N*, mean index of stature; *NI*, mean length; *Nn*, mean width of 8 snails fed leaf lettuce and filter paper the first 25 days and afterwards a diet of boiled wheat, baked potato and leaf lettuce until 57 days old when they were given leaf lettuce only and excrement removed every 7 days. *C*, mean index of stature; *L*, mean width; *O*, mean length of 10 individuals, each of which was reared in isolation from hatching and kept on a diet of leaf lettuce, filter paper, and occasionally boiled wheat was added and excrement removed two to three times each week. *H*, mean length of 6 larger individuals from an over-crowded mass culture which were placed in an aquarium containing about 7 litres of tap water and fed leaf lettuce and filter paper. *L*, see *C*. *Lob*, master control (mean length of 15 individuals, Fig. 1, *O*). *O*, see *C*. Snails represented by graphs *B*, *Bb*, *Bl*, *N*, *NI*, and *Nn* are from one egg mass; *C*, *H*, *L* and *O*, from another, and *Lob* from a third mass of eggs.

idea of three "cycles" in the growth of an individual to the extent that there is an initial period of relatively slow growth followed by a period of relatively rapid growth which is succeeded by a slowing up in the growth of the anterior margin and an increase in growth of the lateral margin of the shell. In *Lymnaea* this last "cycle" continues until death. These changes in length are attended by changes in the relative width of the shell (Fig. 2, *Bl, N*).

It is to be regretted that circumstances prevented rearing larger numbers of individuals in certain of the following experiments, as well as having made it impractical for me to supplement them adequately.

MATERIAL AND METHODS.

The original stock for these experiments was obtained from Third Sister Lake, near Ann Arbor, Michigan. The animals used in this work were free from trematode infection, thus obviating a factor, common to wild snails, which Hurst (1927) shows markedly affects vital activities in *Physa occidentalis*; neither were they retarded in growth or age of maturity by low temperatures, such as Weymouth, McMillin and Holmes (1926) have clearly shown is the case in the Pacific razor clam, *Siliqua patula*, along the coast from Washington to Cordova, Alaska. In order to eliminate, as far as possible, factors which might arise from genetic or extrinsic causes controls were usually selected from the same mass of eggs as the experimental animals and, whenever practical, the graph of the "master control," which is the mean length of 15 individuals (Fig. 1, *O*), is shown in each chart to facilitate comparisons.

The size of the shell, instead of the weight of the animal, is used to determine growth in this snail because adult individuals are capable of retaining quantities of water varying to more than a cubic centimeter.

The quantity of medium in the various cultures was maintained by replacing that lost in siphoning out excrement or by evaporation when the snails were fed, unless otherwise stated. In the isolation cultures, unless otherwise explained, a single egg or a single snail was placed in a clear glass fingerbowl of about 200 ml.

capacity, but containing 150–175 ml. of medium, and covered with a clear glass plate to prevent the escape and death by desiccation of the snail as well as to inhibit evaporation of the media.

By means of a room thermostat water in the various cultures was kept at approximately 18–20° C. throughout the year, except during a few successive days of very warm weather during the summer of 1925. The temperature of the tap water was raised to the desired degree before subjecting the snails to it.

Unless otherwise stated, the snails were never without food, a sufficient quantity being given to them to last until the next feeding time, when the remaining food was removed and fresh supplied.

Aëration was accomplished by allowing air from the compressed air system to bubble through the water in which the snails lived.

Direct sunlight was applied by setting the uncovered finger-bowls on the broad ledge outside the window.

The measurements are all in millimeters and represent the maximum length, or width, of the shell, with the aperture turned down as in the crawling posture, taken with fine-pointed dividers and recorded to the half millimeter. Very small individuals were placed on a Carl Zeiss Objectmikrometer, all free water removed with a piece of filter paper to eliminate refraction, and the measurements read to one fifth of a millimeter with a Leitz stereomagnifier using 7× oculars. After the width was recorded it was necessary to turn the snail onto its back and orient the shell with needles so that the true length could be obtained. This tedious procedure was made necessary by the fact that in the young shell the plane of the aperture lacks several degrees of coinciding with that of the apex; therefore, when placed on its ventral surface this factor and that of the protruding body whorl and exuding mucous fluid caused the shell to lie in such a position that the observed length is much less than the actual caliper length. The comparatively dry dorsal surface of the shell adheres sufficiently to the moist glass rule to facilitate orienting it. These two axes more nearly coincide in the larger shells, and too one's ability to orient the

shell and measure it with dividers obviates the difficulties encountered in obtaining the length in young individuals. The index of stature is the width times 100 divided by the length and is graphed to show the relation of width to length in terms of percentage. A total of 136 isolation and 177 mass-reared snails survived and were used in these experiments.

The writer wishes to take this opportunity to thank the Department of Zoölogy of the University of Michigan for having generously supplied the laboratory facilities and equipment for the experiments done from December, 1924, to May, 1926; Professor George R. La Rue and Dr. A. E. Woodhead for supplying stock material from Michigan, and Edward Vanatta, Assistant Curator in the Academy of Natural Sciences of Philadelphia, for kindly showing him specimens and data of *Lymnaea stagnalis*. Without the assistance of Ruby M. Crabb this paper would not have been undertaken.

OPTIMUM CULTURE CONDITIONS.

There are indications that in nature this snail does not develop sufficiently the first year to reproduce. However, numerous masses of viable eggs found as late as the last week in October may have been laid by snails hatched during the preceding May. "The duration of life in the family Lymnæidæ is from three to four years, full maturity being reached in about two years" (F. C. Baker, 1911). My *L. stagnalis appressa*, reared under standard isolation conditions, reached maturity within three months and few of them lived longer than nine months; due, no doubt, to the fact that since the snails had no rest-periods, such as are brought about by seasonal conditions in nature, the vital processes continued actively with the result that their life span was reduced to a few months.

Although my records are not sufficiently complete to establish the minimum age at which isolated individuals of various growth-rates may be expected to begin laying, they do show that in all cases individuals reared under optimum conditions lay more eggs per week, a total of many more eggs during life, and that these eggs have a much higher percentage of viability than was the case in individuals reared under conditions that did not result

in optimum growth-rate. The percentage of viable eggs appears to be related to the direct effect of the medium upon the eggs after laying rather than indirectly through affecting the mother during development of the eggs. The growth-rates represented by Fig. 1 bring out this point well. Eggs laid by the fourteen individuals of the *N*-group were worthless for experimental purposes because of the very high death rate which increased as the snails grew older and the medium became more unfavorable for hatching. In this case it was clear that high mortality of the embryos and low growth-rate of the mothers were correlated. The specific effects of the medium were not investigated. In groups *B* and *O* the growth-rate is nearly the same, the difference being in favor of *B* between the ages of 27 and 88 days, but the eggs of *O* had a higher percentage of viability than those of *B*. From the point of early egg production, it seems that the *O* group is inferior to either of the other two groups. In group *N* (foul culture) the first individual laid at the age of 70, the second at 88, and the third at 118 days. In the *B*-group the first five snails laid at ages of 85-90 days while in the *O*-group only two individuals had laid at the age of 85-90 days. Soon, in quantity as well as quality, the eggs of the *O*-group surpassed those of the other two groups. Therefore the *O*-group was used as a "master control" for all the experiments. Three snails isolated before hatching and reared in fingerbowls at this laboratory under conditions as nearly like those used at Michigan as was possible had the following measurements when 172 days old: 40×20 , 42×21 and 44×21 mm.

EFFECT OF FOOD ON GROWTH.

Several experiments were undertaken with the idea of determining the effect of different foods on growth-rate. That boiled wheat is superior to hard boiled eggs and random microorganisms is indicated by the difference between *Nl* and *B*, Fig. 2 and also by the fact that *Nl*, Fig. 2, failed to keep pace with *B*, or *O*, Fig. 1. Although there is a paucity of data recorded (Fig. 7, *B*, *C*; 8, *N*) iceberg lettuce appears to be far inferior to leaf lettuce, especially for young snails; large snails do much better on the green outside leaves than on the more tender white leaves.

Whether or not this is the result of a higher chlorophyl and vitamine content has not been proven. It was found that when large snails were fed an abundance of leaf lettuce, iceberg lettuce, green cabbage leaves and *Elodea* they ate the leaf lettuce, rejected the others and laid their eggs on the green cabbage (Crabb, 1927) and *Elodea*. When the leaf lettuce was not replenished they ate the iceberg and continued to lay on the cabbage and *Elodea*. When green cabbage alone was supplied they subsisted upon it, but thin slices of sugar beet, carrot and spinach leaves were eaten more readily than cabbage, and *Elodea* was very seldom eaten. Incidental food stuffs range from the flesh of their own kind to many plants, for this snail will try its "teeth" on anything it may chance upon, especially if it is something unusual, and usually swallows whatever may get into its mouth.

Desiccated, pulverized endocrin glands (Armour & Co.) were mixed with flour and water to the consistency of bread dough, rolled thin, marked off into equal squares, dried and fed in addition to leaf lettuce. Three snails (Fig. 6, *H*) received anterior lobe of the hypophysis, two, thymus (Fig. 6, *N*) and three others thyroid (Fig. 6, *O*). Since in each case the "gland-bread" began to putrify in a few hours, and since in all three groups growth was retarded to so nearly the same extent, it was concluded that putrefactive products acting on the media, rather than hormones, were responsible for the stunted, malformed shells (Fig. 9, Nos. 19-25).

EFFECTS OF MEDIA, TEMPERATURE AND LIGHT.

The popular belief that snails live in water having a relatively low calcium content led us to attempt to rear individuals in media of distilled water and cistern water so that the food would be the only source of calcium. In every instance snails reared in calcium-free water failed to grow normally (Fig. 4, *C*, *II*; 5; 6, *L*, *E* and 9, Nos. 1-7). To test the effect of calcium in the water five sets of three individuals each were isolated when one week old in molar solutions of CaCl_2 ranging from $m/100$ to $m/10,000$. One individual lived to be 71 days old and attained a length of 8.5 mm. and another, 14 days and 3.25 mm. in $m/100$ solution. Two others in $m/10,000$ solution lived 34 days, length 8.25 mm.

and 9 days, length 3.25 respectively. Since the control consisting of 6 groups of three each from the same mass of eggs all died within three weeks, and other individuals, mentioned above, lived in calcium free media 155 days, the calcium experiments have no marked significance. However, deVorges (1903) maintains that a bivalve, *Anadontia cygnea*, obtained calcium from the water alone.

Temperature and light are undoubtedly factors in the growth and reproduction of this snail, but our preliminary work does not indicate the quantity or the quality which might be tolerated. Two individuals (Fig. 8, *Nn*) reared in isolation in complete darkness at 18° C. did not make the growth of the master (*E*, Fig. 8) or any of the isolation controls. Four others (Fig. 8, *N*) reared under the same conditions, except for diet, and from the same egg mass did not attain the rate of growth of *B*, Fig. 7, which were fed about the same food, but reared in more light and at two degrees higher temperature. A snail which was isolated at hatching in tap water and fed leaf lettuce was kept in a room in which the temperature remained about 15° C. until 113 days old when it had a length of 7.50 mm.; from this time on the individual was kept in another room at about 20° C. and given the usual care and when 151 days old its length was 8 mm.; 165, 24 × 9 mm.; 179, 30 mm.; 201, 35 mm.; 242, 38 × 18 mm.

Direct sunlight does not appear to increase the growth rate, for three isolated individuals which were thus treated one to three hours daily and fed the standard diet (Fig. 8, *B*) grew no faster than the master control (Fig. 8, *E*) and only one of the three made as rapid growth as the single living isolation control which received an equal amount of sunshine through a plate glass window. Six individuals were treated as in *B*, Fig. 8, except that excrement was not removed and three of the snails were not exposed to direct sunshine. Since the mean length of each group of three did not vary as much as one half millimeter at any measurement, both groups were graphed as *Bl*, Fig. 8.

EFFECTS OF CROWDING AND POLLUTION.

Mass cultures have a retarding effect on all individuals and give variable growth-rates usually resulting in "dwarfs" and

"giants" in each culture. The results of the following experiments show that when such individuals are transferred to favorable conditions they may reasonably be expected to rapidly reach the normal, or near normal, adult size. Eight snails were kept in a 100 ml. wide-mouth bottle until 151 days old, when three of the smallest, having a mean length of 26 mm., were isolated under standard conditions. When 165 days old their mean length was 29.75 mm.; 169, 32 mm.; 179, 36.33 mm.;

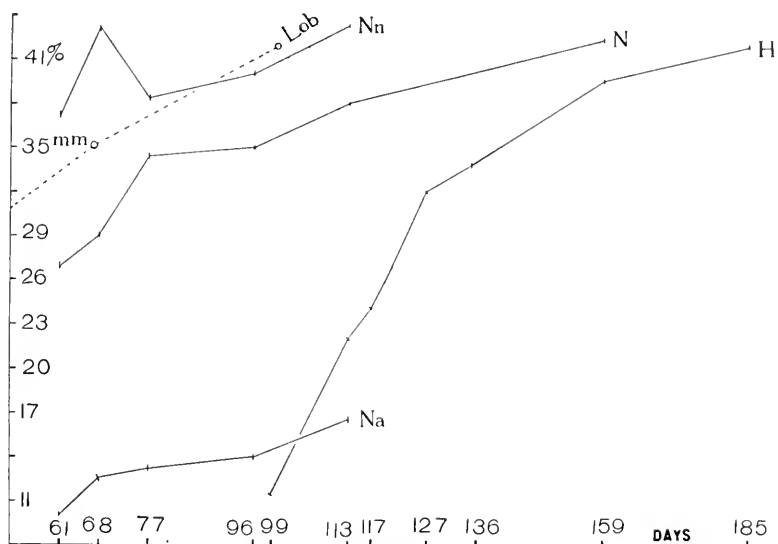

FIG. 3. Crowded compared with isolation cultures. *II*, mean length of the 3 largest and 2 smallest in a mass culture of 24 individuals kept in a fingerbowl until 99 days old then isolated and given standard treatment. *Lob*, master control. *N*, mean length of 6 individuals isolated at time of hatching and fed leaf lettuce, filter paper, an occasional bit of apple peel and boiled wheat; food and water changed twice each week. *Na*, mean width of *N*. *Nn*, index of stature of *N*. All individuals, except *Lob*, are from the same mass of eggs.

188, 37.66 mm.; 201, 39 mm. and 242, 41 mm. Five of the largest of a mass culture of 24 individuals reared in a fingerbowl and isolated when 99 days old had a mean length of 11.50 mm. and attained 42 mm. when 185 days old (Fig. 3, *II*).

Six snails (Fig. 7, 4) reared in a round battery jar containing approximately 150 liters of tap water and fed green lettuce, boiled wheat and filter paper failed to keep up with the control (Fig. 3, *N*) by about five mm., from the 55th to the 185th day.

Two masses of eggs were placed in a battery jar containing approximately 1,500 cc. of tap water and when about 88 days old they were transferred to a round clear glass jar containing about two gallons of tap water. The excrement was siphoned

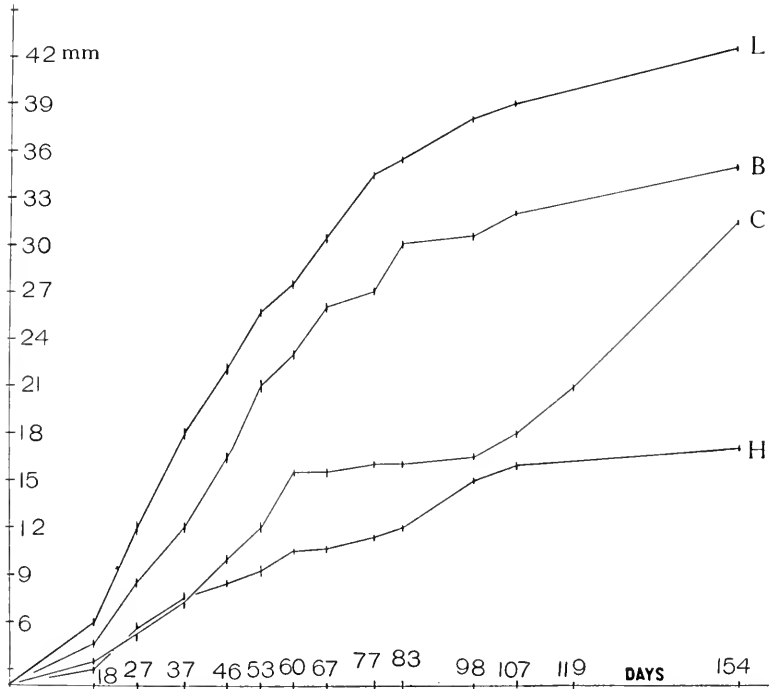

FIG. 4 gives the growth rate as shown by the mean length of the shell in isolated snails fed leaf lettuce and filter paper; all conditions, except those of media, were the same in each case. The snails were fed, excrement siphoned off and fresh medium added three times each week. *B*, three snails, medium, equal parts of distilled and city tap water. *C*, two snails, medium, cistern water until 119 days old when tap water was substituted. *H*, two snails, medium, distilled water. *L*, control, two snails, medium, city water. Although the curve represents the mean length of two individuals, in only one instance, age 107 days, did the measurements of these two vary as much as two mm. All are from the same egg mass.

off and water renewed two or three times each week, the animals fed leaf lettuce and occasionally boiled wheat and filter paper were added to the diet. When about 169 days old they were sorted according to size and placed in three groups to determine their rate of growth. In group I. there were 9 individuals, the smallest measuring 18 mm. in length and 6.5 mm. in breadth,

the largest 25 mm. in length and 11 mm. in width. The mean length and mean width for this group was 23.11×9.33 mm. and the mean index of stature was 40.37. In group II. there were 21 individuals which had a minimum and maximum length and breadth of 26×11 and 28×12.5 mm. respectively with a mean of 26.8×11.78 mm. and a mean index of stature of 41.60. In group III. there were 14 individuals which had a minimum

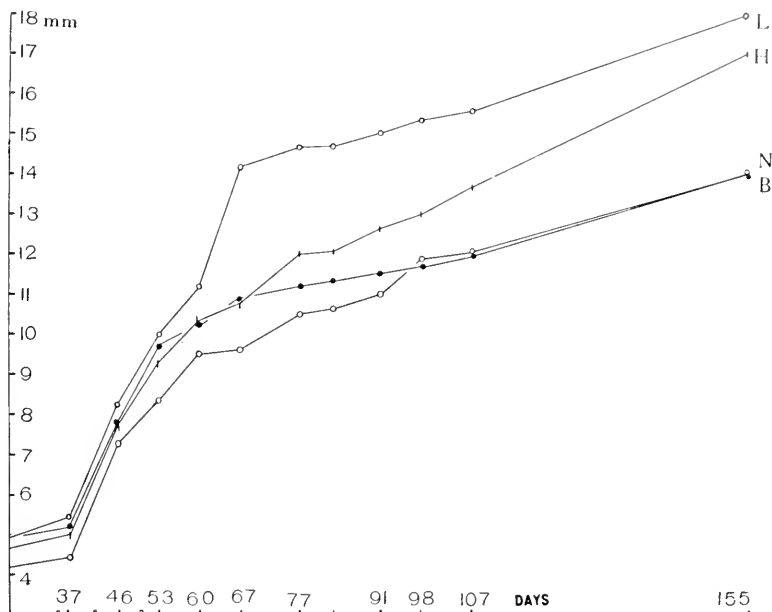

FIG. 5 shows the effect of distilled water. The snails used in this experiment are from the same egg mass as those in Fig. 6 and were reared in a fingerbowl until 26 days old when they were isolated in distilled water, fed leaf lettuce and filter paper, excrement siphoned off and fresh medium added every two or three days. *B*, 3 individuals kept away from the window so that no sunshine could pass through glass to them. *H*, 3 individuals kept near the window so that the sun could shine through glass onto them about 45 minutes each bright day. *L*, 3 individuals, kept away from window with *B*, but aerated 15–20 minutes during the day at least four times each week. *N*, 3 individuals kept near the window with *H* and aerated with *L*. Since the controls died with Fig. 7, *B*, *C*; 8, *N* and with the master control.

and maximum length and breadth of 29×12 and 32.5×15 mm., a mean of 31×13.5 and an index of stature of 43.55. Thus the mean measurements of these 44 individuals at the age of 169 days was 26.97×11.53 mm. and index of stature, 41.87.

The length of these 44 snails which spent the last 81 days of their lives in favorable mass culture conditions is about half that of ten individuals (Fig. 2, *C*), reared in isolation from hatching.

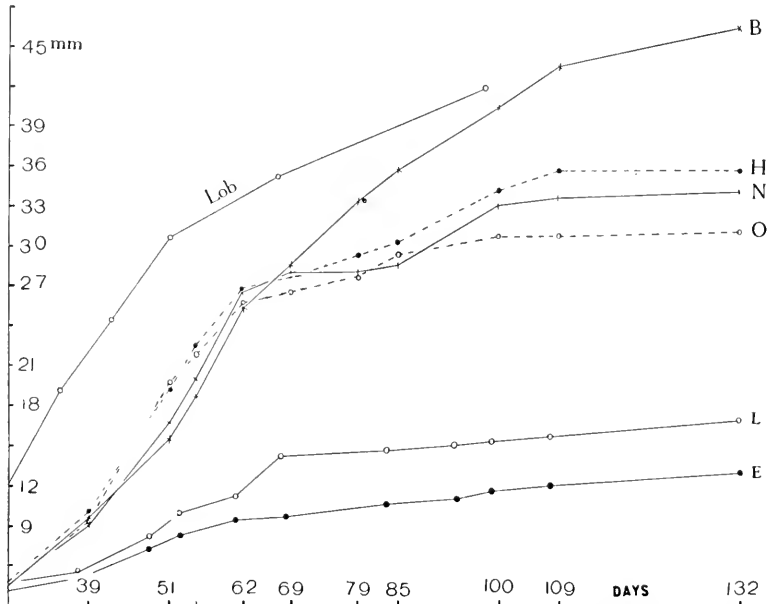

FIG. 6 shows effects of endocrin glands added to standard food (foul media?) and of distilled water on the mean length of snails hatched from the same mass of eggs and isolated at the age of 27 days. Light, temperature and volume of medium were the same except that two of *B* and 2 of *H* were kept in such broad flat vessels that the medium was less than one inch deep. All were fed leaf lettuce in quantity and kept in tap water, except *E* and *L*. *H*, *N*, and *O* were also given desiccated glands, mixed with wheat flour to make a dough and dried, two to three times each week. *B*, controle, 3 individuals. *E*, 3 individuals, distilled water, aerated 15-30 minutes daily, no sunlight, leaf lettuce and filter paper (Fig. 5, *N*). *H*, 3 individuals, anterior lobe of hypophysis. *N*, 2 individuals, thymus. *O*, 3 individuals, thyroid. *L*, 3 individuals treated as in *E*, except, sunlight through window daily (Fig. 5, *L*). *Lob*, master control (Fig. 1, *O*).

Twenty-four individuals hatched and were kept in a finger-bowl until they were 99 days old when the three largest (20, 15 and 10 mm. long) and the two smallest (7 and 5.50 mm. long) were changed to standard isolation cultures (Fig. 3, *H*) and within 60 days almost caught up with six snails which were isolated before hatching and fed leaf lettuce and filter paper (Fig. 3, *N*).

A mass of eggs was allowed to hatch and the 51 surviving young to remain in a fingerbowl until 70 days old when the two smallest individuals (Fig. 8, *S*) and the two largest individuals (Fig. 8, *C*) were isolated and reared under standard condition. Another mass of eggs was allowed to hatch and the 33 young to remain in a fingerbowl until 61 days old when the two smallest (Fig. 8, *II*) and the two largest (Fig. 8, *O*) were isolated and reared under standard conditions. Each mass culture was fed and water changed three to six times a week. The most significant points in the last two experiments are that even the

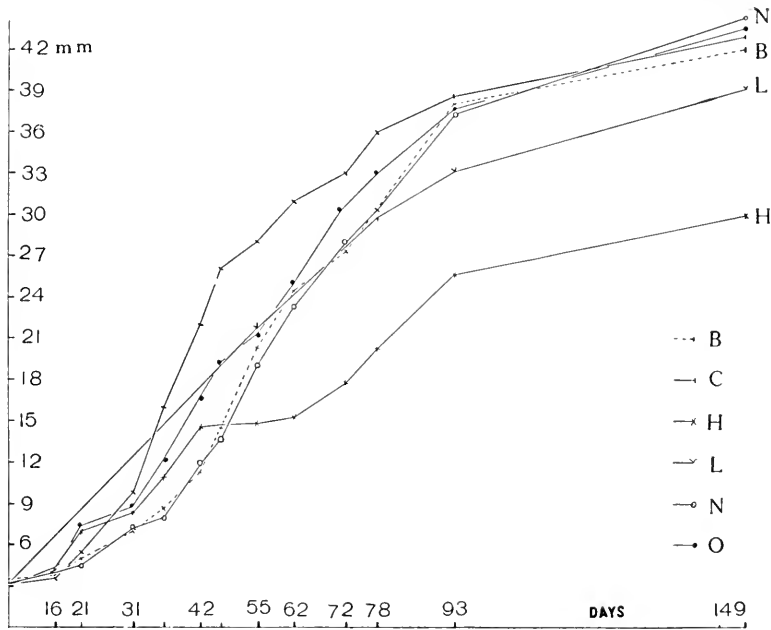

FIG. 7 shows effects of different food and media on snails all from a single mass of eggs, isolated when one week old (except that *L* is a mass culture) fed, excrement syphoned off two or three times each week and water poured out when foul, except *H*. All other conditions were the same. The mean length and age in days are given. *B*, 3 snails, one died before 71st day; iceberg lettuce and filter paper and occasionally boiled wheat. *C*, 3 snails, one died before 71st day, another died before last measurement, iceberg and leaf lettuce, dry elm leaves, apple peel and blotting paper. *H*, 3 snails, one died before last measurement; excrement not removed. *L*, mass control, 6 snails reared in a battery jar containing approximately 1500 ml. of tap water; leaf lettuce, boiled wheat and filter paper. *N*, isolation control, 3 snails; leaf lettuce boiled wheat and filter paper. *O*, 3 snails; same conditions as *H*, except that each was aerated 15-45 minutes every 2-3 days. All individuals are from one egg mass.

largest individuals were much stunted, that both the smallest and the largest individuals responded to the standard isolation treatment and that the worst stunted individuals grew more rapidly than the largest individuals. Since this snail reproduces by self-fertilization (Crabb, 1927*b*) individuals obtained from the same egg mass would be expected to have very similar genetic constitutions. Therefore, one would attribute the common occurrence of a few "dwarfs" and one to three "giants" in a

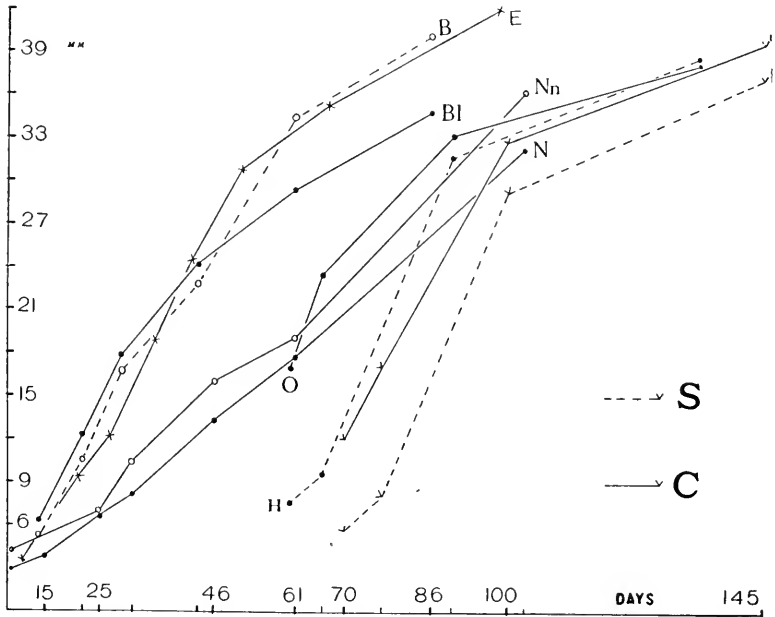

FIG. 8 shows effect of light, medium, crowding and food. The mean length only is given in each case. *B*, 3 snails reared in isolation from hatching, tap water, leaf lettuce, boiled wheat and filter paper; food and water changed 3 times each week; direct sunlight 1 to 3 hours daily. *Bl*, 6 snails treated as in *B*, except that excrement was not removed. *C*, see *S* and *C*. *E*, master control of 15 individuals (Fig. 1, *O*). *H*, 2 "dwarfs" and *O*, 2 "giants" of a mass culture of 33 individuals all hatched from the same egg mass and reared in a fingerbowl until 61 days old when *H* and *O* were isolated in fingerbowls and reared under standard conditions. *N*, 4 individuals, isolated in tap water in fingerbowls, fed iceberg lettuce, filter paper and occasionally boiled wheat and kept in total darkness at about 18° C. Food and water changed at night 2-3 times each week. *Nn*, mean length of 2 individuals (only one in last measurement) conditions the same as *N*, except that food was leaf lettuce, boiled wheat and dry elm leaves. *O*, see *H*. *S*, 2 "dwarfs" and *C*, 2 "giants" of a mass culture of 51 individuals, all hatched from the same egg mass and reared in a fingerbowl until 70 days old, when *S* and *C* were isolated in fingerbowls and reared under standard conditions.

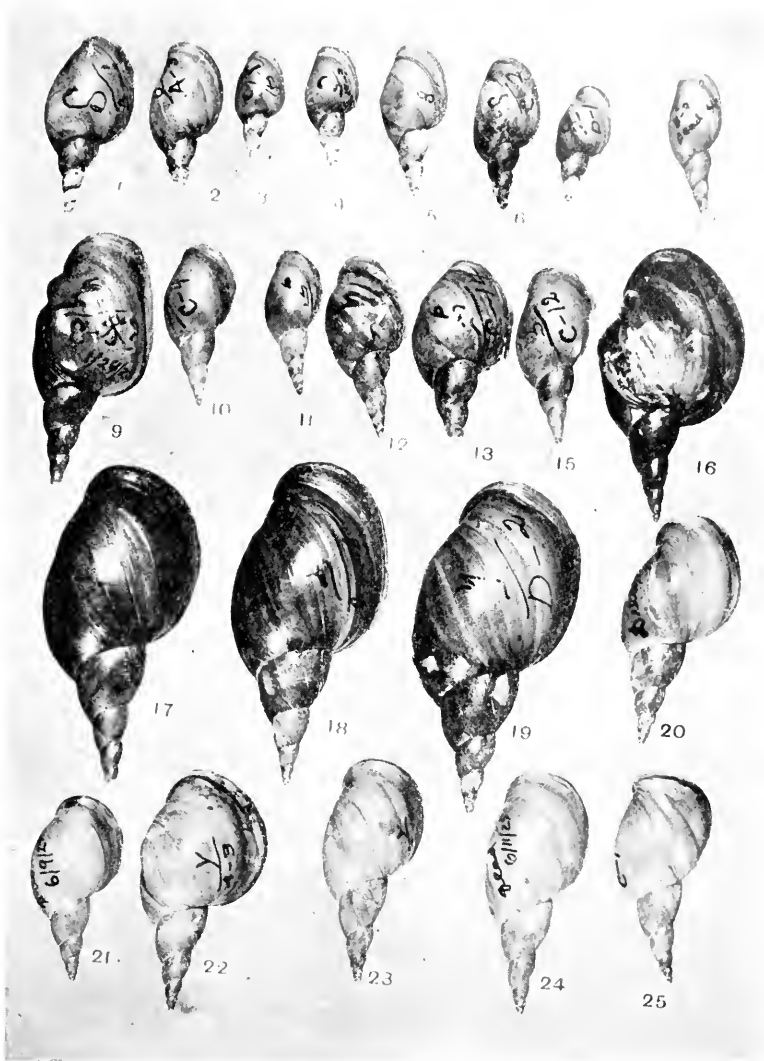

FIG. 9 shows the effect of favorable (Nos. 17-19) and unfavorable culture media on growth; food and other factors being equal. ($\times 1$.) Nos. 1-7, distilled water and leaf lettuce (see Figs. 5, 6, *L*, *E*); ages at death were as follows; No. 1, 231 days; 2, 235; 3, 199; 4, 175; 5, 168; 6, 269; 7, 196. Nos. 1 and 2 are from group *B*, Fig. 5; Nos. 3 and 4, *H*, Fig. 5; 5 and 6, *L*, Figs. 5 and 6; 7, *N* Fig. 5 or *E*, Fig. 6. No. 8 (Fig. 7, *B*), tap water and iceberg lettuce, age 74 days. Nos. 9-16, foul media (Fig. 1, *N*) ages: No. 9, 306 days; 10, 80; 11, 97; 12, 165; 13, 168; 15, 70; 16, 280; No. 17 age 280 days; 18, 183 (from master control, Fig. 1, *O*). Nos. 19-25, ductless gland experiment (Fig. 6, *B*, *H*, *N*, *O*); No. 19, control (*B*), age 158 days; 20 (*N*), 196; 21 (*O*), 135; 22 (*O*), 165; 23 (*O*), 151; 24 (*N*), 135; 25 (*H*), 151.

crowded culture to competition for food, rather than to pollution of the media. The common occurrence of markedly dwarfed individuals reared in isolation (Fig. 1, *C, II, Nn*) and their sudden increase in growth at advanced ages (Fig. 1, *C, II*) makes the explanation of the factors involved in dwarfing and the response of the "dwarfs" and "giants" to good treatment (Fig. 8, *II, S*, and *O, C*) more obscure. However, it appears that the critical age at which this snail may be transferred from a crowded mass culture to standard isolation conditions and then attain normal adult size is near 150 days.

I have ascribed the retarded growth and highly convoluted shells of the eight snails fed endocrine glands (Fig. 6, *II, N, O*; 9, Nos. 20-25) to pollution of the media brought about by decomposition of gland tissue and flour rather than to direct results following ingestion of the gland mixture. It is to be regretted that these results are based upon so few experiments and that flour controls were not raised. The relation of age to the amount of shell distortion indicates that if pollution factors are responsible for the dwarfed, convoluted shells, those factors resulting from the decomposition of excrement (Fig. 1, *N*) are less potent than those resulting from decomposition of desiccated glands and flour (Fig. 6) as may be seen by comparing Nos. 9-16 with Nos. 20-25, particularly No. 12 with No. 22, which are the same age, in Fig. 9. Since for the last two years I have been successful in maintaining stock animals in crowded culture by keeping the aquaria well supplied with *Daphnia*, which markedly retard pollution, it appears probable that different results might be obtained by feeding certain endocrine glands to snails kept in much larger volumes of *Daphnia* stocked media.

The experiments described in this paper show that markedly retarded growth in the presence of adequate food is normally accompanied by pollution in any reasonable volume of media. Thus, after all, in the growth of this snail, pronounced effects of crowding are chiefly expressions of foul media.

CONCLUSIONS.

1. A method of rearing pond snails in the laboratory for experimental purposes is described.

2. A diet composed of lettuce, boiled wheat grains and filter paper produced the best results in growth and in number and viability of eggs laid, provided the medium was favorable.

3. Food insufficiency and foul media are the most common growth inhibiting factors in snails reared in otherwise favorable media.

4. Extreme crowding markedly retards growth, but the individuals rapidly reach the norm after being isolated under standard conditions unless too old at this time, when they may fail to reach normal adult size.

5. Volume of medium appears to have relatively little effect on the growth of isolated snails, provided foulness is not permitted.

6. *Daphnia* introduced into the media markedly retard fouling in stock cultures.

7. Aëration promotes growth through reducing foulness of medium, by oxidizing decaying substances, but has no appreciable respiratory significance, since these animals normally breathe atmospheric oxygen.

8. Direct sunlight does not appear to increase the growth-rate over that of sunlight which has passed through plate glass.

9. There is no evidence that dwarfing produced by unfavorable culture conditions is transmitted.

LITERATURE CITED.

Baker, F. C.

'11 The Lymnæidæ of North and Middle America, Recent and Fossil. Chicago Acad. Nat. Sci., Special Pub. No. 3.

Coker, R. E., A. F. Shira, H. W. Clark and A. D. Howard.

'22 Natural History and Propagation of Fresh-water Mussels. Bull. U. S. Bur. Fisheries, Vol. 37 (Document 893): 75-182.

Colton, Harold S.

'12 *Lymnæa columella* and Self-Fertilization. Proc. Acad. Nat. Sci., Philadelphia, 64: 173-82.

Crabb, Ed. D.

'27a Genetic Experiments with Pond Snails, *Lymnæa* and *Physa*. Amer. Nat., 61: 54-67.

Crabb, Ed. D.

'27b The Fertilization Process in the Snail, *Lymnæa stagnalis appressa* Say. BIOL. BULL., 53: 67-109.

Diver, C. C.

'25 Inheritance of Inverse Symmetry in *Limnæa peregra*. Jour. Genetics, 15: 113-200.

De Vorges, Domet.

- '03 Note sur l'utilisation des sels calcaires de l'eau par les Mollusques. Bull. Soc. Zoöl. France, 28: 149-150.

Ellis, Arthur Erskine.

- '26 British Snails. A Guide to the Non-marine Gastropoda of Great Britain and Ireland, Pliocene to Recent. Clarendon Press.

Greenleaf, W. E.

- '26 The Influence of Culture Medium and Cell Proximity on the Rate of Reproduction of Infusoria. Jour. Exp. Zoöl., 46: 143-167.

Hoffmann, H.

- '27 Physiologie. C. Wachstum. Bronns Klassen u. Ordnungen des Tier-Reichs. 3 (Buch 3): 1101-1108.

Hogg, Jabez.

- '54 Observations on the Development and Growth of the Water-snail (*Limneus stagnalis*). Trans. Microsc. Soc. of London in Quart. Jour. Microscop. Sci., N.S., 2: 91-103.

Hurst, Clarence T.

- '27 Structural and Functional Changes Produced in the Gastropod Mollusk, *Physa occidentalis*, in the Case of Parasitism by the Larvæ of *Echinostome Revolutum*. Univ. of Calif. Pub. Zoöl., 29 (14): 321-404.

Isely, Frederick B.

- '14 Experimental Study of the Growth and Migration of Fresh-water Mussels. Report U. S. Commissioner of Fisheries, 1913 (Appendix III).

Kulagin, N.

- '99 Zur Biologie der Infusorien. Le Physiologiste russe, 1.

Legendre, R.

- '07 Sur un facteur important du nonisme expérimental: les excréta. C. R. Assoc. Française p. l'avance. d. Sciences, 36^e Session (Reims, part 2): 607-610.

Legendre, R.

- '08 Recherches sur le nanisme expérimental. Influence des excréta. Arch. de Zoöl. Exp. et Gen., 4 Ser. 8 (Notes et Revue, No. 3), pp. lxxxix-lxxxiv.

Mozley, Alan.

- '28 The Variation of *Lymnaea traskii* Tryon in Pond and Lake Habitats. Amer. Nat., 62: 286-288.

Popovici-Bazosanu, A.

- '21 L'influence de quelques facteurs sur l'accroissement des gastéropodes d'eau douce. Arch. Zoöl. Exper., 60: 501-521.

Robertson, T. B.

- '23 The Chemical Basis of Growth and Senescence. J. B. Lippincott Co.

Semper, Carl.

- '74 Ueber die Wachstums-Bedingungen des *Lymnaeus stagnalis*. Arbeiten aus dem zoologisch-zootomischen Institut im Wurzburg, 1: 137-167.

de Varigny, Henri.

- '94 Recherches sur le nanisme expérimental, contribution à l'étude de l'influence du milieu sur les organismes. Jour. d'Anatomie et Physiol. (30^e ann.): 147-188.

Vernon, H. M.

- '95 The Effect of Environment on the Development of Echinoderm larvæ, an Experimental Inquiry into the Causes of Variations. Philos. Trans., 186 (B): 577-632.

Vernon, H. M.

- '99 The Relations Between Marine Animal and Vegetable Life. Mittheilungen a.d. Zool. Stat. z. Neapel 13: 341-425.

Vernon, H. M.

- '03 Variation in Animals and Plants. Henry Holt & Co., New York.

Warren, Ernest.

- '00 On the Reaction of *Daphnia magna* (Straus) to Certain Changes in its Environment. Quar. Jour. Microsc. Sci., 43: 199-244.

Weymouth, F. W., H. C. McMillin and H. B. Holmes.

- '26 Growth and Age at Maturity of the Pacific Razor Clam *Siliqua patula* (Dixon). Bull. U. S. Bur. Fisheries (Document No. 984): 201-236.

Whitefield, R. P.

- '82 Description of *Lymnaea (Bulimnaea) megasoma* Say, with an Account of Changes Produced in the Offspring by Unfavorable Conditions of Life. Bull. Amer. Mus. Nat. Hist. 1 (2): 29-37.

Willem, Victor.

- '96 Observations sur la respiration cutanée des Limnees et son influence sur leur croissance. Bull. de l'Acad. Roy. des Sciences, des Beaux-Arts de Belgique, 66^{me} Année, 3^{me} Sér., 32: 563-577.

Woodruff, L. L.

- '11 The Effect of Excretion Products of *Paramecium* on its Rate of Reproduction. Jr. Exp. Zoöl., 10: 557-581.

Woodruff, L. L.

- '13 The Effect of Excretion Products of Infusoria on the Same and on Different Species, with Special Reference to the Protozoan Sequence in Infusions. Jour. Exp. Zoöl., 14: 575-582.

Yung, Emile.

- '85 De l'influence des variations du Millieu physico-chimique sur le developement des animaux. Arch. d. Sci. Phys. et Nat., 14: 502-522.

PERMEABILITY DIFFERENCES BETWEEN NUCLEAR
AND CYTOPLASMIC SURFACES IN
AMÆBA DUBIA.

YUN-ICHI MORITA AND ROBERT CHAMBERS,

LABORATORY OF CELLULAR BIOLOGY, DEPARTMENT OF ANATOMY, CORNELL
UNIVERSITY MEDICAL COLLEGE, NEW YORK CITY.

Fresh water amebæ readily stain with the pH indicator, methyl red (1). Not only is the hyaline cytoplasm colored yellow with the dye but also the nucleus, the contractile vacuole and the various cytoplasmic inclusions. This occurs within a few minutes in a concentration prepared by adding 1 cc. of the standard 0.4 per cent. Clark and Lubs solution of the dye (Hynson, Westcott and Dunning) to about 8 cc. of the culture water. In this mixture the amebæ survive for over twenty-four hours with no appearance of being injured.

The fact that the yellow color is the color of the alkaline range of the dye ¹ suggested the possibility of testing the penetrability of hydrochloric acid into the nucleus from the cytoplasm of the ameba. It is already known that the living cell-membrane is impermeable to hydrochloric acid but it is not known whether the acid, when once introduced into the cytoplasm, will pass through the surface membrane of the nucleus.

The various structural components of amebæ immersed in a solution of methyl red take up the dye at different rates. The hyaline cytoplasmic matrix is the first to color yellow, then the nucleus, and finally the contractile vacuole and the food vacuoles. The food vacuoles, however, always remain distinctly paler than the contractile vacuole.

EXPERIMENTAL RESULTS.

I. *Amebæ Stained with Methyl Red and Immersed in Solutions of Hydrochloric Acid.*

Amebæ, stained yellow with methyl red and then immersed in concentrations of N/1,600 and N/3,200 of HCl, usually became

¹ An aqueous solution of methyl red is yellow in its alkaline and red in its acid range. The turning point of the color is at the pH of about 5.5.

injured within 2-5 minutes. The injury was made apparent by a sudden change in color from yellow to red of a localized area which was quickly pinched off. Every few minutes this process was repeated so that the healthy remnant of the Ameba became successively smaller until the entire ameba was killed. In a moving ameba the first part to be injured was the tip of an extending pseudopodium. This phenomenon was best observed when the amebæ are placed in concentrations of $N/400$ to $N/800$ HCl, where the injury usually manifested itself within a couple of minutes, and in amebæ which put out large pseudopodia. In such cases there was a rapid flow of the yellow protoplasm to the tip of the pseudopodium where a small red spot suddenly appeared. The red color increased in extent as the injury effect spread. Usually the injured area is pinched off before the entire ameba becomes involved.

In strong solutions of the acid, *e.g.*, $N/200$, the injury quickly spreads from several spots on the surface of the ameba with the result that the entire ameba is killed before any pinching-off process can occur.

2. *Injection of Hydrochloric Acid into Stained Amebæ.*

An amount of approximately the volume of the nucleus of $N/200$ HCl or stronger was injected into the cytoplasm in the vicinity of the colored nucleus. The nucleus and the cytoplasm, about the site of the injection, immediately changed in color from yellow to red and the entire red mass, consisting of the injured cytoplasm and the nucleus, were then pinched off and discarded by the ameba.

With a more dilute concentration of HCl ($N/400$) the effect is not so drastic so that a reversible reaction could frequently be obtained. A small amount of $N/400$ HCl was micro-injected into a stained ameba, the tip of the micropipet being directed toward the nucleus at a distance of about half the diameter of the nucleus. Immediately after the injection the cytoplasm about the tip of the pipet turned red, after which the color of the nucleus likewise became red. The yellow color of the nucleus changed to red in a wave which spread from the border near the site of the injection. Within one or two seconds the red

color of both cytoplasm and nucleus returned to the original yellow. The reversion in color always occurred more rapidly in the nucleus than in the cytoplasm. The change in color of the nucleus from yellow to red and back to yellow was unaccompanied by any appreciable morphological change such as occurs when the nucleus is irreversibly injured.

Amebæ, in which the reversible reaction had been noted, were kept under observation for several days during which time they appeared to be quite normal.

3. *Injection of the Acid into Stained Amebæ in the Vicinity of the Contractile Vacuole.*

Injection of hydrochloric acid in the vicinity of the contractile vacuole produced no change in color of the interior of the vacuole unless the concentration of the acid is enough to cause irreversible injury. This is in marked contrast to the ease with which the nucleus changes in color and suggests that the membrane of the contractile vacuole, in this one respect, differs from that of the nucleus but is similar to that on the surface of the ameba. An alternative to this suggestion is that the HCl does enter but that the content of the vacuole is too highly buffered to be affected by the acid. However, the results of recent work (2) indicate that the concentration of dissolved substances in the vacuole is fairly low and that its content is mainly water.

SUMMARY.

1. *Immersion Experiments.*

Amebæ, stained yellow with methyl red and immersed in solutions of HCl, exhibit injury effects by a sudden change in color from yellow to red in localized regions on the periphery. These regions are pinched off and discarded. In a moving ameba this injury first occurs at the tip of the extending pseudopodia.

2. *Injection Experiments.*

Sublethal concentrations of HCl which do not penetrate the ameba from without, will, when injected into the cytoplasm, readily diffuse into the nucleus without causing irreversible injury. On the other hand, the wall of the contractile vacuole

appears to be similar to that of the plasmalemma of the amoeba in regard to the nonpenetrability of HCl.

BIBLIOGRAPHY.

1. **Chambers, R.**

'28 Intracellular Hydrion Concentration Studies. I. The Relation of the Environment to the pH of Protoplasm and of its Inclusion Bodies. BIOL. BULL. 55,369.

2. **Howland, R. B., and Pollack, H.**

'27 Micurgical Studies on the Contractile Vacuole. I., II. J. Exp. Zool., 48, 441.

THE CULTURE OF *AMŒBA PROTEUS* IN A KNOWN SALT SOLUTION.

D. L. HOPKINS¹ AND PERCY L. JOHNSON.

(Contribution from the Zoölogical Laboratory of The Johns Hopkins University,² October, 1928.)

INTRODUCTION.

Many methods³ have been described for the culture of *Amœba proteus*; but in them very little attention has been directed to the salt composition of the media used. The method adhered to in this laboratory for several years is described by Edwards ('23). It consists of adding a few short pieces of timothy hay to spring or distilled water in finger bowls with subsequent inoculation with amœbæ and *Chilomonas*. Hopkins ('26), however, has shown that for certain types of physiological work this method is not satisfactory since the salt and H-ion concentrations do not remain constant. To obviate these difficulties he raised amœbæ in a modification of Ringer solution supplemented by a daily feeding schedule. Later he used another modification of Ringer solution which contained only the chlorides of calcium, sodium and potassium with a phosphate buffer, pH 6.6 (Hopkins, '28). In this solution it was found that the amœbæ could be raised only after a considerable period of adaptation. Amœbæ from a culture of any other composition placed into this solution, disappeared.

Aside from the adaptation process there was still another difficulty of equally as great importance. Hay contains considerable salt so that when it is added to cultures the inorganic compositions are altered in an unknown way. Roberts ('26) presents a salt analysis of timothy hay which will suffice to illustrate the salt composition (Table I.). The salt content of timothy hay is not always constant, varying from six to eight

¹ National Research Fellow.

² The authors are indebted to Professor S. O. Mast for helpful criticism and advise.

³ Dawson ('28) gives a thorough review of this literature.

per cent. ash, depending upon the environmental conditions, *e.g.*, climate, altitude, etc.

TABLE I.

Salts	Per Cent. Dry Weight.
Total ash.....	7.70
Silica free.....	4.00
P ₂ O ₅	0.4712
CaO.....	0.3942
Fe ₂ O ₃	0.0393
Na ₂ O.....	0.0023
K ₂ O.....	2.375
Cl.....	0.239

It appears from this analysis of the inorganic composition that a considerable amount of physiologically active substances is introduced into amœbæ cultures with the hay, thus causing alterations in the composition of the culture media. An attempt was made, therefore, in the experiments described in the following pages, first, to remove the salts from the hay and then to adjust the salt composition favorably for the growth of amœbæ and yet to control the H-ion concentration.

METHODS AND RESULTS.

Two methods were used to extract salts from timothy hay, *A* and *B*.

A. Since hay contains protein probably in the form of ampholytes, it is expected that it holds salts in combination which are not removed when extracted with distilled water. The procedure adopted by Loeb ('22) for extracting the salts from gelatin when the H-ion concentration has a value equal to the isoelectric point of the ampholyte, was applied to timothy hay. The method used follows: 75 gm. hay were ground in a meat chopper and extracted two times with 1.5 liters of distilled water. The hay was then added to 1.5 liters of distilled water and the mixture brought to a H-ion concentration of pH 8.0 by the addition of 60 cc. *M*/20 KOH, then the solution was filtered off. After washing with distilled water the hay extract had a H-ion concentration of pH 6.6. Following this, more distilled water was added and the H-ion concentration increased to pH 4.5 by the addition of 10 cc. *M*/5 HCl. The acid was then washed out until the filtrate had a H-ion con-

centration of pH 5.8. The hay was then dried at a temperature of 50°. After burning a sample of this hay it was found that only 1.1 per cent. of the total dry weight remained as ash.

B. In extracting the salts from the hay as described above, considerable organic substance was removed. In order to avoid this, another method was resorted to which afforded better results. This method of electro-dialysis was used by Livingston ('07) for separating electrolytes from non-electrolytes in manure extracts. The apparatus used is represented in Fig. 1. In this

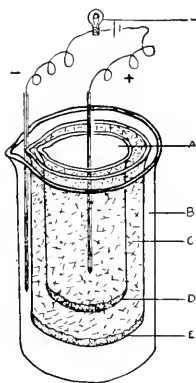

FIG. 1. Apparatus for dialyzing timothy hay. *A*, inner chamber containing distilled water into which is inserted the anode of the electric circuit; *B*, outer chamber containing distilled water into which is inserted the cathode; *C*, middle chamber containing finely ground hay; *D*, and *E*, collodion membranes (the collodion imbedded in bolting cloth for support); *L*, carbon lamp in the circuit to increase the resistance.

apparatus when the circuit¹ is closed the cations collect at the negative pole and the anions at the positive pole, leaving the undialyzable material behind. Frequently the acid and basic solutions formed at the two electrodes were replaced by distilled water. The dialysis was carried on for three days.² The hay was then dried in an oven at 50° C., after which a sample was tested and the ash content found to be 1.3 per cent. Since owing to the relative immobility of silicon ions it is very probable that 75 per cent. of the inorganic substances remaining in the

¹ A P. D. of 55 V. is best.

² Since it is difficult to prepare the collodion membranes, in the way used here, so that they will not leak, the use of diffusion shells is more practicable.

hay after dialysis consisted of silicon compounds and these are very inactive physiologically. This method of removing the salts appears to be very satisfactory.

This hay with very much reduced salt content was now used to culture amœbæ. We tried various mixtures containing different concentrations of the chlorides of calcium, sodium, potassium, and potassium phosphate buffer. After a number of attempts we found a mixture which on the first trial gave satisfactory results in all of fifteen cultures; the amœbæ on being placed in these cultures multiplied rapidly until at the end of two weeks each culture contained amœbæ in considerable numbers. The composition of this mixture is given in Table II.

TABLE II.

SOLUTION I.

CaCl ₂02219 gm.....	.0002 M.
NaCl.....	.23380 gm.....	.004 M.
KOH.....	.0499 gm.....	.00088 M.
KH ₂ PO ₄34030 gm.....	.0025 M.
Dialized hay extract.....	10 cc.	
H ₂ O.....	to 1,000 cc.	

This mixture was ordinarily prepared by making a solution of the first two mentioned salts thirty times as concentrated, then taking 33.3 cc. of this and adding to it 50 cc. of Clark and Lubb's phosphate buffer 6.6 (with KOH instead of NaOH); to this was added 2 gm. of the dialyzed hay, 10 cc. of the resulting dialyzed hay extract, a liberal amount of centrifuged *Chilomonas* or better *Colpidium* grown on the same media and distilled water to make 1,000 cc. The cultures made up in finger bowls, 100 cc. solution to a dish, were then inoculated with *Amœba proteus*.

The original success with this medium seems to have been accidental, since subsequent attempts to culture amœbæ in the medium were not universally successful. If fresh cultures were inoculated with amœbæ from the original fifteen cultures they were as successful as the originals, but if inoculated with amœbæ from spring water cultures uninterrupted growth and reproduction occurred in a relatively few cases. Therefore, it was concluded that in the inoculation of the original fifteen cultures, amœbæ were used, which accidentally happened to be in the right physiological condition, perhaps the culture from which

they were obtained had nearly the same composition as the new medium.

For inoculation with amœbæ from ordinary dilute spring water cultures, the buffer in the medium of Table II. appears to be too concentrated. Therefore, in order to insure success with amœbæ from dilute cultures, it is necessary to reduce the amount of buffer considerably, inoculate with amœbæ, then gradually increase the amount of buffer until sufficient buffer is present to keep the H-ion concentration constant. To do this the buffer content of the medium was reduced to 5 cc. standard buffer per 1,000 cc. medium and inoculated with amœbæ from ordinary spring water cultures. In the medium with this reduced buffer content, a high degree of success was obtained, in over 70 per cent. of the cultures, the amœbæ on being placed in it continued to grow and multiply such that within two weeks great numbers of amœbæ were present in the cultures. Then 10 cc. of standard buffer was added per 1,000 cc. culture. This addition did not noticeably affect the rate of growth and multiplication. In this manner by adding the buffer gradually healthy cultures of amœbæ, rapidly dividing by fission, could always be obtained, which contained sufficient buffer to hold the H-ion concentration constant, namely, 50 cc. standard buffer per 1,000 cc. culture.

DISCUSSION.

In making up a 100 cc. culture with solution I., .2 gm. of hay is added. If this hay is undialyzed it contains approximately 8 per cent. salts or 0.016 gm. salts of an unknown nature. The weight of the known salts in 100 cc. of solution I. is 0.0647 gm. Therefore, if undialyzed hay is added, the unknown salt concentration of the culture is 19.9 per cent. of the total salts present. When .2 gm. of dialyzed hay, having from 1.0 to 1.4 per cent. inorganic material in it, is added in place of the undialyzed hay, there is introduced only from .002 to .0028 gm. unknown salts, *i.e.*, 2 to 3 per cent. As stated above since it is probable that the greater amount of the salts left in the dialyzed hay is silicon compounds, those that are left have little physiological effect.

SUMMARY.

A medium, the inorganic composition of which is accurately known, was devised, in which *Amœba proteus* grows and multiplies rapidly. By adding potassium phosphate buffer gradually, so as to allow time for adaptation on the part of the amœbæ a concentration of buffer may be added which is sufficient to hold the H-ion concentration constant and yet not interfere with the growth and multiplication of the amœbæ.

BIBLIOGRAPHY.

Dawson, J. A.

'28 The Culture of Large Free-living Amœbæ. *Am. Nat.*, Vol. 62, pp. 453-466.

Edwards, J. G.

'23 The Effect of Chemicals on Locomotion in *Amœba*. I. Reactions to Localized Stimulation. *Jour. Exp. Zoöl.*, Vol. 38, pp. 1-44.

Hopkins, D. L.

'26 The Effect of Hydrogen ion Concentration on Locomotion and Other Life-processes in *Amœba proteus*. *Proc. Natl. Acad. Sci.*, Vol. 12, pp. 311-315.

Livingston, B. E.

'07 Further Studies on the Properties of Unproductive Soils. U. S. Dept. Ag. Bureau of Soils. *Bull. No. 36*, p. 51.

Loeb, Jacques.

'22 *Proteins and the Theory of Collodial Behavior*. First Edition, New York. 292 pp.

Roberts, E. N.

'26 Wyoming Forage Plants and their Chemical Composition. *Studies No. 7*, Univ. Wyoming Ag. Exp. Stat. *Bull. No. 146*, p. 35.





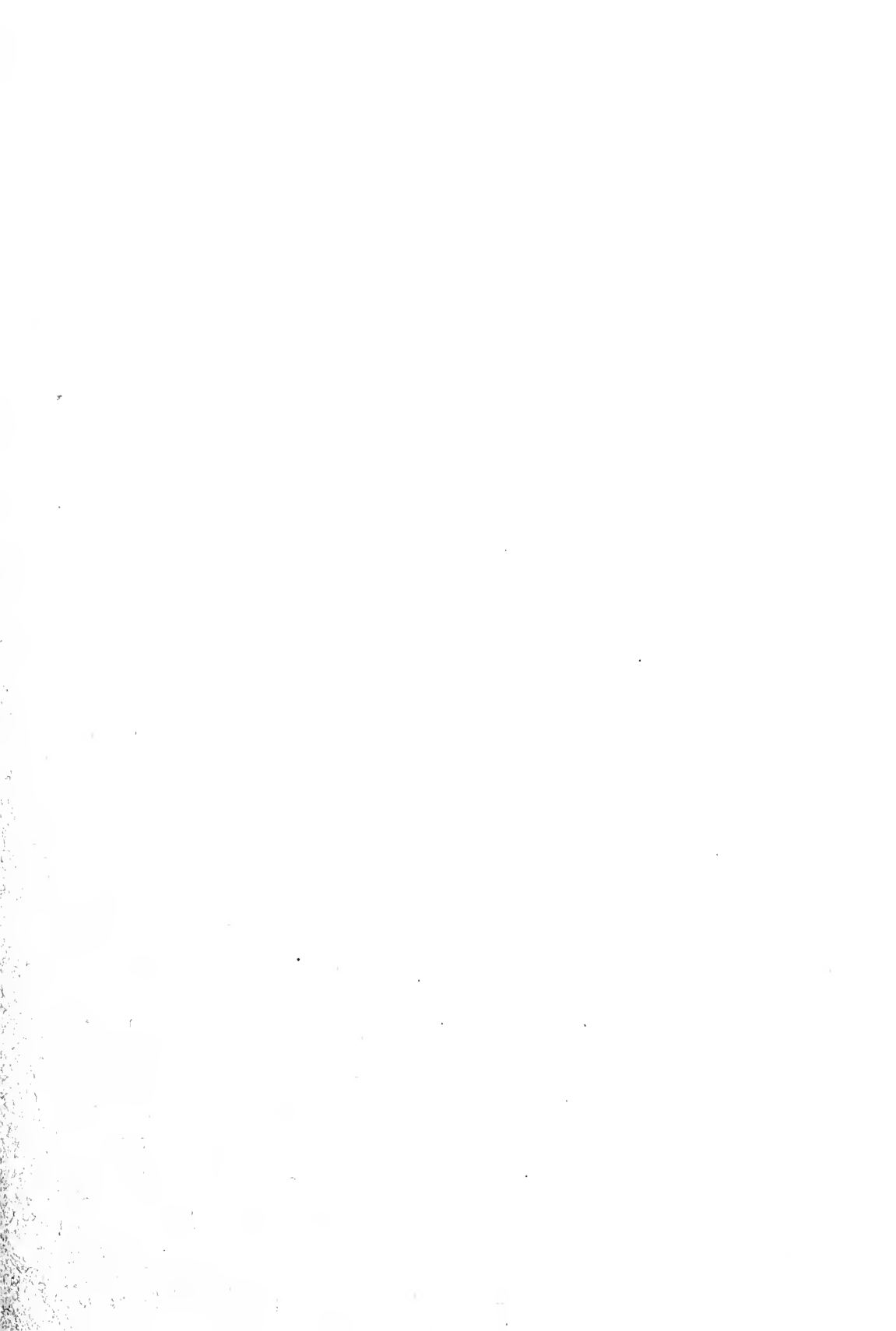

BIOLOGICAL BULLETIN

OF THE

Marine Biological Laboratory

WOODS HOLE, MASS.

VOL. LVI

FEBRUARY, 1929

No. 2

CONTENTS

- | | | |
|--|--|-----|
| OKADA, YÔ K. | <i>Supplementary Note on the Double Formation in the Echinus Germ in Diluted Sea Water</i> | 75 |
| DAWSON, J. A., AND
BELKIN, MORRIS | <i>The Digestion of Oils by Amœba proteus</i> | 80 |
| BUTCHER, EARL O. | <i>The Origin of the Germ Cells in the Lake Lamprey (Petromyzon marinus unicolor)</i> | 87 |
| FRY, HENRY J. | <i>The So-called Central Bodies in Fertilized Echinarachnius Eggs</i> | 101 |
| NABOURS, ROBERT K., AND
FOSTER, MARTHA E. | <i>Parthenogenesis and the Inheritance of Color Patterns in the Grouse Locust Paratettix texanus Hancock</i> | 129 |

PUBLISHED MONTHLY BY THE
MARINE BIOLOGICAL LABORATORY

PRINTED AND ISSUED BY
LANCASTER PRESS, INC.
LANCASTER, PA.

AGENT FOR GREAT BRITAIN
WHELDON & WESLEY, LIMITED

2, 3 and 4 Arthur Street, New Oxford Street, London, W. C. 2

Single Numbers, \$1.00. Per Volume (6 numbers), \$4.50

Editorial Staff

GARY N. CALKINS—*Columbia University.*

E. G. CONKLIN—*Princeton University.*

M. H. JACOBS—*University of Pennsylvania.*

FRANK R. LILLIE—*University of Chicago.*

GEORGE T. MOORE—*The Missouri Botanic Garden.*

T. H. MORGAN—*Columbia University.*

W. M. WHEELER—*Harvard University.*

E. B. WILSON—*Columbia University.*

Managing Editor

C. R. MOORE—*The University of Chicago.*

All communications and manuscripts should be sent to the Managing Editor, the University of Chicago. Subscriptions and other matter should be addressed to the Biological Bulletin, Prince and Lemon Streets, Lancaster, Pa.

BIOLOGICAL BULLETIN

SUPPLEMENTARY NOTE ON THE DOUBLE FORMATION IN THE *ECHINUS* GERM IN DILUTED SEA WATER.

YÔ K. OKADA

NABA, HYOGO-KEN (JAPAN).

“The eggs of sea-urchins absorb so much water in the diluted sea water that their membranes burst and part of their protoplasm flows out. The eggs then consist of two connected spheres of protoplasm, as the extruded part of protoplasm in consequence of its surface tension assumes a spheric form, as does the protoplasm remaining behind inside the membrane.” On treating the eggs of *Arbacia* 10 minutes after fertilization with sea water, to which 100 per cent. of its volume of distilled water had been added, and on replacing them in ordinary sea water, J. Loeb (1894) had the good fortune to obtain double or triple larvæ developed from the egg with extra-ovates. The experiments were repeated by B. Rawitz (1896) at Rovigno with the eggs of *Strongylocentrotus*, by F. A. Janssens (1904) at Naples with the eggs of *Arbacia*, and by N. Yatsu (1910) with those of Neapolitan *Echinus*, *Arbacia* and *Strongylocentrotus*. All obtained extra ovates but did not succeed in getting multiple embryos.

Doubt has been cast upon this part of Loeb's account of the artificial production of twin embryos, but in 1926 G. Fadda not only confirmed the double gastrulation in the eggs with extra-ovates, but theoretically demonstrated the causes of its occurrence. ‘Wenn die Blastomeren nur einer einzigen Kugel angehören, wird die Differenzierung eine einheitliche sein, weil alle andere nachfolgenden Blastomeren an der ersten dicht anliegen können. Wenn aber eine Einschürung von einem gegebenen Grade gewisse Blastomeren verhindert, von einer Krümmung zur anderen überzugehen, dann werden zwei Punkte der Differ-

enzierung entstehen, durch die Einschnürungsfurche getrennt, so dass auf diese Weise die Bildung einfacher oder doppelter Embryonen von der Tiefe dieser Furche und mithin vom Durchmesser der — — — — beiden abgeschnürten Teile abhängt." Applying the formula of Giglio-Tos—

$$\delta = \sqrt{\frac{r^2 + r'^2}{2}}$$

so far as δ remains larger than half of the square root in the sum of squares of the diameters of both parts, namely that of the egg (r) and that of the extra-ovate (r'), the embryonic formation will be simple, while when δ becomes smaller than the value in question, the formation will be double. δ may be the same value as the right-hand side of the equation, and then the formation cannot be determined by this method; it is sometimes simple, sometimes double as the case may be.

Coming back to Yatsu's observations, the eggs with extra-ovates, though they failed to develop into multiple embryos, are still capable of dividing and "some in *Arbacia*, and all in *Strongylocentrotus*, cleaved more or less abnormally." Under the same treatment the fertilization membrane in the eggs of *Echinus* does not burst, and there is consequently no extra-ovation. "This is due" states Yatsu, "to the fact that in *Echinus* the space between the egg and the membrane is so wide that the turgid egg does not reach the membrane while in a hypotomic solution."

According to M. Konopacki (1918) such eggs of *Strongylocentrotus lividus* "können sich bis zum Larvenstadium in einer aus 70 Teilen Seewasser und 30 Teilen Süßwasser bestehenden Lösungen entwickeln" but "in einer Lösung 60/40 können sie kaum drei bis vier Furchungen durchlaufen."

The eggs of the Japanese *Strongylocentrotus* (*S. plucherimus*) show still stronger resistance to the dilution of sea water with distilled water than the European form does, and I have got plutei (if not entirely normal ones) even in a mixture of 14 parts of sea water and 6 parts of distilled water, *i.e.*, about 37 per cent. of distilled water against only 23 per cent. in Konopacki's experiment.

Up to a dilution of 10 per cent. of distilled water, the eggs of *Strongylocentrotus plucherimus* develop normally and the plutei formed do not differ from those grown in the normal medium. Plutei developed in a solution of 14 parts of sea water and 6 parts of distilled water are without arms, but the structure of their alimentary tract and body skeleton is quite normal. Unexpectedly, only in those lots in 16 parts of sea water plus 4 parts of distilled water there appears an interesting monstrosity. In three of my experimental glasses, more than one third of the larvæ all have the same abnormality, the posterior part of their body being widened, and more or less bifid. Such a larva has generally double sets of the body rods in its skeletal framework, while in the anterior part the ciliary bands, the arms, as well as the alimentary tract, remain normal as in the ordinary pluteus of the species. A representation of the larvæ is shown in Fig. 1a, which is sketched from the living, with a camera lucida.

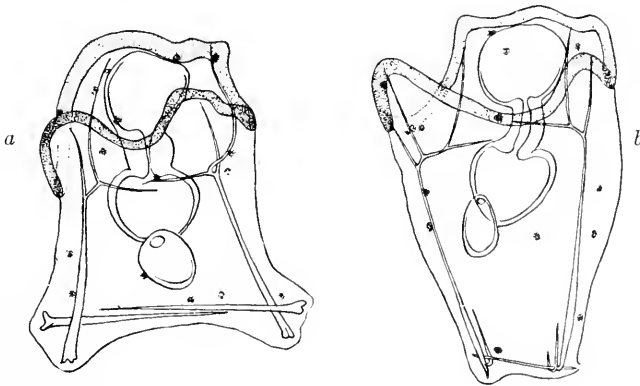

FIG. 1.

Besides the monsters just mentioned there were in another glass, larvæ in which the abnormality was not so pronounced as before. One of these is shown in Fig. 1b. In this latter type, the posterior end of the body is neither so broad nor so distinctly bifid as in the first type, and there is only one extra spicule, which is transversely placed between two body rods at the posterior end of the body; the body rods in the normal larva approach closely to one another and one may even fall upon the other.

Comparing these two types of the abnormal plutei, it is easy

to suppose that the second type is a less modified condition of the first. The duplication of the plutei in this case is due to the appearance of an extra transverse bar of spicules connected with the process of widening the posterior part of the body. The single extra bar then divides into two, and each gives rise to an independent, extra body rod. It remains now for us to consider whether the extra transverse bar of spicules always appears when the posterior end of the pluteus widens or whether it is a special effect of the dilution of sea water with distilled water.

We can easily produce plutei, with a broader posterior extremity, by treating fertilized eggs of *Strongylocentrotus placherimus* for a certain time (before the blastula stage), with a weak Li-Cl solution, and then replacing them in normal sea water. Fig. 2 represents one such production. The posterior

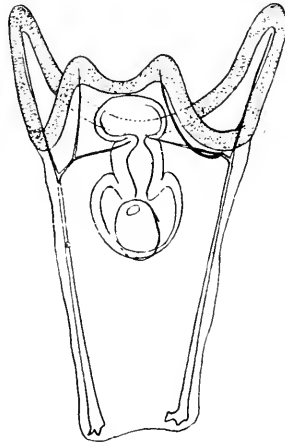

FIG. 2.

end of the pluteus is unmistakably widened, even more than in the second type of the preceding experiment, but there is no appearance of the extra transverse bar of spicules this time, nor, of course, of the extra body rods, which now may be considered specific to the dilution of sea water with distilled water.

A fairly large number of different types of double monsters have already been described in echinoid larvæ, but I do not know of another case of such partial bifurcation of the posterior

part of the body, with double sets of skeletons, and with the anterior part and the alimentary tract remaining entirely normal. Hence the reason for this small note, which also demonstrates that double formation is possible in the eggs of sea urchins, which have developed in diluted sea water, even when extra-ovates have not been produced.

REFERENCES

Fadda, G.

'26 Über die Bildung der Doppelebryonen. Arch. f. Entw'mech. Vol. 107, p. 213.

Janssens, F. A.

'04 Production artificielle des larves geantes et monstreuses dans l'*Arbacia*. La Cellule, Vol. 21.

Konopocki, u.

'18 Untersuchungen über die Einwirkung verdünnten See-wassers auf verschiedene Entwicklungs-Stadien der Echinoiden (*Strongylocentrotus lividus*). Arch. f. Entw'mech., Vol. 44, p. 337.

Loeb, J.

'94 Über eine einfache Methode Zwei oder mehr zusammenwachsene Embryonen aus einem Ei hervorzubringen. Pflüger's Arch., Vol. 55, p. 525.

Rawitz, B.

'96 Über den Einfluz verdünnter See-wasser auf die Furchungsfähigkeit der Seeigel Eier. Arch. f. Anat. u. Phys. (Phys. Abth.).

Yatsu, N.

'10 Extra-ovate Experiments on the Egg of Sea-urchin. Ann. Zool. Jap., Vol. F, p. 213.

THE DIGESTION OF OILS BY *AMÆBA PROTEUS*.

J. A. DAWSON AND MORRIS BELKIN,

ZOOLOGICAL LABORATORY, HARVARD UNIVERSITY.

In a previous paper by the writers ('28) an account was given of the digestion of various oils by *Amæba dubia*. The present account deals with a series of similar experiments performed under similar conditions in which the same oils were used with another species of large free-living ameba, *Amæba proteus* (Schaeffer, '16). The procedure in this work was in every respect identical with that used with *Amæba dubia*, except that none of the oils used in this series were radiated. In the previous account as well as in this no attempt to study the rate of break-down of the various oils has been made; the sole object has been to establish the fact that a considerable variety of oils has been definitely acted on by the amebæ. A study of the rate and nature of the break-down process is now in progress.

The result of this series of injections may be tabulated as follows:

TABLE I.

Oil.	No. of Amebæ Injected.	No. of Amebæ Digesting Oil.	Ave. Total Vol. in μ^3 Digested per Ameba.	Ave. No. Days Injected Amebæ Lived.	Ave. No. Days Control Amebæ Lived.
1. Codliver.....	17	7	27,600	7-8	7-8
2. Cottonseed..	20	7	22,300	7.5	7.5
3. Olive.....	21	13	13,000	10.9	10.1
4. Peanut.....	21	17	12,600	8.5	6.6
5. Sperm.....	23	10	9,600	8.0	8.0
6. Linseed.....	15	8	8,800	7.5	9.0
7. Oleic.....	28	9	6,400	6.4	6.0
8. Oxfoot.....	13	8	5,300	6.0	5.4
9. Nujol.....	17	0	0.	6.0	6.0

The outstanding fact in this series of experiments with *A. proteus* is the same as in the former series with *A. dubia*, i.e., that different oils are broken down. As can be seen by a comparison of the figures in the tables the relative digestibility of the

oils appears to differ in *A. proteus* and *A. dubia*. We wish, however, to point out that no great significance should be attached to these figures as such. They should be considered only in a broad relative aspect, although our observations lead us to the belief that distinctive differences do exist.

In any comparison of the relative volumes digested the respective volumes of the amoebae must be considered. The volume of *A. proteus* was determined by the same method as that used for *A. dubia*. The average of measurements of 50 representative amoebae gave an average volume of approximately $1,000,000\mu^3$.¹ If the ability of amoebae of these two species to break down oils is quantitatively similar it should be expected that the amounts of oil digested would be in the same ratio. The results indicate that *A. dubia* breaks down a greater volume of oil on the average than *A. proteus* although from the data given there is slight adherence to this ratio.

In the case of oleic acid and linseed oil (non-radiated in the *A. proteus* series as shown in Table 1 some digestion took place whereas none occurred in *A. dubia*. With nujol, an inert paraffin oil, as in the previous work no break-down was expected or found.

As can be seen from Table 1 there is no significant difference in most cases between the length of life of controls and experimental animals. In the case of olive and peanut oils the experimental animals lived longer on the average than the controls. In the case of linseed oil, non-radiated, the controls lived longer than the experimental animals. This effect with linseed oil may be due to the presence of traces of lead and other heavy metals which analysis showed to be present in the oil.

The entire process of breaking down of the oils in *A. proteus* is, so far as observation shows, entirely similar to the phenomenon in *A. dubia*. As in *A. dubia*, digestion did not take place in every case of injection (See Table 1). The reasons for the variation in digestion of any one oil among the individual amoebae are no doubt many; but important factors are the physiological condition of the amoeba as a whole and its immediate condition from a nutritive standpoint. Temperature conditions were the same for all cases. The temperature, however, was not controlled; all the experiments being done at room temperature which varied between 68° and 74° F.

So far as our observations and data warrant it thus appears that oils of diverse types are successfully broken down by both *A. proteus* and *A. dubia* in a similar manner. Further attempts are now in progress to ascertain the precise physiological nature of this reaction in these two species of amebæ.

SOME SIGNIFICANT DIFFERENCES BETWEEN *A. dubia* AND *A. proteus*.

The two species of large free-living amebæ which have been used by the writers in a preceding paper ('28) and in the present work were first adequately described by Schaeffer ('16). In a recent publication (Dawson, '28) mention has been made of the fact that in long-continued mass cultures the specific differences as pointed out by Schaeffer are retained. During the course of the micro-injection studies carried on by the authors a number of fundamental differences between these two species have been disclosed.

1. *Differences in the Ability to Break Down Oils.*

As has been pointed out above the two species of amebæ show some differences in their reactions to injected oils. *A. dubia* not only did not break down the oleic acid, oxfoot and linseed oils used in this series but retained these oils for relatively short periods after injection. *A. proteus* on the other hand, in numerous cases retained and broke down these same oils.

2. *Morphological Differences.*

From the very beginning of our work difficulties in manipulative technique when working with *A. proteus* indicated that the nature of the pellicle (outermost layer) differed from that of *A. dubia*. When attempting to inject *A. proteus* using a fairly fine pipette with a slender shaft (about 2-3 μ in diameter) bending of the pipette could be seen to take place, whereas in injection of *A. dubia* such bending rarely or never occurred. If a pipette of larger diameter (about 7-8 μ) was used the pellicle of *A. proteus* in direct contact with the pipette could invariably be seen to yield or give before the pipette until the two outermost layers of the ameba almost touched each other. Such a pipette could be used to

inject *A. dubia* with comparative ease, and with a minimum amount of yielding of the pellicle before the pipette as the latter was inserted into the amoeba. This would seem to indicate clearly that the pellicle of *A. proteus* is tougher than that of *A. dubia*. Our measurements have shown us that *A. dubia* is thicker in cross section than *A. proteus* ($70\ \mu$ vs. $40\ \mu$). We have found that *A. proteus* does not lend itself as easily to microinjection technique as *A. dubia*. The greater thinness of *A. proteus* and the toughness of its pellicle may account largely for this difficulty.

3. Capping.

Early in the work of injecting oil in *A. dubia* an interesting phenomenon was encountered. In many unsuccessful attempts at injection it appeared that the oil, instead of being injected into the organism, was merely brought into intimate contact with the outermost surface of the amoeba. When the pipette was withdrawn the oil did not become dislodged from the surface of the amoeba as might be expected but continued to remain attached to it, usually assuming roughly the form of a slightly concave hemisphere with the concave face in contact with the amoeba. Whenever this occurred there was instant and typical response on the part of the organism. The protoplasm in contact with the oil extruded to form a pseudopodium, with the oil giving superficially the appearance of adhering to it at its outermost tip, and the main body of the amoeba continued to flow into this pseudopodium. In about 30 seconds the entire amoeba had assumed the form of the type known as *A. limax* and its endoplasmic streaming and nature of locomotion were in practically every respect identical with or markedly similar to that of an amoeba of the "limax" type. In every case the amoeba progressed so that the oil was pushed in advance, never dragged behind. This phenomenon the writers have termed "capping." The 'cap' might remain attached for days to the amoeba and there was little or no change in either its shape or that of the modified "limax" shape of the amoeba. Eventually either the cap was dislodged or the amoeba died with the oil still adhering. In no case was there ever noticed any action upon the oil by the amoeba which might be observed by appearance of oil in the amoeba or by decrease in the size of the cap. This "capping" is

fairly easy to accomplish with *A. dubia* and when once begun invariably goes on to completion. Within one second the cap is formed and the ameba begins to assume the "limax" form immediately. With *A. proteus*, however, in no instance has a cap ever been successfully completed to remain lodged for more than a few minutes on the anterior end of the ameba as is the case in *A. dubia*. In the case of *A. proteus* only the first beginnings of the process take place; the oil when in contact with the ameba results in the formation of a very small pseudopod which protrudes in a manner very similar to that of *A. dubia* but which in a few seconds or, at most, minutes loses its contact with the oil and flows back into the main body of the ameba.

It was found that these caps as described in the preceding paragraph could be formed very frequently if a droplet of oil was forced out of the pipette but permitted to remain attached to it and then approximated to the ameba until it just came in contact and was allowed to remain thus for several seconds. If the oil was then very slightly retracted by withdrawing the pipette the capping process frequently went on to completion doing so with great speed (less than one second). For best results in obtaining caps the diameter of the droplet should not be more than approximately $50\ \mu$. An optimum size is from 25 to $30\ \mu$. If the droplet exceeded $50\ \mu$ in diameter there was only slight cap formation followed almost immediately by the breaking away or the separation of the oil from the ameba.

4. Ingestion.

During the course of these attempts it was found that if the oil was permitted to remain in contact with the ameba without retraction for several seconds, the ameba reacted by flowing around and over the oil forming a normal food cup, and, when the pipette was gently withdrawn, complete ingestion of the oil took place. After ingestion the oil was moved about in the endoplasm behaving precisely like a droplet which had been injected and was subsequently broken down in exactly the same manner as after injection. It was found that for ingestion to take place the oil had to be supported against the pipette, for if the droplet was ejected into the medium directly in the path of the ameba the

latter extruded pseudopodia toward it but ingestion failed because the streaming pseudopodium pushed the oil away from it. That this difficulty was purely a mechanical one was proved by piercing the same droplet with the pipette and holding it firmly whereupon it was ingested by the ameba. Ingestion did not take place every time a droplet of suitable size was presented to an ameba. Sometimes the ingestion reaction would be repeated several times by the same ameba unsuccessfully, followed by successful ingestion on the presentation of the oil immediately following. As is well known the previous condition of the experimental protozoon in respect to nutrition controls in large part the response in regard to further food taking. Whether this is the case in respect to this phenomenon we are unable to state at present.

The optimum size of oil droplet for ingestion comprises all sizes up to $50\ \mu$. Very small droplets may be ingested but present technical difficulties, as they tend to adhere to the pipette and to be withdrawn from the ameba.

Contrasted with this reaction of *A. dubia* ingestion has never been accomplished with *A. proteus*. With this ameba there is only a very slight attempt at foodcup formation. *A. proteus* always moves away from the oil even when the droplet is brought into contact with the animal and held so for several seconds.

The breakdown of ingested droplets in *A. dubia* takes place so far as observation and quantitative data show in precisely the same way as with injected droplets. So far, ingestion experiments have been carried on with five oils, viz., nujol, olive, codliver, sperm and cottonseed. *A. dubia* ingested all of these oils in the same way. In no case of ingestion of oil droplets was a vacuole ever formed about the oil. Likewise no vacuole was ever formed about any injected oil drop.

5. Comparative Length of Life of Controls.

The behavior of these two species of ameba when placed in distilled water as controls was markedly different from the standpoint of length of survival. *A. dubia* lived on the average from 4 to 5 days under these conditions at room temperature. None survived beyond six days. The average length of life for *A. proteus* under the same conditions was from 7 to 8 days with cer-

tain series living up to 11 days, and with numerous instances of individuals living for 18 days. This indicates a greater degree of hardiness on the part of *A. proteus* which is fully substantiated by experience in the mass culture of both these organisms.

SUMMARY.

1. *A. proteus* successfully breaks down, after micro-injection, the following oils: codliver, cottonseed, olive, peanut, sperm, linseed, oleic, oxfoot.

2. A number of significant differences have been found between *A. dubia* and *A. proteus*.

a. In their respective ability to break down oils.

b. Morphological differences as revealed by injection, measurement of volume and nature of pellicle.

c. Under certain conditions *A. dubia* undergoes the phenomenon of 'capping' with oil. No permanent "capping" ever takes place with *A. proteus*.

d. *A. dubia* will under suitable conditions ingest oil. *A. proteus* under similar conditions never ingests oil.

e. *A. proteus* has the ability to live longer under similar adverse conditions than *A. dubia*.

LITERATURE CITED.

Dawson, J. A.

'28 The Culture of Large Free-living Amebæ. Amer. Nat., Vol. 62, 453-466.

Dawson, J. A., and Morris Belkin.

'28 The Digestion of Oils by *Amæba dubia*. Proc. Soc. Exp. Biol. and Med., Vol. 25, 790-793.

Schaeffer, A. A.

'16 Notes on the Specific and Other Characters of *Amæba proteus* Pallas (Leidy), *A. discoides* spec. nov., and *A. dubia* spec. nov. Arch. f. Protistenk., Bd. 37, 204-228.

¹ Due to error the volume of *A. dubia* was given as 500,000 μ^3 . This should be 2,500,000 μ^3 . Thus the percentages given in Table 1, column 4, in our previous paper should be multiplied by 0.2.

THE ORIGIN OF THE GERM CELLS IN THE LAKE
LAMPREY (*PETROMYZON MARINUS*
UNICOLOR).

EARL O. BUTCHER

FROM THE LABORATORY OF ZOÖLOGY, CORNELL UNIVERSITY, ITHACA, N. Y.

INTRODUCTION.

Among the numerous articles concerning the sex cells in the vertebrates, one of the most striking features is the varied opinion on their origin and on the time of their earliest appearance in the embryo. For a long time, this has provided the basis for the much debated question of whether reproductive cells are segregated early or arise from epithelial cells as the result of cellular differentiation.

In lower vertebrates, so-called germ cells are described in the entoderm and mesoderm by various authors (Woods, '02; Wheeler, '99; Humphrey, '25, and others) both before and after the formation of the somites. These cells, which are described as reaching the genital anlage through various means, are usually larger than their immediate neighbors, and have a more distinct nucleus and a fairly definite boundary. The above characteristics and the fact that they can be distinguished from other surrounding cells at an early period lead some (Beard, '02; Allen, '09; Okkelberg, '21, and others) to think that they are early segregated cells. They have not, however, been traced, in most instances, into early cleavage stages, and thus no positive proof of an early separation and a definite germ tract has been offered.

Some of the other lower vertebrates provide well known instances of the formation of germ cells from the peritoneal epithelium. Bouin ('00) in his critical study of amphibia concludes that the reproductive cells have a mesenchymal and a peritoneal origin. In *Rana temporaria*, Gatenby ('16) describes the transition of peritoneal cells into germ cells. In the same manner, Lubosch ('03) accounts for the origin of the sex cells in *Petromyzon planeri*.

Literature provides us with practically no evidence of the presence of germ cells before the appearance of the gonad in higher vertebrates, especially in mammals. Their source here is said to be the peritoneal epithelium and in many cases the first generation of sex cells (Kingery, '17; Winiwarter and Sainmont, '08) is found to degenerate, the definitive cells being formed from the germinal epithelium (Allen, '23; Papanicolaou, '25, and others).

Wherever germ cells are found to be formed from epithelial cells it seems to support the increasing evidence in favor of the theory that sex cells may be differentiated from body cells and do not have a specific character.

It is with one of the cyclostomes, *Petromyzon marinus unicolor*, that the present investigation is principally concerned. The study¹ is made as an effort to ascertain whether germ cells are segregated early, or arise as the result of cellular differentiation.

OBSERVATIONS.

Large cells with round vesicular nuclei, which apparently are identical with those germ cells found by Okkelberg ('21) in the brook lamprey, have been observed by the writer in the caudal end of the embryo just before the appearance of the distinct entoderm and mesoderm. At this time the greater number of these cells lie immediately below the ectoderm ventro-lateral to the position of the future pronephric duct. Their distinct cell boundaries and characteristic roundness render them distinguishable from the irregular surrounding cells. Previous to this time, they are apparently similar in structure to other embryonic cells. As development proceeds and the mesoderm separates from the entoderm, these yolk laden cells are found in the mesoderm. Goette ('90) recognized similar cells (*Petromyzon fluviatilis*) occurring in the mesodermal plates directly ventrad and laterad of the pronephric duct. Large round masses of yolk, distinctly marked off from other entodermal cells just laterad to the myotomes, are considered by Wheeler in *Petromyzon planeri* to be reproductive cells. He finds that they become included in the mesoderm upon its lateral extension.

¹ The writer desires to express his appreciation for the helpful suggestions of Prof. H. D. Reed. To Prof. Gage he is, likewise, indebted for the loan of a complete series of early lake lampreys.

As the embryo of the lake lamprey becomes older, the number of these yolk-laden cells increases in the mesoderm as it separates from the entoderm caudally. Judging from the series at my disposal, there is apparently no particular arrangement of these cells at first, but with further differentiation of the mesoderm, they become grouped in bands, ventro-lateral to the pronephric ducts. Their characteristic large size and roundness make them easily recognizable among the neighboring cells.

At approximately the time that the larva breaks out of the egg membrane, the cells of the anterior levels reach a more medial position probably through a dorso-medial shifting of structures. In their new location they are now situated, for the most part, ventral to the pronephric ducts. Their roundness of form has been lost to some extent and they now possess a more flattened appearance, due, probably to the pressure of adjacent parts. In the caudal end of the embryo the bands of cells are still in the more lateral position and are widely separated.

In the cephalic region of a larva, older than the one described above, these large groups of cells are seen to practically come together medially. Often the nucleus with its vesicular appearance is hard to distinguish on account of the yolk-laden character of the cells. In the caudal direction, the large cells are still in a ventro-lateral position with respect to the pronephric duct. They retain a round form, in most instances, due to the more embryonic character of this part of the larva.

When the coelomic cavity forms, these yolk-laden cells become included in the somatic mesoderm. Their yolk granules, however, having begun to disappear, remain in a somewhat fragmented condition. As the yolk is gradually absorbed, the cell becomes smaller. By referring to Fig. 1, it will be seen that the chromatin granules in the large spherical nucleus appear large and stain deeply. One and sometimes two nucleoli are present. In the latter instance, one is usually larger and more intensely staining than the other. These large yolk-retaining cells, as Okkelberg claims in the brook lamprey, are always beneath the peritoneal epithelium from the time that it can be recognized as such.

At the same time that these yolk granules are being absorbed and are becoming less distinct, certain of the peritoneal cells

ventral to the aorta and medial to the pronephric ducts begin to enlarge in situ. At this time the cells of the epithelium vary in shape, but most of them are of a flat elongated type. The first indication that some of these possess different potentialities is their increased size and a transition to a more spherical form. From this stage, they undergo a period of fairly rapid differentiation and acquire characteristics of germ cells found later in the definitive gonad.

The formation of germ cells from the peritoneal epithelium in the lamprey is not an entirely new observation. Lubosch ('03) believed that the peritoneal epithelium was the source of germ cells and follicle cells in *Petromyzon planeri*. He, however, did not give a detailed description of the process. On the other hand, since the germ cells were never seen in the peritoneal epithelium and because of their early history and structural characters in *Entosphenus wilderi*, Okkelberg concluded that the sex cells were not derivatives of the epithelium.

The process of the transition of peritoneal cells into germ cells can easily be found in larvæ which are 7-10 mm. in length. In these individuals, numerous cells of the peritoneal epithelium with deep staining nuclei are seen to be gradually changing from an oval to a spherical form (Fig. 3). The cell boundaries begin to appear more distinct. The cytoplasm is clearer as a whole, and seems to be proportionally larger in amount with respect to the nucleus. This is due to growth and also partly, no doubt, to a change in form.

As differentiation proceeds, the nucleus of the transforming cell becomes more vesicular and the chromatin is seen to clump, so to speak, at the intersections of the linen network (Fig. 2). Often two nucleoli are readily distinguishable. Figs. 4 and 7 show that during this time a change is also occurring in the cytoplasm. Besides increasing in amount, although slightly granular, it is becoming somewhat clearer.

In the course of further development, there is a corresponding change in the form of the immediately adjacent cells. They become flattened against the sex cells, presenting the appearance of crescent-shaped structures. From this stage they soon begin a growth up and over, so as to push the reproductive cells inward

(Fig. 6). Fig. 7 shows that some cells reach a greater size than others before being completely covered over by the growth of the adjacent peritoneal cells. In some cases such a large growth is attained that large bulgings are noticeable (Fig. 5).

As the cell is pushed under the epithelium, it enlarges slightly. The final result is a germ cell with moderately well defined cell boundary and a slightly granular cytoplasm. A definite nuclear membrane is noticeable. Oftentimes the reticulum is poorly defined and the deeply staining chromatin granules present a somewhat isolated appearance. A small lightly staining nucleolus and a larger more distinct one are usually present. In comparison to the final stage of the yolk-laden cells, they are identical in structure, and cannot be told from them. Both have reached a position immediately below the peritoneal epithelium.

Successive transitional stages provide evidence that germ cells arise from the peritoneal epithelium. Further support is furnished from the observation that germ cells attain a considerable size in the epithelium of which they are a part before being pushed inward.

This proliferation and formation of reproductive cells from the peritoneal epithelium is noticeable for a considerable time (7-15 mm. larvæ). The ability of the epithelium to transform into germ cells is gradually reduced, however, as the time is approached when a distinct gonad is recognizable.

Only a few enlarging peritoneal cells are found in 16 mm. larvæ. In some places, however, large germ cells are still found as a part of the epithelium. At this stage a thickening, indicating the region of the future gonad, is beginning to appear immediately below the dorsal aorta. The gonad is noticeable as a distinct structure in 18 mm. larvæ. This agrees with the conditions found in *Pctromyzon planeri* by Lubosch. The germ cells found continuous with the epithelium at this time are not different structurally from those found in earlier stages.

The gonad appears as a single ventral median diverticulum in a 20 mm. larva (Fig. 9). For the most part, it is made up of germ cells and an epithelial covering, consisting of flat elongated cells with oval nuclei. Some of the germ cells still lie in the dorsal mesenchyme and have not migrated, or have not been included in

the gonad. Epithelial cells are seen to be proliferated inward to furnish the bulk of the follicle cells. The follicular tissue soon isolates the germ cells, forming small follicles. In some cases, the large sex cells are very near the coelomic cavity, the only separation being the intervening cytoplasm of a flattened follicle cell. The structure of the gonad varies somewhat in its longitudinal extent. In some regions, it consists mainly of follicle and germ cells; at other levels, stroma is its chief constituent.

Later in a 26 mm. larva, after the migration of blood vessels and mesenchyme ventrally into the gonad, the sex gland is less dense than at 20 mm. At about this time, the germ cells begin a period of division and ordinary mitotic figures are occasionally encountered. The reproductive cells are arranged both in nests and as single elements. Where the latter condition occurs, the sex cell, in most cases, remains in a resting stage and has not undergone mitotic division. Nests, which are found less frequently, comprise a varying number of secondary germ elements. Already, in some places, the mass of germ cells is being broken up by the continual ingrowth of follicle cells. The gonad is a narrow diverticulum in some regions, being little wider than a single germ cell. At other levels, no reproductive cells are present, and the sex gland consists of a loose stroma and a cuboidal epithelial covering. For the most part, the majority of the germ cells are in a resting condition, though mitotic stages and completely divided cells are found.

The sex gland, meanwhile, is extending in a cephalic and caudal direction. This leads to the question of whether the germ cells of these extremities arise as a result of division of resting cells or are formed anew from the epithelium of the growth areas. In the larvæ which I have studied, evidence indicates that the former occurs in most instances. Numerous mitoses are found in the peritoneal epithelium but there is little evidence of a great transition of epithelial cells of these regions into reproductive cells.

In 30-33 mm. larvæ, the gonad extends a greater part of the length of the coelom. In Fig. 8 it is also seen to be considerably larger than in the 20 mm. larva of Fig. 9. Some of the germ cells are still in the resting condition, but, apparently, the greater amount of division occurs at this time, from the frequent mitotic

figures encountered. Many nests with various numbers of secondary sex elements are present. The reproductive cells, for the greater part, are peripherally situated in the gonad, being directly under the epithelium. The central part of the sex gland consists mainly of loose stroma and blood vessels. No maturation phenomena are observed in larvæ of this stage.

In the sex gland of a 50 mm. larva, the nests of germ cells are arranged around a medulla of connective tissue which is continuous dorsally with that of the mesentery. Evidently the nest is differentiated as a whole. Some nests contain, for the most part, cells in a resting condition, while in others various mitotic figures are found. In very large nests indications of degeneration are found. Since this appears in only the large ones, the insufficient blood supply and crowding are probably the causes. It is impossible to say whether all the cells of an individual nest result from the mitosis of an original single germ cell, since the migration of follicle tissue inward causes a breaking up and a continual rearrangement. At this time, the sex cells are apparently of an indifferent character, and the sex of the individual could not be established with certainty. Beyond this stage, a detailed study was not made. The maturation stages and the various factors that may be influential in deciding sex were not investigated.

Very few large cells are found to originate from the epithelium after the formation of the gonad. In a 33 mm. larva a few peritoneal cells are found enlarging and figure 8 shows a large reproductive cell continuous with the epithelium of the sex gland. Since the proliferation is usually not great in larvæ as old as this, this is regarded as an unusual occurrence, depending in all probability upon the environmental changes, and various conditions existing within the gonad. Of course, there is the possibility that germ cells might arise from follicle cells or be proliferated inside the gonad before a great growth is attained. In all the material examined, however, there is no indication of such a phenomenon. If there is much formation from the peritoneum after a distinct gonad is recognizable, one would expect to find large and enlarging cells in the epithelium. The increased number of reproductive cells after the appearance of the gonad results, mainly, I believe from mitotic division of germ cells already differentiated.

DISCUSSION.

In this study of the origin of the germ cells, the first question that arises is the one concerning the fate of the yolk-retaining cells, distinguished as primordial germ cells by some authors. Apparently from the previous investigations on vertebrates, they have two alternatives; either they persist to form the definitive germ cells of the adult, or they degenerate and disappear, the definitive sex cells then arising from peritoneal cells. Just how extensive this degeneration is seems to vary in the different vertebrates studied. Bouin holds that most of the primordial germ cells degenerate in *Rana temporaria* and the definitive sex cells have both a mesenchymal and a peritoneal origin. According to Dustin ('07), in Amphibia (*Triton alpestris*, *Bufo vulgaris* and *Rana fusca*) some of the primordial germ cells which do not degenerate form functional cells in the gonad. He states, however, that a second generation from the epithelial covering of the gonad furnishes the greater portion of the definitive sex cells. Okkelberg believes that the primordial germ cells are the sole source of the definitive cells in the brook lamprey, and none are formed from the epithelium.

In *Petromyzon marinus unicolor*, most of the large yolk-laden cells, which for the sake of clearness may be termed primordial germ cells, after losing their yolk are indistinguishable from those sex cells having a peritoneal origin. From their position many of them would naturally become included in the gonad. My material shows that some may degenerate, and evidently the rest persist and finally become definitive germ cells. Most of the definitive sex cells, however, probably originate from peritoneal cells. Of course, there is the possibility that these epithelial cells which differentiate into germ cells were the primordial germ elements that reached this position through shifting of structures. That this is not the case, is evidenced by the fact that ordinary epithelial cells indistinguishable from others of the peritoneum are seen to transform into germ cells. It is, likewise, illogical to conceive of the primordial germ cells dedifferentiating into cells indistinguishable from other peritoneal cells and then again gradually take the characteristics of sex cells. To believe that these peritoneal cells are not somatic cells, but cells which have maintained

their embryonic structure and have not specialized in a particular direction would seem even more unreasonable.

If germ cells do not have an epithelial origin, there is no way of accounting for the varying sizes found, since it is highly improbable that the so-called primordial germ cells would exhibit such a variation in size and such a close relation and resemblance to the peritoneal cells. Although large germ cells may appear to be continuous with and actually a part of the epithelium, this does not necessarily justify, in my mind, the conclusion that they have a peritoneal origin. To be certain that germ cells are derived from the epithelium, it is necessary for one to identify successive transitional stages.

Another important question is the significance of the primordial germ cells. Structurally and morphologically at one time, they are indistinguishable from other embryonic cells in the lamprey. Since they cannot be traced back to cleavage stages, there seems to be no logical justification for a belief in a distinct line of germ cells which differ physiologically from other embryonic cells. If, then, there is apparently no basis for the evidence of an early germ tract, the question naturally arises why some cells differ from other embryonic cells in having a yolk-retaining property for so long a time.

Two suggestions are given in the following pages as possible explanations for the presence of these so-called primordial germ cells. In the first place, it is evident that, at one time, the primordial germ cells are in the same position as the cells which later become part of the peritoneal epithelium, but as the latter are organized, the yolk-retaining cells take their position below the peritoneum. If this is the case, the process of germ cell formation is no different from that in later stages (transition of peritoneal epithelial cells into germ cells). The whole thing represents, then, a continuous process of germ cell formation as a result of cellular differentiation from a very early stage up until, and after in some particular cases, the formation of the gonad. If one accepts this analysis, the fundamental property of growth and differentiation becomes the explanation of germ cell formation. No doubt, the reason for degeneration, in some instances, would be the environmental factors, insufficient vascular supply,

and unfavorable conditions existing within the body of the individual.

The second suggestion is one from a phylogenetic point of view. In some arthropods, where all the egg and larval material is laid out for the formation of definite areas in the adult, germ cells may be specially provided with a large amount of nutrient material (Gatenby '24). How this extra supply of food material acts is not known, but as Gatenby intimates it may contain enzymes or other substances which suppress the differentiation of the germ cells during the embryo formation, and keeps them isolated. This, no doubt, prevents their passage into the stream of differentiating somatic cells, whose influence might result in the loss of germ-cell integrity. In mammals, on the other hand, where evidence is increasing that a somatic cell may become a germ cell under the proper stimulus, and where no special provision is made, as in insects, there is found no proof of segregation in cleavage stages. In these higher vertebrates, the cell nucleus has apparently unlimited power and germ cell formation is the result of growth and differentiation.

In the lamprey, it may be that these large yolk-retaining cells are the remnants of the conditions found in lower forms. The germ cells which are formed from peritoneal cells represent a step in that evolutionary process which reaches its height in the mammals.

Even a third interpretation might be presented, namely, that the primordial germ cells may act as a stimulating factor to the formation of germ cells from the epithelium and a gonad. They are found in many vertebrates, yet positive proof that they give rise to all of the definitive sex cells is lacking.

Further comment does not seem necessary. It is evident that the definitive germ cells have, for the most part, a peritoneal origin in the lake lamprey, yet there are primordial germ cells, the presence of which is perplexing.

CONCLUSIONS.

1. The definitive sex cells of the lake lamprey originate from the so-called primordial germ cells and also from peritoneal cells.
2. The primordial germ cells are first distinguishable as large

yolk-laden cells in the caudal end of the embryo just before the appearance of a distinct mesoderm and entoderm.

3. The finding of the successive stages from the ordinary epithelial cell to the definitive germ cell offers evidence that germ cells are formed from the peritoneal cells.

LITERATURE CITED.

Allen, B. M.

'09 The Origin of the Sex Cells of *Amia* and *Lepidosteus*. *Anat. Rec.*, Vol. 3.

Allen, Edgar.

'23 Ovogenesis during Sexual Maturity. *Am. Jour. Anat.*, Vol. 31, no. 5.

Beard, J.

'02 The Numerical Law of the Germ Cells. *Anat. Anz.*, Bd. 21.

'02 The Germ Cells in *Pristiurus*. *Anat. Anz.*, Bd. 21.

Bouin, M.

'00 Histogenese de la glande genitale femelle chez *Rana temporaria* (L.). *Arch. de Biol.*, T. 17.

Dustin, A. P.

'07 Recherches sur l'origine des gonocytes chez les Amphibiens. *Arch. de Biol.*, T. 23.

Gatenby, J. Bronte.

'16 The Transition of Peritoneal Cells into Germ Cells in Some Amphibia *Anura*, especially in *Rana temporaria*. *Quart. Jour. Micr. Sc.*, Vol. 61.

'24 The Transition of Peritoneal Epithelial Cells into Germ Cells in *Gallus Bankiva*. *Quart. Jour. Micr. Sc.*, Vol. 68.

Goette, A.

'90 Entwicklungsgeschichte des Flussneunauges (*Petromyzon fluviatilis*). *Abhandlungen zur Entwicklungsgeschichte der Thiere*, Heft. 5, Teil 1. Hamburg u. Leipzig.

Humphrey, R. R.

'25 Primordial Germ Cells of *Hemidactylum* and Other Amphibia. *Jour. Morph.*, Vol. 41, no. 1.

Kingery, H. M.

'17 Oögenesis in the White Mouse. *Jour. Morph.*, Vol. 30, no. 1.

Lubosch, W.

'03 Über die Geschlechtsdifferenzierung bei *Ammocoetes*. *Verb. Anat. Ges. Vers.*, 17.

Okkelberg, Peter.

'21 The Early History of the Germ Cells in the Brook Lamprey, *Entosphenus wilderi* (Gage), up to and Including the Period of Sex Differentiation. *Jour. Morph.*, Vol. 35, pp. 1-152.

Papanicolaou, George N.

'25 Oögenesis during Sexual Maturity as Elucidated by Experimental Methods. *Soc. Exp. Biol. and Med.*, Vol. 21, p. 393.

Wheeler, W. M.

- '99 The Development of the Urogenital Organs of the Lamprey.
 Zoöl. Jahrb., Abth. Anat., Bd. 13, 1-88.
- Winiwarter, H. von, et J. Sainmont.
- '08 Nouvelles recherches sur l'ovogénèse et l'organogénèse de
 l'ovaire des Mammifères (chat). Arch. de Biol., T. 24.
- Woods, F. A.
- '02 Origin and Migration of the Germ Cells in *Acanthias*. Am.
 Jour. Anat., Vol. 1, pp. 307-320.

EXPLANATION OF FIGURES.

FIG. 1. Transection of a 6.5 mm. larva, showing primordial germ cell in which the yolk is disappearing. $\times 380$.

FIG. 2. Transection of a 9 mm. larva, showing the second stage in the transition of a peritoneal cell into a germ cell. $\times 640$.

FIG. 3. 9 mm. larva, showing the first stage in the enlargement of a peritoneal cell. $\times 640$.

FIG. 4. Enlargement of a definitive sex cell in the peritoneal epithelium of a 7 mm. larva. $\times 380$.

FIG. 5. This illustrates the large size that some germ cells reach before being proliferated. Section of a 10 mm. larva. $\times 790$.

FIG. 6. Section through a 10 mm. larva. The adjacent epithelial cells are growing up around the germ cell. $\times 380$.

FIG. 7. 9 mm. larva. Enlarged germ cell is shown in the epithelium. $\times 790$.

FIG. 8. Gonad of a 33 mm. larva. Germ cell is continuous with the epithelium. $\times 380$.

FIG. 9. Section through gonad of a 20 mm. larva. $\times 380$.

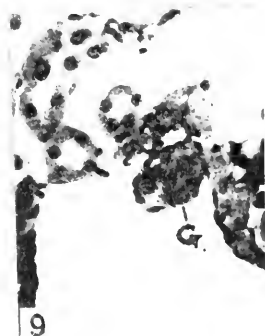
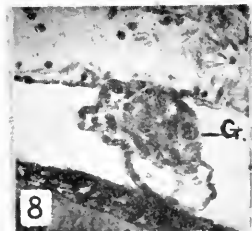
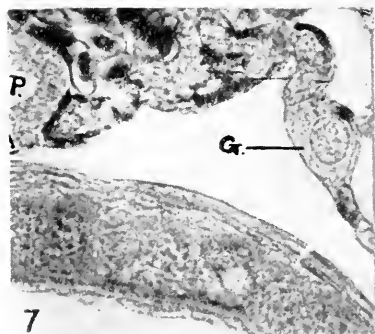
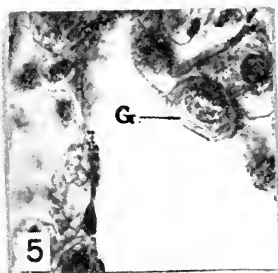
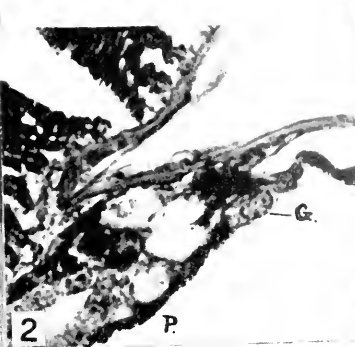
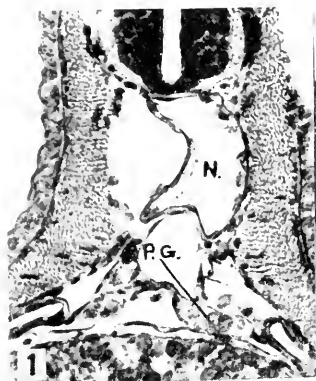

THE SO-CALLED CENTRAL BODIES IN FERTILIZED
ECHINARACHNIUS EGGS.

I. THE RELATIONSHIP BETWEEN CENTRAL BODIES AND ASTRAL
STRUCTURE AS MODIFIED BY VARIOUS MITOTIC PHASES.¹

HENRY J. FRY,

WASHINGTON SQUARE COLLEGE, NEW YORK UNIVERSITY.

TABLE OF CONTENTS.

INTRODUCTION.

Hypotheses Concerning the Mitotic Rôle of Central Bodies	101
Morphology and Terminology	104
Previous Studies of Central Bodies in Echinoderm Fertilization . . .	105

THE RELATIONSHIP BETWEEN CENTRAL BODIES AND ASTRAL STRUCTURE
AS MODIFIED BY VARIOUS MITOTIC PHASES IN FERTILIZED *ECHINARACH-*
NIUS EGGS (BOUIN'S FIXATION).

Method of Study	109
History of the Sperm-aster	113
History of the Cleavage-amphiaster	115

DISCUSSION.

The So-called Central Bodies in Fertilized <i>Echinarachnius</i> Eggs . .	118
The So-called Central Bodies in Fertilized Echinoderm Eggs	120
Hypotheses Concerning the Mitotic Rôle of Central Bodies in the Light of the Present Investigation	121

RÉSUMÉ	123
------------------	-----

LITERATURE CITED	126
----------------------------	-----

INTRODUCTION.

Hypotheses Concerning the Mitotic Rôle of Central Bodies.

Certain hypotheses have been proposed concerning the mitotic rôle of central bodies (centrioles, centrosomes) in the animal cell. There is a diversity of opinion in evaluating these generalizations since the evidence is conflicting and uncertain at many points. An examination of recent cytological textbooks reveals their present status.

¹ The experiments were performed at the Marine Biological Laboratory, Woods Hole, Massachusetts, 1927. A preliminary report of the paper was presented at one of the Research Seminars of the Laboratory, July 31, 1928.

It is generally taken for granted that central bodies are the formative foci about which the mitotic mechanism arises, and that they are its most persistent element. Central bodies "play a preponderant part in the mechanism of cell division" (Doncaster, '20, p. 21); they are the "dynamical centers of the cell" (Agar, '20, p. 4); about them "as a center arise the asters" (Wilson, '28, p. 26).

There is diversity of opinion, however, as to whether or not central bodies maintain genetic continuity from one cell generation to another. On the one hand there is evidence that they arise by the growth and division of preëxisting bodies of the same kind and keep their identity as individualized structures throughout the cell history. Such behavior is shown during the final divisions of the germ cells in many species. On the other hand there are cases where they seem to arise *de novo*, as in cytasters of artificially activated eggs. The question, therefore, presents itself, do central bodies have a dual mode of origin, in some cases maintaining genetic continuity from cell to cell, but in others arising *de novo*; or can the two modes be brought under one category? Wilson ('23 and '28) has given most consideration to this subject. "In the very fact of such a double mode of origin (if it can be accepted) lies the peculiar interest of the central bodies in their relation to the protoplasmic metastructure" ('28, p. 672). As a possible explanation of cases where they disappear and later reappear during the cell history, he suggests that ". . . the centrioles are bodies of such extreme minuteness that if not surrounded by astral rays they might readily be lost to view among the protoplasmic granules of the egg or they may even become reduced to ultra-microscopical dimensions" ('28, p. 444). "When, therefore, they seem to make their appearance *de novo* in the hyaloplasm it is entirely possible that they may preëxist in a form too minute to appear above the horizon of visibility" ('28, p. 720). "Manifestly it is quite illogical to affirm an origin *de novo* of any formed body because it first becomes visible at a particular enlargement, even the greatest at our present command" ('23, p. 24).

In contrast to this attempt to save the theory of genetic continuity with reference to central bodies that seem to arise *de novo*,

is the view of other authors such as Sharp. He suggests ('26, p. 188) that ". . . the regular appearance of the centrosome in successive mitoses is closely associated with regularly recurring physiological conditions in the cell; and . . . its presence in successive cell-divisions does not require an uninterrupted morphological continuity through the intervening stages." Thus it is seen that there is diversity of opinion concerning the genetic continuity of central bodies as individualized structures from cell to cell.

There is equally conflicting evidence and opinion with reference to their genetic continuity from generation to generation. The usual hypothesis concerning the rôle of central bodies in fertilization is as follows: "Clearly, . . . something is introduced into the egg by the middle-piece of the sperm that either is a central body or has the power to incite the formation of one; . . . some kind of specific genetic relation exists between the central bodies of successive generations" (Wilson, '28, p. 441). "There is no doubt that the middle-piece of the spermatozoon is at least partly formed from the centrosome of the cell which gives rise to the spermatozoon, and that after fertilization the centrosomes of the first segmentation division of the egg arise from or in connection with the middle-piece" (Doncaster, '20, p. 43). In the fertilized eggs of about five species (Yatsu, '09, pp. 371-372) the central body phenomena seem to be in harmony with this hypothesis, but even in these most favorable cases the evidence is uncertain at various points. Furthermore, there are many species where the theory is without support. Hence a wide range of attitudes is found among different authors toward the hypothesis. Agar ('20, pp. 74-76) accepts it with but slight reservations. On the other hand, Lillie ('19, pp. 70-75), and Lillie and Just ('24, pp. 461-464) practically reject it. Wilson ('28, p. 438-449) gives the fullest account of the facts. He gives greater weight to the hypothesis than do most authors, because of his interest in the theory of genetic continuity as applied to cytoplasmic components. He is very careful to observe, however: "Even in the typical case (e.g., in the sea-urchin, tunicate or nematode) two difficult questions still remain, namely, whether the cleavage-centers are actually derived from the sperm-center, and whether the latter is

actually brought into the egg by the sperm ('28, p. 443). Additional discussions concerning the rôle of central bodies are given by Brachet ('17), and Hertwig ('23).

The present status of the hypotheses concerning the mitotic rôle of central bodies in the animal cell may be summed up as follows. There is general agreement that they are the formative foci about which the astral mechanism arises. There is a conflict of opinion as to whether or not they maintain genetic continuity from cell to cell and from generation to generation; there is a tendency in some quarters to tentatively regard such an assumption as a fruitful working hypothesis.

Morphology and Terminology.

Wilson fully discusses the morphology and terminology of central bodies. The following résumé of the subject is composed of sentences and phrases quoted verbatim from him ('28, pp. 30, 119, 672-680). "Much confusion still exists in the literature concerning the terminology and relationships of the central body. Its most constant and essential component is the *centriole*, a minute granule or rod, often double, in some cases lying naked in the cytoplasm, more often surrounded by a cytoplasmic investment of various degrees of complexity. In some cases the latter is a rather definite small rounded spheroid, the *centrosome*; when larger it is often spoken of as the *sphere* (or *centrosphere*). The word "centrosome" will be found in the literature in at least four different senses, namely: (1) In a general physiological sense as the division center of the cell. (2) As the innermost differentiated body at the center of the aster, the only persistent element of the whole system, equivalent to the central granule or centriole. (3) In Boveri's original sense as a larger body surrounding the centriole, having a persistent identity and independent of the aster. (4) As a transitory structure, representing the innermost astral zone. In practice it is often difficult to distinguish certainly between centriole and centrosome; it was this ambiguity that led Flemming ('91) and later Heidenhain and many others, to adopt the more inclusive and noncommittal term central body, (which is historically the older), which leaves open the question as to its precise homology in any particular case. The facts indicate that

the particular type of configuration in the centrosome is a matter of secondary importance, and that the centriole constitutes the most stable and constant feature of the whole astral system of which it forms the center."

The fact that the terms, *central body*, *centriole*, and *centrosome*, are used in different ways by various authors causes much confusion. It would be desirable if the term *centriole* were applied only to a minute, period-like type of central body, such as occurs in spermatogenesis. The term *centrosome* should designate only the more diffuse types.

Previous Studies of Central Bodies in Echinoderm Fertilization.

The chief studies of central bodies in echinoderm fertilization have been made by Wilson ('95), (Wilson and Leaming '95; Wilson and Mathews '95), and Boveri ('00). Boveri illustrates the early sperm-aster of *Echinus* eggs as centered about a body

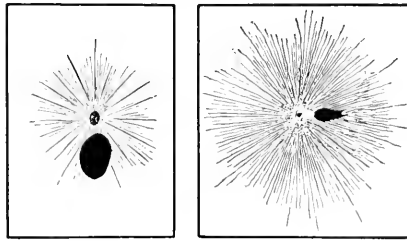

FIG. 1.

FIG. 2.

Central bodies in sperm-asters of *Echinus* (Boveri, '00). Figs. 1 and 2 are reproduced from Boveri, '00, Plate V., Fig. 72, and Plate IV., Fig. 55b. For discussion see pp. 105 and 120.

containing a granule that may be single or double (Figs. 1 and 2). He interprets these phenomena as a centrosome containing a centriole that divides into two; about this structure arises the sperm-aster; later the two centrioles become the centers of the cleavage-amphiaster. Various workers have clearly established the fact that this configuration is actually a bi-lobed granule of chondriosome material contained within the sperm's middle-piece (Field, '95; Wilson, '97, '99; Meves, '12; and Just, '27). When sectioned in various planes it gives the appearances Boveri illustrates. During the earliest history of the aster this structure is at its

center, but within several minutes it moves to one side of the astral focus, and within about ten minutes it wanders out at random into the cytoplasm, having no further connection with the mitotic mechanism (Figs. 11 to 16). Hence Boveri's observations concerning central bodies of the sperm-aster may be dismissed.

In Wilson's earlier work ('95), (Wilson and Mathews, '95; Wilson and Leaming, '95) the central body of the sperm-aster in *Toxopneustes* is illustrated as a rather large, homogeneously granular structure, which draws apart into two portions during the late astral history. (The middle-piece was mistaken for the central body during the earliest astral stages). At no time is

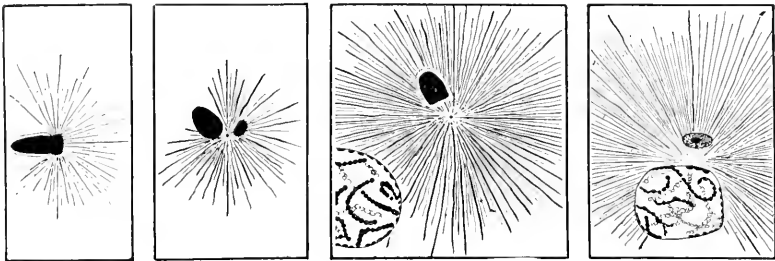

FIG. 3.

FIG. 4.

FIG. 5.

FIG. 6.

Central bodies in sperm-asters of *Toxopneustes* (Wilson, '00). Figs. 3 to 6 are reproduced from Wilson, '00, Figs. 94E to 94G. For discussion see pp. 106 and 120.

there a minute, period-like centriole. These figures are similar to those of the present study (Figs. 11 to 18). They have been reproduced in text-books only occasionally, e.g., Doncaster ('20, Plate 12). In the first edition of "The Cell" ('96, p. 138) Wilson reproduces the same illustrations but in the discussion he points out that modifications of the original interpretation are necessary (cf. also Wilson, '97 and '99). In the second edition of "The Cell" ('00, p. 189) these modifications are embodied in a new series of illustrations (Figs. 3 to 6). The aster is at first focused about the middle-piece (Fig. 3); the latter soon moves to one side and the focus is occupied by a typical period-like centriole (Fig. 4); somewhat later the middle-piece disappears from the astral area but the centriole is still present (Fig. 5); at later stages the centriole is not shown (Fig. 6). At no time is there the large,

diffuse type of central body illustrated in the earlier work. The later figures, showing a typical minute centriole, have been widely copied not only as delineating the events of echinoderm fertilization specifically but also as showing the typical phenomena of fertilization generally (Hertwig, '23, Fig. 250; Lillie, '19, Fig. 7; Lillie and Just, '24, Fig. 7; Wilson, '28, Fig. 184; Buchner, '15, Fig. 110; etc.).

The following types of central bodies in echinoderm spermasters are illustrated in other studies. A large, vaguely-delimited, homogeneously-granular body without a period-like centriole (a configuration similar to that shown by Wilson ('95 and '96) in his earlier work on *Toxopneustes*) is illustrated by Wilson and Mathews ('95) in *Asterias* and in *Arbacia*; and by Ziegler ('04) in *Echinus*. A period-like centriole, without a surrounding homogeneously-granular body (a configuration similar to that shown by Wilson ('00) in his later work on *Toxopneustes*) is illustrated by Kostanecki ('96) in *Echinus*; by Wilson ('23, Fig. 12) in *Asterias*; and by Wilson ('01) in *Toxopneustes* (etherized). A period-like centriole (or centrioles) within a surrounding homogeneously-granular body is illustrated by Hill ('95) and by Erlanger ('98) in *Spharechinus*.

Turning from observations concerning central bodies in the sperm-aster to those of the cleavage-amphiaster, it is found that Wilson ('95, '96, '00, '28) illustrates structures similar to those of the present study (Figs. 19 to 26). In metaphase asters (Fig. 22) the center is a mulberry-like, spheroidal structure of moderate size, not traversed by rays and having a definite contour; it "contains a group of irregular granules so as to give almost the appearance of a small nucleus in which the centrioles cannot be distinguished" (Wilson, '28, p. 677). In anaphase and telophase (Figs. 23 and 24) this relatively small and condensed body gives place to a very large vacular one which is spoken of as a centrosphere.

Boveri ('00), on the other hand, presents a very different picture of central bodies in cleavage-asters. His various plates show considerable variations of central body phenomena in different series. In all of them, however, there is a body at the center of each metaphase aster; it divides into two during the

astral history, keeping its identity as an individualized structure. One of his series is an almost diagrammatic presentation of such a sequence of events where in every stage there is a typical period-like centriole surrounded by a larger centrosome, about which are the rays; both centriole and centrosome divide, maintaining their identity throughout the process (Figs. 7 to 10). Boveri's figures have been reproduced by Buchner ('15, Fig. 17); by Hertwig ('23, Fig. 156); by Wilson ('28, Fig. 327); etc.

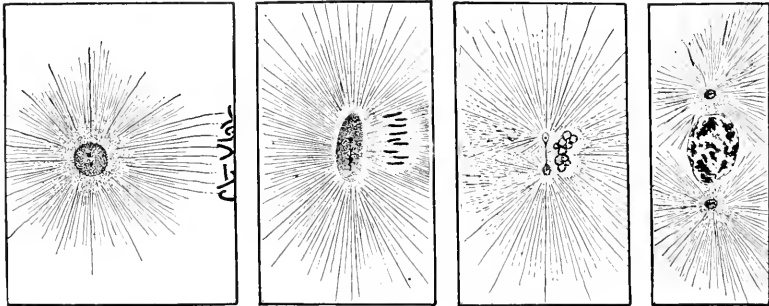

FIG. 7.

FIG. 8.

FIG. 9.

FIG. 10.

Central bodies in cleavage-amphiesters of *Echinus* (Boveri, '00). Figs. 7 to 10 are reproduced from Boveri, '00, Plate V., Figs. 56, 58, 64 and 69. For discussion see pp. 107 and 120.

The following types of central bodies in echinoderm cleavage-amphiesters have been illustrated in other studies. A centriole (or centrioles) without a surrounding "centrosome" is shown by Kostanecki ('96) in *Echinus*. A centriole (or centrioles) surrounded by a "centrosome" (a configuration similar to that illustrated by Boveri ('00)) is shown by Hill ('95) and by Erlanger ('98) in *Sphaerechinus*. A mulberry-like, large, spheroidal structure containing a number of granules (a configuration similar to that of Wilson ('95, '96, '00, '28)) is shown by Butschli ('92) in *Sphaerechinus*; and by Wilson and Mathews ('95) in *Arbacia*. A clear, empty area at the center of the aster which may contain some scattered granules is shown by Ziegler ('04) in *Echinus*; and by Meves ('12) in *Parcechinus*.

Whatever the structural details may be and whatever terminology is used by an investigator, it is widely taken for granted that central body behavior in echinoderm fertilization is typical of

central body behavior in fertilization generally. Boveri's paper ('00) developing his celebrated theory of the central apparatus was based as much upon investigations of *Echinus* eggs, as upon those of *Ascaris*. Yatsu includes Boveri's work on *Echinus* as one of the five cases "in which the centriole has been satisfactorily traced" in fertilization ('09, p. 371). Wilson cites central body behavior in the sea-urchin as a "typical case," mentioning it in this respect as in the same category with tunicates and nematodes ('28, p. 443, also footnote 4, p. 444). When various authors present generalized diagrams of fertilization, and of mitosis in cleaving eggs, some of them are based on the sea-urchin egg (Wilson, '28, Figs. 45, 46, 47 and 186; Hertwig, '23, Fig. 248; etc.). These diagrams are of course entirely schematic, but this is their very significance, since any phenomena delineated in such charts, whether they concern central bodies or asters or nuclei, present in diagrammatic form the most generally accepted ideas. The diagrams show a single central body (centriole) in the early sperm-aster; it divides into two, and they become the central bodies of the cleavage-amphiaster; they in turn later divide and a pair are passed to each daughter cell. Up to the present time, therefore, the central body phenomena of fertilized echinoderm eggs have been regarded as typical. Most investigators illustrate a minute period-like centriole which is frequently surrounded by a larger "centrosome." Not only are the central bodies of echinoderms assumed to give rise to the astral mechanism, but they are also supposed to maintain genetic continuity from cell to cell and from generation to generation.

THE RELATIONSHIP BETWEEN CENTRAL BODIES AND ASTRAL
STRUCTURE AS MODIFIED BY VARIOUS MITOTIC PHASES
IN FERTILIZED *ECHINARACHNIUS* EGGS
(BOUIN'S FIXATION).

Method of Study.

A previous study of central bodies in cytasters of artificially activated *Echinarachnius* eggs (Fry, '28) proves that central bodies are present only if the rays satisfy two conditions: first, that they reach the center of the aster; second, that they are clear. Central bodies are always absent in cytasters if rays are very

vague, even though they do reach the astral center. They are also absent if the rays are clear peripherally but fail to reach the center. This invariable relationship between the occurrence of central bodies and the presence of well-formed rays reaching the center, holds good in cytasters no matter what are the modifications of astral structure caused by: (1) various intervals in its history; (2) various coagulation products produced by different fixatives; and (3) various effects of modifications of environmental factors. The conclusion is reached that the so-called central bodies seen in sections of fixed cytasters are nothing but the coagulated focal point of clear rays reaching the center and have no existence in the living cytasters as individualized entities.

The question arises, therefore, is it possible that central bodies of normally fertilized echinoderm eggs are likewise nothing but a coagulation product of the focal point of clear rays, having no existence in the living egg as individualized bodies? To investigate this problem there has been planned a series of five experiments with fertilized eggs of *Echinarachnius parva*. In each of them there are produced various modifications of astral structure, in order to observe whether or not central bodies occur only when clear rays reach the astral center and are always absent otherwise. In this group of experiments astral structure is modified by: (1) the various mitotic phases of the astral cycle; (2) different fixatives; (3) modifications of environmental factors; (4) differences in astral size during successive cleavages; and (5) hybridization. The first experiment on the effects of various mitotic phases is the subject of the present paper; the others are in process of completion.

The present investigation of fertilization asters was carried out by the same method used in the study of cytasters (Fry, '28, pp. 387-392). Its assumptions are as follows: (1) The form of a cell component when coagulated may be like that of the living condition, but on the other hand, it may differ to a greater or lesser degree. In how far the coagulation product is an "artifact" of the living component must be very carefully considered. (2) Within any one fixative, at each significant interval, it is necessary to study a large number of cells, so as to secure an adequate random sample. (3) They must be chosen at random, in such a way

as to avoid all unconscious selection of certain types. (4) Every part of the component, in each cell studied, should be accurately measured, and observations should be made concerning its physical structure. The surrounding related structures should also be analyzed in the same detail. This should be done in tabular form so that every individual is carefully checked with reference to each varying factor. The tabular form is necessary, otherwise omissions are made when analyzing many cells each with respect to a large number of points. If the component occurs in more than one section, it is necessary to study all the serial sections involved. In making certain measurements it is necessary to know in what plane the component has been cut. (5) The percentage of each class, at each interval, is accurately ascertained. Only those individuals are included within a class that are very similar with reference to all the variables. Unusual combinations of the variables are listed separately so as not to pass by small but possibly significant groups by paying attention only to the larger ones. (6) In compiling the data for any one fixative, all classes at all intervals are taken into account and none are omitted. (7) Whatever the abnormalities introduced by a fixative, at least that is a constant throughout the various intervals of that series. If significant relationships are apparent, they probably represent similar relationships in the living condition, despite any abnormalities introduced by fixation. (8) This technique should be repeated in a similar manner in a group of diverse fixatives. If a conclusion is reached that takes into consideration the relationships apparent in them all, it is probable that the results are valid for the living component, although they must be used with great caution. (9) It is assumed that the investigator takes into consideration any data concerning the chemistry of the coagulation products. (10) It is also taken for granted that he uses every means at his disposal to study the component in the living condition.

In the present investigation each sperm-aster was measured and analyzed with reference to about twenty items, listed in Table I. The cleavage-amphiasters were studied in like manner to analyze the interrelationships of their parts. About a hundred asters were so studied at each of nine intervals after fertilization (5

min., 7.5, 10, 15, 30, 45, 1 hr., 1 hr.-15 min., 1-30). The temperature of the living eggs was 20° C.

The results of the investigation, therefore, are based upon an exceedingly detailed analysis of about nine hundred asters. The method involves but the simplest quantitative principles as applied to cytological research. At each significant interval there is studied a sufficiently large number of individuals chosen at random. Each one is accurately measured and observations are made concerning a number of varying factors. The relations are noted. All classes are considered in arriving at the conclusion.

RAYS	
<i>Length:</i>	In that region of the aster between edge of egg and male nucleus (designated as "male side").
	In that region of the aster on the opposite side, toward female nucleus (designated as "female side").
<i>Physical Structure:</i>	Vague or clear? at "male side"; at "female side."
	Delicate or coarse? at "male side"; at "female side."
	Separate or close? at "male side"; at "female side."
	Straight or crooked? at "male side"; at "female side."
	<i>Where are rays of early aster focused with respect to head and middle-piece of sperm?</i>
CENTRIOLE	
	<i>Is the bi-lobed granule present? Where located?</i>
	<i>Are cytoplasmic granules present? How many? Size? Where located?</i>
	<i>Is there any evidence of a true centriole?</i>
CENTROSOME	
	(Any structure at the center of the aster differentiated from the ray area, other than granules and nuclear material.)
	<i>Width: at "male side"; at "female side."</i>
<i>Physical Structure:</i>	Granular, corpuscular, etc.? at "male side"; at "female side."
	Traversed by rays? at "male side"; at "female side."
	Delimited from ray area? at "male side"; at "female side."
	How stained in contrast to ray area? at "male side"; at "female side."

TABLE I.

LIST OF STRUCTURAL DETAILS WITH REFERENCE TO WHICH SPERM-ASTERS WERE ANALYZED (cf. Figs. 11 to 18).

Cleavage-amphiesters were measured and analyzed in a similar manner. For discussion see p. 112.

The drawings of the various classes (Fig. 11 to 26) are not each a delineation of a single "typical" or "best" cell, as is usually the case in cytological illustrations. Each dimension and the physical appearance of each part is an average of all the observations concerning that structure, made in all the members of that class. Thus, although the figures have the value of usual illustrations, and are "typical," they also have the value of charts that show the interrelations of a number of varying factors. The eggs were studied at $750\times$ magnification.

The eggs were fixed with Bouin's fluid (saturated aqueous solution of picric acid, 75 parts; formol, 25 parts; glacial acetic acid, 5 parts). This was selected because it is one of the reagents most effective in coagulating asters in such a manner as to show clear and distinct rays. It is certain that living asters have a radiate configuration at least in their outer portions. This is clearly seen when using water-immersion objectives of high magnification. It is probable that such reagents as Bouin's fluid coagulate asters with a minimum distortion of their radiate structure, although it must be kept in mind that the detailed structure of the coagulated rays may be quite different from that of the living ones. The eggs were sectioned $5\ \mu$ thick, and stained with Heidenhain's hæmatoxylin.

History of the Sperm-aster.

During the early history of the sperm-aster when it is small, the rays are delicate and are similar in structure on all sides (Figs. 11 to 15). During its middle history, when the aster reaches its maximum size and fills the egg, the rays become quite coarse on the side between the male chromatin and the edge of the egg ("male side") but remain delicate in the opposite portion ("female side") (Figs. 16 and 17). During the late history, when the nuclei fuse, the rays suddenly become very faint in all parts of the aster, although they still fill the egg, and continue to maintain a difference as to clarity between "male side" and "female side" (Fig. 18).

A darkly-staining, roughly-granular area is present at the center of the aster only at those times when the rays are coarse. It does not exist either at the beginning or at the end of the astral cycle

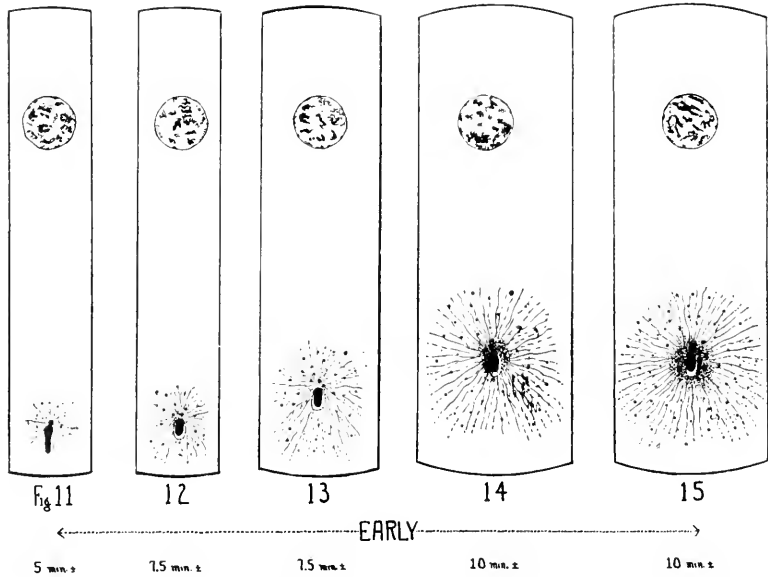

←----- EARLY ----->

"CENTRAL BODIES" IN THE SPERM-ASTER

The illustrations are $650\times$ enlarged. In each figure every dimension and the physical structure of each part is an average of all the observations made in a large number of eggs belonging to that class (cf. p. 110).

The diffuse granular "central body" is present only during that period of the astral cycle when rays are coarse, and only in that portion

when they are delicate. Furthermore, during the period when it is present, it exists only on the "male side" where there are coarse rays, and it is absent (or is occasionally present only to a very slight extent) on the "female side" where rays remain delicate. It is further to be noted that the size of the central granular area is proportional to that of the aster. In about four hundred sperm-asters studied by the exceedingly detailed method outlined above, there are no exceptions to the correlation between the presence of coarse rays and the presence of a central granular configuration; and between the absence of coarse rays and the absence of such a configuration. It appears and disappears when and where coarse rays appear and disappear. This suggests the conclusion that the granular center (centrosome) is nothing but a coagulation product of heavy rays at the inner ends where they converge.

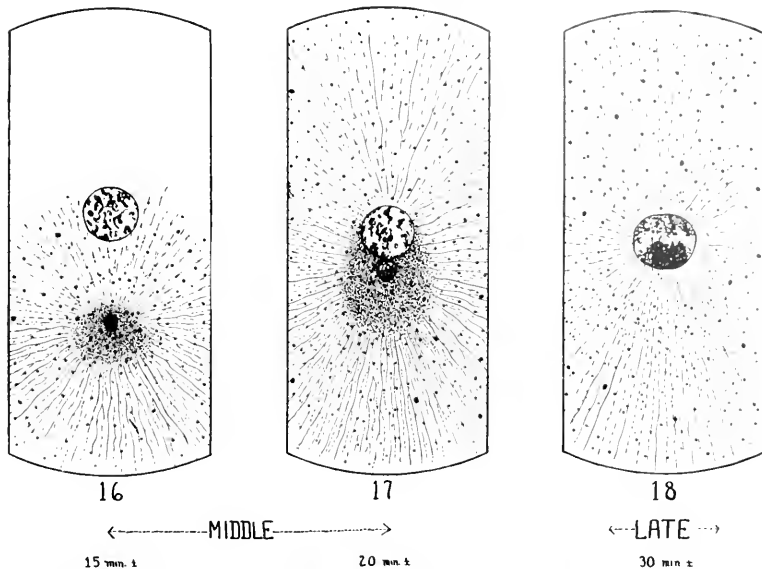

OF ECHINARACHNIUS EGGS [BOUIN'S FIXATION]

of the aster (the "male side") where they are coarse. The "central body" appears and disappears as heavy well-formed rays appear and disappear. It is a coagulation artifact of rays substance at the astral center produced only when rays are coarse. For discussion see pp. 113 and 118.

The entire aster, including the central area, always contains a number of the deeply-staining granules of various sizes that are abundant throughout the cytoplasm. If, as occasionally happens, there are but one or two at the center, such a configuration simulates a centriole, single or double, surrounded by a vague type of centrosome, but it is without significance.

As noted above, the bi-lobed granule of chondriosome material, introduced by the sperm's middle-piece, is present only during the first ten minutes of the astral history (Figs. 11 to 15). Thereafter it wanders out into the cytoplasm.

History of the Cleavage-amphiaster.

During the earliest and latest stages of the cleavage-amphiaster, *i.e.*, in early prophase and late telophase (Figs. 19 and 26), the rays are exceedingly vague, and the physical structure of the

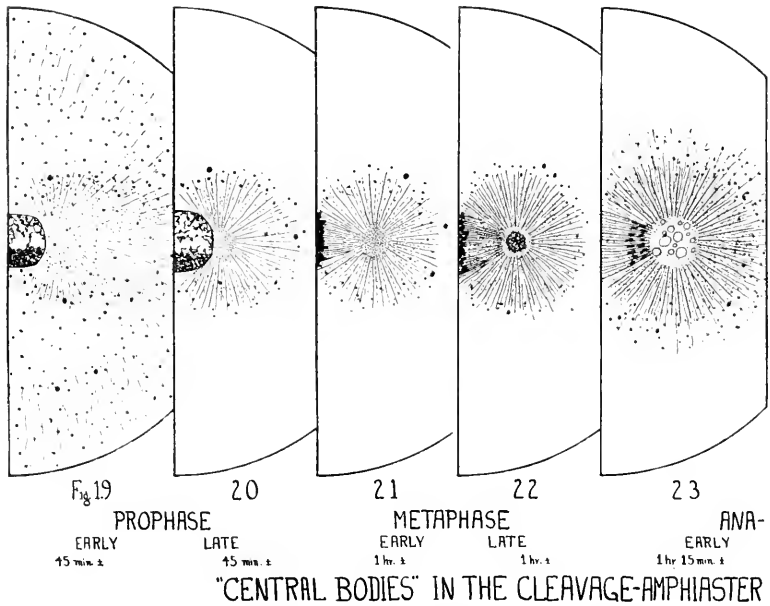

The illustrations are $650\times$ enlarged. In each figure every dimension and the physical structure of each part is an average of all the observations made in a large number of eggs belonging to that class (cf. p. 110).

The "pleuricorpuscular central body" which enlarges into the "centrosphere" is present only during that period of the astral cycle

central area at both times is like slightly vacuolated cytoplasm. There are two periods when the rays are clear though very delicate; the first of them is during late prophase and early metaphase (Figs. 20 and 21); the second is during early telophase (Fig. 25). During both these periods the central area is granular and not delimited. Only during the aster's middle history, from late metaphase to late anaphase, are the rays coarse (Figs. 22 to 24), and only at this time does there exist the so-called central body. At first, during late metaphase (Fig. 22), it is a small darkly-staining, mulberry-like structure, like a cluster of closely-aggregated vacuoles. During the anaphase stages (Figs. 23 and 24) it enlarges as the aster enlarges, and becomes a lightly-staining vascular area, the echinoderm "centrosphere."

The central body structures of cleavage-amphiassters, like those of sperm-asters, exist only when rays are coarse; they are absent

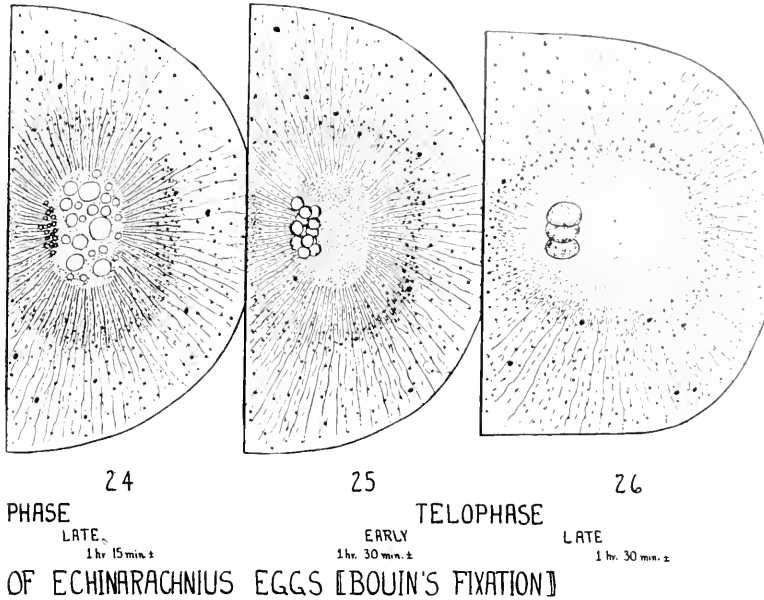

when rays are coarse. It appears and disappears as heavy well-formed rays appear and disappear. It enlarges and changes shape as the aster enlarges and changes shape. It is a coagulation artifact of ray substance at the astral center produced only when rays are coarse. For discussion see pp. 115 and 118.

when rays are delicate. They appear and disappear as coarse rays appear and disappear. This suggests the conclusion that the central bodies of cleavage-asters, as in the case of sperm-asters, are not individualized entities, but are nothing but a coagulation product of heavy rays at the inner ends where they converge.

In about five hundred cleavage-asters studied in the detailed manner previously described, there were found no exceptions to the correlation between the presence of coarse rays and the occurrence of a central body. This is strikingly shown in comparing early metaphase asters with late ones (Figs. 21 and 22). They are similar as to size; in both, the chromosomes are at the mid-point of the spindle; they differ only in the fact that the earlier stage has delicate rays and the later one has coarse rays. The former has no central body; the latter has a fully-formed central body. In over a hundred and fifty such metaphase asters studied,

there is not one case where the "central body" exists when rays are delicate, or where it does not exist when rays are coarse. Similarly, a comparison of late anaphase asters with early prophase ones (Figs. 24 and 25) shows the same relationship. Both are of maximum size; both are elongate at right angles to the spindle axis; both have asters with inner and outer zones; in both, the chromosomes occur at the inner edge of the spindle, existing as vesicles (small and numerous in the early stage; larger and partially fused in the later one). The only difference between the asters concerns the rays which are heavy and coarse in late anaphase, but delicate in early telophase. A well formed "centrosphere" is present in the former; there is no "centrosphere" in the latter. Not a single case occurs among the asters studied in these two stages where one with delicate rays has a "centrosphere"; nor is there a single case where one with coarse rays is without a "centrosphere."

In the cleavage-amphiaster the rays are coarser and straighter and lie more closely together than is the case in the sperm-aster. All cytoplasmic granules, with but rare exceptions, are completely excluded from the central area and from among the inner portions of the rays. They occur occasionally among the tips of the rays and are very abundant in the surrounding cytoplasm. This situation is in strong contrast to the condition in the sperm-aster where granules are common between the rays throughout their entire length, as well as in the central area. In those very rare cases among cleavage-asters where one or two granules do occur at the center, they simulate centrioles, but are without significance.

DISCUSSION.

The So-called Central Bodies in Fertilized Echinarachnius Eggs.

In *Echinarachnius* the conditions under which "central body" structures are present in cleavage-amphiassters are very similar to those necessary for their presence in sperm-asters. In both, they are present only when rays are coarse, and are absent when rays are delicate; they appear and disappear with the appearance and disappearance of heavy rays. In both, the size of the configuration is proportional to that of the aster; in the case of the cleavage-amphiaster not only does the "central body" enlarge as the aster enlarges, but it changes shape as the aster changes shape

(Figs. 23 and 24). In both, the evidence is equally strong that the "central bodies" are nothing but the coagulated inner ends of heavy rays.

If "central bodies" of sperm-asters and cleavage-asters are produced by a similar mechanism, how are the differences in their structure explained? Comparing the situation with reference to rays, the contrasting factors are as follows: in sperm-asters rays are heavy, but are not as coarse as in cleavage-asters; in sperm-asters they are farther apart than in cleavage-asters, as shown by the presence of cytoplasmic granules between the rays of the former and their absence among those of the later. The most important difference, however, between the two types of asters, concerns whether or not the focal center is occupied by nuclear material. In the sperm-aster there is a nucleus (whether male alone, or male and female; whether separate or fused), whereas in the cleavage-asters there is no nuclear material at the center during the period when "central bodies" are present. These differences probably account for the morphological differences between "central bodies" of sperm-asters and those of cleavage-asters.

The behavior of "central bodies" in nuclear asters of fertilized echinoderm eggs is in complete harmony with central body phenomena in cytasters of artificially activated ones (Fry, '28). In both of them, the so-called central bodies appear and disappear with the appearance and disappearance of coarse rays; in both, they are the coagulated center where the rays converge.

It is proved in the case of fertilized eggs of *Echinarchnius* that the asters form "central bodies" only when rays are coarse. Furthermore, it is probable that this occurs only as a result of coagulation, and that in the living condition the "central body" is actually nothing but ray substance at the astral center. Live asters have been carefully studied at high magnifications with water-immersion objectives. A radial configuration can be seen distinctly in the outer parts. The central areas are perfectly structureless and hyaline, except for the possible presence of nuclear material. Were the "central bodies" seen on slides of coagulated asters, actual structures present in the living condition, it is at least probable that they would be visible since they are larger than nuclear structures than can be seen.

The usual hypotheses concerning the mitotic rôle of central bodies in animal cells (pp. 101-104) are shown to be meaningless in the case of fertilized eggs of *Echinarachnius*. They are not the "dynamical centers," the "formative foci," the "most persistent element of the astral mechanism," nor have they genetic continuity. *It is probable that the so-called central bodies of fertilized Echinarachnius eggs are nothing but coagulation artifacts.*

The So-called Central Bodies in Fertilized Echinoderm Eggs.

"Central body" phenomena in *Echinarachnius* are probably typical of echinoderms generally. The general features of the illustrations of the present study (Figs. 11 to 26) are very similar to those of previous investigations. The differences that occur with respect to the detailed structure of central bodies are explained by the use of different fixatives which produce various differences in the coagulation products of the rays and hence form various types of central bodies. The effects of different coagulation agents is now under investigation and the results will be reported in the next paper of the present series. In those cases where the central bodies of sperm-asters are illustrated as large homogeneously-granular structures without a period-like centriole (Wilson '95, '96; Wilson and Leaming '95; Wilson and Mathews '95; Ziegler '04) the coagulation products are similar to those of the present study. In cases where there is a period-like centriole, or centrioles (Hill '95; Kostanecki '96; Erlanger '98; Wilson '00, '01, '23, '28), the situation is probably explained by the fact that those asters which happen to contain one or two cytoplasmic granules at their mid-point were selected as "normal" whereas the others were dismissed as "poorly fixed"; or such "centrioles" may be small clearly-delimited coagulation products of the focal point of astral rays. (The study that is now in progress dealing with the effects of various fixing agents upon "central bodies" shows that they may vary from large vaguely-delimited diffuse types to small condensed delimited structures, depending upon the fixative that is used.) The misinterpretation by Boveri ('00) of the bi-lobed granule has already been noted. The wide variety of central body struc-

ture in cleavage-amphasters is likewise probably explained by different coagulation products, coupled with a misinterpretation of cytoplasmic granules that sporadically occur at the astral center. It is possible, of course, that the central body phenomena of *Echinarachnius* are not typical of echinoderms. Furthermore, modifications due to species differences must be kept in mind. Nevertheless, it is probable that the present study is valid for echinoderms generally.

Boveri ('97) reports a case in *Echinus* eggs where at the first cleavage an isolated central body passes into one blastomere, whereas all the nuclear material and the other central body remains in the other blastomere. The isolated center is described as dividing synchronously with the other. This observation is given considerable theoretical importance by Wilson ('28, p. 441). If the results of the present paper are valid and generally applicable to echinoderms, there is some source of error in Boveri's observations. The discrepancy awaits further study, but it is to be noted that he worked with eggs that had been shaken. The supposedly enucleated blastomere may have contained some scattered nuclear material that was invisible.

Hypotheses Concerning the Mitotic Rôle of Central Bodies in the Light of the Present Investigation.

The assumption that central bodies are the formative foci of the astral mechanism, and the hypothesis that they maintain genetic continuity from cell to cell, are well illustrated in many species during the final divisions of the germ cells. The question arises, however, to what extent can their behavior at this period be regarded as typical? It is an accepted biological principle that the fundamental phenomena of any one type of cell will probably be found to be true of many other cells. This is a very dangerous assumption, however, to apply to the rôle of cell components during spermatogenesis. The behavior of the chromosomes with reference to synapsis and reduction, the behavior of the Golgi-bodies in giving rise to the acrosome, the behavior of the chondriosomes in forming the nebenkern, are not thought of as typical of those components generally. The same is true of the behavior of central bodies in producing the axial filament. In how far,

therefore, can other phases of central body behavior occurring during gametogenesis be regarded as typical? Is it safe to assume that because they give rise to asters and maintain genetic continuity during this very specialized phase of cellular history, that therefore this is probably typical of their mitotic rôle in most cells? The fact that central bodies occur in higher plants only in the final divisions of the spermatozoid-forming cells, indicates that their behavior during the formation of motile gametes generally may be peculiar to that period. Their chief function at that time is probably that of a blepharoplast. In any event it is very unsafe to reason from any phase of central body behavior during the history of germ cells to their behavior in fertilization and mitosis generally.

The conclusion of the present study is that the so-called central bodies in fertilized eggs of *Echinarachnius* are nothing but coagulation artifacts. To what extent this conclusion may be true of central bodies in other species awaits further study by the same method used in this investigation. There are various facts indicating that the present result may have wide-spread application to central bodies in fertilization and in mitosis (with the exception of the final divisions of motile germ cells). It is well known that central bodies occur only in connection with asters; they are absent in higher plants (except in spermatozoid formation) where asters are absent. There are many cases in animal cells where the central bodies disappear at certain stages in the cell history and later reappear; they disappear as the asters fade, and reappear as the asters reform. In those animal eggs where polar bodies are formed by a spindle without asters, there are no central bodies at the ends of the spindle although they are present in the same eggs at the center of the sperm aster. It is frequently stated that it is "difficult to fix" central bodies during that stage of fertilization, the so-called "pause," after the sperm-aster has faded and before the cleavage-asters have become well-formed. These facts indicate that it is not an unreasonable suggestion that the result of the present study may have wide application. In many cases central bodies of fertilization and mitosis (except in gametogenesis) may have no existence as individualized structures, and may be nothing but coagulation artifacts produced by

fixation of ray material at the center of asters having clear rays. This idea is put forward tentatively as a working hypothesis only. It is possible, of course, that central body phenomena of fertilization and mitosis may not fall under one category of behavior. At least the present study raises serious doubts concerning the usually accepted theories.

RÉSUMÉ.

1. The present status of the hypotheses concerning the mitotic rôle of central bodies in the animal cell may be summed up as follows. There is general agreement that they are "division centers," the formative foci about which the astral mechanism arises and its most persistent element. There is difference of opinion as to whether or not they maintain genetic continuity from cell to cell and from generation to generation, but there is a tendency in some quarters to tentatively accept such a hypothesis as a fruitful working assumption.

2. Much confusion exists in the literature concerning the terminology and relationships of the central body. Its most constant and essential component is a minute period-like *centriole*. This is usually surrounded by a larger structure, the *centrosome*, about which is the ray area. The term "centrosome," however, is used in widely different ways by various authors. Furthermore, in some cases it is often difficult to determine whether the central apparatus is a "centriole" or a "centrosome." These ambiguities led to the adoption of the more inclusive and non-committal term *central body*. This is historically the older and leaves open the question as to precise homologies in any particular case.

3. There is a wide variety in the structure of echinoderm central bodies as reported by various investigators. The majority of studies illustrate a minute period-like centriole which is usually surrounded by a larger structure, the centrosome. Whatever the structural details may be in any given study, and whatever terminology is used, it is taken for granted that central body behavior in echinoderms is "typical." Echinoderm central bodies are assumed to give rise to the astral mechanism, and it is regarded as highly probable that they maintain genetic continuity from cell to cell and from generation to generation.

4. In the present investigation about nine hundred asters in the

eggs of *Echinarachnius parma* were studied at various stages during the mitotic cycle from fertilization to first cleavage. They were fixed in Bouin's fluid, a reagent that clearly coagulates rays. Each aster was measured and analyzed with reference to about twenty points concerning its rays and central bodies. The study was conducted upon the following assumptions: in the cytological investigation of a cell component it is necessary to study large numbers of cells at each interval of significant change; to choose them by a method that prevents all unconscious selection of certain classes; to analyze and measure each individual with reference to the maximum number of factors; to determine relations; and to take all classes into consideration in arriving at the result. The method involves only the simplest quantitative principles as applied to cytological research.

5. Such a quantitative analysis of about four hundred sperm-asters shows that a granular configuration ("centrosome") is present at the astral center only during its middle history when rays are coarse, and that it is absent at the beginning and at the end of the cycle when rays are delicate. Its size is proportional to that of the aster. It appears and disappears as coarse rays appear and disappear.

6. A similar analysis of about five hundred cleavage-asters shows that the "pleuricorpuscular" echinoderm central body which enlarges into the "centrosphere," is present only during the middle-history of the aster when rays are coarse, and is absent at the beginning and at the end of the cycle when rays are delicate. Its size and shape are proportional to that of the aster. The central body appears and disappears as coarse rays appear and disappear.

7. The conclusion is suggested, therefore, that the so-called central bodies of both sperm- and cleavage-asters are not individualized entities giving rise to the asters, but that they are formed by the aster only when rays are coarse. Furthermore, it is probable that the aster forms the "central body" only when it is coagulated. Live asters were carefully studied at high magnifications with water-immersion objectives. A radial configuration is distinctly visible in the outer parts; the central areas are perfectly hyaline, except for the possible presence of nuclear material.

Were the so-called central bodies of coagulated asters, actual structures present in the living condition, it is at least probable that they would be visible, since they are larger than nuclear structures that can be seen.

8. The behavior of "central bodies" in nuclear asters of fertilized *Echinarachnius* eggs is in complete harmony with central body phenomena in cytasters of artificially activated ones (Fry, '28). In both, the so-called central bodies appear and disappear as coarse rays appear and disappear; in both, they are the coagulated center where well-formed rays converge.

9. The usual hypotheses concerning the mitotic rôle of central bodies in animal cells are meaningless in the case of *Echinarachnius* fertilization. The so-called central bodies of fertilized *Echinarachnius* eggs are nothing but coagulation artifacts. The situation in this species is probably typical of echinoderms in general, as the phenomena of the present study are very similar to those illustrated by previous students of echinoderm fertilization. It is probable that the central bodies previously described in echinoderm fertilization are either cytoplasmic granules that happen to be at the center of the aster or that they are nothing but the coagulated focal point of rays. Differences in structural details, as reported by various investigators, are probably due to the effects of various fixatives.

10. The assumption that central bodies are the formative foci of the astral mechanism, and the hypothesis that they maintain genetic continuity from cell to cell, are well illustrated in many species during the final divisions of the germ cells. The behavior of all cell components, however, during gametogenesis, including that of central bodies, is in many ways different from their usual rôle. It is very dangerous, therefore, to expect that the phenomena found during this specialized phase of cell history may be typical of cells generally. It is very unsafe to reason from central body behavior during gametogenesis to their behavior in fertilization and mitosis.

11. The conclusion of the present study that "central bodies" in fertilized *Echinarachnius* eggs are nothing but coagulation artifacts may possibly have wide-spread application to the rôle of central bodies in fertilization and mitosis generally (with the

exception of the final divisions of motile germ cells). It is well known that central bodies occur only in connection with asters; they are absent in higher plants (except in spermatozoid formation) where asters are absent. There are many cases in animal cells where the central bodies disappear at certain stages in the cell history and later reappear; they disappear as the asters fade, and reappear as the asters reform. In those cases where polar bodies are formed by spindles without asters, central bodies are absent from the ends of the spindle although the same cell contains a central body in the sperm-aster. They are "difficult to fix" during the "pause" in fertilization, after the sperm-aster has faded and before the cleavage-asters have become well-formed. Hence it is not an unreasonable tentative suggestion that the results of the present study may be found to have wide application, and may fundamentally modify current hypotheses concerning central bodies in fertilization and mitosis.

LITERATURE CITED.

- Agar, W. E.**
'20 Cytology. Macmillan and Co., Limited, London.
- Boveri, T.**
'97 Zur Physiologie der Kern- und Zellteilung. Sitz.-Berichte der Phys.-med. Ges. Würzburg.
'00 Zellen-Studien. Heft 4. Ueber die Natur der Centrosomen. Jen. Zeitsch., 25.
- Brachet, A.**
'17 L'œuf et les facteurs de l'ontogénèse. Octave Doin et Fils, Paris.
- Buchner, P.**
'15 Praktikum der Zellenlehre. Gebrüder Borntraeger, Berlin.
- Bütschli, O.**
'92 Untersuchungen über microscopische Schäume und das Protoplasma. English translation by E. A. Minchin. Adam and Charles Black, London.
- Doncaster, L.**
'20 An Introduction to the Study of Cytology. The Cambridge University Press.
- Erlanger, von R.**
'98 Zur Kenntnis der Zell- und Kernteilung. II. Ueber die Befruchtung und erste Teilung des Seeigel-Eies. Biol. Cent., 18.
- Field, G. W.**
'95 On the Morphology of the Echinoderm Spermatozoön. Jour. Morph., 11.
- Flemming, W.**
'91 Neue Beiträge zur Kenntniss der Zelle, II. Arch. mikr. Anat., 37.

Fry, H. J.

- '28 Conditions Determining the Origin and Behavior of Central Bodies in Cytasters of *Echinarachnius* Eggs. *BIOL. BULL.*, 54.

Hertwig, O.

- '23 *Allgemeine Biologie*, seventh edition. G. Fisher, Jena.

Hill, M. D.

- '95 Notes on the fecundation of the egg of *Sphærechinus granularis* and on the maturation of the egg of *Phallusia mammillata*. *Quart. Journ.*, 38.

Just, E. E.

- '27 History of the Middle-piece of the Spermatozoön in the Fertilized Egg of *Echinarachnius parma*. *Anat. Rec.*, 37. (Abstract, p. 162.)

Kostanecki, K.

- '96 Ueber die Gestalt der Centrosomen im befruchteten Seeigelei. *Anat. Hefte*, 22.

Lillie, Frank R.

- '19 *Problems of Fertilization*. The University of Chicago Press.

Lillie, Frank R., and Just, E. E.

- '24 *Fertilization*. This discussion is Chapter VIII of *General Cytology*, edited by Edmund V. Cowdry. The University of Chicago Press.

Meves, R.

- '12 Verfolgung des sogenannten Mittelstückes des Echinidenspermiums im befruchteten Ei bis zum Ende der ersten Furchungsteilung. *Arch. mikr. Anat.*, 80.

Sharp, L. W.

- '26 *An Introduction to Cytology*. The McGraw-Hill Book Co., New York.

Wilson, E. B.

- '95 Archoplasm, Centrosome and Chromatin in the Sea-urchin Egg. *Jour. Morph.*, 11.
- '96 *The Cell in Development and Inheritance*, first edition. The Macmillan Co., New York.
- '97 Centrosome and Middle-piece in the Fertilization of the Egg. *Science*, 5.
- '99 On Protoplasmic Structure in the Egg of Echinoderms and Some Other Animals. *Jour. Morph.*, 15, suppl.
- '00 *The Cell in Development and Heredity*, second edition. The Macmillan Co., New York.
- '01 *Experimental Studies in Cytology*. II. Some Phenomena of Fertilization and Cell-division in Etherized Eggs. *Arch. f. Entw.-mech.*, 13.
- '23 *The Physical Basis of Life*. Yale University Press.
- '28 *The Cell in Development and Heredity*, third edition, 1925, with corrections. The Macmillan Co., New York.

Wilson, E. B., and Leaming, E.

- '95 *An Atlas of the Fertilization and Karyokinesis of the Ovum*. The Macmillan Co., New York.

Wilson, E. B., and Mathews, A. P.

'95 Maturation, Fertilization and Polarity in the Echinoderm Egg.
Jour. Morph., 10.

Yatsu, N.

'09 Observations on Oökinesis in *Cerebratulus lacteus*. Jour. Morph.,
20.

Ziegler, H. E.

'04 Die ersten Entwicklungsvorgänge des Echinodermeneies insbesondere die Vorgänge am Zellkörper. Denkschrift med.-naturw. Gesell. Jena (Festschrift z. E. Haeckel).

PARTHENOGENESIS AND THE INHERITANCE OF
COLOR PATTERNS IN THE GROUSE LOCUST
PARATETTIX TEXANUS HANCOCK.

ROBERT K. NABOURS AND MARTHA E. FOSTER.¹

INTRODUCTION.

Newell (1914) reported segregation of genetic factors in parthenogenesis, wherein hybrid Carniolan-Italian queen bees gave equal numbers, respectively, of pure Carniolan and Italian drones. Previously, Perez (1879) and Cuénot (1909) had noted variations among the drones from hybrid queens, but more than one pair of factors had apparently been involved. Observations were made in 1923-24, in the apiary of the Kansas Agricultural Experiment Station of the offspring of separate queen bees considered hybrid. The drones varied greatly in their characteristics, especially with respect to color, ranging from black, through various degrees to the yellow of the Italian. These queens thus exhibited a considerable degree of genetic complexity, indicating the presence of two or more independent pairs of factors for color and other characteristics.

Parthenogenesis in the grouse locusts was first recognized in 1915, in attempts to crossbreed males of *Paratettix texanus* with females of *Apotettix curycephalus*. It was noted that the offspring from such matings were exclusively females, and carried the color pattern of the female of the pair if she were homozygous, or segregated into her component, or cross-over patterns if she were heterozygous. Then it was soon ascertained that *A. curycephalus* females which had never been exposed to males of any kind behaved in these respects precisely as did those exposed to *P. texanus* males. As many as 4,470 females and seven males produced in parthenogenetic breeding, mostly from females which had not been exposed to males at all, many showing segregation and crossing-over of factors for color patterns, had been re-

¹ Contribution No. 110, Department of Zoölogy, Kansas Agricultural Experiment Station.

corded by August 1, 1918 (Nabours, 1919). Later, some females of *A. curycephalus* were bred seven consecutive generations parthenogenetically, and there was further rather extensive experimental breeding of this species both bisexually and parthenogenetically (Nabours, 1925, 1929).

Segregation of factors for color patterns in parthenogenesis was found to occur also in *Telmatettix aztecus* (Nabours and Snyder, 1928). There have been a few females of *Tettigidea parvipennis pennata* produced in this laboratory from unmated parents. One unmated individual of this species of the genetic composition F/M, (for color patterns see Bellamy, 1917), gave two F/F and three M/M females (1922, unpublished).

Whiting (1921a) reported on the wasp *Hadrobracon brevicornis*, wherein the unmated females, hybrid for black and orange eyes, gave nearly equal numbers, respectively, of black and orange eyed males. He also reported a factor for lethal (Whiting, 1921b) which exhibited 19.5 per cent. of crossing over with the factors for orange and black eyes in parthenogenetic breeding.

Hybrid moths from the crossing of *Tephrosia bistortata* males with *T. crepuscularia* females reproduced parthenogenetically, and there was segregation with respect to wing color and pattern. The unmated females of neither species alone would give progeny. In connection with the report of these results, the authors (Peacock and Harrison, 1925) advanced the hypothesis that parthenogenesis was consequent upon hybridity. In a later paper (1926), these investigators adduced from my tables (Nabours, 1919, 1925) that all the parthenogenous females of the grouse locust *A. curycephalus* had been hybrids from the crossing of one variety of the species from Tampico, Mexico, with another from the region of Houston, Texas. They welcomed this as evidence constituting strong confirmation of their hypothesis.

Progeny have resulted in this laboratory in three of eight attempts to cross males of *A. curycephalus* with females of *P. texanus*, once in 1912 and twice in 1915. In the first case, the female, one generation from Many, Louisiana, gave five females, all appearing to be like herself. In the other cases, an I/P female gave one I/I, or +/I, and two P/P, or +/P, females, and a B/C female gave two C/C, or +/C, females. Both these parents

were one generation from Houston, Texas. Since these three females had been probably also exposed to brothers, and as none of the progeny was tested, the results had been regarded with doubt. However, a reëxamination of the records, in the light of further experience, strengthens the possibility that these were also cases of parthenogenesis.

Females which are exposed to males of any kind are considered as having reproduced parthenogenetically (1) if the contrasting dominant characteristics of the males do not develop in the offspring, (2) if practically all the offspring are females, or (3) if the offspring, when bred further, are found to be homozygous for those factors for which they should be heterozygous had the eggs been fertilized. At least two, or sometimes all of these criteria are applied in the determination of each case. It is obvious that, in those matings where the males give some or all recessive gametes, a proportionate number of the female progeny which are not tested by further breeding, or determined histologically, may possibly be, in fact, of parthenogenetic origin.

PARTHENOGENESIS IN *Paratettix texanus*.

Parthenogenesis in *Paratettix texanus* was first definitely recognized on November 14, 1922, when the offspring of a pair of heterozygous individuals of contrasting dominant color patterns exhibited segregate patterns of the female only, and all were females (Table II., item 1). During the five years following, until November, 1927, 32 other females that had been similarly exposed to males of contrasting dominant color patterns produced 187 recorded females and one male, all bearing exclusively the maternal characteristics, Table II., items 2-17, 30, 32-34, 36, 40, 44-50, 52, 79 and 81. Of these offspring, 26 were successfully tested in matings, or by reproducing again parthenogenetically, and all were found to have been homozygous for the dominant maternal patterns, Table II., and V.

Some of the males to which the 33 females had been exposed were thought to have been impotent, while the others died, or escaped from the cages before matings occurred. In both *Apotettix curycephalus* (Nabours, 1919, 1925, 1929) and this species, *P. texanus*, it has appeared that any female, if potent at all, re-

produced bisexually, rarely, if ever parthenogenetically, when mated with a potent male.

These 33 cases of parthenogenesis among females exposed to males have occurred during the last quarter of a period of the breeding of *P. texanus* covering nineteen years, although there had been many opportunities for parthenogenesis from the beginning. In numerous cases males had died, or escaped from the cages after the matings had been made, and the females remained for long periods without offspring ensuing. The matings and records of the entire period have been made in such a manner that, with comparatively few exceptions, parthenogenesis would have been indicated.

Following the observations of the first few cases of occasional parthenogenesis among females that had been exposed to males, and having in mind the experiences with *A. curycephalus* (Nabours, 1919, 1925, 1929) a number of females of *P. texanus* were separated from the males. From 75 of these which were not exposed to males after becoming adult, 625 offspring were secured and transferred from the parent to the progeny cages. Of these, 393 females and one male became large enough to permit records being made of their sex and color patterns, and there were seven the sex of which was not noted (Table II.).

MATERIALS AND METHODS OF BREEDING.

The specimens used in these experiments were taken from the stocks of *P. texanus* which had been bred in the greenhouse, beginning with individuals secured at Houston, Texas, in September, 1908 (Table IV.). New specimens had been added nearly every year, during the first 13 years, or until 1921, from Houston, San Antonio, Sugarland, Mackay and Beaumont, Texas, and Many and Baton Rouge, Louisiana, but principally from Houston and Sugarland. Specimens were secured and added to the stocks during the last five years from San Antonio, Houston, Sugarland, and, in addition, from Austin and College Station, Texas. Therefore, there has been abundant opportunity for hybridization of probably slightly differing varieties, a feature which will be discussed farther on.

Most of the elementary color patterns of *P. texanus*, and some

of their hybrid complexes, have been previously approximately described and illustrated (Nabours, 1914, 1917, 1923, and Plate III., 1929). The full list of those employed in experimentation up to date may be described, though inadequately, as follows: (1) $+/+$ (old AA), mottled gray, a pattern common to practically all the grouse locusts, and now considered the normal recessive, or "wild type"; (2) B/B, white over pronotum and parts of posterior femora; (3) C/C, white anterior pronotum, posterior dark or mottled, reddish brown legs; (4) Cext/Cext, the same as C/C, but with an extension of the white of the anterior pronotum posteriorly, and the line between the white anterior and dark posterior is not sharp; (5) Cof/Cof (old QQ) practically the same as C/C, but with red middle legs and conspicuously orange colored femora of the jumping legs; (6) D/D, the same as $+/+$, but with conspicuous white spots on hind femora; (7) E/E, broad yellow stripes along median pronotum and on distal ends of posterior femora; (8) F/F, broad mahogany stripes along median pronotum and posterior femora; (9) S/S, broad yellowish gray, nearly white stripes along median pronotum and on distal ends of hind femora; (10) Sm/Sm (old ISIS), broad brown, slightly red stripes along median pronotum and on distal ends of posterior femora (distinctly different from the other stripes and the only mutant observed to occur in the greenhouse); (11) S_1/S_1 , broad nearly clear white stripes along median pronotum and on distal ends of hind femora, and with red middle legs; (12) P/P, broad brown stripes along median pronotum and on distal ends of posterior femora; (13) L/L, trilineate, three nearly white lines along the pronotum and one along femora of hind legs; (14) K/K, narrow white stripe along median pronotum, and red middle legs, almost indistinguishable from K/K, of *Apotettix curycephalus*, (Nabours, 1925); (15) J/J, conspicuous large white spot over broad part of pronotum, identical with Y/Y in *A. curycephalus* (loc. cit.); (16) Jof/Jof, the same as J/J, but with prominently orange colored posterior femora and red middle legs; (17) H/H, large yellow, or orange spot covering the same area as the white spot of J/J; (18) Hm/Hm, a gray, slightly orange spot, covering the same area as the spot H/H; (19) I/I, a dark mahogany spot over the same area as that of J/J; (20) M/M,

brown all over pronotum. Hybrid M/S looks precisely like Sm/Sm. It is now thought, contrary to the previous idea, that the origin of Sm was due to the mutation of a gene closely linked with the S gene (Nabours, 1917, pp. 48, 52, 53); (21) N/N, a brown gray all over; (22) N₁/N₁, dull orange, or henna all over; (23) N₂/N₂, brilliant orange all over. These first named twenty-two factors for color patterns are extremely closely linked. Hm is the only one to have crossed over at all. Some of them may be actually multiple allelomorphs. (24) Θ/Θ , dense black over anterior pronotum, fading somewhat towards the posterior, and extending over the hind femora; (25) sf/sf, white spots on posterior femora, resembling D/D, but recessive in heterozygotes, and not showing well, even in homozygous condition, with some of the dominant patterns, as C, Cof, Jof; (26) ϕ/ϕ , reddish, or pink all over, hardly discernable, almost recessive in heterozygotes. These two, sf/sf and ϕ/ϕ , are the only colors so far discovered in all the grouse locusts, except the normal recessive, +/+, that can in any sense be considered recessive, and they are only partially so. These last described three are extremely loosely linked with each other and all the others, or they may be on separate pairs of chromosomes (For Θ , see Haldane, 1920).

The breeding methods have been about the same as those employed in all the experiments with the grouse locusts (loc. cit.). A longer time is required to obtain offspring from unmated females, and they are fewer in numbers, than from mated ones. A comparison of the productivity of unmated individuals with their mated sisters is shown in Table I, covering the period, January–October, 1925. This comparison shows that 46.6 per cent. of the unmated females were productive, while 62.5 per cent. of their mated sisters gave offspring. The average number of offspring for the unmated individuals was 9, while the average number hatched from the mated sisters was 60.13, or more than six times as many. Sixty-seven and five tenths per cent. of the offspring hatched from unfertilized eggs, against 53.75 per cent., of those hatched from the mated sisters, were recorded. The discrepancy in the proportions recorded, however, might not have been due so much to the greater viability of the parthenogenous progenies as to the care they were given, and early age at which

records were made. These were noted every day, while the progenies of the mated sisters were part of the larger breeding projects and were recorded only in their turn, which was sometimes long after they were large enough, and after considerable mortality.

Miss Isabel Potter has had a considerable share in conducting these experiments, and the principal task in the preparation of the tables.

TABLE I.

PRODUCTIVITY OF UNMATED FEMALES COMPARED WITH MATED SISTERS
(JANUARY-OCTOBER, 1925).

Months Females Were Placed in Mating Jars.	Unmated Females.				Mated Females.			
	Number of Unmated Females.	Number Productive.	Number of Offspring Transferred.	Number of Offspring Recorded.	Number of Mated Sisters.	Number Productive.	Number of Offspring Transferred.	Number of Offspring Recorded.
January.....	1	1	24	17	2	1	128	66
February....	1	0	0	0	2	2	175	100
March.....	27	23	250	188	15	14	1,078	731
April.....	7	7	32	24	0	0	0	0
May.....	12	8	75	39	5	3	402	171
June.....	31	4	26	9	33	18	665	285
July.....	18	3	20	7	9	5	168	84
August.....	0	0	0	0	0	0	0	0
September...	8	3	14	14	5	2	90	17
October.....	0	0	0	0	1	0	0	0
Totals....	105	49	441	298	72	45	2,706	1,454

46.6% productive;
average 9. offspring;
67.5% recorded.

62.5% productive;
average 60.13 offspring;
53.75% recorded.

THE EXPERIMENTS.

The data are presented mainly in tables with explanations, and their use illustrated by a few succinctly elaborated examples. The tables have cross references so that the progenitors, or posterity, both males and females, of any individual, so far as they appear to be related to parthenogenesis, may be traced. Table II. shows the parthenogenetic breeding of 108 females, composing 83 items of individuals and groups. Thirty-three of the females, items 1-17, 30, 32-34, 36, 40, 44-50, 52, 79 and 81, had been exposed to males; the other 75 had not, after becoming

adult. Table III. shows the 15 matings in which, in addition to the bisexual progeny, each female also gave from one to seven parthenogenetic offspring. Table IV. gives the sources of the male and female progenitors of the parthenogenetic individuals over a period of years in various places in nature. Table V. indicates the further breeding of the partheno-produced¹ individuals of Table II. in matings with males. This table also includes two matings, 208 and 216, in which there were also partheno-produced offspring.

Explanation of Table II.—The second column gives the sources of the females, respectively. Those of the first 31 items had no parthenogenesis in their recorded ancestry, and are referred to Table IV. where their lines may be traced to the various places in Louisiana and Texas, where their progenitors were collected. The females of the remaining 52 items, 32-83, were the daughters, or the descendants through only one, or a few parthenogenetic, or bisexual generations of these first parthenogenetic individuals of items 1-31.

The symbols, in parentheses, in the third column indicate the factors for color patterns of the males to which the 33 females were exposed. This column is blank in those items where the females were not so exposed.

The fourth column, after the X's, shows the symbols representing the factors for the color patterns of the females. The figures, in parentheses, before these, when there was more than one, show that two or three sisters of the same genetic composition were used.

The next groups of symbols and figures represent the factors for the color patterns and the numbers of the progeny. The number of males is at the left, and the number of females at the right of the hyphen, invariably; a number after a second hyphen indicates those the sex of which was not determined, items 31, 37, 51 and 67, Table II. The last numbers, in parentheses, indicate the items, or matings in Tables II. and V. where the results of the further breeding of the progeny are shown.

Elaboration of the Use of Table II.—Item 1: Table IV. is

¹ This composite word was suggested by W. R. B. Robertson.

where the ancestry of this female, which had no recorded parthenogenesis in her line, may be traced to individuals secured, over a period of several years, at several places in Texas and Louisiana. J/Sm represents the factors for the dominant color patterns of the male to which the female, B, Cof, next after the X, was exposed. The next two groups show the progeny, two females each of the segregate patterns, B/B and Cof/Cof, respectively, and exclusively of the female of the pair.

Item 42: Bis. 204-6 indicates that these females, K θ /S, had descended through one bisexual generation, mating 204, Table V., from the parthenogenetic female, I/S, item 6, Table II. The four groups of symbols and figures show the non-crossover and crossover progeny, all females. The final figures 234-237, in parentheses, are the numbers of the matings, Table V., which give the results of the mating with males of four of these parthenogenetic progeny.

Item 55: The female parent, B/H, had descended through one, (1), bisexual generation, not noted in these data, from mating 205, Table V., the female of which, in turn, had been one of the parthenogenetic progeny of item 7, Table II. Two of these progeny, H/H, later produced 13 females, all like themselves, item 60. Dir. 55, item 60, means that the two females came directly from the parthenogenetic progeny of item 55.

Item 75: The female parent, L θ /M, was descended from three parthenogenetic progenitresses as follows: (a) A Cof/Cof female of the parthenogenetic progeny of item 4, Table II., was mated, 202, Table V. An individual from this mating was, in turn, mated, and so on for four generations, five in all, when, from this fifth bisexual generation, the L θ /M female was taken. Bis. (4) 202-4 = four bisexual generations to mating 202, five bisexual generations in all, to parthenogenetic item 4. (b) Another parthenogenetic progenitress was from item 37, bred bisexually in mating 208, and then another bisexual generation, not noted in these data, to item 75. (c) The line of descent then extends from item 37, through one biparental generation, 203, to the parthenogenetic female, item 6, Table II. It is to be observed that this female, item 75, had none of the color characteristics of her three respective parthenogenetic progenitresses, items 4, 37

TABLE II.
SHOWING PARTHENOGENESIS IN *Paratettix texanus*.

Items.	Source.	Males.	Females.	Offspring.
1	Table IV	(J/Sm)	× B/Cof	B/B 0-2, Cof/Cof 0-2
2	Table IV	(Cof/KΘ)	× B/P	B/B 0-2, P/P 0-1
3	Table IV	(KΘ/P)	× B/Cof	B/B 0-1, Cof/Cof 0-1 (200)
4	Table IV	(B/KΘ)	× Cof/S	Cof/Cof 0-5, S/S 0-3 (201, 202)
5	Table IV	(B/I)	× J/N ₂	J/J 0-3, N ₂ /N ₂ 0-3
6	Table IV	(Jof/K)	× I/S	I/I 0-2, S/S 0-1 (203, 204)
7	Table IV	(Cof/K)	× E/H	E/E 0-7, H/H 0-5 (205)
8	Table IV	(IΘ/K)	× J/P	J/J 0-2, P/P 0-1 (206)
9	Table IV	(C/EΘ)	× B/Jof	B/B 1-5, Jof/Jof 0-8
10	Table IV	(+KΘ)	× C/N ₁	C/C 0-2, N ₁ /N ₁ 0-3 (207)
11	Table IV	(+BΘ)	× C/Jof	C/C 0-1, Jof/Jof 0-1
12	Table IV	(L/Sm)	× Hm/MΘ	Hm/Hm 0-3, HmΘ/HmΘ 0-4, M/N 0-3, MΘ/MΘ 0-5 (209, 210, 211, 212, 33, 34, 247)
13	Table IV	(K/S)	× +/J	J/J 0-1 (213)
14	Table IV	(CofΘ/E)	× Hm/Hm	Hm/Hm 0-2
15	Table IV	(N/S)	× BΘ/Hm	B/B 0-1, BΘ/BΘ 0-1, Hm/Hm 0-2, HmΘ/HmΘ 0-1
16	Table IV	(EΘ/K)	× +/B	+/+ 0-2, B/B 0-4
17	Table IV	(E/L)	× F/HΘ	F/F 0-1, H/H 0-2, HΘ/HΘ 0-6 (249)
18	Table IV		Cof/S	Cof/Cof 0-3, S/S 0-2
19	Table IV		(3) K/K	K/K 0-13
20	Table IV		(2) K/M	K/K 0-3, M/M 0-3 (233, 76)
21	Table IV		(2) C/K(Φ)	C/C 0-2, K/K 0-2, CΦ/CΦ 0-1, KΦ/KΦ 0-1 (227)
22	Table IV		(2) Jsf/Jsf	Jsf/Jsf 0-5 (35)
23	Table IV		KΘ/P	KΘ/KΘ 0-1, P/P 0-2
24	Table IV		HΘ/S ₁	HΘ/HΘ 0-2
25	Table IV		(2) BΘ/H	H/H 0-4 (223, 47)
26	Table IV		(2) K/PΘ	K/K 0-3, KΘ/KΘ 0-2, P/P 0-2, PΘ/PΘ 0-4 (225, 238)
27	Table IV		(2) CofΘ/S	Cof/Cof 0-2, CofΘ/CofΘ 0-5, S/S 0-3, SΘ/SΘ 0-2.
28	Table IV		EΘ/S	EΘ/EΘ 0-1, (231)
29	Table IV		(2) Jsf/Ksf	Ksf/Ksf 0-4, Jsf/Jsf 0-1 (239, 240)
30	Table IV		× Hm/K	K/K 0-7, Hm/Hm 0-1
31	Table IV		H/F	H/H 0-1-1, F/F 0-1
32	Bis. 205-7	(CofΘ/E)	× Hm/K	H/H 0-2, K/K 0-2
33	Dir. 12	(Cof/S)	× HmΘ/HmΘ	HmΘ/HmΘ 0-6 (214, 215)
34	Dir. 12	(K/Sm)	× HmΘ/HmΘ	HmΘ/HmΘ 0-12 (216)

TABLE II. (*Continued*).

Items.	Source.	Males.	Females.	Offspring.
35	Dir. 22		Jsf/Jsf	Jsf/Jsf 0-2
36	Dir. 35	(B/KO)	× Jsf/Jsf	Jsf/Jsf 0-1 (217)
37	Bis. 203-6		Cof/I	Cof/Cof 0-7-1, I/I 0-9 (208, 38, 39) (Later mated to ♂ Eθ/K and produced Cof/K 0-1)
38	Dir. 37		Cof/Cof	Cof/Cof 0-3
39	Dir. 37		Cof/Cof	B/B 0-2, E/E 0-3, (220, 221)
40	Bis. (1) 208-37	(KO/L)	× B/E	
41	Bis. (4) 202-4		(2) Cof/S	Cof/Cof 0-8, Cofθ/Cofθ 0-22, S/S 0-1,3, Sθ/Sθ 0-1,3 Cofθ/S(θ ?) 0-1, Cof/Cofθ 0-1 (229, 230, 244, 245).
42	Bis. 204-6		(2) KO/S	K/K 0-11, Kθ/Kθ 0-11, S/S 0-10, Sθ/Sθ 0-17, (234, 235, 236, 237)
43	Bis. (1) 229-41		Eθ/S	E/E 0-3, Eθ/Eθ 0-1, Sθ/Sθ 0-1
44	Bis. (1) 235-42	(B/Jofθ)	× Cof/K	Cof/Cof 0-1, K/K 0-3 (218, 219)
45	Bis. (4) 202-4		× Hm/K	K/K 0-1
46	Bis. (1) 235-42	(Sθ/Sθ)	× Hm/K	
47	Bis. (3) 204-6	(+/+)	× Cof/Hmθ	Cof/Cof 0-2, Cofθ/Cofθ 0-1, Hmθ/Hmθ 0-2 (222)
48	Dir. 25	(Cofθ/K)	× H/H	H/H 0-3
49	Bis. (5) 202-4	(F/J)	× Eθ/Ksf	Kθsf/Kθsf 0-1
50	Bis. (2) 208-37	(Cof/Kθ)	× Jsf/Psf	Jsf/Jsf 0-8, Psf/Psf 0-10
51	Bis. (5) 202-4	(H/Sθ)	× Kθsf/Psf	Ksf/Ksf 0-1, Kθsf/Kθsf 0-1, Pθsf/Pθsf 0-1
52	Bis. (2) 235-42		B/K	B/B 0-3-1, K/K 0-4 (224)
53	Bis. (2) 208-37	(I/Sθ)	× B/K	B/B 0-3, K/K 0-5
	Bis. (1) 205-7		(2) +/KO	+ θ / + θ 0-1
	Bis. (2) 226-76			
	Bis. (3) 211-12			
	Bis. (4) 208-37			
	Bis. (2) 224-51			
	Bis. (6) 202-4			
	Bis. (4) 235-42			
	Many, La., 1925			
	Bis. (2) 233-20			
	Bis. (2) 235-42			

TABLE II. (Continued).

Items.	Source.	Males.	Females.	Offspring.
54	Bis. 205-7		(2) B/H	H/H 0-1
55	Bis.(1)205-7		B/H	B/B 0-4, H/H 0-7 (60)
56	Bis.(1)205-7		B/H	H/H 0-1
57	Bis.(1)205-7		B/H	B/B 0-2, H/H 0-4
58	Bis.(1)205-7		B/K	K/K 0-1
59	Bis.(1)205-7		B/K	B/B 0-2
60	Dir. 55		(2) H/H	H/H 0-13
61	Bis. 205-7		(2) H/K	H/H 0-15, K/K 0-4 (246)
62	Bis.(1)205-7		H/K	H/H 0-1, K/K 0-1
63	Bis.(1)205-7		H/K	H/H 0-2, K/K 0-2
64	Bis.(1)205-7		H/K	H/H 0-5 (232, 248)
65	Bis.(5)202-4		(2) Cof/Eθ	Cofθ/Cof 0-1
66	Bis.(1)233-20 Bis.(1)236-42		(2) Cof/E	Cof/Cof 0-1, E/E 0-1
67	Bis.202-4		Cof/K	Cof/Cof 0-0-4, K/K 0-4 (228)
68	Bis.204-6		(2) Cof/S	Cof/Cof 0-5, S/S 0-5
69	Bis.(1)203-6		E/K	E/E 0-3, K/K 0-3
70	Bis.(3)202-4		I/Kθ	I/I 0-1
71	Bis.(1)209-12		(2) H/Kθ	H/H 0-1, Hθ/Hθ 0-2, K/K 0-1, Kθ/Kθ 0-2
72	Bis.(1)208-37		(2) I/K	K/K 0-1
73	Bis. 204-6		(2) K/S	K/K 0-8, S/S 0-10
74	Bis. 204-6		(2) K/S	K/K 0-1, S/S 0-3
75	Bis.(4)202-4		Lθ/M	L/L 0-6, Lθ/Lθ 0-4, M/M 0-2, Mθ/Mθ 0-2
76	Bis.(1)208-37		M/M	M/M 1-1 (226, 226a)
77	Many, La., 1925 Bis. 222-46		(2) Hmθ/L	Lθ/Lθ 0-1 (78)
78	Dir. 77		Lθ/Lθ	Lθ/Lθ 0-24 (241, 242)
79	Bis.(2)204-6	(Eθ/M)	× Cof/K	K/K 0-1, Cof/Cof 0-1
80	Bis. 213-13		(2) Jsf/Kθsf	Jsf/Jsf 0-3, Jθsf/Jθsf 0-1, Ksf/Ksf 0-1
81	San. Ant., 1926 Bis.(3)213-13	(+ +)	× Eθ/L	E/E 0-2, Eθ/Eθ 0-1, L/L 0-2, Lθ/Lθ 0-2
82	Bis.(4)208-37 Sugarland, 1926 Bis(8)202-4		(2) + φ/Psfθ	+ Oφ/+ Oφ 0-3, + Osf/+ Osf 0-1, + φ/+ φ 0-1, Psf/Psf 0-2, POsf/ POsf 0-1
83	Bis.(4)213-13 Sugarland, 1926 Bis.(8)202-4 Bis.(4)213-13		B/POsf	BO/BO 0-1, Psf/Psf 0-1, PO/PO 0-1

and 6, having lost them in the several bisexual generations (on record, but not essential to this inquiry) through which her ancestry had passed.

In a few cases the ancestries of parthenogenetic females trace back, through biparental breeding, to two, item 40, et al., three, items 44, 49, 50, or six, item 52, different parthenogenetic progenitresses.

Explanation and Illustration of the Use of Table III.—These are simple matings with the progeny showing preponderantly participation of the males in the parentage. However, one to seven individuals of each mating did not show any of the color characters of the male members of the matings, and all such were females. Since the dominant characters of the males, according to all experience, were due to show in any possible biparental progeny, these aberrant individuals are thought to have developed from unfertilized eggs.

The sources are to be read in the same way as in Table II. The ancestry of the females, only, is traced. Example, mating 101: The regions in nature from which the progenitors of the female B/S₁ came may be noted in Table IV., item 101. She had no parthenogenesis in her recorded progenitorship. Example, mating 110: The ancestry of the female parent, B/K, goes back to a progenitor, each, from Many, La., 1925, and Sugarland, Texas, 1926 (Neither of these is shown in Table IV.). Her line also goes back through six bisexual generations, not included in these data, through mating 202, Table V., to the parthenogenetic female of item 4, Table II., indicated by the Bis.(6)202-4. The Bis. (3) 235-42 means that the ancestry of this female, B/K, also goes back through three bisexual, Bis., generations, not included in the tables, to mating 235, Table V., to the parthenogenetic female of item 42, Table II.

Explanation and Illustration of the Use of Table IV.—In this table are denoted the males and females secured at various places, over a period of years, which constituted the progenitorship from nature of the 47 females, items 1-31, Tables II. and IV., and matings 100-106, Tables III. and IV., which first gave offspring parthenogenetically. The lines of ancestry of all the other 68 parthenogenetic females, Table II, and the other eight of Table III., in turn, extend back to some of these.

TABLE III.
MATINGS THAT GAVE SOME PARTHENOGENETIC INDIVIDUALS.

Mating Number.	Source.	Parents.	Offspring.
100	Table IV	P/P × +/KΘ	+/P 7-14, +Θ/P 6-12, K/P 9-12, KΘ/P 5-13, +/+ 0-2, K/K 0-1, KΘ/KΘ 0-1
101	Table IV	F/HΘ × B/Si	B/F 1-2, B/FΘ 3-4, B/H 1-1, B/HΘ 0-1, F/Si 2-5, FΘ/Si 0-1, H/Si 0-3, HΘ/Si 2-0, B/B 0-2, Si/Si 0-5
102	Table IV	J/K × Cof/SmΘ	Cof/J 4-6, CofΘ/J 2-2, Cof/K 2-1, CofΘ/K 3-1, J/Sm 3-3, J/SmΘ 2-2, K/Sm 3-5, K/SmΘ 1-2, Sm/Sm 0-1
103	Table IV	CofΘ/Sm × J/P	CofΘ/J 1-1, CofΘ/P 1-0, J/Sm 4-1, J/SmΘ 0-1, P/Sm 0-2, P/SmΘ 0-1, J/J 0-1
104	Table IV	E/K × B/I	B/E 1-2, B/K 1-3, E/I 3-1, I/K 3-1, B/B 0-1
105	Table IV	Cof/K × B/JΘ	B/K 8-12, BΘ/K 5-7, J/K 4-6, J/K 2-5, JΘ/K 5-5, JΘ/K 3-3, B/Cof 11-9, BΘ/Cof 7-7, Cof/J 6-4, Cof/JΘ 12-8, BΘ/BΘ 0-1
106	Table IV	P/S × CΘ/K	C/P 0-1, KΘ/S 0-1, CΘ/S 0-1, C/S 1-0, CΘ/CΘ 0-1
107	Bis.(1)208-37 Bis.(2)202-4	B/M × IΘ/K	B/I 5-6, B/IΘ 4-4, B/K 3-2, B/KΘ 3-2, I/M 4-3, IΘ/M 3-6, K/M 4-5, KΘ/M 4-3, K/K 0-1
108	Many, La., 1925 Bis.(1)233-20	Cof/KΘ × +/M	+/Cof 4-1, +/K 1-0, +/KΘ 2-2, Cof/M 3-4, CofΘ/M 0-1, K/M 0-1, KΘ/M 3-2, M/M 0-1
109	Bis.(5)202-4 Bis.(2)208-37 Bis.(2)235-42	I/LΘ × Cof/Sm	Cof/J 9-1, Cof/JΘ 1-1, Cof/L 2-1, Cof/LΘ 4-3, I/Sm 3-2, IΘ/Sm 1-3, L/Sm 0-2, LΘ/Sm 4-0, Cof/Cof 0-1
110	Many, La., 1925 Sugarland, 1926 Bis.(6)202-4	C/P × B/K	B/C 1-0, B/P 0-3, C/K 3-0, K/P 0-2, K/K 0-1
111	Bis.(3)235-42	D/SΘ × H/K	D/H 1-5, DΘ/H 0-2, D/K 1-3, H/Si 3-8, H/SiΘ 1-2, K/Si 1-3, K/SiΘ 4-2, H/H 0-1
112	Bis.(7)202-4	BΘ/Sm × +/Jof	+/BΘ 0-1, +/Sm 1-0, BΘ/Jof 1-0, Jof/Sm 1-0, +/+ 0-1, Jof/Jof 0-3
113	Bis.(3)210-12 Bis.(4)209-12 Bis.(7)202-4	BΘ/I × Jof/L	B/Jof 3-9, BΘ/Jof 15-7, B/L 7-4, BΘ/L 9-6, I/Jof 10-9, IΘ/Jof 9-2, I/L 12-8, IΘ/L 6-3, Jof/Jof 0-1
114	Bis.(5)208-37 Bis.(2)202-4	B/B × H/SΘ	B/H 11-7, B/HΘ 7-7, B/S 10-7, B/SΘ 18-7, H/H 0-1

The abbreviations, in the first column, are as follows: B.R. '10, Baton Rouge, La., 1910; Many, La., 1909, 1911, 1914; Mac. '17, Mackay, Texas, near Wharton, 1917; Bea. '17, '18, Beaumont, Texas, 1917, 1918; C.S. '21, College Station, Texas, 1921; Sug. '13, '21, '22, Sugarland, Texas, 1913, 1921, 1922; Hou. '08, '11, etc., Houston, Texas, 1908, 1911, 1913, 1914, 1916, 1918, 1921, 1922; Aus. '21, '22, '23, Austin, Texas, 1921, 1922, 1923; S.A. '11, '24, San Antonio, Texas, 1911, 1924. Tables II. and III., at the bottom reading to the right, refers to the items 1-31, Table II and matings 100-106, Table III. The column of small letters above each of these indicates the number of ancestors, male or female, or both, from each place and date. Items 15, 25, in the thirteenth column, 18, 27, 28, in the sixteenth, and 23, 26, 29 and mating 103, in the twenty-third column, had the same progenitorship, respectively.

Reading from left to right, the same letters, after a place and date, denote the same individuals. Examples: The small letters, a-d, repeated 29 times, after B.R. '10, means that four individuals, males or females, or both, named a, b, c and d, respectively, collected at Baton Rouge, La., in 1910, were ancestors from nature of all, except those of the last three columns, items 2, 10 and 31. Reading to the right of Hou. '14, there were 13 individuals, a, b, c, d, e, f, g, h, i, j, k, l and m (a-m) which were in the line of descent of all except the last three, items 2, 10 and 31. Reading up from item 22, there were 71 progenitors of this female from nature; two, a and b, from S.A. '11; ten, a-d, k, l, o, p, w and x, from Aus. '22; seven, a-g, from Aus. '21; one, c, from Hou. '22; one, a, each from Hou. '21 and Hou. '18 and so on up to the top where four, a-d, were from B.R. '10. From Aus. '21, item 6 had c, d, e, f and g (c-g); item 104 had e, f, g (e-g); item 1 and mating 106 had the same four, c, d, e, f (c-f); item 3 had two, e and f, of these; all others, except items 2, 10 and 31 had these four, c-f, and, in addition, a, b and g (a-g) in their lines. The largest number of progenitors, 26 in all, was from Austin, 1922. Items 1, 4, 5, 10, and 31, are clear of these; one, y, contributed to the progenitorship of item 2, and the largest contribution, a-g, i-p, s-v and z, 20 in all, was to the female of mating 105.

Item 2 had one progenitor from Sug. '22, 2 from Hou. '22 and

one from Aus. '22. The parent in item 10 came directly from a pair from S.A. '24, and 31 from a pair from New Braunfels, Texas, 1926.

This is a most intricate and, perhaps, formidable table into which many pages of writing have been condensed, but, with the aid of the references in Tables II., III. and V., one may trace the progenitorship of every parthenogenetic individual, either directly, or through one or more parthenogenetic lines, to nature where and when it became possible to begin the records.

Explanation and Example of the Use of Table I'.—The second column shows the sources, in Table II., of the parthenogenetically derived females of these matings. The matings represented in this table constitute tests of the homozygosity of these females, and of the one male, matings 226, 226a. Mating 215, Table V., gave one offspring without the \cdot for which the female parent was supposed to be homozygous. One individual, the female of mating 229, proved to be heterozygous for a factor. These cases will be reviewed in the discussion section.

Example 204: The female S/S was of the parthenogenetic progeny of item 6, Table II. The figures 41, 42, 68, 73 and 74 indicate that females from these bisexual progeny may be found to have repeated the parthenogenesis of their grandmother in the respective items, 41, 42, etc., Table II. The formula (2)79, means that some of these progeny were bred bisexually for two generations (not included in these tables) and then one of the females reproduced parthenogenetically, item 79, Table II. The last figures, (3)45 show that some of these progeny were bred three bisexual generations (not shown here), probably being mated with unrelated stocks, and then one of the females produced parthenogenetically, item 45, Table II.

Examples, matings 209–212: The females were all of the parthenogenetic progeny of item 12, Table II. The figures, in parentheses, at the right, show that some of these progeny were bred, one in 209, through one, (1) 71, bisexual generation and then two of the females used in parthenogenesis, item 71, Table II.; another one on 209, through four, (4) 113, bisexual generations to mating 113, Table III.; the one in 210, through three, (3) 112, bisexual generations to mating 112, Table III.; the one in 211

TABLE V.
TESTING PARTHENOGENETICALLY PRODUCED INDIVIDUALS.

No.	Source of Female.	Parents.	Offspring.
200	3	J θ /K \times B/B	B/J θ 1-0
201	4	K/P θ \times Cof/Cof	Cof/K θ 1-0, Cof/P θ 0-1
202	4	E θ /K \times Cof/Cof	Cof/E 0-1, Cof/E θ 3-2, Cof/K 6-4, Cof/K θ 2-1 67, (2) 115, (3) 70, 72, (4) 40, 44, 75, 107, (5) 48, 49, 50, 65, 109, (6) 52, 110, (7) 111, 113, (8) 82, 83, 114
203	6	Cof/E \times I/I	E/I 4-4, Cof/I 7-8 37, (1) 69
204	6	Cof θ /K \times S/S	Cof/S 2-2, Cof θ /S 7-4, K/S 5-8, K θ /S 1-2 41, 42, 68, 73, 74, (2) 79, (3) 45
205	7	B/K \times H/H	B/H 4-3, H/K 5-6, 32, 54, 61, (1) 51, 55, 56, 57, 58, 59, 62, 63, 64, (7) 114
206	8	I/K \times J/J	I/J 2-1
207	10	K/S θ \times C/C	C/K 0-2
208	37	K/L θ \times I/I	I/K 18-13, I/K θ 6-5, I/L 6-3, I/L θ 17-9, I/I 0-1, 70, (1) 40, 72, 75, 107, (2) 49, 50, 109, (3) 52, (4) 81, (5) 113
209	12	K θ /N \times M/M	N θ /M 1-4, K/M 2-0, K θ /M 5-5, N/M 3-3, (1) 71, (4) 113
210	12	Jof/J θ f \times M θ /M θ	Jof/M θ 1-1, (3) 112
211	12	K/L θ \times Hm/Hm	Hm/L θ 2-0, Hm/K 0-1, Hm/K θ 0-1, (3) 52
212	12	Cof θ /K \times Hm/Hm	Hm/K 3-3, Hm/K θ 0-1, Cof θ /Hm 1-1, (1) 45
213	13	K θ /P \times J/J	J/K θ 3-7, J/P 3-2, J/P θ 2-2, J/K 5-2, (1) 80, (3) 81, (4) 82, 83
214	33	B/K \times Hm θ /Hm θ	B/Hm θ 3-4, Hm θ /K 5-3
215	33	Cof/K \times Hm θ /Hm θ	Hm θ /K 27-14, Cof/Hm θ 24-18, Cof/Hm 1-0, (1) 46, (3) 114
216	34	E/S \times Hm θ /Hm θ	E/Hm θ 2-1, Hm θ /S 2-2, Hm θ /Hm θ 0-1
217	36	K θ /P \times Jsf/Jsf	Jsf/K 4-2, Jsf/K θ 10-8, Jsf/P 14-9, Jsf/P θ 7-3
218	44	Cof/E θ \times K/K	Cof/K 1-0, Cof θ /K 2-0, E/K 1-0, E θ /K 4-1
219	44	Cof/E θ \times K/K	E/K 1-0, E θ /K 3-1
220	40	J θ /K \times B/B	B/J 1-1, B/J θ 1-5, B/K 1-5, B/K θ 0-1 (2) 114
221	40	J/K θ \times E/E	E/J 4-5, E/J θ 1-1, E/K θ 4-3
222	46	L/Sm \times Hm θ /Hm θ	Hm θ /L 2-3, Hm θ /Sm 2-4 77
223	25	B/Cof θ \times H/H	B/H 1-3, Cof θ /H 1-0

TABLE V. (Continued).

No.	Source of Female.	Parents.	Offspring.
224	51	I/KØ × B/B	B/KØ 0-2, B/HØ 0-2 (2) 52
225	26	B/S × PØ/PØ	B/PØ 6-10, PØ/S 4-6
226	76	M/M × Cof/L	L/M 13-6, Cof/M 15-11 (2) 52
226a	76	M/M × B/K	B/M 15-15, K/M 23-14
227	21	CofØ/E × K/KØØØ	Cof/KØ 1-0
228	67	E/J × K/K	E/K 4-3, I/K 8-3 69
229	41	K/S × Cof/CofØ	Cof/K 2-3, Cof/S 6-6, CofØ/K 6-3, CofØ/S 4 5 (1) 43, 44
230	41	+Jof × SØ/SØ	+SØ 5-1, Jof/SØ 2-4
231	28	K/N ₁ × EØ/EØ	EØ/K 0-1
232	64	CofØ/K × H/H	Cof/H 0-1, CofØ/H 2-4, H/KØ 2-0
233	20	CofØ/E × M/M	E/M 11-10, EØ/M 8-2, Cof/M 9-6, CofØ/M 12-9 (1) 66, 108, (2) 53, (5) 114
234	42	Cof/EØ × S/S	Cof/S 3-0, CofØ/S 1-0, E/S 1-2, EØ/S 7-2
235	42	EØ/L × K/K	E/K 2-3, EØ/K 7-5, K/L 13-8, K/LØ 1-0 (1) 43, 44, (2) 49, 50, 53, 109, (3) 110, (4) 52
236	42	CofØ/E × K/K	E/K, +EØ/K 7-5, Cof/K 6-3, CofØ/K 4-2 (1) 66
237	42	B/H × SØ/SØ	B/SØ 15-13, H/SØ 10-14 (5) 114
238	26	BØ/Hm × K/K	B/K 1-0, BØ/K 2-1, Hm/K 1-3, HmØ/K 1-0
239	29	K/LØ × Kst/Kst	Kst/K 0-2, Kst/L 1-0
240	29	+SØ × Jst/Jst	+Jst 2-4, Jst/S 1-0, Jst/SØ 6-3
241	78	C/S ₁ × LØ/LØ	C/LØ 1-0
242	78	C/S ₂ × LØ/LØ	C/LØ 2-1, LØ/S ₁ 0-2
243	37	IØ/K × Cof/Cof	Cof/J 7-4, Cof/JØ 15-7, Cof/K 6-8, Cof/KØ 6-4
244	41	M/Sm × CofØ/CofØ	CofØ/Sm 1-1, CofØ/M 2-1
245	41	I/K × Cof/Cof	Cof/I 2-5, Cof/K 6-1
246	61	I/LØ × K/K	I/K 0-1, IØ/K 0-1, K/LØ 0-1
247	12	Cof/K × MØ/MØ	K/MØ 3-5, Cof/MØ 6-0
248	64	CofØ/K × H/H	CofØ/H 1-0, H/K 1-1, H/KØ 1-2, Cof/H 0-1
249	17	Cof/K × F/F	Cof/F 1-0

through three, (3) 52, bisexual generations to item 52, Table II., and the one in 212 through one, (1) 45, bisexual generation to item 45, Table II., respectively.

DISCUSSION.

The comparatively sudden inception of a considerable degree of parthenogenesis in *P. texanus*, beginning in 1922, after fourteen years of perhaps exclusively bisexual reproduction, implied the recent introduction, prior to this date, of some causative factor, or factors. Then came the proposals of Peacock and Harrison (1925, 1926): (1) The generalization, deduced largely from the results of their own experiments, that *parthenogenesis was consequent upon hybridity*, and, (2) from my data, that the rather extensive parthenogenesis exhibited by *A. curycephalus* (Nabours, 1919, 1925) was the result of hybridizing one variety of this species from Tampico, Mexico, with another from the region of Houston, Texas.

In 1921, the year preceding the onset of this period of parthenogenesis in *P. texanus*, specimens had been secured at Austin and College Station, Texas, new areas along the northeastern boundary of the range of the species (Table IV.). It was noted that all the parthenogenetic individuals, 1922-1926, had in their ancestry progenitors from these new areas, except that those of item 3, Table II. and IV., did not connect with College Station. Item 2, Table II. and IV. had one ancestor from Austin, 1922. The females of items 10 and 31 were from parents collected at San Antonio, 1924, and New Braunfels, 1926, respectively.

The arrangements of the data in the tables, especially Table IV., have been influenced by these considerations. The ancestry of all the parthenogenetic individuals may be traced to their various origins in nature. The 40 females of items 1-31, Table II., and 7 of matings 100-106, Table III., had no recorded parthenogenetic progenitresses; the other 68 females of Table II., and 8 females of Table III., in turn, were descendants of these.

An examination of Table IV. reveals a very complex ancestry for these 47 females which first displayed this characteristic, and from which all the other parthenogenous ones were descended. But it appears to have remained for the introduction of the speci-

mens from Austin, 1921, to bring in the factor, or *the complementary climaxing factor, or factors*, responsible for the significant measure of parthenogenesis which ensued.

However, possibly opposing this tentative suggestion were the two cases of parthenogenesis, items 10 and 31, Table IV., directly from San Antonio and New Braunfels (about half way between San Antonio and Austin), respectively. The female of item 2, Tables II., and IV., had few recorded progenitors, but one of them was from Austin, 1922. It is difficult to estimate the importance of the three cases of probable parthenogenesis of 1912 and 1915 (see pp. 130, 131).

The narrow confines of Shoal Creek, near Austin, is the only new area that contributed to the progenitorship of all the parthenogenetic females, except items 10 and 31, beginning in 1921. The female of 10 was from San Antonio, but taken 13 years after the two original progenitors (Table IV.). The female of item 31 was from New Braunfels, which was also a new area, near Austin. The factor, or factors responsible for parthenogenesis may even have been contributed from Houston, or Sugarland, 1922, the several previous collections from these areas having possibly simply missed the parthenogenetic strain, if such there was.

It was urgent that a strain highly parthenogenous should be hybridized with one which was not so at all, and then the causative factors recovered. A few such experiments have been attempted, the least unsatisfactory one having been conducted as follows: The male B/K, mating 205, Table V., had no parthenogenesis in his recorded ancestry. The female, H/H, was a parthenogenetic product, item 7, Table II. They gave bisexually both males and females in F_1 . Eight of the nine female F_1 progeny were disposed of as follows: Four unmated, two in one cage and two in another, gave offspring, items 54, 61, Table II. (obviously one of those in 54 did not reproduce). Three were mated out; one gave no offspring, one gave bisexual (not included in the tables) and the other parthenogenetic progeny, item 32, Table II. The eighth female was mated to a brother and they gave a numerous F_2 progeny (not included in tables). From these F_2 (parthenogenetic by nonparthenogenetic?) progeny, eighteen females were separated, one each, in cages; nine gave offspring, and two

others were known to have laid a batch of eggs each which were not given opportunity to hatch, items 51, 55-59, 62-64, Table II. Some of the other seven may have laid eggs, but they did not reproduce. The quantitative results of this experiment thus appeared to constitute a superb and convincing case of parthenogenesis as a dominant Mendelian characteristic.

However, the following facts concerning the conditions of the experiment should be taken into consideration: Five of the F_2 females, the first to become adult, had been placed in their respective cages on May 23; the other 13 had been placed on June 14, twenty-two days later, that much farther on into the hot summer, and past the optimum breeding season which was March-May (See Table I.). The records show that the five placed first all gave progeny of 3, 9, 17, 17, and 20, respectively. Only three of the 13 females, placed 22 days later, gave offspring, two hatching one each, and the other, five. As noted above, at least two others laid batches of eggs. The question is still open: What would have been the result if all eighteen of these F_2 females had been placed May 23 or earlier? Or, what would have happened if all of them had been placed on June 14, or later?

All the females and one male of *A. curycephalus* hatched from unfertilized eggs, which were tested by further breeding, proved to be homozygous for all the observable characteristics. Obviously, it could not be stated categorically that any of the untested ones were homozygous since the color patterns were dominant (Nabours, 1919, 1925). The females and one male of *P. texanus*, so far as they were tested, were also homozygous, except that one individual of item 41, Table II., had the appearance of having both the alternatives Cof and S, and another also from 41, was proved to be heterozygous for Θ , mating 229, Table V. Mating 215, Table V., contained one Cof/Hm, the only one in 84 without the Θ for which the female parent was supposed to be homozygous. Cof and S are certainly very closely linked, if not precisely alternative; so it is unlikely that there was crossing over. The failure to breed this animal leaves the question of her actual genetic composition in obscurity. About the Cof/Cof Θ individual, there was only the question of the cause. The factor for Θ appears to be near the end of the chromosome (Haldane, 1920).

As is shown by W. R. B. Robertson (MSS, 1929, Nabours, 1929), the homologous chromosomes of the germ and somatic cells of the parthenogenetic offspring have a tendency to lie together in pairs, often even adhering, so that a pair may appear as one, double in size. Pending further developments, it may be suggested that these aberrances were brought about through, perhaps, an adherence, in the one case, and an elimination of the ends of the chromosomes containing Θ , in the others.

The inheritance results in parthenogenesis indicate that segregation and crossing over occur before the inception of the parthenogenetic processes, and that up to this stage in gametogenesis there is no essential departure from the usual procedure in bisexual reproduction (Nabours, 1925, 1929).

Dr. W. R. B. Robertson, working in our laboratory, has discovered that the numbers of chromosomes in some of the soma cells, likewise the oögonial cells, of the parthenogenetically produced females of *A. curycephalus* and *P. texanus* appear to range from seven to fourteen, though there are actually fourteen in all of them. When the full fourteen are manifest, the members of the homologous pairs, respectively, lie together in early cell division, and not far apart, each from the other in later cell generations, in such positions as to suggest the second polar body division had been inhibited.

When only seven chromosomes appear to be present in these parthenogenetically produced individuals, *each has twice the bulk in transverse thickness (broadness of the equatorial plane) of either member of the similarly numbered pair in the cells containing seven discreet pairs*. Furthermore, in these parthenogenetically produced grouse locusts, Robertson notes that in those soma and oögonial cells *containing above seven chromosomes, there is one less of the broad chromosomes for every additional one above seven*. For example, if the *apparent* number is nine, there are five of double equatorial broadness, or bulky ones, and four smaller ones in two pairs, the homologues of which always lie together, or not far from each other, in the same manner as the similar pairs do in those cells of the parthenogenetically derived females containing the fourteen discreetly paired chromosomes. An analogous situation is found in the cells of the parthenogeneti-

called derived males which he has examined (Robertson, 1929, MSS., Nabours, 1929).

The entrance of the sperm is probably necessary to the second polocyte division in the *Tettigidae* (loc. cit.), as in other forms, another "case of a later stage of maturation being overlapped by an earlier stage of fertilization" (Wilson, 1925). Fertilization lacking, there is a resultant partial or complete inhibition of the last polocyte division which restores or retains the condition of diploidy (See Robertson's observations on the chromosomes pp. 151, 152 and in MSS., and Nabours, 1929). When the specific gene or complementary genes responsible for parthenogenesis are present, development is initiated. As already stated (pp. 131, 132), probably no female would be partheno-producing if mated with a potent male (those not carrying the specific genes probably require fertilization). Therefore such initiation of development as this might, in effect, be termed *artificial* parthenogenesis.

The kind of parthenogenesis shown by the grouse locusts can hardly be called *facultative*, and certainly not *obligatory* (See definitions, Wilson, 1925, pp. 228, 229). It might perhaps be best entitled *tychoparthenogenesis*, and preponderantly *gynogenetic*.

In a parthenogenetic line of *P. texanus*, a female exposed to a male gave parthenogenetic progeny. Seven of these were mated out; five gave biparental offspring, but the other two again gave parthenogenetic progeny in spite of the males to which they had been exposed. However, the progeny of the second parthenogenetic generation, when exposed to males, mated and gave offspring from fertilized eggs (items 12, 33, 34, Table II., and matings 209-212, 214-216, Table V.).

There have been other cases of two succeeding parthenogenetic generations while the females were exposed to males in *P. texanus* and *A. eurycephalus* (not included in the attached data). It has been thought that a female might mutate in some way which would render her incapable of mating with a male of her own species. In such a case, she should reproduce by parthenogenesis. Then, if her progeny, due to the same mutation, could not mate back to the males of the original stock, and parthenogenesis should go on till the occasional male appears (see items 226, 226a, Table

V., and mating 5027, Nabours, 1925), the "event for which we wait" (Bateson, 1922) might be achieved. However, it is likely that the cases of succeeding generations by parthenogenesis, although the females were exposed to males, were due to impotency of the males rather than to mutations in the females. Nevertheless, there may be possibilities in this direction.

The hypothesis of Peacock and Harrison that parthenogenesis is consequent upon hybridity (loc. cit.) has probably received further support from the results of the parthenogenetic breeding of *P. texanus*, as described, if it be provided in addition that the process of hybridism may bring together specific complementary, or climaxing genes which are responsible for, or cause the development of unfertilized eggs.

SUMMARY AND CONCLUSIONS.

1. There is indication of a genetic factor, or a group of complementary factors responsible for parthenogenesis in these grouse locusts.

2. The hypothesis of Peacock and Harrison (1925, 1926) that parthenogenesis is consequent upon hybridity is probably further supported if it be provided, as these authors did not, that it is necessary to bring together in the processes of hybridism the specific complementary, or climaxing genetic factors which may cause the development of unfertilized eggs.

3. The members of the species *Paratettix texanus* Hancock are bisexual, the fertilized eggs producing males and females in equal numbers, and parthenogenetic, the unfertilized eggs, with rare exceptions, hatching females.

4. A mated female may have part of her ova fertilized, and also produce from unfertilized ova, by parthenogenesis, an additional number of offspring which are nearly always females.

5. The segregation and crossing over of factors occur in individuals reproducing by parthenogenesis to the same extent as in those reproducing bisexually.

6. If fertilized, the egg proceeds with the second polocyte division and develops bisexually. In the absence of the fertilizing sperm the last polocyte division does not occur, or if it does the polar body is not eliminated. If the specific complementary gene,

or genes responsible for initiating parthenogenesis be present, diploidy is retained, or restored, and development may begin, consequentially as a kind of *artificial* parthenogenesis.

7. The progeny from unfertilized eggs are usually homozygous for all the factors they carry, though rarely one proves to be heterozygous for factors.

LITERATURE CITED.

Bateson, Wm.

'22 Evolutionary Faith and Modern Doubts. *Science*, **55**: 55-61.

Bellamy, A. W.

'17 Multiple Allelomorphism and Inheritance of Color Patterns in *Tettigida*. *Jour. Genetics*, Vol. VII., No. 1, pp. 55-70.

Cuénot, L.

'09 Les Males d'abeilles proviennent—ils toujours d'oeufs parthenogenetiques. *Bull. Sci. France et Belg.*, XLIII.

Haldane, J. B. S.

'20 Note on a case of Linkage in *Paratettix*. *Jour. Genetics*, Vol. X., No. 1, pp. 47-51.

Hancock, J. L.

'02 The *Tettigida* of North America. Chicago, 188 pp.

Harman, Mary T.

'15 Spermatogenesis in *Paratettix*. *Biol. Bull.*, Vol. XXIX., pp. 262-277.

Nabours, Robert K.

'14 Studies of Inheritance and Evolution in Orthoptera I. *Paratettix texanus*. *Jour. Genetics*, Vol. III., No. 3, pp. 141-170.

'17 Studies of Inheritance and Evolution in Orthoptera II. and III.: *Paratettix texanus* and a Mutant. *Jour. Genetics*, Vol. VII., No. 1, pp. 1-54.

'19 Parthenogenesis and Crossing Over in the Grouse Locust *Apotettix*. *Am. Nat.*, Vol. LIII., No. 625, pp. 131-142.

'23 A New Dominant Color Pattern and Combinations that Breed True in the Grouse Locusts. *Genetica*, Vol. V., Nos. 5 and 6, pp. 477-480.

'25 Studies of Inheritance and Evolution in Orthoptera. V. The Grouse Locust, *Apotettix curycephalus* Hancock. *Kan. Agri. Exp. Sta., Tech. Bull.* **17**: 1-231.

'27 Polyandry in the Grouse Locust, *Paratettix texanus* Hancock, with Notes on the Inheritance of Acquired Characters and Telegony. *Am. Nat.*, Vol. LXI., pp. 531-538.

'29 The Genetics of the Tettigidae (Grouse Locusts). *Bibliographica Genetica*, Vol. 5, pp. 27-101.

Nabours, Robert K., and Snyder, Bertha.

'28 Parthenogenesis and the Inheritance of Color Patterns in the Grouse Locust, *Telmatettix aztecus* Saussure. *Genetics*, Vol. XIII., pp. 126-132.

Newell, Wilmon.

- '14 Inheritance in the Honey Bee. *Science*, N. S., Vol. XLI., No. 1049, pp. 218-219.

Peacock, A. D., and Harrison, J. W. Heslop.

- '25 On Parthenogenesis Originating in Lepidopterous Crosses
*Trans. Nat. Hist. Soc. Northumberland, Durham and New
Castle-upon-Tyne, N. S.*, 6, Part II.
- '26 Hybridity, Parthenogenesis and Segregation. *Nature*, 117: 378-379.

Perez.

- '79 The Theory of Dzierzon. *Am. Bee Jour.*, XV.

Robertson, W. R. B.

- '15 Chromosome Studies, III. Inequalities and Deficiencies in Homologous Chromosomes: Their Bearing upon Synapsis and the Loss of Unit Characters. *Jour. Morph.*, Vol. XXVI., pp. 109-141.
- '29 Chromosome Studies, V.: The Retention of Diploidy in Partheno-produced *Tettigida*, including two rare males, and the Tendency of Chromosomes to Persist in Their Original Gametic Position in the Cells of These and Their Biparentally Produced Relatives (*Apotettix curycephalus* and *Paratettix texanus*). (In manuscript.)

Whiting, P. W.

- '21a Studies on the Parasitic Wasp, *Hadrobracon brevicornis* (Wesmael), I. Genetics of an Orange-eyed Mutation and the Production of Mosaic Males from Fertilized Eggs. *Biol. Bull.*, Vol. XLI., No. 1, pp. 42-54.
- '21b Studies on the Parasitic Wasp, *Hadrobracon brevicornis* (Wesmael), II. A Lethal Factor Linked with Orange. *Biol. Bull.*, Vol. XLI., No. 3, pp. 153-155.

Wilson, Edmund B.

- '25 The Cell in Development and Heredity. Macmillan, New York, 1232 pages.

BIOLOGICAL BULLETIN

OF THE

Marine Biological Laboratory

WOODS HOLE, MASS.

VOL. LVI

MARCH, 1929

No. 3

CONTENTS

- THORNER, MELVIN W. *Recovery of the Heart Beat of Fundulus Embryos After Stoppage by Potassium Chloride.* 157
- REICHLÉ, HERBERT S. *The Diagnosis of the Type of Twinning.* 164
- WHEDON, ARTHUR D. *Muscular Reorganization in the Odonata During Metamorphosis.* 177
- SUMWALT, MARGARET. *Potential Differences Across the Chorion of the Fundulus Egg.* 193
- GEROULD, JOHN H. *History of the Discovery of Periodic Reversal of Heart-Beat in Insects.* 215
- LAMBERT, W. V., AND CURTIS, V. *Further Studies on the Sex Ratio in the Chicken.* 226

PUBLISHED MONTHLY BY THE
MARINE BIOLOGICAL LABORATORY

PRINTED AND ISSUED BY
LANCASTER PRESS, INC.
LANCASTER, PA.

AGENT FOR GREAT BRITAIN
WHELDON & WESLEY, LIMITED
2, 3 and 4 Arthur Street, New Oxford Street, London, W. C. 2

Single Numbers, \$1.00. Per Volume (6 numbers), \$4.50

Editorial Staff

GARY N. CALKINS—*Columbia University.*

E. G. CONKLIN—*Princeton University.*

M. H. JACOBS—*University of Pennsylvania.*

FRANK R. LILLIE—*University of Chicago.*

GEORGE T. MOORE—*The Missouri Botanic Garden.*

T. H. MORGAN—*Columbia University.*

W. M. WHEELER—*Harvard University.*

E. B. WILSON—*Columbia University.*

Managing Editor

C. R. MOORE—*The University of Chicago.*

All communications and manuscripts should be sent to the Managing Editor, the University of Chicago. Subscriptions and other matter should be addressed to the Biological Bulletin, Prince and Lemon Streets, Lancaster, Pa.

BIOLOGICAL BULLETIN

RECOVERY OF THE HEART BEAT OF *FUNDULUS* EMBRYOS AFTER STOPPAGE BY POTASSIUM CHLORIDE.

MELVIN W. THORNER,

ZOÖLOGY LABORATORY, UNIVERSITY OF PENNSYLVANIA AND THE BIOLOGICAL
LABORATORY, COLD SPRING HARBOR.

INTRODUCTION.

Loeb and Cattell (1) found that when the embryonic hearts of fertilized *Fundulus* eggs have begun to pulsate, they may be completely stopped by placing the eggs in a solution of KCl. They found further that when eggs so treated were placed again in sea water, the hearts resumed beating. These authors also pointed out that "embryos whose hearts had stopped beating under the influence of a sufficient dose of KCl did not begin to beat when put into distilled water." However, in another part of the same paper a table is given in which it is shown that three of thirty of the hearts stopped by KCl recovered in distilled water after a short period. The experiment was discontinued at the end of this time.

Although Loeb and Cattell noted these facts, they failed to extend their investigations in a quantitative manner. This paper endeavors to determine the quantitative relationships of the various factors concerned in effecting recovery of the heart-beat after stoppage by KCl. This recovery was studied in sea water, distilled water and in various salt solutions.

MATERIAL.

The material used was the developing egg of *Fundulus heteroclitus*, collected at the Biological Laboratory, Cold Spring Harbor. The eggs were "stripped" from the females within an hour of

the time the fish were taken from the ocean. The eggs were then immediately fertilized by a sperm suspension milked from the males. The egg stock thus prepared was kept at room temperature (22–24° C.) in sea water changed daily.

At the end of the fourth day after fertilization the heart normally begins to pulsate. All experiments were carried out at room temperature (22–24° C.). The heart was considered as "stopped" when all three chambers had ceased pulsating.

EXPERIMENTS.

(a) Recovery in Sea Water.

The first set of experiments represents an attempt to determine the relationship between the time of immersion in KCl and the time of recovery in sea water. Also different concentrations of KCl were tried to see if the relationship varied for different strengths. For this purpose lots of from 40–75 eggs were chosen for each experiment. The heart of each embryo was observed to be in good physiological condition. Each lot was placed in a

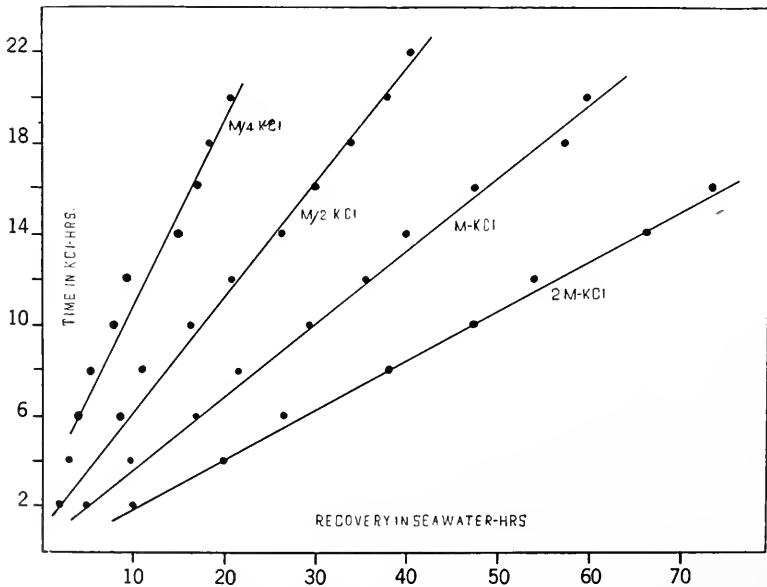

FIG. 1. Shows relation between period of recovery in sea water and period of immersion in different strengths of potassium chloride for hearts of *Fundulus* embryos.

KCl solution, the strength of which varied from 0.25 M to 2.00 M, for a period varying from 2 to 22 hours. The eggs were then rinsed in distilled water and placed again in sea water and observed at intervals and the time of recovery (*i.e.*, recovery of all three chambers) for each egg noted and the average time computed. By rinsing the eggs in two changes of distilled water each time they were to be placed in a new solution, the possible salt antagonism at the surface of the egg was reduced. At the same time the immersion in the distilled water was too short to cause permeability changes in the membrane. Fig. 1 shows results of such experiments.

From Fig. 1 it may be seen that the time of recovery is directly proportional to the duration of immersion in KCl solution—all other factors remaining constant. This relationship holds within the limits of 0.25 M and 2.00 M.

The next experiments to be tried were an endeavor to determine the relationship between the strength of KCl used and the period of recovery in sea water. Again lots of 40-75 eggs were selected. Each lot was placed in a KCl solution of from

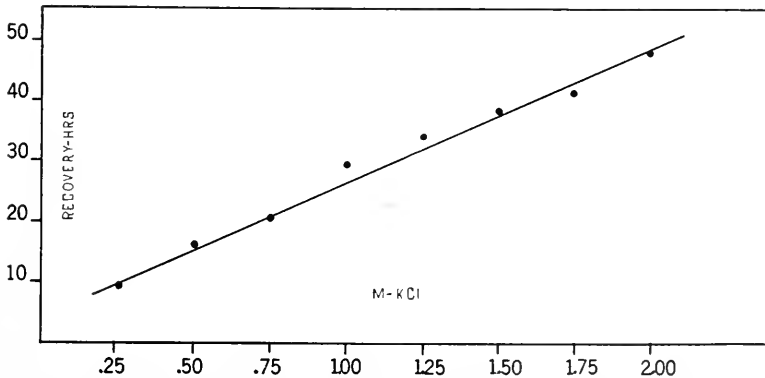

FIG. 2. Shows relationship between concentration of potassium chloride and period of recovery in sea water for hearts of *Fundulus* embryos after immersion in KCl for ten hours.

0.25 M to 2.00 M for ten hours. The periods of recovery were noted and averaged as before. Fig. 2 shows the results of this group of experiments.

From Fig. 2 it is evident that the duration of the period of re-

covery is directly proportional to the concentration of KCl used.

It was then decided to determine the relation of strength of KCl to the time required for complete heart cessation at the various strengths (Fig. 3).

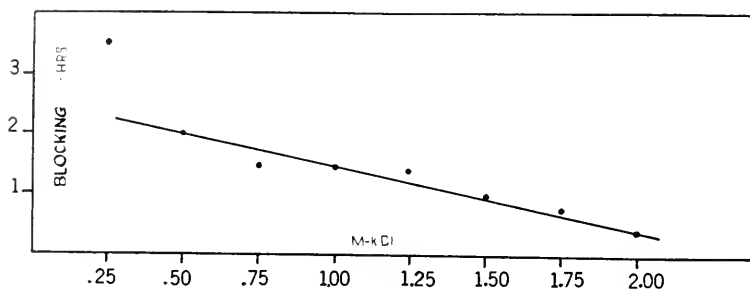

FIG. 3. Shows relationship between molar strength of potassium chloride and the time required for complete heart cessation in *Fundulus* embryos.

Figure 3 suggests the possibility of a direct proportionality. If the assumption of Loeb is correct, *i.e.*, that the same amount of KCl is needed each time to block completely the heart-beat and if the rate of entry of KCl is directly proportional to the concentration of KCl, the relation between concentration and time should be represented by a straight line. This is approximately true and hence it is probable that Loeb's assumption is correct.

(b) Recovery in Distilled Water.

Lots of 200 eggs each were selected one by one, washed free of adhering salts and placed for varying lengths of time in $M/2$ KCl. They were washed in several rinsings of distilled water. Then they were placed in distilled water changed daily. The period of recovery in distilled water was noted for the individual eggs at intervals. The average of each lot was then calculated.

From Fig. 4 it may be seen that, contrary to the opinion of Loeb, recovery of an appreciable number of eggs is effected in distilled water. Instead of merely non-recovery, coagulation of the embryo was used as a criterion of death and each egg was carried through to either coagulation or recovery. It was found that mortality increases with the length of immersion in KCl. The extreme variation from the mode also increases with the length of immersion.

In an attempt to confirm Loeb's statement (1) that "KCl cannot diffuse out of *Fundulus*' egg in distilled water" and assuming that it does diffuse in instead of remaining at the vitelline membrane, we endeavored to discover why the heart-beat recov-

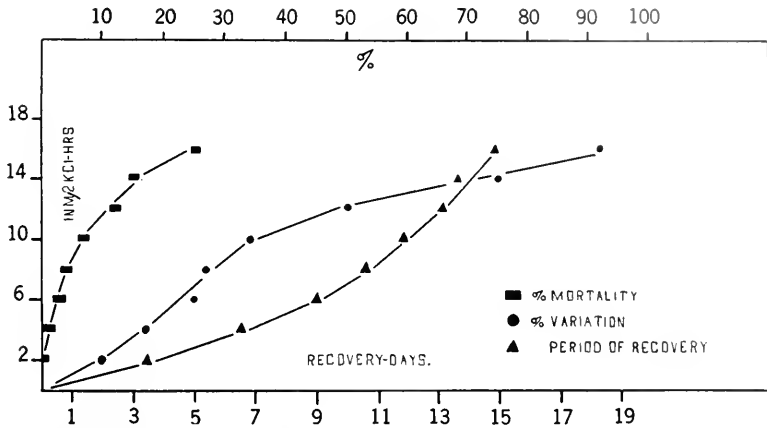

FIG. 4. Shows relationship between time for recovery in distilled water and length of exposure to M/2 KCl for hearts of *Fundulus* embryos. The percentage mortality and percentage variation for same eggs are also indicated.

ered in distilled water. Three lots of 200 eggs each were selected, washed and placed in M/2 KCl for six, eight and twelve hours, respectively. Then each lot of eggs was washed and put into 40 mls. of distilled water (in a 200×25 mm. test tube) changed daily. The daily increase in electrical conductivity was followed. (Before each conductivity measurement the water was boiled momentarily to free it from CO_2). Limited time made necessary the omission of a quantitative chemical analysis of the K content but conductivity measurements furnish a possible indication of the K extruded.

The graph of Fig. 5 shows that some electrolytic substance was extruded through or at least given off from the membranes of the egg. The fact that the hearts began to beat again leads one to suppose that it is at least partly KCl. With one exception there was found to be a daily increase in the rate of extrusion. The rate increased most just before recovery of the hearts began to be manifest. The amount extruded was dependent on, but not proportional to the length of immersion in M/2 KCl.

It is readily apparent that the mechanism of recovery in sea water and in distilled water is fundamentally different. That in sea water is affected by concentration and duration of immersion

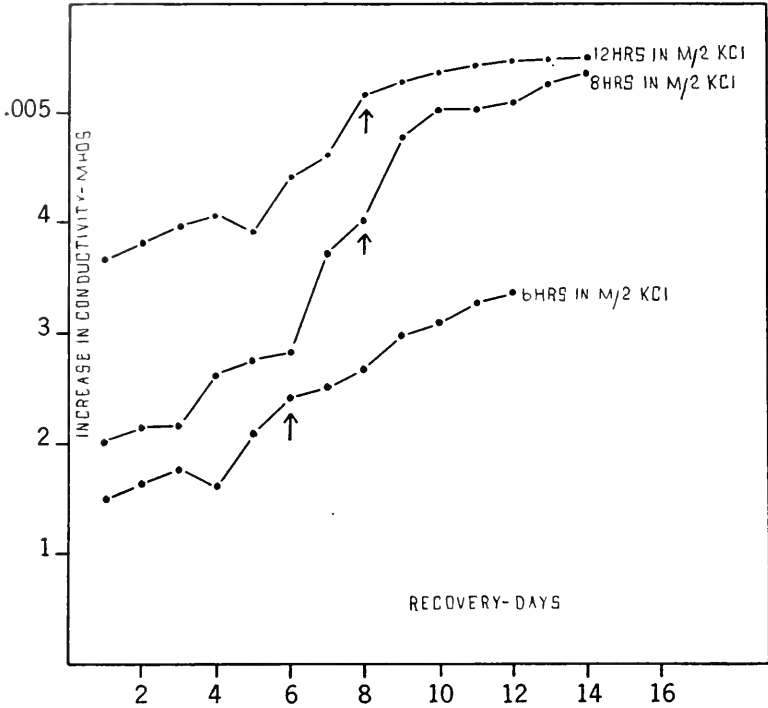

FIG. 5. Shows increase in electrical conductivity of distilled water in which eggs, immersed for different periods in M/2 KCl are placed. Arrows indicate time heart resumed beating.

in KCl in direct proportionality. The recovery in distilled water is more complicated.

Loeb (1) noted recovery with various cations and anions. The cations here tried effect a momentary recovery. This is probably not due to salt antagonism but to a direct overstimulation resulting in death of the temporarily aroused hearts.

SUMMARY.

1. The heart-beat of eggs blocked completely by KCl recover in both sea and distilled water although the two recovery processes are dissimilar.

2. In sea water the duration of the period of recovery is directly proportional to the concentration of KCl and to the time of immersion in KCl. The same amount of KCl is required to block completely the heart-beat.

3. The recovery of eggs in distilled water was studied with the aid of electrical conductivity.

I am deeply indebted to Dr. J. H. Bodine for suggestion of the problem and for his valuable assistance and advice. I am also indebted to Dr. R. G. Harris, Director of the Biological Laboratory, for making research facilities available to me.

LITERATURE CITED.

1. **Loeb and Cattell.**

- '15 The Influence of Electrolytes upon the Diffusion of Potassium out of the Cell and into the Cell. *J. Biol. Chem.*, 23, p. 41.

THE DIAGNOSIS OF THE TYPE OF TWINNING.

I. DERMATOGLYPHICS.

HERBERT S. REICHLER, M.D.¹

In the first systematic study of monoovular twins Galton (1) in 1883 demonstrated its unique value in genetics. Little further advance was made until recent years. The emphasis placed upon dramatic but unusual cases of identity had given a romantic and burlesque character to this subject and had inhibited methodical research. Wilder's (2) studies of palm prints and still more Siemen's (3) ingenious diagnostic scheme have opened this field anew to scientific inquiry.

The interest which the monoovular twin—abbreviated in this article to M. T.—holds for biologists lies in the identity of their germ plasm. The two individuals constitute a natural clone—an experiment out of nature's laboratory by which we might hope to separate the influences of inheritance from those of environment. By the latter term we signify all those extrinsic factors which act upon the cell and its successive forms from the moment of conception. Complications such as idiokinesis, unequal equatorial division and extraordinary parakinetic influences in utero may render the interpretation difficult. A few writers (4) regard these phenomena as not uncommon. They, therefore, question the value of the method. It is impracticable for us to discuss these objections in the present paper. We realize that the entire structure of our investigation rests upon the assumption that these doubts are unjustified. We believe that a vast weight of authority (5) accepts the truly equatorial division of the chromosomes and denies the somatic segregation of characteristics except in special instances. Moreover, M. T. are universally regarded as the product of one sperm and one ovum. Without the first two assumptions in particular the Mendelian theory is an incongruity.

The chief difficulty lies not in these theoretical objections but

¹ From The Babies' and Children's Hospital of Cleveland and the Department of Pediatrics, Western Reserve University.

in the practical insecurity of the diagnosis of monoovularity. In a future paper we shall discuss the different methods that have been proposed. We reserve for this publication the one first suggested by Wilder—the identity of palm and sole prints.

The first part of our work was an investigation of the dermatoglyphics of double monsters (*cosmobii*), the only twins about whose monoovularity there can be no doubt. We then examined forty pairs of non-conjoined twins and attempted to correlate their palm prints with sex likeness and the data obtained by Siemen's method of twin study. We have selected from the very extensive literature on twins and twin diagnosis only such papers which bear directly upon our main argument, which is, that dermatoglyphics is not a reliable method of determining whether twins are monoovular or dioovular.

The early history of the work on skin patterns can be found in the publications of Wilder (2) and Schlaginhaufen (6). The latter gives a complete discussion of the anatomy, embryology and comparative anatomy. In Mrs. Wilder's article (Inez Whipple) (7) the last subject is exhaustively treated. The epidermal ridges, which we shall discuss, have nothing in common with the lines of the palmist. The latter are mere folds of the skin that follow the direction of joint movement. The lines with which dermatoglyphics is concerned appear on the surface of the skin as ridges and intrude as thin papillæ into the corium. Through these papillæ the sweat gland ducts pass to empty at the summit of the ridge; Blaschko, therefore, called them "Druesenleisten." Between each pair of Druesenleisten there is another shorter papilla which corresponds to the epidermal furrow of the upper skin layers; these are the folds of Blaschko. According to Schlaginhaufen (6) the epidermal ridges appear in the fourth month of prenatal life whereas the Druesenleisten are not definitely defined before the fifth and the folds of Blaschko not before the sixth months. Schultz (8), however, found no trace of epidermal ridges either on soles, palms or tails of Guiana Howling monkey foetuses which had reached the second stage of their development—which is perhaps equivalent to the twentieth week of human ontogeny. From both observations we can conclude that the ridges

and the subsequent patterns are relatively late structures—an important fact in any consideration of their genetic value.

There seems to be no doubt that the patterns found on palms, soles and finger tips are the result of the surge of lines about the interdigital and apical pads of the lower animals. Traces of these pads can still be seen on some adults and they are well developed in the human foetus. As these pads degenerated or became modified, the patterns have undergone a synchronous change. In some cases where the mechanism has been fully realized, they have disappeared altogether. We, therefore, find in man a pattern picture much simpler than in his nearer biological relatives. Their inheritance has been proven by Bonnevie (9); very suggestive evidence had previously been offered by Wilder (2). The determination of the patterns cannot however be a direct or absolute one, since Cummins and Sicomo (10) (11) have shown that malformations of the hand and feet may modify or even suppress them entirely. We can harmonize this conflicting evidence if we assume that it is the form of the hands, feet, digits and apical pads which is determined by the germ plasm. Their growth is subject to modification by parakinetic factors in utero. The patterns and lines, being merely the result of the peculiar features of the pads and members, would be subject *indirectly* to a plastic inheritance. This hypothesis would explain not only the close relation between the patterns of a family group but also the frank and frequent exceptions to the demands of a strict inheritance.

In our examinations of M. T. we might hope to find that they and they only possessed dermatoglyphics identical in the form and the number of patterns and in the direction of the flow of the open fields. They might differ in minutæ² and minor purely quantitative details. There are, however, several carefully studied cases in the literature which prove that individuals manifestly not M. T. may possess such prints. Waardenburg (13) describes two brothers, the one of whom was eight years older than the other, whose fingers were absolutely alike in their fundamental features, only slight differences were present and those were mostly quantitative, *i.e.*, differences in the number of lines which

² Term coined by Galton to describe small variations in the lines which do not alter the general picture of the pattern.

separated individual patterns. On one finger there was a small pattern below the crease of the last joint which was merely suggested and not completed in the homologue of the brother. For evidence concerning palm prints we can go to no better witness than to Wilder (2)—to whose conservatism in the use of the prints we must pay tribute. He tells of a father and son who had palm prints identical except for dimensional differences (Coll. 96). Case No. 99 is of still greater importance. The two individuals, a father and a son, had the same palm prints, which moreover were of a rare type and showed a suppression of the C triradius and an unusual form of the hypothenar pattern. In one of his earlier publications Wilder (2a) describes like sexed twins who were remarkably alike in color, figure, and features so that their best friends confused them. Their papillary prints were alike but their palm prints absolutely different. Wilder commented on this case: "It may also be possible to find a case of unlike fraternal (dioovular—Ed.) twins with very similar palm formulas." This may be true of his two cases who were not "identical" to all observers but who had similar palm prints. Lauterbach (14) found two pair of different sexed twins in a mixed group of 74 pairs who fulfilled Wilder's conditions. The photographs of the prints in the one case shows such a remarkable similarity as is in the author's experience rarely found even in "identical" and most probably monoovular twins.

It should be particularly observed that we have attempted to quote only cases which can be classified without much doubt as either M. T. or D. T. With the exception however of sex, it is impossible to use any characteristic with any degree of certainty. We have no standard by which we can measure our diagnostic accoutrement and far too little time and thought have been spent in correlating the different methods suggested so as to clear this fog of uncertainty. There is, however, one group of twins about whose monzygotism there is no reasonable doubt. All authorities seem to agree that the conjoined twins and double monsters (cosmobii) represent the product of one ovum. The suggestion that such abnormalities are caused by a multiple fertilization has not gained many adherents. We refer the reader who is interested in this intricate question to Broman (15) and Wilder (2a) and (d).

The usual inking method for recording prints was useless, since all of our specimens had been in preserving fluids for years. We, therefore, sketched the patterns freehand with the aid of a binocular dissecting microscope (Leitz). Naturally such a method can lay no claim to strict quantitative accuracy. The patterns, however, were copied faithfully in respect to position and form and as no quantitative identity of the patterns was expected, this sufficed. The specimens were washed in running water for 12 to 24 hours, in some cases the tissues were softened in moderately hot water. Sometimes the superficial cuticle of the palms and soles had to be removed with a fine brush and pincette. The lines then stood out clearly on the fresh surface of the epidermis.

We have used the ingenious Wilder (2) formula in describing the palms and soles and the Galton scheme for the fingers. The modification of Wilder's method as applied to the palms which has been prepared by the painstaking labor of Cummins (16) has been of immense value to us. The attempt to visualize the formulas of earlier workers who used the simpler Wilder formula taught us the value of Cummins' work.

An examination of the prints and formulæ of Table I. reveals astonishing differences between these indubitably monoovular twins. In T. 61 we call attention to the similarity of the three hands and the dissimilarity of the fourth—the right hand of the right twin. By some authors this condition is considered to be quite frequent among same-sexed twins. It might, therefore, be of importance in the diagnosis of monoovularity. There is, moreover, a close relationship between the formulæ $9. \times 5.3$ and $10.7.6.5$ ". In T. 144 the palms again show differences which are of only quantitative value, a shift of the radiant of D but a few lines distally would produce the same formula as is found in the left twin. In T. 60, however, we find in the absence of pattern B and the entire disappearance of Triradius D from the right palm of the left twin gross quantitative differences which together with the minor differences in the left palm of the left twin produce a picture which is indistinguishable from the palms of most different sexed and therefore dizygotic twins.

The sole prints are perhaps still more confusing. T. 60, which showed palm prints of great dissimilarity, has sole prints which

are asymmetrically very similar; *i.e.*, right corresponds to left. In T. 61 and T. 16 we find a similarity between the three members but striking differences in the fourth: in T. 61 pattern W takes the place of A in the right foot of the left twin, and in T. 16 the entire print of the right foot of the left twin differs from its homologue. T. 144 and T. 7 have sole prints that exhibit remarkable dissimilarity in all members.

In T. 70 complete finger prints were obtained. There is a very close relationship between all these prints. The one noteworthy feature is that the spiral character of the patterns on both thumbs of the right twin is not present in any of the patterns of the left twin. Bonnevie (9) believes that the shape of the pattern—circular or elliptical—and the twisting tendency of the ridges are hereditary and that they are perhaps even dominant characteristics. Our observation seems to speak strongly against the purely hereditary nature of the twist. Bonnevie expects to find these characteristics present in both of all M. O. twins.

Though these results were very disappointing, we did not believe that they eliminated dermatoglyphics as diagnostic aids. It might be that the coincidence in dermatoglyphic similarity between twins is much greater for the M. O. than for the D. O. It is, however, evident that the moment we abandon the hope of finding an exact identity—which of course we must do!—and speak of similarities, we have assumed a quantitative attitude toward the problem. Cummins³ suggested a method which is perhaps of value in racial comparison but which proved quite useless in our study. The classification which we propose is not based on mensuration and therefore cannot exclude the element of personal judgment; it does however permit a correlation of the palm print with other methods of zygotic diagnosis. Until some more rigid scheme be discovered, it should prove of value.

Our prints and those found in the literature seem to fall into five classes which we have termed: (1) absolute identity, (2) apparent identity, (3) probable identity, (4) transitional, (5) non-identity.

I. *Absolute Identity*—Ab. I.

All four hands or two by two, either symmetrically or asymmetrically, are the same in formula and print. In the print small differences may

³ Personal communication.

be present which are due to the minutiae and which do not appear in the formula.

II. *Apparent Identity*—Ap. I.

All four hands or two by two, symmetrically or asymmetrically, are the same except for slight differences in the formula as well as the print which are however purely quantitative. Another type of difference found is that due to segregation: the appearance of some striking difference in one hand only, when the differences between the hands otherwise do not exceed the limits prescribed above. This is found particularly in the thenar and hypothenar patterns. The appearance of an anomalous characteristic on one side of one M. O. twin has been described for numerous other characteristics such as Darwin's node, etc.

III. *Probable Identity*—P. I.

Three hands are absolutely alike in formula and in print (except for minutiae). The fourth hand reveals general similarity in the flow of the lines but has minor though radical differences. The group has been separately classified because Lauterbach (14) has been impressed by its prevalence among like sexed twins. (*e.g.*, *Cosmobii* T. 61.)

IV. *Transitional*—T.

Two by two, the same, symmetrically or asymmetrically, except for unimportant differences which are however not merely quantitative. The prints must show closely related forms. The frequency of this type of print in our group is most likely due to the inheritance of the family type.

V. *Non-Identity*—N. I.

All prints which show radical differences that are not related forms. There is no identity between any three hands as in P. I.

A correct classification of the palm prints can be undertaken only if the publications of Cummins (16), Midlo (16), Sicomo (10), etc., have been studied. Apparently different symbols often disguise a very close resemblance. For instance X, 0, 7 and 9 in the C position are often very similar, a mere shift of one or two lines may change the formula from the one to the other. In the same way 9 and 10 are only quantitatively different whereas a change from 10 to 11 would entail a change in the pattern B, etc.

In obtaining our material for the investigation of the palm prints of non-conjoined twins, we took pains to avoid selection of material and therefore examined all twins who came as patients to the ward or dispensary. Our technique of printing was similar to the ink method as described by Wilder (2) and Cummins (10), (11), (16). We found it important to ink the hand lightly; for this purpose we secured a marble slap and rolled out the printer's

ink (mimeograph) in a thin film with a rubber roller. The exact amount of ink which is used is of great importance. A double weight glazed paper greatly improved the clarity of the print. The printing itself is best done by wrapping the paper around a wood or glass cylinder about 6 cm. in diameter and rolling off the hand quickly and lightly, preferably from the distal end toward the wrist. Proper assistance is absolutely necessary when printing the palms of infants or young children. The assistant should hold the wrist firmly and bring the thumb into extreme abduction. The operator presses the four fingers flatly within his one hand and rolls off the print with the other. It was frequently necessary to secure an enlarged photograph of the print to elucidate the extremely fine lines of the young child. A negative will do for this purpose. Palm printing of infants is in every case difficult. Despite skill and care blurred prints will often be obtained which allow us to trace the general flow of lines and the position of patterns with certainty but which cause many dimensional errors. Our classification rests upon general similarities and not on identities. We, therefore, believe it is possible to utilize such prints.⁴

We obtained forty pairs of satisfactory prints. Our first observation was, that two different sexed twins—and therefore undoubtedly diovular—had prints of the class, Apparent Identity. Unfortunately the number of unlike sexed twins is too small (six) to reveal the frequency of such cases. We therefore resorted to a correlation with the results obtained by examining the twins according to Siemen's method (3).

The author has reserved for a second paper an exposition of Siemen's method and its limits of error. The diagnosis is made on the basis of identity in a number of different characteristics such as iris color, hair form, distribution and color, skin type and color, face form, lanugo distribution, etc. The probability that a pair of twins is monovular increases with the number of identities in genetically unrelated characteristics. It is essential that characteristics are chosen which show a wide range of variability. It then becomes increasingly improbable that any two individuals not possessing the same germ plasma would show such identity.

⁴We had less success with sole prints. It is likely that the Mathew method of sole printing would have improved our results. The formulation of sole prints meets with greater difficulties too.

This assumption is not forced; its theoretical statistical justification is the basis of the Bertillon system. It will suffice to say that the method has given satisfactory results in the hands of a number of observers.

The twins who have been hitherto examined however were all adults or older children. Our own investigation was confined to infants and young children. This may be the cause of the failure of the method in our hands. We were unable to obtain the sharp differentiation of M. O. and D. O. twins which other workers have apparently secured. For a further discussion of this point we refer the reader to our second paper. Case No. 24 does however offer a serious objection to the use of dermatoglyphics. These were twins who had the same skin type, iris, hair color and sex and whose skin color and lanugo distribution showed only slight differences. Seventeen of twenty-two major characteristics were identical in both twins. Yet their palm prints were absolutely dissimilar.

Such results are undoubtedly in contradiction to the popular conceptions of dermatoglyphics. Misled by the inheritance and the complicated structure of the patterns, we have assumed that they must necessarily be different in individuals of different germ plasm. We have failed to consider the rôle which purely parakinetic factors in utero must exert upon the form and growth of the primitive pads and hence upon the patterns. Cummins (10), (11), (16) has published a number of cases in which abnormal patterns have been found in association with syndactylism. We call attention to the bizarre pattern on the right foot of the parasite in our case T. 7. We may therefore conclude: (1) That like finger and palm form will lead to fundamental—though not detailed—similarity in patterns and (2) that parakinetic factors in utero will modify both. The late appearance of the ridges in the embryo of course increases the risk of such a modification.

It has been repeatedly suggested by various writers that a valuable criterion for the differentiation of M. O. and D. O. twins is the comparison of the differences which exist between the two halves of the individual twin with those that exist between the pair. In the M. O. twins the latter differences are supposed to be no greater than the former. In palm prints we have not found

this to be of any value. On the contrary Case 25 whose prints show almost symmetrical identity with obvious differences between the rights and lefts of each twin, had dissimilar iris color, lanugo distribution and skin color. Lauterbach's (14) case 101 shows the same type of formula. Here there can be no doubt about the zygosity as the pair was different sexed.

Only two other workers have examined the dermatoglyphics of a sufficient number of *unselected* twins.⁵ None have correlated their results with Siemen's technique. Lauterbach (14) has published a number of cases of dizygotic twins who had identical palm prints. Montgomery (20) is more enthusiastic about sole prints. We believe that his own statistics show that they cannot have the absolute value which was at first accredited to them. Only twelve of his fifty-seven like sexed twins had like sole prints whereas his group—which was unselected—must have had about twenty-eight M. O. pairs.⁶ In other words here, too, only half or less of the M. O. twins had similar sole prints. His different sexed twins show that similar sole prints are rare among dizygotic pairs. Bonnevie's work (9) is strangely discordant. Her ingenious method which permits an exact mensuration of finger prints has proven that these are dependent in large measure upon inheritance factors. Her examination of twins is of special interest to us. Fifteen pairs which she regards as undoubtedly M. O. had an r of 0.924 ± 0.037 . Fraternal twins showed an r of 0.535 ± 0.082 and siblings of different sexes, 0.595 ± 0.118 . The r of unrelated individuals was 0.27 ± 0.128 . In other words we have a remarkable correlation of finger prints in M. O. twins which is not present in siblings. These statistics however obscure great individual variations. Among the siblings, for instance, we have 9 pairs out of thirty in which the percentage differences fall within the group of the M. O. twins though the arithmetic average of the percentage differences for the former is 28 whereas it

⁵ Newman's article on the same subject which appeared in the Biological Bulletin of October, 1928, came to our attention too late for discussion in this paper. We shall discuss it in our second article.

⁶ According to Weinberg's differential method (18) (19) in any unselected group of twins, about $\frac{1}{2}$ of all twins and about $\frac{1}{2}$ of all like sexed are M. O. In small groups the figures are naturally merely approximately correct. Recent statistics and all theoretical conclusions justify Weinberg's assumptions.

TABLE I.

- T. 60.* Duplicitas asymmetros. Thoracopagus. Tetrabrachius.
Palm Prints: Right Twin, (R.) 10.7.6.3/B.O.O.Ac.L.C13.
 (L.) 10.87.86.3/B.O.O.Ac.L.C12.
 Left Twin, (R.) 10.0.6.3/O.O.O.Ac.Z.C12.
 (L.) 9.7.5'.3/B.O.O.Ac.L.C12².
 Classification—Transitional.
Sole Prints: Right Twin, (R.) (U + U + U + U) od.
 (L.) (U + U + U) + U. Id.
 Left Twin, (R.) (U + U + U + U) od.
Finger Prints: Right Twin, (R.) SW—RL—UL—UL—UL.
 (L.) SW—RL—UL—UL—UL.
 Left Twin, (R.) W—UL—UL—UL—UL.
 (L.) UL—RL—UL—UL—UL.
- T. 16.* Duplicitas symmetros. Dicephalus. Dibrachius. Dipygus.
Sole Prints: Right Twin, (R.) BC—(U + U + U) od.
 (L.) BC—(U + U + U) od.
 Left Twin, (R.) B—U + (U + U) Id.
 (L.) BC—(U + U + U) od.
- T. 61.* Cephalothoropagus, Syncephalus Asymmetros.
Palm Prints: Right Twin, (R.) 10.7.6.5''/O.OO.Ac.L.C13.
 (L.) 9.X.5''3./O.O.O.Ac.Ac(C13).
 Left Twin, (R.) 9.X.5.3/O.O.O.Ac.Ac.C13.
 (L.) 9.X.5.3/O.OO.Ac.Ac.C13.
 Classification—Probable Identity.
Sole Prints: Right Twin, (R.) A—(U + U + U) d'meet.
 (L.) A—(U + U + U) d'meet.
 Left Twin, (R.) W—(U + U + U) d'meet.
 (L.) A—(U + U) + O d'in.
- T. 7.* Duplicitas asymmetros, Autosite et Parasite. Thoracopagus asymmetros. Epigastricus. Cyclopia.
Sole Prints: Autosite, (R.) A—O + U + O. Id.
 (L.) A—O + (U + U). Id.
 Parasite, (R.) O—O + O + O. hy. od.
 (L.) AB—(U + U + U) Id.
- T. 144.* Cephalothoracopagus asymmetros
Palm Prints: Right Twin, (R.) 8.6.5'.3./O.O.O.O.L.C12.
 (L.) 8.6.5.3/O.O.O.O.L.C12.
 Left Twin, (R.) 7.5.5'.3/M.O.O.O.L.C13.
 (L.) 7.5''5.3/O.O.O.O.L.C11.
 Classification—Apparent Identity.
Sole Prints: Right Twin, (R.) A—O. + Π . + U. 2d.
 (L.) A—O + Π + U. 2d.
 Left Twin, (R.) A—O + (U + U). Id.
 (L.) A—O + O + Π . 2d.

Legend: We refer the reader to Montgomery (20) for formulation of sole prints. The parentheses include patterns which are apparently united in one. The finger print formula is the common one of Galton. S.—Spiral. W.—Whorl. L.—loop opening radially, (R.) or ulnarly (U.).

The reader is referred to the work of Cummins and Wilder for the

is only 3.5 for the latter. As siblings are the genotypic equivalents of fraternal twins, we may assume that Bonnevie's method can be of no use to us in the diagnosis of individual pairs of twins. Possibly a large group of unselected twins may show that M. O. twins never or rarely have a high percentage difference. In that case Bonnevie's method would be a valuable negative trait; that is to say the presence of a high percentage difference would exclude M. O. Bonnevie's study suggests this conclusion. We wish to call attention to the numerous cases of extremely small percentage differences among siblings whereas the groups of fraternal twins show a general high level. We believe that this is due to sampling; inevitable, as Bonnevie was not working on the same problem as we are. Her experience, however, illustrates how necessary it is in research along this line to avoid artificial and undesired selection.

CONCLUSIONS.

A method of classifying palm prints is suggested. Forty pairs obtained on non-conjoined twins were correlated with the results obtained by Siemen's method of diagnosis. No strict parallel between the identities in skin color, iris color, hair color, lanugo distribution, etc., and the similarities in palm prints could be found. The correlation of the degree of similarity with the sex of the pair suggests that palm prints are of little value in selecting monoovular twins. The study of palm, sole and finger prints in conjoined monsters leads to the same results.

We believe that characteristics of value in the diagnosis of monoovularity can be objectively chosen and their exact nature and evaluation elucidated only by studying unselected groups of like and unlike sexed twins indiscriminately.

The writer wishes to express his sincere appreciation to Professor T. Wingate Todd and to Professor N. William Ingalls for the permission to use the specimens of The Hamann Anatomical Museum and for much valuable advice.

formulation of the palm prints. Slight changes made by the author are as follows: *Ac.* = arch. *L* = Loop: small loop represented by small *l*. *O* = no pattern. *hC* = high carpal pattern. *d* = extra triradii distal to *Y* of a pattern with index number showing position on palm. When capital (*D*) the extra triradius is peripheral to *Y*. *Z* = missing pattern due to lack of triradius at that point. *X* = triradius has a straight *Y*. Doubtful readings are represented by a circle about the symbol.

LITERATURE.

1. (a) Galton. *Inquiries into Human Faculty and its Development.* Macmillan, London, 1883.
(b) Galton. *Finger Prints.* Macmillan, London, 1892.
2. Wilder. (a) *American Journal of Anatomy*, 3, 387, 1904; 1, 423, 1902.
(b) *Anatomischer Anzeiger*, 32, 193, 1908; 13, 250, 1897.
(c) *Journal of Heredity*, 10, 410, 1919.
(d) *Biological Bulletin*, 30, 135, 1916; 30, 211, 1916; 50, 393, 1926.
(e) *A. J. of Phys. Anthropology*, 5, 143, 1921.
3. Siemens. *Zwillingspathologie.* Verlag Springer, 1924; *Virchows Archiv*, 253, 746, 1924; 263, 666, 1927.
4. See discussion between *Siemens* and *Meirowsky.* *Virchows Archiv*, 266, p. 313, 1927.
5. Just. *Die Biologie der Person Brugsch-Lewy.* Urban-Schwarzenberg, 1926, No. II.
Lenz, also Bauer. *Handbuch der normalen u. path. Physiol.*, XVII. (III.). Springer, 1926.
Siemens. *Konstitutions- u. Vererbungspath.* Springer, 1921, p. 76.
6. Schlaginhaufen. *Morph. Jahrbuch*, 33, 577, 1905; 34, 1, 1905.
7. I. Whipple (Mrs. Wilder). *Zt. f. Morph. u. Anthropol.*, 7, 261, 1904.
8. Schultz. *Zoologica*, III., No. 12.
9. Bonnevie. *J. of Genetics*, 15, 7, 1924.
10. Cummins & Sicomo. *Anat. Record*, 25, 355, 1923.
11. Cummins. *Anat. Record*, 26, 1, 1923.
Cummins. *A. J. of Anatomy*, 38, 89, 1926-27.
12. Poech. *Mitt. Anthro. Ges. Wien.*, 1925, LV., 133-159, abst. in *A. J. of Phys. Anthropol.*, 9, 384, 1926.
13. Waardenburg. *Klin. Wochenschrift*, 5, 2115, 1926.
14. Lauterbach. *Genetics*, 10, 525, 1925.
15. Broman. *Normale u. abnormale Entwicklung des Menschen* Bergmann, 1911.
16. Cummins & Midlo. *A. J. of Phys. Anthropol.*, IX., 471, 1926.
Cummins et al. *A. J. of Phys. Anthropol.*, 11, No. 3, 1928.
17. Verschuer. *Ergeb. der Inn. Med. u. der Kinderheilkunde*, 31, 35, 1927. (Has extensive literature!)
18. Weinberg. 1901—discussed in Newman's *Biology of Twins* (U. of Chicago Series), 1917. Literature in Verschuer (q.v.).
19. Dahlberg. *Twin Births and Twins from a Hereditary Point of View* (in English). Stockholm, 1926, Bokfoerlags—A. B. Tidens Tryckeri.
20. Montgomery. *BIOL. BULL.*, 50, 293, 1926.

MUSCULAR REORGANIZATION IN THE ODONATA DURING METAMORPHOSIS.

ARTHUR D. WHEDON,

DEPARTMENT OF ZOÖLOGY, NORTH DAKOTA AGRICULTURAL COLLEGE.

INTRODUCTION.

Extensive investigations have been made into tissue reorganization in the Holometabola, especially the Lepidoptera, Diptera and Hymenoptera. The profound nature of these changes has probably overshadowed the less extensive ones which might be seen in the Hemimetabola. At least, no study has been devoted to the latter. Indeed, so little is known of the Neuropteroid and Orthopteroid insects in this respect, and perhaps so much inferred from the Holometabola, that a gross misconception has persisted almost to the present regarding even the period in the life cycle of such an insect when tissue reorganization is accomplished, to say nothing of uncertainty as to the nature of the metabolic processes responsible for the changes. The Odonata, perhaps typical of those forms which pass rather suddenly from aquatic larva to aerial imago, is a good example.

In his "Biology of Dragonflies," Tillyard (1917) states that "The emergence of the imago from the larval skin or exuviae, usually spoken of as metamorphosis, is in point of fact only the consummation of an internal metamorphosis which begins a considerable time before. The beginning of this change is marked by an alteration in the color and behavior of the larva. The color darkens considerably, greenish larvæ becoming a dull opaque brown. The larva becomes listless and refuses to feed. Rapid proliferation of the hypodermal cells, preparatory to the formation of the imaginal exoskeleton, causes the larva to appear tense and swollen." The changes in the eyes and other parts are then mentioned but nothing is said of the retraction of the labium, which begins at the time the insect ceases to feed, or of the degeneration of the gills within the rectum and of the opening of

the thoracic spiracles at the time the larva comes to the surface. Then Tillyard continues "As soon as the changes are practically complete, the larva climbs out of the water, usually upon a stick, rock, reed-stem or other suitable object." A description of the final ecdysis follows.

As early as 1918 the writer observed considerable variation in the structure of the adult abdomen in the Odonata (Whedon, 1919), especially in *Anax*. Specimens which had been collected at various times without reference to their exact ages, when dissected showed now the presence and again the absence of certain muscles in a way very puzzling to one possessed of the idea that all reorganization had been completed before transformation. It later became clear that newly emerged specimens (teneral) retained wholly or in part the larval structures. In 1924 Miss Ford (Ford, 1924) also discovered this and briefly discussed the condition in the muscles of *Libellula quadrimaculata*. She, further, gave a homology of the abdominal muscles of the larva and the adult based upon her findings. So much, however, remained vague or unknown that the present study was deemed worth while.

MATERIALS AND METHODS.

Most of the work which follows was done upon *Anax junius*, although *Libellula* and *Sympetrum* have occasionally served for comparison. Specimens were collected and prepared at Woods Hole and Fargo during the seasons between 1919 and 1928. They were usually decapitated, opened, spread in a wax tray and immediately fixed. Bouin's Fluid, Zenker-formol, 10 per cent. formalin and 95 per cent. alcohol were used. Other specimens were injected with methylene blue and fixed in ammonia molybdate in an attempt to stain the nerve branches leading to muscles in different conditions. While not very successful for nerve endings, these methylene blue preparations were excellent for dissection.

The dissections were made under a Greenough binocular in a paraffin tray with translucent bottom, thus permitting of both reflected and transmitted light. The specimens were kept immersed in the preserving fluid.

Muscles and other tissues were also imbedded in paraffin or

celloidin, sectioned and stained with iron-haematoxylin to determine the normal or pathological conditions at various stages during metamorphosis. This paper makes no attempt, however, to discuss the cytological and histological changes in muscular tissue during its degeneration.

The author wishes to acknowledge the kind assistance of Doctor Philip P. Calvert of the University of Pennsylvania, especially in connection with the bibliography and the loan of papers. The Academy of Natural Sciences of Philadelphia, also, very generously furnished photographic copies of Rogozina's plate of the nerve branches of an abdominal segment of *Æschna*.

THE ESSENTIAL CONDITIONS OF TRANSFORMATION.

Transition from a well adapted aquatic larva to a highly specialized aërial adult does not require profound changes in all of the animal's systems. At least, this is true so far as superficial anatomy is concerned. The nerve chain, the heart, the Malpighian tubules, and the gonads develop quite directly and progressively from embryo to adult, though the histology of the ganglia, the atrophy of nerve branches and formation of new ones would be expected to adjust themselves to the reorganization of the digestive and muscular systems. On the other hand, the alimentary canal, the tracheæ and their air sacs, the fat body, and the muscles are extensively modified. The greatest change in the alimentary canal is due to the relatively sudden loss by the rectum of its respiratory function, resulting in this organ becoming as inconspicuous in the adult as it is remarkable in the larva. This rectal modification leads in turn to the disuse of the large tracheal trunks and branches which supplied it, the necessity of opening the spiracles, first the thoracic and then the abdominal, and the development or enlargement of numerous air sacs. New thoracic muscles must be built to equip the wings, but the heavy musculature of the abdomen, correlated with respiration and locomotion, must be greatly reduced.

The time necessary for the formation of new muscles is, of course, much greater than that for the atrophy of the superfluous ones, and thus the muscles for the wings appear gradually from instar to instar during larval growth (Poletaiew, 1881). The

degeneration of the abdominal muscles was thought, as stated earlier, to be accomplished while the larva was in the quiescent stage just preceding transformation but is shown by this study to occur mainly, if not entirely, after the emergence of the imago. The period of emergence itself is very short, scarcely ever exceeding an hour (*Anax*, *Plathemis* and *Sympetrum*), and is occupied with the more physical necessities of expansion.

THE DEGENERATION OF ABDOMINAL MUSCLES.

While many stages have been dissected and sectioned for the determination of the muscle condition, the following will be sufficient for a clear demonstration of what takes place: (*a*) the normal fully grown larva, (*b*) the quiescent larva with retracted labium, (*c*) the transforming larva, (*d*) the newly emerged imago, and (*e*) the imaginal stages at about three, eight, eighteen, thirty-seven, sixty and eighty-three hours.

Full descriptions and figures of the muscles of *Lestes*, *Anax*, *Libellula* and *Tramea* have been given by the writer in an earlier paper (Whedon, 1919). A comparison of the abdominal muscles of a normal larva of *Anax* with those of a larva with retracted labium reveals no macroscopic differences. Under the binocular microscope the muscles are compact and functional in appearance (Fig. 1). Sections at this stage stained either in methylene blue or iron-hæmatoxylin show no distinct signs of degeneration. Teased muscles seem perfectly normal and are possessed of what seems their usual plentiful supply of tracheæ and nerves. These muscles must function actively, also, for when a larva is disturbed it swims vigorously by means of rectal contractions and abdominal movements. Perhaps this could not continue to the moment of emergence, however, due to the changes in the respiratory system.

Dissection of a specimen well along in this stage shows that the gill system of the rectum is breaking down, the lining is being shed and the tracheal connections with the wall of the rectum are degenerated though still to be seen. It is the progress of this degeneration that forces the larva to the surface of the water to breathe, first through the rectum and later through the thoracic spiracles. Such larvæ drown if kept under the surface of the

water. Specimens not too far gone, have been resuscitated after respiratory movements have ceased, by gentle manipulation in the air. Dissection shows the tracheal trunks and branches identical with those of the full-grown larva except for the connections with the rectum and the beginnings of air sacs. Many of these tracheæ run quite parallel to the main nerves. Teased fragments and sections of tergal and sternal muscles show large numbers of tracheoles, apparently in functional connection with the fibers.

The nervous system and its neuromotor connections also seem indistinguishable from those of the normal larva. The nerves of a central abdominal segment have been dissected out in a fully grown larva, in a larva with retracted labium, and in a specimen in the act of emerging. The nerves are identical except for such changes in position as result from the elongation of the abdomen (Fig. 9). The more minute branches have not been followed in many cases. Efforts to use methylene blue *intra vitam* have not met with pronounced success, so that the nature of the nerve junctions with muscles about to degenerate is not known with certainty.

Specimens fixed by different methods during transformation all show the same condition of the muscles. In dissections they seem identical with those of the normal larva, with no outward sign of degeneration (Fig. 9). Longitudinal sections of the whole body wall with its muscles in place when stained in iron-hæmatoxylin give little or no evidence of general disintegration in the large sternal and tergal muscles. Fibers in various states of contraction (Jordan, 1919, 1920) are present. A few muscles and portions of muscles, however, show a flaky condition and lack of affinity for stain which is not easy to interpret; their nuclei are still normal though perhaps slightly smaller than usual. Something similar to these conditions may be seen, however, in a highly contracted normal muscle fiber.

At this stage the rectum has contracted to nearly its final size and condition, the lining, together with the remnants of the rectal gills, has been shed and the surrounding tracheæ are largely disintegrated.

Special attention was given to the nervous system of the transforming larva and of the newly emerged imago in the hope of

learning the relations of the nerve branches with the muscles doomed to degeneration. Dissection showed minute nerves penetrating these muscles, though, as stated earlier, nothing conclusive has been determined with respect to their neuromuscular junctions proper. An attempt to show the nerve distribution is made in Fig. 9. The literature contains little of an accurate nature respecting either the distribution or the nomenclature of the nerves of the abdominal segments. Rogozina (1924) has sketched in much detail the distribution of the nerves and their branches of the right side of an abdominal segment of the larva of *Aeschna*. Unfortunately the figure does not make clear the more exact relations of these nerves to the various muscles. Many of the larger branches, also, do not occur as in *Anax* (Fig. 9) and there are many variations in the smaller branches. The unpaired ventral nerves she omits entirely. The three main lateral nerves from the ganglion she designates, as do all other authors consulted, N_1 , N_2 and N_3 . Reference to the excellent figures in Zawarzin's histological paper (1924) and to Fig. 9 below will clearly establish their relations. The remainder of Rogozina's labels are in Russian and have not been translated, so exact descriptions must here be omitted. Perhaps the greatest differences between Rogozina's figure and Fig. 9 are to be found in the branches of N_3 . She shows no branching until this nerve has run caudad and laterad to the pleural region, while in *Anax* repeated dissections show it to run directly caudad to a point slightly beyond the origin of the Tertiary Longitudinal Sternal Muscle (*tls*) where it divides into ventral and dorsal branches of about equal size. The former passes transversely beneath the bases of the Tertiary and the Quaternary Longitudinal Sternal Muscles (*tls* and *qls*) to the pleural region where it supplies the Median Dorso-Ventral Muscle (*dvm*). The dorsal or more internal branch passes over the ends of the muscles named (*tls* and *qls*) and on to the pleural region where it joins a branch of N_2 on its way to the Dorso-Ventral Oblique Muscle (*dvo*) and perhaps the other muscles and hypodermis of this region.

There is no agreement as to the functional nature of the three main pairs of nerves from each abdominal ganglion. To the writer, they all seem to be mixed nerves. This accords with the

results of Zawarzin (1924) but differs from those of Rogozina, in Odonata, and of Hilton (1924 and 1925) and others in Coleoptera and other insect groups. N_1 , the largest and most anterior of the three, is certainly a mixed nerve. It can be plainly seen to be made up of two branches confluent at about the point of crossing the Dorso-Ventral Oblique Muscle (*dvo*). The anterior and more dorsal branch carries the fibers from innumerable nerve endings in the hypodermis of the tergum, while the more posterior and ventral one is made up of the fibers from nerve endings in all of the tergal muscles: from those which are to degenerate as well as those to persist in the imago. N_2 , the second nerve, seems to have a similar constitution but to supply the pleural region. Basal branches are apparently concerned with the muscles and hypodermis of the sternal region. The distribution of the divisions of N_3 have been described above.

Neither dissections or sections give evidence of a degenerating nerve supply to the Primary and Secondary Sternal and Tergal muscles. If such exists it is in the neuromuscular end-plates and here further investigation is necessary.

A comparison of the retracted labium stage and the transforming stage makes it certain that (1) there is little if any degeneration of the muscles preceding the imago, (2) there is still a full tracheal supply to the muscles, though that to the rectum has atrophied, and (3) nerve branches still connect with all of the muscles. This, of course, refers primarily to the abdomen.

From emergence on through many hours degeneration of superfluous larval structures continues. Adjustment and coördination of imaginal organs occurs at the same time. The length of this period varies with different genera. As determined by dissections, the reorganization seems completed in *Anax* in seventy-five to eighty hours, but *Libellula* at four hours has reached about the same condition as *Anax* at eighteen. *Plathemis* is about like *Libellula*. Miss Ford records a similar condition in *Libellula quadrimaculata* at three hours.

The grosser indications of this change in the muscles are an increasing flaky or granular appearance and the formation of oil droplets in both the muscles and the atrophying fat-body, together with the disappearance of the tracheoles and nerve branches. At

eight to sixteen hours the nerves to the degenerating muscles are gone while those to the remainder are very clear. Sections of degenerating muscle stained in iron-haematoxylin show first a lack of affinity for the stain and loss of striations, then later disappearance of the nuclei, irregularity in staining and a lumpy segregation which no longer yields histological detail. The sternal and tergal muscles go at the same time.

The progress of muscle degeneration with increasing age shows clearly in dissections made at eighteen, thirty-seven, sixty and eighty-three hours, the fifth segment being used in each case for examination (Figs. 5, 6, 7 and 8). By sixteen to eighteen hours in *Anax* (three to four in *Libellula*) the degenerating muscles are all distinctly granular and yellowish, though the forms of the muscles and muscle fibers are still retained and are of nearly their original bulk. At thirty-seven hours these have been reduced to a thinner sheet, more or less broken and perforated, and with the identity of the fibers nearly gone. At sixty hours but a thin, broken or lacy film remains, and at seventy-five to eighty-five hours the last traces of even this have disappeared, leaving only the marks of attachment on the skeleton to define their original positions.

The dissection of a single specimen of *Anax* at an age between eighteen and twenty-four hours yields a sequence in degeneration in the segments from anterior to posterior quite comparable to the progression just stated. When the muscles of segment 5 are at the stage shown for eighteen hours, segment 1 approximates the forty hour condition, while segments 7 and 8 are just beginning to possess a distinctly granular structure (Figs. 2, 3, or 5, and 4). Thus traces of certain muscles will remain in the posterior segments of the abdomen for some time after most of the segments have reached the adult condition.

No new muscles develop in the abdomen as the insect passes through the transformation period, except perhaps those of the copulative organs. The adult musculature is, in the main, the remnant of that of the larva. When all degeneration is completed the muscles which remain are the Tertiary, Internal Tertiary and Quaternary Longitudinal Sternals; the Tertiary, Quaternary, Quinary and Sextic Longitudinal Tergals; and the Anterior and Pos-

terior Dorso-Ventral Muscles. With the lengthening of the abdomen after emergence certain of these muscles which lay near together in the larva are drawn so close as to overlap or combine to form the apparently single adult muscles. It is clear that the three pairs of Longitudinal Sternals of the larva thus combine to form the Longitudinal Sternal muscles of the adult, and the Tertiary and Quaternary Longitudinal Tergals unite to form the Superior Longitudinal Tergals. *Anax* at eighteen hours gives indications of these in process of union (Fig. 3). The Sextic Longitudinal Tergals form the Inferior Longitudinal Tergals, and the Quinary Longitudinal Tergals, lengthened and reduced, become the Tergo-Pleurals (*tp*). The anterior and posterior Dorso-Ventral muscles remain and retain the same names in the adult.

In her paper on the abdominal musculature of Orthopteroid insects, Miss Ford quotes (pages 255 and 256) the writer's work of 1919 regarding the difficulty of homologizing the larval and adult muscles, and follows up her discussion with a table listing the homologous muscles. Comparison will show that her conclusions do not agree with those here stated. The present results are, however, based upon many and repeated observations over a period of several years and it is hoped they will be found correct.

The chief purpose of this short paper has been to establish the facts regarding the outstanding changes in musculature during metamorphosis in order to lead to the more fundamental problems of the histology, cytology and physiology of muscle histogenesis and degeneration in the Hemimetabola.

SUMMARY.

1. There has long existed a misconception as to the time and nature of tissue and organ reorganization in the metamorphosis of the Hemimetabola. It is now determined that most of the changes in the muscles occur after emergence.
2. New thoracic muscles, ultimately to serve the wings, are added from instar to instar during the growth of the larva, and are carried over into the adult stage. The full complement of larval abdominal muscles is present through all the later instars and no new muscles are developed during transformation.
3. The heavier inner layers of larval abdominal muscles (the

Primary and Secondary Longitudinal Sternals and Tergals, the Middle Dorso-Ventral Muscles, and the Dorso-Ventral Oblique Intersegmental Muscles) degenerate soon after transformation. The outer and much lighter set remains to function in the adult.

4. For a short time after emergence the muscles which are to degenerate retain their normal appearance and are well supplied with tracheæ and nerves. Later they become yellowish and granular and gradually disappear. The time at which degenerative changes become noticeable varies with the genus, being early in *Libellula*, *Plathemis* and *Sympetrum* and much later in *Anax*.

5. Degeneration begins in the first segment of the abdomen and proceeds gradually to the last. It is completed in *Anax* in about three days.

6. The facts recorded make possible a statement of the homologies between the larval and adult abdominal muscles.

BIBLIOGRAPHY.

Cuvier, Georges.

1836-1846 Le Regne Animal. Les Insectes. 4 vols. Paris.

Deegener, P.

1912-1913 Nervensystem, Sinnesorgane. Handbuch Entom. (Schröder), Bd. I., p. 76-233, 77 figs.

Dufour, Leon.

1841 Recherches Anatomiques et Physiologiques sur les Orthopteres, les Hymenopteres et les Neuropteres. Mem. Math. Savants Etrangers, Acad. Sci. Paris, 1841, Tome VII., pp. 265-647, pls. 1-13.

1852 Etudes Anatomiques et Physiologiques, et Observations sur les Larves des Libellules. Ann. Sci. Nat., 3e Serie, Tome XVII., pp. 56-110, pls. 3-5.

Ford, Norma

1924 A Comparative Study of the Abdominal Musculature of Orthoperoid Insects. Trans. Royal Canad. Inst., Vol. XIV., Part II., pp. 207-319, pls. VII.-XXIII.

Hilton, William A.

1924 Afferent and Efferent Pathways in an Abdominal Segment of an Insect. Jour. Comp. Neur., Vol. 36, No. 3, pp. 299-308, 8 figs.

1925 Nerve Endings in Insects. Trans. Am. Micro. Soc., Vol. XLIV., No. 3, pp. 132-137, pl. IX.

Jordan, H. E.

1919 Studies on Striped Muscle Structure. V. The Comparative histology of the leg and wing muscles of the Mantis, with special reference to the N-discs and Sarcosomes. Anat. Rec., Vol. 16, no. 4, pp. 217-246, pls. 1-3.

1920 Studies on Striped Muscle Structure. VI. The Comparative Histology of the Leg and Wing Muscles of the Wasp, with special reference to

the phenomenon of the stripe reversal during contraction and to the genetic relation between contraction and intercalated discs. *Am. Jour. Anat.*, Vol. 27, no. 1, pp. 1-68, 48 figs.

Leydig, Franz.

- 1864 Vom Bau des Thierischen Körpers. Handbuch der Vergleichenden Anatomie. Erster Band, pp. VI., 278. Tübingen.

Morrison, Guy D.

- 1927 The Muscles of the Adult Honey-bee. *Q. J. M. Sc.*, Vol. 71, Part III., pp. 395-463, 12 figs.
1928 Ditto, Part II. *Q. J. M. Sc.*, Vol. 71, Part IV., pp. 563-651, 41 figs.

Poletaiev, Nicolas.

- 1881 Du Développement des Muscles d'Ailes chez les Odonates. *Horae Soc. Ent. Ross.*, Tome XVI., pp. 10-37, pls. IV-VIII.

Rogozina, M. C.

- 1924 Die peripheren Nerven der Aeschnalarven. 1. Die Nerven der Abdominalsegmente. *Bull. Inst. Recherch. Biol. Univ. Perm.*, T. 3, p. 141, 1 Taf. Paper in Russian; "Resume" in German.

Tillyard, R. J.

- 1917 The Biology of Dragonflies. Cambridge Univ. Press.

Viallanes, H.

- 1884 Anatomie et Dissection de la larve de Libellule. Feuille des jeunes Naturalistes, Tome XIV., pp. 81-87, pl. II. Paris.

Whedon, Arthur D.

- 1919 The Comparative Morphology and Possible Adaptation of the Abdomen in the Odonata. *Trans. Am. Ent. Soc.*, Vol. XLIV., pp. 373-437, pls. XXI-XXIX.
1927 The Structure and Transformation of the Labium of *Anax junius*. *BIOL. BULL.*, Vol. LIII., no. 4, pp. 286-301, 2 pls.

Zawarzin, Alexius.

- 1912 Histologische Studien über Insekten. II. Das sensible Nerven-system der Aeschnalarven. *Zeitschr. Wiss. Zool.*, Band 100, pp. 245-286, 3 Taf., 9 figs.
1924 Über die histologische Beschaffenheit des unpaaren ventralen Nervs der Insekten. *Zeitschr. Wiss. Zool.*, Band CXXII., pp. 97-115, 5 figs.
1924 Zur Morphologie der Nervenzentren. Das Bauchmark der Insekten. Ein Beitrag zur vergleichenden Histologie (Histologische Studien über Insekten VI). *Zeitschr. Wiss. Zool.*, Band 122, pp. 323-424, 8 figs., Taf. III-X.

DESCRIPTION OF FIGURES.

All drawings were made with the camera lucida and Greenough binocular by the author. The magnification is approximately ten diameters unless otherwise noted. All dissections were pinned out flat in a tray. Healthy muscles are shaded with parallel lines, while those undergoing degeneration are stippled. The extent of degeneration is shown, roughly, by loss of definite outlines and lighter stippings. Abbreviations used in labeling are as follows:

- ag*—abdominal ganglion.
- car*—mid-dorsal carina.
- dva*—dorso-ventral segmental muscles, anterior part.
- dvm*—dorso-ventral segmental muscles, middle part.
- dvp*—dorso-ventral segmental muscles, posterior part.
- dvo*—dorso-ventral oblique intersegmental muscle.
- lpsp*—lateral primary longitudinal sterno-pleural muscle.
- N_1, N_2, N_3 —first, second and third pairs of lateral nerves from abdominal ganglion.
- nc*—nerve cord.
- N_1m —motor branch of N_1 .
- N_1s —sensory branch of N_1 .
- nmu*—unpaired nerve.
- pls*—primary longitudinal sternal muscle.
- qlt*—quaternary longitudinal tergal muscle.
- qlt*—quinary longitudinal tergal muscle.
- sp*—spiracle.
- slt*—secondary longitudinal tergal muscle.
- s.slt*—sextic longitudinal tergal muscle.
- tls*—tertiary longitudinal sternal muscle.
- ilt*—tertiary longitudinal tergal muscle.
- trs*—transverse sternal muscle.

PLATE I.

FIG. 1. Right half of abdominal segment 6 of a larva with retracted labium. All muscles are present and apparently in functional condition. Organs other than the muscles and main nerve cord have been removed.

FIG. 2. Left half of tergum of segment 2 of an imago eighteen hours after transformation. The stippled muscles are extensively degenerated, others normal.

FIG. 3. Sternum and right tergum of segment 5 of another imago eighteen hours after emergence. The heavier degenerating sternal muscles are dissected away on the right side. The overlapping and uniting of the Tertiary and Quaternary Longitudinal Sternals to form the Longitudinal Sternals of the adult, and a similar condition in the tergal muscles, can be seen. Nerve branches are not shown in detail. The degeneration of the larval muscles has not gone as far as in segment 2. Compare with Fig. 5.

FIG. 4. Left side of tergum of segment 7 of the same specimen shown in Fig. 1. The larval muscles show still less disintegration than in segment 5.

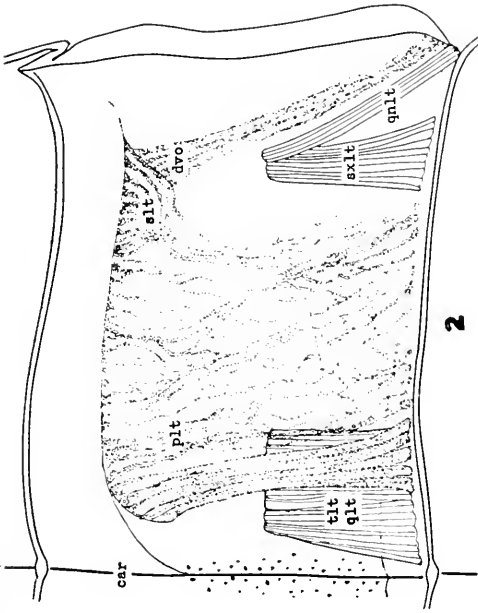

2

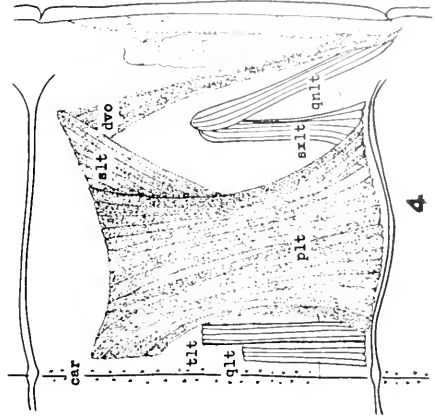

4

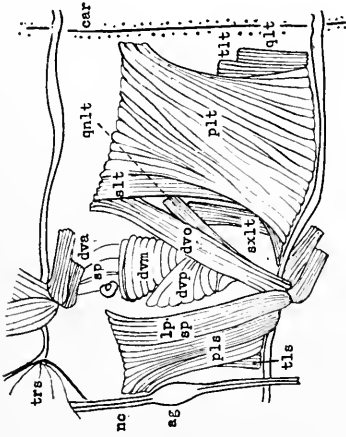

1

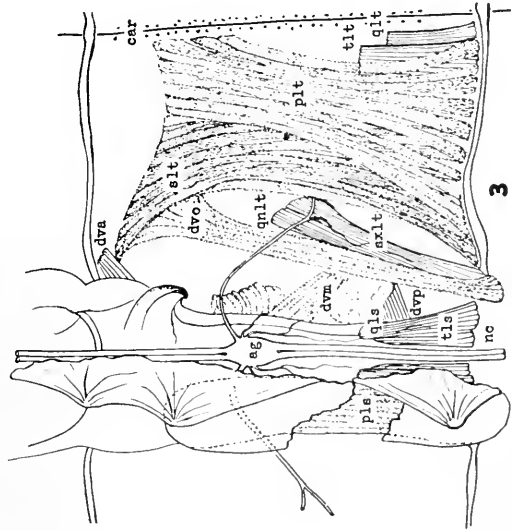

3

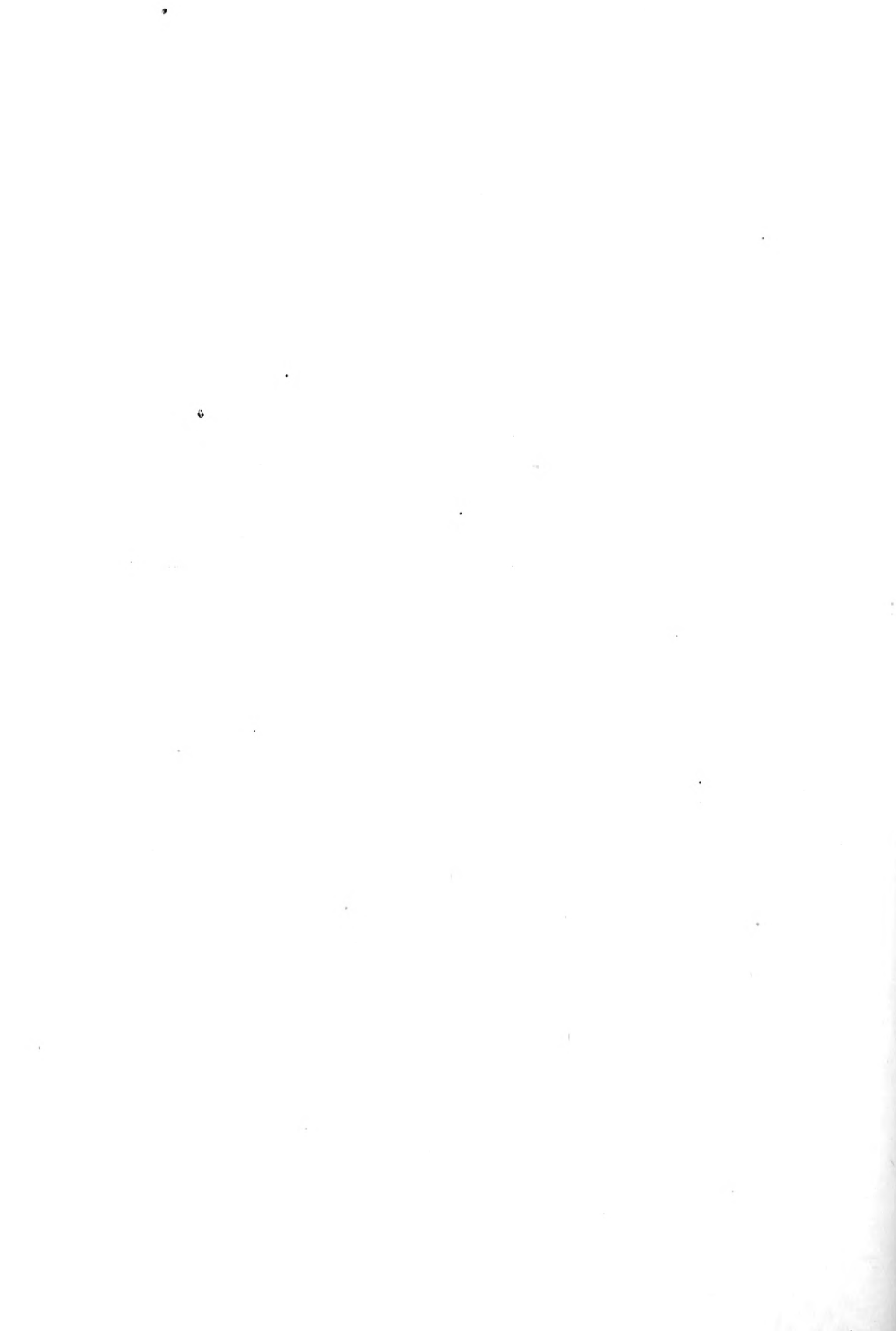

PLATE II.

All figures on this plate are of dissections of the left half of the tergal portion of the fifth abdominal segment at various ages after emergence. Taken together with Figure 1 they show the progress of disintegration of superfluous larval muscles from the normal condition to complete disappearance.

- FIG. 5. Eighteen hours.
- FIG. 6. Thirty-seven hours.
- FIG. 7. Sixty hours.
- FIG. 8. Eighty-three hours.

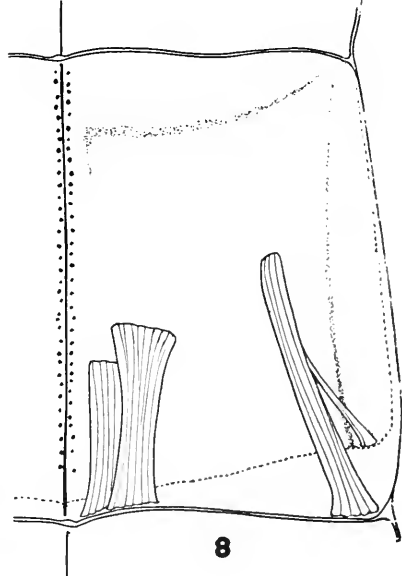
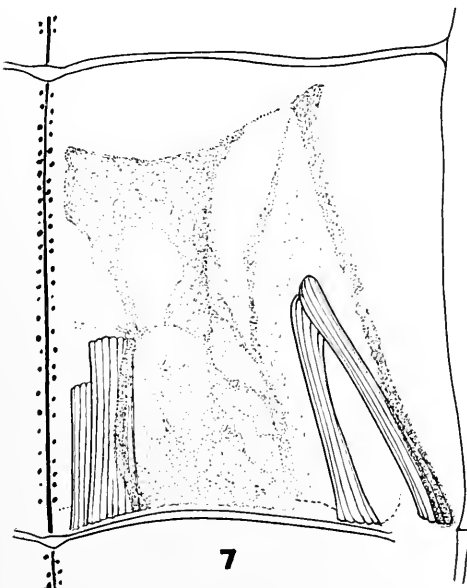
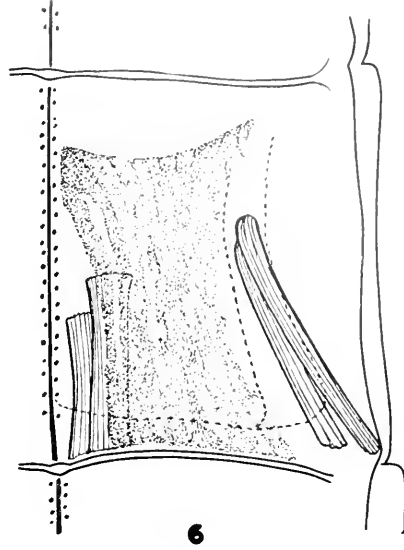
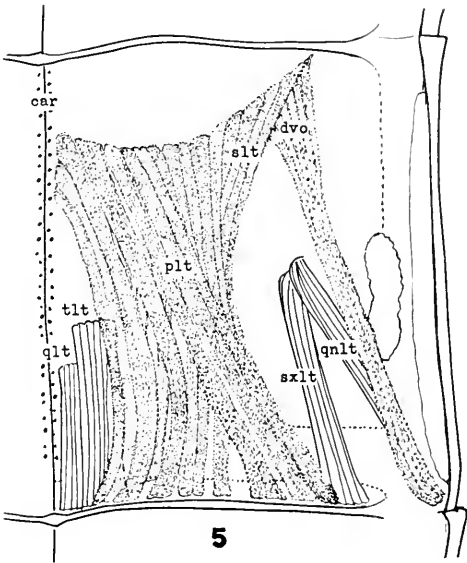
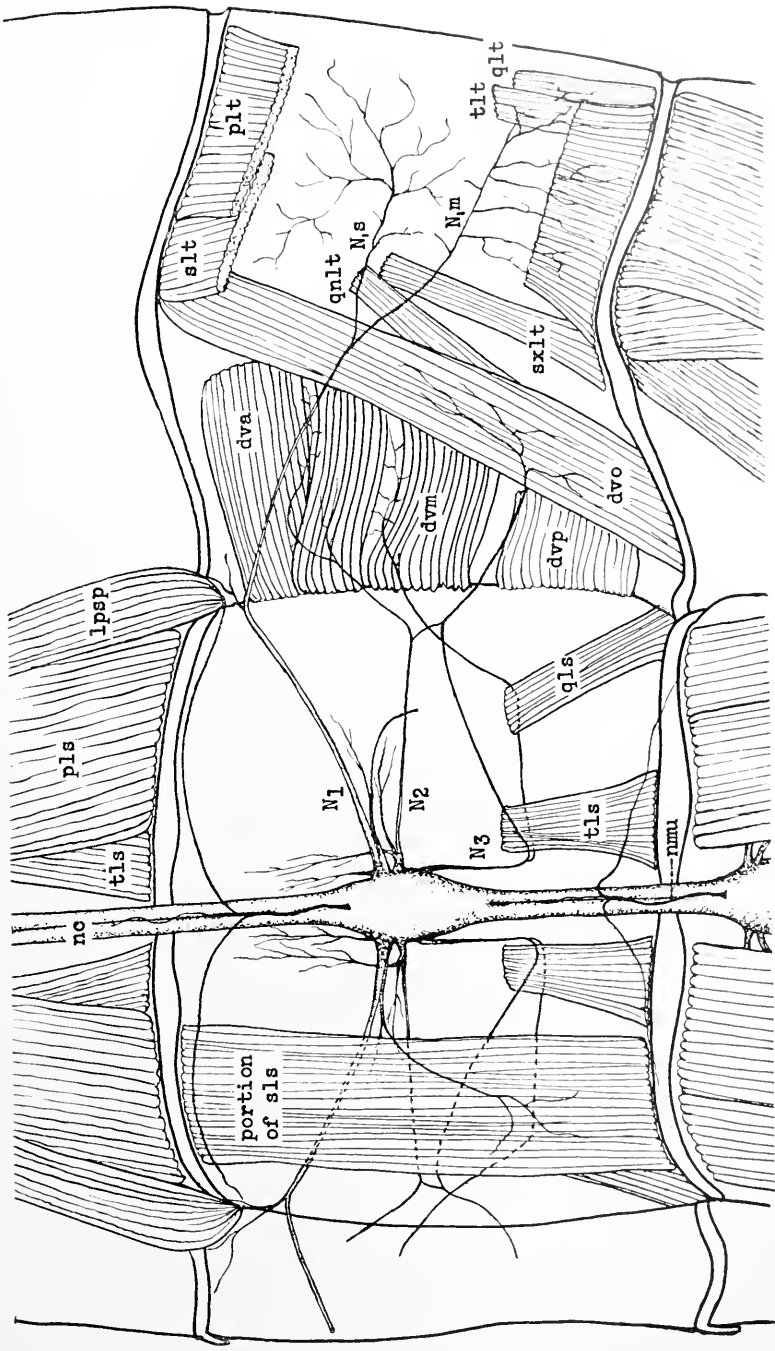

PLATE III.

FIG. 9. Sternum and right half of tergum of abdominal segment 7 of a specimen injected during emergence with methylene blue, fixed in ammonium molybdate, and dissected for nerve-muscle relations. The central portions of the Primary and Secondary Longitudinal Tergals together with practically all of the Primary and Secondary Longitudinal Sternals have been removed in order to expose the nerves and more peripheral muscles. For clearness the three main nerve branches on each side of the ganglion have been slightly separated in dissection. All muscles seem in normal condition. Nerves running beneath muscles are shown in dotted lines, but no attempt has been made to show the complete system of nerve branches.



POTENTIAL DIFFERENCES ACROSS THE CHORION
OF THE *FUNDULUS* EGG.

MARGARET SUMWALT.*

(From the Department of Physiology, Medical School, University of Pennsylvania, Philadelphia, and the Marine Biological Laboratory, Woods Hole.)

Loeb and Cattell (16) in 1915 reported the results of certain experiments on *Fundulus* eggs, which they did not satisfactorily explain. The central observation was that when KCl had penetrated the egg in sufficient amount to stop the heart of the embryo, it could escape, effecting recovery of the heart beat, if the eggs were placed in a solution of some other salt or in a dilute solution of acid, but not if they were placed in distilled water. An analogous observation on very different material was made ten years later by Michaelis and Fujita (20, 21), who found that K and other cations will pass through apple skin and dried collodion membranes into salt solution, but not into distilled water. Their explanation was that these membranes are permeable for cations but not for anions; when it is possible for cations on the two sides of such a membrane to be exchanged, movement of cations across the membrane can occur, but not otherwise. This explanation Michaelis, with several collaborators, has supported by abundant electrical and chemical evidence (5, 20-26).

In the present experiments some of the electrical methods used by Michaelis and his collaborators in the study of apple skin and artificial membranes have been applied to the chorion of the *Fundulus* egg. The results obtained indicate that the electrical properties of this membrane are similar in many respects to those of dried collodion membranes. If they are interpreted analogously, a partial explanation of the results of Loeb and Cattell is afforded.

*I wish to express my indebtedness and gratitude to Dr. M. H. Jacobs who suggested this application of electrical methods to the study of the permeability of the *Fundulus* egg, and to Dr. William R. Amberson with whom the problem was at first prosecuted jointly. Part of the work was done during my tenure of a Dean Van Meter Alumnae Fellowship from Goucher College.

MATERIAL AND METHOD.

The *Fundulus* embryo is enclosed by two membranes: the chorion, a non-cellular, tough, but elastic shell, and the ectoderm of the embryo. In the experiments to be reported, potential differences were measured across the chorion only. It is hoped, however, that a similar study of the ectoderm may be made in the near future.

The properties of the chorion do not appear to vary greatly with the age of the egg, except for a slight decrease in elasticity with time. Fertilized eggs of any convenient age could therefore be used. Most of those employed in these experiments were between 5 and 9 days old at a season when hatching occurred between the 10th and 13th day. A few experiments were performed with satisfactory results on unhatched cold storage eggs 28 days old.

Potential differences were measured between the inside and the outside of the chorion of single eggs. The subchorionic fluid surrounding the embryo constituted a constant environment for the inner surface of the membrane, while solutions of various compositions and concentrations were applied to the outside. In an ideal system, successive applications of two different solutions to the outside of a membrane should produce a change in the membrane potential equal to the P.D. which would be observed if the membrane were placed between the solutions in question. Though the egg is not an ideal system, potential differences arrived at by this method are probably not greatly in error. Measurements across apple skin are, of course, subject to the same disadvantage, but in the hands of Fujita (5) have, by the use of the method here employed, yielded significant results.

To make the inside electrical contact, a capillary pipette was inserted into an egg so that its orifice lay in the subchorionic fluid between the embryo and the chorion. The pipette was filled with saturated KCl and communicated with a saturated KCl calomel half cell. Outside contact was made by dipping a like half cell into the solution in which the egg was immersed. The arrangement of the apparatus is shown schematically in Fig. 1.

The two electrodes were connected into a simple potentiometer circuit. A Leeds and Northrup student potentiometer was used, and the null instrument was a d'Arsonval galvanometer of high

sensitivity. The electrical resistance of the system without an egg was from 10,000 to 100,000 ohms, according to the diameter of the pipette and concentration of the solution into which the electrodes dipped. With an egg on the pipette, the resistance was still higher. Since the galvanometer deflections diminished as the resistance increased, readings were more accurate when the egg lay in concentrated solutions than in dilute. The sensitivity of the galvanometer was sufficient to give a deflection of at least 1 mm. for 5 millivolts with an egg on the pipette in M/20,000 KCl. In this, the most dilute solution used in any of the experiments, the P.D. was sufficiently large to render the experimental error reasonably small (about 5 per cent.). In M/2,000 KCl the galvanometer deflections were of the order of 1 mm. for 1 millivolt, so that considerable accuracy was possible in the determinations at this and greater concentrations.

So high was the resistance in the circuit when an egg was impaled on the electrode that, because of the humid weather conditions prevailing at Woods Hole, and the presence in the laboratories of traces of salts from the sea water, none of the precautions originally used to shield the apparatus prevented short circuit leaks. The work must have been abandoned had not independence of weather conditions been finally secured in a dry room.¹ Here no leaks occurred so long as door and windows were kept closed.

When Osterhout, Damon, and Jacques (28) measured P.D. in *Valonia*, they immersed the cells only partly in the experimental solution, and tested for short circuits at the hole where the pipette entered the cell by comparing the values for part immersion with others obtained when the cell was completely submerged in the same experimental solution. The presence of a leak was shown by diminished P.D. in the latter case.

The *Fundulus* egg, however, is too small for partial immersion without danger of complete wetting by capillarity. In the present study, therefore, an egg was completely immersed in the experimental solutions throughout a determination. That little or no leakage occurs ordinarily under these conditions is indicated by

¹ This was a room in which there was no running water, which had never been used for any experimentation, and which had been closely shut up. Solutions were prepared elsewhere, and the area of free water surfaces was reduced to a minimum.

the constancy and reproducibility of the P.D.'s obtained. After puncturing an egg in sea water, successive washings in the first experimental solution usually gave steadily ascending P.D. values until a definite maximum was obtained, and this maximum was reproducible within certain limits which will be mentioned later. But, occasionally, the wound failed to close tightly around an entering pipette, and in such a case the observed P.D.'s were small and erratic. This behavior occurred with large pipettes and with pipettes improperly shaped for making a clean puncture, and was more frequent with older eggs in which the chorion was less elastic. Failure to obtain a tight seal about the electrode could often be detected by the visible escape of subchorionic fluid. But the presence of even an invisible leak was recognizable by the inconstancy of the observed P.D. Results on leaky eggs were always discarded.

The difference of potential between the electrodes alone, dipping directly into an experimental solution, amounted at times to 2 or 3 millivolts, but it was reproducible no matter what the dilution or composition of the solution, so long as sufficient pressure was maintained to keep a gentle stream of KCl issuing from the mouth of the pipette electrode. The density of the saturated KCl made this flowing junction visible. If the pressure dropped to zero, however, so that the visible flow of KCl ceased, anomalous P.D.'s were observed whose magnitude increased with the dilution of the solution surrounding the electrode tips. In the most dilute solutions used, these sometimes attained a magnitude of 100 millivolts or more. The site of these P.D.'s was the mouth of the pipette electrode, as was shown by short circuiting² it; and the cause, at least in part, its small size. Pairs of large tubes showed no such effect. Agar-filled tips of unequal size showed them even more markedly. All of the data presented in this paper have been

² The pipette electrode was short circuited as follows: As Fig. 1 shows, the pipette is not the only avenue of contact with its calomel half cell. There is also a communication with that half cell through a siphon dipping into a reservoir. When the P.D. between the calomel half cells was to be measured, free from the influence of the P.D. occurring at the mouth of the pipette, the experimental solution was placed in some vessel other than the egg chamber. Into this dipped the calomel half cell which usually made contact with the solution in which an egg was immersed; and the other half cell was put in contact with it through the siphon.

corrected for the electrode potential measured just before or just after each egg determination, with the electrodes dipping into sea water and a flowing junction at the mouth of the pipette electrode.

Although a flowing junction could be maintained between the pipette and the experimental solution during preliminary tests of the electrodes, such a junction was impossible between the pipette and the subchorionic fluid of an egg. In fact, to prevent contamination of the egg contents with saturated KCl, a pressure was maintained in the capillary which, though sufficient to produce a flowing junction in open solution, permitted a slight ascent of egg substance into the capillary when balanced against the turgor of the egg. Two considerations, however, support the belief that the experimental data are free from artefacts produced by the electrodes. First, the tests of the electrodes alone show that high anomalous P.D. values were due to the pipette and appeared only when it was in dilute solutions. During a measurement of P.D. across the chorion the pipette was in subchorionic fluid, the concentration of which was of the same order as that of sea water. The pipette was thus protected by the egg against the environment in which the high P.D. at its mouth was produced. Second, the subchorionic fluid—KCl junction in the pipette was constant throughout an experiment. If there was a P.D. at this junction, the effect which it had disappears when *differences* between observed P.D.'s are considered; and this is the case with all the results given.

Pressure control in the pipette electrode was desirable for the two reasons already discussed: to maintain a flowing junction during the preliminary tests of the electrodes; and to prevent a flowing junction during egg measurements. Therefore an apparatus patterned after that used by Landis (7) for capillary injections was used. (See Fig. 1.) A Luer syringe communicating with the pipette half cell system made small sudden changes of pressure possible, and a reservoir in communication with the system through a siphon at another point maintained a constant head of pressure, the influence of which could be controlled by a stop cock.

The pipette communicated with the pressure control through a coil of hard rubber tubing sufficiently flexible to permit control

of the movement of the pipette with a Chambers micromanipulator. The egg lay in a chamber on the stage of a microscope, and the position of the pipette within it could be observed at all times during the course of the experiments.

The inside diameters of the capillary electrodes used were about 70μ . In experiments with eggs, no systematic variation in P.D. was observed with pipettes of different sizes, except when so large a one was used that the chorion failed to close tightly around it. The puncture of an egg was always carried out in sea water in order to avoid carrying into it excess KCl on the outside of the pipette.

As a precaution against contamination of the experimental solution by diffusion of saturated KCl from the outside electrode, the electrode dipped not directly into the egg chamber, but into a thistle tube communicating with the egg chamber through 7 or

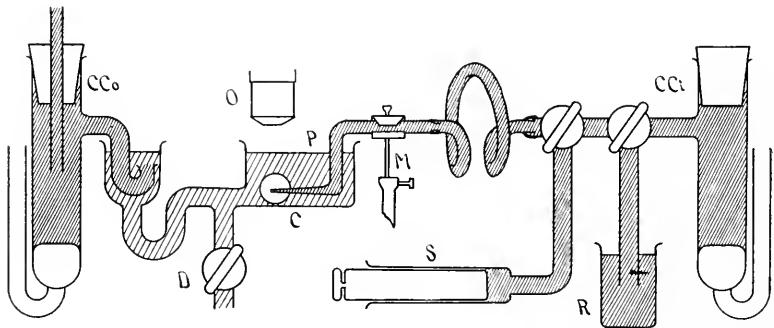

FIG. 1. Diagram of apparatus. The egg, impaled on the capillary pipette *P*, lay in a chamber *C* beneath the microscope objective *O*. Outside electrical contact was made through a calomel half cell *CC0* which dipped into the solution in which the egg was immersed at some distance from the egg, and drainage of the chamber was effected through the tube *D* at an intermediate point. The movements of the pipette were controlled by a Chambers micromanipulator *M*. The pipette is in communication through a coil of hard rubber tubing not only with the other calomel half cell *CC1*, but also with a Luer syringe *S* for pressure control, and with a reservoir *R*, the height of which was adjustable.

8 cm. of glass and rubber tubing (Fig. 1). Drainage of the chamber and the thistle tube was effected through a side arm midway between them. The solution was added by pouring it into the egg chamber from above. The outside electrode, itself, after

dipping into experimental solutions, could be flushed from a reservoir of saturated KCl and calomel.

It was found that variation in the magnitude of concentration potentials among different batches of eggs occurred, a striking fact in view of the negligible variation with age in the eggs from one female. A comparison of Tables 2, 3, 4, 5, and 8 shows, in KCl solutions at the same concentration range, slightly more than 100 per cent. variation of concentration potentials. Since conclusions drawn from these experiments are in every case based on relative rather than absolute values, however, the conclusions are not vitiated by this variation, because control experiments in any given study were always run within 24 hours on the same batch of eggs.

More difficult to cope with was the variation of P.D. across the same egg membrane, with time, and with successive washings in the same solution. This variation seemed to depend chiefly on differences in the thoroughness of washing; and secondarily on movements of the embryo within the egg, which disturbed the tightness of the electrical seal where the pipette penetrated the chorion. Probably in the brief time occupied by most of the experiments (less than half an hour for each egg), the factor of chorion permeability, which is discussed in connection with the experimental results of Table 1, was not important. The egg was washed with fresh solution after each reading until two successive readings were obtained which checked within about 5 per cent. A different experimental solution was then used.

The pH determinations required by the experiments were made with a quinhydrone electrode calibrated against standard buffer mixtures. The so-called neutral solutions were solutions of the pure salts made up in distilled water without the addition of any acid. Determinations of the pH of such solutions are of doubtful value, but a few which were made seemed to show that these solutions had a pH in the neighborhood of 5.4.

The experiments were carried out at temperatures which ranged from 20° to 26°, though they did not vary over more than 3° in the course of any one set of observations.

EXPERIMENTS AND DISCUSSION.

One may recognize a membrane which is not equally permeable for all ions by the magnitude and direction of the potential differences to which it gives rise under certain sets of conditions. The dried collodion membrane has been shown by Michaelis and his colleagues (19, 22-27) to be of this sort. Out of the variety of criteria which these investigators have used to demonstrate the differential permeability of this and other membranes to ions, two were chosen for use with the *Fundulus* chorion. The first was the application to the membrane in question of two different concentrations of the same electrolyte solution; the second, the application of like concentrations of two different electrolytes.

When a dried collodion membrane (which is permeable for cations, but hardly, if at all, for anions) separates two different concentrations of the same electrolyte solution, a concentration potential results of such polarity that the dilute solution is positive with respect to the more concentrated solution. For any given electrolyte two features of such a concentration potential are of interest, namely, the sign, which is dependent on the greater permeability for cations, and the magnitude, which is a function of the degree of difference between the cation and the anion permeability. In the best dried collodion membranes the magnitude of the concentration potential with an electrolyte of univalent ions is close to the maximum theoretically possible (19) with a membrane perfectly impermeable for anions, but permeable for cations.

When a single egg was exposed to a series of dilutions of a KCl solution ranging by tenfold steps from M/2 to M/20,000, a series of concentration potentials was obtained (Table 1). In M/2 KCl (which is approximately isosmotic with sea water) the outside solution was usually slightly negative with respect to the contents of the egg. All the more dilute solutions were positive with respect to the egg. The more dilute the solution, the greater was the degree of this positivity. The sign of these concentration potentials, therefore, is indicative that the chorion is more permeable for cations than for anions. The direction of polarity in M/2 KCl is such as would be obtained if the subchorionic fluid of the egg were slightly less concentrated with respect to electrolytes than this solution, though more concentrated than the rest.

The magnitude of the negative P.D.'s, however, is too small for much emphasis to be laid upon this point.

TABLE I.
CONCENTRATION SERIES.

Potential differences between the inside and the outside of 5 eggs immersed in a succession of KCl solutions of the indicated concentrations. The sign of the outside solution was positive except where the negative sign occurs.

No.	Age in Days.	$\frac{M}{2}$.	$\frac{M}{20}$.	$\frac{M}{200}$.	$\frac{M}{2,000}$.	$\frac{M}{20,000}$.	$\frac{M}{2,000}$.	$\frac{M}{200}$.	$\frac{M}{20}$.	$\frac{M}{2}$.
1	5	0.8 -	0.3	10.6	55.9	107.7	46.7	3.7	0.8 -	0.8 -
2	7	2.4	5.3	18.0	55.0	99.2	56.0	8.8	0.7	0.4
3	7	0.3 -	3.1	14.5	49.7	95.7	58.0	17.8	1.2	0.3
4	7	0.1 -	0.7	6.7	37.9	91.9	53.6	8.2	0.6	0.3 -
5	6	1.9 -	1.6	13.1	44.8	84.3	50.9	10.7	2.4 -	1.9 -

It will be observed in Table I that the concentration potentials (*i.e.*, the changes of P.D. between any two successive readings) increase markedly with dilution. Those from the ascending part of the series are shown in Table 2. The average value rises from

TABLE II.

VARIATION OF CONCENTRATION POTENTIALS WITH DILUTION.

Concentration potentials obtained by subtracting adjacent values in the ascending parts of the series shown in Table I. The more dilute solution was positive.

No.	$\frac{M}{2} - \frac{M}{20}$.	$\frac{M}{20} - \frac{M}{200}$.	$\frac{M}{200} - \frac{M}{2,000}$.	$\frac{M}{2,000} - \frac{M}{20,000}$.
1.....	1.1	10.3	45.3	51.8
2.....	2.9	12.7	37.0	44.2
3.....	3.4	11.4	35.2	40.0
4.....	0.8	6.0	31.2	54.0
5.....	3.5	11.5	31.7	39.5
Average.....	2.3	10.4	36.1	47.1

one negligibly small in the interval between $M/2$ and $M/20$ to 47.1 mv. between $M/2,000$ and $M/20,000$, which is of the order of magnitude of the maximum of 58 mv. theoretically possible for a membrane completely impermeable for anions. In this be-

havior the egg membrane resembles a "poor" or large pored dried collodion membrane (24, 25). "Good" dried collodion membranes give very nearly the theoretical maximum even in fairly concentrated solutions.

An important feature of such a concentration series is the reversibility and reproducibility of the P.D.'s obtained when an egg is exposed to the same series of concentrations in the reverse order. In the experiments summarized in Table 1 each reading was obtained after the egg had been washed in at least six changes of the solution, but more prolonged washing, until two readings were obtained that checked, was not attempted. Such a series required for its completion approximately 45 minutes, with an exposure of about 5 minutes to each solution. The values obtained in this way were, therefore, probably lower on the ascent, and higher on the descent, than the definitive values for the concentrations in question; but the similarity shown by the experimental results for ascent and descent makes it appear probable that they were actually close approximations to these definitive values. The fact that in most cases the descending value was higher than the ascending one in the same solution indicates that dilution of the subchorionic fluid did not occur during the experiment, since this would have diminished the second P.D. observed.

When the concentration potentials obtained across a membrane with solutions containing ions of different valence are compared, further information is furnished as to the differential permeability of the membrane. If it is impermeable for anions but permeable for cations, concentration potentials across it are independent of the valence of the anion in the electrolyte solutions used, but are, theoretically, halved by doubling the valence of the cation (19).

The concentrations $M/200$ – $M/2,000$ ³ were arbitrarily chosen as a test range for the study of concentration potentials with salts yielding bivalent anions or cations. It was found that the concentration potential for a bivalent anion, SO_4 , was identical with that for the univalent Cl . Table 3 shows typical results on 5 eggs in KCl and 5 others in K_2SO_4 . There was less than 1 mv. of difference between the averages. This failure of the valence of

³ The concentrated solution was always used before the dilute.

the anion to affect the concentration potential is another point of resemblance between the *Fundulus* chorion and the dried collodion membrane, and is additional evidence that the chorion is at least relatively impermeable for anions.

TABLE III.

EFFECT OF ANION VALENCE ON CONCENTRATION POTENTIALS.

Concentration potentials were measured between M/200 and M/2,000 solutions of KCl and K₂SO₄, a different egg being used for each measurement. The more dilute solution was positive.

KCl.	K ₂ SO ₄ .
32.4	39.3
32.7	33.5
33.7	29.3
30.3	33.6
38.4	36.2
Average 33.5	34.4

On the other hand, when it was the cation whose valence was doubled, the concentration potential across the *Fundulus* chorion was approximately halved. The effect was shown with CaCl₂, MgCl₂, and BaCl₂ (Table 4). The behavior of the chorion is

TABLE IV.

EFFECT OF CATION VALENCE ON CONCENTRATION POTENTIALS.

Concentration potentials were measured between M/200 and M/2,000 solutions of KCl, CaCl₂, BaCl₂, and MgCl₂. The effects of Ba and Mg were not studied in the same batch of eggs with Ca, and are therefore exhibited with a different set of controls in KCl. In every case the more dilute solution was positive.

	KCl.	CaCl ₂ .	KCl.	BaCl ₂ .	MgCl ₂ .
	39.0	17.1	18.8	6.4	9.9
	31.6	16.3	23.7	15.4	13.0
	29.4	14.5	21.3	9.7	6.8
	30.9	13.8	22.7	9.8	14.1
	33.5	17.0	19.5	6.6	11.9
Average ..	31.6	15.7	21.2	9.6	11.1

precisely what would be predicted by the simplest theory for an ideal membrane. It is different, however, from the behavior of a

dried collodion membrane, which with CaCl_2 gives no concentration potential at all, because it happens to be impermeable for Ca as well as for Cl (30).

Most of the experiments with valence effects of cations were made with equimolecular solutions of the different salts, *i.e.*, solutions containing equal numbers of cations. In a few experiments equivalent solutions, containing equal numbers of anions were used for comparison. Thus, as an example of the latter type of experiment, the concentration potential for M/400–M/4,000 CaCl_2 instead of M/200–M/2,000 CaCl_2 was compared with that for M/200–M/2,000 KCl. As might have been expected, the results obtained in this way (Table 5) did not differ greatly from those in which equimolecular solutions were employed.

TABLE V.

EFFECT OF CATION VALENCE ON CONCENTRATION POTENTIALS. CHOICE OF CONCENTRATION RANGE.

Concentration potentials with KCl and CaCl_2 were compared in both equivalent and equimolecular solutions. Two sets of controls in KCl appear because the CaCl_2 experiments were made on different days.

	$\frac{\text{M}}{200} - \frac{\text{M}}{2,000}$ KCl.	$\frac{\text{M}}{400} - \frac{\text{M}}{4,000}$ CaCl_2 .	$\frac{\text{M}}{200} - \frac{\text{M}}{2,000}$ KCl.	$\frac{\text{M}}{200} - \frac{\text{M}}{2,000}$ CaCl_2 .
	31.5	20.7	32.7	14.2
	42.5	19.4	44.2	18.4
	23.6	9.4	40.3	11.7
Average. . .	32.5	16.5	39.1	14.8

Still further evidence for the relative impermeability of the chorion for anions was obtained when the second test was applied: *i.e.*, the exposure of the egg to a series of salt solutions alike in concentration but differing in composition. Against the dried collodion membrane equal concentrations of different salt solutions containing the same cation are isoelectric; but when the anion is the common ion, they give rise to P.D.'s differing in magnitude in the same order as the classic mobility values of the cations used (19).

Tables 6 and 7 show the P.D. in mv. between the inside and outside of eggs each of which was exposed successively to all the

solutions shown in that table. The values obtained with different eggs in the same solution are of no interest, except to show the fair constancy of the material; but the values obtained with a

TABLE VI.

P.D. AGAINST DIFFERENT ANIONS OF THE SAME CONCENTRATION.

P.D.'s between the solution and the egg contents are given from six typical experiments in each of which one egg was exposed to all of the following salts of K. Variation of the order in which the solutions were used had no effect.

No.	Cl.	Br.	I.	SCN.	Acetate.	NO ₃ .
1.....	46.4	40.8	44.0	44.1	42.1	44.2
2.....	48.6	43.9	49.2	47.5	44.6	45.5
3.....	50.6	45.6	50.9	48.8	44.0	46.9
4.....	52.6	45.6	49.7	50.0	50.8	45.5
5.....	41.7	42.1	43.5	43.2	41.0	41.5
6.....	42.1	42.4	42.0	40.0	37.9	40.9
Average.....	47.0	43.4	46.5	45.6	43.4	44.1

given egg in different solutions are of interest, and the averages of these indicate the general trend of the effects. It will be seen from Table 6 that there is no difference of potential which may be

TABLE VII.

P.D. AGAINST DIFFERENT CATIONS OF THE SAME CONCENTRATION.

Single eggs were exposed to a succession of M/2,000 solutions of the following chlorides. P.D.'s across the chorion from 5 typical experiments are given. Variation of the order in which the solutions were used had no effect.

No.	Li.	Na.	K.	Rb.	Cs.
1.....	61.3	55.0	54.0	38.1	31.9
2.....	47.8	48.6	48.7	28.7	29.8
3.....	59.3	49.3	48.1	33.4	32.1
4.....	58.8	58.4	49.2	37.7	31.7
5.....	63.4	57.9	56.1	37.8	38.2
Average ...	58.1	53.8	51.2	35.1	32.7

considered significant among the K salts of Cl, Br, I, SCN, acetate, and NO₃. But when the anion is kept constant and the cation is varied, a series appears in which the cations, Li, Na, K,

Rb, and Cs, are arranged in the order of their classic mobility values, LiCl being positive to all the other chlorides used, and CsCl negative. It is interesting to note that while the order for the series is correct, the values obtained with Li, Na, and K are very close together, while those with Rb and Cs fall in a separate group at some distance from the others; whereas the most pronounced break in the mobility values for free diffusion is not between K and Rb, but between Na and K. The results of this experiment may be interpreted to mean not only that the membrane possesses differential permeability for ions of opposite sign, but also that differences are present, though to a lesser degree, in the permeability for univalent cations. Of the ions studied, Cs appears to penetrate most readily, and Li least readily.

The results of these experiments, in which the dilution, valence, and chemical identity of the different ions in the solution applied to the membrane has been systematically varied, may be confidently interpreted to mean that in approximately neutral solutions the chorion is more permeable for cations than for anions. This conclusion may be used as the basis of the following partial interpretation of Loeb and Cattell's results (16), though the complete explanation must be impossible until the electrical properties of the ectoderm have been studied in addition to those of the chorion.

If K, in order to stop the heart-beat of a *Fundulus* embryo, must penetrate both chorion and ectoderm, then recovery can be effected only by exit of K through that double membrane. The escaping K must either be accompanied by anions in an equivalent amount or exchanged for cations from the outside solution. Most of the movement of the cations must be accomplished in the second way because, as the present experiments indicate, anions pass with difficulty across the chorion. Therefore K escapes much more slowly into distilled water than into a solution, whether of salt or of acid.⁴ The same explanation holds for the retardation of K penetration into eggs which have been soaked for 24 hours in distilled water. In these, Armstrong (2) has found that the sub-

⁴ McClendon (17) gave this explanation briefly for the failure of Mg to escape from *Fundulus* eggs into distilled water; but when he reported later (18) that Mg also failed to escape into Van't Hoff's solution, he offered a different explanation, not only for this, but for the former result.

chorionic fluid has the pH of the surrounding medium. It seems probable, therefore, that the subchorionic fluid in these eggs has been largely replaced by distilled water.

The results of other experiments by Loeb are not so easily related to the theory of differential permeability of the chorion for ions; for instance, the observation (11, 12, 13, 16) that K enters unwashed eggs more readily from a pure KCl solution than from a mixture of KCl with some other electrolyte. The additional electrolyte in this case may perhaps alter the degree of differential permeability of the membrane. This possibility will be mentioned in another connection.

Although measurements of P.D. yield direct evidence for the relative numbers of ions of opposite sign penetrating the membrane, the absolute numbers are not so directly indicated. Results of the type obtained would be possible under several states of ion permeability. For example, ions of both signs may traverse the chorion fairly readily, but at different rates; or both may fail almost completely to penetrate, though having sufficiently different penetrating tendencies to yield a P.D.; or, finally, cations may pass without anions. The results of several investigators working with different methods and criteria make it appear that the chorion is at least somewhat permeable for cations. Loeb (11, 19) found the eggs permeable for a dye cation, neutral red. Armstrong (3) showed that when heart standstill was brought about by excess K or acid in the surrounding solution there was no difference between the kind of effect on naked embryos and on embryos surrounded by a chorion. Bodine (4) has reported that the only difference under such circumstances is one of time. The chorion is probably permeable for all ions applied in sufficiently concentrated solutions or over long enough periods of time; and for cations even in dilute solutions, provided that electrical neutrality can be maintained by an exchange with other cations.

Several studies by Loeb (8, 9, 10, 14, 15) and one by Armstrong (3) on salt antagonism for acid penetration into *Fundulus* eggs, as well as a few experiments reported by Loeb (10) and Loeb and Cattell (16) on the opposite, namely, acid antagonism for salt penetration, have been of considerable interest; yet their

mechanism is imperfectly understood. It was thought, therefore, that an investigation of potential differences across the membranes of eggs in acid solutions might throw some light on this problem. Accordingly, the first of the tests used on eggs in neutral solutions was made, *i.e.*, the application to the chorion of different concentrations of the same electrolyte solution, with the modification that the solutions were brought to a desired pH value by the addition of an appropriate acid. The sign and magnitude of the concentration potentials were studied, and a comparison was made of the effects on them of di- and uni-valent ions.

When an egg was exposed in succession to two solutions of KCl, one M/20, the other M/200, to both of which sufficient HCl had been added to bring the pH to 3.0, a concentration potential was obtained with the polarity the reverse of that found in neutral solutions; that is, the more dilute solution was negative to the more concentrated. The experimental results given in the middle column of Table 8 deal with 5 eggs, each of which was studied in

TABLE VIII.

REVERSAL OF KCl CONCENTRATION POTENTIALS WITH INCREASE IN THE H ION CONCENTRATION.

Concentration potentials were measured between M/20 and M/200 solutions of KCl to which sufficient HCl had been added to give the desired pH. A different egg was used for each measurement. Sign of the dilute solution was positive except where the negative sign occurs.

pH.				
2.0	2.5	3.0	3.5	4.0
0.5	1.7 -	5.8 -	4.7 -	38.2
1.3	9.1 -	8.9 -	3.2 -	34.0
0.7	7.4 -	9.6 -	18.0	46.7
2.1 -	9.8 -	10.0 -	3.4 -	30.6
4.4	11.8 -	12.6 -	9.8	37.7

CONTROLS.

Concentration potentials previously shown by the same 25 eggs between M/20 and M/200 solutions of pure KCl.

18.4	23.1	20.9	25.6	35.3
25.8	26.5	22.0	28.4	38.0
22.6	25.4	—	30.9	39.7
21.1	24.3	—	30.8	40.4
16.3	25.7	25.5	33.0	36.8

pure solutions of KCl as well as in KCl at pH 3.0. The concentration potential values obtained at pH 3.0, while smaller than those in pure KCl, were manifestly in the opposite direction.

The range of salt concentrations chosen for these experiments with acid solutions was higher than in the experiments with neutral solutions because it was desired to study the concentration effect of the salt itself, rather than that of total electrolyte content. The complexity introduced by the use of a solution containing two electrolytes is simplified somewhat if the salt is relatively concentrated as compared with the acid. For the same reason, a pH of 3.0 was chosen for the subsequent comparison of KCl with other salts, rather than one of 2.0 or 2.5, where the acid would be a more significant element in the concentration. The addition of HCl in equal amounts to both concentrated and dilute solutions reduces the ratio of their concentrations with respect to total electrolyte. At a pH of 3.0 the HCl has approximately a concentration of 0.001 M. Thus the total electrolyte concentrations of the two solutions compared were 0.051 M and 0.006 M, respectively, and their ratio was 8.5 instead of 10. At pH, 2.5, their ratio was approximately 6.6, and at pH, 2.0, 4. The order of these relationships is not altered if activities are substituted for concentrations. The concentration potentials to be expected in acid solutions must therefore be less, in accordance with this reduction of the concentration ratios.

Despite the disadvantages of the more acid solutions (both because of their disturbance of the concentration ratio, and also because of their destructive effect on the membrane, to be referred to later), a study of concentration potentials was made at a series of different pH values in order to determine, if possible, the point at which reversal occurs. Table 8 also shows the results of these experiments, presenting under each of five pH values the concentration potentials obtained in both acid and neutral solutions with the same eggs. At a pH of 4.0, the concentration potentials were found to be in the same direction as the control values, and very slightly smaller. At 3.5, all were much reduced and 3 out of 5 were reversed. At 3.0 and 2.5 all were reversed and of considerable magnitude, but at 2.0 there was scarcely any concentration potential in either direction. Apparently the reversal point

lies slightly above a pH of 3.5, probably in the neighborhood of 3.7.

The marked reduction of the concentration potentials at pH 2.0 was in part to be expected because of the reduction of the concentration ratio which the addition of acid brings about. But it seems probable that at this lower extreme of the pH range there is also a destructive effect of the acid on the membrane which occurs too rapidly to permit detection of the characteristic potential differences. In harmony with this suggestion are two instances, shown in the column for pH, 3.0 in which, contrary to the procedure with the other eggs, the acid solutions were used before the neutral ones; with the result that no concentration potential was obtained in the subsequent control experiment. Apparently even this dilution of acid, in a period of 10 or 15 minutes, exercised some irreversible destructive effect on the membrane which abolished its differential permeability for ions.

The acid reversal of the sign of concentration potentials in KCl suggested the possibility that acidity might operate also to reverse the valence effect on concentration potentials, so that CaCl_2 would give values equal to those obtained with KCl, and K_2SO_4 values less by half. To test this theory, 5 eggs were studied in CaCl_2 solutions M/20 and M/200 at pH 3.0, and 5 other eggs in equimolecular solutions of KCl at the same reaction. It was found (Table 9), as had been expected, that concentration potentials with

TABLE IX.

EFFECT OF CATION VALENCE ON CONCENTRATION POTENTIALS AT pH 3.0.

Concentration potentials were measured between M/20 and M/200 solutions of KCl and CaCl_2 , all brought to a pH of 3.0 with HCl. A different egg was used for each measurement. Sign is that of the dilute solution.

KCl.	CaCl_2 .
14.5—	23.3—
13.1—	13.8—
13.4—	19.2—
7.6—	20.6—
4.4—	19.0—
Average 10.6—	19.2—

CaCl_2 at this pH were also reversed and were not smaller than those obtained with KCl. Indeed they were considerably larger.

(The difference was somewhat greater when they were compared in equivalent concentrations.) On the other hand, K_2SO_4 , gave concentration potentials of the same sign as at neutrality (Table 10). The reversal point with K_2SO_4 , if one exists, must be at a pH lower than 3.0.

TABLE X.

EFFECT OF ANION VALENCE ON CONCENTRATION POTENTIALS AT pH 3.0.

Concentration potentials were measured between M/20 and M/200 solutions of KCl and K_2SO_4 adjusted to a pH of 3.0 with HCl and H_2SO_4 respectively. A different egg was used for each measurement. The dilute solution was positive except where the negative sign occurs.

KCl.	K_2SO_4 .
11.2—	22.3
10.2—	13.6
4.4—	28.8
12.1—	15.0
16.6—	8.9
Average 10.9—	17.7

Such results as these acid effects on concentration potentials are not obtained across dried collodion membranes (19). An inversion of concentration potentials with increased acidity has been reported for membranes of other materials by Mond (27), Fujita (6), Rein (29), and Amberson and Klein (1), but not for any membranes across which chemically controlled diffusion experiments have also been made. Nevertheless, logically interpreted, the reversal of concentration potentials across the *Fundulus* chorion in KCl and $CaCl_2$ solutions seems to mean that in acid solutions of those salts the chorion is more permeable for anions than for cations. The reversal point, then, is the pH where the membrane is equally permeable for ions of both signs.

The application of these results to interpretation of the studies by Loeb and by Armstrong of the antagonistic action between salt and acid is very difficult. More electrical experiments are needed, testing the effect of a greater variety of salts, concentrations, and pH values; but the direction in which such further experiments will be useful may be indicated here. We may assume that the hindrance either of KCl or of acid penetration involves a decrease in the permeability of the membrane for cations. But, as has already been pointed out, the actual number of ions

of either sign which penetrates cannot be directly determined from measurements of P.D. Equal ion permeability at the reversal point may be due to a diminution in permeability for cations, or to an increase in that for anions, or to both. So far, then, as acid antagonism for salt penetration may be correlated with the present results, Loeb's experiments (10) give more than they receive of illumination: because the fact of acid antagonism for salt penetration implies that the reversal point in the electrical experiments is produced mainly in the first way, *i.e.*, by diminution in permeability for cations.

At least two features of the results secured have not been explained. These are the facts that concentration potentials with CaCl_2 exceed those with KCl at pH 3.0, and that concentration potentials with K_2SO_4 are not reversed at all at that reaction. These facts seem to mean that the properties of the chorion are not due entirely to the pH of the medium, but depend also on its salt content. They may perhaps furnish a clue to the way in which salt antagonism for acid penetration, and perhaps also for the penetration of other salts, may be brought about. However, it should be remembered that the simple interpretation of the potential differences obtained across the chorion in terms of its differential permeability for ions does not explain the more fundamental question of how such differences in its ion permeability are produced.

SUMMARY.

1. Potential differences were measured across the chorion of single eggs of *Fundulus heteroclitus*. The chorion was shown by three lines of evidence to be more permeable for cations than for anions:

a. Concentration potentials were of such a sign that the dilute solution was positive to the concentrated.

b. Concentration potentials with K salts of divalent and univalent anions were equal, whereas concentration potentials with chlorides of divalent cations were about half of those with K.

c. Equal concentrations of different anions were equipotential against the egg, whereas equal concentrations of different cations gave various potential differences whose magnitudes were in the

same order inverted as the mobilities of those cations in free diffusion.

2. The difference between the permeability of the chorion for anions and its permeability for cations increased with dilution of the solution in which the egg was immersed.

3. In KCl and CaCl₂ solutions the ratio of chorion permeability for anions to permeability for cations increased with the H ion concentration, and was inverted with sufficiently increased acidity.

4. The pH of the reversal point, where permeability for anions was equal to permeability for cations, depended on the salt used. For KCl in the concentrations used it lay in the neighborhood of 3.7.

BIBLIOGRAPHY.

1. **Amberson, W. R., and Klein, H.,**
'28 *J. Gen. Physiol.*, XI., 823.
2. **Armstrong, P. B.**
'27 *Proc. Soc. Exp. Biol. and Med.*, XXV., 146.
3. **Armstrong, P. B.**
'28 *J. Gen. Physiol.*, XI., 515.
4. **Bodine, J. H.**
'28 *Biol. Bull.*, LIX., 396.
5. **Fujita, A.**
'25 *Biochem. Z.*, CLVIII., 11.
6. **Fujita, A.**
'25 *Biochem. Z.*, CLXII., 245.
7. **Landis, E. M.**
'26 *Am. J. Physiol.*, LXXV., 548.
8. **Loeb, J.**
'12 *Biochem. Z.*, XLVII., 127.
9. **Loeb, J.**
'12 *Science*, XXXVI., 637.
10. **Loeb, J.**
'15 *J. Biol. Chem.*, XXIII., 139.
11. **Loeb, J.**
'15 *Proc. Nat. Acad. Sc.*, I., 473.
12. **Loeb, J.**
'16 *Proc. Nat. Acad. Sc.*, II., 511.
13. **Loeb, J.**
'16 *Science*, XLIV., 574.
14. **Loeb, J.**
'17 *J. Biol. Chem.*, XXXII., 147.
15. **Loeb, J.**
'22 *J. Gen. Physiol.*, V., 231.
16. **Loeb, J., and Cattell, McK.**
'15 *J. Biol. Chem.*, XXIII., 41.

17. **McClendon, J. F.**
'11 *Am. J. Physiol.*, XXIX., 289.
18. **McClendon, J. F.**
'13 *Science*, XXXVIII., 280.
19. **Michaelis, L.**
'25 *J. Gen. Physiol.*, VIII., 33.
20. **Michaelis, L., and Fujita, A.**
'25 *Biochem. Z.*, CLVIII., 28.
21. **Michaelis, L., and Fujita, A.**
'25 *Biochem. Z.*, CLXI., 47.
22. **Michaelis, L., and Fujita, A.**
'25 *Biochem. Z.*, CLXIV., 23.
23. **Michaelis, L., and Hayashi, K.**
'26 *Biochem. Z.*, CLXXIII., 411.
24. **Michaelis, L., and Perlzweig, W. A.**
'27 *J. Gen. Physiol.*, X., 575.
25. **Michaelis, L., Ellsworth, R. McL., and Weech, A. A.**
'27 *J. Gen. Physiol.*, X., 671.
26. **Michaelis, L., Weech, A. A., and Yamatori, A.**
'27 *J. Gen. Physiol.*, X., 685.
27. **Mond, R.**
'24 *Arch. ges. Physiol.*, CCIII., 247.
28. **Osterhout, W. J. V., Damon, E. B., and Jacques, A. G.**
'27 *J. Gen. Physiol.*, XI., 193.
29. **Rein, H.**
'26 *Z. Biol.*, LXXXV., 195.
30. **Weech, A. A., and Michaelis, L.**
'29 *J. Gen. Physiol.*, XII., 487.

HISTORY OF THE DISCOVERY OF PERIODIC REVERSAL OF HEART-BEAT IN INSECTS.¹

JOHN H. GEROULD,

DARTMOUTH COLLEGE, HANOVER, N. H.

Malpighi's discovery of periodic reversal of direction in the heart-beat of the silkworm pupa and moth has remained almost in oblivion for nearly 260 years. Réaumur held that in the pupa and adult moth the heart beats backward; in the caterpillar, forward. Cornalia confirmed Malpighi's observations regarding the pupa, but made no observations on the adult. Bataillon's description of periodic reversal during and around metamorphosis is mainly correct, but he wrongly held that inverse (backward) circulation exclusively occurs in the pupa after the first few hours and forward circulation exclusively in the adult. Fischer and Gerould independently discovered periodic reversal in the chrysalids of various Lepidoptera (*Colias*, etc.). Bataillon and Fischer regarded reversal and slow backward beating as due chiefly to increased acidity of the blood at metamorphosis. Gerould later found that periodic reversal is not transitory but characteristic of the adult in Lepidoptera generally, as well as of the prepupa and pupa, and that, as in Ascidians, it cannot be explained by the back-pressure hypothesis which he at first advanced. Its explanation must be sought in chemical conditions, and these conditions persist to the end of adult life.

The phenomenon of periodic reversal in the direction of peristalsis of the heart in Ascidians is well-known to zoölogists. The heart beats rapidly backward, in the direction of the viscera, a

¹ Introductory to a series of papers reporting investigations assisted by a grant from the Joseph Henry Fund. The major part of this paper was written at the Laboratoire d'Entomologie in Paris of Professor E. L. Bouvier, for whose friendly assistance, as well as for that of Drs. F. Le Cerf, L. Berland and others of the staff, the writer makes grateful acknowledgment.

certain number of times (15-83 in *Ascidia atra*, Hecht, 1918), and then, reversing, beats more slowly, a smaller number of times (14-43), forward and toward the branchial sac. Advisceral and abvisceral phases alternate with each other, the former being the longer and more vigorous.

It is not generally known, however, that a similar phenomenon occurs in mature Lepidoptera. The dorsal vessel or heart in the caterpillar beats forward, as in insects generally, but in the pre-pupa, pupa and adult alternating phases of rapid forward and slower backward pulsations occur. Forward phases in the moth or butterfly resemble in strength and rapidity of pulsation the advisceral or backward phases in the Ascidian. Backward phases in the moth resemble abvisceral or forward phases in the Ascidian in being as a rule less rapid. On the basis of observations on translucent pupæ of various butterflies and moths, I first reached the conclusion that the phenomenon is universal in the pupæ of Lepidoptera. The fact that it continues through adult life in the silk-worm moth, *Telca polyphemus*, *Actias luna*, *Samia cynthia*, *Sphinx chersis*, *Ctenucha virginica*, *Notolophus leucostigma*, *Argynnis aphrodite*, etc., leads me to think that the same is probably true of all adult Lepidoptera.

Whether a corresponding phenomena occurs in any other order of insects is still unknown. A statement by Kirby and Spence (1828) suggests that it probably has been observed in the drone fly, *Syrphus pyrastris* (see below, p. 224).

It is a curious fact that Malpighi's discovery (1669) of periodic reversal in direction of peristalsis in the heart of the silkworm has been buried almost in oblivion for nearly 260 years. His account dealt chiefly with the adult moth, about which his successors have had most diverse and conflicting opinions.

During the past two summers (1927, 1928) I have had the opportunity to study the phenomenon of periodic reversal of heart-beat in the silkworm from its beginning in the mature larva to the end of the life of the adult moth, and have found that Malpighi's brief description based on the vivisected moth was in the main correct. It was an extraordinary achievement when one considers the limitations of the lenses at his command.

Recognition of his discovery has been balked by various preju-

dices such as the idea prevalent in the early part of the nineteenth century that there is no circulation of hæmolymp in insects and by the equally false idea now widespread in scientific circles that the insect heart is always provided with valves between real or imaginary chambers so situated as to prevent the blood from flowing backward. Such chambers and such valves have no existence in the silkworm heart, which is a simple muscular tube. The valvular ostia are so small in the adult that they are difficult to detect even in stained and cleared preparations. They were carefully studied by means of sections by Verson ('08) and found to be lateral bottomless pockets extending forward from near the posterior part of each muscular *ala cordis*, the fan-shaped "wings" which extend laterally from the heart in intersegmental pairs. The ostia thus are not far from the middle of abdominal segments.

Examination of the beating heart of the silkworm moth makes it evident that the valves in the ostia have as little effect on the flow of blood backward within the tube as the abutments of a long bridge spanning a river have upon the flow of water which washes past them. They are so inconspicuous that Cornalia (1856) and Maestri ('56) did not find them, and even such excellent modern treatises on the silkworm as that of Vieil (1920, p. 119) state that the heart is without ostia or valves and that the blood enters it by endosmosis.

The wrong conception of the silkworm heart as a chain of separate chambers was held even by Malpighi, who regarded the dorsal vessel as a series of little "hearts" with a high degree of independence of one another, but his description of periodic reversal is, nevertheless, remarkably accurate.

Of periodic reversal, he says in brief: "The movement in the hearts established during the first days of the chrysalis stage still continues, directed from the front parts backward, and a succession of systoles propel the liquid. But the nature of the movement [in the moth, laid open] is by no means constant, so that even a slight cause may produce a change; nothing, perchance, could be more variable." He illustrates by saying: "I remember to have seen in the moth ("Papilione") the movement of the heart forward from behind, which is uncommon;² then, after a

² On the contrary, forward phases are as frequent as backward.

short time, the movement changed its point of departure, directing itself from in front backward and so continued for a long time."³

Another example is worth quoting: "Likewise, in a moth, the heart began to beat from behind toward the head; meanwhile the canal of the heart was cut across; the posterior section then beat forward from behind but in the following way: the hindmost part beat rapidly, that contiguous to it less frequently, whereas the other [anterior] portion beat in the opposite direction."

"In certain other adult moths, in which the heart had been similarly cut, the two separate parts showed contractions directed at first toward the head, then toward the tail, and the liquid flowed out at each pulsation." In a silkworm about to pupate, normal forward peristalsis was observed until he cut the ventral body wall, whereupon "the direction of the movement changed, and 70 pulsations were counted which ran freely backward along the whole length of the hearts; but presently the movement began again from tail to head and finally, by manipulating with the finger nail the posterior hearts, beating began once more from in front backward."⁴

Malpighi extended his observations to the pupa of a moth popularly called "Pino." He describes a fresh chrysalis in which the heart-beat was first from the head backward to the posterior extremity: "The liquid was propelled thence to the middle of the body, then from the middle back to the same [posterior] extremity, like a ball thrown back and forth by players, and this play of nature continued for a while, until two opposite movements began from the middle forward and backward; and at last only one persisted, which went from head to tail."

These are perfectly conceivable variations of inverse circulation. First complete backward pulsation, then, probably, conflicting pulsations imperfectly seen, then double action from the 3-4 abdominal segment, finally complete backward pulsation.

³ Translation made from Maillot's ('78) French version.

⁴ Malpighi was correct in finding that the dorsal vessel beats after the moth is apparently dead, but he drew on his imagination in describing the various movements which then occur in the "long series of partial hearts which intercommunicate." "In one of these hearts, he says, three beats occur, in the next heart only one or two; indeed variations occur in the same partial heart."

Passing on nearly a half century to Réaumur (1732) we find in his great work on insects no original observations on circulation in the pupa, but, after referring to Malpighi's account of reversal in the pupa and moth of the silkworm and its individual variations, he says: "However, if one will take the trouble to observe the movement of the blood in the big vessel of a large number of adult moths, he will be convinced that the true course is from the front backward, whereas in the caterpillar it is from behind forward." (" Dans le papillon, la vraie route est des parties supérieures vers les inférieures, au lieu que dans la chenille elle est des parties inférieures vers les supérieures.")

Thus Réaumur did not describe periodic reversal but states positively that in the adult moth and in the pupa peristalsis is backward, whereas in the caterpillar it is forward.

Herold (1823) expressly repudiated Malpighi's description of periodic reversal as a manifest error, for which he accounted as follows: The shortening of the dorsal vessel at pupation to about half its former length would give the enclosed blood much less room, the vessel being closed at both ends according to his conception. Hence the blood of the pupa propelled forward from the large posterior end might rebound from the smaller anterior extremity and make a wavelike movement backward. This might give anyone observing for the first time the pulsation in a pupa which had just shed its larval skin the impression of periodic reversal. "But," he adds, "such an apparently double direction of movement of the dorsal vessel has never come to my attention."

Cornalia (1856) very definitely confirmed the observations of Malpighi. In describing circulation in the chrysalis of the silkworm, he calls attention to the interesting fact, already noticed by Malpighi, denied by many, and recently reconfirmed by Professor De Filippi: "This movement operates first in one direction then in the other; that is to say, the blood is carried by certain pulsations from the anal to the head regions, and then, by others, from the head to the anus; in this respect the circulation of the chrysalis is strangely different from that of the caterpillar." He adds that probably the same phenomenon occurs in the perfect insect but that the opacity of the skin renders observation difficult. It evidently did not occur to him to rub the scales off from the back,

or he would have observed that the skin is, on the contrary, very transparent.

Bataillon's ('93) more detailed account of periodic reversal in the silkworm agrees in most respects with my observations so far as it applies to the mature caterpillar just preceding pupation, to which period his observations were mainly confined and for which they are trustworthy, but he was wrong in stating that backward or inverse circulation occurs *exclusively* in the chrysalis after the first few hours after pupation and that normal or forward pulsation exclusively occurs in the adult.

His conclusions are as follows:

1. Appearance on the second day of spinning of an inverse circulation alternating at regular intervals with direct circulation.
2. Gradual predominance of this inverse circulation.
3. Rising of the curve of direct circulation toward the period of pupation.
4. Indifferent circulation [double action in both directions from the middle of the body] during the few hours which precede and follow pupation.

To these four conclusions we may in general subscribe but the two following, as has been indicated, were based on insufficient evidence.

5. Inverse circulation exclusively during pupal life.
6. Reappearance of normal circulation toward the head, exclusively, the day before eclosion of the adult.

To Bataillon periodic reversal was a transitory phenomenon, due to asphyxiation, comparable to disturbances in circulation accompanying metamorphosis in tadpoles, which he had previously observed. It was not a new and permanent type of circulation characteristic of pupal and adult life, as I have found it to be.

Vieil ('20) states quite correctly⁵ that in the chrysalis of the silkworm, the rare, irregular pulsations of the dorsal vessel appear to originate in the third abdominal segment and to move from there forward and backward. Thus he finds only double action in the

⁵ True of the fresh chrysalis immediately after pupation. Later, phases of backward pulsation through the whole dorsal vessel alternate with phases of forward beating.

chrysalis. In the spinning caterpillar, quoting Maillot, he describes a backward phase of slow beating (9 beats per minute) alternating with a forward phase of rapid pulsations (50 per minute).

Entirely without knowledge of the previous observations on the silkworm, Fischer ('18) and Gerould ('24a, '24b) independently rediscovered periodic reversal of peristaltic heart movements in the pupæ of various lepidoptera.

Fischer, in 1900, while examining chrysalids of *Charaxes jasius* at a high temperature (38° C.), saw the heart suddenly cease beating and then after a long pause beat backward, continuing afterwards to alternate in the direction of pulsation until the pupæ were returned to room temperature (18° C.). He satisfied himself that, thereupon, the direction of the peristalsis became "normal," that is, forward. Later, a moth, *Deilephila vespertilio*, responded in a similar manner to the stimulus of heat, and *Charaxes jasius* to the mechanical stimulus of blows with a small rod of wood. In the summer of 1917 he observed in the mature larva of *Colias hyale* and fresh pupæ of *Pararge mæra* that "antiperistalsis" occurred at room temperature (18°-21° C.) without recognizable changes in external or internal conditions. He was impressed by the remarkable slowness of the pulse in antiperistalsis, as well as by the variability of rate in different individuals. *Colias hyale* showed 54-66 forward pulsations per minute in the full-grown caterpillar but only 16 in antiperistalsis. In full-grown caterpillars of *Pararge mæra* he counted: 40 pulsations per minute at 20° C., 80 pulsations per minute at 30° C., 130 pulsations per minute at 40° C., but in a caterpillar suspended for pupation the number of pulsations fell from 40 to 25 at 20° C. He apparently did not observe reversal in this species until after pupation, when antiperistalsis appeared at the slow rate of 18 beats per minute or less. He argues that, if the heart is closed at the posterior end and provided with lateral valves by which a back-flow of the blood would be made impossible, the facts which he has observed afford a physiological puzzle, for if the blood were driven back it would find at the blind end no means of exit.

He suggests that this puzzle may be solved by assuming that reversal of the blood stream is only an illusion. If the blood, as

is commonly believed, cannot flow backwards, it must during antiperistalsis still be flowing forward. It is interesting to note that Hecht ('18) had a similar view in regard to the reversal of peristalsis in the tunicate *Ascidia atra*, viz., that the flow is constantly advisceral in spite of the alternating advisceral \leftrightarrow abvisceral peristalsis.

Fischer sought an explanation of periodic reversal and the slowing of the pulse in antiperistalsis in the profound transformation of the structure of the body and especially in the change in the blood at pupation from an alkaline to an acid condition. The deep, slow, breathing which occur in human beings when acids accumulate in the blood, as in diabetes, he suggests, is somewhat comparable to the slow beating of antiperistalsis in insects.

The present writer in October 1924, while examining freshly formed chrysalids of *Colias eurytheme*, the alfalfa butterfly, quite unexpectedly and without any previous knowledge of the subject, observed antiperistalsis and periodic reversal. The following is a brief abstract of the report of these observations which appeared in *Science* and of a paper read before the American Society of Zoölogists (Gerould, 1924a, '24b).

The heart beats forward in the caterpillar until the approach of pupation. Then short backward phases alternate with longer forward phases. During pupation a long phase of double action, forward from the third, backward from the fourth, abdominal segment alternates with forward peristalsis. A few hours later, the double action becomes limited to a few (25) seconds followed by complete reversal. Except during pupation, when the phase of double action is inordinately long, the proportion between the length of the backward and the forward phases increases with age up to about 48 hours. Thereafter a decrease in the relative length of the backward phase and a slackening in rate occur. In the oldest chrysalis with visible pulse a long forward phase alternated, after a complete rest of several minutes, with a very brief backward action. The rate of beating backward is regularly about half that of beating forward, though the proportion of backward beats to forward changes and much individual variation occurs in the number of beats in a phase.

Reversal of heart-beat is an important feature of metamorphosis

connected with the rapid development of the wing buds and constriction of the base of the abdomen. Increased blood pressure in head and thorax thus relieves itself, either by complete direct reversal of peristalsis or by intermittent expulsion of haemolymph backward through the thoracic sinuses into the base of the abdomen and up into the pericardium at the 3-4 abdominal segments, resulting in double action.

The constricted waist of holometabolous insects assists in the rapid increase in blood pressure necessary for the expansion of the wings. Such a constriction may serve a similar function in the rapid expulsion from the silk glands of large quantities of soft silk.

Search of the literature on circulation in insects gradually brought to light Malpighi's discovery of periodic reversal in the pupa and moth of the silkworm, Bataillon's excellent paper on metamorphosis in *Bombyx*, and the other literature already noted.

No observer since Malpighi, so far as I can ascertain, has given any definite information as to the real nature of the pulse in the adult moth or butterfly. Réaumur thought that pulsation in the adult was always backward; Cornalia believed that Malpighi was probably correct, but made no observations himself; Bataillon regarded periodic reversal as a transitory phenomenon connected with metamorphosis. Brocher ('17a, '17b, '19) who has made extensive and valuable studies on circulation in insects had apparently overlooked periodic reversal.

Such was the conflicting state of the case when I began in 1927 to study the silkworm. It did not take long to find that Malpighi was in the main correct as to periodic reversal in the adult moth. In the season of 1928 I confirmed the observations of the previous year on all stages from the prepupa onward and brought to light facts in regard to variations in the rate of backward and forward peristalsis which are to me of great interest. Some of these results were reported at the 4th International Congress of Entomologists, at Ithaca in August, 1928, and will appear in the proceedings of that session. A more complete account will be published in the *Journal of Morphology and Physiology*.

Only a single reference has yet been found to the occurrence of

this phenomenon in any other order of insects than Lepidoptera, viz., an interesting passage in Kirby and Spence (1828⁶) which suggests that in the adult drone fly (*Syrphus pyrastris*) periodic reversal may have been seen just a century ago. Observing the dorsal vessel through the transparent skin at the base of the abdomen, "which exactly forms such a window as physicians have sometimes wished for in order to view the interior of their patients," they remark:

"The included fluid does not run in the dorsal vessel in a regular course, but is propelled at intervals by drops, as if from a syringe, first from the wide end toward the trunk [thorax] and then in the contrary direction, forming a very interesting and agreeable spectacle."

LITERATURE CITED.

Bataillon, E.

- 1893 La métamorphose du ver à soie et le déterminisme évolutif. Bull. Sci. France et Belgique, 25, p. 18-55.

Brocher, F.

- 1917a Étude expérimentale sur le fonctionnement du vaisseau dorsal et sur la circulation du sang chez les insectes. 1^e Partie. Le *Dytiscus marginalis*, Arch. de Zool. expér. et gén., 56, p. 347-358.
 1917b 11^e Partie. Les larves des Odonates. Ibid., 56, p. 445-490.
 1919 Les organes pulsatiles méso et métatergaux des Lépidoptères. Ibid., 58 p. 149-171.

Cornalia

- 1856 Monographia del Bombyce del Gelso. Mem. dell'I. R. Instituto Lombardo. Milano, 6, p. 388, 15 pls.

Fischer, E.

- 1918 Eine bei Raupen und Puppen beobachtete Umkehrung der peristaltischen Herzbewegung. Entom. Rundschau. Stuttgart. 35, p. 9-10.

Gerould, J. H.

- 1924a Periodic reversal of heart-beat in a chrysalis. Science, 60, p. 570-572.
 1924b Periodic reversal of heart-beat in the chrysalis of *Colias*. Anat. Record, 29, 2, p. 90.

Hecht, S.

- 1918 The physiology of *Ascidia atra*, Lesueur. III. The blood system. American Jour. of Physiol., 45, p. 157-187.

Herold.

- 1823 Physiologische Untersuchungen über das Rückengefäß der Insecten. Marburg, 67 pp.

Kirby, W., and W. Spence.

- 1828 An introduction to entomology. 4 vols. (*Vide* Vol. 4, p. 97.) London.

Maestri, A.

- 1856 Frammenti anatomici, fisiologici sul baco da seta. Pavia.

⁶ Vol. 4, p. 97.

Maillot, E.

- 1878 *Traité du ver à soie par Malpighi. Texte original et planches, avec une traduction et des notes en français. Station Séricicole de Montpellier.* 12 pls., pp. 154.

Malpighi, M.

- 1669 *Dissertatio epistolica de bombyce.* London.

Réaumur, R. A. F. de.

- 1734 *Mémoires pour servir a l'histoire des insectes.* 1, p. 643. Paris, 1734-1742.

Verson, E.

- 1908 *Sul vaso pulsante della sericaria. Atti del reale Inst. Veneto di sci., lett. ed arti., 67, p. 1291-1321, 2 pls.*

Vieil, P.

- 1920 *Sériciculture. Encyclopédie Agricole. Baillière et Fils.* Paris.

FURTHER STUDIES ON THE SEX RATIO IN THE CHICKEN.¹

W. V. LAMBERT AND V. CURTIS.

In the chicken, as in other animals, various attempts have been made to influence the proportion of the sexes normally obtained. While many claims have been made to the effect that it is possible to control sex, at least to a certain degree, most of these claims have not been substantiated when put to a careful analysis. Since such claims have been and will, no doubt, continue to be made it is desirable to have at hand a large body of data on the normal sex ratio for the fowl collected in different localities and over a considerable period of time.

It was in the hope that the observations here reported will add materially to this question, as well as to the question of the normal embryonic sex ratio in the fowl, that the present data were collected. Since the observations were made incidental to another problem, it is deemed wise to publish them at this time.

As these data were collected over a period of fourteen weeks and upon the chicks from hens of different ages they offer information as to the normal variability that may be expected in the sex ratio from week to week, and, also, from females of various ages. In addition, some data relative to the influence of previous and concurrent egg production on the sex ratio were accumulated.

MATERIAL AND METHODS.

The data reported herein were obtained primarily on the chicks from White Leghorn or White Leghorn by Rhode Island Red matings. In addition a few chicks were from pure Rhode Island Red stock. As a part of the chicks were obtained from sources other than pedigreed matings no attempt was made to keep the sex ratio for the two breeds and the hybrids separately.

All eggs were candled on the fourteenth and eighteenth days of

¹ Paper No. 30—Department of Genetics, Iowa State College, Ames, Iowa.

incubation and the sex of all embryos dead after the fourteenth day of incubation was determined by dissection. Likewise, the sex of all chicks dead before their sex could be ascertained from external examination, was made in a similar manner.

The sex ratio, as used in this report, expresses the percentage of males to females in the population.

THE NORMAL SEX RATIO IN THE CHICKEN.

Most of the investigators who have reported upon the sex ratio of the chicken have observed a slight excess of females. The results of all the separate investigators with a total of all the results are shown in Table I. A total of 38,907 observations have been

TABLE I.

A SUMMARY OF THE RESULTS OF ALL INVESTIGATORS OF THE SEX RATIO IN THE CHICKEN.

Author.	Year.	Total No. of Observations.	Ratio of ♂♂.
Darwin.....	1871	1,001	48.65 ± 1.06
Field.....	1901	2,103	44.63 ± 0.73
Thomson.....	1911	805	47.82 ± 1.19
Pearl ¹	1917	22,791	49.45 ± 0.22
Crew and Huxley.....	1923	753	49.26 ± 1.23
Jull.....	1924	2,396	48.88 ± 1.69
Mussehl.....	1924	1,514	52.24 ± 0.87
Lambert and Knox.....	1926	2,910	51.13 ± 0.62
Horn.....	1927	2,131	51.62 ± 0.73
Lambert and Curtis.....	(This report)	2,501	46.82 ± 0.67
Totals.....		38,907	48.76 ± 0.17

¹ All sized families.

made, upon chicks and embryos, and the sex ratio for this total group is 48.76 ± 0.17 . The lowest sex ratio, 44.63, was reported by Field (1901) and the highest, 52.25, by Mussehl (1924). The largest series of observations, 22,791, on the sex ratio in the chicken has been made by Pearl (1917). These observations were made over a period of eight years (1908-1915), and the range in the percentage of males reported by Pearl for the different years is from 46.16 to 49.99. Two other ratios above fifty have been reported, 51.13 (Lambert and Knox, 1926) and 51.62 (Horn, 1927).

The observations reported herein were made over a period of fourteen weeks, from April 11 to July 17, 1928. During this period a total of 2,501 chicks and embryos were examined for their sex. The total results listed by weeks for both chicks and dead embryos are given in Table 2. Of the 2,501 chicks and embryos examined 1,171 were males and 1,330 were females, or a sex ratio of 46.82 ± 0.67 . Considerable variation was exhibited in the sex ratio for the various weeks, this ranging from 38.67 for the week of June 27 to 55.75 for the week of July 5. These are rather extreme deviations for the normal sex ratio, but as they are based upon rather small populations they are probably due entirely to chance. It is noteworthy, however, that in only three out of the fourteen weeks were sex ratios as high as fifty observed.

TABLE II.

THE SEX RATIO LISTED BY WEEKS THROUGHOUT THE HATCHING SEASON FOR ALL CHICKS AND EMBRYOS EXAMINED.

Date of Hatch.	Dead Embryos.		R. ♂♂.	Chicks.		Total.		R. ♂♂ Total.
	♂♂.	♀♀.		♂♂.	♀♀.	♂♂.	♀♀.	
April 11.	34	38	47.22	57	63	91	101	47.39 ± 2.43
" 18.	67	68	49.62	3	2	70	70	50.00 ± 2.85
" 25.	55	64	46.21	13	17	68	81	45.63 ± 2.76
May 2.	12	20	37.50	57	67	69	87	44.23 ± 2.70
" 9.	37	43	46.25	46	42	83	85	49.40 ± 2.60
" 16.	21	27	43.75	77	79	98	106	48.03 ± 2.36
" 23.	13	13	50.00	115	133	128	146	46.71 ± 2.04
" 30.	10	5	66.67	66	85	76	90	45.78 ± 2.62
June 6.	15	14	51.72	47	78	62	92	40.25 ± 2.72
" 13.	15	23	39.47	72	81	87	104	45.54 ± 2.44
" 20.	13	4	76.47	102	104	115	108	51.56 ± 2.26
" 27.	11	13	45.83	30	52	41	65	38.67 ± 3.27
July 5.	6	5	54.54	62	49	68	54	55.73 ± 3.05
" 17.	15	23	39.47	100	118	115	141	44.92 ± 2.11
Totals.	324	360	47.36 ± 1.29	847	970	1,171	1,330	46.82 ± 0.67

No definite trend in the sex ratio is apparent as the season advanced, as both the lowest and the highest ratios appear in the last three weeks of the hatching season.

During the hatching season a total of 3,907 eggs were set and of this total 2,965 proved to be fertile. Of the fertile eggs, as determined by candling on the fourteenth day of incubation, 424

were embryos dead before the fourteenth day. A total of 684 embryos died between the fourteenth and twenty-first days of incubation, while 1817 of the eggs hatched. Forty of the chicks were lost before their sex was determined. These data, therefore, represent 84.35 per cent. of all the fertile eggs that were set. This figure is probably slightly high as some of the eggs classed as infertile must have been dead germs, although the percentage of such eggs cannot have been large.

Most of the chicks and embryos examined for their sex were from pedigreed matings, and the results for each colony of matings are listed in Table 3. Only one male was used in each of the

TABLE III.

THE SEX RATIO LISTED BY COLONIES. ONE MALE WAS USED IN EACH COLONY.¹

Colony No.	No. of Females.	Dead Embryos.		Chicks.		Total.		R. ♂♂.
		♂♂.	♀♀.	♂♂.	♀♀.	♂♂.	♀♀.	
1.....	23	62	58	90	75	152	133	53.33 ± 2.00
2.....	10	25	28	71	80	96	108	47.95 ± 2.30
3.....	12	4	7	41	43	45	50	47.37 ± 3.46
4.....	8	25	28	66	62	91	90	50.27 ± 2.51
5.....	7	3	3	19	18	22	21	51.16 ± 5.14
6.....	12	37	38	79	85	116	123	48.53 ± 2.14
7.....	11	24	40	90	113	114	153	42.70 ± 2.06
8.....	12	39	40	86	87	125	127	49.60 ± 2.12
9.....	11	17	17	56	71	73	88	45.34 ± 2.66
10.....	11	22	27	50	43	72	70	50.70 ± 2.83
11.....	10	10	9	14	21	24	30	44.44 ± 4.59
Totals ...		268	295	662	698	930	993	48.36 ± 0.77

colonies. From this series of matings a total of 1,923 chicks and embryos was examined. Of this number 930 were males and 993 were females, the sex ratio being 48.36 ± 0.77 . The range noted in the sex ratio of the different matings was from 42.70 to 53.33. While these are rather wide deviations from the average they are undoubtedly due to chance. When the sex ratio for each

¹Some females were transferred from one colony to another during the course of the hatching season, after being away from the male of the first colony for a period of at least ten days. Altogether 79 females were used in this series of matings.

separate mating is considered it is found that most of the deviation in colony 1 is due to the aberrant ratio of two females and in colony 7 to the high percentage of females produced by three hens. In neither colony is the deviation great enough for any one hen, when both embryos and chicks are considered, to lead to the suspicion of factors other than chance having been responsible for the ratio in question.

The females used in this study were of different ages and the sex ratio from different aged females has been listed in Table 4. Five females were in their third or fourth year of production, 11 in their second year and 63 in their first year. The sex ratios for these three groups were 50.38, 44.03 and 48.79 respectively. While the number of birds in the first two groups is obviously too small to make sweeping conclusions it is apparent that age does not seem to modify the sex ratio greatly. The ratio of males is rather low for the two-year-old hens, but if reference is made to Tables 1, 2 and 3 it will be seen that deviations equally as great are not infrequent in populations as large or larger.

TABLE IV.
THE SEX RATIO CONSIDERED BY AGE OF DAM.

Year of Production.	No. of Females.	Dead Embryos.		Chicks.		Total.		R. ♂♂.
		♂♂.	♀♀.	♂♂.	♀♀.	♂♂.	♀♀.	
4	5 ¹	18	21	48	44	66	65	50.38 ± 2.62
2	11	21	30	75	92	96	122	44.03 ± 2.28
1	63	229	244	539	562	768	806	48.79 ± 0.85
		268	295	662	698	930	993	48.36 ± 0.77

THE EMBRYONIC SEX RATIO IN THE CHICKEN.

In some species of animals, notably man, a considerable body of evidence has been presented to show that the primary sex ratio differs rather markedly from the secondary ratio. In fowls this does not seem to be the case. While the data on this question are not as extensive as might be desired they all point to the above conclusion. Pearl (1917) reports a sex ratio of 48.30 from a

¹ Four of the females were in their fourth year of production, one in the third.

total of 1,921 embryos examined from the tenth to twenty-first days of incubation. Jull (1924) a ratio of 42.10 in embryos dying naturally after the eleventh day of incubation, Thomson (1911) a ratio of 47.82 in 805 embryos, and Crew and Huxley a ratio of 45.24 in a total of 420 observations. Lambert and Knox (1926) observed a sex ratio of 51.43 in 1,048 embryos dead after the twelfth day of incubation, and Horn (1927) a ratio of 52.17 in 1,248 embryos examined from the tenth to the twenty-first days of incubation. This is a total sex ratio for dead embryos examined by all investigators heretofore of 48.80 ± 0.44 .

In this study a total of 684 embryos dead before hatching were sexed. Of this group 324 were males and 360 females, giving a sex ratio of 47.36 ± 1.29 . This result agrees well with the findings of other investigators, and when compared with the sex ratio of chicks it does not offer any evidence for a selective prenatal mortality of one sex in the chicken, at least during the latter part of the incubation period.

All of the observations on the embryonic sex ratio have been made only during the latter half, or less, of the incubation period. To change the sex ratio to an equality of males and females, it would be necessary to assume a very heavy mortality of males during the first half of the incubation period, and there is no good reason for believing that the early embryonic death ratio would be greatly different from that observed in the late stages of hatching.

ANTECEDENT PRODUCTION AND THE SEX RATIO.

Jull (1924) in a study of the sex ratio based upon continuous hatches throughout the year found a correlation of $-.704 \pm 0.031$ between the sex ratio and antecedent egg production. The ratio of males was found to decrease as the season advanced and total egg production increased, and Jull concluded that the cause for this decrease was directly related to antecedent egg production. Such a decrease was not noted by Jull during the normal hatching season.

Lambert and Knox (1926) did not find any significant correlation with the sex ratio, either for rate of production preceding the normal hatching season, or the actual production during the

normal hatching season. The respective correlations reported by them were $-.048 \pm 0.111$ and $-.009 \pm 0.108$.

Similar studies have been made for the data here reported. Correlations were calculated between the sex ratio and the rate of production for the three months preceding the hatching season, and for the actual production from March 1 to June 1. Only hens producing at least ten sexed offspring have been used in these calculations. The results with the sex ratio as the dependent variables are as follows:

Variables.	Correlation Coefficient.
A. Rate of production preceding the hatching season (per cent.)	$-.05 \pm 0.19$
B. Actual production (March 1 to June 1) ..	$.09 \pm 0.13$

The size of neither of the correlation coefficients is great enough to indicate that there was a relationship between production and the sex ratio. While the number of hens upon which these observations were made was not large it is certain that the immediate antecedent production or concurrent production did not exert any noticeable influence upon the sex ratio of the chicks from these hens. These findings are in accord with those of previous investigators.

SUMMARY.

1. The sex ratio for a total of 2,501 chicks and dead embryos examined from April 11 to July 17, 1928, was 46.82 ± 0.67 . This represents the sex ratio upon 84.35 per cent. of all fertile eggs set during this period.

2. The sex ratio observed for dead embryos alone was 47.36 ± 1.29 and for chicks alone it was 46.61 ± 0.79 .

3. Evidence is presented to show that there is not a selective mortality against one sex previous to the time of hatching.

4. No definite tendency of the sex ratio to increase or decrease was observed during the hatching season.

5. Separate tabulations for the sex ratio upon eleven colony matings, one male with several females in a colony, did not show significant differences between the colonies that might be traceable to individual differences.

6. No significant differences for the sex ratio of hens of different ages were noted.

7. Egg production for the three months immediately preceding the hatching season, or egg production during the hatching season did not influence the sex ratio. The respective correlation coefficients were $-.05 \pm 0.19$ and $.09 \pm 0.13$.

LITERATURE CITED.

Crew, F. A. E., and Huxley, J. S.

- '23 The Relation of Internal Secretion to Reproduction and Growth in the Domestic Fowl. I. Effect of Thyroid Feeding on Growth Rate, Feathering, and Egg Production. *Vet. Jour.*, 79: 343-348.

Darwin, Charles.

- '71 *The Descent of Man*. Vol. 1, p. 296. D. Appleton and Co., New York.

Field, G. W.

- '01 Experiments on Modifying the Normal Proportion of the Sexes in the Domestic Fowl. *BIOL. BULL.*, 2: 360-361.

Horn, E.

- '27 Untersuchungen über die Möglichkeit einer Geschlechtsvorausbestimmung beim Hühnerei nebst einer Factorenanalyse der Befiederungsgeschwindigkeit von Kücken. *Zeitschr. Tierzucht. u. Zuchtungsbiol.* 10: 179-224.

Jull, M. A.

- '24 The Relation of Antecedent Egg Production to the Sex Ratio of the Domestic Fowl. *Jour. Agr. Res.*, 28: 199-224.

Lambert, W. V., and Knox, C. W.

- '26 Genetic Studies in Poultry. I. The Sex Ratio in the Domestic Fowl. *BIOL. BULL.*, 51: 225-236.

Mussehl, F. E.

- '24 Sex Ratios in Poultry. *Poult. Sci.*, 3: 72-73.

Pearl, R.

- '17 The Sex Ratio in the Domestic Fowl. *Proc. Amer. Phil. Soc.*, 56: 416-436.

Thomsen, E.

- '11 Die Differenzierung des Geschlechts und das Verhältnis der Geschlechter beim Hünchen. *Arch. Entwickl. Organismen*, 31: 512-530.



BIOLOGICAL BULLETIN

OF THE

Marine Biological Laboratory

WOODS HOLE, MASS.

VOL. LVI

APRIL, 1929

No. 4

CONTENTS

- NABRIT, S. MILTON *The Rôle of the Fin Rays in the Regeneration
in the Tail-fins of Fishes* 235
- MOENCH, G. L., AND *Microdissection Studies on Human Spermatozoa*. 267
HOLT, HELEN
- YOCHER, DONALD E. *Spermatozoön Life in the Female Reproductive
Tract of the Guinea Pig and Rat* 274
- RICHARDS, OSCAR W. *The Correlation of the Amount of Sunlight with
the Division Rates of Ciliates* 298
- COE, WESLEY R. *The Excretory Organs of Terrestrial Nemerteans*. 306

PUBLISHED MONTHLY BY THE
MARINE BIOLOGICAL LABORATORY

PRINTED AND ISSUED BY
LANCASTER PRESS, Inc.
LANCASTER, PA.

AGENT FOR GREAT BRITAIN
WHELDON & WESLEY, LIMITED
2, 3 and 4 Arthur Street, New Oxford Street, London, W. C. 2

Single Numbers, \$1.00. Per Volume (6 numbers), \$4.50

Editorial Staff

- GARY N. CALKINS—*Columbia University.*
E. G. CONKLIN—*Princeton University.*
M. H. JACOBS—*University of Pennsylvania.*
FRANK R. LILLIE—*University of Chicago.*
GEORGE T. MOORE—*The Missouri Botanic Garden.*
T. H. MORGAN—*Columbia University.*
W. M. WHEELER—*Harvard University.*
E. B. WILSON—*Columbia University.*
-

Managing Editor

- C. R. MOORE—*The University of Chicago.*
-

All communications and manuscripts should be sent to the Managing Editor, the University of Chicago. Subscriptions and other matter should be addressed to the Biological Bulletin, Prince and Lemon Streets, Lancaster, Pa.

BIOLOGICAL BULLETIN

THE RÔLE OF THE FIN RAYS IN THE REGENERATION IN THE TAIL-FINS OF FISHES.¹

(IN *FUNDULUS* AND GOLDFISH.)

S. MILTON NABRIT,²

GENERAL EDUCATION BOARD FELLOW IN BIOLOGY, BROWN UNIVERSITY.

The experiments which form the basis of this paper were planned for two purposes:

1. To reëxamine the facts, as set down by Morgan:

(a) The rate of growth is greatest where most material is needed to complete the typical form of the tail (1902) (*i.e.*, the controlling factors are not those usually considered as physiological ones—the availability of food or blood at the level of the cut—but certain formative factors).

(b) These formative factors are internal and may be expressed in terms of tension or pressure relations that initiate growth, govern the return to form, and cause a cessation of growth (1906).

2. To present, if possible, new data that would throw additional light upon the problem of regeneration and morphogenesis in the tail-fins of fishes.

Under the direction of Professor J. Walter Wilson, the experiments discussed in this paper were begun at the Arnold Biological Laboratory of Brown University (1927), and continued at the Marine Biological Laboratory at Woods Hole, Massachusetts (1928).

¹ I am particularly indebted to Professor Wilson for his valuable assistance in the preparation of this paper.

² Biological Laboratory, Morehouse College. (On leave 1927-28.)

HISTORICAL.

Broussonet (1786) recorded the following results of his experiments in regeneration: (1) Fins reproduce themselves in slow degrees; more rapidly in young fishes than in old; more rapidly in some species than in others. (2) "Poissons dore's de la Chine" regenerate fins: new rays can be distinguished after three months; a severed "right fin" reaches original growth in eight months; both ventral and caudal fins regenerate after oblique and transverse cuts. (3) There is correlation between liability to injury and power to regenerate (Bonnet's conception). (4) A part of the "osselets" is necessary for regeneration; otherwise new fins are not produced.

Unaware of Broussonet's work, Mazza (1890) found that regeneration takes place in the tail of the goldfish (*Carassius auratus*).

Weissman (1892) was aware of the fact that the Salamander would regenerate a lost limb, but did not believe that fins of fishes would regenerate.

Unaware of the works of Broussonet and Mazza, Nussbaum and Sidoriak (1900) published results of experiments in regeneration on a young brook trout (*Salmo fario*), discussing, for the first time, the histology of regeneration in tail fins.

T. H. Morgan (1900) was probably the first one to experiment on the tails of fishes from a standpoint of *morphogenesis*. His work was done largely on *Stenopus*, *Fundulus*, and *Carassius*; his findings were published in 1900, 1902, and 1906. He held the view that *differentiation* is an expression of certain pressure relations: Typical form is established and growth is completed when resulting pressures no longer act as a stimulus on the growing region; the formed part exerts upon the unformed parts an influence of pressure. Quoting Morgan, "The failure of the maximum potential of growth over the more distal parts of an oblique surface is due directly to the new growth below it not having reached the same level, and owing to this difference there arises a pull or tension on the part that retards its maximum possible rate."

MATERIAL AND METHODS.

The nearness of Brown University to the collecting grounds of Narragansett Bay makes it possible to experiment upon *Fundulus heteroclitus* and to keep salt water aquaria with daily changes of water brought in by boats from the collecting grounds. The fresh water forms were in an aquarium that had a daily change of fresh water. Both types of aquaria were aerated by means of an electrically driven air pump and green water plants. Worms, wafers and granulated fish food were the types of food used. The temperature of the water was from 19° to 21° C. At Woods Hole, aquaria with running salt water were used.

Cuts were made with scissors and scapels with reference to base of the scales. (The base of the scales as shown in Text fig. *b.* is important, because of the difference of rate of growth from cuts made at each side of this circular base of scales. A strong *Sodium Chloride* solution was used for the removal of any fungus growth. Mild cases thus treated were cured, but the more pronounced cases resulted in death, though, perhaps, slightly retarded by the treatment.

Observations were largely made on living specimens wrapped in wet cloths under the binocular dissecting microscope. Some observations have been made on individuals preserved in formalin and under low power of the microscope. *Camera lucida* has been employed for some detailed observations on regeneration from squares cut in the tails of *Fundulus* and *Carassius*. Photographs of goldfish were made from chlorotoned specimens while the tail was spread out in a thin film of water. The photographs of *Fundulus* were made from preserved specimens. The flesh and scales were scraped off and the skeleton of the tail was stained in *alizarin*. They were cleared and photographed in *oil of wintergreen*. The tails were cut from the body by an oblique cut which had the short end of the cut surface of the vertebral column ventral, and the extended end dorsal. This served to orient the tail readily.

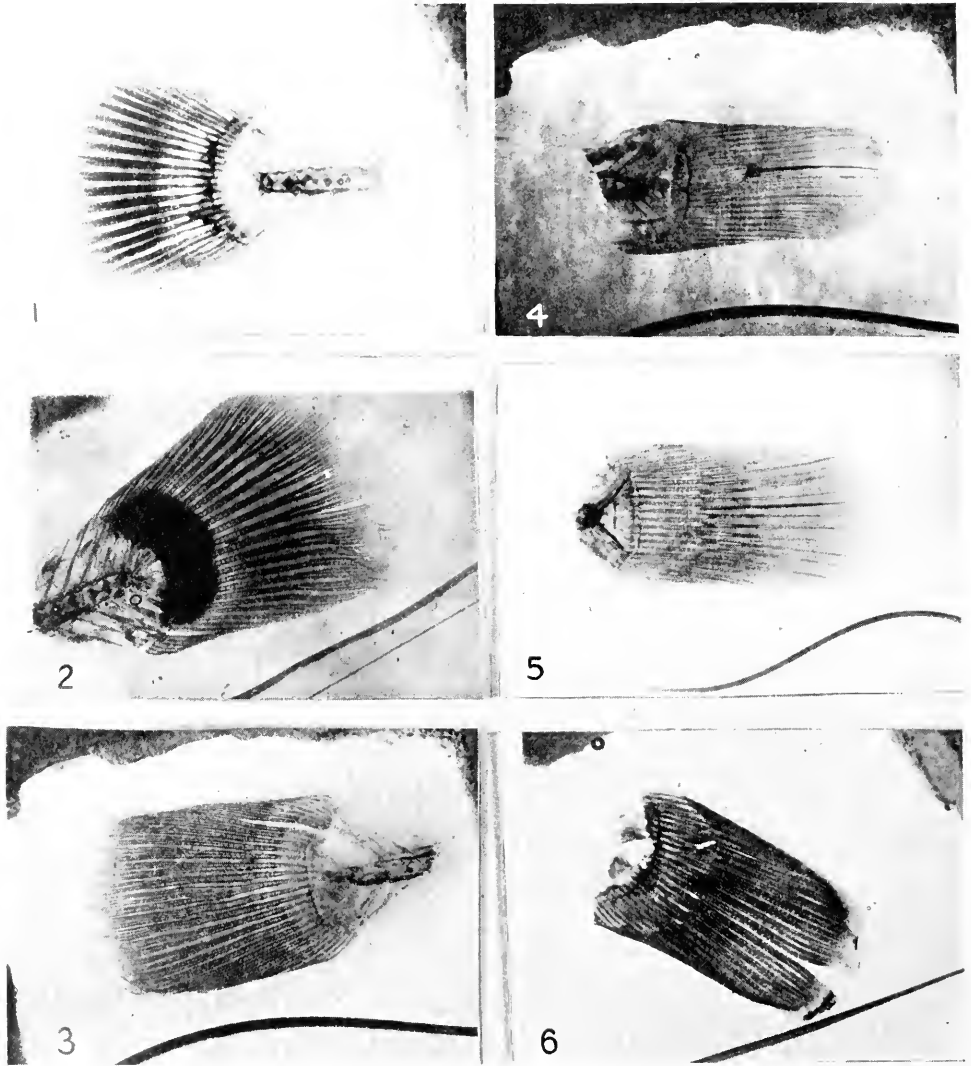

FIGS. 1-6. The shapes or the forms of the tails are correlated with the mode of branching of the fin rays.

FIG. 4. The regenerate from the anterior face of a square hole grew past the posterior face of the hole from which no regeneration had started.

EXPERIMENTAL SECTION.

I.

Description of Tails Used.

The tails of *Fundulus heteroclitus* vary in shape and size (Figs. 1-6). There is a close correlation between the shape of the tail and the mode of branching of the fin rays. The more rounded the tail, the more branched are the fin rays of the tail, especially the rays bordering the dorsal and ventral regions of the tail. The rays articulate with a basal plate at the end of the vertebral column. They are smallest distally and all the rays appear the same size at their distal ends. At the proximal ends the rays are larger than they are at the distal end, and have an articulating knob or enlargement. From the knob the ray becomes smaller until it reaches the base of the scales in the tail; from the *scaly base* it becomes segmented, and more distally there is a doubling of the segments prior to the branching of the rays. This doubling of the segments increases the cross-sectional area of the rays in the middle third of the tail. There is a difference in the number of branching rays in the dorsal and ventral regions of the tail and there is also a difference in position at which the rays of the dorsal and ventral regions branch. The fin rays of the ventral region of the tail branch nearer the scaly base than those of the dorsal region, but more rays of the dorsal region branch than of the ventral region. This difference in mode of branching is already apparent in the early larval stages of the animal, being observed on about the second day after hatching.

In the diagrammatic plate (Fig. 7) it is noticed that the eleventh fin ray from the central one in the dorsal region of the tail doubles its segments and forms secondary branches. The eleventh ray from the central one in the ventral region of the tail does not double and does not form secondary branches. It is readily seen that in this tail more end surface would be exposed in the dorsal region of the tail than in the ventral region, although the cut is supposed to be at the same level in both regions. Neglect of this difference in distribution of fin-ray material gives rise to misleading suggestions as to the controlling factors in growth in tails of fishes,

when distance from base of tail is alone taken as a criterion of level without taking into account these internal structures (see page 252).

The tail of the goldfish differs from that of *Fundulus* in that the largest rays are in the dorsal and ventral lobes and the smallest ones are in the central region (Fig. 8). The rays branch only

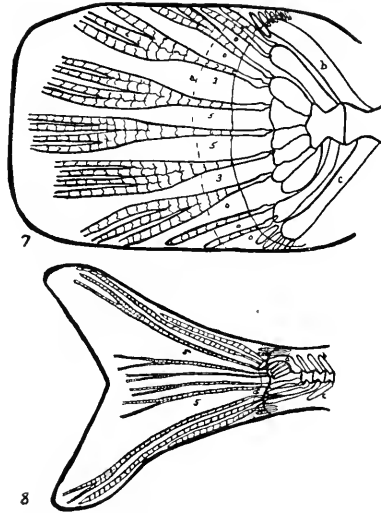

FIG. 7. Diagrammatic and exaggerated sketch of the tail of *Fundulus* which was made from the photograph in Fig. 2. The numbers indicate the omitted rays between any two. (a) Scaly base of the tail; (b) neural spines; (c) hæmal spines.

FIG. 8. Goldfish. (a) Urostyle; (b) neural spine; (c) hæmal spine; (d) scaly base.

once instead of twice as in *Fundulus*. Sometimes a goldfish has rays that branch a second time and sometimes in *Fundulus* the rays branch a third time. The shape of the tail is correlated with the mode of branching of the fin rays. The base of the bilobed tail of the goldfish is *heterocercal*, but the tail is *homocercal*. *A. urostyle* projects into the dorsal lobe of the tail. The rays are small near the base of the tail. Prior to branching, the rays enlarge and the segments of the rays divide to form secondary segments. This enlargement of the rays is intimately correlated with the branching of the rays, and occurs in the middle third of the tail. After branching, the rays become small distally. The final

size of all the rays is apparently equal. The rays of the lobes branch after those in the central region of the tail.

The fan-tailed goldfish has the equivalent of two bilobed tails, with the outer rays of the two dorsal lobes being attached along their long axes.

A study of the development of *Fundulus* shows that there is a *primitive natatory fold* and the mesenchymal mass from which the fin rays and the articulating base develop migrates between the extremity of the fold and the end of the notochord and the spinal cord, and from the mesenchymal mass the central rays are the first ones to differentiate. At this time the natatory fold is

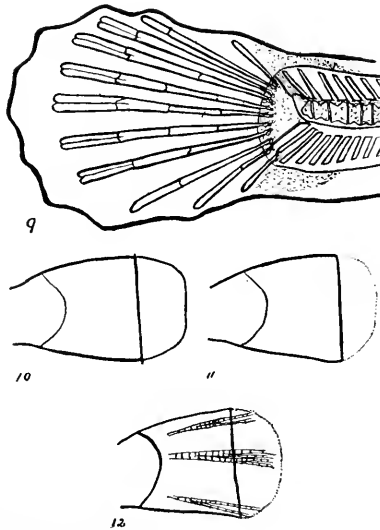

FIG. 9. A camera drawing of the tail at the stage of development when the differences in the distribution of the fin-ray material are first observed. The rays are longer and segmentation is farther from the base in the dorsal region of the tail. The rays in the dorsal region are slightly larger than those of the ventral region. One more ray shows doubling for branching in the dorsal region than in the ventral region.

FIGS. 10, 11, 12. This cut was made at the level where there is a transition from large branching rays.

farther from the base of the notochord and the spinal cord at the central region than it is in the dorsal and ventral regions. In individuals that hatched in sixteen days this streaking of the rays begins on the seventh day. The additional rays are added dorsally

and ventrally, but the blood vessels that come to pass between the rays loop in their paths before the rays are stainable vitally with *Nile blue sulphate* or with *alizarin* after fixation. On the eighteenth day (Fig. 9), or two days after hatching, the rays in the dorsal region of the tail become larger and more branched than the rays of the ventral region.

GENERAL FEATURES OF REGENERATION OF TAILS.

Cut surfaces of various kinds have certain features in common when they regenerate. The proliferation of new tissue, in the forms studied, has proceeded until it is visible at the end of one week in all cases. Cuts at corresponding levels in two different kinds of individuals regenerate at rates that are very close to one another. The rays appear in the new tissue in a period that varies from two to three weeks. The rays can be observed grossly by transmitted light earlier than they can be observed microscopically. This appears to be due to the particular type of condensation in the regenerate before pigmentation begins.

The form of the end of the tail is early observed in all types of regeneration, such as the *diphycercal*, *homocercal* or fan-tailed fish. The nearer the distal end of the tail that the cut is made, the earlier is the difference in rates of growth observed in the various regions which establish the form of the particular tail. In *Fundulus*, a *primitive diphycercal-tailed* genus, there is an early rounding of the regenerate at its distal extremity. In the *homocercal* tails of the goldfish there is a very early lobing of the tails from cuts near the distal end of the original tail. Pigmentation in the regenerate occurs in most cases after a streaking of the rays is visible. In *Fundulus*, the invasion of the connective tissue regions by pigment is useful in observing the appearance of the rays. In goldfish the gold pigment does not become visible in the regenerate until after the melanophores appear, provided that *melanophores* appear at all. The new tissue can still be distinguished from the old after six months have elapsed.

REGENERATION FROM CROSS-CUT SURFACES IN THE TAILS OF FISHES.

When *cross-cuts* are made at various levels of the tail (Figs. 10-15), the proliferation of new tissue becomes visible in about

four days. It is apparently equal in amount across the entire surface at the end of the first week. For cut surfaces in the inner two thirds of the tail, measured from the circular base of scales, the apparent rates of growth at different levels at which the cuts

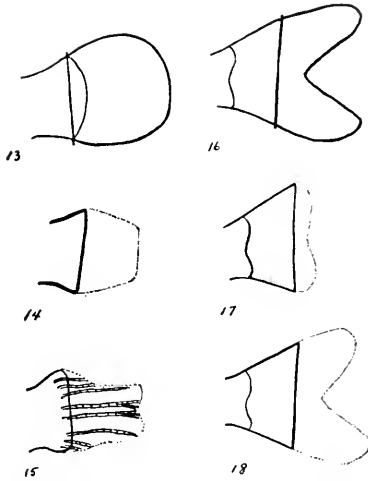

FIGS. 13, 14, 15. This cut was through the region of the tail anterior to the scaly base. The rays of the center branched once at their distal ends. The dorsal and the ventral rays did not branch. Five months after the cut was made, the fish was killed and the sketch made.

FIGS. 16, 17, 18. The different stages of regeneration from a cross cut in a bilobed tail are pictured.

were made are practically equal. During the first week after proliferation has become visible, a difference in the rate of growth between the center of the cut surface and the dorsal and ventral regions is noticed. In *Fundulus* the tail is rounded up so that the typical curved form of the tail extremity is approached. In the lobed-tail goldfish (Figs. 16-18) the typical lobing is very early approached. In the former case the growth is more rapid at the center, and in the latter it is more rapid in dorsal and ventral regions of new tissue.

An explanation of the difference in rate in the center of the tail of *Fundulus* and the dorsal and ventral surfaces on a *cross-cut* surface may be based on the fact that more cut edge of the osseous fin rays is exposed in the center of the tail than is exposed dorsally and ventrally. This is very striking in view of the fact that in

the bilobed tail of the gold-fish the greater quantity of exposed fin-ray material is dorsal and ventral and diminishes toward the center.

The fin rays in the tail of the goldfish are so arranged that the smallest rays are in the center of the tail and the largest rays in the dorsal and ventral lobes of the tail, so that in the *cross-cut* more end surface of fin ray is exposed in the dorsal and ventral regions than in the center. This accounts for the early lobing of the tail.

REGENERATION FROM ANGULAR AND PARTIAL CUT SURFACES.

The regeneration from a *partial cut* or *angular cut* in general is not very different from that of other types of cuts, except that a more limited area of the tail is involved.

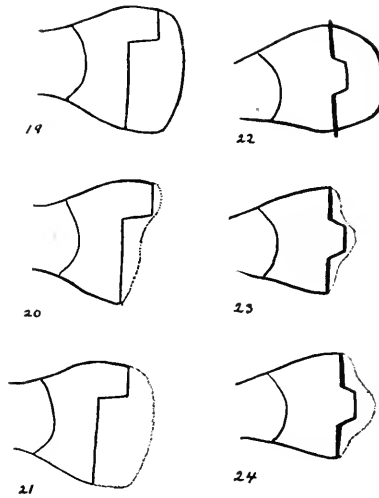

TEXT FIG. c. Regeneration from partial surfaces in *Fundulus*.

FIGS. 19, 20, 21. Regeneration from a small dorsal and distal partial surface is slower than that from the central proximal cut.

FIGS. 22, 23, 24. The retardation in regeneration from a central distal and partial surface is not as great as that from a dorsal distal and partial surface.

In *Fundulus* cut so that the distal part of the partial surface (Figs. 19-21) (*a*) (Text Diagram *a*) is dorsal to and smaller than the proximal ventral surface (*b*), growth is more rapid from the latter surface (*b*) than from the former surface (*a*), and the

most rapid growth on the proximal ventral cut is in the region of the central rays of the tail. The proximal surface regenerated faster than the distal surface, and when the rounded distal end of the tail was formed, they proceeded together to complete the parts of the tail then lacking.

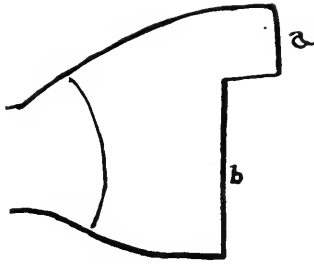

TEXT DIAGRAM a.

Quoting Morgan (1906), from page 482:

“The rate of regeneration from the outer *partial cut* surface is greater the broader, *i.e.*, the higher dorso-ventrally, the cut surface. This result shows that the retardation is directly connected with the height of the cut surface, and only secondarily with its distance from the base of the tail.”

In other words, Morgan finds it necessary to conclude that tall *partial cuts* are less influenced by pressures and tensions than small ones. But it seems more likely that the regeneration is faster from the tall *partial cuts* because more rays are cut and more surface is exposed than in a smaller cut.

When there are three approximately equal partial cuts (Text Diagram *b*) with the portion including the central rays distal, and

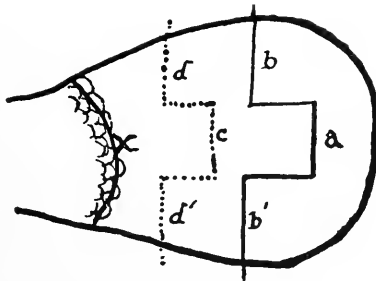

TEXT DIAGRAM b.

the ventral and dorsal portions proximal, two types of regeneration are obtained.

When the *partial cuts* are made so that the distal surface (*a*) is through the tertiary branches of the central rays and the proximal surfaces (*b* and *b'*) are through secondary branches of rays that are adjacent to the central ones, the rate of growth is more rapid from the proximal surfaces (*b* and *b'*). In such a case, the rate is slowest from the rays that border the dorsal and ventral surfaces. When the cut is made so that the partial distal surface (*c*) passes through the central rays before they branch and the proximal surfaces (*d* and *d'*) are nearer the scaly base of the tail (*x*), then regeneration is faster from the distal surface (*c*) than from the proximal surfaces (*d* and *d'*). In neither case is the distal central surface retarded in its rate of growth until the proximal surfaces have regenerated enough material to form a rounded distal end.

The results from the three equal *partial cuts* seem to be due to the length of the distal partial surface; for if the distal cut surface is such that the end surface of the rays is exposed at their largest point or some point larger than the point of the dorsal or ventral rays, the distal surface will regenerate faster. But if the distal edge is at a point where the rays are smaller and less surface is exposed than in the proximal regions, then the rates will be reversed.

When a *dorsal distal partial cut surface* is compared with a *ventral distal partial cut surface* at apparently the same level in the tail (Figs. 25-27), the rate of growth, if the level of comparison is near the scaly base of the tail, is faster in the *ventral distal partial cut surface* than it is in the *dorsal distal partial cut surface*. But if the level of comparison is in the middle third of the tail, the rate of growth is faster in the *dorsal distal partial cut surface*.

The explanation for this reversal in the rate of growth between the dorsal and ventral regions lies in the fact that the distribution of the larger amount of fin-ray substance is reversed in the two regions. The rays branch nearer the scaly base in the ventral region than in the dorsal region of the tail, but more fin rays branch in the dorsal region. Therefore, near the base of the tail the rate of regeneration is faster in the ventral region because

the cut was made through the point of doubling of segments prior to branching in the ventral region, whereas this doubling of segments prior to branching had not started in the dorsal region of

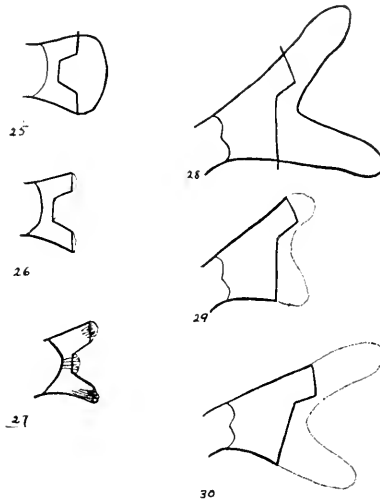

TEXT FIG. *f*. Regeneration from partial surfaces in *Fundulus* and in a bilobed goldfish.

FIGS. 25, 26, 27. The regeneration from two free partial distal surfaces in the tail of *Fundulus* shows regeneration faster dorsally than ventrally. The cuts were made as far as it appeared in the same region and level in the tail. As far as the rays are concerned, the cuts are made at two different levels, with more secondary branches cut dorsally than are cut ventrally.

FIGS. 28, 29, 30. Regeneration from a small distal and dorsal partial surface is not retarded by the more proximal surface. Regeneration from the ventral region of proximal surface is faster than that from the central region of the same surface.

the tail. But in the middle third of the tail the level of the cut passes through the point of doubling of the segments of the primary branches or through the secondary branches, whereas in the ventral region the plane passes through the point of doubling of the segments of the secondary branches or through the tertiary branches.

From a *distal dorsal partial cut* as (*a*) in Text Fig. *a*, in the tail of a goldfish (Figs. 28-30), the rate of regeneration from the distal surface is more rapid than the rate from the proximal surface. There is no "holding back" on the free distal partial sur-

face. From a free distal central surface as (*a*) in Text Fig. *b*, the rate of regeneration is less rapid than from the proximal partial surfaces (*b* and *b'*). In this case, the "holding back" or retardation of growth is on the central region of the tail.

In the bilobed tail of the goldfish, *partial cuts* regenerate at rates opposite to those of *Fundulus*, the rates being faster dorsally and ventrally where the rays are larger when the *partial cuts* in these regions are either proximal or distal to the central region. Just as in *Fundulus*, the initial rate is about equal, and if the cut passes through the branching region of the central rays, and the other cuts through the distal ends of the dorsal and ventral rays, the rate is faster from the central rays.

REGENERATION FROM OBLIQUE CUT SURFACES.

From *oblique cuts* in the tail of *Fundulus*, the rate of growth is faster in the proximal region of the cut and slower in the distal region (Figs. 31-33). The new rays from the *oblique cut* stand at an angle with the cut surface that approaches a right angle, and it is from five to six months before the necessary adjustment for straightening the rays occurs.

The visible change in the adjusting regenerate of the tail of the fish is a closer compacting of the regenerated ray with the cut edge of the old ray and an apparent increase of rigidity of new rays as they become more like the old rays. This compacting and increase of rigidity of new rays may explain the pulling of the new part into the axis of the removed part. The compacting of new rays on the ends of the old rays and the gradual becoming rigid of the new ones, exerts a leverage influence on the regenerate. The power and fulcrum are nearly at the same point, hence a rather slow pulling into line of the new part. This adjustment takes from five to six months from a marked oblique cut in *Fundulus*.

The exposure of the end substance by an *oblique cut* would explain the fact that the new tail is at an angle with the old, if it is true that the ends of the rays initiate growth in the tails of fishes. The end of the ray is cut at an angle that exposes an oblique surface from which the new tissue would grow at the rate that it would from a transverse cut across the surface at the same level.

When Morgan noticed, as a result of *partial cuts* in the tail of the same fish, that there was a more rapid rate of growth of the part nearer the base of the tail, he stated that the factors

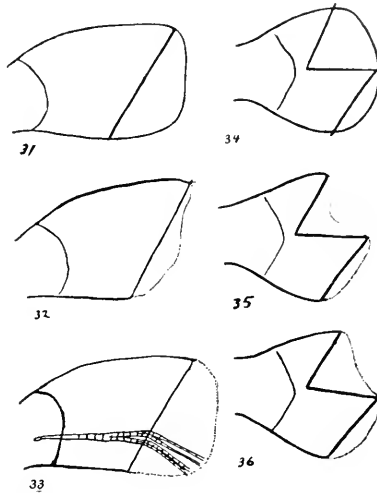

TEXT FIG. *g*. Regeneration from oblique cuts in the tail of *Fundulus*.

FIGS. 31, 32, 33. The rate of growth from an obliquely cut surface is faster proximally than it is distally. More fin-ray end substance is exposed where the rate of growth is faster.

FIGS. 34, 35, 36. When two oblique cuts are so made that the distal end of dorsal surface is the same distance from the base of the tail as the proximal end of the ventral surface, the rate of growth is faster at the latter. The two points of comparison are not at the same level in terms of the amount of exposed fin-ray material. More secondary rays are cut across in the proximal region of the ventral surface. In the proximal region of the dorsal oblique surface more ray stubs are exposed than in either of the two surfaces; from there the rate of growth is faster.

there were different from those controlling the rate from an oblique cut surface. By means of a series of elaborate *oblique cuts* and *partial cuts*, he set out in 1902 to prove this point. In 1906 he had satisfactorily proved it, although he left an opening for modification of the theory as long as the general principles were retained.

In *Fundulus*, the slow proximal rate of growth in the dorsal or ventral *oblique cuts* can be explained by the fact that the fin rays severed by the proximal cut are first or second order rays, while the distal ones are third order rays. Also that in some

cases, the proximal end passes through the point of branching of some rays. In some cases even here, the regeneration is faster in the center of the *oblique cut*. The type of regenerate is dependent upon the points at which the cut begins and ends. Tails of *Fundulus* vary in the time of branching of the rays and and various shapes of tails are produced by regeneration which depends on the mode of branching of the fin rays.

A marked *oblique cut* of a fin ray which exposes more end cut surface than a transversely cut fin ray at the same level will regenerate more new ray stuff than the transversely cut ray. If the normal pattern of branching is for two orders of fin rays, primary and secondary ones, it is possible for the new ray material from the obliquely cut ray to differentiate into three orders of rays. Figures 37 and 38 show the regeneration from obliquely cut fin rays in the ventral lobe of a goldfish compared

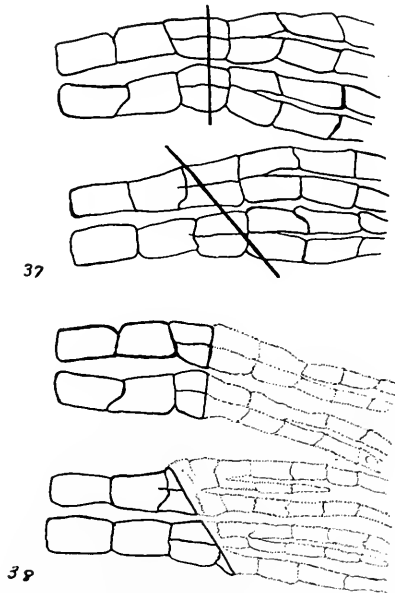

TEXT FIG. h. Comparison of regeneration of an oblique and a crosscut in rays.

FIGS. 37, 38. The rays in the dorsal lobe of the tail were cut transversely and those of the ventral lobe were cut obliquely. The end surface exposed by oblique cut was the greater. From the oblique surface, additional secondary rays or branches were formed in the regenerate and from the transverse surface only the normal number of rays regenerated.

with the regeneration from transversely cut rays in the dorsal lobe at the same level in the same tail.

The regenerated ray from the oblique cut may be larger than the ray which gives rise to it. This shows that the cut surface regenerates along its entire surface. More fin-ray end sub-

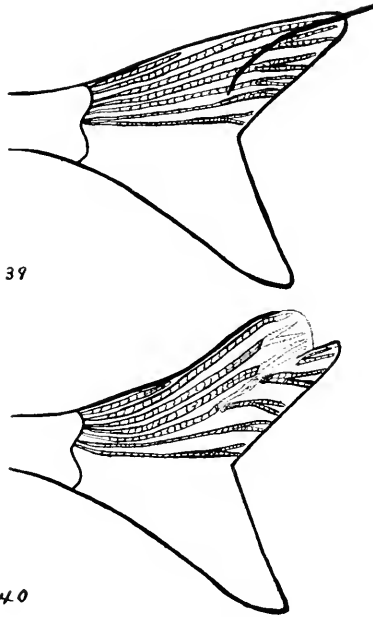

TEXT FIG. i. Regeneration from oblique cut in the dorsal lobe of the tail of the goldfish.

FIGS. 39, 40. Regeneration from an oblique cut in the dorsal lobe of the tail of a goldfish. An extra lobe is formed in the tail by rays that grow up and around their dissevered posterior mates.

stance was exposed. The view that the fin ray exerts the initiating influence is in harmony with the theory of Morgan in that he admits that the fin ray must be cut so that an end is exposed in order for regeneration to take place.

The shape of the tail can be altered by an *oblique cut* into the lobe of the tail when no part is removed. There is healing and also regeneration of rays from both sides of the cut. The rays from the anterior face of the cut grow upwards and around the severed posterior rays to form a new lobe in the tail (Figs. 39 and 40).

The form or shape of the tail does not appear to depend upon any pressure or tension regulating system. The fin rays determine the shape of the tail by their mode of branching and the direction of their growth.

When *double oblique cuts* are made so that the proximal level of the ventral cut is on a perpendicular axis with the distal level of the dorsal cut surface, the rate of growth is faster in the proximal region of the ventral cut surface than it is in the distal region of the dorsal cut surface (Text Diagram *c*) (Figs. 34-36).

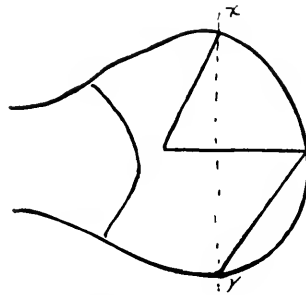

TEXT DIAGRAM *c*.

The most convincing evidence by Morgan that the rate of growth from oblique surfaces was not due to the nearness of one part of the base of the tail, was a cut in which two oblique surfaces were made in the same tail; neither cut directly connected with the other, and the distal end of one cut at the same level as the proximal end of the other. In such a case, the regeneration from the surfaces at the same level were not so close together. His conclusion is that the proximal end exerts a retarding tension on the more distal level of an oblique cut.

In *Fundulus*, the rays are larger in the center of the tail and by normal branching, the central rays reach the minimum size much farther from the base than do the outer fin rays. From double oblique cuts, as before-mentioned, regeneration at the same level of the tail was faster on the proximal surface of one cut than at the distal surface on the other cut. In *Fundulus*, the longitudinal cut in this experiment is adjacent to, or includes the largest rays of the tail, the central rays. The dorsal oblique sur-

face at its distal end is at the end of the final branches of the first (about five) few rays coming from the base of the tail, and at its proximal end intersects the longitudinal cut and the central rays. The ventral oblique surface has its proximal end distal to the final branches of the fin rays that leave the base of the tail. The dorsal cut passes through the smallest branches of the central rays at its distal end and increasingly larger rays towards its proximal end. Hence growth is faster proximally and slower distally. The ventral cut passes through the larger rays proximally and the smaller ones distally. The rate of growth is faster proximally. Further, the rays are correspondingly smaller in most tails at the level of the proximo distal axis (x, y —Text Diagram c) in the dorsal region than in the ventral one. The rays branch nearer the base in the ventral region than in the dorsal, but more rays branch in the dorsal than in the ventral. They tend to reach their minimum size sooner. The middle of the ventral oblique cut is really its fastest point of growth. Moreover, there is a much greater rate of growth at the proximal end of the dorsal cut than at the proximal end of the ventral cut. This is apparently due to the visible difference in size of the rays and the quantity of exposed surface. The rays are different at the two points (x, y) compared.

Assuming the *formative influence* of the rays themselves, and that quantity of cross-cut ray material determines the rate of growth, it will be seen that the same factors controlling the rate of growth from the cross surfaces in the tails of fishes govern the growth from the oblique surface.

Regeneration from an obliquely cut surface in a bilobed tail is faster in the dorsal and ventral lobes when the cut is only slightly oblique. Marked *oblique cuts* regenerate fastest at the proximal end of the cut, and slowest at the center of the cut (Figs. 41, 42, 43). At some points the rate of growth is faster at the center of the cut than at the distal end. Lobing of the tail in the oblique cut is noticed almost as early as in the case of the cross cut in the bilobed-tail fish. The first proliferation of tissue in *oblique cuts* which is observed in about a week seems equal in rate along the entire cut surface. The general tendency, however, is for the rate to be faster at the proximal end, but this is

not pronounced until after the second week. The lobing occurs much earlier when the oblique cut is nearer the original point of lobing of the tail, though when even more than half of the tail is removed, the lobing is noticed before that quantity of new tissue has been restored.

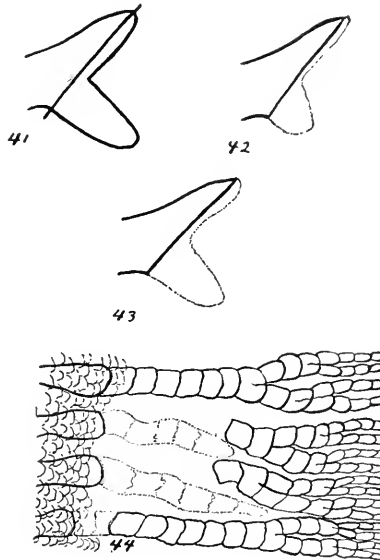

TEXT FIG. *j*. Regeneration from obliquely cut surfaces in the tail of a goldfish and regeneration in a small hole cut in the tail of *Fundulus*.

FIGS. 41, 42, 43. The regeneration from an obliquely cut surface is faster distally than it is in the more proximal central region. The rate of growth is fastest at the most proximal region. The most distal and proximal regions are regions where the rays are larger and where the cut exposes more end substance. More end substance is exposed at the proximal end than at the distal one.

FIG. 44. The new rays from the anterior face of the hole do not connect with their mates at the posterior face of the hole (*Fundulus*).

In the bilobed *Carassius* (goldfish) the rays in the center reach their minimum size first, while the dorsal and ventral rays are much larger, hence much longer. The smaller the branches of the rays are, the slower is the rate of growth in the region of their cut surfaces.

When a *double oblique cut* is made in *Carassius*, so that the distal end of one is at the level of the proximal end of the other in the bilobed tail, the rate of growth is faster at the proximal end.

In some cases, however, the cut can be made so that the distal end of the *dorsal oblique cut* regenerates at practically the same rate as the proximal end of the *ventral oblique cut*.

In the bilobed tail, the longitudinal cut is adjacent to, or includes, the smallest rays in the tail and hence the shortest ones. The distal end of the *dorsal oblique cut* is at the same level as the proximal end of the *ventral oblique cut*. The distal end of the *ventral cut* intersects the distal end of the longitudinal cut. The proximal end of the *dorsal cut* intersects the longitudinal cut near the point of branching of the central rays. The point of the most rapid regeneration is on a line extended directly from the outer ventral ray which is the largest ventral ray, and the most proximal point of the cut. The proximal point on the *dorsal cut* sometimes shows a more rapid rate of growth than the more distal points on the same surface.

The outer ray, while itself larger than any one ray, does not divide, or if it does, not as early as the rays on the inner surfaces. Cuts through a ray just at the point of division expose more surface as a result than do cuts of a single ray, and that which is not at the point of division is slightly larger than the one that is dividing. Near this is a region where the rate again is faster on the ray that has not reached its minimum in size, for the branches after separating do not expose as much surface as the two when they first separate. Whenever the proximal end of the *dorsal oblique cut* is distal to the point of branching of the central rays of the bilobed tail, the regeneration is faster distally than it is proximally. Morgan's theory would assume that suddenly a region of great retarding tension was reached that held back the center and the proximal end of the *oblique cut*. It seems, however, that the rays near the center are smaller, hence do not have to grow so far to attain minimum size.

The mode of growth is just the opposite in the bilobed goldfish type from the type of *Fundulus* and seems to be associated with the fact that the fin rays are just the opposite in size arrangement.

In the elaborate fan-tailed goldfishes the longer parts in the normal tail are supported by the larger rays. The regeneration

is faster where the cut exposed the greater amount of cut end substance. When two parts of such a tail—one directed posteriorly and one directed ventrally, are cut off, it was observed that both regenerated equally. Normally, the two parts had approximately equal lengths, and there is a very close correlation between the sizes of the rays. They regenerated equally in rate or with no noticeable difference.

When an *oblique cut* was made of a fan-tail fish so as to remove the entire piece that is ventrally directed and the outer margin of the adjacent posteriorly directed part so as to present an unbroken cut surface, regeneration took place faster proximally than distally. Examination of the tail showed that the proximal cut passed through the main body of the branches of the first order and that the distal cut passed through the distal ends of the branches of the second order. In the fan-tailed forms as in the bilobed forms, two orders of branches is the typical condition. Hence regeneration takes place more rapidly from the cut ends of rays where more ray surface is exposed.

REGENERATION IN SQUARE CUTS IN THE TAIL FINS OF FISHES.

Small squares cut in the tails of fishes provided a very suitable means of studying regeneration from four surfaces in the same tail—two longitudinal and two transverse surfaces.

Regeneration takes place only from the two transverse surfaces of the square and only healing takes place along the longitudinal surfaces. Cuts nearer the base are better in that they can be made much larger and do not break as easily as the more distal ones. In small cuts 0.2×0.2 cm. square, regeneration takes place by a multiplication of cells around the cut ends of the fin rays and gradually filling in along the longitudinal surfaces by migration from the cross-cut surfaces until a compact mass completely fills the cut square. From the anterior cut surface of the square and from the ends of the cut rays the new rays appear during the third week following the cut. No rays streak out from the posterior or distal face of the square. Sometimes the rays do not unite with their mates, but become distorted or continue to grow and encroach upon the connective tissue region distal to the posterior face of the square (Fig. 44).

But usually the rays unite with their mates at the posterior surface and form the original missing number of segments (Figs. 45-47). Small fragments of rays broken in cutting migrate to the surface of the cut and are eliminated by rupturing the surface of the closed wound or the regenerated tissue.

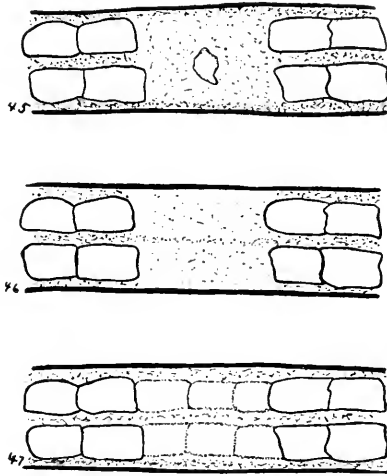

TEXT FIG. *k*. Regeneration from a small hole cut in the tail of goldfish.

FIG. 45. Granulation tissue before hole is completely closed.

FIG. 46. After closure of hole.

FIG. 47. The new rays united with their mates.

From squares of 0.4×0.4 cms. a larger breadth and length, regeneration may occur from the posterior and anterior face of the square (Figs. 48-49). The hole never closes and from the anterior face rays continue to grow beyond the posterior face of the cut, in some cases to the original length of the tail. From the posterior face, the maximum length of the regenerated rays so far obtained in *Fundulus* has been eight segments. In several cases of large cuts no growth started from the distal face of the cut and the proximal face produced rays before reaching the distal face. In these cases the proximal growth continued beyond the distal face and did not connect with it. On the distal face there was only healing over. There was no regeneration along the longitudinal surfaces of the square (Fig. 4).

In a goldfish in which a large square had been cut and which subsequently broke, some important facts were observed. In the breaking of the square two posterior faces were left intact

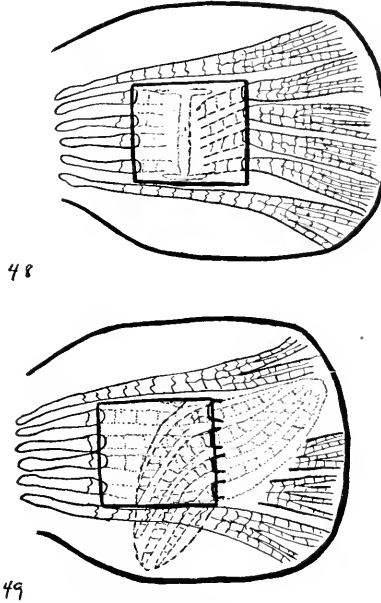

TEXT FIG. 1. Regeneration in large holes cut in the tails of *Fundulus*.

FIGS. 48, 49. The rays from the anterior and from the posterior face of the square have regenerated. The rays from one face of the square pass out to one side of the tail and those from the face pass out to the other. Eight segments have been formed in the reversed direction.

as only the center broke out (Fig. 50). Regeneration was faster from the anterior face and rays of the regenerate curved around the edges of the posterior faces from which new tissue was just proliferating. These rays continued growing to form the center of the tail and also three rays in the dorsal lobe of the tail and two in the ventral lobe. At the end of 45 days, eight segments had been formed in the reversed growth from the posterior face of the square. By 73 days after cutting, the rays from the posterior face of the square had reached the same number of branches as were in the part distal to the posterior face of the cut. A complete reproduction of the skeletal elements from the posterior face of the square was obtained, as would have been the case had a simple cross cut been made at that level.

The form of the lobing of the tail was altered in the before-mentioned goldfish. The normal lobing of the tail was altered to form a lobe within a lobe, as is shown in Fig. 50. The lobe of the tail was altered by the rays from the anterior face of the square that were originally the first rays of the ventral and dorsal lobes. These rays continued in their growth until they reached their limit; their limit was beyond the point of the original center of the tail, even after curving to enter the central portion. The original central rays ceased to grow at their orig-

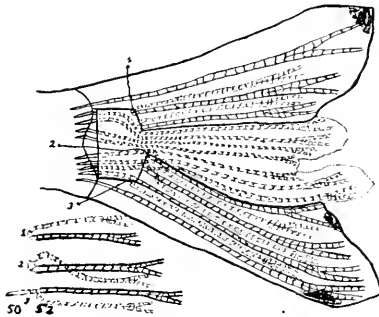

TEXT FIG. *m*. Regeneration in a large hole cut in the tail of a goldfish.

FIG. 50. A drawing of a tail with a large square that had its distal center broken out. (1 and 2) Enlargements of two rays that reversed in the opposite direction. (3) A ray growing from the anterior face of the square unites with a reversed ray from the posterior face of the square at the point of the reversal.

inal limit and a lobing was formed between them and the distorted rays. A second lobing may be said to exist between the distorted and the original lobes. Growth through the center has no retarding influence on rays that normally belong in the lobes.

Reversal of rays in their direction of growth in square holes and formation of all the branches that would have been formed if a cross cut had been made at the level indicate that the power to regenerate and differentiate rests within the fin rays themselves, for they were completely disconnected from the base of the tail. One ray from the anterior face of the hole connected with a ray with reversed growth. The ray from the anterior surface ceased growing and the one from the posterior surface which was nearly complete continued to completion; (the reversed part exits from

between the two rays at their point of fusion in a somewhat lateral direction). *Cessation of growth* in the anterior ray seems related with the fact that its surface was no longer exposed, for it had not yet reached the minimum size, and would have continued to grow if it had not met the ray from the posterior face

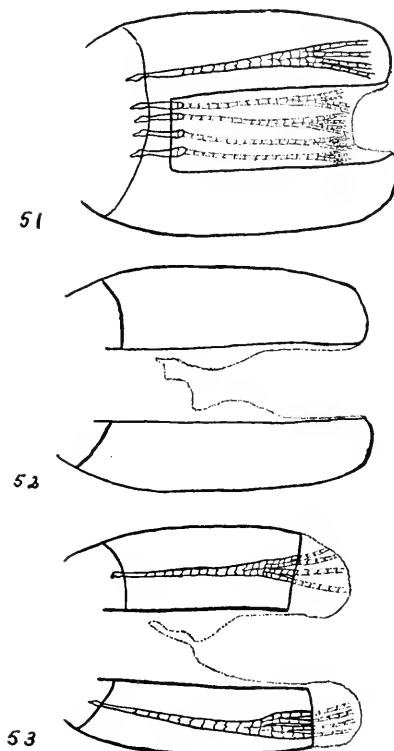

TEXT FIG. n. Regeneration after picking out the rays in a given region of the tail in *Fundulus*.

(Comparisons were made after four and one-half weeks.)

FIG. 51. Four central stubs were left in the tail. The new rays branched and the regenerate filled out space made by the cut.

FIG. 52. The entire four central rays were removed and only unformed connective tissue returned. Alizarin staining did not show any rays. The base of the tail was not injured.

FIG. 53. The entire four central rays were removed. Staining showed small rays coming out from the articulating basal plate. There was no form in the regenerate. The base was broken in removing the rays. From cross cuts in the remaining portion of the tail, rays regenerated in three weeks and were visible without staining.

of the hole. It is not obvious how Morgan's pressure theory would explain these phenomena.

REGENERATION AFTER REMOVAL OF THE FIN RAYS.

Regeneration of the tail when some of the fin rays are removed has been obtained (Figs. 51-53). The rays are picked from the tail in a given region with forceps and a hole is thus made in the tail, as the adjoining tissue is also removed except in the muscle region of the tail. Healing of the wound may take place. If the rays in a goldfish are removed so that a central small ray is left adjacent to a long ray of the lobe, healing may take place so that the quantity of tissue added is the same as that between any two normal rays.

If a very large area from the tail is removed by picking the rays out from the base, a permanent separation in the lobe persists until new tissue grows out from the base. If a transverse cut is made in the portion of the tail in which the rays are intact at the same time that the rays are picked out, the rate of growth and establishment of typical form is faster by weeks than the rate of growth and establishment of form in the region from which the rays were removed. It does appear, however, that it is possible for new rays to grow out from the base when the old ones have been removed. This has been true in three fish—one *Fundulus* and two goldfish. Many fish, however, have not regenerated rays. It is difficult to make sure in such an operation whether a piece of ray has been left or whether the base of the tail has been injured, either of which conditions may account for new rays being produced. It appears from the stained and cleared tail that the new rays replacing those completely picked out in the tail of *Fundulus* came from the articulating base which was injured in the removal of the old rays.

DISCUSSION.

Broussonet first showed that if the dorsal fin was cut off so that none of the "osselets" is left, wound closure takes place by a closing of the cut surface by the *ectoderm*, but no regeneration occurs. Morgan and others have repeated the experiment with the same results. The tail-fin will not regenerate if all the fin

rays are cut off by means of a cut anterior to their articulation with the neural and hæmal spines of the vertebral column.

When a ray is split by means of a longitudinal cut it repairs itself, but there is no lateral regeneration of the ray substance (Morgan). The surrounding tissue is simply replaced between it and the adjacent ray. When new growth from a partial cross cut reaches a split and repaired ray which has no external adjacent mate, then and only then is there a filling-in of new material in a lateral direction along the longitudinal cut. Morgan states that the ray must be cut across if regeneration is to occur; regeneration from ventral, pectoral and dorsal fins shows that growth occurs in any direction and any plane from a cross cut. Additional evidence for regeneration from a cross cut in any direction is presented as a result of a reversal of growth from the normal to the opposite direction in the tail-fin from cross-cut faces of a large square.

Ryder (1882) in discussing the development of the tail in fishes points out that in *Alosa* and in *Pomalobus* the tail is fan-shaped before the rays are developed, whereas in *Salmo* and *Onchorynchus* the fan-shape is not developed until after the rays have appeared. In *Gambusia*, *Siphostoma* and *Hippocampus* there is no primitive natatory fold from which the tail develops.

Braus (1906) showed that in embryonic *Elasmobranchs*, the *cartilaginous fin rays* would develop independently of the muscle buds of the fin by separation and transplantation of the fin-ray bud. This was also shown to be the case in some *teleosts*.

Harrison (1925) and Detwiler (1925) have shown in *Amblystoma* that the forelimb develops from a *self-differentiating and equipotential* system. The *mesenchymal anlage* may be transplanted and it will differentiate into a limb without its usual nerve supply and dependent upon blood for nourishment only. Detwiler even showed that the development of the forelimb is not dependent on the shoulder girdle. They suggested that the growth of the limb may be controlled by the distance of a part from the center of the bud; after arriving at a certain distance from the center of the anlage, growth would cease. Other mesenchyme could, however, in a restricted sense, due to varying potencies, simulate the extirpated anlage and produce an ap-

parently normal limb. The explanation of these experiments is based on the *mesenchyme* as a formative factor in growth and seems to be in the same category as the explanation offered for the types of regeneration in the tails of fishes.

To Morgan, the early laying down of the distal form of the tail is due directly to differences in tensions and pressure relations between parts. In *Fundulus* there is a "holding-back" tension dorsally and ventrally that produces the rounded tail. In bilobed *Carassius* the "holding-back" tension is greater in the center, and the dorso-ventral surfaces grow more rapidly to form the bilobed tail. From partial cross surfaces at different levels in the same tails, Morgan observed that the rate nearer the base of the tail was slightly faster than at a more distal cut surface. Quoting Morgan: "From this evidence there does not seem to be any doubt that when two *cross-cut* surfaces are present on the same tail, the new part generally grows somewhat faster from the inner of the two surfaces. Comparing this result with the growth when the whole tail is cut off squarely, the conclusion seems highly probable that the differences in the rate of growth over the outer and inner cut surface of the same tail is due to the region of the cut, and not to a regulative influence of one region on the other. This factor may also be present in the regeneration from an oblique surface, but in addition there is also present a regulative influence that holds in check the regeneration from the more distal parts of the new tail."

Barfurth (Morgan, 1902) performed some experiments on tadpoles by means of oblique cuts, and on the regenerate from such cuts, to find the forces that bring the regenerate into the position of the removed part. He observed that from oblique cuts the regenerate makes an angle with the oblique surface that approaches a right angle. Barfurth believes that swimming caused the regenerate eventually to come in line with the old part. By tying down regenerating tadpoles, to prevent swimming, some made the adjustment, but some did not. The evidence that he presented is not conclusive.

Inasmuch as the fin rays are of a mesenchymatous origin, and because of the independence of the muscle buds of cartilaginous rays in *Elasmobranchs* and some teleosts, it seems that the possi-

bility of the fin rays themselves playing a formative rôle in growth rate and morphogenesis in the tail-fins is more than probable. An explanation on such a basis was arrived at as a natural result of an attempt to apply several formative systems and theories that have been suggested; namely, the nervous system, circulatory system, distance from the base of the tail, *axial gradient of metabolism*, and the *tension regulating* mechanism of Morgan.

When the mesenchymatous tail-fin anlage differentiates into rays and connective tissue, the contained formative influences could either be distributed into the formed parts; *e.g.*, to the rays as a result of differentiation, or remain in the tail bud in the form of undifferentiated tissue. But, since regeneration of the tails is due to growth by mitoses at the level of the cut instead of migration, it seems that the result of original embryonic differentiation must be the segregation of the formative influence to the fin rays, or to an interaction of products of differentiation at the level of the cut. Of the two alternatives, the former seems to be the more plausible. The reversal of direction of growth and branching to duplicate the distal parts of the rays from square holes seems to support such a view, for here the rays are disconnected from the base.

The evidence presented in this paper concerning the rate of growth from various types of cuts is essentially in agreement with the results of Morgan. Morgan showed that the fin rays must present an exposed transverse surface in order that regeneration may take place. He thought that the rate of growth in the different regions of the tail is due to differences in tensions and pressures in different parts of the tail, and that proximal ends of oblique cuts exert a "holding-back" tension on the more distal portion of the surface. The form of the tail in various fish is due to differences in pressures and tensions. Evidence has here been presented to show that the fin rays play a formative rôle in the regeneration of the tails of fishes. The mode of branching of the fin rays and the form of the tail are intimately correlated, and regeneration has been shown to take place faster from surfaces where more fin-ray material has been cut across. Braus has shown that the fin-ray anlage will differentiate independently of the muscle bud of the tail, and other mesenchymal

structures have been shown to differentiate independently of the muscular and nervous systems. It is therefore concluded that in the development of the tail of the fish, the rate of growth of the fin comes to be regulated by the size of the rays, and in regeneration the rate of growth and consequently the form is controlled locally by the cross-sectional area of the fin rays exposed.

SUMMARY.

1. Regeneration is faster from the level of the cut that exposes more fin-ray cross surface. The difference in arrangement of the fin rays in the tails of *Fundulus* and goldfish accounts for the rate of growth being faster or slower at opposite regions of the two types of tails.

2. Regeneration from square holes cut in the tails of fishes shows that a reversal of growth of the rays from the posterior face of the hole is possible. Healing in the longitudinal faces and repairing of the injured rays take place. Regeneration takes place only from the cross-cut ends of fin rays. The reversed rays are of the same branching pattern as the distal portion from which they are produced; that is, the same pattern that a cross cut would regenerate posteriorly from that level.

3. When rays that normally would grow into the lobe of the tail are displaced into the central portion of the tail of a goldfish, they are not "held back" by any tension in the center of the tail. The rays continue to grow and form abnormal lobes in the central portion of the tail.

4. Correlation between size and branching is brought out by two types of cuts. (a) A cut surface anterior to the scaly base of the tail in *Fundulus* regenerates "abnormal" rays. The shape of the tail can thus be changed from rounded to straight, and persists as such for more than seven months. (b) An oblique cut at the point of doubling of rays in the goldfish exposes more cross surface than a straight cross cut. The regenerate from such a surface has produced a third set of branches instead of two sets, as would be typical in the goldfish used.

5. There is a minimum size of all rays in a particular kind of tail, and the size is apparently equal for all the rays.

6. The evidence herein presented suggests that the fin rays are self-differentiating structures.

(a) The initiation of growth is due to cutting the fin rays crosswise.

(b) Rate of growth seems to depend on the amount of exposed surface of the fin rays.

(c) Cessation of growth appears to be due to the attainment of the minimum size of the ray at which no further growth takes place.

(d) Form of the tail appears not to be associated with pressure or tension relations but with the mode of branching of the fin rays and hence their size and the formative influences that they possess.

LITERATURE CITED.

Braus, H.¹

- '06b Ist die Bildung des Skeletes Von Den Muskelanlagen Abhängig? Eine experimentelle untersuchung an der Brustflosse von Haiembryonen Morphol. Jahrb., 35. Also, Exp. Beitt. Z. Morphol., 1.

Broussonet¹

- 1786 Observations sur la Régénérations de Quelques Parties du Corps des Poissons. Historie de l'Acad. Roy. des Sciences.

Derwiler, S. R.

- '18 Experiments on the Development of the Shoulder Girdle and the Anterior Limb of *Amblystoma punctatum*. Journal of Expt. Zoöl., 25.

Harrison, R. G.

- '18 Experiments on the Development of the Forelimb of *Amblystoma*, a Self-differentiating Equipotential System. Ibid.

Mazza

- 1890 Sulla rigenerazione della pinna Caudale in Alcini Pesci. Atti. Soc. Ligust., Sc. 1.

Morgan, T. H.

- '00 Regeneration in Teleosts. Arch. Entw.-Mech., 10.
'02 Further Experiments on the Regeneration of the Tail of Fishes. Arch. Entw.-Mech., 14.
'06 The Physiology of Regeneration. Jour. of Expt. Zoöl., 3.

Nussbaum and Sidoriak

- '00 Beiträge zur Kenntniss der Regenerations—Vorgänge noch künstlichen Verletzungen bei älteren Bachforellen—Embryonen (*Salmo fario*). Arch. Entw.-Mech., 10.

Ryder, J. A.

- 1882 Embryography of Osseous Fishes. Report of the Commissioner of Fisheries.

Weismann.

- 1892 The Germplasm: Translation by W. Newton Parker. New York.

¹ Only an abstract of the paper was read.

MICRODISSECTION STUDIES ON HUMAN SPERMATOZOA.

G. L. MOENCH, M.D., F.A.C.S., AND HELEN HOLT, B.S.

Although microdissection studies have been carried out by Barber (1, 2, 3), Tschachotin (4), Weber (5), Peterfi (6, 7), and others, and Chambers (8, 9, 10, 11), has given a comprehensive review of the subject, no such studies, it would seem, have been attempted on human spermatozoa. Through the courtesy of Dr. Robert Chambers, whom we want to thank here most sincerely, we were allowed the use of his laboratory and one of his microdissection apparatuses. We equipped this for our purpose with a special Leitz No. 28,340 substage condenser and a 10X and 25X compensation ocular, giving up to 2,640 diameters magnification.

Our original idea in making these studies was to determine whether double appearing cells were really double, or only two separate but contiguous or adherent cells, and whether other cell characteristics or abnormalities, such as apparent head caps, coiled tails, tapering heads, and so forth (see Fig. 1) could be produced artificially or dissected so as to give some clue as to their mode of origin.

Our results, due in part to the nature of the work itself, have thus far not been conclusive, but some rather interesting facts have nevertheless been met with.

We turned our attention first to the double forms, since it has been claimed that most of these are only apparent, and not real. In no case, however, did the dissection of such a double sperm cell prove it to be made up of two single and separate cells. The spermatozoa always proved to be attached to one another at one or more points, so that separation was impossible without injury to at least one of the cells. Even such cells as are shown in Fig. 1, 10, and Fig. 2, a_1 to a_4 , have been proved to be of significance, since they show definitely incomplete separation. This strengthens the previously expressed view of the senior

author that this type of cell indicates some disturbance of spermatogenesis. We have also been able to dissect cytoplasmic masses off the base of the cell (Fig. 2, e_1 and e_2 , and i) which suggests that such thickened membranes as are shown by Fig. 1, 7, are remnants of the cytoplasm, present at an earlier stage.

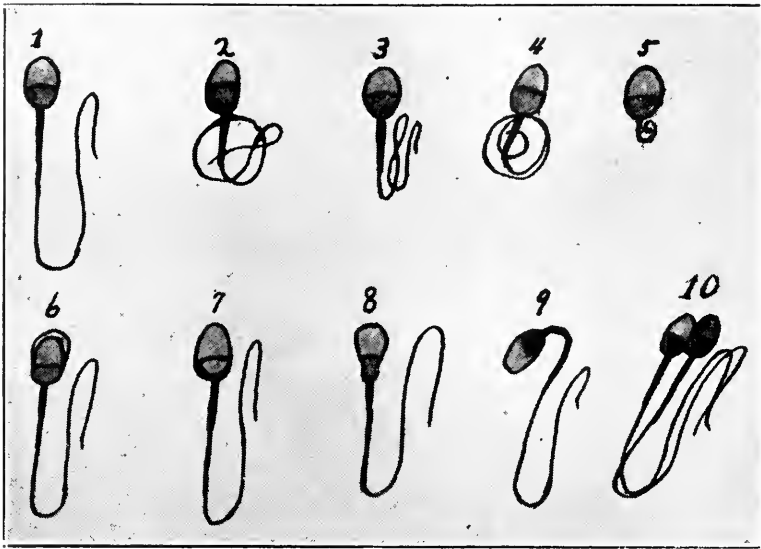

FIG. 1.

1. Normal human spermatozoon.
2. Spermatozoon with a coiled tail, undoubtedly due to purely accidental causes.
3. Spermatozoon of same class as 2.
4. Spermatozoon with type of coiled tail which may be an artefact or may be an actual change in the cell. It is at any rate a late change and of relatively little significance with reference to spermatogenesis. Such cells have been seen motile, although their motility is of necessity limited (see text).
5. Spermatozoon with coiled rudimentary tail. Such cells are useless as they have nothing to propel them.
6. Spermatozoon with head cap. Whether this represents a true head cap such as is found in the guinea pig or a separation of the cell membrane is still under investigation.
7. Spermatozoon with basal portion of cell membrane thickened. Remnant of cytoplasm?
8. Tapering spermatozoon head.
9. Spermatozoon with bent body.
10. Lack of complete separation of two sperm cells with small narrow heads.

That a cell with a bent body or middle piece is not an artefact, but represents some inherent disturbance of this region could also be definitely demonstrated, since we were able to straighten out such cells with the microdissection needles, and saw them assume their original deformity immediately upon the release from the needles. It is important to note here that live spermatozoa did not become immotile, as Peterfi (7) has described in the case of *Leishmania Tropica*, when touched by the microdissection needles, nor did the sperm cells exhibit any recognizable change.

Cells as depicted in Fig. 1, 4, were also investigated. This form of coiling of the tail had occasioned us some trouble of interpretation in our studies in human fertility. The coiling did not seem to be purely artificial, since this type of cell was usually motile in fresh semen specimens, and occurred sometimes with great frequency, even in the semen of normally fertile men. Thus this malformation could not represent a fundamental disturbance of spermatogenesis, but rather only a late change. After many futile attempts to produce this form of coiling, by heating, centrifugation, slow drying, and various reagents, we at last succeeded by using distilled water. This is especially remarkable because distilled water otherwise produced no visible effect upon the spermatozoön, and did not lead to any apparent change in the sperm head, while at the same time it caused both spermial body and tail to coil up in a half minute or less into a spiral as shown in Fig. 3.

Those sperm cells which had tapering heads were also interesting to dissect. In confirmation of the fact that such cell heads are often seen free without attached body or tail we found that the body in this type of cell could be broken off from the head by the micromanipulations more easily than in the normally shaped cell. Likewise the bodies of sperm cells kept for several days after emission broke off more easily than those of spermatozoa only two or three hours old. Perhaps this mechanical factor also has to be considered in explaining why spermatozoa retain their motility longer than their fertilizing power, since the tails might break off when such cells are called upon to overcome obstacles, for instance, to penetrate the ovum.

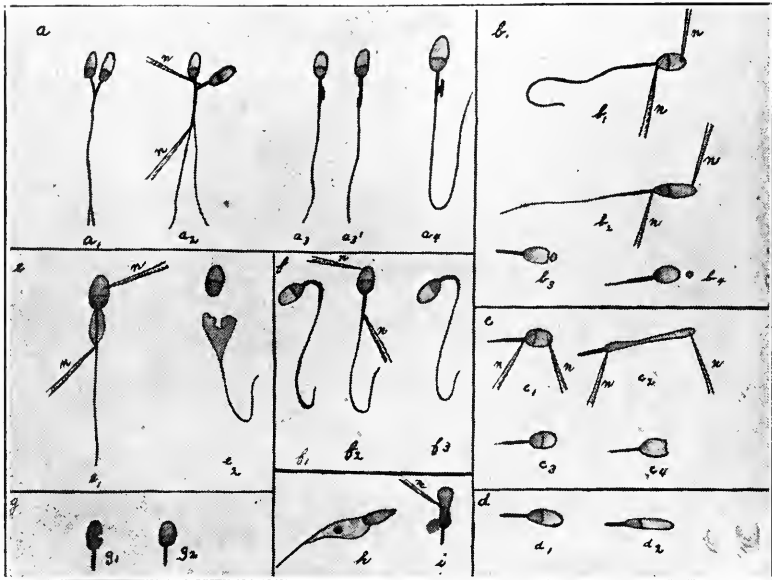

FIG. 2. In many of the spermatozoa only part of the attached body is shown. Unless specially shown, the body and tail were always normal in these cells.

- a*₁. Two spermatozoa closely attached to each other.
*a*₂. Microdissection needles (*n* and *n*) separating the two spermatozoa.
*a*₃. One spermatozoon completely separated from the other (*a*₃ and *a*₃¹)
*a*₃ has a projection on its body, and *a*₃¹, a depression where the two cells were torn apart.
*a*₄. Represents *a*₃ at a higher magnification.
*b*₁. Normal motile spermatozoon grasped by the two microdissection needles and still motile.
*b*₂. Spermatozoon stretched with full tension on needles.
*b*₃. Small piece broken off at anterior end of the head which in breaking released the cell from the pull of the needles and it snapped back, assuming its original shape and the torn off fragment became spheroidal (*b*₄) (cell no longer motile after being stretched, see text).
*c*₁. Three day old non-motile spermatozoon, normal in appearance.
*c*₂. Extreme elasticity of head shown.
*c*₃. Normal shape regained immediately on releasing the needles.
*c*₄. Small piece of head broken off after several restretchings. Broken out piece not to be located.
*d*₁. Spermatozoon with tapering head (3 days old).
*d*₂. Cell after being stretched by needles did not regain former shape.
*e*₁. A spermatozoon with a swollen body (cytoplasm not cast off completely).
*e*₂. Mass dissected off with needles.
*f*₁. A motile spermatozoon with bent body.

An interesting and we believe hitherto unknown physical property of the sperm head is the elasticity which we discovered these cells to have. It is most marked in old, non-motile cells, but present to a certain degree also in perfectly fresh cells. Even the head of the live sperm cells seems, as far as we have been able to determine, rather elastic. Fig. 2, b_1 and b_2 , for instance, represents a spermatozoon still actively motile held by the two needles. This sperm head stretched, as shown, until a piece broke off the anterior portion of the head, releasing it from the pull of the needles. The cell now was no longer motile, but we could not determine exactly when motility ceased. Due to the fact that the cell, to manipulate it, was pulled out of the main body of the small drop of semen to its shallow edge, the motility of the spermatozoon may also have been affected by the extreme shallowness of the seminal fluid at this point. We hope with more practice to be able to manipulate the cells in the deeper portions of the seminal drops. Old, non-motile cells stretched very far (Fig. 2, c_1 to c_4). While it is true that dead leucocytes can likewise be stretched to a considerable degree these white blood cells show no sign of the surprising degree of elasticity exhibited by the dead sperm heads. It must be remembered, however, that the sperm head consists probably entirely of nuclear material. Under all the conditions tried, even in perfectly fresh semen, the sperm head was found to be tough and viscid, and even when cut with the needles, gave no evidence of any escape of nuclear material. On the contrary, the cell injury tended to disappear, so that in a minute or two no evidence of the original injury was to be seen (Fig. 2, g_1 and g_2). Nevertheless, the repair of the lesion was often more apparent than real, because in pushing the head into various positions with the needle, the original gap might reappear, even if this area were not again

*f*₂. Same cell straightened out with the microdissection needles.

*f*₃. Same cell after release from the needles.

*g*₁. Head of motile cell 2 hours old with a gaping tear produced by a needle.

*g*₂. Gap has disappeared, cell again looks normal.

h. Unusual type of spermatozoon with much unshed cytoplasm, seen motile in a semen specimen.

i. Tapering sperm head surrounded at base by cytoplasm which has been dissected off on one side.

touched. In several cases, however, the size of the gap was distinctly smaller than the originally produced separation of the tissues. The elasticity of the sperm head substance was also shown by the fact that irregularly shaped pieces broken off from the head with the needles tended to assume a spheroidal, or at

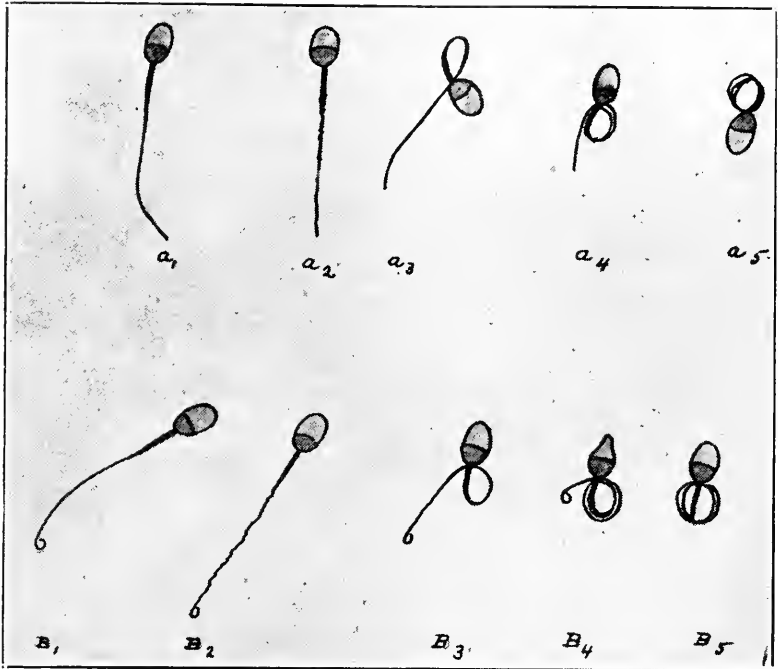

FIG. 3. Coiling of tails of sperm cells in distilled water.

*a*₁. Normal spermatozoön in seminal fluid.

*a*₂. Same cell a few seconds after it was pulled into distilled water by the microdissection needles. Tail fibrillating like frog's muscle in rigor mortis. Nevertheless this whole process of coiling of the tail must not be considered as a dying reaction of the cell as motile cells like *a*₁ to *a*₅ have been frequently seen (see text and Fig. 1).

*a*₃. First whip-like lash of tail.

*a*₄. Second convulsive jerk of tail.

*a*₅. Third stage of reaction. Tail completely coiled.

*b*₁ to *b*₅. Same stages in another normal spermatozoön which had, however, a small loop at the end of the tail from the start.

*b*₄. Cell head seen on edge.

It is easy enough to see how in cells like *a*₅ and *b*₅ the tail by folding over in the long axis at the junction of the body and head may come to surround the spermial head.

least a more compact shape, and when stretched, showed an elasticity similar to that of the intact sperm head. It is worth noting, however, that a tapering cell after being stretched did not always contract to its former shape, and it would seem in general that this type of sperm head has less elasticity than normally shaped heads.

Our experiments thus far, at least prove that the various differences in size and shape of the sperm heads observed in seminal smears are really what they appear to be, and not due simply to external influences at work during the process of preparing and staining the sperm cells.

30 EAST 58TH STREET,
NEW YORK CITY.

BIBLIOGRAPHY.

1. Barber.
'04 Jour. Kansas Med. Soc., vol. 4.
2. Barber.
'11 Jour. Inf. Dis., vol. 8.
3. Barber.
'14 Phillip. Jour. Sci., Sect. B (Trop. Med.), vol. 9.
'15 Abstr. Ztschr. f. wiss. Mikros., vol. 32.
4. Tschachotin.
'12 Ztschr. f. wiss. Mikros., vol. 29.
5. Weber.
'23 Handb. biol. Arbeitsmethoden (Abderhalden), vol. II, p. 655.
6. Peterfi.
'23 Handb. microbiol. Techn., p. 2471, Berlin.
7. Peterfi.
'28 Arch. f. Protistenkunde, vol. 60, p. 492.
8. Chambers.
'18 BIOL. BULL., vol. 34.
9. Chambers.
'22 Anat. Rec., vol. 24. Reprinted Jour. Roy. Micros. Soc.,
Dec., 1922.
10. Chambers.
'26-'27 General Cytology. Harvey Lectures, p. 41.
11. Chambers.
'21 The Microtometist's Vade Mecum. By Arthur Boles Lee.
P. Blakiston's Son and Co., Philadelphia. Ed. 8.

SPERMATOZOÖN LIFE IN THE FEMALE REPRODUCTIVE TRACT OF THE GUINEA PIG AND RAT.¹

DONALD E. YOCHEM,

HULL ZOÖLOGICAL LABORATORY,

THE UNIVERSITY OF CHICAGO.

CONTENTS.

I. Introduction	274
II. Relative amount and motility, and the location of guinea-pig spermatozoa in the female reproductive system after:	
<i>A.</i> Normal copulation (Table 1)	275
<i>B.</i> Injection of the spermatozoa into the guinea-pig uterus at œstrum (Table 2)	278
<i>C.</i> Injection of the spermatozoa at inter-œstrum (Table 3).....	280
<i>D.</i> Injection of guinea-pig spermatozoa into the rat uterus at œstrum (Table 4)	282
III. Relative amount and motility, and the location of rat spermatozoa in the female reproductive system after:	
<i>A.</i> Normal copulation (Table 5)	284
<i>B.</i> Injection of rat spermatozoa into the rat uterus at œstrum (Table 6)	286
<i>C.</i> Injection of rat spermatozoa into the guinea-pig uterus at œstrum and at inter-œstrum (Table 7)	288
IV. Discussion	289
V. Summary and Conclusions	295
VI. Bibliography	295

I. INTRODUCTION.

The problem of the vitality of the gametes is an important one, and especially in the mammals a problem that deserves additional study. The length of the life of the spermatozoa after introduction into the vagina at mating periods, the fate of excess sperm, and the influence of different physiological states of the uterus upon them are problems requiring additional consideration.

The work of Hammond and Asdell ('26) on germ cell viabil-

¹This investigation has been aided by a grant from the committee on research in problems of sex of the National Research Council; grant administered by Prof. F. R. Lillie.

ity and fertility in the rabbit has done a great deal toward dispelling apparently erroneous conceptions promoted by statements from casual observations, often under conditions where the true state of affairs has been difficult to determine.

Stimulated by direct association with the study of Moore ('27, '28) on the viability of spermatozoa within the male tract, and at his suggestion, I have extended the study to the spermatozoa after their introduction into the female reproductive system. The rat and guinea pig have supplied the material for the experiment; and attention has been directed not only to the length of life of spermatozoa after introduction into the female at normal copulation, but also to spermatozoa after artificial introduction into the uterine tubes at inter-œstrum, both in the same species and in a foreign species. The results of this study are presented in the following pages.

I take this opportunity of expressing my indebtedness to Prof. Carl R. Moore for suggesting the problem, and for counsel and guidance during its progress.

II. RELATIVE AMOUNT AND MOTILITY, AND THE LOCATION OF GUINEA-PIG SPERMATOZOA IN THE FEMALE REPRODUCTIVE SYSTEM AFTER:

A. Normal Copulation.

Stockard and Papanicalaou ('17, '19) have clearly demonstrated the details of the œstrous cycle in the guinea pig. By noting the vaginal orifice one is able to select females as the period of œstrum approaches; and by introducing them into a cage containing the male animal, matings can be observed and the exact time of introduction of the sperm into the vagina recorded. Such females have been sacrificed at variable periods after copulation, and a routine search made for spermatozoa as follows:

Upon opening the body cavity dry slides were pressed against the ovary and surrounding region, normal saline was added to the smear, and an immediate microscopic search made for the presence of spermatozoa. Following this examination, the horns, oviducts, and ovaries were relieved from the posterior abdominal wall, and a hemostat placed at the junction of the oviduct and uterine horn. A hemostat was also placed at the bifurcation

of the horns and the body of the uterus. The ligature of these places prevented any sperm cells from passing out or contaminating one part or another. The oviducts were severed, placed in a depression slide containing normal saline, finely hashed with scissors, and the slide examined for the presence of spermatozoa. The uterine horns were examined differently. After cutting the horn from the body of the uterus, it was placed on a depression slide, cut longitudinally, normal saline added, and the contents scraped into the depression and examined. The horn was then transferred to another slide containing saline, but the epithelial side was inverted and allowed to stand until the previous slide had been examined. By this procedure it was hoped that most of the sperm were recovered.

The reproductive tract of thirteen female guinea pigs were examined as outlined above, between three and forty-five hours after witnessed matings. The observations on the spermatozoön condition in the various regions are presented in Table 1.

Since it was early appreciated that the motility of the spermatozoa was preserved for several hours after normal copulation, the majority of the observations were made during the second day. Reference to Table 1 emphasizes the fact that spermatozoa disappear from the vagina rather rapidly. One female examined at three hours after mating showed a few motile spermatozoa, but neither motile nor dead sperm were found in the vagina after nineteen hours in eleven cases examined.

Shortly after copulation quantities of spermatozoa that show vigorous motility can be recovered from the uterine horns. As the interval after mating is increased the vigor of motility can be seen to decrease. In nine females sacrificed on or before forty-one hours after mating motile sperm were recovered from the uterine horns. In four animals sacrificed at forty-four and forty-five hours only a few non-motile spermatozoa were recovered.

The quantity of spermatozoa within the uterine horns diminishes fairly rapidly during the second day. I have been unable to satisfy myself as to the exact method of their elimination, but believe it to be largely due to the phagocytic action of cells within the lumen of the tract. One is able to note the collection of cells, probably leucocytes, about individual or several sperms. Continued

observation revealed that the head of the spermatozoa was the first to be taken in by the phagocytes. Indeed, it was very common to see the head of an engulfed sperm within the cell, while the tail, in some cases, remained free and moved back and forth. Such

TABLE I.

CONDITIONS OF THE SPERMATOZOA IN THE FEMALE GUINEA PIG AFTER NORMAL COPULATION.

No. of Animal.	Hrs. after Cop.	Relative Number and Motility of the Spermatozoa in:			Remarks.
		Vagina.	Uterine Horns.	Oviducts	
23	3	Few, feebly motile	Many present, highly motile	Few, feebly motile	
3A	14	Not examined	Many present, highly motile	Few, feebly motile	
17A	19	None present	Many present, highly motile	None present	
5	24	None present	Many present, highly motile	None found	
3	27	None present	Very few, feebly motile	Very few, feebly motile	Found 3 dead sperm in body cavity near ovary
15	30	None present	Few, highly motile	Very few dead	None found in body cavity
13	30	None present	Few, feebly motile	Few, feebly motile	Found dead sperm in body cavity near ovary
5A	35	None present	Few, feebly motile	Very few dead	Dead sperm in body cavity near ovary
6A	41	None present	Few, feebly motile	Very few, feebly motile	No sperm found in peritoneal cavity
15A	44	None present	Very few dead	Very few dead	No sperm found in peritoneal cavity
9A	45	None present	Very few dead	Very few dead	Few dead sperm found in body cavity
11A	45	None present	Very few dead	Very few dead	Some dead sperm found in body cavity
7A	45	None present	Very few dead	Very few dead	No sperm found in peritoneal cavity

observations appear to be in accord with those of Hoehne and Behne ('14) and other experimenters who believe that phagocytosis of the spermatozoa by leucocytes is largely responsible for

their destruction in many animals. Histological sections of the female tract were not made; therefore, I am unable to offer an opinion concerning the possible phagocytic action of the intact epithelium.

The fact that eleven females observed between nineteen and forty-five hours after mating failed to show the presence of living or dead spermatozoa in the vagina indicate that they are not removed by being passed from the tract externally.

Spermatozoa have been recovered from the oviducts three hours after mating. Motile sperm were found in the majority of the females examined forty-one hours or earlier, but later than this only non-motile ones were seen.

Examinations of the body cavity in five cases revealed dead spermatozoa. These had ascended through the uterine horn and oviduct, and passed through the slit-like communication between the ovarian bursa and the body cavity, Zuckerandl ('97). No motile spermatozoa, however, were recovered from the body cavity.

From these observations one may conclude that spermatozoa introduced into the female guinea-pig at coitus may retain their motility for forty-one hours. This is no implication that their fertilizing capacity is retained for this length of time.

B. Injection of Spermatozoa into the Guinea-pig Uterus at Œstrum.

Few, if any, attempts have been made to correlate spermatozoön activity with different physiological conditions of the uterus. It is an interesting question to enquire whether differences in viability might exist at different periods within the œstrous cycle, due perhaps to physiological conditions produced by the uterine rhythm.

Since the female guinea pig will not mate with the male except at œstrum, sperm suspensions were injected through the wall of the uterine horns after these had been exposed through a small aperture in the abdomen. Spermatozoa introduced into the uterus thus differed from their normal introduction in that no coitus occurred, an abdominal aperture and uterine wall puncture were experienced, and the spermatozoa were not mixed with the normal secretions of the seminal vesicles, prostate, nor Cow-

per's glands. Departing so radically from the ordinary course of nature it was thought necessary to compare the viability of the spermatozoa so introduced with the normal by making observations at œstrum. The effect of the unusual procedures should therefore be appreciated before comparisons are made with the

TABLE 2.

CONDITIONS OF THE SPERMATOZOA IN THE FEMALE GUINEA PIG AFTER INJECTION AT ŒSTRUM.

No. of Animal.	Hrs. after Inj.	Relative Number and Motility of the Spermatozoa in:			Remarks.
		Vagina.	Uterine Horns.	Oviducts.	
8A	19	Ligated	Few present, feebly motile	Few present feebly motile	
16A	20	"	Few dead	None found	
2A	24	"	Few, very feebly motile	Very few dead	Note animal No. 18, Table No. 2.
12A	26	"	Very few, feebly motile, few dead	Very few dead	Note animal No. 9, Table No. 2.
19A	30	"	Few dead	Few dead	
25	30	"	Very few dead	Very few dead	Sperm from same male inj. into No. 26 at same time
26	30	"	Very few dead	Very few dead	
20A	32	"	Many dead, 2 feebly motile	4 or 5 dead, few feebly motile	
23A	36	"	Very few dead, few feebly motile	None found	
28	40	"	Very few dead	3 or 4 dead sperm found	
21A	41½	"	Many dead, many fairly motile	Few dead	50% present in the horns were motile

inter-œstrous period. The procedure was as follows: Females in "heat" can be detected either with vasectomized males, or sometimes by the "touch" method and coitus be avoided. Such females were operated to expose the uterus and by means of a hypodermic syringe approximately ½ cc. of a sperm suspension was injected into each horn of the uterus. The vagina was ligated, usually to prevent discharge of the injected material but care was exercised to avoid hindrance to the blood supply. The sperm suspension was made by finely hashing two epididymides in a few

drops of physiological saline solution. Epididymal spermatozoa are thus obtained in high concentration, unmixed with seminal vesicle, prostate or Cowper's glands secretion. The female tract was examined for spermatozoa as after normal mating.

The results obtained from injecting such spermatozoön suspensions into the uterus of guinea pigs at œstrum are given in Table 2. Among eleven females sacrificed between nineteen and forty-one hours after injection, six showed motile sperm in the uterus, and the other five only non-motile cells. Motile spermatozoa were recovered from the oviducts in only two.

It is perhaps surprising to note that motile sperm were recovered from the uterine horns forty-one and one half hours after their artificial introduction by the above method. Since I was unable to find motile sperm for periods longer than this after normal copulation, it becomes apparent that epididymal sperm introduced at œstrum by injection through the uterine horns retain their motility for approximately the same length of time as those introduced in mating. It is interesting to note that spermatozoa taken directly from the epididymis, unmixed with the secretions of the seminal vesicles, prostate, and Cowper's glands, remained alive for as long a time as those mixed with the secretions of the accessory glands at normal coitus.

C. Injection of Spermatozoa at Inter-œstrum.

Since the persistence of motility of injected sperm was found to be of approximately the same duration as those introduced at coitus, one is able to study the effect of the uterine conditions at inter-œstrum. As the guinea-pig œstrous cycle has been shown to be approximately fifteen days in duration (Stockard and Papanicolaou), the mid or inter-œstrum was considered to be present about the eighth day after a definitely detected "heat" period.

Observations were made upon twenty-three female guinea pigs, into the uterus of which sperm suspensions had been injected, as described in section B. The results obtained are grouped in Table 3. Nine of the twenty-three females sacrificed between the fifth and fortieth hours after sperm injections showed motile spermatozoa in the uterine horns, and from six others motile sperm were recovered from the oviducts. Some non-motile sperm

TABLE 3.

CONDITIONS OF THE SPERMATOZOA IN THE FEMALE GUINEA PIG AFTER INJECTION AT INTER-ŒSTRUM.

No. of Animal.	Hrs. after Inj.	Relative Number and Motility of the Spermatozoa in:			Remarks.
		Vagina.	Uterine Horns.	Oviducts.	
4	5	Not ex. tied off	Many present highly motile	Not examined ligated	
10	10	Ligated	Few feebly motile, many dead	Not examined ligated	
12	10	"	Many motile, many dead	Not examined ligated	
10A	13	"	None found	Not examined ligated	
8	14	"	Few motile, many dead	Few highly motile	I sperm vigorously motile in oviduct
14A	14	"	None motile many dead	Few dead, few feebly motile	
1	16	"	None found	Ligated	A very good injection was made
2	16	"	Few feebly motile, many dead	Very many, highly motile	
21	17	"	Very many dead	Ligated	
14	18	"	Very few present dead	Few present feebly motile	
19	19	None found	Few dead	Few dead	Sperm injected through the vagina
7	19	Tied off	Few feebly motile	Few feebly motile	
11	19	"	Few dead	None found	
6	20	"	Very few dead	Very few dead	
20	20	"	Very many dead	Very few dead	
22	20	"	Few motile, few dead	Few motile, few dead	
18	24	"	Very many dead	Very many dead	Sperm from same male also injected into animal 2A, Table 3
9	26	"	Many dead, few motile	Very many dead	Sperm from same male inj. into No. 12A, Table 3
22A	36	Ligated	Very many dead, very many motile	Two dead sperm found	
28	40	"	Few dead	None found	
31	40	"	Many dead	Few dead	
29	40	"	Many dead	6 or 8 dead, sperm found	
30	40	"	Very many dead	Very few dead	

were present in all. Thirty-six hours after injection, motile spermatozoa were recovered from the uterine horns; and in four females examined at the fortieth hour only dead cells were observed.

Animal number 22A, examined at thirty-six hours after injection, however, showed relatively large numbers of motile spermatozoa, and the motility was yet quite vigorous. It is quite certain that these sperm would have retained their motility for some time longer than thirty-six hours, but for how long is unknown. The difference of only five hours maximum duration of motility between sperm injected at œstrum and those injected at inter-œstrum does not appear to me to be of any real significance. So far as my results are concerned there is little or no indication of a characteristic differential survival time of spermatozoa introduced into the uterus at œstrum as compared with inter-œstrum.

D. Injection of Guinea-pig Spermatozoa into the Rat Uterus at Œstrum.

In order to obtain further knowledge on the behavior of guinea-pig spermatozoa they were injected into the uterine horns of the rat at œstrum. In this way the influence of the environment upon the life of the sperm could be studied.

The female rats were observed in the evening, for at that time the heat period is more likely to be detected. One female at a time was placed with a vasectomized rat, and the reactions observed. As soon as an animal came into "heat," it was operated and the uterus ligated at its junction with the vagina. In connection with this procedure it was noted that in every case the uterine horns were distended with a clear watery fluid. Long and Evans ('22) have described this condition at the œstrous period in the rat.

The sperm were taken from the epididymides of the guinea pig, mixed with a few drops of physiological saline to make about 1 cc., and half of this injected into each uterine horn.

A condensed outline of the results is given in Table 4. Nine female rats, into the uterine horns of which guinea-pig spermatozoön suspensions had been injected, were observed between the ninth and twenty-first hours after injection. Of the nine animals

TABLE 4.
INJECTION OF GUINEA-PIG SPERMATOZOA INTO THE RAT AT ŒSTRUM

No. of Animal.	Hrs. after Inj.	Relative Number and Motility of Spermatozoa in:				
		Vagina.	Left Horn.	Right Horn.	Left Oviduct.	Right Oviduct.
5A	9	Ligated	Many dead	Very many dead	Many dead	Many dead
6A	10	"	Very few dead	Few dead	Many dead, 1 feebly motile	Many dead
3A*	11	"	Very few dead	Very few dead	None found	None found
4A	11	"	Few dead	Many dead	2 or 3 dead	Many dead
7A	11	"	Few dead	Few dead	Many dead, 2 feebly motile	Few dead
8A	13	"	Many dead	Many dead	Few dead	None found
9A	14	"	Few dead	Many dead	Few dead	Few dead
1A†	20	"	Very few dead	Very few dead	None found	None found
2A†	21 1/2	"	None found	None found	None found	None found

Note: the uterine fluid was withdrawn, before the sperm were injected, from the left horn of all animals except 1A, 2A, 3A.

* The fluid was withdrawn from both horns.

† The fluid was not withdrawn from either horn.

examined only two were found to possess motile spermatozoa, one at the tenth and at the eleventh hour. In each case, however, only one or two cells were found that showed any movement, and this was very slight.

Not only are the spermatozoa of the guinea pig rapidly killed after introduction into the rat uterus, but also the dead sperm are rapidly removed from the horns. Large masses of dead sperm were obtained from the guinea-pig uterus up to forty hours, but after injection of similar guinea-pig sperm suspensions into the rat uterus they are practically all removed within one half this time.

These findings clearly show that the environment (uterus) has a remarkable effect upon the spermatozoön life, for whereas a guinea-pig sperm suspension injected into the guinea-pig uterus shows some motility up to about forty hours, with quantities of dead sperm remaining, similar suspensions injected into the rat uterus is followed by loss of all motility within approximately eleven hours, and a rapid removal of dead spermatozoa.

III. RELATIVE AMOUNT AND MOTILITY, AND THE LOCATION OF RAT SPERMATOZOA IN THE FEMALE REPRODUCTIVE SYSTEM AFTER:

A. Normal Copulation.

Experiments with the rat which duplicated those on the guinea pig were conducted for the purpose of comparing the length of spermatozoön life in the two.

Normal copulations were witnessed, the time recorded, and the females sacrificed as desired for observation. My observations on the persistence of motility of spermatozoa in the rat after normal coitus are recorded in Table 5. Various parts of the reproductive system were clamped off, and search for spermatozoa was conducted as in the case of the guinea pig.

The female rat was not examined earlier than twelve hours after mating. Fourteen animals were sacrificed between twelve and twenty-three hours after copulation. Motile sperm were recovered from only four animals, and dead cells from all but one. The latter was not observed until twenty-three hours after mating.

TABLE 5.
CONDITION OF THE SPERMATOOZA IN THE FEMALE RAT AFTER NORMAL COPULATION.

No. of Animal.	Hrs. after Cop.	Relative Number and Motility of Spermatozoa in:			Remarks.
		Vagina.	Uterine Horns.	Oviducts.	
1	12	Not examined	Very many, highly motile	Very many, highly motile	
2	13	None found	Few dead	None found	Vaginal plug found
3	13	Very few dead	None found	Few dead	Vaginal plug present
4	14½	Very many motile	Few dead	None found	The horns were distended with fluid
5	16	Few dead	None found	None found	
6	16	Many dead	Many dead	Very few dead	Few dead sperm found in body cavity near ovary.
9	16	Few dead	None found	None found	Both horns filled with fluid when examined
11	16	Many dead	One dead sperm in right horn	Many dead, few highly motile	
10	16½	None	Many dead	Few dead	
14	17	Few dead	Few dead	Few fairly motile	
7	20	Many dead	Few dead	Few dead	
12	20	None	Few dead	Few dead	
8	21	Many dead	Few dead	Few dead	
13	23	None	None found	None found	Both horns were filled with fluid when examined

Motile sperm were recovered from the oviducts sixteen and seventeen hours after copulation, from the vagina at fourteen and one half hours in one animal, and from the uterine horns and oviducts in larger quantities and more vigorously motile at twelve hours after mating.

B. Injection of Rat Spermatozoa into the Rat Uterus at Œstrum.

Rat spermatozoa were injected into the female rat at œstrum in order to compare the conditions found after normal copulation with those caused by the injection of the sperm, and also to compare the results of injecting the sperm into the guinea pig.

One female rat at a time was placed with a vasectomized male, and as soon as an animal was found to be in "heat" the rat sperm were injected. The injections consisted of a spermatozoön suspension made by finely hashing two epididymides in a few drops of normal saline. The resulting concentrated sperm suspension was then strained through a piece of sterile gauze, and drawn into a hypodermic syringe. The volume of sperm and saline thus obtained was about 1 cc. The female was opened and the horns were ligated near their junction with the vagina, care being taken to avoid interference with the blood supply of the genital tract. About $\frac{1}{2}$ cc. of this sperm suspension was injected into each horn, and later the animal was killed for examination.

Table 6 shows a record of the observations made, and it will be noticed that motile spermatozoa were found up to twelve and one half hours after injection as compared to seventeen hours after normal copulation. Evidently rat spermatozoa are more sensitive to injection than guinea-pig sperm, for there is a difference of four and one half hours in the length of time they were found alive. It was found that injection of guinea-pig spermatozoa into the guinea pig did not show this percentage difference.

The uterine fluid was removed from only one animal, 2B, and that from the left horn. However, in this case dead spermatozoa were found in the right oviduct, but none were found in the left one. This indicates that the uterine fluid may assist the sperm in their ascension toward the ovary. It does not necessarily preserve their life, for motile sperm were found in the left horn while only dead ones were found in the right horn.

TABLE 6.
INJECTION OF RAT SPERMATOZOON INTO THE RAT AT ŒSTRUM

No. of Animal.	Hr. after Inj.	Relative Number and Motility of the Spermatozoa in:					
		Vagina.	Left Horn.	Right Horn.	Left Oviduct.	Right Oviduct.	
1B*	11 1/2	Ligated	Many dead	Many dead	Few dead, 1 motile	Few dead	
2B†	12 1/2	"	Many dead, very few motile	Few dead	None	Few dead	
3B*	12 1/2	"	Few dead	Few dead	Few dead	Few dead	
4B*	15	"	Few dead	Few dead	Few dead	3 or 4 dead	
5B*	15	"	Few dead	Many dead	Few dead	None found	
6B*	15	"	Many dead	Many dead	Many dead	Few dead	

* No fluid was withdrawn from the uterine horns before the spermatozoa were injected.

† The fluid was removed from the left horn, but not from the right horn before the spermatozoa were injected.

C. Injection of Rat Spermatozoa into the Guinea-pig Uterus.

Suspensions of rat spermatozoa, prepared as above outlined, were injected into the guinea-pig uterus to study the effect of a foreign uterine environment upon their motility.

TABLE 7.

INJECTION OF RAT SPERMATOZOEA INTO THE GUINEA PIG AT ŒSTRUM AND AT INTER-ŒSTRUM.

No. of Anim.	Hrs. after Inj.	Relative Number and Motility of Spermatozoa in:			Time of Injection in Sexual Cycle.
		Vagina.	Uterine Horns.	Oviducts.	
25A	4	Ligated	Many dead, 2 or 3 motile	Few dead	At œstrum
32	4½	"	Many dead, 2 or 3 motile	Few dead	At inter-œstrum
1B	6	"	Many dead	5 or 6 dead	" "
2B	6	"	Few dead	Many dead	" "
3B	6	"	Many dead	Few dead	" "
24	6	"	Many dead	Many dead	At œstrum
33	6	"	Few dead	Many dead	" "
34	6	"	Many dead	Many dead	" "
26A	6	"	Many dead	Few dead	" "

Nine female guinea pigs (five at œstrum and four at inter-œstrum) were injected with rat spermatozoön suspensions, and the reproductive tract examined between four and six hours after the injection. The record of observations given in Table 7 consists of the nine injections at the two different stages of uterine development.

Two animals of the nine examined revealed motile sperm at four and four and one half hours. Seven females examined six hours after injection showed dead spermatozoa in both the uterine horns and the oviducts, but none were found alive.

Since rat spermatozoa injected into the rat uterus in the same manner as those injected into the guinea pig were found to possess motility for 12½ hours whereas in the guinea-pig uterus motility survived for less than six hours, it is evident that the species foreign uterus does present an environment in which motility is more rapidly lost.

IV. DISCUSSION.

Several, possibly the majority, of the current textbooks of gynecology, embryology, and obstetrics state that human spermatozoa retain their motility in the female reproductive tract for three and a half weeks. So far as I can ascertain such statements are based upon the report of Dührssen ('93) who claims to have found twelve motile sperm in a diseased Fallopian tube removed nine days after admission of the patient to the clinic; and according to the patient the last coitus had occurred three and one half weeks previous. Strict dependence cannot always be placed upon such verbal statements; and it would appear that in the absence of substantiation of such reports from carefully conducted investigation, the idea if untenable should be relegated to history.

After a brief survey of the length of life of spermatozoa in some of the lower vertebrates, some data pertaining to spermatozoön life in the human female will be given. Readily admitting the risk of drawing conclusions for one animal species on data obtained from a different species, one should not be deterred from conducting sufficient investigation to appreciate the general biological principles underlying the question.

My own observations upon laboratory mammals have convinced me that spermatozoa introduced into the female guinea-pig reproductive tract at a normal mating do not retain their motility for longer than approximately 40 hours. I have found them consistently up to 40 hours, but in ever diminishing numbers and intensity of motility as this period is approached. Forty-one hours is the maximum time motility was observed in the guinea pig, and beyond this time only non-motile sperm were observed.

In the rat, spermatozoa live for even a shorter time after copulation. In one case examined 17 hours after mating a few motile spermatozoa were present, but in the majority of cases examined 12 to 16 hours post-coitus, the cells were present but non-motile.

Turning to the literature dealing with similar studies on mammals, other than man, we find many similar experiences. Hensen ('81), cited by Hoehe and Behne, stated that sperm in the guinea pig were immotile 16 hours after copulation. It is certain, how-

ever, that a more extensive study would have extended the period of life, as my experiments show. In the mouse Sobotta ('95) claims that spermatozoa live only 9 to 10 hours and are then absorbed by the uterus. In the rabbit Hammond and Asdell ('26) showed that the spermatozoa were motile and capable of fertilizing the ovum for but 30 hours. The maximum persistence of motility was not determined. They state: "With regard to the time differences observed between the loss of motility of the sperms and the loss of their power to fertilize ova, the writers are not inclined to think that there is any abstruse mechanism involved in these differences whereby the fertilizing power is destroyed without affecting the motility. The results given above suggest rather that difficult conditions which exist for the sperm in the female passages, which allow of a life of 30 hours instead of 33 days (in the male tract), are sufficient to kill off sperms of low vitality under 10 hours, the time at which ovulation normally occurs after coitus in the rabbit."

Hochne and Behne ('14) found a few motile sperm in the uterus of a rabbit two days post-coitus, but none were found in the oviducts. In the mare, Anderson ('22) found vigorously motile sperm in the uterus and tubes $7\frac{1}{4}$ hours post-coitus. It is, however, not known how long the spermatozoa would have lived. His experiments and observations on the persistence of life of spermatozoa lead him to believe that they rarely live longer than 48 hours in the female tract.

Lewis ('11) sacrificed 25 sows after normal matings, and examined them for the distribution and persistence of sperm. In three cases only could live spermatozoa be found for periods longer than 20 hours after coitus. One showed a few motile cells at $41\frac{1}{2}$ hours.

In all literature reports, with which I am familiar, the persistence of spermatozoa in the female genital tract of lower mammals all agree in one general respect, namely: that the life of sperm after introduction into the female tract is to be reckoned in terms of a few hours (30 to 40 hours). One outstanding exception for mammals (the bat), and conditions found in fowl are to be noted. Several different accounts of copulation and fertilization in the bat agree in the general idea that copulation occurs

before the winter hibernation, that the spermatozoa remain alive, though quiescent, over winter and fertilize the ovum during the following spring. The account of Courier ('27) is an extensive review of this general situation. In the bat conditions are complicated by the hibernating state: the spermatozoa apparently exist in quiescent clumps, and are not in a state of motility; hence, the persistence of life in such a state, and in an organism at a low metabolic level, is on a different plane from the rapid and continuously motile sperm in the uterus of the average mammal. In other words, the sperm are in a state similar to that of their quiescence in the male genital tract.

In the fowl, it has been generally stated that fertile eggs may be laid for a period of approximately two weeks after isolation of the cock. However, in the duck Chappellier ('14) found absolute sterility from the 7th to 11th day. In the case of fowl, as will be discussed later, the testis is abdominal and the natural temperature at which the sperms are formed is similar to that of the oviduct, which is not the case in most mammals where the scrotal temperature is lower than the abdominal temperature.

If we examine the data on spermatozoön motility in the human female tract we have the older conception of Dührssen ('93) that they remain alive for three and one half weeks. Pertaining to the report of Dührssen, Hoehne ('14) states: "such vital energy in the sperm is rather unusual in my opinion. It may be explained by the lack of reaction (phagocytosis of the sperm by leucocytes) in the diseased Fallopian tube." Bossi ('91) refers to a case in which the sperm are said to have survived over 12 days. Nürnbergger ('20) demonstrated motile spermatozoa in normal Fallopian tubes, which had been removed 13 or 14 days after the last stated cohabitation. Strassmann ('95) records the occurrence of living sperm in the human female a week after the last coitus. Triepel ('14, '19) assumes that the spermatozoa live only a short time in the female tract.

Huhner ('28) states that sperm lose much of their motility within 15 minutes and are dead within 4 hours in the vagina; and that many cases of sterility are attributed to the fact, under certain conditions, that the spermatozoa are rendered immotile by the unfavorable conditions of the vagina before they reach the

cervical canal. Hoehne and Behne ('14) made a thorough study of sperm motility in the human and found that in most cases the spermatozoa were killed within one hour in the vagina and within 2 or 3 days in the uterus and tubes. They conclude that there is no evidence that the sperm live longer than 3 days in the normal human female uterus.

Runge ('09) also conducted an extensive experiment on this problem and agrees very closely with the latter's results. He conducted 32 observations on 17 women (non-gravid) and found that the sperm are killed much quicker in the vagina than in other parts. He was able to find live spermatozoa in the uterus 36 hours post-coitus in a few cases, but failed to observe living spermatozoa in the uterus after 3 days.

The fact that usually the assertion of the individual as to the time of the last coitus is the basis upon which the length of life of the spermatozoa in the tract, where recovery and motility have been noted so long, give the feeling that many reports have to be discounted. Such reliance may account for so many conflicting statements.

A biological fact that has but recently been appreciated is the deleterious effects body temperature has upon the sperm. Moore ('28) and Benoit ('26) have shown that guinea-pig spermatozoa in the tail of the epididymis will remain alive and capable of motility for as long as 65 days, provided the epididymis remains in the scrotal sac and subject to its normal heat regulating properties. Moore ('26) and Heller ('29), working under Moore's direction, have shown, however, that after the same operation if the epididymis is elevated into the abdomen where it is subjected to the normal body temperature the sperm remain alive for but 14 days.

In the rabbit Hammond and Asdell ('26) found that the average scrotal temperature taken from a number of bucks was 3° F. lower than the abdominal temperature. The general body temperature, therefore, reduces the life of sperm, even when they are confined within the male reproductive tract and in a quiescent state amid the secretion material normal for them.

Comparing the life in the male tract with my findings in the female tract in which the spermatozoa retain their motility for but 40 hours, even when introduced with the male secretions at copu-

lation, one appreciates that their life is greatly curtailed. This is not due alone to the action of body temperature, which must be recognized as a factor, but to constant and vigorous motility tending to exhaustion, and to the action of phagocytes, and possible uterine secretions harmful to them.

Considering all these elements and the report of more recent observations in the human, it is probable that we will have to consider motility in the human female tract as more truly being expressed in terms of a few days (2 to 3 days) than in terms of weeks as most textbook accounts indicate. Again, it should be emphasized that we are speaking of mere capacity to show motility and not fertility. Lillie ('15) emphasized that the fertilizing capacity of invertebrate sperm is lost considerably earlier than motility. However, Hammond and Asdell ('26) believe that in the rabbit loss of fertility and motility are closely related.

On general principles one might assume that the changes in the uterus would be such as to favor the retention of motility of the spermatozoa at the time they would normally be introduced at mating, or conversely, that the uterus at inter-œstrum would be less favorable for the male sex cells. My observations, however, do not support such a conception. Spermatozoa introduced into the uterus at œstrum either by normal copulation or by introducing them with a hypodermic needle through the uterine walls have been seen to retain their motility for 40 hours. When they were introduced at inter-œstrum they were observed to retain their motility to 36 hours. The difference of four hours in duration of motility in the uterus at œstrum and inter-œstrum is so small that I do not consider it of importance. At 36 hours movement of a fairly vigorous type in a fair percentage of the remaining spermatozoa leads me to believe that more cases examined would serve to extend somewhat the maximum period of motility observed.

To emphasize the variable period of sperm motility in different species it may be recalled here that guinea-pig spermatozoa remain motile after coitus for longer periods than do rat spermatozoa. The maximum periods observed by me were 41 hours in the guinea pig and 17 hours in the rat. One must exercise caution in making too strict an application of the period of motility retention in one animal to the possible length in an animal of another species.

Hoehne ('14) and Hoehne and Behne ('14) injected foreign and species specific sperm to study the persistence of motility. They do not give the procedures or methods but a brief summary of their results may be noted. Hoehne ('14) states that if rabbit sperm are injected into the guinea pig and vice versa, after 9 hours there are many dead sperm in the uterus and tubes, after 2 days the number of motile sperm is less; after 4 days there are only a very few living spermatozoa. However, if the sperm are injected into the body cavity they are eliminated within 4-20 hours by phagocytosis. Hoehne and Behne ('14) injected human spermatozoa into the rabbit uterus, and after 3 or 4 days the findings were negative; in one case one live sperm was found 18 hours after the injection. When rabbit sperm were injected into the rabbit most of the sperm were dead after 2 days, and all were dead after 6 days. After normal coitus in the rabbit a few motile spermatozoa were found in the uterus after 2 days.

Perhaps the guinea pig and rabbit are more closely related in this respect than the guinea pig and the rat, but it is interesting to note the effect of a strange uterine environment on the persistence of sperm motility. In my experiments guinea-pig spermatozoa injected into the guinea-pig uterus with a hypodermic needle have been found to be motile for 40 hours. Similar guinea-pig sperm injections into the rat uterus, however, showed motility for but 11 hours as a maximum. A similar reduction in the length of time spermatozoa remain motile was seen when rat sperm suspensions were injected into the rat uterus and guinea-pig uterus. Rat sperm injected into the rat uterus were observed to be motile for approximately 12 hours, whereas in the guinea-pig uterus the maximum period of motility observed was 4 hours. The effect of a foreign species uterus on spermatozoön motility is possibly due to enhanced phagocytic action and possible to incompatible secretions produced by the uterus.

The fact that there is such a pronounced effect of the uterine environment on spermatozoa from a different species seems to indicate that radically different physiological uterine states should express themselves by affecting differentially the length of persistence of motility. The fact that guinea-pig spermatozoa injected into the guinea-pig uterus at oestrus and at inter-oestrus

retain their motility for similar periods of time affords additional evidence that the inter-œstrous uterus is not sufficiently different physiologically from the uterus at œstrum to have a detectable effect upon spermatozoön life.

V. SUMMARY AND CONCLUSIONS.

1. A few feebly motile spermatozoa were found in the uterine horns and oviducts of the guinea pig up to 41 hours after normal copulation.

2. Motile sperm were observed in the horns of the guinea pig uterus 36 hours after injecting guinea-pig sperm into the uterus with a hypodermic needle at inter-œstrum.

3. Live sperm were found 41½ hours after injecting guinea-pig spermatozoa into the guinea-pig uterus at œstrum.

The fact that live sperm were observed 5½ hours longer after their injection at œstrum than inter-œstrum does not signify that the physiological conditions at œstrum are more favorable than at inter-œstrum.

4. Guinea-pig spermatozoa were observed to be motile for only 11 hours when injected into the rat uterus.

5. Motile sperm were found in the oviducts 17 hours post-coitus in the rat.

6. Rat spermatozoa injected into the rat uterus with a hypodermic needle were observed to retain motility for 12½ hours.

7. Rat sperm remained motile for but 4½ hours when they were injected into the uterus of the guinea pig.

8. It appears that a non-species uterus has a marked effect upon the destruction of spermatozoa.

9. No physiological difference between the uterus at œstrum and inter-œstrum was detected by using the duration of spermatozoön life as the indicator.

VI. BIBLIOGRAPHY.

Anderson, W. S.

'22 Vitality of Spermatozoa. Kentucky Agricultural Expr. Station Bull., No. 239.

Benoit, J.

'26 Recherches anatomique cytologique et histophysiologiques sur les voies excrétrices du testicule chez les mammifères. Arch. d'anat., d'hist. et d'embryologie, vol. 5: 173-412.

Bossi.

- '91 Quoted by Marshall and Jolly: Contributions to the Physiology of Mammalian Reproduction. Philosophical Trans., 1906 (198B).

Chappellier.

- '14 Quoted from Hammond and Asdell. (See reference.)

Courrier, R.

- '27 Etude sur le determinisme des caracteres sexuels secondaires chez quelques mammiferes activite testiculaire periodique. Arch. de Biol., 37: 175-334.

Duhrssen.

- '83 Quoted from Hoche ('14) and Hoehne and Behne ('14).

Hammond, John, and Asdell, S. A.

- '26 The Vitality of Spermatozoa in the Male and Female Reproductive Tracts. British Jour. Exp. Biol., 4, No. 2, 155-185.

Hammond and Marshall.

Reproduction in the Rabbit. Biological Monographs and Manuals (Oliver and Boyd: London).

Heller, R. E.

- '29 New Evidence for the Function of the Scrotum. Physiological Zoölogy, vol. II, No. 1, Jan., 1929.

Hoehne, O.

- '14 Experimentelle Untersuchungen über das Schicksal art eigener und artfremder Spermatozoen im weiblichen Genitalapparat und in der Bauchhöhle. Deutsche Gesellschaft Für Gynec., 1914, pp. 514-516.

Hoehne, O., and Behne, K.

- '14 Über die Lebensdauer homologer und heterologer Spermatozoen im weiblichen Genitalapparat und in der Bauchhöhle. Zentble. für Gynec., 38, No. 1, pp. 5-20.

Hensen.

- '81 Cited by Hoehne and Behne.

Huhner.

Quoted by Meaker. Journal American Medical Assn., vol. 90, No. 2, January 14, 1928.

Lewis, Lowery L.

- '11 The Vitality of Reproductive Cells. Oklahoma Agricultural Expr. Station Bull. No. 96.

Lillie, F. R.

- '15 Studies of Fertilization, VII. Analysis of Variations in the Fertilizing Power of Sperm Suspensions of *Arbacia*. BIOL. BULL., 28.

Moore, Carl R.

- '26 The Biology of the Mammalian Testis and Scrotum. Quart. Review in Biol., vol. I, pp. 4-50.

- '28 X. Spermatozoön Activity and the Testis Hormone. Jour. Expr. Zoöl., 50, pp. 455-494.

Nürnbergger.

- '20 Quoted from Williams' Obstetrics, fifth edition, revised.

Runge, E.

- '09 Beitrag zur Aetiologie und Therapie der weiblichen Sterilität.
Archiv. für Gynec., 87: 1909, pp. 572-585.

Sobotta, J.

- '95 Arch. Mikr. Anat., 46, 15. Also quoted by Hoehne and Behne.

Strassmann

- '95 Quoted from Marshall and Jolly.

Stockard and Papanicalaou.

- '17 The Existence of a Typical Œstrous Period in the Guinea Pig with a Consideration of the Histological and Physiological Changes. Amer. Jour. Anat., 22, No. 2, Sept., 1917.

Stockard and Papanicalaou.

- '19 The Vaginal Closure Membrane, Copulation and the Vaginal Plug in the Guinea Pig, with Further Consideration of the Œstrous Rhythm. BIOL. BULL., 37, No. 3.

Triepel.

- '14 Anat. Anz. Xlvi; (1915) XI viii; (1919) lii. Quoted from Hammond and Marshall.

Zukerandl, E.

- '97 Zur vergleichenden Anatomie der Ovarialtaschen, Anat., Hefte, Wiesb., Bd. 8, S. 705-799.

THE CORRELATION OF THE AMOUNT OF SUNLIGHT WITH THE DIVISION RATES OF CILIATES.

OSCAR W. RICHARDS.

(From the Department of Biology, Clark University, Worcester.)

The analysis of the division rates of ciliates of three diverse orders which had been cultured under practically identical conditions, disclosed only a secular trend and a yearly cycle of change. The maximum of the yearly cycle¹ occurred during the month of July and the cycles of each organism were similar. The slopes of the secular trends were different for each organism. No evidence of the special "cycles" and "rhythms" which protozoölogists had reported in other investigations was found. This paper will show that the cycle of seasonal variation is closely related to the amount of sunshine recorded during the cycle and may perhaps be determined by solar radiation. Evidence from other investigations will be cited to support this conclusion.

I.

The division rates of *Paramecia aurclia* (mutant), *Blepharisma undulans*, and *Histrio complanatus* grown in pedigree isolation culture, with the same culture media, for three years, were obtained by Dawson.² These data were used in a previous analysis by Richards and Dawson.³ The monthly averages of the sunlight recorded at the Boston and Block Island Stations of the U. S. Weather Bureau in terms of the per cent. of possible sunlight were furnished to me through the courtesy of Mr. G. A. Loveland. The figures for the Block Island Station for July and August were used as being the best available representation of the sunlight at Woods Hole, where Dawson kept the protozoa during

¹ *Rhythm* and *cycle* are here used with their usual meaning. The terms will be enclosed in quotation marks when given the special and restricted meaning found in the protozoölogical literature.

² Dawson, J. A., 1926, *J. Exp. Zool.*, XLIV., 133; 1926-27; XLVI., 345.

³ Richards, O. W., and Dawson, J. A., 1927, *J. Gen. Physiol.*, X., 853.

the summer. The per cent. of possible sunlight, for each month, is the ratio of the recorded number of hours of sunlight to the maximum number of hours of sunlight that could occur that month if there was no cloudiness, etc. The per cent. of possible sunlight is used here because it saves the first step of the analysis, namely the converting of the number of hours into percentages.⁴ This method includes and emphasizes the cycle of sunlight variation and introduces no significant error.⁵

The average yearly cycle of seasonal variation for each organism is shown in Fig. 1. The statistical methods used in obtain-

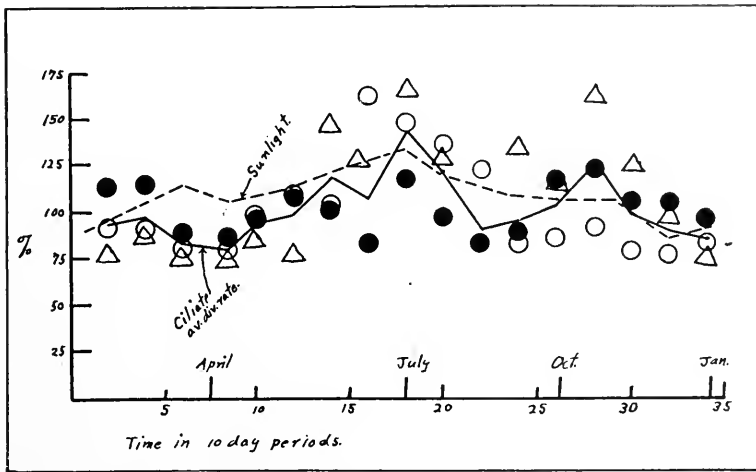

FIG. 1. The yearly cycle of seasonal variation for each organism and the average amount of sunlight. Note: maxima in July. o, *Paramaecium*. ●, *Blepharisma*. Δ, *Histrio*.

ing this cycle, and employed for the further analysis of the sunlight data, are the same and are described in the previous paper.³ The variation in the amount of sunlight is very similar to the variation in the magnitude of the average division rate of the

⁴ Cf. previous analysis³ and Rietz, H. L., *Handbook of Mathematical Statistics*, New York, 1924, 151 ff.

⁵ When the means of the curve of percentage of possible sunlight and the curve of total hours of sunlight are superimposed the deviations of the monthly values from each other average 2.6 per cent. which is only 0.4 unit of Fig. 2c and does not effect the calculations. The mean absolute deviation is — 0.36 per cent. which shows that since the deviations almost cancel each other they may be ignored in this analysis.

organisms. Since the amount of sunlight for any given month was different in each year, as is shown in Fig. 2*a*, an accurate comparison can only be made by first removing the amount of the division rate cycle that corresponds to the amount of sunlight for each time and then comparing the residues. This is the procedure that was used in the original analysis of the data, except that this time we use the recorded amount of sunshine for each month instead of a generalized statistically determined cycle to eliminate the observed cyclic variation in the division rates which have been corrected for the secular trend, Fig. 2*b*. (This figure is identical with that of Fig. 2*d* of the original analysis.³) After the sunlight cycles, Fig. 2*a*, are removed from the division rate

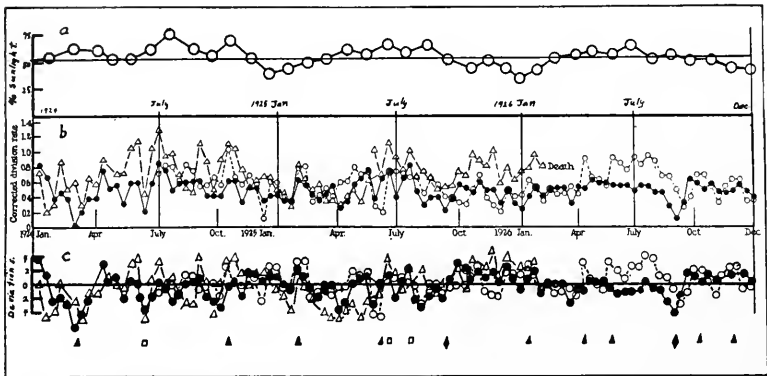

FIG. 2. *a*, the amount of sunlight. *b*, the division rate corrected for secular trend (Cf. Fig. 2*d*, Richards and Dawson³). *c*, division rate residues after minimizing secular trend and variation associated with sunlight. \circ , *Paramaecium*. \bullet , *Blepharisma*. Δ , *Histrio*. \blacktriangle , deviations associated with a change of water source. \blacksquare , deviations associated with removal to Woods Hole or Cambridge. \blacklozenge , deviations associated with temporary change of technician during the absence of Dawson.

data, Fig. 2*b*, there is left a residual amount of variation which is plotted as deviations from the superimposed mean division rate for each organism, in Fig. 2*c*.

II.

The residual curves may now be directly compared, as the disturbing effect of trend has been eliminated. If the amount of solar radiation determines the yearly cycle of seasonal variation

in the division rates, all relation of the division rate curve of each organism to those of the others will have disappeared and the remaining deviations of the rates will be due to other influences not completely controlled by the culture technique.

The maximum correlation of the corrected *Paramecium* rates (x) with the *Blepharisma* rates (y) is their partial correlation independent of time, and is $r_{xy,t} = -.001$. The *Histrio* rates (z) may be correlated with the composite of the *Paramecium* and

TABLE I.
THE LEXIAN RATIOS* OF THE DIVISION RATES.

Organism.	Original Data.	Original Corrected Data.	Final Original Data.†	Corrected for Sunlight.	Final Corrected for Sunlight.†
<i>Paramecium</i>	2.19	1.54	1.19	1.33	1.15
<i>Blepharisma</i>	1.81	1.61	1.31	1.28	1.07
<i>Histrio</i>	3.28	1.50	1.21	1.51	1.44

* The ratio of the relative standard deviation of the series to the relative Bernoulli standard deviation for the same series.

† These columns are for the corrected data less those deviations due to known disturbances (Cf. legend Fig. 2).

Blepharisma rates by means of the multiple correlation $r_{z,xy} = 0.08$. These coefficients demonstrate no relation between the corrected division rates. The unifying effect of the seasonal variation is removed. This removal is more complete than the removal of the statistically determined cycle of the previous analysis because the correlation coefficients of the original analysis³ were -0.08 and 0.29 , respectively. Consequently, the amount of sunlight seems to have ordered the similar yearly cycle of variation in the division rates of these representatives of three different orders of the ciliate infusoria.

III.

By means of the Lexian ratio the deviations of the residual curves of the previous analysis³ were examined to disclose whether or not these remaining variations were due to chance experimentally uncontrolled factors alone or if they were due to definite unifying effect. The numerical values of the Lexian ratio

are given in Table 1. When the deviations known to be caused by a change of medium, by removal from Cambridge to Woods Hole, or return, or by changes in culture technique are omitted the Lexian ratios more nearly approached unity. Purely chance deviations of a constant probability would give a Lexian ratio close to unity.

The Lexian ratios for the data of Fig. 2c, after the variations associated with the amount of sunlight are removed, are less than the figures of the previous analysis and, after the disturbances correlated with known causes are removed, the ratios are very nearly unity for all but the *Histrio* data. This probably indicates the inability of the *Histrio* to become adapted to the environment of the cultures, which ultimately resulted in its death.

The residual variation of the *Paramecium* and *Blepharisma* rates shows little disturbance beyond what might be attributed to chance influences. It is possible that if a corresponding ten day average, or, better, a running average of the sunlight for ten-day periods, were available and were used in place of the monthly averages of the sunlight, more of this remaining variation might have been removed. This analysis of the data leaves no trace of "cycles" or "rhythms" that might be attributed to cellular reorganization; and in fact none were observed by Dawson.⁶ Consequently, it is an external influence, connected with sunlight, and not an internal organization that makes the inherently different division rates follow a uniform seasonal course. The division rate of the *Blepharisma* follows the amount of sunlight more closely than the others which may be due to the greater absorption of sunlight by the pigment of this organism.

IV.

This analysis shows that the yearly cycle of seasonal variation in the division rates of these ciliates, revealed in the original statistical analysis by Richards and Dawson,³ is correlated with the variation in the amount of sunlight at different times of the year. The maximum of the division rate data occurs in July; likewise the maximum amount of sunlight in this region occurs in July (Fig. 1). This is not true in other localities. Wang⁷ finds that

⁶ Dawson, J. A., 1928, *J. Exp. Zool.*, LI., 199.

⁷ Wang, C. C., 1928, *J. Morph. and Physiol.*, XLVI., 431.

there were more sunny days at Philadelphia during September and October, and further that there were more infusoria in the surface water of an open pond during these same months. His figures show that the number of infusoria is more closely related to the amount of sunshine than to the temperature of the water. I have superimposed his figures for temperature and for the number of infusoria, and have added the approximate amounts of

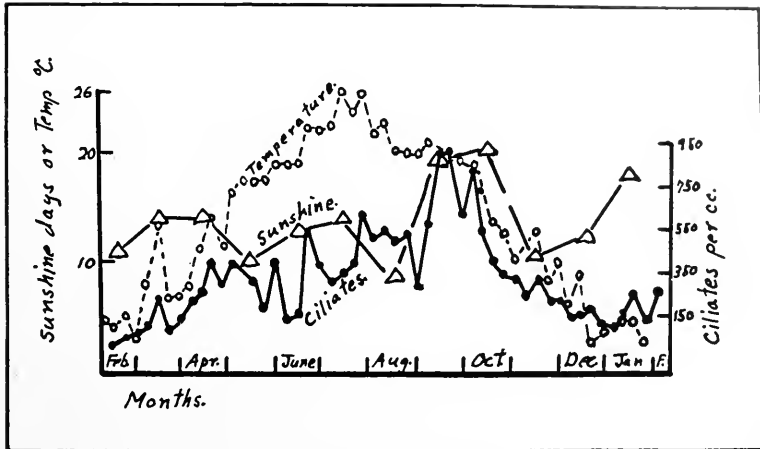

FIG. 3. Data from Wang.⁷ The number of ciliates, temperature and amount of sunlight for the surface water of an open pond at Philadelphia. Note: Maximum number of organisms and sunlight in September and October. (Cf. Fig. 1).

sunshine in Fig. 3.⁸ An inspection of the figure supports this conclusion.

Further corroborating evidence is to be found in another recent paper of Beers⁹ who cultured *Didinium* under carefully controlled conditions and found no rhythms during a period of 265 days. The organisms were maintained in "diffused daylight" during the day time and in total darkness in an incubator at night. Dawson, however, kept his organisms in front of a window that received sunlight during a considerable part of the day protected

⁸ Wang,⁷ Chart 1, graph 1, and Chart 2, graph 3. He gives sunlight as days clear and partly cloudy. I have counted a partly cloudy day as about 55 per cent. of a clear day, which Dr. Brooks, meteorologist, Clark University, advises me may be less than the true value. The unsatisfactory histogram plot that Wang uses is avoided in Fig. 3. (Cf. Footnotes 3 and 6.)

⁹ Beers, C. D., 1928, *J. Exp. Zool.*, LI., 485.

only by a drawn, light window curtain. Hence Dawson's data (used in the present study) would be expected to exhibit an effect of sunlight more clearly than would be expected with the more completely controlled environment used by Beers.

V.

No record of the temperature of Dawson's cultures is available. Since January and February, at Cambridge, are colder than the latter part of the year we might expect a lower rate of division early in the year, and this may account for the fact that the division rate is lower during the first quarter of the year than would be expected from the amount of sunshine at this time. This is also true of Wang's observations. The food supply of a pond is less in January and February than in the latter part of the year, which also explains part of this difference. Part of this deviation (Fig. 1) is due to the differences in amount of sunshine recorded for this part of the year for the different years. The drop in the composite division rate curve for June is due to the disturbance of moving the cultures to Woods Hole. They are again disturbed when they are returned to Cambridge. The effect of the return is not as obvious because the time of return varied from year to year while the opening of classes brought Dawson to Woods Hole at essentially the same time each year. During September 1925 and 1926 the cultures were cared for by an assistant during the absence of Dawson with a resulting abnormal drop of the division rate during this month.

Examination of the division rates of these organisms since the original analysis shows that the secular trend has continued until almost the end of 1928 when a new upward trend begins.⁴ The data are too few to establish this new trend. The yearly cycle of variation is less pronounced the longer the cultures are maintained which suggests an accumulative effect of some unfavorable influence, or, of some deficiency, in the protoplasm of these organisms. Such an effect would be more obvious with unicellular than with multicellular organisms owing to the direct continuity of the protoplasm of the former. This trend has persisted despite gradual improvement and refinement of the technique for culturing. The relation between the trend and the diminution of

the magnitude of the cycle suggests that the loss of the ultra-violet or near ultra-violet rays may be the cause of the downward trend and diminished cycle of seasonal variation. The organisms are kept in glass moist chambers inside of a glass window so that a considerable part of the shorter wave lengths of light must be absorbed before reaching the animals. The influence of the shorter wave lengths of light on the division rate of protozoa could be determined by suitable experiment and should be evaluated in future studies made with these animals in more adequately controlled environments.

SUMMARY.

1. Previous analysis of the division rates of *Paramecium aurelia* (mutant), *Blepharisma undulans*, and *Histrio complanatus* grown separately in pedigree isolation culture, under as nearly identical conditions as possible, for a period of 3 years, disclosed a secular trend and a seasonal rhythm for each organism. The seasonal rhythm has a maximum in July.

2. This seasonal rhythm is shown to be related to the amount of sunshine reaching the locality of the cultures. The maximum amount of sunshine is received in July also.

3. After the effect of trend and the influence of the amount of sunlight are removed from the division rates, they show no relation to each other except for deviations caused by known changes in the culture technique. Each organism has a division rate varying independently of the others, when the effect of external unifying influences are removed.

4. Consequently, the amount of sunlight, other conditions held constant, seems to determine the similarity of the division rate of these diverse organisms. The temperature is a secondary determining factor which has apparently less influence than sunlight when both variables are present in these experiments. Data from other investigations supports these conclusions.

5. It is suggested that the downward trend of the rates and the diminution of seasonal cycle which continue under laboratory conditions may be due to an accumulative deficiency of light of the shorter wave lengths which is absorbed by the containers, and that this effect be evaluated in studies made with more nearly constant environments.

THE EXCRETORY ORGANS OF TERRESTRIAL NEMERTEANS.

WESLEY R. COE,

OSBORN ZOÖLOGICAL LABORATORY, YALE UNIVERSITY.

In all except one of those species of terrestrial nemerteans which have been fully studied histologically the excretory system consists of numerous isolated nephridia, each of which leads to the surface of the body by a separate efferent duct. Such a system differs from that found in typical marine nemerteans mainly by the absence of the pair of longitudinal collecting tubules usually so conspicuous in the latter.

In a recent paper, dealing with the land nemerteans, Mary L. Hett ('27) has included an excellent comparative statement of the principal anatomical details which characterize the twelve known species of the genus *Geonemertes*. In regard to the nephridia of *G. agricola*, however, the brief description of this system given in my paper ('04) leaves some ambiguity as to the precise relations of terminal organs and efferent ducts. For this reason, and because further insight into the relationships of the different species of these aberrant land forms is highly desirable, this supplementary note on the nephridial system seems appropriate.

A recent study of well preserved material of sexually mature individuals of *G. agricola* collected near the shore of Hungry Bay, Bermuda, proves that the excretory system agrees rather closely with that described by Schroeder ('18) for *G. palaensis* and by Miss Hett ('24) for *G. hilli*. In all three species the system extends throughout the entire length of the body, with hundreds or thousands of isolated nephridia and the same number of efferent ducts.

Each of these numerous nephridia consists of a cluster of slender terminal organs (flame cells), with a comparatively thick-walled convoluted tubule and a slender efferent duct. Sections of the convoluted tubule, except for their smaller size, are similar to those of the longitudinal collecting tubules which join together all the

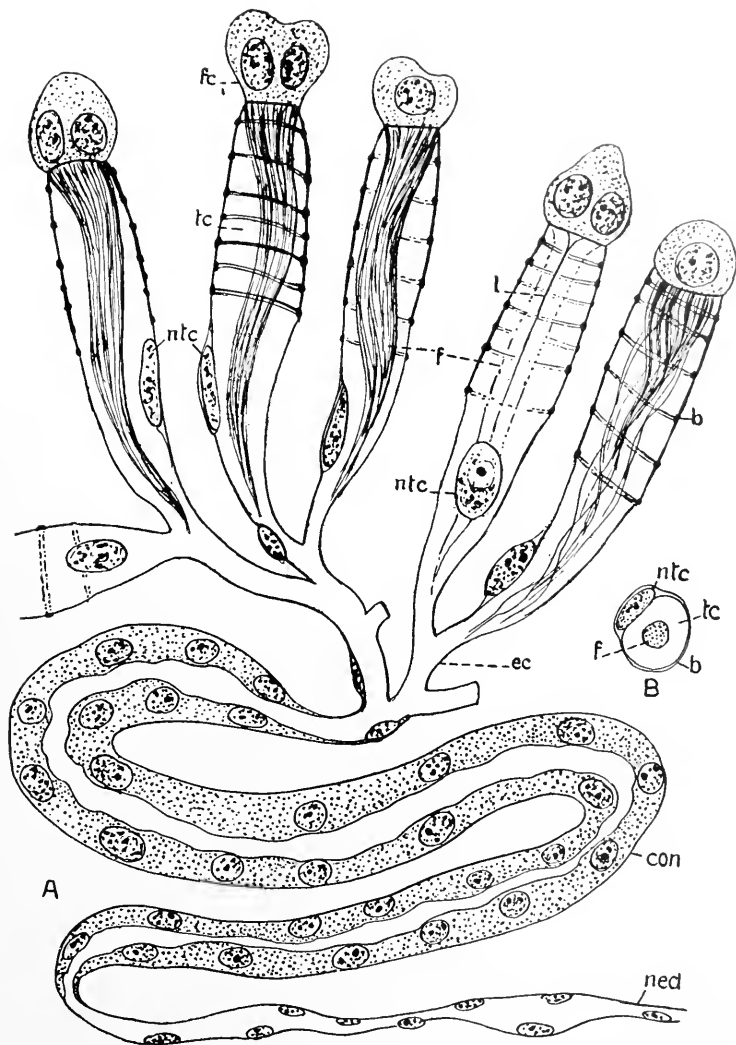

FIG. 1. *A*, Diagram of a single nephridium of *Geonemertes agricola*, showing five terminal organs connected with the convoluted tubule (*con*) which leads to the exterior of the body by the slender efferent duct (*ned*); *b*, thickened bar in wall of terminal chamber (*tc*); *ec*, end canal; *f*, flagellum arising from flame cell (*fc*); *l*, longitudinal bar; *ntc*, nucleus of terminal chamber. *B*, transverse section through a terminal organ. $\times 2500$.

flame cells on each side of the body in the more typical nemerteans. In my earlier paper ('04) I came to the conclusion that several convoluted tubules from adjacent clusters of flame cells were, in fact, actually thus united but I am now convinced that this is not the case, except, possibly, in rare instances, and that longitudinal collecting tubules do not occur. Each cluster of flame cells has a separate duct to the surface of the body.

I take this opportunity of describing in more detail the excretory system of *Geonemertes agricola*, the common land nemertean of Bermuda, and of comparing it with that of the other species of the genus in so far as our present knowledge will permit.

The most anterior nephridia are found in the head, about half way between the brain and the anterior extremity. They lie imbedded in the parenchyma and open to the exterior by the most direct path, either to the dorsal or to the ventral surface, according to their position. Posterior to the brain they occur in the parenchyma on all sides of the fore gut and proboscis sheath, but are most numerous near the dorsal and ventral aspects of the lateral nerve cords and near the ventrolateral margins of the proboscis sheath. In most regions of the body they are more abundant in the parenchyma on the ventral side of the lateral nerve cords than elsewhere. The total number is several hundred.

The number of terminal organs (flame cells) connected with each nephridium varies considerably, but is usually between six and ten. They frequently occur in pairs, each end canal supplying two terminal organs. Each of the latter consists of a slender, cylindrical terminal chamber from 0.015–0.024 mm. in length and from 0.0025–0.0038 mm. in diameter. Occasionally the chamber is distended to a width of 0.0045 mm. These dimensions differ but slightly from the figures given by Schroeder ('18) for the corresponding chamber in *G. palaensis* (0.014–0.02 mm. long and 0.004 mm. wide). Miss Hett ('24) finds very much smaller chambers in *G. hilli*, the average size in that species being only 0.008 by 0.0015 mm.

At the distal end of the chamber is a binucleated cell body of somewhat greater diameter than the chamber itself. Each of the two nuclei is about 0.002 mm. in diameter. It is quite possible that each nucleus represents a separate cell, but I have found no indication of a separating cell membrane.

The lash of cilia fills the greater part of the chamber (Fig. 1). Occasionally the preservation is such as to reveal the individual flagella of which the lash is composed, as indicated in one of the chambers shown in the figure.

The wall of the terminal chamber is extremely thin but is reinforced by a parallel series of six to eight narrow circular or spiral bars, or thickenings, situated at regular intervals (Fig. 1). A more delicate longitudinal bar is sometimes seen to extend about half the length of the chamber, starting at the base and joining the circular bands. Since this longitudinal bar is often placed symmetrically with regard to the two nuclei in the terminal cell body it is possible to conceive of the wall of the chamber as being formed of two symmetrical halves, joined together by the longitudinal bar. A third nucleus lies close against the wall of the chamber near its connection with the end canal (Fig. 1) and this presumably represents a cell which is actively concerned with the formation of the wall.

The series of circular bars extends through about half the length of the chamber, the most proximal bar lying not far removed from the nucleus near the proximal end of the chamber (Fig. 1). These relations are considerably different from those described and figured by Schroeder ('18) for *G. palaensis*, where the series of bars reaches only half way from terminal cell to the proximal nucleus. Schroeder also describes two longitudinal bars of considerable prominence.

A short, narrow and thin-walled end canal, with a branch to each of the flame cells of the cluster, leads directly into the distal end of the convoluted tubule (Fig. 1). The latter has relatively thick walls with granular cytoplasm and scattered nuclei, but is without cell boundaries. This portion of the nephridium also lies in the parenchyma and doubtless has an active excretory function.

The convoluted tubule is similar to the main longitudinal canal of typical nemerteans in its essential structure and its function is presumably identical. After making one or two loops in the parenchyma the walls become gradually thinner, leading to the slender efferent duct which passes through the body walls to the minute opening on the surface of the ciliated integument.

Comparison with Other Species.—In only five of the twelve

described species of terrestrial nemerteans have the nephridia been found but, as Miss Hett ('28) has pointed out, this fact should not be taken as indicating that they are not present in life. Such delicate structures are always difficult to find in improperly fixed material. All except one of these five species agree in having very numerous isolated clusters of flame cells, each group with its own efferent duct to the exterior and thus lacking the longitudinal collecting tubule which is frequently the only part of the system mentioned in anatomical descriptions of most littoral nemerteans. *G. chalicophora*, the natural habitat of which is unknown, is the only terrestrial form described as having a pair of such longitudinal tubules. Böhmig ('98) mentions ten pairs of efferent ducts for this species.

Schröder ('18) found that the excretory system in *G. palaensis* consists of many thousands of isolated nephridia, each with its own efferent duct. The number in the single specimen available for study was estimated by him to be about 35,000. Each nephridium is composed of several pear-shaped terminal organs, situated in the parenchyma internal to the body musculature, the extremely slender efferent duct passing with many convolutions through the muscular layers, cutis and epidermis to open at the outer surface of the ciliated cells on the lateral, latero-dorsal and latero-ventral aspects of the body. Usually ten or more pairs of terminal organs open into each tubule. The cytoplasm of the cells of the tubule contains granules and globules, but no cilia were found. In some sections the flame cells are so numerous as to make an almost continuous layer beneath the body musculature.

Only in minor details therefore does the system in that species differ from the conditions found in *G. agricola*, although the estimated number is vastly greater than in the latter species. In other anatomical features the two species differ widely.

The excretory organs of *G. hilli* have also been fully described and figured by Hett ('24). This species likewise has very numerous isolated nephridia of similar structure but of much smaller size. She has also ('28) found in *G. australiensis* organs of a similar type.

In no other nemerteans, so far as known, is the excretory system closely similar to that of the terrestrial species, the nearest approach, perhaps, being in the fresh water species of the genus

Prostoma. Here the terminal organs lead to a number of short and disconnected longitudinal canals. In species of *Cephalothrix* there are numerous isolated nephridia, as described by Wijnhoff ('10), but in those species the terminal organs are more nearly spherical and are multinucleate, with only a single terminal organ connected with each efferent duct.

All parts of the nephridium, except the efferent duct where it passes through the body wall, lie free in the parenchyma and hence are not in contact with the blood vessels. The fluid excretions of the terminal chamber as well as the substances excreted by the convoluted tubule must therefore be taken directly from the parenchyma. The latter is of a semifluid or gelatinous consistency and hence readily permeable by soluble materials brought to the vicinity by the blood vessels.

The blood-vascular system of the land nemerteans differs from that of most other groups in having numerous valve-like cells in the walls of the smaller vessels. In *G. agricola* the vessels are profusely branched in the anterior half of the body and the valve cells are very conspicuous. Similar cells are found in the vessels of some of the fresh-water nemerteans, and this is a further indication of the close relationships of the two groups.

LITERATURE.

Böhmig, L.

- '98 Beiträge zur Anatomie und Histologie der Nemertinen. Zeits. wiss. Zoöl., 44, pp. 479-560.

Coe, W. R.

- '04 The Anatomy and Development of the Terrestrial Nemer-
tean (*Geonemertes agricola*) of Bermuda. Proc. Boston
Soc. Nat. Hist., 31, pp. 531-569.

Hett, Mary L.

- '24 On a New Land Nemertean from New South Wales. Proc.
Zoöl. Soc. London, 1924, pp. 775-787.
'28 On Some Land Nemerteans from Upolu Island (Samoa),
with Notes on the Genus *Geonemertes*. Proc. Zoöl. Soc.
London, 1927, pp. 987-997.

Schröder, O.

- '18 Beitr. zur Kenntniss von *Geonemertes palaensis* Semper.
Abh. Senckenb. Nat. Ges., 35, pp. 155-175.

Wijnhoff, G.

- '10 Die Gattung *Cephalothrix* und ihre Bedeutung für die Sys-
tematik der Nemertinen. Zoöl. Jahrb., Abt. Anat. u. Ont.,
30, pp. 427-534.





BIOLOGICAL BULLETIN

OF THE

Marine Biological Laboratory

WOODS HOLE, MASS.

VOL. LVI

MAY, 1929

No. 5

CONTENTS

REICHLER, HERBERT S.	<i>The Diagnosis of Monoövarular Twinning...</i>	313
NADLER, ERNEST J.	<i>Notes on the Loss and Regeneration of the Pellicle in Blepharisma undulans.....</i>	327
FEDERIGHI, H.	<i>Rheotropism in Urosalpinx cinerea Say...</i>	331
MCCONNELL, CARL H.	<i>Experimental Observations upon the Endodermal Glands of Pelmatohydra oligactis</i>	341
HUFF, CLAY G.	<i>Ovulation Requirements of Culex pipiens Linn</i>	347
ROMANOFF, ALEXIS L.	<i>Study of the Physical Properties of the Hen's Eggshell in Relation to the Function of Shell-Secretory Glands</i>	351
MARTIN, J. HOLMES	<i>Effect of Excessive Dosages of Thyroid on the Domestic Fowl.....</i>	357
BRINLEY, FLOYD J.	<i>The Effect of Ammonium Salts on Proto-plasm of Amöba.....</i>	371

PUBLISHED MONTHLY BY THE
MARINE BIOLOGICAL LABORATORY

PRINTED AND ISSUED BY
LANCASTER PRESS, INC.
LANCASTER, PA.

AGENT FOR GREAT BRITAIN
WHELDON & WESLEY, LIMITED
2, 3 and 4 Arthur Street, New Oxford Street, London, W. C. 2

Single Numbers, \$1.00. Per Volume (6 numbers), \$4.50

Editorial Staff

- GARY N. CALKINS—*Columbia University.*
E. G. CONKLIN—*Princeton University.*
M. H. JACOBS—*University of Pennsylvania.*
FRANK R. LILLIE—*University of Chicago.*
GEORGE T. MOORE—*The Missouri Botanic Garden.*
T. H. MORGAN—*Columbia University.*
W. M. WHEELER—*Harvard University.*
E. B. WILSON—*Columbia University.*

Managing Editor

- C. R. MOORE—*The University of Chicago.*
-

All communications and manuscripts should be sent to the Managing Editor, the University of Chicago. Subscriptions and other matter should be addressed to the Biological Bulletin, Prince and Lemon Streets, Lancaster, Pa.

BIOLOGICAL BULLETIN

THE DIAGNOSIS OF MONOÖVULAR TWINNING.

II. CLINICAL ASPECTS.

HERBERT S. REICHLÉ, M.D.¹

Since earliest times the occasional occurrence of extraordinarily similar twins has aroused the interest of mankind. The importance of this observation was however ignored by many centuries of scientists until Galton (1) in his researches into genetics in 1883 established the essential principles of our subject. Galton differentiated sharply between characteristics which are determined by the germ plasma and those which are developed by the interaction of organism and environment. He called attention to the existence of twins who showed remarkable resemblances and by refinements of differentiation he attempted to discover traits in them which were usually dissimilar. These differences, he suggested, defined the limits of inheritance. In them the individual play of chance or the effects of environment had exerted their influence.

The principles of modern genetics permit us to regard Galton's "identical" twins as products of the union of one egg and one spermatozoön. Evidence for this statement can be drawn from numerous sources. Obstetricians agree that the monochorionic twin is also a monoövuular one. It is difficult to explain the large percentage of monochorionic births by any other embryological mechanism. Modern conceptions of teratology ascribe the formation of double monsters (*cosmobia*) to the incomplete division of two growth centers in the developing ovum. Weinberg (2) was the first to call attention to the statistical proof of monoövuular

¹From the Department of Pediatrics, Western Reserve University and the Babies' and Children's Hospital, Cleveland, Ohio.

twinning. Statistics from all over the world give the following ratio of sex correlation in twin births:

$$\frac{\text{♂♂}}{1} : \frac{\text{♂♀}}{1} : \frac{\text{♀♀}}{1}$$

Sex is however a Mendelian characteristic and should therefore be present in quite different proportions, namely:

$$\frac{\text{♂♂}}{1} : \frac{\text{♂♀}}{2} : \frac{\text{♀♀}}{1}$$

It follows that there are twice as many same sexed twins as there would be if sex selection were uninfluenced by other factors than Mendelism. This phenomenon is best explained by the assumption that about one half of all likesexed twins and about one third of all twins are monoövuilar. The latter are of course always likesexed. Observations from experimental biology (Loeb (3), Spemann (3) established the possibility of a monoövuilar development of two or more individuals and Newman's (4a) and Patterson's (5) work on the armadillo give us an almost complete history of the normal development of such individuals. The possibility that two individuals of different germ plasm can possess the striking resemblances often seen in so-called "identical" twins is, as Siemen has pointed out, infinitely small.

Such a phenomenon is of the greatest biological importance since it offers unique possibilities to the student of genetics. In such a pair of twins we have a clone, an identity in inheritance, which must of necessity be subjected to different environmental influences. We should be able therefore to discover the purely inherited factors of the human constitution and the degree to which these are modified by the environment; in the technical language of genetics we should be able to differentiate sharply between the genotype—the potential individual—and the phenotype—the actual individual. It should be possible to determine by a study of known monoövuilar and known diovular twins the acquired or inherited nature of any characteristic.

It is obvious that such a technique must be of immeasurable value to genetics. Its very promise however impels us to examine critically the premises upon which it is based. We must for the

present regard the fact that monoövuular twins are the product of one sperm and one ovum as undebatable. We approach more debatable territory in our second assumption that such individuals possess identical germ plasms. The objections advanced against this assumption do not appear to us to be serious. Unless the chromosome division which precedes cell multiplication is equational—we except of course the maturation divisions which do not concern us in the discussion of our problem—Mendelism and in fact all our conceptions of cell inheritance must be worthless fictions. Such abnormal cell divisions do occur; but these exceptional cases do not destroy the universal validity of the biological law. Nature's mechanisms are rarely flawless. Idiokinesis—the phenomenon of unexplained chromosomal disturbance—is also a rare occurrence; moreover it has been observed chiefly in lower animals. We must also consider the possibility that the division of the egg into two independent units occurs later in its development, at a time when some division of cell potentialities has taken place. Characteristics would then have been segregated in the cells of the one individual and a difference in the phenotype would result. This is the one serious objection of all those that have been advanced.¹ Such an assumption is but ill supported by accepted biological observations. Serious—mostly lethal—results follow the separation of the developing organism into its constituent units at such a stage. Until more conclusive evidence is advanced we must accept the classical viewpoint that such a separation occurs very early in embryological development before segregation has taken place.

An article of Newman (4b) which appeared while we were correcting this paper accepts the view that segregation does take place. Newman believes that we can explain the varying similarity of monoövuular twins by hypothecating a variation in the time period of the blastomeric separation. If this occurs after an axial asymmetry of the ovum has been established, important differences must appear in monoövuular individuals. It is not the province of the author of this paper to discuss the possibilities of such a biological mechanism. It certainly does not appear that the

¹ Lenz (6), Newman (4) and Corner (7) are the principal proponents of this view.

biologists themselves are agreed upon the matter. We must however observe that if Newman's hypothesis is correct, the value of Siemen's technique for genetics must become very small indeed. It is therefore a very important question which Newman raises. The study of conjoined twins should aid us in answering this question for they—together with the double monsters—would in the light of Newman's hypothesis be the products of a late separation. They therefore should reveal greater dissimilarities than non-conjoined M. O. twins. We know of no facts which support such an assertion. More work along this line is indicated. It is however possible to explain the differences between monoövuular twins in a manner quite different from Newman's, namely by the influence of early environmental changes in utero and after birth. We call attention to Schatz's (10) work, to the influence of the birth mechanism on the first twin born and to parakinetic factors which may differ for the twins during life. How incisive the latter may be has been described by Lange (22) in a very excellent article.

After we have satisfied ourselves that our theoretical premises are sound, there still remains the eminently practical question—how shall we recognize monoövuular twins? Evidently we must be very sure of this point before we can draw any legitimate conclusions from the use of our technique. The first attempt at a solution of this problem was made by Wilder (8) in his fundamental studies of palm and sole prints. We devoted our first paper to a discussion of their diagnostic value. We attempted to correlate similarity of palm and sole prints or the lack of this similarity with sex likeness in twins, as well as with the results of Siemen's diagnostic method. We also examined the palm and sole patterns of combined monsters (cosmobia), which are certainly monoövuular twins. The three methods convinced us that dermatoglyphics¹ failed to give a clear and persuasive answer to our questions (24). Newman (4b) and Taku Komai (23) have arrived at different conclusions. However Taku Komai admits that he saw examples of discordancy between dermatoglyphics and other diagnostic signs of zygosity. We therefore do not

¹ Term coined by Cummins to include studies on sole, palm and finger prints.

believe that our disagreement with the Japanese writer is very serious. Newman on the other hand is very positive that dermatoglyphics is "the best single diagnostic aid." He says "a great deal of stress has been laid [by us] upon the diagnostic value of the palm and finger patterns. While this criterion is inadequate for certain diagnosis, it is surprising how few mistakes are made." Our experience with cosmobia and the many discordant results found in the literature do not permit us to share Newman's view. He might suggest and—if his theory of blastomeric separation be accepted—with right, that cosmobia are not the equivalents of his "identical" monoövuular twins since they are the products of a separation occurring after axial asymmetry has been established. This would not decrease the value of our observations for as Newman himself will admit there is no essential difference between cosmobia and true monoövuular twins. What is true for cosmobia, would therefore also be true for a certain percentage of monoövuular twins.

The character of the birth membranes has always been considered the most significant sign of monoövuular twin pregnancy. The relation between monozygotism and monochorionic membranes has been somewhat obscured by the misinterpreted observations of several prominent obstetricians. Strassmann (9) called attention to the fact that twins with monochorionic membranes usually show differences in weight and length that are greater than those of dichorionic twins. It is an error however to assume from this that monochorionic membranes are not associated with monoövuularity or that such twins do not possess identical germ plasms. These differences are the greatest in early embryonic life (Schatz (10)) and grow smaller with the age of the foetus. The lines of development continue to converge after birth as Verschuer's (12) figures prove conclusively. He found that the percentage difference of weight at birth was 7.8 for monoövuular twins, whereas for diövular pairs it was only 6.3. For twins at the age of 19 years, however, these figures were 2.6 and 4.6 respectively. Schatz's work on the "third circulation" of the placenta in monochorionic twins explains this phenomenon. This painstaking worker showed that in such membranes there is an intimate anastomosis between the vascular systems of the

twins so that the blood from the one can flow freely into the circulatory system of the other. If through some trick of chance, the cardio-vascular mechanism of the one is superior to that of the other, the fortunate twin will gain an advantage in cellular nutrition. This leads to a hypertrophy of the one twin or to a hypotrophy of the other; in extreme cases the handicapped twin may develop hypoplasias of the cardiovascular apparatus which are incompatible with post-fœtal life or it may die in utero and degenerate into a fœtus papyraceous. After birth nutritional equality between the twins is restored and the genotypic identity may in the course of years eliminate these differences.

Siemens (11) has recently offered additional objections to the use of birth membranes in the diagnosis of monozygotism. He and Verschuer (12) have published observations on several individuals who showed an apparent conflict between the birth membrane diagnosis and the results obtained by comparing the bodily characteristics of the twins. We are not prepared to accept the radical view of these authors that monoötvular twins may occasionally have dichorionic birth membranes, and diovtular, monochorionic. The difficulties which embryology throws in the way of such an hypothesis are as yet too formidable to be overthrown by the evidence which results from the clinical study of twins. Despite decades of scientific obstetrics no case of monochorionic membranes in different sexed twins has yet been discovered. This is a crucial case which might establish Siemen's objections upon a legitimate basis.

The real difficulty of membrane diagnosis is the inadequate nature of the examination. In the majority of cases, of course, the results of the examination will not be available. When the reports are available, the investigator often discovers that the membranes have been examined solely to guard against retention of membrane parts and that no conclusion as to the nature of the twin pregnancy can be drawn. This at least was our experience. The description is usually summarized in a few words, such as: "Membranes entire, one placenta present." Of course dichorionic membranes may possess one placenta and it is probably possible for monochorionic membranes to have two. Equally unsatisfactory is a report which reads: "The twins are dichorionic."

This is a diagnosis and the investigator does not know the observations from which the conclusion has been drawn. The only report which can be safely used is one which describes the condition of the septum or which states that the two chorio-amniotic sacs were entirely separate. In monochorionic twins the septum should be composed of amnion only. Usually the two original layers cannot be separated. In rare cases even this sheet of tissue may be absorbed and the twins may lie in one cavity. In dichorionic twins the septum can usually be easily separated by blunt dissection into two amniotic layers, between which one or two chorionic layers are found. The answer to the question—monochorionic or dichorionic—is therefore given by an investigation of the septum. If the septum has been torn to shreds, it may be necessary to study microscopic sections.

One pair of our twins illustrates how misleading an incomplete report may be. Case No. 7 were unlikesexed twins, hence certainly diovular. They had dissimilar iris color, hair color, skin color, skin type, and dissimilar lanugo distribution. Yet the report of birth membrane examination is: "Placenta ovoid, 30 x 25 cm., two cords measuring 60 cm. each and inserting laterally. Single chorion with two amnions." It is evident that reports which neglect to describe the septum are valueless for the purposes of genetic study even though the records may have been made in a Class I Obstetrical Hospital, as was the case with us.

We must therefore agree with Siemens that the records of birth membranes will rarely be of value in differentiating monoövdular from diovular twins. We do not however accept a diagnosis of monoövdularity which is at variance with an authenticated membrane diagnosis. Cases of apparent conflict such as Siemens and Verschuer have described are not fit subjects for genetic research.

As can be deduced from the foregoing remarks, the diagnosis of monozygotism has hitherto been a difficult and an uncertain procedure. In 1924 Siemens (11) suggested an entirely new approach to this problem. He pointed out that monoövdular twins must show a greater number of similarities in characteristics determined or modified by the germ plasm than diovular twins. Therefore twins possessing close similarities in essential characteristics are probably monoövdular, the probability growing with the num-

ber of similarities. This assumption needs fear no statistical criticism; it is well known that in such a series the probability increases not arithmetically but geometrically. It is circumstantial evidence of the highest order and is the basis of the Bertillon and other like systems of individual identification. Several rules however must be observed. The characteristics which are chosen must be genetically unrelated;¹ otherwise their association in two individuals will constitute a spurious series. They must moreover be independent of environmental influence to a relatively high degree; we must therefore weigh very carefully the differences in the life histories of twins. It should not be forgotten that even in foetal life remarkable parakinetic influences may develop. Thirdly, the characteristics must show a wide range of variation in the population from which the objects of the investigation are taken. For example, blue eyes, blond hair and florid complexion would be of little positive value in a Scandinavian country. The greater the heterogeneity of the population, the more valuable will be the comparison of similarities.

Siemens (11) selected the following characteristics for his system:

Group A. Traits "which are practically always exactly the same in the case of monoövuular twins, and practically never so in the case of diovuular." They are: Hair color and form, iris color, lanugo distribution.

Group B. Traits "which vary only slightly and rarely in monoövuular twins but more so in diovuular." They are: freckles, characteristics of skin vessels (*cutis marmorata*, telangiectasis, *akroasphyxia*), keratoses and folliculoses (*ichthyosis*, *keratosis follicularis*, *acne*), tongue furrowing.

Group C. Traits which "are usually alike in monoövuular, rarely much alike in diovuular twins." They are: face and head forms; ear, hand and nail forms, body build. To these Siemens adds the psychical attitude and inheritable diseases and malformations.

Other authors have suggested different methods. Schiff (14) and Wiechmann and Paal (15) have published articles on indi-

¹ Muller (13) believes that such a relation—linkage of the genes—is rare in man.

vidual blood grouping. Mayer-List and Hübener (16) have described the micro-capillary pictures of monoövascular and diovascular twins. Gantner and Rominger (17) presented new investigations in favor of the use of palm prints. Anthropometry has been exhaustively discussed by a number of writers: Schultz (18), Beckershaus (19), Siemens (11), Verschuer (12) and Dahlberg (20). Beckershaus (19) has compared the refractive indices of eyes and other data obtained by ophthalmometric technique.

Siemens (11), Verschuer (12), Dahlberg (20) and Newman (4b) have all published favorable reports of their use of the Siemens' method. The individuals examined by these authors were adults or older children. The present publication concerns itself with infants and younger children. This is an important difference, since there are a number of factors which make the application of the method more difficult in the younger subject. Perhaps the most important source of error is the delay in the manifestation of congenitally determined characteristics. The late development of the individual's permanent iris color is an example of such and it is easy to understand how fruitful of error the use of eye color would be if, as so frequently happens, the changes in the iris do not occur simultaneously in both twins. Many of the traits moreover do not appear until later in life. There is therefore a lack of differentiation in young children. The difficulty of all examinations at this age will also play a rôle. Lastly there is the important fact that monoövascular twins will tend to converge in their lines of development, whereas diovascular twins show divergence with their advancing years, as has been demonstrated above.

In order to avoid an artificial selection of our subjects, we examined all twins who were admitted to the Babies' and Children's Hospital and Dispensary of Cleveland. We also examined a series of twins who were born at the Maternity Hospital of Cleveland.¹ Our conclusions are drawn from the results of the examination of 38 pairs of twins whose ages ranged from new-born to 8 years. Four were new-borns and only four were over 5 years of age. Thirty pairs were likesexed; eight were unlike. Every

¹ We are indebted to Dr. Arthur H. Bill, Professor of Obstetrics and Gynecology, Western Reserve University for the permission to examine these infants.

precaution was taken to avoid any prejudice in diagnosing the type of twinning. No attempt was made to form a judgment of "identity" at the time of examination; the traits were noted on prepared blanks for each twin separately in a purely descriptive fashion. The similarities in the various traits were diagnosed many weeks later and an attempt was then made to diagnose the twinning by Siemen's method. This result was compared with the palm prints and, when it was available, with the birth membrane diagnosis. We have therefore avoided prejudice as far as possible. We made no attempt to obtain an exact mensuration of color and size since it was our intention to study the application of Siemen's method without burdening it with refinements which would hamper or nullify its routine clinical use. Verschuer (12) and Dahlberg (20) have used anthropometry with considerable success in the study of older subjects. However it seems to have only a statistical value at present since the average differences between monoövular and dioövular twins are usually not large enough to exclude many cases which overlap.

The crucial test of Siemen's method must be our ability to demonstrate two groups of twins. The one must have identities in a large percentage of characteristics, the other must show a low percentage of identities. The members of the first group must be identical in the major characteristics of Siemen, namely, eye, hair and skin color and lanugo distribution, characteristics which Siemen together with other students of genetics regards as undoubtedly inherited. To these characteristics we must add sex; the members of the first group must always be alike in sex. In fact this is the one point about which there can be no argument. Monoövular twins must be likesexed.

We selected characteristics which were found in most of the twins of our group. These were:

<i>Eyes</i>	Sclera color
	Iris color
	Lashes, color and length
	Brows, color and length
<i>Hair</i>	Amount
	Distribution

	Color
	Texture and form
	Lanugo distribution
<i>Skin</i>	Color
	Type
<i>Face</i>	Form with detailed description of the various parts, such as brow, chin, malars, etc.
<i>Mouth</i>	Form
	Size
<i>Teeth</i>	Number
	Size
	Shape
	Character
<i>Ears</i>	Size
	Shape with detailed description of lobe, tragus, helix, etc.
<i>Fingers</i>	Size
	Shape
<i>Temperament</i>	

Thirty-eight pairs of twins who had been adequately examined were utilized in our study. The percentage of identities in the above mentioned traits was computed for each pair. We expected to find the monoövuular twins in the group with the higher percentage of identities. Our actual results do not support this hypothesis. It is true that the six cases with a birth membrane diagnosis which had been made by personal examination show no discrepancy between identity percentage and membrane diagnosis. On the other hand twins No. 30 which have a high identity percentage of 70 are unlikesexed, hence certainly diövuular. Our expectation that this group of twins would be identical in the major traits of Siemens, iris, hair and skin color and lanugo distribution, was also unfulfilled. There are three pairs with high general identity percentages and notable discrepancies in the major traits. Twins No. 4 which have a general identity percentage of 64 have unlike skin color and lanugo distribution; twins No. 24 with a percentage of 77 have skin colors and lanugo distribu-

tions that vary in minor points, and twins No. 8 with a percentage of 78 have dissimilar irises. The case of twins No. 30 is however crucial. These twins had identities in all the major traits and the high general percentage of 70; yet they were unlikesexed and hence must be dioöular. Cases 4, 24 and 30 were colored individuals. It is well known that variations in the darker shades of color are much more difficult to differentiate than those of the lighter. It is therefore possible that the high percentage of negroes in our group is in part responsible for the failure of Siemen's technique in our hands. This does not however explain all the discrepancies. In the entire series of cases—whether white or colored—there was a notable absence of that striking similarity between monoövular twins which one sees so frequently in the case of adults. This difference is probably due to the reasons which were enumerated above.

We must therefore conclude that Siemen's method is unreliable when applied to young children. We know of no other method which can replace it. We therefore do not believe that it is possible at the present time to diagnose with certainty the type of twinning when the subjects are of an immature age. Deductions drawn from such work are not above question. The results of our investigation do not of course apply to the use of the Siemen's technique when applied to older children or adults. Yet even within these limitations a sceptical attitude towards the method is still justified. There is perhaps at present a tendency to be overly anxious to reap the harvest from a technique which though very ingenious and promising has not yet passed out of the hypothetical stage. Despite the opinions of Siemens (11) and Newman (4b) we believe that more work must be done with *unselected* groups that include both like and unlikesexed twins. The absolutely determinate character of sex is too important in this field to be abandoned because of the complicating factor of sex linked genes. It is likely that such an investigation will substantiate Dahlberg's (20) opinion that Siemen's method is satisfactory if applied to a series of cases but that we cannot be absolutely certain of the diagnosis in an individual case.

After the completion of this study we discovered the publication of Klein (21). This author examined fourteen pairs of twins.

Only one pair was five years of age, the others were below two and one-half. In every case the birth membranes had evidently been carefully and adequately examined. Five dichorionic twins were identical in all of Siemen's twelve important traits; four other pairs showed great discrepancies between the birth membrane diagnosis and that made by the Siemen's method. Klein's work therefore substantiates our results.

CONCLUSIONS.

1. Our present methods of diagnosing the type of twinning are either impracticable or unreliable when applied to young children and infants.

2. Our most dependable source of information is the investigation of the birth membrane.

3. Reports of birth membrane examinations are valueless unless they describe the condition of the septum. It should be noted in the records of obstetrical institutions whether or not a layer of chorion was found between the two amniotic sheets.

1. **Galton, F.**

'83 *Inquiries into Human Faculty and its Development.* Macmillan, London. (Also to be had in Everyman's Library.)

2. **Weinberg, W.**

'02 *Pflüger Archiv. f. d. gesamt. Physiologie*, Bd. 88, 346.

3. **Loeb, et altera.**

Quoted from Verschuer.

4. (a) **Newman, H. H.**

'23 *The Physiology of Twinning*, University of Chicago Press.

'24 *The Biology of Twins*, University of Chicago Press.

(b) **Newman, H. H.**

'28 *BIOLOGICAL BULLETIN*, 55, 283.

5. **Patterson, J. Th.**

Quoted from Newman and Verschuer.

6. **Lenz, F.**

'26 *Handbuch der normalen u. path. Physiologie*, xvii (III). Springer.

7. **Corner, G. W.**

'22 *John Hopkins Hospital Bulletin*, 33, 389.

8. **Wilder, H. H.**

'04 *American Jour. of Anatomy*, 3, 387.

'02 *American Jour. of Anatomy*, 1, 423.

'16 *BIOLOGICAL BULLETIN*, 30, 135; 30, 211.

'26 *BIOLOGICAL BULLETIN*, 50, 393.

9. **Strassmann, P.**
'04 Die mehrfache Schwangerschaft, v. Winkel's Handbuch der Geburtshilfe, Bd. I.
10. **Schatz, F.**
'84 Archiv f. Gynäkologie, Bd. 24, 336.
11. **Siemens, H. W.**
See Verschuier for list of publications.
12. **Verschuier, O. von.**
'27 Ergeb. der Inn. Medizin u. Kinderheilkunde, 31-35. Complete literature.
13. **Muller, H. J.**
'25 Jour. of Heredity, 16, 437.
'26 Jour. of Heredity, 17, 195 and 204.
14. **Schiff, F.**
'14 Berl. klin. Wochenschrift, 51, 1405.
15. **Wiechmann, E. and Paal, H.**
'27 Münch. med. Wochenschrift, 74, 271.
16. **Mayer-List, R. and Huebener, G.**
'26 Münchener med. Wochenschrift, 72, 2185.
17. **Ganther, R. and Rominger, E.**
'23 Zeitschrift f. Kinderheilkunde, 36, 212.
18. **Schultz, A.**
'26 The American Naturalist, 60, 297.
'21 Zoologica, 3, 243.
19. **Beckershaus, F.**
'26 Zeitschrift f. Augenheilkunde, 59, 264.
20. **Dahlberg, G.**
'26 Twin Births and Twins from a Heredity Point of View (in English). Stockholm Bokforlags, A. B. Tidens Tryckeri.
21. **Klein, P.**
'27 Archiv. f. Gynäkologie, 130, 788.
22. **Lange, J.**
'28 Zeitschrift f. Kinderforschung, 34, 377. (Abst. by author in A. J. of Dis. of Children in 1929.)
23. **Taku Komai.**
'28 Quart. Review of Biology, Vol. III., Sept., p. 408.
24. **Reichle, H. S.**
'29 The Diagnosis of Monoövuular Twinning—I. Dermatoglyphics.
BIOLOGICAL BULLETIN.

NOTES ON THE LOSS AND REGENERATION OF THE
PELLICLE IN *BLEPHARISMA UNDULANS*.

J. ERNEST NADLER.

(From the Department of Physiology, University of Pennsylvania Medical School, Philadelphia.)

The color which is so characteristic of *Blepharisma undulans* has been the object of study and interest of many protozoölogists. It is usually a pink purple but may vary from deep purple violet to light rose, or the animals may be perfectly colorless. It has been recently suggested by Dawson (1929) that color changes accompany the process of digestion. It is believed that a somewhat different light is thrown on this general question by the observations here recorded.

When a drop of M/10,000 strychnine sulphate is added to individuals of this species on a slide they soon cast off their pellicles, swim away and leave the empty capsules behind. The color, so characteristic of this ciliate, is seen to be restricted to the pellicle which retains its color, the "naked" organism, on the other hand, being colorless.

During the process of shedding the pellicle, the cilia are withdrawn inside it where they go on beating in coördination (Fig. 1). This retraction starts at the anterior end of the animal and proceeds as a wave backward. After rotating for a short time inside of the pellicle the naked animal escapes by gradually working its way out in an ameboid-like manner through either the region of the posterior contractile vacuole or the base of the gullet. If for any reason the naked organism is unable to escape from the pellicle, death invariably follows. Dividing individuals shed their pellicle as one. Pieces of the ciliate, cut with a microdissection needle, are likewise able to shed their pellicles. Conjugating pairs shed their pellicles as do non-conjugants but always escape through the gullet, either as separate individuals or as one, depending on the stage of conjugation and the degree of union.

During this process the conjugants frequently fuse giving rise to double monstrous forms.

The cast off pellicle is easily studied and presents a continuous

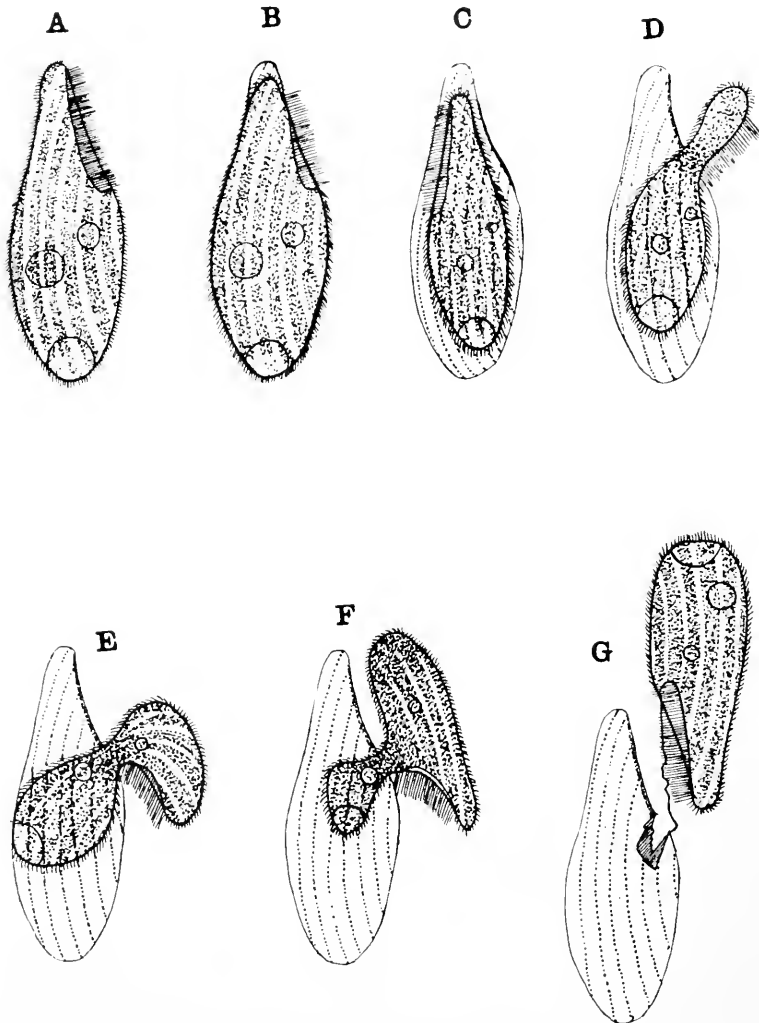

FIG. 1. Diagrams showing the method of shedding of the pellicle, the animal escaping by way of the gullet.

membrane-like structure with rows of small holes running lengthwise, through which the cilia had protruded, showing a definite arrangement of the cilia in from ten to eighteen rows. The

pellicle appears to be fastened more firmly at the base of the gullet than elsewhere and the empty membranous shell is usually dragged around by the animal for a short time by a strip of the pellicle attached to the base of the gullet.

The naked animal is much more flexible and is cut more easily with a microdissection needle than when the pellicle is intact. When cut, in this condition, the cut end instantly closes and the pieces behave like those with a pellicle.

The process of shedding may also be induced by a low concentration (M/100 to M/10,000) of morphine sulphate, codeine sulphate, cocaine hydrochloride and novocaine while it has not been found possible to produce it by the use of caffeine citrate, brucine, apomorphine, mercury succinate, picrotoxin, phenacetin, quinine hydrochloride, carbon tetrachloride, veronal, veratrine, nictotine, and saponin over a wide range of dilutions. Alcohol, ether and chloroform first decolorize and then dissolve the pellicle, both on the animal and when cast off. The chemicals that produce shedding do not seem to have any very obvious underlying property common to all, and little light is therefore thrown on the mechanism of the process. This fact is even more striking when the substances which produce shedding are compared with those which do not. The hydrogen ion concentration does not appear to play any great rôle in the process, as shedding can take place within the range of pH 5.6 to pH 8.2. Likewise, drastic alterations in the tonicity of the solutions by addition of salt or sugar do not cause shedding. This shedding is not merely due to a shrinking of the organism away from the pellicle, as caffeine produces such a shrinking without shedding of the pellicle taking place.

If *Blepharisma* is allowed to remain in a non-lethal concentration of the drugs which cause shedding, the pellicle after being lost is not regenerated. Individuals grown in M/100 morphine sulphate for 110 days did not form new pellicles although they grew, divided and moved perfectly normally. If removed to pure culture media as soon as the pellicle is shed the animals grow and divide, and after some time (1 to 12 days), regenerate new pellicles. Naked ex-conjugants may regenerate new pellicles in as short a time as 24 hours.

Regeneration is best obtained in culture media of wheat (average time for regeneration 9 days) and least successfully in hay infusion (average time 11 days, color pale). On a malted milk diet the pellicle is regenerated in about 10 days. The test for a new pellicle is the presence of color and the ability again to go through the shedding process.

Cultures with limited food supply are light pink in color while those with an excess of food are deeply colored. If starved, the organisms lose their color and pellicles in about 24 hours; the pellicle in this case does not appear to be shed but gradually becomes lighter in color and finally disappears (absorbed?). While the kind of food is likely an important factor in modifying the thickness of the pellicle the differences in color observed appear to depend to a marked degree on the thickness of the pellicle and this in turn on the amount of food available.

Further studies on the function and nature of the pellicle are in progress. It is a great pleasure to thank Professor M. H. Jacobs for many valuable suggestions.

SUMMARY.

1. It has been observed that when *Blepharisma undulans* is treated with strychnine sulphate, morphine sulphate and several other chemicals the pellicle is shed. The pellicle and the "naked" animal have been studied.
2. The pink color so characteristic of this animal is restricted to the pellicle.
3. The pellicle is not essential for life, division or motion and its character is dependent on the amount of food available.
4. Under favorable conditions the pellicle is easily regenerated.

LITERATURE CITED.

Dawson, J. A.

- '29 Cannibalism in a Ciliate, *Blepharisma*. Proc. Soc. Exp. Biol. & Med., XXVI., 335.

RHEOTROPISM IN *UROSALPINX CINEREA* SAY.¹

H. FEDERIGHI.

UNITED STATES BUREAU OF FISHERIES.

Rheotropism has been observed in many animals (Schulze, 1870; Parker, 1903, 1908; Lyon, 1904; Jennings, 1904; Dimon, 1905; Hadley, 1906; Allee, 1912; Jordan, 1917; Arey and Crozier, 1919, 1921), and the receptors for this response appear to vary in the different species. Stahl (1884, from Verworn, 1899) and Verworn (1899) believed rheotaxis to be a positive response to pressure stimulation, a theory that was used by Wheeler (1899) to explain anemotropism as a special form of rheotropism. According to Schulze (1870) and Bonnier (1896) the reaction in fishes is brought about by the stimulation of the lateral line organs, an interpretation that was shown to be untenable for *Fundulus heteroclitus* (Parker, 1904) and for *Epinephelus striatus* Bloch (Jordan, 1917), where the organs of touch serve also as the essential organs of stimulation by water currents. Tullberg (1903) eliminated the ear of fishes and found that the animals operated upon were insensitive to water currents, from which he assumed that the ear was the receptor for this response. To this theory there are serious objections, as was pointed out by Parker (1903). A theory first proposed by Lyon (1904, 1909) and accepted by Loeb (1918) stated that in fishes "the primary cause of orientation in streams of some uniformity of motion is an optical reflex, a tendency on the part of the animals to follow the field of vision. . . . The essential element of stimulation is the environment not the current. . . . Contact between the fishes and stationary objects may lead to orientation. . . . In violent streams. . . . the fish may be oriented without sight or contact with solid objects. . . . here. . . . relative velocities constitute the essential elements of stimulation. If part of the water moves, and the next to it is

¹ Published by permission of the United States Commissioner of Fisheries

relatively at rest, the fish may respond just as it does to contact with solids" (Lyon, 1904). "Fish with one eye blinded react to currents of water like normal fish. The usual form of stimulation is visual. The fish turn the nearest way to face the current, whether in so turning the motion be toward or from the injured side. . . . It seems to the writer impossible to bring these observations into accord with the tropism scheme of one-sided response to one-sided stimulation" (Lyon, 1909). Hadley (1906, 1908) showed that the lobster is rheotactic during its free swimming larval stage and by moving the environment rather than studying the animals in a current he showed that the optical stimulus alone is capable of producing this reaction. He adds that the rheotactic reaction *induced by currents* is more definite at night, tending to show that this is not optical. Main (1928) in the course of some experiments on the phototropism of fishes states "fish do not orient themselves in such fashion as to keep the *static* visual field the same."

In the literature on rheotropism there are no quantitative data available such as obtain for phototropism and geotropism. This may be due to the fact that the animals so far investigated have not permitted this type of study. For instance, it would be difficult to determine the rate of orientation of a fish in a stream of a given velocity. In a snail such as *Urosalpinx cinerea*, on the other hand, we have an animal that not only exhibits a precise and immediate reaction to water currents but is also admirably suited to quantitative study.

The following is a report of some observations on the effect of a current upon the movements of *Urosalpinx cinerea*. The interest of the data lies in the fact that this animal in its behavior to currents appears to follow Loeb's (1918) theory of tropistic conduct. Hitherto it has been impossible to interpret the reaction of animals to currents as a simple tropistic response (Lyon, 1909).

If *Urosalpinx cinerea* is placed in a current of water it orients itself so that the siphon is pointing upstream and then moves against the current. The response is definite and immediate. The removal of the eyes or of the tentacles does not disturb the precision and character of this reaction. Furthermore, light does not interfere with the orientation and movement, since experiments

carried on in the darkroom give results similar to those obtained in daylight. From these preliminary and general observations the work was expanded to include the following: (1) a study of the relation between the rate of current and the rate of creeping; and (2) a study of the relation between the rate of current and the rate of orientation (turning).

The apparatus used in these experiments consisted of a celluloid trough 2" x 2" x 20", open at either end and suspended in a water current on an even keel so as to eliminate geotropic effects. Figure 1 gives two views of the apparatus and shows the direction of flow of the current. The lower view (1) shows a longitudinal half of the apparatus. The upper sketch (2) is a top view of the apparatus. The arrows indicate the direction of the flow of water in the various parts of the two troughs.

The rate of the water current was determined by noting the time necessary for uniformly-sized bits of cork to travel five inches. Fifteen to twenty readings were taken for each velocity. These were averaged and the figure thus obtained was used as the surface velocity of the current, from which the bottom velocity was determined (Gibson, 1925). Surface velocities from 1.25 to 7.60 cm. per second were used. The water temperature was kept constant by means of a thermostat, to within $\pm 2^\circ$ Centigrade. The current was of the turbulent type, the only kind obtainable under these conditions.

The experimental animals were chosen for the definitiveness of their response alone, no attempt being made to obtain animals of the same size. Such selection is not only permissible but desirable (*cf.* Crozier, 1928). In all, twenty-five animals were used; eleven for the observations on the rate of turning, and fourteen for the experiments on the rate of creeping.

The data for the two series of experiments were collected in different ways. For the study of the relation between the rate of current flow and the rate of creeping, the time necessary for the animal to creep one half inch, directly against the current, was taken as a measure of the response. The procedure was as follows: after the desired current velocity had been obtained the animal was placed in the trough *B*. In a short while the animal would orient and begin creeping against the current. The time

(with a stop watch) necessary for it to creep one half inch was then noted. Since only those readings in which the animal crept actively and without apparent interruption were used, a mark on the shell was made to determine when the required distance had been traversed. Observations in which the animal pushed its shell forward without any actual translatory movement of the pedal mass were discarded. There were other factors which at times influenced the rate of creeping. For instance, the animal would sometimes veer off and strike the sides of the trough, and

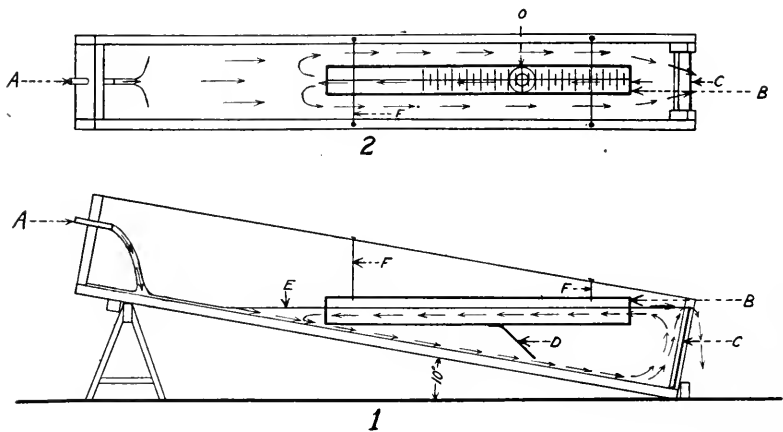

FIG. 1. Top (1) and side (2) views of apparatus. *A*, water inflow from coils placed in constant-temperature bath; *B*, celluloid experimental trough; *C*, glass front of outer tank; *D*, mirror at 45° angle to bottom of *B*; *E*, water level; *F*, wires supporting *B* on even keel; and *O*, system of circular and radial coordinates by which path taken by animal was copied.

occasionally a small mass of foreign substance resting on the bottom would interfere. All these records were disregarded. In a short while one could easily distinguish when the animal was moving actively and uninterruptedly. After each reading it was lifted from the substratum and the slime track cleaned away. In this way the influence of a previous track upon the movements of an animal was obviated. After approximately two to three minutes the next record was made. On the average ten readings were taken for each animal.

For these experiments fourteen animals were used, for which thirty-five satisfactory series of observations were made. In all

three hundred creeping rates at twenty-five different current rates were collected for the fourteen animals. Fig. 2 shows the results graphically when the current rate is plotted against the rate of creeping, both in inches per second.

Some slight but necessary modifications in procedure were made in the experiments on the effect of the current rate upon the rate of turning, but before giving these a word of explanation as to the apparatus is necessary. In Figure 1 (top view) there is seen the inner celluloid trough, in about the center of which are two concentric circles with perpendicular diameters. Immediately under this [as can be seen in the longitudinal section (2)] is placed a mirror (*D*) at an angle of 45° to the bottom of the trough. If one looks through the glass side (*C*) of the outer trough at the mirror (*D*) he sees reflected on the mirror the concentric circles (*O*). Thus when an animal is placed on "O," by

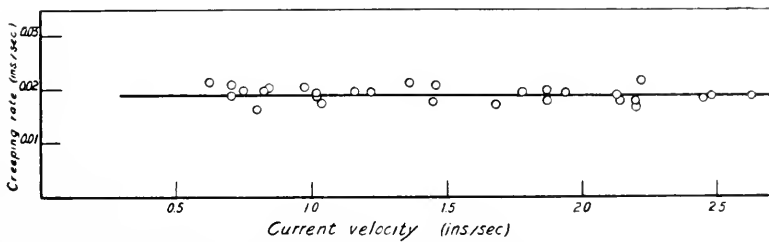

FIG. 2. Graph showing the relation between the rate of creeping and the surface current velocity both in inches per second.

looking through "C" at "D" one can observe the movements of its pedal surface. By the use of a similarly prepared record sheet the path of the animal is easily traced and a true record of the path of the animal's movements obtained.

The animal was placed at "O" and as soon as it began to creep and orient, its path was copied on the record sheet by observing continuously the path taken by a point on the pedal surface immediately behind the anterior transverse ridge, and a record was made of the time necessary for this movement. After each observation the slime track was removed. At least ten records were made for each animal. These were then measured for the total length of path and for the angular displacement of a tangent to the path, giving therefore three sets of figures for each trail: (1) the

total length of path; (2) the time required for such movements; and (3) the total number of degrees turned.

For these observations eleven animals were used at six different rates of current for a total of three hundred and two records. The results are shown in Fig. 3, where the square of the bottom

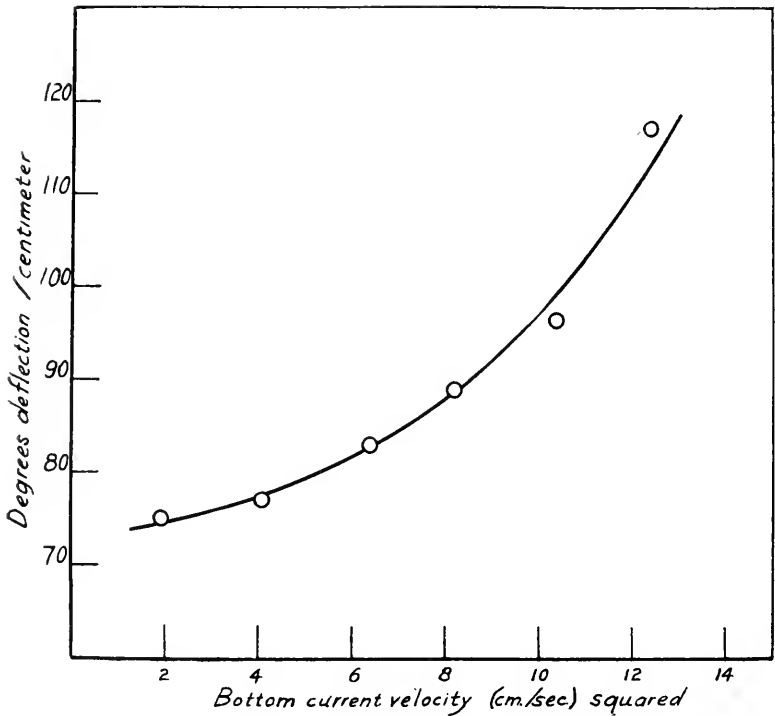

FIG. 3. Graph showing the relation between the bottom current velocity (cm./sec.) squared (Intensity) and the degrees deflection per centimeter of path (Effect).

current velocity is used as a measure of the intensity of stimulation and the degrees deflection per centimeter of path is a measure of the effect produced.

It is seen that the degrees turned per centimeter of path is a function of the rate of water current and that the curve (Fig. 3) is possibly the lower half of the S-shaped curve that one often obtains when the effect is plotted against the intensity (Hecht, 1922-23; Crozier, 1928). It was impossible to obtain points for

current rates higher than 7.60 cm. per second (at the surface) because above this the animal does not exhibit precise orientation and furthermore the stronger currents sometimes lift the animal from the substratum and passively wash it away. The receptors for this response seem to be the proprioceptors located in the symmetrical parietal muscles. The unequal tension on these muscles, produced by the pull of the shell which in a stream tends to straighten out so that the shell presents the least resistance to the

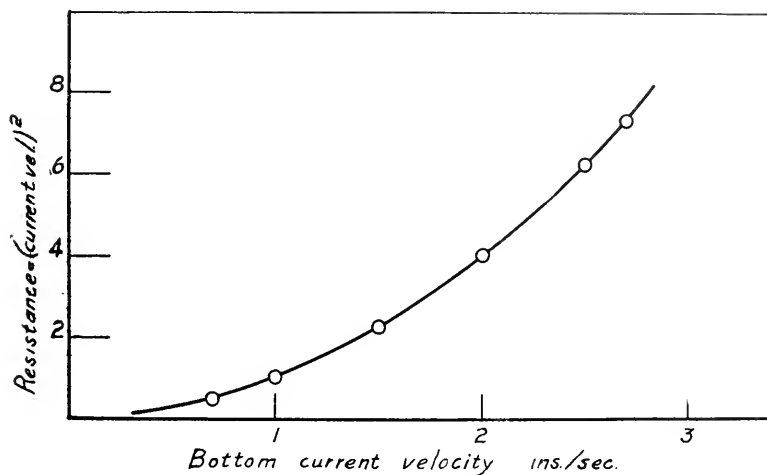

FIG. 4. Graph showing the relation between the bottom velocity in inches per second and the resistance overcome by the animal creeping against the current.

flow of water turning with the foot-mass as a pivot, is the stimulus which brings about orientation. This seems to be the same mechanism that functions in the geotropism of certain animals where it is proposed that the gravity responses depend on the stimulation of the proprioceptors in the parietal elements (Cole, 1925-26; Crozier and Federighi, 1924-1925; Wolf, 1926-1927; Crozier, 1928).

Whether the mechanism of creeping in *Urosalpinx cinerea* is the ciliated epithelium of the pedal surface (Copeland, 1919, 1922), or whether creeping is due to "arhythmic" pedal waves (Parker, 1911; Crozier, 1919) it is evident that the rate of creeping is not affected by the velocity of the current (Fig. 2). It

is necessary however to note that although the rate of creeping is constant the resistance overcome is greater as the current-rate increases. Thus the animal must do more work as the velocity increases in order to maintain its uniform rate of progression since the pressure exerted by a flowing stream of water is proportional to approximately the square of the velocity (Gibson, 1925). In other words, since in the results all other factors remain constant and only the resistance overcome or the pressure exerted by the flowing stream varies as the current varies, this may be taken as a measure of the effect produced upon the animal. In Fig. 4 these derived data are given in graphical form. The effect is given as the pressure exerted by the flowing stream of water (resistance overcome) which is equivalent to the square of the current velocity; the intensity of stimulation is given as the bottom current velocity. This means that if the resistance overcome by the animal is taken as a measure of the effect produced, then the effect is proportional to the square root of the current velocity.

These conclusions are important because for the first time it has been shown that the orientation and the creeping of an animal in a water current is a function of the intensity of the current. It has been possible to measure both intensity and effect and to show that: (1) the rate of turning is a function of the current velocity, and if these are plotted there is obtained a curve which is similar to that obtained for other intensity *vs.* effect curves; and (2), the rate of creeping is independent of the current rate, but if one takes the resistance overcome rather than the rate of creeping as a measure of the effect then the effect is proportional to the square root of the current velocity.

SUMMARY.

If *Urosalpinx cinerea* Say is placed in a current of water it will orient and move against the current. It has been possible to measure the rate of turning and the rate of creeping at various current rates. These results indicate that the rate of turning (degrees deflection per centimeter of path) is a function of the current velocity and that when plotted respectively as effect and intensity the curve obtained follows the usual effect *vs.* intensity curve obtained for other tropistic reactions. The organs of

stimulation for this response seem to be the proprioceptors in the symmetrical parietal musculature of the animal. Although the rate of creeping is independent of the rate of current, the amount of resistance overcome (or the work done) is also a function of the current velocity.

CITATIONS.

Allee, W. C.

- '12 An Experimental Analysis of the Relation between Physiological States and Rheotaxis in *Isopoda*. Journ. Exp. Zool., Vol. 13, pp. 269-344.

Arey, L. B., and W. J. Crozier.

- '19 The Sensory Responses of *Chiton*. Journ. Exp. Zool., Vol. 29, pp. 157-260.

Arey, L. B., and W. J. Crozier.

- '21 On the Natural History of *Onchidium*. Journ. Exp. Zool., Vol. 32, pp. 443-502.

Bonnier, P.

- '96 Sur les sens latéral. Compt. rend. soc. biol., sér. 10, T. 3, pp. 917-919.

Cole, W. H.

- '25-'26 Geotropism and Muscle Tension in *Helix*. Journ. Gen. Physiol., Vol. 8, pp. 253-263.

Copeland, M.

- '19 Locomotion in Two Species of the Gastropod Genus *Alcitrion* with Observations on the Behavior of Pedal Cilia. Biol. Bull., Vol. 37, pp. 120-138.

Copeland, M.

- '22 Ciliated and Muscular Locomotion in the Gastropod Genus *Polinices*. Biol. Bull., Vol. 41, pp. 132-142.

Crozier, W. J.

- '19 On the Use of the Foot in Some Mollusks. Journ. Exp. Zool., Vol. 27, pp. 359-366.

Crozier, W. J.

- '28 Tropisms. Journ. Gen. Psychol., Vol. I., pp. 213-238.

Crozier, W. J., and H. Federighi.

- '24-'25 Phototropic Circus Movements of *Limax* as Affected by Temperature. Journ. Gen. Physiol., Vol. 7, pp. 151-169.

Dimon, A. C.

- '05 The Mud Snail: *Nassa obsoleta*. Cold Spring Harbor Monographs, No. 5, 48 pp.

Gibson, A. H.

- '25 Hydraulics and its Applications. 3d Ed., xv + 801 pp. New York.

Hadley, P. B.

- '06 The relation of optical Stimuli to Rheotaxis in the American Lobster, *Homarus americanus*. Amer. Journ. Physiol., Vol. 17, pp. 326-342.

Hadley, P. B.

- '08 The Behavior of the Larval and Adolescent Stages of the American Lobster (*Homarus americanus*). Journ. Comp. Neur. and Psychol., Vol. 18, pp. 199-301.

Hecht, S.

- '22-'23 Sensory Adaptation and the Stationary State. Journ. Gen. Physiol., Vol. V., p. 555.

Jennings, H. S.

- '04 The Behavior of *Paramecium*. Additional Features and General Relations. Journ. Comp. Neur. and Psychol., Vol. 14, pp. 441-510.

Jordan, H.

- '17 Rheotropic Responses of *Epinephelus striatus* Bloch. Amer. Journ. Physiol., Vol. 43, pp. 438-454.

Loeb, J.

- '18 Forced Movements, Tropisms, and Animal Conduct. Monographs on experimental biology. 209 pp. Philadelphia.

Lyon, E. P.

- '04 On Rheotropism. I. Rheotropism in Fishes. Amer. Journ. Physiol., Vol. 12, pp. 149-161.

Lyon, E. P.

- '09 On Rheotropism. II. Rheotropism of Fish Blind in One Eye. Amer. Journ. Physiol., Vol. 24, pp. 244-251.

Main, R. J.

- '28 Phototropism in Fishes, and its Relation to the Results Obtained by Eye-dislocation. Zeitschr. f. vergl. Physiol., Bd. 7, s. 611-616.

Parker, G. H.

- '03 The Sense of Hearing in Fishes. Amer. Nat., Vol. 37, pp. 185-204.

Parker, G. H.

- '04 Hearing and Allied Senses in Fishes. Bull. U. S. Fish Comm. (1902), Vol. 12, pp. 45-64.

Parker, G. H.

- '08 The Sensory Reactions of *Amphioxus*. Proc. Amer. Acad. Arts and Sci., Vol. 43, pp. 415-455.

Parker, G. H.

- '11 The Mechanism of Locomotion in Gastropods. Journ. Morph., Vol. 22, pp. 155-170.

Schulze, F. E.

- '70 Ueber die Sinnessorgane der Seitenlinie bei Fischen und Amphibien. Arch. f. mikr. Anat., Bd. 6, s. 62-88.

Tullberg, T.

- '03 Das Labyrinth der Fische. Bihang K. Svenska Vet. Akad. Handlingar, Stockholm, Bd. 28, No. 15.

Verworn, M.

- General Physiology. Trans. by T. S. Lee. From 2d German Edition. xvi + 615 pp. New York.

Wheeler, W. M.

- '99 Anemotropism and Other Tropisms in Insects. Arch. f. Entwickl.-mech., Bd. 8, s. 373-381.

Wolf, E.

- '26-'27 Geotropism in *Agriolimax*. Journ. Gen. Physiol., Vol. X., pp. 757-765.

EXPERIMENTAL OBSERVATIONS UPON THE ENDO-
DERMAL GLANDS OF PELMATOHYDRA
OLIGACTIS¹

CARL H. McCONNELL,

UNIVERSITY OF VIRGINIA.

The species dealt with was determined to be *Pelmatohydra oligactis* (Pallas) according to Schulze ('17). This polyp has been under frequent observation in this laboratory for years. Kepner and Hopkins ('24) described two sets of glands present in the endoderm of *Pelmatohydra oligactis*. These are, first, the peristomal glands located in the peristomal region around the mouth, and second, the isolated secretory cells scattered throughout the endoderm. The presence of these two sets of glands led to the suggestion that the secretions of one set might be essential for the functioning of the secretions of the other set.

Experiments were devised to test the validity of this suggestion. Threlkeld and Hall, in this laboratory this year, determined that the range of the greatest tolerance of hydras to hydrogen ion concentration lay between pH 8.0 and pH 7.6, in other words upon the alkaline side of neutrality. Since the first phase of digestive processes in the lower invertebrates is usually acid, the inference was made that the peristomal glands discharged an acid secretion which activated the general secretory cells of the endoderm. To test this inference search was made for a microscopic organism that would tolerate an alkaline medium. After several trials, *Paramœcium caudatum* was selected. This organism will live for hours in the range of hydrogen ion concentration which represents the optimum for *Pelmatohydra oligactis*. Having found this fact the following procedure was planned: Inject living paramœcia into two sets of polyps; one set having the peristomal glands and the other set having had them removed. To obtain the latter, normal hydras were placed under a binocular microscope and their

¹ These experiments were carried out at the suggestion of Dr. W. A. Kepner.



TEXT FIG. 1.

Explanation of Figures.

FIG. 1. Middle third of longitudinal section of complete polyp. *a*, wound made by pipette; *b*, remains of paramæcium 34 minutes after injection. $\times 750$.

FIG. 2. Region of endoderm of complete polyp showing condition 34 minutes after injection of paramæcia. Gland cells (*gc*) stand out clearly in contrast with vacuolated epithelio-muscular cells. (*epm*). $\times 1500$.

peristomal regions and the tentacles were removed with the aid of a small knife and were then allowed 8 to 10 hours to regenerate. Both sets of hydras were kept for 24 hours previous to injection in a covered dish in pH 7.8 solution without food. One hour previous to injection with food they were washed out with pH 8.0 solution by injecting it into the hydra just above the basal disc with a small, finely drawn pipette. The process of injection with food consisted of taking the paramœcia culture from the bottom of a centrifuge tube and mixing it with five times its volume of pH 8.2, being mixed in this proportion to insure that the injection solution would be well above neutral; the resulting mixture being pH 8.0. This mixture was also injected into the polyps above the basal discs and the hydras observed to see their reactions.

The first reaction of the complete hydra after such injection was to contract sharply, later contracting and expanding normally. The paramœcia, within the polyp, swam freely about for from 9 to 15 minutes and then began to appear in great distress, eventually becoming still. In all cases only after the paramœcia had become quiet did the hydras fix themselves by their basal discs and resume their normal positions. These were killed and sectioned in from 34 minutes to 1 hour and 40 minutes after the paramœcia had ceased swimming about. The sections when stained and studied showed paramœcia in various stages of having been digested by the hydras (Text Fig. *A*, Fig. 1, *b*). The endoderm of the hydra appeared normal and digestion appeared to be taking place normally. The sections of the complete hydras that were fixed 34 to 40 minutes after the introduction of the paramœcia into the body showed a perfectly normal endoderm. The epithelio-muscular cells are practically empty and highly vacuolated, as is usually the condition in a polyp from which food has been withheld for a period of 24 hours (text Fig. *A*, Fig. 2, *cpm*). Not much of the material of the digested paramœcium had been absorbed during the relatively short period following the introduction of the ciliates into the cœlenteron. Another feature that is characteristic of the normal hydras is that the gland cells of the general endoderm stand out in sharp contrast with the epithelio-muscular cells (Text Fig. *A*, *gc*) in that they have inclusions that are peculiar to themselves. No such inclusions are to be found in the epithelio-

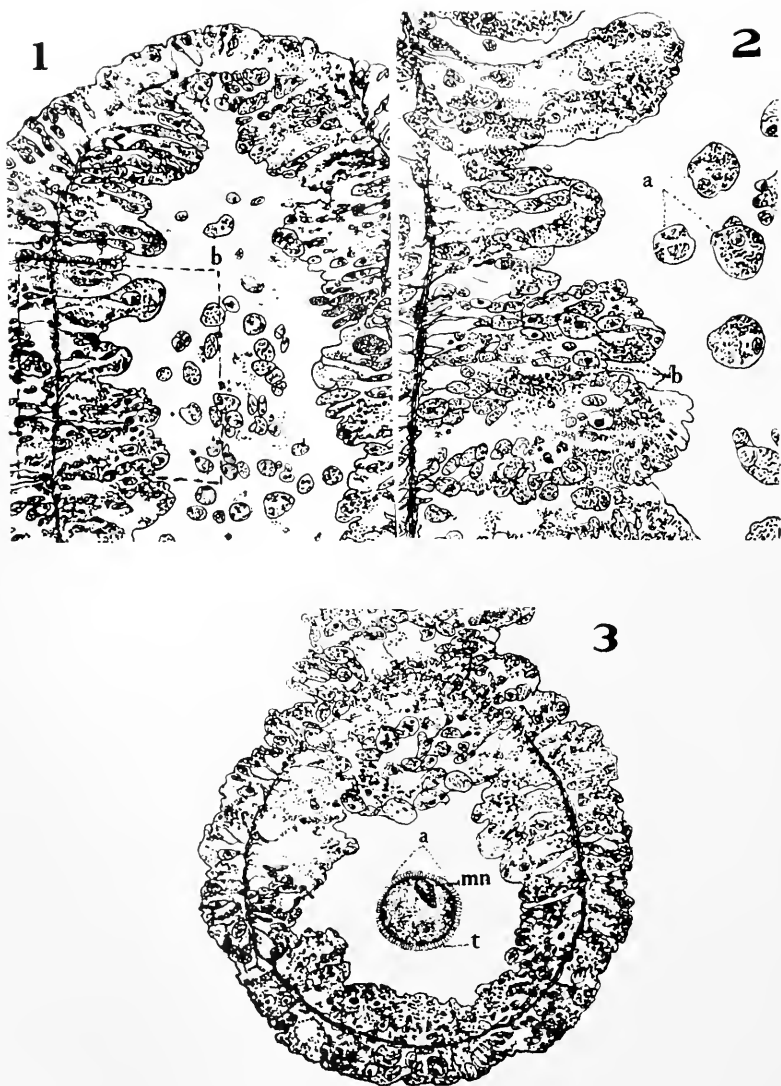

TEXT FIG. B.

FIG. 1. Longitudinal section of oral third of incomplete polyp 24 hours after removal of peristome and tentacles. Note absence of peristomal glands. Specimen fixed 5 hours and 10 minutes after injection with paramoecia. *a*, some of numerous endodermal cells that had migrated into coelenteron; *b*, rectangle indicating region from which Fig. 2 has been taken. $\times 750$.

FIG. 2. Region of endoderm of incomplete polyp 5 hours and 10 minutes after being injected with paramoecia. *a*, endodermal cells that had migrated

muscular cells. (Text Fig. *A*, Fig. 2, *cpm.*) Another interesting feature of the histological picture presented by the complete polyps is the fact that in reacting to the introduced paramœcia few, if any, cells migrated from the epithelium of the endoderm into the cœlenteron (Text Fig. *A*).

The reactions of the hydras from which the peristomal glands had been removed were markedly different. Upon injection with paramœcia they expanded their fullest possible length and remained in this position for as much as twenty minutes. While in this position it was possible to see paramœcia swimming freely about in the cœlenteron. Eventually the hydras contracted to about one half their normal length. The paramœcia swam freely about and seemed to suffer no inconvenience from their close confinement. These hydras were observed for from 1 hour to 5 hours and eventually each of them egested the living paramœcia which swam freely away. Parenthetically, it may be of interest to record that not until the hydras had freed the paramœcia did they attach their basal discs to the substrata. This was done, however, by all of them after the paramœcia had been egested. It was interesting to observe that after having remained within these hydras for such long periods the paramœcia swam away in perfect condition. Not even their cilia appeared to have been eroded by digestive enzymes. But another observation was made that later proved to bring out, in sharp contrast, the reaction of the two sets of polyps upon which the experiment was performed. This observation was made upon many masses of refractive material which were thrown out of the cœlenteron together with the egested paramœcia from the incomplete hydras that had been injected with paramœcia. Upon examination under the 4 mm. objective, these masses appeared like minute conglomerations within which were many refractive bodies. In some cases an opaque, more or less centrally disposed body was seen. There

into cœlenteron; *b*, indicates the many inclusions to be found within the endoderm, which make it difficult to distinguish gland cells and epitheliomuscular cells. $\times 1500$.

FIG. 3. Oblique transverse section through the basal third of polyp shown in Fig. 1. Observe transverse section of paramœcium (*a*) that shows no erosive effects of digestive enzymes. At the time the polyp was fixed paramœcium was alive, though 5 hours and 10 minutes had passed since it and many of its fellows had been injected into the polyp. *mn*, meganucleus; *t*, trichocysts. $\times 750$.

were numerous such masses ejected in the case of each incomplete hydra. Their unstained condition suggested that they might have been general endodermal secretory cells that had left the epithelium of the endoderm.

These observations make the histological pictures of the incomplete hydras of interest. The histology of these hydras show that, in the first place, the introduced paramœcia had not been attacked by digestive enzymes. In one case, a paramœcium that had remained 5 hours and 10 minutes within the polyp and did not happen to be egested with its fellows was found in the sections. It proved to be well fixed, stained and sectioned. Even the trichocysts were clearly seen to be undischarged and lying within the ectoplasm (Text Fig. B, Fig. 3, *a*). Another conspicuous feature of the histology of these incomplete hydras is that there are numerous spheroidal inclusions within all the endodermal cells. These inclusions so much resemble those ordinarily encountered in the general gland cells of the endoderm and not ordinarily found in the epithelio-muscular cells, that one cannot here distinguish between general gland cells and epithelio-muscular cells with certainty (Text Fig. B, Fig. 2, *b*). Moreover, the histology of these polyps indicates that, though many cell-like bodies had been egested with the paramœcia, there yet remained numerous freed bodies which in the sectioned and stained material proved to be actually cells that had migrated from the epithelium of the endoderm (Text Fig. B, Fig. 1, *a* and Fig. 2, *a*).

SUMMARY.

It appears that the presence of peristomal cells are necessary for the killing and digestion of paramœcia when they are thrown into the cœlenteron that has been previously rinsed out with an alkaline medium. This raises the suggestion that the preliminary (acid) phase of digestion is induced by the secretions of the peristomal gland cells.

LITERATURE.

1. **Kepner, W. A., and Hopkins, D. L.**
'24 Reactions of Hydra to Chloretone. Jour. Exp. Zoöl., Vol. 38.
2. **Schulze, P.**
'17 Neue Beiträge zu einer Monographie der Gattung *Hydra*. Arch. f. Biontologie, Vol. 4, Heft 2, pp. 33-119.
3. **Threlkeld, W. L., and Hall, S. R.**
In Manuscript. Observations on the Reactions of Hydra under a Determined pH.

OVULATION REQUIREMENTS OF *CULEX PIPIENS*
LINN.

CLAY G. HUFF,*

DEPARTMENT OF TROPICAL MEDICINE, HARVARD UNIVERSITY MEDICAL SCHOOL,
BOSTON, MASS.

It is very generally known that ovulation and oviposition in mosquitoes occurs after a blood meal. Females caught in their natural habitats or grown from larvæ will lay eggs within a few days or weeks after being fed upon an animal with blood. There seems to be a tendency among students of mosquito biology toward a tacit acceptance of the corollary that a blood meal is necessary to egg laying. Goeldi (1905) fed *Aedes aegypti* on many substances such as fruit and honey and concluded that blood was necessary for ovulation in that species. It is altogether possible that such is the case with some of our species of blood-sucking mosquitoes. However, it will be shown in this paper that it is not true of one of our most domestic mosquitoes, *Culex pipiens*. There seems to me to be no *a priori* reasons for assuming that any species of mosquito should absolutely require blood in its diet before being able to ovulate and oviposit. Quite highly organized dipterous insects such as many of the muscoid flies, are able to lay eggs after feeding on such substances as sugar, honey, and milk. Most mosquitoes will imbibe many kinds of liquids and in nature they feed upon fruits and the nectar of flowers. One genus of mosquitoes, namely *Megarhinus*, has mouthparts of such construction that none of them can ever suck blood, and yet they persist in nature.

There are records of attempts to induce mosquitoes to lay eggs after meals other than blood some of which met with success. Ken (1917) working with *Aedes scutellaris* was successful in getting eggs laid after meals of milk and sugar, peptone and sugar,

* National Research Fellow. This research was supported by a grant from the Wellington Fund. Thanks are extended to Dr. L. R. Cleveland for suggestions and aid.

and sugar only. This species failed to lay eggs after meals consisting of legumin and sugar and urea and sugar. In 42 experiments in which he fed milk and sugar, peptone and sugar, and sugar only, eggs were laid in 10 cases. Experiments by Fielding (1919) on *Aedes aegypti* (*Stegomyia fusciflata*) showed that eggs could be laid after diets of peptone and sugar but that all other foods used failed to bring about oviposition. These substances included sugar solutions, sugar and haemoglobin, milk and sugar, banana, peptone solution, syrup, honey, dates, and apple.

In my own experiments I found no such elaborate technique as that employed by Ken (1917) necessary. The substances, in solution, were poured on absorbent cotton and this was placed on the gauze netting of the cage. When the mosquitoes had been kept away from food and water sufficiently long no difficulty was experienced in getting them to imbibe any of the liquids used. Some of the substances were offered each day for a week. This was not necessary in case of the richer foods such as serum and egg yolk. After 3 to 5 days the cages were placed over water. Oviposition occurred from 4 to 13 days after the first meal. The following table shows the results of experiments in which the larvæ had been fed upon high dilutions of milk and the resulting adults fed on the substances indicated.

TABLE I.
SHOWING THE RESULTS OBTAINED AFTER DIETS OF VARIOUS SUBSTANCES
FED TO *Culex pipiens*.

Substance Fed	Result	Time Required	Viability
Peptonized milk	No ova		
Whey broth	No ova		
Whole milk	No ova		
Cabbage infusion	No ova		
Malt extract	No ova		
Raisins + haemoglobin	Ova	13 days	Hatched
Loeffler's blood serum	Ova	9, 10, & 11 days	Not viable
Haemoglobin solution	Ova	9 days	Hatched
Egg yolk	Ova	5 days	Hatched
Ox blood serum	Ova	6 days	Hatched
Ox gall	Ova	4 days	Hatched
Blood peptone	Ova	?	Hatched
Potato juice	Ova	6 days	Hatched
Carrot juice	Ova	5 days	Hatched
Apple juice	Ova	8 days	Hatched
Cell broth	Ova	7 days	Hatched

Some explanation about certain of these substances is desirable. The hæmoglobin was obtained from commercial hæmoglobin scales. Peptonized milk, whey broth, cabbage infusion, ox blood serum, ox gall, malt extract, and peptone were made from dehydrated products (Digestive Ferments Co.). Potato, carrot, and apple juice were expressed from the macerated vegetables or fruit, filtered, and fed undiluted to the mosquitoes. Cell broth was prepared by boiling a solution obtained from hæmoglobin scales and then using the clear supernatant fluid. (I am grateful to Dr. Cleveland for the method of preparing this medium.)

It will be noticed from these results that many substances may serve as adequate diets for the production of ova by *Culex pipiens*. These experiments were all done at least twice, with the same result each time. One exception not listed in the table was as follows. Ferric nitrate was added to milk to make a 10% solution. The filtrate was a clear, amber-colored liquid. In one experiment with this substance viable ova were obtained, but I was unable to get the same result upon repetition of the experiment.

Believing that the food of the larvæ might affect the ovulation of the adults I next tried experiments in which the larvæ were kept in a rich solution of hæmoglobin from the time of hatching from the egg to pupation. The adults from larvæ so grown were fed milk in one case and soaked raisins in another. In 5 days eggs were laid which hatched, and produced larvæ as vigorous in all appearances as those from ova laid under normal conditions. Larvæ grown in the routine way—that is, upon the bacteria and yeasts of cultures—have never produced adults capable of laying eggs upon a diet of milk or soaked raisins.

Gordon (1922) tried to determine what fraction of blood is necessary to ovulation in *Aedes aegypti*. His summary is quoted "In a series of experiments in which fifty-four females were offered as food either serum, washed cells, or whole blood (the two latter being diluted with normal saline), it was found that the mosquitoes absorbed any of the fluids offered, but that oviposition only resulted in the case of whole blood." It is my opinion that the number of mosquitoes in each experiment was too small to permit us to conclude that whole blood is essential to ovulation in this species. It should be noted that *Culex pipiens*, as shown by

my experiments, is able to lay eggs after meals of blood serum, hæmoglobin, peptone, and cell broth, all of which are blood derivatives. In addition, they could ovulate and oviposit after meals of substances other than blood, including three substances of purely vegetable nature.*

These results lead me logically to conclude that *Culex pipiens* might persist very well in nature without having the opportunity to feed upon animals with blood. They also prove that there is nothing magical about the rôle of blood in the ovulation of this species.

LITERATURE CITED.

Fielding, J. W.

'19 Notes on the Bionomics of *Stegomyia fasciata* Fabr. Ann. Trop. Med. & Parasit., 13: 259-296.

Goeldi, E. A.

'05 Os mosquitos no Pará. Memoires do Museu Goeldi (Museu Paraense) de historia natural e ethnographica. 4. Pará Brazil.

Gordon, R. M.

'22 Notes on the Bionomics of *Stegomyia calopus* Meigen, in Brazil. Ann. Trop. Med. & Parasit., 16: 425-439.

Ken, S. K.

'17 A Preliminary Note on the Rôle of Blood in Ovulation in Culicidæ. Ind. Journ. Med. Res., 4: 729-753.

* Since this paper went to the Editor, I have observed one case in which a female laid viable eggs within 18 hours after emerging and *without having taken food, of any kind*. About 50 eggs were laid and these produced larvæ of exceptional vigor as shown by the fact that they pupated on the fifth day after hatching. This experiment proves beyond any doubt that under optimum conditions the species could breed in the absence of many foods formerly considered essential to oviposition.

STUDY OF THE PHYSICAL PROPERTIES OF THE HEN'S EGGSHELL IN RELATION TO THE FUNC- TION OF SHELL-SECRETORY GLANDS.

ALEXIS L. ROMANOFF,

CORNELL UNIVERSITY.

A hen's eggshell plays an important rôle in the development of the embryo. It gives a physical protection; governs the embryonic respiration, serving as a membrane in the free interchange of gases; and it is also of value in the embryonic metabolism, notably in the mineral metabolism. For example, the calcium in the embryo largely comes from the mineral portion of the eggshell.

Besides its importance to the embryo, the eggshell has a great bearing on the food value of eggs. The physical condition and the perishability of an egg's contents largely depend upon the physical quality of the eggshell. Thus, a thin, a rough, or a cracked shell allows easy penetration by bacteria and molds, loss of moisture and carbon dioxide, and absorption of outside odors. At the same time such a shell breaks easily in handling or in transit.

All the above factors seem to have been recognized by both the scientists, in the fields of physiology and nutrition, and the practical men, in the fields of poultry production and marketing of eggs. Yet up to the present time very little work has been done on the determination of the physical properties of the eggshell. Among the workers to be mentioned here is Rizzo ('99). He, in the study of twelve hen's eggs, found that the number of pores per square millimeter of shell surface varied from 0.86 to 1.44 with an average of 1.23.

The present investigation concerns itself with the breaking strength, thickness, and porosity of the hen's eggshell, in relation to the function of the shell-secretory glands.

METHODS AND MATERIALS.

All the eggs used were from a flock of 91 White Leghorn pullets. During the experimental period of 16 weeks (from December 10, 1924, to March 31, 1925) the flock laid 3,998 normal

eggs. Production varied from 2 to 79 eggs per hen. The eggs were tested, the day that they were laid, for breaking strength and for thickness of eggshell. The breaking strength was measured by applying pressure to both ends of the egg in a specially constructed eggshell-testing machine (Fig. 1). The thickness was

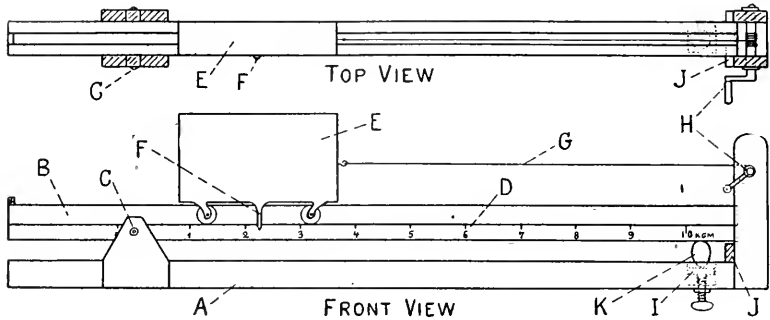

FIG. 1. A diagram of the eggshell-testing machine. *A*, frame; *B*, lever; *C*, fulcrum; *D*, scale; *E*, carriage; *F*, pointer; *G*, string; *H*, winch; *I*, adjusting stand; *J*, safety pin; *K*, egg.

measured by the micrometer caliper with ratched stop. Many eggs were also observed for the size and the location of pores on both the outer and inner surfaces of the eggshell.

RESULTS AND DISCUSSION.

The experimental data show that the breaking strength of the eggshell varies greatly not only among individual eggs but also among hens. The highest breaking strength was found to be 8.5 kilograms, while the average for 3,998 eggs was 4.46 kilograms. It was also determined that the average breaking strength of eggshell was less by one to two kilograms if the eggs were broken by applying pressure on the sides instead of the ends of the eggs. The tested eggs usually broke either on the blunt or on the pointed end, but very seldom on both ends at the same time. Of the whole number, 48 per cent. broke on the blunt end, and 52 per cent. on the pointed end.

The frequency distribution of variation in breaking strength is illustrated in Table I.

TABLE I.
FREQUENCY DISTRIBUTION OF VARIATION IN BREAKING STRENGTH OF EGGSHELL.

Breaking Strength (Kgm.).	Frequency Occurrence.		
	Number of Hens.	Number of Observations.	Number of Eggs per Hen.
2.01-2.40	1	2	2.0
2.41-2.80	1	37	37.0
2.81-3.20	3	117	39.0
3.21-3.40	7	224	32.0
3.41-4.00	9	329	36.6
4.01-4.40	20	848	42.4
4.41-4.80	23	1,097	47.6
4.81-5.20	18	858	47.7
5.21-5.60	8	439	54.9
5.61-6.00	1	47	47.0
Total	91	3,998	—

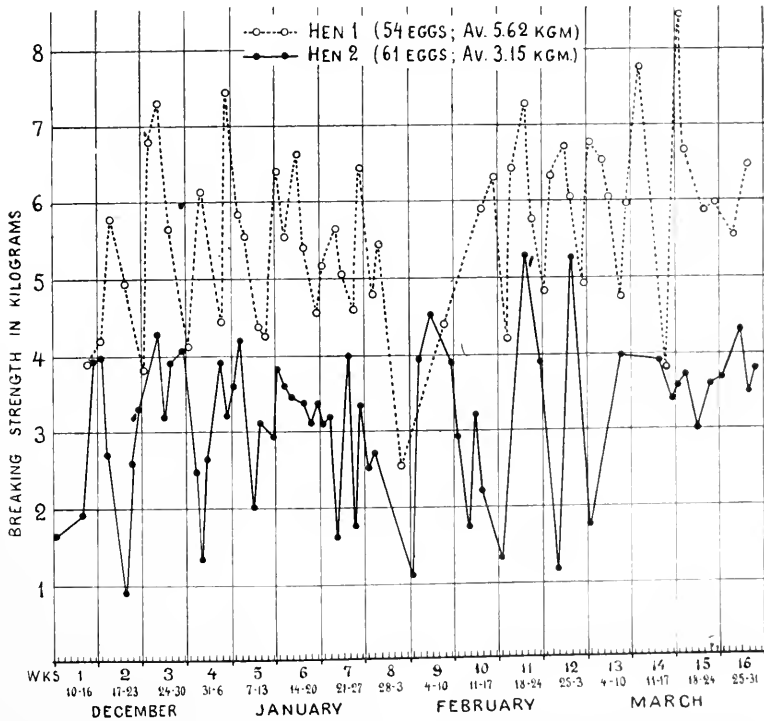

FIG. 2. Comparison of the breaking strengths of eggshell from two hens laying during the entire (16 weeks) period of observation.

The largest number of hens was found to be in the group averaging 4.4 to 4.8 kilograms. The number of eggs per hen, or the index of production, shows an increase with the strength of eggshell. In other words, the egg production stimulates the normal function of the reproductive organs and the eggshell secretory glands as well.

There is enough evidence to prove that the strength of eggshell varies with individuals. Figure 2 demonstrates a typical case, when two hens of almost equal production give a quite uneven average for the breaking strength of eggshell; the individual curves run distinctly apart throughout the observation period. The above figure and numerous observations by other individuals, show that the strength of eggshell is more uniform during a cycle of heavy egg production. Evidently, the secretory glands work normally at such times; and in practice, therefore, it would be advisable to select the hen for the strength of eggshell.

TABLE II.

RELATION BETWEEN BREAKING STRENGTH AND THICKNESS OF EGGSHELL.

Breaking Strength.	Thickness.			
	Broken End.	Unbroken End.	Blunt End.	Pointed End.
Kgm.	mm.	mm.	mm.	mm.
2.01-2.40.....	—	—	—	—
2.41-2.80.....	.246	.284	.290	.244
2.81-3.20.....	.259	.285	.287	.259
3.21-3.60.....	.274	.292	.291	.277
3.61-4.00.....	.287	.295	.292	.295
4.01-4.40.....	.302	.315	.312	.307
4.41-4.80.....	.325	.325	.325	.325
4.81-5.20.....	.333	.348	.333	.347
5.21-5.60.....	.343	.358	.343	.358
5.61-6.00.....	.356	.366	.345	.373
Average.....	.303	.319	.313	.309

Table II. indicates that the thickness is in direct relation to the breaking strength of the eggshell. The average thickness of all eggs was 0.311 millimeters. Eggs approaching this average had an almost equal thickness at both ends; while in general the broken end was thinner than the unbroken, and the blunt end was

thicker than the pointed. The pointed end, being the posterior part of the egg during its formation, gets comparatively less accumulation of the material in a weak and more in a strong eggshell.

The external structure of the eggshell, as seen under magnification (Fig. 3), suggests that a strong, thick eggshell has a large

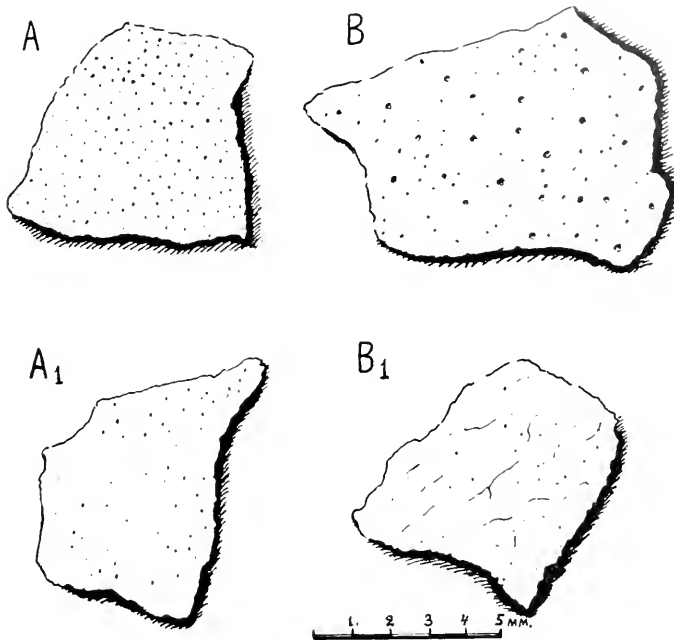

FIG. 3. Size and number of pores of eggshell as seen under magnification. *A*, outer, *A*₁, inner surface of a strong, thick eggshell. *B*, outer and *B*₁, inner surface of a weak, thin eggshell.

number of minute pores; while a weak, thin eggshell has few pores, but some of these are quite large in size. Besides, the inner surface of a weak eggshell has many grooves of various depths. Observation of the outer surface of the eggshell for the number and size of pores, may guide us in judging the breaking strength and thickness of the eggshell.

ACKNOWLEDGMENTS.

The eggs for this study were furnished by the Poultry Husbandry Department of Cornell University. To Dr. C. K. Powell,

of Cornell, I owe thanks for many suggestions, especially regarding apparatus and methods.

SUMMARY.

1. The data from 3,998 eggs show that the breaking strength and the thickness of eggshell are in the average 4.46 kilograms and 0.311 millimeters.

2. There exists a positive relation between the breaking strength and the thickness of an eggshell.

3. The breaking strength and the thickness of eggshell vary with individuals.

4. The variation of breaking strength and thickness of eggshell is the least at the time of heavy egg production. Therefore, the mean value of either the breaking strength or the thickness of eggshell may be easily determined by a few observations during the cycle of heavy egg production.

5. The porosity vary with the breaking strength and thickness of eggshell. The pores of the thick shell are small and numerous, while those of the thin shell are large and few in number.

6. The physical properties of eggshell presumably depend upon the individual function of the secretory glands during egg formation more than any other external factors.

REFERENCE.

Rizzo, A.

'99 Sul numero e sulla distribuzione dei pori nel guscio dell'ovo di gallina. *Ricerche lab. di anat. norm.*, 7: 171-177.

EFFECT OF EXCESSIVE DOSAGES OF THYROID ON THE DOMESTIC FOWL.*

J. HOLMES MARTIN,

KENTUCKY AGRICULTURAL EXPERIMENT STATION.

In attempting an analysis of the character of barring in poultry its physiological basis was studied. Since barring is due to the rhythmic deposition of black pigment and since other workers who fed the thyroid gland of cattle to poultry found that the pigmentation of the feathers was affected, it was decided to study the effect of feeding thyroid to Barred Plymouth Rocks.

The thyroid, which is one of the endocrine or ductless glands, is located in the fowl on the ventral side of the common carotid artery at a point where it touches the jugular vein. It is a small, oval, red body with a fibrous capsule. There are two small parathyroid bodies attached to the lower pole of the thyroid.

OTHER WORK.

Much work has been done with the treatment of various species of animals with thyroid. However, the work with the domestic fowl is somewhat limited. The earliest work was done by C. J. and C. Parhon (1914), who fed dry thyroid powder every other day (.15 grams) to 6 pullets. Marked excitability resulted, with tremors and ischemia or local anemia of the comb. Five of the thyroid-fed pullets were at the end of a year exposed to cholera, 2 surviving (40 percent. survival). Of nine similar control pullets one survived (11.11 percent. survival). The authors were led to conclude that "this confirms the rôle of the thyroid gland in the production of immunity."

* Published with the approval of the Director of the Kentucky Agricultural Experiment Station. The investigations reported were initiated November, 1924, at the Kentucky Experiment Station. From September, 1925, to June, 1926, they were continued at the Wisconsin Agricultural Experiment Station, and subsequently completed at the Kentucky Agricultural Experiment Station. Published with the approval of the Director of the Wisconsin Agricultural Experiment Station.

Torrey and Horning (1925) suggested "a certain antagonism between ovary and thyroid in connection with pigment formation that has no counterpart in the male." Crew and Huxley (1923), with daily feeding of 2 grams of desiccated thyroid per chick from 3 months to 7 months of age, to R. I. Reds or Light Sussex males, failed to observe the assumption of hen-feathering noted by Horning and Torrey.

Giacomini (1924) fed raw ox thyroid to fowls, starting with pieces the size of a hemp seed, gradually increasing the dosages until in some cases as much as 5 grams was fed daily. He observed depigmentation and a "profound stimulating and accelerating action of the thyroid hormones" upon basal metabolism, especially catabolism. Zavadovsky (1925a) fed excessive dosages, which were highly toxic and caused a precipitous molt followed by striking depigmentation in the new feather growth. Zavadovsky (1925b) notes that with single dosages of 30 to 50 grams of desiccated thyroid gland there was a complete fall of the feathers by the seventh to fourteenth day, followed by a new growth of plumage by the 21st to 30th day. He attributed the striking change in plumage to the specific action of the thyroid on the pigment-forming mechanism. Horning and Torrey (1927) criticize this explanation and in referring to the excessive dosages as highly toxic state that the striking change in plumage is "induced by an excessive, essentially toxic dosage of thyroid rather than a specific action of the latter (thyroid) on the pigment-forming mechanism." In all their work they used non-toxic dosages, usually 1 gram of desiccated thyroid per 5,000 grams of body weight of the fowl. With such dosages they were able to maintain the health of the hens, which in turn also laid hatchable eggs.

METHOD OF PROCEDURE.

In order to study the effect of large dosages of desiccated thyroid on barred plumage, hens, cockerels and capons were fed single doses varying from 10 grams to 35 grams. On January 9, 1926, ten Barred Plymouth Rock hens (hatched April, 1925) from the production-bred strain kept at the University of Wisconsin, were penned separately and fed thyroid.¹ Since large dosages

¹ Armour's desiccated ox thyroid, U. S. P. 0.2 per cent. Iodine.

were fed it was thought best to add it to the mash. In several cases the hens did not eat all the mash so the remaining portion was weighed back and the approximate consumption of thyroid computed. The birds were weighed at the start of the test and observed for condition of molt. The feathers loosened and a molt occurred in all hens fed 10 or more grams.

GENERAL RESULTS ON HENS.

In all cases, thyroid administration was followed by an increased nervousness and activity. Plymouth Rock hens, normally of a rather gentle or phlegmatic disposition soon changed to a highly nervous condition. They resembled more the Leghorn in nervous temperament and activity, indicating the possibility of a breed difference in basal metabolism, having its seat in the thyroid gland. The thyroid-fed hens developed a high, shrill voice uncommon to Barred Plymouth Rocks.

Among the eight hens which survived thyroid administration seven showed a loosening of the feathers, which pulled out quite easily from 4 to 9 days later. A rather precipitous molt followed in these 7 hens in from 7 to 10 days (see figure 1). Careful

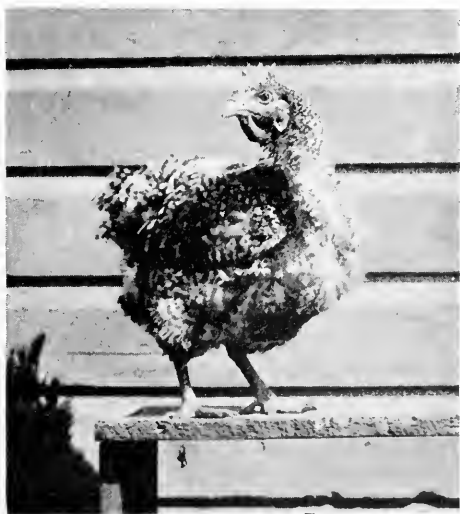

FIG. 1. Hen 4101 showing molt induced by single heavy dose of thyroid: fed 20-22 gms. thyroid Jan. 24, 1926; photographed Apr. 5, 1926.

records of the rate of molt were kept for hens 112 and 152. The feathers apparently loosen by the fourth day after thyroid administration and a molt follows by the seventh day, reaching its height by the eighth to eleventh day and then slackening rather abruptly by the fourteenth day, after which only a few occasional feathers fall. It is interesting to note that the incoming feather germs

TABLE I.
SHOWING DOSAGES FED HENS AND EFFECT ON FEATHERS.

Band Number.	Amount of Thyroid.	Days Elapsing Until		
		Feathers Loosen.	Body Molt.	White Appears.
57.....	8 to 9 Grams	No molt		None
2355.....	12 to 14 Grams	9	9	None
3670.....	10 Grams	8	10	None
4101.....	20 to 22 Grams	5	9	30
3930.....	23 to 25 Grams	Died Five Days Later		
47.....	15 Grams	No molt		
	15 Grams ¹	Died One Day Later		
110.....	20 to 25 Grams	Loose at start	9	30
119.....	15 to 18 Grams	8	10	44
152.....	8 to 9 Grams	No molt		None
	24 Grams ²	4	7	40
112.....	0 Grams	Not loose	None	None
(Control)....	30 Grams ²	4	8	40

take several days longer to loosen the primary and secondary wing feathers than the body feathers. This precipitous type of molt is not uncommon to heavy layers which molt late (October and November).

The fact that such sudden and precipitous molts do occur in late-molting heavy-laying hens under normal conditions and that molt was not precipitated when 50 mg. of sodium arsenite was fed to 3 different Leghorn pullets (75 mg. proving lethal) tends to indicate that the striking molt was due to a hyperthyroid condition, speeding up abnormally the basal metabolism, rather than to the toxic effect of larger than physiological doses.

¹ Additional dose fed 7 days later.

² Fed in capsules 30 days after negative treatment noted above.

FEATHER RENEWAL.

In five of the seven hens in which molt occurred there was noticeable depigmentation in the new feathers. All seven hens showed a silky nature of the feathers growing in after thyroid feeding. Horning and Torrey (1923) noted "a corresponding in-

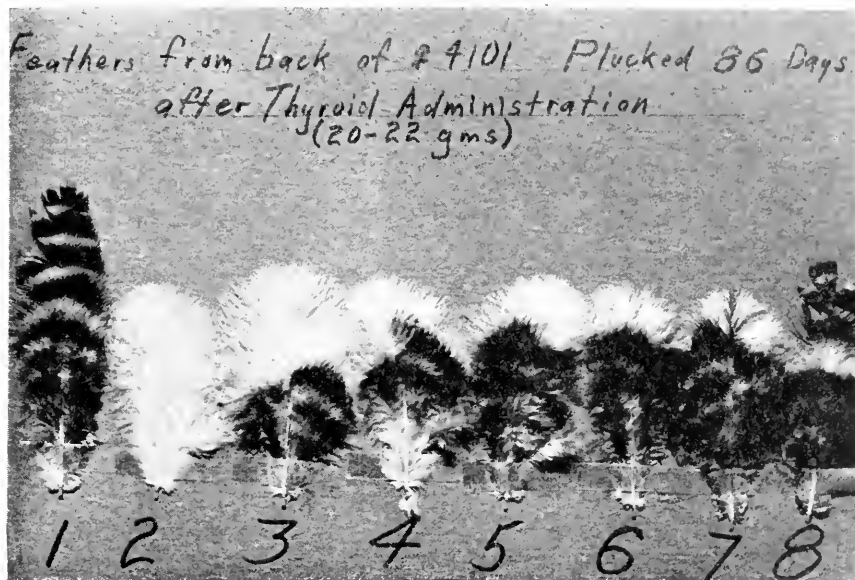

FIG. 2. Effect of thyroid administration on feather structure and pigmentation.

crease in the number and distribution of the barbules on the barbs" following thyroid feeding. Later, these authors (Horning and Torrey, 1927) report that "as a rule, this pigment is carried by the barbules and limited by their distribution."

Figure 2 shows feathers taken hen 4101 (fed 20 to 22 grams) after renewal of the feathers subsequent to thyroid feeding. Feather No. 1 shows the normal plumage, since it is a feather that was not molted. Feathers 2 to 7 show increasing amounts of pigmentation. All 8 feathers were taken from the back of Hen 4101, illustrated in Fig. 1. The heavy condition of molt of the hen is noticeable in Fig. 1 (Note the similarity to a rapid molting high producer). The photographs of the hen were taken 70 days

after thyroid administration. Feathers 2 to 5 (Fig. 2) are completely silky in appearance, there being on observation with the naked eye no apparent interlocking of barbules on adjacent barbs as illustrated and described by Lloyd-Jones (1915). Feathers 6 and 7 show a slight interlocking close to the shaft at its distal end.



FIG. 3. Hen 4101 showing depigmented feathers under left wing (also abundant under right wing and on back). After subsequent molt, feathers in these same areas were normally barred when observed, Aug. 30, 1926.

Feather 8 had obviously commenced its growth prior to thyroid feeding as the distal end, including the first three black bars and two white bars, is normal in every respect (the portions missing in feathers 1 and 8 were removed for microscopical examination). The abnormally wide white bar in feather 8 resulted from thyroid feeding. This white bar and the remaining proximal portion of the feather are of the silky nature indicating the absence of interlocking barbules. A microscopical examination reveals the absence of the hooked hæmules of the barbules in the lower silky-

appearing portion of the feather and their presence in the distal (normal appearing) end. This is illustrated in Fig. 4. The "silky" barbule has essentially the same appearance as in the silky fowl. This similarity indicates the possibility that the mechanism causing the presence of silky feathers in the silky fowl has its seat

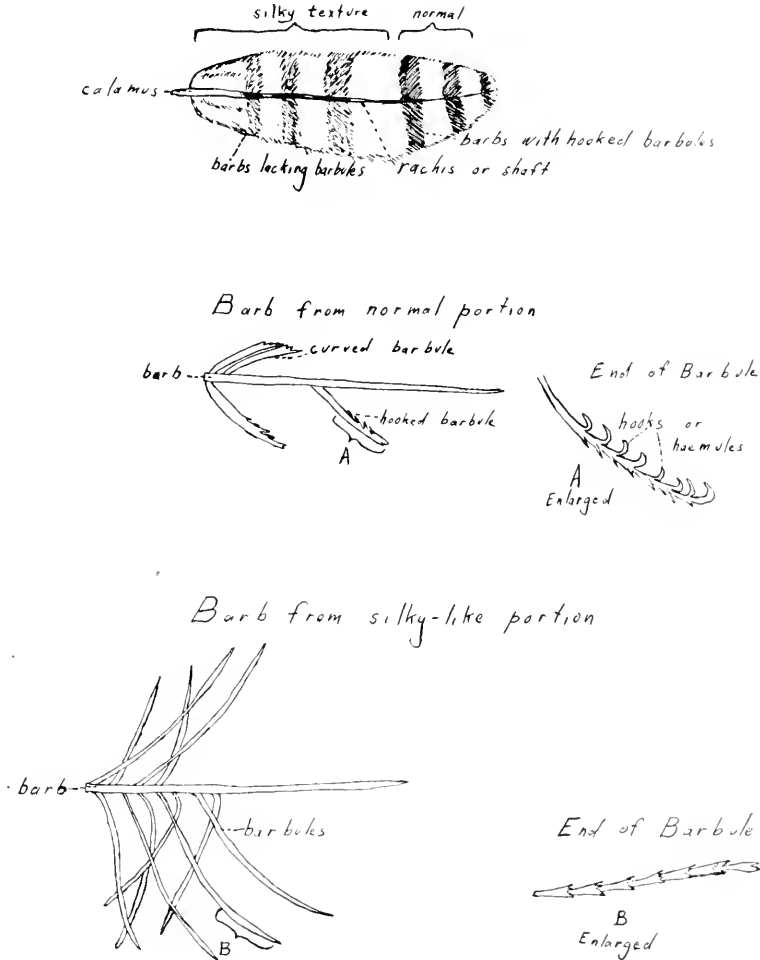

FIG. 4. Feather No. 8 from ♀ 4101. (See Fig. 2.)

in the thyroid gland. Perhaps a hormone from the thyroid gland in this breed, transmitted to each feather germ through the blood

stream, has an inhibitory effect on the barbules thereby preventing the development of hooks (hæmules).¹

It is noticeable from a glance at Figs. 2 and 3 that feathers being renewed at the same time have black pigment (melanin) deposited in differing amounts. While pigment was being deposited in rhythmic waves in feathers 5, 6 and 7, resulting in well-defined bars, no pigment was being deposited in feather 2 and numerous other white feathers (note Fig. 3). This indicates that the rhythmic deposition of pigment in each feather, resulting in barring, is not centralized or synchronized for all feathers, but is rather a phenomenon separately controlled by each feather germ. This independent effect on each feather germ is further borne out by observations of normally molting hens in which some feathers are growing the black portion of the feather while others are growing the white. The author's findings are in agreement with those of Torrey (1926), who observed when studying the rhythmic deposition of pigment that "whatever the underlying mechanism, its activity has been associated experimentally with the activity of the thyroid."

COCKERELS AND CAPONS.

In order to observe the interrelationship, if any, between the hormones from the testes and the thyroid hormones, both capons and cockerels of the Barred Plymouth Rock breed were fed dosages varying from 10 grains to 35 grams. In order to check accurately the amount fed, the thyroid was placed in gelatin capsules.¹ This experiment was started December 22, 1926. The stock was March hatched and from a strain bred the preceding eight years at the University of Kentucky. When two or more

¹ The paper by Danforth and Foster (1929), on skin transplantations, appearing in *Jour. of Exp. Zoology*, Vol. 52, No. 3, pp. 443-470, came to the author's attention after this manuscript had been submitted. Their findings that "With the Silkie . . . the determining factors for both color and texture (hookless barbs) seem to reside in the follicles themselves" do not lend apparent support to this supposition. However, both findings indicate that certain genes in the feather germ for a character are expressed with the aid of hormones circulating through the blood stream to the feather during its development.

¹ Quarter-ounce capsules, each containing 5 grams of thyroid, were used. The large end of the capsule was dipped in cod liver oil before administration to aid in the passage through the gullet and the crop.

doses were fed they were administered on succeeding days. Ten cockerels and ten capons were given doses as indicated in Table II. Two controls were kept of both capons and cockerels.

It should be noted that 2 capons and 1 cockerel died after administration of thyroid. The temperature of the capons was extremely high just prior to death ($111\frac{1}{2}^{\circ}$ and 116° F.) The birds were down on their legs, giving the appearance of paralysis, and they died in convulsions and tremors. Post-mortem examination revealed in both cases contracted ventricles, dilated auricles and an excessive amount of straw-colored fluid in the pericardial sac. The anterior lobe of the left kidney was enlarged in each case. Edema of the lungs was marked. The cockerel showed no adverse symptoms the evening before his death. A post-mortem examination showed appearances similar to those of the capons except that only a small amount of fluid was found in the pericardial sac.

TABLE II.
SHOWING DOSAGES FED MALES AND EFFECT ON FEATHERS.

Coop.	Amount of Thyroid.	Days Elapsing Until		
		Feathers Loosen.	Slight Molt.	Heavy Molt.
Capons				
1.....	Control	Not loose	No molt	No molt
2.....	10 Grams (1) ¹	9	9	23
3.....	15 Grams (1)	6	9	10
4.....	15 Grams (1)	6	10	23
5.....	20 Grams (1)	3	3	9
6.....	20 Grams (2)	6	10	Not heavy
7.....	25 Grams (2)	6	9	10
8.....	25 Grams (5)	6	9	10
9.....	30 Grams (2)	3	9	10
10.....	30 Grams (3)	3		(Died—5 days)
11.....	35 Grams (2)	3	3	(Died—5 days)
12.....	Control	Not loose	No molt	No molt
Cockerels				
21.....	Control	Not loose	No molt	No molt
22.....	10 Grams (1)	10	10	Not heavy
23.....	15 Grams (1)	6	9	Not heavy
24.....	15 Grams (1)	9	10	10
25.....	20 Grams (1)	6	10	Not heavy
26.....	20 Grams (2)	6	10	Not heavy
27.....	25 Grams (2)	6	7	10
28.....	25 Grams (5)	6		(Died—7 days)
29.....	30 Grams (2)	6	10	13
30.....	30 Grams (3)	6	9	10
31.....	35 Grams (2)	6	9	10
32.....	Control	Not loose	No molt	No molt

¹ Total amount divided into number of doses indicated in parenthesis.

FEATHER CHANGES.

Areas of the saddle and back were plucked at the time of thyroid administration in order to check on the new feathers grown. In addition to the growth of feathers in the plucked areas, new feathers grew to replace those molted. In structure and depigmentation the new feathers resembled those discussed in detail in the case of the hens. However, the depigmentation was not nearly so marked in the males.

EFFECT ON WEIGHT.

All the males were weighed at the time of thyroid administration and at stated intervals thereafter. At the same time, body temperature was taken by inserting the bulb of a clinical thermometer well into the vent. Work of Fronda (1921) shows that the body temperature of the fowl is nearest the average or normal from 4 to 6 P.M. and 8 to 10 A.M., hence the temperatures were

TABLE III.

BODY WEIGHT OF MALES.

Coop.	Weight at Start.	Gain ¹ at 48 hrs.	Gain ¹ at 5 days.	Gain ¹ at 7 days.	Gain ¹ at 12 days.	Gain ¹ at 31 days.
Capon						
1 (Control)	6 lbs. 12 oz.	0 oz.	-2 oz.	-4 oz.	+1 oz.	+4 oz.
2	6 lbs. 15 oz.	-3	-9	-9	-4	+5
3	7 lbs. 12 oz.	-11	-15	-12	-11	-3
4	7 lbs. 8 oz.	-8	-9	-4	0	+2
5	7 lbs. 15 oz.	-6	-10	-11	-3	+1
6	8 lbs. 15 oz.	-9	-14	-7	-5	+5
7	7 lbs. 2 oz.	-4	-18	-21	-9	-2
8	7 lbs. 2 oz.	-1	-6	-14	-11	+3
9	8 lbs. 8 oz.	-6	-12	-15	-9	-3
10	6 lbs. 12 oz.	-8	-12	Dead		
11	8 lbs. 4 oz.	-4	-13	Dead		
12 (Control)	7 lbs. 0 oz.	+4	+4	+2	+7	+8
Cockerels						
21 (Control)	7 lbs. 12 oz.	+5	+1	+3	+8	+9
22	8 lbs. 12 oz.	-4	-7	-4	+1	+8
23	8 lbs. 0 oz.	-1	-1	0	+4	+16
24	7 lbs. 8 oz.	-4	-11	-17	-8	+3
25	7 lbs. 10 oz.	-2	-5	-1	+2	+17
26	8 lbs. 8 oz.	-1	-11	-19	-11	-3
27	7 lbs. 14 oz.	-3	-18	-9	-7	+2
28	8 lbs. 6 oz.	-1	-6	-20	Dead	
29	7 lbs. 15 oz.	-3	-11	-14	-13	+1
30	8 lbs. 9 oz.	-3	-5	-7	-4	+1
31	7 lbs. 11 oz.	-3	-11	-7	-3	+5
32 (Control)	7 lbs. 9 oz.	+8	+7	+9	+11	+19

¹ Based on weight at start.

taken at those times. Table III. shows the effect of thyroid administration on weight and Table IV. the effect on temperature. The average weight of the four controls was 7.26 pounds, while

TABLE IV.
TEMPERATURE OF MALES.

Coop.	Temperature at Start.	Decrease ¹ at 48 hrs.	Decrease ¹ at 5 Days.	Decrease ¹ at 7 Days.
Capon				
1 (Control)	107 1/5° F.	0.2° F.	0.2° F.	0.2° F.
2	106 4/5°	1.4°	0.2°	0.4°
3	106 2/5°	1.2°	0.8°	0.0°
4	106 4/5°	2.4°	0.4°	0.4°
5	106 4/5°	1.4°	0.4°	0.4°
6	106 2/5°	0.8°	0.4°	0.4°
7	106 2/5°	1.4°	1.6°	0.4°
8	106 4/5°	1.2°	2.2°	2.0°
9	106°	0.8°	0.0°	0.6°
10	107 4/5°	2.4°	3.7°	Dead
11	106 4/5°	1.6°	9.2°	Dead
12 (Control)	106 3/5°	0.0°	0.6°	0.2°
Average of treated birds		1.46°	1.95°	0.57°
Average of controls		0.1°	0.4°	0.2°
Cockerels				
21 (Controls)	107 3/5°	0.6°	1.0°	0.2°
22	106 4/5°	1.8°	0.2°	0.2°
23	106 4/5°	1.0°	0.0°	0.4°
24	106 4/5°	1.2°	0.4°	0.4°
25	107°	0.8°	0.0°	0.4°
26	106 2/5°	0.2°	0.0°	0.2°
27	106 4/5°	1.6°	0.0°	0.6°
28	106 3/5°	0.8°	0.4°	Dead
29	106 3/5°	0.8°	0.2°	0.4°
30	106 2/5°	1.0°	0.6°	0.0°
31	106 2/5°	0.6°	0.2°	0.4°
32 (Control)	106 2/5°	0.4°	0.4°	0.4°
Average of treated birds		0.82°	0.2°	0.33°
Average of controls		0.5°	0.7°	0.3°

that of the 20 thyroid-fed males was 7.88 pounds, hence it may be seen that the birds to be fed thyroid had a slight advantage in size at the start of the test. At the expiration of 48 hours after administration of the first dose, all thyroid-fed males had lost weight (varying from 1 to 11 ounces per bird) whereas no loss of weight appeared in the controls. In 19 of the 20 thyroid-fed males loss in weight increased from the 2d to the 5th day. By

¹ Based on temperature at start, capon temperatures taken from 4 to 6 P.M., and cockerel temperatures taken from 8 to 10 A.M.

the 7th day 9 of these had regained some of the loss in weight. The capons averaged a loss of 6 ounces each by the second day, whereas the cockerels lost only 2.5 ounces. By the 5th day the capons had lost an average of 11.8 ounces each and the cockerels 8.6 ounces each. When compared with the controls it may readily be seen that a decided loss in weight occurred subsequent to thyroid administration, the loss being more pronounced in the capons than in the cockerels. This loss in weight was found by Giacomini (1924) to follow thyroid administration in larger than physiological doses, and was attributed by him to the stimulus given to basal metabolism (especially catabolism), rendering such birds unable to utilize properly the carbohydrates in the feed. However, he reported no difference in the effect on capons and cocks, whereas the writer found indications of a greater disturbance, occurring more quickly, with the capons, substantiated by the greater drop in temperature. Perhaps this may be due to a lack of compensatory hormones from the testes.

EFFECT ON TEMPERATURE.

The average temperature of the controls was 106.95° F., and of the birds to be fed thyroid 106.68° F. at the beginning of the test. Thyroid administration resulted in a significant decrease of the body temperature. Forty-eight hours after giving the first dose the average temperature of the controls was 106.65° F. whereas that of the 20 birds fed thyroid was 105.54° (1.11 degrees lower than controls). The average decrease for the capons was 1.46° , while for the cockerels it was only 0.82° .

SUMMARY.

1. Single doses of desiccated thyroid ranging from 8 to 30 grams although producing physiological shock were not lethal to hens.
2. Single doses of 30 to 35 grams proved lethal to two out of three capons.
3. Cockerels are able to withstand single dosages as large as 35 grams.
4. Single doses varying from 8 to 35 grams cause a loosening

of the feathers in from 3 to 10 days. Molt commences in from 3 to 10 days.

5. Depigmentation occurs during feather renewal following the precipitous molt. It was quite noticeable in 30 days after feeding.

6. A silky texture to the feathers was noticeable following thyroid feeding.

7. The hooks or hæmules are absent from the barbs in the feathers growing in immediately following thyroid feeding in larger than physiological dosages.

8. Thyroid feeding in large doses causes a change in nervous temperament of the Plymouth Rock, making it highly excitable.

9. Loss in body weight follows feeding of thyroid in large dosages, more especially in capons.

10. Thyroid feeding has a depressing effect on body temperature when fed in large dosages, capons showing a greater depression than cockerels.

BIBLIOGRAPHY.

Crew, F. A. E., and Huxley, J. S.

'23 The Relation of Internal Secretion to reproduction and growth in the domestic Fowl. I. *Vet. Jour.*, Vol. 29, pp. 343-348.

Fronza, F. M.

'21 A Comparative Study of the Body Temperatures of the Different Species and Some Representative Breeds of Poultry. *Poultry Science*, Vol. 1, No. 1, pp. 16-22.

Giacomini, E.

'24 Color Changes in Plumage of Poultry after Thyroid Administration. Report of Second World's Poultry Congress, Part II., pp. 45-47.

Horning, B., and Torrey, H. B.

'23 Effect of Thyroid Feeding on the Color and Form of Feathers of Fowls. *Anat. Rec.*, Vol. 24, No. 6, pp. 395-396.

'27 Thyroid and Gonad as Factors in the Production of Plumage Melanins in the Domestic Fowl. *Biol. Bull.*, Vol. 53, No. 4, pp. 221-232.

Lloyd-Jones, O.

'15 Studies on Inheritance in Pigeons. II. A Microscopical and Chemical Study of Feather Pigments. *Jour. Exp. Zoöl.*, Vol. 18, No. 3, pp. 453-495.

Parhon, C. J. and C.

'14 Note sur l'hyperthyroïdisation chez les oiseaux et sur la resistance des animaux ainsi traites aux infections spontanées. *Comp. Rend. Soc. de Biol.*, Vol. 76, pp. 662-663.

Torrey, H. B.

- '26 A Relation between Experimental Type Thyroidism and Barring in Poultry. *Proc. Soc. Exp. Biol. and Med.*, Vol. 23, pp. 536-537.
- '25 On the Antagonism between Thyroid and Ovary in Relation to the Formation of Plumage Melanins in the Domestic Fowl. *Anat. Rec.*, Vol. 31, No. 4, pp. 330.

Zavadovsky, Boris.

- '25a The Effect of Feeding Fowls on Thyroid Gland. *Endocrinology*, Vol. 9, No. 2, pp. 125-136.
- '25b The Effect of Single Doses of Thyroid Gland on Fowls. *Endocrinology*, Vol. 9, No. 3, pp. 232-241.

THE EFFECT OF AMMONIUM SALTS ON PROTOPLASM OF AMOEBA.

FLOYD J. BRINLEY,¹

PHYSIOLOGICAL LABORATORY, BATTLE CREEK COLLEGE, MICHIGAN.

There has been a vast amount of work done on the effect of chemicals on plant and animal cells. The methods employed in studying this effect have been largely confined to immersion of the cells in solutions of the various reagents. It is well known that immersed cells may be affected in a number of ways: the reagent may act on the plasma membrane, may affect the internal protoplasm without injuring the membrane or it may affect both the membrane and the internal protoplasm. Until the advent of the micropipette (Barber, 1911; Kite, 1915; Chambers, 1922) it was not possible to ascertain how the substances affect or react with a cell. The work of Chambers (1926), Reznikoff (1926), Pollack (1927), Hiller (1927) and others have brought to light, by micro-injection studies, many facts concerning the differences between the plasma membrane and the internal protoplasm and their reactions with various chemicals. Many substances such as narcotics, carbon dioxide, hydrogen cyanide, hydrogen sulfide, picric acid and certain salts which are lethal to immersed cells (*amœbæ*) have been found to be only reversibly injurious when injected into the cell. The action of strong acids and bases has been found (Chambers and Reznikoff, 1926) to be largely confined to the surface of the cell. HCl, pH 3, and NaOH, pH 9, when injected into *amœba* do not irreversibly injure the internal protoplasm, while *amœbæ* immersed in these solutions die very quickly.

From the work of Harvey (1911), Jacobs (1920) and others it appears that strong acids and bases enter living cells very slowly whereas weak acids and alkalies penetrate cells with little if any resistance. It has been rather generally accepted that the toxicity

¹ National Research Fellow 1927-1928. The author wishes to express his appreciation to Dr. C. E. McClung, University of Pennsylvania, for the use of a laboratory during the tenure of the fellowship.

of the weak acids and bases is due to their ease of penetration. However, the question of whether their toxicity is due to the effect on the plasma membrane or on the internal protoplasm has not been satisfactorily answered. Recently it has been shown that CO_2 (Chambers and Reznikoff, 1926), HCN and H_2S (Brinley, 1927 and 1928) when injected into amœba do not kill the cell unless the dosage is so large that it ruptures the plasma membrane. On the other hand, amœba die very quickly when immersed in these solutions. These experiments seem to prove conclusively that CO_2 , HCN, and H_2S exert their lethal action primarily on the cell membrane and not on the internal protoplasm.

In view of the fact that ammonia enters cells very rapidly, in this respect being similar to the weak acids, it was thought desirable to ascertain whether the toxicity of ammonium hydroxide and other ammonium salts was due to their action on the plasma membrane or on the internal protoplasm. The present paper deals with the effect of certain ammonium salts, namely, hydroxide, chloride, citrate, phosphate and acetate on the protoplasm of amœba as determined by immersion and injection experiments.

IMMERSION EXPERIMENTS.

Amœbæ were immersed in solutions of the following ammonium salts: hydrate, chloride, citrate, phosphate and acetate, and their effects on the organisms were studied. The species of amœba was not determined but it undoubtedly belonged to the proteous group. The concentrations of the solutions were N/10 and N/100. No attempt was made to control the H ion concentration but the pH was determined in each case by the colorimetric method. The reaction of the amœba to each salt will be discussed separately.

Ammonium hydroxide: Amœbæ immersed in N/10 ammonium hydroxide (pH 9.8) withdrew their pseudopodia and assumed a spherical form. The plasma membrane ruptured within a few seconds and the cell disintegrated. When amœbæ are immersed in N/100 solution the cell assumes a spherical form and swells slightly. Brownian movement becomes very rapid. The cell membrane dissolves within 3 to 5 minutes and the fluid protoplasm disperses into the surrounding solution.

Ammonium chloride: Amœbæ immersed in $N/10$ NH_4Cl , pH 6, elongate into the limax form and continue locomotion at a reduced rate for over an hour. The viscosity of the protoplasm seems to be slightly increased. At the end of two hours locomotion ceases, the animal rounds up and the cell disintegrates. When amœbæ are immersed in $N/100$ solution they assume the limax form and locomotion continues for over eighteen hours.

Ammonium carbonate: Immersion of amœbæ in $N/10$ or $N/100$ $(\text{NH}_4)_2\text{CO}_3$ results in an immediate cessation of locomotion, the pseudopodia remain extended and there appears to be a slowing down in the rate of Brownian movement. The cells swell slightly and the granules collect near the center of the cell and the protoplasm coagulates.

Ammonium acetate: Amœbæ placed in $N/10$ acetate solution continue to move at a slow rate for two hours. Finally the cell assumes a spherical form and disintegrates within two or three hours. They remain alive and continue locomotion in $N/100$ solution for over eighteen hours.

Ammonium citrate: Amœbæ immersed in $N/10$ or $N/100$ citrate solution elongate into the limax form and resume locomotion. The cell finally rounds up and the protoplasm coagulates.

Ammonium phosphate: Amœbæ placed in $N/10$ or $N/100$ phosphate solution $(\text{NH}_4\text{H}_2\text{PO}_4)$ continue locomotion for several hours. The streaming of the protoplasm becomes sluggish and finally the protoplasm coagulates and the animal dies.

TABLE I.

THE COMPARATIVE TOXICITY OF CERTAIN AMMONIUM SALTS TO *Amaba proteus* (?).

Salt.	Concentration.	Time Required to Kill 75 per cent of the Organisms.	pH
Hydroxide	$N/10$	15 to 30 seconds	9.8
	$N/100$	3 to 5 minutes	
Carbonate	$N/10$	1 hour	8.5
	$N/100$	1.5 hours	
Citrate	$N/10$	5 to 10 minutes	5.4?
	$N/100$	3.5 hours	
Phosphate	$N/10$	2 hours	6.8
	$N/100$	4 hours	
Chloride	$N/10$	2 hours	5.0
	$N/100$	Alive after 18 hours	
Acetate	$N/10$	3 hours	6.4
	$N/100$	Alive after 18 hours	

The prominent feature of these experiments is the marked resistance of amœbæ to the ammonium salts. The salts, with the exception of the hydroxide, produce an increase in viscosity of the protoplasm and death is accompanied by coagulation of the protoplasm. The toxicity of the hydroxide may be due to the alkalinity of the solution. Table I. gives a summary of the comparative toxicity of the ammonium salts to amœbæ. The time of death is only approximately correct for it is very difficult to determine the exact death point.

INJECTION EXPERIMENTS.

The ammonium salts used in the immersion experiments were injected into amœbæ by means of Chambers' micromanipulator. The concentrations used were N/1 to N/100. The salts, with the exception of the carbonate, were non-lethal even in high concentrations (N/1) when injected into amœba in amounts equal to one fourth the volume of the cell. Injections of normal solutions of the hydroxide, chloride, phosphate, acetate and citrate result in a local elevation of the membrane in the form of a blister near the point of entrance of the pipette. The solutions rapidly diffused throughout the cell, producing a reversible gelation of the protoplasm. The animals gradually withdrew their pseudopodia and assumed a spherical form. Eventually, streaming of the protoplasm occurs, Brownian movement is resumed and the organism recovers. Usually one large pseudopodium is formed and the animal adopts a limax form. The rate of recovery depends upon the salt injected. Cells injected with the chloride and phosphate require a much longer time for recovery than those injected with citrate, acetate and hydroxide. The approximate rate of recovery is as follows: chloride > phosphate > citrate > acetate > hydroxide.

A normal solution of ammonium carbonate is lethal to amœbæ when injected in amount equal to the volume of the nucleus. Injections of N/1 or N/10 solutions of the carbonate result in an initial increase in viscosity, the animal withdraws its pseudopodia and becomes spherical; finally the cell membrane dissolves and the protoplasm remains as a gelatinous mass. The cell recovers from a dosage of N/100 ammonium carbonate.

TEARING THE PLASMA MEMBRANE.

Amœbæ were immersed in N/10 and N/100 solutions of the above ammonium salts and the cell membrane torn with microdissection needles. If a small tear is made in the membrane a portion of the internal protoplasm escapes but the cell rapidly forms a new membrane over the injured surface. The rapidity of the formation of the membrane depends upon the salt used. More protoplasm escapes from a tear in the membrane when the cells are placed in the hydrate and carbonate than in the chloride, acetate, citrate or phosphate.

DISCUSSION.

Ammonium salts hydrolyze to different degrees depending upon the acid radical which is combined with the ammonia. The entrance of ammonia into the cell from solutions of ammonium chloride has been studied by Jacobs (1922), who has conclusively shown that a cell (*Rhodendron* or starfish egg) may develop an intracellular alkalinity when placed in a solution of ammonium chloride which is decidedly acid. This change in internal pH is undoubtedly, as Jacobs concludes, due to the selective permeability of the cell membrane. Chambers (1922) has verified this conclusion by injecting ammonium chloride into starfish eggs, thereby producing an intracellular acidity which demonstrates that the selective permeability is confined to the membrane and not to the internal protoplasm.

Harvey (1911) has shown by using intracellular neutral red as an indicator that ammonia and its primary, secondary and tertiary alkyl substitution products enter cells with very little if any resistance and that death of the cell does not result from the intracellular alkalinity as is evident by the ability of the cell to recover when removed from the ammonia solution and placed in pure water. On the other hand, Harvey concludes that strong alkalis do not enter the cell until the surface is destroyed. The process is irreversible. He also states that the strong alkalis kill by affecting the plasma membrane and likewise on pages 534 and 547 he states that ammonia must affect the membrane since it produces changes in behavior similar to those produced by NaOH—vesicle formation, cessation of movement and finally death—but the

changes produced bear no relation to the speed of entrance. The results of the present experiments seem to confirm Harvey's conclusions that ammonia and certain ammonium salts exert their lethal effects on the plasma membrane and not on the internal protoplasm. The question may be raised that the non-toxicity of the injected salts is due to their outward diffusion from the cell. This is not probable for there is no reason to believe that the salts would diffuse out of the cell any faster than they would enter the cell. It may also be thought that if the toxicity of the ammonium salts is due to their actual passage—dissociated or undissociated—through the membrane or to a chemical combination between the salts and plasma membrane that the outward diffusion, if it occurs, from the injected cell would produce death. This, however, is not the case. So it may possibly be that the two sides of the membrane are different chemically or that the ammonium salts are adsorbed as molecules or ions on the external surface of the cell or they unite with some constituent of the outer surface of plasma membrane.

SUMMARY.

A study was made by immersion and injection on the effects of the following ammonium salts: hydroxide, carbonate, chloride, phosphate, acetate and citrate on the protoplasm of *Amœba proteus* (?).

The effects of the ammonium salts are essentially due to the cations but may be modified by the anions.

The ammonium salts produce an increase in viscosity of the protoplasm in immersed amœbæ which is followed by a slight swelling of the protoplasm and disintegration of the cell. Injections of the salts, except the carbonate, into amœbæ produce a reversible increase in viscosity. The animals recover from dosages in amounts equal to one fourth the volume of the cell. Injection of the carbonate results in a disintegration of the cell.

When amœbæ are immersed in N/100 solutions of the salts and the cell membrane torn, a new membrane is formed over the injured surface.

These results seem to indicate that the toxicity of certain ammonium salts is due to their action on the plasma membrane and not on the internal protoplasm.

LITERATURE CITED.

Barber, M. A.

- '11 The Effect on the Protoplasm of *Nitella* of Various Chemical Substances and Micro-organisms Introduced into the Cavity of the Living Cell. *Jour. Inf. Dis.*, 9: 117-29.

Beerman, H.

- '24 Some Physiological Actions of Hydrogen Sulfide. *Jour. Exp. Zoöl.*, V., 41: 33-42.

Bodine, J. H.

- '24 Some Physiological Actions of Cyanides. *Jour. Gen. Phy.*, Vol. VII., 19-23.

Brinley, F. J.

- '27 Studies on the Physiological Effects of Hydrogen Cyanide. *Biol. Bull.*, LIII., 365-389.

Brinley, F. J.

- '28 Physiological Action of Cyanide on Protoplasm. *Proc. Exp. Biol. & Med.* XXV., 305-306.

Brinley, F. J.

- '29 Physiological Action of Hydrogen Sulfide on Protoplasm of *Amœba*. *Science*, LXIX., 336.

Chambers, R.

- '22 New Apparatus and Methods for Dissection and Injections of Living Cells. *Anat. Rec.*, Vol. 24: 1-19.

Chambers, R.

- '22 Microinjection Study on the Permeability of the Starfish Egg. *J. Gen. Phy.*, 5: 189-193.

Chambers, R., and Reznikoff, P.

- '26 Micurgical Studies in Cell Physiology. I. The Action of the Chlorides of Na, K, Ca, and Mg on the Protoplasm of *Amœba proteus*. *J. Gen. Phy.*, VIII., 369-401.

Harvey, N. H.

- '11 Studies on the Permeability of Cells. *J. Exp. Zoöl.*, Vol. X., 507-556.

Hiller S.

- '27 Action of Narcotics on *Amœba* by Means of Microinjection and Immersion. *Proc. Exp. Biol. & Med.*, XXIV., 427-28.

Jacobs, M. H.

- '20 The Production of Intracellular Acidity by Neutral and Alkaline Solutions Containing Carbon Dioxide. *Am. J. Phy.*, 53, 457-63.

Jacobs, M. H.

- '22 The Influence of Ammonium Salts on Cell Reaction. *J. Gen. Phy.*, 5, 181-88.

Kite, G. L.

- '15 Studies on the Permeability of the Internal Cytoplasm of Animal and Plant Cells. *Am. J. Phys.*, 37, 282-299.

Osterhout, W. J. V.

- '25 Is Living Protoplasm Permeable to Ions? *J. Gen. Phy.*, VIII., 131-46.

Osterhout, W. J. V., and Dorcas, M. J.

- '25 The Penetration of CO₂ into living protoplasm. J. Gen. Phy., IX., 255-267.

Pollack, H.

- '27 Action of picric acid on living protoplasm. Proc. of Exp. Biol. & Med., XXV., p. 145.

Reznikoff, P.

- '26 Micurgical Studies in cell physiology. II. The action of the chlorides of lead, mercury, copper, iron and aluminum on the protoplasm of *Amœba proteus*. J. Gen. Phy., Vol. X., 9-21.



BIOLOGICAL BULLETIN

OF THE

Marine Biological Laboratory

WOODS HOLE, MASS.

VOL. LVI

JUNE, 1929

No. 6

CONTENTS

- RIZZOLO, ATTILIO. *The Effect of Caffeine and Theine upon the Excitability of the Spinal Cord* 379
- RIZZOLO, ATTILIO. *A Study of Equilibrium in the Smooth Dogfish—*Galeus canis* (Mitchill)* 383
- WENRICH, D. H. *The Structure and Behavior of *Actinobolus vorax* n. sp. (Protozoa, Ciliata)* 390
- KOSTOFF, DONTCHO, AND KENDALL, JAMES. *Studies on the Structure and Development of Certain Cynipid Galls* 402
- DOMM, L. V. *The Effects of Bilateral Ovariectomy in the Brown Leghorn Fowl* 459
-

PUBLISHED MONTHLY BY THE
MARINE BIOLOGICAL LABORATORY

PRINTED AND ISSUED BY
LANCASTER PRESS, INC.
LANCASTER, PA.

AGENT FOR GREAT BRITAIN
WHELDON & WESLEY, LIMITED
2, 3 and 4 Arthur Street, New Oxford Street, London, W. C. 2

Single Numbers, \$1.00. Per Volume (6 numbers), \$4.50

Editorial Staff

- GARY N. CALKINS—*Columbia University.*
E. G. CONKLIN—*Princeton University.*
M. H. JACOBS—*University of Pennsylvania.*
FRANK R. LILLIE—*University of Chicago.*
GEORGE T. MOORE—*The Missouri Botanic Garden.*
T. H. MORGAN—*Columbia University.*
W. M. WHEELER—*Harvard University.*
E. B. WILSON—*Columbia University.*

Managing Editor

- C. R. MOORE—*The University of Chicago.*
-

All communications and manuscripts should be sent to the Managing Editor, the University of Chicago. Subscriptions and other matter should be addressed to the Biological Bulletin, Prince and Lemon Streets, Lancaster, Pa.

BIOLOGICAL BULLETIN

OF THE

Marine Biological Laboratory

WOODS HOLE, MASS.

Editorial Staff

GARY N. CALKINS—*Columbia University.*

E. G. CONKLIN—*Princeton University.*

M. H. JACOBS—*University of Pennsylvania.*

FRANK R. LILLIE—*University of Chicago.*

GEORGE T. MOORE—*The Missouri Botanic Garden.*

T. H. MORGAN—*Columbia University.*

W. M. WHEELER—*Harvard University.*

E. B. WILSON—*Columbia University.*

Managing Editor

C. R. MOORE—*The University of Chicago.*

VOLUME LVI.

WOODS HOLE, MASS.

JANUARY TO JUNE, 1929

LANCASTER PRESS, INC.
LANCASTER, PA

Contents of Volume LVI

NO. 1. JANUARY, 1929.

TURNER, C. L. <i>Studies on the Secondary Sexual Characters of Crayfishes, IX. Females of Cambarus with Aberrant Female Characters</i>	1
MACKEY, MARGARET E. <i>The Digestive System of the Eel-Pout (Zoarces Anguillaris)</i>	8
MACKEY, MARGARET E. <i>Note on the Bile in Different Fishes</i>	24
RICHARDS, OSCAR W. <i>The Effect of Neurophil Drugs on the Fiddler Crab, Uca pugnax</i>	28
RICHARDS, OSCAR W. <i>The Conduction of the Nervous Impulse through the Pedal Ganglion of Mytilus</i>	32
CRABB, EDWARD D. <i>Growth of a Pond Snail, Lymnaea stagnalis appressa, as Indicated by Increase in Shell Size</i>	41
MORITA, YUN-ICHI, AND CHAMBERS, ROBERT. <i>Permeability Differences between Nuclear and Cytoplasmic Surfaces in Amæba dubia</i>	64
HOPKINS, D. L., AND JOHNSON, PERCY L. <i>The Culture of Amæba proteus in a Known Salt Solution</i>	68

NO. 2. FEBRUARY, 1929.

OKADA, YÔ K. <i>Supplementary Note on the Double Formation in the Echinus Germ in Diluted Sea Water</i>	75
DAWSON, J. A., AND BELKIN, MORRIS. <i>The Digestion of Oils by Amæba proteus</i>	80
BUTCHER, EARL O. <i>The Origin of the Germ Cells in the Lake Lamprey (Petromyzon marinus unicolor)</i>	87
FRY, HENRY J. <i>The So-called Central Bodies in Fertilized Echinarachnius Eggs</i>	101
NABOURS, ROBERT K., AND FOSTER, MARTHA E. <i>Parthenogenesis and the Inheritance of Color Patterns in the Grouse Locust Paratettix texanus Hancock</i>	129

NO. 3. MARCH, 1929.

THORNER, MELVIN W. <i>Recovery of the Heart Beat of Fundulus Embryos After Stoppage by Potassium Chloride</i>	157
REICHLÉ, HERBERT S. <i>The Diagnosis of the Type of Twinning</i>	164
WHEDON, ARTHUR D. <i>Muscular Reorganization in the Odonata During Metamorphosis</i>	177
SUMWALT, MARGARET. <i>Potential Differences Across the Chorion of the Fundulus Egg</i>	193
GEROULD, JOHN H. <i>History of the Discovery of Periodic Reversal of Heart-Beat in Insects</i>	215
LAMBERT, W. V., AND CURTIS, V. <i>Further Studies on the Sex Ratio in the Chicken</i>	226

NO. 4. APRIL, 1929.

NABRIT, S. MILTON. <i>The Rôle of the Fin Rays in the Regeneration in the Tail-fins of Fishes</i>	235
MOENCH, G. L., AND HOLT, HELEN. <i>Microdissection Studies on Human Spermatozoa</i>	267
YOHEM, DONALD E. <i>Spermatozoön Life in the Female Reproductive Tract of the Guinea Pig and Rat</i>	274
RICHARDS, OSCAR W. <i>The Correlation of the Amount of Sunlight with the Division Rates of Ciliates</i>	298
COE, WESLEY R. <i>The Excretory Organs of Terrestrial Nemerteans</i>	306

NO. 5. MAY, 1929.

REICHLÉ, HERBERT S. <i>The Diagnosis of Monoövular Twinning</i>	313
NADLER, ERNEST J. <i>Notes on the Loss and Regeneration of the Pellicle in Blepharisma undulans</i>	327
FEDERIGHI, H. <i>Rheotropism in Urosalpinx cinerea Say</i>	331
MCCONNELL, CARL H. <i>Experimental Observations upon the Endodermal Glands of Pelmatohydra oligactis</i>	341
HUFF, CLAY G. <i>Ovulation Requirements of Culex pipiens Linn</i>	347
ROMANOFF, ALEXIS L. <i>Study of the Physical Properties of the Hen's Eggshell in Relation to the Function of Shell-Secretory Glands</i>	351

- MARTIN, J. HOLMES. *Effect of Excessive Dosages of Thyroid on the Domestic Fowl* 357
- BRINLEY, FLOYD J. *The Effect of Ammonium Salts on Protoplasm of Amœba* 371

NO. 6. JUNE, 1929.

- RIZZOLO, ATTILIO. *The Effect of Caffeine and Theine upon the Excitability of the Spinal Cord* 379
- RIZZOLO, ATTILIO. *A Study of Equilibrium in the Smooth Dogfish—Galeus canis (Mitchill)* 383
- WENRICH, D. H. *The Structure and Behavior of Actinobolus vorax n. sp. (Protozoa, Ciliata)* 390
- KOSTOFF, DONTCHO, AND KENDALL, JAMES. *Studies on the Structure and Development of Certain Cynipid Galls* 402
- DOMM, L. V. *The Effects of Bilateral Ovariectomy in the Brown Leghorn Fowl* 459

BIOLOGICAL BULLETIN

THE EFFECT OF CAFFEINE AND THEINE UPON THE EXCITABILITY OF THE SPINAL CORD.

ATTILIO RIZZOLO,

UNITED STATES BUREAU OF FISHERIES, WOODS HOLE, MASS.

In previous publications,¹ we have reported data concerning the effect of strychnine, cocaine, morphine and nicotine upon the excitability of the spinal cord in the selachians *Trygon vulgaris*, *Raja pastinaca*, *Scylliorhinus canicula*. Local applications of each alkaloid upon a motor point located on the dorsal side of the spinal cord first increased and later diminished the excitability of the motor point; local applications of one or other alkaloid on a motor point located on the ventral side of the cord caused no change in the excitability of the motor point. We have continued our study with the local applications of the alkaloids caffeine and theine.

The smooth dogfish (*Galus canis* Mitchell) has served as subject of experiment. The size of the animal varied from fifty to sixty centimeters. Each alkaloid has been applied locally on the dorsal and ventral sides of the spinal cord. The excitability of the spinal cord has been determined before applications of one or the other alkaloid and after each application. The alkaloids have been prepared at a concentration of 2 per cent. in sodium chloride solution (8/1000).

For each alkaloid two series of experiment have been made. Each series consisted of six animals. In the first series, the dorsal side of the spinal cord was denuded in the region immediately anterior to the base of the posterior dorsal fin. In the second series, the ventral side of the spinal cord was exposed immediately

¹ See "Action de la strychnine sur les faces dorsales et ventrales de la moelle lombaire," by A. Rizzolo, *C. R. Soc. Biol.*, XCVI, 1927, p. 1207. "Effet de la cocaïne de la morphine, et de la nicotine sur l'excitabilité de la moelle épinière," by A. Rizzolo, *C. R. Soc. Biol.*, XCVII., 1927, p. 1073.

anterior to the anal fin. In both series, the spinal cord was exposed to the extent of six millimeters. Motor points determining the movement of the posterior dorsal fin were located in the region immediately anterior to the base of the posterior dorsal fin; motor points determining the movement of the anal fin were located in the region immediately anterior to the anal fin. The excitabilities of the motor points located in each region were carefully measured in order to locate the motor point having the greatest excitability. We have designated the motor point having the greatest excitability as the optimum motor point. Local applications of caffeine or of thine were made on the optimum motor point and the excitability of the motor point was redetermined after each application. Briefly stated, the procedure of experiment was as follows:

1. The dorsal or the ventral side of the spinal cord was exposed.
2. The optimum motor point determining the movement of the posterior dorsal fin or of the anal fin was located; the excitability of the motor point was measured several times.
3. Applications of the alkaloid to be tested were made on the optimum motor point.
4. Immediately after each application, the excitability of the optimum motor point was redetermined.

DOGFISH V.—CAFFEINE.

Ventral side of the spinal cord immediately anterior to the anal fin. Measurements of the chronaxie made from the optimum motor point determining the movement of the anal fin.

A. Measurements Before Applications of the Alkaloid.

Rheobase (Volts).	Chronaxie (♂).
3.2	0.2
2.8	0.2
2.8	0.2
2.6	0.2

B. Measurements After Applications of the Alkaloid.

Rheobase (Volts).	Chronaxie (♂).
3	0.1
3	0.05
2.6	0.05
2.8	0.3
3.2	0.4
2.8	0.6

All animals have been operated without the employment of anesthetics. The animal was fastened to a cork board tilted so that the animal's head and gills remained completely submerged under water. The board was tilted in a large dissecting pan provided with a continuous flow of sea water.

The alkaloids were applied according to the method of Baglioni and Amantea. A piece of filter paper one and one half to two ($1\frac{1}{2}$ -2) millimeters square was soaked in the solution of the alkaloid to be studied and was placed on the optimum motor point. Each application was made for a period of three minutes.

DOG FISH IV.—THEINE.

Ventral side of the spinal cord immediately anterior to the anal fin. Measurements of the chronaxie made from the optimum motor point determining the movement of the anal fin.

A. Measurements Before Applications of the Alkaloid.

Rheobase (Volts).	Chronaxie (σ).
3.4	0.3
3.4	0.3
3.2	0.3
3.6	0.3

B. Measurements After Applications of the Alkaloid.

Rheobase (Volts).	Chronaxie (σ).
3.4	0.1
3.8	0.1
3.6	0.2
4	0.6
3.8	0.7
3.6	0.9

The measurements of excitability were made in function of time according to the method of the "Chronaxie" devised by L. Lapique. Employment of Lapique's electrical rheotome "le chronaximetre" permitted the measurements to be made directly in thousands ($1/1000$) of a second—sigma. As positive electrode, Lapique's modification of D'Arsonval's non-polarizable was employed; as negative electrode a silver wire was used. The negative electrode was plunged into the muscular tissue surrounding the region of the cord exposed. The positive electrode was held locally and placed intermittently by hand on a motor point whose excitability was being measured.

In this experiment, animals in which the optimum motor points measured chronaxies below 0.2 sigma were not accepted as subject of experiment.

Results and Conclusions.—The data obtained in each series of experiment for each alkaloid was concordant.

1. Four local applications of caffeine or theine at a concentration of 2 per cent. on the optimum motor point located on the dorsal side of the spinal cord and determining the movement of the posterior dorsal fin affected no change in the original chronaxie of the motor point. The motor point retained its original chronaxie after each application.

2. The first application of one or the other alkaloid on the optimum motor point located on the ventral side of the spinal cord and determining the movement of the anal fin diminished the original chronaxie from 33–67 per cent.; the fourth application increased the original chronaxie from 50–100 per cent. The sixth application affected an increase of even 200 per cent.

A case reporting the measurements made from the ventral side of cord is given for each alkaloid.

Summer, 1928.

A STUDY OF EQUILIBRIUM IN THE SMOOTH DOG-
FISH—*GALEUS CANIS* (MITCHILL).*

ATTILIO RIZZOLO.

Sewell (1882) maintained it would be a bold assumption to assume the semicircular canals, ampullæ and vestibule (utricle and saccule) indispensable to the equilibrium of the selachians. Steiner (1886-1888) stressed the dispensability of these organs; Lee (1884-1886) contended their indispensability. Gaglio (1901) after bilateral ablation of a large part of the labyrinth obtained little or no disturbance of equilibrium. J. Loeb (1891) obtained disturbance of equilibrium following removal of the otolith from one saccule. G. H. Parker (1909) observed no disturbance following removal of the otolith from one or both saccules; section of both acoustic nerves caused profound disturbance of equilibrium. S. S. Maxwell (1910-1923) has observed that the animal swims quite normally after section of the two eighth nerves or after destruction of the two labyrinths. In the teleosts, Tomaszewicz (1877) observed no disturbance of equilibrium after destruction of the semicircular canals and their ampullæ; Kiesselback (1882) cutting the horizontal canals on both sides obtained similar negative results.

In this paper we report our observations concerning the equilibrium of the *Galeus Canis* when the selachian was subjected to

- (1) Bilateral sectioning of the olfactory tracts.

- (2) Bilateral sectioning of the optic nerves.
- (3) Bilateral destruction of the labyrinths.
- (4) Bilateral sectioning of the olfactory tracts, bilateral sectioning of the optic nerves and bilateral destruction of the labyrinths.

The animals were operated without the employment of local or general anæsthesia. Special care was taken to operate while the

* This investigation was undertaken at the U. S. Marine Laboratory, Woods Hole.

animal's head and gills remained submerged in sea water. The animal was fastened to a cork board tilted at an angle of 45° in a large dissecting pan provided with a continuous flow of sea water.

The behavior of the animals was studied in an aquarium $2\frac{1}{4}$ meters in length, $1\frac{1}{4}$ meters in width, and $\frac{4}{5}$ meter in depth.

The experiments were limited to animals measuring 50 cm. to 75 cm. in length.

OPERATIONS.

Sectioning of the Olfactory Tracts.—Part of the cranial encasement (prefrontal and frontal regions) covering the olfactory tract and olfactory lobe was removed. A cavity was exposed which permitted sectioning of the tract. After sectioning the tract, the cavity was filled with cotton. The cotton was held in place by means of drawing stitches at right angles to each other immediately above it. No skin flap was made.

Sectioning of the Optic Nerves.—Cutting through the roof of the mouth a rectangular flap consisting of cartilage and palatal epithelium was made immediately over the junction (chiasma) of the optic nerves. The optic nerves were sectioned 1 mm.— $1\frac{1}{2}$ mm. from their place of junction. The flap was sutured into place again.

Destruction of the Labyrinths.—The approach to the labyrinth was made through the roof of the otic capsule. The destruction involved removal of the membranous vestibule (utricle and sacculus, the three membranous semicircular canals and the three membranous ampullæ. The cartilaginous labyrinth corresponding to these parts of the membranous labyrinth was lacerated. The resulting cavity was thoroughly cleansed with cotton. After the cleansing, the cavity was filled with a cotton pack and the skin flap made over the roof of the capsule at the beginning of the operation was replaced and sutured.

EXPERIMENTS AND RESULTS.

Bilateral Sectioning of the Olfactory Tracts.—Sectioning both olfactory tracts in the same animal caused no disturbance of equilibrium. Swimming remained normal. The animal died five to

six days after sectioning of the tracts. Six animals were operated upon.

Bilateral Sectioning of the Optic Nerves.—In the same animal, both optic nerves were sectioned. In two cases, swimming remained normal; in five cases movement in the horizontal plane was disturbed. In the latter cases, the animal at times swam around the dorso-ventral axis in circles or in the path of a curved line. Changing the direction of the animal changed the direction of its swimming. Turned to the right, the animal swam to the right around the dorso-ventral axis; turned to the left, it swam to the left. In other planes, the animal swam normally. Twelve to fifteen hours after sectioning of the nerves, the tendency to swim around the dorso-ventral axis disappeared; movement was normal in all planes. The animal died three to four days after the operation.

Bilateral Destruction of the Labyrinths.—In the same animal both labyrinths were carefully and neatly destroyed. In all cases, disturbances of equilibrium resulted. All animals died within three days. The cases may be grouped as follows:

1. Cases (6) in which movement was defective in the vertical and oblique planes to the surface of the water. In other planes, movement was normal. Rotation around the longitudinal axis when swimming in a plane vertical or oblique to the surface of the water never disappeared; it continued until the animal died.

2. Cases (14) in which the animal manifested unsteadiness in keeping the dorsal side up and difficulty in righting itself if placed on its back. The animal swam normally in all planes. At times its ability to keep the dorsal side up becoming critical, the animal would make a turn to the right or to the left towards the bottom of the aquarium. By so doing, it controlled its equilibrium and swam away normally—dorsal side up. Placed ventral side up at the surface of the water, the animal swam on its back a considerable length of time before righting itself. The righting movements were difficult. After a lapse of twenty-four hours, the tendency to be occasionally unsteady in keeping the dorsal side up disappeared; the animal continued to right itself with difficulty when placed on its back.

3. Cases (19) in which the animal retained temporary control

of equilibrium. At times, the animal swam normally in all planes; at other times it lost complete control of its equilibrium. When equilibrium was lost, the animal swam on its back, rotated around its axes, spiraled through the water and nose dived. Rotation around the axes and spirals were made indiscriminately to the right and left. After a period of disturbed equilibrium, the animal regained normal equilibrium only to lose it again sooner or later. The periods of normal and disturbed equilibrium were equally divided. Four to twenty-four hours after destruction of the labyrinths, movement was normal in all planes but if placed ventral side up at the surface of the water the animal swam on its back until it righted. In this respect, equilibrium remained disturbed.

4. Cases (11) in which the animal did not retain temporary control of equilibrium. Following the destruction of the labyrinths, equilibrium was lost for a period of four to twenty-four hours. Movement was disturbed in all planes. As in the case of the preceding group, the animal rotated around its axes, spiraled through the water, swam on its back and nose dived. Twenty-four hours after removal of the labyrinths, movement was normal in all planes. The animal's equilibrium was comparable to the equilibrium of the normal animal but for one exception. Placed ventral side up at the surface of the water, the animal righted itself with difficulty; it swam on its back until it righted. The difficulty in righting itself when placed on its back was always present; it did not disappear.

Bilateral Sectioning of the Olfactory Tracts, Bilateral Sectioning of the Optic Nerves and Bilateral Destruction of the Labyrinths.—In each animal both olfactory tracts, both optic nerves and both labyrinths were destroyed. The olfactory tracts were sectioned first. Two hours later the optic nerves were sectioned. When sectioning of the optic nerves caused the animal to rotate in circles or in the path of a curved line around the dorso-ventral axis, the labyrinths were destroyed after movement in the horizontal plane had become normal. When sectioning of the optic nerves permitted movement in the horizontal plane to remain normal, the labyrinths were destroyed four hours after sectioning of the nerves. The disturbances of equilibrium following destruction of the labyrinths were the same as the disturbances described

when only the labyrinths were destroyed; the improvements in the animal's movements following the disturbances of equilibrium were also the same. In brief, the same types of case were obtained when the destruction of the labyrinths was preceded by sectioning of the olfactory tracts and optic nerves as when only the labyrinths were destroyed. Nineteen animals were operated upon. In four cases, the animal rotated around the longitudinal axis when swimming to the surface of the water; in three cases, the animal manifested unsteadiness in keeping the dorsal side up and difficulty in righting itself when placed on its back; in seven cases, temporary control of equilibrium was retained; in four cases, equilibrium was lost for a period of four to twenty-four hours.

CONCLUSIONS.

1. *Bilateral Destruction of the Labyrinths Causes Disturbances of Equilibrium in All Animals.*—In some animals the disturbance is more marked than in others. When the disturbance is not very marked, the animal either rotates around its longitudinal axis when swimming to the surface of the water or swims on its back and rights itself with difficulty when placed ventral side up; when the disturbance is very pronounced the animal rotates around the longitudinal, transverse and dorso-ventral axes, nose dives, spirals, and swims on its back.

2. Allowing the factor of time to intervene, the animals which suffer profound disturbances of equilibrium—such as rotation around the axes, spirals and nose diving—regain most of their equilibrium within twenty-four hours. The animal swims normally in all planes, but if placed ventral side up, it swims on its back and rights itself with difficulty.

3. After sectioning the olfactory tracts or the optic nerves, the animal's equilibrium remains normal. Movement to the right or left around the dorso-ventral axis during the first hours following the sectioning of the optic nerves can not be accepted as disturbance of equilibrium because changing the direction of the animal changes the direction of its swimming.

4. Destruction of the labyrinths after sectioning of the olfactory tracts and optic nerves disturbs the animal's equilibrium similarly as the destruction of the labyrinths alone.

BIBLIOGRAPHY.

Cyon, E.

- '97 Recherches expérimentales sur les fonctions des canaux semi-circulaires et leur rôle dans la formation de la notion de l'espace. *Ann. Sci. Nat. (Zoöl.)*, VI., sér. 7, no. 8, p. 96.

Gaglio, G.

- '02 Esperienze sull'anestesia del laborinto dell'orechio nei pesci cani. *Rend. C. Acc. Lincei, Roma*, XI., p. 277.

Gaglio, G.

- '02 Expériences sur l'anesthésie du labyrinthe de l'oreille chez les chiens de mer. *Archiv. Ital. de Biol.*, XXXVIII., p. 384.

Kiesselback, W.

- '82 Zur function der halbzirkelförmigen kanäle. *Archiv. f. Ohrenhk.*, XVIII., p. 152.

Lafite-Dupont, J.

- '05 Expérimentation sur l'orientation des poissons. Lésions des canaux semi-circulaire de l'oreille interne. *Trav. Labor. Soc. Sci. Arcachon*, p. 103.

Lafite-Dupont, J.

- '06 Expérimentation sur les canaux semi-circulaire de l'oreille des poissons. *Archiv. Internat. Laryngol.*, p. 155.

Lee, F. S.

- '94 A study of the Sense of Equilibrium in Fishes. *Jour. Physiol.*, XV., p. 311.

Lee, F. S.

- '94 The Functions of the Ear and the Lateral Lines in Fishes. *Amer. Jour. Physiol.*, XVII., p. 192.

Lee, F. S.

- '98 The Formation of the Ear and the Lateral Line in Fishes. *Amer. Jour. Physiol.*, I., p. 128.

Loeb, J.

- '91 Ueber geotropisms bei tieren. *Archiv. f. ges. Physiol.*, LXIX., p. 175.

Loeb, J.

- '91 Ueber den anteil des hörnerven an den nach gehirnverletzung auftretenden zwangsbewegungen, etc. *Arch. f. ges. Physiol.*, p. 66.

Maxwell, S. S.

- '10 Experiments on the function of the internal ear. *Univ. Calif. Pub. in Physiology*, IV., p. 1.

Maxwell, S. S.

- '12 On the Exciting Cause of Compensatory Movements. *Amer. Jour. Physiol.*, XXIX., p. 367.

Maxwell, S. S.

- '19 Labyrinth and Equilibrium. I. A Comparison of the Removal of the Otolith Organs and of the Semi-circular Canals. *Jour. Gen. Physiol.*, II., p. 123.

Maxwell, S. S.

- '20 Labyrinth and Equilibrium. II. The Mechanism of the Dynamic Functions of the Labyrinths. *Jour. Gen. Physiol.*, II., p. 349.

Maxwell, S. S.

- '20 Labyrinth and Equilibrium. III. The Mechanism of the Static Function of the Labyrinths. *Jour. Gen. Physiol.*, III., p. 157.

Maxwell, S. S.

- '21 Equilibrium Functions of the Internal Ear. *Science*, LIII., p. 423.

Maxwell, S. S.

- '23 Labyrinth and Equilibrium. One volume.

Parker, G. H.

- '04 The Function of the Lateral Line Organs in Fishes. *Bull. Bur. Fish.*, XXIV., p. 185.

Parker, G. H.

- '09 The Influence of the Eyes, Ears and Other Allied Sense-organs on the Movements of the Dogfish. *Bull. Bur. Fish.*, XXI., p. 45.

Parker, G. H.

- '10 The Function of the Ear in Cyclostomes. *Science*, XXXI., p. 470.

Sewall, H.

- '82 Experiments upon the Ears of Fishes with Reference to the Function of Equilibrium. *Jour. Physiol.*, IV., p. 339.

Steiner, J.

- '86 Ueber das centralnervensystem des haifishes und des amphioxus, und über die halbzirkelförmigen canäle des haifischen. *Sitzb. d. könig. Preuss. Akad. d. Wiss. Berlin*, I., p. 495.

Steiner, J.

- '87 Sur la fonction des canaux semicirculaires. *C. R. Acad. des Sc.*, CIV., p. 1116.

Steiner, J.

- '89 Der meniere'sche schwindle und die halbzirkelförmigen canäle. *Deutsch. med. Woch.*, XLVII., p. 958.

Tomascewicz, A.

- '77 Beiträge zur physiologie des ohrlabyrinths. *Inaug. Diss. Zurich*, p. 91.

THE STRUCTURE AND BEHAVIOR OF *ACTINOBOLUS*
VORAX N. SP. (PROTOZOA, CILIATA).

D. H. WENRICH,

DEPARTMENT OF ZOÖLOGY, UNIVERSITY OF PENNSYLVANIA.

Actinobolus radians was first described briefly by Stein in 1867 and since then a number of observers have given descriptions of what they considered to be the same species. Thus, Entz ('82), Erlanger ('90), Calkins ('01), Moody ('12), Penard ('22) and Fauré-Fremiet ('24) have all described what they have called *Actinobolus radians*. But a review of their descriptions and illustrations makes it apparent that they were not all dealing with the same species. However the matter of the identity of the several species represented in the literature will not be dealt with here. It is sufficient at this time to point out that the species now to be described is different from any of those indicated in the available literature, and is therefore given a new name.

It is the purpose of the present paper to record some observations on the structure and behavior of this new species of *Actinobolus* which was found in the pond of the Botanical Gardens of the University of Pennsylvania. This ciliate appeared in considerable numbers in this pond during May, 1926. A number were fixed in various fixatives, chiefly Schaudinn's sublimate-alcohol-acetic and Bouin's picro-formol-acetic. Some were stained in toto with hæmalum and other stains, while others were sectioned and stained in a variety of ways but chiefly with Heidenhain's iron-alum hæmatoxylin.

Drawings represented by figures 1, 3 and 4, were made by Mr. R. M. Stabler to whom great credit is due for his care in executing them. I am also indebted to the Pennsylvania chapter of the Society of Sigma Xi for a grant of funds which made it possible to employ Mr. Stabler to make the drawings.

Actinobolus vorax is rather large, most specimens measuring between 100 μ and 200 μ in length with a width from $\frac{1}{2}$ to $\frac{3}{4}$ as great. The form varies from an elongate oval to spheroid. The more elongate individuals are narrower and more tapering

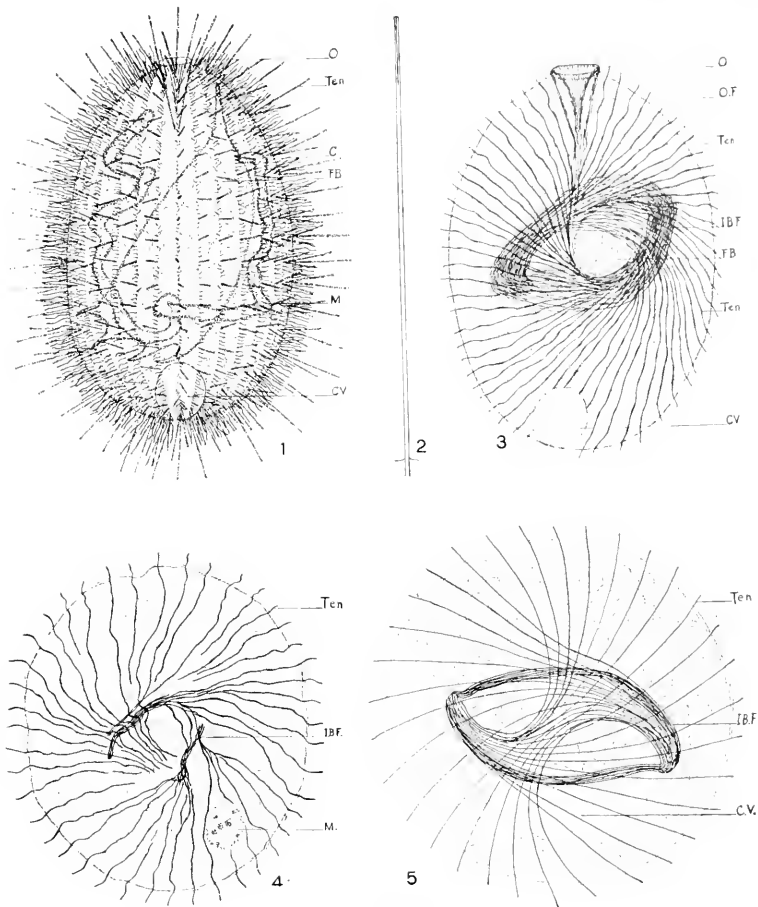

FIG. 1. Diagrammatic figure of *Actinobolus vorax* showing details of organization and the inclusion of an ingested *Anurca*. Tentacles partly extended. FIG. 2. Single tentacle, fully extended; toxicyst at distal end. FIG. 3. Side view showing inner extensions of tentacles and their association with the skein of internal fibrils. FIG. 4. Cross section of *A. vorax* showing tentacles and inner bundles of fibrils as seen in a thin section. FIG. 5. Whole animal viewed from posterior end; partly diagrammatic, showing bilateral arrangement of tentacles and their inner extensions connected with the skein.

EXPLANATION OF FIGURES.

All figures have been drawn at a magnification of 1000 and have been reduced about 3/5 in printing.

ABBREVIATIONS.

- | | |
|-----------------------------------|---------------------|
| C.—cilia. | M.—macronucleus. |
| C. V.—contractile vacuole. | O.—oral opening. |
| F. B.—food body. | O. F.—oral fibrils. |
| I. B. F.—inner bundle of fibrils. | Ten.—tentacles. |

anteriorly and more rounded posteriorly (Fig. 1). They are commonly a light yellowish brown in color. As in most other members of the family Encheliniidæ, the body is approximately radially symmetrical about its long axis with a mouth at the anterior pole and a cytopyge at the posterior pole.

Figure 1 indicates the general morphology of *Actinobolus vorax* with the tentacles only partially extended. This specimen is 110 microns long by 70 microns wide. The mouth at the more tapering anterior end does not usually protrude much beyond the general contour in the normal living animal but often protrudes slightly in fixed and stained animals, as indicated in the figure. Here it is about ten microns wide but the width varies in different specimens. The mouth is followed by a pharyngeal apparatus which is conical in shape, with the narrower end of the cone reaching into the body a distance of 20 to 25 microns. There are two sets of pharyngeal fibrils, an outer and an inner set. These fibrils do not seem to be of the nature of trichites. The inner group appears to be a thicker one, containing more fibrils and the outer set may include tentacles in its make-up as seen in some of the sections. The two sets of fibrils appear to converge at their outer extremities in what may be called the lip of the cytostome. In this lip there is a circular strand of more deeply staining material which may possibly be a sphincter for closing the mouth or may possibly be some part of a neuromotor system. In some stained specimens a second circular strand is seen a short distance outside the one just mentioned. Just how the two sets of longitudinal fibrils function is not known, but if they are contractile, the outer set might serve to open the mouth and the inner set serve to help close it or perform peristaltic movements which would aid in swallowing. While these animals were never seen to ingest anything except the rotifer, *Anureca*, stained specimens have, at times, revealed within them euglenoids, both encysted and not encysted, and several kinds of diatoms. In figure 1 an ingested *Anureca* is indicated.

At the posterior end one finds the large contractile vacuole (c.v.) which is usually subterminal (Fig. 3), and near it the terminal cytopyge which is not visible except during defecation and is not illustrated in the drawings. In many specimens there is a smaller

contractile vacuole on one side a little anterior to the middle of the body. It is not certain whether it is always present or may merely anticipate the next division. It has been noted more frequently in the more elongated specimens, but in stained animals it is seen in those in which there was no evident preparation for division.

The protoplasm is rather uniformly vacuolated or alveolar and contains the long, rope-like macronucleus which may be irregularly bent, is sometimes branched, and commonly makes a complete loop within the body, with the free ends at the anterior part of the animal (Fig. 1). Micronuclei were not definitely made out, although some small bodies were found which were tentatively identified as micronuclei.

The long cilia are arranged in from 30 to 60 longitudinal or slightly spiral rows. The tentacles are in the rows with the cilia, there being about thirty in each row. Thus the cilia are not arranged in groups about the bases of the tentacles, as described by Erlanger ('90), Calkins ('01), Moody ('12) and Penard ('22). The tentacles are fairly uniformly spaced through the mid-body region but less so toward the ends. There are usually from four to eight cilia between two adjacent tentacles in a row (Fig. 1).

The most interesting morphological character of *Actinobolus* consists in the series of tentacles which appear to be so unusual among the Ciliata although true tentacles are characteristic of the Suctorina. These tentacles are capable of being extended out in all directions to a distance as great as twice the diameter of the animal, yet may be withdrawn till they no longer protrude above the body surface. They are thus customarily withdrawn in actively swimming specimens but if a moving *Actinobolus* be followed for a time it will usually not be long till the tentacles gradually emerge from the surface and as they become longer and longer the swimming activities of the cilia gradually diminish till the animal comes to rest with the tentacles fully extended. After a few seconds or minutes the cilia become more active while the tentacles begin to shorten and soon *Actinobolus* begins swimming forward while the tentacles complete the process of re-entering the body.

The relatively long tentacles of this *Actinobolus* are uniform in diameter and at first appeared to be homogeneous throughout.

However, more careful study has revealed a highly refractive region within the outer portion for a distance of about ten to twelve microns from the tip (Fig. 2). This highly refractive rodlet is believed to be a trichocyst of the chemical type and therefore may be referred to by Visscher's ('23) term, toxicyst. The species of *Actinobolus* under consideration fed primarily upon the rotifer, *Anurca cochlearis* and the paralyzing effect of these toxicysts on *Anurca* is very evident whenever one of them comes into contact with the "forest of tentacles" presented by *Actinobolus*. One may therefore consider the tentacles as devices for extending the toxicysts out from the body, increasing thereby the area of possible contact between the ciliate and its prospective prey.

Each toxicyst is thus placed at the outer end of a relatively long and retractile stalk. But what becomes of the stalks when they are retracted into the body? What is the nature of these stalks? Are they composed of material that dissolves or changes to the sol state as they retreat inwardly, to be reformed when they emerge again, or are they permanent structures which must be accommodated within the animal's body? If the latter, how are they managed; what causes them to be withdrawn; what causes them to be extended? Have they extensile and contractile properties within themselves or do they wind up in some way as on a spindle or windlass when retracted and unwind when they are extended?

The inner structure of *Actinobolus vorax* as revealed by staining both entire animals and sections indicates that the stalks of the toxicysts are permanent structures that are accommodated within the animal when they are withdrawn.

In a specimen stained entire with hæmalum a group of fibrils was noticed in the interior of the animal arranged as shown in figure 3. Careful examination revealed that the tentacles could be traced inward from the surface of the body to join with an inner skein-like arrangement of fibrils. These findings were confirmed by the study of many other specimens both mounted entire and sectioned.

For example, Fig. 5 illustrates another individual as seen from the posterior end. This drawing is somewhat diagrammatic in that only enough of the tentacles and inner fibrils are shown to illustrate the general features of the arrangement. Fig. 4 repre-

sents a cross section outlined under the camera lucida. Apparently this section is viewed from the anterior end. Here, as in the two other drawings the inner extensions of the tentacles are seen to converge into two fibrillar bundles. The following statements will refer primarily to figure 3 since the entire system is more completely illustrated by this drawing. Here it will be seen that the inner extensions of the tentacles of the left side of the animal merge into the more posterior portion of the skein and converge at the right hand angle of the skein. From this angle a series of inner fibrils extend around and across the body by a somewhat anterior route to the left hand angle of the skein, being joined by the inner extensions of the tentacles from the right side of the body. From this left hand angle a bundle of fibrils extends around and joins to the right hand angle of the skein, thus completing the system.

There can be recognized four parts to this integrated system of fibrils: (a) a peripheral portion consisting of (1) the tentacles with their inner extensions from left side of the animal which converge to a point on the opposite side, and (2) the corresponding set of tentacles with their inner extensions from the right side of the animal; and (b) the anterior and the posterior groups of connecting fibrils which complete the skein. With such an arrangement it is difficult to avoid the impression that withdrawal of the tentacles would be accompanied by a winding up of the skein and extension of the tentacles would be accompanied by an unwinding movement. However, it is entirely possible that the extension and withdrawal of the tentacles may be due to extensile and contractile properties within the tentacles themselves.

A system of fibrils connecting with the cilia has not been made out but the inner ends of the pharyngeal sets of fibrils do seem to be connected with this system (Fig. 3).

The system of fibrils just described cannot be thought of as rigid in structure nor constant in position, although the general relationships are doubtless persistent. When one realizes that *Actinobolus vorax* will swallow such a relatively large object as a rotifer (*Anurca*, as in Fig. 1) and that room is sometimes made for two or three of these food bodies, it will be realized that this system of fibrils must accommodate itself to these relatively large

masses of food. In whole mounts of some specimens, the skin can be seen to be wrapped tightly around ingested Anureas.

In connection with the arrangement of the inner connecting fibrils and their accommodation to varying amounts of food, it may be noted that, as shown both in the sideview and polar views, the tentacles do not usually extend out in a strictly radial direction. When a living specimen is viewed from either pole, it can be seen that the tentacles extend out at such an angle as to indicate that their inner extensions pass somewhere between the center and the periphery of the body. In the living animals it is also noticeable that not all the tentacles extend out to the same distance from the body, some appearing to be shorter than others. It may be supposed that food bodies within the animals would interfere with the full extension of some of the tentacles.

Altogether, the evidence indicates that the tentacles are permanent structures, each bearing a toxicyst at its outer end, and also so connected and arranged within the animal to make an integrated system of fibrils, which presumably function in such a manner as to bring about the extension of the tentacles and their complete withdrawal.

BEHAVIOR.

The behavior of *Actinobolus vorax* is highly interesting as is that of all the species of *Actinobolus* so far described. If one chances upon one of these ciliates with its tentacles fully extended and then watches patiently it will usually not be long before the cilia become more active and the tentacles begin their retreat into the body. This withdrawal of the tentacles is gradual but takes only a few seconds. By the time the tentacles have been withdrawn about two thirds of their length, the cilia may be active enough to start the animal slowly on its way. Also one may see that the tentacles can be caused to wave about somewhat by the beating of the cilia, but they do not become bent in the process. As the ciliary activity increases, the animal gathers momentum and the tentacles complete their retraction so that they may be completely out of sight by the time the individual is going at full speed. In specimens that do not appear to be normal, the retraction of the tentacles may not be entirely completed and such

individuals may swim about with the tentacles partly protruding from the surface. As *A. vorax* swims forward it describes a spiral path and rotates on its long axis.

After a specimen has wandered about for a time, the tentacles begin to emerge again while the speed of progression gradually diminishes; and the longer the tentacles become, the slower is the swimming movement till the tentacles are fully extended and the individual is at rest, with its long axis horizontal. During this period of relative quiescence the cilia continue to move fitfully and sluggishly, but usually with the effective stroke toward the anterior end. After another period of quiescence, which may last for a matter of seconds or many minutes, the tentacles are again withdrawn and the animal swims away to come to rest in some other place. These alternate periods of swimming and quiescence are continued indefinitely and constitute the normal round of activity of this species.

If, now, while *A. vorax* is in its quiescent state with its tentacles extended out in all directions, a rotifer of the genus *Anurea* should swim against the tentacles, one would observe that the rotifer stops all movements as if completely paralyzed. The *Anurea* is then gradually drawn to the surface of the ciliate and is passed to the anterior end where it is brought in front of the mouth which expands sufficiently to engulf this relatively large food mass. All this indicates that the tips of the tentacles contain a paralyzing substance (in the toxicysts), that retraction of the tentacles draws the prey toward its captor and that either by the activity of the tentacles or the cilia, or possibly by both combined, the prey is carried forward to the mouth which opens and swallows the prey.

Watching the activities of *Actinobolus vorax* one is reminded of a fisherman who goes fishing with a copious supply of tackle. This fisherman wanders about till he sees a likely-looking place, then sets out all his lines and waits for the fish to "bite." If, after waiting till his patience is exhausted, he gets no "bites," he takes in all his tackle, goes in search of another promising spot and again puts out all his lines, repeating the process over and over again.

Actually, of course, *Actinobolus* does not *see* anything and makes no choice of a "fishing location." Under normal condi-

tions of the environment, the observed behavior constitutes its normal method of obtaining food; and since this behavior contributes to the welfare of the animal it may have the appearance of being purposeful. However, this behavior must be considered to be as automatic as any reflex action of a higher animal. If the environment becomes unfavorable, the behavior may be changed and the animal may swim indefinitely without coming to rest to "go fishing." Here again, its behavior contributes to the welfare of the animal, since continued swimming is more likely to bring it into a more favorable environment than would quiescence.

DISCUSSION.

It is a little surprising that the internal structure of *Actinobolus* has not heretofore been described, but all the authors mentioned in the introduction, except Moody ('12) limited themselves to the study of animals in the living condition or else in temporary mounts after treatment with various agents.

The only internal structure mentioned by Stein ('67) was the nucleus. Entz ('82) stated that the tentacles could not be followed into the body but that when they are withdrawn they appear to vanish completely; and he found no trace of them after the use of reagents. Erlanger ('90) could make out the refractive trichocysts in the body after the tentacles were withdrawn, and could follow the inner part for some distance when the tentacles were partially extruded. Calkins ('01) does not mention the inner part of the tentacles but Moody ('12) traced them into the cortical region but not into the "endoplasm." Penard ('22) thought he could see the trichocysts imbedded in the cytoplasm when the tentacles were withdrawn, and Fauré-Fremiet ('24) reported and figured the tentacles as being visible for some distance into the body. However, none of these authors followed the tentacles inward to their connection with an internal system of fibrils, such as the present study has revealed.

Entz and Fauré-Fremiet described the cilia as arranged in rows as I have found them in *A. vorax*, while Erlanger, Calkins, Moody and Penard describe them as arranged in rows of clumps, each clump consisting of several cilia surrounding a tentacle. The animals with the cilia in clumps can scarcely be thought of as be-

longing to the same species as those with the cilia singly in rows. However, the animals described by Entz and by Fauré-Fremiet are so different in other respects from *A. vorax* that they can not be considered to be the same species.

It may also be noted that the feeding habits of the kinds of *Actinobolus* heretofore described are different in detail from those of *A. vorax*. Thus, Entz thought the kind described by him was capable of dissolving the cellulose walls of filamentous algæ and then devouring the cell contents. Calkins and Moody report that the *Actinobolus* studied by them "fished" always with its mouth downward and fed only on Halteria. *Actinobolus vorax* rests with the long axis horizontal and feeds primarily on *Anurea cochlearis* but mounted specimens have revealed within them other food bodies such as Euglenoids and diatoms. In its feeding activities, therefore, *A. vorax* appears to be as distinct from the other species as it is in morphological characters.

It may be pointed out that the system of fibrils here described has not been referred to as a neuromotor apparatus. It is doubtful if this term should be used for a set of fibrils that have no obvious connection with the locomotor organs, the cilia. However, there is a certain similarity between the system of fibrils in *Actinobolus vorax* and the system of fibrils described by Rees ('22) for *Paramecium*. One striking point of similarity is the bilaterality of the system, the fibers from each side of the body converging toward different centers. In his rather casual observations on the system of fibrils in *Paramecium*, the writer has come to believe that the distal ends of the fibrils connect with the trichocysts rather than with the cilia, although Rees thought that they connected with both sets of organelles. If their attachment should be found to be limited to the trichocysts, then the similarity between the system of fibrils of *Paramecium* and these inner extensions of the tentacles of *Actinobolus* would be fairly complete.

SUMMARY.

Actinobolus vorax n. sp. is elongate oval to spheroid in contour and usually varies between 100 and 200 microns in length. There are between 30 and 60 longitudinal or slightly spiral rows of long cilia and about 30 tentacles distributed along each row. The cilia are not grouped about the tentacles.

The cytosome at the anterior pole of the body is followed by a pharyngeal apparatus which extends 20 to 25 microns into the body and consists of an inner and outer group of fibrils. These two groups of fibrils converge in the lip where there is a chromophylic circular strand which may be a sphincter or a part of a neuromotor system. There is a large subterminal contractile vacuole at the posterior end and usually a smaller lateral contractile vacuole a little in front of the middle of the body.

The protoplasm is rather uniformly vacuolated, although the central portion is sometimes more uniformly granular. The macronucleus is a long, irregular, rope-like strand, U-shaped, with the free ends in the anterior part of the body. Micronuclei were not definitely identified.

The tentacles are of uniform diameter throughout but contain a toxicyst at the distal end. They may be extended to a length equal to twice the diameter of the body and may be completely withdrawn into the body. They have inner extensions associated with an inner skein of fibrils. The inner extensions of the tentacles of the left side of the body converge to a point at the right side and vice versa. The internal skein is completed by connecting fibrils passing from the right hand center around the body to the left hand center and from the left hand center around to the right-hand center. It is suggested that retraction of the tentacles is accompanied by a winding up process and that extension is accompanied by an unwinding process. It is, on the other hand, possible that the tentacles have extensile and contractile properties within themselves.

In swimming, *Actinobolus vorax* turns on its long axis and describes a spiral path. While swimming the tentacles are withdrawn, but begin to emerge as the animal slows down and become fully extended when the animal comes to rest, as it regularly does with the long axis in a horizontal position. Alternate periods of swimming and quiescence constitute its normal behavior.

Actinobolus vorax feeds primarily on the rotifer, *Anurca cochlearis*. When one of these rotifers swims into the tentacles it stops all movement as if completely paralyzed. It is then drawn near to its captor and passed along to the mouth which opens and engulfs the prey. The same individual may ingest as many as

two or three of these large food bodies. In stained specimens of *A. vorax* euglenoids and diatoms have occasionally been seen.

REFERENCES CITED.

- Calkins, G. N.**
'01 Some Protozoa of Especial Interest from Van Cortlandt Park, New York. *Am. Nat.*, **35**: 645-658.
- Entz, G.**
'82 Beiträge zur Kenntnis der Infusorien. *Zeitschr. wiss. Zoöl.*, **38**: 167-189.
- Erlanger, R.**
'90 Zur Kenntnis einiger Infusorien. *Zeitschr. wiss. Zoöl.*, **49**: 649-662.
- Fauré-Fremiet, E.**
'24 Contribution à la connaissance des Infusoires planktoniques. *Bull. Soc. Zoöl. France et Belg. Suppl.* 6.
- Moody, Julia.**
'12 Observations on the Life History of Two Rare Ciliates, *Spathidium Spathula* and *Actinobolus radians*. *Jour. Morph.*, **23**: 349-407.
- Penard, E.**
'22 Études sur les Infusoires d'eau douce. Geneva.
- Rees, C. W.**
'22 The Neuromotor Apparatus of *Paramecium*. *Univ. Calif. Pub. Zoöl.*, **20**: 333-364.
- Stein, F.**
'67 Der Organismus der Infusionsthier. Abt. II. Leipzig.
- Visscher, J. P.**
'23 Feeding Reactions in the Ciliate, *Dileptus gigas*, with Special reference to the Function of Trichocysts. *Biol. Bull.*, **45**: 113-143.

STUDIES ON THE STRUCTURE AND DEVELOPMENT OF CERTAIN CYNIPID GALLS.

DONTCHO KOSTOFF¹ AND JAMES KENDALL,

BUSSEY INSTITUTION, HARVARD UNIVERSITY.

CONTENTS.

Introduction	402
Material	403
Technique	403
Description of the Galls	404
<i>Neuroterus batatus</i> form <i>bisexualis</i> Kinsey	404
<i>Neuroterus minutus</i> form <i>minutus</i> Bassett	406
<i>Andricus petiolicola</i> Bassett.	408
<i>Andricus palustris</i> form <i>palustris</i> Osten Sacken	410
<i>Andricus futilis</i> form <i>futilis</i> Osten Sacken	412
<i>Amphibolips conflucns</i> Harris	413
Enzymes in the Galls	415
Somatic Cell Division in the Plant and Larval Tissues during Gall Formation	418
Generalization of the Data and Discussion	421
Conceptions before Beyerinck as to the cause of gall formation, Adler, Weidel; Beyerinck's view; oviposition and primary impulses for gall formation; activity of the stimuli during gall development; mitogenic rays; Haberlandt's wound hormones; criticism of Weidel's objections to Beyerinck's view; the cessation of gall de- velopment; the nutritive zone starch content, enlargement of the cells, destructive processes, unicellular organisms; the sclerenchyma, lignification, observations of analogous lignification phenomena, reduction of the sclerenchyma; cell division in the gall tissue, separation and tearing, irregularity of cell division, shape of the somatic chromosomes in the gall tissue; cell division in the larvæ; criticism of Wells' "Evolution of Zoöcecidia;" conclusive note.	
Literature Cited	440
Plates I.-VIII.	444

INTRODUCTION.

Our object in this paper is to present data from some macro-
scopical, histological, cytological, and physiological studies of
certain Cynipid galls, and to correlate them with the work of
previous investigators. In this way we have attempted to reach a

¹ Fellow of the International Education Board from Sofia University.

general explanation of these observations that is more in harmony with the more recent concepts of physiology and morphology and enables us to include apparently discordant theories as parts of a larger concept of the mechanics and physiology of gall formation.

MATERIAL.

The material used for our investigations, with the exception of the galls of *Andricus futilis* form *futilis* O. S. from Sterlington, N. Y. in June, was collected from the trees of the Arnold Arboretum at Forest Hills, Boston, Massachusetts. Collections were made at intervals during May and June, beginning with the earliest determinable stages of the galls and ending with the emergence of the insect. The galls of *Amphibolips cookii* Gill. and *Disholcaspis globulus* Fitch used in the physiological experiments were collected during the first part of September.

Morphological and histological descriptions of the galls of the six Cynipids studied will be given in the following order: *Neuroterus batatus* form *bisexualis* Kinis., *Neuroterus minutus* form *minutus* Bass., *Andricus petiolicola* Bass., *Andricus palustris* form *palustris* O. S., *Andricus futilis* form *futilis* O. S., and *Amphibolips confluens* Harris.

TECHNIQUE.

For killing and fixing the gall tissues, Allen's modification of Bouin's solution was used and gave very good fixation in the insect tissues as well as in those of the plant. The very small galls were fixed whole, but the larger ones were cut into suitable portions to permit rapid and thorough penetration of the fixative. The material, after embedding in paraffin, was sectioned by the microtome to thicknesses of 6, 8, 10, and 12 microns. Hand sections of the living material were made for a few observations. Heidenhain's iron-alum hæmatoxylin together with orange "G" proved to be the most satisfactory combination of stains for general use, though safranin and gentian violet were also used in staining some of the sections. The presence of starch was detected by the use of a potassium iodide-iodine solution, confirmed by the use of polarized light. A solution of phloroglucine-hydrochloric acid was applied to sections to test for the presence of lignin.

DESCRIPTION OF THE GALLS.

The earlier and in some instances the more recent descriptions of the structure of galls were published by those interested in taxonomy rather than by morphologists. We have noted these macroscopic conditions but our attention has been directed more particularly to the histology. For three of the galls, *Andricus petiolicola*, *Andricus palustris*, and *Amphibolips conflucns*, Cook (1904) gave the first partial description of microscopical conditions, and Cosens (1912) added other observations on their anatomy.

Neuroterus batatus form *bisexualis* Kins.

Host: *Quercus alba*.

The gall of this insect is usually an irregularly elongate, polythalamous twig gall but it has also been reported on the petioles and mid-veins. Normal and deformed leaves may arise very close together due to the extremely short internodes of the dwarfed twig. A dense whitish pubescence covers the abnormal parts of the twig, but is not conspicuous on normal portions. The larval cavities are arranged in an irregular girdle about the twig outside the pericycle.

The epidermis of the gall, with the exception of the region about the entrance of the canal leading to each larval cavity, does not differ markedly from that of the normal twig. There are great numbers of very long trichomes clustered together about the entrance of each canal. The large number of larval cavities, each usually with a separate canal, makes it appear in a macroscopic view that the gall is covered by a dense, whitish pubescence. The wide zone of parenchyma between the epidermis and the tissue immediately under the influence of the larvæ is roughly divisible into two regions. One of these is 5 to 10 layers of cells in depth directly below the epidermis where the cell walls are thick; the other extends inward to the region of larval cavities where for the most part the cell walls are not thickened. Through this inner region of thin walled parenchyma scattered bands of cells with thick walls form an open network. Between the parenchyma proper, with cells quite normal in appearance, and the parenchyma that has differentiated itself into the zone designated as nutritive

there is a region in this gall, as there is before complete differentiation of the tissues has occurred in all the galls investigated, where slightly differentiated cells of meristematic nature show a transition to cells characteristic of the two adjoining zones. The innermost nutritive zone, sometimes in combination with the sclerenchyma when the latter is differentiated in the region of meristematic activity after this activity has ceased, is commonly spoken of as forming the larval chamber of the Cynipid gall. The cells of the nutritive zone, here a zone that varies from 8-12 layers in depth, are characterized by an increasing enrichment of protoplasm and by an increasing size of the nucleus and nucleolus as the larval cavity is approached. A few cell layers nearest to the larval cavity show a radial arrangement of the cells (Fig. 2). Cells of this kind are more abundant in the hemisphere of nutritive tissue toward the pith of the twig. This tissue nearest the larvæ always contains many cells with large nucleoli and a few with nuclei in various stages of fragmentation. A band of walls of recently emptied cells and remnants of other cells in advanced stages of dissolution border the larval cavity. It appears that the walls of these cells nearest the larva suffer gradual dissolution after the cell content is utilized. Between this band and the larva, there is usually what appears to be a mass of amorphous, jelly-like material which was observed in several cases to extend into an invagination on the ventral apical region of the larva. Toward the pith, there is a transition back from the nutritive cells to those of the parenchyma in contact with the vascular tissue of the twig. The outermost cells of the nutritive zone show an increase in the thickness of the cell walls as the larval cavity expands. A cessation of activity of the meristematic region intervening between this zone and the parenchyma proper is followed by a thickening of the cell walls in that intermediate region. In this gall, there is not, however, the pronounced lignification that commonly occurs in the mature galls of many species of Cynipids. This thick walled zone corresponds to the "protective zone" of some authors. In many other galls the completion of this process of lignification results in the formation of the stone cell type of sclerenchyma which forms a hard capsule about the larva.

It has already been noted that a canal leading to each of the

larval cavities is marked on the surface of the gall by an abundance of trichomes which arise from the epidermis of the surrounding region. This canal is usually clearly defined where it extends through the epidermis and parenchyma, but ends rather abruptly at the inner border of the latter zone. Through the nutritive zone the path is closed by parenchyma cells lacking the enriched protoplasm usually characteristic of the cells of that zone, and by a ribbon of dead and partially disintegrated cells. The clearly defined portion of the canal is lined with these partially disintegrated dead cells and is surrounded by two or three layers of parenchyma cells elongated parallel to the slightly curved canal.

When the tissues of the gall in various stages of development were tested with iodine, no stored starch was found. Under this treatment, a yellow to deep orange staining granular cytoplasmic content appears highly concentrated in the cells of the nutritive zone nearest the larva and gradually diminishes in quantity toward the parenchyma where it is no longer conspicuous.

Neuroterus minutus form *minutus* Bass.

Host: *Quercus alba*.

This is a polythalamous gall causing the leaves of the terminal buds to remain clustered to form an ovoid mass with a few crowded larval cavities in each of the small deformed leaves. The innermost leaves are not distinguishable but are fused into a mass of rudimentary leaf tissue crowded with the larvæ of the parasite. The galls are green and pubescent at the beginning of bud expansion, but mature rapidly and soon after the emergence of the insects become dry, shrivelled, and brown. These galls average 5-10 mm. in length and 5-8 mm. in diameter.

Cells varying in size and elongation form an epidermis with an irregular outline. Trichomes appear to arise most abundantly from the epidermis in the region of the entrance of the canals, as was found to be the case in *Neuroterus batatus*; but are neither so long nor so abundant as the trichomes on that gall. In the outermost leaves where some differentiation of tissue is noticeable, the cells of the parenchyma tend to radiate toward the larval cavity nearest them. The number of layers of parenchyma cells separating the cavities from the epidermis vary from three to as many as

fifteen. The innermost cells of this zone are radially elongated and adjoin the narrow sclerenchyma zone of small tangentially elongated cells with heavily lignified walls that abruptly separates it from the nutritive zone (Figs. 9 and 11). This zone has usually two layers of cells, though a depth of four layers is not uncommon, with the greatest lignification occurring on the inner tangential walls. Within the sclerenchyma, the cells are more or less oval with their greater extension radial toward the larva, and show the characteristic condition for nutritive cells as described in the preceding gall. The larval cavity is bordered, as is usual in the case of Cynipid galls, by a band of walls of recently emptied cells and remnants of others, with the adjacent cells in various stages of dissolution. Here also, as in the larval cavity of *Neuroterus batatus*, a mass of jelly-like material lies between the insect and the border of the nutritive zone. This intervening material is very similar in general appearance to the contents of the alimentary tract of the insect larva. It probably represents the secretions of the insect together with the dissolved cell contents of the adjoining nutritive zone, and the unicellular organisms that will be mentioned later. A distinctly uneven utilization of the nutritive zone is especially noticeable during the late larval stages of the insect (Fig. 11). In the inner part of the gall, the vascular tissues branch through the parenchyma and weave about among the crowded larval chambers. Here, as in the gall of *Neuroterus batatus*, the gall chambers are close to a comparatively large vascular system where there is a rapid movement of the nutritive material of the host.

The entrance of the canal is accompanied here also by an increase in trichome growth in the region immediately surrounding it. With the exception of the funnel-shaped opening extending for a short distance below the epidermis, the path of injury is marked only by the line of disintegrating cells which extend to the larval cavity itself. In the region of sclerenchyma, a conical plug of 5-10 layers of heavily lignified cells, with the point of the cone toward the end of the funnel-shaped opening, forms about the thin line of dead cells.

Sections of the galls containing larvæ, when stained with the iodine solution, showed starch to be present in the outer layers

of cells of the nutritive zone and in all the cells of the sclerenchyma zone. In the parenchyma, starch appeared in irregular patches; only a few grains occurring in the cells of this region, in contrast to the great quantity of grains in the other two zones nearer the larvæ. In the sections of galls containing pupæ, the starch had disappeared from the nutritive and sclerenchyma zones, but some of the cells of the parenchyma still contained a few grains. The cells of the nutritive zone, with the exception of the few outer layers in the cases of the younger galls, show no starch but contain an abundance of the granular content that stains yellowish or orange when treated with iodine, and which takes readily the hæmatoxylin stain. When the insect is ready to emerge from the gall, or has completed its demand for nourishment, the nutritive zone is usually exhausted and the starch also has now disappeared from the cells of the parenchyma.

Andricus petiolicola Bass.

Host: *Quercus alba*.

The gall is green, polythalamous, roughly club-shaped, or globose, and results from the swelling of the twig, petiole, or midrib of the leaf. Our observations were made from galls where both the twig and petiole were involved in the swelling. Galls involving these two plant parts were of extremely common occurrence. There is usually a short projection arising from some point on the gall with an opening into the interior. About the region of this opening there is an abundance of coarse trichomes. The larval cavities are more or less regularly arranged encircling the long axis of the gall, about equally distant from the center. The galls average about 8–10 mm. in diameter by 10–12 mm. in length.

With the exception of the region of abundant trichome growth about the opening of the canal, the epidermis shows no remarkable irregularities. The parenchyma zone is separable into two parts; the outer, immediately below the epidermis, is a broad region of thick walled cells; the inner portion lacks these thick walled cells and has vascular elements forming a more or less complete ring in its central region. In sections of very young galls, loops of small deeply staining cells of meristematic nature inter-

vene between this inner part of the parenchyma zone and the nutritive zone with its larger and richer cells (Figs. 1 and 3). In older galls, with the cessation of meristematic activity, secondary thickening occurs in the regions of these loops so that a region of stone cells (sclerenchyma) occupies approximately the same relative position as the earlier meristematic tissue. The cell walls of the sclerenchyma are in this instance generally uniformly thickened. The cells of the more central layers of this region show a greater thickness of cell walls, while toward the nutritive and parenchyma zones there are layers of cells with less heavily lignified walls; the outer layer of the nutritive zone and the adjoining parenchyma zone show a slight lignification of the cell walls. Relative to the larval cavity the two inner zones of tissues (nutritive and sclerenchyma, also the meristematic region while it is separate as such) show a notable eccentric disposition.

A common, large canal, presumably the path of the ovipositor, here reaches in from the epidermis and terminates in a more or less irregularly fusiform cavity from which smaller and shorter canals open toward the individual larval cavities. Cells resembling those of epidermal tissue were found lining this main canal only as far as the cavity. Many long trichomes arise from the epidermis about the opening of this canal while others appear to originate from the epidermoid cells lining the canal. There is a tendency for the epidermis to produce an increased number of trichomes wherever dead and disintegrating tissue occurs near the epidermis. Below the cells lining the common canal, 2-3 layers of much larger parenchyma cells appear; and these larger cells, below a border of injured and dead cells, mark the path of the shorter individual advance of each of the larvæ from the cavity at the end of the large canal into the plant tissues. About this cavity, between the paths of entrance to the larval cavities, regions of meristematic tissue occur in the very young galls in which many cells were observed in the process of division. This activity would appear to result from the stimulative influence of the disintegrating cells in the path of injury passing to the surrounding cells.

When sections of the very young galls (2-4 mm. in diameter) were tested with iodine or observed with the polariscope, no starch was observed. With the iodine treatment, the cells of the nutri-

tive zone showed an increasing enrichment of protoplasm as the larval cavity was approached. In older galls, where the larvæ were more advanced, starch was observed in the cells of the nutritive zone near the irregular surrounding sheath of sclerenchyma forming in the region previously occupied by the meristematic cells. The enrichment of the cytoplasmic content of the cells of the nutritive zone increases with the extension of the larval cavity and the resultant increasing proximity of the cells to the influence of the insect. There is a marked eccentricity of nutritive deposition in this gall (Fig. 1) with the tendency for the greater number of nutritive cells to coincide with the direction of greatest tension of the sap. The cells nearest the larva are marked by a process of dissolution resulting in a condition similar to that already described in the same region in the gall of *Neuroterus batatus*.

In the cells of the nutritive zone what appear to be unicellular organisms were observed to be very abundant. Fig. 7 shows some cells from this region containing such organisms, apparently bacteria. The presence of these organisms was checked in this and other galls by mounting and observing razor sections of the living tissues.

Andricus palustris form *palustris* O. S.

Hosts: *Quercus alba*, *Shumardii*, *palustris*, *ellipsoidalis*, *borealis maxima*, *Ludoviciana microcarpa*.

This form of *Andricus palustris* produces a spherical, monothalamous leaf gall that extends equally from the upper and lower surfaces. The gall occurs also quite commonly on the peduncles of the catkins. Until it reaches a size of 3-4 mm. it consists of a solid sphere of tissue surrounding the larva of the insect. With the cessation of meristematic activity and differentiation of the sclerenchyma tissue, the two inner zones of nutritive and sclerenchyma tissue separate from the outer parts of the gall. The small (1-2 mm.) spherical chamber composed of these two inner zones rolls freely about, in the mature gall, within the hollow sphere (8-12 mm. in diameter) resulting from the swelling and distention of the outer rind of parenchyma and epidermis. The old galls are green, mottled with whitish blotches that often assume a reddish color later. The very young galls show varying degrees of

pubescence and roughness of outline, but these features are lost as the gall matures.

The epidermis of the very young galls shows certain differences from that of the unaffected leaf, of which the increased length and number of trichomes is particularly noticeable. As has been already stated, there are slight differences in the cutin deposit and in the outline of the epidermis in different hosts. This variation applies to the parenchyma between the epidermis and the larval chamber where a variation in the number of cell layers appears, but there is no such observable variation in the inner two zones. Directly below the epidermis, the parenchyma has several layers of cells with thickened walls, while the remainder lacks the heavier walls and shows a gradual transition inward to the small, more or less isodiametrical cells of the region where cell division occurs. After growth has ceased in this narrow region of meristem, a lignification of the cell walls is effected which often extends in a lesser degree to the outer layer of nutritive cells. Thus it happens that a zone of sclerenchyma with ovoid, commonly binucleate cells, forms about the nutritive zone before the tissues separate. With the separation of the two outer from the two inner zones, the four layers of sclerenchyma cells that are generally present before the separation are then difficult to distinguish. It now appears as though there were only two layers with unequally thickened walls, the outer walls of the inner layer and the inner walls of the outer layer appearing much thicker than the others instead of the earlier condition in which the walls appeared equally lignified. With complete separation, a number of small undifferentiated parenchyma-like cells cling at intervals to the sclerenchyma and the inner rim of the parenchyma (Fig. 8).

In the nutritive zone the cells show the increase in size, the enrichment of protoplasm, the larger nuclei, and the increasingly prominent nucleoli characteristic of that zone. The increase in the size of the nucleolus (Fig. 17) is striking as the cells approach the region of contact with the larva. The cells bordering the larval cavity show various stages of dissolution. The depth of the nutritive zone is greatest at the time of separation; thereafter, it suffers increasing dissolution as the larva proceeds to make its demand for nourishment; finally, at the time the insect completes

the pupal stage, there is nothing left but a lining of a few incompletely utilized cells and remnants of cell walls bordering the sclerenchyma sheath. As in the other galls, a jelly-like material occurs between the larva and these tissues.

In our material the only indications of a canal or pathway leading to the larval cavity consisted of a band of dead tissue which is probably compressed by a healing process along the path of entrance of the insect into the plant. In much younger stages of the gall, Cosens has found a distinct canal with a lining continuous with the epidermis and bearing trichomes of the same kind as those appearing there.

Iodine preparations showed the starch to be restricted to the cells of the nutritive and sclerenchyma zones. As usual, the starch appears in increasing amounts in the cells not in immediate contact with the larva, while the yellow to orange staining granules increase in the reverse direction. Fig. 13*B* shows the starch distribution in a very young gall before separation of the zones has taken place. Fig. 12 shows under higher magnification the location of starch at the time of separation. In Figs. 13*A* and 13*B* it is possible to compare the amount of starch with the extension of the larval cavity and consequently increased sphere of parasitic influence, the greater amount of starch being present in the younger gall (Fig. 13*B*).

Andricus futilis form *futilis* O. S.

Host: *Quercus alba*.

This gall is polythalamous. It originates from the mesophyll of the leaf, and projects about equally from both the upper and lower surfaces of the blade. It resembles superficially the gall described by Cosens (1912) for *Andricus singularis* Bass. The lower projection of the gall is rather globular, but the one from the upper surface is like a flattened or suppressed cone in shape. Within the gall, two or three spheroidal larval chambers are suspended by fine strands of parenchymatous tissue. The galls have a diameter averaging about 4-5 mm.

The epidermal cells covering the gall differ from those of the normal leaf in being more flattened than cuboidal, and in having slightly thicker walls. Below the epidermis, there is a layer of

parenchyma cells not much larger than those of the epidermis but with thicker walls. Adjoining this layer is a region of larger, thick walled parenchyma cells which show a gradual change toward the interior until the inner region of parenchyma consists of more distended cells with thinner walls. It is from this inner region that the strands of cells are torn, radiate to the sclerenchyma, and hold the larval chambers in the center of the gall. In the mature gall the sclerenchyma is usually represented by two layers of cells with their outer walls much more heavily lignified than the inner ones, and conspicuously porous. The cells of the nutritive zone show conditions very similar to those of *Andricus palustris*, but show some variation in their arrangement about the larval cavity. In this gall, the nutritive zone assumes a slightly eccentric form with the greater depth of tissue opposite the region where the sclerenchyma zones of two or three larval chambers adjoin. In this region the cells are elongated and arranged radially with reference to the larva, while those nearer the place where the chambers join are smaller and more or less rhomboidal. Fig. 6 shows the relative position of the inner portions of part of a single chamber. The path of entrance of the insect into the tissue is similar to that in the preceding gall.

When sections of the galls were tested with iodine the starch was found to be confined to the sclerenchyma and nutritive zones. The innermost layers of the nutritive zone showed no starch, but contained the usual abundance of granular protoplasm.

Amphibolips conflens Harris.

Hosts: *Quercus velutina*, *Q. coccinea*.

Amphibolips conflens produces a large, monothalamous, globular gall that arises from the petiole or midrib of the leaf, and is filled with a succulent, white, spongy, fibrous tissue. In the center of this spongy tissue, there is embedded a comparatively large, thick, woody capsule which incloses the nutritive zone and the parasite. The galls are green and pubescent when they are young, but the green color changes to a light, lustrous brown, and the pubescence disappears as the gall reaches maturity. There is usually a noticeable protrusion from some place around the periphery marking the entrance of the canal leading to the larval cavity.

When the gall has a diameter of 3-4 mm., the epidermis has numerous clusters of trichomes and the epidermal cells are larger and thicker walled than those of the normal leaf tissues. Immediately below the epidermis, there is a region of parenchyma cells about six layers in depth showing a transition from thick walled cells with small vacuoles to larger, thinner walled cells with increasingly prominent vacuoles that adjoin the elongate parenchyma cells which are arranged in rows radiating toward the center of the gall. At this stage of development, separation of the rows of cells into strands has already begun in the region of elongation. Toward the center of the gall there is a transition from the elongate, radiating cells to smaller and more spherical ones with many minute vacuoles, a granular cytoplasmic content, and often two nuclei. These cells in turn show a transition to those of the nutritive zone which are much larger and assume a radial arrangement (Fig. 4). The vascular tissue radiates abundantly through the region of small cells outside the nutritive zone and in the inner region of the parenchyma; but appears to turn and run parallel to the periphery in the outer part of the parenchyma, and is more abundant at the region of attachment of the gall. The isodiametric, or slightly ovoid cells observed at this stage surrounding the nutritive zone, represent the previously active meristematic tissue. These cells from now on have their walls increasingly lignified, until in the later stages they form the sclerenchyma zone inclosing the parasite in a woody capsule.

The opening of the canal into the larval cavity is marked by a small delta from which a band of disintegrating cells and a ribbon of cell remnants extend outward to the epidermis. About this band of tissue, there are large cells, often polynuclear (Fig. 26), which are elongated parallel to the path of the canal. From these cells, there is a transition back to the type found in the zone through which the canal passes. A conical protrusion of the epidermis and outer layers of the parenchyma marks the opening of the canal to the exterior. A conical depression lined with a heavy band of dead tissue surrounded by thick walled parenchyma cells occurs within the conical protrusion. The epidermis does not appear to line the entrance of the canal, but ceases at the edges of the opening. The trichomes seem to be most abundant near the

entrance of the canal, but appear never to arise from the interior of the canal.

Starch is present as small grains in the cells of the outer layers of the nutritive zone and in those of the layers of isodiametric cells. The granular cytoplasmic content of the cells is greater nearer the larval cavity and less in the cells more distant, as in the preceding galls.

When the gall has reached a diameter of 10 mm., the epidermis has stretched until the cells are long and narrow, and the trichomes are lost. The cells of the parenchyma zone have increased greatly in size with an enlargement of the vacuoles. The separation of the inner region of parenchyma into strands has progressed until the two inner zones which surround the larva are suspended by them from the outer thick walled region of parenchyma, together with the radiating fibro-vascular bundles. The nutritive zone shows greater dissolution in the innermost layers. The zone of adjoining small cells is narrower, and occasionally some of them develop a form more characteristic of the nutritive zone on the one side and of the parenchyma on the other, their walls have become slightly lignified, and the elements of vascular tissue are now more distinct (Fig. 5). This same photograph shows that there has been a marked increase in the quantity of starch in the cells of the outer layers of the nutritive zone and in those which lead toward the region of radiating parenchyma.

In the late stages of the gall, the strands holding the inner two zones to the outer zones become more attenuated; the region adjoining the nutritive zone is now prominent and its 10-15 layers of cells with heavily lignified walls form a woody capsule of stone cell sclerenchyma. Nearest the nutritive zone, the walls of these cells appear to be slightly more lignified away from the larva, while the remainder appear to have uniformly lignified walls. The large quantity of starch observed in the young galls has entirely disappeared and only the orange staining granular content appears in the remaining nutritive cells.

ENZYMES IN THE GALLS.

The morphology of the galls indicates the presence of certain definite enzymes that act in a centrifugal direction from the larval

cavity. In the course of the larval development, the abundant accumulation of starch in the nutritive zone of the gall gradually disappears, first from the inner, then from the outer layers; that is, a gradual hydrolyzation of the starch occurs in a centrifugal direction. Hand sections from the galls of *Disholcaspis globulus* treated with the potassium iodide-iodine solution showed a gradation of the intensity of the blue color of the starch grains. The grains in the outermost layers of the nutritive zone stain a very deep blue, but the intensity of this color decreases in the direction of the larva until the starch grains of the innermost layers of the zone take no stain. These non-staining grains are apparently no longer real starch grains but are merely the membranes of the grains whose starch has been already hydrolyzed. We have naturally inferred that diastase must be present in the very innermost layers of the nutritive zone, and similarly protease, phytoprotease, and amidase to effect the destruction of the contents of the cells surrounding the larval cavity; hadromase to bring about the reduction of the sclerenchyma. Finally, we must mention the presence of cytase to effect the hydrolysis of the cell walls which takes place where their contents are in very advanced stages of dissolution.

The presence of diastase was confirmed by physiological experiments. Well developed galls produced by *Amphibolips confluens* on *Quercus velutina* were collected and carefully opened without injuring the larvæ. The larvæ were washed with distilled water and the pH of the solution obtained was tested by the Clark (1920) color indicators. In the same manner, the larvæ of a parasite of *confluens* were washed and the solution tested. Both of these solutions had a pH of 7.0. Extracts from the few inner layers of the nutritive zone were prepared with distilled water and found to have a pH of 6.7. The solution obtained by extraction from the parenchyma tissue of the gall with distilled water was found to have a pH of 4.6, while extracts of the normal leaf tissues of this host had a pH of 4.0 to 4.6. These data are tabulated in table 1 together with those for the activity of these solutions and of saliva on potato starch.

TABLE I.

No.	Solution.	pH.	Change Effected in Starch.
1	Solution obtained by washing larvae of <i>Amphibolips confluentis</i> with distilled water.	7.0	No morphological change in the starch grains.
2	Solution obtained by washing the parasitic larvae with distilled water.	7.0	No morphological change in the starch grains.
3	Extraction from the inner layers of the nutritive zone tissue with distilled water.	6.7	Most of the starch grains shrunken and broken; emptied of starch content.
4	Extraction from the gall parenchyma tissue with distilled water.	4.9	No morphological change in the starch grains.
5	Extraction of normal leaf tissue with distilled water.	4.0 to 4.6	No morphological change in the starch grains.
6	Saliva.	7.3	A few of the starch grains broken; solution is less active than No. 3

The starch was obtained from potatoes and was washed thoroughly four times in distilled water before being treated with the various solutions of extracts. The presence of a hydrolytic enzyme was observed only in the third combination of table 1, that is, when the starch is subjected to the activity of the extract from the inner layers of the nutritive zone (Fig. 16). The activity of this extract is much more effective in hydrolyzing starch than is saliva. Starch grains stained by iodine solution destained gradually after adding an extraction of the nutritive zone in distilled water. In reality, no destaining of the iodine stained starch grains takes place, but a hydrolyzation of the starch is effected, so that, in place of starch grains, sugar and empty grain membranes result, neither one of these substances staining when treated with iodine. With hydrolysis, the starch grains are readily broken and destroyed (Fig. 16). Cosens (1912) has carried out experiments showing hydrolysis of starch to sugar under the influence of the larvæ. As yet, however, no experiments answer the question of whether all the starch is hydrolyzed directly by the insect secretions, or whether there are other sources for the production of agents of hydrolysis in Cynipid galls. This question appears to be reasonable, since unicellular organisms, also capable of producing enzymes, are abundant between the insect and the plant, appearing in the jelly-like material already noted in permanent preparations,

and in the inner layers of cells of the nutritive zone. The questions also arise: To what extent are the insect secretions responsible for the formation of the gall and for the gradual destruction of the plant tissues about the larval cavity? And to what extent are the activities of the unicellular organisms found in the gall responsible for these phenomena? The answer to such questions must await the performance of extensive experiments dealing with this aspect of gall formation.

The gradual decrease of the pH value in the galls in a centrifugal direction from the larvæ is further shown in tests made on the tissues of the galls produced by *Amphibolips cookii* Gill. on *Quercus alba* (Table 2). The data from these two tables (Tables 1 and 2) suggest an ion exchange between the larval and plant tissues.

TABLE II.

No.	Solution.	pH.
1	Extraction of larval tissue of <i>Amphibolips cookii</i> Gill. with distilled water.	7.0
2	Extraction of the nutritive zone tissue of the gall with distilled water.	6.7
3	Same as No. 2 but tested twelve hours after extraction.	6.7
4	Extraction of the parenchyma strands of the gall with distilled water.	5.6

The reduction in extension and number of layers of the sclerenchyma zone just outside the nutritive zone is indicative of the presence of hadromase. In some cases, as in the gall of *Andricus palustris*, the apparent reduction of the number of layers of cells in the sclerenchyma zone may be due rather to the mechanical compression than to the hadromatic activity. This question will be discussed more thoroughly later.

SOMATIC CELL DIVISION IN PLANT AND LARVAL TISSUES DURING THE FORMATION OF THE GALLS.

The effect of mechanical and chemical stimuli on the living tissues during gall formation appears to be similar to that in plant and animal tumors, graft unions, bacterial nodules, and certain calluses.

The plant cells, in all of the galls studied, which are in immediate contact with the insect or are exposed to direct influence

of the larval secretions and of unicellular organisms do not divide. The lysins first break down the nuclear membrane of the plant cells (Fig. 10) and then gradually dissolve the entire cellular content. The nuclei of the cells which are under intensive attack by the lysins resemble the nuclei of the cells of the nodules of *Phaseolus vulgaris* which contain nodule bacteria (Fig. 15).

The entire nutritive zone, being under direct and powerful influence of the larval secretions, is characterized by swollen cells and by the absence of cell division. The cells outside the nutritive zone, namely those of the sclerenchyma zone, very often contain two and sometimes three or more nuclei (Fig. 19). Binuclear and often multinuclear cells appear also in the few layers of parenchyma cells adjoining the sclerenchyma zone (Fig. 22). The occurrence of multinuclear cells appears to be a general phenomenon when plant and animal cells are exposed to certain very active stimuli. Such is the case in animal tumors (cancers) and plant tumors (nodules caused by bacteria, callus tissues, and gall tissues). The opinion that an increase in the number of nuclei in the cells of such tissues is brought about by amitotic division appears very frequently in the literature. Our figures show what may be considered to be a common occurrence in such cases; namely, that the chromosomes divide mitotically but are highly inactivated by foreign stimuli so that their separation and removal from the equatorial plate is delayed (Fig. 21). The two chromosome sets, lying very close together as a result of this delay, form two nuclei between which no cell wall forms. The inactivation of the chromosome separation by the larval influence is well shown in the cells of the gall produced by *Neuroterus batatus bisexualis* on *Quercus alba* (Fig. 23). When the spindle is perpendicular to the direction of the activity of the stimuli, larval secretion, etc., as in Fig. 23, the inactivation of the chromosome separation is usually greater from the side toward the larval cavity, the source of stimuli, and causes irregularity of the somatic cell division (Figs. 23 and 25 A).

The somatic chromosomes of the cells which are in the region of the active influence of the larval secretion—that is, in the meristematic region of the gall—appear round or ovoid in permanent preparations. Conformations such as these are charac-

teristic of the pollen mother cells and embryo sac mother cells, the chromosomes here also being often found to lag on the spindle. At a greater distance from the larva, where the larval secretions are apparently inactivated by the protective substances of the plant, the somatic chromosomes are slender, prolonged, and U, J, or I shaped (Fig. 25 *B*)—the usual conformation of normal somatic chromosomes. In *Quercus alba*, 22 somatic chromosomes were counted in most cases; but in a few plates, 24 chromosomes were observed. Apparently 2 of the chromosomes have a tendency to fragment.

Around the canal of the gall produced by *Amphibolips confluens* on *Quercus velutina*, cells with several nuclei were observed. In some of these cells, the chromatin to all appearances divides continuously without separation of the chromosomes and forms large chromatin masses usually imperfectly organized into nuclei of different sizes (Fig. 26). A similar phenomenon was observed by Němec (1924) in the galls of *Eriophyes padi* Nal. on *Prunus spinosa* L. The substances which are products of the disintegration of the dead cells along the canal are evidently the agents responsible for the abnormality of the cells surrounding it.

Multinuclear cells (Fig. 24*A*) were also observed in the larval tissues. Certain cells, especially those around the alimentary tract, are very large—often 200 times larger than some of the cells of other parts of the body—and have exceedingly large nuclei (Figs. 14 and 18). These conditions are evidently due to the activity of foreign substances on the larval cells and apparently result from numerous chromosome divisions without any accompanying cell division. This phenomenon appears to be very common in other larval tissues. Cells of *Andricus palustris palustris* with 10 chromosomes (Fig. 20), with 20 chromosomes (Fig. 24*B*), with about 40 chromosomes, and sometimes cells with many more chromosomes were observed. In many instances, irregularities in somatic cell division, such as lagging of chromosomes (Fig. 27), were observed in the larval tissues. The appearance of polyploid cells and irregular mitoses in the larval tissues would seem to indicate the presence of active foreign substances. These substances are produced by derivatives of plant tissues and of disintegrated plant cells, unicellular organisms, and by phenomena

connected with the metamorphosis in the insect itself. The mutual reaction between the plant and the larva, in the presence of the unicellular organisms, is apparently expressed similarly in both plant and larval tissues. Thus, cells of Figs. 10 and 26 from the plant correspond to cells of Figs. 14 and 18 from the animal, Fig. 22 corresponding to Fig. 24*A*, and Fig. 23 corresponding to Fig. 27.

GENERALIZATION OF THE DATA AND DISCUSSION.

Malpighi (1686), the earliest writer on gall formation, postulated an introduction of a substance into the plant tissue which caused gall development ("vitrioli enim portio, quæ in *Quercubus* luxuriat, infuse terebræ ichore, turgentiam concipit"). Lucaze-Duthiers (1853) divided the problem into two parts, the definition of a gall and the cause of a gall. The latter phase he divided again into three parts, these concern: (1) the wound, (2) the action following the wound, and (3) a "special liquid" which is deposited in the region where the gall develops. The first two points he recognized as secondary in importance; the real cause was thought to be in the third point, the "venin" deposited by the insect with the eggs into the plant tissue. A similar view was expressed by Prilleaux (1876). He assumed that the cause of gall formation was mainly ". . . l'irritation spécifique que accompagne le dépôt de l'œuf et que cause probablement une sorte de venin que l'insecte verse dans la plaie."

Adler (1881) supposed that the biting of the larva was the responsible factor in gall production: "In den Augenblick nun, wo die Eihaut durchrochen hat und zum ersten Male mit den feinen Kiefern die nächstgelegenen Zellen verwundet, beginnt eine rapide Zellen-Wucherung." Two years later, Adler's conception was questioned by Beyerinck (1883): "Einige Autoren (meaning Adler) haben in dem Nagen der Gallenlarve einem Reiz sehen wollen, welcher, noch ihrer Ansicht die pflanzliche Gewebe affizieren, möglicherweise zur Wucherung bringen konnte. Freilich besitzen die Cynipidenlarven schon dann, wenn dieselben noch als wollständig kugelförmige Thiere innerhalb der Eischale eingeschlossen sind, feine Chitinkiefer, allein, zu dieser Zeit, wenn von einem Zernagen der pflanzlichen Zellen natürlich kein Reden sein kann, ist das Wachstum des Gallplastems schon in vollen Flusse."

The active substances for the gall formation, according to Beyerinck, are the "Wuchsenzyme," that is, diffusible excretions at first from the egg and later from the larva.

The interpretations of Adler and of Beyerinck on gall production were accepted by the recent investigators of galls, very often with only slight modifications. We may cite Weidel (1911), Küster (1911), Cosens (1912), etc. Since a full treatment of hypotheses concerning gall development was given by Magnus (1914), we will not go into detail here. Studies on plant and animal tumors, on graft unions, and on species hybrids, and the accumulation of new data on the physiology of development and immunology correlated with the observations of previous investigators and our own observations given in the present paper offer a new basis for the discussion of gall development and its causal interpretation.

In the course of our discussion, the first general question is how a gall begins. It is better to orient ourselves with a brief description of oviposition. Beyerinck (1883) points out three possible methods for the deposition of the Cynipid egg: . . .

"entweder schiebt das Thier die Legeröhre zwischen die Pflanzentheile, ohne diese und das gallbildende Gewebe zu verwunden; oder es erzeugt zwar eine Verwundung, um das Ei jedoch an eine vollständig unversehrte Stelle zu bringen oder endlich ist legt das Ei in eine in unmittelbarer Nähe des gallbildenden Gewebes angebrachte Öffnung. Auch für diesen Fall werde ich zeigen, dass die Gallbildung durch die Verwundung nicht beeinflusst wird."

The first real causal interpretation of the beginning of gall formation dates from Beyerinck, older investigators having given a rather teleological explanation of its development. His thorough investigations (1883) demonstrated that:

"Wenn die Eier an die äussere Oberfläche der Organe der Nährpflanze niedergelegt werden, ist es klar, das Plattenwall, welcher sich ringsum den Larvenkörper erhebt und diesen zuletzt gänzlich vergräbt, überall von dem ursprünglichen Hautgewebe der Pflanze bekleidet ist, und dass demzufolge auch die Gewebe des Kammerloches und der Larven Kammer aus der Epidermis der Nährpflanze entstehen. Die Gallen welche sich auf dieser

Weise entwickeln, und deren Narbe,—das heisst die Stelle wo sich der ursprüngliche Plastemwall nach der vollendeten Umwallung geschlossen hat,—irgend auf der freien Gallenoberfläche vorkommen muss, kann man 'Gallen mit äusseren Verschlusse' nennen. Werden dagegen die Eier innerhalb der Gewebe der Nährpflanze gelagt, so schliesst das Plastem sich in der Weise, dass die Narbe vollständig verborgen im Innern des betreffenden Organes zu liegen kommt, und solche Gallen liessen sich unter den Namen 'Gallen mit innerem Verschlusse' " (p. 182). In the first case, the larva . . . "im Gallplastem vergraben ist. Dem Frasse an und für sich, kann man demnach keine Bedeutung bei der Gallbildung anerkennen" (p. 180).

Just the opposite opinion was defended by Weidel (1911).

" Die in der Eihaut noch vollständig eingeschlossene Larve durchbricht diese an einer Stelle und senkt in die Epidermis des Blattes ein Organ ein, durch das die Cuticula durchbrochen und das Pflanzliche Gewebe verletzt wird, ganz analog der von Magnus festgestellten Verletzung bei der Rose, nur dass sie dort schon bei der Eiablage stattfindet" (p. 287). He assumes . . . "dass die Kiefer seien, die in die pflanzliche Epidermis eingesenkt werden."

On this point, we entirely agree with Cosens (1912) that, though the excellent work of Weidel cannot be questioned concerning this particular gall, it is not necessary to assume that this is the only method by which a larval cavity is formed.

In each method of oviposition, whether accompanied by wounding or not, the egg has on its surface substances which irritate the plant cells as they are foreign for the plant tissue. Many investigators have observed an egg excretion, a fluid between the egg and the plant cells. This is the stage when the unicellular organisms (generally bacteria) start their activity between the egg and plant tissue, no matter whether the plant tissue has suffered any mechanical injury or not. The substances around the egg—the egg excretions, the irritable substances produced by the bacteria and probably the other unicellular organisms, and the wound hormones (Haberlandt, 1922), when the oviposition is accompanied by an injury to the plant tissue—are the substances which give

the first impulse for the development of a gall. The wound hormones produced in the injured tissues must certainly be included among the substances which give the first impulse for the gall formation. Our conception of these wound hormones will be given more fully later.

The next question is how the irritable substances act to cause the development of a gall. This question can be easily answered when one considers that the single cell, as a member of the whole tissue, acts and reacts very similarly to an organism as a whole. When the latter, the organism, is exposed to a very insignificant stimulus, it does not react at all or but very slightly. With the increasing of the quantity of the stimulus, the reactivity of the organism also increases; this is expressed by increased metabolism, more rapid growth, *i.e.*, by more intensive cell division. When the stimulus increases quantitatively, this growth does not continue at an increased rate. There is an optimal point beyond which a quantitative increase of the stimulus causes retardation of growth until an entire inhibition of cell division is effected. If the quantity of the stimulus is increased beyond this point, the organism dies. When the stimulus is localized, the same sequence is true for a single cell, for a group of cells, or for a tissue. In gall formation, there is a series of stimuli as described above, which are localized at a definite place, *i.e.*, around the egg and later around the larva, acting in a centrifugal direction from this center of irritation.

Shortly after oviposition, the response to the stimuli is limited to a very small area around the egg. The first impulse is a stimulation of cell division below or around the egg. With increasing stimuli, the responsive area increases, but, at the same time, a gradation in the intensity of the stimuli occurs. The stimuli are too strong for the cells with which they are in immediate contact and later they become too strong for the cells a few layers further away. These cells do not divide; they are inactivated and swollen; some of them undergo dissolution because of the lytic activity of the foreign substances. Beyond the highly inhibited cells, there is a region where no very intensive cell division occurs because the quantity of the irritable substances is still in excess of the optimum. Then comes the zone with the greatest frequency of cell

division; this is under the activity of the optimum quantity of the stimulative substances. Still beyond this optimum region, the rate of cell division is relatively low due to an insufficient amount of inductive substances, and to all appearances parasitic influence does not extend to the more distant regions.

It is pertinent to mention two recent conceptions for the cause of cell expansion and division in normally growing tissues—the one, the “growth substances” of Went (1928); the other, the “mitogenic rays” of Gurwitsch and his students (1926, 1927, etc.)—and to point out the significance of the same cause for cell division in the plant galls caused by Cynipids. There is a high degree of probability that in the near future the two terms just mentioned will be found to be two components of the growth phenomenon. Generalizing from the experimental data of Gurwitsch and others, one arrives at the conclusion that growth *i.e.*, cell division, is induced by mitogenic rays. Magrou and Magrou (1927) succeeded in inducing cell division in onion root tips by cultures of *B. tumefaciens* located at certain distances from the root tips, as Baron (1928) did later with many other bacteria, and concluded that the tumors were induced by the mitogenic rays emanating from the bacteria. It would seem at first glance that their supposition would be plausible for the tumors and applicable to the development of Cynipid galls where the growing insect and a multitude of unicellular organisms, including bacteria, are present in plant tissues. When we consider the chemical phenomena resulting from various substances and enzymes introduced by the parasites and the reaction of the plant to these diffusing substances, together with the necrosis of the plant tissues resulting from the activity of the parasite, any possible part played by the mitogenic rays emanating from the parasites in the development of the Cynipid galls appears very insignificant in comparison with the other physiological factors concerned.

An opinion about the activity of the “Wundhormone” and “Necrohormone” which were studied by Haberlandt (1922) may be expressed here in connection with our studies. As Haberlandt (1922) and others have shown, when cells are wounded or die from some unknown internal cause, intensive cell division occurs around the injured or dead cells. But we must ask whether there

is any necessity accepting a special terminology as Haberlandt proposed, when we do not know whether definite substances of the same nature as the hormones produced by the thyroid, hypophysis, and other glands of internal secretion that induce cell division in animals, are always present at the injured place. When a cell dies from mechanical or chemical injury, its content undergoes disintegration; the cell and body specific substances are destroyed and change into other substances foreign for the surrounding tissues no matter of what kind they are. These disintegration products irritate the surrounding tissue and stimulate cell division.

Cell division in gall development can be attributed partly to the disintegration products of the cells injured: (1) mechanically during the first period of development when a wounding by oviposition occurs, and later when wounding occurs by chewing if the larva is one which feeds in this way; (2) chemically by the action of the egg or larval secretions and the toxic substances produced by the unicellular organisms. Hence, we can not agree with Beyerinck (1883): "Dem Frasse an und für sich kann man demnach keine Bedeutung bei der Gallbildung anerkennen" (p. 180). At the same time, we can not agree with Weidel's objections (1911) against Beyerinck's interpretations of the "Umwallung," "Sinken," and "Vergraben" when he questions: "Wie kommt es, dass an der Stelle, wo das von der Larve abgesonderte Enzym am stärksten wirken muss, keine Vergrößerung der Zellen stattfinden soll, sondern nur in einiger Entfernung? Was wird aus Epidermis unmittelbar unter dem Ei? Aus Beyerinck's Figuren muss man annehmen, dass sie in Nährgewebe umgewandelt wird, da sie die Larve unmittelbar berührt. Wie kommt das "Sinken" oder "Vergraben" zustande, Vorgänge, für die ihn seine Erklärungen selbst nicht befriedigen?" (p. 290).

If Beyerinck (1883) could have foreseen the later developments of physiology and immunology, perhaps, he would have interpreted his observations in another light, and if Weidel (1911) could have had at his disposal the still later discoveries in the same fields, he would have seen that his observations and those of Beyerinck could be correlated. Weidel believed that the larval chamber was formed by a dissolution of the subjacent tissue not from a process of "Umwallung" such as Beyerinck supposed.

When oviposition occurs on the surface of the plant, the process of enclosing the eggs and later of the larvæ occurs by "Umwallung," "Sinken," and "Vergraben," and also by "Lösungsvorgang" (Weidel), terms which we will discuss in a moment. The metabolic processes of the cells exposed to the strongest activity of the stimuli differ from those of the ones further removed. These cells do not divide; they are too highly inactivated. They only enlarge because of the very abundant sap supply, which represents a part of the reaction of the plant tissue against the irritable substances. The lytic substances, the enzymes, attack the cells in immediate contact with the parasite and dissolve them. This process of dissolution occurs continuously and as a result the egg, and then the larva, enter gradually into the plant tissues. This corresponds to Weidel's "Lösungsvorgang" and Beyerinck's "Sinken." If any chewing occurs on the part of the insect, the sinking is accelerated.

Beyond the zone of inactivated cells subjected to progressive dissolution, where no cell division occurs, is the zone exposed to the optimum stimulation in which there is a very intensive cell division. The latter zone forms in a position approximately concentric to the former, *i.e.*, like an hemispheroid. The physiological processes are expressed shortly in mechanical deformations and transformations. The hemispheroidal area with intensive cell division tends continuously to complete a spheroidal form. This process corresponds to Beyerinck's observation on "Umwallung." When the complete spheroid develops from the earlier hemispheroid as a consequence of the intensive cell division in the zone with optimum irritation for cell division, the irritable and destructive substances act symmetrically in all directions from the center of irritation, *i.e.*, from the larval cavity. This is the stage Beyerinck calls "Vergraben." His terminology is perhaps too rough for these processes, if one treats them in the light of the physiology of development; yet his observations come into accord with those made by Weidel (1911), Cosens (1912), Magnus (1914), etc. only on the basis of the above interpretation. Serious discrepancies which occur in the cecidological literature are not in the observations but in the interpretation of the facts observed. We hope that our interpretation gives a causal explanation of these processes and their consequent morphological manifestation.

With the preceding discussion we answered the question "why and how does a Cynipid gall begin?" Next, one must ask when, why, and how does the growth of the gall cease? In order to answer these questions, we have to consider the ability of the plant tissue to react against foreign substances. Here, another question arises: Is the plant organism or plant tissue able to produce antibodies against foreign substances as the animal organism or animal tissue is able to do? It has already been shown by the senior author (Kostoff, 1928) that plant tissues can acquire immunity against certain antigenic agents of other species by some type of antibody production. Normal precipitins occur in leaf and stem extracts and the precipitin potency of certain species and genera is increased after grafting; moreover, in certain combinations whose extract shows no precipitin reaction before grafting, the capacity to produce precipitins is acquired during the growth of the graft unions. Considering these facts, one can give a plausible theoretical interpretation of gall formation and answer the above question.

The larval secretion, the products of the unicellular organisms around the larvæ, the disintegration products from the destroyed cells of the innermost layer of the nutritive zone, and the disintegration products of the cells destroyed by the larval chewing, if any occurs, represent the stimulative and antigenic agents that penetrate into the plant tissue. At the beginning of the gall formation their amount is, relatively speaking, very limited, but their quantity increases with the time of larval growth. At first, the penetration of these stimulative substances is prevented, not only by mechanical retardations, but to a certain extent by the normal unspecific protective substances (antibodies) which are present in the plant. Later, when the quantities of the stimulative substances increase enormously, they effect a greater area of the surrounding tissue in which there is an optimum region of intensive cell division. The affected regions, however, do not spread proportionately to the amount of irritable substances produced. There is a period of time when the quantity of the latter continuously increases without any further increase of the affected area. At this time the plant tissue begins to produce a sufficient amount of protective substances induced by the penetration of foreign sub-

stances. During the course of larval development, the amount of these foreign substances in the plant tissues increases; at the same time, however, the production of the protective substances also increases. There is a time when the quantity of the latter increases to such an extent that it neutralizes the effect of the foreign substances, even in the region where cell division is most intensive; in other words, *the protective substances eliminate the stimulus for the cell division and the growth of the gall stops.* This defense extends to the highly inactivated nutritive zone. Outside this zone, in a region of a varying thickness in different galls, the neutralization between foreign and protective substances occurs. This neutralization zone is the one marked by the sclerenchyma in the galls described.

We have given the general outline of gall formation, and may now inquire whether all the individual morphological and physiological observations can be arranged under the preceding outline. This question may be subdivided into three parts for greater convenience of treatment: (1) observations on the nutritive zone; (2) observations on the sclerenchyma zone; (3) cell division in the gall.

The term "nutritive zone" was used generally by most of the cecidologists before Beyerinck to indicate that this tissue nourished the larvæ and by most of the students after Beyerinck to indicate that this tissue was rich in nutritive substances. Just why does this tissue contain so much of these nutritive substances; *i.e.*, mainly starch (Figs. 5, 12, 13) and proteins (Figs. 8, 10)? When foreign substances attack plant tissues, there is a demand for an abundant supply at the place of irritation. The sap carries, besides many other substances, carbohydrates, aminoacids, polypeptides, and includes some normal unspecific protective substances. The latter tend to inactivate and convert the irritable substances into substances tolerable for the plant organism until the tissue acquires the potency to produce more, and to a certain extent specific, antibodies against the irritating substances. Parallel with this series of reactions in the plant tissue, many others develop. The carbohydrates undergo dehydration and form larger molecules. The tissue becomes rich in starch grains which grow larger and larger during the period of the irritation (compare Fig. 13B

with Fig. 12). Carbohydrates, aminoacids, and polypeptides build protein molecules which form protein grains. Some of the protein components are apparently used at the same time for the formation of protective substances. These series of reactions appear to be general phenomena always occurring when foreign substances are introduced into the living tissues. In this connection we want to recall the following points: the accumulation of the starch above the callus in interspecific and intergeneric grafting (Kostoff, 1928); the accumulation of starch in the integument around the nucellus when the nucellus envelops endosperm and embryo produced after species crosses (Kostoff, 1929); the accumulation of glycogen in human tumors (Sokoloff, 1926); and finally the accumulation of starch and proteins in the gall tissue around the center of irritation.

The enlargement of the cells of the nutritive zone is due to the abundant storage of nutritive substances. The agents primarily responsible for this enlargement are the foreign substances. These are also responsible for a decreased division of the cells in the nutritive zone, and for the gradual destruction and dissolution of the cell elements surrounding the center of irritation. The foreign substances responsible for these destructive processes are of enzymatic nature. The morphological change in the nutritive zone indicates that diastase is present among the various substances which enter into the plant tissue. The presence of diastase was proved by experiments described above. This enzyme hydrolyzes the starch gradually and continuously in a centrifugal direction from the larval cavity. In very young galls (Fig. 13*B*), its affect is not strikingly manifested. Complete hydrolyzation of the accumulated starch has occurred, however, in the cells closely surrounding the larval cavity in the more advanced stages of the gall (Fig. 12). In old galls (Fig. 13*A*), the starch is present only in the very outermost layers of the nutritive zone and in the sclerenchyma; the entire storage of starch is usually hydrolyzed at the time the insect is ready to leave the gall. Other destructive processes run parallel with that of starch hydrolyzation. The destruction of protein grains and nuclear membranes (Fig. 10) is followed by the destruction of the entire cell content. This destruction is a manifestation of the presence of the proteolytic

enzymes. A gradual and continuous hydrolyzation of the cell walls (cellulose and lignin) following this proteolysis indicates the presence of cytase and hadromase.

The presence of enzymes opens the question whether all the enzymes originate exclusively from the larvæ (larval secretion) or have other sources for their production. The presence of unicellular organisms in the larval cavity has already been mentioned. Brown (in Lutz and Brown, 1928) isolated a new species of bacteria, *Erwinia spinosa*, from the spiny aphid gall on witch-hazel (*Hamamelistes spinosus* S. on *Hamamelis virginiana* L.) and found it able to hydrolyze starch. Similar conditions to those in the galls are found in the bacterial nodules of leguminous plants where the lysins dissolving the nuclear membrane in the nodules (Fig. 15) are beyond doubt bacterial products. Since unicellular organisms are found in the plant tissues about the larvæ and in the larval cavity, one questions whether the agents responsible for the dissolution of the nuclear membrane in the cells of the innermost layers of the nutritive zone (Fig. 8) originate from the larvæ or from the unicellular organisms, or whether they arise from both sources. A definite answer to this question must await an exact experimental analysis; though from a comparison of the phenomenon which occurs in the nodules with the observation on the nutritive tissue of the gall, one may assume that the unicellular organisms in the galls play an important rôle during the dissolution of the cells of the nutritive zone. On the other hand, there is some evidence that the larvæ also excrete enzymes. Cosens (1912) has shown the presence of an enzyme, diastase, in a series of experiments with larvæ of *Amphibolips conflucus*. A morphological condition, an eccentric utilization of the nutritive zone, often occurring below the ventral region of the larvæ would seem to give some morphological evidence for this excretion of enzymes by the larvæ.

The sclerenchyma zone occurs in most of the mature Cynipid galls and immediately adjoins the nutritive zone. This zone has been, and is still, very often called "the protective zone" by cecidologists. It is pointed out by some of them that it serves for the protection of the larvæ, by others that it serves for the protection of the plants. Some cecidologists now use the term

"sclerenchyma" for this zone, since its cells with their heavily sclerified (lignified) walls resemble most closely the stone cell type of sclerenchyma. These walls were found to stain a red-violet with phloroglucine-hydrochloric acid, a test for lignin. It appears preferable to use the term sclerenchyma. We cannot accept the teleological conception whereby this zone serves for protection either for the insect or the plant, but consider it to be a product of plant reaction where the interaction between foreign substances and the plant protective substances takes place.

In discussing the reason for the cessation of growth in the gall, we concluded that the cause was to be found at first in the appearance of a balance between the foreign substances coming from the larval cavity and the plant protective substances and later in an excess of the latter. Sclerification in young galls usually affects first a larger spheroidal area around the nutritive zone which is more than 4-5 layers in *Andricus* galls where the thick cell walls show lignification. This coincides approximately with the time at which intensive cell division ceases, *i.e.*, when inactivation is effected for all foreign substances outside of the nutritive zone. In a later stage, the sclerification is limited in *Andricus* galls to 2-4 layers immediately adjoining the swollen cells of the nutritive zone. This is the time when the plant has acquired the potency for higher production of protective substances which neutralize in a very small area the foreign substances coming from the nutritive zone.

Just how sclerification occurs is a question which cannot be answered with our present knowledge, but it is a matter of fact that it is morphologically manifested as a reaction product in the plant tissue where the plant substances inactivate the foreign substances into ones tolerable for the plant tissue. This appears to be a general phenomenon. The senior author has found that the nucellus which envelops endosperm and embryo obtained after species cross pollination in *Nicotiana* suffers greater sclerification than the nucellus which envelops endosperm and embryo obtained after self fertilization in a pure species. In the first case, the nucellus cells sometimes divide and form more than one layer of very heavily sclerified nucellus. The sclerification is much greater and affects a broader area in the region where the most

active exchange of substances between the maternal tissue and the hybrid endosperm and embryo occurs, *i.e.*, in the region of the chalaza and the region directly opposite it. Secondary thickening in the parenchyma also occurs in interspecific and intergeneric graft unions in a small area around the callus (Kostoff, 1928) as a mutual reaction between the scion and stock. Further, in the parenchymatic region in plant tumors, he has found that it occurs as a result of the plant reaction against the agents which cause the tumor. The xylem in the higher plants is subjected to this process of secondary thickening and is the tissue which carries the unelaborated non-specific substances for the plant organism. One may correlate here the abundance of sclerenchyma cells occurring in the cortex of dicotyledonous plants, where they develop by sclerification of the thin walled parenchyma, with the fact that the bark represents the region exposed during the whole life of the plant to the attacks of bacteria, fungi, etc. The haustoria of *Cuscuta europæa* when they enter into the tissues of *Urtica dioica* become tracheid-like and lignified (Haberlandt, 1909). There is in this instance also a mutual interactivity between the haustoria of *Cuscuta* and the living tissues of its host. Striking sclerification of the cell walls in the tissues surrounding embryos is a very common phenomenon (all nuts, fruits of the Rosaceæ, etc.). Since it is well known that an absolutely mathematical homozygosis does not exist even after selfing in self pollinating plants, one may always treat the embryo more or less as a foreign implantation for the mother organism and the sclerenchyma around it as an inter-reaction product. Moreover, the embryo is always the locus in the plant where certain specific, entirely different metabolic processes develop with specific metabolic products that increase the inter-reaction between the maternal and embryonic tissues.

In closing the discussion of the appearance of sclerenchyma, one may formulate the facts in the following manner: everywhere foreign substances penetrate into the living tissue of higher plants, the plant reacts with formation of sclerenchyma. This can not be treated as a narrow dogma, since we do not think that everything is "inter-reaction," but, when one finds a correlative tendency in some phenomena, it is significant if one can show whether

such phenomena represent isolated occurrences or whether they are fundamentally similar.

In very old galls, it was observed that a reduction in the number of layers of sclerenchyma occurs. In some cases, such as *Andricus palustris* where the separation occurs between the sclerenchyma and adjoining parenchyma, the reduction of the sclerenchyma layers can be treated sometimes as a purely mechanical compression caused apparently by the drying of the outermost layers so that the tangential walls of the cells adhere closely and appear in permanent preparations as a single very thick wall. This is not the only cause, for in other instances a reduction without compression was observed. Two factors may possibly be responsible for such a reduction of the sclerenchyma. One factor, the appearance of a balance of neutralization between the foreign substances and the protective substances produced by the plant and the subsequent localization of this process to a smaller area, has already been mentioned. The other factor may be the larvæ and unicellular organisms, both of which apparently produce the delignifying enzyme, hadromase. It is known that bacteria are capable of destroying and utilizing lignin (van Wisselingh 1925, etc.).

In the gall of *Andricus petiolicola* on *Quercus alba* where the petiole and twig are involved, there is an eccentric deposition of the zones about the larvæ (Fig. 1). The gall axis coincides nearly with the axis of the petiole or twig (diagram 1). The direction of the sap stream through the gall coincides with the gall axis, *viz.*, the sap comes first through the narrowest side of the zones. The deposition of the gall zones in such an ovoid form can be explained only on the basis of our general outline of the cause of gall formation. The irritable substances spread easier and to greater distances in the direction of the sap stream. Their inactivation occurs more quickly below the larvæ where the sap comes sooner, and more slowly in the opposite region above the larvæ, since the greater part of the protective substances is already used below the larvæ where the sap first meets the irritable substances. Thus, the protective substances are much more active below the insect where the sap stream passes first; this is later the place that less tissue is deposited. Foreign substances are much more active

above the insect and this is later the location of the broader region of tissues, where the sap stream passes later. In very early stages of gall development, the region with intensive cell division (the meristem) tends to form a spheroid at a certain distance from the

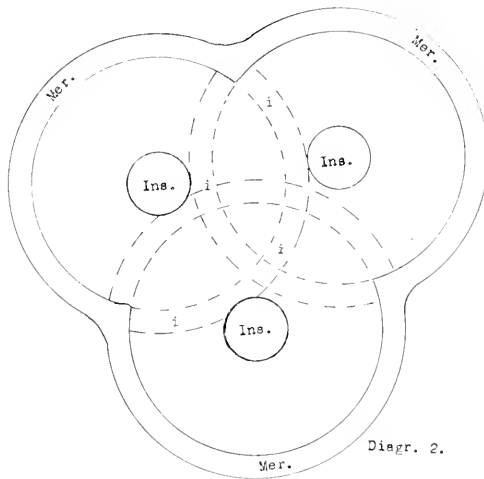
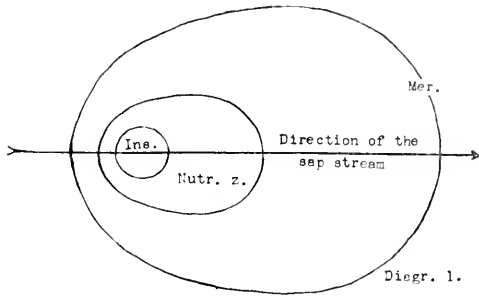

larva, since the foreign substances from the larval cavity tend to spread out radially at a uniform rate. If two or more larval cavities are located near each other, as often happens in the galls of *Andricus petiolicola* (Fig. 3), the meristematic regions between the larvæ come to overlap each other. These overlapping portions of the meristematic tissue between the two larvæ become the region of greater activity of the foreign substances which come from the adjacent larval cavities, and their cells lose the ability to divide (diagram 2, *i*); so that several adjacent larvæ often induce

such a composite region of meristem (diagram 2, *Mer*) as appears in Fig. 3.

In the meristem of some Cynipid galls, cell division is so intensive that the cells, though they continue to divide, do not succeed in reaching their normal size. In this manner, the meristem becomes composed of very small cells. The time soon comes when the plant succeeds in producing a large amount of protective substances and the inactivation of the irritable substances in the meristem takes place. With the increasing amount of the protective substances, the inactivation takes place in a small area just outside the nutritive zone and here the sclerenchyma begins to form. Cell division in the meristem ceases as soon as the elimination of the irritable substances takes place and the cells, now having sufficient food supply without stimuli for division, expand rapidly to reach their normal size. The result is a remarkable distention of all the tissues outside the sclerified region. This leads to separation processes outside of the sclerenchyma in certain leaf galls (*Andricus palustris*, Figs. 8, 12, 13), and a rupture of the tissues immediately outside the sclerenchyma in other leaf galls (*Amphibolips conflucens*, Fig. 5; and *Andricus futilis*, Fig. 6).

The processes of separation and rupture were not observed in terminal bud and twig galls, since these have a greater sap supply which can bring considerable amounts of normal protective substances from the very beginning of the gall development and inactivate a great part of the irritable substances during the entire process of the gall development. As a result of this constant process of inactivation, the meristem of the terminal bud and twig galls is stimulated by smaller amounts of the irritable substances; there is less intensive division and fuller growth of the meristematic cells, due to this more active elimination of the irritable substances and to the more abundant supply of sap and nutritive substances, than in the case of the leaf galls. Here too, the plant finally acquires the potency to transform all the irritable substances outside the nutritive zone into tolerated and non-irritable ones. After this series of processes, which differ quantitatively from those in the leaf galls, the maturation process of the meristematic cells in the terminal bud and twig gall is not sufficient to effect separation or rupture since this process is gradual and not abrupt as in the leaf galls.

The appearance of irregular cell division such as retarded separation of divided chromosomes, binuclear and multinuclear cells, nuclear hypertrophy, etc., is common in the gall tissue under the influence of the foreign substances that penetrate into the plant tissues. These seem to be general phenomena wherever foreign substances attack living tissue. The senior author has found similar abnormalities in tobacco plant tumors. Smith, Brown, and McCulloch (1912) found giant cells with several nuclei, rapidly proliferating anaplastic cells, "amitotic division," and occasional abnormal mitotic divisions in crown gall tissues. They deduce then the "morphological likeness of crown gall to malignant animal tumors." In *Heterodera* galls on plants, multinuclear cells were found by: Němec (1904, 1910), Molliard (1900), Houard (1906), Tischler (1901), Küster (1916), etc. Multinuclear cells and other cellular abnormalities were found by Němec (1924) in galls caused by the Eriophyidae. Kostoff and Kendall (1929) have found that when these gall mites attack flower buds of *Lycium halimifolium* irregular meioses occur. Abnormalities in cell division also appear when the tissue is exposed to definite chemical agents (Klebs 1896; Demoor 1895; Andrews 1905), to narcosis (Němec, 1910; Sakamura, 1920; etc.), to low temperature (Sakamura, 1920; Belling, 1925; etc.), and other conditions and factors. Plant and animal tissues react in the same way also when they are exposed to Radium and X-rays; the literature of the latter subject has been recently reviewed by Miss Paula Hertwig (1927).

An example of retardation of the chromosome separation in the gall of *Andricus petiolicola* is given in Fig. 23. The chromosomes are usually more highly inactivated on the side from which the foreign substances attack the cells. The chromosomes of the cells which are under the influence of these foreign substances are spherical or ovoid in permanent preparations just as they usually appear in the pollen mother cells and the embryo sac mother cells. A similar parallelism was observed by Cosens (1912) and Cosens and Sinclair (1916) concerning the appearance of trichomes on the gall and on the reproductive axes of *Acer*, etc.; the abnormal forms are usually found duplicated on the reproductive axes of the host.

Irregularities in cell division occur not only in the plant tissues but also in the animal tissues when they are under the effective influence of foreign substances. All that has been said about plant tissues is equally true for those of the animal. In Fig. 27, certain cell divisions with lagging chromosomes on the spindle are from cells of the larvæ of *Andricus palustris*. In some of the cells retardation of the chromosome separation is so great that tetraploid and octoploid nuclei are formed. Apparently, chromosome division without cell division goes so far in the cells about the mesenteron that giant cells about 200 times larger than the smallest cells of the larval tissue are formed (Figs. 14, 18). Similar somatic poliploidy was observed by Miss Holt (1917) in the alimentary tract of *Culex pipiens* where the number of chromosomes in the cells of the pupal intestine is considerably increased during metamorphosis. In *Culex*, the agents responsible for the foreign substances produced during the pupal stage are apparently bacteria which are active in the alimentary tract during this stage. However, during metamorphosis, there is always present in the pupal organism an abundance of lytic agents, and irritable, toxic, and otherwise intolerable substances. These latter represent the autolytic products from the larval cells. They are as capable as quite foreign substances from external sources in causing irregularities in the mitoses of certain cells. Toumanoff (1927) found that the honey bee was able to acquire immunity to *Bacillus alvei*, and cites the work of Metahnicoff and his students, where other insects were found to possess the ability to produce antibodies.

From the immunological standpoint, an organism produces antibodies against certain substances when they are parenterally introduced into the organism. The conditions, however, in which the Cynipid larvæ live are different. The larva is surrounded with all the products of dissolution from the plant tissue and the products of the unicellular organisms. Some of these products are very highly toxic. When some of them, substances with relatively small molecules, penetrate into the larval or pupal body, the latter does not always succeed in altering them into tolerable substances and they may possibly affect the cell division. This factor must be taken into consideration, as well as the more prominent activity of the lytic agents during the process of his-

tolysis in metamorphosis, as a cause of the irregularities of the cell division in the insect tissues.

There is, however, nothing to be gained for the explanation of gall formation in the suggestion of Magnus (1914): “. . . einer Gallwirkung durch Antikörper, welcher unter der pflanzlichen Stoffe selbst im Parasiten erzeugt werden . . .” (p. 142). He made this suggestion chiefly on the basis of the Beyerinck-Sachs hypothesis for gall formation: “Eine wesentliche Stütze für die Beyerinck-Sachsche Hypothese, dass wirklich die Gallen unter der Einwirkung bestimmter formbildender Stoffe entstehen, müsste aber der sichere Nachweis sein, dass auch in der normalen Entwicklung solche organbildenden Stoffe eine Rolle spielen” (Magnus, 1914, p. 142). To show that one can arrive at absurd conclusions when building upon such insecure foundations, we quote Wells' (1916) sentence: “. . . the germ plasm of the cecidozoön is the place of origin of the gall forms.” This is in direct contradiction to the findings of immunology and genetics. Formative substances usually build characters and organs in the specific medium of the species. In species crosses, their formative potency is gradually diminished with the gradual decrease in the closeness of relationship between the parents. The crossing of very distantly related species and very nearly related genera may often produce hybrid embryos, but these die in very early stages as the result of formative and immunological causes according to unpublished observations of the senior author. This accounts for the rarity of genus hybrids.

On the basis of his statement just quoted, Wells (1921) derived the “Evolution of Zoöccidia”: Zoöccidial evolution then is a complex in which, in its early stages (kataplasmas) with regard to certain characters, the plant's *germ plasm*¹ dominates, while in its later stages (prosoplasmas) the animal's *germ plasm*¹ gains control; the whole, however, constituting a single progressive series of factorial transformation as far as the changes in the animal *germ plasm*¹ are concerned” (p. 374, 375). It is difficult to conceive how any kind of germ plasmic control of the animal tissue over the plant tissue, or *vice versa*, can exist when as soon as foreign substances are introduced into an organism the latter strives to change the former as soon as possible.

¹ Italics are the authors.

In conclusion, on the basis of the present studies and those of various previous authors, one can formulate the general morphological appearance of the Cynipid galls as a reaction product of the plant tissue dependent on:

1. Plant specificity, including the amount of normal protective substances in the plant, and the plant potency of acquiring protective substances against invading foreign substances.
2. The quantity of sap entering the organ or tissue where the gall originates.
3. The specificity of the insect, which one considers in the quality of the foreign substances (excretions) originating from this source.
4. Quantity of the foreign substances.
5. Mechanical injuries and their disintegration products.
6. The presence of unicellular organisms and the activity of their products, qualitative and quantitative.

Cynipid galls appear as a reaction product of all these factors and not as a result of any one factor, nor does it seem plausible to consider evolutionary concepts such as those advanced by Wells (1921) in their formation.

The authors are greatly indebted to Professor Edward M. East and Professor Charles T. Brues, in whose laboratories the present work was done, for valuable suggestions during the investigations and the preparation of the present paper.

LITERATURE CITED.

Adler, H.

- '81 Über der Generationswechsel der Eichen-Gallwespen. *Zeitschr. Wiss. Zool.*, **35**: 151-246.

Andrews, F. M.

- '05 The Effect of Gases on Nuclear Division. *Ann. of Bot.*, **19**: 521-530.

Baron, M. A.

- '28 Bakterien als Quellen mitogenetischer (ultravioleter) Strahlungen. *Centralbl. f. Bakt.* **73**: 373-379.

Belling, J.

- '25 The Origin of Chromosome Mutation in Uvularia. *Jour. Genet.*, **15**: 245-266.

Beyerinck, M. W.

- '83 Beobachtungen über die ersten Entwicklungsphasen einiger Cynipidengallen. *Verh. K. Acad. Amsterdam*, **22**: 1-198.

Clark, W. M.

- '20 The Determination of Hydrogen Ions. Williams and Wilkins Co., Baltimore, 1920.

Cook, M. T.

- '04 Galls and Insects Producing Them. Ohio Naturalist, 4: 115-147.

Cosens, A.

- '12 A Contribution to the Morphology and Biology of Insect Galls. Trans. Canadian Inst., 9: 297-387.

Cosens, A., and Sinclair, T. A.

- '16 Aceriferous Tissue in Willow Galls. Bot. Gaz., 62: 210-224.

Demoor, J.

- '95 Contribution à l'étude de la physiologie de la cellule. Arch. de Biol., 13: 163-240.

Felt, E. P.

- '17 Key to American Insect Galls. New York State Museum Bulletin No. 200. 1917.

Gurwitsch, A.

- '26 Das Problem der Zellteilung physiologisch betrachtet. Julius Springer, Berlin. 1926.

Gurwitsch, A., and Franck, G.

- '27 Sur les rayons mitogénétiques et leur identité avec les rayons ultraviolets. Compt. Rend. Acad. Sci., Paris. 184: 903-05.

Haberlandt, G.

- '09 Physiologische Pflanzenanatomie. Wilhelm Englemann, Leipzig. 1909.

- '22 Über Zellteilungshormone und ihre Beziehungen zur Wundheilung Befruchtung, Parthenogenesis und Adventivembryonie. Biol. Zentrbl., 32: 145-172.

Hertwig, P.

- '27 Partielle Keimesschädigungen durch Radium und Röntgenstrahlen. Baur-Hartmann's Handb. der Vererbwiss., 3C: 1-48.

Holt, C. M.

- '17 Multiple Complexes in the Alimentary Tract of *Culex pipiens*. Jour. of Morphol., 29: 607-618.

Houard, C.

- '06 Sur les caractères histologiques d'une cécidie de *Cissus discolor* produite par *l'Hétérodera radicolica* Greeff. Assoc. franc. Adv. Sc. Lyon, 1906: 447-453.

Kinsey, A. C.

- '20 Life Histories of American Cynipidæ. Bull. of Am. Mus. of Nat. Hist., 42: 319-357.

- '23 The Gall Wasp Genus *Neuroterus*. Indiana Univ. Studies, No. 58, 10: 3-150.

Klebs, G.

- '96 Die Bedingungen der Fortpflanzung bei einigen Algen und Pilzen. G. Fischer, Jena, 1896.

Kostoff, D.

- '28 Induced Immunity in Plants. Proc. Nat. Acad. Sci., 14: 236-237.

- '28a Studies on Callus Tissue. Amer. Jour. of Bot., 15: 565-576.

- '29 Acquired Immunity in Plants. Genetics, 14: 37-77.

Kostoff, D., and Kendall, J.

- '29 Irregular Meiosis in *Lycium halimifolium* Mill, Produced by Gall Mites (*Eriophyes*). Jour. Genetics, 21: 113-115.

Küster, E.

- '11 Die Gallen der Pflanzen. S. Hirzel, Leipzig, 1911.

- '16 Pathologische Pflanzenanatomie. G. Fischer, Jena, 1916.

Lucaze-Duthiers.

- '53 Recherches pour servir à l'histoire des galles. Ann. Sc. Nat., 19: 273-354.

Lutz, F., and Brown, M.

- '28 A New Species of Bacteria and the Gall of an Aphid. Amer. Mus. Novitates, 305: 1-4.

Magnus, W.

- '14 Die Entstehung der Pflanzengallen. G. Fischer, Jena, 1914.

Magrou, J.

- '26 Le *Bacterium tumefaciens* dans les tissus de cancer des plantes. Compt. Rend. Acad. Sci. Paris, 183: 804-806.

Magrou, J., and Magrou, M.

- '27 Radiations mitogénétiques et génèse de tumeurs. Compt. Rend. Acad. Sci. Paris, 184: 905-906.

Malpighi, Marcelli.

- 1686 Opera omni: De Gallis. Londini, 2: 17, 1686.

Molliard, M.

- '00 Sur quelques caractères histologiques des cécidies produites par *l'Hétérodera radicolica* Greff. Revue génér. Bot., 12: 157-165.

Němec, B.

- '04 Über ungeschlechtliche Kernverschmelzungen, IV. Sitz. Ber. böhm. Ges. d. Wiss. Prag. Math. nat. Kl. Sep.: 14.

Němec, B.

- '10 Das Problem der Befruchtungsvorgänge und andere zytologische Fragen. Berlin, 1910.

- '10a Über Degeneration der Zellkerne. Bull. inter. Acad. Sci. Boheme., Sep. 1910: 8.

- '24 Untersuchungen über Eriophyidengallen. Stud. Plant Phys. Lab. of Charles Univ., Prague, 5: 47-94.

Prilleaux, Ed.

- '76 Étude sur la formation et développement de quelques galles. Ann. des Sc. Nat., 3: 113-137.

Réaumer.

- 1737 Mémoir's pour servir à l'histoire des insectes. Tome III, 12 mémoire, Des galles des plantes et des arbres. Paris, 1737.

Sakamura, T.

- '20 Experimentelle Studien über die Zell- und Kernteilung u. s. w. Jour. Coll. Sci. Tok. Imp. Univ., 39: 1-221.

Sakamura, T., and Stow, I.

- '26 Über die experimentell veranlasste Entstehung von Keimfähigen Pollenkörnern mit abweichenden Chromosomenzahlen. Japan. Jour. of Bot., 3: 111-137.

Smith, E. F., Brown, N. E., and McCulloch, L.

- '12 The Structure and Development of Crown Gall: A Plant Cancer.
U. S. Dep. of Agr. Bur. of Pl. Ind. Bull. N. 255: 1-60.

Sokoloff, B.

- '26 Canceration de la cellule: II Les incorporations cellulaires et leur rôle dans la vie de la cellule maligne. *Biologia Generalis*, 2: 457-484.

Tischler, G.

- '01 Über *Heterodera*-Gallen an den Wurzeln von *Circaea lutetiana*
L. Ber. d. D. Bot. Ges., 14: 95-107.

- '21-'22 Allgemeine Pflanzenkaryologie. Linsbauer's Hdb. d. Pflanzenanatomie. Gebr. Bornträger, Berlin, 1921-1922.

Toumanoff, K.

- '27 Essais sur l'immunisation des abeilles. *Compt. Rend. de l'Ac. de Sci.*, 185: 1078-1080.

Weidel, F.

- '11 Beiträge zur Entwicklungsgeschichte und vergleichenden Anatomie der Cynipidengallen der Eiche. *Flora*, 102: 279-334.

Weld, Lewis H.

- '26 Field Notes on Gall Inhabiting Cynipid Wasps with Descriptions of New Species. *Proc. of U. S. National Museum*, 68: 1-131.

Wells, B. W.

- '16 The Comparative Morphology of the Zoöcecidia of *Celtis occidentalis*. *Ohio Jour. Sci.*, 14: 249-290.

- '21 Evolution of zoöcecidia. *Bot. Gaz.*, 71: 358-376.

Went, F. W.

- '28 Wuchsstoff und Wachstum. *Récueil de travaux bot. néderlan.*, 25: 1-116.

van Wisselingh, C.

- '25 Die Zellmembran. Gebr. Bornträger, Berlin, 1925.

DESCRIPTIONS OF PLATES.

Abbreviations.

L—larva.	V—vascular
M—meristematic region.	S—sclerenchyma zone.
N—nutritive zone.	a—cells of mesenteron.
P—parenchyma zone.	

PLATE I.

FIG. 1. *Andricus petiolicola* on *Quercus alba*. A section of larval chamber showing eccentricity of the tissues about the larva, the greatest amount of nutritive as well as other tissues being away from the central axis of the gall, and meristematic region (M).

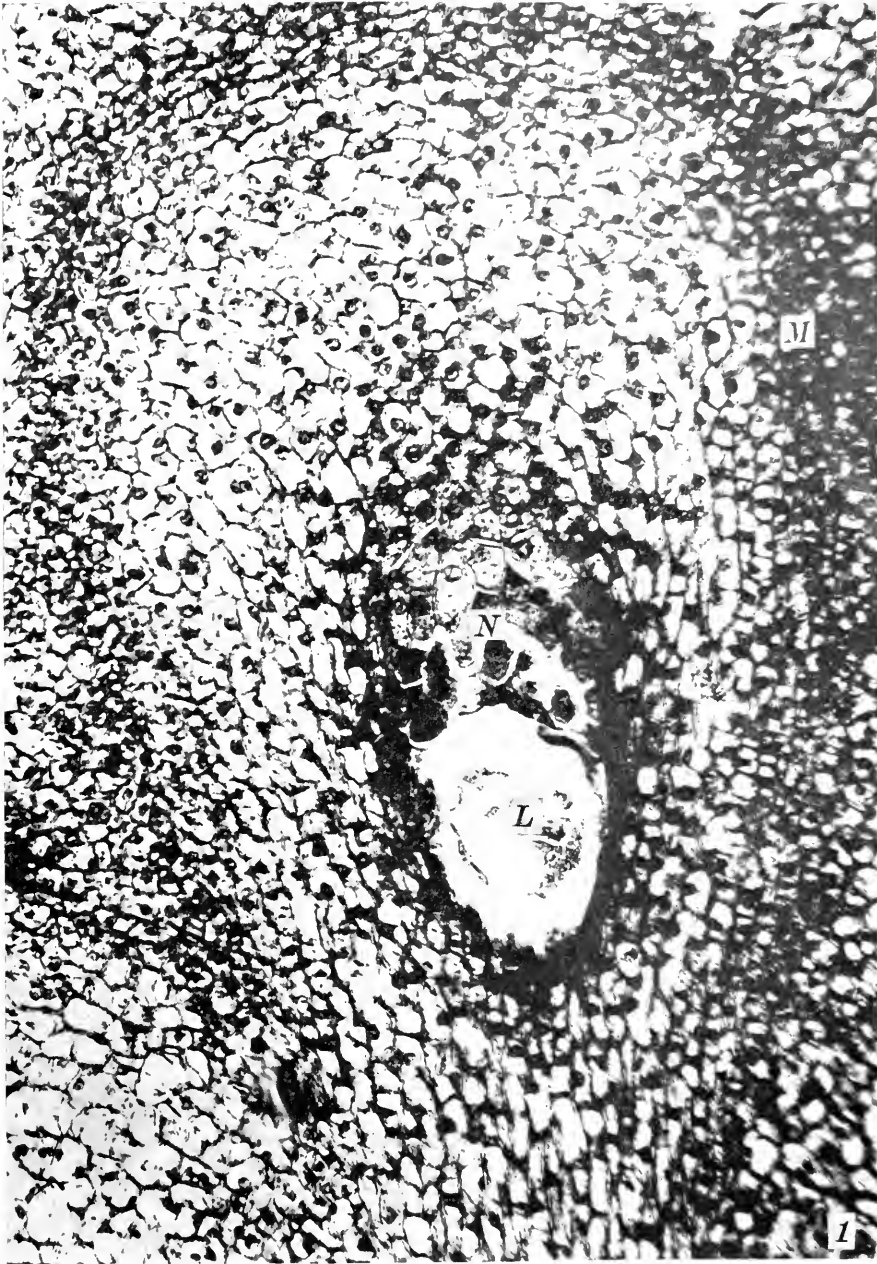

D. KOSTOFF AND J. KENDALL.

PLATE II.

FIG. 2. *Neuroterus batatus* form *bisexualis* on *Quercus alba*.

FIG. 3. *Andricus peticolicola* on *Quercus alba*. A section of a younger gall than the one in Fig. 1 showing the meristematic regions about the chambers fusing and appearing as a curving band of very deeply stained cells (M).

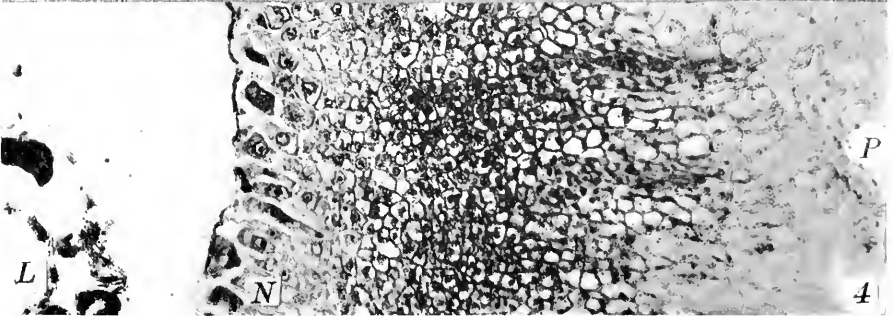
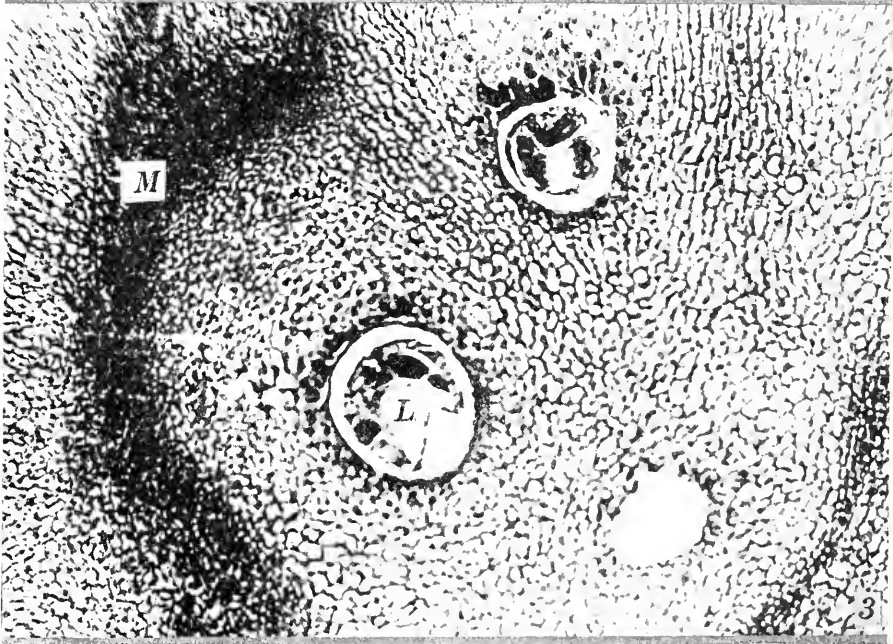
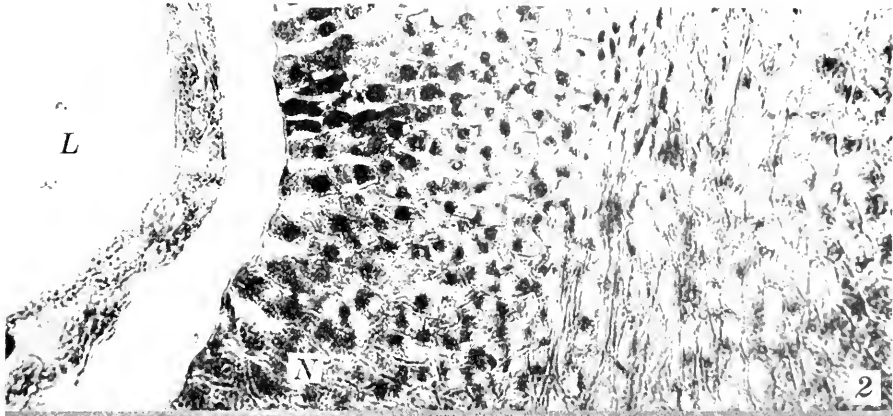
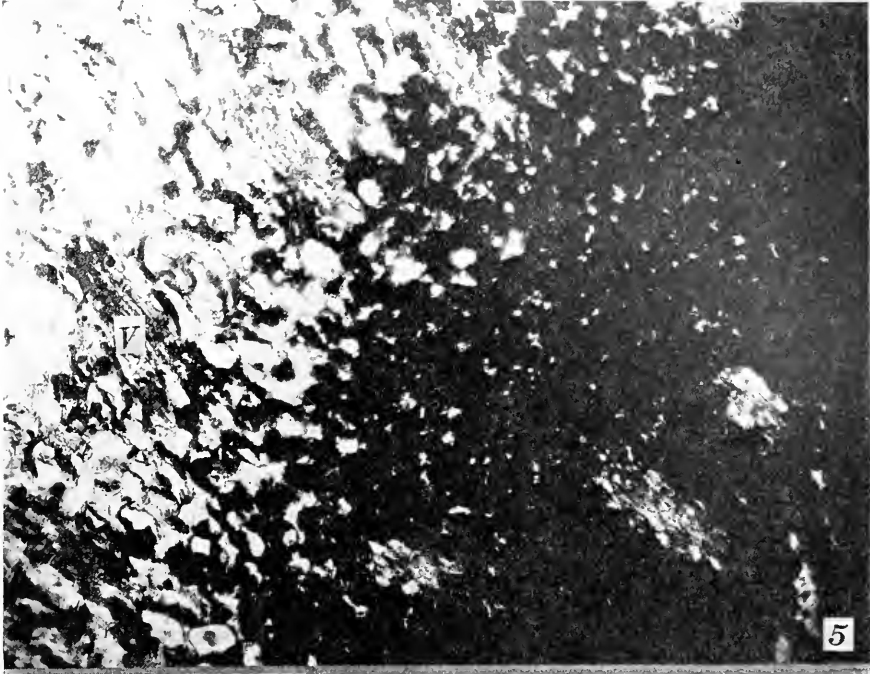

PLATE III.

FIG. 4. *Amphibolips confluens* on *Quercus velutina*. A section of a very young gall (about 5 mm. in diameter).

FIG. 5. *Amphibolips confluens* on *Quercus velutina*. An iodine preparation of a section of a gall about 12 mm. in diameter showing the starch accumulation in the cells of the outer layers of the nutritive zone and in the cuboidal cells, between it and the parenchymous strands, which become increasingly lignified and come to form the sclerenchyma zone.

FIG. 6. *Andricus futilis* form *futilis* on *Quercus alba*. A section showing a portion of one larval chamber of sclerenchyma and nutritive zones suspended by strands of the torn parenchyma tissue.



D. KOSTOFF AND J. KENDALL.

PLATE IV.

FIG. 7. *Andricus petiolicola* on *Quercus alba*. Some cells from the nutritive zone of section shown in Fig. 1 showing bacteria-like content.

FIG. 8. *Andricus palustris* form *palustris* on *Quercus palustris*. A section showing the beginning of the separation between the sclerenchyma and parenchyma zones in the region of small undifferentiated cells.

FIG. 9. *Neuroterus minutus* form *minutus* on *Quercus alba*. A section showing the cells of the nutritive zone enclosed in a narrow zone of sclerenchyma with an outer zone of elongated parenchyma cells.

FIG. 10. *Andricus palustris* form *palustris* on *Quercus palustris*. Several cells from the innermost layers of the nutritive zone showing the fragmenting nuclei.

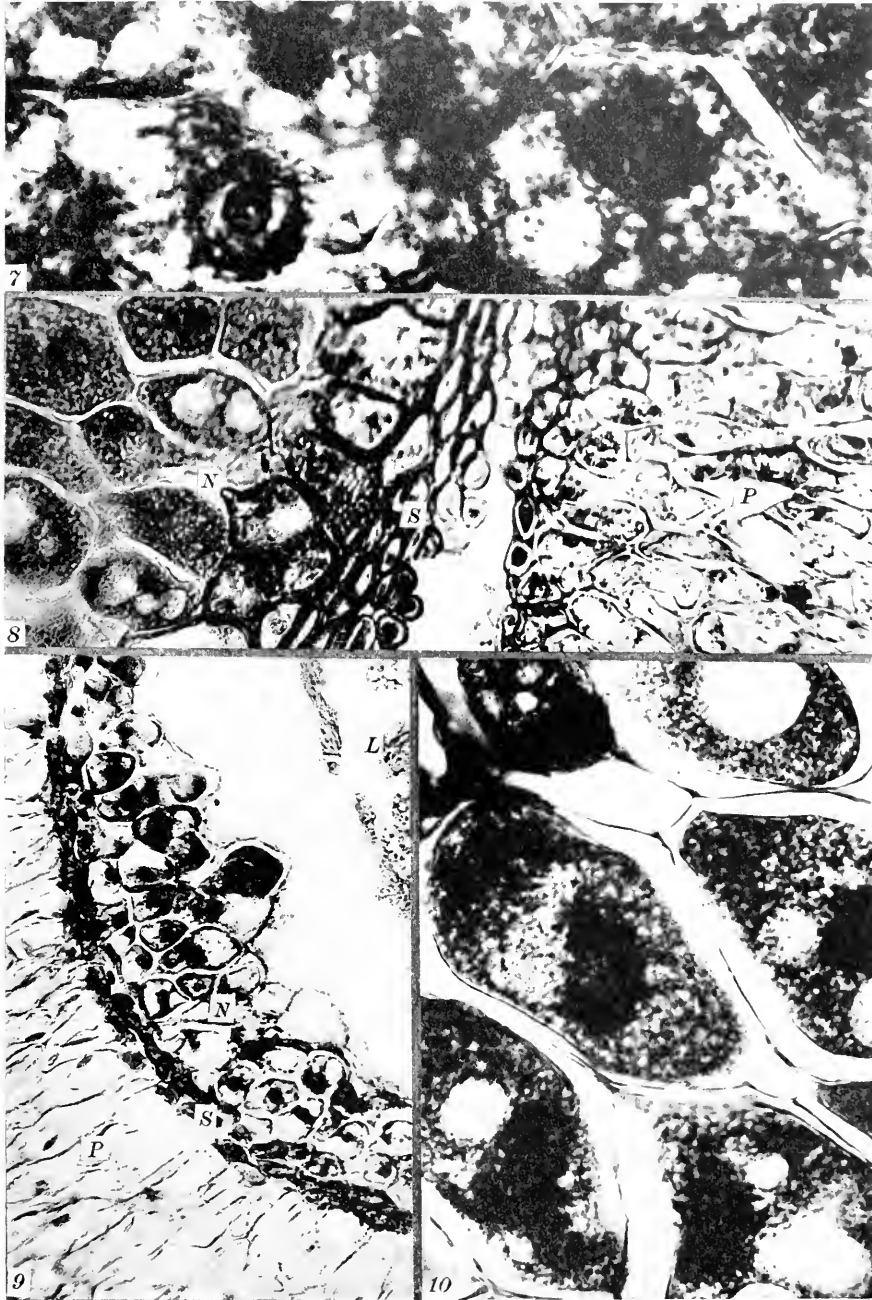

D. KOSTOFF AND J. KENDALL.

PLATE V.

FIG. 11. *Neuroterus minutus* form *minutus* on *Quercus alba*. Portions of three larval chambers showing various degrees of utilization of the nutritive zone; the upper one showing an unequal progress of dissolution.

FIG. 12. *Andricus palustris* form *palustris* on *Quercus velutina*. An iodine preparation of a section of the gall showing the distribution of the starch at the time of separation of the two inner zones, which contain starch, from the two outer ones of parenchyma and epidermis, which do not contain any starch.

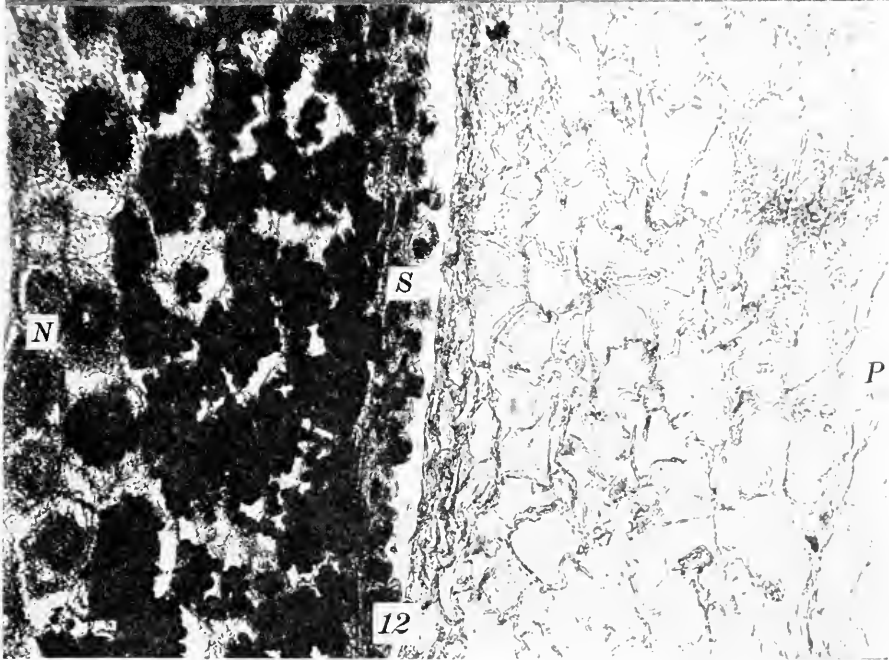
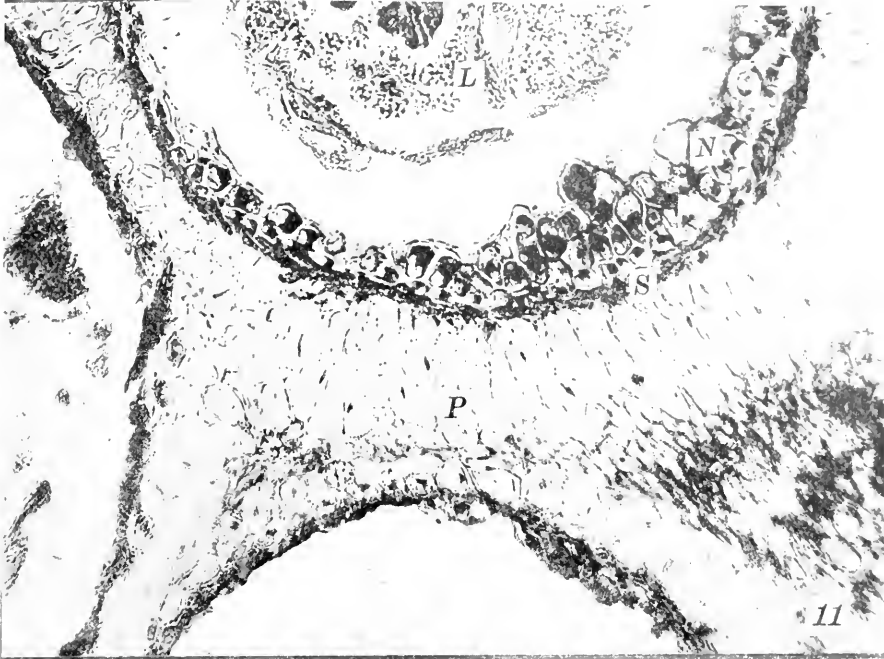

PLATE VI.

FIG. 13A. *Andricus palustris* form *palustris* on *Quercus ellipsoidales*. An iodine preparation of a section of the larval chambers of two galls of different ages; the younger gall represented on the left.

FIG. 13B. *Andricus palustris* form *palustris* on *Quercus Ludoviciana microcarpa*. An iodine preparation of a section of a gall before the separation of the zones showing the distribution of starch.

FIG. 14. A section of the larva of *Andricus palustris* form *palustris* showing two very large cells (*a*) of the mesenteron wall, and the comparatively small cells of the adjoining tissues.

FIG. 15. Cells from the nodules of *Phascolus vulgaris* caused by nodule bacteria showing different degrees of dissolution (destruction) of the nuclear membrane.

Remark: Figs. 13A and 13B are less magnified than Fig. 12.

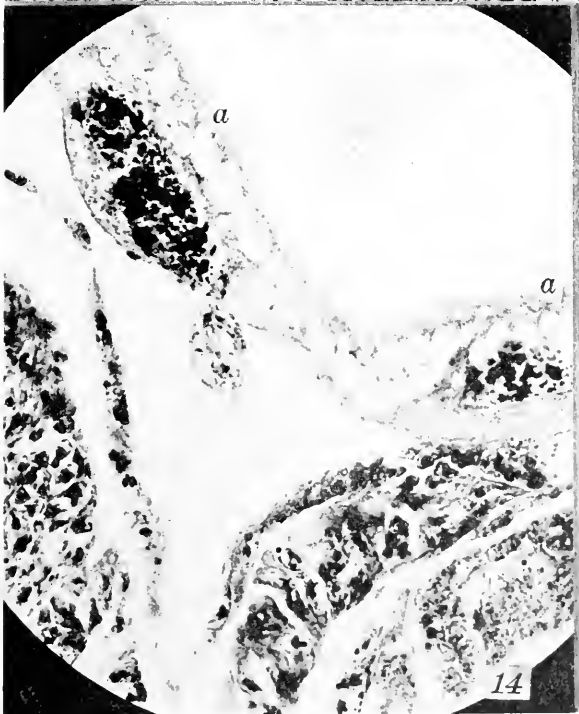
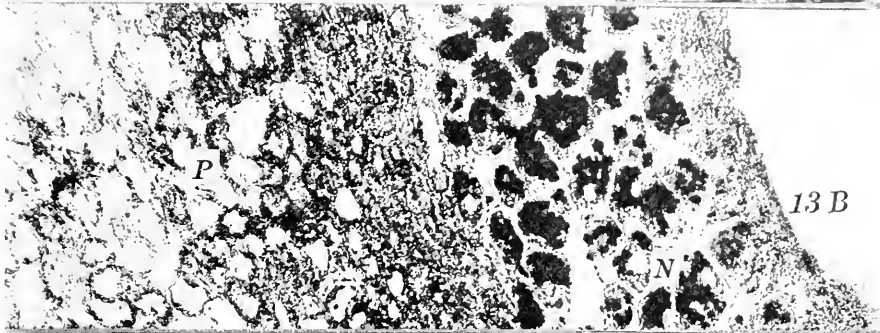
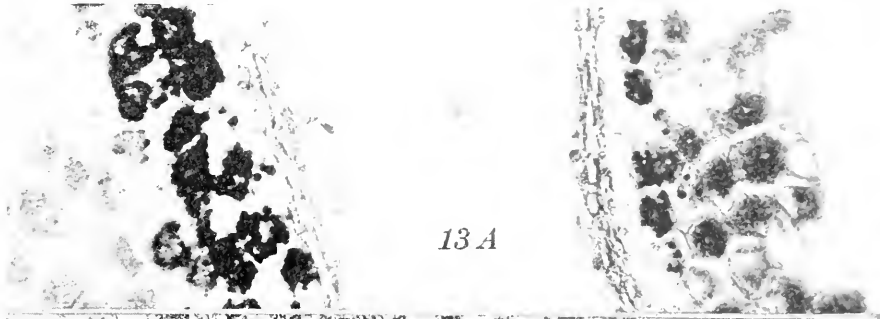

PLATE VII.

FIG. 16. Grains of potato starch hydrolyzed by treatment with the extraction of the nutritive zone of gall of *Amphibolips conflucns* on *Quercus velutina*.

FIG. 17. *Andricus palustris* form *palustris* on *Quercus Shumardii*. Cells of the innermost part of the nutritive zone showing the increasing size of the nucleolus as the larval cavity is approached.

FIG. 18. Cell from mesenteron wall (*a*) in an older larva than shown in Fig. 14, with adjoining tissue cells, adipose, etc.

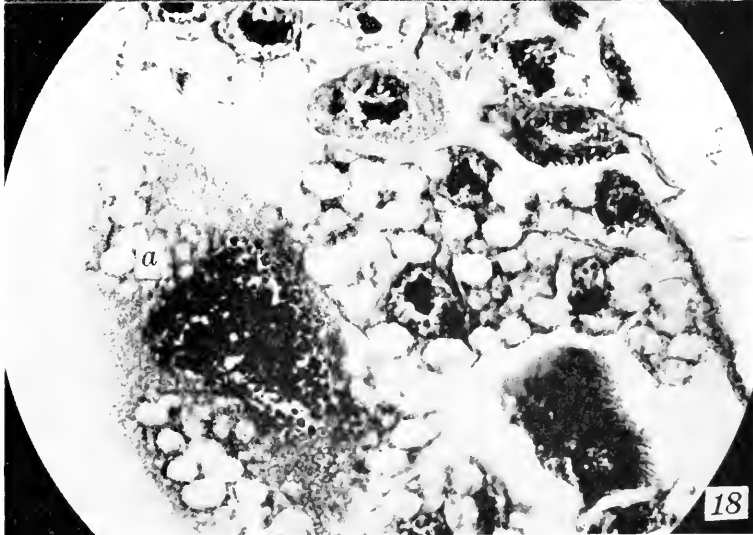
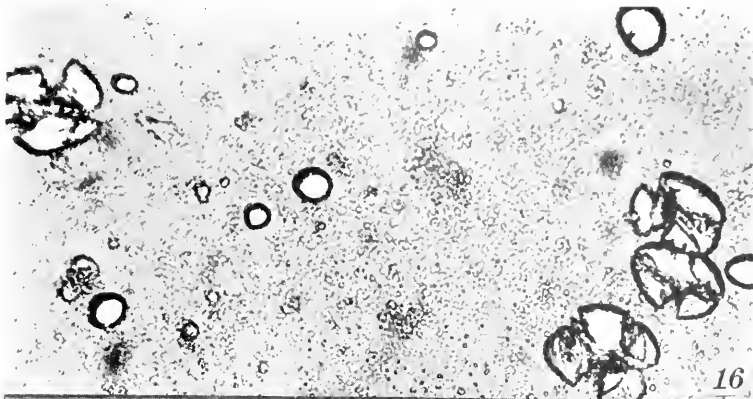

PLATE VIII.

FIG. 19. Sclerenchyma zone (S) of the gall of *Andricus palustris* form *palustris* with adjoining layer of nutritive zone (N) showing the relative abundance of binucleated cells of the former. Camera lucida drawing with 4 mm. obj. and 12.5 × occ.

FIG. 20. Metaphase from the cells of the larval tissues of *Andricus palustris* form *palustris* with 10 chromosomes. Camera lucida drawing, 1.9 mm. obj. and 12.5 × occ.

FIG. 21. Incomplete nuclear division in cell from the region just inside the region of most intensive cell division in gall of *Andricus petiolicola* on *Quercus alba*. Camera lucida drawing, 1.9 mm. obj. and 12.5 × occ.

FIG. 22. Two binucleate cells from the inner region of radiating parenchyma in gall of *Amphibolips conflucens* on *Quercus velutina*. Camera lucida, 1.9 mm. obj., 12.5 occ.

FIG. 23. Cells from same gall as Fig. 21, but from region of intensive cell division; arrows indicate direction of stimulus centrifugally from larval chamber with complete inactivation of chromosomes toward it and lagging of those away from it. (Camera lucida, 1.9 mm. obj., 12.5 occ.)

FIG. 24. Cells from the larva of *Andricus palustris* form *palustris*. A—Binuclear cells from the larva. B—Cell from the same larva with 20 chromosomes. Camera lucida, 1.9 mm. obj., 12.5 × occ.

FIG. 25. Drawing from the cells of the gall of *Neuroterus batatus* form *bisexualis* on *Quercus alba*. A—Cell from region of intensive cell division showing the chromosomes lagging on the spindle; chromosomes ovoid or round. B—Metaphase of cell from region of the plant tissue beyond the influence of the insect larva; the chromosomes are prolonged and slender as they usually appear in normal somatic cells. Camera lucida, 1.9 mm. obj., 12.5 × occ.

FIG. 26. Two polynuclear cells from the tissue about the canal of the gall of *Amphibolips conflucens* on *Quercus velutina*. Camera lucida, 1.9 mm. obj., 12.5 × occ.

FIG. 27. Irregular cell division in the larvæ of *Andricus palustris* form *palustris* from various regions of the body. Camera lucida, 1.9 mm. obj., 12.5 × occ.

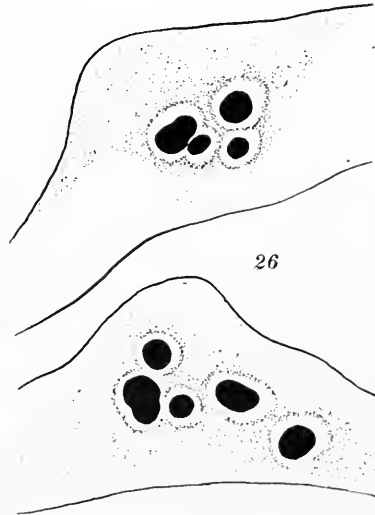
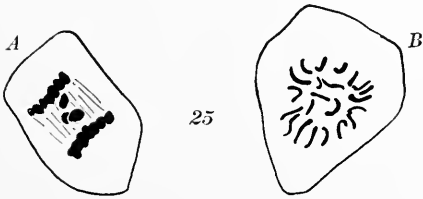
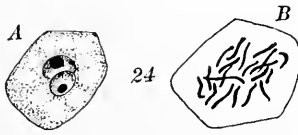
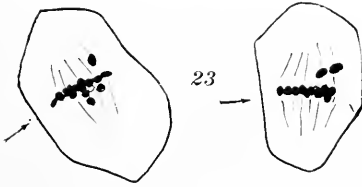
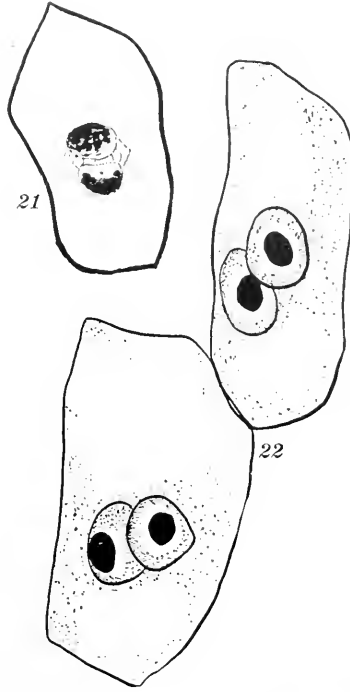
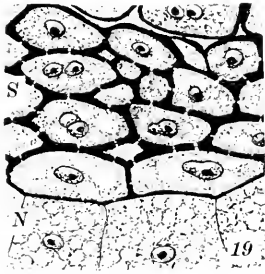

THE EFFECTS OF BILATERAL OVARIOTOMY IN THE BROWN LEGHORN FOWL.¹

L. V. DOMM,

WHITMAN LABORATORY OF EXPERIMENTAL ZOOLOGY,
THE UNIVERSITY OF CHICAGO.

TWO PLATES (4 FIGURES).

INTRODUCTION.

In a previous report (Domm, '27*a*) the effects of complete ovariectomy were recorded in detail. It was shown that following the total ablation of the normal left ovary in the brown Leghorn fowl the right gonad, which normally is a minute rudiment, hypertrophies and forms an organ usually of testis-like form and structure. In these earlier cases, where the operation was performed at a relatively late age, these testis-like right gonads were always sterile. In a subsequent series (Domm, '28, '29), in which the operations were performed at a very early age, some of the hypertrophied testis-like right gonads thus far examined reveal active spermatogenesis, though in other respects, relating principally to secondary sexual characters, these individuals are essentially similar to those described in our earlier series (Domm, '27*a*). The rudimentary wolffian ducts respond to the presence of these testis-like gonads by growth and often by coiling. The left oviduct, in the absence of the ovary, shows varying degrees of reduction. Such birds develop the secondary sexual characters of the male. Hence the plain female plumage is gradually replaced by the more gaudy male plumage (see bird no. 1018, Plate 1) but this is subsequently replaced by henry plumage when the testis-like gonads attain sufficient activity (see bird no. 845, Plate 1). The head furnishings usually relatively small and fine in texture after a time, varying somewhat in different individuals, become large.

¹This investigation was supported in part by a grant from the Committee for Research in Problems of Sex of the National Research Council; grant administered by Prof. Frank R. Lillie.

coarse, and male-like (see Plate 1). Spurs develop and attain varying dimensions (see Plate 1). Behavior is likewise modified. The normal female is comparatively peaceable. Following the operation many of them eventually become pugnacious, acquire an interest in the female, crow, and attempt to tread.

The experiments on castration and those on transplantation of male gonads in the cock (Domm, '27c, and others) have shown that the testes have a pronounced effect on the development of the dependent sex characters. Hence in the presence of the male gonad the dependent characters, including head furnishings, behavior, and to a lesser degree the sexual ducts, are well developed while in the absence of the male gonad they become reduced and inconspicuous or disappear (for type of head furnishings in capon see bird no. 608, Plate 2). The development of certain male characters in the poulard, such as masculine head furnishings, behavior, and growth of the wolffian ducts was therefore attributed to the presence of the testis-like compensatory gonad found on the right, or a similar gonad occasionally regenerated on the site of the removed left ovary (Domm, '27a). In order to verify this supposition it was essential to remove these gonads and observe the effects on these characters.

Benoit ('23) performed an operation of this type on a white Leghorn female when approximately 6 months old. This bird had been previously ovariectomized at the age of 26 days. Whether this operation was completely successful in removing all gonad tissue beyond the possibility of subsequent regeneration is not known, as the bird was not kept a sufficient length of time, though from our experience we would surmise the contrary. Zawadowsky ('26) likewise reports a case in which he endeavored to remove the right testis-like gonad. The ovary had been previously removed on November 15, 1919 (age not given), and on May 18, 1922, approximately 2½ years later, the bird was opened on the right and the oval testis-like gonad incompletely removed.

In our earlier series of ovariectomy experiments (Domm, '27a) attempts were made to remove some of the hypertrophied right gonads by secondary operations. However, removal of the gonad at this late stage in its development was found to be difficult and exceedingly hazardous owing to its firm consistency and its posi-

tion over, and close adherence to the large post caval and right iliac veins. These gonads are never attached by a narrow mesorchium, as is the normal testis, but they invariably show a more diffuse area of attachment rendering their extirpation extremely hazardous. A considerable number of extirpations of the fully formed gonad were attempted. However only a few of these attempts were completely successful in the sense that no regeneration of the gonad had subsequently occurred as witnessed by post-mortem examination.

The hazards involved in completely disposing of all gonad tissue once the organ has fully hypertrophied, allied with its subsequent regeneration and growth, made it advisable to perform this operation at a much earlier age before the right rudimentary gonad had shown any appreciable hypertrophy. In the normal female fowl the rudimentary right gonad consists merely of a long, narrow, flattened sheet of tissue extending posteriorly from the median border of the right adrenal on the vena cava and junction of the right iliac veins. Following ovariectomy its growth is usually negligible macroscopically prior to the third week. Attempts to remove it surgically in this state would essentially be equivalent to an attempt to remove a part of the wall of the post caval itself. A new technique was therefore devised by which the rudimentary gonad was destroyed prior to hypertrophy by means of a small electric cautery. This method differs from that previously employed only in the destruction of the gonad at an early stage by cautery rather than its much more hazardous surgical removal at a later stage. This method has several obvious advantages. It enables one to perform the operation anytime prior to, or shortly following, ovariectomy. The operation also has the pronounced advantage of being much less hazardous for with moderate care one may completely destroy the rudimentary gonad with no, or very little, hemorrhage, a state of affairs practically impossible with the former method. Furthermore, any small part of the gonad not destroyed by the initial operation may readily be destroyed by a subsequent cauterization.

This investigation is part of a larger program on the biology of sex now being pursued at this laboratory under the direction of Prof. Frank R. Lillie. Acknowledgments are due Prof. Lillie for his assistance in making this study possible.

EXPERIMENTS.

Thirty birds of the same age and approximately the same size were selected for this experiment. These were ovariectomized late in the summer and early fall of 1926 at ages ranging from 76-79 days. Each of these birds was subsequently opened on the right side between 16 and 22 days following the initial operation (see table) and the rudimentary gonad destroyed by thoroughly searing with a small electric cautery. Nineteen of the birds thus operated form the basis for this report while the findings in the rest of the series will be recorded at a later time. No difficulty was encountered during the course of this new method of operation. With very few exceptions the operation was completed with no, or very minor, hemorrhage and in most instances the bird was in good condition and recovered rapidly following the operation. In a few cases where recovery was slow the difficulty could be traced to the initial, more severe, sinistral operation.

RESULTS.

In the experiments forming the basis for the present report the birds were deprived of both right and left gonads practically simultaneously; hence no dependent male characters ever developed. The changes observed following these operations coincide more closely, in some respects, with those *immediately* following sinistral ovariectomy than with those observed where the secondary dextral ovariectomy is performed at a much later time when the bird had assumed masculine characters. In the latter case there is usually a rapid decrease or disappearance of the dependent male sex characters, such as head furnishings and behavior, associated with a reversion to male plumage if the bird had assumed female plumage prior to the operation (Domm, '27a). A general categorical description of the effects of these operations will be given. All individual cases can obviously not be described in detail hence the description given in the text will be of a general nature with frequent reference to the tables to which the reader is referred for detailed case histories. For details on methods of operation, records, and preservation of materials the reader is referred to an earlier paper (Domm, '27a).

Effect on Head Furnishings.—The birds selected for these operations were relatively young growing pullets whose head furnishings at the time of operation were juvenile and had not yet attained very prominent proportions. The head furnishings therefore did not show a reduction in size as is frequently the case in the pullet ovariectomized at a later age when these characters have become relatively prominent. In a few instances where these characters were conspicuously red at the time of operation they became noticeably pale subsequently. In the completely successful cases these characters showed a slight gradual increase in size corresponding, in all probability, to the general increase in body size of the growing bird, until the bird matured, following which there is but little fluctuation in size (see table, cases no. 875, 876, 882, 884, 895, 897, etc.). Hence such a mature female completely deprived of all gonad tissue shows small, usually pale, comb, wattles, and earlobes (see bird no. 876, Plate 2).

In a number of cases the head furnishings later became red and turgid and manifested signs of growth though the size attained varied in each instance (see table, cases no. 874, 878, 880, 893, etc.). It is interesting to note that in each of these cases this growth was subsequently followed by a marked decrease. In a few cases this decrease was probably due to the general condition of the bird as it will be noted by reference to the table that a number of these birds died. In a few of the cases it may justly be attributed to this cause as the birds were sick for some time prior to the time of death (see table, cases no. 874 and 878). However one of the birds died because of crop-binding in which case it was afflicted for but a short period and when killed showed no symptoms of organic disease (see table, case no. 898). A few of these lived to the termination of the experiment and were killed in good condition (see table cases no. 880 and 893). Hence this reduction in size of head furnishings is not attributable in all cases to the poor physiological condition of the bird, though this is very frequently the case (see Domm, 27*a*), but must be imputable to other causes.

It will be noted by reference to the table that each of the cases showing conspicuous growth of head furnishings also reveals varying amounts of testis-like gonad. It is significant that such

birds may show the small capon-type head furnishings for practically $1\frac{1}{2}$ years and subsequently show pronounced development of head furnishings indicating regenerating gonad (see table, case no. 894). This bird, whose complete history is given in the appended table, showed small capon-type head furnishings for 18 months following the operation, indicating a successful operation, which later became red, turgid, and conspicuously prominent. Bird no. 890 is exceptional and warrants mention in this particular. The head furnishings of this bird showed conspicuous growth between the 5th and 8th months following the operation (see table) after which there was a slight decrease. Post-mortem examination revealed no gonad tissue on either gonad site indicating successful removal. It is very probable that the growth observed here was due to an accidental autoplasmic ovary graft which was being resorbed when the head furnishings began to decrease hence it could not be found at the autopsy.

Effect on Plumage.—The general differences in plumage exhibited by the sexes of the domestic fowl are fairly well known. For details of the plumage dimorphism, which is very pronounced in the light brown Leghorn, the reader is referred to an earlier paper by the writer (Domm, '27a).

The birds used in the present experiment had assumed the early female plumage at the time of operation. Following the operation they developed the juvenile plumage of the male to varying degrees (see table). These feathers are particularly conspicuous on the back, saddle, and wing areas. The new feathers on the breast and laterally, while juvenile for a time after the operation, early became black as in the mature male. This precocious development of definitive male feathers in these areas coincides with their earlier development in these regions in the male. However new juvenile feathers did not appear indefinitely in any region of the body for by 4 to 6 weeks after the operation the new ingrowing feathers were of the definitive male type in all areas. Mention should perhaps be made of the fact that the juvenile plumage is not lost as soon as adult plumage begins to appear but that this is usually a very gradual process, hence the presence of juvenile plumage at 6 months after the operation as the table reveals in a number of cases. Unfortunately the table does not give changes

between 6 and 12 months, if it did it would reveal the fact that some of these individuals retain this type of plumage even longer than 6 months. In exceptional cases where birds are in poor physiological condition and fail to mature before the onset of cold autumn weather these feathers may be retained until the following spring. By two to three months after the operation most of the birds in the experiment presented a conspicuous plumage consisting of some scattered old female feathers, a few scattered feathers showing female tips and male bases, particularly conspicuous on the breast and lateral areas, numerous juvenile feathers conspicuously confined to the back, saddle, and wing areas, and many adult male feathers most abundant on the breast and laterally but not by any means inconspicuous in all other areas. By five to six months after the operation the plumage had become completely male in all areas with some scattered juvenile feathers on the back, saddle, and wing areas in some cases (see table). If the operation is completely successful such a bird develops and retains (in these cases approximately $2\frac{1}{2}$ years) a brilliant, luxuriant, adult male plumage (see table cases no. 875, 876, 882, 884, etc.), showing no subsequent reversion to female plumage as does the female in which merely the functional left ovary has been removed (see bird no. 845, Plate 1, also Domm, '27*a*). The successful bilaterally ovariectomized female therefore approximates the castrated male in this particular (compare birds nos. 876 and 608, Plate 2).

In several cases (see table, birds no. 880, 891, 893, 894) the bird developed male plumage for a time following the operation and later reverted to female plumage. Reference to the table will reveal that in each of these cases this reversion in plumage was preceded by considerable increase in the size of the head furnishings which in turn disclosed the presence of regenerating gonad. Bird no. 891 revealed such a reversion in plumage following considerable increase in size of head furnishings. Later these again decreased in size following which the new plumage again became male in character. About this time (October 16, 1927) a dextral laparotomy was performed, revealing a small mass of right gonad which was thoroughly seared. During the following 16 months to the time the bird was killed (March 1, 1929) the plumage remained male in character and the head furnishings small and

capon-like. Post-mortem examination revealed no gonad on either right or left sides. In bird no. 880 there was likewise a reversion in plumage to the female type following considerable growth of head furnishings followed by a reversion back to male after these characters had regressed for a time. Birds no. 893 and 894 showed a similar reversion to female plumage, though at widely different intervals, but differed from the above in that they did not revert back to male again but they probably would have done so given sufficient time correlated with no gonad activity as evinced by decrease in head furnishings.¹ Birds no. 874, 878, and 898 developed and retained male plumage to the time of death. In each post-mortem examination revealed some gonad (see table) correlated with growth of head furnishings which was most pronounced, though of short duration, in bird no. 898 and negligible in each of the others.

Effect on Spurs.—The effects of castration on the spurs of the male are incompletely understood. The Leghorn capon in our experiments always has well developed spurs (see bird no. 608, Plate 2). They however do not seem to grow any longer than those of the normal cock. The only appreciable difference we have been able to observe concerns their development. The spurs of the capon become sharp and pointed early in their development while those of the normal male remain stout and blunt for a considerable period, sometimes well into the second year.

The normal female of the Leghorn breed usually lacks spurs

¹ The gonadal plumage relationship in the poulard is evidently explicable on a quantitative basis. In the absence of gonad the female develops and maintains cocky plumage; the presence of small amounts of regenerating gonad does not alter this condition. As the mass of regenerating gonad gradually increases in size and presumably also in hormone production it eventually attains the point where it partially inhibits male plumage, and intermediate plumage develops. If the volume of hormone produced becomes still greater it ultimately attains the point where it completely inhibits male plumage and female plumage develops. This is to be explained by a secondary gradual development of female hormone as will be described in other studies by Domm and Gray. The parallel regression of head furnishings and secondary reversion of plumage from female to male in the cases described above indicate that the hormone production of the compensatory gonads was not much above the threshold of effectiveness and was readily depressed below it by sickness or lowering of vitality of the bird. The same principle was found to apply in our cases of sinistrally ovariectomized birds previously described (Domm, '27a).

though cases are known where otherwise normal females showed well developed spurs (cf. Domm, '27a, p. 86, also Goodale, '16). The young pullet of our breed shows no spurs, though one may always identify the small, oval, imbedded, spur rudiment on the inner surface of the shank. These rudiments gradually become more conspicuous throughout the life of the fowl though in no instance have we observed them more than a few millimeters in length in the old spurless hen.

Following sinistral ovariectomy in the Leghorn spurs have developed in all cases without exception (see birds no. 1018 and 845, Plate 1). The rate of growth and the ultimate size attained varies somewhat in individual cases though relatively well developed spurs are nevertheless the rule in all such birds. The development of spurs in the bilaterally ovariectomized birds of this series differed in no important respect from those in which merely the left ovary had been removed (see bird no. 876, Plate 2). Individual differences occur though the size attained in individuals of comparable age is apparently no greater in the one group than in the other. The table gives the length of the spurs in centimeters at the time of autopsy. For data on spur growth following sinistral ovariectomy the reader is referred to a previous publication (Domm, '27a).

It was pointed out above that the spurs of the capon become sharp and pointed earlier than those of the normal cock. Indications are that the spurs of the sexless female may not become pointed as early as those of the capon in at least certain individuals. Birds no 902 and 903 (see table) show spurs at $9\frac{1}{2}$ and $8\frac{1}{2}$ months following operation which are well rounded and blunt at the ends. On the contrary bird no. 878 (see table) shows sharp pointed spurs at 10 months. All individuals sacrificed toward the termination of the experiment had well pointed sharp spurs though the actual length attained varied considerably.

Effect on Voice and Behavior.—It is generally conceded that the normal female does not tread, that she is less combative than the male and that she does not crow. It is likewise held by many that the capon does not tread nor crow and that he is inclined to be non-combative. Following sinistral ovariectomy the female may develop the behavior of the male to a striking degree (see Domm,

'27a). Such a bird will crow, fight the male, call the female to an alleged morsel of food and attempt to tread but, while these reactions are very common and characteristic, instances where such a bird will actually tread are apparently very exceptional. It was previously pointed out (Domm, '27a) that when such an ovariectomized fowl is later completely castrated she loses her masculine voice and behavior and becomes capon-like.

In the present experiments the birds were bilaterally ovariectomized at a relatively early age. In cases where this experiment was completely successful, in disposing of all gonad tissue so that none regenerated subsequently, the bird never developed or exhibited the masculine voice or behavior. Such a bird develops much as does the capon in this respect. They were found to be relatively inactive and non-combative. They are noticeably more quiet than the normals of either sex. It was further observed that they will not receive or interest themselves in the male but are rather inclined to avoid him. They were never observed to brood, neither did they build nor sit on the nest nor did they appear to interest themselves in chicks; however the broody instinct has practically been lost in the variety of brown Leghorn with which we are here concerned. The broody instinct has been manifested in but a few cases in our flock of normal hens and communication with fanciers on this point indicates that this instinct is nearly lost in certain varieties of Leghorns at least. Hence this reaction is probably not to be expected in the sexless females in this experiment. Birds in which the operation has been incomplete as witnessed by the presence of regenerating gonad of testis type exhibited degrees of masculine behavior no different from that found in the sinistrally ovariectomized fowl.

Effect on size.—The size differences between the sexes of most breeds of fowl are well recognized. The Leghorn breed does not appear to be exceptional for here the male is conspicuously larger than the female. The stance in the two sexes also differs. The cock is characterized by a noticeable upright stance while that of the female is more horizontal. It is quite generally conceded that the male fowl when castrated, at a relatively early age, grows larger than the normal. The normal Leghorn capon in our flock has grown somewhat heavier than the normal cock but whether this is

due to excessive accumulation of fat, for which the capon is renowned probably due to his lethargy, or to an actual increase in skeletal proportions we have as yet not established. The probabilities however are that both factors are involved. Following castration the stance of the cock is altered, becoming horizontal so that it approximates more nearly that of the female.

No actual measurements have been made to show whether the fowl shows any changes in size of skeleton following sinistral ovariectomy. The general impression is that the poulard is no larger than the normal hen. Goodale ('16) contends that the poulard probably does not exceed very appreciably, if any, the size of the normal hen. He admits that his data have not been of sufficient extent, nor his stock sufficiently homogeneous in respect to weight, to give results of value. Finlay ('25) states that the ovariectomized female (sinistral) retains the skeletal characters and body shape of normal females but gives no measurements to substantiate his contention. We have found exceptional cases (Domm, '27*a*, also unpublished data) where the poulard was noticeably larger though in general we are inclined to believe that such size changes, while they may occur, are in most instances negligible. Furthermore since sinistral ovariectomy in the fowl does not produce a gonadless bird, as was formerly supposed, it is perhaps not to be expected that she would change appreciably in size if at all.

Size differences in the bilaterally ovariectomized Leghorn in our experiments deviating from the normal are not very conspicuous if they occur at all. In fact we are inclined to believe that they do not change in size or, if they do changes certainly are not as obvious as they appear to be in the capon. As concerns weight we find that many of our sinistrally ovariectomized females exceed the weight of the sexless bilaterally ovariectomized birds in this experiment. The average weight of the normal female when one year old is approximately 1,400 grams. This weight is not exceeded by the sexless females of this series. The age at the time of operation in these experiments coincides with that at which castration is usually performed in the young male following which there is generally an increase in size. The statements made here are based on general observations and the weights of the birds. No further

commitment can be made until further data are available on this question to be gathered from preparations now being made.

Effect on Accessory Organs.—The term accessory organs is here employed in its customary significance, namely the ducts that convey the products of the gonads to the exterior, the vasa deferentia and the oviducts. In the normal mature male the vasa deferentia are prominent convoluted ducts having a perceptible diameter. Following castration the convolutions are lost accompanied by a marked reduction in size so that one sometimes experiences difficulty in finding these small straight ducts in the adult capon. We have never found any indication of oviducts in the mature Leghorn male. The normal female has but one functional oviduct that on the left side. The right oviduct, present in early embryonic life, degenerates leaving a small rudiment, varying in size in different individuals, attached to the side of the cloaca. The wolffian ducts persist as small slender threads in the normal female. Following ablation of the left ovary the wolffian ducts hypertrophy and frequently become convoluted under the stimulus of the hypertrophying testis-like right gonad (Domm, '27a). The oviduct in such cases shows varying degrees of reduction though it is rarely entirely infantile. The highly glandular nature of the oviduct in a certain number of cases of complete sinistral ovariectomy indicates that it is receiving a stimulus in such cases comparable to that furnished by the normal left ovary.

The disposition of the accessory organs in the bilaterally ovariectomized fowl may differ greatly from that found in those merely sinistrally ovariectomized. If the bilateral operation was completely successful in removing all gonad tissue it was found that the wolffian ducts remained small and rudimentary comparable to those found in the normal female (see table, cases no. 875, 876, 882, 887, etc.). The stimulus furnished by very small masses of gonad is apparently insufficient to provoke growth changes as disclosed by case no. 878 (see table). In cases where the mass of regenerated gonad is of considerable size the wolffian ducts have responded to the stimulus furnished by considerable increase in size (see table cases no. 880 and 898). Such a result was to be expected on the basis of the writers earlier observations (Domm, '27a). A definite correlation between the amount of hyper-

trophied testis-like gonad present and the growth of these ducts would be difficult to establish though there can be no question as to its existence.

In all cases showing a total absence of gonad the oviduct consists of a small straight flattened tube having a diameter of only 2 to 3 millimeters (see table, cases no. 875, 876, 882, 884, etc.). Even in cases showing small masses of regenerated gonad the oviducts are small and straight and approximate the above in size (see table, cases no. 874, 878, 880, etc.). In only 3 of the cases included in this report were the oviducts other than exceedingly small (see table, cases no. 890, 893, and 894). In each of these cases the oviducts were convoluted and showed a diameter of 4 to 6 millimeters. It should be indicated that in each of the above three cases there is a definite correlation between stimulation of oviduct and reversion to female plumage. In cases no. 878, 884, 887, 899, and 902 (see table), different parts of the oviduct were inflated, to varying degrees, with a clear watery fluid. This condition is not uncommon in our ovariectomized birds and is probably associated with the atrophy of the oviduct in conjunction with the obstruction of both openings thereby preventing the escape of secreted fluids. Our practice of resecting all or a large part of the infundibulum prior to sinistral ovariectomy is no doubt responsible for sealing this end of the oviduct. Rudiments of the right oviduct were found in all cases attached to the side of the cloaca. These rudiments are very small in all of the cases belonging to this series though whether they show a greater reduction in these birds than they do in the normal or the sinistrally ovariectomized fowl would be difficult to estimate. In both our series of sinistrally ovariectomized fowl (Domm, '27*a*, and '28) we encountered many right rudimentary oviducts that were larger than the ones found in the present series but because of the great variation revealed by these structures this is probably not very significant.

DISCUSSION.

The gonadless male and female of the Leghorn variety have a great many points of similarity. In both types the head furnishings remain small and pale and fluctuate little, if any, in size. Both types develop a brilliant, luxuriant, male plumage. The capon

develops long spurs which become sharp and pointed early in their development. The spurs of the gonadless female likewise become long though it appears that they become sharp and pointed somewhat later than those of the capon. The behavior of both types is neutral, neither exhibits the behavior of the normals of either sex. The wolffian ducts, which in the normal male are prominent and convoluted, become very small and straight in the capon so that it is frequently difficult to find them. These ducts are likewise very small and straight in the gonadless female and frequently very difficult to demonstrate. Her oviduct is also greatly reduced to a straight slender tube. The only apparent difference between these two types is that of size. The normal male of the Leghorn variety is larger than the female. Following early castration the male increases somewhat in size as compared with the normal. It is questionable whether the female, bilaterally ovariectomized at a corresponding age, increases in size above the normal. Hence the normal size differences between the sexes appear to persist and may even become somewhat aggravated owing to the increase in size of the capon above the normal male. Studies are now in progress to determine skeletal changes in the castrates of this breed.

The earlier experiments of the writer (Domm, '27a) and others have revealed the striking capacity of the female to assume male characters both in anatomy and behavior. These investigations have further shown that the female fowl possesses tissues in the hypertrophied right gonad, which are similar in their effects to the endocrine cells of the testes, upon which this transformation in large measure depends. The experiments of Goodale ('16) Zawadowsky ('22) Finlay ('25) and of ourselves (Domm, '28) reveal the fact that the male may undergo a corresponding transformation of male into female only by operative interference. Hence by grafting ovary into the castrated male such an individual may assume the plumage and head furnishings of the female. The present experiments further reveal the striking identity of the gonadless bird whether originally male or female. The results of castration thus lead to a type common to both sexes designated as the asexual or neutral type by various authors. Lipschutz ('24) maintains that during embryonic life the soma in birds is asexual,

and that the development of male and female characters takes place only under the influence of the sex specific hormones produced by the gonads. Zawadowsky ('22) on the basis of extensive work in the bird concludes that the soma of the male and female is essentially identical, and that differentiation is brought about only by the stimulus of sex specific hormones. He asserts that removal of the gonads leads to an asexual type hence the soma of either sex is "equipotential." Zawadowsky ('26) further reminds us that the development of the right rudimentary gonad in poularden brings forth a morphogenetic reaction which is an indication of the bisexual nature of the hen. He maintains that not only is the somatic body potentially bisexual but that the left ovary and the right rudimentary gonad of the hen can both produce both male and female morphohormones presumably under given conditions. Furthermore these gonads may produce a typical testicular structure, with active spermatogenesis not infrequently occurring in the activated right gonad (cf. Benoit, '23, Zawadowsky, '26, Domm, '29). Hence Zawadowsky's theory of equipotency would include not only the somatic tissues but also the gonads and presumably the germ cells. Crew ('23) in fact postulates equipotency of the primordial germ cells of both sexes. Greenwood's and Crew's ('25) assertion of a difference in intensity, or quantitative difference, in male and female hormone and not a sex specific or qualitative difference as is postulated by Lillie ('27), Lipschutz ('24), Zawadowsky ('22 and '26) and others would in addition imply equipotentiality of the hormone secreting cells.

According to Lillie ('27) the real issue is, "what tissues of the male and of the female react equally to the two hormones, whether with respect to growth or alternate potentialities?" Our earlier experiments (Domm, '27a) and those of others have shown that in the female fowl the head furnishings, feathers, spurs, wolffian ducts, and to a certain degree the behavior, permanently retain the capacity to react to the male hormone as the corresponding characters of the male normally do. Feminization experiments by ourselves, and others, reveal a similar double potentiality on the part of the corresponding characters of the male. The above observations thus seem to show that the somatic tissues may react equally in both sexes to either male or female hormone while

Crew would include germ cells and Zawadowsky gonads and germ cells also. However as regards equipotency of gonad tissues the theory can apply only to the female and not to the male since no one has ever observed male gonad give rise to ovarian cortex in birds, or mammals for that matter, in spite of the numerous castration and transplantation experiments that have been performed.

If we accept the doctrine of equipotency in its fullest meaning as implied by Zawadowsky, Lipschutz, and others, should we then expect complete sex reversal in cases where the hormone is present in early embryonic life prior to the onset of sexual differentiation? If this is implied these authors would ignore the efficacy of the genetic sexual constitution as factors of differentiation for all extragonadal characters in the presence of the hormones. The observations of Lillie ('17 and '23) on the free-martin reveal a situation in which the production of the sex hormone for the male is demonstrated from the earliest period of sex differentiation. Lillie examined a case of a free-martin in which fusion of the membranes, according to his reconstruction of the probable history of this case, was possibly complete at least at the 10 mm. stage and a vascular anastomosis must have been established at the same time. Such a case, according to Lillie, would seem to have afforded the maximum opportunity of masculinization by the hormones of the male partner on account of the early time of onset and the long duration of possible action. However the modification of the free-martin in this case was not particularly extreme. Lillie ('23) says: "If there were no other factors at work in determining the sex differentiation of embryonic primordia than the specific sex hormone, it is difficult to understand why the free-martin, which receives only male sex hormones, should not become completely male." The chick embryo seemed to offer suitable material for a demonstration of the action of sex hormones on relatively early stages of the developing embryo. Minoura ('21) grafted gonad onto the chorio-allantoic membrane of developing chick embryos. His results seemed to show a definite modification of the female reproductive system in the male direction under the influence of an engrafted testis. Subsequent experiments by Greenwood ('25) Willier ('27) and Willier and Yuh ('28) would seem to show that gonad grafts on the chorio-allantoic membrane

do not exert a specific effect on the reproductive system of the host embryo as maintained by Minoura. The criticism that these grafts had to be made in the second week of incubation when sexual differentiation had already begun is perhaps not very weighty.

Present experiments do not justify the conclusion that sex hormones are absent or are not involved in sexual differentiation in the chick embryo; yet observations on the action of sex hormones in the fowl after hatching make it difficult to accept such a conclusion. Our present evidence on the participation of sex hormones in the development of sexual characters is in evident conflict. The observations of Lillie ('17) on the free-martin, those of Burns ('25) and Witschi ('27) on parabiotic twins in amphibia, and those of Burns ('27) on the effects of gonad grafts in amphibian larvæ, furnish evidence for the participation of sex hormones in the embryonic development of sexual characters. On the contrary the observations of Greenwood ('25), Kemp ('25 and '27), Willier ('27), and Willier and Yuh ('28), on gonad grafts in the chick embryo, as well as those of Humphrey ('27) and Witschi ('27) on gonad grafts in amphibian larvæ, furnish negative evidence.

The theory of equipotentiality should receive a more rigorous test than it has hitherto received. There is no question of an apparently equal reaction capacity in males and females of feather germs, head furnishings, spurs, in short all the more obvious external secondary sex characters, to the presence of ovary or testis. The same thing may be true of the sexual ducts though the evidence is less conclusive; there is also evidence that sex behavior is strongly influenced by the heterologous sex hormones in the parallel direction. However the most interesting and fundamental question suggested by this work is whether the earliest lines of germ cells are also equipotential and capable of forming ova or spermatozoa according to internal environmental conditions. Benoit's ('23) implication is that they are not equipotential. He explains his cases of sex transformation in the female by assuming the presence of two distinct germ lines in the female, the male line, in the medulla of the ovary, and the female line, in the cortex "the one as rigorously fixed as the other from the point of view

of their cyto-sexual determinism." Our recent experiments (Domm, '29) have confirmed the occurrence of spermatogenesis following ovariectomy in the fowl and explained the causes of its occurrence. It seems to us more reasonable to believe that the primordial germ cells, of the female at least, are equipotential, and that their ultimate fate as male or female is determined by environmental exigencies; hence, when they become incorporated in the cords of the medulla they produce spermatogenesis and when in the cortical elements of the gonad they produce ovogenesis. This agrees with Witschi's ('29) interpretation of sex reversal in female tadpoles following the application of high temperature.

Are the endocrine cells of the gonad also equipotential and thus capable of producing male or female secretions according to environmental exigencies? Our present indications are that these cells are of two kinds, the male secreting and the female secreting. The female possesses both, the male secreting cells in a reserve of specific tissue the medulla, normally inhibited by the cortex, but capable of growth and secretion when this inhibition is removed (Domm, '27a, '28, '29), and the female secreting cells in the cortical elements of the gonad. The male possesses but one the male secreting cells. Our experimental results (Domm, '27a and unpublished data) demonstrate quite clearly that male hormone may be produced either by testis or ovarian medulla but that female hormone is produced only by ovarian cortex. There is therefore no indication of equipotentiality of these cells and according to Lillie ('27) "none is to be expected, seeing that these cells are the source of the postulated inductions of the double potentialities."

SUMMARY.

1. Complete bilateral ovariectomy in the brown leghorn fowl leads to an asexual or neutral type common to both sexes in many of its characters.

2. The head furnishings which become large and male-like following sinistral ovariectomy remained small and fluctuated little in size following complete bilateral ovariectomy.

3. Following sinistral ovariectomy the plumage becomes male but at a later period, varying greatly in different individuals, it reverts to the female type. In our cases of complete bilateral ovariectomy

the plumage became male following the operation and retained this character to the termination of the experiment.

4. Well developed spurs were found in all cases. The amount of spur tissue developed does not seem to be greater in the bilaterally ovariectomized fowl than in those sinistrally ovariectomized.

5. The behavior of these individuals is neither male nor female but neutral. Comparable in this respect to that of the capon.

6. The Wolffian ducts hypertrophy following sinistral ovariectomy. No such hypertrophy is perceptible in the bilaterally ovariectomized fowl, these ducts being small, straight and often very difficult to find.

7. The amount of oviduct tissue varies greatly in the sinistrally ovariectomized fowl. In the cases of complete bilateral ovariectomy here recorded the oviduct is reduced to a very small straight flattened tube, 2-3 mm. in diameter. Very small rudiments of the right oviduct were found in all cases.

8. No changes were observed in size. The birds retained approximately the size of normal hens.

EXPLANATION OF TABLE ON BILATERAL OVARIOTOMIES.

The table includes cases of complete as well as incomplete bilateral ovariectomy. The complete cases are those in which no gonad regenerated on either right or left sides as determined by post-mortem examination. In incomplete cases masses of gonad varying in size are found on either right or left sides or both. On account of the length of the records each case is continued on a second page.

The record of each case consists of selections, from very much more complete records, considered to be most important for the operation history. In some cases other data are recorded in the text. The preserved records consist of notebooks containing complete histories of all birds, photographs, feather records for each case, skins, preserved Sacra with the urinogenital organs in situ for each case, and other anatomical preparations. All entries have been checked thrice from the original records.

Column 1 gives the identification number of each bird.

Column 2 gives the age of the bird in days at the time of the first sinistral operation. It also gives the dates of the sinistral and dextral operations in their order. The sinistral operation always preceded.

Column 3 gives the date of death and autopsy and, if the bird was found dead, this fact and the cause of the death, if known. Cb. signifies crop-binding revealed at post-mortem.

†. A "secondary operation" for removal of regenerated gonad.

"Successive changes in plumage" and "successive changes in head furnishings" are recorded at 3 months, 6, 12, 18, 24, and 30 months following

the date of the operation. These periods are not always the best for recording changes, hence observations at other times are frequently entered in the nearest column and indicated by a number in parenthesis giving the actual age in months above the individual entry. All such dates are approximate only, but on account of the relative slowness of the changes they are sufficiently exact.

Plumage Changes.—The changes recorded are, in general, the natural plumage changes, not forced by plucking. The only exceptions are operation sites though, because of the rapid continuous development of male plumage in most of these cases, these are not long apparent.

♂ indicates feathers of cock or capon type not distinguished.

♀ indicates feathers of female type.

“Tipped” always refers to feathers with female tip and male base which appear shortly after ovariectomy; these feathers have commonly a very sharp line of demarcation between the components, and are frequently referred to as “gynandromorph” feathers in the literature. Such feathers may begin to appear in 10 to 14 days after a successful operation, and they are commonly abundant at 3 months interspersed with new completely male feathers. I. signifies “intermediate,” and represents the beginning of the secondary transformation from the male to the female type of feathers in these birds. These feathers may have male tips and female bases, but the transition zone is not sharp but diffuse. In some instances the entire feather is intermediate or of this diffuse nature.

Where regions are indicated, abbreviations are used Br. for breast, Ba. for back, Sa. for saddle, T. for tail, W's. for wings, Wc's. for wing coverts, Juv. for juvenile, etc.

Head Furnishings (measurements are in centimeters).—The comb is given first, the length of the main blade of the comb from front to back being the numerator and the greatest depth from the highest point to the base the denominator; the wattles come second, width over depth; the vertical diameter of the ear-lobe comes last.

Spurs.—Spurs are recorded by their length in centimeters at date of autopsy.

Findings at Autopsy.—At the time of autopsy, the head was preserved separately in formalin, the skin with, or without, legs attached removed, cured and preserved, and the entire sacrum with urinogenital organs including gonads, if present, fixed in Bouin's fluid.

Right and Left Gonads.—None signifies no gonad, T. signifies “testis-like” gonad macroscopically, † see column 3. Measurements are length over transverse diameter, in centimeters. These ‘regenerated’ gonads are less irregular than the normals frequently are hence the measurements are fairly good comparative estimates of volume in these cases.

Right and Left V. D. (vas deferens).—For purposes of succinct characterization the arbitrary scale previously devised (Domm, '27a) was utilized in which 1 corresponds to the condition of the normal right vas deferens in the female and 5 that of the male; 2, 3, and 4 represent intermediate conditions; 2, wide, straight; 3, slightly convoluted; 4, strongly convoluted. Observations are more difficult to make on the left side on account of accumulations of fat in the mesentery of the oviduct where the

was lies; a question mark in this column indicates only that the observation could not be made owing to fat (*c.g.*, 875, 882, 884, etc.).

Oviduct.—Similarly, a scale of 6 points was adopted for recording variations of the left oviduct. 1, the most reduced type, straight and only 2-3 mm. in diameter; 2, straight, 4 mm. or more in diameter; 3, convoluted, 3-5 mm. in diameter; 4, convoluted, 6-9 mm. in diameter; 5, convoluted, 10+ mm. in greatest diameter; 6, oviduct of a normal laying hen (see Domm, '27*a*, compare plate 8, Fig. 2*b*; plate 9 and 10; also plate 11, no. 729). * Varying portions of oviduct inflated with fluid (see text page 19).

SUMMARY OF BILATERAL OVARIOTOMIES.

Bird No.	Operation age and Date.	Autopsy Date.	Successive Changes in Plumage.						Spurs.		
			3 months.	6 months.	12 months.	18 months.	24 months.	30 months.	Rt.	Lt.	
874	76 d. 9-14-26 9-30-26	Died 4-16-28	Predom. ♂, some Juv. Some old ♀ and ♀ Tp'd. New ♂.	♂ in all areas. New ♂.	♂ in all areas New ♂.	♂ in all areas. New ♂.	♂ in all areas. New ♂.	(19) ♂ in all areas. New ♂.		2.0	1.9
875	76 d. 9-14-26 9-30-26	Died 10-11-28	Predom. ♂. Many Juv. Some old ♀ and ♀ Tp'd. New ♂	♂ in all areas, few scat. old ♀ WC's. New ♂.	♂ in all areas. New ♂.	♂ in all areas. New ♂.	♂ in all areas. New ♂.	(25) ♂ in all areas. New ♂.		1.8	1.9
876	76 d. 9-14-26 9-30-26	Died 11-11-28	Predom. ♂. Many Juv. prim. on Ba. and Sa. Some old ♀ and ♀ Tp'd. New ♂.	♂ in all areas. Some Juv. on Ba. and Sa. few scat. old ♀ WC's. New ♂.	♂ in all areas. New ♂ numer- ous. Molting.	♂ in all areas. New ♂.	♂ in all areas. New ♂.	(26) ♂ in all areas. New ♂.		2.3	2.3
878	76 d. 9-14-26 9-30-26	Died 7-20-27	Predom. ♂, few Juv. on Ba. Sa. and W'S. few old ♀ and ♀ Tp'd. New ♂.	♂ in all areas. New ♂.	(10) ♂ in all areas. New ♂.					1.7	1.7
880	76 d. 9-14-26 9-30-26	Died 11-2-27	Predom. ♂. Many Juv. on Ba. and Sa. few on W'S. few old ♀ and ♀ Tp'd. New ♂.	♂ in all areas. Some old ♀. few I. New ♀.	(8) Predom. ♂. ♀ bec. numerous. few I. New ♀.	(12) Predom. ♂. many ♀. few I. New ♂.	(13½) Predom. ♂. few Scat. ♀ and I. New ♂.			0.5	1.1

Bird No.	Successive Changes in Head Furnishings.										Findings at Autopsy.			
	At Operation.	3 months.	6 months.	12 months.	18 months.	24 months.	30 months.	Rt. Gonad.	Lt. Gonad.	Rt. V.D.	Lt. V.D.	Lt. Ovid.		
874	2.1 1.0 1.1 0.6 0.4	2.6 1.6 1.4 1.4 0.6	3.6 2.0 1.6 2.1 1.1	5.2 2.4 1.6 2.5 1.9	5.2 2.2 1.7 1.9 1.7	(19) 4.8 1.9 1.6 1.7 1.3		None	T. 1.5 0.5		1-2	1-2	1	
875	1.0 1.3 1.1 0.5 0.3	2.5 1.6 1.4 1.1 0.6	2.8 1.5 1.5 1.4 0.5	3.0 1.9 1.5 1.4 0.9	3.0 2.0 1.5 1.3 1.0	(25) 2.8 2.0 1.4 1.1 1.0		None	None		?	?	1	
876	2.1 1.5 1.1 0.6 0.4	2.9 1.9 1.2 1.4 0.6	2.7 1.5 1.3 1.4 0.5	4.3 1.7 1.5 1.6 1.3	4.3 1.9 1.5 1.6 1.3	(26) 4.1 2.1 1.4 1.4 1.1		None	None		1	1	1	
878	2.1 1.3 1.0 0.7 0.4	2.6 1.5 1.5 1.4 0.6	3.7 2.0 1.6 2.3 1.2	(8) 4.5 2.1 1.8 2.8 1.5	(10) 4.2 1.9 1.6 2.4 1.0			None	T. 1.1 0.3		1	1	1 *	
880	2.1 1.3 1.1 0.6 0.1	2.8 1.5 1.6 1.1 0.6	6.9 3.3 2.4 3.0 3.6	(8) 8.9 3.9 2.8 5.1 4.1	(12) 6.8 2.6 2.5 3.0 3.0	(13) 1.2 5.7 2.1 2.3 2.6 2.3		None	T. 1.2 0.3		2	2	1	

Bird No.	Operation age and Date.	Autopsy Date.	Successive Changes in Plumage.						Spurs.	
			3 months.	6 months.	12 months.	18 months.	24 months.	30 months.	Rt.	Lt.
882	78 d. 9-16-26 9-30-26	3-2-29	Predom. ♂. Many Juv. on Ba. and Sa. few on W'S. Some old ♀ and ♀ Tp'd. New ♂.	♂ in all areas. Some Juv. on Ba. and Sa. New ♂.	♂ in all areas. New ♂.	♂ in all areas. New ♂.	(25) ♂ in all areas. New ♂.	(29 1/2) ♂ in all areas. New ♂.	2.0	1.4
884	78 d. 9-16-26 10-6-26	2-8-29	Predom. ♂. Many Juv. on Ba. and Sa. few on W'S. few old ♀ and ♀ Tp'd. New ♂.	♂ in all areas. few Juv. few old ♀ on W'S. New ♂.	♂ in all areas. New ♂.	♂ in all areas. New ♂.	(25) ♂ in all areas. New ♂.	(28 3/4) ♂ in all areas. New ♂.	3.0	3.3
887	78 d. 9-16-26 10-5-26	3-1-29	Predom. ♂. Many Juv. on Ba. and Sa. few on W'S. few old ♀ and ♀ Tp'd. New ♂.	♂ in all areas. few old ♀ on W'S. New ♀.	♂ in all areas. New ♂.	♂ in all areas. New ♂.	(25) ♂ in all areas. New ♂.	(29 1/2) ♂ in all areas. New ♂.	1.0	1.5
888	78 d. 9-16-26 10-5-26	Died 12-6-26	(2 3/4) Predom. ♂. Many Juv. on Ba. Sa. and W'S. Some old ♀. New ♂.						0.2	0.2

Bird No.	Successive Changes in Head Furnishings.								Findings at Autopsy.			
	At Operation.	3 months.	6 months.	12 months.	18 months.	24 months.	30 months.	Rt. Gonad.	Lt. Gonad.	Rt. L.t. V.D.	L.t. L.t. V.D.	L.t. Ovd.
882	2.2 1.0 0.9 0.7	2.9 1.6 1.4 0.7	2.9 1.7 1.5 0.7	3.1 1.8 1.4 0.8	2.9 1.9 1.3 0.8	(25) 3.0 1.9 1.3 1.0	(29 ^{1/2}) 2.9 1.8 1.2 1.0	None	None	1 ?	1	1
884	2.0 1.4 0.7 0.3	2.5 1.5 1.0 0.5	2.7 1.4 1.1 0.4	2.7 1.4 1.1 0.4	2.9 1.4 1.1 0.7	(25) 2.8 1.5 1.0 0.6	(28 ^{3/4}) 2.8 1.5 0.9 0.5	None	None	1 ?	1 *	
887	1.8 1.2 0.7 0.3	2.5 1.6 1.4 0.6	4.6 2.0 2.5 1.3	4.0 1.7 2.1 0.9	4.1 1.8 1.6 1.0	(25) 4.1 1.9 1.7 1.1	(29 ^{1/2}) 4.1 1.7 1.6 1.1	None	None	1 ?	1 *	
888	2.0 1.4 0.8 0.3	(2 ^{3/4}) 2.9 1.8 1.1 0.4						None	None	1 ?	1	1

Bird No.	Operation Age and Date.	Autopsy Date.	Successive Changes in Plumage.						Spurs.	
			3 months.	6 months.	12 months.	18 months.	24 months.	30 months.	Rt.	Lt.
890	78 d. 9-16-26 10-5-26	8-12-27	Predom. ♂, few Juv. on Ba. and W'S. Many old ♀ Some ♀ Tp'd. New ♂.	Predom. ♀. Many scat. ♂. Some I. New ♀.	(8) Predom. ♀. Many Scat. ♂. Some I. New ♀.	(11) approx. 1½ ♂ 1½ ♀. Some I. New Ba. ♂.			0.3	0.3
891	78 d. 9-16-26 10-5-26	3-1-29 †	Pract. all ♂. Many Juv. few scat. old ♀ and ♀ Tp'd. New ♂.	Predom. ♂. Many new ♀. Some I. New ♀.	Approx. 1½ ♂ 1½ ♀. New ♂.	♂ in all areas. New ♂.	(29 1/2) ♂ in all areas. New ♂.		2.7	2.7
893	79 d. 9-17-26 10-5-26	7-23-27	Predom. ♂. Many Juv. on Ba. and Sa. few on W'S. few old ♀ and ♀ Tp'd. New ♂.	Predom. ♂. Some I and new ♀. New ♀.	(10 1/2) Predom. ♂. Many ♀. Some I. New ♀.				1.3	1.3
894	79 d. 9-17-26 10-6-26	5-6-29	Pract. all ♂. Some Juv. on Ba. Sa. and W'S. few old ♀ and ♀ Tp'd. New ♂.	♂ in all areas. Some Juv. on Ba. and Sa. New ♂.	♂ in all areas. New ♂.	♂ in all areas. New ♂.	(31 1/2) Predom. ♀ in all areas. few scat. ♂ and I. New ♀.	(25) Predom. ♂. Many ♀. few I. New ♀.	4.4	Lost

Bird No.	Successive Changes in Head Furnishings.										Findings at Autopsy.			
	At Operation.	3 months.	6 months.	12 months.	18 months.	24 months.	30 months.	Rt. Gonad.	Lt. Gonad.	Rt. V.D.	Lt. V.D.	Lt. Ovd.		
	890	2.1 1.3 0.8 0.3	2.6 1.4 1.2 0.3	7.4 3.2 3.6 3.1	(8) 9.4 4.0 4.3 4.2	(11) 6.8 2.6 2.8 2.8			None (See text p. 8)	None	1	1	3	
891	2.3 1.4 1.0 0.3	3.1 1.7 1.2 1.7 0.5	(7) 9.5 3.7 5.4 3.6	5.1 2.4 2.6 2.2	4.8 2.2 2.3 1.6	(25) 4.6 2.3 2.2 1.8	(29 1/2) 4.5 2.2 1.8 2.2 1.8	† 10-16-27 T. Small Cauterized. 3-1-29 None	None	1	?	1		
893	2.2 1.3 1.1 0.3	2.7 1.6 1.6 0.6	7.7 3.5 5.1 3.4	(8) 9.3 4.3 6.1 4.8	(10 1/4) 5.4 2.3 2.9 2.2			T. 0.6 0.3	T. 0.8 0.2	1	1	3		
894	1.8 1.4 0.5 0.3	2.6 1.8 1.2 0.4	3.0 1.6 1.4 0.4	3.6 1.7 1.4 1.0	5.7 2.3 2.5 1.8	(25) 9.0 3.3 4.3 3.2	(31 1/2) 10.8 3.8 2.3 5.9 3.8	T. 1.5 1.1	T. 0.0 0.0	3	3	4		

Bird No.	Operation age and Date.	Autopsy Date.	Successive Changes in Plumage.						Spurs.	
			3 months.	6 months.	12 months.	18 months.	24 months.	30 months.	Rt.	Lt.
895	79 d. 9-17-26 10-6-26	3-1-29	Pract. all ♂. Many Juv. on Ba. and Sa. few on W'S. few old ♀ and ♀ Tp'd. New ♂.	♂ in all areas. Some Juv. on Ba. and Sa. New ♂.	♂ in all areas. New ♂.	♂ in all areas. New ♂.	(25) ♂ in all areas. New ♂.	(29 1/2) ♂ in all areas. New ♂.	3.0	3.0
897	79 d. 9-17-26 10-5-26	9-29-27	Pract. all ♂. Many Juv. on Ba. and Sa. few on W'S. Some old ♀ WC'S. New ♂.	♂ in all areas. exc. few old ♀ WC'S. New ♂.	(12 1/2) ♂ in all areas. New ♂.				1.4	1.2
898	79 d. 9-17-26 10-5-26	Died 6-7-27 Cb.	Pract. all ♂. Many Juv. on Ba. and Sa. few on W'S. few old ♀ and ♀ Tp'd. New ♂.	♂ in all areas. exc. few old ♀ Tp'd. WC'S. New ♂.	(8 1/2) ♂ in all areas. New ♂.				1.6	1.6
899	79 d. 9-17-26 10-6-26	2-24-27	Pract. all ♂. Many Juv. on Ba. Sa. and W'S. few old ♀ and ♀ Tp'd. New ♂.	(5 1/4) ♂ in all areas. Many Juv. few old ♀ WC'S. New ♂.					0.6	0.6

Bird No.	Successive Changes in Head Furnishings.								Findings at Autopsy.				
	At Operation.	3 months.	6 months.	12 months.	18 months.	24 months.	30 months.	Rt. Gonad.	Lt. Gonad.	Rt. Lt. V.D.	Lt. Lt. V.D.	Ovd.	
895	2.0 1.4 ----- 0.7 0.3	2.6 1.6 ----- 1.4 0.6	3.1 2.0 ----- 1.6 0.5	3.3 2.0 ----- 1.5 0.8	3.4 2.0 ----- 1.3 1.0	3.5 2.0 ----- 1.3 1.2	(29) 1.2 3.5 2.0 ----- 1.3 1.1	None	None	1	1	1	
897	2.1 1.2 ----- 0.9 0.4	2.8 1.4 ----- 1.2 0.6	3.2 1.6 ----- 1.5 0.7	(9) 3.2 1.6 ----- 1.6 1.0	(12) 1.2 3.2 1.6 ----- 1.7 0.8	3.2 1.6 ----- 1.3		None	None	1	1	1	
898	1.9 1.2 ----- 0.7 0.3	2.6 1.6 ----- 1.3 0.7	8.1 2.4 ----- 3.2 1.8	(8) 1.2 5.2 2.1 ----- 2.4 1.4				T. 0.3 ----- 0.2	T. 1.0 ----- 0.2 +		3	3	1
899	2.0 1.1 ----- 0.9 0.2	2.7 1.4 ----- 1.1 0.3	(5) 1.4 2.5 1.2 ----- 1.2 0.2					None	None	1	1	1	*

Bird No.	Operator age and Date.	Autopsy Date.	Successive Changes in Plumage.						Spurs.		
			3 months.	6 months.	12 months.	18 months.	24 months.	30 months.	Rt.	Lt.	
902	79 d. 9-17-26 10-5-26	Died 7-4-27	Predom. ♂. Many Juv. on Ba. and Sa. few on W'S. Some old ♀ and ♀ Tp'd. New ♂.	Predom. ♂. few Juv. few old ♀ WC'S. New ♂.	(9 1/2) ♂ in all areas. New ♂.					0.5	0.5
903	79 d. 9-17-26 10-6-26	6-3-27	Predom. ♂. Many Juv. on Ba. and Sa. few on W'S. Some old ♀ and ♀ Tp'd. New ♂.	Predom. ♂. Some Juv. on Ba. Sa. and W'S. few old ♀ WC'S. New ♂.	(8 1/2) ♂ in all areas. Some Juv. on Sa. and W'S. New ♂.					1.1	1.1

Bird No.	Successive Changes in Head Furnishings.										Findings at Autopsy.				
	At Operation.	3 months.	6 months.	12 months.	18 months.	24 months.	30 months.	Rt. Gonad.	Lt. Gonad.	Rt. V.D.	Lt. V.D.	Lt. Ovd.			
902	1.9 1.2 0.7 1.2 1.1 0.3	2.5 1.7 1.2 0.3 1.4	2.8 1.4 1.7 0.3 1.6	(9) ¹ / ₂ 2.9 1.6 1.5 1.7 0.3				None	None	1	1	1	*		
903	2.0 1.1 0.8 0.2 1.1 0.2	2.4 1.3 1.1 0.3 1.3	2.7 1.4 1.2 0.3 1.3	(8) ¹ / ₂ 2.8 1.4 1.3 0.3				None	None	1	1	1	1		

LITERATURE CITED.

Benoit, Jacques.

- '23 A propos du changement expérimental de sexe par ovariectomie chez la Poule. C. R. Soc. Biol., T. 89, pp. 1326-1328.

Burns, R. K. Jr.

- '25 The Sex of Parabioc Twins in Amphibia. Jour. Exp. Zoöl., Vol. 42, pp. 31-89.
- '27 Some Results of the Transplantation of Larval Gonads in Urodele Amphibians. Anat. Rec., Vol. 37, p. 163.

Crew, F. A. E.

- '23 Studies in Intersexuality. II. Sex Reversal in the Fowl. Proc. Roy. Soc. B., Vol. 95, pp. 256-278.

Dommm, L. V.

- '27a New Experiments on Ovariectomy and the Problem of Sex Inversion in the Fowl. Jour. Exp. Zoöl., Vol. 48, No. 1, pp. 31-173.
- '27b Observations on Female Fowl Rendered Completely Sexless. Anat. Rec., Vol. 37, No. 2, p. 142.
- '27c Autoplastic Testis Grafts in the Leghorn Fowl. Anat. Rec., Vol. 37, No. 2, p. 143.
- '28 The Effects of Early Ovariectomy in the Brown Leghorn Fowl. Anat. Rec., Vol. 41, No. 1, p. 27.
- '29 Spermatogenesis Following Early Ovariectomy in the Brown Leghorn Fowl. Proc. Soc. Exp. Biol. and Med., Vol. 26, No. 4, p. 338.

Dommm, L. V., and Juhn, Mary.

- '27 Compensatory Hypertrophy of the Testes in Brown Leghorns. BIOL. BULL., Vol. 52, No. 6, pp. 458-473.

Finlay, G. F.

- '25 Studies on Sex Differentiation in Fowls. Brit. Jour. Exp. Biol., Vol. 2, pp. 439-468.

Goodale, H. D.

- '16 Gonadectomy in Relation to the Secondary Sexual Characters of Some Domestic Birds. Carnegie Inst. Wash., Publ. No. 243.

Greenwood, A. W.

- '25 Gonad Grafts in Embryonic Chicks and their Relation to Sexual Differentiation. Brit. Jour. Exp. Biol., Vol. 2, pp. 165-188.

Greenwood, A. W., and Crew, F. A. E.

- '26 Studies on the Relation of Gonadic Structure to Plumage Characterisation in the Domestic Fowl. I. Henny Feathering in an Ovariectomized Hen with Active Testis Grafts. Proc. Roy. Soc. B., Vol. 99, pp. 232-241.

Humphrey, R. R.

- '27 The Specificity of the Sexual Organization in the Preprimordium of the Gonad in *Amblystoma* as Shown by Transplantation of the Intermediate Mesoderm. Anat. Rec., Vol. 37, pp. 165-166.

Juhn, Mary, and Mitchell, James B., Jr.

- '29 On Endocrine Weights in Brown Leghorns. *Am. Jour. Physiol.*, Vol. 88, No. 1, pp. 177-182.

Kemp, Tage.

- '25 Recherches sur le rapport entre les caractères sexuels et les hormones des glandes génitales chez les embryons de poulet. *C. R. Soc. Biol.*, T. 92, p. 1318.
- '27 Studier over kønskarakterer hos fostre (with an English summary). København.

Lillie, Frank R.

- '17 The Free-martin; a Study of the Action of Sex-hormones in the Foetal Life of Cattle. *Jour. Exp. Zoöl.*, Vol. 23, pp. 371-452.
- '23 Supplementary Notes on Twins in Cattle. *Biol. Bull.*, Vol. 44, pp. 47-78.
- '27 The Present Status of the Problem of 'Sex-inversion' in the Hen. Comments on Doctor Domm's paper. *Jour. Exp. Zoöl.*, Vol. 48, pp. 175-196.

Lipschutz, Alexander.

- '24 The Internal Secretions of the Sex Glands. Cambridge, Eng., W. Heffer & Sons, Ltd., and Baltimore, Williams & Wilkins Co.

Moore, C. R.

- '26 On the Properties of the Gonads as Controllers of Somatic and Psychological Characteristics. IX. Testis Graft Reactions in Different Environments (rat). *Am. Jour. Anat.*, Vol. 37, pp. 351-416.

Morgan, T. H.

- '19 The Genetic and Operative Evidence Relating to Secondary Sexual Characters. Carnegie Inst. Wash., publ. No. 285.

Pezard, A.

- '18 Le conditionnement physiologique des caractères sexuels secondaires chez les Oiseaux. *Bull. Sc. France et Belgium*, T. 52, pp. 1-176.

Willier, B. H.

- '27 The Specificity of Sex, of Organization and of Differentiation of Embryonic Chick Gonads as Shown by Grafting Experiments. *Jour. Exp. Zoöl.*, Vol. 46, pp. 409-465.

Willier, B. H., and Yuh, Eliot C.

- '28 The Problem of Sex Differentiation in the Chick Embryo with Reference to the Effects of Gonad and Non-gonad Grafts. *Jour. Exp. Zoöl.*, Vol. 52, No. 1, pp. 65-125.

Witschi, E.

- '27a Sex-reversal in Parabioc Twins of the American Wood-frog. *BIOL. BULL.*, Vol. 52, pp. 137-146.
- '27b Testis Grafting in Tadpoles of *Rana temporaria* L., and its Bearing on the Hormone Theory of Sex Determination. *Jour. Exp. Zoöl.*, Vol. 47, pp. 269-294.
- '29 Studies on Sex Differentiation and Sex Determination in Amphibians. II. Sex Reversal in Female Tadpoles of *Rana*

Sylvatica following the application of high temperature. Jour. Exp. Zool., Vol. 52, pp. 267-291.

Zawadowsky, M.

- '22 Das Geschlecht und die Entwicklung der Geschlechtsmerkmale. Moscow.
- '26 Bisexual Nature of the Hen and Experimental Hermaphroditism in Hens. Trans. Lab. Exp. Biol., Zoopark, Moscow, Vol. 2, pp. 164-179.

PLATE I.

Explanation of Figures.

No. 1018. Poulard *Sinistrally ovariectomized*. This bird was hatched on May 9, 1927, and sinistrally ovariectomized on May 22, 1927, when 13 days old. This photograph was taken on May 22, 1929, 2 years following the operation. The bird at this time was completely male plumaged, showed well developed masculine head furnishings and long spurs. The new in-growing feathers at this time were intermediate heralding the inevitable change to female plumage which apparently all these birds ultimately undergo.

No. 845. Poulard *Sinistrally ovariectomized*. This bird was hatched on June 16, 1926 and sinistrally ovariectomized on August 11, 1926, when 56 days old. This photograph was taken on May 22, 1929, approximately two years and nine months following the operation. The bird at this time was completely female plumaged though it showed prominent masculine head furnishings, spurs, and behavior. The definitive condition thus is one in which the sinistrally ovariectomized fowl becomes female plumaged while she retains her other acquired male characters. Complete dextral ovariectomy in such a bird brings about the re-assumption of male plumage and a loss of the dependent sexual characters leading to the asexual capon type (see Domm, '27a). (Compare bird no. 876, Plate 2.)

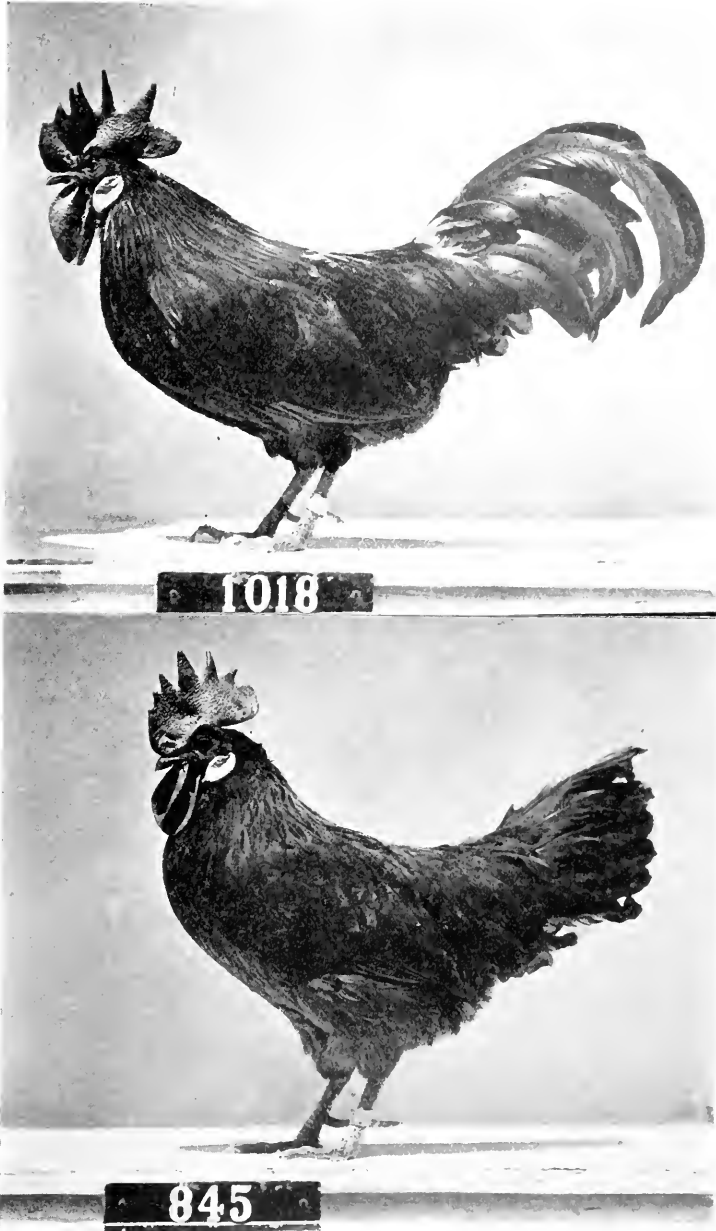
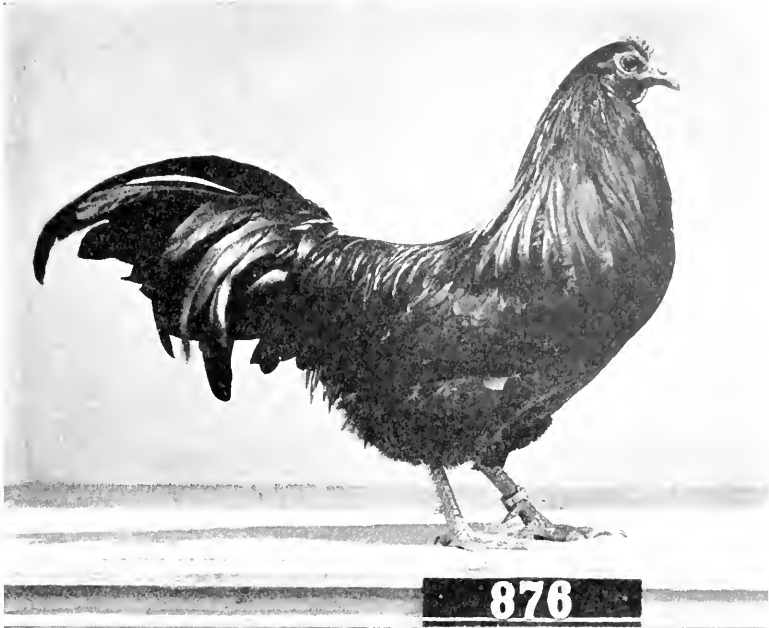

PLATE II.

Explanation of Figures.

No. 876. Poulard *bilaterally ovariectomized*. For detailed history see table. This bird was hatched on June 30, 1926. A sinistral ovariectomy was performed on September 14, 1926, when the bird was 76 days old and 16 days later on September 30, a dextral operation was performed destroying the right rudimentary gonad by electric cauterization. This photograph was taken on June 11, 1928, 1 year and 9 months following the operation. Its appearance was typically capon showing luxuriant male plumage, small head furnishings, well developed spurs, and neutral behavior (compare bird no. 608 this plate). The bird retained these characters up to the time of its death on November 11, 1928. Post-mortem examination revealed no gonad tissues on either right or left gonad sites.

No. 608. Capon. This bird was hatched on April 15, 1927. Its left testis was removed on May 7, 1927, when 22 days old; the right testis on June 9, 1927, 33 days later. This photograph was taken on May 22, 1929. The bird was killed on May 24, 1929, post-mortem examination revealed no gonad tissue. The bird had been a typical capon during the entire period it was under observation showing luxuriant male plumage, small head furnishings, well developed spurs, and neutral behavior.



6983 080





MBL/WHOI LIBRARY



WH 1718 /

