

QL
1
,B716
NH

BONNER ZOOLOGISCHE MONOGRAPHIEN

Nr. **54**
2007

Herausgeber: Zoologisches Forschungsmuseum Alexander Koenig, Bonn

Andrei Y. Utevsky

ANTARCTIC PISCICOLID LEECHES

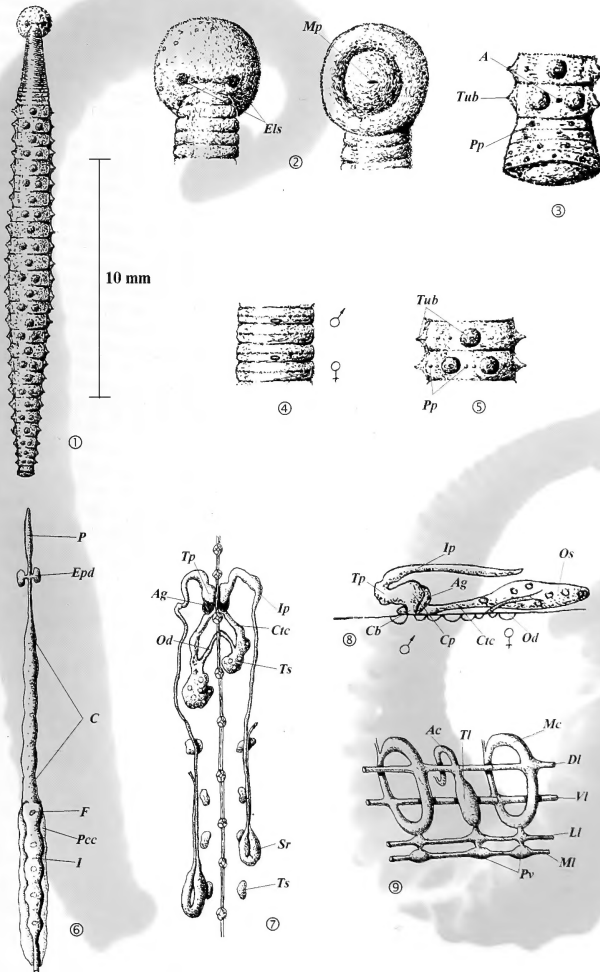

BONNER ZOOLOGISCHE MONOGRAPHIEN

Schriftleitung / Editor

Karl-L. Schuchmann

Zoologisches Forschungsmuseum Alexander Koenig (ZFMK)

Ornithologie

Adenauerallee 160

D-53113 Bonn, Germany

Email: kl.schuchmann.zfmk@uni-bonn.de

Die Reihe BONNER ZOOLOGISCHE MONOGRAPHIEN (BZM) erscheint seit 1971 in regelmäßiger Folge. Publiziert werden Originalbeiträge in englischer Sprache. Die BZM nehmen vor allem solche Arbeiten auf, die zu umfangreich sind, um in der Zeitschrift BONNER ZOOLOGISCHE BEITRÄGE zu erscheinen. Schwerpunkte der BZM sind: Systematik, Taxonomie, Biogeographie, Anatomie und Evolutionsbiologie. Alle eingereichten Manuskripte werden begutachtet. Autoren werden gebeten, sich vor Manuskriptvorlage mit dem Schriftleiter in Verbindung zu setzen.

Erwerb der BZM: Bibliothek, Zoologisches Forschungsmuseum Alexander Koenig (ZFMK), Adenauerallee 160, D-53113 Bonn, Germany.

The peer-reviewed series BONNER ZOOLOGISCHE MONOGRAPHIEN (BZM) has existed since 1971. The BZM consist of original zoology papers too long for inclusion in our institute's journal BONNER ZOOLOGISCHE BEITRÄGE. Preferred manuscript topics are: systematics, taxonomy, biogeography, anatomy, and evolutionary biology. Manuscripts must be in American English. Authors are requested to contact the editor prior to manuscript submittal.

The BZM may be obtained from: The Library, A. Koenig – Zoological Research Institute and Museum of Zoology, Adenauerallee 160, D-53113 Bonn, Germany.

Author of this issue: Andrei Y. Utevsky

Published: November 2007

Bonner zoologische Monographien Nr. 54, 80 pp.

Editorial assistants of this issue: Angela Schmitz Ornés, Brian Hillcoat

Cover: *Moorebdellina biannulata*, external and internal structure. A. Y. Utevsky.

Price: EUR 36,-



Andrei Y. Utevsy

ANTARCTIC PISCICOLID LEECHES

CONTENTS

Abstract	5
Acknowledgments	6
Glossary of special terms	7
1. Introduction	9
2. History of the study of Antarctic leeches	10
3. Morphology and anatomy of piscicolid leeches	12
Proportions of the body	12
Suckers	12
Trachelosome	12
Urosome	12
Digestive system	15
Reproductive system	15
Male reproductive system	15
Female reproductive system	15
Coelomic system	16
4. Biology of piscicolid leeches	22
5. Collection and preservation	26
6. Systematic part	27
Classification of the Family Piscicolidae	27
Key to the Subfamilies of the Family Piscicolidae	28
“Subfamily Pontobdellinae”	28
Key to the Antarctic Genera of the “Subfamily Pontobdellinae”	28
Genus <i>Pontobdella</i>	28
Genus <i>Moorebdellina</i>	30
Genus <i>Megaliobdella</i>	39
“Subfamily Platybdellinae”	40
Key to the Antarctic Genera of the “Subfamily Platybdellinae”	40
Genus <i>Epsteinia</i>	41
Genus <i>Austrobdella</i>	42
Genus <i>Pleurobdella</i>	46
Genus <i>Glyptonorobdella</i>	49
Genus <i>Cryobdella</i>	52
“Subfamily Piscicolinae”	60
Key to the Antarctic Genera of the “Subfamily Piscicolinae”	60
Genus <i>Trachelobdellina</i>	60
Genus <i>Trulliobdella</i>	63
Genus <i>Galarbeabdella</i>	69
Genus <i>Trachelobdella</i>	72
Genus <i>Nototheniobdella</i>	75
7. References	77
8. Index	79

ABSTRACT

Fish leeches (Piscicolidae) occur in continental fresh waters and in marine habitats. Some members of the family are restricted to the southern ocean only and have not been recorded from other parts of the world. This monograph is focused on this group of annelids to summarize the existing knowledge of Antarctic leeches. At present 21 species belonging to 13 genera and 3 "subfamilies" have been recorded from the Antarctic Seas. Most of them were characterized and illustrated using a uniform standard, which, in particular, includes the map of geographical distribution and a photograph. Based on the detailed descriptions, identification keys were composed. Host data were summarized in the list of all known hosts and tables with infestation rates.

Key words: Antarctica, Hirudinea, Piscicolidae, *Pontobdella*, *Moorebdellina*, *Megaliobdella*, *Epsteinia*, *Austrobdella*, *Pleurobdella*, *Glyptonotobdella*, *Cryobdella*, *Trachelobdellina*, *Trulliobdella*, *Galatheabdella*, *Trachelobdella*, *Nototheniobdella*, identification key.

ACKNOWLEDGMENTS

I could not have written this monograph without the help of my colleagues and friends. My interest in leeches is due to V. M. Epshtein, the advisor of my PhD research. I am grateful to many zoologists and parasitologists who collected and sent specimens of Antarctic leeches to me. They include A. F. Pushkin, A. B. Neelov, I. S. Smirnov, E. N. Gruzov, S. Potin, B. I. Sirenko (Zoological Institute, St. Petersburg, Russia), V. V. Avdeev (Pacific Research Institute of Fisheries and Oceanography, Vladivostok, Russia), A. A. Kovaleva, G. N. Rodiuk (Atlantic Pacific Research Institute of Fisheries and Oceanography, Kaliningrad, Russia), V. N. Ljadov (Research Institute of Biology of Southern Seas, Sevastopol, Ukraine). H. H. Janssen gave me a specimen of *Glyptotobdella antarctica* and his informative letters helped me in understanding the biology of Antarctic leeches. Stephano Chiaparelly (University of Genoa, Italy) gave me a very rich collection of Antarctic leeches with unique specimens of *Megaliobdella szidati*. I am very grateful to those who have given permission to reproduce copyright material: R. T. Sawyer (Biopharm (UK) Ltd.), E. M. Burreson (Virginia Institute of Marine Science, Gloucester Point, USA) and American Geophysical Union through Michael Connolly. Special thanks go to V. V. Murina (Research Institute of Biology of Southern Seas, Sevastopol, Ukraine) and A. V. Korniushev (Schmalhausen Institute of Zoology, Kyiv, Ukraine) for useful criticisms and a good piece of advice. I am extremely grateful to V. M. Nazarov, former Head of the Department of Zoology and Animal Ecology, V. N. Karazin Kharkiv National University, Kharkiv, for his support in writing this book. My brother, Serge Utevsky (Department of Zoology and Animal Ecology, V. N. Karazin Kharkiv National University, Kharkiv, Ukraine), an expert in Arctic leeches, my wife Olga Utevskaia (Department of Genetics and Cytology, V. N. Karazin Kharkiv National University, Kharkiv, Ukraine) read drafts of the text and provided valuable criticisms.

My mother, Lidiya Utevskaia, my son, Yuriy, gave me the freedom and peace of mind to spend long hours in front of journals and computer screens.

This research was supported in part by the National Antarctic Scientific Center of Ministry of Education and Science of Ukraine and the Society for Underwater Activity (Kharkiv, Ukraine).

GLOSSARY OF SPECIAL TERMS

- Accessory connection [Ac]:** transverse coelomic channel connecting the testicular lacunae with the dorsal and/or ventral lacunae
- Accessory glands [Ag]:** glandular cells covering the external surface of posterior parts of the male reproductive system
- Body [B]:** the trachelosome and urosome without suckers
- Clitellum [Cl]:** a posterior part of the trachelosome with gonopores on the ventral surface
- Conductive tissue [Ct]:** a part of the female reproductive system serving for storing and passing spermatozooids to ovisacs; present in form of a mass [Ctm] and/or cord a [Ctc]
- Copulatory area [Ca]:** external or internal, the modified ventral surface of the clitellum around one or both gonopores, or modified internal surface of the copulatory bursa
- Copulatory bursa [Cb]:** a nonpaired terminal part of the male reproductive system terminating at the male gonopore
- Crop [C]:** a part of the digestive system in the testicular region of the urosome
- Crop chambers [Cc]:** dilations of the crop between testisacs
- Crop region [Cr]:** a part of the urosome possessing the crop
- Dorsal lacuna [DI]:** a longitudinal coelomic channel possessing the dorsal vessel [Dv]
- Ejaculatory ducts (atrium) [Ed]:** parts of the male reproductive system between seminal reservoirs and the copulatory bursa including paired initial [Ip], and terminal [Tp] parts, and nonpaired common part [Cp]
- Esophageal diverticula [Epd]:** lateral dilation of the esophagus
- Esophagus [Ep]:** part of the digestive system located between proboscis and crop
- Eye-like spots [Els]:** light-sensitive pigmented areas on the dorsal surface of the anterior sucker
- Eye [E]:** several integrated optic cells in pigment cup forming small symmetrical pigment zones on the dorsal surface of the anterior sucker and first annuli of the trachelosome
- Intestine [I]:** a part of the digestive system extending from the Crop to the Anus [A]
- Intestinal region [Ir]:** a part of the urosome possessing the intestine, the rectum and posterior crop caeca
- Lateral lacunae [LI]:** paired longitudinal coelomic channels located under the muscular layer on both sides of the body
- Lateral processes [Lp]:** lateral dilations of the crop, intestinal chambers and posterior crop caeca
- Main connection [Mc]:** a part of the coelomic system in the ganglion region [Gr] of somite
- Marginal flanges [Mf]:** external laterally located fin-like folds
- Marginal lacunae [MI]:** paired longitudinal subepidermal coelomic channels on both sides of the body
- Mouth-pore [Mp]:** aperture through which the proboscis everts
- Ocelli [O]:** small pigment cells on the dorsal surface of suckers, and the dorsum and the venter of the body
- Oviducts [Od]:** parts of the female reproductive system communicating ovisacs with the vagina
- Ovisacs [Os]:** specialized part of the coelomic system with oogenic tissue
- Papillae [Pp]:** small tubercles on the dorsal surface of the anterior sucker and the body
- Posterior crop caeca (last crop diverticula) [Pcc]:** elongated processes of the 6th crop chamber number directing posteriorly
- Preclitellum [Pc]:** first 3 somites of the trachelosome between the anterior sucker and the clitellum region
- Proboscis [P]:** an initial muscular part of the digestive system everting through the mouth-pore
- Pulsatile vesicles [Pv]:** segmental subepidermal muscular coelomic dilations on both sides of the body
- Rectal dilation [Rd]:** a dilation of the terminal part of the intestine (rectum [R])
- Seminal reservoirs (epididymis) [Sr]:** paired parts of the male reproductive system communicating vasa deferentia and initial parts of ejaculatory ducts
- Sucker (anterior [As], posterior [Ps]):** muscular discs formed by some fused somites
- Tentacles [T]:** large projections on the dorsal surface of the anterior sucker

Testicular lacuna [Tl]: part of the coelomic system surrounding testisacs

Testisacs [Ts]: isolated parts of the coelom filled by spermatogenic tissue, indicated the testicular region [Tr] of somite

Trachelosome [T]: first 6 somites of the body including preclitellar and clitellar regions of the body

Tubercles [Tub]: projections on the dorsal surface of the suckers and on the body

Urosome [U]: a part of the body between the trachelosome and the posterior sucker

Vagina [V]: a nonpaired structure of the female reproductive system communicating with oviducts and opening by the gonopore on the ventral surface of the clitellum

Vasa deferentia [Vd]: a pair channel connecting a vasa efferentia with a seminal reservoir (a part of the male reproductive system)

Vasa efferentia [Ve]: a channel connecting each testisac with a vasa deferentia (a part of the male reproductive system)

Ventral lacuna [Vl]: a longitudinal coelomic channel possessing the nerve cord [Nc] and the ventral vessel [Vv]

1. INTRODUCTION

Leeches are fascinating animals, which are the most specialized annelids. Characteristic features of leeches are determined by the transition of their ancestors to temporary external parasitism on large animals. Although they are all popularly considered to be bloodsuckers, a large number of leeches are not parasitic.

Leeches of the Antarctic Seas are restricted to the family Piscicolidae, the order Rhynchobdellida. Marine piscicolid leeches are ectoparasitic on fishes and very few species presumably parasitize on crustaceans and pycnogonids. The Antarctic Seas harbor the diverse and relatively well known fauna of leeches ex-

plored by the outstanding zoologists: C. Badham, A. Brinkmann, E.M. Burreson, R. Dollfus, V.M. Epstein, W.A. Harding, M.C. Meyer, J.P. Moore, L.R. Richardson, R.T. Sawyer, and L. Szidat.

However, Antarctic piscicolids need further consideration. Their biology, taxonomy and phylogenetic relationships have not been adequately studied. Until the present time there has not been any detailed monograph on known representatives of the Antarctic leech fauna. We hope that the review of present knowledge of Antarctic leeches will be of value to marine zoologist and parasitologists and it will be favourable for progress in hirudinology (bdellology).

2. HISTORY OF THE STUDY OF ANTARCTIC LEECHES

The first information on Antarctic fish leeches is due to W.A. Harding who published in 1922 a short paper based on an examination of leeches collected by the *Terra Nova* Expedition in 1911 (Harding 1922). All the leeches caught in the coastal waters of Victoria Land were found to belong to a new species. The author assigned this species to a new genus and named it *Cryobdella levigata*. However, as early as 1916 C. Badham described the leech *Austrobdella translucens* which was found in fish-farming ponds and off the Southeast coast of Australia (Badham 1916). Subsequently, the British-Australian-New Zealand Expedition (BANZARE) found these leeches in the vicinity of Kerguelen Island and in Antarctic coastal waters in 1930 (Moore 1957).

In 1938 J.P. Moore published information on collections of the Australasian Antarctic Expedition by *Aurora* (1911–1914). Sir Douglas Mawson, the supervisor of the Expedition, passed on the materials collected in Antarctic coastal waters, in the Durville Sea and Davis Sea to J.P. Moore. Two new species, *Pontobdella rugosa* and *Oxytonostoma varituberculata*, were found in the collections (Moore 1938). Moore's descriptions lack information on the digestive and reproductive systems of these leeches. The author noted that it was necessary to verify their taxonomic status because members of the genus *Pontobdella* Leach, 1815 occur in the tropics while *Oxytonostoma* Malm, 1863 is restricted to the North Atlantic and Arctic. In addition, the collections involved several specimens of *C. levigata* Harding, 1922 from the Davis Sea. Moore commented on the problem of its taxonomic status and assigned this species to the genus *Platybdella* Malm, 1863.

Leeches collected by the Norwegian Antarctic Expedition (Norway, 1927–1928) were not examined by K. Brinkmann until 1948. He described two new species and genera, *Trulliobdella capitata* and *Cryobdellina bacilliformis* (Brinkmann 1948). The author provided rather adequate descriptions of external and internal characters, but committed a number of errors, resulting in confusion about these species and some others.

Leeches collected by the British-Australian-New Zealand Expedition (BANZARE) in the Risser Larsen Sea and Commonwealth Sea and given by Sir D. Mawson and J. Harvey Johnson to J.P. Moore were described in 1957 as *Pontobdella biannulata* and *Tra-*

chelobdellina glabra (Moore 1957). These descriptions lack information on the digestive, reproductive, and coelomic systems. A short description lacking figures of internal characters of *T. glabra* was provided by M.C. Meyer and E.M. Bureson (1990).

In 1964 R. Dollfus described a new species assigned to a new genus, *Antarctobdella tcherniai* (Dollfus 1964/1965). The leech was collected by Paul Tchernia during the Commandant Charcot Expedition in the vicinity of Heard Island in 1950. In 1965 L. Szidat described a new species, *Ophthalmobdella bellisioi* from the region of the South Shetland Islands (Szidat 1965).

R.T. Sawyer described two new species and one new genus: *Glyptonotobdella antarctica* collected on isopods in the vicinity of the South Orkneys Islands in 1966 (Sawyer & White 1969) and *Antarctobdella crozetensis* collected in the vicinity of Marion Island in 1962 (Sawyer 1972).

Owing to the Soviet Antarctic Expeditions of USSR (SAE), which have been regular since 1955, V.M. Epshtein described 4 new species and one new genus of leeches:

Cryobdella antarctica collected near Mirnyi Station in 1956 (Epshtein 1970b);

Prerobdellina australis collected by the 3rd SAE on diesel-electric ship Ob', in coastal waters of Argentina (Epshtein 1970a) and by the Evrika 22nd expedition in 1987 near the South Orkney Islands;

Trulliobdella alba collected by the 8th SAE on diesel-electric ship Ob' in 1963 (Epshtein 1970b);

Moorebdellina uschakovi collected by the *Skiff III* Expedition in 1970 (Epshtein 1974).

Since 1970 researchers have concentrated their attention not only on descriptions of new species, but also on general systematic problems. Epshtein established the subfamily Platybdellinae, considered patterns of the distribution of the subfamilies and revised the taxonomic status of a number of species: *Pontobdella rugosa* Moore, 1938 (Epshtein 1972) and *Pontobdella biannulata* Moore, 1957 (Epshtein & Okun' 1991) were assigned to the genus *Moorebdellina* Epshtein, 1972.

Sawyer (1986) revised the world fauna of Hirudinea, including Antarctic fish leeches, in his three-volume monograph. He shares Epshtein's system of the subfamilies but provisionally included *Cryobdella antarctica* in the genus *Glyptonotobdella*, proposed

to consider species of the genera *Trulliobdella*, *Cryobdellina*, *Antarctobdella*, *Ophthalmobdella* as synonyms of *Trulliobdella capitata* and *Moorebdellina uschakovi* as a synonym of *Moorebdellina rugosa*. Meyer and Burreson's revision of 1990 is based on an examination of the material collected by the Australian National Antarctic Research Expedition to Heard Island (1949–1950), Melbourne (ANARE); Virginia Institute of Marine Science (1959–1967), Gloucester Point, Virginia (VIMS); USNS *Eltanin* cruises (1962–1968), R/V *Hero* cruises (1968–1982) and *Islands Orcadas* supported by the National Science Foundation of U.S. and Argentine Navy; German Antarctic Expedition (1977–1978), Hamburg (GAE) (Meyer & Burreson 1990). The authors proposed new synonyms for Antarctic leeches; described two new species *Trachelobdella bathyrax* from the S. Shetland Islands, *Megaliobdella szidati* from the Ross Sea and a new genus *Megaliobdella*; reported on new distribution records for species previously unknown in Antarctic Seas (*Galatheabdella bruuni* Richardson & Meyer, 1973; *Pontobdella tasmanica* Hickman, 1947)

and provided new information on the distribution of other Antarctic species.

A detailed study of external, internal characters, and of coelomic system in particular, in the majority of fish leeches recorded from the Antarctic Seas, as well as a description of 4 new species (*Nototheniobdella sawyeri*, A. Utevsky, 1993; *Cryobdella ljadovi* Epstein & A. Utevsky, 1994; *Cryobdella pallida* A. Utevsky, 1996; *Moorebdellina meyeri*, 1997) led the author to undertake a new revision and write this book.

Recent phylogenetic analyses have revealed the paraphyletic and/or polyphyletic nature of the traditional piscicolid subfamilies. According to principles of the phylogenetic systematics the subfamilies Pontobdellinae, Platybdellinae, and Piscicolinae are unnatural groupings with no formal status (Williams & Burreson 2006, Utevsky *et al.* 2007). However we still employ the traditional system (Utevsky 2005) because of its practical usefulness. The system seems quite morphologically grounded and convenient to purposes of identifying fish leeches by non-experts in the field.

3. MORPHOLOGY AND ANATOMY OF PISCICOLID LEECHES

The piscicolid leeches (Hirudinea: Piscicolidae) differ from other leeches by their suckers which are usually clearly marked off from the body. The anterior sucker consists of the fused prostomium and 5 somites. The body is divided into two distinct regions (Fig. 1 A). The short anterior portion is called the trachelosome. The longer and wider posterior portion is called the urosome. The trachelosome involves the preclitellum and clitellum, each consisting of 3 somites (6–11). The urosome is subdivided into the crop region (7 somites, 12–18) and intestinal region (8 somites, 19–26). The posterior sucker is made up of 7 fused somites (27–33).

Other features, which define leeches, concern detailed characters of the body and internal organs. The body and suckers may be described by a model of body shape. This model simulates the body as the horizontal and vertical projections of the system of 6 trapezoids: trachelosome as 2 trapezoids, urosome as 4 trapezoids; and suckers as ellipses (Fig. 1 B). The first trapezoid usually lies between the site of attachment of the anterior sucker and the male gonopore. The second trapezoid usually extends from the male gonopore to the urosome. The first trapezoid of the urosome usually extends from the bound of the trachelosome and urosome to the level of the first pair of testisacs (to the second pair if the first pair are absent), the second trapezoid includes the rest of the crop region, the third trapezoid includes the urosome from the boundary of the crop and intestinal region to the site of termination of the posterior crop caeca or beginning of the rectal dilation, and fourth trapezoid extends to the site of attachment of the posterior sucker.

Proportions of the body

According to the body model of leeches (Fig. 1 B) may be:

cylindrical ($D/N \approx 1$) or subcylindrical ($1 < (D/N) < 1.5$) (round or ellipse transverse sections); narrow, long ($7 < (L/D_2 \leq 17)$) or short ($L/D_2^a \approx 7$);

subcylindrical ($1 < (D/N) < 1.5$) or flattened ($1.5 < (D/N) \leq 5$); short and wide ($3 \leq (L/D_2) < 7$).

By length, leeches can be classified into:

small – up to 20 mm;

not large – 21 – 30 mm;

medium – 31– 60 mm;

large – more than 60 mm (very large – more than 100 mm).

Suckers

1. Size of the anterior and posterior suckers: large $C'/D_2 > 1$; medium $C'/D_2 \approx 1$; small $C'/D_2 < 1$.

2. Mode of attachment to the trachelosome or urosome: centrally ($R/M \approx 1$); eccentrically ($R/M > 1$).

The posterior suckers may face ventrally (Fig. 4 A, B) or directly posteriorly (Fig. 4, C, D).

3. Characters of dorsal surface.

The dorsal surface of anterior and posterior suckers may be smooth (Figs. 2 A, 4 D), with transverse furrows or may bear small tubercles, papillae or tentacles. The edge of the anterior sucker may be rough (Fig. 2 B), its dorsal surface may possess eyes, eye-like spots, ocelli (Fig. 3) or a number of papillae. The posterior sucker may possess a number of ocelli near the edge (Fig. 4 C).

4. Location of the mouth-pore.

Mouth-pore centrally located (Fig. 5 A), or lies prior to the centre (Fig. 5 B) or at the anterior margin of the sucker (Fig. 5 C).

Trachelosome

The trachelosome like the urosome may be smooth or bear small and/or large tubercles and papillae, and marginal flanges.

Some first annuli of the trachelosome may possess eyes or ocelli. A more important feature of the trachelosome is the structure of the clitellum. The clitellum may be marked by deeper furrows or larger annuli. Annuli of the clitellum may differ from preclitellar annuli in their surface. It bears male and female gonopores, which may be surrounded by the external copulatory area. In different leeches, gonopores are separated by a species-specific number of annuli. The structure of the copulatory area is also an important character. The copulatory area usually surrounds the female gonopore or is situated near it and serves for attachment of a spermatophore, but the copulatory area may surround both the gonopores or the male gonopore (Fig. 6).

Urosome

In addition to tubercles, papillae and marginal flanges, the urosome may bear external lateral pulsatile vesicles and segmental ocelli, which are located on the dorsum and the venter (Fig. 7). The structure of the complete somite is of taxonomical significance. These somites are situated in the crop region of the urosome

(Fig. 8). The ancestral somite is 3-annulate, includes annuli A_1 , A_2 , and A_3 . The number of these annuli may reduce (2-annulate somite) or increase by additional annulation.

Annulus A_2 may bear pulsatile vesicles and segmental ocelli. The number of annuli per somite may decrease in the intestinal region. The location of the anus on the dorsum is taken into consideration.

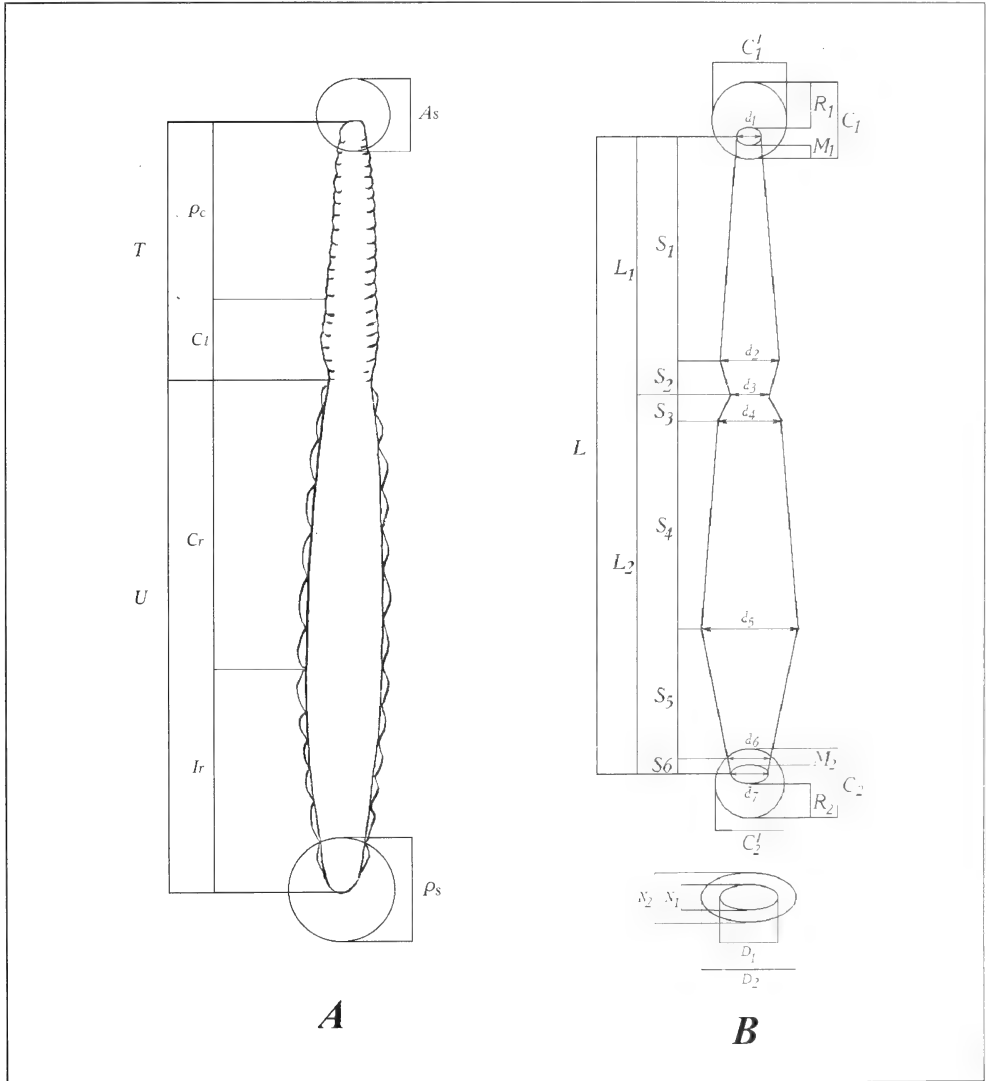

FIG. 1. Body model: A, subdivisions of the body; As, anterior sucker; T, trachelosome; U, urosome; Ps, posterior sucker; Pc, preclitellum; Cl, clitellum; Cr, crop region; Ir, intestinal region; B, dimensions of the body: L, common length; L_1 , length of trachelosome; L_2 , length of urosome; S_1 - S_6 , heights of trapezoids; d_1 - d_7 , width of bases of trapezoids; C_1 , C_2 , lengths of suckers; C'_1 , C'_2 , widths of suckers; R_1 , R_2 , lengths of external parts of suckers; M_1 , M_2 , lengths of internal parts of suckers; N_1 , N_2 , maximal thickness of urosome and trachelosome; D_1 , D_2 , maximal width of urosome and trachelosome.

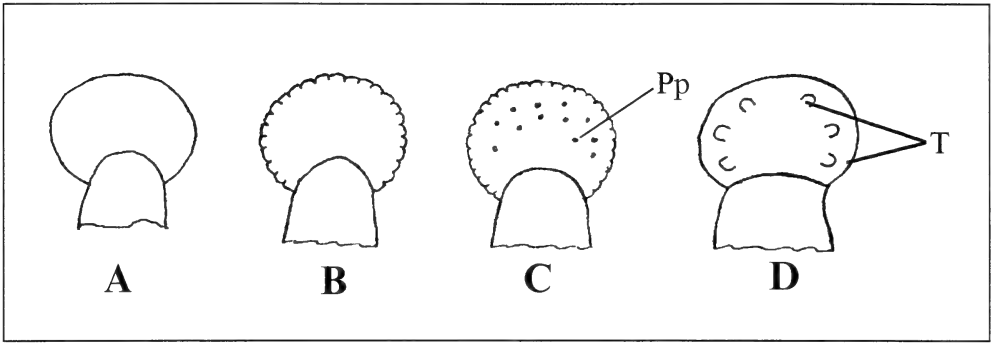

FIG. 2. Characters of dorsum of anterior sucker: Tub, tubercles; Pp, papillae; T, tentacles.

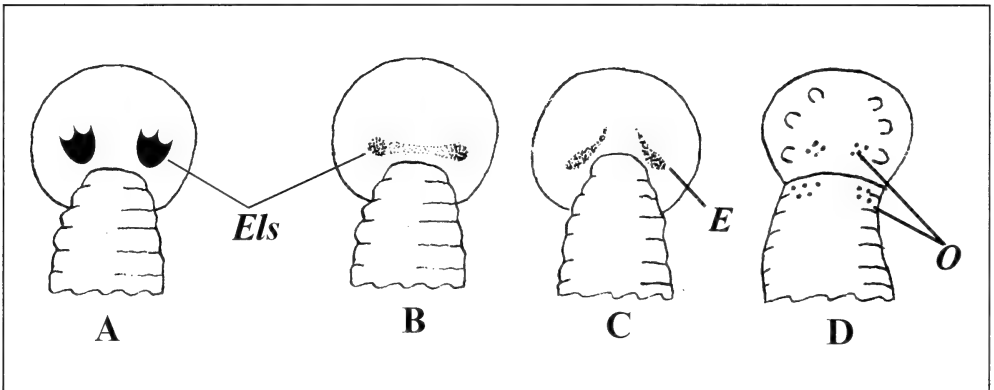

FIG. 3. Location of eyes, eye-like spots, ocelli on anterior sucker: E, eyes; Els, eye-like spots; O, ocelli.

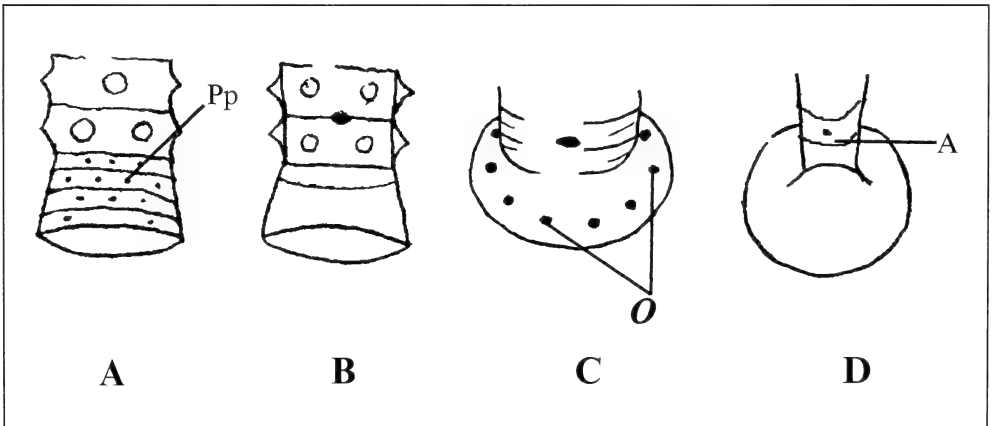

FIG. 4. Surface and attachment of posterior suckers: Pp, papillae; O, ocelli.

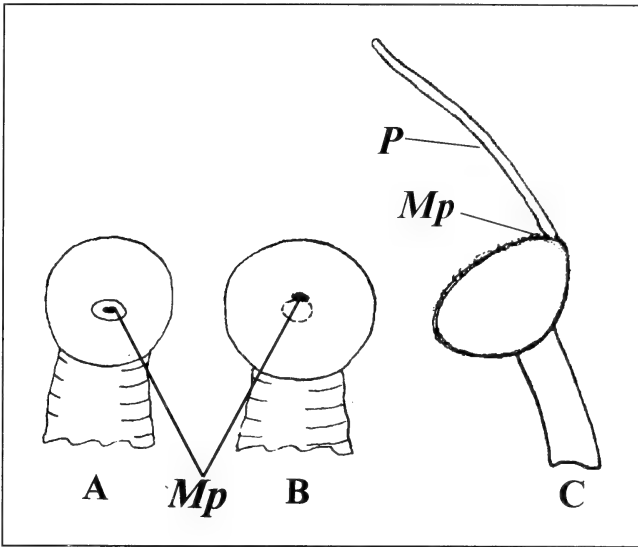

FIG. 5. Location of the mouth-pore: Mp, mouth-pore; P, proboscis.

Digestive system

In piscicolid leeches, the proboscis is an eversible muscular tube lying within a proboscis cavity. It may extend from ganglion 1 to ganglion 5 of the ventral nerve cord. The proboscis is connected with the short esophagus, which often has diverticula located between ganglia 3 and 5. The esophagus opens into the long crop. The crop usually possesses 6 or 5 chambers, but the crop may be tubular without distinct chambers. The crop chambers may be ovoid or diamond-shaped, with lateral processes of various form or without them. The posterior crop caeca are cau-

dal processes of the posterior chamber of the crop. In the family Piscicolidae, the posterior crop caeca show different degrees of junction; they may be completely separated, nontotally fused with various number and size of fenestrae, or completely fused together without fenestrae. The posterior crop caeca may be absent. The intestine has various numbers of lateral chambers (5 at most). They show different degrees of developing and may have lateral processes of different structure. The posterior chamber may be modified into the "folded organ". The intestine is terminated by the rectum, which may be tubular or with a side dilation of varying size (Fig. 9).

Reproductive system

Male reproductive system

The piscicolid leeches have 4, 5, or 6 pairs of testisacs located between chambers of the crop. The existence of 5 pair is caused by missing the 1st pair of testisac; in leeches with only 4 pairs of testisac the first two pairs are missing. A short vasa efferentia connects each testisac to a vas deferens, which extends anteriorly on each side of the body. Each vasa deferentia opens into a seminal reservoir, which has various shape and size. It may be straight, loop-like or very coiled and may be located between ganglia 6 and 7 or extend to ganglion 12 of the ventral nerve cord. Seminal reservoirs empty into ejaculatory ducts. An ejaculatory duct is divided into initial, terminal and common parts, which vary in form and size. Terminal parts and the single common part of ejaculatory ducts (atrium) are highly muscular and often covered by accessory glands, which open through walls into the lumen. The copulatory bursa varies in length and opens to the exterior through the male gonopore.

Female reproductive system

Female reproductive organs include a pair of ovisacs and the conductive tissue. The ovisacs may be straight or coiled, short or long. Some piscicolid leeches have conductive tissue, which may be absent in many genera. Ovisacs empty into oviducts, which lead to

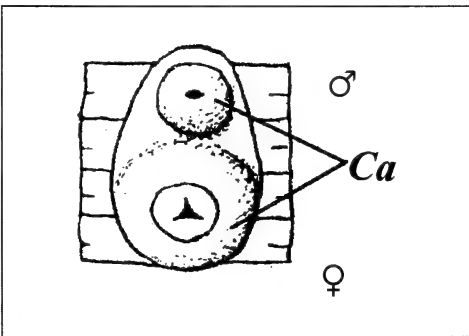

FIG. 6. Ventrum of clitellum: Ca, copulatory area.

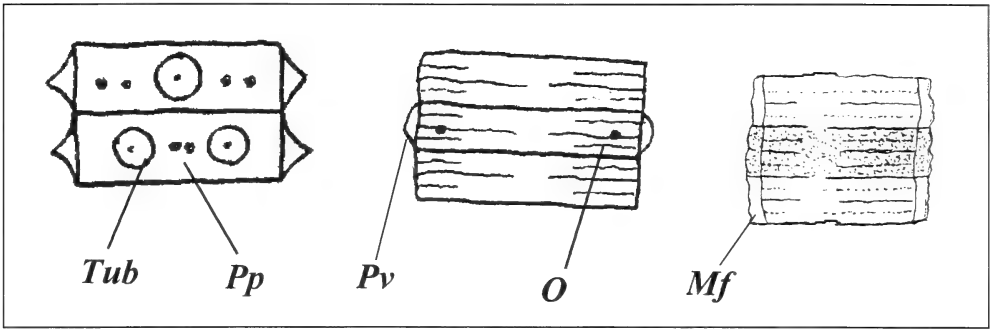

FIG. 7. External features of somites: Tub, tubercles; Pp, papillae; Pv, pulsatile vesicles; O, ocelli; Mf, marginal flanges.

the nonpaired vagina. The vagina opens to the exterior through the female gonopore, which may be surrounded by the copulatory area. The conductive tissue connects the ovisacs with the copulatory area (which may be external or internal and located on the male bursa) if it is present. It may possess some parts such as reservoirs, cords and mass with an internal lumen.

The conductive tissue acts as a pathway for spermatozooids from a spermatophore to the ovisacs (Fig. 10).

Coelomic system

In most piscicolid leeches, there is commonly a well developed coelomic (lacunar) system which is a modi-

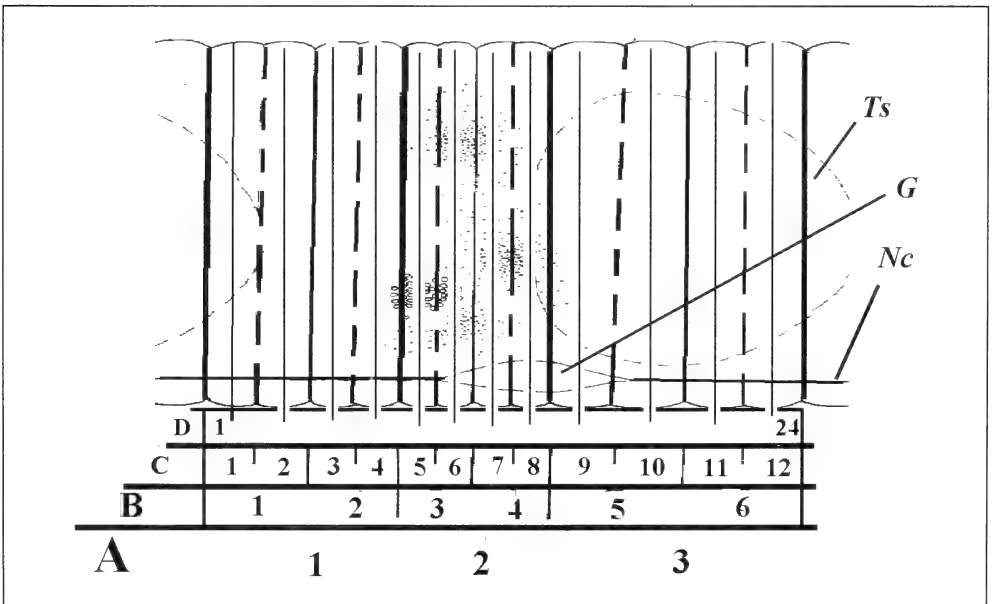

FIG. 8. Model of annulation of complete somite: A₁₋₃, annulation of first degree; B₁₋₆, annulation of second degree; C₁₋₁₂, annulation of third degree; D₁₋₂₄, annulation of fourth degree; Ts, testisac; G, ganglion; Nc, nerve cord.

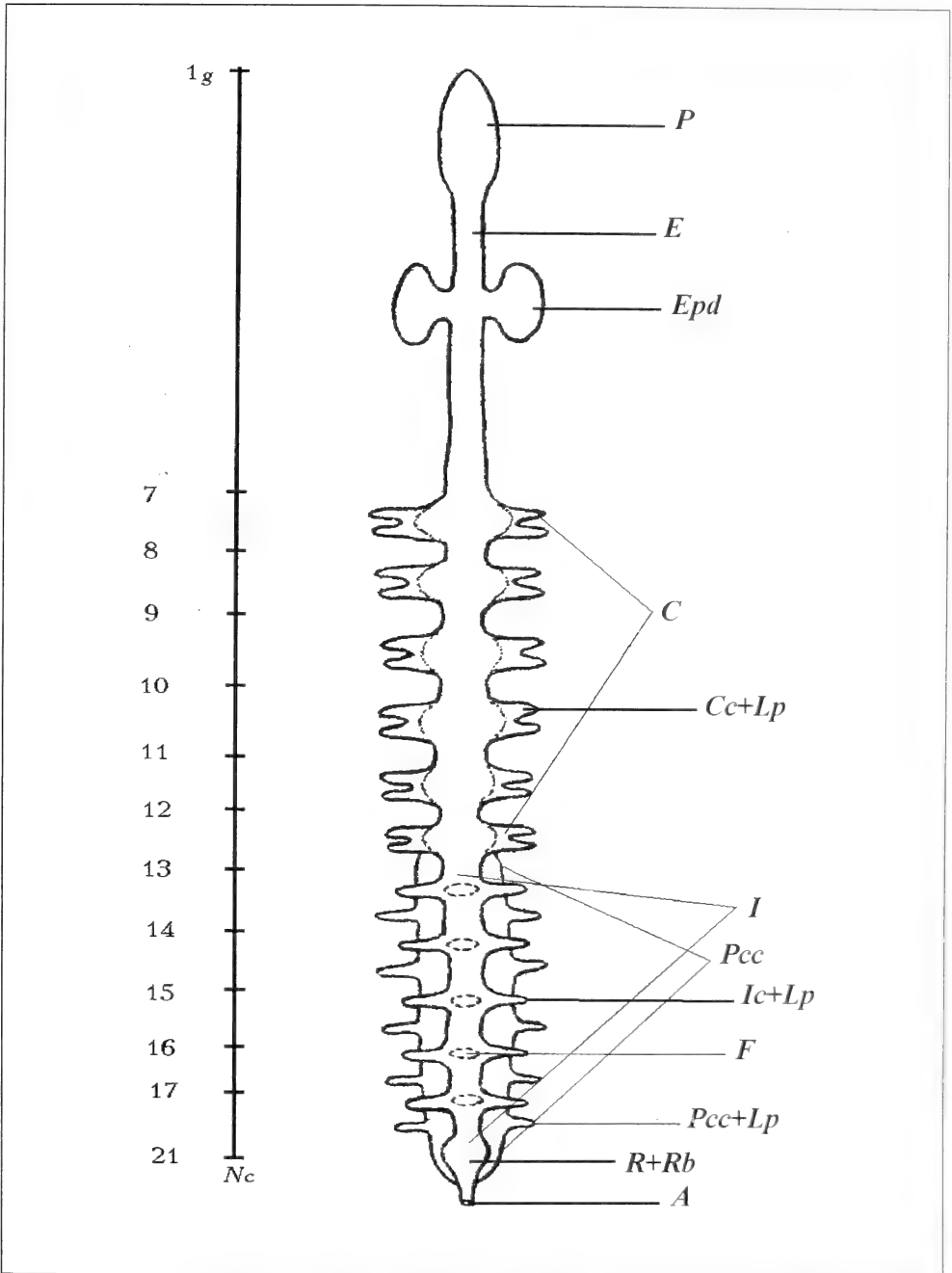

FIG. 9. Model of digestive system of piscicolid leeches: P, proboscis; Ep, esophagus; Epd, esophageal diverticula; C, crop; Cc+Lp, crop chamber with lateral processes; I, intestine; Ic+Lp, intestinal chamber with lateral processes; R+Rb, rectum with rectal dilation; A, anus; Pcc, posterior crop caeca; F, fenestrae; Pcc+Lp, lateral processes of posterior crop caeca; Nc, nerve cord; g, ganglion.

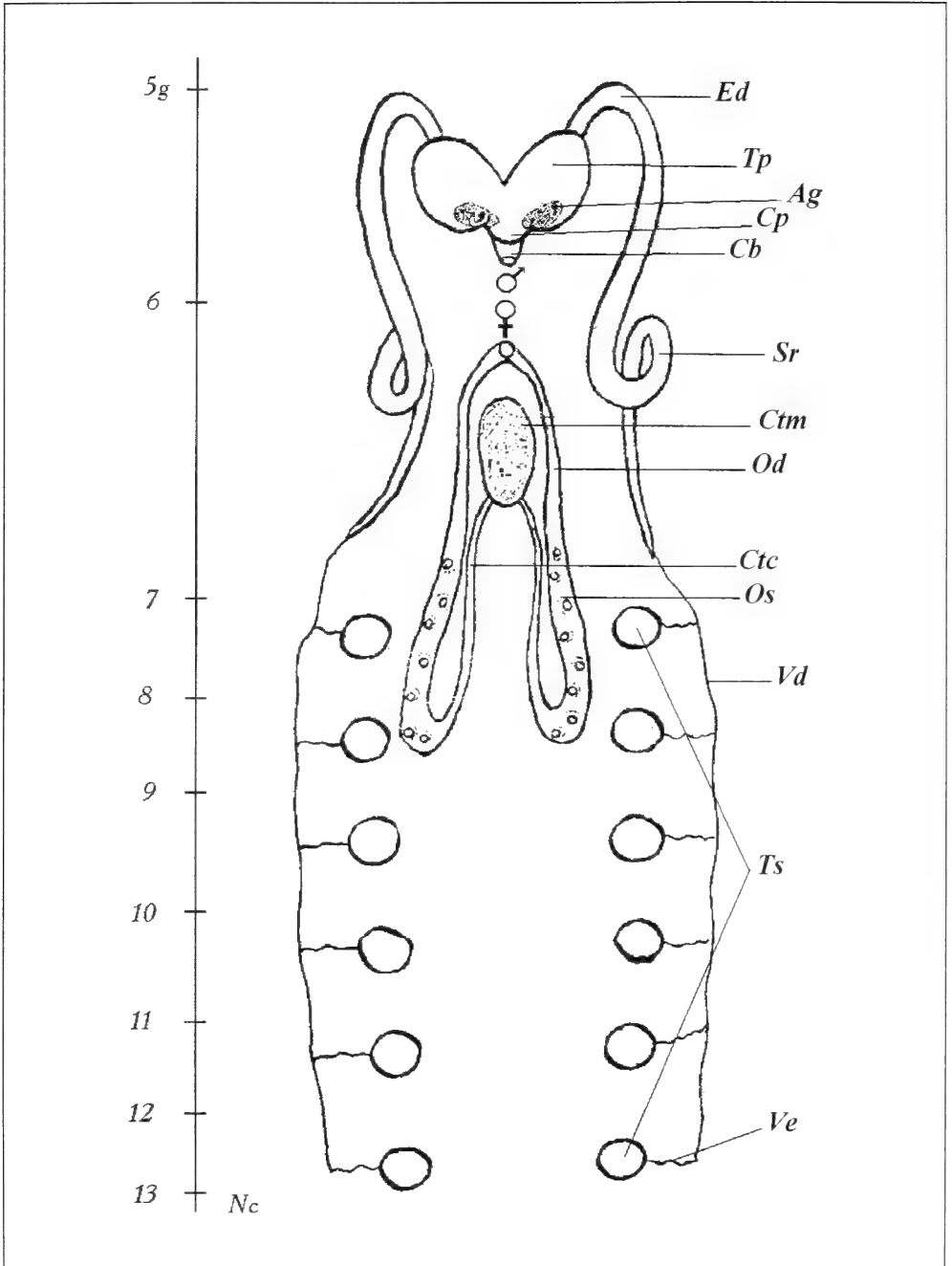

FIG. 10. Model of reproductive system of piscicolid leeches: Ts, testisacs; Ve, vasa efferentia; Vd, vasa deferentia; Sr, seminal reservoir; Ed, ejaculatory ducts; Tp, terminal parts of ejaculatory ducts (atrial cornu); Cp, common part of ejaculatory ducts (common atrium); Ag, accessory glands; Cb, copulatory bursa; Os, ovisacs; Od, oviducts; Ctm, conductive tissue mass; Ctc, conductive tissue cord; Nc, nerve cord; g, ganglion.

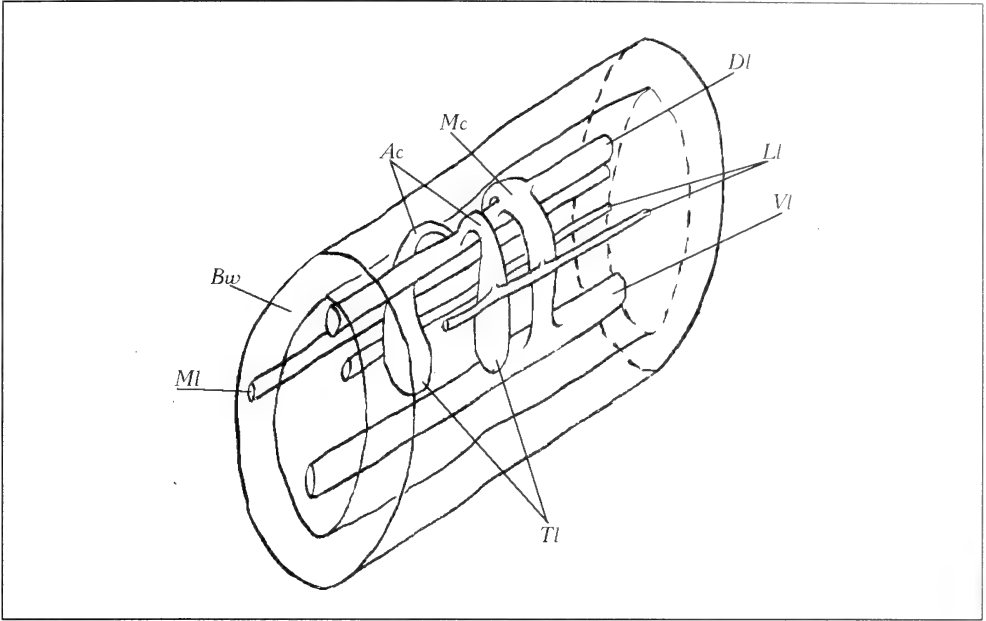

FIG. 11. Model of coelomic system of piscicolid leeches: Dl, dorsal lacuna; Vl, ventral lacuna; Ll, lateral lacuna; Ml, marginal lacuna; Tl, testicular lacunae; Mc, main connection; Ac, accessory connection; Bw, body wall.

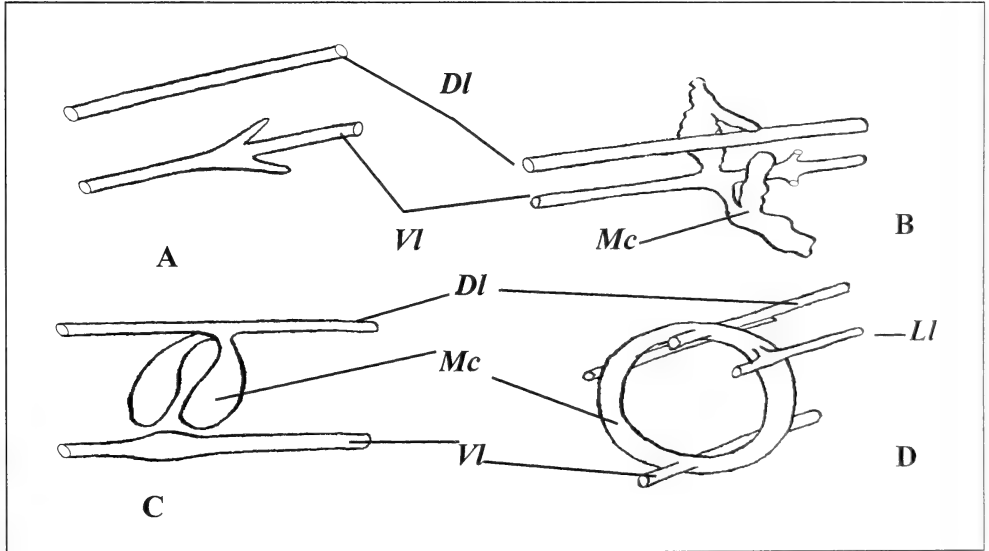

FIG. 12. Coelomic system in ganglion region and main connections. A, absence of main connection; B, unconnected main connection with processes of the ventral lacuna; C, unconnected main connection with processes of the dorsal lacuna; D, connected main connection; Dl, dorsal lacuna; Vl, ventral lacuna; Ll, lateral lacuna; Mc, main connection.

fication of the coelom, and forms a regular system of channels (lacunae). It may consist of dorsal, ventral, lateral and marginal lacunae, pulsatile vesicles and lacunae of testisacs (Fig. 11). The dorsal lacuna may contain the dorsal blood vessel and the ventral lacunae contain the ventral blood vessel and the nerve cord. The marginal lacunae are located between the epithelium and muscle layer, and are usually muscularized. The arrangement of coelomic channels in a somite of the crop region which contains all main parts of this system is of great taxonomical significance. The structure of the coelomic system is very variable. The dorsal lacuna may be absent or present. This lacuna may be divided into two channels. The dorsal blood vessel may be located outside of the lacuna. The lateral, marginal and testicular lacunae may be absent or present. The lateral lacunae may be connected with various elements of the coelomic system: testicular lacunae, main and accessory connections, marginal lacunae and pulsatile vesicles.

Main connections (formed by ventral and dorsal lacunae) are located in the ganglion region, and vary in their development. They may be absent, with a small dilation of the ventral lacuna in the ganglion region (Fig. 12 A); unconnected, with longitudinal processes of the ventral lacuna which extend to the dorsal lacuna in the same region (Fig. 12 B); unconnected, with processes of the dorsal lacuna which extend to the ventral lacuna in the ganglion region (Fig. 12 C); connected by a junction of the ventral and dorsal lacunae in the ganglion region (Fig. 12 D).

The accessory connection (formed by ventral, dorsal and testicular lacunae) located in the testicular region of the somite between two adjacent ganglia, may be developed to different degrees: it may be absent (Fig. 13 A); unconnected, with junction of testicular and ventral lacunae (Fig. 13 B); unconnected, with junction of testicular and dorsal lacunae (Fig. 13 C); connected by junction of dorsal, testicular and ventral lacunae (Fig. 13 D).

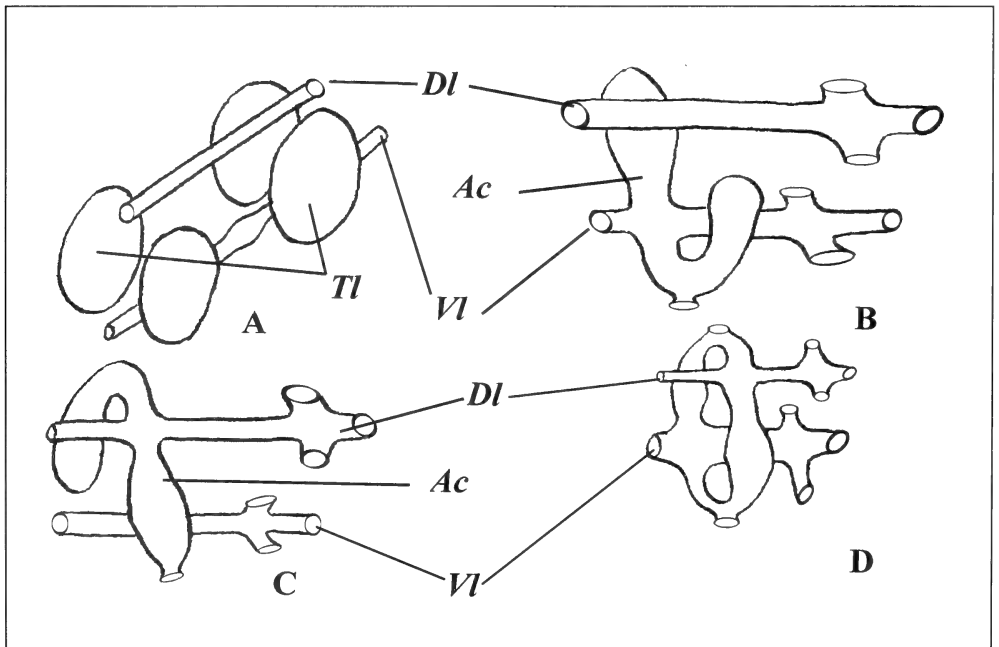

FIG. 13. Coelomic system in testicular region and accessory connections: A, absence of accessory connection; B, unconnected accessory connection with processes of the ventral lacuna; C, unconnected accessory connection with processes of the dorsal lacuna; D, connected accessory connection; Dl, dorsal lacuna; Vl, ventral lacuna; Tl, testicular lacunae; Ac, accessory connection.

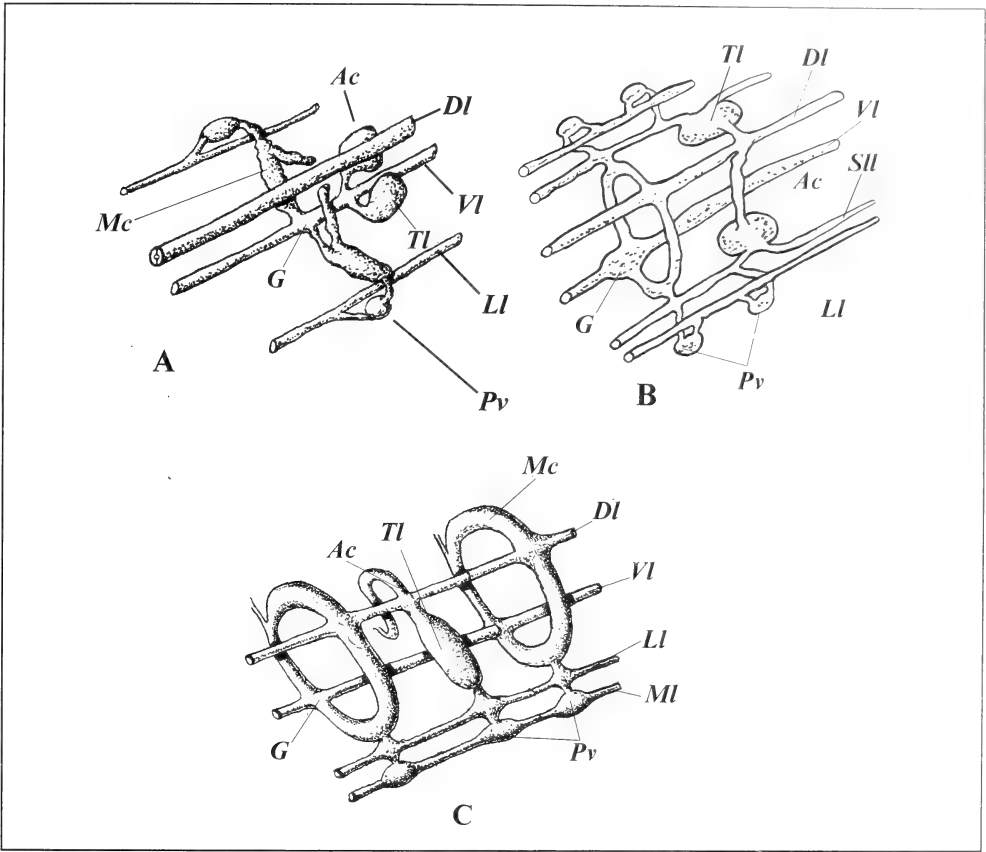

FIG. 14. Pulsatile vesicles: A, pulsatile vesicles of the subfam. Piscicolinae; B, pulsatile vesicles of the gen. *Pontobdella* (subfam. Pontobdellinae); C, pulsatile vesicles of the gen. *Moorebdellina* (subfam. Pontobdellinae); Dl, dorsal lacuna; Vl, ventral lacuna; Ll, lateral lacuna; Sl, sublateral lacuna; Ml, marginal lacuna; Tl, testicular lacunae; Mc, main connection; Ac, accessory connection; Pv, pulsatile vesicles.

Pulsatile vesicles may be absent (subfam. Platybdellinae) or present. It may be of different origin: pulsatile vesicles located in places of connections of lateral lacunae with the main connection (one pair of external vesicles per somite in leeches of the subfam. Piscicolinae) (Fig. 14 A); two pair of subepidermal vesicles per somite located in places of connections

of lateral lacunae with the main and accessory connections in the leeches of the subfam. Pontobdellinae (gen. *Pontobdella*) (Fig. 14 B); pulsatile vesicles as dilation of marginal lacunae (one or two pair of subepidermal vesicles per somite in leeches of the subfam. Pontobdellinae (gen. *Moorebdellina*) (Fig. 14 C). External pulsatile vesicles differ in size.

4. BIOLOGY OF PISCICOLID LEECHES

Piscicolid leeches (Hirudinea: Piscicolidae) inhabit fresh, brackish and salt waters all over the world. Marine leeches are benthic animals, which occur from the littoral to more than the 4000 m depth. Antarctic piscicolids may be classified into both stenobathic and eurybathic species, which are respectively stenothermic and eurythermic (Table 1). Leeches are parasitic on benthic and benthophagous fishes because they deposit their cocoons on bottom substrates such as stones, rhizoids, hard shelled invertebrates; young leeches infest demersal hosts (Meyer & Burreson 1990, Utevsky 2000).

Life histories of the majority of Antarctic leeches are poorly known and their host-parasite relationships need further investigation. Unlike representatives of other families of Hirudinea, piscicolid leeches are closely associated with their hosts. A number of piscicolid leeches from the North Atlantic, the North Pacific and the Arctic lay their cocoons on decapod crustaceans and pycnogonids but feed on the blood

of various fishes (Meyer & Barden 1955, Bakay *et al.* 1998). Similar cocoon-laying was found in the Antarctic leech *Glyptonotobdella antarctica* (Sawyer and White 1969). The leeches and their cocoons occur on the isopod *Glyptonotus antarcticus* (Janssen 1993). In addition, the sea urchin *Sterechinus* sp. and the benthic octopus *Pareledone (charcoti?)* serve as hosts. According to Janssen (1993), *G. antarctica* moves between Antarctic octopuses and their potential prey. There is no evidence of leeches feeding on these invertebrates.

Piscicolid leeches may deposit their cocoons on eggs of their host fishes. Young leeches infest fish larvae (Khan & Paul 1995). There are no similar records for Antarctic leeches. However, it was found that the eggs of unidentified fishes and cocoons of unidentified leeches (*Trulliodbella bacilliformis* (Brinkmann 1948)?) stuck together in one of the lots of our collection.

Many marine leeches deposit their cocoons on rocks (Khan & Paul 1995). Some Antarctic leeches frequently occur on rocks, rhizoids, etc., but there are

TABLE 1. Depth of founding Antarctic piscicolid leeches.

Species	Depth (m)
1. <i>Cryobdella levigata</i> Harding, 1922	10–40
2. <i>C. antarctica</i> Epstein, 197	11
3. <i>C. ljadovi</i> Epstein & A.Utevsky, 1994	360–500
4. <i>C. pallida</i> A.Utevsky, 1997	–
5. <i>Austrobdella translucens</i> Badham, 1916	193
6. <i>Glyptonotobdella antarctica</i> Sawyer & White, 1969	0–665
7. <i>Epsteinia alba</i> (Epstein, 1970)	–
8. <i>Pleurobdella varituberculata</i> (Moore, 1938)	128–546
9. <i>P. australis</i> (Epstein, 1970)	100–400
10. <i>Pontobdella tasmanica</i> Hickman, 1947	27–891
11. <i>Moorebdellina rugosa</i> (Moore, 1938)	15–300
12. <i>M. biannulata</i> (Moore, 1957)	137–580
13. <i>M. uschakovi</i> Epstein, 1974	58–410
14. <i>M. meyeri</i> A.Utevsky, 1997	140–300
15. <i>Megaliobdella szidati</i> Meyer & Burreson, 1990	549–556
16. <i>Trulliodbella capitis</i> Brinkmann, 1948	170–270
17. <i>T. bacilliformis</i> (Brinkmann, 1948)	5–500
18. <i>Trachelobdella bathyrajae</i> Meyer & Burreson, 1990	–
19. <i>Trachelobdellina glabra</i> Moore, 1957	20–437
20. <i>Nototheniobdella sawyeri</i> A.Utevsky, 1993	50–200
21. <i>Galatheadbella bruuni</i> Richardson & Meyer, 1973	4052

TABLE 2. Hosts of the Antarctic piscicolid leeches.

Hosts	Leeches																					
	<i>P. tasmanica</i>	<i>M. rugosa</i>	<i>M. biannulata</i>	<i>M. uschakovi</i>	<i>M. meyeri</i>	<i>Meg. szidati</i>	<i>E. alba</i>	<i>A. translucens</i>	<i>P. varituberculata</i>	<i>P. australis</i>	<i>G. antarctica</i>	<i>C. levigata</i>	<i>C. antarctica</i>	<i>C. ljadovi</i>	<i>C. pallida</i>	<i>Tr. glabra</i>	<i>T. capitis</i>	<i>T. bacilliformis</i>	<i>G. brunni</i>	<i>T. bathyrhaje</i>	<i>N. sauyeri</i>	
Phyl. Pycnogonida																						
1. <i>Colossendeis</i> sp.	■								■													
Phyl. Arthropoda																						
Cl. Crustacea																						
Ord. Isopoda																						
2. <i>Glyptonotus antarcticus</i>											■					■						
Phyl. Chordata																						
Cl. Elasmobranchii																						
Ord. Rajiformes																						
Fam. Rajidae																						
3. <i>Bathyraja maccaini</i>																						■
Fam. Rhinobatidae																						
4. <i>Trygonorrhina fasciata</i>	■																					
Cl. Actinopterygii																						
Ord. Gadiformes																						
Fam. Muraenolepidae																						
5. <i>Muraenolepis marmoratus</i>																■						
6. <i>M. Microps</i>																■						
Fam. Macrouridae																						
7. <i>Coryphaenoides</i> sp.																						■
Ord. Ophidiiformes																						
Fam. Ophidiidae																						
8. <i>Bassozetus</i> sp.																						■
Ord. Perciformes																						
Fam. Nototheniidae																						
9. <i>Notothenia rossi</i>													■					■				
10. <i>N. coriiceps</i>																						■
11. <i>N. neglecta</i>																						■
12. <i>Nototheniops larseni</i>																						■
13. <i>Lepidonotothen squamifrons</i>								■					■		■							
14. <i>Gobionotothen gibberifrons</i>													■		■							

TABLE 2. Continued.

Hosts	Leeches																					
	<i>P. tasmanica</i>	<i>M. rugosa</i>	<i>M. biannulata</i>	<i>M. uschakovi</i>	<i>M. meyeri</i>	<i>Meg. szitladi</i>	<i>E. alba</i>	<i>A. translucens</i>	<i>P. varituberculata</i>	<i>P. australis</i>	<i>G. antarctica</i>	<i>C. levigata</i>	<i>C. antarctica</i>	<i>C. ljadovi</i>	<i>C. pallida</i>	<i>Tr. glabra</i>	<i>T. capitis</i>	<i>T. bacilliformis</i>	<i>G. bruuni</i>	<i>T. bathyratae</i>	<i>N. sawyeri</i>	
15. <i>Trenatomus borchgrevinki</i>							■															
16. <i>T. bernacii</i>												■	■									
17. <i>T. hansonii</i>												■	■									
18. <i>T. centronotus</i>												■	■									
Fam. Bathydraconidae																						
19. <i>Parachaenichthys georgianus</i>																	■		■			■
Fam. Chaenichthyidae																						
20. <i>Chaenichthys rhinoceratus</i>								■										■	■			
21. <i>Neopagetopsis ionah</i>																		■	■			■
22. <i>Pseudochaenichthys georgianus</i>													■					■	■			■
23. <i>Chaenocephalus aceratus</i>													■					■	■			■
24. <i>C. bouvetensis</i>													■					■	■			■
25. <i>Cryodraco antarcticus</i>													■					■	■			■
26. <i>Champscephalus gunnari</i>													■					■	■			■
27. <i>Chionodraco katmleena</i>													■					■	■			■
28. <i>C. hamatus</i>													■					■	■			■
29. <i>C. rastrospinosus</i>													■					■	■			■
30. <i>Chaenodraco wilsoni</i>													■					■	■			■
Fam. Harpagiferidae																						■

no records on cocoon-laying on the bottom substrates and hosts of the leeches are unknown (Table 2).

Young leeches hatch within from 30 to 300 days after cocoon deposition. There are annual and more long-term life cycles (Khan & Paul 1995). As for Antarctic piscicolids, it seems likely that small leeches are characterized by annual life cycles while large leeches live for a longer time.

The list of host fishes and carrier invertebrates is given in Table 2. *C. pallida*, *E. alba*, *G. antarctica*, and *T. bathyratae* may be classified as species-specific parasites. Broader host ranges are recorded for *C. ljadovi* (2 host species of one genus), *C. levigata* (3 host

species of 2 related genera of one family), *A. translucens* (2 host species of related families of one superfamily), *C. antarctica* (11 host species of 10 genera of 2 families of one superfamily). The lowest host specificity is peculiar to *N. sawyeri* (7 host species of 6 genera of 3 related families) and *T. bacilliformis* (10 host species of 8 genera of 3 related families). Hosts of the other leeches are unknown.

Piscicolid leeches may be grouped according to the duration of stay on a host fish as temporary or permanent parasites. The former usually leave their host when sated and reattach to different host when hungry. The latter do not detach from their hosts (Sawyer

TABLE 3. Intensity of infestation of the hosts.

Species	Infestation
1. <i>Cryobdella levigata</i> Harding, 1922	1-4
2. <i>C. antarctica</i> Epstein, 1970	1-36
3. <i>C. ljadovi</i> Epstein & A.Utevsky, 1994	1-21
4. <i>C. pallida</i> A.Utevsky, 1996	1-6
5. <i>Austrobdella translucens</i> Badham, 1916	1-2
6. <i>Glyptonotobdella antarctica</i> Sawyer & White, 1969	1-132
7. <i>Epsteinia alba</i> (Epstein, 1970)	1
8. <i>Pleurobdella varituberculata</i> (Moore, 1938)	1
9. <i>P. australis</i> (Epstein, 1970)	1
10. <i>Pontobdella tasmanica</i> Hickman, 1947	-
11. <i>Moorebdellina rugosa</i> (Moore, 1938)	1
12. <i>M. biannulata</i> (Moore, 1957)	-
13. <i>M. uschakovi</i> Epstein, 1974	-
14. <i>M. meyeri</i> A.Utevsky, 1996	-
15. <i>Megaliobdella szidati</i> Meyer & Bureson, 1990	-
16. <i>Trulliobdella capitis</i> Brinkmann, 1948	1-36
17. <i>T. bacilliformis</i> (Brinkmann, 1948)	1-19
18. <i>Trachelobdella bathyrajae</i> Meyer & Bureson, 1990	3
19. <i>Trachelobdellina glabra</i> Moore, 1957	-
20. <i>Nototheniobdella sawyeri</i> A.Utevsky, 1993	1-29
21. <i>Galatheabdella bruuni</i> Richardson & Meyer, 1973	-

1986). Leeches locate on sites like fins, folds between pectoral fins and body, head, mouth and gill cavities where the proboscis might easily penetrate through the fish skin.

Leeches of the genus *Cryobdella* are examples of permanent parasites. They have a relatively large posterior sucker for long-term attachment. An extreme case of such is the adaptation is *C. ljadovi*. The unique shape of its posterior sucker is adapted to attachment to gill rakers. The lack of posterior crop caeca is another evidence of permanent parasitism. The leech has to feed on its host all the time because

of impossibility of storing blood. *E. alba* also lacks posterior crop caeca. However, it is unknown whether the leech is a permanent parasite because only one specimen has been recorded.

Leeches of the genera *Pleurobdella*, *Moorebdellina*, *Megaliobdella*, *Galatheabdella*, and *Trachelobdellina* found free living are apparently temporary parasites. Findings of some leeches of the above genera on arthropods support this supposition.

Little is known about intensity and prevalence of infestation by Antarctic piscicolids. Intensity varies within a broad range (Table 3).

5. COLLECTION AND PRESERVATION

Leeches may be collected from the fins, the head, the mouth and gill cavities of fishes. It should be emphasized that these parasites often leave their hosts immediately after capture. Therefore it is necessary to examine a lot of fishes at once. Leeches may be found on crustaceans, among rhizoids of algae, and free-living on the bottom. They may be collected by dredge, Petersen grab, Otter trawl, Blake trawl, Menzies trawl, and divers.

Collected specimens should be narcotized in 10% ethanol, 7% $MgCl_2$, $CdSO_4$ or in chloral hydrate for relaxation. But eyes, eyes-like spots, segmental ocelli, ocelli on the posterior sucker and the coloration must be examined before narcotization and preservation

because leeches may be depigmented by these substances.

After relaxation the leeches should be fixed in 5% formalin, or Bouin's fluid for histological preparations. The leeches may be stored in these fluids, large specimens should be injected with fixative fluid for valid preservation of internal organs. Preserving and fixing solution based on formalin preserves pigmented structures and coloration longer than that based on ethanol (70%). Moreover, ethanol macerate the body wall, internal organs and worsens histological staining. Preserved specimens must be stored in opaque vials.

Leeches may be fixed in 96% ethanol and stored at low temperature conditions for DNA analysis.

6. SYSTEMATIC PART

Classification of the Family Piscicolidae Johnston, 1865.

“Subfamily Platybdellinae” Epstein, 1970

- Genus *Platybdella* Malm, 1863
No Antarctic representatives
- * Genus *Cryobdella* Harding, 1922
C. levigata Harding, 1922
C. antarctica Epstein, 1970
C. ljadovi Epstein & A.Utevsky, 1994
C. pallida A.Utevsky, 1997
- Genus *Cottobdella* S.Utevsky, 1997
No Antarctic representatives
- Genus *Heptacyclus* Vasilyev, 1939
No Antarctic representatives
- Genus *Malmiana* Strand, 1942
No Antarctic representatives
- Genus *Oceanobdella* Caballero, 1956
No Antarctic representatives
- Genus *Sanguinotus* de Silva & Burdon-Jones, 1961
No Antarctic representatives
- Genus *Arctobdella* de Silva & Kabata, 1961
No Antarctic representatives
- Genus *Phyllobdellina* Epstein & S.Utevsky, 1993
No Antarctic representatives
- * Genus *Austrobdella* Badham, 1916
A. translucens Badham, 1916
- Genus *Pterobdella* Kaburaki, 1921
No Antarctic representatives
- Genus *Phyllobdella* Moore, 1939
No Antarctic representatives
- Genus *Pterobdellina* Bennike & Bruun, 1939
No Antarctic representatives
- Genus *Notostomum* Levinsen, 1882
No Antarctic representatives
- Genus *Ostreobdella* Oka, 1927
No Antarctic representatives
- * Genus *Glyptonotobdella* Sawyer & White, 1969
G. antarctica Sawyer & White, 1969
- Genus *Myzobdella* Leidy, 1851
No Antarctic representatives
- Genus *Piscicolaria* Whitman, 1889
No Antarctic representatives
- Genus *Illinobdella* Meyer, 1940
No Antarctic representatives
- Genus *Crangonobdella* Selensky, 1914
No Antarctic representatives

- Genus *Beringbdella* Caballero, 1976
No Antarctic representatives
- * Genus *Epsteinia* A.Utevsky, 1993
E. alba (Epstein, 1970)
- Genus *Mysidobdella* Selensky, 1927
No Antarctic representatives
- Genus *Marsipobdella* Moore, 1952
No Antarctic representatives
- Genus *Hemibdella* van Beneden & Hesse, 1863
No Antarctic representatives
- Genus *Aestabdella* Burreson, 1976
No Antarctic representatives
- Genus *Ringueleobdella* Epstein, 1994
No Antarctic representatives
- Genus *Makarabdella* Richardson, 1959
No Antarctic representatives
- Genus *Bathybdella* Burreson, 1981
No Antarctic representatives
- * Genus *Pleurobdella* A.Utevsky, 1995
P. varituberculata (Moore, 1938)
P. australis (Epstein, 1970)

“Subfamily Pontobdellinae” Llewellyn, 1966

- * Genus *Pontobdella* Leach, 1815
P. tasmanica Hickman, 1947
- Genus *Oxytonostoma* Malm, 1863
No Antarctic representatives
- * Genus *Moorebdellina* Epstein, 1972
M. rugosa (Moore, 1938)
M. biannulata (Moore, 1957)
M. uschakovi Epstein, 1974
M. meyeri A.Utevsky, 1997
- * Genus *Megaliobdella* Meyer & Burreson, 1990
M. szidati Meyer & Burreson, 1990

“Subfamily Piscicolinae” Johnston, 1865

- Genus *Piscicola* Blainville, 1818
No Antarctic representatives
- Genus *Codonobdella* Grube, 1873
No Antarctic representatives
- Genus *Baicalobdella* Dogiel, 1957
No Antarctic representatives
- Genus *Zeylanicobdella* de Silva, 1963
No Antarctic representatives
- Genus *Caspiobdella* Epstein, 1966
No Antarctic representatives
- Genus *Italobdella* Bielecki, 1993
No Antarctic representatives

* Genera represented in the Antarctic region

- Genus *Acipenserobdella* Epstein, 1969
No Antarctic representatives
- Genus *Limnotrachelobdella* Epstein, 1968
No Antarctic representatives
- Genus *Taimenobdella* Epstein, 1964
No Antarctic representatives
- * Genus *Trulliobdella* Brinkmann, 1948
T. capitis Brinkmann, 1948
T. bacilliformis (Brinkmann, 1948)
- * Genus *Trachelobdella* Diesing, 1850
T. bathyrajae Meyer & Burreson, 1990
- * Genus *Trachelobdellina* Moore, 1957
T. glabra Moore, 1957
- * Genus *Nototheniobdella* A.Utevsky, 1993
N. sawyeri A.Utevsky, 1993
- Genus *Bdellamaris* Richardson, 1953
No Antarctic representatives
- Genus *Branchellion* Savigni, 1822
No Antarctic representatives
- Genus *Orientobdella* Epstein, 1962
No Antarctic representatives
- Genus *Johanssonia* Selensky, 1914
No Antarctic representatives
- Genus *Cystobranchnus* Diesing, 1859
No Antarctic representatives
- Genus *Calliobdella* van Beneden & Hesse, 1863
No Antarctic representatives
- * Genus *Galatheaobdella* Richardson & Meyer, 1973
G. bruuni Richardson & Meyer, 1973
- Genus *Brumptiana* Knight-Jones & Llewellyn, 1984
No Antarctic representatives

Key to the Subfamilies of the Family Piscicolidae

The keys are based on characters peculiar to Antarctic leeches and are not intended for identifying any taxa beyond the Antarctic region.

- 1a Externally visible pulsatile vesicles absent ... 2
- 1b One pair of externally visible pulsatile vesicles per somite ... "Subfamily Piscicolinae" (p. 60)
- 2a Body with large tubercles; annuli distinctly divided; pulsatile vesicles subepidermal "Subfamily Pontobdellinae" (p. 28)
- 2b Body with small tubercles and papillae or smooth; annuli indistinctly divided; pulsatile vesicles absent..... "Subfamily Platybdellinae" (p. 40)

* Genera represented in the Antarctic region

"Subfamily Pontobdellinae"

Diagnosis. Leeches of varying sizes; body long, cylindrical or subcylindrical. Externally visible pulsatile vesicles, segmental ocelli and ocelli on posterior sucker absent. Annuli of somites distinctly divided, with tubercles and papillae.

Anterior sucker may bear tentacles, tubercles, papillae, and eye-like spots.

Digestive system of varying structure, posterior crop caeca totally or nontotally fused (with fenestrae).

Reproductive system of varying structure, copulatory area absent.

Coelomic system possesses dorsal, ventral, lateral, testicular lacunae; marginal lacunae absent or present. Usually with two subepidermal pulsatile vesicles on each side of an urosomal somite.

References: Sawyer 1986, Epshtein *et al.* (1994).

Key to the Antarctic Genera of the "Subfamily Pontobdellinae"

- 1a Number of annuli in complete somite less than 12, tubercles of varying size; not very large leeches 2
- 1b Complete somite 12-annulate with equal large conic tubercles; very large leeches Genus *Megaliobdella* (p. 39)
- 2a Large or medium-sized leeches, three peak eye-like spots on anterior sucker, posterior crop caeca totally fused, accessory glands absent Genus *Pontobdella* (p. 28)
- 2b Not large leeches, eye-like spots without peaks, posterior crop caeca nontotally fused with fenestrae, accessory glands present Genus *Moorebdellina* (p. 30)

Genus *Pontobdella* Leach, 1815

(Syn.: *Stribarobdella* Leigh-Sharpe, 1925;

Pentabdella Lewellyn, 1966)

Type species: *Pontobdella muricata* Linnaeus, 1758.

Medium-sized or large leeches. Body long, cylindrical or subcylindrical, indistinctly divided into trachelosome and urosome. Complete somite sharply divided into small number of annuli with tubercles. External copulatory area on clitellum absent.

Anterior sucker: small, sharply divided from trachelosome, with tentacles, tubercles and eye-like spots.

Posterior sucker: small, indistinctly divided from urosome, facing directly posteriorly.

Digestive system. Esophageal diverticula absent. Crop chambers lacking lateral processes. Posterior

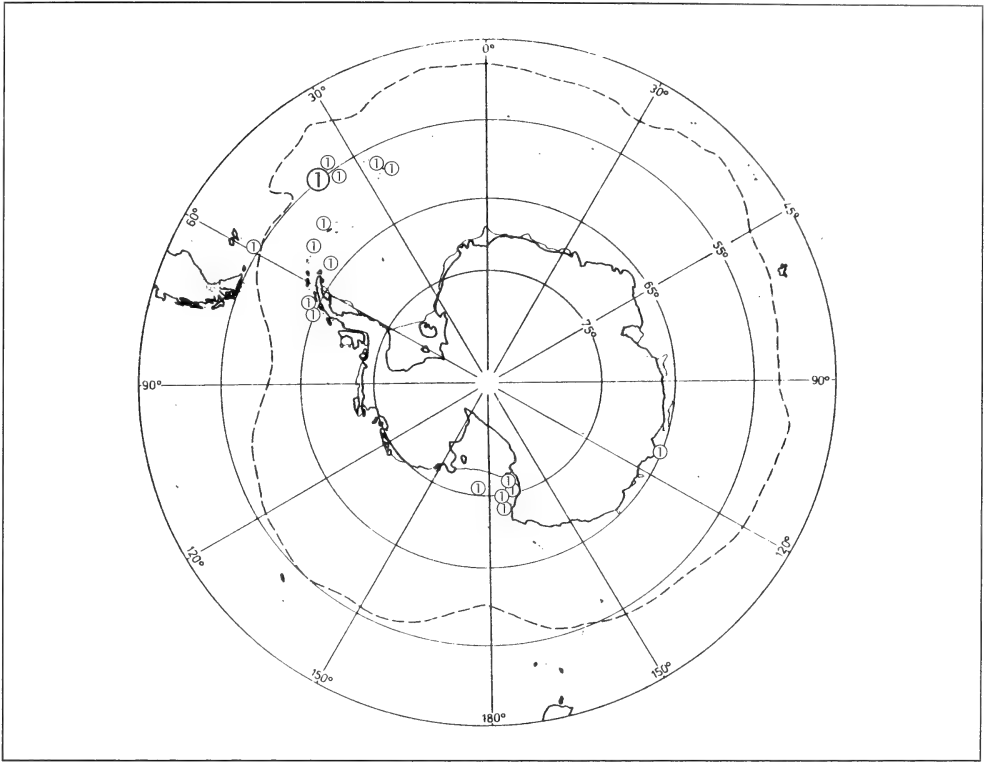

FIG. 15. Distribution of the *Pontobdella tasmanica*.

crop caeca totally fused. Intestine possesses weakly developed chambers without lateral processes.

Reproductive system. Seminal reservoirs long, bursa short, accessory glands absent. Ovisacs small, conductive tissue well developed.

Coelomic system. Dorsal, ventral, lateral, and testicular lacunae present. Two pairs of small subepidermal pulsatile vesicles per somite present.

Host data: skates and sharks.

Distribution: absent in polar waters of the Northern Hemisphere, most abundant in tropical waters.

Congenitors:

- P. macrothela* Schmarda, 1861 - equatorial world-wide
- P. tarpobanensis* de Silva, 1963 - Sri Lanka
- P. planodiscus* Baird, 1869 - Patagonia
- P. vosmaeri* Apathy, 1888 - north-eastern Atlantic, Mediterranean
- P. australiensis* Goddard, 1909 - Australia
- P. moorei* Oka, 1910 - Japan

- P. bimaculata* Oka, 1910 - Japan
- P. loricata* Harding, 1924 - India
- P. dispar* Cordero, 1937 - Brazil
- P. tasmanica* Hickman, 1947 - Tasmania, Antarctica

References: Lewellyn 1966, Sawyer 1986; Epshtein *et al.* (1994).

Pontobdella tasmanica Hickman, 1947*
(Syn. *Stibarobdella tasmanica* (Hickman, 1947))

1. External characters. Large leeches. Up to 80 mm in length and 10 mm in width. Body indistinctly divided into trachelosome and urosome, with tubercles. Anterior sucker small, distinctly divided from trachelosome, eccentrically attached, directed ventrad, cup-shaped, with 4 pairs of submarginal tentacles. One pair of three peak eye-like spots on anterior

* Species described on literature data

sucker. Mouth-pore centrally located. Posterior sucker small, but larger than anterior one, cup-shaped, centrally attached, facing directly posteriorly.

Annulation. Clitellum 6-annulate, including 4A₃, biannulate 5 and 6, 7A₁ which slightly constricted in diameter and lacking large tubercles, annulus 7A₁ very small. Male gonopore between annuli 5A₁ and 5A₂, female gonopore between annuli 6A₁ and 6A₂. Copulatory area absent. Complete somite 3-annulate; annulus A₂ slightly wider than A₁ and A₃. Annulus A₂ with 4 dorsal and 4 smaller ventral papillae; A₁ and A₃ with 6 dorsal and 6 smaller ventral papillae. Anus on papilla, separated by 2 annuli from posterior sucker.

Coloration. Body and suckers unpigmented, only clitellum with brownish tinge.

2. Digestive system. Structure unknown.
3. Reproductive system. Structure unknown.
4. Coelomic system. Structure unknown.

5. Host data: *Trigonorhina fasciata* (Rajiformes, Rhinobatidae) and unidentified skate.

6. Distribution (Fig. 15): Hobart, King Island, Kingston (Tasmania) - Pacific Ocean; Subantarctic region of Atlantic Ocean, S. Sandwich Is., S. Orkney Is., S. Georgia, S. Shetland Is., Elephant I., Graham Land - Atlantic sector, Ross Sea, Mawson Sea - Pacific sector.

References: Hickman 1947, Llewellyn 1966, Meyer & Burreson 1990.

Genus *Moorebdellina* Epstein, 1972

Type species: *Pontobdella rugosa* Moore, 1938

Not large leeches. Body long and cylindrical or short and subcylindrical, with large papillae. Complete somite strictly divided into 2–4 annuli (additional annulation may occur).

Anterior sucker: medium-sized, eccentrically attached, with tubercles and papillae, and two eye-like spots, mouth-pore centrally located.

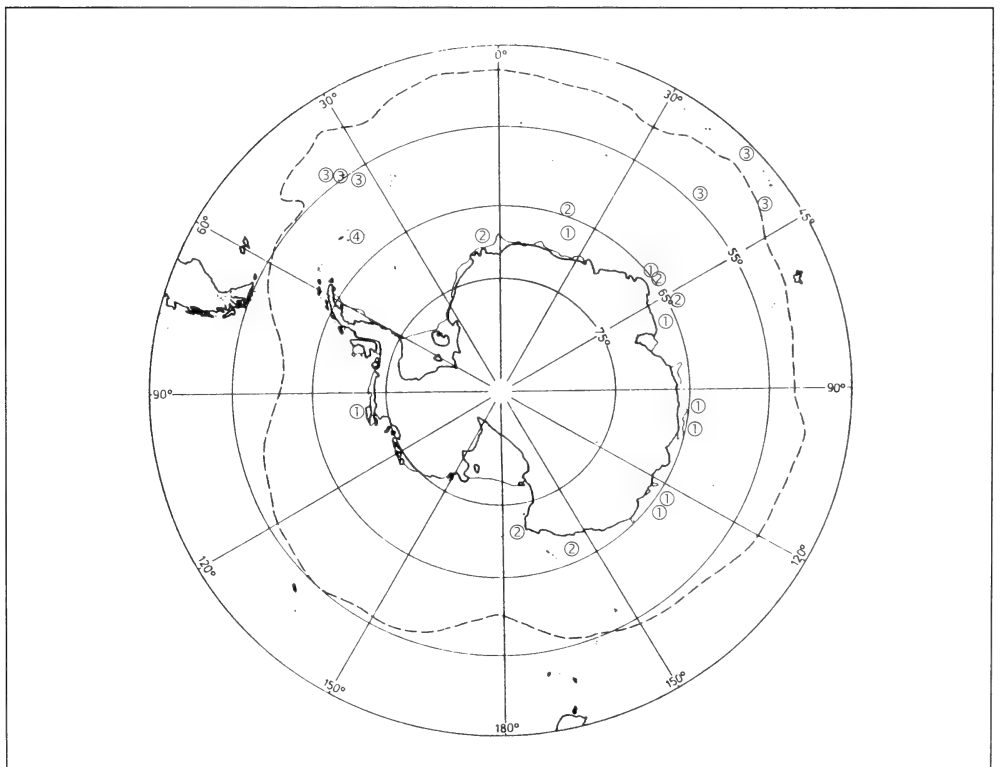

FIG. 16. Distribution of the gen. *Moorebdellina*: 1 – *M. rugosa*; 2 – *M. biannulata*; 3 – *M. uschakovii*; 4 – *M. meyeri*.

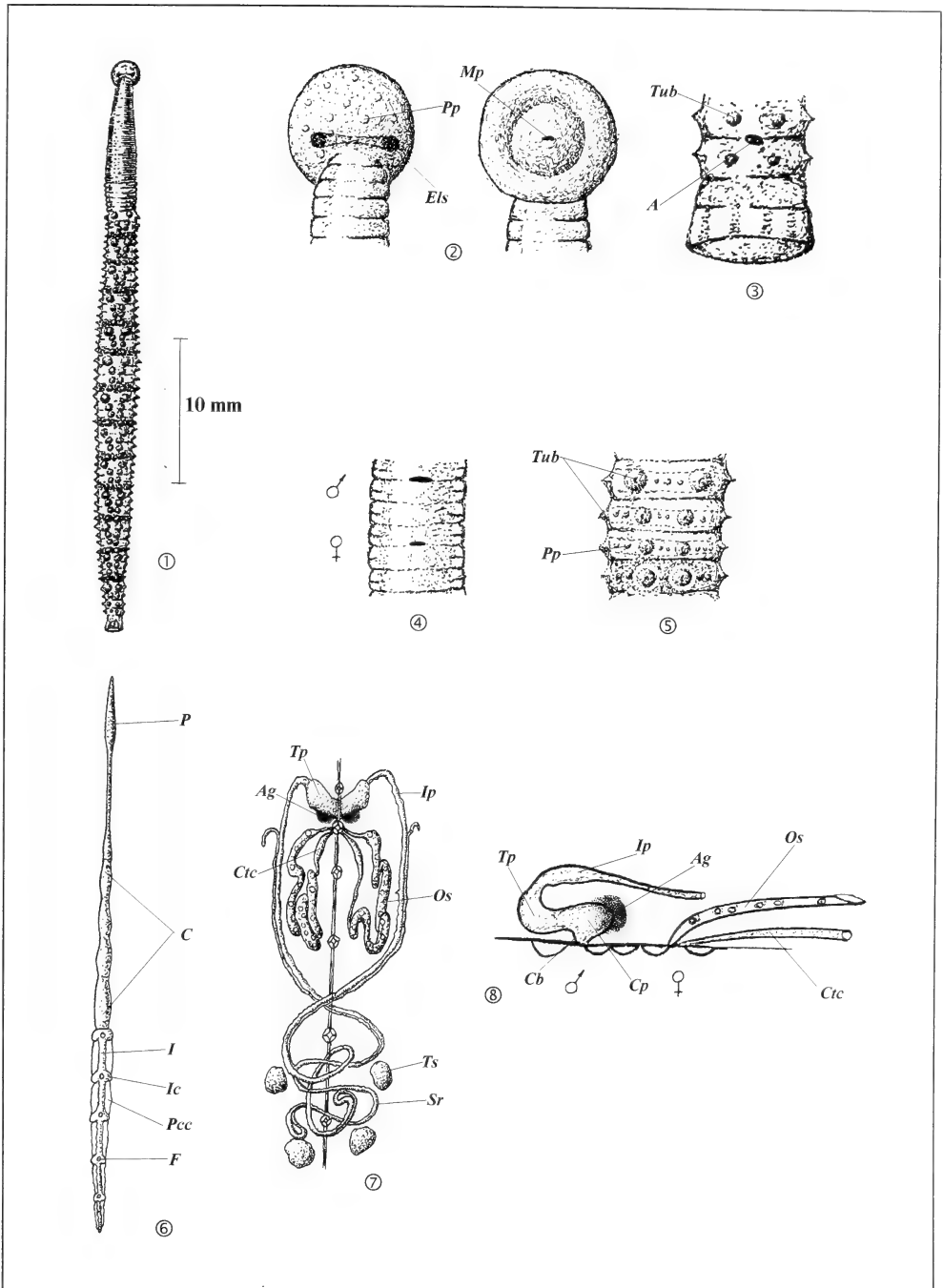

FIG. 17. *Moorebdellina rugosa*, external and internal structure: 1, common view; 2, anterior sucker (dorsal and ventral view); 3, posterior sucker; 4, clitellum (ventral view); 5, somite; 6, digestive system; 7, reproductive system (dorsal view); 8, reproductive system (lateral view).

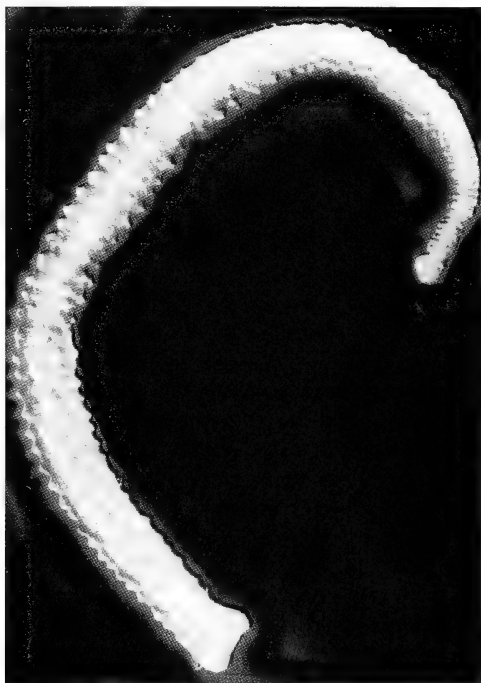

FIG. 18. *Moorebdellina rugosa*, lateral view.

Posterior sucker: medium sized, centrally attached, facing directly posteriorly, ocelli absent.

Digestive system. Esophageal diverticula present or absent. Crop chambers developed in varying degrees, without lateral processes. Posterior crop caeca nontotally fused with 5 fenestrae without lateral processes. Intestinal chambers varying in their development, lateral processes present or absent. Rectum varying in its development.

Reproductive system. Four to six pairs of testisacs. Seminal reservoirs long, loop-like. Common parts not great. Accessory glandular mass small, covering posterior surface of common part of ejaculatory ducts. Bursa short or long. Ovisacs not extending posterior to ganglion 8. Conductive tissue present. Copulatory area absent.

Coelomic system. Dorsal, ventral, lateral, marginal, and testicular lacunae present. Main and accessory connections present. Small pulsatile vesicles (dilations of marginal lacunae) located at site of connection with lateral lacuna.

Host data: only one specimen was collected from Pycnogonida.

Distribution (Fig. 16): Atlantic, Indian and Pacific sector of Antarctic region.

Congenitors: *M. biannulata* Moore, 1957; *M. uschakovi* Epstein, 1974; *M. meyeri* A.Utevsky, 1997. Found only in Antarctic region.

References: Moore 1938, Epshtein 1972, Sawyer 1986, Utevsky 2000.

Key to the Species of the Genus *Moorebdellina*

- 1a Complete somite 2-annulate
..... *M. biannulata* (p. 34)
- 1b Complete somite more than 2-annulate ... 2
- 2a Complete somite 4-annulate; A₁ with 6 papillae; A₂, B₅, B₆ with 8 papillae
..... *M. rugosa* (p. 32)
- 2b Complete somite 3-annulate 3
- 3a Annuli A₁ and A₃ with many small tubercles, A₂ with 4 papillae *M. uschakovi* (p. 36)
- 3b Annulus A₁ with 6 papillae, A₂, and A₃ with 8 papillae *M. meyeri* (p. 38)

Moorebdellina rugosa (Moore, 1938)
(Syn. *Pontobdella rugosa* Moore, 1938)

1. External characters (Figs. 17, 18). Medium-sized leeches. Up to 40.5 mm in length and 2.5 mm in width. Body long, cylindrical, distinctly divided into trachelosome and urosome. Anterior sucker small, distinctly divided from trachelosome, eccentrically attached; with two eye-like spots and small tubercles and papillae; mouth-pore centrally located (Fig. 17: 2). Posterior sucker medium-sized, but larger than anterior sucker, centrally attached, facing directly posteriorly, divided into 2 rings by furrows, without papillae (Fig. 17: 3).

Annulation. Clitellum 6-annulate (Fig. 17: 4). Male gonopore located between annuli 1 and 2, female gonopore between 4 and 5. External copulatory area absent. Complete somite 4-annulate (annulus A₃ include annuli B₅, B₆), and annulus A₁ with large papillae; A₂, B₅, B₆ with 8 large papillae 2 or 3 small papillae situated between large tubercles; additional annulation sometimes present (Fig. 17: 5). Anus on first annulus from posterior sucker (Fig. 17: 3).

Coloration. Anterior sucker with transverse bar which unites a pair of eye-like spots. Radial brownish stripes on posterior sucker. Its dorsal surface light brownish with unpigmented spots around papillae; its ventral surface light-colored. Trachelosome with 5 pigmented bands. Each side of urosome with 13 oval

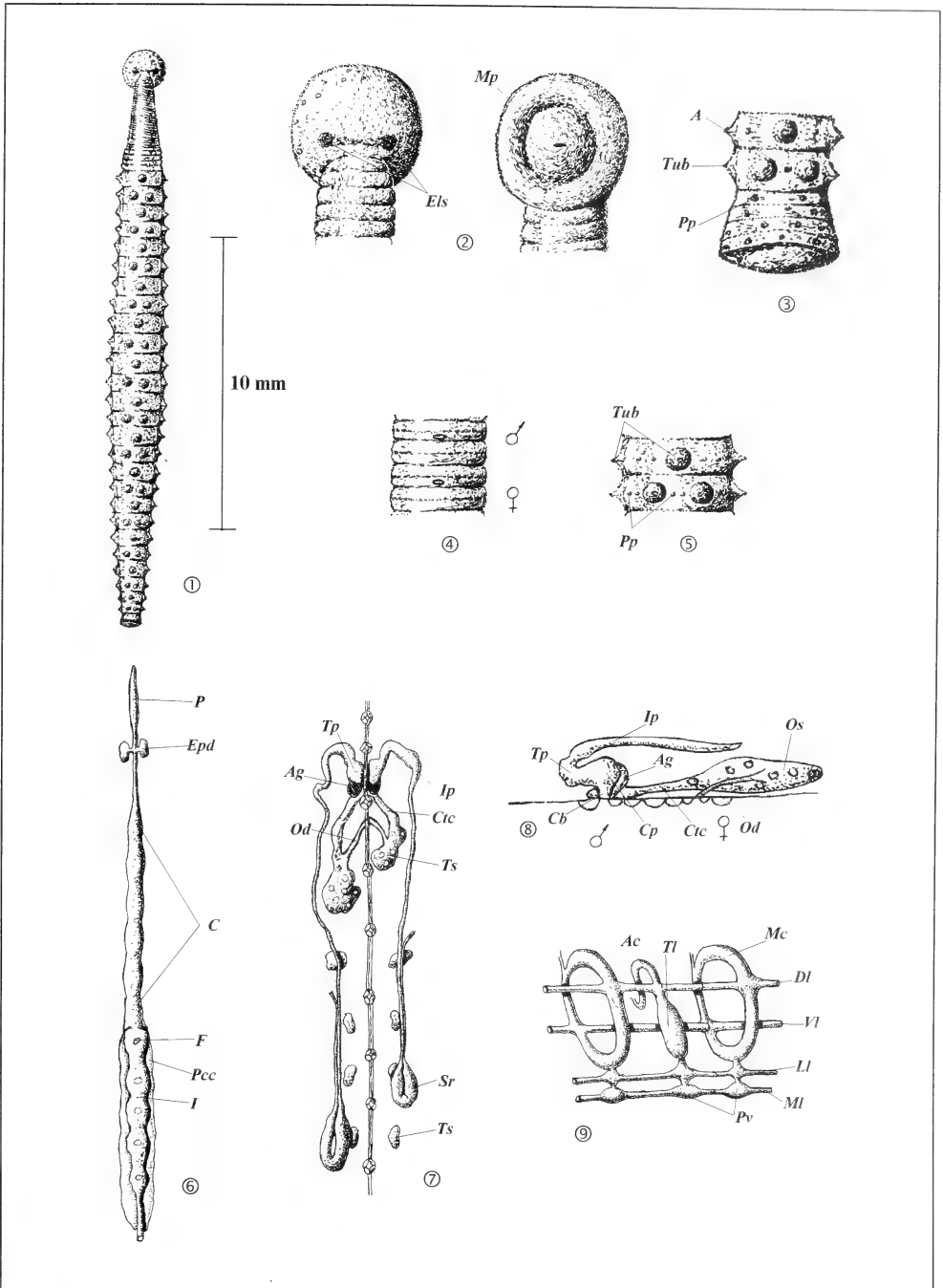

FIG. 19. *Moorebdellina biannulata*, external and internal structure: 1, common view; 2, anterior sucker (dorsal and ventral view); 3, posterior sucker; 4, clitellum (ventral view); 5, somite (dorsal view); 6, digestive system; 7, reproductive system (dorsal view); 8, reproductive system (lateral view); 9, coelomic system (reconstruction).

unpigmented spots on 1-3 annuli of somite sharply narrowing on more pigmented annulus 4.

2. Digestive system (Fig. 17: 6). Base of proboscis at ganglion 3 of ventral nerve cord. Esophageal diverticula absent. Crop chambers weakly developed, lateral processes absent. Posterior crop caeca nontotally fused with 5 fenestrae, without lateral processes. 5 well developed intestinal chambers, without lateral processes. Rectal dilation weakly developed.

3. Reproductive system (Fig. 17: 7, 8). 3 or 4 pairs of testisacs. Long seminal reservoirs extended to ganglion 10 of ventral nerve cord to coil. Ejaculatory ducts short, terminal parts wide. Accessory glandular mass covering posterior surface of common part of ejaculatory ducts. Common part small, bursa short. Ovisacs long, loop-like, extending to ganglion 8. Conductive tissue in form of two cords connected with ovisacs and fused posterior to vagina.

4. Coelomic system. Structure unknown.

5. Host data: one specimen collected from Pycnogonida.

6. Distribution (Fig. 16): Antarctic shelf between 50°-110°E - Indian sector of Antarctic region, Enderby Land - Atlantic sector.

References: Moore 1938; Epshtein 1972.

Moorebdellina biannulata (Moore, 1957)
(Syn. *Pontobdella biannulata* Moore, 1957)

1. External characters (Figs. 19, 20). Small or not large leeches. Up to 20 mm in length and 3.5 mm in width. Body long, cylindrical, distinctly divided into trachelosome and urosome (Fig. 19: 1). Anterior sucker medium-sized, distinctly divided from trachelosome, eccentrically attached, with two eye-like spots and small tubercles, mouth-pore centrally located (Fig. 19: 2). Posterior sucker small, smaller than anterior sucker, centrally attached, facing directly posteriorly, divided by furrows into 4 rings with papillae (Fig. 19: 3).

Annulation. Clitellum 4-annulate, with secondary annulation (Fig. 19: 4). Male gonopore located in posterior part of annulus 1, female gonopore in posterior part of annulus 3. External copulatory area absent. Complete somite 2-annulate. Annulus 1 with 6 large tubercles, annulus 2 with 8 tubercles, 2 or 3 papillae situated between tubercles; skin with longitudinal and transverse folds (Fig. 19: 5). Anus separated by 4 annuli from posterior sucker (Fig. 19: 3).

Coloration. Anterior sucker with two brownish transverse bars separated by unpigmented area. Second bar uniting a pair of eye-like spots. Radial light

brownish stripes on posterior sucker. Segmental bands of same color alternated with unpigmented areas on dorsum.

2. Digestive system (Fig. 19: 6). Base of proboscis at ganglion 3 of ventral nerve cord. Esophageal diverticula located between ganglia 4 and 5. Crop chambers weakly developed, lateral processes absent. Posterior crop caeca nontotally fused with 5 fenestrae, without lateral processes, extending to ganglion 21. Intestinal chambers weakly developed, without lateral processes. Rectal dilation weakly developed.

3. Reproductive system (Fig. 19: 7, 8). Four or five pairs of testisacs. Seminal reservoirs long, loop-like, usually extending to ganglion 12 of ventral nerve cord, enlarged at ganglion 12. Initial parts of ejaculatory ducts short, loop-like; terminal parts wide, oval. Accessory glandular mass covering posterior surface of terminal and common parts of ejaculatory ducts and bursa. Common part small, bursa short. Ovisacs short, voluminous, usually extending to ganglion 7. Conductive tissue in form of mass located adjacent to bursa and connected by two cords with ovisacs.

4. Coelomic system (Fig. 19: 9). Dorsal, ventral, lateral, testicular and marginal lacunae present. Main connections connecting dorsal and ventral lacunae at each ganglion. Accessory connections connecting each

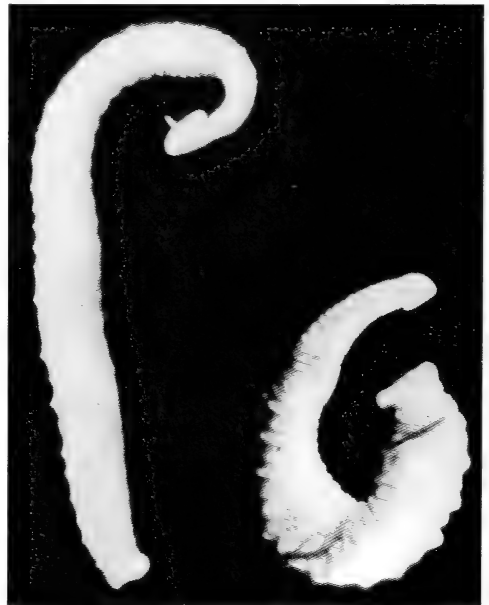

FIG. 20. *Moorebdellina biannulata*, lateral view.

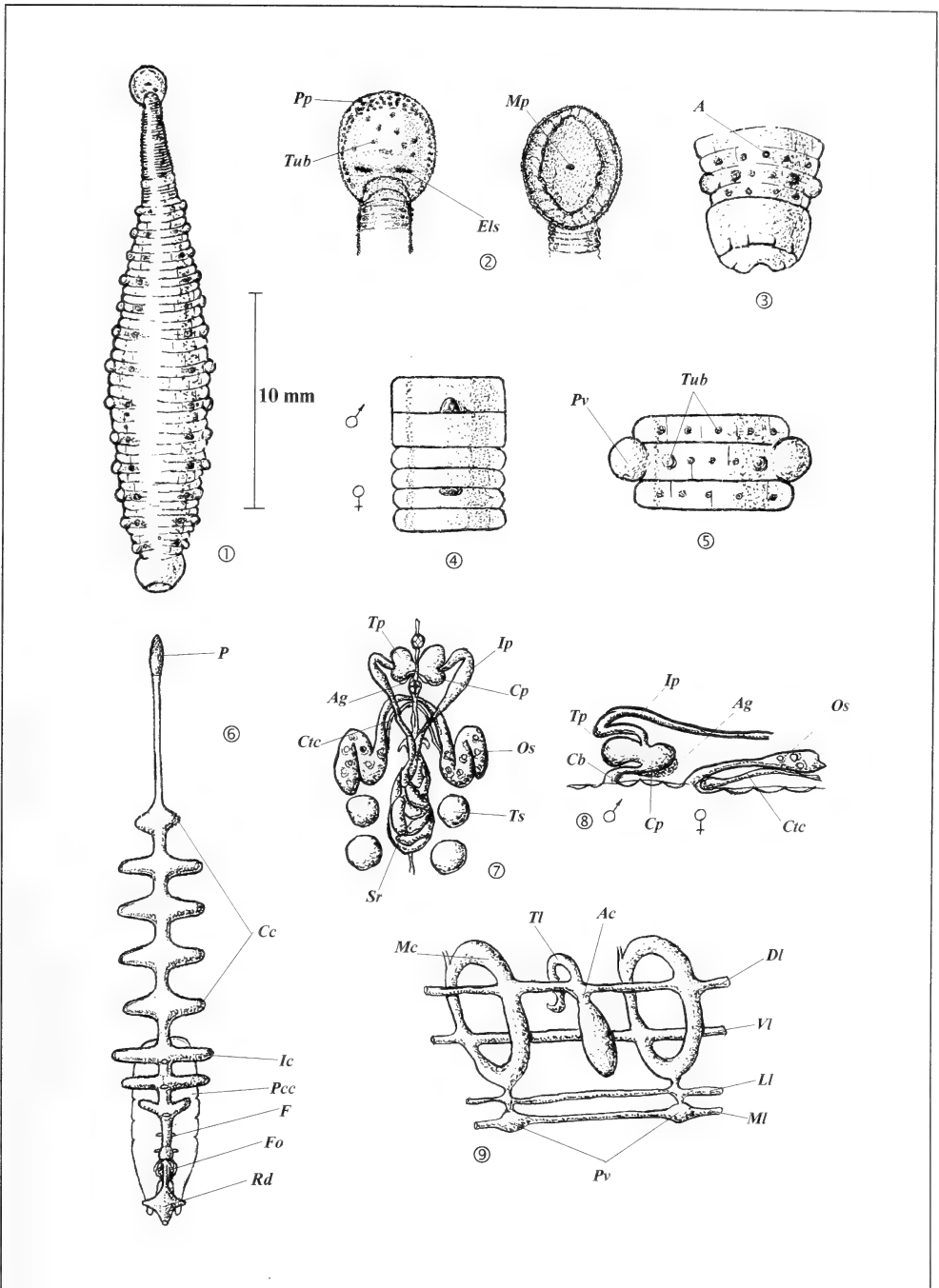

FIG. 21. *Moorebdellina uschakovi*, external and internal structure: 1, common view; 2, anterior sucker (dorsal and ventral view); 3, posterior sucker; 4, clitellum (ventral view); 5, somite (dorsal view); 6, digestive system; 7, reproductive system (dorsal view); 8, reproductive system (lateral view); 9, coelomic system (reconstruction).

testicular and dorsal lacunae. Lateral lacunae connecting main connections with accessory connections. Two pairs of small pulsatile vesicles (dilations of marginal lacunae) per mid-body somite. Pulsatile vesicles of one pair connected with main connection. Pulsatile vesicles of another pair connected with accessory connection.

5. Host data: all specimens were collected free-living.

6. Distribution (Fig. 16): Princess Martha Coast, Riiser-Larsen Sea - Atlantic sector of the Antarctic region; between 50°-70°E - Indian sector; Oates Coast and Cape Adare - Pacific sector.

References: Moore 1957, Epshtein & Okun' 1991.

Moorebdellina uschakovi Epstein, 1974

1. External characters (Figs. 21, 22). Not large leeches. Up to 25 mm in length and 3.0 mm in width. Body short (may be stretching), cylindrical, distinctly divided into trachelosome and urosome (Figs. 21: 1; 22). Anterior sucker small, distinctly divided from trachelosome, eccentrically attached; with two eye-like spots, papillae and tubercles, mouth-pore centrally located (Fig. 21: 2). Posterior sucker small, but larger than anterior sucker, centrally attached, facing directly posteriorly, without papillae (Fig. 21: 3).

Annulation. Clitellum 6-annulate (Fig. 21: 4). Male gonopore located between annuli 1 and 2, female gonopore between 4 and 5. External copulatory area absent. Complete somite 3-annulate, annuli A₁ and A₃ with many papillae, A₂ with 4 tubercles (two lateral papillae larger than two dorsal), 2 or 3 papillae situated between tubercles on dorsum of A₂ (Fig. 21: 5). Anus on third annulus from posterior sucker (Fig. 21: 3).

Coloration. Dorsal surface light brownish with tints of violet, ventral surface light. Annuli A₁ and A₃ pigmented, A₂ without pigment.

2. Digestive system (Fig. 21: 6). Base of proboscis at ganglion 3 of ventral nerve cord. Esophageal diverticula absent. Five diamond-shaped crop chambers without lateral processes. Posterior crop caeca non-totally fused with 5 fenestrae, without lateral processes, extending to ganglion 20. Three intestinal chambers with lateral processes and "folded organ" [Fo]. Rectal dilation present.

3. Reproductive system (Fig. 21: 7, 8). Five pairs of testisacs. Seminal reservoirs well developed, in form of a number of loops, extending posterior to ganglion 12 of ventral nerve cord. Initial parts of ejacula-

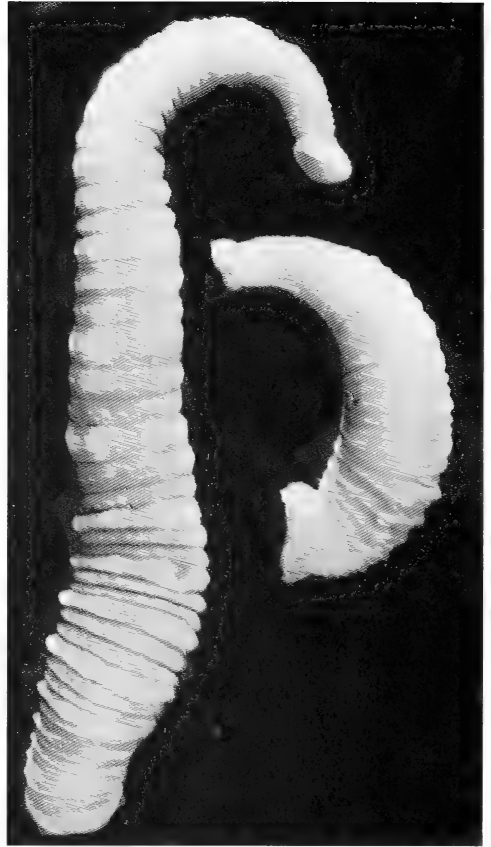

FIG. 22. *Moorebdellina uschakovi*, lateral view.

tory ducts short, terminal parts wide, kidney-shaped. Accessory glandular mass covering posterior surface of common parts of ejaculatory ducts and bursa. Common part short and wide, bursa long. Ovisacs long, in form of a number of loops located between ganglia 6 and 9. Conductive tissue in form of mass located posterior to female gonopore and connected by two cords with ovisacs.

4. Coelomic system (Fig. 21: 9). Dorsal, ventral, lateral, testicular, and marginal lacunae present. Main connections connecting dorsal and ventral lacunae at each ganglion. Accessory connections connecting each testicular and dorsal lacunae. Lateral lacunae connecting main connections with accessory connections. One pair of pulsatile vesicles (dilations of marginal lacunae) per complete somite. Pulsatile vesicles connected with main connection.

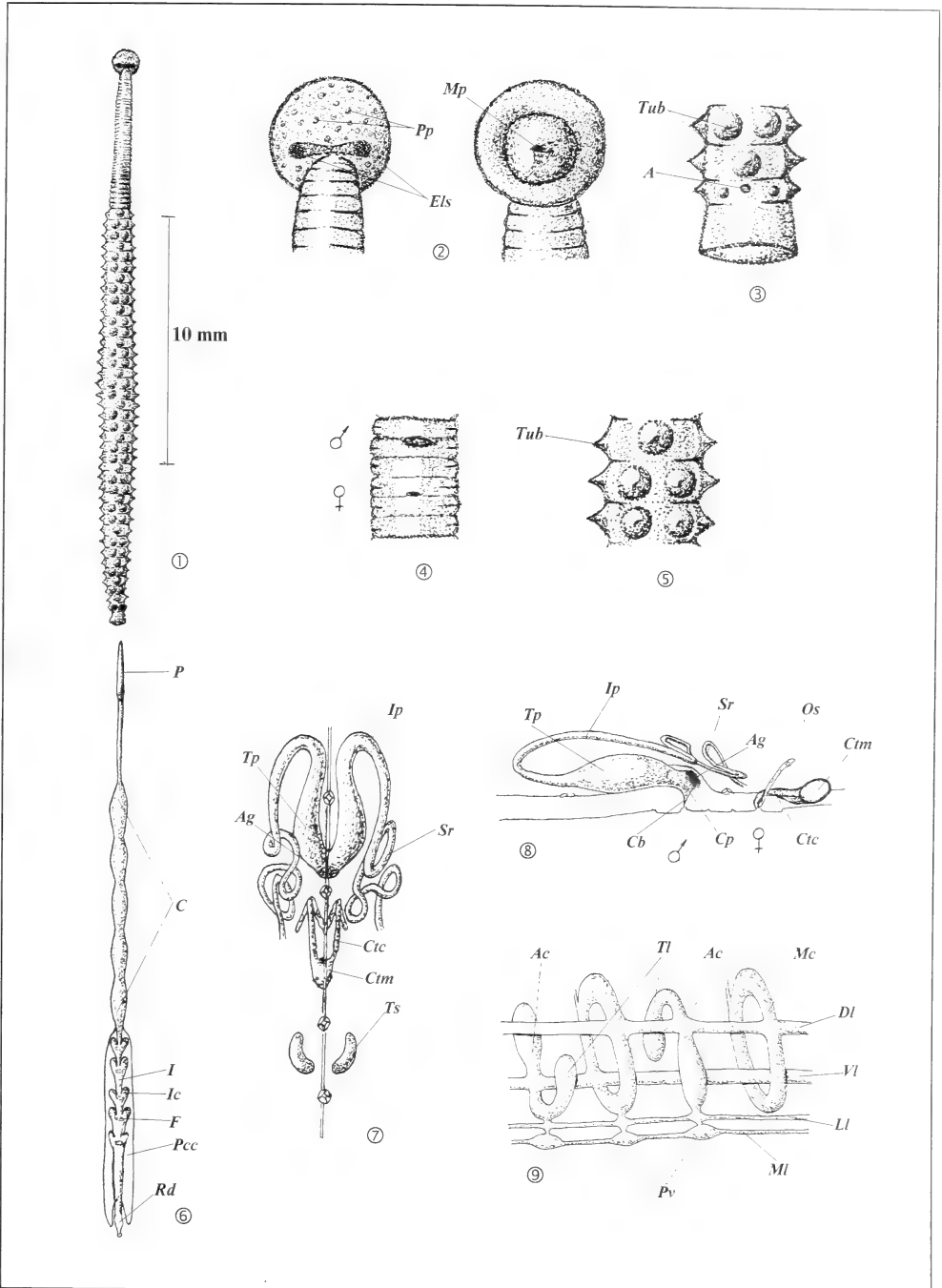

FIG. 23. *Moorebdellina meyeri*, external and internal structure: 1, common view; 2, anterior sucker (dorsal and ventral view); 3, posterior sucker; 4, clitellum (ventral view); 5, somite (dorsal view); 6, digestive system; 7, reproductive system (dorsal view); 8, reproductive system (lateral view); 9, coelomic system (reconstruction).

5. Host data: all specimens were collected free-living.

6. Distribution (Fig. 16): Crozet Is. - Indian sector of the Antarctic region; S. Georgia I. - Atlantic sector.

References: Epshtein 1974.

Remark: this species has been included in the genus *Moorebdellina* by Epshtein (1974). However coelomic system differs from those in other members of Pontobdellinae by having only one pairs of pulsatile vesicles per somite. Thus, the subfamilia affiliati-on open to question.

Moorebdellina meyeri A.Utevsky, 1997

1. External characters (Figs. 23, 24). Not large leeches. Up to 23.5 mm in length and 1.5 mm in width. Body long, cylindrical, distinctly divided into trachelosome and urosome (Figs. 23: 1; 24). Anterior sucker small, distinctly divided from trachelosome, eccentrically attached; with two eye-like spots and papillae; mouth-pore centrally located (Fig. 23: 2). Posterior sucker small, smaller than anterior sucker, centrally attached, facing directly posteriorly, without papillae (Fig. 23: 3).

Annulation. Clitellum 6-annulate (Fig. 23: 4). Male gonopore located between annuli 1 and 2, female gonopore between 4 and 5. External copulatory area absent. Complete somite 3-annulate, annulus A₁ with 6 tubercles, A₂ and A₃ with smaller tubercles (Fig. 23: 5). Anus on first annulus from posterior sucker (Fig. 25: 3).

Coloration. Anterior sucker with two pigmented area around eye-like spots. Body with light pigment bands (the examined specimens most likely are unpigmented after alcohol fixation).

2. Digestive system (Fig. 23: 6). Base of proboscis located between ganglia 3 and 4 of ventral nerve cord. Esophageal diverticula absent. Crop chambers weakly developed, without lateral processes. Posterior crop caeca nontotally fused with 5 fenestrae, without lateral processes, extending to posterior ganglion mass. Posterior portion of posterior crop caeca separated. 5 intestinal chambers well developed, without lateral processes. Rectal dilation present.

3. Reproductive system (Fig. 23: 7, 8). Six pairs of testisacs. Seminal reservoirs long, loop-like, usually located between ganglia 6 and 7 of ventral nerve cord, very coiled. Initial parts of ejaculatory ducts short, loop-like; terminal parts wide. Accessory glandular mass small, covering posterior surface of common part. Common part small, bursa short. Ovisacs short,

usually located between ganglia 6 and 7. Conductive tissue in form of mass located between ganglia 6 and 7, and two cords extending to vagina and connected with ovisacs.

4. Coelomic system (Fig. 23: 9). Dorsal, ventral, lateral, testicular, and marginal lacunae present. Main connections connecting dorsal lacuna with ventral lacuna near each ganglion. Accessory connections of 1–2 pair of testisacs connecting testicular lacunae with ventral lacuna. Accessory connection of 3–6 pairs of testisacs connecting testicular lacunae with dorsal lacuna. Lateral lacunae connecting main connections with accessory connections. Two pairs of small pulsatile vesicles (dilations of marginal lacunae) per complete somite. Pulsatile vesicles of one pair connected with main connection. Pulsatile vesicles of another pair connected with accessory connection. The number of vesicles per somite may be inconstant.

5. Host data: all specimens were collected free-living.



FIG. 24. *Moorebdellina meyeri*, dorso-lateral view.

6. Distribution (Fig. 16): S. Orkney Is.- Atlantic sector of the Antarctic region.

References: Utevsky 1997.

Genus *Megaliobdella*

Meyer & Burreson, 1990

Type species: *Megaliobdella szidati* Meyer & Burreson, 1990

Very large leeches. Body long, cylindrical, tapering to suckers, with large, cone-like tubercles. Complete somite sharply divided into annuli. External copulatory area on clitellum absent.

Anterior sucker: small, eccentrically attached, sharply separated by neck from trachelosome; with one pair of eyes; with transverse furrows on dorsal surface.

Posterior sucker: small, indistinctly divided from urosome; without ocelli, with papillae on dorsal surface.

Structure of Digestive, Reproductive and Coelomic systems poorly known.

No host data.

Monotypic genus.

Distribution (Fig. 25): Pacific sector of the Antarctic region.

Reference: Meyer & Burreson 1990.

Remark: *Megaliobdella szidati* was placed only provisionally in the subfam. Pontobdellinae (Meyer & Burreson 1990). The description of this species and genus was based on external characters. Thus, the subfamilial affiliation of *M. szidati* is open to question.

Megaliobdella szidati Meyer & Burreson, 1990*

1. External characters (Fig. 26). Very large leeches. Up to 340 mm in length and 13 mm in width. Body long, cylindrical, indistinctly divided into trachelosome and urosome, enlarged from anterior to posterior sucker, with many truncated conic tubercles on trachelosome and urosome. Anterior sucker small, sharply separated by neck from trachelosome, eccen-

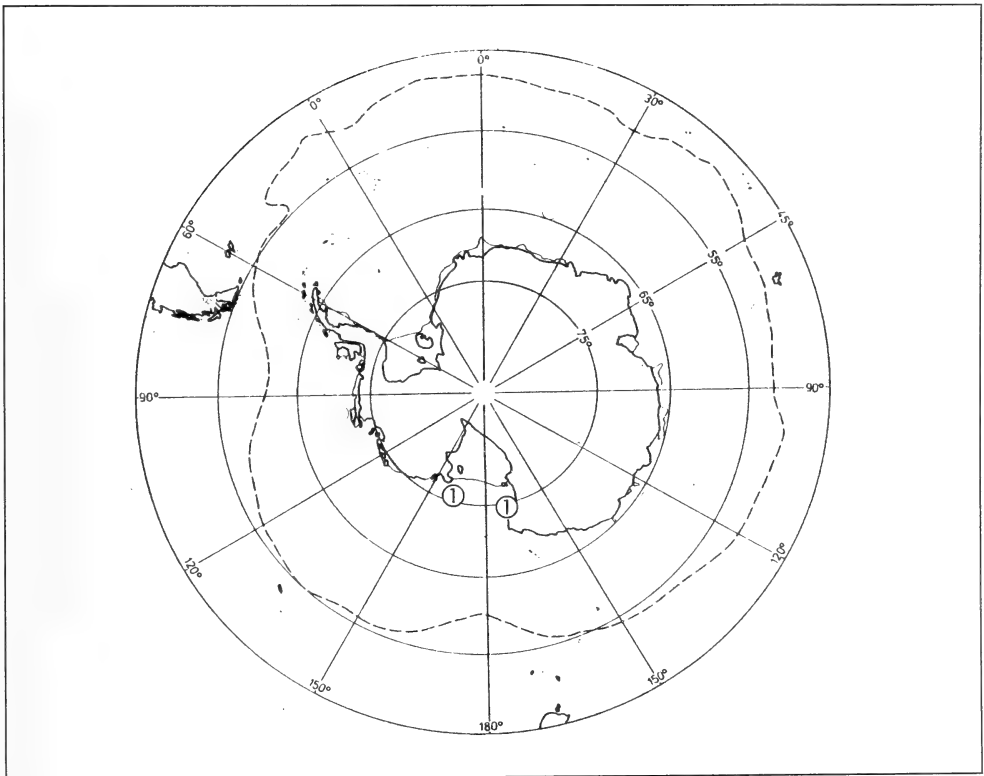

FIG. 25. Distribution of the *Megaliobdella szidati*.

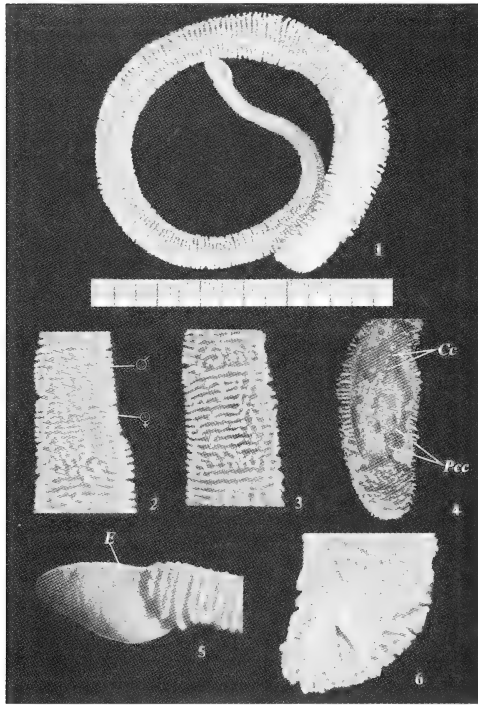

FIG. 26. *Megaliobdella szidati*, external and internal structure: 1, common view; 2, clitellum (ventral view); 3, somite; 4, elements of digestive system (dorsal view) 5, anterior sucker (lateral view); 6, posterior sucker (ventral view).

trically attached, with 9 transverse furrows on dorsal surface; one pair of eyes present (Fig. 26: 4). Posterior sucker small, but larger than anterior sucker, terminal, indistinctly divided from urosome, eccentrically attached, with many tubercles similar to those on body, margin of sucker with smaller tubercles, ocelli absent (Fig. 26: 5).

Annulation. Preclitellar region 60-72-annulate, clitellum 12-17-annulate, male gonopore on annulus 1, female gonopore between annuli 10 and 11 (copulatory area absent) (Fig. 26: 2). Complete somite 12-annulate with 18-25 large tubercles on each annulus and some small tubercles (papillae) (Fig. 26: 3).

Coloration. Dorsal surface with two brownish stripes. Ventrums lighter. Segmental bands absent. Body of preserved specimens light brown.

2. Digestive system. Structure poorly known. Last chamber of crop with 3 pairs of short lateral processes. Posterior crop caeca nontotally fused, with 3

chambers and 3 fenestrae, without lateral processes. Intestine wide, without lateral processes and distinct chambers. Rectal dilation absent.

3. Reproductive system. Structure unknown.

4. Coelomic system. Structure unknown.

5. No host data.

6. Distribution (Fig. 25): collected at 77°42.0'S, 167°22.0'W (Ross Sea) - Pacific sector of the Antarctic region.

Reference: Meyer & Bureson 1990.

“Subfamily Platybdellinae”

Diagnosis. Leeches of varying sizes; body long or short, cylindrical, subcylindrical or flattened. Externally visible pulsatile vesicles absent. Tubercles, papillae, marginal flanges, eyes, eye-like spots, segmental ocelli, ocelli on posterior sucker absent or present.

Digestive system of varying structure, posterior crop caeca of varying degrees of fusion (from totally free to totally fused) or absent.

Reproductive system of varying structure.

Coelomic system of varying structure: from simple coelomic system consisting of ventral lacunae only to well developed system with connections, lateral and marginal lacunae. Pulsatile vesicles absent.

References: Sawyer 1986; Epshtein *et al.* 1994.

Key to the Antarctic Genera of the “Subfamily Platybdellinae”

- 1a Body sharply divided into trachelosome and urosome, wide and flattened 2
- 1b Body not sharply divided into trachelosome and urosome, not wide and not flattened ... 3
- 2a Eye, eye-like spots, ocelli absent; tegument opaque; posterior crop caeca absent Genus *Epsteinia* (p. 41)
- 2b 2 eye-like spots on anterior sucker; tegument translucent with pigment cells; posterior crop caeca nontotally fused with 4 fenestrae Genus *Austrobdella* (p. 42)
- 3a Body with marginal flanges Genus *Pleurobdella* (p. 46)
- 3b Body without marginal flanges 4
- 4a 10–12 pairs of tubercles on urosome; anterior sucker with eye-like spots; posterior sucker small, facing directly posteriorly Genus *Glyptonotobdella* (p. 49)
- 4b Tubercles absent; anterior sucker without eye-like spots; posterior sucker medium-sized or large, facing ventrally Genus *Cryobdella* (p. 52)

Genus *Epsteinia* A. Utevsky, 1994

Type species: *Trulliobdella alba* Epstein, 1970

Not large leeches. Body distinctly divided into trachelosome and urosome. Segmental ocelli absent. Complete somite 3-annulate with additional annulation.

Anterior sucker: small, distinctly divided from trachelosome, surface smooth, eyes or eye-like spots absent.

Posterior sucker: small, distinctly divided from urosome, surface smooth, ocelli absent.

Digestive system. Esophageal diverticula present. Crop chambers diamond-shaped with small lateral processes. Posterior crop caeca absent. Intestine with lateral processes. Rectal dilation present.

Reproductive system. Five pairs of testisacs. Seminal reservoirs long, ejaculatory ducts short, terminal parts wide, common part small, bursa short, acces-

sory glands absent. Conductive tissue absent, external copulatory area present.

Coelomic system. Structure unknown.

Host data: fam. Nototheniidae (Ord. Perciformes).

Distribution (Fig. 27): Enderby Land - Atlantic sector of the Antarctic region.

Monotypic genus.

References: Epshtein 1970b, Utevsky 1994.

Epsteinia alba (Epstein, 1970)

(Syn. *Trulliobdella alba* Epstein, 1970)

1. External characters (Figs. 28, 29). Not large leeches. Up to 30 mm in length and 8 mm in width. Body short and wide, distinctly divided into subcylindrical trachelosome and flattened urosome. Anterior sucker small, distinctly divided from trachelosome, centrally attached, surface smooth, mouth-pore centrally lo-

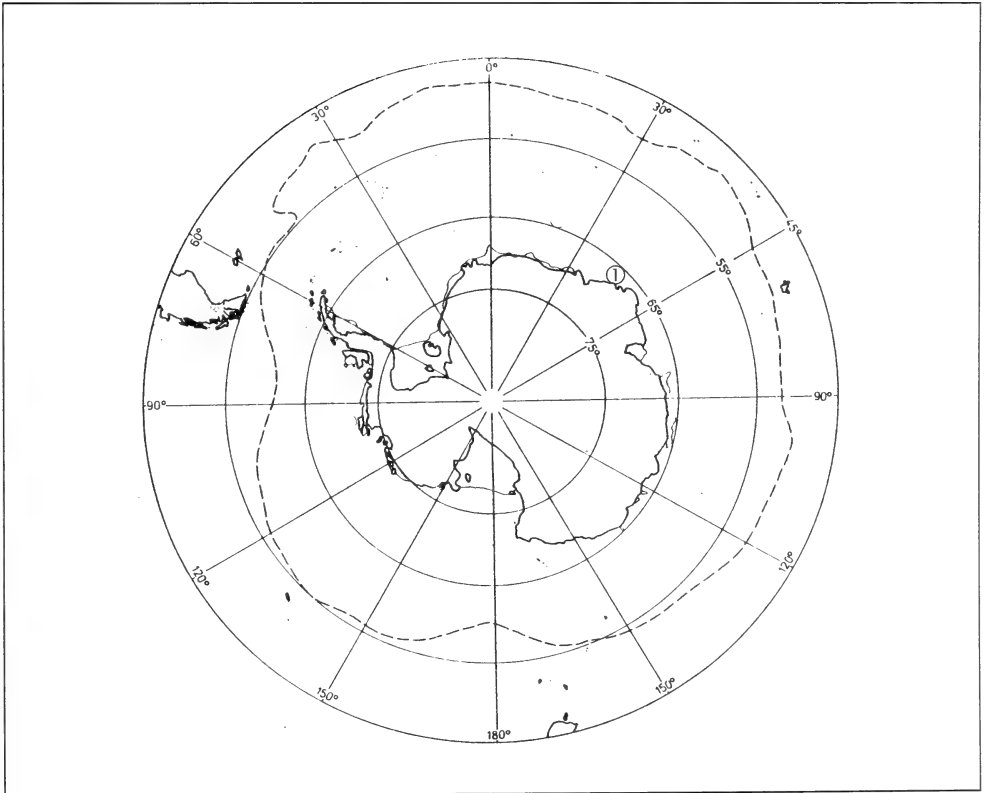

FIG. 27. Distribution of the *Epsteinia alba*.

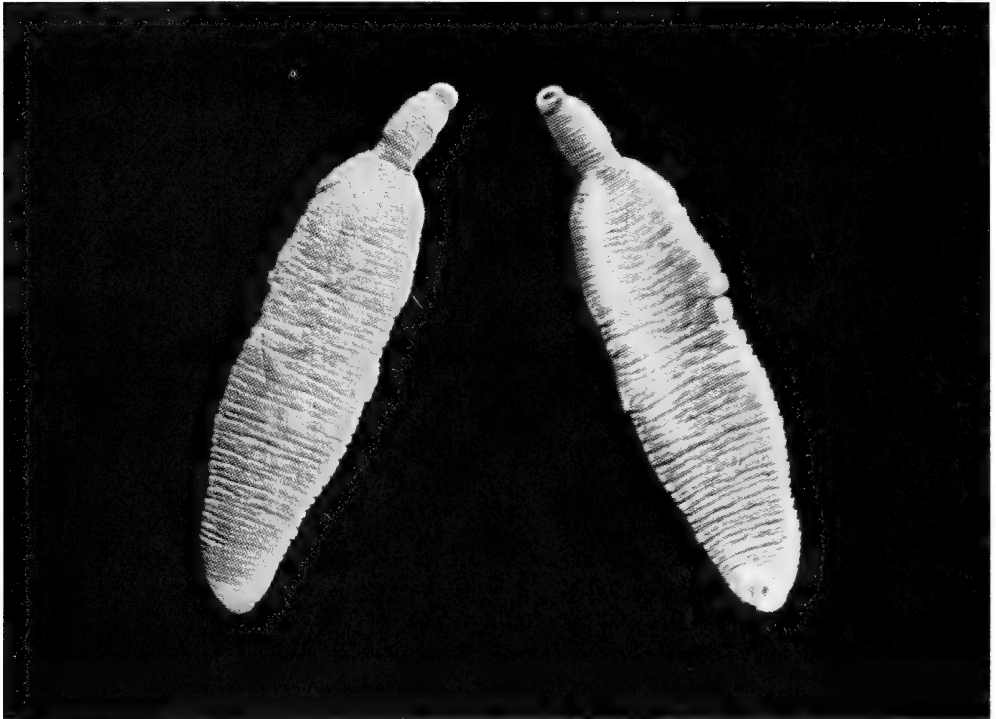

FIG. 28. *Epsteinia alba*, dorsal and ventral view (Photo. Epshtein V.M.).

cated (Figs. 28, 29: 2). Posterior sucker small, but larger than anterior one, excentrically attached, surface smooth (Figs. 28, 29: 3).

Annulation. Clitellum 8-annulate (Fig. 29: 4). Male gonopore located in depression between annuli 3 and 4, female gonopore in depression between annuli 6 and 7. 3rd annulus enlarged in central part, 4th bent posteriorly and covering annuli 5 and 6, annulus 7 bent posteriorly also. Copulatory area in depression around female gonopore. Complete somite 3-annulate with additional annulation of 2nd degree. Dimensions of annuli variable, without tubercles or papillae, wrinkled.

Coloration. Body light colored but dorsum more dark than venter. No numerous large brown pigment cells visible in skin.

2. Digestive system (Fig. 29: 5). Base of proboscis located between ganglia 3 and 4 of ventral nerve cord. Large esophageal diverticula between ganglia 4 and 5. Five diamond-shaped crop chambers with small lateral processes. Posterior crop caeca absent. Five well

developed intestinal chambers with voluminous lateral processes. Rectal dilation weakly developed.

3. Reproductive system (Fig. 29: 6, 7). Five pairs of testisacs. Seminal reservoirs well developed in form of some loops between ganglia 6 and 7 of ventral nerve cord. Initial parts of ejaculatory ducts slightly coiled, sharply divided from more wide terminal parts. Accessory glands absent. Common part small, bursa short. Ovisacs voluminous extending behind ganglion 8. Conductive tissue absent.

4. Coelomic system. Structure unknown.

5. Host data: on caudal fin of *Trematomus borchgrevinki*.

6. Distribution (Fig. 27): Enderby Land - Atlantic sector of the Antarctic region.

References: Epshtein 1970b, Utevsky 1994.

Genus *Austrobdella* Badham, 1916

Type species: *Austrobdella translucens* Badham, 1916.

Not large or small leeches. Body flattened, distinctly divided into trachelosome and urosome, surface

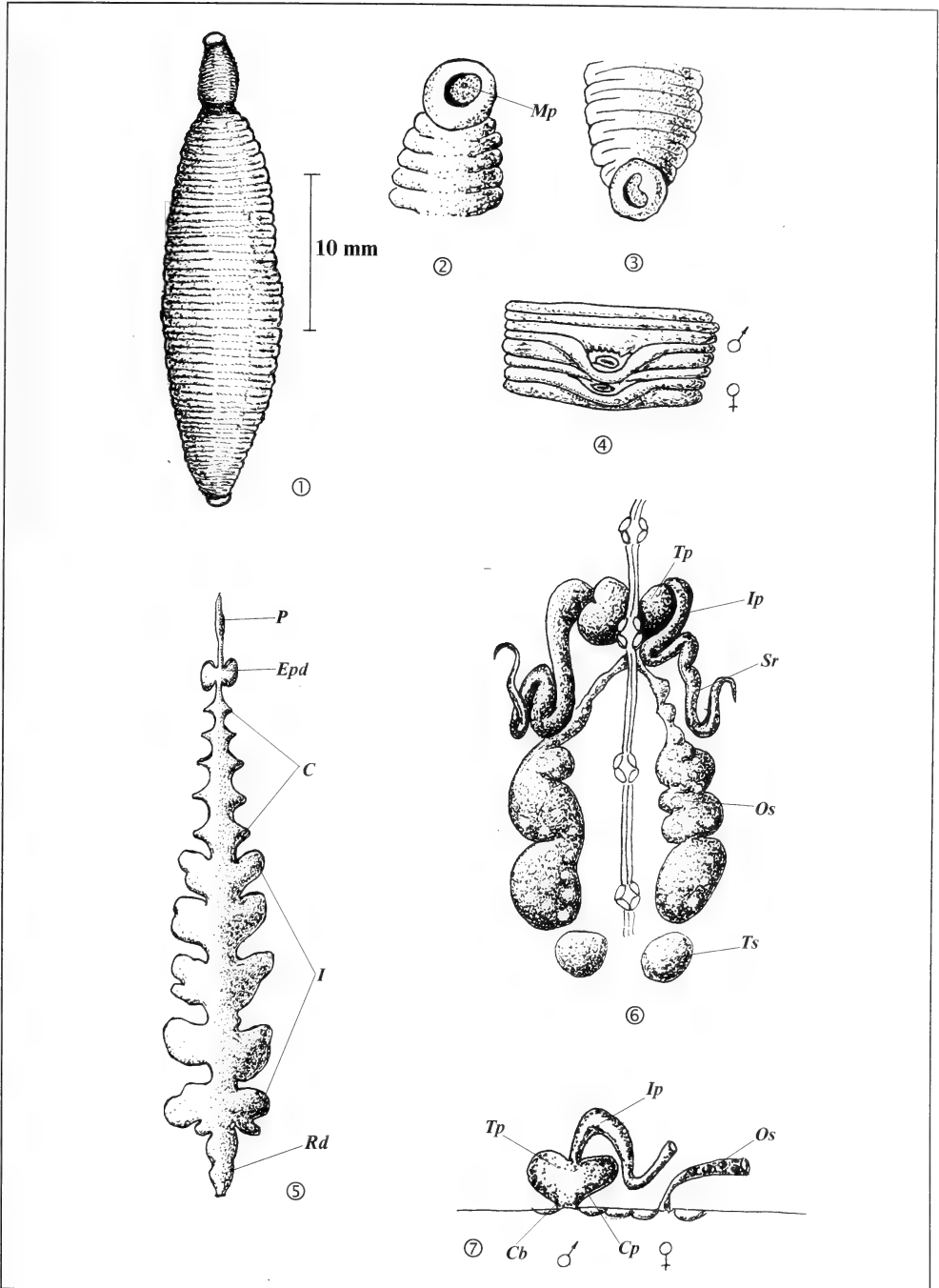

FIG. 29. *Epsteinia alba*, external and internal structure: 1, dorsal view; 2, anterior sucker (ventral view); 3, posterior sucker (ventral view); 4, clitellum (ventral view); 5, digestive system (dorsal view); 6, reproductive system (dorsal view); 7, reproductive system (lateral view).

smooth, without ornamentation. Complete somite 6-annulate, without segmental ocelli and pigment bands.

Anterior sucker: small, distinctly divided from tracheosome, surface smooth, eye-like spots present or absent.

Posterior sucker small, distinctly divided from urosome, surface smooth, ocelli absent.

Digestive system. Esophageal diverticula present or absent. Crop chambers well developed, lateral processes present or absent. Posterior crop caeca nontotally fused, with fenestrae. Intestine with chambers, lateral processes present or absent.

Reproductive system. Bursa long, accessory glands present. Conductive tissue and copulatory area absent, vagina long.

Coelomic system. Dorsal, ventral, marginal and testicular lacunae present. Main connections absent, accessory connections present or absent.

Host data: *Sillago ciliata* (*A. translucens*), *Rhombosolea tapirina* (*A. bilobata*); *Hippoglossina stomata*, *Pleuronichthis verticalis*, *P. decurrens*, *Scorpaena guttata* (*A. californiana*)

Distribution (Fig. 30): coastal waters of Greenland, California, Tasmania, Australia and East Antarctica.

Congenitors: *A. aniculata* Moore, 1940 - Greenland
A. bilobata Ingram, 1957 - Tasmania, Pacific Ocean
A. californiana Burreson, 1977 - California, Pacific Ocean

References: Badham 1916, Sawyer 1986, Epshtein *et al.* (1994).

Austrobdella translucens Badham, 1916*

1. External characters. Small leeches. Up to 13 mm in length and 3.25 mm in width. Body short and wide, distinctly divided into subcylindrical trache-

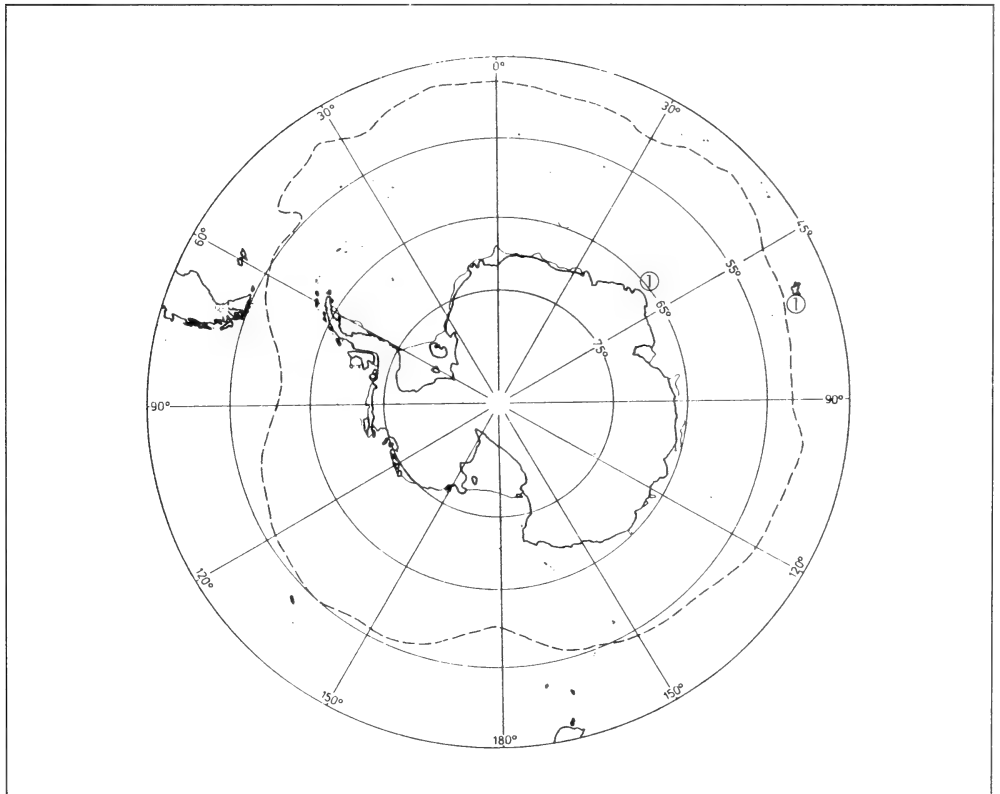

FIG. 30. Distribution of the *Austrobdella translucens*.

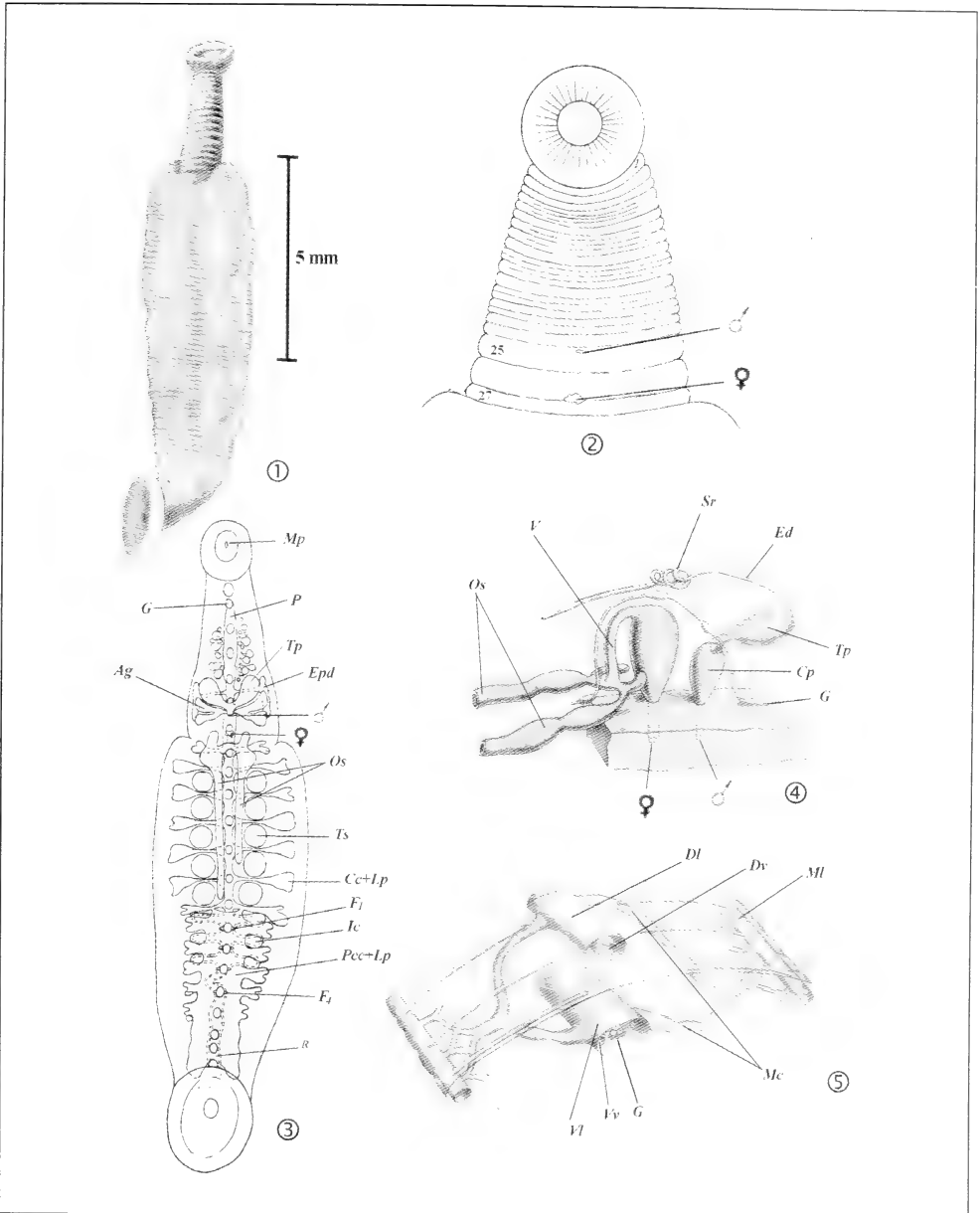

FIG. 31. *Austrobdella translucens*, external and internal structure (reproduced and modified from Badham 1916).

losome and flattened urosome (Fig. 31: 1). Anterior sucker small, distinctly divided from trachelosome, surface smooth with pair of eye-like spots, mouth-pore centrally located (Fig. 31: 2). Posterior sucker

small, but larger than anterior one, distinctly divided from urosome, surface smooth without ocelli.

Annulation. Complete somite 3-annulate with additional annulation of 2nd degree.

Coloration. Skin semitransparent with brownish-red, yellow and purple individual pigment cells.

2. Digestive system (Fig. 31: 3). Base of proboscis near ganglion 3 of ventral nerve cord. Esophageal diverticula between ganglia 4 and 5. Six small crop chambers with long lateral processes which may be bifurcated at their endings. Posterior crop caeca non-totally fused with 4 fenestrae and 6 lateral processes which may be bifurcated to end. Intestine with 3 large chambers. Rectal dilation absent.

3. Reproductive system (Fig. 31: 3, 4). Five pairs of testisacs. Seminal reservoirs short, coiled at ganglion 6 of ventral nerve cord. Initial parts of ejaculatory ducts short, loop-like, terminal parts wide, common part voluminous, bursa long. Accessory glandular mass covering terminal and common parts of male reproductive system. Ovisacs long, extending to ganglion 12, vagina long and glandular. Ovisacs with projections in place of connections with vagina. Conductive tissue and copulatory area absent.

4. Coelomic system (Fig. 31: 5). Dorsal, ventral, marginal lacunae present. Main connection completely closed: connecting dorsal and ventral lacunae. Marginal lacunae connected with main connections and hypodermal lacunae.

5. Host data: Collected from *Sillago ciliata* - Pacific Ocean, *Nothothenia* sp. and *Chaenocephalus* sp. in the Antarctic region.

6. Distribution (Fig. 30): Southern Coast of Australia, Kerguelen Is. - Indian sector of the Antarctic region.

References: Badham 1916, Moore 1957.

Genus *Pleurobdella* A.Utevsky, 1995

Type species: *Oxytonostoma varituberculata* Moore, 1938

Not large leeches. Body long, cylindrical or sub-cylindrical, with tubercles, papillae, and/or marginal flanges from anterior to posterior sucker. Complete somite 6-annulate, with additional annulation. Segmental pigmentation present.

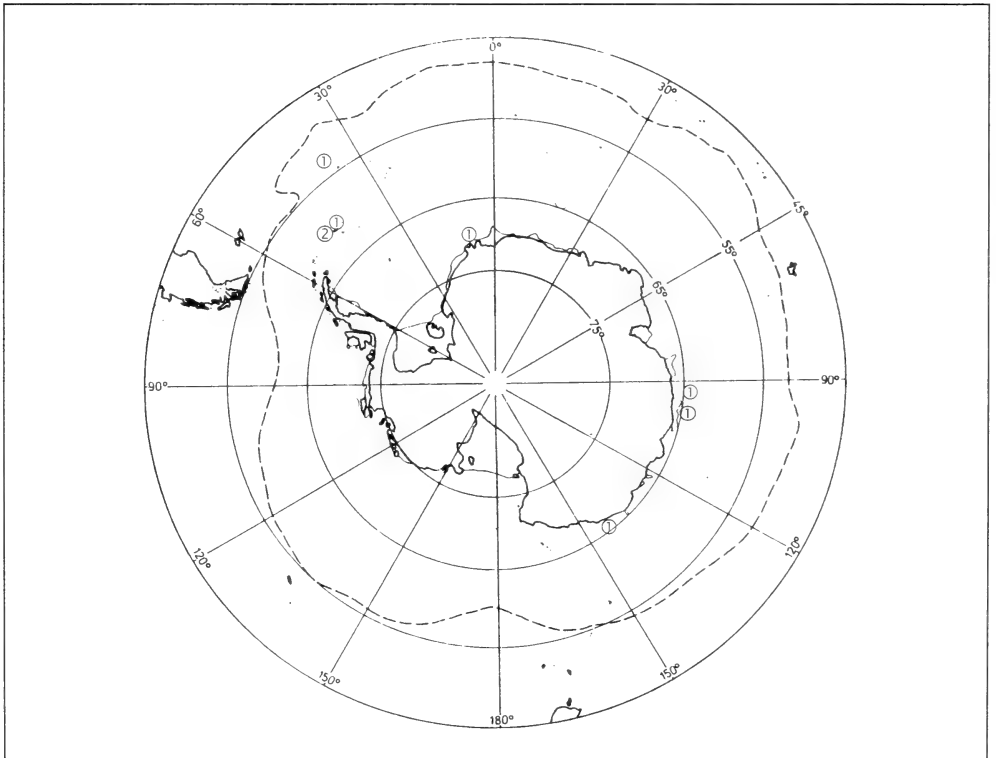

FIG. 32. Distribution of the gen. *Pleurobdella*. 1 – *P. varituberculata*; 2 – *P. australis*.

Anterior sucker: various size, eccentrically attached, with pair of eye-like spots, mouth-pore centrally located.

Posterior sucker: small, indistinctly divided from urosome, facing directly posteriorly.

Digestive system. Small esophageal diverticula present. Crop chambers with small double lateral processes. Posterior crop caeca nontotally fused, with 5 fenestrae. Intestine chambers with small lateral processes. Rectal dilation present.

Reproductive system. Five or six pairs of testisacs. Seminal reservoirs long, loop-like. Common part small. Accessory glands absent. Bursa long, with internal copulatory area. Ovisacs long. Conductive tissue well developed, beginning prior to terminal parts of male reproductive system, rounding terminal parts, common part, and copulatory bursa and extending to posterior parts of ovisacs. External copulatory area absent or present.

Coelomic system. Dorsal, ventral, marginal and testicular lacunae present. Main and accessory connections absent.

Host data: Pycnogonida.

Distribution (Fig. 32): Atlantic and Indian parts of the Antarctic region.

Congenitors: *P. australis* (Epstein, 1970).

References: Moore 1938, Utevsky 1995, Utevsky 2000.

Key to the Species of the Genus *Pleurobdella*

- 1a Anterior sucker small, body with small tubercles *P. varituberculata* (p. 47)
 1b Anterior sucker large, body with small papillae *P. australis* (p. 49)

Pleurobdella varituberculata (Moore, 1938)

(Syn. *Oxytonostoma varituberculata* Moore, 1938)

1. External characters (Figs. 33, 34). Not large leeches. Up to 27 mm in length and 2.4 mm in width. Body long, subcylindrical, sharply narrowing to anterior sucker, indistinctly divided into trachelosome and urosome. Body surface with small tubercles and papillae. Two marginal flanges extending from anterior to posterior sucker (Fig. 33: 1). Anterior sucker small, distinctly divided from trachelosome, eccentrically attached; papillae and eyes-like spots on dorsal surface, edge rough, mouth-pore centrally located (Fig. 33: 2). Posterior sucker small, but larger than anterior

sucker, indistinctly divided from urosome, centrally attached, facing directly posteriorly, divided by 2 furrows into 3 rings with papillae (Fig. 33: 3).

Annulation. Clitellum 5-annulate with additional annulation of 2nd degree, annulus 5 more shorter than other (Fig. 33: 4). Male gonopore at posterior part of annulus 2 on tubercle; female gonopore in centre of annulus 5, external copulatory area absent.

Complete somite 6-annulate with obscure additional annulation. Each annulus may be divided into 3 annuli, annulus 2 with small tubercles. Anus between annuli 1 and 2 from posterior sucker (Fig. 33: 5).

Coloration. Margin of anterior sucker brownish. Posterior sucker with brownish stripe on dorsum which narrowing to margin. Body with bands of same colors, dorsum more colored than venter. Three bands on trachelosome and 15 on urosome. On urosome, annuli B1-B3 bearing segmental bands. This annuli more pigmented than B4-B6 which unpigmented on their lateral surface. Annuli B4-B6 longer than B1-B3.

2. Digestive system (Fig. 33: 6). Base of proboscis located anterior to ganglion 3 of ventral nerve cord. Esophageal diverticula posterior to ganglion 3. Five voluminous crop chambers with small double lateral processes. Posterior crop caeca nontotally fused, with 5 fenestrae, separated anterior to ganglion 21 and extending to posterior ganglion mass, lateral processes absent. Five intestinal chambers with small lateral processes. Rectal dilation weakly developed.

3. Reproductive system (Fig. 33: 7, 8). Five pairs of testisacs. Seminal reservoirs long, forming 2 loops between ganglia 8 and 9. Initial parts of ejaculatory ducts loop-like, terminal parts wide. Accessory glands absent. Common part medium-sized, bursa long. Ovisacs medium-sized, wide, extending almost to ganglion 8. Hollow conductive tissue mass beginning at ganglion 4 and dividing into 2 cords rounding terminal, common parts and bursa, fusing at ganglion 6 to form mass located between ganglia 7 and 8. Internal copulatory area formed by conductive tissue cords adjoining to bursa.

4. Coelomic system (Fig. 33: 9). Dorsal, ventral, testicular and marginal lacunae present. Main connections absent: ventral lacuna enlarged at ganglia, not extending to dorsal lacuna. Accessory connections absent: testicular lacunae not joining with dorsal and ventral lacunae. Marginal lacunae not traced for their entire length.

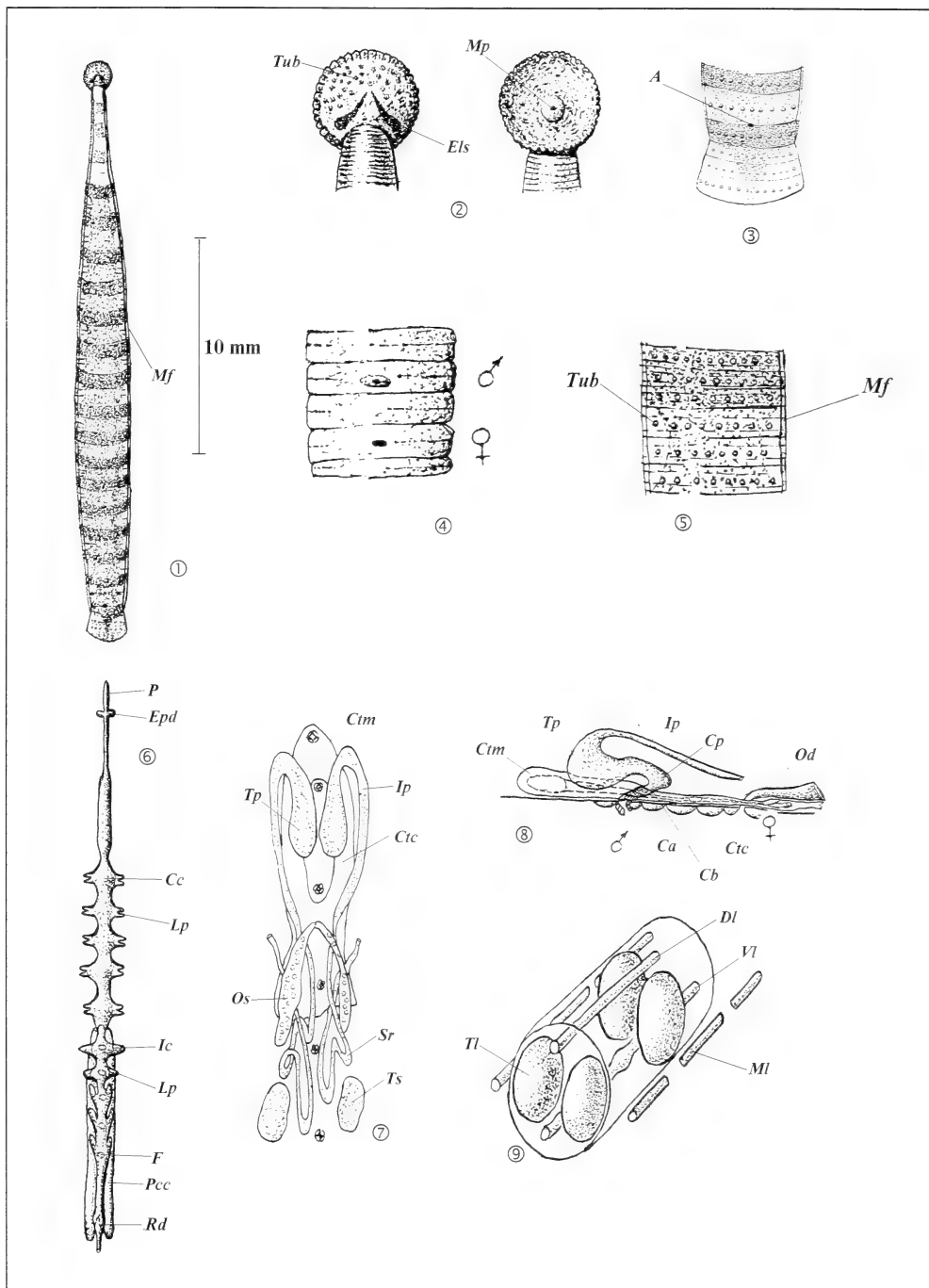

FIG. 33. *Pleurobdeella varituberculata*, external and internal structure: 1, common view; 2, anterior sucker (dorsal and ventral view); 3, posterior sucker; 4, clitellum (ventral view); 5, somite (dorsal view); 6, digestive system; 7, reproductive system (dorsal view); 8, reproductive system (lateral view); 9, coelomic system (reconstruction).



FIG. 34. *Pleurobdella varituberculata*, dorsal view.

5. Host data: only one specimen collected from Pycnogonida.

6. Distribution (Fig. 32): S. Orkney Is., Enderby Land - Atlantic sector of the Antarctic region; Wilkes Land - Indian sector.

References: Moore 1938, Utevsky 1995.

Pleurobdella australis (Epstein, 1970)

(Syn. *Pterobdellina australis* Epstein, 1970)

1. External characters (Figs. 35, 36). Not large leeches. Up to 27 mm in length and 2.4 mm in width. Body long, subcylindrical, sharply narrowing to anterior sucker, indistinctly divided into trachelosome and urosome. Body surface with small papillae. Two marginal flanges extending from anterior to posterior sucker (Fig. 35: 1). Anterior sucker large, distinctly divided from trachelosome, eccentrically attached; surface smooth with oval eye-like spots, mouth-pore centrally located (Fig. 35: 2). Posterior sucker small, not larger than anterior sucker, indistinctly divided from urosome, eccentrically attached, facing directly posteriorly, surface smooth (Fig. 35: 3).

Annulation. Clitellum 8-annulate with additional annulation of 2nd-3rd degree. Male gonopore on tubercle between annuli 3 and 4 (2 folds formed external copulatory area), female gonopore between

annuli 6 and 7 (Fig. 35: 4). Complete somite 6-annulate with additional annulation, surface smooth. Anus on annulus 3 from posterior sucker (Fig. 35: 5).

Coloration. Margin of anterior sucker brownish. Radial brownish stripes on posterior sucker. Body pigmented by brownish pattern against gray background which may form some black bands on trachelosome.

2. Digestive system (Fig. 35: 6). Base of proboscis located between ganglia 3 and 4 of ventral nerve cord. Esophageal diverticula between ganglia 4 and 5. Six voluminous crop chambers with small double lateral processes. Posterior crop caeca nontotally fused, with 5 fenestrae, separated anterior to ganglion 21 and extending to posterior ganglion mass, lateral processes absent. Five intestinal chambers with small lateral processes. Rectal dilation weakly developed.

3. Reproductive system (Fig. 35: 7, 8). 6 pairs of testisacs. Seminal reservoirs long, forming loops posterior to ganglion 8. Initial parts of ejaculatory ducts loop-like, terminal parts wide. Accessory glands absent. Common part short and wide, bursa long. Ovisacs long, wide, extending posterior to ganglion 8. Hollow conductive tissue mass beginning at ganglion 5 and dividing into 2 cords rounding terminal, common parts and bursa, fusing at ganglion 6 to form mass extending posterior to ganglion 8. Internal copulatory area formed by conductive tissue cords adjoining to bursa.

4. Coelomic system (Fig. 35: 9). Dorsal, ventral, testicular and marginal lacunae present. Main connections absent: ventral lacuna forming small lateral processes at ganglia, not extending to dorsal lacunae. Accessory connections absent: testicular lacunae not joining with dorsal and ventral lacunae.

5. Host data: only one specimen collected from Pycnogonida.

6. Distribution (Fig. 32): Atlantic Ocean near Argentina, S. Orkney Is. - Atlantic sector of the Antarctic region.

References: Epshtein 1970a, Utevsky 1995.

Genus *Glyptonotobdella* Sawyer & White, 1969

Type species: *Glyptonotobdella antarctica* Sawyer & White, 1969

Not large leeches. Body long, cylindrical, indistinctly divided into urosome and trachelosome. Complete somite 12-annulate, with pair of lateral tubercles, segmental ocelli absent.

Anterior sucker: small, distinctly divided from trachelosome, eccentrically attached, with one pair of eye-like spots.

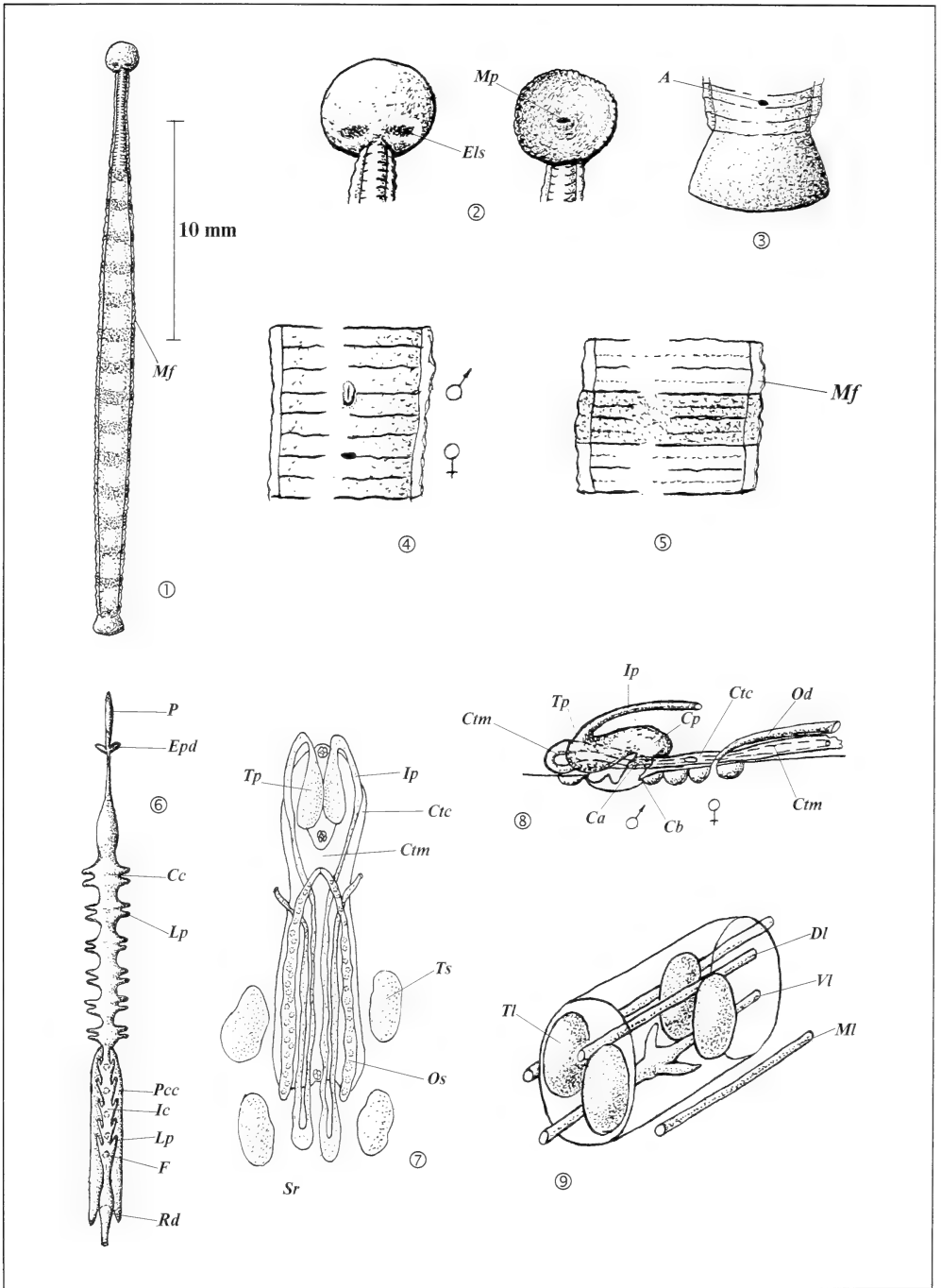

FIG. 35. *Pleurobdella australis*, external and internal structure: 1, common view; 2, anterior sucker (dorsal and ventral view); 3, posterior sucker; 4, clitellum (ventral view); 5, somite (dorsal view); 6, digestive system; 7, reproductive system (dorsal view); 8, reproductive system (lateral view); 9, coelomic system (reconstruction).



FIG. 36. *Pleurobdella australis*, dorsal view.

Posterior sucker: small, centrally attached, cup-shaped, facing directly posteriorly, ocelli absent.

Digestive system. Esophageal diverticula absent. Crop chambers without lateral processes. Posterior crop caeca nontotally fused, with fenestrae. Intestinal chambers and rectal dilation weakly developed.

Reproductive system. Six pairs of testisacs. Bursa long, accessory glands absent. Ovisacs short, conductive tissue and copulatory area absent.

Coelomic system. Dorsal lacuna absent. Main and accessory connections absent.

Host data: *Glyptonotus antarcticus* (Ord. Isopoda), fam. Chaenichthyidae (Ord. Perciformes).

Distribution (Fig. 37): Atlantic and Indian parts of the Antarctic region.

Monotypic genus.

References: Sawyer & White 1969, Sawyer 1976, Sawyer 1986, Janssen 1993.

Glyptonotobdella antarctica Sawyer & White, 1969
(Syn. *Notobdella streptocheles* Yang, 1987)

1. External characters. Not large leeches. Up to 26 mm in length and 1.0 mm or more in width. Body long, cylindrical, indistinctly divided into trachelosome and urosome, with 10–12 pairs of lateral tubercles on urosome (Fig. 38: 1). Anterior sucker small, distinctly divided from trachelosome, eccentrically attached; edge rough, surface smooth with pair of eye-like spots on pigment area, mouth-pore centrally located (Fig. 38: 3). Posterior sucker small, not larger than anterior, distinctly divided from urosome, centrally attached, facing directly posteriorly, divided by furrows into 4–5 rings, without papillae (Fig. 38: 4).

Annulation. Clitellum 7(14)-annulate, male gonopore between annuli 7 and 8, female gonopore between annuli 12 and 13, external copulatory area absent (Fig. 38: 5). Complete somite 12-annulate (may be 12–18 annulate), annulus A_3 wider than A_1 and A_2 , lateral tubercles on annulus A_2 (Fig. 38: 6). Anus on annulus 3 from posterior sucker (Fig. 38: 4).

Coloration. Trachelosome with 5 red-brown pigment bands, urosome with 14 bands of same color, which include annulus A_2 . Anterior sucker with shoe-like pigment bar which unites eye-like spots, posterior sucker with some pigment radial stripes. Coloration varying from translucent ochre to light brownish-red.

2. Digestive system (Fig. 38: 2). Base of proboscis at ganglion 3 of ventral nerve cord. Esophageal diverticula absent. Six crop chambers large, without lateral processes. Posterior crop caeca nontotally fused, with 5 fenestrae, without lateral processes. Intestine chambers weakly developed, without lateral processes. Rectal dilation weakly developed.

3. Reproductive system (Fig. 38: 2). Six pairs of testisacs. Seminal reservoirs narrow. Initial parts of ejaculatory ducts voluminous, loop-like, extending anteriorly to ganglion 5. Terminal parts deflected anteriorly. Common part large, wide. Accessory glands absent. Bursa long (?). Ovisacs short, located between ganglia 6 and 7. Conductive tissue absent.

4. Coelomic system. Dorsal and lateral lacunae absent. Ventral lacuna forming wing-like projections in ganglion region. Main and accessory connections absent.

5. Host data: most specimens collected from *Glyptonotus antarcticus* (Eights, 1852), other specimens

collected from *Chionodraco* sp. and *Chaenocephalus aceratus*.

6. Distribution (Fig. 37): S. Orkney Is., S. Sandwich Is., Scottia Sea, Princess Martha Coast - Atlantic sector of the Antarctic region; McMurdo Sd. (Ross Sea) - Pacific sector; Marion I. - Indian sector.

References: Sawyer & White 1969; Yang 1987.

Genus *Cryobdella* Harding, 1922

Type species: *Cryobdella levigata* Harding, 1922.

Not large or small leeches. Body cylindrical or sub-cylindrical. Annulation nondetermined, surface smooth, without tubercles and segmental ocelli. Pigmentation variable.

Anterior sucker: varying in size, eccentrically attached, mouth may be prior to centre, without eyes or eye-like spots.

Posterior sucker: large, strictly divided from urosome, centrally or eccentrically attached, without ocelli.

Digestive system. Esophageal diverticula absent or present. Crop chambers varying in their development, without lateral processes. Posterior crop caeca non-totally fused, with fenestrae, without lateral processes. Intestine chambers developed in varying degrees. Rectum varying in their development.

Reproductive system. Two to six pairs of testisacs. Seminal reservoirs short, common part of ejaculatory ducts small, accessory glands absent, bursa short. Ovisacs short, conductive tissue and copulatory area absent.

Coelomic system. Dorsal, ventral, testicular lacunae present. Lateral lacunae present or absent. Main and accessory connections developed in varying degrees.

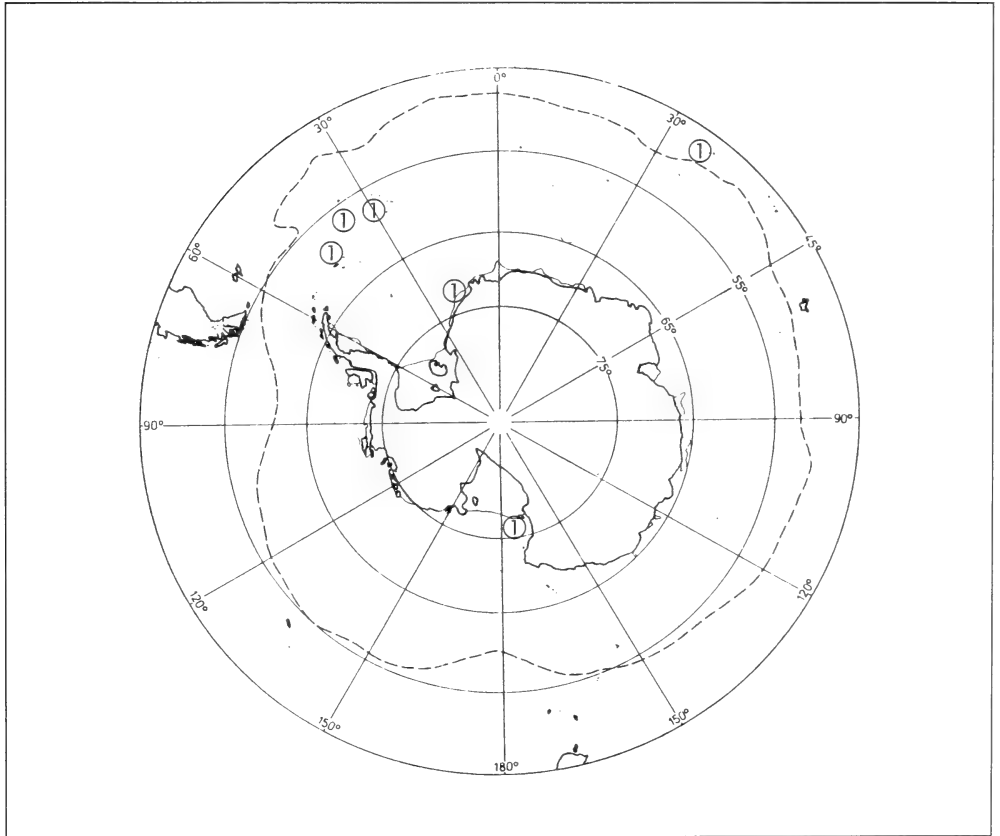

FIG. 37. Distribution of the *Glyptonotobdella antarctica*.

Host data: fam. Nototheniidae (ord. Perciformes),
Muraenolepidae (ord. Gadiformes).

Distribution (Fig. 39): Atlantic, Indian and Pacific sectors of the Antarctic region.

Congenitors: *C. antarctica* Epstein, 1970

C. ljadovi Epstein & A.Utevsky, 1994

C. pallida A.Utevsky, 1997

References: Harding 1922, Sawyer 1986, Epstein *et al.* (1994), Utevsky 2000.

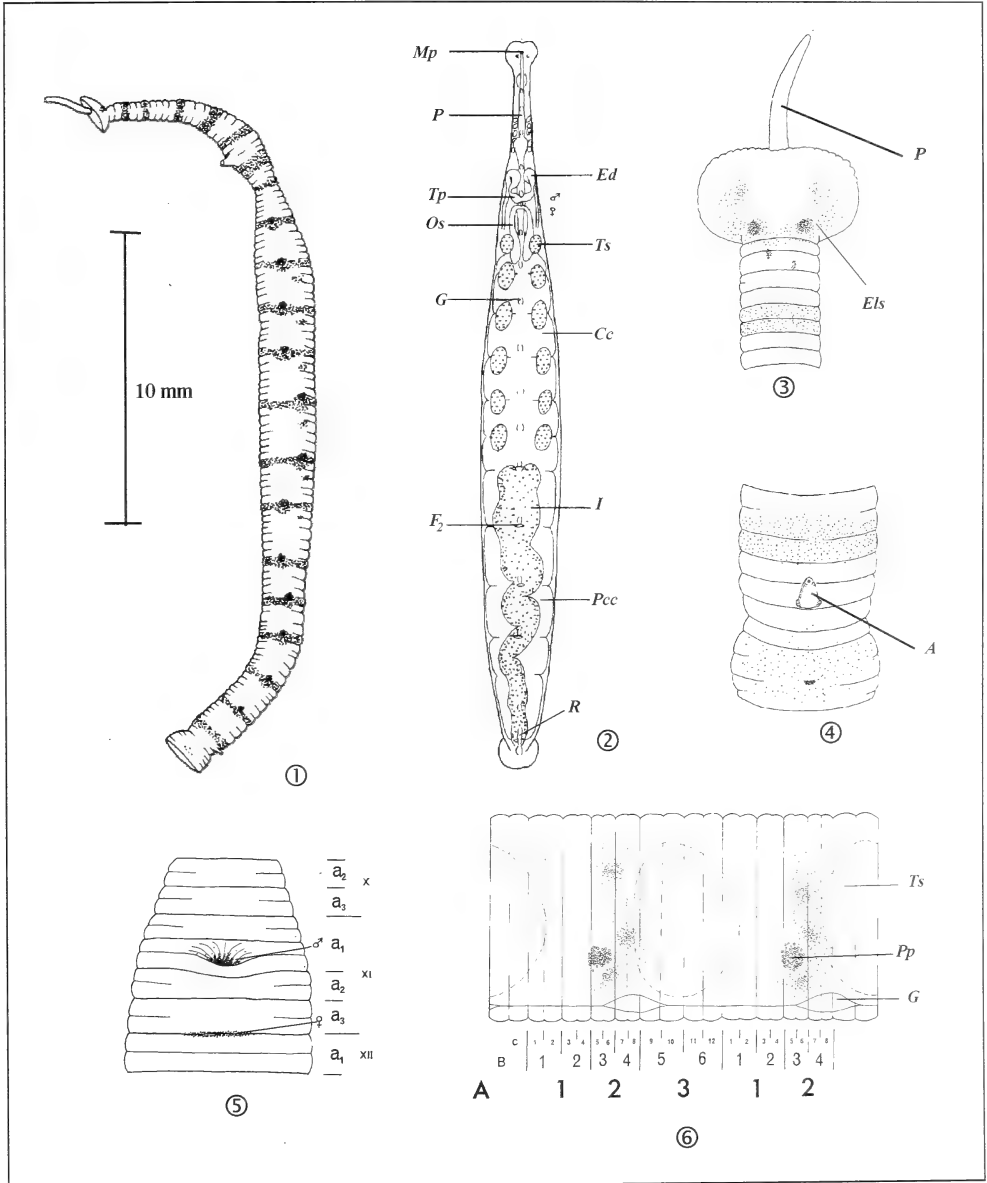

FIG. 38. *Glyptonotobdella antarctica*, external and internal structure (reproduced and modified from Sawyer and White 1969, by permission of R.T. Sawyer, BIOPHARM (UK) Ltd).

Key to the Species of the Genus *Cryobdella*

- 1a Posterior sucker in complicated form, large, possesses two parts which just one to ones *C. ljadovi* (p. 56)
- 1b Posterior sucker round form, medium-sized or small 2
- 2a Proportion of posterior sucker $C_2/D_2 > 2$... *C. pallida* (p. 58)
- 2b Proportion of posterior sucker $C_2/D_2 \approx 1$... 3
- 3a Posterior sucker centrally attached *C. levigata* (p. 54)
- 3b Posterior sucker eccentrically attached *C. antarctica* (p. 56)

Cryobdella levigata Harding, 1922
(Syn. *Platybdella levigata* (Harding, 1922))

1. External characters (Fig. 40). Not large leeches. Up to 29 mm in length and 3.5 mm in width. Body

long, subcylindrical, distinctly divided into trachelosome and urosome. Anterior sucker small, distinctly divided from trachelosome, eccentrically attached; surface smooth, edge rough, mouth-pore prior to centre. Posterior sucker large, larger than anterior sucker, centrally attached, facing directly posteriorly surface smooth (Fig. 40: 1).

Annulation. Clitellum 8-annulate. Male gonopore located between annuli 3 and 4, female gonopore between annuli 5 and 6. External copulatory area absent. Complete somite 3-annulate, additional annulation present, pattern of additional annulation variable. Anus between annuli 2 and 3 from posterior sucker.

Coloration. After alcohol fixation brownish-grey or fully pigmented.

2. Digestive system (Fig. 40: 2). Proboscis extending prior to 2nd ganglion of ventral nerve cord. Esophageal diverticula present. Crop chambers 1 and 2 weakly developed without lateral processes, other

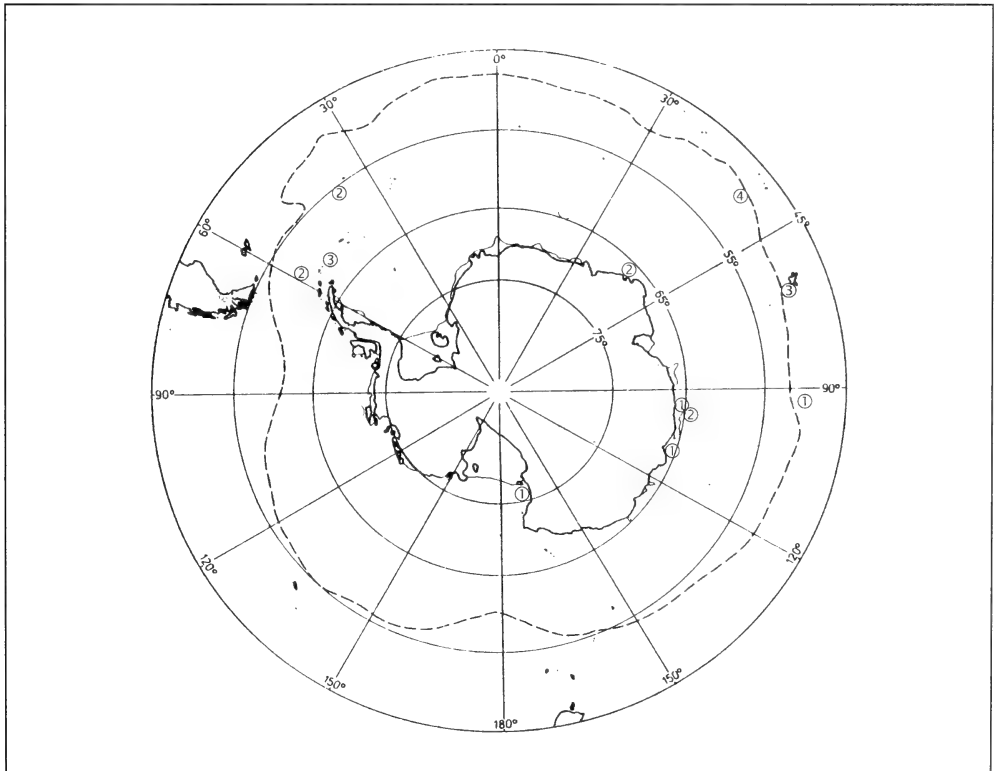

FIG. 39. Distribution of the gen. *Cryobdella*. 1 – *C. levigata*; 2 – *C. antarctica*; 3 – *C. ljadovi*; 4 – *C. pallida*.

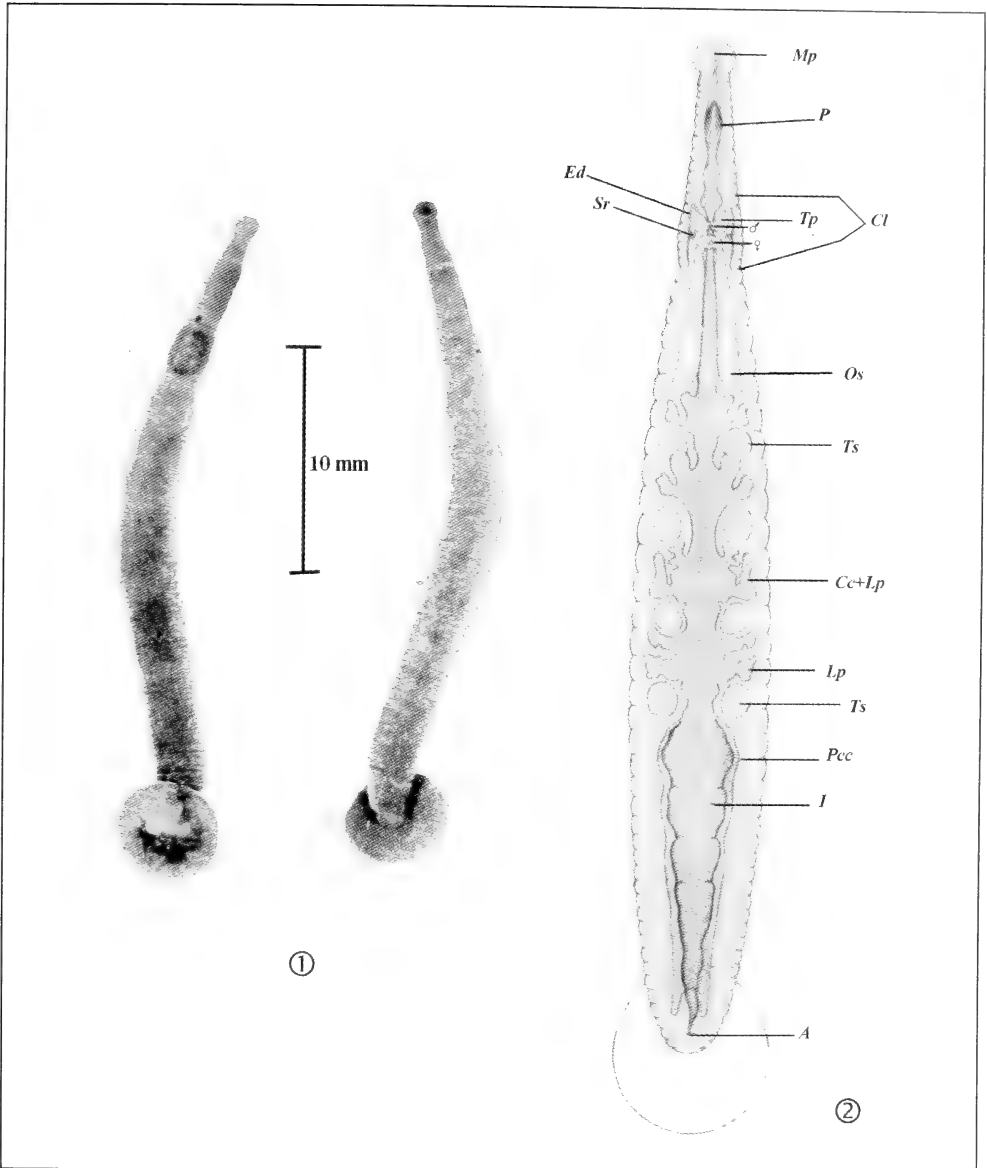

FIG. 40. *Cryobdella levigata*, external and internal structure: 1, common view (reproduced from Moore 1938); 2, internal structure (reproduced and modified from Harding 1922).

four chambers with two pairs of lateral processes. Posterior crop caeca nontotally fused with 5 fenestrae, without lateral processes. Three chambers of intestine well developed, without lateral processes. Rectal dilation well developed.

3. Reproductive system (Fig. 40; 2). Four pairs of testisacs. Seminal reservoirs very short, extending to ganglion 6 of ventral nerve cord. Initial parts of ejaculatory ducts short and thin, terminal parts wide, oval. Accessory glandular mass absent, common part

very small, bursa very short. Ovisacs long and wide, extending to ganglion 8. Conductive tissue absent.

4. Coelomic system. Structure unknown.

5. Host data: collected from *Trematomus hansonii*, *T. bernacchii*.

6. Distribution (Fig. 39): Ross Sea (Victoria Land) - Pacific sector of the Antarctic region; Davis Sea, Mawson Sea, Kerguelen Is. - Indian sector.

References: Harding 1922, Moore 1938, Meyer & Bureson 1990.

Cryobdella antarctica Epstein, 1970

(Syn. *Glyptonotobdella epshtei* Sawyer, 1986)

1. External characters (Figs. 41, 42). Not large leeches. Up to 22 mm in length and 1 mm in width. Body long, cylindrical, indistinctly divided into trachelosome and urosome (Fig. 42). Anterior sucker medium-sized, distinctly divided from trachelosome, eccentrically attached, the first one third with many small papillae; the other two thirds without papillae, divided by 6 transverse furrows, mouth-pore centrally located (Fig. 41: 2). Posterior sucker medium-sized, but larger than anterior one, distinctly divided from urosome, eccentrically attached; the first one third adjacent to urosome divided by 2 transverse furrows, other two thirds divided by 5–6 longitudinal furrows, with small papillae (Fig. 41: 3).

Annulation. Clitellum 4-annulate with additional annulation of second degree (Fig. 41: 4). Male gonopore located between annuli 2 and 3 of 2nd degree, female gonopore between annuli 5 and 6. External copulatory area absent. Annulus 3 with row of small papillae on dorsum, small papillae on other annuli disorderly located. Complete somite 3-annulate with additional annulation of 2nd degree (Fig. 41: 5). Annulus A_3 shorter than others. Annuli with small papillae. Anus between annuli 3 and 4 from posterior sucker (Fig. 41: 3).

Coloration. Segmental brownish bands alternated with unpigmented areas. Unpigmented after alcohol fixation.

2. Digestive system (Fig. 41: 6). Base of proboscis posterior to 2nd ganglion of ventral nerve cord. Esophageal diverticula absent. Crop chambers weakly developed, without lateral processes. Posterior crop caeca nontotally fused with 5 fenestrae, without lateral processes. Two chambers of intestine developed without lateral processes. Rectal dilation absent.

3. Reproductive system (Fig. 41: 7, 8). Two to six pairs of testisacs (3–6 pairs may be reduced). Seminal reservoirs well developed, in form of a number of

loops, extending to ganglion 6 of ventral nerve cord. Initial parts of ejaculatory ducts short and wide, loop-like, sharply divided from wide terminal parts. Accessory glands absent. Common part small, bursa very short. Ovisacs long and wide, extending to ganglion 8 (may be willed between ganglia 6 and 7), asymmetrical. Conductive tissue absent.

4. Coelomic system (Fig. 41: 9). Dorsal, ventral, lateral and testicular lacunae present. Lateral lacunae with muscular layer. Main connection connecting dorsal lacuna with ventral lacuna near each ganglion. Accessory connections connecting dorsal and testicular lacunae. Main and accessory connections connected through lateral lacunae.

5. Host data: one specimen collected from body of *Trematomus bernacchii*.

6. Distribution (Fig. 39): Davis Sea - Indian sector of the Antarctic region; Scotia Sea - Atlantic sector.

References: Epshteyn 1970b, Sawyer 1986.

Cryobdella ljadovi Epstein & A. Utevsky, 1994

1. External characters (Figs. 43, 44). Small leeches. Up to 13.4 mm in length and 2.2 mm in width. Body short, cylindrical, distinctly divided into trachelosome and urosome, sharply narrowing to posterior sucker, surface smooth (Fig. 44). Anterior sucker small, indistinctly divided from trachelosome, eccentrically attached; surface smooth, edge rough, mouth-pore prior to centre (Fig. 43: 2). Posterior sucker large, larger than anterior sucker, sharply divided from urosome, centrally attached, facing directly posteriorly, surface smooth (Fig. 43: 3). It divided into right and left halves. Each half divided into two parts. Left half juts into right one.

Annulation. Clitellum 8-annulate. Male gonopore between annuli 3 and 5, female gonopore between annuli 6 and 7, external copulatory area absent (Fig. 43: 4). Annulation of complete somite and location of anus obscure.

Coloration. All specimens unpigmented after alcohol fixation, skin semitransparent.

2. Digestive system (Fig. 43: 5). Base of proboscis located immediately prior to ganglion 2 of ventral nerve cord. Esophageal diverticula located between ganglia 3 and 4. Four crop chambers small, diamond-shaped, without lateral processes. Posterior crop caeca absent. Four intestinal chambers spherical, without lateral processes. Rectal dilation present.

3. Reproductive system (Fig. 43: 6, 7). Five pairs of large testisacs. Seminal reservoirs in form of several

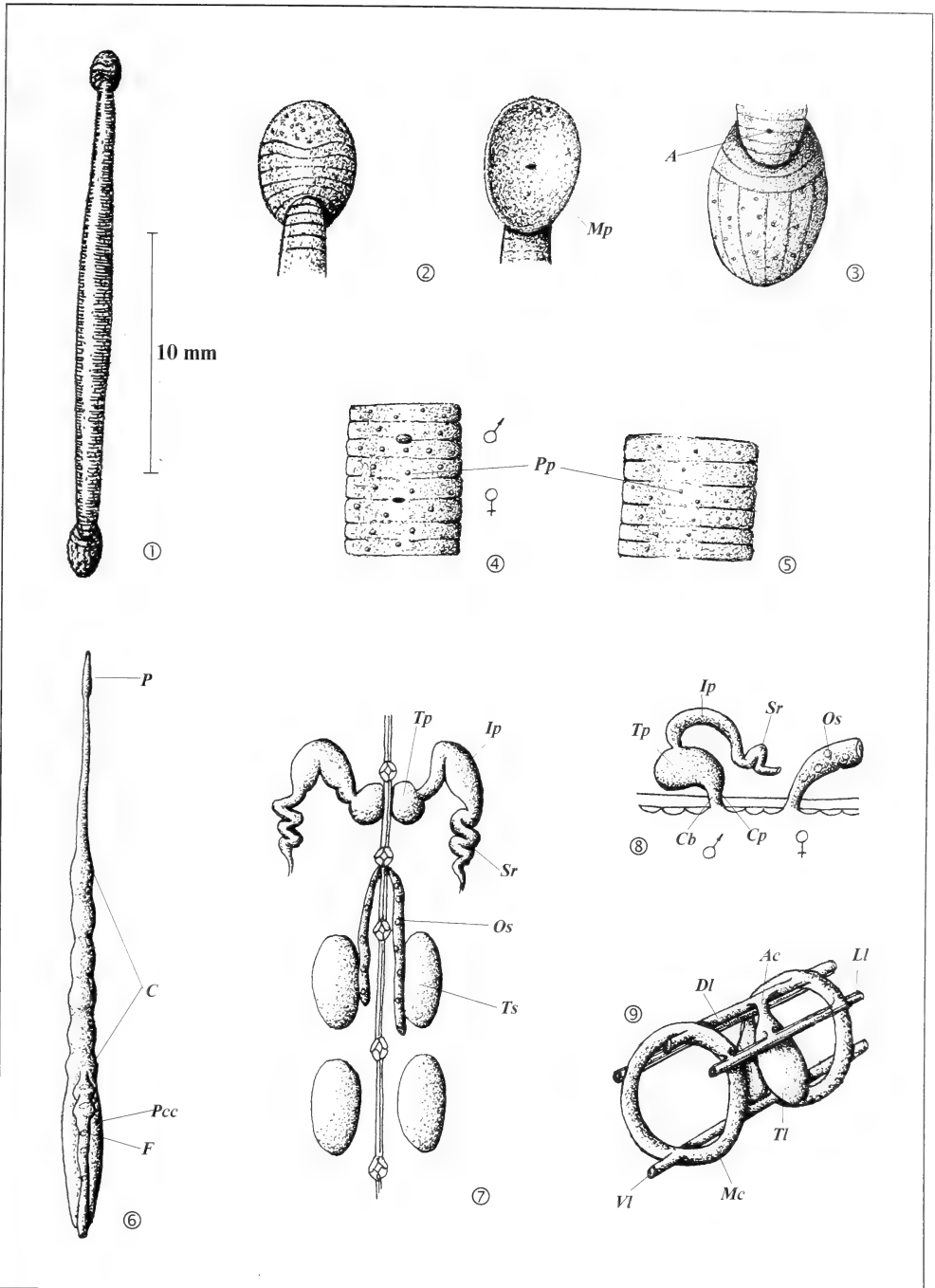

FIG. 41. *Cryobdella antarctica*, external and internal structure: 1, common view; 2, anterior sucker (dorsal and ventral view); 3, posterior sucker; 4, clitellum (ventral view); 5, somite (dorsal view); 6, digestive system; 7, reproductive system (dorsal view); 8, reproductive system (lateral view); 9, coelomic system (reconstruction).

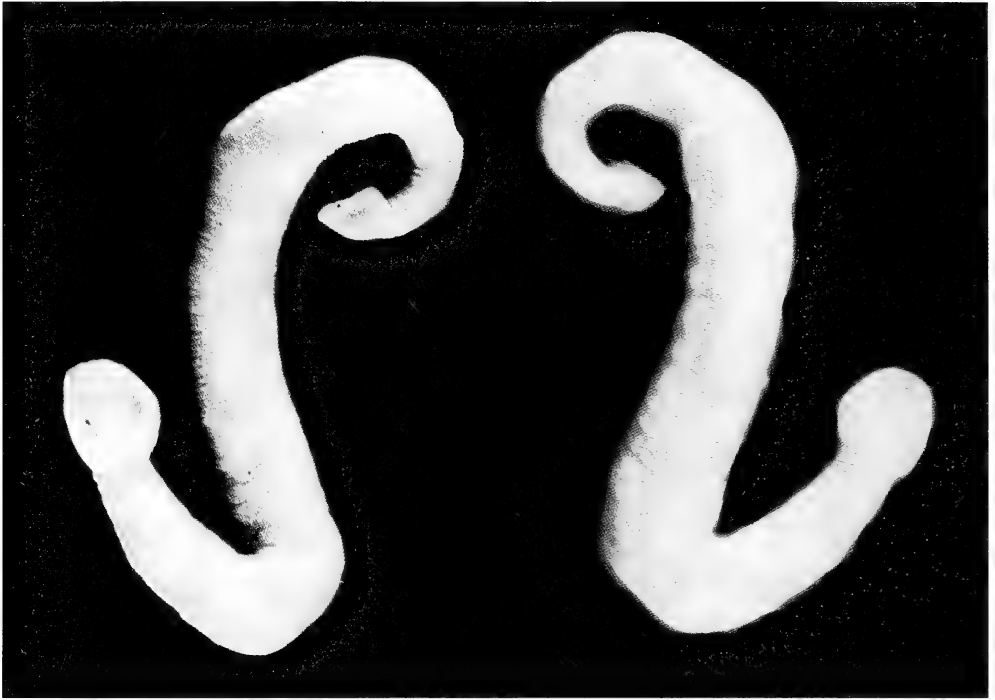

FIG. 42. *Cryobdella antarctica*, dorsal and ventral view.

loops between ganglia 5 and 6. Initial parts of ejaculatory ducts short, coiled in the form of several loops, indistinctly divided from wide terminal parts. Accessory glands absent. Common part small, bursa very short. Ovisacs of intermediate length extending to ganglion 8. Ovisacs coiled between ganglia 6 and 7. Conductive tissue absent.

4. Coelomic system (Fig. 43: 8). Dorsal, ventral and testicular lacunae present. Main connections absent: ventral lacuna forming a small lateral processes at ganglion region. Accessory connections unclosed: connecting dorsal and testicular lacunae.

5. Host data: collected from gill rakers of *Muraenolepis marmoratus* and *Muraenolepis microps*.

6. Distribution (Fig. 39): Kerguelen coastal waters - Indian sector of the Antarctic region; S. Orkney Is. - Atlantic sector.

Reference: Epshtein & Utevsky 1994.

Cryobdella pallida A.Utevsky, 1997.

1. External characters (Figs. 45, 46). Small leeches. Up to 9 mm in length and 0.7 mm in width. Body

long, cylindrical, indistinctly divided into trachelosome and urosome (Fig. 46). Anterior sucker large, distinctly divided from trachelosome, eccentrically attached, surface smooth, edge rough, mouth-pore prior to centre (Fig. 45: 2). Posterior sucker large, larger than anterior sucker, eccentrically attached, surface smooth (Fig. 45: 3).

Annulation. Clitellum 5-annulate (may be annulation of 2nd degree). Male gonopore located on annulus 2, female gonopore on annulus 3. External copulatory area absent (Fig. 45: 4). Annulation of complete somite obscure, basically 3-annulate with annulation of 2nd-3rd degree (Fig. 45: 5). Surface of annuli smooth. Anus on annulus 2 from posterior sucker (Fig. 45: 3).

Coloration. Skin semitransparent (all examined specimens unpigmented after alcohol fixation).

2. Digestive system (Fig. 45: 6). Proboscis extending to 1st ganglion of ventral nerve cord. Esophageal diverticula located between ganglia 4 and 5. Five crop chambers well developed, diamond-shape without lateral processes. Posterior crop caeca non-

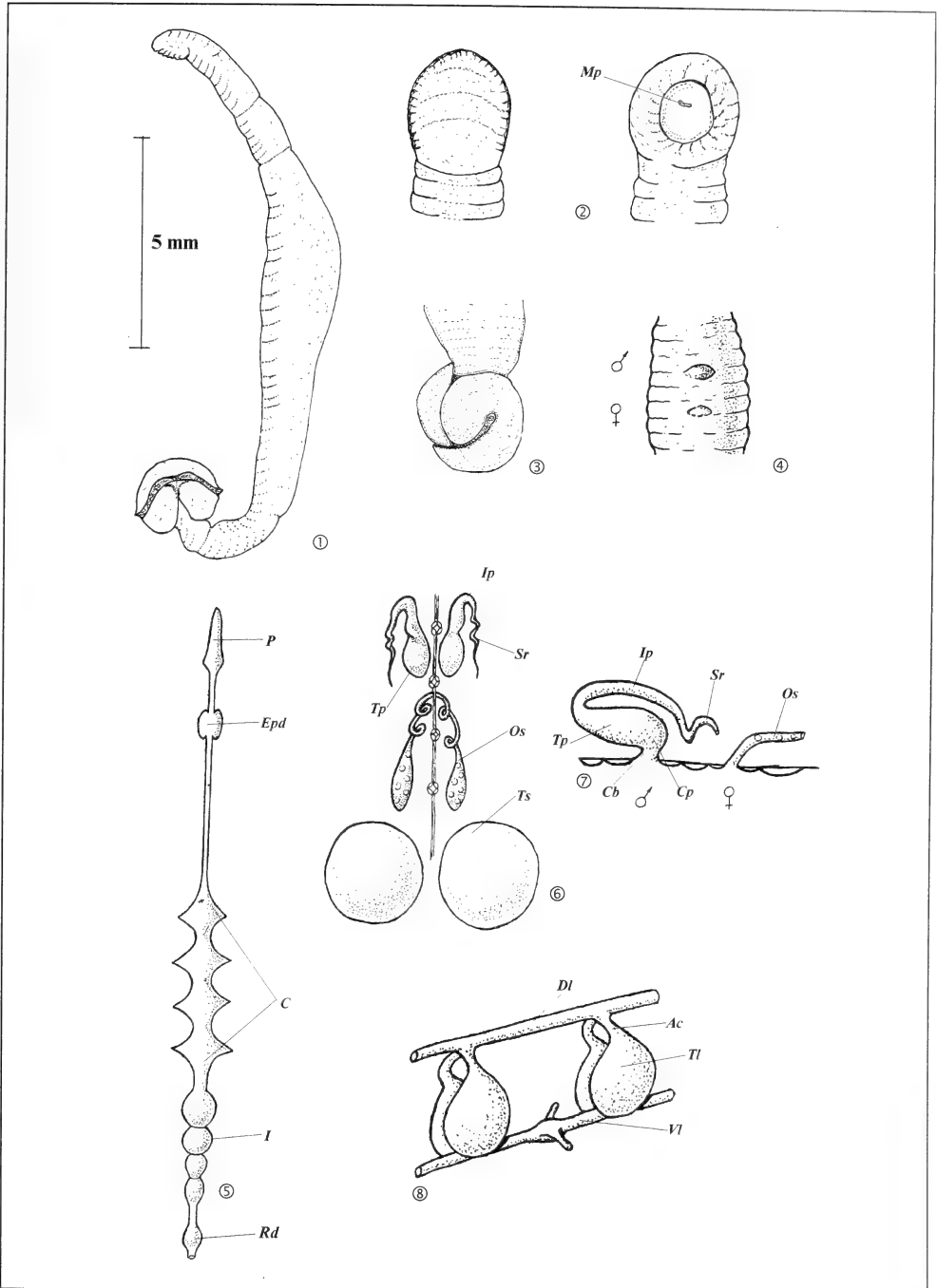

FIG. 43. *Cryobdella ljadovi*, external and internal structure: 1, common view; 2, anterior sucker (dorsal and ventral view); 3, posterior sucker; 4, clitellum (ventral view); 5, digestive system; 6, reproductive system (dorsal view); 7, reproductive system (lateral view); 8, coelomic system (reconstruction).



FIG. 44. *Cryobdella ljadovi*, ventral view.

totally fused with 5 fenestrae, without lateral processes, extending to posterior ganglion mass. Intestinal chambers weakly developed, without lateral processes. Rectal dilation weakly developed.

3. Reproductive system (Fig. 45: 7, 8). Five pairs of testisacs. Seminal reservoirs short and wide, extending posterior to ganglion 6 of ventral nerve cord. Initial parts of ejaculatory ducts short and wide, sharply divided from roundish-wide terminal parts. Accessory glands absent. Common part small, bursa very small. Ovisacs long and voluminous, asymmetrical, extending posterior to ganglion 7. Conductive tissue absent.

4. Coelomic system (Fig. 45: 9). Dorsal, ventral, lateral, and testicular lacunae present. Main connection nontotally close, ventral lacuna enlarges at ganglion region, dorsal lacuna forms two long projections extended to dilation of ventral lacuna. Accessory connection absent. Testicular lacunae connected by lateral lacunae on each side.

5. Host data: all specimens collected from gills of *Notothenia squamifrons*.

6. Distribution (Fig. 39): Crozet I.- Indian sector of the Antarctic region.

References: Utevsky 1997.

“Subfamily Piscicolinae”

Diagnosis. Leeches of varying sizes; body long or short, cylindrical, subcylindrical or flattened. Tubercles, papillae, eyes, eye-like spots, segmental ocelli, ocelli on posterior sucker present or absent.

Digestive system of varying structure, posterior crop caeca of varying degrees of fusion or absent.

Reproductive system of varying structure.

Coelomic system possesses dorsal, ventral, lateral, testicular lacunae, main and accessory connections of varying degrees developed, one pair of externally visible subepidermal pulsatile vesicles formed by modified lateral lacunae per urosomal somite.

References: Sawyer 1986; Epshtein *et al.* 1994.

Key to the Antarctic Genera of the “Subfamily Piscicolinae”

- 1a Body wide and flattened 2
- 1b Body long, cylindrical or subcylindrical 3
- 2a Pulsatile vesicles well developed; $L_1 \approx L_2$; surface of anterior sucker smooth, 1 pair of eyes, posterior sucker without ocelli Genus *Trachelobdellina* (p. 60)
- 2b Pulsatile vesicles small; $L_1 < L_2$; anterior sucker with papillae and 2 groups of ocelli; posterior sucker with ocelli; 2 groups of ocelli on first annulus of trachelosome Genus *Trulliobdella* (p. 63)
- 3a Posterior crop caeca absent Genus *Galattheabdella* (p. 69)
- 3b Posterior crop caeca present 4
- 4a Anterior and posterior suckers small; facing directly posteriorly; prepuce present Genus *Trachelobdella* (p. 72)
- 4b Anterior and posterior suckers large, facing ventrally; prepuce absent Genus *Nototheniobdella* (p. 75)

Genus *Trachelobdellina* Moore, 1957

Type species: *Trachelobdellina glabra* Moore, 1957

Not large leeches. Trachelosome cylindrical, up to one half of the entire body length; urosome wider and

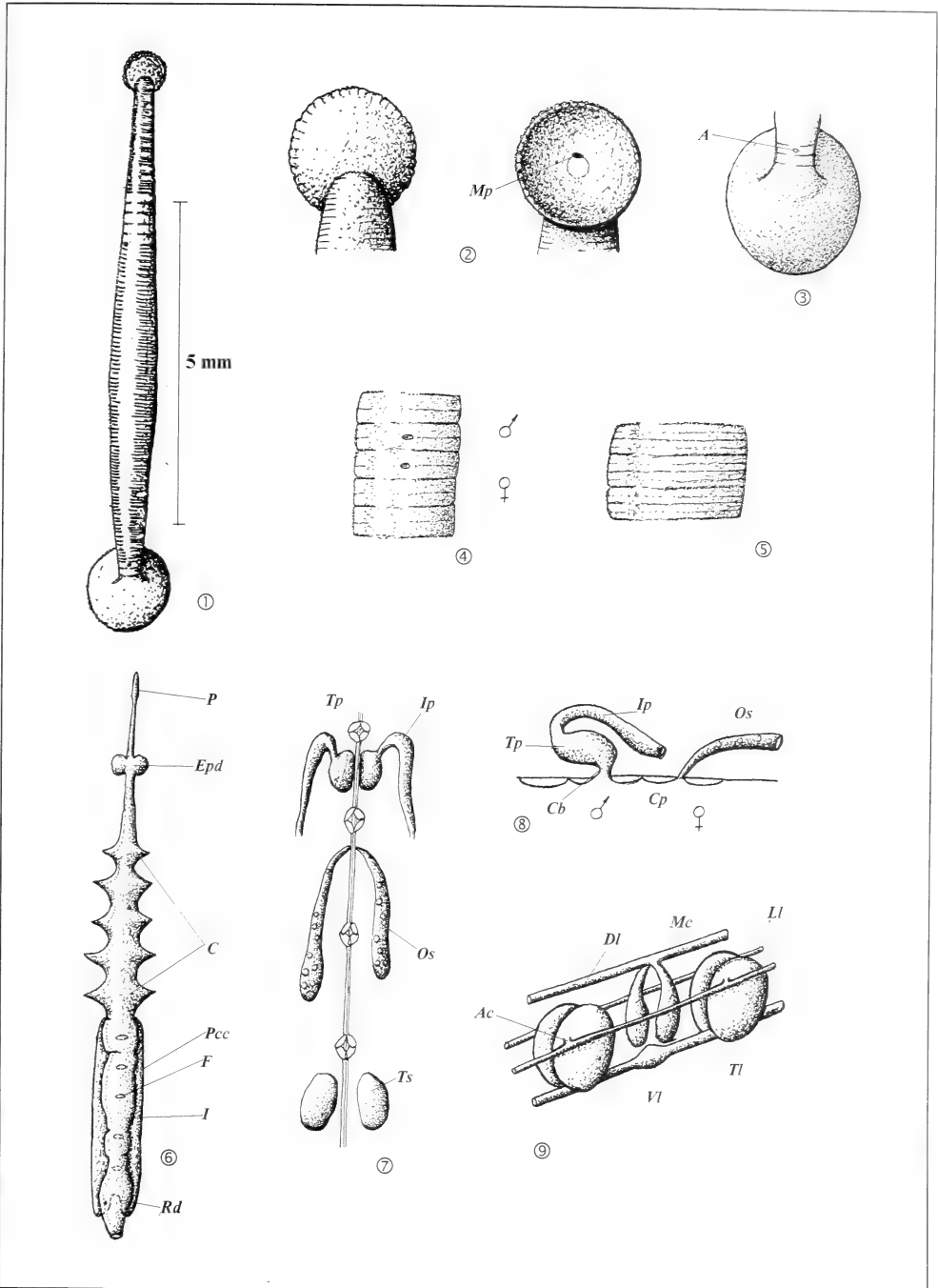

FIG. 45. *Cryobdella pallida*, external and internal structure: 1, common view; 2, anterior sucker (dorsal and ventral view); 3, posterior sucker; 4, clitellum (ventral view); 5, somite (dorsal view); 6, digestive system; 7, reproductive system (dorsal view); 8, reproductive system (lateral view); 9, coelomic system (reconstruction).

more flattened than trachelosome. There are ocelli on the dorsum and venter of the body. Complete somite 6-annulate with pair of pulsate vesicles. Segmental pigmentation absent.

Anterior sucker: small, cardiform, with pair of eyes.

Posterior sucker: small, without ocelli.

Digestive system. Esophageal diverticula present, posterior crop caeca nontotally fused, number of lateral processes of intestine reduced.

Reproductive system. Five pairs of testisacs, bursa short, accessory glands absent.

Coelomic system. Dorsal, ventral, pair of lateral and testicular lacunae present. Main and accessory connections present.

Host data: hosts poorly known, one specimen collected from *Glyptonotus antarcticus* (Isopoda).

Distribution (Fig. 47): Indian and Atlantic parts of the Antarctic region.

Monotypic genus.

Reference: Moore 1957.

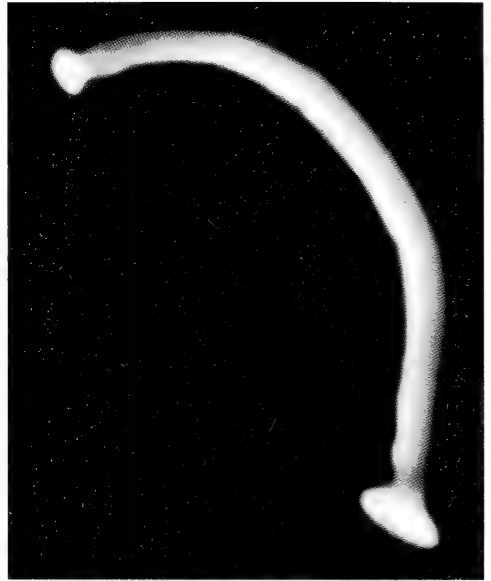

FIG. 46. *Cryobdella pallida*, lateral view.

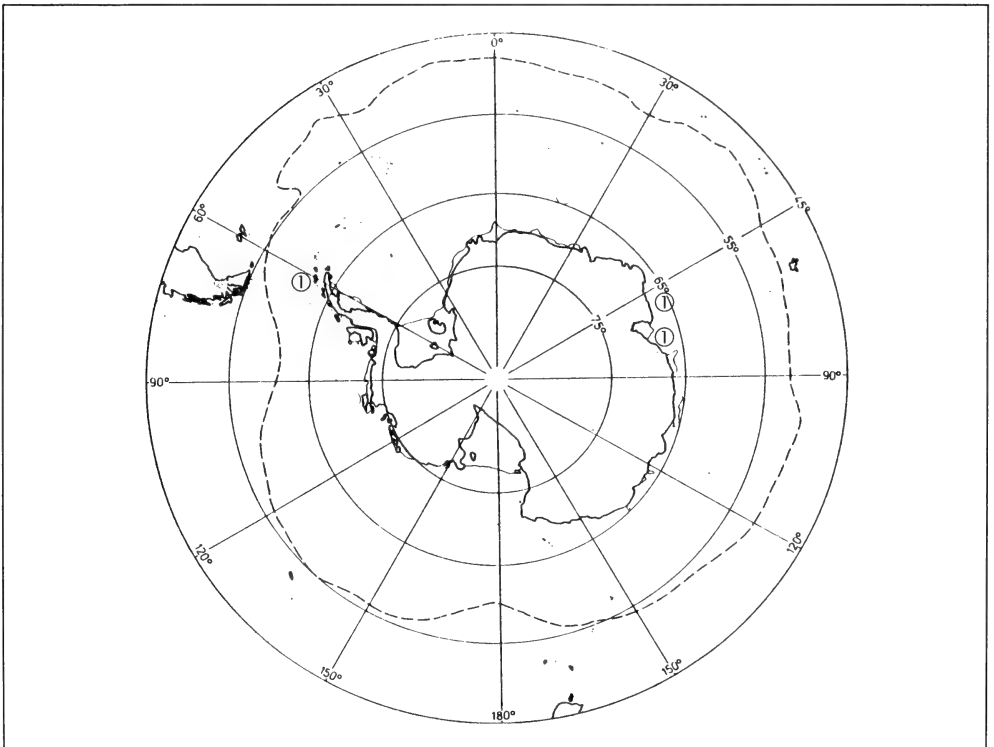

FIG. 47. Distribution of the *Trachelobdellina glabra*.

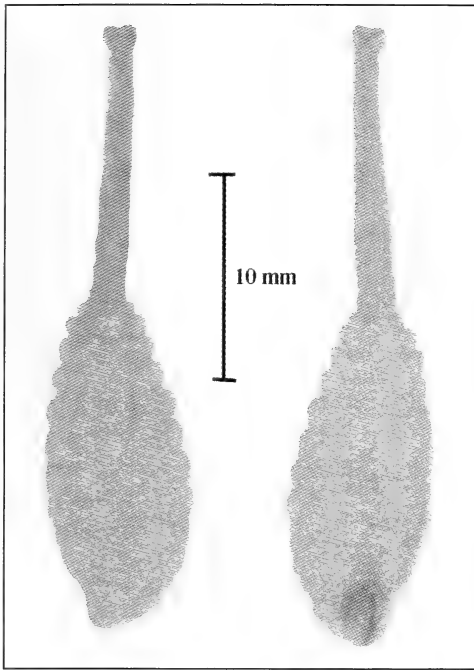

FIG. 48. *Trachelobdellina glabra*, common view (reproduced from Moore 1957).

Trachelobdellina glabra Moore, 1957*

1. External characters (Fig. 48). Not large leeches. Up to 30 mm in length and 7 mm in width. Body distinctly divided into long, narrow trachelosome and wide, subcylindrical urosome. They are approximately equal in length. Body smooth, with 12 pairs of large pulsatile vesicles on urosome, five pairs of ventral and dorsal ocelli: three pairs on clitellar segments, one pair on last trachelosomal segment and one pair on first urosomal segment. Anterior sucker small, cardiform, with a pair of anterior rounded lobes separated by a median cleft, distinctly divided from trachelosome, eccentrically attached. One pair of eyes. Mouth-pore centrally located. Posterior sucker small, but larger than anterior one.

Annulation. Clitellum 9-annulate; somites of trachelosome 3-annulate, without additional annulation. Male gonopore between annuli 3 and 4, female gonopore between annuli 8 and 9 (according to Moore 1957, male gonopore between annulus A_3 of 10th somite and 11 somite, female gonopore between annuli A_2 and A_3 of 12th somite). Complete somite 6(8)-annulate with additional annulation.

2. Digestive system. Proboscis extend to ganglion 6 of ventral nerve cord, very coiled at ganglion 3. Esophageal diverticula based between ganglia 5 and 6, extending cephalad between ganglia 4 and 5. Crop tubular, without distinct chambers and lateral processes. Posterior crop caeca nontotally fused, with fenestrae. Intestine tubular, with 1 pair of lateral processes at ganglion 13.

3. Reproductive system. Five pair of testisacs. Terminal parts of male reproductive system typical (?). Bursa short. Accessory glands absent.

4. Coelomic system. Dorsal, ventral, lateral and testicular lacunae present. Lateral lacunae paired (thin- and thick-walled) on each side of the body. Main connections closed, dorsal and ventral lacunae connected through thin-walled ventro-lateral lacunae in ganglion region. Accessory connection closed, dorsal and ventral lacunae connected through testicular lacunae. Thin-walled ventro-lateral lacunae connected with testicular lacunae. Anterior parts of pulsatile vesicles connected with thin-walled ventro-lateral lacunae at ganglion region. Posterior part of pulsatile vesicles connected with thick-walled lateral lacunae.

5. Host data: 1 specimen collected from *Glyptonotus antarcticus* (Isopoda).

6. Distribution (Fig. 47): Mawson Coast - Indian sector of the Antarctic region, S. Shetland Is., Arthur Harbor (Palmer Station) - Atlantic sector.

References: Moore 1957, Meyer & Burreson 1990.

Genus *Trulliodbella* Brinkmann, 1948

(Syn.: *Cryobdellina* Brinkmann, 1948;

Antarctobdella Dollfus, 1964; *Ophthalmobdella* Szidat, 1965)

Type species: *Trulliodbella capitis* Brinkmann, 1948

Medium-sized leeches. Body variable in form, distinctly divided into trachelosome and urosome. Trachelosome with 2 groups of 3–5 ocelli in each on annuli 1–3. Complete somite 3-annulate with additional annulation, pulsatile vesicles on annulus A_3 . Segmental ocelli in young individuals specimens on dorsum and venter of annulus A_3 or absent. Segmental pigmentation absent.

Anterior sucker: small, eccentrically attached, with 4–6 tentacles and two 2 groups of 5 ocelli in each.

Posterior sucker: small, surface smooth, with 7–15 ocelli.

Digestive system. Large esophageal diverticula present. Crop chambers with long and voluminous double lateral processes. Posterior crop caeca nontotally fused, with 4 large fenestrae and lateral processes similar to processes of crop chambers. Intestine

with 4 small chambers and long lateral processes. Rectal dilation present.

Reproductive system. Five pairs of testisacs. Seminal reservoirs short. Initial parts of ejaculatory ducts thin. Posterior parts wide. Common part voluminous. Bursa short. Accessory glands absent. Oviducts and conductive tissue cords connects with voluminous seminal receptacle, which form internal copulatory area. External copulatory area around gonopores present.

Coelomic system. Dorsal, ventral, lateral and testicular lacunae present. Dorsal lacuna divided into two coelomic channels. Main and accessory connections unclosed. Lateral lacunae form typical for Piscicolinae pulsatile vesicles.

Host data: fam. Nototheniidae, Bathyracoonidae, Chaenichthyidae (ord. Perciformes).

Distribution (Fig. 49): Atlantic, Pacific and Indian parts of the Antarctic region.

Congenitors: *T. bacilliformis* (Brinkmann, 1948)

References: Brinkmann 1948, Sawyer 1986, Meyer & Burreson 1990, Utevsky 2000.

Remark: Meyer & Burreson (1990) synonymized species of the genera *Cryobdellina*, *Trulliobdella*, *Antarctobdella*, *Ophthalmobdella* with *Notobdella nototheniae* Benham, 1909. We cannot hold this synonymy as the description of latter species is based on some external characters and lacks any illustrations. Benham did not record tentacles on the anterior sucker. The shape, arrangement and the number of the eyes do not agree with the characters of the other "tentacled" leeches.

Key to the Species of the Genus *Trulliobdella*

1a Body yellowish gray, posterior sucker with 7 ocelli *T. capitis* (p. 65)

1b Body without pigment, semitransparent; posterior sucker with 15 ocelli
 *T. bacilliformis* (p. 66)

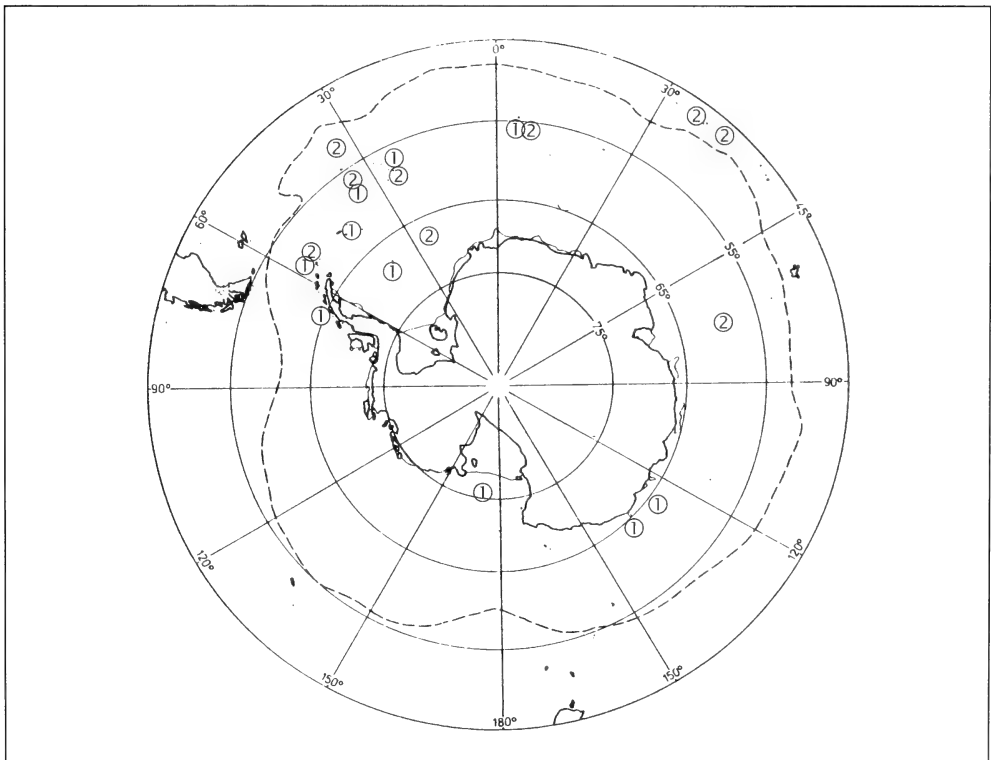

FIG. 49. Distribution of the gen. *Trulliobdella*: 1 - *T. capitis*; 2 - *T. bacilliformis*.

Trulliobdella capitis Brinkmann, 1948

1. External characters (Figs. 50, 51). Medium-sized leeches. Up to 60 mm in length and 12 mm in width. Body short and wide, leaf-shaped (body shape vari-

able from leaf to cylindrical) sharply narrowing to suckers, distinctly divided into subcylindrical tracheosome and lancet-shaped (more flattened) urosome. Ten to twelve pairs of very small pulsatile vesicles, seg-

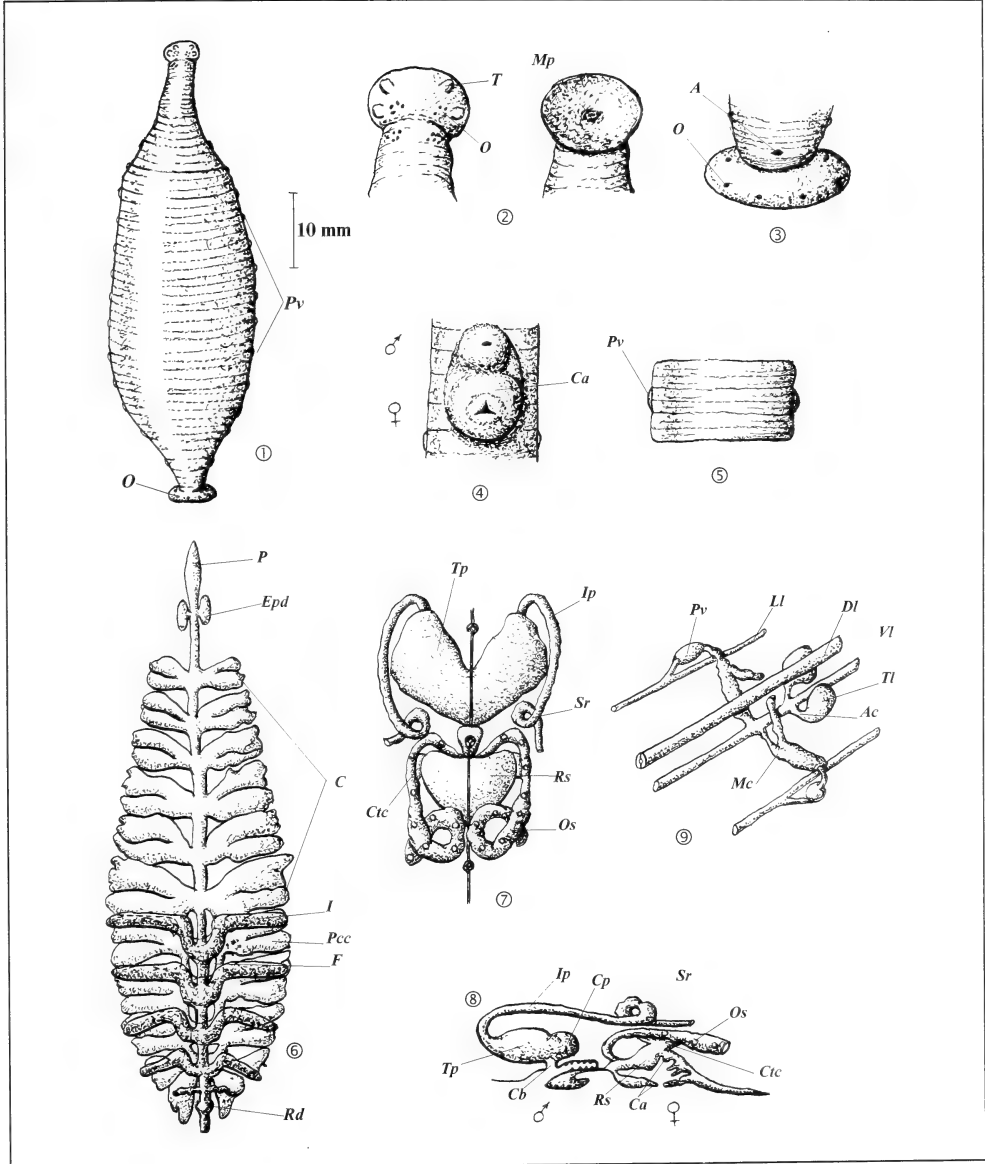

FIG. 50. *Trulliobdella capitis*, external and internal structure: 1, common view; 2, anterior sucker (dorsal and ventral view); 3, posterior sucker; 4, clitellum (ventral view); 5, somite (dorsal view); 6, digestive system; 7, reproductive system (dorsal view); 8, reproductive system (lateral view); 9, coelomic system (reconstruction).

mental ocelli absent on urosome (Fig. 50: 1). Anterior sucker small, distinctly divided from trachelosome, eccentrically attached; with 4 tentacles and 2 fields with 3–5 ocelli in each near the base of sucker (Fig. 50: 2). Ocelli present in 2 fields of 3 first annuli of trachelosome, each field consisting of 5 ocelli; mouth-pore prior to centre. Posterior sucker small, but larger than anterior one, nearly centrally attached; surface smooth, with a maximum 7 ocelli on its marginal dorsal posterior part (Fig. 50: 3).

Annulation. Clitellum 4-annulate (may be additional annulation of 2-3 degree). Male gonopore on annulus 1, female gonopore on annulus 4. Gonopores situated on swelling of ventral surface of clitellum. This swelling is the external copulatory area (Fig. 50: 4). Complete somite 3-annulate (may be additional annulation of 2nd-3rd degree), surface smooth, without segmental ocelli (Fig. 50: 5). Annulus A₂ consists of a pair of pulsatile vesicles. Anus on 2nd annulus from posterior sucker (Fig. 50: 3).

Coloration. Body and suckers yellowish gray, ocelli may be depigmented after fixation.

2. Digestive system (Fig. 50: 6). Base of proboscis between ganglia 3 and 4 of ventral nerve cord. Esophageal diverticula between ganglia 4 and 5, long and voluminous. Five small crop chambers with double lateral processes which may be bifurcated in turn. Posterior crop caeca nontotally fused with 4 large fenestrae and 5 pairs of lateral processes similar to crop chamber processes, do not extend to posterior ganglion mass. Four intestinal chambers small with long processes laterally directed, 5th chamber in form of "folded organ". Rectal dilation small.

3. Reproductive system (Fig. 50: 7, 8). Five pairs of testisacs. Seminal reservoirs short, in form of small loops between ganglia 6 and 7 of ventral nerve cord. Initial parts of ejaculatory ducts short and thin, sharply divided from spherical wide terminal parts. Accessory glands absent. Common part extensive, bursa short. Ovisacs long, coiled between ganglia 7 and 8, flowing extensive seminal receptacle which formed internal copulatory area (depression of ventral body wall). Conductive tissue in form of short cords between ganglia 6 and 7 which connect seminal receptacle and ovisacs.

4. Coelomic system (Fig. 50: 9). Dorsal, ventral, lateral and testicular lacunae present. Dorsal lacuna consisting of two channels. Main connections unclosed, projections of ventral lacuna extending to dorsal lacuna in ganglion region. Accessory connec-

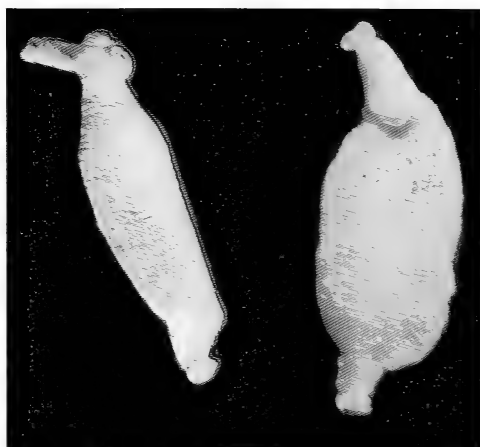

FIG. 51. *Trulliobdella capititis*, lateral and ventral view.

tions unclosed, connecting ventral and testicular lacunae. Lateral lacunae connected with main connections through pulsatile vesicles in ganglion regions.

5. Host data: *Notothenia rossi*, *Parachaenichthys georgianus*, *Neopagetopsis ionah*, *Pseudochaenichthys georgianus*, *Chaenichthys rhinoceratus*, *Chaenocephalus bouvetensis*, *Cryodraco antarcticus*, *Champscephalus gunnari*, *Chionodraco kathleenae*, *C. hamatus*, *C. rastrospinosus*, *Chaenodraco wilsoni*.

6. Distribution (Fig. 49): Bouvet I., S. Shetland Is., S. Orkney Is., Weddell Sea, Argentine Is. - Atlantic sector of Antarctic region; Wilkes Land - Indian sector; Ross Sea - Pacific sector.

References: Brinkmann 1948, Meyer & Burreson 1983, Meyer & Burreson 1990, Sawyer 1986.

Trulliobdella bacilliformis (Brinkmann, 1948)
(Syn.: *Cryobdellina bacilliformis* Brinkmann, 1948;
Antarctobdella tcherniai Dollfus, 1964;
Antarctobdella crozetensis Sawyer, 1972;
Ophthalmobdella bellisioi Szidat, 1965)

1. External characters (Figs. 52, 53). Medium-sized leeches. Up to 45 mm in length and 9 mm in width. Body short and wide, leaf-shaped (body shape variable) sharply narrowing to suckers, distinctly divided on subcylindrical trachelosome and lancet-shaped (more flattened) urosome (Fig. 52: 1). Urosome possessing 10–12 pairs of very small pulsatile vesicles and segmental ocelli on venter and dorsum. Anterior sucker small, distinctly divided from trachelosome, eccentrically attached; with 6 tentacles and 2 fields

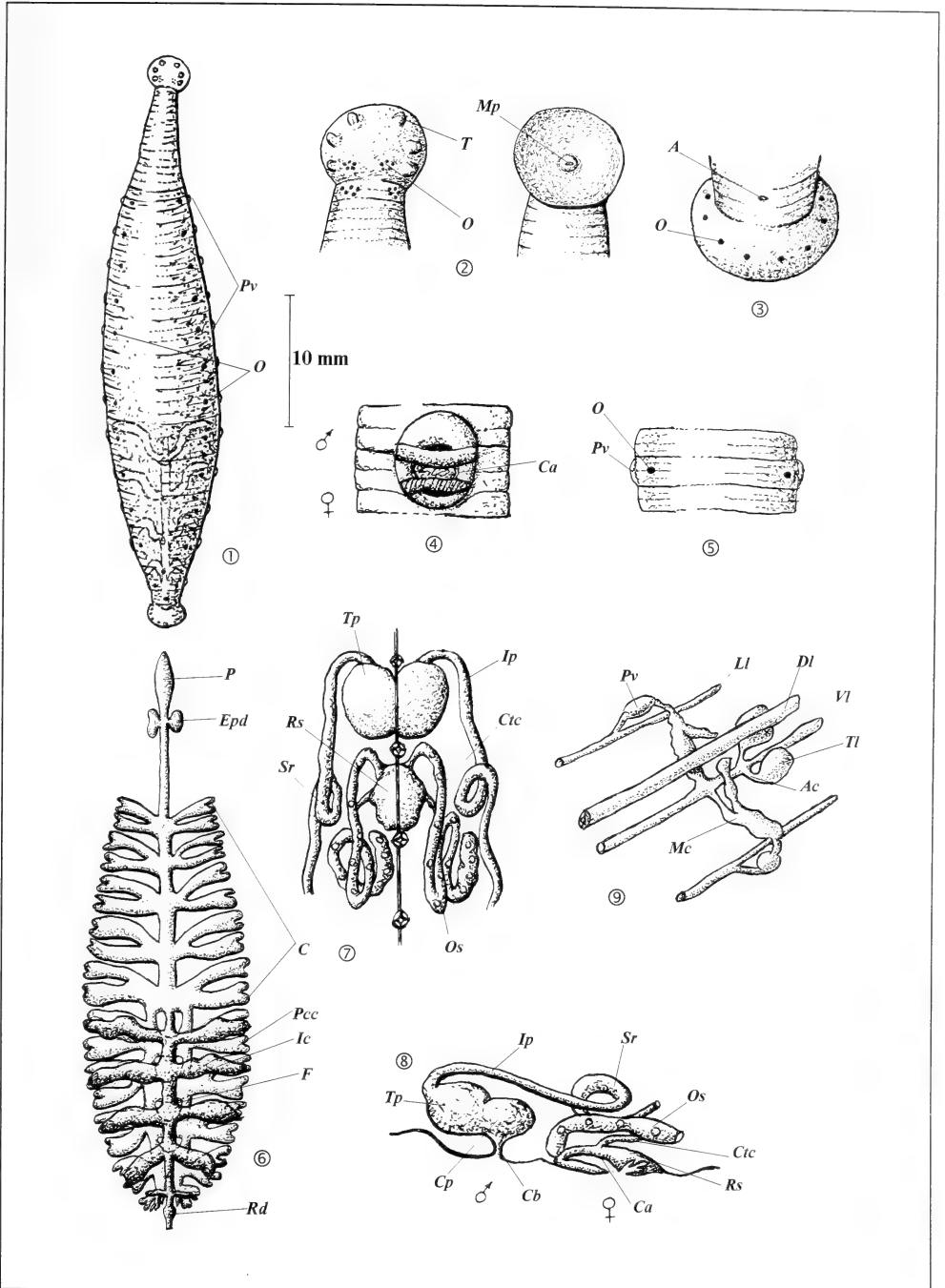

FIG. 52. *Trulliobdella bacilliformis*, external and internal structure: 1, common view; 2, anterior sucker (dorsal and ventral view); 3, posterior sucker; 4, clitellum (ventral view); 5, somite (dorsal view); 6, digestive system; 7, reproductive system (dorsal view); 8, reproductive system (lateral view); 9, coelomic system (reconstruction).

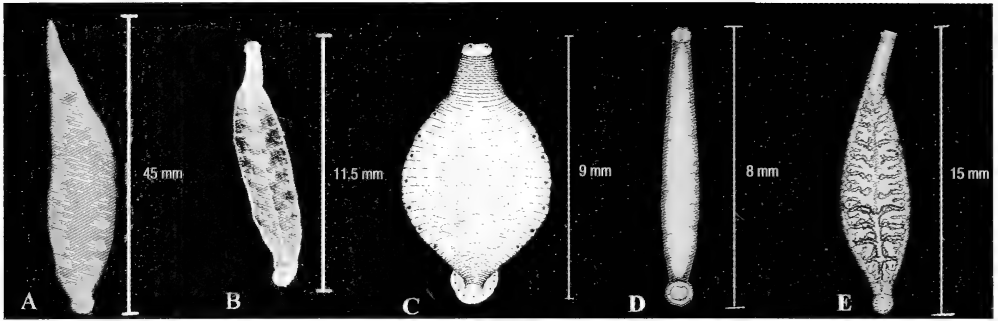

FIG. 53. *Trullibdella bacilliformis* and other "tentacled" leeches: A, *Trullibdella bacilliformis* (Brinkmann, 1948); B, *Antarctobdella tcherniai* Dollfus, 1964; C, *Antarctobdella crozetensis* Sawyer, 1972 (reproduced from Sawyer 1972); D, *Cryobdellina bacilliformis* Brinkmann, 1948 (reproduced from Brinkmann 1948); E, *Ophthalmobdella bellisioi* Szidat, 1965 (reproduced from Szidat 1965).

near the base with 3–5 ocelli per each (Fig. 52: 2). Ocelli present in 2 fields of 2 first annuli of tracheolosome, each field consisting of 5 ocelli; mouth-pore prior to centre. Posterior sucker small, but larger than anterior one, eccentrically attached; surface smooth, with a maximum 15 ocelli on its marginal dorsal posterior part (Fig. 52: 3).

Annulation. Clitellum 5-annulate (may be additional annulation of 2nd–3rd degree). Male gonopore between annuli 2 and 3, female gonopore between annuli 4 and 5. Gonopores situated on swelling of ventral surface of clitellum which evidently formed external copulatory area (Fig. 52: 4). Complete somite 3-annulate (may be additional annulation of 2nd–3rd degree). Annulus A₂ consists a pair of pulsatile vesicles and two pair of segmental ocelli on dorsum and venter (Fig. 52: 5). Anus on 2nd annulus from posterior sucker (Fig. 52: 3).

Coloration. Body without pigments, ocelli may be absent.

2. Digestive system (Fig. 52: 6). Base of proboscis between ganglia 2 and 3 of ventral nerve cord. Esophageal diverticula based after ganglion 3 and extending to ganglion 5, long and voluminous. Six small crop chambers with double lateral processes which may be bifurcate also. Posterior crop caeca nontotally fused with 4 large fenestrae, possessing 5 pairs of lateral processes similar to processes of crop chambers, do not extend to posterior ganglion mass. Four intestinal chambers small with long lateral "V"-shaped processes at their base. Fifth chamber in form of "folded organ". Rectal dilation small.

3. Reproductive system (Fig. 52: 7, 8). Five pairs of testisacs. Seminal reservoirs (short) in form of small loops near ganglion 6 of ventral nerve cord. Initial part of ejaculatory ducts short and thin, sharply divided from trapezium-shaped wide terminal parts. Accessory glands absent. Common part extensive, bursa short, opening in pocket (depression of ventral body wall). Ovisacs long, coiled at ganglion 7, flowing into extensive seminal receptacle which forms internal copulatory area (depression of ventral body wall) also. Conductive tissue in form of very short cords near ganglion 6 which connects seminal receptacle and ovisacs.

4. Coelomic system (Fig. 52: 9). Dorsal, ventral, lateral and testicular lacunae present. Dorsal lacuna consisting of two channels. Main connections unclosed, projections of ventral lacuna extending to dorsal lacuna in ganglion region. Accessory connection unclosed, connecting ventral and testicular lacunae. Lateral lacunae connected with main connections through pulsatile vesicles in ganglion regions.

5. Host data: *Notothenia coriiceps*, *N. neglecta*, *Nototheniops larseni*; *Parachaenichthys georgianus*; *Pseudochaenichthys georgianus*, *Chaenichthys rhinoceros*, *Chaenocephalus aceratus*, *C. bouvetensis*, *Champscephalus gunnari*, *C. nastrospinosus*.

6. Distribution (Fig. 49): Bouvet I., S. Shetland Is., S. Orkney Is., S. Georgia I.- Atlantic sector of the Antarctic region; Prince Edward Is., Marion I., Crozet Is., Kerguelen Is.- Indian sector.

References: Brinkmann 1948, Benham 1909, Dollfus 1964, Sawyer 1972, Szidat 1965.

Genus *Galatheabdella* Richardson & Meyer, 1973

Type species: *Galatheabdella bruuni* Richardson & Meyer, 1973

Large leeches. Body long, cylindrical, distinctly divided into trachelosome and urosome; tapering towards suckers; with 11 pairs of pulsatile vesicles, without ornamentation and segmental ocelli. Complete somite 14-annulate.

Anterior sucker: medium-sized, distinctly divided from trachelosome, eccentrically attached, surface smooth, eyes or eye-like spots absent, mouth-pore prior to centre.

Posterior sucker: large, distinctly divided from urosome, eccentrically attached, surface smooth, without ocelli.

Digestive system. Esophageal diverticula absent. Crop tubular, without distinct chambers and lateral processes. Posterior crop caeca absent. Intestine with chambers. Rectal dilation present.

Reproductive system. Six pairs of testisacs. Seminal reservoirs long, ejaculatory ducts long, common part small, bursa long. Accessory glands present. Conductive tissue mass present, copulatory area absent.

Coelomic system. Structure unknown.

Host data: *Coryphaenoides* sp., *Bassozetus* sp.

Distribution (Fig. 54): Tasman Sea; Atlantic sector of the Antarctic region.

Monotypic genus.

Reference: Richardson & Meyer 1973.

Galatheabdella bruuni Richardson & Meyer, 1973*

1. External characters (Figs. 55, 56). Large leeches. Up to 90 mm in length, 5 mm in width. Body long, cylindrical, distinctly divided into trachelosome and urosome; surface smooth, semitransparent, without ornamentation and ocelli, 11 pairs of pulsatile vesicles on urosome (Fig. 56). Trachelosome tapering cephalad. Urosome tapering caudad. Anterior sucker medium-

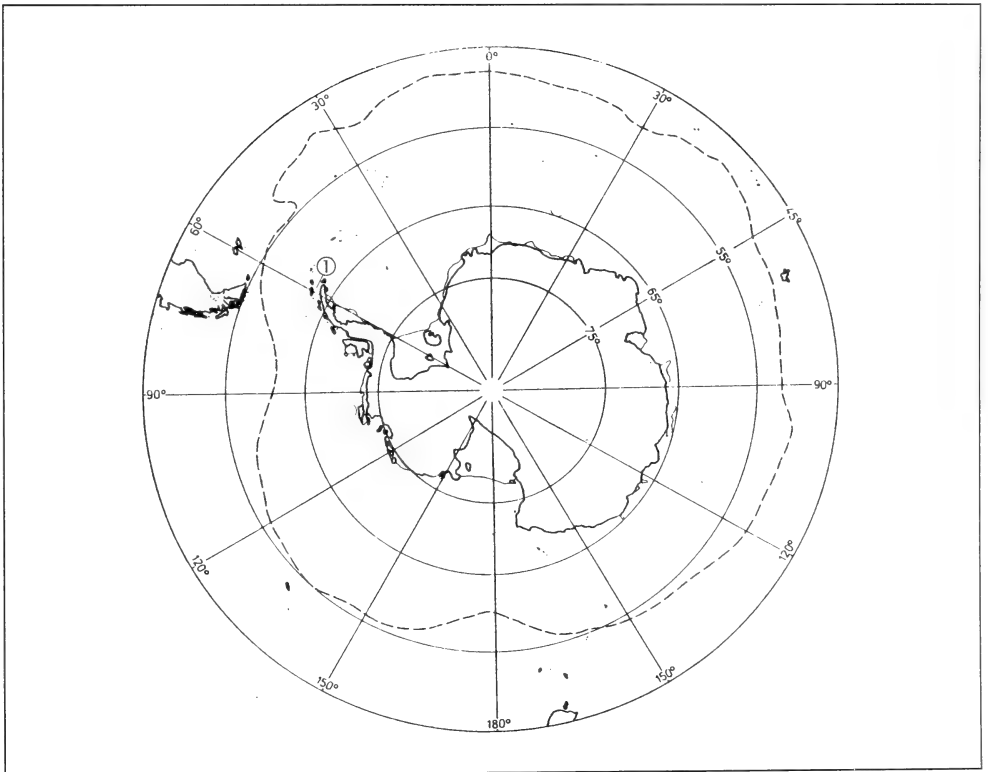

FIG. 54. Distribution of the *Galatheabdella bruuni*.

sized, distinctly divided from trachelosome, eccentrically attached, eyes or eye-like spots absent, mouth-pore prior to centre (Fig. 55: 2). Posterior sucker large, larger than anterior sucker, distinctly divided from

urosome, eccentrically attached, surface smooth, ocelli absent (Fig. 56).

Annulation. Clitellum 7-annulate, annulation weakly defined. Male gonopore located between an-

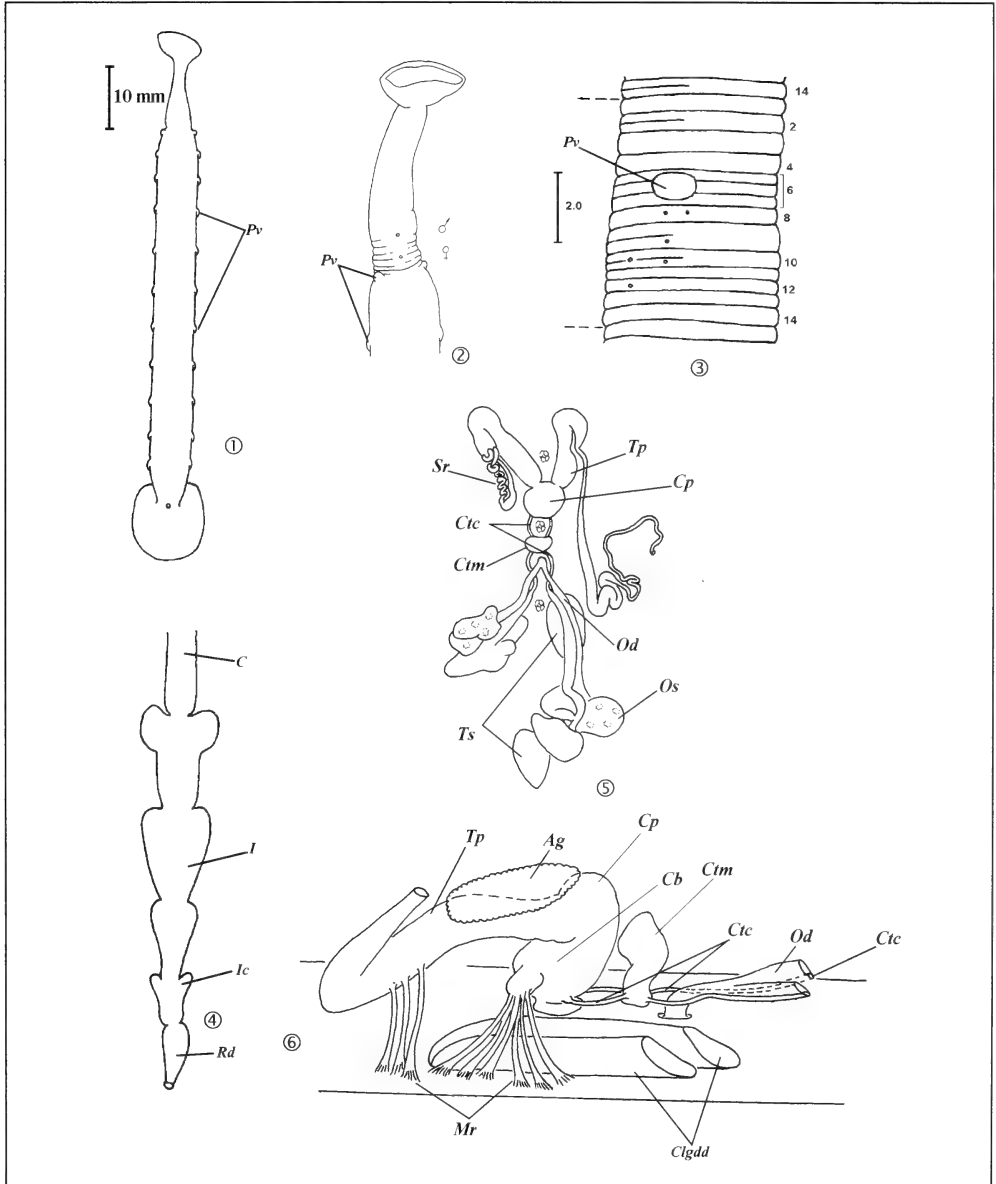

FIG. 55. *Galatheabdella bruuni*, external and internal structure: 1, common view; 2, anterior sucker with trachelosome and clitellum; 3, somite; 4, digestive system; 5, reproductive system (dorsal view); 6, reproductive system (lateral view) (reproduced and modified from Richardson & Meyer 1973).

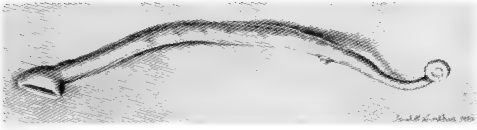

FIG. 56. *Galatheabdella bruuni*, common view (reproduced from Richardson & Meyer 1973).

nuli 1 and 2, female gonopore between 4 and 5. External copulatory area absent (Fig. 55: 2). Complete somite 14-annulate (with additional annulation), annulation weakly defined (Fig. 55: 3). Length of annuli variable. Pulsatile vesicles situated on annuli 4-6 and crossed by two interannular grooves, first pair of pulsatile vesicles on first annuli of urosome. Anus on annulus 2 from posterior sucker.

Coloration. No dark pigment and pattern, testisacs and ganglia of ventral nerve cord not visible,

pinkish individual large cells visible through the body wall, other body wall accepting this area dusky white.

2. Digestive system (Fig. 55: 4). Base of proboscis located before ganglion 3 of ventral nerve cord. Esophageal diverticula absent. Crop tubular, without distinct chambers and lateral processes. Posterior crop caeca absent. Four intestinal chambers small, without lateral processes. Rectal dilation present, tubular, reducing in diameter before ending at the anus.

3. Reproductive system (Fig. 55: 5, 6). Six pairs of elongate ovoid testisacs covered by clitellar gland cells and difficult to detect. Vasa deferentia joining smoothly seminal reservoir at ganglion 6 of ventral nerve cord. Seminal reservoir extending caudad to ganglion 7 to coil severely (may be asymmetrical), continue cephalad to ganglion 5, joining initial portions of curved, loop-shaped in vertical plane ejaculatory ducts. Ejaculatory ducts sharply divided from

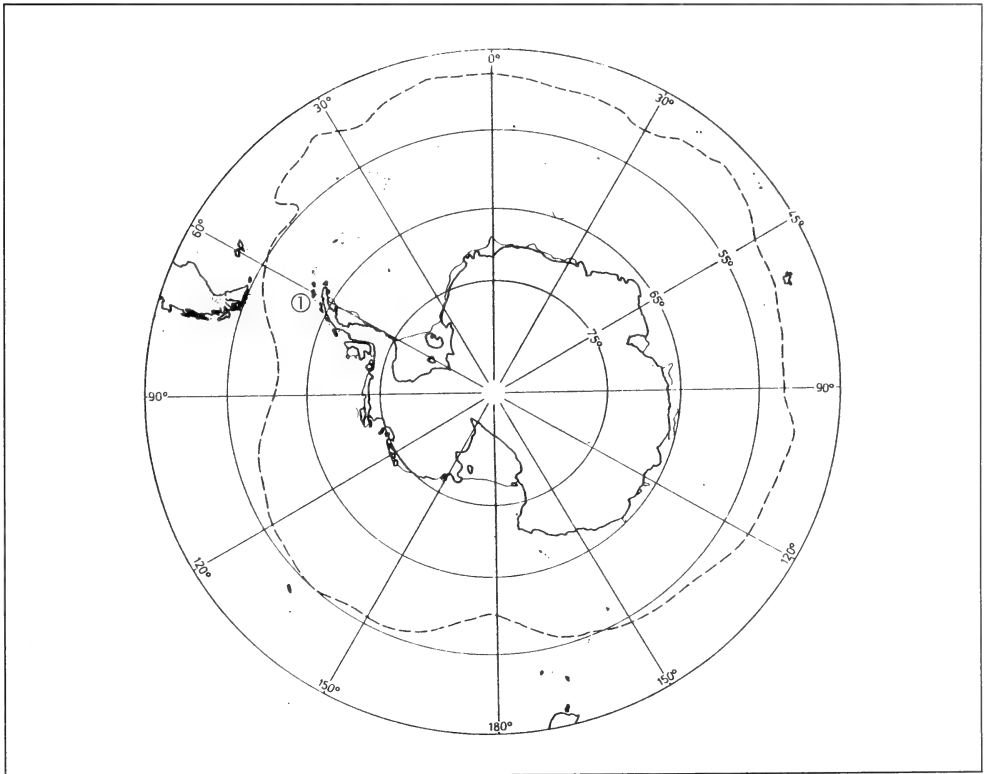

FIG. 57. Distribution of the *Trachelobdella bathyrajae*.

wide terminal part. Common part small, obtusely conical; bursa long, evertable by muscular strands which connected with lateral papillae on each side of lower region of common part of male reproductive system. Accessory glandular mass covering posterior portions of loops of ejaculatory ducts and its common part. Ovisacs extending caudad to ganglion 8 of ventral nerve cord, consisting of some lobes, asymmetrical. Conductive tissue in form of vertical, obtusely cylindrical fibrous mass between gonopores, which is connected by two fibrous cords with bursa and by two similar cords with ovisacs which extend caudad to each lobe.

4. Coelomic system. Structure unknown.

5. Host data: collected from *Coryphaenoides* sp., *Bassozetus* sp. in Tasman Sea; in Antarctic no host data.

6. Distribution (Fig. 54): Bransfield Str. - Atlantic sector of the Antarctic region; Tasman Sea - Pacific Ocean.

References: Richardson & Meyer 1973, Meyer & Burreson 1990.

Genus *Trachelobdella* Diesing, 1850

Type species: *Trachelobdella muelleri* Diesing, 1850

Not large or small leeches. Body short (may be stretching), distinctly divided into cylindrical trachelosome and subcylindrical or flattened urosome with 12-13 pairs of pulsatile vesicles. Complete somite 3-annulate, with additional annulation.

Anterior sucker: small, eyes present or absent, mouth-pore centrally located.

Posterior sucker: small, ocelli absent.

Digestive system. Esophageal diverticula absent or present. Crop chambers various in shape. Posterior crop caeca nontotally fused, with fenestrae. Lateral processes of intestine chambers weakly developed or absent. Rectal dilation present.

Reproductive system. Five to six pairs of testisacs. Seminal reservoirs very coiled. Initial parts of ejaculatory ducts short. Terminal parts wide, with accessory glands. Bursa long. Ovisacs short, with long muscular vagina. Conductive tissue and copulatory area absent.

Coelomic system. Dorsal, ventral, lateral and testicular lacunae present. Main and accessory connections in different structure. Lateral lacunae forming pulsatile vesicles typical for Piscicolinae.

Distribution (Fig. 57): Atlantic, Pacific, Indian Ocean, Antarctic Seas.

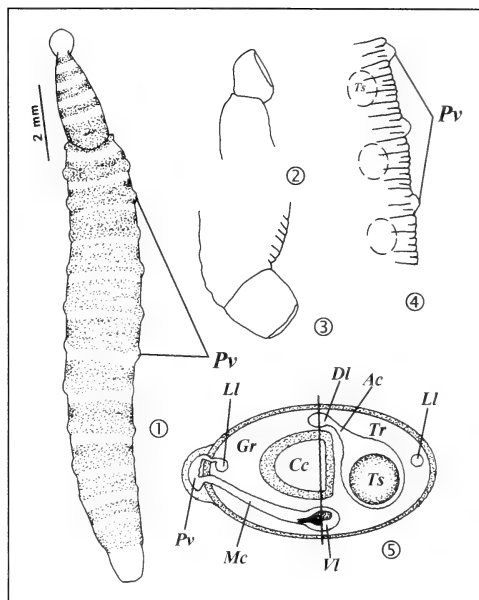

FIG. 58. *Trachelobdella bathyratae*, external and internal structure: 1, common view; 2, anterior sucker; 3, posterior sucker; 4, complete somite; 5, coelomic system (reconstruction) (© 1990 American Geophysical Union. Reproduced /modified by permission of American Geophysical Union and E.M. Burreson, Virginia Institute of Marine Science. M.C. Meyer and E.M. Burreson Some leeches (Hirudinea: Piscicolidae) of the Southern oceans. *Biology of the Antarctic Seas XXI*, Antarctic Research Series, V. 52, p 231).

Congenitors: *T. lubrica* (Grube, 1840) - equatorial world-wide

T. maculata Moore, 1898

T. rugosa Moore, 1898

T. vividus Moore, 1898

T. australis Blanchard, 1900 - South America

T. luederitzi Augener, 1936 - south-west Africa

T. leptcephali Ingram, 1957 - Tasman Sea

T. oregonensis Burreson, 1976 - North Pacific

T. bathyratae Meyer & Burreson, 1990 - Antarctic Seas

References: Epshtein 1968, Epshtein *et al.* (1994), Sawyer 1986, Meyer & Burreson 1990.

Trachelobdella bathyratae Meyer & Burreson, 1990*

1. External characters (Fig. 58). Small leeches. Up to 13 mm in length and 2 mm in width. Body long, sub-

cylindrical, tapering to suckers, distinctly divided into trachelosome and urosome by prepuce, without tubercles. Urosome with 11 pairs of pulsatile vesicles (Fig. 58: 1). Anterior sucker small, distinctly divided from trachelosome, eccentrically attached, without eyes, eye-like spots and tubercles, mouth-pore in centre (Fig. 58: 2). Posterior sucker small, but large than anterior sucker, centrally attached, indistinctly divided from urosome, cylindrical, facing directly posteriorly; without ocelli and tubercles (Fig. 58: 3).

Annulation. Male and female gonopores separated by 3 annuli. Complete somite 6–13 annulate (additional annulation), pulsatile vesicles on annulus B₃, segmental ocelli absent (Fig. 58: 4).

Coloration. 5 yellowish bands on trachelosome and 13 band of same color on urosome, annuli B₄ and B₅ unpigmented. Suckers unpigmented.

2. Digestive system. Base of proboscis located near ganglion 3 of ventral nerve cord. Esophageal diverticula based between ganglia 3 and 4. Crop enlarged

between testisacs. Posterior crop caeca nontotally fused with 4 fenestrae between ganglia 13 and 16, without lateral processes. Five intestinal lateral processes directed anteriorly, decreasing in size from 1st to 5th pair. Rectum tubular, tapering to anus.

3. Reproductive system. Six pairs of testisacs. Seminal vesicles small, tubular, located near ganglion 7. Ejaculatory ducts long, loop-like, extending to ganglion 4. Terminal and common parts tubular, bursa long. Accessory glands present, covering terminal parts of male reproductive system. Ovisacs short, tapering to gonopore. Copulatory area and distinct conductive tissue mass absent.

4. Coelomic system (Fig. 58: 5). Dorsal, ventral lateral and testicular lacunae present. Main connections unclosed, projections of ventral lacuna connected with pulsatile vesicles. Accessory connections unclosed, connecting dorsal and testicular lacunae. Lateral lacunae connected with main connection through pulsatile vesicles in ganglion region.

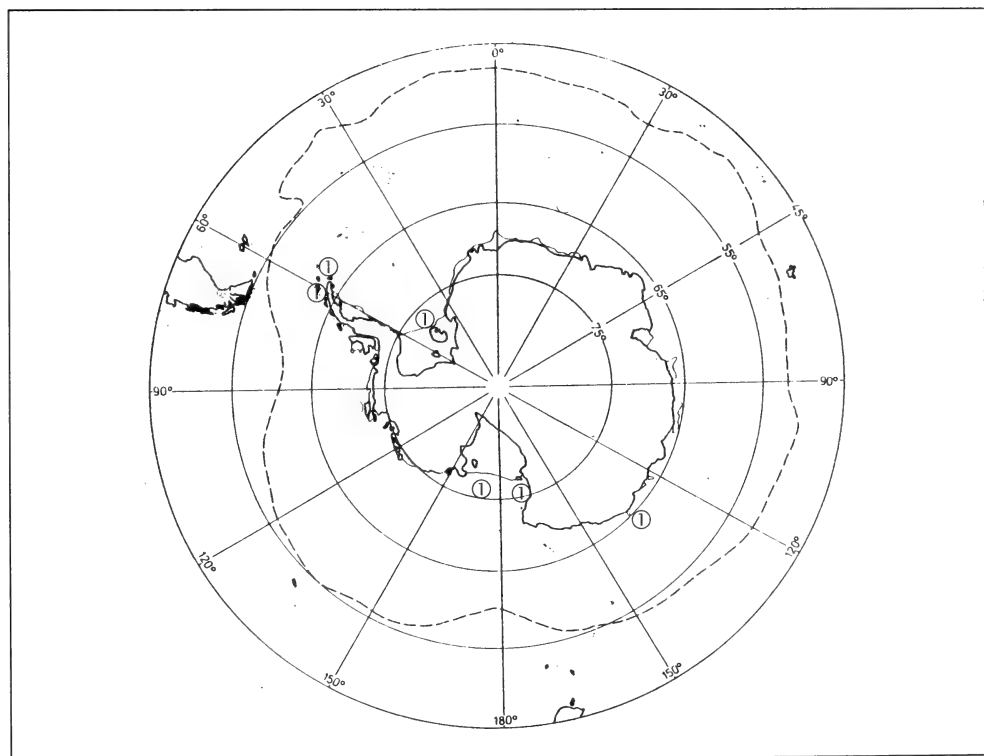

FIG. 59. Distribution of the *Nototheniobdella sawyeri*.

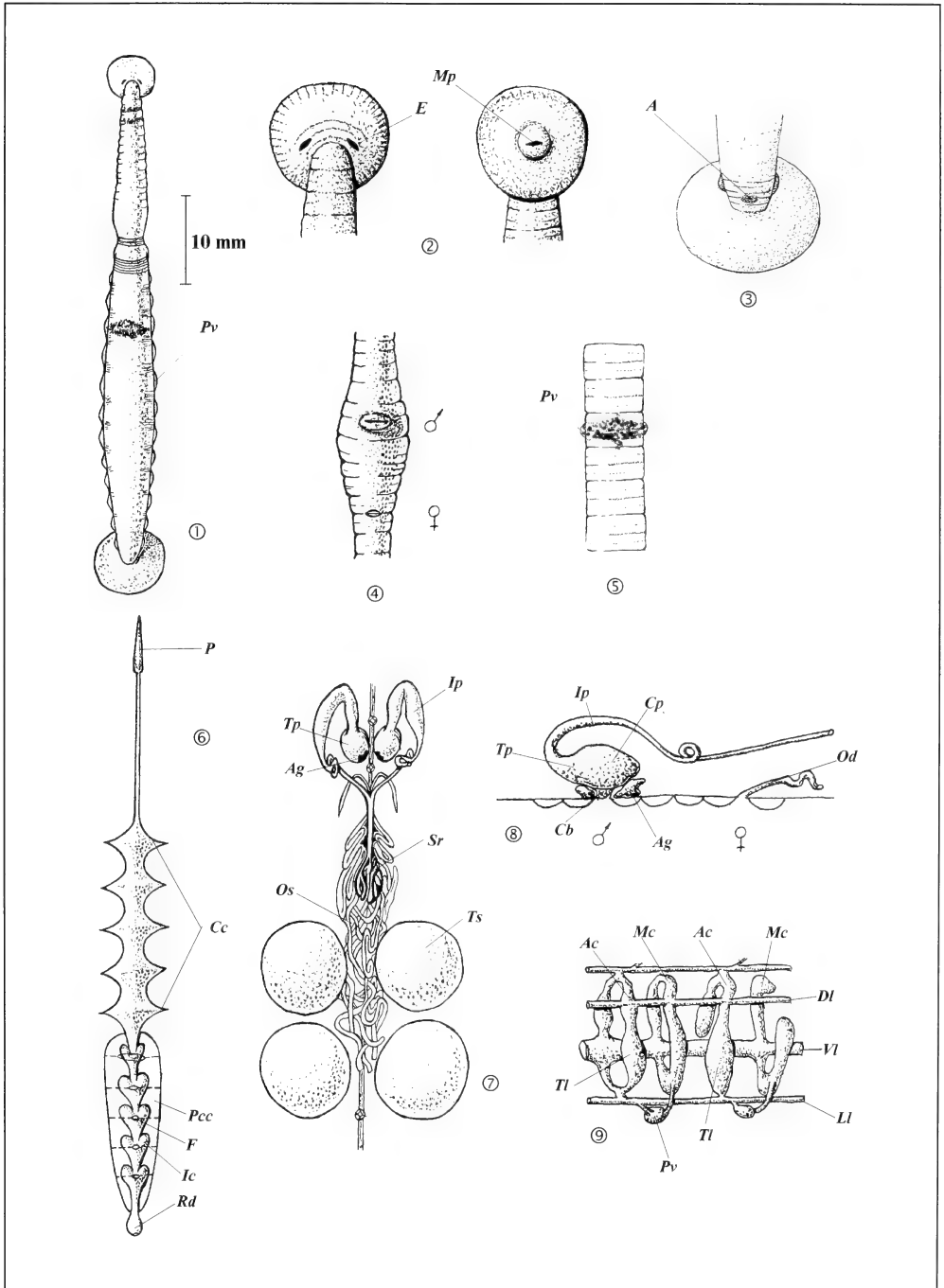

FIG. 60. *Nototheniobdella sawyeri*, external and internal structure: 1, common view; 2, anterior sucker (dorsal and ventral view); 3, posterior sucker; 4, clitellum (ventral view); 5, somite (dorsal view); 6, digestive system; 7, reproductive system (dorsal view); 8, reproductive system (lateral view); 9, coelomic system (reconstruction).



FIG. 61. *Nototheniobdella sawyeri*, lateral view.

5. Host data: collected from *Bathyraja maccaini*.
 6. Distribution (Fig. 57): S. Shetland Is. - Atlantic sector of the Antarctic region.
 Reference: Meyer & Burreson 1990.

Genus *Nototheniobdella* A. Utevsky, 1993
 Type species: *Nototheniobdella sawyeri* A. Utevsky, 1993

Medium-sized leeches. Body long, cylindrical, without papillae, tubercles, segmental ocelli and segmental pigment bands. Complete somite with well defined annulation.

Anterior sucker: large, strictly divided from trachelosome, eccentrically attached, with one pair of eyes, mouth-pore centrally located.

Posterior sucker: large, strictly divided from urosome, centrally attached, without ocelli.

Digestive system. Esophageal diverticula absent. Crop chambers without lateral processes. Posterior crop caeca nontotally fused with 5 fenestrae, without lateral processes.

Reproductive system. Five to six pairs of testisacs. Accessory glands present, bursa short. Ovisacs long. Conductive tissue, internal and external copulatory area absent.

Coelomic system. Structure of main and accessory connections variable in different somites.

Host data: fam. Nototheniidae, Bathydraconidae, Chaenichthyidae (ord. Perciformes).

Distribution (Fig. 59): Atlantic, Indian and Pacific parts of the Antarctic region.

Monotypic genus, 1 species in Antarctic region.

References: Utevsky 1993, Utevsky 2000.

Nototheniobdella sawyeri A. Utevsky, 1993

1. External characters (Figs. 60, 61). Medium-sized leeches. Up to 60 mm in length and 5 mm in width. Body long, cylindrical, sharply narrowing to anterior sucker, distinctly divided into trachelosome and urosome. Trachelosome narrower and thinner than urosome, clitellum somewhat wider than preclitellum. Urosome with 12–13 pairs of pulsatile vesicles (Fig. 61). Anterior sucker small, distinctly divided from trachelosome, eccentrically attached, with one pair of eyes, surface smooth (may be transverse furrows and rough edge) mouth-pore centrally located (Fig. 60: 2). Posterior sucker large, larger than anterior sucker, centrally attached, surface smooth (Fig. 60: 3).

Annulation. Clitellum 11-annulate (may be additional annulation). Male gonopore located on annulus 5, female gonopore between annuli 9 and 10, external copulatory area absent (Fig. 60: 4). Complete somite 6-annulate with additional annulation of 2nd–4th degree (Fig. 60: 5). Annulus B₃ bearing a pair of pulsatile vesicles. Anus on 2nd annulus from posterior sucker (Fig. 60: 3).

Coloration. Segmental brownish bands on trachelosome and urosome present. 10 bands on trachelosome and 12–13 ones (which include the annuli with pulsatile vesicles) on urosome. Body and suckers unpigmented after alcohol or formalin fixation.

2. Digestive system (Fig. 60: 6). Base of proboscis located before ganglion 3 of ventral nerve cord. Esophageal diverticula absent. Five diamond-shaped crop chambers without lateral processes. Posterior crop caeca nontotally fused, with 5 fenestrae which are filled by connective tissue. Five intestinal chambers well developed, without lateral processes. Rectal dilation present.

3. Reproductive system (Fig. 60: 7, 8). Six pairs of testisacs, testisacs of first pair may be reduced. Laterally located vasa deferentia joining smoothly seminal reservoir at ganglion 6 of ventral nerve cord. Medial seminal reservoir extending caudad to ganglion 7 to coil severely, continuing cephalad, joining greatly

coiled initial portions of curved, loop-shaped ejaculatory ducts. Ejaculatory ducts sharply divided from spherical wide terminal parts. Common part small, bursa short. Accessory glandular mass covering posterior parts of terminal, common parts and bursa. Ovisacs long, forming numerous loops and extending posterior to ganglion 8. Conductive tissue absent.

4. Coelomic system (Fig. 60: 9). Dorsal, ventral, lateral and testicular lacunae present. Main connections at ganglia 8 and 9 completely closed: connecting dorsal and ventral lacunae; other main connections unclosed: long projections of ventral lacuna extending to dorsal lacuna in ganglion region. Accessory connections of testisacs 1st and 2nd pairs connecting dor-

sal, ventral and testicular lacunae. Lateral lacunae connecting testicular lacunae and forming pulsatile vesicles connected with projections of ventral lacunae in ganglion region.

5. Host data: collected from body, mouth and gill cavity of *Neopagetopsis ionah*, *Cryodraco antarcticus*, *Chaenodraco wilsoni*, *Chionodraco kathleenae*, *C. hamatus*, *Parachaenichthys georgianus*, *Harpagiferidae* (?).

6. Distribution (Fig. 59): Palmer Coast, S. Shetland Is., Filchner Ice Shelf (Weddell Sea) - Atlantic sector of the Antarctic region; Clarie Coast - Indian sector; Scott Coast, Franklin I. (Ross Sea) - Pacific sector.

Reference: Utevsky 1993.

7. REFERENCES

- Badham, C. 1916. On an ichthyobdellid parasitic on the Australian Sand whiting (*Sillago ciliata*). Quart. Journ. Micr. Sci. 62: 1–41.
- Bakay, Yu.I., Kuzmin, S.A., & S.Y. Utevsky. 1998. Ecological and parasitological investigations on the Barents Sea Red Crab *Paralithodes camtschatica* (the first results). In: International Council for the Exploration of the Sea (Session on Stock Components in Management, AA 4, 195–202).
- Benham, W.B. 1909. Preliminary report on two Hirudinea from the subantarctic islands of New Zealand. Pp. 372–376 in Chilton, C. (ed.). The Subantarctic Islands of New Zealand. Philosophical Institute of Canterbury, Wellington.
- Brinkmann, A. 1948. Some new and remarkable leeches from the Antarctic seas. Sci. Results Norw. Antarct. Exped. 1927–1928. 29: 1–12.
- Dollfus, R. 1964/1965. Sangsue tentaculifere de la peau d'un teleosteen du genre *Chaenichthys* J. Richardson, 1844. Bull. Mus. D'Hist. Naturelle 2-e Serie, 36: 831–843.
- Epshtein, V.M. 1967. Regularities of the geographical distribution of the marine fish leeches (Hirudinea, Piscicolidae). Zool. Zhurn. XLVI: 680–691 (in Russian).
- Epshtein, V.M. 1968. Zoological analysis of the fish leeches in the Antarctic and a revision of the genus *Trachelobdella* Diesing, 1850. Pp. 137–138 in Fifth All-Union Conference of the Diseases and Parasites of Fishes and Marine Invertebrates. Leningrad (in Russian).
- Epshtein, V.M. 1970a. Bipolar distribution of marine fish leeches (Hirudinea, Piscicolidae). Pp. 143–146 in Volyanitsky, V.A. (ed.). First All-Union Symposium Diseases and Parasites of Marine Animals. Sevastopol, Kiev (in Russian).
- Epshtein, V.M. 1970b. Fish leeches (Hirudinea, Piscicolidae) in the Antarctic seas from the collection of the Zoological Institute of the Academy of Sciences of the USSR. Pp. 146–149 in Volyanitsky, V.A. (ed.). First All-Union Symposium Diseases and Parasites of Marine Animals. Sevastopol, Kiev (in Russian).
- Epshtein, V.M. 1972. Systematic status of the Antarctic leech *Pontobdella rugosa* Moore (Piscicolidae). Zool. Zhurn. LI: 1142–1146 (in Russian).
- Epshtein, V.M. 1974. New data on tropical origin elements in Antarctic Piscicolid Leech fauna. Pp. 301–305 in Six All-Union Symposium Diseases and Parasites of Marine Animals. Moscow (in Russian).
- Epshtein, V.M., & S.V. Okun'. 1991. On the structure, systematic status and distribution of the antarctic leech *Pontobdella biannulata* Moore, 1957. Informatsionnyi bjulleten' Sovetskoi Antarkticheskoj Ekspedicii 116: 99–103 (in Russian).
- Epshtein, V.M., & A.Y. Utevsky. 1994. A new marine leech *Cryobdella lyadovi* sp.n. from Antarctic Seas. Zoosystematica Rossica 3: 86–88.
- Epshtein, V.M., Utevsky, A.Y., & S.Yu. Utevsky. 1994. The system of fish leeches. Genus 5: 401–409.
- Harding, W.A. 1922. Hirudinea. Nat. Hist. Rep. Br. Antarctic. Terra Nova Exped. 1910. Zool. X: 257–261.
- Hickman, V.V. 1947. *Pontobdella tasmanica* nom.nov. (Hirudinea). Pap. Proc. R. Soc. Tasmania 27.
- Janssen, H.H. 1993. Morphology, egg cocoons, and transmission paths of the Antarctic leech *Glyptonotobdella antarctica* Sawyer & White, 1969 (Hirudinea: Rhynchobdelliformes: Piscicolidae). Polar Biol. 13: 347–354.
- Khan, R.A., & A.J. Paul. 1995. Life cycle studies on arctoboreal leeches (Hirudinea). J. Helminthol. Soc. Wash. 62: 105–110.
- Llewellyn, L.C. 1966. Pontobdellinae (Hirudinea: Piscicolidae) in the British Museum (Natural History) with a revue of the Subfamily. Bull. of the British Museum (Natural History). Zoology 14: 341–439.
- Meyer, M.C., & A.A. Barden. 1955. Leeches symbiotic on Arthropoda, especially Decapoda Crustacea. Wassmann Journal of Biology 13: 297–311.
- Meyer, M.C., & E.M. Bureson. 1983. Redescription of the piscicolid leech *Trullibdella capitis* Brinkmann. Proc. Helminthol. Soc. Wash. 50: 138–142.
- Meyer, M.C., & E.M. Bureson. 1990. Some leeches (Hirudinea: Piscicolidae) of the southern oceans. Biology of the Antarctic Seas. Antarctic research series. 52: 219–226.
- Moore, J.P. 1938. Leeches (Hirudinea). Australasian Antarctic Expedition 1911–1914. Sci. Rep.(C) 10: 5–16.
- Moore, J.P. 1957. Hirudinea. B.A.N.Z. Antarctic Research Expedition. Rep. Ser. B (Zoology and Botany) 6: 102–105.
- Richardson, L.R., & M.C. Meyer. 1973. Deep-sea fish leeches (Rhynchobdellae: Piscicolidae). Galathea report: Scientific Results of the Danich Deep-Sea Expedition Round the World 1950–52. Pp. 113–126.
- Sawyer, R.T. 1972. A new species of "tentacled" marine fish leech parasitic on Notothenia from subantarctic Marion and Crozet Islands. Hydrobiologia 40: 345–354.
- Sawyer, R.T. 1976. Notes on two marine leeches (Annelida, Hirudinea) from Subantarctic Marion Islands including a new record. Hydrobiologia 48: 267–268.
- Sawyer, R.T. 1986. Leech biology and behaviour. Feeding biology, ecology, and systematics. Oxford.
- Sawyer, R.T., & M.G. White. 1969. A new genus and species of marine leech, *Glyptonotobdella antarctica*, from the antarctic isopod. Brit. Antarct. Surv. Bull. 22: 1–14.

- Szidat, L. 1965. Los parasitos de *Notothenia neglecta* Nybelin. Estudios sobre la fauna de parasitos de peces Antarticos. Republica Argentina, Secretaria de Marina, Servicio de hidrografia naval. 910: 1–84.
- Utevsky, A.Y. 1993. A new marine leech *Nototheniobdella sawyeri* gen.nov., sp.nov. (Hirudinea, Piscicolidae) from Antarctic seas. Zoosystematica Rossica 2: 237–240.
- Utevsky, A.Y. 1994. A new Genus of Antarctic Piscicolid leeches (Hirudinea, Rhynchobdellida). Vestnik Zoologii 4-5: 73–76 (in Russian).
- Utevsky, A.Y. 1995. A New Antarctic leech genus (Hirudinea, Piscicolidae). Vestnik Zoologii 5-6: 3–12 (in Russian).
- Utevsky, A.Y. 1997. A new species of piscicolid leeches (Hirudinea, Piscicolidae) from Antarctic seas. Vestnik Zoologii 31: 17–24 (in Russian).
- Utevsky, A.Y. 2000. Fauna of Antarctic fish leeches (Hirudinea, Piscicolidae). Visnyk Kharkivskogo Universytetu 456: 104–107 (in Russian).
- Utevsky, A.Y. 2005. An identification key to Antarctic fish leeches (Hirudinea: Piscicolidae). Ukrains'kij Antarktychnij Zhurnal 3: 135–144.
- Utevsky, S.Y., Utevsky, A.Y., Schiaparelli, S., & P. Trontelj. 2007. Molecular phylogeny of pontobdelline leeches and their place in the descent of fish leeches (Hirudinea, Piscicolidae). Zoologica Scripta 36: 271–280.
- Williams, J.I., & E.M. Burreson. 2006. Phylogeny of the fish leeches (Oligochaeta, Hirudinida, Piscicolidae) based on nuclear and mitochondrial genes and morphology. Zoologica Scripta 35: 627–639.
- Yang, T. 1980. Two marine leeches from Antarctic fish of the genus *Notothenia*. Acta Zool. Sinica 33: 373–377.

8. INDEX

- Accessory connection 7, 19-21
 Accessory glands 7, 15, 18
Antarctobdella crozetensis 10, 66, 68
Antarctobdella tcherniai 10, 66, 68
 Anus 7, 17
 Atrium 7, 15
Austrobdella 27, 40, 42
Austrobdella translucens 10, 22-25, 27, 42, 44, 45
- Body 7, 12
- Clitellum 7, 12, 13, 15
 Coelomic (lacunar) system 16, 19-21
 Common part (ejaculatory ducts) 7, 15, 18
 Conductive tissue 7, 15, 18
 Conductive tissue cord 7, 18
 Conductive tissue mass 7, 18
 Copulatory area 7, 15
 Copulatory bursa 7, 15, 18
 Crop 7, 15, 17
 Crop chambers 7, 15, 17
 Crop region 7, 12, 13
Cryobdella 25, 27, 40, 52
Cryobdella antarctica 10, 22, 23-25, 27, 53, 54, 56-58
Cryobdella levigata 10, 22-25, 27, 54, 55
Cryobdella ljadovi 11, 22-25, 27, 53, 54, 56, 59, 60
Cryobdella pallida 11, 22-25, 27, 53, 54, 58, 61, 62
Cryobdellina bacilliformis 10, 22-25, 64, 66, 68
- Digestive system 15, 17
 Dorsal lacuna 7, 19-21
 Dorsal vessel 7, 20
- Ejaculatory ducts 7, 15, 18
 Epididymis 7
Epsteinia 27, 40, 41
Epsteinia alba 22-25, 27, 41-43
 Esophageal diverticula 7, 15, 17
 Esophagus 7, 15, 17
 Eye-like spots 7, 12, 14
 Eyes 7, 12, 14
- Female reproductive system 15, 18
- Galatheabdella* 11, 28, 60, 69
Galatheabdella bruuni 69-71
 Ganglion region 7, 19
Glyptonotobdella 10, 27, 40, 49
Glyptonotobdella antarctica 10, 22-25, 27, 49, 51-53
Glyptonotobdella epshteini 56
- Hosts 23, 24
- Initial part (ejaculatory ducts) 7, 15
 Intestinal region 12, 13
 Intestine 15, 17
- Lateral lacunae 7, 19-21
 Lateral processes 7, 17
- Male reproductive system 15, 18
 Main connection 7, 19, 20
 Marginal flanges 7, 16, 48, 50
 Marginal lacunae 7, 19-21
Megaliobdella 11, 27, 28, 39
Megaliobdella szidati 11, 22-25, 39, 40
Moorebdellina 10, 27, 28, 30, 32
Moorebdellina biannulata 22-25, 27, 30, 32-34
Moorebdellina meyeri 11, 22-25, 27, 30, 32, 37, 38
Moorebdellina rugosa 11, 22-25, 27, 30-32
Moorebdellina uschakovi 10, 11, 22-25, 27, 30, 32, 35, 36
 Mouth-pore 7, 15
- Nerve cord 15, 17, 18
Notobdella nototheniae 64
Notobdella streptocheles 51
Nototheniobdella 11, 28, 60, 75
Nototheniobdella sawyeri 11, 22-25, 28, 73-75
- Ocelli 7, 12, 14
Ophthalmobdella bellisioi 10, 11, 66, 68
 Oviducts 7, 15, 18
 Ovisacs 7, 15, 18
Oxytonostoma varituberculata 10, 46, 47
- Papillae 7, 14, 16
 Piscicolinae 21, 27, 28, 60
Platybdella levigata 10, 53
 Platybdellinae 21, 27, 28, 40
Pleurobdella 27, 46, 47
Pleurobdella australis 22-25, 27, 46, 47, 49-51
Pleurobdella varituberculata 22-25, 27, 46-49
Pontobdella 10, 11, 27, 28
Pontobdella biannulata 10, 34
Pontobdella rugosa 10, 30, 32

Pontobdella tasmanica 11, 22-25, 27-29
Pontobdellinae 21, 27, 28
Posterior crop caeca 7, 15, 17
Preclitellum 7, 12, 13
Preservation 26
Proboscis 7, 15, 17
Pterobdellina australis 49
Pulsatile vesicles 7, 20, 21

Rectal dilation 7, 15, 17
Rectum 7, 15, 17

Seminal receptacle 66, 68
Seminal reservoirs 7, 15, 18
Sucker 7, 12-14
Stibarobdella tasmanica 28, 29

Tentacles 7, 14
Terminal part (Ejaculatory ducts) 7, 15, 18
Testicular lacuna 8, 19-21

Testicular region 7, 20
Testisacs 15, 16, 18
Trachelobdella 11, 28, 60, 72
Trachelobdella bathyrajae 11, 22-25, 28, 71, 72
Trachelobdellina 10, 11, 28, 60
Trachelobdellina glabra 10, 22-25, 28, 62, 63
Trachelosome 8, 12, 13
Trulliobdella 10, 11, 28, 60, 63
Trulliobdella bacilliformis 22-25, 28, 64, 66-68
Trulliobdella capitata 10, 11, 22-25, 28, 63-66
Trulliobdella alba 10, 41
Tubercles 8, 16

Urosome 8, 12, 13

Vagina 8, 16
Vasa deferentia 8, 18
Vasa efferentia 8, 18
Ventral lacuna 8, 19-21
Ventral vessel 8, 20

Author's address

Andrei Y. Utevsky, Ph.D.
Dept. of Zoology and Animal Ecology
V.N. Karazin Kharkiv National University
61077, Kharkiv, Ukraine
Email: autevsk@yandex.ru

SMITHSONIAN INSTITUTION LIBRARIES



3 9088 01388 4101

BONNER ZOOLOGISCHE MONOGRAPHIEN Nr. 54, 2007

Editor: Karl-L. Schuchmann

Zoologisches Forschungsmuseum Alexander Koenig (ZFMK)

Ornithologie

Adenauerallee 160, D-53113 Bonn, Germany

Druck: JF. CARTHAUS, Bonn

ISBN-13: 978-3-925382-58-1

ISSN 0302-671X