

*

UMASS/AMHERST

*



312066 0333 3293 8

LIBRARY
OF THE



MASSACHUSETTS
AGRICULTURAL
COLLEGE

SOURCE.



Laces April 15th 1891

THE
British Bee Journal,

AND BEE-KEEPERS' ADVISER.

EDITED BY

THOS. WM. COWAN, F.G.S., F.L.S., F.R.M.S., &C, AND W. BROUGHTON CARR.

— . . . —
VOLUME XXV.

JANUARY-DECEMBER, 1897.

— . . . —
PUBLISHED BY

SIMPKIN, MARSHALL, HAMILTON, KENT, & CO., LIMITED,

23, PATERNOSTER ROW, E.C.

LIBRARY

UNIVERSITY OF
MASSACHUSETTS

AMHERST, MASS.

LONDON :

PRINTED BY LOVE AND WYMAN, LIMITED,
GREAT QUEEN STREET, W.C.

INDEX.

- EDITORIALS:**—Directly Personal, 1; Cultivation of Bacterium, 11; Bee Associations and Legislation, 31; Points Requiring Attention, 51; Assisting "The Cause," 71; County Associations and Legislation, 91; Sending Live Bees by Post, 121; Compulsory Powers, 151; Plain Words Regarding Plain Facts, 171; Improving the Occasion, 181; June First, 211; The Jubilee Week, 241; Judging at Shows, 251; Shallow Frames for Extracting, 331; Buying Diseased Bees, 391; Dairy Show, 401; Record "Take" of Honey, 411; Foul Brood Legislation, 451; Unreported Bee Talks, 461; To our Readers, 511
- Agricultural Tenants, Legal Rights of, 438**
American and Colonial Bee Journals, 120, 430
Anti-swarming Chambers, 35, 65
Apiaries, Photos of, 100
Apiary, Re-arranging, 7
APICULTURAL NOTES (by Allen Sharp): On Candy Feeding and Wintering Bees, 16; Packing Honey for Rail, 33; Shall we Produce 2 lb. Sections? 46; Plain facts on the Price of Honey, 67; Mainly about Weather and Bees, 67; Driven Bees and Spring Feeding, 127; Foul-brood Legislation and Selling Bees, 143; Bee Season of 1897, 483, 493
- Apis Dorsata, Domesticating, 435**
Appliance Dealers and Customers, 119, 310
April Showers, 177
"Art Honey," Swiss Bee-keeping and, 244
Artificial Increase, 215
Assisting the Cause, 71
ASSOCIATIONS, BEE-KEEPERS'—
 British, 11, 62, 91, 101, 111, 121, 131, 161, 182, 271, 352, 361, 491, 421, 441, 481, Berks, 232, 396; Bristol, Somerset, and Gloucester, 41; Cornwall, 153; Derbyshire, 22, 361; Dairy, 373; Essex, 136, 161, 443; Gloucester, 355; Helmsley and District, 53; Herefordshire, 91, 372, 439; Irish, 22, 63, 92, 161, 183, 318, 355, 490; Kent and Sussex, 31, 91, 161, 353; Lancashire and Cheshire, 71, 313; Lanark, 491; Leicestershire, 92, 312, 372; Lincolnshire, 192, 291, 391; Middlesex, 281; Northamptonshire, 63, 313, 346; Nottinghamshire, 82, 246, 291; Northumberland and Durham, 183; North Norfolk, 321; Perthshire, 373; Pickering and District, 424; Roxburghshire, 393; Staffordshire, 141, 334; Scottish, 291, 337, 463; Surrey, 362, 433, 422; Shropshire, 332; South of Scotland, 336; Wotton-under-Edge, 63; Warwickshire, 153; Worcestershire, 233; Wilts Border Co-operative, 354; Wellington and District, 416; Yetminster County Council District, 336
- Association for Bucks, an, 207; for Cumberland, 452; for Devon and Exeter, 482; Village Bee-keepers', 486**
Average Returns, 50
Bacterium, Cultivation of, 11
BEE AND HONEY SHOWS at:
 Barrow - in Furness, 341; Basingstoke, 492; Biggar, 342; Blankney, 391; Buntingon-Trent, 334; Bradford Abbas, 336; Bramhall, 359; Chester, 391; Delapre Park, Northants, 313; Dumfries, 237; Derby, 361; Edinburgh, 463; Fallowfield, Manchester, 313; Fairfield, Manchester, 343; Farnham, 433; Gloucester, 335; Goole, 341; Glasgow, 424; Harrogate (Yorks), 221, 302, 319, 343; Hampton, 281; Hamilton, 491; Hucknall, 291, Helsby, 314; Hastings, 353; Hereford, 372; Juniper Green, 341; Jedburgh, 393; Kingsbridge, 322; Leicester, 312; Loughborough, 373; Ludlow, 452; Manchester, 251, 261, 262, 271; Melton Constable Park, 321; Notts, 246; Northenden, 342; Neston (Wilts), 354; Perth, 373; Reading, 232; Sleaford (Lincs), 291; Southwell, 291; Shrewsbury, 332; Woking, 392; Welbeck, 322; Lthlin, 591
- Bee as a Weather-prophet, the, 512**
Bee Associations and Legislation, 143
 " " and Foul Brood, 68
Bee-Clubs, Suggested, 364, 351
Bee-County, Wiltshire as, a, 129, 136
Bee Case, a Pending, 366
 " " at New Romney, 380
Bee Firm, Location for, 36; an American, 95; in Scotland, Starting a, 194; New Zealand, 199, 119
BEE FOOD: Granulated Honey for, 97; Preparing, 199, 379; Unrefined Cane-Sugar for, 119; Carbolic Acid for use in, 199; Medicated, 290, 380; Cane-Sugar for, 299, 340; Using Honey for, 330; for Autumn, 349, 379; Suitable Sugars for, 351; Extracted Honey as, 389; Salted Pichards as, 418; Using Honey from Diseased Hives as, 470
BEE FLORA: 139, 155, 156, 337, 340; Chapman's Honey-Plant, 4, 40; *Echinops Sphaerocephalus*, 66, 77; *Eryngium Maritimum*, 83; *E. celestium*, 84; *E. pandifolium*, 84; *E. giganteum*, 84; Eryngiums and Pianos, 109; Sea Holly, 77; *Petasites vulgaris*, 160
Bees and Early Spring Flowers, 155
 " Intimidants, 110
Bee Items, Miscellaneous, 292
Bee-man's Trip to the "Dukeries," 13
Bee Notes from Sussex, 34, 114, 126, 176, 194; from North Hampshire, 56; from Derby, 77; from Ross, 594
Bee Pasturage, 27
 " Parasites, 296, 356
Bee Possession, an Awkward, 367
Bee Stings, 139; Recipe for, 398
 " Season, the, 128, 412, 494
Bee Talks to Myself, 214
 " Talks, Unreported, 461
 " Work, Saving time in, 149
 " " Neglected, 452
Bee Legislation, 143; County Associations and, 91; Compulsory Powers, 151, 175; Bill for Dealing with Foul Brood, 151; What the Cranleigh Bee Club think of it, 164
Bee Shows to Come, 150 (continued weekly)
Bee-keepers and Food Adulteration, 84
 " on the Foul Brood Bill, opinion of, 196, 208
 " Important Decision as Affecting, 391
Bee-keeper's Paradise, 427
Bee-keeping, Starting, 7, 139, 359; in the Lake District, 57; in West Dorset, 77; around Manchester, 86; Lecture on, 37; Swiss, 244; Beginning, 349; in the Isle of Man, 399, 443; and County Councils, 414; Teaching, 476, 486, 508
Bee-keepers' Experience, a Hampshire, 494
BEEs: and Sportsmen, 438; and the Garden, 456; a Dozen Questions on, 297, 322; Application of Law of Breeding to, 8; with Queen on her Mating-
- trip, 279; Blocking Entrances, 30; Buying, 198; Buying Diseased, 117, 384, 390, 391; and Drinking Troughs, 19; and Honey Production, 34; and Birds, 93; and Spring Feeding, 127; and Aphids, 212; and Historic Devices, 222; by Post, Sending, 121, 141, 256, 314, 322; Bad Start with, 278; Building Combs in Trees, 298; Cyprian, 99; Cast Out, Dead, 219; Dying, 19, 98, 189, 379, 500; Dying in Snow, 78; Dying behind Queen Excluder, 338; Dead through Famine, 140, 157, 170, 189; Deserting Brood in "Wells" Hives, 200; Drivelling, 280; Ecclesiastical, 498; for Profit, Keeping, 6, 329; for Transit, Packing, 36, 265; for Object Lessons, 460; Flowers for, 147; from House Roof, Removing, 237; Fighting among Themselves, 189, 387; Hybridising, 267, 508; Hedgehogs and, 306; in Railway Lamp, 329; Dividing, 327; Dysentery, 339; in a Rectory House, 449; in co. Kilkenny, 116, 404; in Cumberland, 362; in co. Down, 416; in Dumfries, 406; in Diseased Hives, Destroying, 346; in Early Spring, Moving, 178; Buying in Frame Hives, 138; in Greenhouses, 90; in India (by Lord Roberts), 119; in Jamaica, 146; in Japan, 402; in New Zealand, 22, 42, 57; in Scotland, 5; in South Africa, 63; in Skips for Travelling, Packing, 310; in the Malay Archipelago, 397; Materials for Packing, 346; in the Far North, 396; in Wales, 5, 17, 26; in "Wells" hives, 5; in West Cornwall, 194; in Winter, Moving, 37; Italian, 119; Leaving Hives, 210; Moving, 39, 109, 156, 310, 508; My First Year with, 448; My, 60; Mice and, 70; Manipulating, 93; Near London, 456; on Frames, Price of, 119; Price of Driven, 80; Planting for, 317, 337; Preventing Swelling when Stung by, 330; Pigeons and, 418; Races of, 229, 329, 429; Refusing to Enter Supers, 248; Refusing Sections, 263; Refusing Foundation, 269; Recording Observations on, 296; Superseding Queens, 18; Safe Journey with Driven, 53; Summer Management of, 131; Short of Stores, 198; Subduing, 280; Specialised Development in, 439; Smothered in Transit, 444; Tits and, 87, 93, 103, 128, 136;**

- Transferring Themselves from Skeps to Frame Hives, 268, 330; Uniting, 147, 179, 217, 226, 310, 319, 324, 350, 368; Utilising Driven, 248, 268, 278, 350; Unable to Fly, 299; Varieties of, 139, 390; Vicious, 279, 289; Short of Food, 81; Italianising, 88; Buying Infected, 117, 218; by Auction, Selling Infected, 211; in Natal, 504; in Essex, 507 Bees' Eggs, Vitality of the, 454 Beginners: Assisting, 155; Advice to, 76; Experiences, 94; Having Swarms for, 97; Balance-sheet, 5, 448; Plans for '98, 499; Queries, 29, 89, 318, 417
- Bell Glasses on Skeps, 266, 292
Bound Volumes of BEE JOURNAL, 50
- British B.K.A. and its Affiliated Associations, 361
Brice, H. W., Mr., his "Goings of the Past Month," 32, 72, 113, 153, 193
- Broad Spreading, 76, 203, 235
" in Spring, 292
" Temperature for Safe Removal of, 208
" in Sections, 267
- Canadian Bee Journal* (an acknowledgment), 150
Candy Making, 26, 46, 70, 78, 90, 100, 378, 460
Carbolised Cloths, Using, 367
Caroliann Queens, Non-Deliverly of, 426, 435
Casts, Returning, 298
Celluloid for Feeding Stages, 17, 36
Chapman Honey Plant, Free Seeds of, 476, 500
Chilled Brood, 179
Christmas Holiday, My, 13
Chickens Stung by Bees, 292
Cider Industry, the, 27
Colony of Bees, What Constitutes a, 516
COMB-FOUNDATION: Is, 87, 89, 98, 103, 179, 259, 263; and Honey Samples, 500; How it should Hang, 146, 164, 168, 229; Bees Refusing, 279, 310; The New Deep-cell "Weed" 282; Thin Super, 389
Comb Cappings, Colour of, 450
Comb-Honey Preserving, 231
Comb-Rack for Fumigating 437
Combs, Hard Pollen in, 60
Combs: Using Mouldy, 160; Utilising Old, 81; Using Discovered, 217; Renewing, 233, 420; Storing Pollen, 339; Storing Empty, 350; With Dead Larvæ, 350; Misshapen, 430; Old Used Up, 140; Patched Up, 448
Contribution from Wilts, A, 187
Contributors, Sparing, 372
Conversazione of B.B.K.A., 111, 182, 407, 406, 421, 431, 441
Copies of JOURNALS for Free Distribution, 370, 476
Cottagers, A Hint to, 214
" Attempt at Modern Methods, 218
County Trophy, Labels, 21
" Competitions, 61, 306
County Associations and their Work, 94, 104, 106, 116
Criticising Contributions, 150
Current Topics, 513
- Dairy Show: 353, 374, 401, 422, 455; Suggestions for next year's, 448; Prize List, 450
Dealers' Catalogues, 60
Dead Bees on Floor Boards, 387
Detecting Disease, 389
Devonshire Bee-keepers, To, 482
Distance Pins in Bottom Bars, 18
Disadvantages of a Warm Location, 226
Diseased or Queenless, 320
Diseased Bees, Buying, 391, 400
Disinfecting Store Combs, 499
Divided Sections, 516
Division Boards in "W.B.C." Hives, 450
Doolittle, Mr. G. M., on Uniting Nuclei and After-swarms, 19; on Giving Foundation in Brood Frames, 39; on Securing Worker Combs, 116; on Increase and Extracted Honey, 223; on the Value of String Colonies, 49; on Saving Time in Bee work, 149; on Feeding Back Extracted Honey, 348; on Combs and Honey for Next Season, 343; on Preparing Honey for Market, 358; on Long Hives & Tiering Up, 376; on Italian Bees not Working in Sections, 377; on Making Sugar Syrup for Bees, 410; on Preventing Swarms in an Out-Apiary, 418; on Winter Passages, 459
Double Queen System, 68
Doubling and Sterilizing, 97, 109, 138
DRIVEN BEES: Utilising, 248, 268, 359, 368; Uniting, 347, 357; Candy for, 360; Deserting Hives, 378; Feeding, 379, 430, 438; Buying by Weight, 436, 447
Driving Bees, 330
Driving Bees, A Lady's Experience of, 73; Date for, 137, 219; Driving Experiences, 108
Drone Brood, Early, 137
" " in Worker Cells, 138
" " Cells in Brood Chambers, 263
Drone-fly, The, 414, 427
Drones: Returning to their Hives, 292; in Autumn, 387; Bees Killing, 299, 310, 490
Drunken Humble Bees, 169
Dysentery through fermenting food, 168; Suspected, 7, 49
- Echoes from the Hives, 38, 59, 60, 89, 149, 159, 169, 189, 199, 216, 288, 309, 319, 348, 368, 380, 419, 438, 470, 508, 516
Editors, Sorrows of, 207
Editorial Notices, &c., 111
Entomologists, Query for, 407
Errata, 40, 95, 122, 136
Exhibits, Disqualifying, 370
Experts and their Work, 140
Experts' Examinations, 37
" Certificates, 89, 103, 279, 400, 439
Expert, a Word from the, 107
" Views on Important Points, 393
Experiments with Non-Swarmers, 458, 468
Extracting, 4, 76, 118, 388
Extracting: Honey in February, 68; Honey by Melting Combs, 460; from Skep Covers, 357; from Brood Chamber, 420
Feeding-Stages, Vulcanite and Celluloid for, 7, 17, 36
FEEDING BEES: Granulated Honey for, 10; Stimulative in Spring and Autumn, 29, 148, 347, 351, 401, 469, 412; Advan-
- tagous? Is it, 202; Driven Bees and Spring, 127; Bought Honey for, 480; for Winter, 340; Inside Open Air, 4 3; Feeding under Difficulties, Late, 399
Feeding Bottles, 230
Feeders, Regulating, 37
Five Days' Weather in May, 204
Floorboards, Thickness of, 6, 18
" Ventilating, 203
Flowering Anemolopsis, 599
Food Adulteration, Bee-keeping and, 84
" in Brood-Combs, Excess of, 138
" for Winter, Amount of, 368
" over Winter, Keeping Unsealed, 410
" Utilising unsealed, 79
Stocks short of, 81
FOUL BROOD: 163, 174, 187, 219, 222, 300, 376, 400, 466; Vitality, of Spores, 36; Suspected, 50, 97, 110, 170, 209, 403; Bee Associations and, 68, 188; and Legislation, 91, 143, 151, 164, 175, 181, 187, 188, 196, 210, 229, 451; Pessimism and, 176; Cottagers and, 187; Comments from Bucks, 188
Foul Brood and its Remedy, 482, 497; How it is Spread, 211, 317, 337; Dealing with, 197, 198, 219, 227, 235, 237, 309, 330, 340, 357; Legislation, Need for, 376; Helping to Stamp out, 397, 437
FRAMES: Glass Covers for, 17; Block for Making, 357, 397, 399; Standard, 296; Disinfecting, 236; Spacing, 326, 459; For Wintering on, 360
FRAME HIVES: Starting with, 28; from Skeps, Stocking, 190, 209; Removing Skeps from, 238; Transferring to 316, 318, 327
French Honey Industry, 509
- Glass Quilts, 17, 60, 65, 66, 136
Glass Covers, Cutting Feed Holes in, 17, 109, 115; and Non-porous Quilts, 100
Gosforth Agricultural Society, 356
Granulation of Honey, 109, 310, 370
Granulated Honey for Bee Food, 97; Judging, 459
- Heather, Varieties of, 370, 390
" Hive for the, 250
Heather Honey Press, A New, 14, 136
" " Extracting, 220
" " Working for, 388
- Hertford, Mr. Robert, Presentation to, 346
HIVE FLOORS: Linoleum for, 17; Thickness of, 18; Willesden Paper for, 110
Hive Roofs: 370; Tar Felt for, 60; Willesden Paper for, 119, 128
Hive Roof, Wild Bees in, 222
HIVES: The Laugstroth, 50; The "Cowan," 70; The "W.B.C.," 245, 256, 299; Can We have Too Many Bees in? 34; Requeening, 300; Kinds of Bees in a, 360; Entrance, Aspect of, 436; Best Aspect for, 59, 80; Buying Second-hand, 128, 327; Black Shiny Bees in, 219; Deserted, 70, 275; Disinfecting, 239; Double & Single Walled, 308;
- Enlarging the Brood Nest of Small, 288; for Ventilation, Wedging up, 28; for a Bee-house, 360; for Transit Abroad, Packing, 390; How Frames Should Hang in, 168; Home-made, 450; Inspecting, 289; in Summer, Shading, 69; in which Bees have Died, Using, 100; Enlarging in Early Spring, 98; Lattice-work in Front of, 99; Loose Stands for, 500; Moving, 400; Mooth Larvæ in, 169; Mice in, 90; Near Public Roads, 430; Weight of on Scales, 221, 234, 254, 263, 274, 286, 287, 302; Suitable for India, 360
Honey Imports, 20, 63, 92, 142, 183, 233, 277, 324, 361, 412, 452, 500
HONEY: Bright Outlook for, 233; a Find of, 409; a Record "Take" of, 492, 411; Buying, 340, 400; Broom, 444; Californian, 110; Cats-Claw, 323; Colour of, 359; Do Early Spring Flowers Yield? 97; Doubling for Extracting, 97; Dark, 360; Extracting and Grading, 118; Effect of Timon, 378, 398, 427, 454, 484, 496; Extraordinary Take of, 411, 415, 427, 449, 456; for Sending by Rail, Packing, 33; Fermenting, 80, 450, 480; of 1896 in Straw Supers, 130; for Showing Infected Hives, 230; for Stamping, 286, 311, 339, 340, 350, 380, 410; from Limes and Heather, 320; for Market, Preparing, 358; for Exhibition, Clearing, 379; for Profit, Comb e. Extracted, 416; Granulation of, 109, 310, 370; Hampshire Heather, 119; Harvest in Athol, 381; Harvest, my Record, 404; Increase and Extracted, 223; Labels, 70; Mount Hymettus (?), 110; My First Take of, 212; November, 468, 478; Out of Condition, 490; Packing, 471; Price of, 449; Quality of, 360; Selling, 445, 214, 371, 387, 402; Storing, 340; Supply, Source of, 360, 389; Shows, Starting, 468; Trophy Class at "Royal" Show of 1897, 3; Trophy, the, 61; the Record "Take" of, 427, 456; Unripe, 299; Varieties of, 350; Welsh, 500; What Plants Yield Best, 417; ending by Parcels Post, 504; Butter and, 507; Australian, 516
Honey-comb Devices, 367
Honey-crates Making, 338
Honey-press, The Peebles, 14, 136
Honey-flow, Duration of, 287, 300
Honey-producing, Does it Pay? 473, 488, 499
Honey-vinger Making, 38, 290
Hornets, 494, 514
How to Make the "W.B.C." Hive, 245, 256
How to Treat Honey After Removal from Hive, 390
HUMBLE BEES: in New Zealand, 21; as the Poet sees Him, 94; Drunken, 169; Nests, Taking, 370; Bees for Australia, 468
Increase, Dividing for, 416
Indian Summer, an, 444
Introducing Bees into New Zealand, 22, 42, 57
Introducing Queens, 9; in "Wells" Hives, 70

Inquiry, an, 134
Irish Bee-keepers, Helping, 481
Irish Exhibits at Scotch Shows, 383, 394, 415

Jottings from Chichester, 136
Judging at the "Royal" Show, 262, 272, 273, 274; Wax and Granulated Honey, 450
Jubilee Designs, 370, 380
Jubilee Show at Edinburgh, 502

Labels, Honey, 70
Labels on the County Trophy, 21

Law of Breeding Applied to Bees, 8
Law of Ownership in Swarms, 179

Lecture on Apiculture, 478
Limes for Bees, 292
Linoleum for Hive-floors, 17
Location for Bee-farm, 36

"LORDSWOOD": Philosophy, 12; a January Day, 48; January Days, 54; Echinops Spherocephalus, 66; Bees and Bob-holders, 74; Eryngium Maritimum, 83; a Correction, 84; an Up-to-date Bee-keeper, 92; Days of February, 107; Eryngiums and Pianos, 109; March Winds, 123; Fardy Spring, 134; My Out-Apiary, 166; April Showers, 177; "Melpop," 184; Memories, 194; a Jubilee Holiday, 204; Days of June, 275, 294; Weather Aftercast, a, 47; Eulogy of the Linden-tree, 306; Condemned Bees, 315; 323; Jack Bannell to "Lordswood," 397; July Days, 382; the Drone Fly, 414; For the Bees Sake, 474; "Christmastide," 502; My Native County, 511

Manipulating, 95
Mead, 90, 170, 200, 310, 320, 244, 356, 418, 436
Methods of Working, 211
Meteorological Observations, 308, 324, 339, 348, 358
Micro Bee-Slides, 190
Mice in Hives, 70, 90
Miscellaneous, 380
My Bee Honours, How I got them, 146, 157
My Christmas Holiday, 13
Moth Larvae in Hives, 169

Naphthal Beta: Phenol and, 69; Solution, 189; Fit for Use, How long, 390
New Zealand, Introduction of Bees into, 22, 42, 57; Bee Farming in, 100, 119; Humble Bees in, 21
New Danger, a, 187
Non-swarmling Chambers, 47, 76, 90; Hives, 414
Notes by the Way: 3, 27, 45, 65, 83, 102, 124, 126, 142, 162, 183, 282, 314, 354, 374, 403, 453, 472, 492

Notes, Northern, 413, 444; Town and Country, 236; Apicultural, 233; from a District Secretary, 56; from Manchester, 155; from Devon, 212; from the West, 235, 283; from Oxford, 284; from the North, 370; from Middlethian, 426; from Yorks, 467

Notes and Queries, A Cot-tager's, 238
NOVELTIES FOR 1897: How-ard's "Weed" Foundation, 277; Jubilee Honey Jar, 329; Raft Honey Press, 358
Nuclei, Uniting, 19; Forming, 79, 118; Building Up Stocks from, 446, 456

OBITUARY: Mr. James Bottom-ley, 162; M. Georges de Layens, 433
Observatory Hive for Indoor Use, 338; Putting in Queens for Exhibition, 330; Making, 360
Old Bee Books, 420
Opening Hives in Winter, 508
Our Contributors, Sparring, 372

Packing, Uses of, 158
Packing Bees for Transit, 36; Honey for Post, 467; Honey for Shows, 471
Parthenogenesis, 25, 122
Patents, Validity of, 486
Payments to BEE JOURNAL, Office, 148
"Peebles" Honey-press, 14, 136
Phenol Solution, 160
Phenyle, Soluble, 199
Points Requiring Attention, 51
Pollen in Combs, Hard, 60; New Use for Surplus, 194; How Bees Gather, 238; Carrying in October, 398
Pollen-mites, 58
Prize Schedule, "Royal," 61, 80
Proposed B.K.A., for Gloucester, 9, 130, 166, 177

QUEENS: Age of, 180, 237, 259; and Queen-cells, 228; Balled, 227, 440; Cast out of Hive, 157, 170, 217, 229, 230, 249, 269, 320; "Case," a, 201; Ceasing to Lay, 222; Cast out after Having Double Swarm, 255; Drone-breeding, 188, 209, 249, 399; Deferred Mating of, 228; Excluders and Winter Pack-ing, 89; Failing, 189; in April, Unmated, 160; in Spring, Suspected Loss of, 184, 186; Killed, 190, 266; Loss of, 218, 220, 227, 247, 288; Laying Two Eggs in One Cell, 278; Mating, 279, 290, 298, 409, 412; Rear-ing, 79, 234, 275, 318, 386; in Canada, 433, 484; Refusing to Leave with Swarm, 229; Rais-ing Carniolan, 330; Rearing, Syrup *c.* Candy and, 438; Sending by Post, 435; Sus-pected Death of, 10, 203; Signs of Age of, 259; Sterile, 378; Smashed in Post, 390; Traps and Drone Traps, 80; Trap-alloys, 90; Traps and Lost Swarms, 169; Unable to Fly, 309; Unmated, 430
Queen Cells in March, 138; Causes of Construction, 158; Distinguishing Used, 229; 118
Raised in One Hive, 447; and Swarmed Hives, 320
Queen Bees from Abroad, 452
Queens and Worker Bees, 130; Superseding, 18, 29; Sending by Post, 370; Capturing, 289; Drone-Breeding, 308; Fly for Mating, Distance, 227; in one Colony, Two, 30; Introducing, 9, 70, 370; Mating of, 466; of any Use? Are Unfertile, 129; on Combs, Finding, 326; Reared

from Drone Eggs, 283; Renew-ing, 363; Piping, 299; Simple Plan of Raising, 146; Select-ing, 449; Thrown Out, 297
Queenless Hives, 70; Bees, Utilising, 160; Bees, Dealing with, 490
Queenlessness, 83, 430
Queries from Would-be Experts, 37
Quilts, Non-Porous, 100

Rack & Crate, 407, 430
Receptacles for Honey, 454
Recipes, Using "Guide Book," 59
Reports of Shows, 321
Re-queening, 444; in August, 326
Report of Bee Work done in Wilts, 414
Revising Bees, 508
Robbing, 379
"ROYAL" SHOW at Manchester:— 3, 66, 152, 221, 251, 261, 271; Exhibits at, 40; Prize Sched-ule, 61, 89; Trophy Class, 3, 201, 253; Judging at, 262, 272, 289; A Protest *re* Trophy Class, 262; Showing at, 37; Berkshire B.K.A. and, 384
Root, A. J., his Visit to the Atchleys, 95
Royal Counties Show at Read-ing, 155

Season: The, 66, 494; The Show, 206; in Scotland, 397; Close of the, 409; in Ireland, 415

SECTIONS: as "Christmas Cards," 449; Brood in, 267, 300; Brace Combs in, 388; Cheap Covers for, 462; Dark Honey in, 350; Divide, 1, 497; for Exhibition, 310; in May, Giving, 199; in Brood Frames, Starting, 246; Leaking, 20; Over Winter, Keeping, 470; Patent Rights in, 498; Re-moing, 70; Railway Com-panies and Damaged, 367; Split-top *c.* Plain, 418; Sladen's, 475, 4-6; Spring Travelling Crates for, 490; Side-cut, 464, 474, 486; Un-finished Heather, 338; Using Excluder Zinc Below, 219

Second Swarm, Adding Bees to, 320
Self-hivers, 78, 128, 146
Shamrock, The, 455, 467, 471, 475

SHALLOW-FRAMES: Cleaning up Boxes of, 387; for extracting, 331; in Surplus Chambers, 18
"Showing", Success in, 488
Sketches by a Roving Bee-keeper, 477, 495, 515

SKEPS, 413
SKEPS: Transferring from, 28, 89, 98, 198, 226, 247, 278; Sus-pected Combs in, 143; Wax-Moth in, 156; Stocking Frame-Hive from, 190, 209; Queen Cast Out of, 217; for Surplus, 247; from Frame-Hives, Re-moing, 238
Stocks: in Autumn, Dividing, 246; from Driven Bees, Estab-lishing, 299; in Autumn, Diseased, 391; in Spring, Dividing, 469; Variations in Strength of, 208
Stings, Effects of, 159, 328
Sugar, Porto Rico, 90; for Bee-Syrup, 310, 320
Sundry Bee Notes, 494
Supernumerary Hives, Date for, 55
Supers, Separate Entrance to, 246
"Honey of '96 in Straw", 130
"Nonsectional", 516
Super-Clearers, 374
Surplus-boxes, Windlows in, 29
Surplus Room, Giving, 231
"Working for, 238"
"Chambers, Bees Refusing to Enter", 248
"Chambers, How Combs Should Run in", 388
"Removing", 340
Swarm-Catchers, 98, 128, 110, 146, 227, 286, 328

SWARM: an Unlucky Stray, 118; Working from Skep into Frame Hive, 267; Leaving Hive, 268; Suffocated, 297; Uniting Queenless Stocks with, 299; Young Bees and, 300; Destroying Vagrant, 330
SWARMS: Dealing with, 217, 221; Artificial, 99, 208, 249, 263; and Undesired Increase, 237; Deserting Hives, 264, 282; Early, 197; Hiving, 300; Loss of, 169; Law of Ownership in, 179, 412; Preventing, 110, 129; Price of, 119; Returning, 340; Virgin, 330
SWARMING: 239; Dealing with Skeps after, 255; Dividing stocks after, 297; Erratic, 280; Excessive, 259, 317, 328, 447; Foul-brood and, 266, 267; Fever, 287; Factors influen-cing, 368; Immature Larvæ cast out after, 279; Natural, 436; or Returning Swarms, 136; Propensity, 255, 257; pre-venting, 456, 506; Queen lost in, 220; Queen "balled" after, 227; Vagaries in 1897, 236, 255, 266, 284, 288, 293
Syrup-making, 78
Syrup, using unsealed, 80

Technical Instruction in S. ot-land, 373
Text-Books, 100, 417
Thaw, the, 41
Tits and Bees, 87, 93, 128
TRANSFERRING BEES: 28, 49, 78, 89, 98, 126, 137, 155, 189, 198, 226, 238, 247, 268, 276, 288, 316, 318, 327, 343, 369
Transferring Cross-built Combs, 249
" from old Hives, 379
" to clean Hives, 420
Two Queen Larvæ in one Cell, 369

Uniting Bees after a Journey, 217
USEFUL HINTS: 21, 41, 61, 81, 141, 172, 189, 201, 221, 231, 311, 321, 351, 371, 401, 451, 471

Value of Strong Colonies, 49
Vegetarians and Honey, 406
Ventilating Hives, 28
Village Bee Associations, 456
Virgin Queen & Princess, 415
Visit to Mr. Lancelot Quayle, 443

WASPS: 10; Protection from, 18; in January, 40; about Hives, Destroying, 128
WAX: 10; Degree of; Bleaching, 440; 487; ? Do Bees Make, 340;

- Extracting, 26, 129, 309, 436;
Judging, 450; Rendering, 404;
Uses of, 466, 478, 487, 489;
Selling, 507
- Wax Imports, 407, 452, 466
- Wax Moth in Skeps and Frame
Hives, 58, 156, 398, 437
- Wax, Moulds for Cakes of, 219
- Weather Reports, 48, 95, 136,
188, 223; in May, Five Days,
204, 508
- Wedding at the "Wells," the,
35
- "Weed" Foundation, Howard's
British made, 277
- "WELLS" HIVES: Bees in, 5,
35; Hiving Bees in, 16; In-
troducing Queens in, 70; Join-
ing with Weak and Strong
Stocks in, 79; My Experience
of, 86; Bees Deserting Brood in,
200; Dividing Colonies in, 326;
Curious Experience with a,
416; Making a, 470
- "Wells," the System, 86, 103,
115, 434, 446, 453, 469
- White Clover at end of July,
306
- When Doctors Differ, 317
- Winter Packing, 89; Removing,
168
- " " Packing Hive-sides for
490
- " " Preparation, 371, 479
- " " Hive, Entrances in, 449
- " " Stores, 466
- " " Weak Colonies for, 489
- " " Preparing Driven Bees
for, 470
- WINTERING BEES in Garret,
390; in Greenhouses, 430; in
Empty Room, 338, 377; on
Unsealed Stores, 409; Pre-
paration for, 311
- Wintering Skeps above Frame-
hives, 379
- " " Unsealed Stores for,
408
- Wilts as a Bee Country, 129,
136; Bee work in, 414
- Work in Advance, Giving Bees,
450
- "W.B.C." Hive, How to Make
It, 245, 256
- " " Packing Hives, 360
- " " Division Boards in,
450
- Works Agricultural Society, 221

ILLUSTRATIONS.

- Thomas W. Cowan (portrait), 1
- Heather Honey Press (diagrams), 14, 15
- "W. B. C." Floor-board, 18
- Prize Trophy at South Kensington, 52
- Summer Management of Bees, 131, 132
- Braulá Cucca, 207
- Bees and Orchids, 213, 214
- Comb Foundation, 146, 168
- Queen Bee on Comb, 241
- Plan of "W. B. C." Hive, 245, 257
- "W. B. C." Hive, 256
- J. H. Howard's Foundation Machines, 277
- County Honey Trophies at "Royal" Show,
1897:—Notls, 295; Yorks, 315; Berks,
335; Kent, 355; Sussex, 375; Hunts,
395
- Jubilee Honey Jar, 329
- Mr. Goodall's Hive, 366
- Rack for Store-combs, 437
- Packing Box for Honey Jars, 472
- A Swiss Bee Valley, 477
- Sladen's Split Section, 487
- "The Home of Industry," 495
- Three-side cut Sections, 498
- Complete Divided Section, 498
- Simmins' Section Holder, 498
- An Italian Valley, 515
- Apiaries of Our Readers:
- Wm. Woodley (Beedon), 21
- Wm. Lister (Gainsborough), 41
- Jas. Gordon (Aberdeen), 64
- John M. Hooker (Sevenoaks), 85
- John Berry (Llanrwst), 105
- C. N. White (Somersham), 125
- W. W. Pryor (Breachwood Green), 145
- W. Dixon (near Leeds), 165
- Apiaries of Our Readers (*cont.*):
- John Todd (Girvan), 185
- H. R. Cadwaladr (Rhostryfan), 205
- Harry Gardner (Turvey), 225
- T. H. Pringle (Charlton), 243
- Thos. Faragher (Isle of Man), 265
- W. B. Webster (Binfield), 285
- F. H. Taylor (near Manchester), 305
- Robert Ness (Helmsley), 325
- Wm. Crisp (Yorkshire), 345
- F. A. Goodall (Tamworth), 365
- J. H. Howard (Holme), 385
- S. Brooks (Newton Abbot), 405
- Chas. Atkinson (Tockwith, Yorks), 425
- Miss H. Laurence (East Keswick), 445
- John Lee (Biggleswade), 465
- Alex Schroder (Trieste), 485
- Robt. Kelly (Fife, N.B.), 505

The British Bee Journal.

No. 759. Vol. XXV. N.S. 367.]

JANUARY 7, 1897.

[*Published Weekly.*]

DIRECTLY PERSONAL.

The portrait which appears on this first page of our twenty-fifth yearly volume will come as a surprise to some

this form. However, the writer—while freely confessing to not a little embarrassment as to the effect of its appearance, under the circumstances,

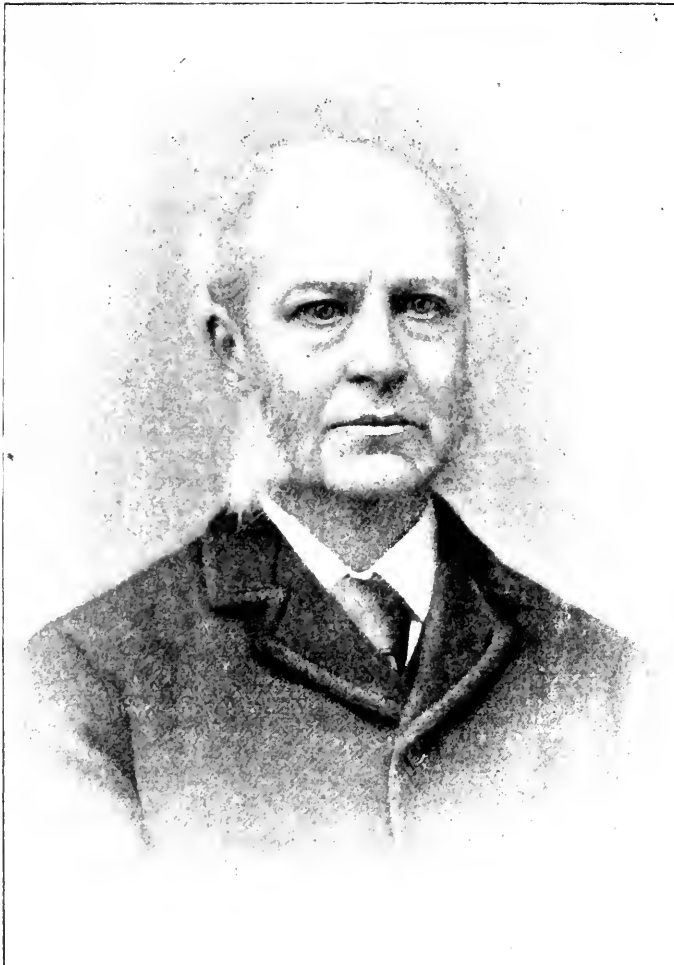

THOMAS W. COWAN, F.L.S., F.G.S., ETC.

who—along with ourselves—know how persistently the original of it has refused his consent to “appearing in public” in

upon his senior—having assumed the responsibility, must perforce face all the consequences of his action.

Whether or not modesty in a public man is recognised as a useful quality, or otherwise, we will not stop to inquire, but, to the writer at least, it has always seemed a remarkable thing that, while men more or less eminent—or even “prominent”—in the world of bee-keeping have been made familiar to all interested in the literature of the pursuit by their portraits, the one among the whole who (it is not too much to say) probably is better known and more universally esteemed the wide world over than any other, has gently, but firmly, withheld his consent to any publicity of this kind for himself.

The unique position held by Mr. Cowan as a bee-keeper is, no doubt, in a measure due first to his being a frequent traveller in foreign countries, and second, his powers as a linguist. Thus, to be present in the flesh with Russian, German, French, Italian, or we don't know how many other nationalities of bee-keepers is one thing, but to be able to converse with them in their own several tongues is quite another, and gives rise to a feeling of brotherhood altogether beyond a mere hand-shake. This, together with an extensive correspondence with bee-keepers and scientific men who are interested in bees dwelling in nearly every quarter of the globe, makes Mr. Cowan's position, as we have said, unique. It is also mainly due to our senior Editor's fondness for foreign travel, and the fact of his being at the present time some six thousand miles distant from King William-street, that the writer, having determined to take upon himself the consequences of his present step, is enabled to do so with the comforting assurance that the mischief—if it comes to be regarded as such—will be done without the risk of a hurried “wire” to “stop press” and “leave out portrait.” Besides, any misgivings we may have are somewhat modified by the fact that these lines will be first seen and read by the subject of them in far-distant California, most likely amid summer warmth and bright sunshine; and we trust that their import will arouse feelings more in consonance with the surroundings than the testiness usually associated with London fogs and the hard frosts of a British winter.

It has been more than once asked why

Mr. Cowan's portrait did not take its place among those of bee-keepers which appeared in this (his own) paper a year or two ago? Well, beyond what is stated in the opening lines of this article, we have never been able to say why. Being, however, already possessed of an excellent portrait in the photo. from which the illustration on page 1 is reproduced, the present occasion appears to us so appropriate for its appearance that we make no further apology than reminding Mr. Cowan that on leaving this country a few weeks ago for a prolonged absence he was good enough to entrust the writer with a “free hand” to do as he thought best with the JOURNAL and its affairs. We have, therefore, decided as above, and also to say a few (a very few) words regarding its proprietor. In doing this we shall—to our certain knowledge—add to the interest of the occasion (as we hope) without offending the susceptibilities of the senior Editor himself, seeing that no more appropriate opportunity could well arise than the commencement of the volume which will, when ended, complete a full quarter of a century's existence for this paper.

As is known to old readers, the BRITISH BEE JOURNAL was purchased from its founder and first Editor, Mr. C. N. Abbott, some ten years or so after its inception in 1873 by the Rev. H. R. Peel, a gentleman enthusiastically devoted to the encouragement of bee-keeping as a means of adding to the minor industries of the country, and also of increasing the incomes of our rural population. Being also at the time determined to make an effort for adding to the usefulness of the British Bee-keepers' Association—just then somewhat failing in the energy of its leading spirits from lack of the requisite funds for carrying out their labours—Mr. Peel thought that this work would be aided by the possession of an official organ, independent and entirely freed from even the suspicion of any trade interest connected with it. He therefore, as we have said, bought the paper outright, and, being possessed of ample means, was well known to have given no thought to profit from its publication. On the death of Mr. Peel in 1885 the paper was taken over by Mr. Cowan, not

from any desire on his part to engage in journalism, but at the earnest request of Mrs. Peel, who was anxious for a continuation of the purpose and objects her husband had in view at the time of his death. The B.B.J., therefore, still occupies the by no means common position of not being "run" for profit—as the trade phrase goes—or in the interests of any supply trade, but because its proprietor entertains the same views as his predecessor, and the same willingness to give effect to them. Especially is this the case with regard to the B.B.K.A. (of which he has for many years past been chairman) having a perfectly independent organ to represent its interests. Hardly less does he realise the need for bee-keepers of all classes possessing a journal by means of which they can interchange views and receive such help as its pages afford in following the pursuit.

Having, then, gone so far, and, for the reason stated, carefully avoided intrusion into matters too directly personal, we cannot resist the desire to raise a corner of the curtain Mr. Cowan elects to place between his journalistic duties and his labours in other directions, just to say—to those who know him only in the former capacity—that hard and continuous work in the cause of charity, religion, temperance, education; in fact, philanthropic effort of all kinds occupy by far the greater portion of a very busy life while in this country. Indeed, he regularly overtakes his strength in this way when occupying his London residence, and after getting "run down" in consequence, as regularly has to go abroad in order to secure the rest and change which impaired health demands. In this way it is his delight to occupy himself in such journeys as he aptly described under the title of "Bee Rambles in Savoy" a year or two ago in the pages of this journal. Had we been free to write of Mr. Cowan as our impulse dictates, these lines would probably have taken a different form, but realising the whole position, we feel that enough has been said if we would avoid even the resemblance of want of consideration or possible cause of offence—however small—to one whose regard we esteem so highly.

THE JUNIOR EDITOR.

THE ROYAL SHOW OF 1897.

SPECIAL COUNTY HONEY-TROPHY CLASS.

We have been requested to draw attention to the "General Regulations and Conditions," printed in the prize schedule of the Royal Agricultural Society, having reference to the hives and honey department of the show. No. 9 of these rules deals especially with the County Honey-Trophy Class, and reads as follows:—

"Not more than one entry in Class 375 can be received from any county. The honey staged must be produced in the county by bees the property of not less than ten bee-keepers, and the minimum quantity contributed to the County Trophy by any one person must not be less than 6lb. The exhibits in this class must be staged by the exhibitors or their representatives."

The fact that some uncertainty exists on the point having been made known to us, renders it necessary that we should also make another thing clear to those interested, viz. :— However desirable it may be that all honey staged in this particular class should have been gathered by bees belonging to members of the respective associations in whose name it is entered and staged, yet there is nothing in the rules or "conditions" to disqualify honey produced in the county from competing, whether the property of members or non-members of the association in whose name it is staged.

Correspondence.

The Editors do not hold themselves responsible for the opinions expressed by correspondents. No notice will be taken of anonymous communications, and correspondents are requested to write on one side of the paper only and give their real names and addresses, not necessarily for publication, but as a guarantee of good faith. Illustrations should be drawn on separate pieces of paper. We do not undertake to return rejected communications.

Communications relating to the literary department, reports of Associations, Shows, Meetings, Echoes, Queries, Books for Review, &c., must be addressed only to "The Editors of the 'British Bee Journal,' 17, King William-street, Strand, London, W.C." All business communications relating to Advertisements, &c., must be addressed to "THE MANAGER, 'British Bee Journal' Office, 17, King William-street, Strand, London, W.C."

** In order to facilitate reference, Correspondents when speaking of any letter or query previously inserted will oblige by mentioning the number of the letter, as well as the page on which it appears.*

NOTES BY THE WAY.

[2745.] *A Fresh Start.*—The new year is already some few days old, but it is not too late to offer my congratulations to the numerous readers of our BEE JOURNAL, and good wishes for a prosperous year in 1897. We have again added another completed volume to the bookshelf, have passed another milestone, if I may term it such, in the industry connected with the keeping of bees, and are all of

us one year nearer the final bourne. We started the year of 1896 with hopes and anticipations which have not been realised. It was hoped that ere the year closed we should have added our "Foul Brood Prevention Bill" to the Statute book, and that the coming spring would have seen us grappling with the pest armed with the powerful majesty of the law. We also hoped for the further development of the self-hiver; both are still in abeyance. There were many individual hopes, too, which have failed in realisation, and our aims must now be for the future. What of the "look-out" for 1897? What will the year, now in its infancy, bring to us and our craft? What are our plans for its furtherance and benefit? We have not yet reached the time to rest and be thankful; therefore let us work for the dawning day of greater prosperity for the bee-keeping fraternity, socially, morally, and financially.

To-day we have in the first number of a new volume; let each of us endeavour to raise the value of its pages as an instructor, and in so doing induce the recipients of its instructions to reciprocate and give of their store of knowledge, as acquired, for the benefit of others. The "old hands" of the craft ought not to be called upon to occupy all the pages of our journal, though mature experience may carry weight in any argument. But all the "kinks," to use an American term, are not exclusively confined to the heads, or within the knowledge of the most experienced. I would therefore ask our younger generation of bee-keepers to give to readers some of their many items of practical "knowings." I freely acknowledge the fact that our regular correspondents write with pens that never grow weary, yet there must often be a repetition of ideas or something very close to it. I would also ask that my regular corresponding brethren will please consider that I include myself, or rather *place* myself, at the head of the "repeaters." I trust this will be received in the spirit in which it is written, for nothing gives me greater pleasure than seeing the old familiar *nom de plume*, or name, or initials appended to an article.

This mention of familiar names starts a train of thought in which I ask myself, where are the familiar names of a decade back? That the coming year may bring some of them out of their hibernation is the ardent wish of W. WOODLEY, *Beeton, Newbury.*

EXTRACTING.

[2746.] "Extracting" is the most important duty that falls to the lot of the bee-keeper. As a rule there are three products of the apiary to be extracted; stings, honey, and wax. The guide books say that stings should be extracted before the poison has time to spread, but this involves a loss of time that can seldom be spared when a hive is open for manipula-

tion, and the better plan, and one that saves time, is to let the stings accumulate and extract the lot after the quilts are on. I find that a little sal volatile eases the pain as much as anything; but perhaps I am out of season in speaking of stings and honey at the present time, wax being the only product with which we have to deal in the extracting line during the winter.

I find that small quantities of wax may be extracted from the old combs easily by means of an earthenware pot. Over the top is stretched a piece of coarse cheese-cloth or canvas, and this—after being tied round the edge—is pressed down in the centre of the pot to form a receptacle for the combs. The latter are then placed on the canvas; boiling water is poured over them until the pot is about one quarter filled with water, and the whole put in a hot oven over night. The next morning nothing remains of the combs but the cocoon cases; and on removal of the canvas a clean cake of wax will be found floating on the surface of the water.

Wax of a better colour may be obtained by placing the pot in a saucepan, filling it half way up the pot with water, putting on the lid and setting on the fire to boil, replenishing the water as it boils away. Very few impurities will pass through the canvas, and a nice cake of wax will be found when the water is cold.—F. CROCKER, *Derby.*

CHAPMAN HONEY PLANT.

CULTURAL DIRECTIONS.

[2747.] I venture to send cultural directions for blooming Chapman honey plant from seed the first year of sowing, as very rarely it will do unless the seedlings are nursed a little in their young life. I had a lovely lot of bloom from plants—raised from seed last March—in August and September, treated in exactly the same way as below. The best time to sow is February, if raiser has a greenhouse or garden-frame, if not, second week in March. The seed must be taken out of the covering or shell which encloses each one. Boxes about 1 ft. deep are most suitable, and put about 3 in. of rough ground or broken pots in bottom, a thin layer of leaves or moss over that to prevent soil from mixing among drainage, then fill box with soil, which should consist of equal parts of loam and coarse sand, to about 3 in. from top of box; flatten soil gently with piece of board or the hand, sow seeds evenly and thinly on this, and cover seeds about $\frac{1}{4}$ in. with fine and sandy soil; place box in warmest part of garden, give a good watering with tepid water through fine rose watering-can, or let water splash on board or piece of slate before going on soil, not to wash seed out of ground; cover box with sheet of glass until up, and gradually admit air as seedlings get stronger. If fine weather and settled, when strong, they can be planted out in their per-

manent places 2 ft. apart each way ; if not, they must be pricked off into boxes 6 in. apart and planted out when bigger. If planted out young there is more chance of slugs destroying them than when they are stronger, as the slugs dislike them then.—C. GOULD, *Guernsey*.

BEEES IN WALES.

A BEGINNER'S DR AND CR. ACCOUNT.

[2748.] I send you an account of my bee-keeping, which I think is very encouraging, and may, perhaps, be of interest to some of the numerous readers of the B.B.J. I started with one stock, purchased on April 1, 1895. From this I had as many as five swarms during the year, and only got thirteen good sections as my whole honey harvest. I disposed, however, of them at 1s. 6d. each. Three of the swarms I hived, one I sold, and the other I returned ; thus going into the winter of 1895-6 with four hives well stocked with bees. In the spring of 1896 I discovered that one of them had lost its queen, and had only a few frames full of bees left. These I united with the next stock.

I endeavoured to prevent swarming in 1896 by giving the bees plenty of room, and I was not disappointed. The following is my crop for the second year of my experience, with three hives of little workers, all blacks :—No. 1, 63lb. extracted honey ; Nos. 2 and 3, 49 and 29 saleable sections respectively.

The extracted honey I sold readily at 1s. per lb., and the sections at 1s. 3d. each, except my last half-dozen, for which I lately got 1s. 6d. each. I consider these very good prices, and I have also inquiries for a lot more, but am unable to supply it.

My profit and loss account has standing to its credit a balance of £11. 17s. 6d. I have charged the separate hives' "revenue account" with all moneys expended whatsoever, including literature. Being an amateur carpenter, I have been able to make all hives myself, except one, which was given me. I am also glad to say that, unlike a good many about here, I have escaped foul brood altogether. No feeding this autumn, the bees having plenty of stores for the present winter.—Wishing you and all the readers of our valuable journal a prosperous 1897, KENELM GOSS, *Langland, near Swansea, January 1.*

BEEES IN "WELLS" HIVES.

[2749.] I, like "A. P. J." (p. 521), have found the same difficulty in putting driven bees into a "Wells" hive. Two successive lots left one side to join forces with the other. I cannot account for their so doing, unless the queens of the driven lots had been lost or balled. The third lot I tried stopped in the right side

without emigrating. Shall be glad to hear of other bee-keepers' experiences, and the way they account for this behaviour of the bees.—H. M., *Atherstone, January 2.*

[We will be glad if Mr. Wells would send a line of reply to the above, as having, no doubt, had more experience on the point than any one else. It is also of much interest (to beginners especially) if those who render help in this way would state exactly what form of the "Wells" hive they have in use. So much of the ultimate results of working the double-queen system depends on this point.—EDS.]

BEEES IN THE NORTH OF SCOTLAND.

[2750.] I suppose you do not hear much about the doings of the genus *apis* in this out-of-the-way corner of the bee-world. I venture, therefore, to pen a few words on the subject, regretting that I am unable to send you more agreeable or encouraging news. The last two or three years were not by any means favourable to the advancement of bee-keeping in this quarter, owing to the superabundance of moisture prevailing, and the lack of sunshine ; but the season of '96 fairly carried off the palm for badness. From beginning to end of the season, I don't believe we enjoyed three days in succession of really good bee-weather ; consequently the poor bees had a very bad time of it. They had enough to do to keep themselves alive, to say nothing of compensating the bee-keeper for his trouble in caring for them. My honey harvest of last year was therefore the worst I ever had, amounting only to 100 lb. or so from over twenty hives ; nor did my neighbours fare a whit better. I do not grumble, however, at my want of success, nor cast any blame on the bees ; but wait patiently for the good time to come. The bees always paid their way with me and left something more until last year, when the income did not equal the outlay, but even then they managed to keep their strength up. In favourable seasons I am persuaded that bee-keeping will yield as much profit for trouble and outlay as any other minor pursuit, while, in addition, it affords its devotee an amount of pleasure and healthy excitement peculiarly its own. None, I presume, are so foolish as to look for a fortune to come to them through the door of a bee-hive ; but the little money that does come that way cannot fail to be a welcome addition to a poor man's income.

My apiary at present comprises twenty-six bar-frame hives and three skeps. The hives are all of my own construction, save one, which was bought from a southern dealer to serve as a model. I bought the bar-frames from an appliance-maker, finding it cheaper to buy them than make them at home. The variety of bees most suitable for this district I find to be a first-cross between Italians and

blacks. These are more active, more prolific, and better honey-gatherers than the blacks, and always manage to have the brood-chamber in good order as regards food. But we cannot call ours a good locality for apiculture; melliferous flowers are scarce, the clover-fields are mostly used as pasturage for sheep, while the heather is too far away for the bees to take full advantage of it.

The ordinary yield of honey here is 20 or 25 lb. (in sections) per hive. If we can get an average of 30 lb. we consider ourselves more than fortunate. The grand harvests of 80 or 100 lb. from one hive are things we can dream of but never realise.

My warm thanks are due to the editors of the BRITISH BEE JOURNAL for the valuable assistance I have obtained from their excellent paper, and that they, together with all who take an interest in the "little busy bee," may enjoy good health and have a right good time of it in the coming season is the sincerest wish of D. MACKAY, *Milleraig Mills, Alness, N.B.*, December 30, 1896.

WEATHER REPORT.

WESTBOURNE, SUSSEX, DECEMBER, 1896.

Rainfall, 4.56 in.	Sunless Days, 8.
Heaviest fall, .86 on 4th.	Below Average, 11.5 hours.
Rain fell on 20 days.	Mean Maximum, 41.2°.
Above average, 2.01 in.	Mean Minimum, 32.2°.
Maximum Temperature, 49° on 28th.	Mean Temperature, 36.7°.
Minimum Temperature, 23° on 17th.	Below average, 1.0°.
Minimum on Grass, 17° on 17th.	Maximum Barometer, 30.39° on 27th.
Frosty Nights, 17.	Minimum Barometer, 28.35° on 4th.
Sunshine, 45.6 hours.	
Brightest Day, 25th, 6.8 hours.	

L. B. BIRKETT.

WEATHER REPORT FOR THE YEAR 1896.

WESTBOURNE, SUSSEX.

Rainfall, 27.74 in.	Brightest Day, June 1, 15.1 hours.
Heaviest fall, 1.11 in., Mar. 20 and Sept. 1	Sunless Days, 68.
Rain fell on 173 days.	Below Average, 89.9 hours.
Below average, 0.9 lin.	Mean Temperature, 47.3°.
Maximum Temperature, 80°, on July 21.	Below Average, 0.2°.
Minimum Temperature, 22°, on Feb. 26.	Maximum Barometer, 30.93°, on Jan. 30.
Minimum on Grass, 16°, on Nov. 7.	Minimum Barometer, 28.35°, on Dec. 4.
Frosty Nights, 75.	
Sunshine, 1,764.9 hrs.	

L. B. BIRKETT.

Echoes from the Hives.

Scriben, near Knaresboro', December, 31, 1896.—Seeing an account of the flight of bees in the *Daily Telegraph* of December 29, also a leading article in the same paper of the following day, I venture to send you the following:—I was amongst my bees on Christmas Day, and was pleased to see them have a beautiful cleansing flight. They look strong and healthy. I may say at the present time I have snow-drops, crocuses, primroses, and violets in bloom in my garden.—Wishing you and all lovers of the honey-bee a happy New Year,—
WM. GILROY.

Queries and Replies.

[1627.] *Keeping Bees for Profit.*—I drove some bees in early August (a small brown bee), and I now find them dropping off the combs inside hive. I took a few indoors and warmed them at the fire, when about one-half of them revived and flew across the room to the window; but they soon became numbed again, as if asleep or dormant. May I ask if these would be the old bees dying off? They seem to have plenty of food left. A friend of mine has a stock hive of the same sort, and in his case there is not one dead bee to be seen. On the other hand I have black bees driven by myself a month after the above, and of these very few are as yet found dead outside the hive. I see some of our brother or sister bee-keepers are at a loss to know how to use carbolic and glycerine as per Mr. Webster's book. I never saw bees, or inside a hive, except at the Norwich Show, about ten years ago, until June, 1896, when I bought a swarm and used the carbolic as given in Mr. Webster's book, and had no bother with it, yet I know a schoolmaster who used some and he spoiled all his honey in consequence, so there must be much depending on the users themselves. If all who read bee-books and journals would be more careful in following the directions, they might "spare the editors" more than they do. You can see by my poor writing it is not my learning which causes me to read and understand properly how to keep my bees for profit, and to manage it, too.—C. R., *Wickford, Essex, January 2.*

REPLY.—It is simply a case of old bees dying off in the ordinary course.

[1628.] *Thickness of Floor-boards.*—The hives offered for sale differ considerably as to the thickness of the floor, while there is a general agreement as to the amount of protection required by bees in winter and summer at the sides and top of the hive. It is, of course, not desirable to load a hive with timber that

serves no useful purpose. On the other hand, if the floor is too thin it may act like a window in a frost, chilling the air in the hive, and condensing moisture, so as to increase damp in the hive. I should be glad to know to what extent the thickness of the floor is increased with advantage, compensating for the added bulk and weight of timber, a matter for experience to settle.—APICOLA.

REPLY.—This query again serves to show how entirely (to use a homely saying) circumstances alter cases; or, in other words, why it is impossible to bring men of even long experience into exactly the same way of looking at things, apart from the fact that "doctors differ," and will continue to differ, with sound reasons for so doing. To illustrate the point—on page 33 of "Guide Book" the author—who is also Senior Editor of this journal—recommends a floor-board of pine 1 in. thick; whereas the Junior Editor, in the hive bearing his initials (p. 43) shows a floor-board only $\frac{1}{2}$ in. in thickness. If, however, the construction of each is carefully considered, it will be apparent why the one is not adapted to the other. In the latter (or "W.B.C." hive) every part is made as light as possible—for convenience of handling, among other reasons—and for the rest, it need only be said that among bee-keepers of long experience, some prefer a thick, strong floor-board, while others choose one of $\frac{1}{2}$ -in. timber as being equally efficient; so it is, after all, just a matter of opinion.

[1629.] *Vulcanite for Feeding Stages.*—Whilst thanking you for kind replies on page 506 might I also ask whether you consider sheet vulcanite a good material for making the diaphragms of feeder bottle stages? I should think it would be warm to the bees, cleanly, and not likely to crack. Also *re* Subjugator. Would Mr. Webster kindly say what proportion of creosote he uses, as on page 50 of his book no mention is made of creosote, and on page 33 the proportions are not given. Is creosote always the same strength?—GEORGE M. SAUNDERS, *Keswick, December 29.*

REPLY.—1. Some fifteen or twenty years ago, we along with many other bee-keepers, used vulcanite for feeding stages and well remember burning the holes therein with hot knitting-needles; also scratching or scoring across the smooth under-surface of the vulcanite to give the bees foothold. For various reasons, however, this material has dropped out of use, and it is now rarely heard of for the purpose of bee-feeding stages.

[1630.] *Re-arranging an Apiary.*—I am desirous of enlarging the boundaries of, and re-arranging, my apiary, which operation will involve the removal, for a few yards, of thirty to forty hives. You will, perhaps, remember my writing you a few weeks ago, on "balled queens," my letter appearing December 10, page 492, No. 2726. Now Mr. Brice in his article, page 512, says, "it is also a good time

to re-arrange the apiary, if necessary," but later on, (referring to my letter) he says "No hammering, digging, &c., in the vicinity of the hives should be permitted." Now, as the actual removal of the hives would be liable to cause more disturbance than hammering, &c., *in their vicinity*, I should be glad of your advice how to proceed. The alteration must be done within two months.—A. R., *Pen-sham, Wilts, December 31.*

REPLY.—The best time for re-arranging an apiary necessitating the removal of hives is the winter season, choosing a time when the bees have been confined by bad weather to their hives for about a fortnight. Although undesirable to disturb the bees at this season more than is positively necessary, yet if they have to be moved advantage should be taken of the first opportunity for doing it. On the other hand, little or no actual disturbance need occur in changing the positions of hives a few yards. Careful liting, with the help of an intelligent lad in carrying the hives, is all that is required to shift about without them knowing they are moved at all, so to speak; and without a single bee taking wing.

[1631.] *Starting Bee-Keeping.*—1. Can you or any reader tell me which is a good district to start bee-farming in on the west coast of Scotland? 2. Where can a beginner best find all information, elementary and otherwise? 3. Which is regarded as the most profitable district in Great Britain? 4. For how long in the winter can bees be left without attention?—NOVICE, *Bournemouth, January 2.*

REPLY.—1. As we have many readers in the district named, perhaps some one of them will send a line of reply to this query. 2. In the several books on the subject advertised in our pages. 3. No district can be specially or rightly regarded as the "most profitable" in Great Britain. All that can be said on the point is that bees may be kept with more or less profit according to the amount of bee-forage, *i.e.*, honey-producing bloom, growing in the district. 4. Bees properly prepared for wintering require no attention whatever, and under such conditions they are best left severely alone.

[1632.] *Suspected Dysentery.*—Will you kindly give me your advice or opinion on the following case? I am only a novice in bee-keeping, and at the beginning of October I was asked by a gentleman owning three stocks of bees to take some honey from them for him. I agreed, but, on examination, I found one lot dead, I think, through robbing. Another one was very badly affected with foul brood, and the third I could not examine at all, owing to the bar-frames having their combs worked in all directions but the right one. The frames being thus fixed and immovable, it was impossible to get at their condition or state. The owner, therefore, gave both hive and bees to me, and they appeared to be doing well until last week, when, from the appearance of the

alighting board, I fear the bees are troubled with dysentery. I see the "Guide Book" recommends clean combs of unsealed honey, but I have none of these by me. I want to know, will the bees hold out till spring? Can I do anything else to help them now?—R. T., *Plymouth, December 31.*

REPLY.—It is by no means certain that the bees are dysenteric because of the flight-board being spotted, for after confinement and removal "spotting" in this way is quite common. We should take the first chance on a fine warm day to watch if the bees seem distended and unable to fly when attempting to do so. If these symptoms are seen, there is danger; but if they fly well and strongly, take no notice of the "spotting."

THE LAW OF BREEDING.

ITS APPLICATION TO BEES.

There is no chapter in recent history more replete with marvel, fascination, and real economic importance than that devoted to the laws and practice of breeding. A single generation has seen the startling development of the Hambletonian trotting-horse. What can rival in interest the work of the florist or plant-breeder as he originates those gems of the floral world, or those wonders of the garden? Who can eat the delicious chop from the Shropshire or Southdown; the appetising steak from the Hereford or Shorthorn, or feast on our luscious fruits, without grateful acknowledgment of the blessings received at the hands of those who have applied the laws of breeding to the arts of life?

It is difficult to name a man who has done more brilliant service in the realm of scientific research than the late Charles Darwin. His writings have stimulated research to a marvellous extent; have quickened thought in all lines of investigation; have revolutionised ideas and theories in all the domains of investigation. Yet Darwin was directed to his fascinating and wonderful studies by consideration of the breeding of plants and animals.

When Theodore Schwann, in 1839, discovered the nature of the cell—that it was the basal structure alike of all animal and vegetable tissue—he conferred an invaluable blessing on the world. Not only have all animals fundamentally the same structure, but all plants have just the same that all animals possess; and so the same laws of growth and development maintain with the simplest plant, like the seaweed and the most complex shrub or tree, and also with the almost structureless protozoan, and the highest of animals, even to man himself. With this truth in view we may, with sufficient caution, assume a truth regarding animal function or law from knowing it true of the vegetable world; likewise, and more safely, can we deduce a law of highest animals, even of man, from the fact that it always holds true of the lower, and,

contrariwise, a law of function in the higher will be likewise true of the lower. We hardly appreciate our indebtedness to this knowledge of the similarity of structure and functions between higher and lower animals.

The wondrous strides in surgery come from knowledge gained by work with lower animals. The beneficent work being done by the student of microbes owes its value to the fact that all animals are similarly affected by the virus resulting from microbe affection. The human death-rate is diminishing rapidly in all civilised countries, and the expectancy of life is correspondingly increasing. This gracious consummation is the result of the knowledge referred to above. Man has studied the lower animals, and by experimentation has arrived at conclusions that are of tremendous importance in maintaining health and prolonged life.

The method of reasoning referred to above applies to the matter of inheritance and variation among animals, and consequently to the laws of breeding. And it is well known that the laws of breeding plants and animals are strikingly alike. All animals and all plants tend ever to vary, probably as they are differently impressed by a different environment. All inherit ancestral characteristics, or we may say that the hereditary tendency is manifest in both plants and animals. We should the more expect that insects and vertebrate animals would come under the same laws of inheritance. We are safe, then, in concluding that any law of breeding that is demonstrated in the vertebrate line of animal life, will hold as true among the insect class.

ESTABLISHED LAWS OF BREEDING.

Every intelligent breeder now recognises that all his animals are subject to the law of variation. No offspring is precisely like its parent. Marked varieties among plants are known as sports, among animals as variations or varieties. Skilful breeders like Bakewell, Bates, Booth, and the Collins Brothers are ever keenly on the watch for variations, and as keenly active to preserve desirable variations, and to suppress unfavourable ones. The most skilful breeder must be an artist. He has his ideal of excellence, and is ever watchful for all appearance of tendencies or variations towards his ideal. He selects with severest exactitude, and thus is ever building towards his idea of perfection. The ablest breeders, then, must have good judgment to decide wisely as to what is nearest perfection; must have quick vision to recognise every departure towards his ideal type; must be resolute that unfavourable results shall be excluded, and full of patience to wait till he may reach the goal of his hopes.

The astute breeder recognises that a long line of excellent progenitors, bred to a type with no out-cross, is very sure to result in progeny of equal or superior excellence. He knows that the parents are practically equal in their influence to control the offspring, if both parents have been well and carefully bred for

a long series of years. He knows that if he persists he will reach excellence that will bless all the future, and reward him for patient waiting. And so he labours on with the enthusiasm and faith that cheer and lift every true artist.

To recapitulate : The master breeder must have wisdom to build, in imagination, a type of animal of highest excellence ; a quick vision to note every variation towards his ideal ; a fixity of purpose that will unhesitatingly exclude any offspring that reaches away from his type ; patience to wait for the slow process of variation and selection to modify, and the sure law of heredity to freeze into fixity the qualities he desires.

From what we have said in the foregoing, it follows that the laws established in breeding higher animals will prove equally potent in forming new breeds or races of bees. The skilful breeder in apiculture will wisely fix upon a high type of excellence. His typical bee will be, first, a business bee ; the bee that will gather most, alike in good and poor seasons ; the bee that will be too occupied with storing and breeding to even think of swarming till it is forced upon it by heedless management of the apiarist ; the bee that will be so intent upon useful work, that it will not think to bristle up in anger except under severe provocation ; the bee that will seek out Nature's sweets with such assiduity that it will have little cause to become a freebooter among its neighbours ; a bee that will satisfy the lover of beauty, because "handsome is that handsome does."

The apiarian breeder will also know from his study of the laws of breeding that both male and female give characteristics, and are equally potent to transmit qualities if equally well bred ; and will also know that prepotency ever hangs upon long, careful breeding.

I think there is everything to encourage the breeder in bee-keeping. I think that there has been very little real, scientific breeding yet practised. If I am right it is a new field, and a wider, surer success awaits the earnest, conscientious, capable artist in this line of work.

As yet, few, if any, breeders of bees have formed, as the result of long, hardy study, a type of perfection in the mind's eye. With no correct ideal before them, they of course could not, did not, work towards the highest excellence. Often—may I not say generally—bright, high colour was the one attraction, and the entire trend was towards such beauty (?). Is not this the reason that our best bee-keepers prefer the less highly-coloured bees to the very gay, showy ones ? From the laws as already explained, any such narrow, one-sided idea would slight all better ideals or qualities, and tend directly towards retrogression.

Again, circumstance has made it hard for resolution and patient persistence to maintain their ground, and work unceasingly, unhesitatingly, courageously, irresistibly towards a real ideal. The commercial spirit, demands of

the market, bread and butter, all stand in the way. The ideal breeder must be one who will never listen to public demand, or trade preference. He must be willing to wait, and go on unmindful of what the public think or the market desires. He must look for his reward to the away-off future. A single generation saw the trotting-horse developed to its marvellous feats of speed. It has taken two or three generations to fashion our best beeves. It will take as many to build up to as great perfection the honey-bee. The fortunate one must have the qualifications already referred to, and, in addition, leisure, means, enthusiasm. We need some philanthropic master, some Cowan or Taylor, to go into this field. This would be a grand work for some experiment station. If these institutions could only be out of politics, and be fortunate enough to be supervised by a Board, wise to forecast results, and to see that scores of years were required to develop a Rothamstead, even though in the hands of a Sir John Lawes!—PROF. A. J. COOK, in *American Bee Journal*.

INTRODUCING QUEENS

BY MEANS OF TOBACCO SMOKE.

I have received five letters requesting me to be more comprehensive in my plan of introducing queens with tobacco smoke, &c.

I received a queen October 20, just at night, too late to hunt up the queen where I was to introduce her, and I had to be away the following afternoon, and robber-bees would be on hand if I introduced in the forenoon. I am pestered constantly with black bees from somewhere, either in a tree or some building. They are evidently in a starving condition, judging by their actions. When I go out with the smoke they are on a watch for a chance for mischief, and when I open a hive they are ready to pounce in. So I cut out a strip of board the length of the width of the hive, and 2 inches wide, then cut out $\frac{3}{4}$ of an inch from one side the length of the entrance ; tacked on a strip of wire-netting, so that when this ventilating strip was placed over the entrance the wire would come down tight on the bottom-board, so that bees could neither get in nor out of the hive.

With a gimlet I bored a hole in each end of the strip for the nails, and thus could quickly fasten it over the entrance. I cut out this notch in the strip $\frac{3}{4}$, so it would be larger and deeper, and then the bees could not choke up the entrance and smother. A wider ventilating strip for a powerful colony, so that one could cut out one or two inches to cover with the wire screen, might be advisable. But the colony that I was operating on was only of medium strength.

I went to town for tobacco stems in the evening, but the cigar factory was closed. But in front of the hatch I picked up a pocketful of cigar-stubs. I was then ready for business.

Early in the morning I picked the old queen out of the hive without disturbing the bees but a mere trifle; closed the hive, and tacked on the ventilator, and only had three bees on the outside. Previous to this, and before daylight, I had taken the queen out of the shipping-cage and placed her in a little round wire-cage. I cut up some of the cigar-stubs quite fine, and rolled them in a piece of cotton-cloth ready for lighting. I had my teacup of honey and a spoon on hand ready to drop the queen in when wanted.

I placed the old queen in the shipping-cage, with five or six of the workers that came with the new queen (as I was to give her to a neighbour); lighted the tobacco, placed it in the smoker, and when I had it well going I puffed about four good puffs in through the screen at the entrance in four different places, so as to have the smoke thoroughly penetrate between each comb. I waited about one minute, took the queen out of my pocket, dropped her into the cage close to the honey then suddenly jarring the other hand so as to have her drop into the honey without a chance to fly. I rolled her over, removed the cover of the hive, and dropped the queen and spoonful of honey into the centre of the hive, replaced the cover, and placed a large blanket over the hive so as to make all dark, and so the robbers could not congregate on the outside of the ventilator.

The whole performance from the time I opened the hive to find the queen and introduce the new one did not occupy over fifteen minutes. You must remember that cigar-stubs are very strong, therefore we must use only in proportion to the strength of the tobacco. I usually use tobacco stems. Then we have to smoke a little longer. All the bees must be stupefied. It is not necessary to smoke the queen. I roll her in the honey to prevent her from flying.

Before I left home in the afternoon I removed the blanket and the ventilator at the entrance of the hive, and the bees went to work as though nothing had happened. And I am inclined to think that the bees do not even discover that their queen has been changed while they were intoxicated, for the fumigation makes them act very much like a drunken man, and the change is made so quickly that they have had no chance to discover the loss of their former queen. But this I do know, that I never have lost a queen by introducing with tobacco smoke, and by this last performance I have solved the problem, so that I can beat the robbers every time.

In extremely hot weather it might be advisable to place screening over a part or all of the top of the hive. Always use a little common sense, and then you are all right.

I think I have made the above so plain that the merest novice can comprehend it. It might be well enough for a novice to roll the queen in the honey inside of some room.—
DR. E. GALLUP, in *American Bee Journal*.

Notices to Correspondents & Inquirers.

Letters or queries asking for addresses of manufacturers or correspondents, or where appliances can be purchased, or replies giving such information, can only be inserted as advertisements. The space devoted to letters, queries, and replies is meant for the general good of bee-keepers, and not for advertisements. We wish our Correspondents to bear in mind that, as it is necessary for us to go to press in advance of the date of issue, queries cannot always be replied to in the issue immediately following the receipt of their communications.

All queries forwarded will be attended to, and those only of personal interest will be answered in this column.

A. C. H. (Oxford).—*Errata*.—The word “depositing” on page 518 is obviously a printer’s error. It should have read “departing without the queen.”

WM. W. JEFFREY (Atherstone).—*Bees and Drinking-troughs*.—1. Honey received is very fair in quality, although, when liquid, it would be rather dark in colour. It is from various sources probably, such as fruit-bloom, field beans, and such like. 2. When queens are beginning to lay you will no doubt see pollen carried into the hives. 3. If there are running water-courses within easy distance, it is quite common for bees to neglect water-troughs placed near the hives.

E. BISHOP (Newbury).—*Early Queen-wasps*.—To find a queen-wasp in your bedroom on New Year’s Day is certainly a distinct sign of the mildness of the season. It affords a good chance of destroying them before they become sufficiently active to evade capture.

E. H. HOPKINS (Bromsgrove).—*Misleading Statements about Bees*.—To state that “the largest bee-farm in the United Kingdom consists of twenty hives” is to display profound ignorance of the subject. There are scores of bee-farms with over fifty colonies of bees, and probably more than a dozen consisting of from 100 to 150 stocks.

CONSTANT READER (Workington).—*Granulated honey in comb for feeding bees*.—If you can be positively assured that the honey comes from healthy hives it might be melted by cutting up combs and immersing the vessel containing them in hot water until the wax rises to the surface, whence it could be removed when cold. This done, the liquid honey might be “thinned down” to the consistency of good syrup (by adding hot water) and given to bees as spring food in March or April next. But without the assurance as to healthiness mentioned above, we would not have the honey at any price for the purpose of feeding bees with it.

MRS. S. E. BIRCH (Eastry).—*Suspected Death of Queen*.—The bee you suppose to be a queen is only a worker. Its abnormal size is due to abdominal distension. No doubt its death has resulted from inability to take a cleansing flight, and afterwards chill.

Editorial, Notices, &c.

BRITISH BEE-KEEPERS' ASSOCIATION.

The monthly meeting of the Council was held at 105, Jermyn-street, S.W., on Friday, January 8. Present:—Mr. E. D. Till (in the chair), Messrs. R. T. Andrews, W. Broughton Carr, W. O'B. Glennie, W. H. Harris, T. I. Weston, J. M. Hooker (*ex officio*), and the Secretary.

The minutes of the previous meeting were read and confirmed.

The following new members were elected, viz. :—

Mrs. M. A. Baker, Village Park, South Ealing.

Cornwall B.K.A.—Mr. T. R. Polwhele, Polwhele, Truro, Hon. Sec.

Mr. Alex. A. Keith, Inverlerry, Uddingston, Lanarkshire.

Mr. A. Staples, Old Harrow Apiary, Westerham Hill, Kent.

The Finance Committee's report recommended payment of numerous accounts, and included a statement of income and expenditure for the year 1896. This being considered satisfactory, was accepted by the Council, subject to the usual audit.

A letter was read from the Rev. R. Errington, resigning his seat on the Council. The Secretary was instructed to acknowledge the retirement with regret, and to intimate to the rev. gentleman the desire of his late colleagues on the Council that he would maintain his connection by accepting the position of Auditor to the Association.

Other matters arising out of correspondence were dealt with and the Secretary instructed in regard thereto.

The remaining business on the agenda was of a routine character relating chiefly to preparations for the approaching Annual General Meeting of Members, which it is proposed shall take place on a day convenient to the President, at or about the end of February. Members desirous of making nominations for the Council can do so prior to January 31.

THE CULTIVATION OF BACTERIUM.

During the proceedings at the Illinois State Bee-Keepers' Convention, held at Chicago in November last, a question arose as to the best means of popularising the use of honey as food. During the discussion which followed, it was stated by one speaker that "in some parts people would readily buy, as honey, a sweet manufactured from glucose—which had not a particle of honey about it at all—provided it was cheap enough." He also declared that "stuff" offered in this way at five cents per lb. "goes like hot cakes."

Coming nearer home, it is quite easy to

believe that the same thing is possible in this country among some classes. Take butter, for instance. We everywhere see "margarine" bought in preference to butter with many of the labouring classes because of its lower price, and this notwithstanding the fact that purchasers are (as required by law) distinctly informed that the substance is perfectly innocent of genuine butter as we know it; moreover, that it is not sold as such! But the grievance of the British bee-keeper consists not in the selling of an entirely spurious article which is not honey at all, but in the offering for sale a product as "British" which is *not* British. Any objection to the sale of artificial or 'manufactured' honey is as untenable as it is to oppose the sale of foreign honey when either are *sold* for what they are, instead of for what they are not.

The mention above of butter in connection with some of the drawbacks bee-keepers complain of calls to mind a leader in a recent issue of the *Standard* dealing with the cultivation of bacterial germs, which is so full of interest to bee-keepers that we reproduce it below for the benefit of our readers. "Bacteria," says our contemporary, "have of late years been getting into bad repute. Whatever may be the malady, people are now ready to say, 'Look for the bacterium.' It is satisfactory, therefore, to find that something may be said for the often justly-abused microbe, and that it can do good work in the production of butter. The recognition of the utility of these tiny plants in dairy farming is a new thing; but it has already become so thoroughly understood, as Mr. Clarke Nuttall tells us in the current number of the *Contemporary Review*, that bacteria have been actually cultivated for use in butter-making, and that a definite trade in the product has been organised. Butter, of course, can be made from fresh cream; it has then a very delicate aroma, but a slightly insipid taste, so that it is by no means preferred by all consumers. The article manufactured from soured cream has a more pronounced flavour, and is not quite so sweet. It has, however, this important quality, that it keeps much longer than the other kind, and thus is very superior for exportation, and for all purposes of trade. In France and Germany the butter is almost always made in this way from soured cream; so is that in Switzerland which is designed for exportation to Paris, where the consumers prefer it, both for its flavour and its 'keeping' properties. Usually, a farmer lets his cream go sour without any artificial process, simply by churning at one time that which has been collected during the previous week. But it has been known for some years that the 'souring' of milk and cream is the work of certain bacteria. They act on the sugar of the milk, and produce lactic ferments. The bacteria engaged in this labour are not of one kind, but of several, and the particular condition of the milk is determined by the predominance of special forms.

These bacteria are derived from different sources. Most of them, no doubt, come from the air, which is always more or less pervaded with invisible living organisms, but others may proceed from the sheds in which the cows are kept, or from the udders of the beasts themselves. It must not be supposed that they are all beneficial organisms. Some, of course, may be the seeds of dire disease; and, even among those which are not poisonous, there are very many which can damage, instead of improving, the butter. Certain kinds produce a ferment which gives it a rancid flavour, others cause a soapy taste; while, on the contrary, some can impart the aromatic flavour characteristic of the best dairy butter. The process of butter-making by bacteria has been the outcome of long and careful experiments, chiefly conducted by Dr. Weigmann, of Kiel. First, he succeeded in isolating the bacteria which turned cream sour; these he cultivated, and added the acidifying product to cream which had been previously deprived of all germs; this mixture was then churned into butter. The result was absolutely pure; it kept well, but it had neither aroma nor flavour. He therefore made a search for the bacterium to which these qualities were due, and having succeeded in capturing it, repeated the former process with an addition of the new culture. He now got butter of an excellent flavour, but it did not keep well; so that its commercial value was impaired. It consequently became evident that several kinds of bacteria had a hand in the production of a first-class butter, and that skilful blending was necessary for complete success. After many experiments the difficult task was accomplished, and from the sterilised cream, soured with the due proportions of the different cultures, an ideal butter was obtained. At first these cultures were in a liquid form, but now a dry preparation has been produced, which is said to be quite equal to the other, and, of course, is far more portable. Briefly, the new process of butter-making may be thus described:—First, some skimmed milk is sterilised, and then 'soured' by the addition of the dry bacterial mixture; then the cream is sterilised; next, the souring mixture (which takes almost a day in preparation) is added, and finally the whole is churned. Thus all danger of the introduction of noxious bacteria is avoided, and the butter is pronounced excellent. The process is said to be coming into general use in Denmark, and our farmers will do well to look to the matter, lest they be altogether outstripped by more scientific rivals abroad.

The mere idea of making a trade of the cultivation of bacterial germs for useful purposes opens up a world of thought to the bee-keeper who is unhappily, and with too good reason, apt to regard these germs as uncanny things, which bring to mind only visions of *bacillus alvei* and ruined apiaries. What, we ask, if some Pasteur among bee scientists were to discover some one of these tiny organisms

capable of so completely getting the upper hand of our specially dreaded bacillus as to prevent its ever reaching the almost invulnerable spore stage? When one reads of isolating certain bacteria, and of readily cultivating others, the possibilities in this direction seem almost unlimited. Meanwhile, however, and pending certain hoped-for legal powers, we must make the best use possible of such means as are within reach for stamping out disease among bees, and look hopefully to the future for what it may bring forth for the advantage or protection of the craft.

Correspondence.

The Editors do not hold themselves responsible for the opinions expressed by correspondents. No notice will be taken of anonymous communications, and correspondents are requested to write on one side of the paper only and give their real names and addresses, not necessarily for publication, but as a guarantee of good faith. Illustrations should be drawn on separate pieces of paper. We do not undertake to return rejected communications.

**.* In order to facilitate reference, Correspondents when speaking of any letter or query previously inserted will oblige by mentioning the number of the letter, as well as the page on which it appears.*

PHILOSOPHY.

BY "LORDSWOOD."

[2751.] I wonder if, considered from a physiological point of view, treacle roll-up pudding, with one of its ingredients—suet—of such a size as to be half an inch in diameter, together with leathery beef's heart, contains just the proper percentage of nitrogen, &c., calculated to make an English boy grow in grace and stature and other desirable qualities?

In my happy school-days, the head-master or his good lady evidently thought so, for they had contracts running with several of the principal butchers of the town for the above-named hearts and suet, and with the adjacent grocers for boiled rice. Some of the boys (those who were weak and had been tenderly reared like hot-house flowers) utterly failed to appreciate the physiological reasons why they should take nutriment in that form. They would sooner receive six strokes of the cane across a young and tender palm. Most of the boys—happily, ever-hungry John Bull boys—swallowed what they could, and put the rest in their pockets. What a study were the faces of the boys at these dinners! Morose despair, heroic determination, fierce struggles to keep what you had consumed in its proper place! If only the heart had not been so "gamey!" and the treacle more evenly distributed over the whole pudding! As it was, the treacle was all concentrated in the middle—absolutely none towards the ends—and somehow, by some strange problem of mathematics, one of these ends always came to me!

Looked at calmly, without sentiment or any glossing over, is it possible to imagine any thing more dreary and desolate, to bicyclists,

to bee-keepers, to botanists, to every one than a winter such as this? Rain, rain, rain; bitter cold rain and sleet, day by day, and month by month, till every green thing—the very grass itself—is killed and rotting away; while the streets are rivers of mud, and the brooks have overflowed their banks and are half a mile wide, and the frosts puts the autumn-planted daisies and violas on the rack, and tears them limb from limb! No matter how carefully painted, how neatly covered with zinc, my hives are saturated with moisture. The air, loaded with vapour, wraps them in a wet blanket continually, so that inside the hive beads of water cling to the sides, and occasionally trickle down on to the quilts. The beds of the poor bees thus being damp, it will surprise me if they are not soon suffering with asthma, bronchitis and rheumatism, so that I will have to buy them bottles of Mother Siegel's Syrup, which has the advantage of curing all the above diseases, and many more.

On the eighth day of the new year it rained all day—the wind lashing in from the north. Towards night and throughout the night it was sleet, which finally in the early morning turned to snow. Yesterday it snowed slightly all day, but at night it came on thickly, and this morning we awoke to a white, silent weary world—the snow was a foot deep! It had drifted half-way up the windows and came down in baby avalanches from the roof. It had blocked the hive entrances and stood ready on plinth and porch to further bath the poor infirm inmates. It had bent down and buried the brown fern fronds, and loaded itself into the pine's magnificent crest; the holly berries gleamed ruddy as they veered over, but the white berries of mistletoe in apple boughs, along Worcestershire lanes, were dingier for the contrast. Why does the snow bring such a deep silence over the landscape, seeming to muffle every sound—except two? Would to heaven it would muffle those—the Salvation Army and that old cracked (the bell, not the church) church bell.

This morning deep snow, and now, to-night, it has nearly gone! To-day greenhouse temperature, to-night another vapour bath, and very likely in the morning a summer's day. On Tuesday we will play lawn tennis, and on Saturday we will skate! And so we go on bearing and enduring and saying to one another, "Isn't it seasonable weather?" "Good morning," when it is dreadful bad! "Won't the snow do the ground a lot of good," &c., &c. And yet we know all the while that the richest land of all is where snow is never seen—nothing but the fierce heat of the sun and deluges of warm rain, together with decaying tropical vegetation!

Still, after all, our school-days were the happiest days of our lives, or we will ever continue to swear by them, even as Mike will swear by "Ould Oireland," or a Scotsman get excited over his dreary moors, or I myself throw the gauntlet to the world and say,

"Where else are there woods like Worcestershire woods, or meadows like these?" Do you say "In Cheshire," Mr. Junr. Editor? Stuff and rubbish! Don't tell me!

"The shuddering tenant of the frigid zone
Boldly proclaims that happy spot his own;
Extols the treasures of his stormy seas,
And his long nights of revelry and ease.
The naked negro, panting at the line,
Boasts of his golden sands and palmy wine,
Basks in the glare or stems the tepid wave,
And thanks the gods for all the good they
gave."
—Goldsmith.

MY CHRISTMAS HOLIDAY.

A BEE-MAN'S TRIP TO "THE DUKERIES."

[2752.] Receiving a pressing invitation from a brother and sisters, living in the county of Notts, to spend a few days with them at Christmas, I prevailed upon "the goodwife" to join me in accepting the invite, and on December 24 we started for the famous district known as "The Dukeries." My brother, well knowing my love for "the bees" took care that I should not fail to have an opportunity for interchanging ideas with a few bee-keepers located in the district, and of holding one of those friendly chats about our hobby which bee-men never fail to enjoy. It was rather late on Christmas Eve when we reached Newark, and the evening was employed in other than bee-talk.

The morning of Christmas day was beautifully fine, the sun shining bright and warm as in spring. We were early among the bees, and I had a good inspection of one apiary where the bees were flying quite freely and strong on the wing. I availed myself of an offer to look into the hives, and was very pleased to be of some service in consequence; for although the bees were in perfect health some stocks were found dangerously short of stores. One queen showed her prolificness and good breeding powers by having already nearly filled a whole comb with brood and eggs. To see the bees of a good queen like this wanting the needful stimulus of a "full cupboard" was more than I could stand, and the owner of the bees, not being very well versed in making candy of the right sort for winter feeding, I volunteered to make some on the spot. Unfortunately there was no cream of tartar in the house, but, not to be put off in so critical a case of impending starvation, I started, accompanied by our friend's son as a guide, for Newark, where, with the help of a friendly chemist, we got our cream of tartar and returned satisfied. It was not long before we got the sugar and "stew-pan" in operation, with myself as chief cook, and you would have been amused to see yours truly—with shirt-sleeves rolled up—at work over a big fire, making—not the pudding—but a Christmas feed for the bees! I explained

the "why" of each part of the process of making soft candy, and our friend, while looking on, said, *his* candy pulled out "stringy" enough, but, as I explained to him, it was on the "cooling off" properly that so much of success depended, and this "cooling off" meant constant stirring—with the pan immersed in cold water—until the mass got stiffish and turned to something like the consistency and colour of honey that was nearly granulated white.

When the candy had cooled sufficiently and was of the proper consistency, while still warm, I showed in practice how food given that way stirred into activity a starving stock on a fine day in December, and made the bees safe for many weeks to come. Having had ocular demonstration of the way it worked, our friend thanked me for the lesson. And later in the day I was introduced to another bee-keeper, then a third proving how readily "birds of a feather flock together." Bees and bee-talk so entirely occupied us that we had, very considerably, assigned to us a separate room all to ourselves, and there with experiences—jovial and otherwise—and all round hearty enjoyment, we sat till the "Sma' hours ayont the twal," as our Scotch friends say.

The bee flora of this part of Notts consists mainly of clover in the meadows, and willows (*Salix viminalis* and *S. triandra*). The pollen-laden catkins of these two species of osier willows have a very stimulating effect on bees in the early spring. I know this from personal knowledge of my own district in Hunts. Altogether, I was very pleased with the surroundings of the whole district comprised in the famed Dukeries from the bee-keeper's point of view, and I hope to make another journey to the same neighbourhood in the coming summer.

After a pleasant time in the interim, I travelled on Monday the 28th to a place near Mansfield, whereto I had sent a stock of bees in the spring. They had gathered enough stores to keep themselves, but no surplus. I therefore concluded that the district was not a good one for bees. This was proved later by our driving over to visit a bee-keeper who has sixteen stocks at a small railway station near by, and where I was told the surplus harvested in '96 did not average 20 lb. per hive. Friend Pugh, of Beeston, will understand this, as he has one stock "boarded out" in this same apiary. On Thursday, the 31st, we drove to Pleasey, and saw there an apiary of twelve stocks. Unfortunately, however, there was no one at home, so no information was obtainable either about bees or the district as a honey-producer. I was quite delighted with the beautiful scenery about here. Friday—New Year's Day—saw us on the road to visit Newstead Abbey, and during the journey we came across some heather, which we don't get in Hunts. On Saturday we started for home after a most enjoyable tour. The final conclusion I arrived at was: Well, our county may be flat and

wanting in the beauty of landscape we had left behind, but, with all its shortcomings, give me old North Hunts for bee-keeping. Wishing all bee-keepers a prosperous honey season in 1897.—RICHARD BROWN, *Flora Apiary, Somersham, Hunts.*

A NEW HEATHER HONEY-PRESS.

[2753.] According to promise I herewith enclose sketches of the honey-press mentioned to you some time ago. As will be seen, it is an adaptation of the principle of the

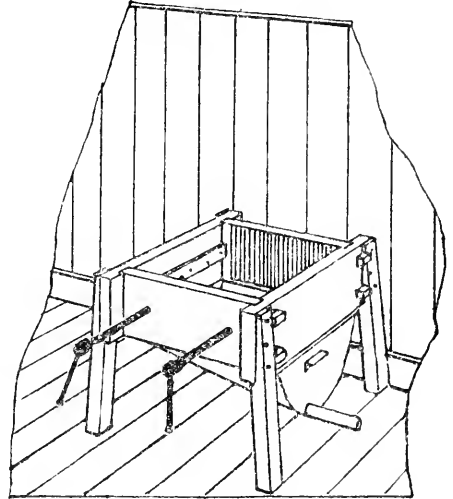

Fig. 1.—Elevation.

"Garstang" press. But never having seen one of these appliances—except in the published illustration thereof—I may say that all I know about it is gathered in this way, and

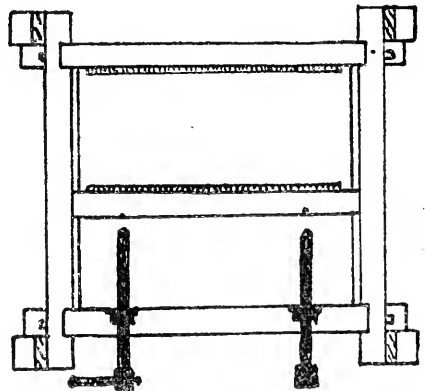

Fig. 2.—Plan.

from descriptions of its working in the journals. For the rest, I made the press entirely for my own use, and after two seasons' experience, I now find the help and benefit of it

in converting what was to me one of the greatest nuisances connected with bee-keeping into one of its greatest pleasures. My press is somewhat different in construction from the "Garstang" as I know it, and it will be found more come-at-able by those who manufacture their own appliances. I have dispensed with expensive screws and cast-iron plates, my object being to introduce a press to the notice of such of your readers as are willing and able to help themselves in providing an appliance for the purpose at a small cost. Further than that I have no interest either in its sale or manufacture.

The press is made of "butternut," a wood close in texture, and comparatively light, and

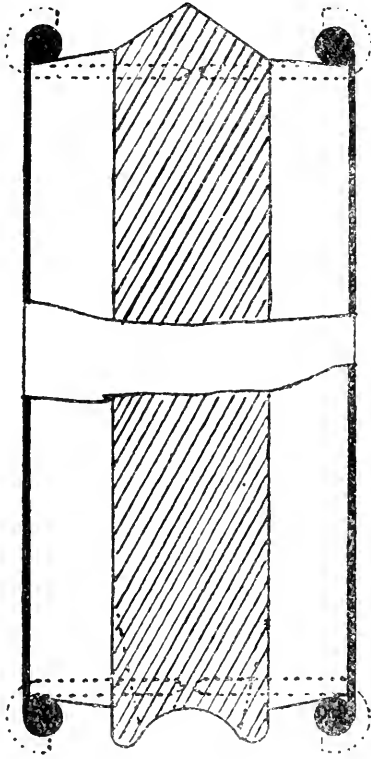

Fig. 3.—Vertical Section. Central Plates (actual size).

which, when coated with spirit varnish, has the clean look about it that every article connected with honey production ought to have. By referring to the plan and elevation, it will be seen that the frame is so constructed that the parts can be taken separate in a few minutes. The back rail constitutes the end-plates, and a corresponding one, but movable, forms the plate against which the two screws act in pressing the combs. There are four central plates (sections of which are shown full size in fig. 3). These reeded plates are covered with tinned wire-cloth (twelve meshes to the

inch), bound on a light wire frame and fixed with wire hooks to the plates. The two bolts are $\frac{3}{4}$ in. diameter, and work through an iron plates 5 in. by 2 in. by $\frac{1}{4}$ in., having a $\frac{3}{8}$ in. thick nut welded on the inside; the pressing-plate has an iron plate sunk into it, with a countersunk hole for the centrepoint of the bolts; the ends of the movable plates are also slightly rounded

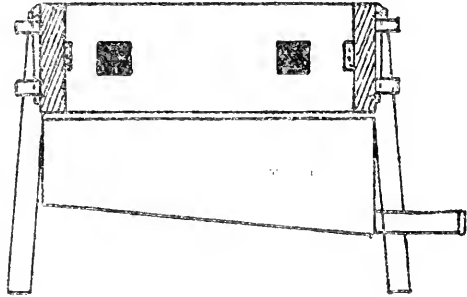

Fig. 4.—Section.

vertically to prevent jamming. "The combs are cut out of the frames, and, without uncapping, are wrapped in one thickness of" cheese-cloth or book-muslin, and placed against the back-plate. One of the central plates is then held hard against the en-wrapped comb, and so on until all five are in place. Then, to again partly quote the "Guide

Book" (page 81):—
 "When the bolts are screwed up and the plates forced together, the pressure forces the honey through the straining and wire-cloths into the grooves, from which it runs down quite clear into the receptacle below. The pressure is so even that every particle of honey is extracted, and nothing remains but a nearly dry sheet of wax." And I may add, if care is taken to keep the outside of the cloths clear of wax or other refuse, the honey may be bottled off direct. After the first lot of combs are pressed I find no difficulty in fixing the combs between the plates. Besides, I do not like the idea of tilting up the frame into a position which, if the screws are applied as described by some, must force the honey over the tops of the plates where it is by no means wanted. The trough is made of tin, hung on two checked fillets screwed to underside of

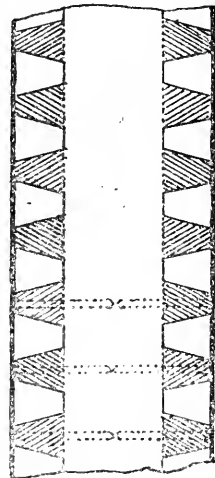

Fig. 5.—Central Plates. (Horizontal Section.)

frame, the edges of the trough being turned so that it slides out or in either way. Across the trough, and soldered to the flanges, are three $\frac{1}{2}$ in. tinned wires, equidistant, to prevent the combs slipping into the trough in case of accident. Although, for the sake of illustration, the press is shown standing on the floor in fig. , it is necessary that it should be placed on a bench or table for comfort and convenience in working. When not in use, if the uncapping board is made the size of and temporarily fixed by two screws to the top, with a neat curtained cushion, it makes a useful piece of furniture. I have only to add that the tracings sent are drawn to scale of 1 in. to the foot (except fig. 3, which is full size); therefore further details are unnecessary.—ROBERT PEEBLES, *Edinburgh*.

APICULTURAL NOTES FROM HUNTS

[2754.] Ever since the honey season closed the weather has been almost one continuation of wet. With the exception of November, part of which was fine but somewhat cold, it has rained more or less almost every day since the third week in August, and at the time of writing we have had in this district four days of continuous rain, bringing about heavy floods. There has been very little fog, and an almost entire absence of frost. Our honey season last year was somewhat poor, the surplus taken being not more than half that of '95. Many of the brood-chambers, however, at the end of the season were heavily laden with honey. Some stocks had more stores than were considered necessary, in which cases a few of the combs were removed, and either given to needy stocks or utilised for driven bees. By that means I was able to prepare upwards of 130 stocks for the winter without the aid of a single pound of sugar. I have just gone through the whole lot, including forty lots located in my out-apiary more than twenty miles distant from home, and which I have visited only twice during the past four months. I am pleased to say, after inspection, all the colonies are safe so far both at home and abroad. In some cases there appears to be a scarcity of food in the immediate vicinity of the cluster, but in all such cases a lump of candy has been given. I don't give candy where there is plenty of honey get-at-able, nor do I ever give candy in early autumn, preferring to wait until the bees have clustered and then place the candy right over the cluster. Hearing so much about foul brood, and having got some naphthol beta by me, I used some in the first few lots of candy I made. But my bees have not been used to this medicating dodge, and they resent it strongly; in fact, they have scarcely touched the candy so made, but the unmedicated is taken freely. This being so, if I come across any really needy cases I shall give unmedicated candy, and run the risk of foul brood rather than risk

starvation of stocks. My old established colonies appear to be as strong as when packed up in the autumn; some of the driven lots, however, have got somewhat weaker in numbers. I am pleased to say there is an entire absence of any signs of dysentery.

I used to use chaff cushions for winter packing, but the last two years I have used meadow hay, which is the best thing I have ever tried for the purpose.

The weather during the last four or five months has been a pretty fair test for hive roofs, and any roofs that will stand such drenching rains without showing the slightest signs of dampness inside, may, I think, be considered as near perfection as can be. I have a large number of such roofs in use, made thoroughly waterproof by being covered with hard pressed tarred felt (like enclosed sample), at a cost of about 4d. per hive. All my new hives are being covered with the same, and another winter I hope to have all colonies housed under felt-covered roofs.—A. SHARP, *The Apiary, Brampton, Hunts*.

HIVING BEES IN "WELLS" HIVES.

[2755.] In response to foot-note on page 5 of last week's BEE JOURNAL, I am willing to afford any information in my power on the subject, but cannot help saying that if persons would adhere strictly to the directions given in my pamphlet, they would find no trouble whatever through bees leaving one side of a "Wells" hive and joining those in the other compartment. Should anything have happened to cause one side of the hive to be queenless, the bees are sure to do so, but this cannot be called a disadvantage, as it not only saves the queenless bees but removes all trouble and risk to the bee-keeper in uniting. Many persons err in stocking a "Wells" hive with bees, especially so with driven lots. In the latter case, one side should have its entrance closed so that a bee cannot enter that compartment. The first lot of bees are then run into the other side and allowed to quiet down, and when all have entered close the entrance so that not a bee can get out. Now open the opposite side and put the bees of the second lot into it, and allow them to become quiet as before. Then open the other entrance. Neither side, however, should have more combs in it than the bees will cover well. If all the combs are crowded in this way with bees both sides will be content. Should one lot have its queen damaged or killed in hiving, the bees in nearly all cases refuse to raise another from eggs or brood given them, as they seem to be aware of the close proximity of a queen in other part of the hive. If there is room for them to crowd into that side, they will do so. If they fail to find room the bees will cluster in the queenless part for a time, and, as the weather gets colder, will gradually join on to where the queen is, and

the other part will in the end be found tenantless. If the queenlessness occurs in the spring, the bees in that side will store honey and pollen, but make no attempt to raise a queen until both sides become overcrowded with bees.

I take this opportunity to say that I have distributed a large quantity of *Melilotus* and Chapman honey plant seeds to those who sent stamped addressed envelopes. Having still seed to spare I can supply further applicants, as all are welcome who require them.—G. WELLS, *Aylesford, Kent, January 9.*

BEES IN WALES.

BALANCING ACCOUNTS.

[2756.] Having read Mr. Kenelm Goss's letter (No. 2748, page 5) I made the following calculation:—

13 sections, '95, at 1s. 6d.	0 19 6
Swarm '95, say	0 10 0
63 lb. extracted, '96, at 1s.	3 3 0
72 sections, '96, at 1s. 3d.	4 10 0
6 sections, '96, at 1s. 6d... ..	0 9 0

£9 11 6

Your correspondent says:—"After having charged the separate hives 'revenue account' with all moneys expended, he has a balance in hand of £11. 17s. 6d." How is it done?

I had a very good crop last season, an average of 66½ lb. from four hives.—S. P. DAVIS, *Salisbury, January 7.*

GLASS COVERS FOR FRAMES.

HOW TO CUT CIRCULAR HOLES IN GLASS.

[2757] In referring to the B.B.J. of November 26 (2711 and 2712, pp. 472-3) there is an obstacle which prevents many from testing the advantages, or otherwise, of glass quilts, viz., cutting the hole for feeding. This obstacle is, however, very simply overcome when you know how; so I will endeavour to explain as clearly as possible the way to do it. First lay the glass on a flat table or board, and, to prevent moving horizontally, nail four pieces of wood ½ in. thicker than the glass close against the sides. Having done this, cut a hole in a piece of ¼-in. board the size required—say 2 in. Place this over the part where the hole is required, then nail to side pieces. All is now ready for the drill to be inserted in the hole in board which prevents drill from slipping on smooth surface of the glass. The drill is composed of a piece of copper tube, 2 in. diameter, fixed into an ordinary carpenter's brace, and fed with turps and powdered corn emery, care being taken not to press too hard, as you will find the drill will cut very quickly with gentle pressure. I hope I have made this subject clear to your readers, but should they require any further details, and will not be backward in communicating with you, Messrs. Editors, I will try to elucidate

the queries raised, as it may be of interest to others besides themselves.—ARTIFICER, *Woolwich, December 31, 1896.* N.B.—The whole cost of above materials should not exceed 6d.

LINOLEUM FOR HIVE FLOORS.

CELLULOID FOR FEEDING-STAGES.

[2758.] Having once been in the same dilemma as "*Apicola*" (1628, p. 6), it may interest him and others of your readers to hear how I got over the difficulty of obtaining a warm, damp-proof floor-board without unduly increasing the weight. A sheet of linoleum, about ½ in. thick, fastened to a board of, say, ½ in. thickness makes an excellent floor to the hive, which is easily kept clean, and has no cracks or crevices to harbour vermin. I have used floor-boards covered in this way for some years, with much saving of trouble to myself, and, I think, with comfort to the bees. "*Apicola*" will recollect that linoleum is to a large extent composed of cork, and is a much worse conductor of heat than wood, therefore ½ in. would be equal to a much greater thickness of wood in this respect. Old linoleum is quite good enough for the purpose, and can be procured at less than half the price of new.

Mr. G. M. Saunders (1629, p. 7) will find celluloid an excellent material for feeding-stages. I enclose for your inspection a feeding-stage such as I have now used for some time, and which answers its purpose well. It has the advantage of being transparent, so that the bees can easily be watched through it. The holes can be punched by means of an ordinary shoemaker's punch, and should be about ⅜ in. in diameter. When of this size the bees can hang by their fore-legs while feeding, and there is no necessity to have the celluloid rough, and therefore opaque. The holes should be at least ¼ in. from centre to centre to prevent overcrowding, and the consequent excitement of the bees. Celluloid, being a bad conductor of heat and transparent, is very useful for many purposes about a hive. From experiments I have made, I have little doubt that bees often refuse to pass through excluder zinc on account of its temperature being lower than the adjoining wood. I now use excluders of celluloid, and shall never return to zinc, as the bees undoubtedly prefer the celluloid. There is another reason why zinc may be distasteful to bees. When the hive moisture condenses upon it a zinc salt is formed, probably the acetate or formate of zinc, and this has not only a very disagreeable taste, but is also probably poisonous.—WALTER F. REID, *Addlestone, January 7.*

[It would be helpful to readers if our correspondent would kindly furnish us with price per superficial foot of celluloid, and where it may be obtained. Also if it is necessary to fix it between two thicknesses of wood (as in sample) to prevent it from twisting out of shape from varying temperature.—Eds.]

Queries and Replies.

[1633.] *Shallow-frame Surplus Chambers.*—

1. Is it advisable to have the top bar of shallow-frames the usual, or standard, length of 17 in.? My reason for inquiring is that I am making my supers from the wood of orange-boxes, sides $\frac{3}{8}$ in., back and front $\frac{1}{4}$ in., with the top bar reduced 1 in. at each end. I can turn out for a few pence a very neat-looking job. An outer case protects the super from weather. Frame-ends in brood-chamber would be covered by a strip of enamel cloth, with plenty of packing on top. By this means I get more room for packing, and I cannot see that the extra length of bar is necessary, but should like to have your valuable advice before making any more supers of the same kind.

Distance Pins in Bottom Bars.—2. Are there any serious objections to putting distance-pins in bottom of side bars? I have great difficulty in getting my frames to hang straight in hive; some of them will almost touch the next frame at one end, while the other end will be just as much too wide. The brads would, of course, be removed when foundation was quite built out.—BLUESTONE, *Rugeley, Staffs.*

REPLY.—1. As a general rule, it is most desirable that the top bars of all shallow-frames be of one uniform length, viz., 17 in. This secures a surplus-chamber which properly covers a body-box fitted with standard frames, and the, perhaps, more important point of uniformity and interchangeability in bee-appliances. The shallow-frame, like the "standard," should not vary in size or shape, so that makers and users alike will know exactly what is meant by the term "shallow-frame." There is no reason why our correspondent should not utilise orange-boxes for making surplus-chambers except that, if he wished to dispose of his appliances, he could not offer them as shallow-frame boxes without misleading a purchaser. 2. Although distance-pins in bottom bars are objectionable for many reasons, they might be used temporarily in order to secure the end referred to. But why not remove the difficulty at the outset by using only well-cut frames which will hang straight in the hive? These may be bought so cheaply that we consider it false economy to use home-made ones.

[1634] *Bees Superseding Queens.*—1. I should like a little advice on the subject of queen-superseding. Is it safe to leave this matter to the bees, as advised by Mr. Doolittle (page 519 of B.J. for December 24 last)? Two of my eight hives have queens of 1896; about the remainder I know nothing as to their age. The BEE JOURNAL for 1886 (page 142), contains a question by the late Rev. F. G. Jevveys on queen-raising in small apiaries. I have looked through the volume, but cannot find any satisfactory answer. If it is safe to

leave it to the bees to remove her majesty when she become too old to perform her duties, I should certainly prefer to do so, for, being a farmer's son, I have quite plenty to attend to without having to raise queens, form nuclei, &c. 2. Will you please say if an ordinary milk-strainer, the wire gauze of which is of brass, would be suitable for straining honey. I have one here quite new, but am afraid the brass wire would have a bad effect upon the honey? — BLUESTONE, *Rugeley, Staffs.*

REPLY.—1. The general opinion of experienced bee-keepers in this country is that queens should be renewed after two full years' breeding; and as a rule it is, we think, admitted that the most uniform success follows this plan. On the other hand, no sensible bee-keeper would think of destroying a queen simply because she had reached the prescribed age if she was found (as some queens are) to be extremely prolific at that time. We may also add that our correspondent will, under the especial circumstances named, not be far wrong in accepting the assurance of so widely experienced a bee-man as Mr. G. M. Doolittle that (subject to the qualifications named) it "is safe" to leave the matter to the bees themselves. 2. The brass wire-cloth will have no bad effect whatever on honey passed through it.

[1635.] *Thickness of Hive Floors.*—Can you kindly inform me what is the minimum thickness of floor that will give bees adequate protection from cold and damp in winter?—APICOLA, *Jan. 7.*

REPLY.—We consider a $\frac{1}{2}$ -in. floor, nailed on to stout side-pieces, $2\frac{1}{2}$ in. deep by $1\frac{1}{2}$ in. thick, constructed as in sketch, will afford

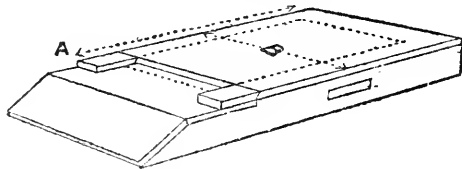

ample protection to bees in winter. The above cut shows the floor-board of the "W. B. C." hive, and will be familiar to readers from having been copied in the catalogues of most appliance manufacturers.

[1636.] *Comb Foundation.*—1. Does the use of thick sheets of comb foundation in brood frames answer the same purpose as wiring the frame, or is it expedient to use wire even with thick sheets? 2. Is it advisable to use flat-bottomed foundation for any purpose? It would seem to afford a better bed for wire, and to bring it better out of the way than the zig-zag foundation. — H. A. C., *Oxford.*

REPLY.—1. Foundation of heavy make is supposed, in more or less degree, to do away with the necessity for wiring, but how far it

secures the object is a matter of opinion—some claim that it succeeds; others the opposite; not a little of the success or failure, however, depends on the bee-keeper himself. A trial of both plans will prove to which class of operator our correspondent belongs. 2. We prefer the natural-base for thick foundation.

[1637.] *Protection From Wasps.*—Am I right in inferring from your kind reply to query 1,622 that it would be useless to try to protect hives against wasps with perforated zinc, as holes which would let bees pass would also allow wasps to get through, because, on an average, wasps are either the same size as worker bees or smaller?—*APICOLA.*

REPLY.—Quite so. In fact, if bees could be guarded against wasps in the simple way mentioned, our correspondent may rest assured it would have been discovered long ago.

[1638.] *Bees Dying in Winter.*—About the middle of December I inserted a hooked wire into the entrances of my four hives, and raked out about half-a-dozen dead bees from each. At the end of the month I again repeated the process, with a like result in three hives, but in the fourth I drew out five or six hundred bees. All the hives are similarly constructed, quilted, and supplied with candy. I send sample of bees, and ask your opinion on this extraordinary mortality as compared with that of the other hives?—*LAMUM, Old Trafford, Manchester.*

REPLY.—The hive in which the greater mortality occurred would, no doubt, have a larger proportion of old and worn-out bees than the others; hence the increase in death rate. It by no means follows, however, that the loss will, for certainty, tell on the prosperity of the stock in the coming season of '97. It is quite common for colonies which suffer great winter losses in the way mentioned to come out well, and be as strong or stronger than those from which very few dead bees are thrown out by the bees, or raked out by the bee-keeper.

SEASONABLE QUESTIONS.

ANSWERED BY G. M. DOOLITTLE.

UNITING NUCLEI AND AFTER-SWARMS.

Question.—Having some nuclei and light after-swarms that have not sufficient bees to winter as they are, I desire to know what is the best way for uniting two or more nuclei or after-swarms in the fall, preparatory to wintering? When is the best time to do it?

Answer.—The time of year to unite nuclei or weak swarms is just as soon as the bees cease to gather honey and you have the extra queens disposed of as you wish. The last half of September and the first half of October is the time when I unite the most of my nuclei, or small colonies, if I have such. The sooner it can be done after September 10 to 15 the better, for then the bees are given more time

to fix up their stores and arrange the hive in the shape they wish them for winter; and the nearer these things are to what they would be in a full colony which has had all summer to prepare for winter in, the more assurance of successful wintering we have. A hive which has had its combs overhauled and put back promiscuously, after October 15, is in poor shape for winter, as the nest prepared for winter, with unsealed honey surrounding it on all sides, is thrown out of shape and made as uncomfortable to the bees as a bed would be to a man were it thrown over a pile of stones, instead of being smoothly placed over a mattress, and that mattress resting on woven wire springs. No disturbing of the bees winter-nest should be done later than October 15 to 20, unless in case of positive necessity, north of 40 deg. north latitude.

Well, how shall we unite? The old way, and the one still adhered to by many, is to draw the hives gradually together by moving them a few feet each day, or after the bees have had a flight each time, till the hives are close side by side, when both colonies are smoked thoroughly, and the bees caused to fill themselves with honey by pounding on the hive, or otherwise roughly using their home. This done, the bees are not liable to quarrel, especially if they are mixed by interchanging frames when putting them in the hive in which they are to stay. Put in their permanent home only such frames as contain the most honey, and place the fullest frames to the outsides of the hive; and those containing the least in the centre. This leaves them more nearly in the shape a full colony would be in when undisturbed, and causes the bees less work in getting their winter quarters arranged. After getting in all the combs the hive will contain, in the same, shake the bees off the remaining frames in front of the entrance, shaking frames from the alternate hives each time, so as to mix all the bees thoroughly as they run in. If any bees stick to the sides of the hive, brush these out also, that all may go into the hive together.

If you have not disposed of all the queens but one, you should do so before uniting, keeping the youngest, and therefore likely to be the most prolific, wherever you can have your choice to do so.

Probably there are more bees united by this plan than by any other known; still, I have always considered it slow and tedious, not giving any better results than a shorter method adopted by myself for the past few years, which is as follows:—When the time comes to unite I select the hive having the queen I wish to retain, as the one to contain the united colony. I now open this hive and take out what combs I consider necessary, leaving those containing the most honey, or otherwise, as the circumstances may direct, although it is seldom that united colonies have too much honey. Those left—after making sure the queen is on one of them—are placed

on one side of the hive, as closely together as I wish them to be left for wintering.

The bees on the combs to be removed are now shaken off the combs and allowed to run into the hive, when, after closing, it is ready to receive whatever is to be united with it.

I next go to the one or more colonies intended to be united with this first one; and if they have a queen she is secured and disposed of as I desire; all the frames are then removed but one, two, or three, according to the number of bees in the colony; few being so small that only one comb is left, and in no case is a colony weak enough in bees to need uniting, unless they can all crowd on three combs fixed as I am about to tell you.

The combs left are generally those containing the most honey, although some years there is little choice of combs on account of all being liberally supplied with stores. The combs (two or three) are now spread apart from 1 to $1\frac{1}{2}$ in., and placed in the centre of the hive, when the hive is closed and the bees shaken off the combs taken out so that they can run in with those left on the spread-apart combs. I fix any others that are to be united in the same way, in some cases putting as many as four or five in with the one having the queen, but not usually more than one, two, or three, according to the number of bees each contains.

I now wait till some cool, cloudy, raw, windy day, or a morning when there has been a frost, or nearly so, when I am ready for the uniting, which is very simple. The hive having the queen is uncovered; or if the cover is a mat or quilt, this is rolled back till the comb next the vacant side of the hive is exposed, when I go, smoker in hand, to those ready to be united with it, blow a few dense puffs of smoke in at the entrance, quickly uncover the hive, blow in freely of smoke over and around the three spread-apart combs, when I place the first finger of each hand between the first two combs; and if three, the big fingers between the next, when the third and little fingers clasp over on the outside of the outside frame, the thumb tightening on the other side at the same time, when the three frames, bees and all, are lifted out all together and carried to the open hive, having the queen, and all lowered into said hive in a body, the same being placed close up to the side of the exposed comb. The quilt is now rolled over all the frames but the last, when another and another lot is brought in the same way till the required number are in, when the hive is closed and the uniting accomplished.

If the day is cool and raw, or the night before has been cold, the bees which are to be carried will all be compactly clustered on and between the spread-apart combs; and after you get the "hang" of the thing a little you can carry them where you wish, without any flying in the air or being left in the hive. Why only three combs are to be left under any circumstances is that a person cannot grasp more than these with the hands; and

to separate the clustered bees in any place is to make a bad job in losing bees and have them fly all over you and out into the cold to perish. By removing the hive and stand from the old location no bees are lost by returning, although some will return and hover over the old spot on the first flight for a little time; but you will soon find them with fanning wings at the entrance of their new home which they accept ever afterward.—*Gleanings.*

HONEY IMPORTS.

An account showing the value of honey imported into the United Kingdom during the month of December, 1896, £1,627.—*From a return furnished to the BEE-KEEPERS' JOURNAL, by the Statistical Office, H.M. Customs, January 6, 1897.*

Notices to Correspondents & Inquirers.

Letters or queries asking for addresses of manufacturers or correspondents, or where appliances can be purchased, or replies giving such information, can only be inserted as advertisements. The space devoted to letters, queries, and replies is meant for the general good of bee-keepers, and not for advertisements. We wish our Correspondents to bear in mind that, as it is necessary for us to go to press in advance of the date of issue, queries cannot always be replied to in the issue immediately following the receipt of their communications.

All queries forwarded will be attended to, and those only of personal interest will be answered in this column.

TRIESTE (Austria).—*Foreign "Homes of the Honey Bee."*—The intention is to complete the series of bee-garden pictures, under this heading, for the United Kingdom first, and then we hope to include some of the apiaries of readers located abroad. We shall, therefore, be very pleased, to receive a photo. of your apiary, together with such particulars connected with it as possess general interest. Your intended visit to this country in June next will afford a good opportunity for visiting the "Royal" Show at Manchester in that month, and also for meeting with some of those prominent in the craft. So far as the actual days for attending the Show, we would suggest the 24th, if only one day can be spared, and the 26th for a second visit, if convenient. The latter will give our correspondent an idea of the number of visitors attending on a popular (or shilling) day.

A. J. ROBERTS (Petersfield).—*Leaking Sections.*—The section sent is of the ordinary bass-wood, of which nearly all American folding sections are made. The statement that "the honey oozes through the grain of the wood so that the sections are dripping all over the top, sides, and bottom," is so entirely outside any experience we have had or heard of, that we cannot understand it at all.

Several Letters and Queries are held over till next week.

Editorial, Notices, &c.

USEFUL HINTS.

WEATHER.—On the evening of the 16th, and for the first time this winter, snow fell in sufficiently enduring quantity to clothe the whole Metropolitan district in seasonable white, enabling us, just before midnight, to look out upon what our friend "Lordswood" calls "a white, silent, weary world," (weary enough to too many dwellers in and around the big city) but inexpressibly beautiful withal, as we saw it. The bright moonlight, helped by the intense whiteness of everything around, made it lighter than any day we have had for ever so long, and the clinging snow so altered the familiar outlines of gable, roof, tree, and every shapable thing within sight as to give them altogether novel shapes, curiously strange to us. Then, too, the "deep silence over the landscape, seeming to muffle every sound," at once recalled the words we have again quoted.

Yes, after all, and drawbacks notwithstanding, we do like a taste of winter, if it will only come at the right time, and not wear out its welcome by stopping too long. Nor does the present promise of its having come to stay fail to give comfort of a reflective kind to the bee-keeper, who—thinking, no doubt, of the bees—says to himself, "winter now won't mean winter in May." Meantime the apiary wears its winter garb; hive entrances snugly shaded from cold winds, or, perhaps, treacherous sunshine; and, should frost continue, the less disturbance of the quiet there prevailing the better. No need to clear away snow from entrances or roofs till signs of thaw begin to appear.

LABELS ON THE "COUNTY TROPHY."
—A question has arisen as to the admissibility or otherwise of county labels on the exhibits comprised in the honey trophies staged at the "Royal" Show in June next. We therefore take the first opportunity for saying that as no labels or anything else indicating ownership are allowed, there must be nothing in this line displayed upon the respective trophies competing. The judges are not supposed to know upon which county's exhibit they are adjudicating, and the

reasons for this will be obvious to all; so that *prior to the awards being made* no name, label, or mark "indicating ownership" must be seen. Once the judging is over the case, of course, becomes entirely different.

HUMBLE BEES IN NEW ZEALAND.—On page 8 of our monthly, the *Record*, for January, there appears a letter from "A Kent Bee-keeper," giving some interesting particulars regarding the successful introduction of humble bees into New Zealand by Mr. Thomas Nottidge, of Ashford, Kent. In the winter of 1884 Mr. Nottidge, who was assisted in the work by Mr. Baldwin, of Bromley, Mr. S. C. Farr, and others, sent out nearly 500 humble bees to the colony, packed in moss, and a sufficient number arrived safely as to become established in their new home. The enormous financial results consequent on the acclimatisation of these insects may be gathered from a communication which reached Mr. Nottidge in 1895 from Mr. H. A. Bruce, secretary of the Canterbury Acclimatisation Society, who under date of Jan. 25, in that year, wrote as follows:—"The humble bees have been a great success in Canterbury, and clover-seed has been *exported* to England for the last three or four years. It is estimated that the clover-seed crop is worth £30,000 per annum to this province, and this *entirely due to the successful importation of the humble bee!*"

In view of the historical interest attached to the above authoritatively recorded facts, we invite attention to an extract on page 22 from *The New Zealand Farmer, Bee and Poultry Journal* of April, 1896. The letters which we print from that paper deal only with the hive-bee, *Apis mellifica*, but they are very interesting not only in connection with the question of the first introduction of bees into the colony, but when considered along with the fact of what has since been done with regard to the fertilisation of clover by humble bees. We have all along disputed the assertion that the Ligurian bee—by reason of its so-called longer tongue—was capable of securing the fertilisation of the seed of red clover and thus proved its superiority over the common brown bee of this country. We have it on record that Mr. Hopkins, whose name appears at foot

of the communication quoted, some years ago imported large numbers of Ligurian bees for the purpose referred to, but failed entirely so far as securing the object aimed at. After the facts detailed above we think it may be safely taken for granted that the supposed superiority of the Ligurian bee is a myth having no foundation in fact.

PAGE 1, VOLUME XXV.—That we were not far astray in our estimate of the pleasure with which we supposed page 1 of vol. 25 would be regarded by readers, is amply proved by the many letters received referring to the subject. Every one acquainted with the original seems struck with the "excellence of the portrait," and all are pleased to see it in print. Beyond this we need only add a personal word to those who expressed a wish to "also see the Junior Editor in print," by observing that the individual referred to—besides having already appeared in these pages a few years ago, is so much in evidence (pictorially) all through the pages of the "Guide Book" that any further appearance "before the curtain" on his part is unnecessary, for the present at least.

DERBYSHIRE B.K.A.

ANNUAL MEETING.

The annual meeting of the Derbyshire Beekeepers' Association was held on Friday afternoon, the 15th inst., at the Y.M.C.A., St. Peter's Churchyard. Mr. J. L. P. Barber, J.P., presided. The minutes of the last meeting having been read and confirmed, the hon. sec. (Mr. Francis Walker) read the annual report, which, after referring to the somewhat unfavourable honey season of 1896, which, however, in no way mutilated the success of the annual show, went on to say: Fourteen lectures and demonstrations were given in various suitable centres during the past season, and 436 bee-keepers were visited, as against 230 the previous year. The total number of stocks in possession of these bee-keepers was 1,630. A satisfactory number of new members had joined during the year. The prevalence of foul brood in the county had caused the committee a considerable amount of anxiety and expense. Special visits and treatment by the expert had been requisite, and several stocks had been destroyed in the attempt to stamp out that ruinous disease. The Technical Education Committee of the County Council had generously granted the Association £50 for educational work in lectures and demonstrations in bee-keeping. The Derbyshire Agricultural Society also granted them £10 towards the

Prize Fund at the annual show. The Chairman briefly moved the adoption of the report, which was seconded by Mr. J. Stone (Cubley), and carried. The balance sheet, showing a slight deficit on the year's working, consequent upon certain unlooked for expenses, was also read and adopted on the motion of Mr. R. Giles (Etwell), seconded by Mr. T. W. Jones. The election of officers was then proceeded with. The Duke of Devonshire was re-elected president, and the vice-presidents were also re-appointed. Mr. Barber was re-elected chairman, Mr. Giles vice-chairman, Dr. Copestake hon. treasurer, and Mr. Walker hon. secretary. The other business transacted included the appointment of the Committee of Management, the appointment of district secretaries and local advisers, and the alteration of certain of the rules.

IRISH BEE-KEEPERS' ASSOCIATION.

The Committee met on 7th inst., present Captain Millner in the chair, the Earl of Rosse, Mr. Read, Mr. Jenkins, and Mr. Chenevix (Hon. Sec., 15, Morehampton-road, Dublin). Sub-committees were appointed to consider the advisability of making further suggestions to the Royal Dublin Society as to honey exhibits, to revise the rules relating to Experts' Certificates, and to draw up the Report for 1896.

BEEES IN NEW ZEALAND.

THEIR FIRST INTRODUCTION INTO THE COLONY.

The Rev. Chas. Cotton—formerly Vicar of Frodsham, Cheshire, and a prominent man in the pursuit in this country for some years before his death—is so generally credited with being the first to introduce the hive bee, *Apis mellifica*, into New Zealand that special interest (from the historical point) attaches to the following correspondence, which appeared in *The New Zealand Farmer*, kindly forwarded to us by Mr. J. W. Rogers, of St. Albans. In the paper before us, the Editor of the Bee Department of *The N.Z. Farmer*, Mr. I. Hopkins, says:—

"Shortly after the publication of the February number of *The Farmer* containing my article on the above I received a letter from Mr. J. H. Cook, of Makara, Wellington, apprising me of the fact that the Miss Wakefield mentioned as having charge of the bees sent by Mrs. Allom came out in the barque *Clifford* to Wellington, landing there in the evening of May 4, 1842. The next day the barque set sail for Nelson. Mr. Cook gave me the name of the lady, now residing in Wellington, who came out in the same vessel, and advised communicating with her, which I did through her son, who holds an official position in the Civil Service. This lady, who was an intimate friend of Miss Wakefield, and constantly with her on shipboard, did not

recollect any bees being on board the *Clifford*. On communicating with Mr. Cook he very kindly sent me the following interesting letter containing additional particulars, which, I think, can leave no doubt about the date of arrival and the vessel Mrs. Allom's bees came out in:—

“Makara, Hutt, Wellington, N.Z.,

February 20, 1896.

“DEAR SIR,—I am pleased my communication was interesting, and hope Mrs. — is able to give you conclusive information about the bees. If she is not, the following may help you to it. The *Clifford* was a Nelson immigrant vessel with large young families on board. There should be about Nelson several persons over, say, sixty-four years old that came out by her, who should remember the bees, and what became of them. The late W. Baigent, of Wakefield, has left sons who, if they can't say they know what became of the bees, should be able to name several who came out with them, or their parents, old enough to remember clearly, and to have taken a lively interest in what was made a show of to them in childhood or youth. With respect to your questions I hope you will not think the following impertinent. I was six years and four months old when my parents with their four children emigrated from England on the *Clifford*, so I think my memory should not be relied on for record. Yet I remember my home in England, prominent incident of the voyage from it to Wellington, the appearance of the vessel, and what she carried on deck—such as a cow, pigs, poultry, amidships, and one or more hives on the poop; there were several quite show-days to see the bees by invitation to the children below the poop, and some days when a few of the older children would be invited up, and once my sister, about nine years old, was persuaded by two girls in their teens to go with them up on one side of our deck to the poop, across it and down the steps on the opposite side, and if spoken to to ask permission to look at the bees, for which, poor child, she was indebted to me, I think, for a scolding. I remember being taking on to the poop once, and not being willing to go a second time to see the bees. I can't remember the shape of the hive, but on looking through a piece of glass perpendicular to a dark background I saw dimly what I was told was a bee and “to look! look! there is another!” I saw it. I had never seen bees before. This is my personal knowledge of the bees. I was reading about six years ago out of your manual to amuse and interest my father who was old and feeble when he said, ‘you know bees came out with us.’ He could not tell where they were landed I feel sure, nor can I.—I remain, yours truly,

‘JOHN HERMAN COOK.’

“Presuming that the bees consigned to Nelson were the only ones landed alive, and allowing, say, four or five days at the outside for the passage of the barque from Wellington

to Nelson, we may fairly conclude, in the absence of direct evidence, that the bees were landed at the latter place during the first half of May, 1842. This would be some few days before Mr. Cotton and his bees arrived in New Zealand, as the 29th May is given as the date of his arrival. So far, then, it seems that we have been able—thanks to Mr. Cook—to fix the date of the arrival of Mrs. Allom's bees, which, contrary to expectations, arrived before the Rev. Mr. Cotton's.”—I. HOPKINS, *The New Zealand Farmer and Bee and Poultry Journal*, April 1896.

HOMES OF THE HONEY BEE.

THE APIARIES OF OUR READERS.

On page 24 we give a view of the “Home of the Honey Bees” at “World's End,” near Newbury, Berks, the owner thereof being Mr. Wm. Woodley, well known to readers of this journal as the contributor of “Notes by the Way” to its pages. The photo from which our illustration is reproduced was taken some six years ago, but the hives occupy the same positions now as then, except that the straw skeps shown in the picture have gone the way of all things of a like nature. Close observation will show a small hole with a round hole in its centre for an entrance, standing on the top of the twin-hive in the foreground. This was the home of a nest of humble bees, the property of Mr. Woodley's son, who, when a lad, used to keep several such hives tenanted during the summer months with colonies of the *Bombus genus*. The figures shown are those of Mr. and Mrs. W., engaged in what will, no doubt, be a daily item of their bee-work during the busy season, viz., that of removing full racks of sections and replacing them with empty ones.

The house in the farther corner, on the left, was erected as a combination summer and manipulating house, at a time when the old shake-off or brush-away process of removing finished sections was in vogue. We learn that many a retreat from troublesome or angry and vicious bees has taken place behind the then thickly-curtained doorway when removing honey; causing the work in the neighbouring farmyard to be carefully studied in order to prevent “war” between the workers of the hives and those in the rick-yard adjoining. This trouble is now happily ended, and, thanks to the super-clearer, we are told that “peace” now reigns between both sets of workers, and honey is removed at any time “even when the neighbours are garnering their corn the other side of the windbreak.” The portion of a building on the right is a Wesleyan chapel, but Mr. W. and family regularly attend Beeton Church, in the parish of Hampstead Norris, three miles from his own village.

In addition to the home-apiary, with its over a hundred hives, shown in the illus-

tration, Mr. Woodley has an out-apiary of fifty to sixty hives at Stanmore, a little over two miles from his house at Beedon. This entails considerable labour during the summer months, and the only help he gets in all the actual work of both apiaries is that of Mrs. Woodley, who may be taken as an ideal bee-man's wife. To use her husband's own words, "she has proved a true helpmeet in everything pertaining to the work in the apiary, either in hiving and packing swarms, folding and preparing sections for putting on the hives, cleaning and glazing sections after removal from the hives, for show or market, and thus handling in some way nearly all the output for

bee-keeping pay seems fairly clear from the above, and although his prices may not be so good as in past years, he still holds his own, and for finest selected glazed sections still gets the good old price of 10s. per dozen wholesale, and corresponding values for second and third grades.

The "home" which contains the leading spirits of this "Home of the Honey Bees" must also be a busy one, winter or summer, for while the bees outside are enjoying their winter's rest, the master and mistress of the "home" are busy the year through, bee-work forming an important item at all seasons. The mistress, we are told, varies her household

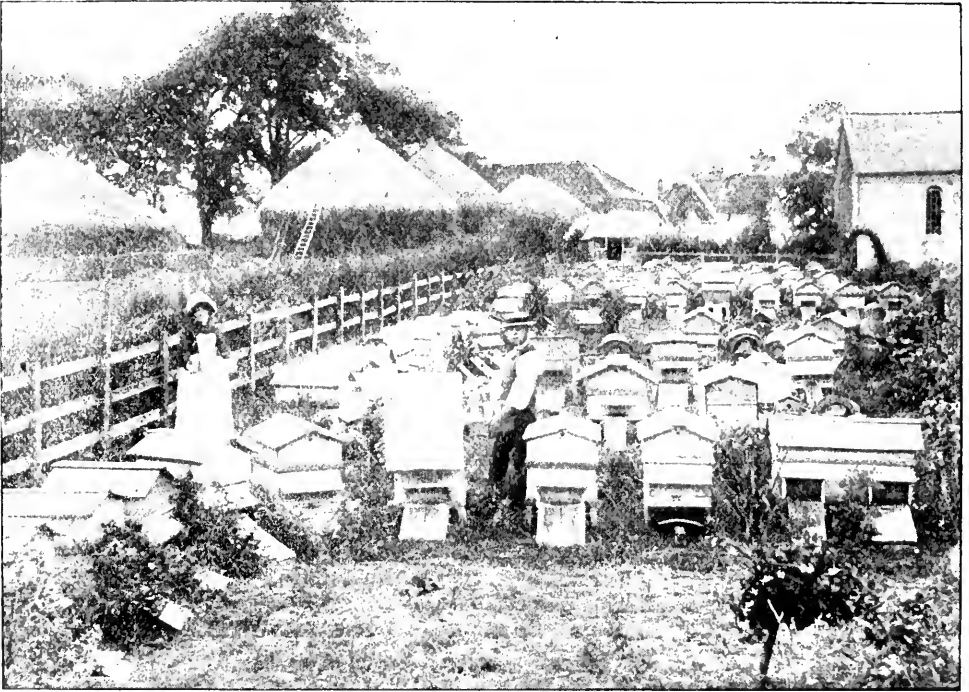

MR. WM. WOODLEY'S HOME-APIARY, BEEDON, NEAR NEWBURY.

the past fifteen years from both apiaries. The only help we have being that of an old man to watch for and hive swarms into straw skeps of the out-apiary during the swarming season." Mr. Woodley further tells us:—"The work of preparing the produce of our apiaries for market is by no means a small job, the bulk being in sections, while nearly every parcel is double glassed with lace-paper edging in our well-known style, and each year brings a wider demand for this form of 'putting up,' without advertising of any kind. In fact, the goods advertise themselves, and inquiries reach us from distant towns for a simple dozen, which invariably leads to repeat orders." That our friend makes

duties with glazing sections as the orders for these come in during the autumn and winter, and in spring and summer with the multifarious jobs incident to a busy life. The master also adds on to the labours of his trade the continual care of the bees; breeding queens, overhauling, cleaning, repairing, and painting hives, and all the hundred items incidental to the well doing of a couple of apiaries two miles apart. A large correspondence also occupies a good deal of time in certain seasons, and when one thinks of the many journeys (to and fro) to the out-apiary (all on foot), not forgetting the packing of—we might say—tons of honey, so that it shall escape damage from the tender mercies of the railway

porter, who will say that the bee-man—like his bees—is not “busy”? But this is not all, for we learn of Mr. Woodley that the public calls on his time are by no means few. Our friend is secretary and agent to a large branch of a benefit club, and vice-chairman of the Parish Council. He is also district councillor and guardian, and acting overseer for the parish of Hampstead Norris, besides being a member of the Council of the Berks Bee-keepers' Association, and of the Committee of the Newbury District Bee-keepers' Association. Mr. Woodley was born in 1846 and Mrs. Woodley in 1852, so that our busy friends are in the prime of life. Before closing, we may mention the interesting fact that on Old Christmas-day, the 6th inst., they celebrated their Silver Wedding.

Correspondence.

The Editors do not hold themselves responsible for the opinions expressed by correspondents. No notice will be taken of anonymous communications, and correspondents are requested to write on one side of the paper only and use their real names and addresses, not necessarily for publication, but as a guarantee of good faith. Illustrations should be drawn on separate pieces of paper. We do not undertake to return rejected communications.

Communications relating to the literary department, reports of Associations, Shows, Meetings, Echoes, Queries, Books for Review, &c., must be addressed only to "The Editors of the 'British Bee Journal,' 17, King William-street, Strand, London, W.C." All business communications relating to Advertisements, &c., must be addressed to "THE MANAGER, 'British Bee Journal' Office, 17, King William-street, Strand London, W.C."

*** In order to facilitate reference, Correspondents when speaking of any letter or query previously inserted will oblige by mentioning the number of the letter, as well as the page on which it appears.*

PARTHENOGENESIS.

"MY THEORY."

[2729.] Excuse the presumption! but as I have not heard or read anywhere in “bee literature” of anybody else having ventilated the same idea, I came to the conclusion that the opinion I am about to explain to my British bee-brethren, whether right or wrong, is my own. Moreover, as it involves a distinctly new theory, I call it “my theory,” and request readers of the B.B.J. to look into it and give their opinion whether they think I am right or wrong. If certain facts in bee life can be explained or accounted for in another and better way than my own, I will be happy to submit to greater wisdom or to superior judgment. Most bee-keepers of any experience know the “theory of parthenogenesis,” so far as its connection with bees—in other words, that both queens and worker-bees issue from impregnated eggs; while drones, perfect in all respects, are produced from eggs which are entirely free from the spermatozoa of the male bee, and are called, in consequence, “virgin born.” This old theory of Dr. Dzierzon has been abundantly proved by eminent scientists,

and is, I believe, generally adopted as a standing fact. Now, departing from the above, how can we explain that yellow queens (I mean queens of a yellow race) mated to a black drone, produce other than perfectly pure yellow drones but show in some degree the relationship to the male parent mated to its mother? According to the accepted theory of parthenogenesis, they have no real father. The queen is mated only once in her life, the fertilising fluid being conserved in a special organ called the “receptaculum seminalis,” by means of which all eggs intended for worker or queen bees are impregnated, while those which produce drones pass by without impregnation. How is it, furthermore, that a yellow queen mated by a black drone produces less black workers in the second year of her laying than in the first season?

These two facts, which all breeders of foreign bees will have observed many a time, have given the impulse to doubt the theory of parthenogenesis; and bee-keepers, both on this and on the other side of the ocean, have tried to throw it overboard; so far, however, without success. Some years ago a Hungarian bee-keeper tried to prove that the queen-bee was an hermaphrodite; that her spermatheca itself produced spermatozoa quite freely after the queen had once been fecundated; and that, in like manner, the eggs from which drones were produced are also impregnated with the liquid containing a male spermatozoa! No life without impregnation was the “war cry” of the new prophet. Zoologists and other scientific men have confuted this new theory, but, so far as I know, nobody ever explained the facts which, I think, gave the origin to the new hypothesis. Now my theory of reciprocal influence of the bee-blood versus the spermatozoa and *vice versa*, explains all questions arising from doubtful cases regarding the theory of parthenogenesis. Permit me to explain myself, so far as my not too perfect command of the English language will allow, or as clearly as I would like to. Let us take an original Cyprian queen bee: she belongs to a race which, from the natural conditions of the island, has been the produce of thousands of years of pure propagation, and thus developed into a distinct race. This queen bee was transported into a country populated entirely by a black race of bees only, and, consequently, all her queen daughters were all impregnated by black drones! Their progeny, however, was, to the astonishment of their first breeders (the Count Kolowrat and Mr. Cori) in Europe, all yellow workers; while the drone somewhat different from the drones of the original queens! Then again, in the second generation of these bees the daughters of the daughters of the original queens, when mated by black drones, produced more black workers in the first year of their laying than in the second laying season, while the drones appeared to be practically nearly all blacks!

I explain the facts as follows:—The male spermatozoa, which is preserved alive in the spermatheca of the queen, by her own blood—which circulates through all of her body, the spermatheca included—takes up some of its peculiarities, but gives also of its own to the same blood, and, while thus circulating and renewing itself continually, assimilates more and more with the queen's blood that of the spermatozoon. The results are darker drones and yellower workers in the second season's layings of a black-crossed yellow queen bee!—ALEX. C. M. SCHRÖDER, *Villa Schröder, Trieste, January 10, 1897.*

WAX EXTRACTING.

[2760.] I have taken your Journal since June, 1894, and find it most useful and interesting. I have only two hives, so far, but hope for a good swarm this season.

I consider bee-keeping both a very great pleasure and also profitable, as I can always sell as much honey as I get.

After reading Mr. F. Crocker's letter (2746, p. 4) in Journal of the 7th, I tried melting down all the wax I had—cappings, combs, and scraps off the sections, &c., and am delighted with the ease with which I did it. In following the advice of Mr. Crocker, I used very fine, close flannel, and think it better than coarse cheese-cloth. I enclose you a small piece of the wax, and shall be glad of your opinion as to its quality, and if I can do anything to improve it. The lump, when I took it off the water in the morning, weighed 1½ lb. It melted in about three hours, and the flannel was a dirty black mass, which I threw away.

Wishing every success to bee-keeping for the coming year.—(MRS.) JESSIE ROWLANDS, *Blundellsands.*

[As a specimen of home-extracted wax, the sample is very fair indeed. Of course, lighter-coloured wax may be got by keeping apart every portion of comb that would tend to discolour the bulk; but for general purposes, a nicer sample of bees-wax than that received need not be wished for.—EDS.]

CANDY MAKING.

[2761.] Mr. R. Brown's letter in last week's B.J. (2752, p. 13) has, no doubt, been read with great interest by many subscribers to your paper. Unfortunately, I am like one of the owners of bees mentioned by Mr. Brown, "not very well versed in making candy of the right sort for winter feeding." It sometimes sets too hard, and at other times is too sticky for use, although, as far as I could judge, the same proportions of sugar and water were used, and the same time allowed for boiling. Would it therefore be asking Mr. Brown too much to fully describe his method of making

soft candy?—Thanking him in anticipation, A. DUMMY, *Wellington, Salop.*

[We will draw Mr. Brown's attention to the above, and hope for his reply.—EDS.]

BEEES IN WALES.

BALANCING ACCOUNTS.

[2762.] Your correspondent, Mr. Davies (2756, page 17), refers to my account (2748, page 5), and wishes to know how it is that I have a credit balance of £11. 17s. 6d. after charging expenditure against the total receipts amounting to £9. 11s. 6d. The accounts I keep are as follows:—A revenue or cost account on each hive, from which I transfer the balance of profit or loss, as the case may be, to the debit or credit of the profit and loss account, after having credited the cost account with the value of the stock at the end of the period. Following is a copy of my cost account of No. 1 hive for 1895:—

DR.	£. s. d.
To bees	1 5 0
„ Hive	0 16 0
„ Foundation	0 6 8
„ Appliances	1 2 0
„ P. & L. account—transfer	2 9 4
	5 19 0
„ Stock	2 2 0
CR.	
By Swarms sold	2 17 6
„ Sections, 13 at 1s. 6d.	0 19 6
„ Stock	2 2 0
	5 19 0

So that No. 1 started 1896 with a debit balance of £2. 2s., and was credited at the end of the year with stock as of the value of £2. 7s., the transfer to P. and L. account being £3. 1s. 4d. to the credit, being made up of the increase in the value of the stock and the balance of receipts over expenditure, so that my P. and L. account for the years 1895 and 1896 combined is as follows:—

DR.	£. s. d.
To B.B.J.'s, <i>Record</i> , and 'Guide	0 17 2
„ Book	0 14 9
„ Sundry Literature	1 5 0
„ Loss of No. 4	12 7 6
„ Balance	15 4 5
CR.	
By Fertilisation of bloom	2 1 0
„ Transfer from No. 1	5 10 8
„ „ „ 2	4 10 9
„ „ „ 3	2 19 6
„ „ „ 4	0 2 6
	15 4 5

By Balance 12 7 6

I made an error of 10s. in my letter, so

that you will notice the credit to P. and L. account is 10s. more.

The item £2. 1s. for fertilising bloom is a subscription I received for the services the bees would render to the fruit and vegetable bloom—which is my father's hobby—in growing them. I think that all will agree that this is a very fair way of keeping the accounts, and I hope I have made everything clear to your correspondent Mr. Davis, and others.—KENELM GOSS, *Langland, near Swansea, January 16.*

NOTES BY THE WAY.

[2763.] The weather is as wintry as the jolliest schoolboy can wish, frost providing ice for some games and snow for others. But what of the bees? Well, during last week they were on the wing for a few hours and got a cleansing flight. In my case all answered to the "roll call," save one colony in a makeshift hive, and examination proved that the bees were dead. On the top of quilts among the wraps I found ensconced a fluffy nest, inhabited by a couple of mice, the mischievous little creatures having made a hole through the quilt and feasted on the contents of the beehive, while, for a change of diet, they had eaten a great portion of the bodies of the dead bees! This was at my out-apiary at Stanmore, which I had not visited for some few weeks; in fact, during the winter months I leave that apiary in charge of an octogenarian bee-keeper, whose flagging interest in the bees I manage to arouse when Christmas comes round by a substantial Christmas box.

Planning for the Season.—Now is the time to plan for the coming season; to place orders with manufacturers for your probable wants in the good time coming. You will now get better attention and—what is still more to the point to a Britisher—better terms than during the rush. Now, also, is the time for reading up articles which received but scant attention during the summer months, and for taking to heart the many items of valuable information which they contain for putting into practice. Let us also endeavour to do better in the coming season than we did last year; to give more attention to our bees, and have everything likely to be wanted ready for use just at the time it is required.

The mention, on page 463 of last volume, of Caucasian bees naturally develops a desire to know more of this race. I gather from a review of foreign bee papers that there are two races of Caucasian bees, one of grey colour similar to the Carniolan race, the other of a bright orange, shading off to light yellow, similar to the Persian and Egyptian races of bees. How or in what form their introduction here may affect our British bees time alone can tell. A cross with the bright-coloured strain may add a few beauty spots to our brown bees, but as they are described as cross and vicious and ready for a robbing expedi-

tion, it may also prove an illustration of the old proverb, "Though it please the eye it may plague the heart."

Mr. E. T. Abbott, in a recent number of the *American Bee Journal*, has something to say against the use of drawn-out combs. His idea is that the bees will store honey in fully-built comb faster than it can be properly ripened, and that there will be a tendency of such unripe honey to sour. This has never been my experience; the difference in climate may have much to do with the matter. Again, Mr. Abbott contends that combs carefully cleaned and preserved from dust and dirt are not—and never can be—so good as new combs built just as the honey is being stored in them. This also is not in line with my deductions of facts gleaned in practice for several years past. I well remember the late Mr. Barnet Taylor's enthusiastic introduction of his comb-leveller to the notice of American bee-keepers, and when my old friend, John Walton, and myself held our next "bee convention," he asked me for my opinion of the aforesaid "comb-leveller?" My reply was that "I wanted a leveller up, not a leveller down!" This opinion he promptly endorsed.

If sections have been worked without separators, and the combs are "bulged," then they will require reducing in thickness so that when finished the comb will allow of glazing or casing. But after the bees have built natural comb, why should we demolish one-third to one-half their work to give them room to rebuild the comb again, and waste all the old material broken off? No; my honey harvests are too short, and my time and that of the bees too valuable to waste in doing over again work which has been well done already. If any one wishes to prove this for himself, let him place an empty comb over a strong colony just as the honey harvest opens, and twenty-four hours afterwards examine the same; he will then see for himself if bees do not know how to clean and polish up a piece of comb preparatory to filling it with honey.—W. WOODLEY, *Beedon, Newbury.*

THE CIDER INDUSTRY

AND BEE-PASTURAGE.

Our attention has been called to the following letter, which appeared in the *Times* of the 6th inst. :—

To the Editor of the *Times*.

SIR.—The Hereford M.P.'s excellent letter in your issue of December 29 induces me to send you a simple fact, which to me has great pomological importance.

We have in this village an industrious old cottager who in the year 1839 planted a "Winter Quoining" in his allotment, of which he has been in undisturbed possession for fifty-seven years. The year before last this tree, which is a most healthy specimen, with a

trunk 4 ft. in circumference, yielded him thirteen bushels of apples!

Had the old man chosen to store his fruit in "liquid form" he could have enjoyed a glass of prime cider every day for a period of something like two years. "If I hadn't planted that tree," said the old man, "when I was young, I couldn't have had all this fruit." In Kent we owe a vast deal to the planting enterprise of our predecessors; but what are we of to-day doing in that direction in our own interest and that of our successors? Let us encourage Mr. Radcliffe Cooke in his good work, and hold an Arbor Day on the 30th of this very month, when every one in Kent who has the opportunity should procure and properly plant an apple tree of good vintage variety; if not (at first for a year or two) in its permanent home, subsequent removal will not hurt it. I have quite sturdy specimens of apple and pear planted in 1887, which for the last three seasons have yielded a liberal supply of fruit, and a farmer here is now planting an acre of vintage varieties and a few ornamental crabs, all of good cooking and keeping sorts, as suitable for market as for cider-making.

Fifty years ago or less cider was made on almost every farm, on which one now sees but ruined remnants of fine orchards, telling both of past prosperity and present neglect. Cider-making is fast coming to the front again, and it behoves every rural parish in Kent to heed the good advice given us by Mr. Radcliffe Cooke in your columns.—Your obedient servant,

E. D. T.

As the above suggestion, if carried out, will provide more bee-pasture, we publish it, and, although practically anonymous to the *Times* readers will with ourselves identify the initials appended as those of a well known correspondent of the BEE JOURNAL. For our own part, we hope that not only Kent, but every other county, will give heed to the subject. Cider is the *wine* of Britain; moreover, it is unquestionably valuable medicinally, and, we hear on excellent authority, an antidote for lumbago and other rheumatic tendencies.

Queries and Replies.

[1639.] *Starting with Frame-Hives and Transferring from Skeps.*—1. Last summer I had two strong swarms given me which I put into skeps; but my intention is in the coming spring to start with frame-hives. I therefore ask: Could I get the bees and combs now in skeps into frame-hives? Or would it be best to let them swarm, and only put the swarms into modern hives in the spring, and drive the old stocks later on? 2. What would be the best way to feed the bees, and with what food, as I am afraid they have not enough stores to carry them through the winter. I gave them a little syrup one warm day this

week in a saucer on the alighting board, but to my surprise and regret I afterwards found a quantity of bees dead in front of the hives. 3. I should be glad if you could tell me the reason of this.—NOVICE, *East Sheen, Jan. 7.*

REPLY.—1. We should not advise an entire novice at bee-keeping to attempt transferring combs and brood from skeps into frame-hives. Having two stocks in skeps, and desiring to furnish two modern, or bar-frame-hives, you might try two well-known and safe plans, and let us know which of these yields the most satisfaction at the close of the season:—With the first skep proceed as follows: Prepare a frame-hive with full sheets of foundation, and covering top bars with a square of leather-cloth with a 4-in. hole in centre. Raise the front of skep in April or early in May next, and if the bees are seen to cover the lower edges of combs, set the skep right on top of cloth which covers top-bars in frame-hive, packing warmly the part not covered by skep. Place the hive on the original stand, and in a week or two the bees will have transferred the brood-nest to frame-hive below, using the skep as brood hatches out of combs as a store-chamber for honey. At close of season the latter may be removed and the honey appropriated. Allow the second skep to swarm. Hive the swarm on about five frames, and set the new hive on the stand of parent skep, removing the latter some distance away. In eight or ten days, if weather is good, give a rack of sections for storing surplus in. Should the season be very good, fill up the hive with full complement of ten frames. Both these plans are easy and safe, and we shall, as stated above, be glad to know which succeeds best with you. 2. Soft candy is the only suitable food at this season; it must be moulded into a ball and pushed into feed-hole at top of skep, covering over all very warmly to prevent through-draught. 3. The excitement of outside feeding has caused some upsets among the bees, and consequent death of a few. It was injudicious to feed with syrup as stated.

[1640.] *Wedging-up Hives for Ventilating.* In the interesting description of storifying, in "Guide Book," p. 60, it is said "the fronts have to be railed, as in fig. 34, by means of wedges about an inch high, to give the bees access on three sides. The outer casing is also raised to allow a free circulation of air." Fig. 34 in "Guide Book" shows with perfect clearness the floor-board, and its ledges, and the cut into it in front. It also shows the fronts of outer case and inner hive, not level with their backs, and in contact with the floor-board (as in fig. 13), but raised up. But if the thickness of the floor-board represents $1\frac{1}{4}$ in, in the drawing, the elevation of the front of case and hive above their ordinary level cannot amount to "about an inch" or anything near it. Hence I fear I have not rightly understood the directions on page 60, which

appear to say that the hive front is to be raised an inch above its previous level; is this so? 2. I should also like to ask—as the bees are given an entrance along the two sides, as well as along the front, are they also given alighting boards at the sides, and is this to be taken as implied in “access.” 3. When the hives are thus raised in front, is it advisable to take precautions against robber bees, moths, and the building of comb under the frames? The wedging-up in front would give bees access at the sides to within 4 in. or 5 in. of the back, and it would give moths access almost to the back, where perhaps the bees might not have sentinels, not regarding it as a thoroughfare.—*APICULTURIST, January 9.*

REPLY.—1. It is only necessary to raise the front “about an inch” as directed on p. 60. A little more or less is of no consequence. 2. No. There is no need for alighting boards at sides; and at such times as ventilation is needed no fear need be entertained of robber bees or moths.

[1641.] *A Beginner's Queries.*—Being only a beginner, I should feel much obliged if you would kindly give me information on the following points:—1. How much flour cake should one put over a stock of bees to start breeding? 2. If syrup is used instead of flour cake, would half a pint once a week be sufficient, allowing the bees only one hole to get it through? 3. From what I have read in *BEE JOURNAL*, 2-lb. sections are almost as soon filled as 1-lb. sections; and if so, would it not pay as well to sell the 2-lb. one at 1s. or 1s. 1d. as the 1-lb. sections at 8d.? 4. To discover the presence of a queen, how long can one be examining a hive, and what would be the best time to do so in view of there being robbers about? 5. I have one stock which did very badly last year; would you advise me to destroy the queen in the spring? On examination yesterday, I found the stock in question very strong. The queen is two years old.—*JERSEYITE, Jersey, January 11.*

REPLY.—1. Early in March, if weather is fine, a 1-lb. cake of soft candy (not “flour cake”) may be given to stocks in sufficiently forward condition to warrant stimulative feeding. When this cake has been consumed, a second, having a little pea-flour in it, may be given, and this feeding continued till the end of the month, after which syrup food may be substituted in a slow-feeder until natural food is obtainable. 2. Yes. 3. Reference to what you may have read in our pages will show that the bulk of the opinion expressed was not in favour of the 2 lb. section. Anything further can only be arrived at by personal experience. 4. Some bee-keepers can usually find a queen in five minutes; it is merely a question of skill and aptness. When robbers are about, a beginner should not open a hive at all. 5. If the queen is at fault, yes, decidedly, but not otherwise.

[1642.] *Packing Bees for Transit.*—Will you kindly give me advice? I have three stocks of bees in bar-frame hives to send a distance of over 100 miles by rail. Please say how they should be packed, and whether passenger or luggage is best way, and which is the best month to send them.—*JAS. ADAMS, Rugby.*

REPLY.—Winter is the best time for sending. Let us know if you have no book on bees by you before we reply as to method of packing.

[1643.] *Windows and Covers in Surplus-boxes.*—I intend cutting a hole and fitting a piece of glass in one side of all my shallow-frame boxes belonging to W.B.C. hives, in order that I may easily ascertain what progress the bees are making when the boxes are tiered, *i.e.*, by being able to see the outside face of one of the end combs, and judge the remainder by it. What I wish to know is, if it is at all necessary or to my advantage to fix hinged shutters on the outside of the glass?—*T. H. B. BURGESS, Exeter, Jan. 11.*

REPLY.—The best plan is to cover the face of the “shutters” with a piece of old black cloth, cutting the latter large enough to cover the edges of wood forming the shutter, which is made so as to fit close in the recess and against the glass. No hinge is then required, but only a “lock screw,” to give finger-hold in lifting shutter in and out.

[1644.] *Stimulative Feeding in February.*—I shall have occasion to give candy to two stocks in the beginning of February. 1. Will it be too early to give flour-candy? 2. If so, how early can this be given with beneficial results? We have a cold climate here.—*R. C. S., Biggar, N.B.*

REPLY.—1 and 2. Give plain soft candy until mid-March. Use flour candy till end of that month, then syrup until natural food comes in.

SUPERSEDURE OF QUEENS.

SHALL BEES OR APIARIST DO IT?

Some think it is best to see that no queen older than two years is left in the apiary, while many of our best bee-keepers believe in letting the bees take care of the matter to suit themselves. I must confess I don't know for certain which is best. Generally I have allowed the bees to choose their own time for superseding. Of the sixty-four queens that started the season this year in the home apiary, six were reared in 1892, twenty-five in 1893, eight in 1894, twenty-four in 1895.

Four of the 1892 queens were superseded in April or May, and the six averaged very poor work in the supers, although two of them did good work. Although there were exceptions, I got my best work generally from the 1895 queens. It is noticeable that the 1893 queens

exceeded in number those reared in 1894 and 1895. Especially noticeable is the very small number of 1894 queens, only eight. I think that may be accounted for by the difference in seasons. The year 1894 was a very poor season throughout, the bees giving no surplus, and not getting enough for winter. So there were not many queens superseded.

The year 1893 was a year of some surplus, so there were a good many supersedures. In 1895 the early crop was a failure; but the fall flow was fine, so there were supersedures enough. In general, it seems that the bees supersede their queens after a hard season's work much more than after a season of light work. Is it because the queens lay more in a good season?

Without going into particulars, I may say that I am well satisfied that it makes a good deal of difference whether a queen is superseded in the spring or the fall. Geo. L. Vinal may be right in thinking late-reared queens superior; but even if they are no better it is not hard to see why a colony changing its queen in April or May will not do so well. Take two colonies alike, and let one of them change its queen at the time when each has its hive about half filled with brood. No eggs are laid in the hive for a week or two, at the very time when it's most important, and one can easily believe that the colony which keeps its queen will surpass the superseding one.

But when the superseding occurs in the fall (and I think by far the greater part occur then), the hive is filled with bees, and the loss of a week or two in laying is scarcely felt. Moreover, the young queen lays enough longer in the fall to make up the deficiency; and this later laying leaves the colony, in the opinion of many, in better condition for wintering, because of the larger number of young bees.

Some queens are better at four years old than some others at a year old; and as the bees seem to have good judgment, and supersede usually at the time when good queens can be reared, and when such rearing will be at least cost to the honey crop, it seems pretty good practice to leave the matter in their hands, especially as that is the easiest way for the bee-keeper. But then there are exceptions, a worthless old queen being sometimes retained, and sometimes being superseded at a loss early in the season, so there's a good deal in favour of at least sometimes taking the thing into one's own hands. If Mr. Doolittle is right, it might at least be well to make sure each fall of the supersedure of each queen whose colony had done poor work during the summer. He says if you put a queen-cell in a super about the close of the honey-harvest, the old queen will be superseded.

TWO QUEENS IN ONE COLONY.

It is nothing unusual for a failing queen to remain in a colony for a time with her laying daughter, but I have at present an exceptional case. June 19 I started a nucleus by putting into No. 36 a frame of brood with

adhering bees and a three-year-old queen. June 23 I found the hive deserted by all but a very few bees. I don't remember how much I looked for the queen, but at any rate I didn't find her. I then put into the hive a frame of brood and bees with a two-year-old queen. This was a very yellow queen. July 8 I was surprised to find in the hive a very dark queen, the three-year-old queen I had first put into the hive. Looking further I was still more surprised to find the yellow queen. No mistake about it, there they both were, doing duty peacefully together.

A curious feature of the case is that the yellow queen shows she has had pretty rough treatment, her feathers being gone as well as her wings, except just a shred of one wing, while the dark queen shows no trace of ill usage. As there were scarcely any bees in the hive except those put in with the yellow queen, one would expect the other queen to be the victim of ill treatment.

To-day, August 1, I have been down to the hive, and both queens are all right after thirty-nine days of friendly association.—Dr. C. C. MILLER, in *Gleanings*.

Notices to Correspondents & Inquirers.

Letters or queries asking for addresses of manufacturers or correspondents, or where appliances can be purchased, or replies giving such information, can only be inserted as advertisements. The space devoted to letters, queries, and replies is meant for the general good of bee-keepers, and not for advertisements. We wish our Correspondents to bear in mind that, as it is necessary for us to go to press in advance of the date of issue, queries cannot always be replied to in the issue immediately following the receipt of their communications.

All queries forwarded will be attended to, and those only of personal interest will be answered in this column.

A. C. DENNY (Haverhill).—*Dead Bees Blocking Hive Entrance.*—The few details given do not quite enable us to account for the heavy mortality mentioned. Either there is something faulty about the hive entrance or several teams of bees have perished through inability to reach the food in cold weather, and have died from consequent starvation. In the latter event the repeated blocking up of entrance with a pint or more of dead bees could be explained, but not otherwise; unless the entrance arrangement is too shallow to allow of the bees carrying out a few dead comrades as occasion requires, and the door becoming blocked in consequence. This, too, would add to the mischief, and cause the death of many bees. Examine the hive on the first fine day, and get rid of all the dead bees from floor-board, then watch if further blocking up occurs.

CALEB GODFREY (Cardiff).—*Moving Bees.*—Bees may at this season be moved any evening. If carefully done, not a bee need leave the hive in moving, even if entrances were left open.

Editorial, Notices, &c.

BEE ASSOCIATIONS AND LEGISLATION.

Seeing that during the next few weeks most of our county Bee-keepers' Associations will be holding their annual meetings, it would be well that resolutions should be passed "Approving of the draft measure for prevention of bee pest (or foul brood), and asking Lord Thring to introduce the measure in the House of Lords during the present session."

Those who have the matter in hand are still pressing the claims of bee-keeping, as involved in the above measure, upon the notice of those of our legislators whose assistance we count upon in the Houses of Parliament, and every bit of additional leverage which can be brought to bear from the outside will be helpful. It is thus most important for county associations to assist in the way we have suggested.

KENT BEE-KEEPERS' ASSOCIATION. ANNUAL MEETING.

The eighteenth annual meeting of this Association was held on Saturday afternoon, the 23rd inst., at the Pump Room, Tunbridge Wells; this centre, which is on the borders of Kent and Sussex, having been selected in view of a proposal to extend the sphere of operations to the county of Sussex. Owing no doubt to the heavy snow-storm, the attendance was not so large as was anticipated. Mr. E. D. Till, Chairman of the Association, presided, and those present included:—Miss Herschel, Messrs. John M. Hooker, W. Broughton Carr, G. C. Lyons, A. J. Carter, R. A. Dallas-Beeching, J. E. Hurst, H. Crowther, Samuel Kendon, Henry Neve, J. Garratt, and H. W. Brice, hon. sec. The Chairman, having heartily welcomed the members, referred to the fact of the Poet Laureate having become a member of the Association. Alluding to the proposal to extend the operations of the Association to Sussex, he observed that it was pleasant for those who had laboured for this alliance to know that Kent and Sussex were now willing to join hands in the interests of bee-keeping.

After the minutes of the previous annual meeting had been read and confirmed, the Chairman called upon the Hon. Secretary to read the annual report.

In their 18th annual report the Council referred to the retirement of the late Hon. Secretary, after many years' service. The report recorded a considerable increase in the strength of the Association, the number of new members who joined in 1896 being 118. The number of local hon. secretaries had also been increased from eighteen in 1895 to forty-five in 1896. After dealing with the past

honey season as it affected the county of Kent, and giving details of the various shows held under the auspices of the Association, the report referred to the expert's spring tour among the apiaries of members, and goes on to say:—"The absolute necessity for legislative measures was very clearly demonstrated by the reports which the Hon. Secretary received day by day during the expert's tour. The state of the finances had steadily improved without in the least degree curtailing the efficiency of the work. More than half the debt with which the year began had been paid off, and in a few months the Council hoped the rest would be entirely extinguished."

Referring to the Eastbourne Show, held in connection with that of the Royal Counties' Agricultural Society, on June 9 to 13, it afforded the Council the opportunity of interviewing many Sussex bee-keepers, and greatly conduced to the decision of the Council to extend the operations of the Association to the county of Sussex. They also owed to the same opportunity the fortunate circumstance of securing the Duke of Devonshire for President. He was much interested in the bee and honey exhibits, and in the contemplated measures for uniting the two counties in the interests of bee-keeping; he was also interested in hearing of the desire to obtain legislative powers in regard to foul brood. Efforts to advance the sale of members' honey have been partially successful, and the Council were still working with a view to some solution of the question. The important county honey trophy competition at the Royal Agricultural Society's Show at Manchester next June had aroused much interest among the members, and endeavours would be made to contribute an exhibit worthy of a high place on the list of prize-winning counties.

The report and balance-sheet having been adopted, the Chairman next moved the following resolution:—

"That in future, the sphere of operations of this Association shall extend to the whole area of the County of Sussex as well as of Kent, and the Association be henceforward known as the Kent and Sussex Bee-keepers' Association."

He said the proposal as to Kent and Sussex had come about slowly, but naturally, and without any forcing of the question. At Eastbourne Bee Show the Duke and Duchess of Devonshire were much pleased with the honey shown, and the Duke said he would do all he could to get a non-contentious measure through Parliament in regard to foul brood. He (the Chairman) had pleasure in asking Miss Herschel—the daughter and granddaughter of famous astronomers—to take charge of a signet ring as representing the bee-keeping "union" of Kent and Sussex.

On the inner circle of the ring were engraved the words—"The Mellific Union of Sussex with Kent. January 23, 1897." Miss Herschel said she would gladly

accept the responsibility of taking charge of the "Union ring" on behalf of the two home counties, and would undertake to convey the signet to the Duchess of Devonshire. Subsequently the Duke of Devonshire was elected President of the new Kent and Sussex Bee-keepers' Association. The hon. secretary and hon. treasurer were re-elected with thanks for their year's services. The Secretary stated, amid cheers, that no less than 100 well-known Sussex bee-keepers had promised to at once join the Amalgamated Association. In order to give the Association a representative character, the following were elected on the Council for 1897:—

Rev. G. W. C. Bancks, Rev. N. R. Nightingale, Mrs. Kynaston Cross, Messrs. G. T. Giddings, M.D., E. D. Till, W. Smith, J.P., W. B. Carr, J. M. Hooker, John Sterry, M.R.C.S., C. G. Kennedy, J.P., F. V. Theobald, F. V. Hadlow, A. J. Carter, Ernest Walker; Lieut.-Col. Reeves; W. Stunt, H. W. Brice, J. C. Roberts, G. C. Lyons, G. Hudson, H. Neve, William Newman, C. Baldwin, and A. A. King.

After the chairman had been heartily thanked for his enthusiastic interest in the work of the Association, the proceedings closed.

Correspondence.

The Editors do not hold themselves responsible for the opinions expressed by correspondents. No notice will be taken of anonymous communications, and correspondents are requested to write on one side of the paper only and give their real names and addresses, not necessarily for publication, but as a guarantee of good faith. Illustrations should be drawn on separate pieces of paper. We do not undertake to return rejected communications.

** * * In order to facilitate reference, Correspondents when speaking of any letter or query previously inserted will oblige by mentioning the number of the letter, as well as the page on which it appears.*

DOINGS OF THE PAST MONTH.

[2764.] Seven consecutive months of wet weather is a fairly good record for one season, especially when it can be safely described as persistent rain. Then, just when we had made up our minds we were to have no severe weather, a "cold snap" visits us that induced dreams of glacial periods, and the skates were at once sought out. With 14 deg. of frost on the nights of the 19th and 20th, and a biting N.E. wind, the bees gave up all ideas of flight, and tucked themselves into closer quarters. I took advantage of this to rearrange my hives, the work entailing the moving of some eighteen stocks to their new quarters. I had them all hand-carried by passing a stout cord securely round each hive, and lifted by the cord by two strong lads and carried smoothly, and gently placed in their new positions. Not a single bee was seen during the whole of the operations. A little thought and personal supervision caused all to go well.

Brood-raising must have started in most stocks, and I am getting anxious to know how it is coming on. Having already prepared a lot of candy-cake ready for use, the first opportunity—when a fine day occurs—will be taken advantage of to give a supply wherever needed. One's thought, however, seems naturally to turn to the bees, and the marvel to my mind is when a cold spell—such as we have recently experienced—intervenes, how does the brood get the necessary attention? Of course one knows that at present there is but a small patch of brood on one, or at most two combs; but, even with ever so small a quantity, my advice is to now place extra quilting on top, and reduce entrances to small width, if possible. I would also shelter hive doorways from the cutting winds so prevalent of late. A visit to the Farningham Apiary disclosed several inches of snow, and nearly all hive-entrances covered over; but I noticed the snow stood a little away from the hive front, clearly indicating life and warmth within.

Bees have taken frequent flights this winter, and in my case it was noticeable that my Caucasians—which have so special an interest for me just now—have been more restful than either the Italians or natives. So markedly was the difference noticeable, that I was prompted during a mild spell to turn up the corner of the quilts of one Caucasian stock to see whether they were still *in esse*. They were found not only quiet, but doing capitably; not a bee of them essayed to fly, they just looked up, and perhaps wondered at the intrusion, but, as is characteristic of the race, took "inspection" as a matter of course. I do not advise such interference at this time of the year, but when information on any given point is really desirable, and sought for only a good purpose, the end justifies the means. Another noticeable thing is that very few bees seem to have perished up to the present; hardly any dead bees turned out, none yet laying on the floor-boards of any of the hives. We must be careful now that bees are not tempted out by the reflection of light from the snow, as many bees are known to perish from this cause. Either cover the entrances over with snow or clear it off the flight-board altogether. We are now close on to the second month of the new year, and the bee-season will be with us ere we can turn round; no time should, therefore, be lost in taking the hint given us by the bees having everything ready. They have made an indoor start for the season, and during the last few weeks I, too, have been doing my best to prepare all requirements, so that when the time comes nothing will be wanted.

I note the reference to Caucasian bees made by our friend Mr. Woodley in last week's B.J., and, being so directly concerned in the introduction of these bees into this country, I may be allowed a word in reply to what cannot be regarded as other than the rather unfavourable inference "gatherable" from what appears on

page 27 of the journal referred to. For Mr. Woodley's information, therefore, and in order to remove any alarm he may either feel himself, or that his remarks may create in the minds of others, let me assure all who are interested in my little venture of introducing these bees into England, that any such bad traits of character as our friend foresees will ensure them prompt banishment from my apiaries. The loss will therefore be entirely my own. On the other hand, I would venture to ask if the evidence as to the character of the Caucasian bee offered at the meeting of the B.B.K.A. at Jermyn-street, and reported in page 463 of B.J. for 1896, is not sufficiently explicit and authoritative to be worth many times over the evidence Mr. Woodley offers on the other side; gathered, too, from "a review of foreign bee papers?" On the page mentioned above, the Chairman (Mr. Cowan)—who had handled Caucasian bees (without smoke or veil) before I had myself even seen them—winds up his remarks by saying:—"In fact, the Caucasian bees were less irritable than the English ones." This view, after several months' experience of handling them in my own apiary, I can fully confirm, and so the hope with which I started out, viz., that of introducing a foreign bee that would prove a real acquisition to our native stock, is in a fair way of being realised. But whether I succeed or not, your readers may rest assured that—so far as personal endeavour goes—I shall take no part in distributing among the bee-keepers of this country bees which will "plague their hearts," no matter how they may "please the eye."

I hope, Messrs. Editors, you will not put your blue pencil through this paragraph of my "doings" as being a free advertisement. I did not seek it, but if your correspondents choose to attack (even by inference) the special "fad" I happen to have a particular interest in just now, you should in fairness allow me space to put them right, so long as I can do it legitimately and honestly. As to the future of the Caucasian bees, all I ask is that deprecatory observations may be reserved for a little while longer, or until I have had them at full work honey-gathering for a season. Pending which experience those who have confidence in my bona fides may leave the matter in my hands.—HENRY W. BRICE, *Dale Park, Upper Norwood.*

APICULTURAL NOTES.

PACKING HONEY FOR SENDING BY RAIL.

[2765.] It is somewhat difficult to add anything to the instructions that have from time to time appeared in the *B.E.J.* on the subject of packing honey, and this being a time of the year when there is very little honey to pack, it may perhaps seem unnecessary even to refer to the matter. But it may be well to choose a time when the bee-keeper has most leisure for reading—and writing too—and this will, I

trust, be sufficient excuse for asking a little attention to the matter. There is reason to fear that the instructions for packing honey which have from time to time been published in your pages have not been read by all classes of bee-keepers, or if read have not been carefully carried out.

During the past season I sent section honey to several dealers whom I had not previously supplied, and in almost every case full instructions for packing, labelling, &c., accompanied the order. In some cases I have been requested to "send by passenger train," in others the request has been to label "Glass, &c.," and have been assured by purchasers that unless such instructions were carefully carried out it would be "useless sending the honey, as it would be sure to get smashed in transit." Now I commend dealers for taking the precaution to give instructions for packing when they have any doubt about it being properly done, but the very fact of it being necessary for them to give such instructions shows clearly that they do sometimes receive honey in damaged condition.

Many dealers will not touch section-honey, owing to the risk of damage in transit, and I know several bee-keepers who will not work for section-honey for the same reasons. Why this should be so, I am unable to understand. I would as soon pack and send by rail a thousand sections of honey as I would so many bricks. Moreover, I should have no more fear of breakage in the one case than in the other. The instructions to send by passenger train, or label "glass," I entirely disregard. I find that sections, unless in small quantities, travel just as safe by "goods" as by passenger train, and, of course, the cost of carriage is much less; and I never label "glass," because anything so labelled would be charged double rate. In other words, a packet which, if labelled in the ordinary way, would cost 1s. for carriage, would be charged 2s. if labelled "glass," a fact which all BEE JOURNAL readers would do well to bear in mind.

Last year I sent a consignment of fifty dozen sections to a firm in London, which in due course were delivered, after which I received a letter from the manager saying that, "out of the fifty dozen, one section was slightly damaged; the whole of the remainder were in perfect condition." A few weeks ago I sent fifteen dozen nearly 200 miles by rail, every one of which arrived in perfect condition, a fact which so pleased the purchaser that he at once wrote and asked me to give him the first offer of my new season's sections. In nearly every case where I have supplied fresh customers I have been complimented on my packing. This is not stated for any purpose of self-glorification but with the simple object of showing that, although so much honey is damaged in transit, the mischief could in nearly every case be avoided if the bee-keeper would but take the necessary trouble in packing properly. If a few simple

rules are observed there is practically no risk in the matter of sending section honey by train, whatever the distance it has to travel. There is one fact which should never be lost sight of, viz., every package of honey sent by train will either benefit or injure the honey trade. If it arrives in good condition the buyer will be pleased, will push the sale of same and be sure to send repeat orders. On the other hand, if there are constant cases of smashed sections leading to disputes, bickerings, and all-round loss and trouble, the buyer will soon incline to give the trade up in disgust.

This is a most serious matter for the honey producer and one that ought not to be thought lightly of. We hear a good deal about the "careless porter," but I am bold enough to assert that nine-tenths of the breakages are brought about not through the "careless porter," but through the downright carelessness of a thoughtless public. I could enlarge very considerably on this matter of "careless porter," but what I have to say thereon I will reserve for future notes. Let every one who has sectional honey to send by rail pack it in the manner described by Mr. W. Woodley, *i.e.*, put the sections up in parcels of half-dozens, and pack ten or twelve such parcels in a "Tate's cube-sugar box." Put a little hay or straw under each layer of sections and at ends. If they are not glazed, use thin strips of board along the ends of each layer of sections to protect the comb surface from damage. Use sufficient packing, so that the case is quite full and firmly pressed down. Bore two holes at each end of case, into which put stout rope or thick cord for handles, which latter should be long enough to lift by without grazing knuckles against case. See that the bottom of the case is perfectly secure, and nail on the lid as though it is never to be removed. Then put a thick wire, or, if you like, two wires, right round the case in the opposite direction to which boards run—pulled up with pliers, and by means of nails at each corner, until the wire is as tight as a fiddle-string. You may then (as our American friends would say) "bet your bottom dollar" that that case of honey will, if necessary, travel round the world without damage, and you won't be disappointed in the matter.—A. SHARP, *The Apiary, Brampton.*

BEEES AND HONEY PRODUCTION.

CAN WE HAVE TOO MANY BEES IN A HIVE?

[2766.] I am obliged for your letter. I have studied the "Guide Book" with the attention which so masterly a treatise invites and rewards. In my desire to avoid the risk of misinterpretation, I fear I have lapsed into asking unnecessary questions. That, of course, is a matter of which experts are the best judges, and I gladly defer to them. If I understand the "Guide Book" aright, it may

be laid down as a rule that you can never have too many bees in one stock, with a view to honey production, and that the honey consumed in rearing a bee is always well invested. To increase the number of stocks as by swarming may not be always desirable, but to increase the number of bees always is. I refer to this because one man to whom I was talking about bees said that if you had a very fertile queen you might find that the result was all bees and no honey. As the "Guide Book" ignores this danger, I presume it is non-existent. I conjecture that where a bee-master finds that he has many bees and no honey, it means that there is no honey to be got about the country, and that having less bees would not mend the matter, but only result in there being no bees, in addition to no honey. But this man seemed to think that if less bees had been reared you would have had more honey—for the honey consumed in rearing would have been stored. If there were much in this, the point would be dealt with in the "Guide Book" no doubt. All this seems fairly obvious, and therefore I do not put it as a question, unless you care to reply to it as being of general interest.—A. C. H., *Oxford, January 19.*

[The question of "all bees and no honey" simply resolves itself into one of time. In other words, if the superabundant bees are produced after the honey harvest is over they not only fail to add to the general store, but live only to consume that gathered by others. This is where too many bees result in "no honey." On the other hand, the experienced bee-keeper strains every nerve to secure as many bees as he possibly can by the time the ingathering begins, this being the main secret of success in honey production.—EDS.]

BEE NOTES FROM SUSSEX.

A RETROSPECT.

[2767.] In looking over the notes made last year in the course of my humble attempts to become a proficient in the gentle craft of bee-keeping, the following points were those which seemed to stand out from the rest in my own experience.

The Yield.—In this neighbourhood the return for 1896 seems to have been fairly abundant, but not above the average. The quality was splendid. It was mostly early, gathered by June 15, little surplus having been stored after that date. I found the honey unusually thick, and difficult to strain. My early sections were grandly filled, some weighing 1½ lb. Clover and late crops were an utter failure, dried up and nectarless.

Swarms.—This is rather like the celebrated chapter on snakes in the description of Ireland: there were none as far as my bees were concerned. That is to say, while I was absent for a fortnight in May, an attempt at swarming was reported, but it

was believed the bees went back, and when I returned I could no longer tell if a swarm had issued from one or two hives, or none.

From that time, I effectually stopped swarming by stretching over the hives a canvas awning, sufficiently broad to well shade them from the sun at all times of the day.

In consequence, I had no use for my two Hole's self-hivers, and can give no report upon them. This year, however, I intend to bring them into use again, especially in case of absence.

Strength of Stocks.—This varied, in some cases, in a remarkable manner in the course of the year. I have been relieved to find that others—Mr. Wells, for instance—noticed the same fact. Four at least of my stocks kept up their strength fairly well the whole year through, and even now are as numerous as they can well be; but with the rest there were two, if not three, periods of great falling off.

The first was in April and May, when other stocks were doing a roaring business, and this in spite of careful feeding, warm coverings, and constant attention. The next was after mid-June, when there was a great falling off in all the hives. I was almost inclined to think I had shaded my hives too much, and so checked brood-laying; but in a recent conversation a practical bee acquaintance drew my attention to a spell of cold weather in May which had affected his bees in a like manner. And this would account for the strong stocks not being so much checked as weaker ones, as their numbers would better maintain the heat necessary for raising brood; and once more the advantage of a large population—at any rate, amongst the bees—was shown. The third epoch was in September, before wintering. Although I never take stores from the brood-nests, although my stocks all seemed well provided, and although I fed lavishly wherever the least doubt could be entertained, many of the hives began the winter very weak in numbers. It is only fair to add that just before the present cold spell the bees had largely increased in all the hives, and if they now survive I believe they will presently give a very good account of themselves; they seem preparing for early work.

"Wells" Hives.—I am still persevering with my one "Wells" hive. I have never yet gone fairly through the year without losing one of the two stocks in some way; but the stocks winter famously, the early spring returns are enormous, and I am interested in the experiment, and am one of those who persevere doggedly until, by dint of profiting by past errors, success crowns the attempt. But I have never had any difficulty in filling both sides at once, one after the other, with driven bees. I have generally put two weak skepfuls on one side, and a strong skepful on the other, transferring them late, sometimes by lamplight, by shaking the driven bees out of the temporary skeps on to the opened hive-top, brushing them

down between the frames, and then quilting over. Where there have been two lots to go in together I have mixed them at the same time and left the queens to settle matters between themselves, which they have done in every case to their and my perfect satisfaction. Those treated in this way, last autumn, are now nestling up against the perforated dummy on either side, and doing well.

Anti-Swarming Chamber.—One of my best hives was one having between the usual ten-frame brood-chamber and the entrance a second brood-chamber fitted with wooden dummies spaced $\frac{1}{2}$ in. apart. This stock never offered to swarm, gave a magnificent return, and is now in first-rate condition. But a very curious thing happened. I suspect the bees must have tried to raise brood between the dummies, and were cramped for cell-room. At any rate, about June, a large number of tiny bees appeared, hardly bigger than house-flies; and it was most comical to see the great burly drones, the normal (rather large-sized) workers, and these dwarf specimens all fraternising and working and living harmoniously together. Perhaps others who may have tried this anti-swarming device, strongly recommended in your columns in 1896 or 1895, will kindly say if they have noticed anything of the sort, and how the plan may have so far succeeded with them?

Envoi.—In conclusion, having once tasted of the bee-fever, I shall now continue, if possible, an ardent bee-keeper to the end. Even if prevented at any time, I shall never lose the interest once aroused in bees and their doings. The work comes at a time of year when it is a pleasure and a benefit to be out of doors as much as possible; and all the rest of the year no pets could give less trouble. Theory and practice are alike absorbing. My hearty wish is—may 1897 put 1896 far in the shade as a bee-year.—W. R. N., *Sussex, January 25, 1897.*

THE "WEDDING AT THE 'WELLS.'" "

SUSSEX AND KENT UNITED!

[2768.] I hope your space for auspicious events will enable me to record a happy union. On Saturday last, the 23rd inst.—that inclement of all inclement days—the eighteenth annual meeting of the Kent B.K.A. was held successfully at Tunbridge Wells. Mr. Brice, the hon. sec., had received nearly two hundred missives in reply to the "invite," but while our railways are deaf as well as blind to the importance of cheap tickets on such occasions (the Council of the K.B.K.A. had pleaded it for their members), nothing but an attendance of some fifty were expected from the promises by post. Despite the storm, several came from remote parts of Sussex and Kent. Among those present, I must not forget Miss Herschel (daughter and grand-daughter of our great astronomers), who most fitly represented our women bee-keepers. The room of

the "Farmers' Club" was indeed a cheerful refuge from the storm that prevailed without on that inclement afternoon. The meeting was presided over by Mr. E. D. Till, chairman of the K.B.K.A. The minutes of the previous annual meeting were read and confirmed. Mr. Garratt expressed regret that the 1895 report had been abbreviated. The Chairman, however, said that nothing but the dictates of a rigid economy—necessary at that period—occasioned that which the late hon. sec. regretted.

Mr. Brice then read the report of the Council for 1896. Before its adoption, Mr. Garratt wished that more had been done to further the sale of members' honey. In reply, the Chairman said he had that very afternoon, in calling on buyers the Association had created in Tunbridge Wells, been complimented for introducing Kent honey. The first grocer in the "Pantiles" assured him that it had knocked the foreign article on the head completely. Very much more *had been done* than the late secretary supposed. Mr. Garratt also desired to show that the improvement in 1896 finance was entirely due to a "windfall" and the refusal of the present hon. sec. to take the customary secretarial allowance; but the meeting saw too clearly that in income, expenditure, work done, and indeed every particular, the secret of the immense improvement was due to other causes. Mr. Garratt was also unfavourably disposed to the alliance proposed, but the practical unanimity of the meeting, and a hundred favourable letters from bee-keepers of the two counties which Mr. Brice held in his hand, were sufficient answer to all objectors. The report was adopted with practical unanimity, and now the Kent and Sussex B.K.A. is an accomplished fact. The Duke of Devonshire was elected president, the new Council too, and Mr. Brice and Mr. Morris were re-elected as hon. sec. and hon. treasurer with *éclat*. Miss Herschel was then desired to hand to the Duchess of Devonshire, to be held during the Duke's presidency, a gold ring engraved with these words:—

"The MELLIFICAL UNION of Sussex with Kent, January 23, 1897."

Thus terminated what I cannot help calling a happy event for our Southern bee-keepers, and I hope none will ever see a just reason or impediment why two contiguous counties should not continue for long, long years working together in mutual esteem and amity.—A MEMBER OF THE K. & S.B.K.A., January 25.

"CELLULOID" FOR FEEDING STAGES.

[2769.] In reply to your editorial footnote to 2758, p. 17, I do not find that celluloid twists or warps in the hive; but by inserting the sheet in a wooden frame thinner material may be used. In the feeding-stage sent for

your inspection, the perforated celluloid is fixed in a saw-cut by means of a waterproof cement. The thickness of the frame being $1\frac{1}{2}$ in., and the celluloid being fixed in the centre, there is a bee-way underneath which—over way the frame is placed.

Celluloid of this thickness costs 8d. per square foot, plain, and can be obtained from Vavasour, Earle & Co., 139, Queen Victoria-street, London, who also supply the solution or cement for fixing it. A coloured kind can be had about 1d. per square foot cheaper, but is not transparent. I perforate the celluloid myself, as I formerly did zinc, to the size which I find by experiment best suits my bees. There is not only a considerable difference in the size of bees, speaking generally, but they differ still more in height; some strains are flatter in proportion than others. While on this subject, can you tell me if any one is now engaged in experiments with a view to increasing the size of bees? I am aware of some experiments made in France with that end in view, but do not know if any one is working at the subject in this country.—WALTER T. REID, *Addlestone, January 25.*

LOCATION FOR BEE-FARM.

[2770.] Could either you or any of your readers kindly inform me of a good locality where to commence a bee-farm on a somewhat large scale. By so doing I should feel greatly obliged.—R. WARD, *January 23.*

Queries and Replies.

[1645] *Vitality of Foul-Brood Spores.*—Has it ever been ascertained the degree of frost which is sufficient to kill the spore of the *bacillus alvei*?—R. HAMLYN-HARRIS.

REPLY.—We do not think so. What has been definitely ascertained is that the spore referred to retains its vitality after both freezing and boiling; but for how long, and what degree of these respective temperatures the spore will remain uninjured, we cannot say.

[1646.] *Packing Bees for Transit.*—Will you kindly give me advice? I have three stocks of bees in bar-frame hives to send a distance of over 100 miles by rail. Please say how they should be packed, and whether passenger or luggage train is best? Also which is the most suitable month to send them?—JAS. ADAMS, *Rugby.*

REPLY.—Packing bees for transit is fully described in "Guide Book," from which we extract a few details adapted to your case as follows:—"Supposing frames to have metal ends or broad shoulders, a rack fixed to floor-

board will keep them from swinging, and a light frame of wood 1 in. square—having its upper side covered with either perforated zinc or coarse net—is made of such a size that its sides rest on the metal ends and on the hive sides. When screwed down this frame not only keeps the frames steady, but allows a full inch of space into which the bees may pass for air." To this we need only add that, as the proposed removal is to take place in cold weather, a single quilt may be used instead of the zinc or net for covering the frame top, these latter materials not being essential in winter. Of course entrance must be covered with perforated zinc, and hives so fixed to floor-boards as to entirely prevent the escape of bees. Passenger train only is suitable for sending live bees by.

[1647.] *Experts Examinations.* — *Queries from Would-be Experts.*—There are a few questions which two young bee-keepers in this part of Norfolk (meaning ourselves) cannot find answers for, and would deem it a great favour if you would answer them for us. They are:—1. How are we to commence gaining first-class knowledge on the subject, such as will enable us to get certificates, and to become thoroughly practical bee-keepers, and, as we hope, eventually "experts"? 2. What good books would you advise us to obtain in order to gain the full knowledge of bee-keeping we aim at? 3. Where do the necessary examinations, &c., take place?—Two YOUNG BEGINNERS, *King's Lynn, January 21.*

REPLY.—1. By studying thoroughly a few reliable text-books on the subject, and by putting the knowledge gained therefrom into practice. To obtain practical experience of handling bees, it would be very helpful if you could get an opportunity of seeing a bee-keeper at work among his hives. Failing this, you might attend a show where lectures are given, and manipulations with live bees take place in the bee-tent. A conversation (easily obtained) with the lecturer would also be advantageous. 2. The books recommended by the Council of the British Bee-keepers' Association for the use of candidates seeking to obtain certificates of the B.B.K.A. are "The British Bee-keeper's Guide Book," Cowan's "Honey Bee," "Modern Bee-keeping," and Root's "A B C of Apiculture." 3. Third-class examinations are held at various shows held throughout the kingdom, and also at such other places as may be appointed. The second-class examination consists entirely of paper-work, and is held at places convenient to the candidate and the superintendent appointed to supervise the work. First-class examinations are only held once a year in London.

[1648.] *Regulating Dummy-board Feeder.*—Can you or any of your readers tell me of a division-board or dummy-board feeder, in which the syrup can be regulated to feed the

bees either slow or fast, in the same way as the bottle-feeder does, *i.e.*, one hole up to, say, eight or ten holes?—W. C., *Blackburn.*

REPLY.—We do not know of any such.

[1649.] *Showing Honey at the "Royal,"* 1897.—In Schedule of Royal Show at Manchester, it states that extracted honey is to be shown in jars not exceeding 2 lb. 1. Does that imply that it must be in either 1-lb. or 2-lb. jars? or, 2. Will a sufficient number of reputed 1-lb. jars to make up a total of 12 lb. do?—J. B., *Llanrwst, January 23.*

REPLY.—1. According to the wording of Schedule, jars of any size, "not exceeding 2 lb. each," are eligible. 2. Their gross weight must "approximate 12 lb." In this way, what are known as "reputed 1-lb. jars," will count as approximating 1 lb. each, and twelve such jars would, of course, make up a correct exhibit. On the other hand, if jars are known to contain as little as 14 oz. each, it would be advisable to send an extra jar to make weight.

[1650.] *Moving Bees in Winter.*—I am desirous of moving my bees to a more isolated position than they at present occupy. Would you kindly say if your answer to query No. 1630, page 7, applies to moving hives a distance of 35 yards?—M. W. S., *Slough, January 22.*

REPLY.—Yes. In winter time, and after the bees have been confined to their hives by cold weather, there need be no hesitation in moving hives into new positions when necessary.

LECTURE ON BEE-KEEPING.

On Saturday, the 16th inst., at the Thornton Heath Polytechnic, Mr. H. W. Brice, Hon. Sec. of the Kent and Sussex Bee-keepers' Association, delivered a lecture of great interest on bees and bee-keeping, Mr. E. A. Martin, F.G.S., being in the chair. Amongst the mass of information Mr. Brice gave on the subject was that in 1716 Dr. Warden, of Croydon, made the discovery that the then so-called "king bee" was really a queen of the hive, and was mother and sole producer of the bees there. He was also able to prove the fact that the working bee was not a neuter, but an undeveloped female. Mr. Brice considered there was no better field of interest open to old or young than bee-keeping, as it provided ample lessons of economy, order, scrupulous cleanliness, tender care of the young and devotion to the queen. In this industry there are many things remaining to be discovered, so that to the student it presents a field for scientific research. He contended, too, that no pastime or pursuit paid so well, especially in rural districts. Bees needed little care, but such care as was necessary must be given at the right time. Mr.

Brice explained, at considerable length and in a lucid style, apparently full of interest to his auditors, all the mysteries of the art and craft of bee-keeping. How the bees are subdued when the hive is uncovered was told. They are made to feel alarmed by the injection of smoke, and in this condition they attack their store of honey, feeding to the fullest extent. By doing this they entirely lose their inclination to sting, and may be handled without danger. Mr. Brice exhibited some excellent lantern slides illustrating both the scientific and practical sides of his subject, explaining each as he went on. Those showing how a model bee-farm is kept were particularly interesting, as was the complete set of bee-keeping apparatus shown and explained. Altogether the lecturer proved to his audience that bee-keeping possesses many attractions.—*Communicated.*

Echoes from the Hives.

Dowthwaite, Keswick, Cumberland, January 25.—The weather here is most changeable—snow, frost, and rain, with bright gleams of sunshine. I omitted to shade my hives during a sunny day, with snow on the ground on Saturday, and on going to inspect them this morning found a few dead and half-alive bees at the entrances, which was to be expected; but what could be the cause of there being honey (quite sweet-smelling) on the floor at the entrance of one of the hives, and the few bees there being in a sticky state, I cannot tell.—GEORGE M. SAUNDERS.

[We should examine the hive floor on the first opportunity. Or perhaps there may be a cake of candy overhead which is deliquescing (or melting), and running down to the floor-board.—EDS.]

HONEY VINEGAR:

HOW IT IS MADE IN AMERICA.

Vinegar originally was only sour wine (*vin aigre*), but it is now made from all sorts of beverages, and the common vinegar of commerce is made by the distillation of wood (pyroligneous acid). Unprincipled dealers have been known to add to the vinegar water and sulphuric acid—a very injurious preparation. Our farmers here make all their vinegar from cider. In England it is made from malt, and even from beer. But the best vinegar is made from grape-wine or from honey.

In making our honey-vinegar we always use a little wine: for two reasons. In the first place, it helps to make it. In the second place, as we are grape-growers, and make a considerable quantity of wine, we often have

remnants that lose in quality or become somewhat sour, and these remnants can only be utilised for this purpose. In making honey vinegar we use only inferior grades of honey, or thin honey that has already fermented. We also use all the washings of our cappings. We have often noticed that many bee-keepers render up their cappings into wax without having previously washed them, and when we receive the beeswax from them it is still sticky with honey. This does no damage to the wax, but it is a waste for the apiarist, and this waste is unnecessary.

When the honey is all extracted and the cappings well drained of their honey, so that they seem entirely dry, we put them into a large boiler with just water enough to soak them. This water is heated a little below the melting-point of beeswax—say, to 120 deg., or a little above this—to a point where you can just endure the fingers in it.

The cappings are stirred in this water, then the water is pressed out. For this purpose we use a very small cider-press; but the same work may be done almost as well with the hands while the wax is soft. The press goes faster and does the work more thoroughly. The water thus obtained is not very clean-looking, but if your cappings have been well cared for, the only thing in them to cause any residue is the propolis, and we all know there is nothing unclean about this. After the vinegar is made, however, all signs even of propolis will disappear, without leaving any trace, as it settles in the dregs. The honey-water is now tested. We use a must-scale, but to such of our readers as do not possess such an instrument, we give an easy test, viz: Take a fresh egg and drop it in the liquid. If it floats, showing a portion of its shell of the size of a sixpence, the liquid is of proper strength. If it sinks, you must add more honey, diluting it well till the egg comes up. If the egg projects too much, add more water.

To make vinegar from honey, we use from 1½ to 2 lb. to the gallon, according to the strength wanted. The sweeter the liquid, the stronger the vinegar when made. But the weaker it is the quicker it is made. The reason of this is that a small percentage of sweet diluted changes more promptly into alcohol and into acid than a large quantity. If you put in too much honey, some of it may remain unfermented for a long time, and a very heavy solution would probably never all change by fermentation. The weaker the beverage, the quicker it sours.

Bear in mind that the fermentation of any sweet or any fruit-juice is first alcoholic, then acetic. No acetic or vinegar fermentation can occur till an alcoholic fermentation has taken place, and the more thorough the alcoholic fermentation is, the more thorough the acetic change will be.

After our honey-water has been made, we must induce the fermentation by some means

The temperature must be right, about 70 deg. Fahrenheit, and it is best to induce by heating the liquid even as high as 90 deg. or 100 deg., if it has not already been heated as above mentioned. A little of excess is not so injurious as a low temperature, provided, however, that you do not reach the germ-killing point (160 deg. to 170 deg.). If your liquid was heated to this point, it would have to stand till it had absorbed more ferment germs from the atmosphere, and this would be slow.

Most honey contains plenty of ferment germs and needs but little inducement to start the alcoholic fermentation. If, however, there is any delay, a little fruit-juice, fresh grape-juice, fresh cider, or even a little yeast, will soon give it a start. The liquid is put into barrels in a warm, sheltered place, the barrel being only about two-thirds filled, as the boiling of fermentation will cause it to rise, and a full barrel would spill part of its contents. The bung-hole is covered with a thick cloth to keep gnats and flies away.

Vinegar made during cool weather is best kept in a warm room. We keep ours in a cellar heated by a furnace. But if you have no convenient place in which the liquor may be kept at a temperature of about 70 deg. Fahrenheit, it may be stored away in a cool place till summer comes again without suffering any harm beyond delaying the process of making.

If your vinegar making is carried on in a warm place in the winter, when there is no fear of flies, give it all the air you can. Bear in mind that it requires oxygen, both for alcoholic and for acetic fermentation, and this oxygen is to be had only in the air. That is why wine-makers leave their casks open as long as the alcoholic fermentation lasts in the wine, but carefully fill and bung up the casks tightly before there is any chance of acetic change taking place. We must therefore give our vinegar all the air we can, and must transfer it from one vessel to another as often as we can if we want to make it rapidly. Vinegar-makers pour their vinegar over beech shavings, which assist in airing it, besides retaining much of the lees or sediment. But it is not necessary to go to all this trouble, for fermentation once well started, will continue with more or less speed, according to circumstances, till good vinegar is produced.

After the alcoholic fermentation has been well started, it is easy to induce acetic fermentation by adding a small quantity of sour wine or sour vinegar. We make it a practice to always keep at least two barrels of vinegar, the one sour, the other souring, and refill the one from the other occasionally.

If clear vinegar is wanted, it must be racked by removing all but the lees, the latter being saved for using with new vinegar to help its formation.

Good wine or cider must not be kept in the same cellar with vinegar, as the germs of

the latter, floating through the air, will induce acetic fermentation very readily in the former.

Good vinegar usually contains millions of small animalculæ, which prevent it from having a bright or crystalline appearance. These may be destroyed by heating to 170 deg., and will then settle to the bottom with the lees or dregs. Let it not be supposed, however, that these minute organisms are injurious, however numerous. In fact, one should beware of vinegar not containing any such organisms, seeing that it is probably made up of poisonous compounds that kill them.

The writer, at the North American Convention, in St. Joseph, Mo., in 1894, met a young bee-keeper who had tried to make vinegar and had succeeded, but said that he had to throw it away because it was full of little snakes, which he had detected by holding a very thin vial of the vinegar in the sunlight. It must have undoubtedly been first-class vinegar, and he was very much astonished to hear that he could with difficulty find any good vinegar that did not contain such "snakes," unless it had been heated.

In order to strengthen vinegar that is fermenting too slowly, pour it over crushed fruits, grape-skins, or even apple parings; but, above all things, if you want to hurry it on, be sure it has plenty of air at the right temperature. We have now in our house cellar three or four barrels of wine and honey vinegar that has been a year in making owing to its not having been kept warm enough.—C. P. DADANT, in *American Bee Journal*.

SEASONABLE QUESTIONS.

ANSWERED BY G. M. DOOLITTLE.

FULL SHEETS OF FOUNDATION IN BROOD-FRAMES.

Question.—Which pays better—to put full sheets of foundation in the brood-frames, or put in only starters and let the bees fill the frames with natural comb?

Answer.—That depends a good deal on the wants of the apiarist. If he is working for extracted honey, and wishes his frames filled with worker comb, so that he can use these combs in any place in the apiary, then it is almost a necessity to use foundation; otherwise only drone comb will be built in the upper stories—over the brood-combs—especially where a queen-excluder is used, as it is best to do when working for extracted honey. Extracted honey is best produced with very strong colonies, and such colonies, as a rule, will build mostly drone comb when a honey-flow is on, while such comb is a disadvantage because of its being only available for special use over queen-excluders. Of course, drone comb works equally well with worker comb for storing extracted honey where queen-

excluders are used; but unless the average apiarist is very different from myself, there will come a time in his life when he will say he would give almost anything if these combs were only worker combs, so he could use them just when and where he pleased. Of course, where half-depth combs are used for extracting, as the custom of some is, it does not make so very much difference whether they are of the worker or drone size of cells; and in this case I would allow the bees to build their own comb in the frames. If the apiarist is working for comb honey, then "which is best" will depend on whether he is going to allow swarming in his apiary or whether he is going to keep his bees from swarming. If the latter (I doubt about his success in this, however), then he will have as much need of foundation when combs are being built as he would if he were working for extracted honey, as strong colonies building combs under any system of non-swarming will give a drone size of cells more often than otherwise. But if he is to work his bees on the swarming plan, and use full sheets of foundation in the sections (such use of full sheets being considered right by the largest part of our practical comb-honey producers), then I should say it would pay to allow the bees to fill the brood frames with natural comb. Each new swarm seems to go prepared for a start at comb-building in its new home, and such building seems to give them a greater activity than they show if the hive is supplied with empty combs or frames of foundation; and I often think that, if the hive is contracted so as to hold two-thirds of the number of frames needed to fill the whole hive, this number of combs will be built by the bees without the loss of a single pound of honey to the apiarist, while the cells will be very largely of the worker size, unless an old or failing queen is used, in which case little else besides drone comb will be the result, under any circumstances.

But, really, the nicest way, where we decide to have our combs built by the bees is to set apart each year all the colonies we may happen to have, when the honey flow commences, that are not strong enough to do good work in the sections, or upper stories of hives for extracted honey; and as soon as the honey-flow commences, take away all their combs, giving the brood to other stronger colonies to make them still stronger; when just what frames these little colonies of bees can work on to the best advantage are to be given them, each having a starter of worker comb or comb foundation in it, say from half an inch to an inch in depth. In this way I can get the nicest of combs built; and by taking them out in such a way as to keep the bees desiring only worker brood, a worth of combs may be obtained greater than any value of honey which it would be possible to produce with them. At least, this is the way I think I have proven the matter;

and if any are sceptical on this point, it will be very easy for them to test the matter for themselves; and if the plan does not prove in their hands as it does with others, then they can change to what seems best with them.—*Gleanings.*

Notices to Correspondents & Inquirers.

Letters or queries asking for addresses of manufacturers or correspondents, or where appliances can be purchased, or replies giving such information, can only be inserted as advertisements. The space devoted to letters, queries, and replies is meant for the general good of bee-keepers, and not for advertisements. We wish our Correspondents to bear in mind that, as it is necessary for us to go to press in advance of the date of issue, queries cannot always be replied to in the issue immediately following the receipt of their communications.

All queries forwarded will be attended to, and those only of personal interest will be answered in this column.

F. EVANS (Kelso).—*Chapman Honey Plant.*

—The botanical name of this is *Echinops sphaerocephalus*. If a stamped addressed envelope is sent to this office, a few seeds will be returned therein free.

E. D. T.—*Wasps in January.*—No doubt it is very unusual to see a wasp on the wing in a City office in London so early as January 15. It must, however, be borne in mind that queen wasps (the only wasps alive at this time) recover from their condition of hibernation whenever a warm day occurs, and at once begin to seek for a "nesting place." We have already had several queens sent to this office captured during this and last month.

ALFRED BISHOP (Bury St. Edmunds).—*Wax Moths.*—We will reply to yours in next issue.

BRUEN (Chester).—*Exhibits at Royal Show.*—We hope to give a satisfactory reply when printing your letter (received too late for this issue) next week.

W. R. N.—*Printer's Errors.*—We have ascertained that the mistake was clearly not yours; and if it is thought desirable we will be very pleased to rectify it in print in our next issue.

Several letters and queries in type are unavoidably held over until our next issue.

* * * *Errata.*—In middle of second column on page 25 of last week's issue, a printer's error makes the line end with the words "a male spermatozo." It should read "male spermatozoa," omitting, of course, the letter "a" before the word "male."

Editorial, Notices, &c.

USEFUL HINTS.

WEATHER.—The frost which began on January 16 continued with unbroken severity till the 29th, when it disappeared. If, therefore, a hard winter is before us its endurance is put off, more's the pity, from the bee-keeper's point of view. Just as we in the south have our eyes again "refreshed with a green bath"—as some one has described a sight of the grass after snow—a Scotch correspondent (dating from Aberdeenshire on the 29th) writes:—"My ten hives are in *good condition*, being at present buried *some feet deep in the snow!*" "But," continues our farmer friend, "how can they escape, when trains are standing for days in 15 ft. of snow! In another month, however," he adds, "we shall, no doubt, have the bees buzzing about again." A cheery hope in which all bee-keepers will concur.

HOMES OF THE HONEY BEE. — Mr. W. B. Webster, in our monthly, the *Record*, for February, makes incidental mention of a lack of "comment" in print on the recently-launched project of publishing the series of pictures now appearing in these pages. Mised, it may be, by the knowledge possessed only by ourselves, it never occurred to us that any misapprehension existed on the subject. The withholding of comment was, therefore, ours, and not because of any lack of it. Moreover, there has not been a single dissentient voice raised, or a word written other than of approval of the idea. So far from either lack of interest or indifference on the part of readers, the project has been taken up with a heartiness and enthusiasm quite beyond our expectations. Indeed, it may be said that if photos of bee-gardens continue to come in as up to now, it will be a long time before we get through the series. We hasten, therefore, to say to those who have expressed a desire to "wait till the bees are in full work, and the apiary is looking its best, before sending a photo, if not too late," that there is plenty of time, as we have already views on hand to occupy us for some months. The point for remembering is to get the work done in suitable weather, and without

any "hurrying," in order to secure the best results. So extensive does the series of pictures promise to become that we have under consideration the publication of them in book form, on fine paper suitable for doing full justice to the beautiful half-tone blocks we already have by us, and hope to acquire as time goes on. This, however, is a matter on which no more need be said just now; but the idea of lack of interest is so new to us, and so contrary to the fact, that we lose no time in removing any such impression if it exists.

THE THAW!—So general has been the rise in temperature just before we go to press, that a general thaw appears to have taken place all over the southern half of the kingdom. This will necessitate an inspection of all hives about which there is any uncertainty as to their being waterproof. Nothing is more searching than melting snow-water, and a serious amount of damage may be done if a "leak" happen to carry the water to the warm brood-nest of a snugly-packed cluster of bees. If wet quilts are found, warm dry ones must be at once substituted, and all leakages remedied where possible.

BRISTOL, SOMERSETSHIRE, AND SOUTH GLOS. B.K.A.

ANNUAL MEETING.

The eighth annual meeting of this Association was held on Thursday evening, Jan. 28, at Stuckey's Restaurant, Wine-street, Bristol, Mr. Hamlyn-Harris presiding. The annual report was read by the Secretary, Miss Hill Dawe, who mentioned that the year past had been a notable one for their Association in several respects. The committee had made a new departure by starting a second annual show, and, though the funds had scarcely borne the strain of another heavy prize list, the encouragement to the members had been so great that it was considered advisable to continue the effort, though the prize lists might have to be curtailed. The Association had lost a valuable expert in Mr. John Martin, who had gone to South Africa. The number of members who had paid their subscriptions for 1896 was 301. There had been an increase of eighty-four new members. There were signs of improvement and advance in many directions, but, taken with this, the Association had to deplore the fact that, in spite of preventive measures, followed often by the total destruction of infected stocks, foul brood was devastating many of their members'

apiaries. They could but feel very grateful to the parent Association for the untiring efforts made to bring about compulsory legislation with regard to the matter, and they trusted as a result of those efforts that very shortly the bee pest would be classed under the Diseases of Animals Act, 1894. With regard to the honey harvest of the previous year, it had been very light owing to the drought; the early honey was, as a rule, particularly good, but the flow soon ceased. Owing to the great scarcity of water little brood was hatched, and very few swarms were heard of. The season being so unfavourable, it was all the more gratifying to find that the exhibits at their shows were not wanting in quantity or quality. Financially, the Association was in need of increased support, and the Committee would lay it upon the members to make an urgent appeal to those who were able to help an industry which benefited so many classes alike. Demonstration lectures had been given at ten different centres, which had doubtless been the means of increasing membership. The total number of stocks possessed by the members was 1,118. After the adoption of the report and balance-sheet, the election of officers took place. Lady Smyth was unanimously re-elected President, Miss Hill Dawe, Secretary and Treasurer, and Mr. Hamlyn Harris, Chairman of the Council. Mr. Brown, who had just returned from a tour round the world, gave an interesting account of "Honey in the Colonies." Later an admirable paper on "Foul Brood" was read by Mr. Jordan, after which a resolution was passed to this effect: "That the Bristol, Somersetshire, and South Gloucestershire B.K.A., assembled at their Annual Meeting, signify to headquarters their approval of the draft measure for prevention of foul brood, and add their earnest request that the measure be introduced in the House of Lords during the present Session."

The business of the meeting was interspersed with excellent music, and the proceedings ended with the singing of the National Anthem.—(Communicated.)

HIVE BEES IN NEW ZEALAND.

THEIR FIRST INTRODUCTION INTO THE COLONY.

On page 22 of BEE JOURNAL for January 21 there appears some interesting particulars regarding the first introduction of the hive-bee, *Apis mellifica*, into New Zealand. We have since received from our St. Albans correspondent a copy of *The New Zealand Farmer* for October, 1896, wherein further light is thrown upon the question of the exact time of the honey-bees being landed in the colony; and a date earlier by over three years—viz., March 13, 1839—is given, on what seems reliable authority, as the correct one. In the

paper before us, the editor of the bee and poultry department of our colonial contemporary says:—

"In the March and April numbers of *The Farmer* for this year some correspondence on the above subject was published. Though it was clearly proved that the claim put forth by a relative of Mrs. Thos. Allom that the introduction of the first bees into this colony was due to the foresight and efforts of this lady was wrong, the correspondence resulted in our being able to fix the dates when both Mrs. Allom's and the Rev. W. C. Cotton's bees arrived. In the March number I made the following remarks:—'At present the case stands thus: Lady Hobson landed bees at the Bay of Islands in the early part of 1840; Rev. W. C. Cotton landed some at same place in the first half of 1842; Mrs. Allom's bees arrived at Nelson, it is believed, in 1843. It was subsequently understood that Mrs. Allom's bees landed a few days before Mr. Cotton's.' I also incidentally remarked that a prior claim to that of Lady Hobson had been made. I had in mind when writing this what Mr. A. E. Hobbs, then of Hamilton, had told me some four years previous, and he, at my request, promised to try and get full particulars. The following letters will explain the matter, and I have to thank Mr. Hobbs for his favour:—

"SIR,—A few months ago I happened to see one of your valuable journals—*The Farmer*—and noticed that a controversy was being carried on as to who brought the first bees to New Zealand. I have not seen how the controversy ended. About four or five years ago Mrs. Gittos, wife of the Rev. W. Gittos, native missionary, and daughter of the late Rev. John Hobbs, one of the earliest native missionaries, while visiting one of our apiaries in Waikato, told me of the first bees she had ever seen, and which were brought to New Zealand in 1839. I observed that the date was earlier than any that had been mentioned by Mr. Hopkins in his 'Australasian Bee Manual,' and so I took down briefly the particulars in my pocket book. I, unfortunately, some time after lost the pocket book, and on seeing that there was some discussion on the subject, wrote to Mrs. Gittos, requesting her to supply a detailed account of the arrival of the first bees, and any particulars of interest, also her own experiences in bee-keeping, as I knew that she had been an enthusiastic and experienced bee-keeper. I herewith enclose the interesting particulars of the first introduction of bees to New Zealand as kindly supplied by Mrs. Gittos.—Yours, &c., A. E. HOBBS, Palmerston North."

"It was on the 13th of March, 1839, that the good ship *James* (Captain Mark Todd) anchored off the Mission Station of Mangungu, Hokianga, New Zealand. This ship brought a party of missionaries, among others the Rev. J. H. Bumby and his sister—Miss Bumby, who accompanied her brother as housekeeper.

This lady brought with her the first bees I ever saw. There were two straw hives, and they were placed in the Mission Churchyard as being a safe place, and free from the curiosity of the Maoris, who, of course, had never even heard of 'the little busy bee.' Some years later on I was writing to a gentleman friend in Tasmania who had been one of the party I have spoken of. I was anxious to know if he remembered their first Sunday in New Zealand and his taking us little children (I was nearly nine years old) to see the bees from England. He replied that he distinctly remembered bees having come in their ship, but what became of them he could not tell, as he removed from that station to another field of labour, and the same thing having happened to our parents, we lost sight of our little new friends, not, however, before we tasted for the first time in our lives real honey in the comb, which Miss Bumby kindly sent to us, knowing our interest in her bees.

"What became of those bees is a question I cannot answer. My own ideas are as follows:—I distinctly remember seeing them working on the clover in our orchard, and in the following spring I used to watch them busy on the peach blossoms, proving they had survived the first winter. They either swarmed away into the forest behind the station, or, what I think more likely, they succumbed to the ravages of the black beetle—the bees' greatest enemy in this country. I think if they had lived they would certainly have increased, and we should have found them in the bush. I was speaking to a lady a few days since who was the daughter of a missionary, and who came from England as far as Tasmania in the ship *James*, and she instantly said, 'Oh, yes, there were certainly bees on board, and they were taken on to New Zealand.' The Rev. Ironside, of Hobart, and Mrs. Padman, of Adelaide, are the gentleman and lady whom I have quoted, and they are, I believe, the only two survivors of that party. I heard of a Mrs. Allom who came to New Zealand with Governor Hobson's retinue, and who brought bees to the Bay of Islands, but I never heard anything more about them, and I think we should if any honey had been produced: and though I am familiar with that locality, I never heard of bees until the arrival of the Rev. Mr. Cotton, who came in 1842 with Bishop Selwyn, and who brought some bees to the Bay of Islands, and liberated them in the garden of Mrs (Archdeacon) Williams at the Mission Station at Pahiia. They were in small wooden hives, with a small window at back and sides, and bars in the roof, to which the bees fastened the combs. Among other wonderful things Mr. Cotton had an observatory hive. It had but one comb, and glass on back and front. This was to observe the habits of the queen, and very closely she was watched by many eager little eyes. There were also bell-glasses in which the bees worked, to our great delight. They increased marvellously, the plan then

being to increase the number of colonies. A small box would throw a swarm in a very short time, and this again would swarm, and so they increased and multiplied greatly.

"Our joy was very great when our father brought home a hive, the generous donor being Mrs. Williams, of the Bay of Islands. Mr. Cotton added the gift of a bell-glass. Then Mr. Cotton came to see how the bees had been fixed up. It required much care to carry the box more than forty miles over rough forest ground, but my father carried them himself, slung by a cord so as not to jolt them, and Mr. Cotton expressed his pleasure at finding them in good order and condition. We seldom lost a swarm, for we watched them narrowly, and soon knew how to find the queen and so secure the swarm. In a year or two we had quite a large apiary, and were able also to supply our friends with stocks to begin with. Soon honey was very plentiful; it varied according to the district in which it was produced. The Bay of Islands honey was, I think, of the first grade, mostly Pohutukawa and Rata. Ours on the West Coast was more mixed in quality. Some crystallised in the cells, and could be picked out like confectionery in little hexagons. This we thought was gathered from the Koromiko, as that shrub abounded in places where we obtained this sort of honey.

"Maoris took kindly to their new friends, and, strange to say, they showed no fear of stings, their skins, perhaps, being thicker than white people. Maori like, they ate honey to excess, and in a short time Dr. Day was called on to perform the part of dentist, such a thing as toothache having been rarely known among Maoris till now. When we left the mission station and moved to Auckland we left, I should say, some fifty boxes of bees, and frequently had taken 200 or more pounds of honey at one time, using it in various ways—vinegar mead and preserves."

(Conclusion next week.)

HOMES OF THE HONEY BEE.

THE APIARIES OF OUR READERS.

Our illustration this week shows the apiary of a veteran bee-keeper, Mr. Wm. Lister, of Morton, Gainsborough. This gentleman, though unknown to most of our readers, may serve as an example to many of our younger bee-keepers, as well as to those who declare they are "too old" to take up bee-keeping. Always used to an active and busy life, an architect and surveyor by profession—though now for some time retired from business—he first began to take an interest in bee-keeping in 1888, when a friend lent him "Cheshire's Practical Bee-keeping." At this time, too, his next-door neighbour, the curate of the parish, commenced to keep bees. This latter, however, although fond of bees, was no adept at any carpentry work, and in consequence used to seek assis-

tance occasionally from our friend, who is an expert in this class of handicraft. At this time, too, be it remembered, Mr. Lister was eighty years of age, and in 1890, nothing daunted by his four score and two years, determined to take up bee-keeping himself. He set to work and built himself a hive which was kept in the window of his workshop with an entrance through the sash for the bees to fly from, and an alighting board and porch outside. This modest beginning did not long satisfy his aspirations, and after building a hive or two he determined to erect a bee-house, and, with the exception of the asphalted floor, he actually made and erected the capital

in stock is kept here. This will doubtless account for the entire absence of spiders, moths, &c., usually too plentiful in this class of house. Outside of the house the porches are painted various colours, and along one side runners are fixed which carry nucleus hives, so that they may be moved either towards the hive from which they were taken to strengthen them or towards the hive to which it is intended to introduce the new queen. The roof on this side projects 18 in., and so protects these from heavy rains. This bee-house cost in material £10, and since it was erected all additions by way of outside hives have been discontinued. Every appliance connected

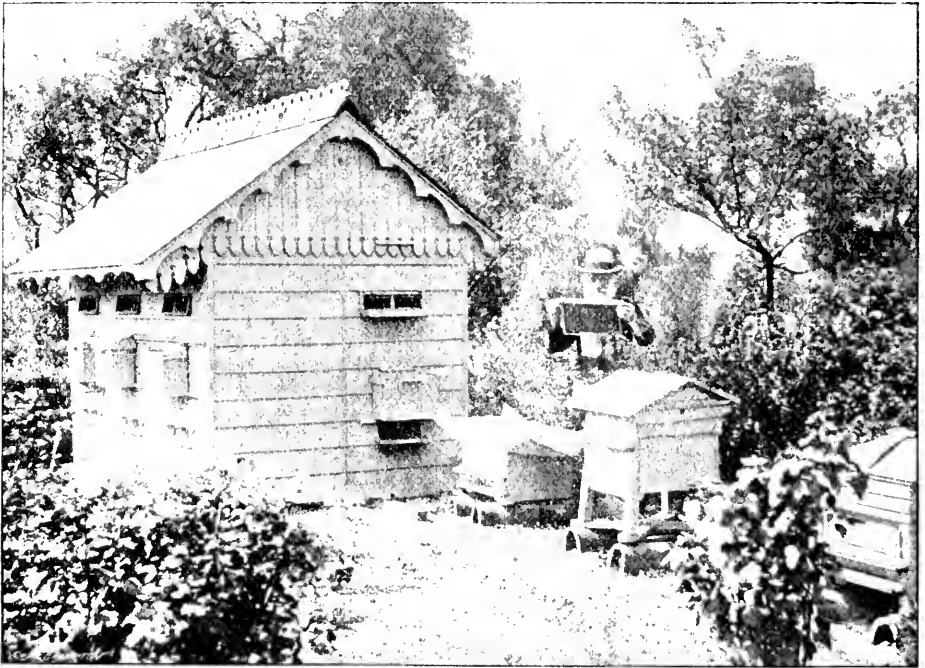

THE APIARY OF MR. WM. LISTER, MORTON, GAINSBOROUGH.

bee-house shown in our illustration. It measures 10 ft. by 6 ft., and is 6 ft. high to the eaves. The walls are double, with an air-space between, and the roof is matchboarded and felted as well as slated. Two sky-lights are fitted which open outwards to allow bees to escape, and shutters are also affixed to darken the interior. Runners to carry single-walled body-boxes are fitted round one side and the end farthest from the door, and sixteen stocks can be thus accommodated in two tiers. On the opposite side of the house is a hinged table for manipulations, and the corner behind the door is fitted as a comb store for 100 frames. A shelf or so accommodates sundry apparatus, and all carbolic acid and naphthaline

with the craft used in the apiary, except smoker and quilts, has been made by our venerable friend himself, even down to the metal-ends and frames. The hives proper are constructed entirely upon a novel design of his own. They have the entrances at the top, with a passage-way along the front of all the frames. Floor-boards are all loose with wedges under, and can be drawn out in an instant: and a ventilating hole is bored at the back of the body-box towards the bottom, through which naphthaline is introduced by sliding the perforated zinc on one side. No impervious quilts are used, yet floor-boards are always dry. The bees work well in the hives and winter well; and the interest and occupation afforded

in looking after his bees and ministering to their wants have brightened the eventide of his life and added to its enjoyments in no small degree, besides giving a zest for outdoor occupations marvellous in one who has already entered upon his eighty-eighth year. Mr. Lister has now for some years been a member both of the British Bee-keepers' Association and the Lincs. B.K.A., and, notwithstanding his age, is still hale and hearty, and looking forward to having some good swarms this season to increase his stocks. Let us all hope he may see his desires fulfilled, and long enjoy his hobby—"the Bees."

Correspondence.

The Editors do not hold themselves responsible for the opinions expressed by correspondents. No notice will be taken of anonymous communications, and correspondents are requested to write on one side of the paper only and give their real names and addresses, not necessarily for publication, but as a guarantee of good faith. Illustrations should be drawn on separate pieces of paper. We do not undertake to return rejected communications.

Communications relating to the literary department, reports of Associations, Shows, Meetings, Echoes, Queries, Books for Review, &c., must be addressed only to "THE EDITORS of the 'British Bee Journal,' 17, King William-street, Strand, London, W.C." All business communications relating to Advertisements, &c., must be addressed to "THE MANAGER, 'British Bee Journal' Office, 17, King William-street, Strand, London, W.C."

In order to facilitate reference, Correspondents when speaking of any letter or query previously inserted will oblige by mentioning the number of the letter, as well as the page on which it appears.

NOTES BY THE WAY.

[2771.] After a fortnight of wintry weather, and the consequent confinement of our bees during that time, the present prospect of a change will be acceptable to both bees and bee-keepers. There has already been an occasional short flight of a few bees where the sun shone directly on the entrances of hives sheltered by trees or buildings.

I paid a visit to my out apiary to see how matters stood there, and found but few signs left of snow drifts. There was, however, strong evidence of the destructiveness of the Tit family scattered on the snow under every tree in the apiary, numberless anatomical fragments of bees lying around. These pests of the apiary are not satisfied with picking up bees that have ventured out for a flight, and after alighting on the snow have perished from chill, but with persistent fluttering and tapping at entrances they tempt the bees to come to the entrance, only to meet with certain death the instant they get within reach of the beak of the destroyer.

When the weather is severe the tits come in numbers from the woods and cause a considerable loss of bee life. I find a small spring trap baited with a piece of suet the best tit eradicator, though one feels some qualms of conscience when taking one of the pretty little creatures out of the trap, dead. How is it

we do not feel the same emotion if the victim happens to be a house sparrow? Is it the homely plumage of the latter?

Sales of Honey.—The market for honey is just now "slow," no demand, no inquiry. Can any one account for such a state of things? Have our bee brethren abroad stolen a march on us and flooded the market? or how are we to account for the present depression? I trust prices will not be brought lower than at present, but a large firm, who in other years have paid 9s. per doz. for sections glazed, and delivered, now offer 7s. 6d., declaring they "cannot give more as the 'stores' are selling very cheap." I ask how can the "stores" sell very cheap unless they buy cheap? and in the latter case where do they get their supply? It is easy to understand where they get cheap extracted honey, but do the "stores" get their supply of comb honey from the Pacific coast? It makes one wonder what the prices will be ten years hence if production increases as rapidly as during the past few years, and the new electrically propelled ships bring us within three days' flight of America! It would be interesting reading if our hive manufacturers would combine to furnish statistics letting us know through these pages the number of hives sent out by each maker, say, during the past decade—we may charitably suppose that even a 10s. 6d. hive sold ten years ago is still in use at the present time—the aggregate number only required, and, of course, strict secrecy kept as to names of those who furnish information.

I am much surprised at the tone of Mr. Brice's remarks in his communication of last week (2764, p. 32) regarding Caucasian bees. I have no wish to do anything tending to make the columns of the B.J. like the doings of a bear-garden, but surely any of your correspondents have a perfect right to safeguard the interest of the industry in which all of us are interested? If, therefore, I notice an item of news in any foreign paper that I think possesses interest or that will be of service to readers of the B.B.J., I feel justified in mentioning the same in my "Notes by the Way." These always appear in the particular column for the opinions expressed in which "the Editors do not hold themselves responsible" (according to the printed notice). My remarks are thus open to correction or contradiction, if false. After reading certain things about Caucasian bees, I embodied what I had gathered in my "Notes" a fortnight ago, and I fail to see any "inferential attack" on any one. Mr. Brice very kindly offered to present me with one of his queens (not Caucasian, of course) a year or two back. I declined to accept it because of his having "foreign blood" in his apiary, and the fact that my queens are always represented by me as "English," and are sold as such. I am therefore not likely to compete with my friend in either foreign or hybrid queens.—W. WOODLEY, *Beeton, Newbury.*

[Referring to the concluding portion of our

correspondent's "Notes" above, we here interpose a word to say how much we regretted Mr. Woodley's allusion on page 27 to what we felt sure was sufficiently personal to call forth a rejoinder or reply. Nor were we wrong. Our regret is now increased that Mr. W. should have felt it incumbent on him to again refer to what cannot be other than sharply contentious matter, bearing in mind how impossible it is, at times, to make two persons "see with the same eye."

Having said this much, we trust the matter will now be allowed to drop. Mr. W. will, no doubt, do so, having had his "say" in the first instance, and a second word on the reply given on page 32. We hope Mr. Brice will—without Editorial interference—also forego any further word he may wish to add. As for our readers, those who are interested can form their own conclusion from what has appeared in our pages. We are most reluctant to use the "blue pencil" on copy kindly sent us by such earnest workers in the craft as "W. W." and "H. W. B.," but we will not allow even *them* to quarrel in print (they are the best of friends in private) if we can help it.—EDS.]

APICULTURAL NOTES.

SHALL WE PRODUCE 2-LB. SECTIONS?

[2772.] The heavy rains which lasted about four months have ceased, and we have now had a fortnight of real winter weather—heavy snowstorms and sharp frosts. The ground here is covered with snow several inches deep, and it is still freezing, with but slight signs of a change.

Bees, so far, are all right; most of my hive entrances are wide open, some of them the full width of the hive. The bees are now clustered in close quarters, from which they will not move so long as this severe weather continues. All stocks are therefore supplied with soft candy, made of best loaf-sugar and honey, which they are taking freely. I used to give a large lump of candy, enough to last several weeks; but I now, especially at this time of year, go on the "little and often" principle. The candy is placed right over the cluster, and a slight examination—sufficient to enable me to ascertain all I want to know—is made of all stocks in my home apiaries once a week, care being taken not to disturb the bees unnecessarily. A thick layer of meadow hay is placed on top of quilts, firmly pressed down, all being kept dry with waterproof roof. In fact, nothing has been left undone that might be conducive to the well-being of the bees. Nevertheless, I am getting just a little anxious about them. It is many weeks since they had a thorough cleansing flight, and if their confinement lasts much longer I fear that dysentery will put in an unwelcome appearance. If the snow would now go and be followed with just one bright day, warm enough to rouse the whole bee-community, it

would indeed be a godsend. After the much-needed cleansing flight, entrances will be narrowed.

At the conversazione at Jermyn-street in October last, a discussion took place on the advisability, or otherwise, of working for 2-lb. sections of honey. No doubt it will be remembered by some who were present that I stated my opinion that if we produce 2-lb. sections the public will soon want them at the price they are now paying for a 1-lb. one. But perhaps I ought to have said: If we produce 2-lb sections, some one will soon be offering them at the price we are now getting for the smaller or 1-lb. one. Well, your correspondent "Jerseyite" (query 1641, p. 293) wants to know if it will pay to produce 2-lb. sections at 1s. each? It might do, but not while extracted honey can be sold wholesale at 6d. per lb. It will also be remembered that at the above-named conversazione a gentleman present offered, yea, almost pledged himself, to take all the 2-lb. sections that I could produce next season at *double* the price of 1-lb. sections, whatever that price might be. Well, I really thought seriously of producing a few hundred just by way of experiment. But since reading query referred to I have come to the conclusion that it will be wise to think twice before I act *once* in the matter. If I or any other large honey producer were to produce 2 lb. sections, and it became known that sales of same had been effected at remunerative prices, scores of others would, no doubt, at once follow suit, and I predict that, such being the case, we should, in less than three years, find the price of 2 lb. sections very little, if anything, above the present price of a 1 lb. one, and that the present price of the latter would consequently still further decline. Now, I think it will be agreed on all hands that the wholesale price of the 1 lb. section is in all conscience low enough already if we are to have a fair return for our labour. My advice, therefore, to all who are about to produce 2 lb. sections is, "*Don't!*"—A. SHARP, *The Apiary, Brampton, Hants.*

CANDY MAKING.

HOW TO MAKE SOFT CANDY.

[2773.] In response to the request of your correspondent, "A. Dummy" (2761, p. 26), I beg to give my method of candy making as follows:—To 10 lb. of pure cane sugar add $1\frac{1}{2}$ pint of clear soft water (not hard water), $\frac{1}{4}$ oz. of salt, and half a teaspoonful of cream of tartar. Put the whole into a copper or brass stew-pan, set it on a brisk fire, and keep continually stirring until the sugar has quite dissolved. When it comes to the boil draw the pan back so that it simmers gently for ten minutes, and as the scum rises to the surface skim it off. If medicated with naphthol beta add the solution about two or three minutes before finally removing the pan from the fire,

stirring in the proper quantity of the solution to medicate 10 lb. of sugar, viz., one table-spoonful, or $\frac{1}{2}$ a liquid oz. Why I have mentioned this is that the methylated spirit used for dissolving the crystals is partly evaporated and there is not the slightest taste of it left in the candy, consequently the bees will take it as freely as if unmedicated. This hint may be useful to our friend, A. Sharp, who on page 16 mentions some trouble in this line. After the syrup has boiled for ten minutes altogether, place the stew-pan in a larger vessel containing cold water, and keep stirring the mixture until it begins to granulate. This continual stirring I find breaks up the granules of the sugar very fine. As it cools to the consistency of thick cream pour it out in moulds on *glazed* (not ordinary) paper. I find ordinary paper is a great absorbent of the moisture of the candy. This—according to my experience—is the cause of a great deal of candy becoming hard after being placed upon the hive. Instead of paper moulds I often use glass-topped boxes (size 8 in. by 4 in. and 2 in. deep). This gave me the cue of retaining the moisture of the candy.

Those who go in for the "Wells System" may by tacking on a piece of Queen excluder feed the two stocks at the same time. That is why I called this form of candy box an "equilizer," or indicating feeder. If you require any more information I shall be glad to answer any further questions.—R. BROWN, *Somersham, Hunts, January 22.*

A WEATHER AFTERCAST.

[2774.] Oh, what a gloomy day! The grey clouds sweep over with a steady persistency which leads one to believe that the tail end of them must still be in Ireland, and they are going westward, *via* America and China, so it will be a fortnight before we may expect to see a rift of blue! The icy north wind which has been blowing "great guns," and from that to penny pistols, for many days, has subsided. The branches of the weeping birch still weep, but their hair is not dishevelled, nor do they wring their hands and waver their arms. The beeches stand dark and silent, grim ghosts of their summer selves; rooks stand disconsolate in their tops, forced to say, as the grey clouds spit sleet down their backs, "Caw-aw, aw-aw!"

It does not thaw. It does not freeze. The sleet stays where it falls; the lover sees his sweetheart's boots imprinted in it, and a coolness springs up between them where all before was love.

Two fields away the landscape is hidden completely, a wet sheet of mist is drawn across, hiding the white hills and lonely vales that lie between them. Hills and vales that are strangely silent, for the wheat-ears have gone south, and no bee—British or musical Italian—was ever found willing to carry his harp there in the bitter winter weather.

In the city the streets are the same as if they had been ploughed. Cabmen and drivers of all sorts mend their whips and look up their vocabulary of swear-words. The human freight, the coal, the sacks of wheat and maize, the bales of merchandise, are just as heavy, or even heavier, as if it were frosty, or dust dry as in summer. They *are* heavier, for trade is brisk; people are hungrier, and, as it seems to me, more thirsty for alcohol. They must have coal, and every one is anxious to get a seat on the omnibus. Thus overloaded, and the wheels sinking in over the tyres, who can be surprised at the volume of steam that rises from the backs of the horses? It is but natural that some of the poor beasts fall down dead, many are "broken-winded," and many a thousand sent to the "block" when winter is over, to be sold for what they will fetch.

Still, they are but horses! And the way man compels them to work is a mere nothing compared to the way he will work himself, involuntarily. (Some, not all) Not all! I myself know a hundred things that want the doing! Gravel wants turning, trees want pruning, manure wants wheeling, leaves (new as well as old!) want turning, hives want making, and yet I look out of the window and see the white spots of water drop, drop, drop from the roofs of the hives—hives that are as silent as the dead! I see the grey sky spitting bits of snow, and mechanically I let down the blind, light the lamps, and touch up the fire.—LORDSWOOD.

NON-SWARMING CHAMBERS.

[2775.] I cannot quite understand how your correspondent "W. R. N." (2767, p. 34) should have had brood raised in what he calls the "anti-swarmer chamber" below the brood nest. If the wooden dummies are properly made and hung in the lower or non-swarmer chamber as first described by me in B. J. for January 23 last year (page 36) there should not be room for raising either diminutive or normal-sized brood. At all events, after my oft-repeated trials of this plan of preventing swarming it has never failed yet. Nor do I think there is any other method which can compare with it for fulfilling the purpose. "W. R. N.," in referring to the excellent harvest obtained from his hive made on this plan, also confirms my own experience of it as a honey-producing hive, for it also beats all others I have tried in this latter respect. My lower, or non-swarmer chamber is in the form of a sliding drawer holding the ten wooden dummies, and it slides in below the brood-chamber from the rear. There is an aperture at back, covered on the inside with fine-hole perforated zinc, and on the outside with a wooden shutter.

In the warm weather of summer the shutter is removed, and a free current of air passes through the dummy-filled chamber, and thus keeps the hive cool and well ventilated.

If, as advised by some, shallow frames of comb are fixed below the brood frames in body box, the bees will continue their brood-nest down into these lower shallow combs, and begin storing honey in the upper frames as the combs become free from brood. With my wooden dummies they cannot do this, and this is why they answer the purpose so much better, besides yielding so great an increase of honey over hives fitted in the ordinary way as my own does.

If, as I hope to do, I send a photo of my apiary, your readers will be able to see hives with the non-swarmling arrangement, and also with my swarm-catchers in use—H. SEAMARK, *Willingham, January 28.*

A JANUARY DAY.

[2776.] A January afternoon, almost a blizzard outside, with fine driving snow. School is over at five o'clock, but several of the scholars who have to tramp home long distances—four and five miles—are allowed to go at four. The master looks at the clock; it is a quarter to four. He says: "Nicholls senior and junior, Gardiner senior and junior, as it is a rough afternoon you may go at once."

The boys fill their satchels with books and are soon fighting with the north wind and stinging snow. Tom and Dick Nicholls proceed through the main street of the country town. The snow is already six inches deep, and many feet where it has drifted. Oh! it is a wild afternoon! Bad for grown-up men; how much worse for tender, childish faces, and slender limbs protected only by stockings!

The cold was intense; the dry snow squeaked under the boys' feet and beat upon their faces till they were almost blinded. They could scarcely speak, so furious was the storm, and it was half-past four and daylight waning before they reached the stile which led across the fields—more than half an hour it had taken to walk a mile.

"Shall we go across the fields to-night, Tom," said Dick. "It will save half a mile."

"No, we had better keep to the road," answered Tom.

And so they trudged manfully on, two small white figures amongst the wind and whirling snow-flakes and deep drifts that were being quickly formed by the roadside.

"We can steer clear of the drifts along the main road," said Tom, "but when we get into Cooper's-lane and up by the Fox Woods we shall have to go through them. I wish we were home."

"So do I," said Dick, who deep down in his heart wished Tom would offer to take his hand—a thing he would have scorned to do any other day.

At last they came to Cooper's-lane, where the drifts were already up to their waists, so that Tom did indeed have to take Dick's hand

to haul him through them. Then through the gloom there appeared a cottage with a light shining in the window. "I vote we go in and get Mrs. Heath to let us have a warm," said Tom. So Tom knocked loudly at the door, and when Mrs. Heath opened it, up went her arms as she ejaculated, "Lawk-a-mussy, did ye ever! Come in by the fire, Master Tom and Dick; never mind makin' a bit of a mess, it's on'y pure snow, an' I can soon clear it oop. Sit ye doon by the fire and I'll get ye some hot elderberry wine. Ye munna stay many meenits or else ye'll nevir get whome this night. Hallo! Master Dick, bin yer cryin'? Come, that wunner do; ye mun be brave! My man's gone round th' sheep, or else he would ha' come wi' yer."

Then the two lads set out again, and they cannot now distinctly remember how they managed to negotiate the last two miles. The snow was so blinding, the wind wrestled with them so strongly, the elderberry wine was strong and they were not used to it. They remember plunging through drifts that took them up to their shoulders; they also remember that the road, which lies high by the Fox Woods, was filled level over with snow, a matter of twelve feet deep, and that they went back some little way trying to find a gap in the hedge to get over into the field, but could not, so there was no other way except to creep through a hole in the hedge.

They remember knocking feebly at the door and seeing the tremendous contrast between the interior of the bright warm kitchen and the world outside. They remember the ice melting off their faces, and their own and mother's tears, and that they could not speak for hours after. They remember that on the morrow the snow was level with the tops of the hedges and they could not get to school for ten days, and one of them is sure that if it had not been for a little elderberry wine there would now have been no Dick, who is—LORDSWOOD.

WEATHER REPORT.

WESTBOURNE, SUSSEX, JANUARY, 1897.

Rainfall, 2.69 in.	Sunless Days, 13.
Heaviest fall, .55 on 8th.	Below Average, 25.8 hours.
Rain fell on 18 days.	Mean Maximum,
Above average, .26 in.	37.4°.
Maximum Temperature, 46° on 3rd.	Mean Minimum,
Minimum Temperature, 20° on 18th.	31.7°.
Minimum on Grass, 15° on 18th.	Mean Temperature,
Frosty Nights, 20.	34.5°.
Sunshine, 50.7 hours.	Below average, 0.1°.
Brightest Day, 26th, 7.1 hours.	Maximum Barometer,
	30.53° on 2nd.
	Minimum Barometer,
	29.08° on 30th.

L. B. BIRKETT.

Queries and Replies.

[1651.] *Transferring to New Hives—Using Old Gift Hives for Swarms.*—1. I have a stock of bees in an old hive, the wood of which is now nearly rotten, and which may tumble to pieces any time. I therefore ask, can I lift the combs and bees bodily into a new frame-hive (placed close beside the old one), and do this safely, without adversely affecting the work of the hive? If safe and practical, I would like to do the transferring as soon as possible. 2. A friend invited me into his garden yesterday to look at his bees, which were being enticed out by the bright sunshine, though the snow lay thickly on the ground. I saw several of the bees alight on the snow and unable to rise; there were also on the flight board, and on the snow around, several rust-coloured spots; does this indicate dysentery? I have never seen the same thing before. If it is as I suspect, what is the remedy? The bees seem a strong stock, and had soft candy given to them early in January. 3. I had some old hives given me this winter. They have not had bees in them for two years. Will it be safe to use them for swarms, or is there risk of foul brood in doing so?—*J. F. G., Stevenage, Herts.*

REPLY.—1. If the frames are sound, and combs in fairly good condition, the transferring will be quite safe if done quickly, and on a fine sunny day. Set the new hive on the old stand, with combs in the same position as before, cover down warmly, and no harm will follow. 2. See reply to H. Crowther regarding dysentery. 3. The hives should on no account be used without being first thoroughly disinfected.

[1652.] *Suspected Dysentery.*—During this last week I have noticed signs on the alighting board, and on the snow around one of my four hives, that make me fear the bees are afflicted with dysentery. Is this not rather strange, as I have not fed them at all? After removal of surplus I left them on seven frames of natural food, and the bees have been very lively, and seem so now—not “slow and weak,” as the “Guide Book” states. I have not opened the hive, but gather my impression from what I have seen at the entrance, as stated above. I should be greatly obliged if you will advise me in this matter. I have no spare combs on hand, and how must I manage about opening the hive this cold weather?—*H. CROWTHER, Pembury, January 30.*

REPLY.—We rather think it is a case of false alarm, and should take no steps in the way of remedies till an opportunity occurs of opening the hive on a fine day, when bees are flying freely. If an examination shows the combs to be spotted as the alighting board is, the remedial measures recommended in “Guide Book” may be adopted; but if combs are all

right, the bees will be all right too, and the marks noticed only a result of long confinement.

THE VALUE OF STRONG COLONIES.

In order to secure section honey we must have plenty of bees in our hives when the honey season arrives, or a failure is almost certain, as those reared as the season draws to a close will be consumers instead of producers. But how shall we secure the bees? is a question frequently asked. I will tell you the best way I know of to secure them. As soon as they are out of winter quarters, see that each colony has plenty of stores to last until pollen becomes plenty, also a queen. The latter is told by the brood they may have and the former by the amount of sealed honey they have. If they do not have honey enough, feed them in some way, frames of sealed honey being preferable at this time. When pollen becomes plenty, reverse the brood nest; that is, put the centre frames of brood on the outside, and the outer ones, or those having the least brood, in the centre. In this way the queen will soon fill the frame having little brood more fully than were the others, thus giving a great gain in brood. In from ten days to two weeks go to the hive again and take an outside frame having as much sealed honey in it as possible, and break the sealing to the cells by passing a knife flatwise over it and place it in the centre of the brood nest. The removal of this honey will stimulate the bees to great activity, cause them to feed the queen, when she in turn will lay many more eggs than otherwise, thus increasing the number of bees which will hatch twenty-one days later. In ten days more reverse the brood nest again and you will find that the bees will soon have every available cell filled with brood, and that from two to three weeks sooner than she would have done had the colony been left to themselves. By June 20 every available cell should be filled with brood and the hive full of bees. By this time white clover is nearly in full bloom and all the sections should be put on, if not already on. I like to put on sections when the hive is so full of brood and the bees so anxious for some place to put honey that they will commence work in the sections at once.

Mr. E. Gallup, who stood first among the bee-keepers of twenty-five years ago, gave us the secret when he said: “Get the bees and they will secure the honey, if there is any to be had.” Keep an eye to business and do things at the right time if you wish success. If we wait about putting on the sections, when our bees have arrived at the condition I have supposed them to be on June 20, and we should have but few days’ honey yield, we should get nothing. It is no unusual thing to secure from eight to twelve pounds of section honey from a colony per day if we have the hive full

of brood and bees, and honey is plenty in the flowers.

Now I will suppose that, instead of managing as given above, we let our bees take care of themselves, leaving weak colonies unprotected, and if any bees have died during the winter, we leave their stores for the bees to carry away. After carrying off this they will be apt to rob our weak colonies, and thus their combs will be filled with honey instead of brood. Soon the willows blossom, then the apple-trees, and thus the hives are kept full of honey. Too much stores in May and June gives about the same assurance of section honey as would be given in letting the colony starve. There is no such thing as having the combs full of honey during the fore part of the season, and then securing lots of sections full of clover honey, for where would the bees come from to gather said honey?

Mr. Gallup said again:—"We must never allow the bees to get in advance of the queen, for if we do the prosperity of the colony is checked at once—that is, if the bees are allowed to fill the combs with honey in the spring, before the queen has filled them with brood, the colony will be an unprofitable one." Honey cannot be obtained without bees. The nine Gallup frames which I use in a hive give about 45,000 worker bees every twenty-five days, and a queen that is worth keeping, worked on the plan given in this article, will keep the frames full of brood after they are once full, till the honey season draws to a close, providing the sections are put on at the proper time; but give the same queen only 5,000 bees, and those old ones, or field workers, and they will keep the combs so filled with honey that no surplus will be obtained. If our hives contained 5,000 bees on May 1, with 10 lb. of honey, they are what would be called extra good colonies. Now if we should give them what honey or syrup they could carry during the month of May instead of using up the 10 lb. in rearing brood, they would store the honey in the brood-cells in addition to the 10 lb. already there, so we would have about 5,000 bees in our hives all the summer. Thus, it will be seen, it is the bees and brood we want in our hives the fore part of the season instead of honey. If by the process given our bees run short of stores, of course we must feed them, and money thus spent in feeding will return a large interest if the season is anything like favourable. There is no time in the whole year that it pays as well to put a little money in feed for the bees, where they need it, as it does at this time, yet how few seem to realise it. I often hear it said if the bees cannot get a living now—during the first half of June—let them die. No greater mistake could possibly exist. When any of the sections are filled, take them off before soiled, and put empty ones having a starter of nice white comb or thin comb foundation, in their places, and thus you will avoid the difficulty, so often experienced, of

getting the bees to work in a second set of sections after a full set has been taken off.

As the season draws to a close, place the unfinished sections together, and as near the brood as possible, contracting the amount of section room to suit the number of bees, and thus you will secure the most of your honey in a saleable form.—G. M. DOOLITTLE, in *American Bee-keeper*.

Notices to Correspondents & Inquirers.

All queries forwarded will be attended to, and those only of personal interest will be answered in this column.

S. CLOUGH (Northwich).—Much obliged for your lines on "My Bees." We shall have pleasure in printing them next week.

FIREMAN (Dundee).—The "*Langstroth*" Hive.—We have never heard of a "*Langstroth*" hive "*Woodbury* size" (printed "*Woodbury*" in list sent), nor do we advise the adoption in this country of any frame other than the British "*Standard*." In B.J. of October 31, 1895, appears an article on the Rev. L. L. Langstroth, with an illustration of the "*Langstroth*" Hive.

F. B. W. (Bath).—*Suspected Foul Brood*.—Comb sent contains chilled brood only, and from the dead bees in cells we gather that scarcity of food in the vicinity of the cluster has caused starvation of the bees and desertion of the brood, resulting in death to the latter.

F. COREY, Jun. (Raholp).—*Average Returns*.—*Swarm-catchers*.—Forty pounds per hive is a fair average in such a moderate season as that of 1896. We would rather advise the use of a queen trap in your case than a self-hiver. The latter needs attention at times or matters often go wrong; but with a queen trap swarms will never be lost, no matter what becomes of the queen.

W. FORD (Wolverhampton).—*Bound Volumes and Illustrations*.—The fault you complain of must lie at the door of your "*binder*." Among all our stock of bound volumes we do not find a single one wherein the illustrations are set-off, or "*transferred to the opposite page*," as yours is said to be. Our correspondent also writes:—"I wish to correct an error on page 452 of volume for 1896. Two paragraphs, headed respectively '*Mr. W. J. Moore*' and '*Another Gentleman*,' contain the remarks made by myself at the conversazione of the B.B.K.A." In a crowded meeting, like the one referred to, where so great a portion of the report comprises colloquial matter, it is not easy for a shorthand writer to secure names of speakers who are strangers. This is how the "*slip*" occurred, no doubt.

Letters on "Candy-making" and "Warmth," together with some queries, will be dealt with in our next.

Editorial, Notices, &c.

POINTS REQUIRING ATTENTION.

At a season when the general interest in all that pertains to bee-keeping—even on the part of known votaries of the craft—is, from the very nature of the surroundings, apt to flag somewhat, it may be well to remind our readers of one or two points that should be kept steadily in view. We say this, feeling convinced that it is most important not to lose sight of them, even for a time, or allow their value to be lessened in the slightest degree if success is to be ensured.

Foremost among the points we have in mind may be named the pressing need of legislation for obtaining compulsory powers for dealing with foul brood. We give this subject the premier place because it is just possible that some good friends and well-wishers to the pursuit of bee-keeping may have begun to imagine that the zeal of those who, some few months ago, were busy with the project referred to are losing heart in the business; that the work already done is intended to go for naught, and that the year 1897 finds us no further forward than we were a couple of years ago. No greater mistake could be made than to suppose that such is the case. But (and there *is* a “but”) it becomes only too apparent that in the present year of grace—when Government is beset on all sides with questions of the gravest import to the world at large—the difficulties of making progress with an Act of Parliament—even of such small proportions as the modest Bill proposed in the interest of bee-keeping—becomes very perceptibly increased. Moreover, it is more than ever necessary that the Bill—if it is to receive favourable consideration—must, on its introduction, be supported by statistics such as will plainly prove that there is a real need for it at all.

It was just this need which impelled us, on page 31 of our issue for January 21, to allude to the fact that County Associations could strengthen the hands of those who have the matter in hand by passing a resolution at their annual meetings approving of the draft Bill prepared for introduction into the House

of Lords at an early date. Reference to the reports in our pages of the meetings of several Bee Associations show that our suggestion was adopted, and we trust it will not be lost sight of at meetings still to be held. The Duke of Devonshire has been successfully approached with reference to the subject, and has promised to do all he can in supporting a non-contentious measure on its introduction to the Upper House. Lord Thring, too, has in the kindest way given a conditional promise to introduce the Bill in the House of Lords, but he insists on being supplied with sufficiently substantial facts, in the form of statistics, showing the extent to which the disease prevails in the various counties, to warrant him in taking charge of the “Bill for Dealing with Bee-Pest or Foul Brood.”

So far as the Joint-Committee of the British Bee-keepers' Association and representatives of County Councils appointed in December, 1895, they have obtained, at considerable expense, such statistics as were available, all of which have been embodied in printed documents for use when needed. It now remains for our County Bee-keepers' Associations to do their part in furthering the object in view. This means supplying properly prepared forms—stating the number of hives inspected and their condition when examined—to all experts who visit members. These forms to be filled up and returned to the secretary of the respective Associations, and by him forwarded to the Secretary of the B.B.K.A., 12, Hanover-square, London. Reliable information from private individuals will of course, be also acceptable. The particulars thus supplied will not be published broadcast; in fact, it need not be published at all, so there should be no personal hesitation in furnishing information on the part of those who, for divers reasons, do not wish it known by every one that their bees are affected. What we desire to impress upon all who have the good of the pursuit at heart is, that such statistics as have been mentioned form the pressing need of the hour, and we trust they will not be asked for in vain.

The second point for consideration at coming Annual Meetings is the County Competition at the forthcoming “Royal”

show in June next. Everything tends to the belief that the "Special County Honey-Trophy Competition" at Manchester will be a memorable event in the history of our County Associations. Nor must we overlook the important influence it will doubtless have upon the future interest of the pursuit. The home honey trade is now in such a position by reason

ing how important are the advantages obtainable from our staging the finest display of county exhibits we possibly can "put up" in June next. It is very pleasing to hear, as we do, of the hearty manner in which the Trophy Class is being entered into by several counties, to whom we say "may the best win." Meantime the note of preparation for the

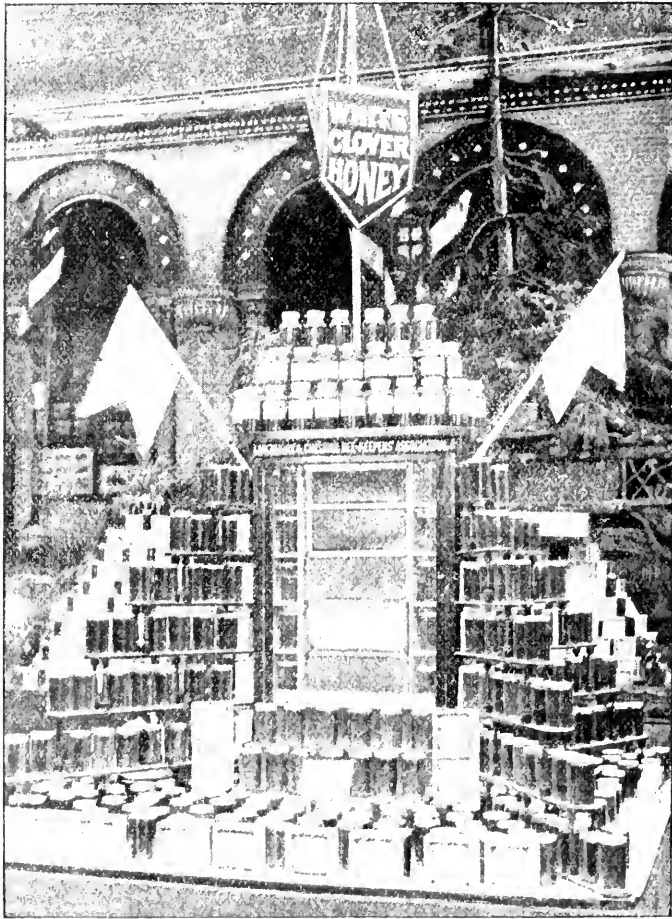

PRIZE COUNTY TROPHY AT SOUTH KENSINGTON.

of foreign competition, that it would be the veriest folly for those who are interested in the sale of British honey to overlook so splendid an opportunity as the occasion affords for displaying to the world what the native product really is. Bearing in mind, too, the scores—we might say hundreds—of thousands who will visit the show, it goes without say-

ing how important are the advantages obtainable from our staging the finest display of county exhibits we possibly can "put up" in June next. It is very pleasing to hear, as we do, of the hearty manner in which the Trophy Class is being entered into by several counties, to whom we say "may the best win." Meantime the note of preparation for the

fray has already been sounded, and as the important matter of "What is to be the shape of our 'Trophy'" is a question of much moment to the active spirits in the movement, we venture to give an illustration of the First-prize Trophy—from a photo taken at the time—at the first and only County Competition hitherto held in this country, viz.

that in the large conservatory of the Royal Horticultural Society, in the grounds of the Colonial Exhibition, South Kensington, in 1886. Unfortunately the handsome surroundings of the building in which the Show was then held, as seen in the picture, will be absent at Manchester, but that will not interfere with the design of the Trophies themselves. What we wish is to show the sort of thing then staged, not by any means as a model—the conditions being entirely different—but as suggesting how an educational aspect may be given to the arrangement of a honey trophy. In the one before us the table-space to be filled was larger than the size at Manchester, consequently the weight of honey shown is much greater. But so far as the design itself, the upright central portion—on the top of which is seen the words "Lancashire and Cheshire B.K. Association"—consisted of a case, glazed on both sides, in which are suspended five shallow-frames, illustrating the modern method of working for extracted honey. The top frame is simply fitted with untouched foundation, followed lower down by combs in various stages of progress, from the partly worked out comb to the fourth one shown filled with honey, fully sealed over, and the lowest one—after being put through the extractor—empty. For the rest, the illustration explains itself, and having taken a share in preparing the design and staging the exhibit as shown, it affords the writer much pleasure to give the picture, just to show the sort of thing we of the older school put up for our county and (we are not too modest to withhold the words) won with.

HELMSLEY AND DISTRICT B.K.A.

ANNUAL MEETING.

The first annual meeting of this association was held on Friday afternoon in the Court House, Helmsley. The Right Hon. the Earl of Feversham, President of the association, presided. The Vice-Presidents are Major the Hon. Hubert Duncombe, M.P., and E. W. Beckett, Esq., M.P. The association was formed in February of last year on the occasion of two lectures delivered at Helmsley by Mr. P. Scattergood, junior. Advantage was then taken of the presence of a goodly number of bee-keepers to form the new district association. Thanks are due to Mr. Scattergood for

his interesting lectures and also to Mr W. Mennell, secretary to the Technical Instruction Committee of the North Riding County Council, for his valuable help in arranging for the delivery of lectures on bees at Helmsley, Stillington, and Northallerton, the prominence thus given to the subject being very helpful to the formation of this association.

Prior to the commencement of the present meeting Mrs. Punshon, of Oldstead Hall, intimated to the hon. sec. her intention to give prizes of 10s., 5s., and 2s. 6d., in a class for "Best rack of sections as it comes off the hive" at the next show, and a hive of bees to the most deserving case of those who felt desirous of commencing bee-keeping in the district. Dr. Frank Collins, Wanstead, Essex, also promised a prize of 10s. for the "Best observatory hive."

The hon. sec. then read the annual report, from which it appeared that the association now numbered thirty-nine members, and there was every prospect of a good increase during the coming season. Though the past honey season was unfavourable in the district, it was gratifying to find that the entries in the nine classes numbered fifty, one lady bee-keeper carrying off six first prizes, and dividing the first and second in other two cases. Votes of thanks were passed to all donors of special prizes, Lord Feversham, the Vice-Presidents, Mrs. Punshon, and others, and those who had assisted the prize list in any way. The noble Chairman, in replying, expressed his gratification at the satisfactory work of the association in its infancy. The hon. sec., in reading the balance-sheet, reported a balance in hand of £1. 8s. 9d.

Several matters were discussed for promoting the successful working of the association.

Mr. Robert Ness, Sproxtton-park, Helmsley, in addition to the office of hon. secretary, was appointed local expert to visit novice bee-keepers.

The report and balance-sheet being adopted, the proceedings closed.—(*Communicated.*)

Correspondence.

The Editors do not hold themselves responsible for the opinions expressed by correspondents. No notice will be taken of anonymous communications, and correspondents are requested to write on one side of the paper only and give their real names and addresses, not necessarily for publication, but as a guarantee of good faith. Illustrations should be drawn on separate pieces of paper. We do not undertake to return rejected communications.

** In order to facilitate reference, Correspondents when speaking of any letter or query previously inserted will oblige by mentioning the number of the letter, as well as the page on which it appears.*

BEES IN SOUTH AFRICA.

A SAFE JOURNEY WITH DRIVEN BEES.

[2777.] I have just arrived in South Africa, and can now tell how the bees have borne the long journey. I could not get any information before leaving England respecting bees out

here, so did the best I could by way of preparing the little emigrants for the road. I got three lots of driven bees from a cottager near Bristol, in October, and put two of these lots in a small box I formerly used for carrying three shallow frames of honey to shows for exhibition. Having these frames of comb by me, they were just the thing for the purpose. I placed one of them on each side of a "Wells" dummy cut the same depth as the frame, putting one lot of bees with their queen each side. They were small lots, consisting of about a thousand in each with their queen. I got them safely on board, and on November 28 left Plymouth in the steamer *Ionic*. The weather being cold, the bees were left free to pass out at the entrance at each end up to the time of our leaving England. It was very rough, and not being used to the sea, for some days I was in no favourable mood to think about bees. However, I put them in under my bed with the flannel wrapper taken off; they could thus get plenty of air from the holes in box, which were covered with perforated zinc. I was glad that the weather was so cold as to keep the bees from humming, as I did not want my fellow-passengers to know I had bees under my bed. So all went well for the time. As we began, however, to get into a warmer climate, I knew the bees would be thinking of gathering honey, and, in consequence, would refuse to keep quiet, so I made the acquaintance of the ship's butcher and got permission to place them in a room near by the ice-house, where the temperature was about 40 deg. Fahr. I thought the ice-house itself would be too cold. When we arrived at Cape Town the bees were brought up on deck, and I was very glad to find were all alive. They did not, however, quite appreciate being kept fastened up, so I had to pass them through the Customs at the first chance. This I did by paying fourpence dock dues, without even being asked what was in the box. I was rather amused at this, as it was a very suspicious-looking package. Once free to look around, the first thing was to get lodgings; but there was no place convenient for bees to be liberated, so I had to keep the box beside me while having dinner. During the meal my fellow-boarders heard "the beehive's hum," and were naturally somewhat solicitous to know whether the bees could get out.

I took an early opportunity to make my way to the Department of Agriculture here, to a Mr. Pillars, who is in the Fruit Department. This gentleman was quite interested in the bees, and kindly invited me to bring them out at Rondebosh, his private residence, about three miles from Cape Town, and liberate them in his garden. He also told me there was a bee-keeper living at Montrose, Sea Point, named Mr. Attridge, and thither I took the bees. I soon found that Mr. Attridge was one of the bee-keepers whose address you kindly gave me as taking in the JOURNAL. He was

pleased to see me, and also glad to see some bees from the old country. When the entrance was opened, the bees, too, were evidently glad to have a flight. They came out in grand style, and in a day or so were busy carrying in pollen as if still flying in old England. I had to wait here for about ten days in order to see a gentleman; and I then shut the bees in again and left by the steamer *Tintagel Castle* for Port Elizabeth. I berthed in a six-cabin bunk, and took the bees in with me, as I expected the queens would be laying, and did not want the brood chilled. Eventually, however, we (bees and myself) landed here at Port Elizabeth, where I had to get my things through the Customs; and, having to stop two or three days on business, the bees got another flight. My next journey was one of eighty miles by rail, and finally I had to carry the bees seven miles across country on horseback, which was safely done. Yesterday (January 8) I put the two lots in separate hives, and found both queens in splendid condition; each having a good patch of brood, nearly ready to hatch out. On one side there were young bees already out.

I can thus congratulate myself on having landed the bees all right; whether they will prove better honey gatherers I cannot say, but they are much larger than the native bee. The latter is a prettily marked bee, not unlike the Ligurian, quite a nimble little chap, sometimes very quiet, at other times quite the reverse, and having, I notice, a very sharp hum. There are very few bees kept in hives here, the natives getting honey from wild bees in the mountains, and—so they tell me—they eat the brood in comb in all stages of growth; but I must "spare the Editors," and readers, too, on this brood eating business; it's nasty! If you think it would interest your readers I will send on an occasional note about my doings here. It is all new, and so very interesting, with much to be learnt, both in fruit-growing, market-gardening, bee-keeping, and ostrich farming. In thinking over it all I get almost bewildered.

I forgot to mention that we had two evenings on "The Bees" while on board ship, which were very well attended. On the first occasion our "talk" was on the "Diagrams," and a couple of nights afterwards we had "Bees and Their Relation to Man." The passengers were very much interested, and I had splendid audiences.

Kind regards to all bee-keepers at home, not forgetting our Editors.—J. MARTIN, *Expert B.B.K.A., Blue Cliff, Port Elizabeth, S. Africa, Jan. 9, 1897.*

JANUARY DAYS.

[2778.] At the beginning of the year we had many warm, spring-like days that were very comforting to the yellow jessamine and Christmas roses. The rooks in the trees even began to repair their nests. The winter aconite pushed up an elbow above the soil, and our last year's chicks became flushed in

their faces and combs, and boldly laid eggs, which we promptly appropriated. Those—and they were many—who had predicted a very severe winter, now thought better of it, and predicted that the rest of it would be unusually mild. They were, however, doomed to be disappointed, for at the middle of the month there began a tug of war between King Frost and Prince Gulf Stream, and, as it proved, after a deal of tugging this way and that, the northern warriors won easily.

Human beings and various other animals, also flowers, such as stocks, wall-flowers, snapdragons, pentstemons, can live through an amazing amount of cold, so long as the air is still, but if, in addition, the north wind coils round and through them like a boa-constrictor—well, no wonder they become shrivelled and constricted.

Thanks to our having laid in a stock of porridge, mutton chops, &c., we have, so far, pulled through, but the above-named flowers, and scores more, are dead. The frost increased nightly, and I watched their death struggles—watched the cabbages till they became mere scare-cabbages, and nothing but the buttons of Mr. Brussels sprouts remained. Oh! it was a dire and dreadful sight. Would that nature might relent and send down a thick, warm eider-down quilt of snow.

Nature, however, cares nothing for our yearnings. It rained and froze at the same time till the roads were an inch thick in ice, and boys skated about them. The June grass and clover were near dead; ice and what appeared like boiled rice, lay among it. At last, on the 22nd, the north wind—which had been sharpening itself to a razor-edge on the sleek sides of icebergs—brought a few storm-clouds, and down came the eider-down snow in giddy, swirling dances. Uncertain of their bearings, like a swarm of bees, the swarm of flakes swayed and drifted, some into the needles of the pines, some into the knuckles of the fist of ferns, on hawthorn and hazel twigs underneath, on celandine and strawberry. Like a swarm of bees the flakes drifted through the hedge, and, settling one by one, the branches became thickly covered till they were hidden completely; fantastic swarms thus hung along every hedgerow. Bents and dry stems of *lychens* became the purest wax candles, while crimson-barked brambles were archways of marble and the whitest alabaster. Sometimes there were ragged rents through the storm vapour, where in the day the sky might be seen looking grandly blue, or, in the evening, the stars tingled with the keenness of the wind.

There seem to be many kinds of snow. In America I see they have had warm hailstones, which were sweet, and flavoured with vanilla! We don't get that sort here, but my barber assures me he saw some snow which resembled frog spawn! This I have never seen, but I have seen everything between water and the fully-fledged flake. The fineness, the dryness,

and crispness of the snow on the 22nd and 23rd were remarkable. It sang under the feet, and you could not make it into snowballs. To show that it was like eider-down, warm and cosy, the thermometer on the ground was six degrees higher than the temperature above! On the 23rd the storm was terrific. Many deaths through exposure were recorded throughout Britain, caused, no doubt, more from lacking a friend at the "halfway" house, and a little hot elderberry wine, than from the severity of the storm. The razor-edged wind lifted the snow, and chopped it into snowmist, so that even the boys—home-fed boys—departed from their tobogganing, with the excuse that they wanted to finish that chapter of "The Skeleton Knights," or "The Mystery of the Dagger," but, if the truth must out, they felt their ears were safer indoors.

Those bees whose houses faced the north had no need to whiten their door-steps or the top of their porch—it was done for them, morning after morning. Mr. Blackbird sat disconsolate on an apple bough, and if looks said anything, he was saying to himself, "Well, this takes the cherries! Can't remember the morn when last I stretched a worm!" Then he put one foot down and held the other against his breast, then slowly closed his eyes. Even Mr. Jolly Sparrow was silent, or only gave a few chirps which, being interpreted, meant, "Aye, billy-ho, I shall have to go and look up a few more of those gooseberry sprouts, and they ain't exactly like ripe peaches!" Rooks and starlings stalked about the frozen fields from force of habit, and larks twittered to one another as they lay shielded from the force of the wind in the furrows. Only one bird sang—sang from the apple boughs in the morning. He had noticed—he, only of all the birds—the elbow of the winter aconite, the sword-blades of snowdrops struggling. He sang sweetly, "Hope on! ye spring is coming." He had the softest of brown coats, the darkest of dark eyes, and a red breast. The bees heard him. Each took a cell of the best clover and drank the toast, "Here's health and long life to our good friend, Cock Robin!"—LORD WOOD.

DATE FOR SUPERING HIVES.

[2779.] The interesting paragraph from the *American Bee-Keeper* on p. 49 suggests the query whether the date for supering there recommended, June 20, applies to the English season as well as to the American. If so, I think many bee-keepers will say that it must be accepted with some latitude. Last season was a capital one in East Yorkshire for early honey. Hives were strong, hawthorn blossom and all other tree blossom profuse, weather favourable for harvesting the stores which were flowing on every side; so that by the end of June supers were well filled with an exceptionally good sample of honey. After that date I fancy little was gathered. Now, if the advice given

by Mr. Doolittle had been strictly followed, the result would have been that we should have kept our bees idle (as far as any control of ours can do that) during the most profitable part of the year, while waiting for a clover harvest, which never came in consequence of the prolonged drought. Why should June 20, or any other fixed date be considered the "psychical moment" for supering our hives? If we can get the brood chamber filled with brood and young bees by May 10, surely the supers should be given them then. I extracted my first box of frames (71 lb.) on June 26. Should I have done so if I had acted on the advice of Mr. Doolittle? May I ask whether the practice of "doubling" holds its ground as firmly since the introduction of shallow frames as it did before? The result of doubling is that you will have a hive of standard frames to fill before your bees take to any shallow frames you may give them in addition. Now when once you have learnt the ease with which a shallow frame is uncapped and extracted you do not view with favour a hive full of standard frames waiting for extraction.—CHARLES E. COCKIN, *Elton, Hull, February 6.*

[The date given by Mr. Doolittle applies no doubt to the district wherein his bees work, and this fact must be considered whenever dates are given. In so comparatively small a place as Great Britain the time of clover blooming differs from twelve to twenty days, taking extreme north and south. We never fail to emphasise the point that bee-keepers—in arranging their work for the season—must bear in mind the flora from which the bees are to gather, and the date of its blooming. Thus we find numbers of those engaged in honey production striving by every means to secure strong stocks for filling sections in April, while those in the Midlands and further north seldom look for or expect bees to be working in supers before mid-June. With bees, as with most other things, to achieve success more or less of intelligence must be brought to bear upon the work, and this means a knowledge of the sources of supply in the district wherein each of us happens to be located.

The shallow-frame super has of late years largely superseded the method of "doubling" with standard frames when working for extracted honey.—EDS.]

BEE NOTES FROM NORTH HAMPSHIRE.

[2780] Following the example of your correspondent "W. R. N.," I send you a few notes of the doings of the bees last year in this district, the borders of Hampshire and Berkshire. The yield was, I think, rather better than usual in these parts, my average from seven single hives being 45 lb., and from two double ones 56 lb. respectively—nothing remarkable you will say, but better than I have done before. According to the local

paper, a bee-keeper last year showed at the flower show at Minley, near Farnborough, 120 lb. from one hive, the said hive being stocked, in the autumn of 1895, with one lot of driven bees, which cost a shilling! We seem to have been more fortunate than neighbouring counties (*e.g.*, Sussex), for on June 10 and 11 we had splendid rains, and the bees, which had been getting on rather slowly during the beginning of June, soon felt the benefit. White clover made its appearance by the road-sides, in the hedges, and even in those fields which, by courtesy, we call "permanent pasture." The honey-flow, in fact, held out better than usual, and there were very few sections still unsealed at end of season.

There were also no end of swarms! All my hives, save one, swarmed. That one, however, gave me the best yield of all, though it was not the first to begin work in the super. Nothing I could do would stop the swarming. "W. R. N." states that he "effectually stopped swarming" by stretching an awning over his hives; but *post hoc ergo propter hoc* is not always a safe argument, though a favourite one with most of us bee-keepers. I can only say that I shaded the hives with wet sacks, and gave abundant ventilation; but all to no purpose. The swarms were all returned, and in some cases would remain at home, but in others would come off again in a week or ten days. I hope next year to try an air-chamber under the brood-nest, either such as Mr. Simmins uses or as "W. R. N." described—a sort of eke fitted with wooden dummies $\frac{1}{2}$ in. apart. The great day for swarms was June 2, when I lost two large double swarms and secured four. One swarm escaped while I was out; the other moved off, being disturbed because a fresh swarm wanted to settle on the same branch. On the same day three other swarms decamped from this village, and three stray swarms were captured, all of the latter being secured earlier in the day than the former escaped; so that there must have been swarms flying all over the country on that particular day.

Some interesting letters appeared last year in the B.B. J. on the way to stop swarming. Perhaps those who took part in that correspondence have had some new experiences or experiments during the season. I see Mr. Dadant says swarming cannot be stopped unless you work for extracted honey.

I shall be ever grateful to you, Messrs. Editors, for telling us about Mr. James Abbott's waxed paper for covering sections, and to that gentleman for introducing it to the notice of bee-keepers. If any one has a difficulty in making the waxed paper stick, he will find that "Stickphast" will do it, as will, I expect, also ordinary paste.

I see that some of your correspondents aim at retailing honey to their customers at 1s. 3d. or 1s. 6d. a pound, while the columns of the B. B. J. offer it at 8d. or 9d. a pound. It is

doubtful whether this is wise as regards their own ultimate advantage. If the farmer who sold me butter were to tell me the price had risen to 2s. 6d. per lb., and I paid him that amount, and afterwards found it advertised for 1s. 5d. and 1s. 6d., I should in future refrain from dealings with that farmer. Of course, honey, like other things, differs in quality and consequently in value; but so it is with butter. Regarding honey, I suppose the question of demand and supply is at present so uncertain that there hardly is a regular market price as yet. Only if we spread abroad these exceptional or "fancy" prices for our honey, we may soon see in England some of the 36,000 lb. of white clover honey which Mr. Dadant harvests in America every year, and is able to sell cheaper than sugar.

Perhaps we bee-keepers, who eat honey whenever we like, hardly realise how rarely an ordinary well-to-do person buys it. He has an idea that it is very costly, and if he produces it at his breakfast-table, it is with an apology for such extravagance. "I have had a little present of honey," or "my gardener keeps bees." If you show him that honey nowadays costs very little more than jam, he cannot get rid of the ingrained notion that to eat honey is very extravagant. To eat butter, jam, or marmalade is all right, but honey is beyond the bounds of legitimate luxury.—H. E. S., near *Winchfield, Hants.*

BEE-KEEPING IN THE LAKE DISTRICT.

[2781.] This district is not well adapted for clover-honey, but is an excellent locality for heather-honey, given favourable weather during August. I have eleven stocks, chiefly blacks, but with a fair trace of Ligurian, some being crossed with English drones. The latter I find are by far the best honey gatherers, one hive yielding over 60 lb. last season, whereas the blacks did not average over 20 lb. per hive. I find pure Ligurians profitless, and my sole reason for keeping the pure breed is for raising hybrid progeny. One bee-keeper in this district averaged about 30 lb. per hive out of a dozen stocks—not a bad record, seeing that it was from May blossom and heather, as the clover crop was practically a failure.

I have one Wells hive, and cannot speak favourably of the system from my own experience of it; one side is pure Ligurian and the other English. I have had no difficulty in introducing queens, but found it very difficult to introduce driven bees into one side, which lost its queen in winter of 1895, as the first lot were almost all destroyed. I succeeded at the second attempt without any fighting, however. The return last season did not equal an ordinary hive, though they were very strong in bees, and only had thirteen brood frames altogether; perhaps the fact of one lot being

pure Ligurians may account for this, as they would not enter the super, though the blacks did.—DR. ALLEN, *Hawkhead, Ambleside.*

HIVE BEES IN NEW ZEALAND.

(Concluded from page 43.)

"When I went to Kaipara in 1857 I may say the bush was full of bees. We seldom went for a walk without seeing a swarm of bees, which we often secured and put into a candle box, and carried it home. In this way we started our apiary, and we made boxes after the fashion of Mr. Cotton's, and employed what were then called 'raisers' for the storing of surplus honey. In this way very nice honey was obtained, and as a luxury we used a glass bell, which, when well filled, made a handsome centre piece for the table. When Mr. Hopkins first published a description of a Langstroth hive I felt it was just what we required in order to obtain control of the bees, and I wrote to him requesting him to send me a sample hive ready for work and some in the flat. I was very much gratified at Mr. Hopkins' reply, and also with a frame of sections with comb attached, which he kindly gave me to make a start. The hives gave me perfect satisfaction, and I increased my apiary to about sixty hives, still keeping some of the old-fashioned box hives, though in time I learned to value the new hive entirely to the exclusion of the old ones. I also tried a honey extractor for the bush honey, but found it too glutinous to flow in sufficient quantities, and also succeeded in using a wax extractor, which gave me much relief in the separation of wax from the old combs. When we removed from the Kaipara I left my apiary in the care of a person who neglected the bees, and as far as I know they have all died out.

"M. GITTO'S."

Thus, there is every reason to believe that we have at last reliable evidence as to the date, &c., of the landing of the first honey bees in New Zealand. There is no possibility of Mrs. Gittos having made a mistake, as she remembers everything so clearly, being at the age when the circumstance took place—nine years—that such an event as the landing of honey bees would make a deep and lasting impression upon her mind. Then, again, there is the evidence of others who were passengers by the same ship referred to by Mrs. Gittos, so that there is not the slightest room for doubt. As to the date of the arrival of the ship *James* at Hokianga, that can be verified by any person through the Customs records, and it is not at all likely any mistake would be made in that matter. Allowing one day after the ship anchored before the bees were landed, this brings us to March 14, 1839, nearly or quite twelve months before the arrival Lady Hobson's bees, and, moreover, the bees in question came from England, not New South Wales.

Mr. Hobbs speaks of Mrs. Gittos as an "enthusiastic and experienced bee-keeper." I can vouch for that, as I well remember some eighteen years ago the pleasing correspondence that passed between us on the matter of scientific bee culture, extending over a period of two years or more, and I believe Mrs. Gittos was the first person I sent a Langstroth hive and other bee-keeping appliances to. I thank Mrs. Gittos for her interesting communication.—I. HOPKINS, *The New Zealand Farmer, Bee, and Poultry Journal*.

Queries and Replies.

[1653.] *The Wax Moth and Pollen Mite*—I send by current post a box containing some insects which I take to be a species of the wax moth. I cannot think it is the common wax moth of this country; the larvæ seems so much larger than what I have hitherto seen, and the grub is brown in colour, while the common moth grub I have seen is usually white. In the summer time the grub is most active, putting one in mind of a weasel in its movements—darting back quickly if you try to catch it. I have referred to the "Guide Book" for instructions how to destroy it but failed to get any information beyond the statement that it is essential to have strong colonies in order to keep it out of hives. I may say, however, mine are all strong colonies; yet the moth gained entrance. I have also been informed that naphthaline is a preventive, but it is not so in my case. I may mention that these grubs and moths I have taken from some comb which was stored away in a warm room. They had naphthaline placed in with them when stored away. You will find them in all different stages of growth, viz., the grub, chrysalis, and the full-grown moth. Will you please give me any information you can respecting the species, and also its destruction? 2. You will also find enclosed in box a small paper parcel containing a large quantity of "mites." I have looked at them through a very strong microscope and find they are white in colour, and their movements puts me in mind of the green fly which attacks plants in greenhouses. Will you kindly tell me what it is?—ALFRED BISHOP, *Bury St. Edmunds*.

REPLY.—1. Box received contains the moth in its "different stages of growth" from larvæ to perfect insect. It is the true wax moth (*Galleria cereana*). Notwithstanding the unreliability implied as to the statement in "Guide Book" regarding this moth, we repeat—without any reservation whatever—that "strong colonies" have nothing to fear from this or any other moth in this country. It is stated above that the "grubs and moth were taken from combs stored away in a warm room." We fail, therefore, to see that the mischief occurred in hive tenanted by bees at all. It would seem as if a moth got at the

combs, maybe prior to the introduction of the preventive, and once the eggs were laid the naphthaline would neither kill the grub nor the moth. It is only placed there to keep away the moth because of its smell being offensive to the latter. Experience has so fully proved that strong colonies are a complete preventive that our correspondent may dismiss any alarm on account of moths. 2. The powder sent contains the common pollen mite frequently generated in combs stored with pollen when kept in a warm room. These mites never appear in hives when the bees are sufficiently numerous to cover the combs.

[1654.]—*Extracting Honey in February—Working for Extracted Honey*.—I am much obliged for the information which you kindly gave me in your issue of the 21st ult., and should be glad to also have replies to the following:—1. Can I extract honey from sections now? I have forty which I cannot sell, but I could dispose of the honey if extracted. If I extract the sections, could they be used again? 2. I shall want to have some labels printed with my name, &c., for the coming season, can you give me the name of a firm who could do this for me? 3. With regard to working for extracted honey, which gives the best results, shallow or standard frames? Also do you recommend *extra* wide frames? 4. Do you recommend the use of excluder zinc when working for extracting? 5. I have one hive, in which the bees have wintered, with twelve frames, and on examination yesterday I found there was a lot of honey. Would you advise me to remove four or five frames on first sunny day and extract with the sections referred to above? 6. Does it follow that when bees collect pollen they also collect honey? What I mean is, can there be pollen without honey? I ask this because I saw some of my bees arrive the other day loaded with pollen.—JERSEYITE, *Jersey, February 5*.

REPLY.—1. There will be little chance of your succeeding in removing honey from combs by means of the ordinary extractor at this season. We should rather cut the combs up into slices and hang them in a coarse muslin bag before a good fire. This would reduce the consistency of the honey and cause it to run into the vessel placed below. If granulated, it would need putting into an earthenware vessel, and immersing the latter in hot water till the wax melted and rose to the surface, whence it could be removed in a cake when cold. 2. Most appliance dealers supply honey labels with blank space for name, which latter could be added by any local printer. 3. It is a moot point which gives best results. We prefer the shallow frame. 4. Yes, zinc is indispensable for success in working for extracted honey. 5. No. Leave it where it is, or give a comb of food to more needy stocks. 6. Bees collect pollen at times when practically no honey is available.

[1655.] *Using "Guide Book" Recipes.*—On page 145 of "Guide Book," when referring to the difference between chilled brood and foul brood, we read with regard to the former that "the dead larvæ are also generally removed by the bees, but they seldom attempt to carry out those which have died from disease, except under certain conditions which we shall presently mention." I also notice on pages 146 and 147 it says:—"It has previously been stated that adult bees are sometimes attacked by the disease. Such bees leave the hive to die, whereas the infected larvæ remain in the cells unless disinfectants to arrest decomposition are used, in which case the bees remove them from the hives." 1. Does this refer to the use of naphthaline, or solution No. 9 as recommended on page 150 for spraying combs? 2. Will solution No. 12 do as well as No. 9 for comb-spraying with brood in cells?—SEEKER, *Long Eaton*.

REPLY.—The quotation is intended to explain that if disinfectants are used in time to arrest decomposition of the larva before it has reached the "ropy" condition, the bees may be able to remove the dead grub from the cell. 2. The passage quoted from page 150 deals specially with the author's experiments with soluble phenyle, and we are therefore not prepared to say that carbolic acid solution will answer the same purpose. In fact, we do not recommend a trial of the latter.

[1656.] *Best Aspect for Placing Hives.*—Up to the present I have kept my bees in the kitchen garden, but, as I now wish to extend my apiary, I propose moving them into a meadow close by, and therefore ask:— 1. Shall I put them in a corner facing S.W., sheltered on the N.W. and N.E. sides by high trees and shrubs, or have them more in the open? It is exposed, being 360 ft. above sea level. 2. Is there any objection to placing the hives close up to 2-in. mesh wire netting? 3. Being in such an exposed place, would it be at all necessary to build a covered apiary? With regard to the illustrations in B.B.J., my own opinion is that they greatly enhance its value.—KENT, *Whitfield, near Dover*.

REPLY.—1. The shelter referred to, and the aspect facing S.W., ought to make an admirable location for the hives, much preferable to their being placed out in the open. 2. No. 3. In exposed situations a covered apiary or a bee-house is, no doubt, advantageous, but, with the protection mentioned above, it becomes less a necessity than a matter of personal comfort of the bee-keeper.

Echoes from the Hives.

Chippenham, Wilts, February 5.—The frost, which commenced to give way on the 29th ult., has been succeeded by almost incessant driving rains, with the wind bearing from S.E. to S.W. A slight break yesterday morn

set the bees in motion, but the strong breeze prevailing at the time, and the clouds coming over, many bees were borne to the ground never to rise, thereby providing a dinner and supper without trouble for the tits, which with me, as with our friend, Mr. Woodley, are a great nuisance. Later on the wind shifted to N.W., and the rain came down in torrents, continuing till this evening (twenty-four hours). Result, the low-lying lands are already flooded and the river rapidly rising. The still more unwelcome result to me, as a bee-keeper, is that the wet has percolated through the corner joints, &c., of hives to an extent I have not experienced for years. Newly painted hives and zinc roofs are not exempt; it really seems a mystery how and where the wet gets in. A warm sunny day would be a great boon, both for the benefit of the bees—they not having had a real flight since December 28—and also that the roofs, lifts, &c., may be turned inside to the sun and air, and thereby get the drying so much needed.—F. WOOLDRIDGE.

Hildenboro', Kent, February 5.—Yesterday being a mild day after the cold snap we have had here in mid-Kent, my bees took advantage and had a good turn out, the first since December 27 last. My nineteen stocks all answered to the roll call. They appear to be well up in bees, and have brought out only a normal quantity of dead, but the flight-boards have been covered with "cappings," which shows that they have been well on the sealed food. From experiments made this year and other years, it appears to me that, given a good queen, plenty of food and a dry hive, chaff cushions, winter passages, &c., may be cast to the winds. I am trying experiments with three hives at the present time as regards wintering. The first is a swarm put into a clean hive on foundation on June 21 last; five days later I gave them a rack of sections, but they did little in them, nothing worth taking off. I therefore decided to leave them and see how the bees wintered with the sections on without any additional covering. I looked at them on the 4th inst. and found the bees up in the sections clearing them out. They appear to be strong in numbers at present. The second is a lot driven of bees from a small skep and put on to five frames of foundation on August 16 and fed with sugar syrup. They went into winter quarters weak in bees, the wasps having been very troublesome to them while feeding was going on. They have, however, plenty of food now to tide them over any risk of a "cold snap." The third is a lot of driven bees also from a small skep, put into a makeshift hive, on five frames of empty comb on September 21 and fed slightly. I should have given more food but the wasps would not let them have it. I feared this lot could not live, but they are all right and I expect to save them now. They have only got a piece of calico and two thicknesses of carpet over the frames.—MAN OF KENT.

MY BEES.

COME, taste of my honey !
 The bee-keeper said,
 For you never before
 On such nectar were fed.

As my bees are my friends,
 Their virtues I sing ;
 Does the sun only shine,
 They are out on the wing,

To the hills and the dales,
 Where cowslips bloom sweet,
 To orchards and gardens,
 Fruit blossoms to greet.

To brookside and woodland,
 Where the wild roses grow,
 To pastures, so fragrant
 With clover, they go.

Bringing in the sweet food
 God's nature supplied ;
 No floweret, though humble,
 Its sweetness can hide.

And so, as they gather
 For their home and for mine,
 In profit and pleasure
 We each of us join.

Oh, yes, my dear friend,
 Their praises you sing,
 And though I believe you,
 I say, "Can't they sting ?"

"Sting ?" why, yes, so they can,
 And so, too, would you
 If riled and handled,
 With no mercy in view.

But kindness and tact
 Are wonderful things
 With man, bird, or beast,
 Or bees that have stings.

SARAH CLOUGH.

Northwich, January 28.

Notices to Correspondents & Inquirers.

All queries forwarded will be attended to, and those only of personal interest will be answered in this column.

A VON KRIEGSHHEIM (Biel, Switzerland).—*Pressed Tar Felt for Hive-roofs.*—Hard felt, as sample referred to by Mr. A. Sharp (2754, p. 16), if properly put on, will make an admirable covering for hive roofs, and would last for years. We could ascertain the price at which it can be had in this country for you, if desired, but cannot say how much transmission to Switzerland would cost.

A. H. (North Bucks).—*Glass Quilts.*—There is no analogy between what are called glass quilts and the use of a covering of

American cloth above porous quilts. When American cloth is used along with porous coverings, the former should be fixed not over but *under* the quilts, with the glazed side next the top-bars of frames, the remaining quilts being placed above. The "glass quilt," on the contrary, does not touch the top-bars at all, but is raised above them sufficiently high to allow passage-way for the bees below the glass. Referring to quotation from "Guide Book," as to size of hive body, if our correspondent will quote the page in book wherein the dimensions are given as stated, we will deal with it.

J. R. T. (Workington).—*Suspected Comb.*—Excepting for one cell—the contents of which are suspicious—the brood in comb sent in is chilled, not foul. The numerous adult dead bees in cells (into which they have crept head-foremost to die) have perished through starvation, or not being clustered within reach of the food. We should give warm soft candy at once, and keep a sharp eye on the hatching brood in spring.

GEO. WELLS (Aylesford).—If the gentleman referred to is not a reader of our journal, anything appearing therein will not be likely to meet his eye. We advise writing to Mr. R. Bainbridge, local secretary, Technical Education Committee, Frosterley, Durham, who will, we think, be able to furnish the address asked for.

R. I. P. (Elgin).—*Phenol and Naphthol Beta.*—Phenol is so far analogous to naphthol beta that both are crystalline substances, obtained by the destructive distillation of certain organic bodies, such as wood, coal, &c. But regarding the particular use for which naphthol beta is recommended to bee-keepers, according to Dr. Lortet's formula, phenol is entirely unsuitable, and would not do at all.

W. J. BROWN (Bridport).—*Hard Pollen in Combs.*—There is no use trying to "pick out" pollen from cells after it becomes hard and mildewed as in comb sent. The comb may, however, be again utilised, in a measure, by cutting down the cells almost to the septum or midrib, and giving them to the bees to rebuild. Hard pollen is useless to the bees.

S. G. LEIGH.—Comb is affected with foul brood.

E. PARSONS (Tunbridge Wells).—*Dealers' Catalogues.*—1. The suggestion that we should print a free list of names and addresses of bee-keepers desiring catalogues sent to them is quite impracticable. 2. The hon. sec. of the Kent and Sussex B.K.A. is Mr. H. W. Brice, Dale Park-road, Upper Norwood. 3. Bees obviously must possess the power either to see in the dark, or be endowed with some equivalent sense of touch, in view of so much of their labours being carried on in darkness.

Editorial, Notices, &c.

USEFUL HINTS.

THE HONEY TROPHY. — From communications received we gather that the illustration on page 52 has not only aroused interest in regard to the Manchester Show, but has given pleasure to some of those purposing to compete in the Trophy Class at the "Royal" in June next. Enquiries have also been made for information as to details of the design in last week's B.J., apparently not quite clear in the illustration. We do not know why such particulars are desired, and only made our description on page 53 so brief because of not deeming anything beyond the picture necessary. However, we now add a few particulars as requested.

The upright glazed case in centre was 3 in. or 4 in. deep, and wide enough for holding within a 1-lb. jar in the spaces on each side of the frames shown. The opposite side of the Trophy was a reproduction of the front view, while the two side displays were necessarily somewhat different, because of there only being space for single sections and jars where the combs show in front. The two rows of 1-lb. jars below the shallow frames stand on shelves of thick glass arranged in step fashion, both shelves being backed with silvered glass.

The main rows of shelves are in four sections, fixed to, and radiating from, the central case, seven rows of jars being staged in each "arm" or set of shelves, which latter are supported by turned pillars of wood. The bottom shelf extends to the extreme corner of the table, while the others gradually shorten in length, the top one holding only three jars. On the platform above the centre case stands a considerable weight of honey in 2-lb. jars. The suspended shields, front and back, on which are the words "White Clover Honey," in white letters on a chocolate ground, and the side bannerets of blue silk, complete the whole.

The explanatory wording printed across the top-bar of each frame of comb (too small to be readable in the picture) simply explained to the uninitiated the various stages in which the combs are shown.

The "feature" of the exhibit, however, was not the design, but the quality of the extracted honey shown, and the fact of its being staged as entirely white clover honey. The bright, pale-yellow colour was uniform throughout. No screw-caps were used, all being tie-over jars, while the vegetable parchment covers were carefully damped before using, so that, when dry, the covers were as "tight as a drum," and perfectly white. The weight of honey was, of course, considerable—probably over 700 lb.—but we cannot now remember the exact quantity.

THE "ROYAL" PRIZE SCHEDULE.— Questions are also arising as to the clear and definite meaning attachable to the mention (in Class 375) of other honey products beyond "comb and extracted honey." To prevent misconception at the outset, we therefore take the earliest opportunity for defining—as clearly as our knowledge of "Queen's English" will allow us—what the words used are intended to convey.

The schedule reads thus:—"SPECIAL COUNTY HONEY TROPHY COMPETITION. Class 375. For the best and most attractive display of COMB AND EXTRACTED HONEY and such Honey products as Wax, Mead, and Vinegar, arranged in Trophy form on a space not exceeding 4 ft. 6 in. square by 5 ft. in height. The gross weight of the Honey (which may be in any form and of any year) must approximate 300 lbs."

We thus see (and the words are capitalised to impress them on the mind) that the Trophy is primarily a Display of Comb and Extracted Honey, and that about 300 lb. weight of this must be staged on a given space. Then, in order to increase the attractiveness of the Trophy and also to bring before public notice certain valuable products obtainable from honey, Wax, Mead, and Vinegar are named. But, so far as these latter products, any *one* or more of them may be included in the exhibit as desired. One *must* be staged; the words "*and* honey products, *such as*, &c." making this point clear. The inclusion of more than one is, however, not actually obligatory, and therefore a matter of choice or convenience to exhibitors, though all three are eligible and may be staged if desired. In other words,

honey and wax, or honey and vinegar, quite cover the requirements of the schedule, as do honey and mead without either wax or vinegar.

In this way then, county associations, unable to include either mead or vinegar, may be perfectly satisfied that they compete correctly so long as honey and wax is staged. No fair-minded person should conclude that those whose duty it may be to make the awards will attach too much importance to the "extras," as they may be termed comparatively. The words of the schedule, as given above, will, we take it, guide the awards, and the "extras" not calculated at more than their proper value; a value altogether secondary, compared with what we have named. Bearing in mind, however, the advisability of beautifying the "Trophy" by every legitimate means, we hope nothing will be omitted that tends to improve its appearance, or show the good taste of those who arrange the display. In this latter respect all have an equal chance, for the good old custom of giving simple and equal table space to all, offers a free field and no favour.

We trust these remarks will remove any possible difference of opinion as to the wording of the schedule, and demonstrate the desire of those who framed it to impose as few restrictions as possible, while doing justice to all.

Since writing the above we note some questions referring to the same subject appear on another page from the pen of Mr. Woodley, to which a word of what we may term unauthorised reply may be here given; official replies can, of course, only be obtained in response to queries addressed in proper form to the B.B.K.A., through their secretary. So far, then, as the stands on which the trophies are staged are concerned, they will, no doubt, be of the usual height of all those on which collections of honey are staged at "Royal" shows. Regarding the question of separate stands for each trophy, we expect these will be arranged for if at all possible, as it would add immensely to the appearance if this can be done. The "size of the top of stand," as Mr. W. puts it, is already clearly defined in the schedule as stated above. It was also considered absolutely necessary to clearly approximate the weight of honey to be staged,

but that the quantities of wax, mead and vinegar respectively should be left to those in whose hands the arrangements are left. In view of what has been said above, there need be no fear, we fancy, of the "extras" being allowed to overshadow the substance of what is to all intents and purposes a HONEY trophy. For the rest, we have endeavoured above to make clear the wording of the schedule as to the need or otherwise of showing all or a part only of the several "honey products" beyond honey at the discretion of exhibitors themselves.

BRITISH BEE-KEEPERS' ASSOCIATION.

The monthly meeting of the Council was held on Friday, February 12, at 105, Jermyn-street, S.W. Present :—Mr. H. Jonas (in the chair), Major Fair, Messrs. H. W. Brice, W. Broughton Carr, W. O. B. Glennie, W. H. Harris, J. H. New, E. D. Till, T. I. Weston, J. M. Hooker (ex-officio), and the Secretary.

A letter was read from the Hon. and Rev. Henry Bligh, apologising for inability to attend.

The minutes of the previous meeting were read and confirmed.

New members of the Association were elected as under :—

Mrs. G. W. Bancks, Green-street-green, Dartford.

Rev. John Barton, The Manse, Wingrave, Aylesbury.

Mr. Robt. Burnett, Creacombe, Morchard Bishop, Devon.

Mr. Archibald Collitt, Nethercoote Apiary, Bourton-on-the-Water.

Mr. W. L. Crowley, 1, Ross-road, Wallington, Surrey.

Lieut. C. L. Hervey, St. Clare, Exeter Park, Bournemouth.

Kent and Sussex Bee-keepers' Association, Mr. H. W. Brice, 2, Dale Park, Upper Norwood, Hon. Sec.

Mr. A. A. G. Kindell, Hillside, Muswell-hill, N.

Miss Louisa King, Swinford, near Rugby.

Miss Nisbett, Durham House, Green-street-green, Dartford.

Mr. Joseph Peckett, Rose Cottage, Havercroft, Wakefield.

Mr. Wm. Spence, Brynfield House, Newtown, N. Wales.

West Dorset Bee-keepers' Association, Rev. H. C. B. Field, Bradpole Vicarage, Bridport, Chairman and Treasurer.

Mr. Jas. V. Wilson, Westal, Cheltenham.

Major Fair presented the report of the Finance Committee, including the Honorary Auditors' report on the accounts for the year 1896, which was duly approved.

It was stated by Mr. Hooker, on behalf of the Exhibitions Committee, that arrangements were in progress for the joint management of the Bee and Honey Department of the Royal Counties' Show at Reading, by the British and the Berks Association. Of the sum to be given as prize money, it had been decided to allocate £10 for local competition only. In all some £30 will be available for distribution in the various classes at this exhibition. The report was received.

The Secretary read a letter from the Lincs. B.K.A. in regard to the approaching County Honey Trophy Competition at Manchester, and received the instructions of the Council in respect to a reply.

It was moved by Mr. Till, seconded by Mr. Weston, and carried unanimously: "That the Secretary issue a form of inquiry to be filled up by the bee-keeping associations, and such individuals as he may deem advisable, with information in regard to foul brood, in order to supplement the data already obtained for advancing legislation on the subject, and that the Secretary be assisted, in the work of framing the circular, by Messrs. Carr, Brice, and Till."

Subject to the approval of the President, March 12 was fixed as the date of the annual general meeting of members, to be followed by the first conversazione of the season. Members desirous of bringing forward matters for discussion at the general meeting should give notice to the Secretary on or before Friday, February 26.

NORTHAMPTONSHIRE B.K.A.

The annual meeting of the Northants Bee-keepers' Association was held in All Saints' schoolroom, Northampton, on Saturday, February 13. Mr. L. Jordan occupied the chair. Amongst those present were Dr. Bellew, Messrs. Winterton, Collis, Craddock, Bragshaw, Timms, England, Collins, Orland, Perry, Wright, Mrs. Ball, &c. The secretary, after stating that he had received apologies for non-attendance from Mr. A. L. Z. Morley, Mr. Nigel Stewart, Mr. Ball, and several others, read the report for the past year, which, together with the statement of accounts as read were passed *nem con.* The committee elected for the ensuing year were Mr. A. L. Z. Morley (chairman), Mr. J. R. Truss, Ufford Heath; Mr. H. Collins, Berry Wood; Mr. O. Orland, Flore; Mr. G. Page, Holcot; Dr. Bellew, Wollaston; and Mr. Francis, Mr. Ball, and Mr. Manning, Northampton; hon. sec., Robert Hefford, Boughton; hon. treasurer, G. E. Atkins; hon. auditor, Mr. J. Francis. Mr. Truss, Mr. Perry, and Dr. Bellew were appointed experts.

The rules and schedule of prizes for the annual show were then revised, and after considerable discussion were agreed to. Dr. Bellew then offered some "suggestions for a mutual

assurance association against loss by foul brood." He also showed a sample of honey vinegar, and explained the many ways honey could be utilised in food, drinks, &c. The meeting, which lasted three hours, concluded with a vote of thanks to the retiring president and officials of the past year and to the chairman for presiding and the manager for use of the schools.—(Communicated).

WOTTON-UNDER-EDGE AND DISTRICT B.K.A.

ANNUAL MEETING.

The Annual General Meeting was held in the Town Hall on Saturday, February 13. Messrs. Watts and Fowler were elected on the committee in the places of Messrs. Tilley and Workman, resigned.

After various discussions relating to local bee-keeping matters, a resolution was carried unanimously "that we heartily approve of the efforts of the B.B.K.A. to promote legislation with regard to the stamping out of Foul Brood." It was greatly regretted that more of our younger men did not take any interest in bee-keeping. The financial condition of the Association was shown to be more satisfactory this year owing to our having dropped the "Fruit, Flower, and Vegetable Section" at the Show.

The secretary suggested that at the usual summer monthly meetings of the Society the articles in the *Journal* should form subjects for discussion. This suggestion met with general approval, as it had always been difficult to get new and original subjects in an association with so few members. It was gratifying that several members had found the books in the library of so much assistance.—(Communicated.)

IRISH BEE-KEEPERS' ASSOCIATION.

The Committee met on 11th inst. Present: Captain Millner (in the chair), Dr. Traill, Mr. Delap, Mr. O'Bryen, and Mr. Chenevix (hon. sec., 15, Morehampton-road, Dublin). Rev. J. G. Digges, of Clooncahir, Lough Rynn, who was co-opted a member of Committee, also attended. Mr. Digges having stated his intention of establishing a Lough Rynn Bee-keepers' Association, the conditions for its affiliation to the I.B.K.A. were settled. It was resolved to supply on loan some show cases to dealers for the sale of members' honey.

HONEY IMPORTS.

The value of honey imported into the United Kingdom during the month of January, 1897, was £267.—From a return furnished to the BRITISH BEE JOURNAL by the Statistical Office, H.M. Customs.

HOMES OF THE HONEY BEE.

THE APIARIES OF OUR READERS.

In response to your invitation of November 5 (p. 441) I beg to send a photo of my Middleburgh apiary, with a short history of my bee experience. Twenty years ago a friend sent me a swarm in a "Ruskie," which was not much appreciated, as you may judge when I tell you that before they were unpacked in my little garden I had to "head" for the house through fear. But I soon got "interested (borrowing the quotation from an enthusiastic cottager neighbour) in the dear little creatures." I was quite at sea, however, with their works

pasture, securing an average yield per hive of about 10 lb. of honey in sections; my greatest drawback, however, was in swarming time, when I had sometimes to "speel" over the tops of neighbouring buildings to secure a swarm. Five years ago I got my bees a mile out into the country, where I have since been more successful. My yield last season averaged 50 lb. per hive, and stocks furnished with stores for wintering in good condition, while some of my less experienced neighbours have not got 1 lb. of honey, and their stocks are about dying for want. This, of course, shows that the season has been a poor one in our locality.

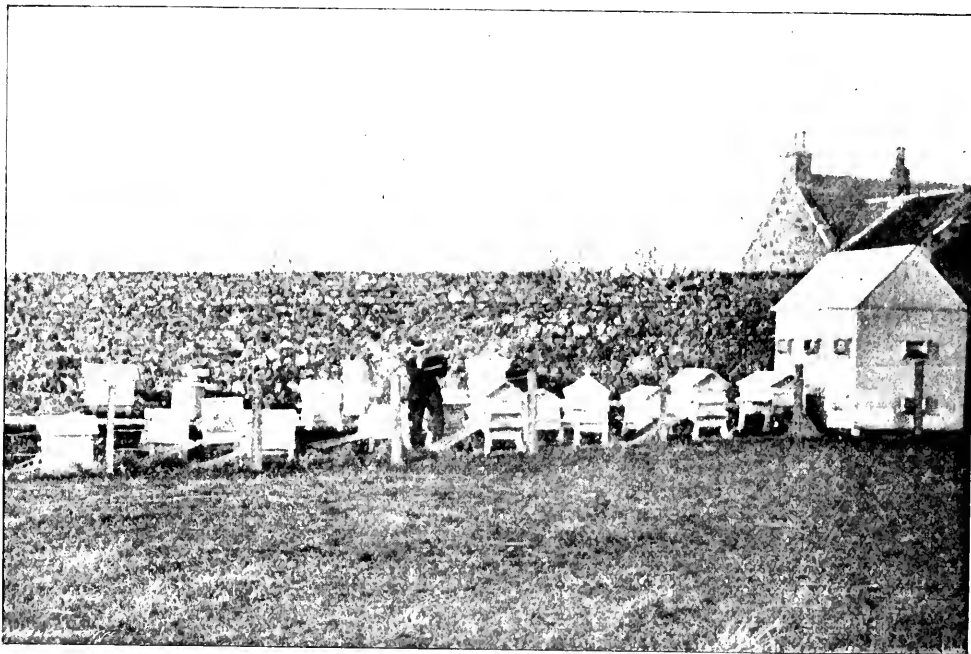

THE APIARY OF MR. JAS. GORDON, MIDDLEBURGH, ABERDEEN, N.B.

and ways; but, coming to know there was such a thing as a bee journal, I at once went in for your very valuable paper, the B.J., then edited by its founder, Mr. C. N. Abbott, also Cowan's *Guide Book*. These I have studied ever since, and they comprise the only learning I have had on bee culture. My first frame-hive was an Abbott's "combination," which gave me an idea of what hives should be, and ever since that time I have made my own, varied according to my ideas of efficiency.

I worked on at bee-keeping under unfavourable circumstances in a small garden of 30 ft. square with high walls in the centre of the town of Fraserburgh, and a mile from the nearest bee

I have no difficulty in disposing of my honey, and have this season sold 500 lb. at 9d., in bulk, and 1 lb. bottles at 1s. I rear most of my queens, and prefer to re-queen every year. I always see to packing well for winter, using one fold of calico, four folds of old carpeting, and one fold of brown paper and with no less than 20-lb. stores. In the whole of my experience have lost no more than eight or ten stocks through wintering.

You are so forbearing with correspondents that I have taken the courage to send you this epistle, but will be neither astonished nor disappointed if it goes into the W.P.B.—JAMES GORDON, *Fraserburgh, N.B., November 26, 1896.*

Correspondence.

The Editors do not hold themselves responsible for the opinions expressed by correspondents. No notice will be taken of anonymous communications, and correspondents are requested to write on one side of the paper only and give their real names and addresses, not necessarily for publication, but as a guarantee of good faith. Illustrations should be drawn on separate pieces of paper. We do not undertake to return rejected communications.

** * In order to facilitate reference, Correspondents when speaking of any letter or query previously inserted will oblige by mentioning the number of the letter, as well as the page on which it appears.*

“NOTES BY THE WAY.”

[2782.] The month of February, so far, is filling the dykes with water. What they will be filled with, during the half of the month still to come, time will prove. Possibly with snow, for some of the last “drifts” are still lying in the ditches, and the old saying here is that “it is waiting for more.” The past week has been as foggy as November. St. Valentine’s Day, however, proved to be the pleasantest we have had in 1897, and the apiary was one merry hum all day long, affording the bees a much-needed cleansing flight, and a chance of replenishing their larder. I noticed a good few dead bees brought out of three of the hives in the home apiary during the days of past week when the bees got a chance to carry on the carrying out work; so, to facilitate matters, I used the hooked wire to clear entrances. I have given to each of these colonies a cake of candy over the cluster, thinking there might be something in the stores to account for the abnormal death rate. If I find the candy a remedy, I will report later on.

Thanks, Messrs. Editors, for another peep at the Prize Trophy, on page 52, last week. The coming show raises a few questions to which I, in company with others who hope to be there, will be glad if the Exhibition Committee of the B.B.K.A. can supply the answers. First—Are the exhibits to stand on separate stands, *i.e.*, one stand for each county, and if so, what will be the height from ground of stand, and the size of the top of the stand? I notice that mead and vinegar may be used in addition to the 300 lb. of honey in making up the trophy. What quantity of each may be staged? I venture to think that the quantities mentioned in classes 385, 387, and 388 would be suitable quantities, and that if restricted quantities are mentioned it will give greater satisfaction than if it is left to the exhibitor’s own choice. Then another matter in connection with the stands will be security from thieves. With all due respect to Cottonopolis, there may possibly be some among the many who will crowd the show who will feel a *penchant* for a wee bottle of mead; and even an attendant continually on guard cannot see all the four sides of the exhibit at one time; therefore I suggest that a wire guard be provided for each trophy.

May I offer a final suggestion for what it is worth, and cash is worth a great deal to most associations, especially those connected with bee-keeping. I refer now to railway fares for the County Association members who are selected to stage their respective exhibits. Through tickets, I believe, can be procured from any railway at half the usual fare for any person acting on the staff of the R. A. Society. Now, as the expenses of the rail-fares will be borne by the Association competing, I trust the B.B.K.A. Executive will endeavour to procure the best terms possible, so that the associations may not be put to more expense than is really necessary.

Referring to the remark of your correspondent “H. E. S.” (2780, p. 56), on the different prices of honey, I take it that one is retail and the other wholesale. I have always contended that it is not doing justice to the grocer or dairyman—who sells your honey, say, at 1s. per section or jar, and for which you have charged, say, 9s. per dozen—to sell retail yourself at 9d. per section or jar. I have lost chances of sales at that price around home. My neighbours who keep bees, never having been in trade, cannot see any unfairness in retailing a pound or two of honey at the same price they get wholesale in the nearest town. But every labourer is worthy of his hire, and the shopkeeper who handles honey should be supported by the producer who supplies him. I am at one with “H. E. S.” as regards exorbitant prices for honey. I would also endeavour to prevent *undue* profits to the middleman.—W. WOODLEY, *Beeton, Newbury.*

BEE NOTES FROM SUSSEX.

ANTI-SWARMING CHAMBERS.—GLASS “QUILTS.”

[2783.] For the first time in my bee-keeping experience all my (fourteen) stocks have so far come safely through the winter. Only one (a late-divided stock) is very weak; some are stronger than I have yet seen them at this time of the year; all are in good condition and spirits.

There are now few days when some bees do not fly. Yesterday (February 11) there was quite a bee-carnival. Inside the hives, all stocks are busily cleaning up, appropriating the soft candy provided, and, in a few instances, making a beginning at comb-building. So, in spite of the dismal state of the weather, I still look forward to an early spring and honey gathering, and am getting everything in readiness for it betimes.

Anti-swarmling Chambers.—I am sorry I have disturbed Mr. Seamark’s equanimity (p. 47, No. 2775) by hinting at brood being possibly raised between the dummies of an anti-swarmling chamber on his plan. I merely suggested that this might have taken place. I have reasons for not wishing to pull the hive in question to pieces for some time yet, but whenever I do I shall, of course, know how

the matter stands for certain, and will announce the result. But surely Mr. Seamark cannot really mean that brood cannot be raised by the bees between dummies hung $\frac{1}{4}$ inch apart? No doubt, regular combs could not be built in the usual way, but rows of cells, even drone size, could certainly be built running lengthwise between the dummies along the $\frac{1}{4}$ -inch interspaces. The bees can build burr combs in situations more cramped than that.

At any rate, that hive, and none other, yielded the curious diminutive bees I mentioned. If, however, the highly satisfactory experience of last season is corroborated by that of the next, as soon as I can afford it I shall double my body-boxes, this being the only way in which I can carry out the system on my pattern of hive. So I thoroughly appreciate the practical advantages of Mr. Seamark's plan, and believe it to be efficacious. The cost of double body-boxes and dummies is its only drawback.

Further, I believe the bees, being distant from the cold outer air by the whole depth of the lower dummy-filled body-box, winter better, with much less loss of bee life. The hive is also much more easy to handle—say in changing floor-boards, for instance: the bees are clustering in an upper story, and have a journey to make before they can come and see what is the matter; and long before their hurried arrival on the scene the little operation is happily over.

Glass "Quilts."—In the Editorial answer to "A. H." (p. 60, foot of first column), it seems to be assumed that the glass "quilt" must necessarily be raised above the top bars, so as to allow the bees free passage below the glass over the tops of the frames. This is my own arrangement, because I believe it to be the most comfortable plan for the bees, and because it enables the glass to be more easily detached in the spring, when the happy tiering-up time arrives.

But the glass could perfectly well, if so desired, rest immediately on the top bars, like an ordinary quilt; only in this case it might be wise to provide winter passages for the bees through the combs beneath.

Let me take this opportunity of thanking "Artificer" (2757, p. 17) for his exceedingly useful and welcome explanation of how to cut the absolutely necessary feed-holes in these glass "quilts." I have not yet been able to try his method, having sufficient perforated panes on hand; but I will do so ere long, and report results. "Glass quilt" is certainly not a satisfactory term. Can any one suggest a better, which will not be mistaken for something else? "Glass cover" sounds like a glass roof, and I can think of no expression free from objection. Hence I have fallen back upon "glass quilt" as the least misleading.

The Season.—Out of doors everything is terribly backward. We have not seen the sun for weeks. Mud and water have everything their own way. In my garden, only

snowdrops are out. Crocuses are coming up only to wither away. Let, however, but a ray of sunshine appear, and how altered will all this be! And vegetation will be all the better for having been kept back.—W. R. N., *Sussex*, February 12, 1897.

THE ROYAL SHOW, 1897.

[2784.] I am very sorry and disappointed to see that in the schedule of prizes for honey at the Royal Show in Manchester one very important and hitherto well patronised class has been left out, viz., that for extracted honey of 1896 (or any previous year) other than granulated. As the schedule now stands, there is only one class for light honey in bottles—that of 1897—and as bee-keepers in the South alone can have any such honey ready for exhibition by June 23, the result will be that very little (comparatively) light honey will be staged, to the great loss—in appearance, at any rate—of the show. Besides, northern bee-keepers will have no opportunity, except in the trophy class, of showing on their own ground the quality of the honey which the North can produce. We have a prize offered for 1896 sections. Why have the bottles been overlooked? As this is the first year we have had classes at the "Royal" for heather and dark honey, the probability is that not much will have been kept back, especially as 1896 was not the best of seasons on the moors, and as a consequence a poor display. Seeing that so much money has been given in prizes, in my humble opinion it is a pity that one class, which has had such a prominent place in previous years, has been withdrawn.—"BRUEN," *Chester*.

[Our correspondent has evidently overlooked the fact that the class for extracted honey of any previous year was not included in the schedule for 1896. Nor do we know of any objection having been made to its omission. Had such been the case the probability is the class for honey of previous years would have again been added.—Eds.]

ECHINOPS SPHEROCEPHALUS.

[2785.] Don't be afraid! It is not a new disease of bees. It is simply the Chapman honey plant or globe thistle. The generic name means "like a hedgehog." The specific or Christian (?) name (spherocephalus) means round-headed. Yet, for all that, you must not read it "round-headed like a hedgehog!"

I used to grow this plant years before it was brought to the special notice of bee-keepers—having begged seed of it from a botanic garden. Very handsome it is on an August day, with its bold, green, and tomentose foliage and stalwart stems branching above you against the horizon wall; but lovelier still, I think, when seen in the stillness that comes with dusk, or under the soft radiance

of the moon, when the hedgehog-like heads are moved mysteriously by fiery-eyed revellers at the midnight feast, and when the moon hides the daggers that lurk among the leaves.

"The sun goes down, and with him takes the coarseness of my poor attire ; The fair moon mounts, and aye the flame of gipsy beauty blazes higher."

There are a dozen or more species of globe thistle, natives of Europe. Two that are dwarf—about 2 ft. high—true perennials, and very handsome in the garden, or, in a dry state, in vases for winter decoration, are *Echinops ruthenicus* from South Russia and *E. ritro* from the countries bordering the Mediterranean. They have lovely metallic-blue heads, and for decorative purposes should be gathered before the florets open. The grey heads of *our* globe-thistle are also worthy of being used for the same purpose.

Our globe thistle is a biennial, but sometimes will live three or more years. In cold districts it is useless to expect it to flower the same year that the seed is sown. The best plan is to sow in April where the plant is to remain ; the seedlings to be thinned out quite 4 ft. apart. It will then make huge plants the first year and flower the year after.

You should present seeds to all your gardening friends, but be careful to call it the Chapman honey plant, for if you call it the globe thistle they will probably forget to sow the seed ; or, when you meet them next and inquire how the plants are progressing, they will say, "Oh, they came up all right, and then a worm got at the roots and killed them." People don't care about thistles, not even globe thistles, in the garden ! Some years ago I gave seeds to a friend who dotes on dahlias and French marigolds. Now, when I go along the road he elevates the tip of his nose and pretends not to know me ! On one round-head you may sometimes count as many as ten bees—mostly humble bees. They frequently stay there all night, and if you touch one, he puts out his arm and says, "Go waysh. I'm all (hic) risch. Lesh 'ave 'nuther boshle !" —LORDSWOOD.

APICULTURAL NOTES.

A FEW PLAIN WORDS ON THE PRICE OF HONEY.

[2786.] In "Notes by the Way," B.J., February 4 (2771, p. 45), Mr. W. Woodley refers to a matter which is affecting all bee-keepers who have embarked in the business with a view of making a profit therefrom, viz., the decline in the price of honey. If we compare present prices with those of ten or fifteen years ago, there is indeed a big difference ; and when we take into account what is now going on in the bee world, it does—to use Mr. Woodley's words—"make one wonder what the prices will be ten years hence." There are, however, so many matters in everyday life to worry and harass one's mind that it would,

I think, be unwise to add to our troubles by worrying about things which may or may not happen ten years hence. At the same time it would be equally unwise to shut our eyes to facts with which we shall sooner or later have to deal. Bee-keeping, during the last ten years, has made rapid strides, and is still on the increase, which, of course, we are glad to know. We who now belong to the craft do all that lays in our power to extend the art of bee-keeping and enlist recruits into our army. We complain of the price of honey being low, but at the same time willingly subscribe to one or more societies whose main object is to extend the bee-keeping industry, or, in other words, bring us more competitors. We throw open our apiaries and workshops to pupils free of charge ; make known ideas which are the outcome of years of hard study, hard work, and the expenditure of hard earnings. We also give freely to any and all who care to benefit themselves at our expense. Then we send our representatives to the County Council, and through them impress upon the said Councils that if they wish to do us bee-keepers a good turn they cannot show their good feeling towards us better than by voting the largest sum of money they possibly can to be spent in a way which will bring us the utmost number of competitors, and in our anxiety to accomplish those ends we paint matters in the brightest of colours. If we have ten hives of bees, one of which gives us 100 lb. of surplus honey in one year, while the other nine do nothing, we very carefully keep the latter nine in the background—that is, we say nothing about them, or very little at all events, and what we do say about them is never repeated. The one thing we harp on is the wonderful return of the *one* hive. We talk about it years and years after it happens, and everybody we tell it to talks about it also, and if our friend, the lecturer, happens to hear of it he drums it into the ears of every audience he is privileged to address. Well, the outcome of all this is a constant increase in the number of bee-keepers, so that year by year the honey dealer finds a widely-extended source from whence to draw his supplies ; with the natural and inevitable result of lower prices. There are a few bee-keepers—myself amongst the number—who begin to wonder how far distant the day is when we shall be called "The Society of Fools," and whether we as members thereof will ever be alive to the wisdom of abandoning philanthropy in favour of utility and common sense ? Were I to stop here I should probably be called a pessimist, selfish, and a host of other unpleasant names which I trust I don't deserve. But I always like to look on both sides of a question, and having said thus much on the somewhat gloomy side of bee-keeping, let us see if anything can be said on the bright side.

In the first place we will take the reduced price of honey, which, if it will only remain where it is and not go any lower, is not, after

all, so bad as at first sight appears. We can through various causes get larger yields of honey now than was the case years ago, which of itself partly compensates for the reduced price. Everything we use in connection with bee-keeping is very much cheaper. Some of the articles are from 60 to 70 per cent. lower than they were when I adopted the modern system of bee-keeping nearly twenty years ago. Honey is not the only thing that has declined in value; everything we eat and nearly everything we use in every shape and form has gone down in price; consequently the purchasing value of a given sum of money at the present time is very much greater than it was years ago—a fact which, if borne in mind, would often enable us to crush dissatisfied feelings. Another thing which we must not lose sight of is the fact that there are thousands of people who have never yet tasted honey, while at the same time tons of honey are wasted because there are no bees to collect it. If this honey which is now wasted could be profitably gathered, not only would it benefit those who would look after the bees, but scores of others would be benefited either directly or indirectly thereby. It is therefore a most desirable thing to increase and extend the bee-keeping business, provided we can in the same ratio increase the demand for honey. But to go on increasing the supply with a constant downward grade of prices means that sooner or later a point will be reached where profit will cease. If, therefore, bee-keeping is to continue to be a profitable and growing industry, we must one and all do our level best to extend the honey market. Those who are in a position to work up a retail trade should not let the opportunity pass. Those who have to rely on the wholesale trade should be careful to send out nothing but good stuff put up in an attractive form and carefully packed for transit, so that the dealer is put to no unnecessary trouble, and has every encouragement offered him to push the sale of honey. Although what may be called an extensive bee-keeper, I am always able to dispose of my produce and more besides; and in spite of low prices, foreign competition, increased competition at home, &c., I am not inclined to take a gloomy view of British bee-keeping. Personally the apicultural outlook was never brighter. I have become acquainted with honest dealers, who are willing to pay me a fair price for a good article. My bees were never at this time of the year in better condition than at the present time.—A. SHARP, *The Apiary, Brampton, Hunts.*

THE DOUBLE-QUEEN OR "WELLS" SYSTEM.

[2787.] Is it possible to get those who have tried the "Wells" system to give their experiences in the B.J., and especially those who have been unsuccessful? A comparison

of such notes may be most useful in the coming season. Now and then we hear of good results, but I must say that though I have mixed much with bee-keepers during the last few years, I have not come across one who has been altogether successful with the double-queen system. I have tried it several times, and have in more ways than one failed. Sometimes, for instance, one of the queens has disappeared before or after the supers have been put on. Sometimes the bees from one side pass over to the other, leaving one queen with a mere handful of bees on two or three frames, and the number seems never to increase, though the other side becomes unusually strong. Perhaps the hive under these conditions has given a little more surplus than a single-queened hive, but still the expected success has not been realised. I am not—as our Editors know—a novice at bee-keeping, and the hives which I have used are by well-known makers. I admit Mr. Wells's own results are invariably wonderful, especially his yield of wax. I cannot think how he gets such a cake from so few hives. I wish the secret of his success could be easily learnt.

I take this opportunity of thanking you for the views of the apiaries which are appearing in the B.J. They are most interesting.—BRUEN, *Chester.*

BEE ASSOCIATIONS AND FOUL BROOD.

[2788.] I write to inform you, though you will have seen it in our communicated report, that at our annual meeting, held on January 28, we passed a resolution approving unanimately of the draft measure for the prevention of bee pest, and earnestly requesting that everything be done to induce the authorities, who have already so far interested themselves, to maintain their interest, and to proceed as speedily as possible with this Bill, which to us and all bee-keepers is of such great import. As secretary of this Association, I am able to judge by our experts' reports of the terrible ravages foul brood is making. Out of our 300 members, over fifty have the disease in their apiaries; while several have at present no bees left at all. I believe the disease to be even worse than I have stated, for in one locality, where the expert returns only four diseased stocks, a member who is the doctor of the place, and much interested in the bee industry, writes:—"I am afraid I shall not be able to attend the annual meeting. I would much like to, as, unfortunately, I am interested in foul brood. Unless we get legislation shortly it will stop bee-keeping in this parish, as every hive is, I believe, affected more or less." The reference to foul brood was owing to the fact of our having arranged to make the matter the *prominent subject* at our annual meeting. A most instructive and helpful paper was read by one of our members, but the meeting was of the opinion that the *only*

permanent help for us lies in the passing of this Bill for dealing with bee pest. Doubtless to the outsider it seems a trivial matter, but it is quite as important to the cottager and small holder—who form the majority of our members—as ever the Diseases of Animals Act was to the farmer. Excuse my troubling you with this lengthy communication, but our Association wants you to know how thoroughly we appreciate the efforts that are being made, and how anxiously we await their results.—H. HILL DAWE, *Hon. Sec. Bristol and District B.K.A.*

Echoes from the Hives.

Honey Cott., Weston, Leamington, February 13.—Up to the end of 1896 the bees had many opportunities to fly, the weather being mild and damp, and very little frost intervening. Christmas Day was particularly mild, the bees turning out in great numbers. This, according to newspaper accounts, caused some people to think the bees had swarmed. January was fairly favourable, but in the latter part of the month we had sharp frost and drifting snow. I shaded the hive entrances, but when the sun shone the reflected light brought some of the bees out, and they had a difficulty in finding the entrance again. On February 9 the thermometer rose to 49 deg. in the shade, and the bees got a much needed flight. When putting up my stocks for winter, I prepared winter passages on tops of the frames, but it continued so mild up to Christmas that I began to think it was a needless trouble. When the frost and snow came, however, my regrets disappeared, and I now find all stocks have come out in fair condition. On February 9 it was a sight to see the bees on the wet snow, and at watering places by hundreds. I had to cover up our water butts, &c., to keep them from drowning. Where the bees had soiled the entrances most, I have given them clean floor-board, and found the bees looked nice and bright, none the worse, because I was under the apprehension some of them had a touch of dysentery. On Saturday at dinner-time I thought I had just time to change a board, so I lifted the stock on to a stand close to the place where they usually stand, and put the clean board on there, so that as soon as I lift them off and on to the fresh board, any bees that fly are right for the old place. Well, this lot I did not go to the trouble to give them a puff of smoke, so when they were lifted I had to beat a hasty retreat, as I had a lot of them at me wizz, wizz, wizzing in my hair and on my coat. For my own usage I much prefer loose boards to those with fixed floor-boards, as they are so much easier manipulated. I was glad to note from last week's B.J. that Mr. Martin had reached South Africa, and got his bees safely through the journey out. I felt interested in reading of it, as he and I rode

together, with Mr. T. Sells and Mr. W. Martin, of High Wycomb, in the same bus from the Agricultural Hall to the conversation at Jermyn-street, and as we went along, Mr. J. Martin told us of his projected journey to South Africa.—JOHN WALTON.

Queries and Replies.

[1657.] *Shading Hives in Summer.*—1. Do you recommend complete shading of hives with calico when working for extracted honey? My hives have a space of 2 in. between the inner and outer sides. My apiary is situated in a garden having a large number of fruit-trees, and, being sheltered from all winds, the hives facing the south will have to stand a lot of heat. 2. I have hitherto used only broad-shouldered frames, but from what I read in BEE JOURNAL I gather that frames with metal ends are preferable. Is this so? And do the metal ends keep the frames in their proper place laterally? Because if they do I would have no trouble in introducing them into my hives. 3. I intend working hives with twelve frames to reduce swarming to a minimum, but, according to catalogues I have, dealers supply only boxes holding ten shallow frames. Would you have boxes made to hold twelve shallow frames so as to exactly cover the twelve frames in body-box? 4. With regard to supering and the use of the extractor, would one shallow-frame box give as good results as two or three tiered, in accordance with the instructions given in Mr. Cowan's "Guide Book"? Referring to what Mr. A. Sharp says in his "Apicultural Notes" in your issue of February 4 (2772), what I wanted to know was whether the 2 lb. section was filled almost as quickly as the 1 lb. one; because, if so, it could be sold proportionately a little cheaper than the latter; and the figures I gave did not necessarily imply that they (2 lb. sections) would be sold at 1s. or 1s. 1d. each. I should be sorry if I were the means of preventing that gentleman from experimenting, as he intended doing. I may say I am only an amateur bee-keeper keeping bees more for my pleasure than anything else, although, of course, I am glad to see them pay more than my out-of-pocket expenses.—JERSEYITE, *Jersey, February 13.*

REPLY.—1. Hives having double walls as stated should do without any shading in hot weather if free ventilation be given. 2. If by "metal ends" you refer only to the "W. B. C." end, these do not regulate lateral spacing; the hive sides beyond the ends of frames do this. The question of superiority of the broad shoulder or metal end for spacing frames is merely one of personal preference. 3. It is certainly advantageous to have brood and surplus chambers uniform in outside dimensions above frames. 4. To use only one box for surplus involves continuous attention and

labour; we much prefer to tier several boxes high.

[1658.] *Introducing Queens in "Wells" Hives.*—Can a queen be successfully introduced in the queenless part of a "Wells" hive with laying queen in the other compartment, or is it necessary to divide with an ordinary dummy before introduction?—SEEKER.

REPLY.—If ordinary precautions are observed a queen may be introduced to a stock in a "Wells" hive as easily as in any other.

[1659.] *Ascertaining if Hives are Queenless.*—In "Work for the Month," in your monthly, the *Record*, for February, we are advised to give a frame of eggs, when queen cells will be seen a few days later; thus preparing the bees for a strange queen being introduced a few weeks hence. Might I ask why the bees may not be left to raise their own queen from these queen cells? They can transfer the eggs, can they not?—GEORGE M. SAUNDERS.

REPLY.—The bees could certainly raise a queen as stated; but of what use would she be when raised, if there are no drones on the wing to secure her being fertilised? The object for which the particular advice is given in our monthly is there fully stated, *i.e.*, to ascertain whether bees suspected of queenlessness are really so.

[1660.] *Deserted Hives.*—What is the best to be done with three frame-hives, which, on examining my stocks the other day, I found completely empty of bees, dead or alive? There is abundance of honey in all three hives, perfectly. The combs being sealed up, some of them contain a certain portion of pollen, which latter is mouldy in places. Will it be advisable to put other bees into them in March out of straw skeps? I have in all twenty-three frame-hives placed quite close together on a long stand. Is it possible that the bees of hives mentioned may have joined their neighbours, owing to want of sufficient space between the hives? Please say what is best to be done, as it is my first year with frame-hives.—AUSTIN ANDREWS, *Easingwold*, February 9.

REPLY.—First remove the sealed combs indoors for safety, if the hives cannot be so closed up as to be made bee-proof from outside. The probability is that the bees have joined their near neighbours after becoming queenless last autumn, or it may be after swarming. A few of the combs of food may be given to swarms, and others given to needy stocks in March or April next.

[1661.] *Making Soft Bee-Candy.*—May I ask your opinion on the enclosed candy, which I made ten days or so ago? Is it too hard, or is it right for the bees? I boiled it half an hour, so fear that may be too long, as one of your B.B.J. contributors last week said he boiled his ten minutes only. The "Guide Book" mentions no time (recipe 5),

but I bravely plunged my forefinger into the boiling syrup, according to directions, but with very poor result as to the "little ball" alluded to, for the syrup did not adhere sufficiently to produce a perceptible lump, but vanished in the cold-water plunge. 2. Also, may I ask your opinion of the enclosed samples of honey, all taken from my hives at different periods? Is any of it first class? It is not for competition, only for my own satisfaction and future guide; so, your opinion would be treated confidentially. 3. Of what species is enclosed bee? I suppose "black," as all my bees are "driven" from neighbouring cottagers' hives. I am the proud possessor of sixteen hives, and must give you their history some time.—QUEEN BEE, *Bridport*, February 13.

REPLY.—1. Sample of candy received is excellent, in fact could not be better for the purpose. 2. Of the four samples No. 1 is best, and is a nice honey; No. 2 is rather coarse in grain, but fairly good; in No. 3 fermentation has started, so this might be used for making honey-vinegar; No. 4 is also beginning to show slight signs of fermentation, and should be warmed up to re-liquefy, then used at once, otherwise it must be utilised as No. 3. 3. Bee is not a "black" but shows signs of carniolan markings.

Notices to Correspondents & Inquirers.

All queries forwarded will be attended to, and those only of personal interest will be answered in this column.

A CORRESPONDENT, who signs himself "Sussex," says I have been expecting to hear suggestions from bee-keepers for a specially-designed honey-label to commemorate the Queen's Diamond Jubilee. Wouldn't a queen-bee printed in gold, with words "The Queen's Diamond Jubilee Year, 1897," look well for a design?

J. M. H. (Worthing)—*The "Cowan Hive."*—Any firm of appliance dealers will make the hive to order. Our rule is not to recommend any special manufacturer, or we could name several who supply the hive referred to.

FIREMAN (Dundee).—The bees sent seem the ordinary or brown variety, but they were so smashed in post as to be almost unrecognisable.

L. F. K. (Belvedere, Kent)—*Mice and Bees.*—The skep has evidently been damaged by the inroads of mice, as shown by the debris found on floor-board. The brown-looking liquid we should take to be honey, run from the cells, eaten by the mice. You do not say if bees are still alive.

ESSEX (Earls Colne).—*Removing Sections.*—If a properly constructed super-clearer is used there need be no such risk of "sections smelling of carbolic acid," as stated. The trouble in "making the bees savage by using the smoker to get the honey" is also entirely obviated, and no intimidant need be used.

Editorial, Notices, &c.

ASSISTING "THE CAUSE."

The prompt response to the request—published in our issue of the 11th inst.—that advantage should be taken of the season for holding the annual meetings of county associations for strengthening the hands of the parent body in their effort to obtain legislation for dealing with foul brood, deserves the best thanks of all bee-keepers; and when supplemented by such a clear statement of the situation as that of the hon. sec. of the Bristol and District B.K.A., on page 68, last week, will greatly help in the direction needed. Several other associations have also rendered assistance by passing resolutions approving of the action of the B.B.K.A.

Those who are specially interesting themselves in this matter may rest assured that the Council of the "British" value their help. The difficulty of obtaining actual statistics is very great, because the mischief, even where it exists, is often unrecognised by many bee-keepers. And still worse, it is, unhappily, often concealed where it is known; hence a double difficulty presents itself in the collecting of information. Nevertheless, all should do their best to supply reliable information.

In view of the criticism which is bound to be directed against evidence tendered in support of the foul brood measure, those who report resolutions passed at association meetings, or at special meetings of bee-keepers convened for the purpose, should make every effort to secure a good attendance, and state:—

- (1) The districts represented.
- (2) Whether the resolution is carried unanimously.
- (3) If any dissentients, state how many.

Special forms for the use of association secretaries or individual bee-keepers will be at once issued by the B.B.K.A., in order to assist the collection of information.

Bee-keepers can render great service at the present juncture by furnishing the required data, and in those districts where no associations exist, individuals who are able to contribute evidence

should at once write to Edwin H. Young, Secretary B.B.K.A., 12, Hanover-square, London, for the forms referred to.

LANCASHIRE AND CHESHIRE B.K.A.

ANNUAL MEETING.

The annual general meeting of the above Association was held on the 15th inst. at Chapman's Vegetarian Restaurant, Eberle-street, Liverpool. There was a very good attendance of members, among those present being Messrs. *T. D. Schofield (hon. treas.), *Geo. Rose, T. H. Hughes, W. E. Hall, *B. E. Jones (hon. sec.), *F. H. Taylor (hon. librarian), T. F. Harrison, J. Ikin, *J. A. Bally, *J. Rodgers, *Thos. Gartland, *J. Bell, L. Collings, W. Forrester, H. Firth, J. T. Hale, *J. Warburton, W. Lewis, J. N. Bold, W. J. Anstey, *Geo. Roberts, T. Shuttleworth, S. Comber, *J. Lamb, *W. H. Chapman, J. L. Titherley, and Revs. T. J. Evans and E. Charley. (Those marked * are officers or members of committee.)

J. Bell, Esq., was voted into the chair, and after the report and balance-sheet had been read and duly approved of by the meeting, the president for the year was chosen, Lord Derby again being elected president. Several new names were added to the list of vice-presidents; all the officers of the Association, except the hon. auditor and three of the Committee, were re-elected. The hon. auditor (Mr. H. W. Johnson, of Preston) having unfortunately died quite recently, a vote of condolence was passed with Mr. Johnson's family.

The work of the Association has been very satisfactory during the past year, the expert work in particular having been well carried out by engaging an expert for each county, and the plan succeeded admirably, the visits to members being got through early, practically every member of the Association receiving a visit. Financially, also, the Association is in a very fair position, and the same plan with regard to the expert work—though rather expensive—is to be followed this year.

The matter of the *County Honey Trophy Competition* at Manchester, in June next, was discussed, and it was resolved to make every effort to get up a good exhibit to represent the Lancashire Association.

A vote of confidence in the B.B.K.A., in their work and efforts to obtain legislation on foul brood, was passed unanimously.

After the meeting most of those present sat down to tea provided by Mr. Chapman, whose courtesy in allowing the use of his rooms for these meetings is greatly appreciated.

The Committee afterwards held their first meeting of the year, when the Chairman, Wm. Tyrer, Esq., J.P., was re-elected.—BENJ. E. JONES, Hon. Sec., *Freckleton, Preston, Feb. 22.*

Correspondence.

The Editors do not hold themselves responsible for the opinions expressed by correspondents. No notice will be taken of anonymous communications, and correspondents are requested to write on one side of the paper only and give their real names and addresses, not necessarily for publication, but as a guarantee of good faith. Illustrations should be drawn on separate pieces of paper. We do not undertake to return rejected communications.

Communications relating to the literary department, reports of Associations, Shows, Meetings, Echoes, Queries, Books for Review, &c., must be addressed only to "The EDITORS of the 'British Bee Journal,' 17, King William-street, Strand, London, W.C." All business communications relating to Advertisements, &c., must be addressed to "THE MANAGER, 'British Bee Journal' Office, 17, King William-street, Strand, London, W.C."

**. In order to facilitate reference, Correspondents, when speaking of any letter or query previously inserted will oblige by mentioning the number of the letter, as well as the page on which it appears.*

DOINGS OF THE PAST MONTH.

[2789.] During the last few weeks I have been impressed by very clear indications, in the shape of correspondence, &c., that bee-keeping is advancing rapidly into a popular pursuit; nor are there wanting signs of its possibly becoming a fashionable pastime. The year 1897, if the weather be propitious—and all the signs point to a good season—bids fair to make a record, so far as new votaries taking up our hobby are concerned. Newspapers and journals dealing with rural matters are devoting more or less space to the matter, and all are ready to welcome articles on bees from any one of repute in the craft. I, however, have not at present much time to devote to contributions beyond this column in the B.J., and my special location in your monthly, the *Record*.

In view of the probability of a large number of beginners swelling our ranks during the now fast approaching season, a word of advice should be given against the purchase of bees and second-hand appliances without a guarantee as to their state and condition with regard to disease. I have before me, as I write, letters from several would-be bee-keepers who, within the last twelve months, have from motives of economy been induced to make purchases which have turned out disastrous in the way indicated. They are naturally disgusted, and in one case the bitten one has abandoned the pursuit, believing all bee-keepers to be rogues. In the other two cases my advice has been sought, and I have given it as follows: Procure natural swarms from healthy districts, and buy new hives and appliances; they are often as cheap as some second-hand ones, and contain no latent germs of "F. B."

Another and very important question—especially to the uninitiated—has been put to me, viz.:—"What kind of bees shall I go in for?" Well, I have tried nearly every race of bees procurable, and my unqualified answer is that there is nothing to beat the hybrid native bee, crossed preferably with Italian. I say

"hybrid native bee" advisedly, as some folk speak of the pure native strain; but for myself I have failed to come across this article, and in my humble opinion there is no such a thing as a pure native bee to be had in this kingdom. The Carniolan bee is in a great measure answerable for this, but so far as my judgment goes all the bees in the United Kingdom have been crossed by the one or other of the imported races. A little thought on the subject will show how difficult it is for any strain of bees in this country to be kept perfectly pure. No bee-keeper can either control the flight of the queen on her mating trip or restrain other people's drones, and the more plentiful bees become the less chance will there be of getting even a percentage of our queens mated exactly as desired. All that can be done in this direction is by careful selection of our queen mothers, and also of drones within our own apiaries; and only when the progeny of the newly-mated queens are actually seen can the bee-man tell how his plans for mating have succeeded or failed. The task of selecting mothers for future queens is one upon which I have been busily engaged for some days past, this being the time to consider and find out the wintering qualities of our stocks, for this is one of the prime factors in securing success in the future; and to this end we must closely watch the powers of queens for building up stocks quickly during the next few weeks, this being a very important point if we would reach perfection in our workers.

Should we regret our inability to control queen-mating? I say not a whit! In my opinion it is the best thing that could happen. If man in the past had had his way in this matter the honey bee in this kingdom would not have been worth the name. Nature scoffs at man's artifices to circumvent her, and has her sway notwithstanding. To keep bees pure for even a limited time there must be—as in every other branch of natural history—a large amount of in-breeding, and it is an incontestable fact that where this is permitted deterioration of all good qualities takes place. The vital forces are weakened and undermined by decay and disease. This is so in everything, and nature's saving clause is fresh blood, which means fresh vitality, and in our craft, hybrid bees.

These, as I have said, and many other considerations have been engaging my attention during the non-active season amongst the bees. I have, however, gone over all hives so far as to ascertain that quilts were dry and given soft candy where needed. That stores are short, I know, and during the next few weeks it is as well to make sure that supplies do not give out entirely, and should another sharp snap of cold occur I shall close entrances to half an inch and add to coverings of all stocks. It is pleasing to see the great interest being taken in the coming County Competition at Manchester. The members of the Kent and Sussex B.K.A. are getting quite enthusiastic over it,

and promises of help are not wanting from very many directions. Though honey is short in the south several are reserving some for this event, and we hope to supplement it with honey of '97, if weather is kind. It seems pretty certain also that activity is being stirred up all round, and an earnest determination shown to prove what British bee-keepers can do by associated effort towards assisting in placing our pursuit prominently to the front, and the "Royal" show of the Jubilee year seems likely to form a red-letter week in the bee-keepers' calendar; 1897 also promises to be a record year in another direction. I refer to the illustrations in *BEE JOURNAL* and *Record*. This is another advance, no doubt appreciated by all readers. One that will enable future generations of bee-keepers to look back upon the aparies of their forefathers and gaze upon pictures from life of the "Homes of the Honey Bees" and of bee-men themselves in the Diamond Jubilee Year of the great Victorian era.—HENRY W. BRICE, *Upper Norwood*.

A LADY BEE-KEEPER'S EXPERIENCE OF BEE "DRIVING."

[2790.] I feel that the time has come when I must unburden myself of some of the cares and anxieties of my numerous and rather lively "family," and make you, Messrs. long-suffering Editors, the sharers, and perhaps easers, of these same anxieties. Perhaps, too, some of my experiences and blunders may interest, amuse, or warn some of my fellow beginners. I may as well confess at once that mere amusement was not my motive for starting bee-keeping, but actual "filthy lucre," and a low desire to add to my revenues. With such sordid motives, perhaps I don't deserve to succeed—but I mean to. No one could have been more thoroughly deluged with cold water in the matter than I and my budding apiarian efforts by my better half. The dismal pictures he held up before my maternal eyes of the terrible disasters that might or would befall our little cherub progeny, till I felt like a monster in human form, and was fully persuaded that through my instrumentality one or another of our olive branches would fall a victim to a whole hiveful of belligerent bees, who, of *malice prepense*, would bury their stings in fair, round, little lumps; and for months after my apiary became an established fact the maternal ear was ever on the rack, straining itself for the sounds of piercing screams and agonised cries for help. But bees are not demons incarnate; or, rather, a special providence watches over children, who go fearlessly and unharmed quite close to "mother's bees;" and, though now I boast sixteen stocks, hardly more than two or three stings have been inflicted on the youngsters. But this is anticipating. Being of a somewhat obstinate disposition, bees I

was determined to have as soon as chance should favour me. So I was delighted when a lady in our parish confided to me that she was very anxious to get rid of hers; they "stung her gardener so," and would I like them? I jumped at the offer, at once ordered a few necessary appliances, veil, &c., and in the course of a few days had them safely conveyed to our own garden (about a mile). I wrote for one of Mr. Redshaw's "Royal" and one Melton hive, and then came the question of driving. Armed with my open "Guide Book," bee veil, and thick gloves, our man similarly attired in attendance, I made my first effort on August 1, 1895, but from pure terror when a few irate bees pounced at me, when prising up the sides of the skep, I let it down again with somewhat of a bang and precipitately fled! Mr. Editor, I must confess that once more I made the attempt and once more failed! Then I thought I would invoke the aid of a cottager close by, who keeps bees and "understands all about them." He came armed with a huge screwdriver, and prised the hive up so vigorously that, notwithstanding my vehement puffs of smoke, the bees were all over the place in the wildest state of ire, and I once more gave the word for retreat, for I saw it would be a hopeless task to do anything with them then. I could not help a sly laugh at my fearless helper when one of the little demons stung him on the throat and he exclaimed, in his broadest "Darseet," "He've got I!" Well, Mr. Editor, I felt thoroughly ashamed of my pusillanimity, so I said to our man the next day, "Hayling, stings or no stings, I'm going to drive those bees to-day." "Very good, num; I'm ready." This time I dispensed with my cottage help, raised the sides of the skep very cautiously, and, in fact, followed the "Guide's" instructions on driving to the letter, and then, with the courage of despair, inverted the skep into the pail, clapped the empty one on the top, fixed the irons and began to beat. It was almost too good to be true when I saw them begin to run up, first in desultory, inquisitive twos and threes, then in brisker half-dozens, and then in hurrying, skurrying, jostling, hustling crowds. On we beat with our hands alternately till almost every bee was up, and, flushed with triumph, we set the skep in a shady place ready for the "hiving" process. In a few minutes all was ready, and I shook the bees (whose amiability had by this time given me confidence) on to the sheet, the top edges of which were fixed under the raised front of my Melton hive, and they soon ran in and seemed quite pleased with their new quarters. After covering them snugly up and returning to see to their old home full of honey, I found, to my dismay, that I had been stupid enough to forget to cover it with a cloth or have it carried to the house, so all the bees in the neighbourhood had taken possession, and we had more trouble to dislodge them than the original bees.

Several of our villagers also wanted to

start bee-keeping, so I had agitated the County Council, and we were to have a bee lecture, demonstration, magic lantern, &c., so I reserved my second hive for this occasion, and our nice and clever old lecturer, Mr. T., "drove" them on our lawn, the villagers standing at a respectful distance from the bees, and our more timorous guests gazing from behind the protection of our drawing-room and study windows; and when Mr. T. lowered the skep full of the clustered, driven bees on to his own bare and veiless head, without a single sting, the enthusiasm of his audience knew no bounds. He gave us many useful hints about hives, management, &c., and, in short, put us in the way wherein we should go.

After this my bravery increased, and with Hayling's help for lifting the heavy skeps of honey and bees on to the bucket, and also to do some of the actual beating, I drove eighteen or twenty cottagers' skeps of condemned bees. I made myself a loose blouse of red Turkey twill to slip over the head, with "elastic" run in the hem round the neck, so that when my veil was tucked in no bees could crawl up or down. Elastic at the wrists and a belt at the waist made me practically bee-proof, save when an occasional crawler would give me an unfriendly dig through my stocking. I kept as near to the "Guide Book" instructions as I could, and an occasional hint from the pages of your B.B.J., and soon the task was quite easy. We gave one or two puffs of smoke to start with in at the entrance, and while the bees were "thinking about it," gently eased up the sides of the skep to free it from the stand, giving one or two more puffs at the sides; then in four or five minutes two rather smart claps with the hands on the sides of the hive, one puff at the entrance, and immediately lift the hive gently, and carry it to the stand, and begin tapping as soon as the inverted empty hive is quickly put over it. I found a wheelbarrow made a capital stand, and was generally available, and a comfortable height. Oh! how my gloves got covered with stings, till they were sometimes quite white with their roots torn from the poor bees. For sometimes you can't help crushing a bee in clapping, and then comes another and another, and the smell of the stings makes them quite angry. So I determined, "stings or no stings," to dismiss the gloves, and soon got braver, and very often drove three or four stocks without a single sting. But, oh! sometimes without, to my knowledge, doing or leaving undone anything I ought not, the bees were very demons incarnate, flying ping, ping, at us, bizz, bizz, into us, nothing, not even a little warm syrup sprinkled over the tops of their combs, seeming to pacify them; but there was nothing for it but to go on, though I confess, Mr. Editor, my hands did smart with twenty or thirty stings in them, and it is not pleasant to have them quite hitting you in their rage. I

know you ought to drive about noon, but for the encouragement of those who can't, I may say that I drove all my lots in '95, after 5.30 or 6 p.m. After driving, I set the skep of bees on a sheet on the ground, and there it stayed while I drove the others. Then, after all were done (three or four perhaps), I shook in each case the few bees that had gathered in the empty skep placed on the old stand on to the sheet close to the driven bees, and they soon gathered in. Then I tied them up securely in the sheet, with a string round near the rim of the hive to keep all in, and then we started homewards, sometimes quite in the dusk, for, perhaps, a six or seven miles drive home; and I think, Mr. Editor, you would have been amused to see my man and myself emerging from beneath numerous white bundles in my little pony cart, looking almost as though we were conveying home clothes-baskets of washing from some big laundry. On arriving home, we put the skeps, still tied up, in the dairy, ready for operations on the morrow; and my cook would be half frightened at the powerful hum of the imprisoned multitudes. I always joined two stocks to make one strong one, and to do this had my sheet spread ready, with its edge under the hive, then carefully loosened the wrap from skep and shook the bees in a heap as near the hive as I could, powdered them well with flour from the cook's dredger, and they soon began to run up (a sloping board from ground to hive was under the sheet), and when well started, I treated the other skep in the same way, dredging them also well with flour, and there was never any fighting, all went in together most amiably.—
"QUEEN BEE," *February 18.*

BEEES AND BOB-HOWLERS.

[2791.] The sun burnt fiercely (as scientists tell us) ninety million miles away; and at that distance from it the loose-strife which coloured the banks of the Severn a rosy hue, cranesbill and soap-wort and meadow-sweet, that grew in tangled thickets—all were glad that they had their roots within reach of the cool and refreshing water. When the sun nears the zenith it is best to lie in the shadow of an elm. The many walls of boughs packed with leaves are excellent non-conductors of heat, and greensward beneath is more to be desired than cushions of feathers or horsehair. Sweet are the sun-flakes that tumble down from between the leaves, sweet as honey are white clover-heads, and very satisfying, even to a daffodil-grower, are a few acres of buttercups. There is a breath of air here by the river, but beyond in the forest, where the young oaks stand islanded in a sea of lavender-coloured scabious, over which sail chequered silver-washed frilliarics; or where the brake-fern has taken possession of miles of territory—soft undulating waves of green fronds that smell delicious as you tread them under foot, or

gather and bruise them in the hand—there it is hot and oppressive. Even when you keep among the ferns and foxgloves you sigh for the cool wind, but how much more along the stony “ride,” where the sun’s rays become Röntgen “X”-rays, for the forest rises steeply to the north and south, more gently to the east and west, so that in this hollow space there is nothing to divert the high tide of heat waves that beat with relentless fury on the furze and wiry heather. Revelling in the heat, however, there were butterflies settled on the hot path, the peacock, and the comma.

After walking in the forest all day I came down to a little stone-built farmhouse, hidden in orchard trees, and after making myself still hotter by drinking tea, I went with mine host into the garden to see how fared the bees. The farmer was a bit of a genius, like most farmers are. He used to argue to himself like this. “Why clean the fowl-roost out, for it will be just as bad again in two or three years’ time? What’s the use of growing eatable apples, for if I do the lads will be breaking down the fences a-getting after them? I wonder what folk grow flowers for; there’s no eatable toobers at the root of them?” By this kind of philosophy Farmer Restharrow saved himself a great deal of work and worry. He is likely to live—all being well—to a good old age, and when he gets past work his children will support him. Scale had attacked the jargonelle pear tree which covered the front of the house, till it was nearly leafless. The garden paths were grass overgrown, and fowls wandered about the perforated cabbages. When a swarm came off, Farmer Restharrow always set it by the spot where it had “lodged,” consequently the hives appeared to have been sprinkled about as you sow turnips. He also, when planting potatoes in the spring, planted them all round the hives. “Twill kip down the weeds,” said he. There were about a dozen hives; three frame hives and the rest skeps. Inside the frame hives he used old jackets and trousers in lieu of quilts. On the skeps, to keep out the wet, were old rotten sacks. “Can’t abide heckles,” said Restharrow. “My farether never would ’ave ’em, either. ‘Corses munny,’ he used to say, and ‘sacks corses nothin’.”

“I dunno’ wots the matter with the bees this ’ear,” he went on to tell me. “They’ve bin a doin’ nothin’; no ’art in ’em loike, and not ’ad a single swarm. That fraame hive there ain’t got above two ’undred bees in ’im. I put a lot o’ squares on top, but they ’aven’t touched ’em, so fur. An it’s a good hive, too. I ’ad ’im from a mon Bridgenorth way as gev thirty shillin’ for ’im from London, but I on’y gev ’im foive-an-twenty. D’yer moind ’avin a look at ’em for me, sir? I’ve got a vaal and sum bellus. The springs broke, but you can make it go by usin’ baath hands. I can do wi’out a vaal, sir, for th’ bees doan’t sting this moon, sir.”

I put on the veil, which was of white muslin

curtain net, and after lighting the bellows, opened, the first frame hive—the one with the two hundred bees. My friend, Restharrow, came and looked on as bold as brass. There was no quilt or anything on the sections! I took them off, lifted out a frame (after cutting through an inch of propolis to set it free), and lo! I set excited eyes, for the first time, on foul brood! The hive was in a fearful state of disease. I opened the other hives, and they were also diseased—some badly. The bees were vicious, as they usually are after a scorching day. In a little while (the moon notwithstanding) half a dozen bees had driven my friend to the hedge, in which he held his head as though he rather thought there might be a bird’s-nest or two found by careful examination. The bees stood on the wing at ease, a few inches from the hedge, ready at a moment’s notice to go mad in his back hair; so there he stood for about twenty minutes while I rigged the apiary to rights. Then I went and rescued him, and we walked up and down the orchard at the back for a space discussing what was to be done.

Said he, “O’ny to think of it! And me a wunderin’ wot was the matter wi’em all the time! Wish I’d never seed them patent fraame hives. I never ’ad the disease afore. It was that Bridgenorth mon a overpersuadin’ me, and it did seem cheap—on’y five-and-twenty shillin’s, and come all the way from London. Wish I’d kep’ to skeps now. My farether never ’ad anything aside skeps. It’s a judgment on me for goin’ in for newfangled things. As you’re stayin’ the night, sir, weel brimstun the worst two when it gets dark, and they’m all back from the forest; an’ if you will be so kind as to send me that stuff you’ve bin tellin’ me of—sally’s-sick, I think you said, sir?—I’ll dose ’em, sir; and maybe Sally will get all right agen, sir. Ah! Ah! What bird was that did you say, sir? It’s what we calls a goatsucker, but some folk call ’im a nightjar. He comes from forrin’ parts in May, and as soon as night draws on he croaks worsen frogs. But I need not tell you, sir; you knows more’n I do about birds and such like. I’ve seed several herons this turn in the lily pool up the forest, and there’s a wonderful sight of woodpeckers and jays about. We’es ’ad to look sharp after the chicks this turn. D’yer mind the time when I found that lobster caterpillar? I’ve kep’ my eyes open, but never seed another. It was a rare ’un, that was! I saw a young feller goin’ up in the forest a bit ago, after the moths. Talkin’ about moths, though, d’yer mind that night when we carried that ‘lightenin’-moth-conductor’ (as you calls it) trap o’ yours up into the ‘Rough,’ where the light shone out o’ the trap right across the forest? By George! To see the bob-howlers a comin’ as thick as snowflakes, a makin’ as if they would break the glass! And you a boxin’ of ’em as fast as children pick bilberries, and me with the net a plungin’ after ’em as come apast the

trap, and a ketchin', my legs in the heather and goin' wallopin' over! And you a tellin' me to stop makin' those cursory remarks about heather and bob-howlers. By George! I never luffed so much in my life afore or since. I wonder all the Earl's keepers from here to Cleobury-Mortimer didn't come to see what was oop. By George! that was a year for butterflies and moths, and for bees; I did 'ave some 'unny, and noa mistaak. D'yer mind the butterfly you call Adippé a swarmin' an' scuttlin' over the bracken in droves, and another as you call Paphia a floatin' and settlin' on the flowers of every Bramble briar? We'se never had so many since. Likely enough they'se got foul brood among 'em. By George! there was some flowers for the bees that year. Primmyrose flowers as thick as grass, and the forest blue up Birchfold way with devil's scabious; and d'ye remember the ling and heather and the beds o' foxgloves by where you found the redstart's nest? By where the King Georges (green dragon-flies) were thicker than gnats over the stream? By George! that was a year!"

And, by George! that was a year (1897) echoes—LORDSWOOD.

APICULTURAL NOTES.

MAINLY ABOUT "WEATHER" AND THE BEES.

[2792.] If at a future time any one wants to know what kind of weather we had during the month of February, 1897, the proper answer will be "samples" of all sorts. That, at least, is what we have had in this locality. The month came in with snow and frost, followed by a rapid thaw and dense fog. Then came heavy rains, in one case lasting three days and nights without ceasing. The result was the deepest flood we have had for a very long time. One bee-keeper in the neighbourhood had to get up early in the morning and wade his way through water several feet deep to rescue his bees, which were in a perilous position, water having already got several inches up the body-boxes, so much so that, when the hives were lifted up, the water ran out of the mouth like running out of a spout. But favourable weather followed, and the bees took no harm. February 8 was a mild day, and a good number of bees were on the wing; the 10th, however, was the day of salvation for the bees—it was a real summer's day. Every hive looked as if it were going to swarm, and there is no doubt that every bee had a cleansing flight, which was badly needed. They had not had such an outing for upwards of five months, and I was getting quite anxious about them. I knew from past experience that unless they soon had a thorough cleansing flight dysentery in a bad form would be the result. But the beautiful summer weather on the day named dispersed all such fear, and there is no longer any dread of an outbreak of the disease. Two little lots left their hives and joined their neighbours, and thus saved

me the trouble of uniting. All hives in my home apiaries—about ninety in number—have been supplied with clean floor boards, and entrances, which were set wide open as a prevention against dysentery, have been narrowed to about 2 in. Up to Christmas bees seemed to consume very little food, but since then it has disappeared at a marvellously rapid rate. During the past week I have found several stocks short of stores, in which cases a quart of warm syrup has been given, together with a lump of candy. You will perhaps say, Messrs. Editors, that it is too early to give syrup, and that the necessity for so doing is the result of bad management. Well, perhaps it is; but how to overcome that "management" I know not. One of the greatest nuisances we have to contend with in this district is a superabundance of pollen, and how to ascertain even approximately how much honey a stock has got is often a very difficult matter. It sometimes happens that a stock which appears to be well provisioned with stores is in a very short time found to be on the point of starvation. That is partly why I make the frequent examinations at this time of year mentioned in previous "notes." As to the time for giving syrup, I may say that I have given bees syrup at all times of the year when necessity has arisen without any bad results following. Candy is a splendid bee-food, but bees will not flourish on candy alone for any length of time, especially if they cannot get water. My advice, therefore, to all who find their stocks short of food is to give, in addition to candy, a quart of warm syrup, and repeat dose as often as necessary. A 3-lb. jam bottle with a piece of coarse strainer over mouth, placed on frames close to cluster, is the best feeder that can be used for the purpose.

So far stocks are coming through well, but, of course, we are not out of the wood yet. There is the risk of spring dwindling, robbing, and queenlessness, all of which we may have to contend with in the near future.—A. SHARP, *The Apiary, Brampton, Hunts.*

ADVICE TO BEGINNERS.

OPINIONS WANTED ON "EXTRACTING," NON-SWARMING, AND BROOD-SPREADING.

[2793.] I am a beginner at bee-keeping. Last year I bought a stock of bees and hive complete, also a swarm in June, was told "not to be disappointed should you get no honey this season." I did get a taste, but hope to get much more this season. I want honey (extracted) not swarms. Reading the "Guide Book" and B.B. JOURNAL had decided me to work on the storifying plans described in "Guide Book" (page 57), but after seeing the letter on "Date for Supering Hives" (2779, p. 55), and your remarks thereto, I am in doubts as to storifying being the best for me considering my total ignorance of all methods.

Will some of the veterans in the craft

kindly give us recruits the benefit of their experience as to the best way of getting extracted honey? The experience of your correspondent referred to—who says on page 56—"I extracted my first box of frames (71 lbs.) on June 26," makes one's mouth water. Referring to the Non-Swarming Chambers mentioned in B.J. of February 4 (pp. 47, 48), are there any sketches of them in back numbers? mine begins in March, 1896. There is a reference to B.J. of Jan. 23, 1896, which I have asked our local agent to get me.

Two other articles in B.J. have greatly interested me, viz., that on "Superseding Queens," on December 24, 1896 (p. 519), and the one entitled "The Value of Strong Colonies" on February 4, 1897 (p. 49). I hope the veterans will have their say on those questions, especially on the subject of "Reversing the Brood Nest," as mentioned on February 4 (p. 49).—W. C. H., *South Devon, February 17.*

[An article on "Prevention of Swarming," with illustrations of non-swarming chamber, appears in B.J. of December 5 and 12, 1895, from the pen of Mr. S. Simmins. The non-swarming chamber referred to on page 47 of our issue of the 4th inst., is fully described (but not illustrated) in B.J. of January 23, 1896. The terms "Reversing the Brood Nest," used by Mr. Doolittle on page 49, are intended to apply to the operation known in this country as "Spreading Brood." But regarding the particular operation so described, while we shall be very pleased to insert any "veteran" opinion with which our correspondent may be favoured in our columns, it is one highly dangerous in the hands of beginners. So much so that, while acknowledging its advantages in experienced hands, we shall never encourage its indiscriminate adoption by novices, who have in times past done so much "brood-chilling" by practising it.—Eds.]

SOME BEE NOTES FROM DERBY.

[2794.] *Soft Candy.*—Your correspondent R. Brown gives a recipe for making candy (2773, p. 46) which I find works out excellently, and removes the difficulty of the time required for boiling. There is one little matter, however, that I would point out, and that is, cottager bee-keepers do not all possess "copper or brass stewpans" in which the sugar may be boiled, and if one of these is not to hand take my assurance that candy may be made in a common iron saucepan with a little care.

Bee-Keeping in West Dorset.—An epidemic of "modern bee-keeping" seems to have broken out in the neighbourhood of Bridport. Hundreds of stocks were rescued from the sulphur pit last autumn, and the driven bees placed in bar-frames. Some of these have wintered remarkably well, and are gathering pollen in large quantities. The old "skeppists" are gravely inquiring what is to be done with all the honey the new-fashioned hives are going to produce? Perhaps the price will have

to come down; if it does, so much the better for those to whom honey has been considered an expensive luxury.

An Experiment on "Old Customs."—According to tradition, every owner of a straw skep and sulphur pit knows that whenever a death takes place in a family, the bees should be apprised of the fact, and the hives decorated with a piece of crape. Now, some friends of mine in Dorsetshire have recently lost the head of the family by death, and although one of the "bearers" reminded the mourners that the bees had not been put into mourning, this important ceremony was neglected, and in all probability some thirty stocks will die off. There is this possibility, however, the bees in the hives were nearly all driven stocks last autumn, and they may—having been in the family for so short a time—overlook the "crape." Further, most of the bees are in "Cowan" hives, and, in consequence, may have modern ideas about funeral reform and going into mourning, and possibly may refuse to keep up the traditions of their ancestors, who only lived in common straw skeps. If the experiment of dispensing with the crape does end disastrously it is proposed to send you a photo of the apiary in question a little later in the season.—F. C., *Derby, February 20.*

ECHINOPS SPHÆROCEPHALUS

AND THE SEA-HOLLY, OR THISTLE.

[2795.] No, Mr. "Lordswood," don't alarm yourself respecting our fears, we have only to cast our "north eye" down to the foot of the paper, see your name, then we take the rest as a matter of course. A kind of "forewarned, forearmed," don't yer know.

But to be serious, have you ever seen the sea-holly, or thistle (*Eryngium maritimum*) growing on the sand-banks of the Welsh coast? If you have, and know the secret of its cultivation, I am certain all bee lovers and amateur gardeners would bless every hair of your head (even your friend (?) who scrapes the sky with "the tip of his nose") if you would "drap the woard." It grows in abundance on Prestatyn banks, a little village three miles from Rhyl. The flowers, which are plentiful, are of a beautiful blue, with leaves of the same shape as our holly (*Ilex*), only in colour varying from lavender to a whitish grey. The whole is a beautiful bunch of ornaunt. The Welsh people use it in the dry state for decorating vases and filling empty fireplaces. The bees, too, are passionately fond of this thistle, no matter when or where you see it you will find scores of bees, to use your own words, "avin' a nuther boshle!"

I might say, *en passant*, that several of my acquaintances have tried to cultivate it, but have failed totally.

If you, "Mr. Lordswood," or our Editors, have not had the pleasure of seeing this beau-

tiful plant, I will gladly forward some when it is in its prime, *i.e.*, in July and August.

I notice that our Editors have had a little "say" about the "homes of the honey bee?" Well, I for one think that it has relieved a want. It has put "life" into the journal, making it more in touch with the readers. Surely, Mr. W. B. Webster knows the old adage, "Silence gives consent."—A. A. WALKER, *The Orchards, Bolchill, Tamworth, February 20.*

[So far as one of "Our Editors," he will be very pleased to have a few seeds for his own garden. Our friend "Lordswood" will, no doubt, answer for himself.—EDS.]

MAKING SOFT CANDY.

[2796.] If you can find space in the JOURNAL I should much like to thank Mr. R. Brown for so fully replying to my query as to making soft candy. I have carefully carried out his instructions (on page 46) with the best results, and have made a candy which the bees have taken with the greatest avidity. I must also thank you, Messrs. Editors, for so kindly laying my inquiry before Mr. Brown.—A. DUMMY (enlightened), *Wellington, Salop, February 22.*

Queries and Replies.

[1662.] *Transferring Bees from Worn-out Hives.*—I have a strong stock of bees in a very old bar-frame hive, the woodwork of which is quite rotten. The combs and frames are so old and dirty and propolised together, that it is impossible to move them. Would it be advisable to wrench off the bottom of the hive (the floor board is fixed) and place it bodily on the top of a new bar-frame hive? Or could I turn the old hive upside down, and place it on the top of the new one? 2. Can either of these plans be carried out now? 3. How long will it take the bees to work down into the new hive, and when could I remove the old hive and put it on another new one, so as to get two stocks of bees this season?—E. C. BIRD, *Chew Magna, Bristol.*

REPLY.—1. We should "wrench off" (as you term it) the floor-board of the hive and set it above a new one, after fitting the frames of the latter with full sheets of foundation. If the nails securing the fixed bottom to body box are not "clinched" it will not be a very difficult job, but an assistant will be needed to keep the bees quiet by smoke while operating. 2. The sooner the fixed floor is loosened the better, if a fine day be chosen when bees are flying, but do not take the board away till the hive becomes fairly full of bees, say, middle of April. To remove the floor-board before there are plenty of bees in the hive would only

retard breeding. 3. "Right here," as the Americans say. You cannot make two stocks from one by moving the old hive to a new stand after the bees have worked down into and taken possession of the new one. To do this would simply mean making an end of the old hive, as the bees would leave it and return to the new hive left on the old stand.

[1663.] *Self-hivers versus Queen Traps.*—I do not quite understand your reply to my question on swarm catchers in JOURNAL for February 4 (p. 50). You say, "By using a queen trap" swarms will never be lost, no matter what becomes of the queen. 1. Will the hives not swarm at all, or what becomes of the queen? I have four new hives, and hope to have as many swarms as I can manage. The skeps are kept for swarms only. Excuse my writing so soon again, but I want to have everything ready for the coming season. 2. I had one hive very thickly populated last summer with drones. Would you advise the use of a drone trap with this hive?—F. C. JUN., *Raholp.*

REPLY.—1. We said "swarms will never be lost" because the queen, being secured in the trap, gets no chance of flight along with the bees, and, in consequence, they return to the hive. The fact is so well known to bee-keepers that a swarm (if left to itself) invariably returns to the hive should any accident happen to the queen, or if by any means she does not leave in the general exodus, that we did not think it needful to explain more fully than we did why this was so. 2. Instead of using a drone trap to rid a hive of superfluous drones, the combs should be overhauled, and any excess of drone-comb cut out from the frames, to be replaced by worker-comb. A very few inches of drone-comb is sufficient for each hive.

[1664.] *Syrup Making.*—1. In B.J. of February 2, 1893 (p. 44), Mr. W. Woodley says—"I pour boiling water on the sugar, stirring until dissolved, and it answers the purpose just as well as the best boiled syrup." Is he still of that opinion? 2. *Soluble phenyle* is mentioned in "Guide Book" (p. 150). Where is this to be got, and at what price?—W. C. H., *South Devon.*

REPLY.—1. We cannot say. Perhaps Mr. W. will himself reply. 2. From Messrs. Morris, Little, & Co., Doncaster, price 6d. and 1s. per bottle.

[1665.] *Bees Dying on Snow in February.*—I have what is, I suppose, the only stock of bees for miles around. I know no bee-keeper personally, and have only seen bees manipulated once, so you will see the need I am in for advice. My only knowledge has been gained by reading. I wintered my stock upon seven frames, with about 3 in. of sealed food and a cake of candy over frames. I saw few bees till the 7th inst., when the bright sun brought them out in great numbers, and some

died on the snow, which latter was spotted a good deal with what I take to be the effect of dysentery. I shaded and narrowed the entrance. Sunday last (February 14) being mild and snow gone, the bees flew out strong, some dropping to the ground and dying in a short time, or going into a stupor; some dozen or so were huddled together till I warmed them in a box, when they flew off all right. I examined the hive and found the end combs uncapped and clean, so I put in a comb of sealed honey at the side from which I had taken it. 1. From the above, can you tell me why the bees die in this way, and a remedy? Can it be lack of proper food, as candy is still on? 2. Is it ever advisable to close the entrance, if it is ventilated when closed? 3. Is it likely the bees will survive for a few weeks, as they seem now strong in numbers? 4. When making candy should it go hard when cold; or be so soft as to be easily impressed with the finger?—*JOHN H. PRIESTLEY, Small Lees Mill, Ripponden, February 16.*

REPLY.—1. We rather think there is not much cause for alarm. If bees are now strong in numbers, and will take soft candy freely, they will probably be all right. It often causes fear among beginners to see dead bees about hives in the early spring, when there is nothing to fear as to the safety of the stock. Keep a supply of soft candy over the cluster and renew as consumed. 2. Do not close entrance entirely on any account. Keep it narrowed to 1 or 2 in., and shade in bright sunshine. 3. Yes. 4. It should be somewhat "buttery" in texture, and easily made soft by rubbing with the finger nail.

[1666.] *Utilising Combs of Unsealed Food.*—What can or shall I do with eight shallow-frames of last season's honey only partly sealed? They are shallow-frames with "wide ends," and were put on a stock above feed-hole in quilts at end of season, hoping the bees would carry the unsealed honey down into body-box below, but they would not, as brood frames were very full of stores. The bees having been packed for winter, I left crate on top of quilts, where it has since remained. Can I give this honey in March as food in place of syrup, or should I put the box of combs on a hive in May and allow the bees to arrange the unsealed stores as they think fit?—*WINDSOR, February 22.*

REPLY.—We should give a frame or more of the unsealed honey to such stocks as need food now or during next month, and let the bees carry it down into brood-nest below, allowing access to the box containing the frames only through feed-hole in quilts, and without further disturbing the latter.

[1667.] *Joining Weak and Strong Stocks in "Wells" Hive.*—Saturday the 6th inst. being so warm, I made an examination of my bees, and found all in excellent condition, with the exception of one hive in which I was sorry to find quite three parts of the bees dead,

not more than a pint of bees being left alive. There is plenty of sealed honey in the hive, so they are not dying off for lack of food. I lifted out one comb and found the queen all right. Will you kindly say:—1. Do you think it possible I shall pull this stock through? I placed a cake of warm candy over the cluster and reduced hive to three frames, then covered up warmly. 2. I have made a "Wells" hive, and, the adjoining stock to this weak one being very strong, would you advise me to put these two stocks in the "Wells" hive, placing one on each side of the perforated "Wells" dummy? I had other intentions for the "Wells" hive, but if you think I shall stand a better chance with the weak stock close to their strong neighbours, I should of course place them thus.—*J. W. BROWNING, Woodchester, Glos.*

REPLY.—1. There is not much hope of building up "a pint of bees" into a useful colony for this season's work, though it would not be difficult to keep the queen alive and well for future use if needed for re-queening with. We have, however, known a pint of bees in February, with a good queen, do well the same season; but it is not, as a rule, advisable to "potter" with such weak lots of bees in spring. 2. We should reserve the "Wells" hive for a better first trial of the double-queen system than your proposal affords, and carry out your "other intentions" with regard to it.

[1668.] *Forming Nuclei and Raising Queens.*—I have one hive, which has an old queen (three years), and I think it would be advisable to introduce another, and have thought out the following plan: "Remove queen from the hive along with three frames—one with a sheet of foundation and two with brood well covered with bees—and form a nucleus colony with these; as the old queen lays eggs in the newly formed cells I should take these out and return them to the old hive, replacing them by fresh frames with new sheets of foundation." 1. Is this plan feasible? 2. What is the earliest date I could form the nucleus if the plan will work?—*C. V. B., Southgate, February 22.*

REPLY.—1. This is practically forming an artificial swarm (or making two colonies from one) on a plan differing from that described on page 92 of "Guide Book," i.e., leaving queen and flying bees to form the swarm on old stand, while new queens are raised in the removed portion. Without declaring that our correspondent's plan is not "feasible," we may say that, compared with the one in book referred to, it is far less reliable. If it is desired to get rid of the old queen, we should adopt the "Guide Book" plan, and remove her a day or two before queen-cells were ready for inserting in her stead. 2. Artificial swarming operations and nucleus forming should not be done until weather is settled and warm (about middle of May) and drones are flying freely.

Echoes from the Hives.

Tothill, Alford, Lincs, February 18.—All my thirty-five stocks have wintered very well, and seem to be wonderfully strong. I have not made a thorough examination, but on lifting quilts the bees are seen in great quantities. I hear of a few stocks being dead, but this is mostly the bee-keeper's own fault.—R. GODSON.

Radstock, Somerset.—After the past few weeks of incessant rain and fog in this part of the bee world, we are at last having a few fine days, Sunday, the 14th, being a lovely day. The bees had a regular turn out; their merry hum in the beautiful sunshine was quite cheering. Nor was this the only bit of enjoyment to be derived from the scene, for I think the most modest of us could not help having a quiet laugh to see a neighbour on passing the apiary saluting right and left, and uttering what one could imagine were nasty names for the poor bees gambolling overhead. On the 15th, and several days since, the bees were busy flying in thousands, many of them coming in loaded with pollen, which, in my opinion, is a good sign of an early spring. To show the mildness of the season here, I might say that, while out for a walk on Sunday, the 14th, I found a beautiful yellow butterfly on the hedge, such, I think, as is seldom seen at the offices of the B.B.J. so early in the year.—J. S. BIGGS.

Notices to Correspondents & Inquirers.

All queries forwarded will be attended to, and those only of personal interest will be answered in this column.

A. P. LUCAS (Aberdeen).—*Price of Driven Bees.*—We send by book post a copy of BEE JOURNAL for the month mentioned in your note (August 20, 1896), wherein the price of driven bees is seen, by advertisements therein, to range from 1s. 3d. to 1s. 6d. per lb. for bees driven and put on rail by sellers. To talk about claiming 30s. for two small lots of bees "driven from skeps by yourself" is simple nonsense, and we should never for a moment think of paying any such sum. If action is taken against you for recovery of the amount, the copy of our JOURNAL will, no doubt, be sufficient to convince any County Court judge of the absurdity of the claim.

GEO. E. BELLEW (Wellingborough).—*Experts' Certificates.—Judging Beeswax.*—1. For the particulars regarding experts' certificates, application must be made to Mr. E. H. Young, Sec. British Bee-keepers' Association, 12, Hanover-square, London. 2. Beeswax at bee and honey shows is judged from the bee-keeper's standpoint, not from the "British Pharmacopœia" standard. For a judge to say that samples staged were "not white enough to answer the 'British Pharmacopœia' standard, and melted just under

150 deg. Fah.," would be to imply that his knowledge was acquired rather from books than from practical knowledge of the subject. Pure beeswax melts at a few degrees below 150 Fah., and white wax is never staged at shows—at least, with a somewhat extended experience, we never saw it staged in competition. It is, therefore, unnecessary to suggest that "white and yellow wax should be shown in separate classes." 3. Candidates are not eligible for first-class certificates without having previously secured those of second and third class.

J. F. G. (Stevenage).—*Fermenting Honey.*—Fermentation is caused through the honey being unripe when extracted. As you have only 4 lb. left we should utilise it in a trial of honey-vinegar making, on the plan described on p. 443 of B.J. for November 5 last. On no account should fermented honey be given to bees as food; it greatly tends to induce dysentery.

R. CHAPMAN (Newton).—*Queen Traps and Drone Traps.*—A trap that will lead drones into a space below the hive entrance and there imprison them without any chance to re-enter the hive would in a measure serve the purpose of a queen-trap, but not so well as one made expressly for avoiding the evil of absconding swarms. The point to bear in mind is that no swarm will fly off and be lost unless the queen be included among the swarms. And the object of the "trap" is to prevent her escape. This done, there need be no fear about losing the swarm.

F. W. MORRY (Ventnor).—*Honey Samples.*—The honey sent is very fair indeed in quality; good in colour and consistency. There is a distinct flavour of "maple" about it however (reminding one of maple syrup), which would, in a measure, reduce its "points" on the show bench.

A. SUBSCRIBER (Rotherham).—*Position for Hives.*—A distance of twenty yards from the public road is quite sufficient, as is ten yards from the house, if the bees are judiciously managed. Four yards from the garden pathway is also ample space in front, so far as accommodating the bees in their flight, but if there is any nervousness on the part of those having to pass the hives, it might however be entirely removed—by growing a row of runner beans in front—as you suggest, or by fixing a screen of lattice-work, made with laths, about three yards in front of the hives, over which the bees would pass and interfere with no one.

X. Y. Z. (Blackley, Manchester).—*Using Unsealed Syrup.*—It will be quite safe at this season to use a comb of unsealed syrup (taken from another hive) for a stock needing food, so long as the bees from which it was removed are healthy.

Replies to NOVICE (Talgarth), C. HOYLE, LILLIE MARTINEAU, JOHN BANTING, and several others will appear next week.

Editorial, Notices, &c.

USEFUL HINTS.

WEATHER.—After a long spell of cold, with dull, cloudy skies, and much rain, we are again beginning to see rifts in the blue, and once more get a glimpse of sunshine. The past winter may, on the whole, be described as a dull and cheerless one, from the bee-keeper's standpoint. And no doubt the temperature has been sufficiently high during most of the time to keep the bees moving indoors, though not suitable for outside flights. According to the *Standard*, a retrospect of the weather during the past winter shows that, while many and frequent changes have been experienced, both the temperature and rainfall for the period, as a whole, are in fair agreement with average conditions. The total winter rainfall has not been heavy in Scotland and Ireland, but the rainfall in December was in excess of the average in most parts of the United Kingdom, while the northern districts especially have escaped the heavy rain since the commencement of the present year, although small amounts have fallen generally and with unusual frequency. In the last two months the deficiency of rain amounts to as much as five inches over the greater part of Scotland, and there is also a considerable deficiency in Ireland; but matters are very different over England. During the latter part of January and for the first fortnight in February the rainfall was excessive over England, the total fall in many places in a few days exceeding the average for a whole month. The temperature, taking the country as a whole, was not very different from the mean for the winter, the period of cold in January being neutralised by the exceptionally mild weather which prevailed during the greater part of February. On three or four days in February, at Greenwich, the black bulb thermometer in the sun's rays has registered 80 deg. or more, while on the 18th it rose to 92 deg. In the middle of February, both at one and two feet deep, the ground was 3 deg. warmer than the average. The sunshine in London has been deficient in all of the winter months, the total deficiency amounting to about 33 hours, the aggre-

gate number of hours of bright sunshine in the three months from December to February being only about 40 hours. In February the total sunshine was only 18 hours, which is 14 hours less than usual. The winter, on the whole, has been particularly free from storms, although December will be remembered as having seen the destruction of the Old Chain Pier at Brighton. The floods, however, in the early part of February proved very destructive over a large part of England.

STOCKS SHORT OF FOOD.—The few recent days of sunshine have brought out bees well, and shows them to be strong on the wing and in numbers. It will, we fear, have also discovered to many bee-keepers the fact that the comparatively open winter has told heavily on stores, necessitating an immediate supply to some colonies. We have already heard of a stock or two—otherwise healthy and strong—being found in almost a state of coma from sheer exhaustion owing to want of food. Nothing can well be more annoying than this, because it nearly always involves chilling of the whole of the brood in the hive. Whenever a case in any way approaching this is discovered in time, the best course is to remove the hive, at dusk, bodily indoors, into a warm room, take out a comb next the benumbed bees, and substitute a frame of comb, the cells of which are well charged with warm syrup. This done, close the hive entrance, replace the quilts, and set above them a couple of warm bricks. In a few minutes the bees—if not too far gone—will begin to revive and may be heard moving; while in the course of a couple of hours they will sometimes have so far recovered as to feed well, and rearrange the syrup in the combs. By the following morning they will have settled down again in a close cluster. They may then be returned to their outside stand and fed up on such combs as are left after removal of those containing chilled and dead brood. It should be clearly understood that, in desperate cases of impending starvation, warm syrup should always be given at once, candy at such times being of little use.

UTILISING OLD COMBS.—It is vain to hope that no hives will be found during the next few weeks in which the bees

have—from one cause or another—perished! This being so, a word of warning may be given not to allow free access to such hives for a day longer than is necessary. Pending an examination as to the cause of death, the entrances should be closed at once. Then, at the first favourable opportunity, carefully examine all the frames and allow no desire to preserve combs “because they are good ones” stand between them and the melting-pot, if suspicious only, and burning outright if affected with foul brood. Destruction of a few pounds of honey and the combs containing it is a matter of trifling moment, yet not a few have recklessly risked contaminating a whole apiary rather than burn the lot! There is no need, however, to go to the other extreme. If no cells of unhatched brood are found—in hives where the bees have perished—the combs are perfectly safe for use either with swarms or in other ways. All we ask in the interest of readers themselves, and of bee-keepers generally, is to avoid carelessness in the matter, and so keep clear of risk.

NOTTINGHAMSHIRE B. K. A.

ANNUAL MEETING.

The annual meeting of the members of this Association was held on Saturday, February 21, at the People's Hall, Heathcote-street, Nottingham, the Rev. H. L. Williams (Bleasby) in the chair. Amongst those present were—Messrs. Geo. Hayes (secretary), P. Scattergood (auditor), A. G. Pugh, R. W. Turner, J. Herrod, W. Herrod, T. Marshall, G. Marshall, J. Wright, G. Wood, A. Warner, J. Rawson, W. Poxon, J. Gray, W. P. Meadows (Syston), R. G. Glew, M. Lindley, J. Annable, and others.

The Secretary read a letter from Viscount St. Vincent (President) expressing his regret at being unable to attend and preside upon this occasion.

In moving the adoption of the balance-sheet, which showed a small deficiency, Mr. Scattergood said he had gone carefully through the accounts, and could bear testimony to the accuracy with which they had been kept.

The Secretary announced that Viscount St. Vincent had sent a cheque for £6, with a request that the balance, after payment of his subscription of one guinea, should go towards making up the deficiency on the balance-sheet.

Mr. Pugh, in seconding the motion, said it behoved them to see if there were not more Lord St. Vincent's in the county.

It was announced that the Chairman, the Rev. H. L. Williams, had doubled his yearly subscription.

The balance-sheet was unanimously adopted.

The Secretary then read the annual report, which dealt with the bee-season of 1896 and the work of the past year generally. Among other items it was stated that there was a small increase of membership compared with that of '95. Also that the Notts County Council had increased their grant for technical instruction in bee-keeping from £20 in '95 to £30 last year. It was also hoped that a further increase would be got for 1897.

The report was adopted unanimously, and a vote of thanks to Viscount St. Vincent for his services to the Association, and a request that his lordship be asked to again accept the position of president, was carried *nem. con.*

Mr. George Hayes was elected treasurer and secretary to the Association, and Mr. P. Scattergood re-appointed auditor. Messrs. Hayes and Pugh were chosen as representatives on the British Bee-keepers' Association.

After which several matters of interest were discussed, including a proposed entry for the County Honey Trophy Competition at the Royal Show at Manchester.

The meeting concluded with a vote of thanks to the chairman for presiding.

At the close of the meeting tea was partaken of by the members, and a distribution of medals and certificates followed. The meeting terminated with the usual prize drawing.—(Communicated.)

Correspondence.

The Editors do not hold themselves responsible for the opinions expressed by correspondents. No notice will be taken of anonymous communications, and correspondents are requested to write on one side of the paper only and give their real names and addresses, not necessarily for publication, but as a guarantee of good faith. Illustrations should be drawn on separate pieces of paper. We do not undertake to return rejected communications.

In order to facilitate reference, Correspondents, when speaking of any letter or query previously inserted will oblige by mentioning the number of the letter, as well as the page on which it appears.

NOTES BY THE WAY.

[2797.] The month of March is opening in characteristic style; rough winds veering from the south with barometer steadily falling betokens March storms. Favourable bee weather prevailed during the last half of February, bees visiting the watering places in large numbers, others got loads of pollen from somewhere, though the barrenness of the land at present makes one wonder where they find flowers from which to gather it. All this points to a new start, and proclaims that the bee season of 1897 has opened. With the increasing brood-nest there will be a greater

demand for food, and care must be taken that colonies are not in a half-starved condition.

The careful bee-keeper who attended to the wants of his bees early last autumn, and knows that his stocks have abundance of stores, will do well to leave them "doing well" till later in the month; but those who are not quite sure of this, or who may have a few lots of driven bees short of stores, should examine such stocks with as little disturbance as possible, and a cake of candy, bottle of syrup, or a frame of food from an established colony—if such can be spared—must be given at once.

This is the see 1-time of the year, now is the best time to sow honey-producing annuals, and also hardy biennials. Cultivated flowers, though not adding many pounds of honey to the brood-nest or super, may prove a help to the bees before the flowers in field or wood are in blossom; I, therefore, always urge that bee-keepers should try and help themselves. Another easy method of extending the breadth of bloom is to distribute your surplus plants freely among neighbours. It pays in more ways than honey and wax, by engendering a kindly feeling; and then, may be in May or June, your swarms settle on a neighbour's fruit-trees no trouble is made if the potato-patch gets trampled somewhat in securing the errant swarm.

Queenlessness.—If colonies are found queenless when examined, I find the best plan to adopt is to unite with the next stock, or with one that is weak in bees. I should not advise purchase of queens. If the stock you wish to unite the queenless bees to is some little distance bring them nearer together—say a yard every day *the bees are flying*. Then choose a fine warm afternoon for the union of forces; a little flour sprinkled over each lot will prevent any fighting, and will be useful to them as pollen. Artificial pollen may now be given in small quantities any day when bees are working. Either pea-flour or ordinary flour does very well, though I myself use a mixture of both. Where bees are located near woods yielding abundant forage, don't bother with artificial pollen: the bees will only clog up the cells with it to the exclusion of brood. I can only throw out hints; it is for every one to use his or her own judgment as to the necessity of following the same method. In large apiaries in exposed places artificial pollen is necessary, also watering troughs, for I feel sure that thousands of bees are saved in early spring by these precautions.

In reply to query 1664, p. 78, last week, I beg to say I still consider syrup made by pouring boiling water on the sugar and stirring till dissolved is equally good for bee food as syrup made by boiling.

I notice that the Foul-brood Inspector of Canada reports having visited eighty-eight apiaries during the year 1896, and found foul-brood in forty-one of them. He enumerates eighteen counties in which the apiaries were located, and says that he did not have to burn

one colony in 1896. His expenses amounted to 658 dols., or nearly 7½ dols. per apiary visited. Foul-brood must be on the decrease in Canada, comparing previous reports with the present one.—W. WOODLEY, *Beeton, Newburg.*

ERYNGIUM MARITIMUM.

THE SEA HOLLY.

[2798]. Your correspondent, A. A. Walker (2,795, p. 77), asks me if I ever saw the above plant. I say "Yes, many a time, and *felt* it also." It is abundant on the sand-hills, or "dunes," all round the coast of Britain and Ireland. I well remember going to bathe one morning on a secluded shore in Wales with my brother. We left our clothes by the sand-hills. I lingered in the briny ocean longer than my brother, and when I had had enough, and came to seek my clothes, I could not find them. The young beggar had hidden them! And there he was on a sand-dune, some distance off, laughing at me. I gave chase, until I saw two female forms looming in the distance, and that frightened me so I dashed, without looking, in among a bed—a lovely bed—of *Eryngium maritimum*! And then the two ladies fled, thinking, no doubt, it was (as the Scotchmen say) the "ill-thief" among the sandy dunes, and I verily believe the marks of that plant are on my feet now!

I understand from Mr. Walker's letter that neither he nor his friends can grow this plant, and if I can let them into the secret they, and all amateur gardeners, "will bless every hair of my head." Now, if this "blessing of every hair" acts in the same way as patent hair renewers are advertised to do, I shall be very glad; and so hasten to tell him that I have grown it by digging out a goodly-sized hole in the garden and filling the same with sand—in the first instance, with a keg of sand brought from the sea shore. It will, however, grow in the sandy soil of my garden with a little care, but is never of that lovely silky lustre as seen in the sweet air that slips off the waves that beat on every beach. The same thing is noticeable in other plants that come from districts where the air is pure. The Edelweiss (the name means "nobly white") grows freely enough with me, but it is certainly *not* nobly white; in fact, ignobly dingy.

There are about forty kinds of sea hollies in cultivation from different parts of the globe, and as some of them are much more beautiful than our own, and more easily grown, I venture to describe a few that I have grown here.

Eryngium giganteum (from Armenia) much resembles our native sea holly. Grows five or more feet high; comes up from self-sown seed, and is splendid for cutting.

E. alpinum, *E. amethystinum*, *E. bourgati*, *E. planum* are also very good. They vary in height and in the size and shape of the bracts. *E. oliverianum*, from the Orient, is however,

the handsomest of all. The stems and bracts have a most beautiful amethystine bloom upon them, and it is excellent for cutting for winter decoration of vases, &c. They may be raised from seed, be increased by division of large clumps, or reared in quantity by the process known to gardeners as root propagation, in very early spring.

Bees are very fond of the blossoms, but I am afraid it is, to give them the Scotch name, the "bum bees" that love them most. If I had an acre to plant for my bees I should not sow the sea hollies, nor the Chapman honey plant, nor Douglas's Limnanthes. I am not quite sure what I should sow, but borage would tempt me strongly. Why does not some one invent a good bee plant with a nice edible "toober" at the root of him?

Thanking Mr. Walker for his kind offer of cut sea holly—which I need not accept, being able to help myself—I am—LORDSWOOD.

A CORRECTION.

When the printer of the B.B.J. makes a common butterfly, such as a fritillary, into a fritillary (sounds like a lady's dress), and a common plant, or rather shrub, such as cotoneaster into coloneaster, I simply sigh and hope for the day when Board-school children (and all others) will be taught more of natural history if less of Euclid and algebra and the piano. When, however, he makes me describe events that appear to have happened at a date which is yet to come, I (being no prophet) am compelled to sigh out loud enough to be heard in the next room—the door shut and all!

The mistake occurs in the concluding lines of my letter in last week's issue. 1897 should, of course, be 1887, *i.e.*, the Jubilee year. May the Diamond Jubilee year be as good!—LORDSWOOD.

[2799.] I have often wondered that the flower *Eryngium* was never mentioned in the B.B.J. as a bee plant, so the letter from A. A. Walker on p. 77 of last week's issue was to me very interesting. I was surprised to hear of them growing wild on the Welsh coast. Being badly hit with an attack of bee fever last summer, and the cultivation of flowers being in my line, all my spare minutes were spent near the flowers the bees liked best, and I must say, although such plants as borage and Chapman honey plant grew near, they were neglected when compared to various species of *Eryngium*. There are three others besides *maritimum*, *viz.*, *coelestium* (which grows 2 ft. high and bears bright blue flowers), *pandifolium* (5 ft. high, leaves like the yucca, and flowers reddish blue), and *giganteum* (3½ ft. high, flowers greyish blue). This latter (the best) makes a nice back row border plant, has light green stems and bracts, and when cut is suitable for decorative purposes. Is it not this the variety A. A. Walker refers to? *Maritimum* only grows 1 ft. high.

They were introduced into England from the

Caucasus in 1820, and thrive in light sandy soil, hence the name sea holly. They can be raised from seed or division of the roots. *Giganteum* is a biennial, sown one year, flowers, and dies the next, and seeds very freely. I shall be pleased to see the opinion of "Lordswood" about these flowers, as I am sure he is no mean authority on such matters. I enclose a few seeds of the latter variety for Mr. Editor, hoping he can find room in his garden for a trial of them.—C. Y., *Dunham Valley*.

[Many thanks for seeds, which we will duly try and grow into plants.—ED.]

[2800.] *Eryngium maritimum* seed is not I think, to be got in ordinary way of commerce, it is perennial, and should be easily grown from sowing in July or August where intended to bloom, and thinned out merely or transplanted—of course, it is quite hardy. Seed sown immediately when harvested would come freely doubtless. They are more of the thistle type of flower, and not much grown.

Perhaps "Lordswood" can say more, and perhaps not so much.—G. R., *Liverpool*, February 26.

[2801.] The letter in your issue of February 25 (2795, p. 77), might be supplemented to the effect that Sea Hollies (*Eryngiums*) are obtainable from most nurserymen, and that now is a very good time to plant them.—F. C., *Hants*.

BEE-KEEPERS AND FOOD ADULTERATION.

[2802.] I am, for one, very pleased to be informed in B.B. JOURNAL of February 11, that the zeal of those who have the matter of foul brood legislation in hand is unabated. Our M.P. (Colonel Lockwood) promised me six months ago that he will support the Bill, and added, "I have kept bees, and know what foul brood is." I see by *The Cable* that a joint deputation of agricultural bodies will wait upon the Minister of Agriculture and other Ministers at 3, St. James's-square, at noon on March 2, on the subject of the adulteration of food products. *The Cable* says: "We understand that the question of asking some leading public analysts and members of the grocery trade to join forces with agriculturists is being considered. I sincerely hope that bee-keepers will be represented by this important deputation, on a subject of such great importance to us as adulteration. But this matter does not appear to have engaged the attention of the Council of the B.B.K. Association at their last meeting. A quantity of adulterated beeswax has recently found its way into this country.

—WILLIAM LOVEDAY.

(Continued on page 86.)

HOMES OF THE HONEY BEE.

THE APIARIES OF OUR READERS.

Our illustration for this week represents the apiary of Mr. John M. Hooker during his residence at Heathfield, Sevenoaks, Kent. The hives were placed round the kitchen garden, and were from thirty to forty in number. It will be seen from the view that they are conveniently situated for manipulation from the garden path behind them. The hives being arranged in a single row so that the flight of the bees was in no way obstructed during examination, as is often the case where, for want of space, they are placed closer together and in front of each other.

of Mr. Hooker's residence—divide the kitchen garden from the ornamental portion of the grounds.

The district of Sevenoaks is very favourable for the production of honey, and Mr. Hooker usually obtained a large quantity of comb honey in sections of good quality, and found no difficulty in disposing of it either in the neighbourhood or at Tunbridge Wells. In the latter place he employed an old country woman to take the sections round to the houses of the resident gentry, and in this way, after paying the old lady liberally, a market was found for the honey at a good price. Mr. Hooker is of opinion that a home market can be found in this way almost in any

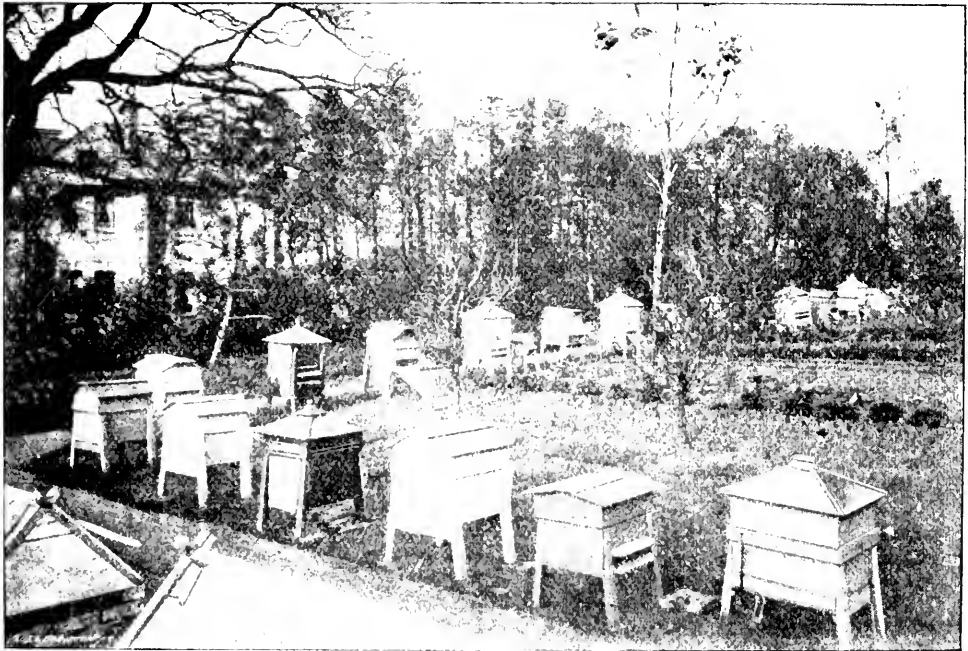

MR. JOHN M. HOOKER'S APIARY AT SEVENOAKS, KENT.

The garden operations were not interfered with by annoyance from the bees, the gardener doing any necessary work immediately in front of the hives either in the very early morning, or after the bees had ceased flying for the day. Mr. Hooker informs us that his apiary was often visited by well-known members of the B.B.K.A., and it was here that Mr. Cowan, Mr. Cheshire, and Mr. John Hunter stayed with him for the purpose of arranging and deciding the preliminary details and scope of the work "Modern Bee Keeping," then proposed to be published by the B.B.K.A.

The belt of trees and shrubbery on the left of the picture—behind which is seen a portion

district for best honey, and that better prices will be got than by putting on the market through a middle-man. On his leaving Sevenoaks the apiary was disposed of, but although living so near London as Lewisham, Mr. H. has always kept several hives, but, of course, the yield of honey from so near town is always small. We understand, his family being now all away, he is giving up his house and going to live in London with one of his sons, and is anxious to find some bee friend who would give him a stand for his bees, as, after having been interested in them so long, he does not like to be without a hive or two he can call his own.

CORRESPONDENCE.

(Continued from p. 84.)

THE WELLS SYSTEM.

[2803.] In reply to your correspondent "Bruen," Chester (2,787, p. 68), my experience of the "Wells system," is, that it answers if you have two weak stocks, which, worked singly, would not give any surplus honey. It also has the advantage of numerous opportunities to form nuclei at swarming time, to those who wish to do so. If one is near home to divide the swarms, knows how to find queens quickly, and can, when returning the swarms, return the queens to their respective compartments of the hive, as well as how to avoid "ructions" at each swarming, a very respectable surplus may be secured, but it takes quite as much work as three single stocks require. I thank Mr. Wells for spreading the knowledge of his system for the benefit of the bee-keeping public, but, in my opinion, two stocks, with two queens, divided, or kept separate, are not one stock, as Mr. Wells claims. I am satisfied with the returns given on Mr. Wells' system, but I am not satisfied with the amount of work required to secure a good return.—WILLIAM LOVEDAY, *Harlow, Essex, February 20, 1897.*

MY EXPERIENCE OF "WELLS" HIVE.

[2804.] In reference to a report on the "Wells" hive which your correspondent "Bruen" (2787, p. 68) is rather anxious to hear about and perhaps glean some slight information upon. In the first place, let me say I make all my own hives; the "Wells" I make to hold twenty frames, or nineteen with two dummies, nine on one side and ten on the other. The "Wells Dummies" I also make myself, with holes twisted through $\frac{1}{8}$ -in. thick board, each hole $\frac{1}{2}$ in. apart. When boring, I use small size wire, as that used for telegraph wires; the entrance is full length of hive front, with a division put between flight and shade board, each side being painted different colours. I place a single-stock hive, painted white, between each "Wells." I had some trouble through one side becoming queenless once during the summer season, and about three times during the back end and the the following spring. But when this takes place in the "Wells" hives, the queenless lot join the other side, if space allows them. The bees do not therefore, like a single stock, become idle, and indifferent about storing honey, when queenless. The cause in most of my "Wells" hives becoming queenless was through the perforated dummy moving a little from the floor board and leaving room for the bees to go under the dummy. This I now prevent by placing a strip of wood, $\frac{1}{2}$ in. thick, the full length of the bottom; fastening the same to the floor board with gimp pins to prevent any chance of the bees working over the top of the perforated division or dummy, and under the quilt I place a flat piece of

wood, about 3 in. wide, right over the centre of dummy, and on the top of the first cover laying on a weight to prevent it moving or working up.

I have worked four "Wells" hives right through the season of 1896, without finding at the back end any of them queenless. I have also wintered the same hives, with two other "Wells" hives, made up with driven bees, and find both sides much stronger to-day (February 26) than I expected. These four "Wells" hives were moved four miles in June and in July twelve miles to the heather—thirty miles or more in all. I may also mention we do not "walk" our bees to the moor, but trot, of course. They travel on a good spring cart.

I would here draw "Bruen's" attention to Mr. Wells's letter a few weeks since in the B.J. about the precaution necessary when stocking a "Wells" hive.

For my first attempt with the "Wells" hive your correspondent will find full report on page 499 of B.J. for December 14, 1893. My second report, in 1894, appears on page 15, January 10, 1895. Below you will find result of the best two single stocks worked in any given season against best "Wells" hive of the same season:—

	Single.	Single.	"Wells."
	lb.	lb.	lb.
1893	80	50 — 130	79
1894	51	43 — 94	216
1895	No account kept.		
1896	33½	28 — 61½	160½

The first season, 1893, I had no extractor until I received it in July, and before it arrived the bees had swarmed.—A. H. HORN, *Bedale, Yorks, February 25.*

BEE-KEEPING AROUND
MANCHESTER.

NOTES FROM A DISTRICT SECRETARY.

[2805.] The returning spring and the wakening up of the bees are rousing from their winter rest the bee-keepers of my district. I am daily receiving letters and calls from our members, all catechising me as to this or that symptom exhibited by their particular hives, along with queries as to the present and future treatment. Most inquirers are very anxious to begin "stimulating" which I, of course, strongly deprecate. I agree to giving flour-candy, having no fear that nitrogenous food in this shape will be injurious. So far all my own stocks are alive and fairly strong, several very strong, judging from a view I got from my window one day early in the month when confined to the house through illness.

On Christmas day, last every one being away "Christmasing," my place was shut up. The postman, on his usual visit, having left the gate open (I say the postman, because he always *does* leave it open). Anyway, I have not heard of any other callers except four-legged ones, regarding which latter I may say

"thereby hangs a tale" (indeed, several tails) which, as it takes the form of a bee tale and an "experience" in the vicissitudes of the craft, it may interest some readers if I briefly relate as follows:—Some calves from the neighbouring farm took it into their heads to commence the study of apiculture. But calves are bad bee-manipulators—not half steady enough—and in their anxiety, as I suppose, to see the queen, they jostled one another against the hive, and somehow overturned it. Having done this they went away evidently in a hurry—without stopping to put on quilts or roof or anything. If those calves were asked to explain, of course *they* would say, "The cow-boy came to fetch them home and they couldn't stop!" Well, to leave the calves and return to my hive—which I only discovered two days afterwards—it was in a bad plight; hive and stand overturned; roof, quilts, and cushions "all over the shop." Fortunately the weather was very mild and the calico quilt securely propolised to the frame-tops. The bees were still alive, so not wishing to expose the combs I quickly packed them up again as best I could. All's well that ends well.

We are specially looking forward to the "Royal" show to be held here in June, and hope to meet thereat our chiefs and some veterans of the craft. I know many will be there with whom I have corresponded, yet never had the pleasure of meeting, and I trust they will not be "backward in coming forward" with a friendly hand-shake. Vegetation here is a month too early, and makes me fear lest cruel winds and frosty March nights should rob me of my jargonelles and my bees of their forage from the gooseberries. Crocuses are out in thousands, and yesterday the bees were very busy on them. At seven this morning, however, everything was white with frost, followed by a dull and cold day. We have arranged with the new South Manchester Horticultural Society for a honey show this year. We had the bee tent at their first show last year, and so greatly was it appreciated that I had little difficulty in getting them to vote us some cash for honey, &c., prizes. These will be supplemented by the medals voted by the L. and C. B. K. A. and prizes by private individuals. I trust that all bee-keepers in the two counties will help to make the show a success, that next year we may "go one" better.

I suppose that with little wars and rumours of big ones, with Education Bills and other "ills," the House of Commons will not have much time to think of a Foul-Brood Bill. Well, in the meantime, let us show our willingness to help each other in our trouble, and prove to Government that we deserve encouragement. County associations can do much in combatting foul brood if they will only be resolute; and I think it should be a condition of membership that every member *must* have his bees examined by the expert. Personally, I am anxious to do my "little

best" in this matter, and am willing to visit and help any bee-keeper within twenty miles on payment of railway fare.—FREDERICK E. TAYLOR, *Local Hon. Sec. for Manchester and District L. and C. B. K. A., February 28.*

TITS AND BEES.

[2806.] Referring to Mr. Woodley's notes *re* the destructiveness of the "Common Blue Tit" (2771, p. 45), I believe that these tits are the worst enemies the bees have, especially in severe weather. I have frequently heard of them tapping at hive entrances, but have not seen them myself. I have, however, repeatedly observed them picking up bees from the hives, flying to the nearest hedge and devouring them rapidly, renewing the process, too, in the shortest of time. It is remarkable that they seem never to be stung. As to the best means of getting rid of the pest (tits produce more eggs than the generality of the Passerine order), one feels reluctant to destroy such prettily marked birds either with trap or poison, although it may be bad policy in the long run. I have tried a capital bait that tends to keep them away—that is, hang up half a cocoanut in a branch of the nearest tree, when they will very soon begin to feed upon it, and will keep them in food for a considerable time.—T. H. WELSH, *Penicuik, N.B.*

COMB FOUNDATION.

[2807.] Will you kindly allow me to give my experience of Bee-keeping in 1896. It may interest those who, like myself, in '94-'95, and partly in 1896, had trouble from "refused" super foundation. I began the season with twenty-one good stocks; nineteen were worked for section honey, two for extracted, until they both swarmed. In all, nine of the twenty-one stocks swarmed. Yet, by transferring the sections from the stocks to the swarms soon after they issued, I got from the whole no less than 1,358 sections, which were sold for £45. 7s. 2d. Moreover, counting those still on hand and all made presents of, the total yield was over 1,500 saleable sections, besides over 200 fairly filled, but not sealed. I might also have taken a large quantity of extracted honey had I chosen, as most of the hives hold thirteen or fourteen frames, and could spare from three to five frames of honey each, which I intend to feed back in the spring.

I was paid this £45. 7s. 2d., less market expenses, through the extremely obliging Hon. Sec. of the Irish B. K. Association, getting 10s. per dozen for one box, 8s. 6d. for another, and 8s. per dozen for the contents of eight boxes, and less for some inferior sections. Latterly, however, sales were very slow, and when for 224 really fine sections I could only get 8s. per dozen after being nearly two months on the market, I warn Irish bee-keepers that the time has already come when it won't pay to increase their stocks.

Though the past season was by no means a good one here, the weather being so unfavourable during the heather season that I did not have even one section of heath honey, instead of at least one rack per hive, which would be over 500 sections. My best have yielded 143 saleable sections, besides unfinished ones. Several stocks gave me over one hundred sections each, and an early swarm, hived (in a ten-frame hive) on frames of honey and placed on the old stand, gave me over ninety saleable sections and over thirty unsealed ones. I did not get less than thirty sections from any first swarm during 1896, all being treated as above. Until last season, I never got seventy sections from my best hive in any one year, and bearing in mind that 1896 was not by any means a good season, it proves conclusively that more depends on how good super foundation is presented to the bees in the sections than inexperienced bee-keepers imagine. Early last season I asserted, in your pages, that with attention to this point, double the number of finished sections could be secured compared with what is obtainable without attention to it. I had beautifully finished sections ready for removal in ten days after putting on the hives. Now, if this is possible in a poor or moderate season, how much will they give in a good year with properly prepared sections? In this preparation the quality of the foundation used is, of course, the main point. I used that of several makers, alternating a sheet of each make alternately a sheet in each rack of sections, initiating the latter so as to know them. In this way, I proved that the makers of the "refused" foundation of '94 and '95 had their samples refused again in '96. I also found that some extremely thin foundation had all the faults inseparable—to my mind—from the very thin, no matter by whom made. It expands, bulges, twists, gets fastened to the separators, falls down, and, not least, loses all impress of the cells when long on and "refused." Any one who uses such is sure to have had results. I strongly advise manufacturers not to make such. I also strongly advise inexperienced bee-keepers to get their super foundation only from reliable people, and not grudge a fair price for it. Seeing that 1 lb. of super foundation may, under favourable conditions, pay twenty times its cost in section honey, cheese-paring in this item is false economy. I say this after years of personal experience. Those who use full sheets should get it cut 13 in. by a shade less than 4 in., and insist on it coming packed so that the sides be not crushed or gapped. The sheet must hang only just clear of the sides if sections are to be free from pop-holes. Be sure also to get the foundation cut so that a line of full cells will lie next and along the sides of the wood; the sheet then will be all drawn out and finished at one and the same time. Whereas, if a line of half or quarter cells run along the sides of the section the results will be unsatisfactory. Exchange-

ing unfinished outside sections with finished ones from centre is also a great help. Colour is not a reliable guide to quality, as attractive colour can be got by the use of an acid. I find also that the use of two sizes of hives strongly helps to successful honey production and to strong stocks. One size of mine holds thirteen and fourteen frames, the other ten frames, I put the strongest stocks in the spring into the larger size, and weaker lots into the smaller. Thus both are nearly fit to super together. I never find a large hive short of honey, as the brood-nest rarely extends beyond ten frames, and the rest of the combs are packed with honey. On the other hand, in a ten-frame hive, after removing sections, I often find the ten frames packed with bees and brood, but empty of honey. I am, however, never short of an ample supply for such hives in autumn, as the larger can always spare enough for them. I have not expended five shillings in sugar-feeding during the last five years. Strong stocks are the rule and not the exception. My bees, during every fine day for some time back, have been carrying in peafflower given them as artificial pollen in small quantities. They would take a pound in the day if I gave it to them. The whole of my thirty stocks are alive and well.—T. KIRWAN, *co. Galway.*

Queries and Replies.

[1669.] *Italianising Stocks.*—I read in the "British Bee-keepers' Guide" that "the Italian bee is more prolific than the black bee, more active, working earlier and later, increases more rapidly, and gathers honey from plants not frequented by the black bee. It is also of a most amiable disposition." I purchased a pure Italian queen from a reliable dealer, intending to re-queen all my hives in the coming spring from her progeny, but my neighbours who are bee-keepers rather turn me against the Italians, hence my application to you for your advice. They say "they are a most savage race, always swarming, and not near so satisfactory as the ordinary English bees." I should esteem your advice in the matter, which I shall certainly follow.—A. N., *Weaverham, February 27.*

REPLY.—Our correspondent will notice that we have corrected his quotations from the "Guide Book," which were not quite as printed on page 132 of that work. For the rest, the author therein gives the result of his own practical experience with the progeny of pure Italian queens imported by himself for his own use only. He also found that out of every dozen queens imported, a small proportion only reached his standard of quality. On the other hand, in the case of "A. N.," it is proposed to work with hybrid bees presumably

from Italian queens crossed by black drones. This alters the conditions entirely; so that the opinion given by neighbours of these hybrids in no way controverts the claim for amiability of temper, &c., made on behalf of pure Italians in the book referred to. So far as our advice, therefore, as to hybridising all stocks by re-queening as proposed is to try a few only, and compare results.

[1670.] *A Beginner's Queries*.—1. Ought hives to consist of double walls on four sides? If not, on how many sides, and which? 2. If the surplus chamber contains frames like the lower box, ought it to have double walls as well? 3. Can sections be substituted for frames in the super? Or, if not, would you kindly explain why, as I am a young beginner?—C. HOYLE, *Welcome, Cornwall, February 12.*

REPLY.—1. Hives may have double walls on four sides or on two, or be single-walled all round. It is largely a matter of personal preference. The best advice we can offer to a beginner is to get a reliable book on bees, see the different sorts of hives described therein, and use his own judgment in choosing after reading what is said on each. We can only tell what hives we like and use; and this has been done many times over in our pages. 2. Above reply covers this one. 3. No, unless a surplus chamber is used which can be converted into one for frames, as some are.

[1671.] *Prize Schedule of "Royal" Show*.—Referring to the prize sheet for the Royal Agricultural Show, Manchester meeting—1. Do Classes 381 to 384 mean six 1-lb. jars or twelve? 2. Also in Class 385, need the wax be in one cake, or, say, four or five?—SIDNEY SMITH, *Wheldrake Rectory, York, February 25.*

REPLY.—1. The jars may be either 1 lb. or 2 lb. each, so long as gross weight approximates 12 lb. 2. In class for beeswax (385), the form and weight of each cake is left entirely to exhibitors, the only condition being "not less than 3 lb. of wax produced by exhibitor's own bees."

[1672.] *Queen Excluders and Winter Packing*.—Will you kindly give your opinion and advice on the undernoted questions? 1. Do queen-excluders require support-strips in the centre to bear on frames when there is a margin giving bee space all round, and a single sheet of zinc used? 2. Do super-boards require bee space above (as they are made), bearing in mind that there is bee space in super box above? 3. I have four plans for packing bees using one "lift," and should like a selection of the best if you approve of any for winter use above frames for winter passages? No. 1, "Hill's Device" quilt, and five or six layers of house-flannel over all? * * *—NOVICE, *Talgarth.*

REPLY.—1. Our own preference is for the zinc laid close on to tops of frames, with the perforations running across the spaces between

frames. If bee-space below excluders is preferred, there is no need for supports. 2. No. 3. Of the four methods of packing described, the first is, to our mind, so much the best that we omit the others.

[1673.] *Transferring Combs from Skeps to Frame-hives*.—I have two stocks of bees in frame-hives, transferred thereto from straw skeps last year. The combs were cut from the skeps and tied into the frames by placing a lath close underneath each comb and tying round it a piece of bass matting, the latter being passed under the lath and over top of frame. Some of the combs, however, gave way through the bees cutting or biting away the matting too soon. Consequently the combs fell one against each other, where they are now all joined and built together by the bees. 1. What had I better do? I examined the hive to-day (February 17), and the bees seem all right, with plenty of sealed stores. I see it is recommended to uncap some of the combs. 2. What benefit is gained by that? I shall be greatly obliged if you will enlighten me on the above questions.—JOHN BANTING, *Hensol Castle-gardens, Llantrisant, S. Wales.*

REPLY.—So far as answering the direct question put, we should leave matters as they are until some competent bee-keeper could examine the frames and advise as to the best method of undoing the mischief caused by improper transferring. It is always matter for regret when plain instructions are disregarded in such bee-operations as transferring old combs to bar-frames. In the first place, bass matting is entirely unsuitable for securing the combs. Tape is the proper material to use (tailors' "stay-tape" for preference); then the combs require cutting (whenever possible) to fit the insides of frames closely all round. Only when a comb happens not to be deep enough is a lath placed below and the tape passed round it. Moreover, the combs should be examined *two days after tying in* to see that all are safely secured by the bees. Any accident or breakdown at that time is, of course, easily remedied. We wish it were as easy to answer the question as it is to ask it, but after the combs have tumbled out and are built or joined together by brace-combs into an inseparable mass, it is by no means easy to give a useful reply to the query put by our correspondent, except to say that to upset the bees' brood and hive at this season would probably be disastrous, and we do not advise it. 2. When the season arrives for stimulating bees to early brood-rearing—say, end of March—it is beneficial to uncap a little honey about twice a week.

Echoes from the Hives.

Havilland Hall Farm, Guernsey, February 22.—Since St. Valentine's Day up to now,

bees have had a splendid time here. On the wing every day in the bright sunshine, collecting pollen in large quantities from the crocuses, which are in full bloom just now, and grown by thousands in private gardens around my locality. I notice that larger balls are carried into the hives while crocuses are in bloom than at any other time of the year, some bees having such big loads in their "pollen baskets" as to appear hardly able to crawl into the hive. Stores are fast disappearing, but will hold out till first week in March. I shall then start stimulative feeding to build up stocks in preparation for the fruit blossoms, which bloom second week in April. If stocks in this place are strong enough to take possession of surplus chambers in April, they generally give a good account of themselves in sections. We have had a very mild winter here so far—no snow and very little frost—and vegetation is in a very early state of growth. I have a plum tree (Rivers's early prolific) in full bloom in my garden, also an apple tree (early harvest) already bursting into bloom.—C. GOULD.

Chichester, February 26.—Crocuses now coming into bloom. Bees gathering pollen freely from this source. We shall soon be looking forward to the time of spring clean-up, and to all bee-keepers who care to take advice I say don't forget to place half a ball of naphthaline on each corner of floor-board (after having cleaned it) as a preventive of foul brood. An ounce of prevention is better than a pound of cure; also don't forget to medicate syrup which you use for stimulating purposes. This advice is gratis from one who has battled with foul brood and overcome the difficulty of getting rid of it. Once get a dose of this disease, and it will take all the bee fever out of a young beginner.—SOUTH-WEST SUSSEX.

Notices to Correspondents & Inquirers.

Letters or queries asking for addresses of manufacturers or correspondents, or where appliances can be purchased, or replies giving such information, can only be inserted as advertisements. The space devoted to letters, queries, and replies is meant for the general good of bee-keepers, and not for advertisements. We wish our Correspondents to bear in mind that, as it is necessary for us to go to press in advance of the date of issue, queries cannot always be replied to in the issue immediately following the receipt of their communications.

All queries forwarded will be attended to, and those only of personal interest will be answered in this column.

JANE B. SHEPHERD (Hest Bank)—*Candy Making*.—It is impossible to tell whether or not pure cane sugar has been used in sample of candy sent, but it is too granular from insufficient boiling. Refer to B.J. of last week (2796, p. 78).

A. VON KRIEGSHEIM (Biel, Switzerland).—*Hard Felt for Hive Roofs*.—Not being dealers in bee appliances we could scarcely undertake to do more than hand over your order

for felt to some tradesman here for dealing with. We notice, however, that the maximum dimensions of parcels to Switzerland from this country is 24 in. by 24 in.; therefore the size you want (29 in. by 30 in.) is too large for post.

L. MARTINEAU (Clapham Park).—*Mice in Hives*.—1. The mouse would in no way contribute to the death of the bees, nor does the fact of there being candy above tops of frames ensure the bees against starvation. On the other hand, the fact of so many being found head foremost in the empty cells unmistakably points to death from cold and famine. Bees should have plenty of sealed food in the combs when packed for winter, because if a portion of the cluster becomes separated from the main body they will often die from cold and starvation with food on the next comb. 2. If combs are quite free from dead brood they will be of service, and may be used for a swarm in the coming season. 3. It is not likely the honey of 1897 will be spoiled as it was in 1896 in some districts. 4. Comb foundation is of the ordinary quality, and both samples are about equal.

GEO. M. SAUNDERS (Keswick).—*Alley's Queen Trap; Non-Swarming Chamber*.—1. The only catalogue we know of wherein this trap is shown is that of C. Overton, Crawley, Sussex. 2. The queen trap you name may be had, we believe, only from Messrs. Lee & Son, whose address is in our advertisement column. 3. The object of Mr. Seemark's non-swarming chamber being made to slide like a drawer is to allow of its being withdrawn for examination, &c., without disturbing the hive above. The wooden dummies in the drawer are, we fancy, about same depth as a shallow frame, viz., 5½ in.

F. W. OSMAN (Wells, Som.).—*Bees in Greenhouse*.—1. A greenhouse wherein "the heat in summer sometimes registers 120 degrees," will not be a suitable place for keeping hives of bees. In fact, we have never heard of other than failure from locating hives in greenhouses. 2. The loss in this way is one of the main evils connected with the matter, and our advice is do not try it.

C. V. B. (Southgate).—*Porto Rico Sugar*.—This sugar is so difficult to obtain that few wholesale grocers "list" it. Besides, dry-sugar feeding for bees is so little practised that we never trouble about "Porto Rico."

J. H. HORN (Bedale, Yorks.).—*Mead*.—The sample of mead cannot be called "sour." The only good quality about it (i.e., aroma) proves the contrary. But it is far from good, and shows that the beer cask into which it was placed had not been sweetened beforehand. We should say the mouldiness therein has set up a second fermentation in the mead. The liquor in itself, however, seems to us little more than water, slightly sweetened with washings of honeycombs, and spoiled afterwards by the cask.

Editorial, Notices, &c.

COUNTY ASSOCIATIONS AND LEGISLATION.

In order to arrive at some definite and tangible result in the matter of obtaining statistics regarding the ravages of foul brood among bees in the United Kingdom, it has been deemed advisable by the Council of the British Bee-Keepers' Association to issue a circular letter to all County Associations affiliated to the parent body, couched in the following terms:—

BRITISH BEE-KEEPERS' ASSOCIATION.

12, Hanover-square,
London, W.

DEAR SIR,—In view of the present effort to obtain legislation on the subject of foul brood, it is necessary to get the fullest information possible as to the present prevalence of the disease in your county.

In order to assist you in accomplishing this object, I enclose a supply of forms drawn up for the purpose, which your expert should fill up and transmit to you daily during his spring tour.

If there are districts in your county which your expert does not visit, I will thank you to send the form to individual bee-keepers likely to furnish the information.

It is of the *utmost* importance that particulars be promptly obtained, to admit of the contemplated measure being brought forward in Parliament this session.

Weekly summaries of the experts' reports, in similar form, should be sent to me, and will be utilised on receipt.

Trusting to your cordial co-operation in the matter,—I am, dear sir, yours faithfully,
EDWIN H. YOUNG, *Secretary*.

Along with the above circular there was enclosed printed directions (on foolscap sheets), in tabular form, for the use of experts employed in visiting the apiaries of members. If these are properly filled up day by day by the expert, and forwarded by him to the Secretary of the County Association whose representative he is, it will confer a service of great and timely value to all concerned with, and interested in, the welfare of the bee industry of the kingdom.

Nor need there be any ruffling of the susceptibilities of those who, for various reasons, object to making public their bee-troubles caused by foul brood. The information sought will not be made

public at all—in the generally understood sense of the phrase—but merely used for the purpose of strengthening the case to be presented to Parliament in the endeavour to pass the proposed Bill for the prevention of bee-pest or foul brood among bees.

This being so, we feel very confident that the good sense of even those to whom we have referred will prevail, and that the urgent need for such statistics as are asked for will create a unanimous desire on the part of all concerned to make the returns from each county as full and complete as possible.

COUNTY ASSOCIATIONS AND FOUL-BROOD LEGISLATION.

KENT AND SUSSEX B.K.A.

At the monthly Council meeting of the Kent and Sussex B.K.A., held on the 6th inst. at the Bridge House Hotel, London Bridge, E.C., the Chairman read a letter from the Secretary of the B.B.K.A., enclosing circulars dealing with the collection of foul brood statistics. Two printed tabular forms were also sent, such as are intended to be used by County Associations and by private individuals respectively. It was proposed and carried unanimously, "That this meeting of the Council urges the prompt and energetic co-operation of all bee-keepers in assisting the B.B.K.A. in their praiseworthy efforts to obtain legislation for dealing with foul brood this session."—HENRY W. BRICE, Hon. Sec., *Dale Park, Upper Norwood, March 8.*

HEREFORDSHIRE B.K.A.

At the recent annual general meeting of the Herefordshire B.K.A., the following resolution was passed:—"That this general meeting of the Herefordshire B.K.A. approve of the efforts of the British B.K.A. to secure compulsory powers for the suppression of foul brood."

PROPOSED ASSOCIATION FOR GLOUCESTERSHIRE.

At a meeting held in Gloucester on Friday, March 5, 1897, presided over by Mr. R. Hamlyn-Harris, of Hambrook, Bristol, to which bee-keepers from various parts of the county had been invited, the following resolutions were passed without any dissent:—

1. "This meeting, of bee-keepers, considers it desirable that the County Association be reformed, and asks the secretary of the Gloucester Bee-Keepers' Association to communicate with the Bristol and Wotton-under-Edge Bee-keepers' Association and request them to give it their serious consideration.

2. "This meeting signifies to headquarters the approval of the efforts made to bring about legislative powers for the suppression of foul brood."

LEICESTERSHIRE B.K.A.

ANNUAL MEETING.

The fifteenth annual general meeting of this Association was held at the Victoria Coffee-house on Saturday afternoon, February 27. In the absence of the Mayor, Mr. Carter occupied the chair. The Secretary, Mr. John Waterfield, of Kibworth, read the report and balance-sheet for 1896. The former stated that the year 1896 had been one of marked importance in the advancement of bee-keeping. The financial position of the Association was very much better than its predecessor, and a substantial balance was left in the hands of the treasurer. In connection with the Royal Agricultural Show an examination for third-class experts was held, three of the four candidates being successful in gaining certificates. The balance-sheet showed receipts amounting to £43. 9s. 6d., and expenses £36. 16s. 7½d., leaving a balance in hand of £6. 12s. 10½d. On the motion of Mr. Meadows (who hoped the county would win the trophy prize at Manchester), seconded by Dr. Emmerson, the report and balance-sheet were adopted. A vote of thanks was accorded the retiring officers, and they were re-elected, with the exception of Mr. E. N. Lewis, whose place on the committee was taken by Mr. J. G. Cotton (Loughborough). It was decided to increase the honorarium to the secretary, as a mark of confidence in him, and approval of the manner he carried out the duties of his office. This concluded the business portion of the proceedings. The members then partook of tea together, after which a social evening was spent, his Worship the Mayor of Leicester, J. H. Marshall, Esq., J.P., presiding. During the evening prizes were given for the best single 1-lb. section and single jar of extracted honey. There was also a prize drawing for hives and other appliances. An interesting scientific lecture on bees was afterwards given by Dr. Percy Sharp, Brant-Broughton, Newark, first-class expert to B.B.K.A. and lecturer on Bee-keeping to the Lincs. County Council. Dr. Sharp's lecture was illustrated by an entirely new set of lantern slides, of his own production, and was much appreciated by the large audience present.—(Communicated.)

IRISH BEE-KEEPERS' ASSOCIATION.

The Committee met on 4th inst. Present—Mr. W. J. Delap in the chair, Dr. Traill, Mr. Read, Mr. O'Bryen, and Mr. Chenevix (Hon. Sec., 15, Morehampton-road, Dublin). It was resolved to offer prizes at the Strabane Show for honey exhibited by members of the Asso-

ciation. Messrs. O. & R. Fry, of 12, Hawkins-street, Dublin, were appointed agents for the sale of members' honey.

HONEY IMPORTS.

The value of honey imported into the United Kingdom during the month of February, 1897, was £1,666.—From a return furnished to the BRITISH BEE JOURNAL by the Statistical Office, H.M. Customs.

Correspondence.

The Editors do not hold themselves responsible for the opinions expressed by correspondents. No notice will be taken of anonymous communications, and correspondents are requested to write on one side of the paper only and give their real names and addresses, not necessarily for publication, but as a guarantee of good faith. Illustrations should be drawn on separate pieces of paper. We do not undertake to return rejected communications.

Communications relating to the literary department, reports of Associations, Shows, Meetings, Echoes, Queries, Books for Review, &c., must be addressed only to "THE EDITORS of the British Bee Journal," 17, King William-street, Strand, London, W.C." All business communications relating to Advertisements, &c., must be addressed to "THE MANAGER, British Bee Journal Office, 17, King William-street, Strand, London, W.C."

** In order to facilitate reference, Correspondents, when speaking of any letter or query previously inserted will oblige by mentioning the number of the letter, as well as the page on which it appears.*

AN UP-TO-DATE BEE-KEEPER.

[2808.] Is *Apis mellifica* an annual? There are, I know, many species of bees that are annuals. Hymenopterists call them "solitary" bees, not because they are bachelors or old maids, but because they go about in pairs (especially along roads where there are no gas-lamps), and have nests in sandy banks, and in walls where bricks have been left out, presumably to act as drain holes, but which are invariably the driest places on earth. These bees are perhaps the happiest kind of bee, for they are not worried with many servants or neuters. They make their own bee-bread, collect their own honey, wash up their own crocks, sand their own floors.

One particular friend of mine decorates the walls of his bungalow residence with art paper, in the shape of pieces cut out of rose-leaves; another is content with mud roof and walls, built on the surface of a brick wall. A house thus built, if lined with feathers, can be cosy enough, as a martian will testify. Some pass the winter in the pupal stage (*i.e.*, as near as bees can get to it), others merely curl themselves up in a dry place and go to sleep, which proves that they have more sense than is usually allotted them.

These, then, may be termed annual bees, but I think every one will agree with me in describing *Apis mellifica* as a perennial—a perennial, however, which may be treated as

perennials amongst plants oftentimes are, either as biennials or as annuals.

Bee-keepers of the old school usually treated their bees as biennials; only as annuals if they were too light to "stand over the year," or, contrariwise, if they were too heavy, when it seemed a pity to let them "stand over."

A friend of mine—a bee-keeper of the new school, an up-to-date sort of fellow—however, treats his bees as annuals! Every autumn he extracts all the honey they have, never feeds them at all, so that they invariably die about November. Then in the spring he buys (from me) either stocks or swarms. Sometimes my bees swarm into his combed hives gratis, and that, of course, saves buying. He buys stocks and swarms from me, but the funny part (perhaps it is part of the system) is this, that he invariably forgets to pay me for them. I think I will send him a copy of the BEE JOURNAL containing this, just as a gentle reminder that a remittance will be esteemed. Then there will be another friend added to my erstwhile double-dahlia friend, who will pass me by with the tip of his nose elevated in the air. But what of that? A man, even if he is a bee-keeper, ought to be able to get hold of his own.

"It's a very nice world in which we live,
If you want to lend, or wish to spend,
Or away your money you wish to give.

But if you want a very small loan,
Or only try to get hold of your own,
'Tis the very worst world that ever was known."
LORDSWOOD.

BIRDS AND BEES.

A WORD IN DEFENCE OF THE BLUE TIT.

[2809.] It is not the first time I have taken up my pen to enter a protest in the pages of the BEE JOURNAL against the wanton destruction of one of our most useful insect feeders, viz., the blue tit. During hard and severe weather, when insect life is scarce to be found, then the blue tit frequents the alighting-boards of our bee-hives and acts as scavenger by picking up dead bees, and flying to some favourite perch near, he most adroitly extracts the sting and poison bag, wipes it off his bill on to the rail, and then devours the *dead bee*. Many years ago I carefully watched his proceedings in order to either verify or disprove the charges brought so freely against him by some bee-keepers, and the balance of evidence is most decidedly in his favour. I admit that he will search the full length of the entrance with his bill in the hope of reaching a dead bee. He will even tap and clean his beak against the ends of the openings, and if he chances to see a spider or other insect, he instantly darts upon it so as to secure his prey. This has brought him into bad odour amongst some bee-keepers under the idea that he "taps" the hive to bring a bee to the entrance.

It is, however, quite a mistake to suppose that at the particular season—when the tit is so often seen on alighting-boards—any bee can be tempted away from the cluster to venture to the entrance to see what such a mild tap indicates. Let any one who doubts this go and tap the hive ten times harder than the poor tit does. It strikes me he will have to wait until fine weather comes before a bee would stir to see who knocked at the entrance. A good proof of the innocence of the blue tit and his utter inability to secure even a few dead bees at times occurred in Weardale during the last hard weather. Bees had been long confined to their hives by continual frost and snow, and blue tits were found near the hives dead for want of food! When the thaw came, thousands of bees came out of the hives to die; sufficient to have kept the starving tits in food for a month or more. Like your correspondent T. H. Welsh, we (or rather the youngsters) often hang a piece of meat outside upon a string; the tits and robins soon find it out, and it is most interesting to watch them feed. I have often felt sorry to see accounts of how some bee-keepers shoot and trap the poor persecuted blue tit upon their hives; I say this because long and extended observation under the most favourable circumstances enables me to say that I have never yet seen the blue tit seize and carry off a live bee. I therefore pen these remarks in the hope of inducing bee-keepers to be more lenient with one of our most useful garden insect feeders.—W. CRISP, Lecturer for Durham County Council, *Eaglescliffe Farm, Yarm.*

MANIPULATING BEES.

A HINT TO LEARNERS.

[2810.] Every week your valuable time and equally valuable space is taken up by replies to amateurs in the very fascinating art of apiculture. I thought if I told all such of a plan I have acted upon during the first year of my bee-keeping experience that it might save you a deal of work, and the space in your paper be devoted to more interesting matter. Last year I had one stock of bees: my knowledge of handling them was worse than useless; so I put myself and my bees in the hands of our clever and genial expert, who has shown me how to manipulate them, stage by stage, all through the season, right up to the present time. I am confident that one practical lesson is better than a dozen letters. I find you gain more confidence and the bees are not so worried by unskilful handling. I have found the plan answers so well that I now feel sufficient confidence to at least try to manage them myself during the coming season. I may say that I have now five stocks of bees, with every encouragement to go on with my hobby, for last season I had no trouble in disposing of my own honey, besides a considerable quantity that I bought to supply the demand. I have

found so much benefit from the practical lessons, and there are so many who appear by their questions to be just where I was last spring, that I thought these few remarks might be useful to some one.—Sincerely wishing every bee-keeper a successful year, (Mrs.) A. FEATHERBY, *Chillingham, Kent, March 8.*

COUNTY ASSOCIATIONS AND THEIR WORK.

[2811.] Referring to last par. of 2805 p. 87, I beg to say should any County Association ever make it a "condition of membership that every member *must* have his bees examined by the expert" and his hives opened whenever it suits him to call, I should advise that County Association to put up the shutters and shut up the shop! Last year when the expert called to examine my bees it was not fit to expose a cat, let alone a tender bee, and I should have dubbed myself a "deep dummy," and not a "shallow" one either, had I allowed him to examine the bees. If experts come to examine bees when the weather is inclement I should certainly forego the pleasure of paying to be a member rather than have chilled brood.

If experts don't know the proper time to open hives, then I say to practical bee-keepers, teach them!

I am often asked by bee-keepers or would-be bee-keepers, "What do I (or what should I) get for being a member of the Association, and what benefit do I get for my 5s.?" I say "You get a visit from the expert, who examines your bees and gives you advice thereon." This is all I can say, and they do not see 5s. worth.

If experts get 2s. for every member they visit, what becomes of the other 3s.? It seems to me it goes to encourage other people to keep bees, so that they can compete with you, and bring down the price you are getting for your honey. — WM. RUSSELL WEST, *Sunnyside Apiary, Northenden.*

[In order to put the matter fairly we have accurately quoted the words which appear in letter referred to, and have also transposed some added words to their proper position following those quoted from page 87. This our correspondent had omitted to do, and it seems to us that the words quoted were meant to convey nothing more than that no one should be accepted as a member whose bees were diseased. If this is so—and we see no reason to doubt it—it is certain that could such a "condition of membership" be found practicable and workable it would indeed be a step in the right direction so far as making "a fair start" between the Association and membership. For the rest, it is never intended that members' hives should be examined against the will of their owners or at such times as would be injurious to the bees.

Referring to the concluding portion of our correspondent's criticism of the work of the

County Association, we have referred to the rules of the L. and C. Association and find printed therein no less than eight cogent reasons why bee-keepers should become members; quite sufficient for any one whose view of the "advantages" extends beyond direct and personal interest only, to the exclusion of all that tends to consideration for the general good of the industry.—Eds.]

A BEGINNER'S EXPERIENCE.

[2812.] I started bee-keeping in June, 1894, with a stock of bees in a cheese-box, for which I gave 5s. The following season I put on a straw super, and from that took 15 lb. of honey, leaving the "cheese-box" brood-chamber untouched. I next made a frame-hive, learned how to drive bees, and had one lot given me for the driving in September, 1895; tied some of the old combs into the frames, and got the bees safely through the winter. So I started 1896 with one frame-hive and my cheese-box hive. The season here opened over three weeks earlier than usual, and I had not fed the bees at all in spring. My cheese-box lot, however, filled a straw super by the end of May, so I gave them another, which was filled by the middle of August, and the two contained 33 lb. of honey, which I considered good without the bees having had any help at all. My frame-hive gave me 15 lb. of honey, leaving abundance for wintering on. I have had no swarms, and very little honey was gathered here after the middle of June. I drove eight straw skeps during the year, three of which I got for the "driving." Two of these I put in a frame-hive, and one in a skep, so I have now two frame-hives, a "cheese-box" hive, and one skep. I am making another frame hive in my spare time, to transfer bees into this spring. It was through Mr. Flood coming here with the Berks bee-van that I began with bees. I had not seen even the inside of a combed skep till 1894. I dare say some of our readers will laugh at my writing of my doings, but every one must have a beginning. I shall go in for using foundation next year. — A YOUNG COTTAGER.

THE HUMBLE BEE AS A POET SEES HIM.

[2813.] The ubiquitous burly bumble bee has been receiving a full meed of praise in a late issue, looked at from a utilitarian point of view. Some time ago your correspondent "Lordswood" (2387, January, 1896), whose poetic prose we all admire and love to read, viewed him from another standpoint. Another (2395, January 23, 1896, *et seq.*) treated him from a purely scientific aspect. The "yellow-breeched philosopher" has had his praises sung by Emerson, and readers may enjoy seeing in your pages what he has to say of one

whom he pictures as being "wiser far than human seer." I therefore enclose a copy of the poem.—D. M. M., *Banffshire, N.B.*

THE HUMBLE BEE.

Burly, dozing humble bee,
Where thou art is clime for me.
Let them sail for Porto Rique,
Far-off heats through seas to seek ;
I will follow thee alone,
Thou animated torrid zone !
Zigzag steerer, desert cheerer,
Let me chase thy waving lines ;
Keep me nearer, me thy hearer,
Singing over shrubs and vines.

Insect lover of the sun,
Joy of thy dominion !
Sailor of the atmosphere,
Swimmer through the waves of air,
Voyager of light and noon,
Epicurean of June,
Wait, I prithee, till I come
Within earshot of thy hum ;
All without is martyrdom.

When the south wind, in May days,
With a net of shining haze
Silvers the horizon wall,
And, with softness touching all,
Tints the human countenance
With a colour of romance,
And, infusing subtle heats,
Turns the sod to violets ;
Thou, in sunny solitudes,
Rover of the underwoods,
The green silence dost displace
With thy mellow, breezy bass.

Hot midsummer's petted crone,
Sweet to me thy drowsy tone
Tells of countless sunny hours,
Long days, and solid banks of flowers ;
Of gulfs of sweetness without bound,
In Indian wildernesses found ;
Of Syrian peace, immortal leisure,
Firmest cheer, and bird-like pleasure.
Aught unsavoury or unclean
Hath my insect never seen ;
But violets and bilberry bells,
Maple-sap, and daffodils,
Grass with green flag half-mast high,
Succory to match the sky,
Columbine with horn of honey,
Scented fern, and agrimony,
Clover, catchfly, adder's-tongue,
And brier roses dwelt among ;
All besides was unknown waste,
All was picture as he passed.

Wiser far than human seer,
Yellow-breeched philosopher !
Seeing only what is fair,
Sipping only what is sweet,
Thou dost mock at fate and care,
Leave the chaff, and take the wheat ;
When the fierce north-western blast
Cools sea and land so far and fast,
Thou already slumberest deep.
Woe and want thou canst outsleep ;
Want and woe, which torture us,
Thy sleep makes ridiculous.

EMERSON

ANOTHER "CORRECTION."

[2814.] Referring to 2798, p. 83, I see "Lordswood" mentions something about the piano being taught to Board School children. I shall be glad to know where and when this takes place. I venture to assert that in no Board School in England are the children taught to play the piano. Perhaps "Lordswood" is joking. I admire his racy epistles, but must uphold our Board School education.—VICE-CHAIRMAN OF A SCHOOL BOARD.

WEATHER REPORT.

WESTBOURNE, SUSSEX, FEBRUARY, 1897.

Rainfall, 4.09 in.	Sunless Days, 17.
Heaviest fall, .95 on 4th.	Below Average, 53.7 hours.
Rain fell on 17 days.	Mean Maximum,
Above average, 2.67 in.	45.3°.
Maximum Temperature, 54° on 27th.	Mean Minimum,
Minimum Temperature, 28° on 17th.	37°.
Minimum on Grass, 22° on 17th.	Mean Temperature,
Frosty Nights, 5.	41.1°.
Sunshine, 44.5 hours.	Above average, 4.5°.
Brightest Day, 21st, 8.1 hours.	Maximum Barometer,
	30.75° on 23rd.
	Minimum Barometer,
	29.05° on 2nd.

L. B. BIRKETT.

AN AMERICAN BEE FARM.

MR. A. I. ROOT'S VISIT TO THE ATCHLEYS.

I reached the Atchley plantation, Beville, Southern Texas, on Saturday night, just at dark. I call it plantation, for no other word seems to describe it. Three years ago they located here, two and a half miles out in the country, that they might have room for their apiaries, and also that their family of children (*nine* at the present time) might be brought up away from the dangers of the town. As ground room is cheap, their buildings are all one storey, and in order to have plenty of room and abundance of ventilation on all sides, their home building extends out pretty long, and the rooms are all separated by broad porches or covered passageways. In these warm climates the cooking-stove is kept well away from the dining and all other rooms. The buildings are all new and well finished—in fact, it is hard to understand how they have been able to do so much in just three years, even if there are nine of them, children and all.

Tamed Bees—Bees are everywhere. A log "bee-gum" stands by the porch, another hive on the porch ; bee-hives all through the front and back yard, and as I write I am cheered by the hum of busy workers going out and in a hive that has stood for months close beside

the office door, the bees going in and out through the open door. Now, this door is a busy thoroughfare all day long; but the bees watch their chances and dodge between your feet, sometimes a yellow shower of them waiting for people to get out of their way; and then the joyous hum as they gain the entrance! These bees never sting; they have become so accustomed to the business of the office that they take it as a matter of course. Moreover, they have not only become accustomed to people passing, but so used are they to the tramping on the floor, that stamping and jarring the floor has no effect on them whatever. They have apparently forgotten how to sting, and, although they are handled repeatedly without smoke or veil, no one has ever been stung by them. Tell me that bees can't be tamed! Why I could sit here for hours, and enjoy watching them.

The hive I am speaking of was started by accident with only a handful of bees. They came through the frosty and cool nights all right, because there is a little fire in the office almost every day, and they are now gathering honey when almost all the strong colonies outside are idle because the morning is too cool. The gentle heat from the fireplace near them sends them out at the open door an hour or two before the rest.

Here I am talking about this one hive of bees when I have not shown you round outdoors at all. Well, right out by the road is the hive factory. It was after dark on Saturday night before the whistle blew for shutting down. The Atchleys have discovered the advantage of filling orders promptly, even if it does require getting up before daylight and working after dark. Of course the factory is not very extensive, but everything is neat and in order. The arrangement of their building facilitates this. The office where I sit writing is far enough away, so as to be safe from fire if the factory burns. The printing office is also a separate building. A shaft carries power from the factory. The latter is not insured, because it can not be done down here for less than 10 per cent.

Mrs. Jennie Atchley, who now sits by my side writing, is a very hard-working woman. I have been pleading for a little vacation for her. She not only raises queens, but she goes into the factory and makes the queen-cages herself. In building their house she sawed off the boards and nailed them on, doing a large part of the inside finish. When we consider that at the same time she looks after nine children, the youngest (Jenny Bee) only fourteen months old, we can realise something what this woman has done. Mr. Atchley himself is the *scholar* of the family. All correspondence, and all that is written for publication, is expected to be revised by himself; in fact, since he has had the typewriter the most of it has been rewritten by himself.

A Mule in a Bee-Veil.—In unloading bees it is often desirable to drive right in among

the hives. Well, bees seldom trouble a horse more than to buzz about his head; therefore, the mule trained for this work wears a bee-veil made on purpose for him, and, thus equipped, he goes anywhere without any reluctance whatever.

The Atchleys have a little more than 500 hives now devoted to queen-rearing; later on they will be divided so as to make a full thousand. They are located in six apiaries, four to seven miles apart. Yesterday we visited the Cyprian apiary, the Holy Land apiary, and the Carniolan apiary. So far as I can learn, they have a locality here that furnishes honey to some extent every month in the year. They do *no feeding*, and with any decent care there need be no robbing. I have looked over hundreds of hives, and there were almost no weak ones, and none but that are well provisioned. As a rule, eight frame dovetailed hives are used. I suggested that these were larger than necessary; but, all things considered, I believe they are about right. With smaller hives there would be more trouble on both extremes—getting out of stores, and getting the hive full of honey or full of eggs and brood before the attendant got round. During 1896 they have raised about 3,000 queens and secured about ten tons of honey.

How to Cut Perforated Zinc for Entrance Passages.—Have the strips so that a *very narrow* piece rests down on the bottom board. It is like this: It bothers a horse to step over a board 1 ft. wide, but he can step over a strip 3 in. wide, when set edgewise on the ground, without any trouble. So with the bees. To get the correct spacing, there must be just a little zinc left on the lower edge, so as to exclude the drones but to admit a worker loaded with pollen; don't trouble him to raise up his heels so he can get over a board more than "knee-high."

A 10-Year-Old Bee-Keeper and Engineer.—Leah Atchley, 10 years old, has just been showing me through her apiary of ten hives. She can lift out the combs and find the queens as deftly as almost any one whose eye meets this. Not only this, but when the factory was started up to fill a small order she took her post as engineer and fireman. It is worth a lot to see her black eyes sparkle as she showed me she was as much at home here as with the inside of a bee-hive. Her father says he would rather trust her to keep up steam and see that everything is "O.K." than any hired man he can get. As the boiler is 12-horse power and the engine only 10, it is, not very hard to do the firing.

It is in just this way that the whole family help in the business. While Leah looks after this department, Charley, aged 17, runs the planer, saw, and other machines. Miss Amanda is cashier for the firm; takes charge of the funds, does the banking, pays off the help, &c.

You must not think from what I have written that their children are all work and no play. If you could hear them now you would

think, from the childish voices and merriment, there was no lack of recreation. It is two and a half miles to school, it is true; but "Nick," aged 13, just brought me his deportment card to show that he stands from 90 to 96 in nearly all his studies. The 96 was for penmanship, and he got it by doing business with a pen in his father's office. His "arithmetic" was almost as high.—*Gleanings*.

Queries and Replies.

[1674.] "*Doubling*" for *Extracted Honey*.—In the coming season I think of "doubling" for extracted honey, and intend to close up frames to $\frac{1}{2}$ in. space to prevent drone comb. This will, of course, take more frames to fill my shallow-frame box (made to hold ten at the ordinary distance apart). On top of body box I shall put another set of brood-frames (alternate ends slipped back as before); this will give somewhere about thirty frames for the queen (reared in 1896) to breed in. Will there be any necessity in this case to put excluder zinc over these double brood-frames before putting on shallow frames above? Bees no doubt work best without excluder zinc, although with a single set of brood combs I always use it, but it occurred to me I might be safe without it with the above amount of brood frames.—WINDSOR.

REPLY.—If the intention is to practise the doubling method described in "Guide Book," our advice is to follow closely the instructions there given. We consider thirty standard frames far too many for breeding in, and to have that number spaced at $1\frac{1}{2}$ in. apart will tend to reduce the gross weight of honey obtainable very considerably. If the queen is confined to two body boxes with eleven or twelve standard frames in each, she will have plenty of breeding room, and the frames above should be separated by excluder zinc and spaced wider apart.

[1675.] *Hiving Swarms for Beginners*.—I have read the chapter in "Guide Book" on hiving swarms, but the instructions given there appear to refer only to swarms from one's own hives. Now, in the case of a beginner like myself, having a swarm sent from a good distance by train (I suppose it will be in a skep), I ask:—1. What would be the best way to hive it into frame-hive? Will the bees be easily manipulated after the delay of a long journey? 2. Ought I to have both worker and drone foundation in my hive for first season? 3. Is it essential for bottom bars of frames to be exactly equal distance from each other as at top?—HUMBLE B., *Heaton Moor*.

REPLY.—1. The directions given apply to hiving swarms from a distance as well as to those from hives in the same apiary. The

bees after a journey by rail or otherwise are very amenable to handling, and rarely give any trouble in hiving. 2. If full sheets of foundation are given to swarms, it should be all worker-cell foundation; the small space allowed at bottom being quite sufficient for the bees to build there all the drone-comb needed. 3. The frames should hang quite true, so that the face surface of the combs may be equi-distant top and bottom. It is also necessary to secure the foundation firmly, by wiring or otherwise, when full sheets are given to swarms.

[1676.] *Suspected Foul Brood*.—During the fine days of last week I examined my hives (twelve) and found all stocks well. In two hives, however, I discovered what may be the presence of foul brood. On one brood comb, in one of them, a single larva had died, and had assumed the flabby aspect as described in "Guide Book." I abstracted the contents of the cell with a penknife, and found the smell very offensive. In the other hive a single cell in one comb alone also appeared to me to be affected. The capping of this cell was perforated. Upon inserting a match-stalk, a coffee-coloured substance adhered to it, having a disagreeable smell. I could discover no further evidences of the pest, even after repeated and careful examination, but in each case appearances exactly corresponded with the "Guide Book" description, except that instead of a large area of the comb, only one cell in each was affected. Will you please answer per BEE JOURNAL:—1. Do you think what I have described indicates the presence of bee pest? 2. Will diluted honey, medicated with naphthol-beta, be equally good as syrup (sugar) to feed with? If so, to what extent should the honey be diluted?—STITCH-IN-TIME, *Essex*, March 1.

REPLY.—1. The description is certainly that of foul brood. Frequent experiences in the past, however, compel us to say that quite as accurate descriptions have been sent by bee-keepers whose diagnosis has been entirely at fault. If a cell containing a diseased larva could be forwarded it would be much more satisfactory. 2. No doubt honey would be as good as sugar, but in view of getting the exact proportions, we should use sugar syrup as directed in "Guide Book."

[1677.] *Granulated Honey for Bee-Food*.—*Do Early Spring Flowers Yield Honey?*—1. Is it injurious to bees to feed them on granulated honey (one would think it their natural candy)? If it is injurious what are the evil effects? 2. During the recent mild weather which we have had a sample of, my bees was very busy. Some bring in pollen, but the greater number have no appearance of pollen upon them. What do they bring home? Can they get any honey yet? There are plenty of snowdrops around, and bees are busy in them, but very little pollen seems to be carried off from these flowers by

them. Do they get honey from snowdrops, wallflowers, or crocuses? 3. Is it wise to fit up sections with foundation now, or would it be better to wait until later?—MARCUS W. B. OSMASTON, *Dover, February 25.*

REPLY.—1. The only objection to feeding bees on granulated honey is that the dry granular portion is wasted by the bees instead of the whole being consumed as with good candy. 2. There can be little doubt that more or less honey is yielded by all blooms visited by bees, since the nectar of the flower is the main attraction to the bee which visits it. The relative honey and pollen values of various flowers, however, differ very much, those blooming in the early spring yielding little honey but an abundance of pollen. 3. If kept in a warm room sections may be prepared for use at once.

[1678.] *Driven Lots of Bees Dying.*—A friend who has gone abroad left in my care four hives of bees with instructions to sell them in spring. Well, I went up to have a look at them a fortnight since, and took with me some candy. I found one lot dead! They seemed to have fallen *en masse* from the combs. There was plenty of food in the hive. I went up again this morning (March 7) and found another lot dead much in the same way. Both these lots were driven bees last autumn, and I am sending you a sample of the food found in one of the hives to see if the fault lies in it. There were plenty of bees in both hives, and though a bee-keeper for some years myself I cannot account for both stocks dying. I warned my friend to be sure and feed with cane sugar. If you could let me know through the JOURNAL what your opinion is as to the cause of death I should be very grateful, as I feel rather concerned about them, not being my own.—HENRY MARGERISON, *Birmingham, March 7.*

REPLY.—We print above query in full, deeming it probable our correspondent may wish to send a copy of it to his friend now abroad. But, beyond saving that the comb sent contains nothing worse than well-made syrup, there is little to guide us in arriving at the cause of bees perishing. We rather fancy they have been killed by cold, and by being forced to cluster on newly-built combs filled with icy-cold and perhaps unsealed syrup. The sample of comb sent favours this notion, while we are not assured of there being a queen with each driven lot. It would add to the risk of wintering safely if bees were queenless.

[1679.] *Transferring from Skep to Frame-Hive*—I want to transfer a stock of bees from a skep into a modern frame-hive: would the following plan be advisable? 1. To fix new hive on top of skep (which has a flat top), the new hive to be fitted with false bottom, bored with two or three holes through, and bore holes in top of old hive or skep so that the bees can go through into the new hive? 2.

In preparing frames for brood-chamber in new hive would it be wise to fill with brood-foundation only, or to have some of the frames filled with worker combs?—NOVICE, *Amlwch, N. Wales, March 3.*

REPLY.—1. On no account do as proposed; it is just the way *not* to succeed. Follow the method always advised in our pages, *i.e.*, put the skep above the prepared frame-hive and let the bees work down into it. 2. A frame or two of built-out worker comb will be advantageous, placing them in centre of the frame-hive, with frames of foundation on each side.

[1680.] *Reliable Swarm-Catchers.*—I ask, is there a cheap and reliable swarm-catcher on the market? I have had to move my bees about three miles away into the country, and shall only be able to see them about once a week. Nor have I any one near to watch for swarms. So they are certain to be lost unless something is done to avoid this. I see swarm-catchers advertised at 10s. each, which will be too expensive when one has ten or a dozen hives.—SWARM-CATCHER, *Sheffield, March 1.*

REPLY.—So far as a reliable swarm-catcher, we can do no more than refer you to those advertised in dealers' catalogues. Some of the plans shown are quite reliable so far as preventing loss of swarms, and cost no more than from 2s. to 3s. 6d.

[1681.] *Unused and Brittle Foundation.*—Wishing to transfer two stocks in cross-built comb in bar-framed hives last June, I placed each as required over the frames filled with comb foundation. These, although not drawn out in the slightest, were left *in situ* until January last, when, owing to wet getting into hives, one was opened, and as it was found to have a good many wood-lice, it was removed, to be replaced at a future date. These frames removed with their box are not wired, and in dusting three or four broke owing to brittleness. Would this brittle foundation, in your opinion, be replaced under stock at an early date, be as readily drawn out, or nearly so, by the bees as new fresh foundation? for if not, it would be a waste of valuable bee-time to replace it, though cost for new would be something. A line in reply in your valuable journal would much oblige.—L. G., *Newport, Isle of Wight, March 1.*

REPLY.—Without going so far as to say that foundation a year old is so acceptable to bees as that freshly made, it need not be cast aside. It will be well, however, to warm the foundation thoroughly before again offering it to the bees. There is surely some reason for the bees not attempting to build out the combs if offered to them under proper conditions?

[1682.] *Enlarging Hives in Early Spring.*—I have a small stock of bees now occupying only five frames, which is the number they were hived on as a small swarm in July last. I intend, a little later on, giving them another

five frames. Will you therefore kindly advise me what kind of foundation to give? When hived last July I put them on full sheets of worker foundation. I am quite a beginner with bees, and am very ignorant, but am learning.—CYMRAES, *Anglesea, March 3.*

REPLY.—Do not give more frames till the bees fully occupy all but the outside spaces. Then add a frame of brood or worker foundation right in centre; three or four days later give—again in centre of brood nest—another frame, and so on till the full complement of frames are introduced.

[1683.] *Lattice work in Front of Hives.*—Would it interfere with the bees going in and out of the hive if I have some lattice-work 2 ft. 9 in. away from mouth of the hive?—NOVICE, *Stetchford, March 2.*

REPLY.—The bees would simply rise over the lattice-work as if it were a wall, so that if not too high it would not appreciably interfere with their flight.

[1684.] *Artificial Swarming.*—Thanking you for the advice you kindly gave me in July last, I am sending you an account of how I succeeded, and also to ask if you will oblige me with some further information. On receipt of your reply to my query (1518, vol. 24), I decided to at once make an artificial swarm, but instead of allowing the bees to rear another queen, I sent away for a hybrid queen to save time. The swarm was made in a few days, and the new queen caged on top of the frames in the evening of the same day. In making the swarm I unfortunately failed to secure the queen from the old hive. I saw her on a frame almost as soon as I opened the hive, but before I could remove it she escaped, nor could I again find her, although I went over the hive several times. I afterwards found that the bottom of the hive did not touch the floor-board by half an inch, and have no doubt she got out of sight there. I have, however, since transferred them into a properly made hive. Fearing I might spoil the swarm because of so great a quantity of bees having gone into the new hive I had placed on the old stand, I removed two frames with brood and bees into the other hive, after making sure the queen was not on them. I then filled it up with five full frames of comb foundation, and covered all up. Both hives did well, and were packed away for the winter on six frames. But I was rather dismayed during the first week in January to find the queen belonging to the new hive nearly dead at the entrance. The bees had not been disturbed, and I am at a loss how to account for it. On the few warm days we had of late the bees of the old stock have turned out in numbers, and are gathering pollen from a peach house we have in bloom. In the new hive there are a nice lot of bees. I therefore ask:—1. What is my best plan to do with them; can I save them? 2. How would you

advise me to deal with the old hive so as to increase my stock? Should I make an artificial swarm from them in May, then buy another queen, and super afterwards? If I only got half the quantity of honey I had last year I should not mind if I could increase my stocks. 3. Does it make much difference in making a swarm if it is done in the way that I was obliged to do last year? 4. If, on receiving a queen from a dealer, and the day is wet and not fit to make a swarm, what is the best thing to do with her?—C. F. M., *Dolgelly, N. Wales, February 22.*

REPLY.—1. We fear there are no means of utilising the queenless bees other than by uniting them to the other stock. 2. The most profitable course will be to get all the advantages possible out of the strong stock by working it up for surplus honey, then increase by dividing into, say, three lots after the honey harvest is over. 3. Yes, all the difference between safe and risky methods. Follow the "Guide Book" closely. 4. Keep queen and the accompanying bees *warm and well fed* in the travelling cage till wanted.

Notices to Correspondents & Inquirers.

Letters or queries asking for addresses of manufacturers or correspondents, or where appliances can be purchased, or replies giving such information, can only be inserted as advertisements. The space devoted to letters, queries, and replies is meant for the general good of bee-keepers, and not for advertisements. We wish our Correspondents to bear in mind that, as it is necessary for us to go to press in advance of the date of issue, queries cannot always be replied to in the issue immediately following the receipt of their communications.

All queries forwarded will be attended to, and those only of personal interest will be answered in this column.

ZANZIBAR (East Coast Africa).—*Cyprian Bees.*—The queen (which reached us quite safe) is a Cyprian. These bees are small, as stated, but their excellent honey gathering powers are admitted by all who have fairly tried them, as is their beauty. In this country, however, the Cyprian bee has—after trial—been discarded because of its uncertain temper. They will for the most part allow of free handling without showing any resentment or giving trouble, when, without warning or from any visible cause, they turn so vicious and untamable as to become entirely unmanageable. Hence their banishment from nearly all British apiaries.

W. MARSTON CLARK (Twickenham).—*Suspected Comb.*—1. We find nothing worse than chilled brood in comb sent. 2. Referring to query as to our method of determining whether foul brood is present or not, we never need go so far as cultivation of the bacillus, our long and extensive experience (too extensive for one's personal comfort) enabling us to detect it from ocular demonstration aided, of course, by the microscope. 3. We think you are in error in supposing the stock from which sample comb was taken to be queenless.

The eggs and just hatched larvæ in cells make it tolerably certain that the queen would be among the dead bees.

A. E. POWELL (Walden, Essex).—*Bee-Farming in New Zealand*.—We believe there is a book on the subject, written by Mr. I. Hopkins, of Auckland, N.Z. If you wish, we will endeavour to get particulars regarding it.

TURPIN (Leyland).—*Preparing Bee Food*.—Our correspondent may take it from us that the several ingredients used besides sugar and water in making bee-candy and bee-syrup are each added for a good and sufficient purpose. But it would be a needless waste of time and space to explain fully the why and wherefore of everything advised or recommended. We are asked, for instance, "What use is cream of tartar in candy, and why is it not used in making syrup?" We reply: Cream of tartar is used in order to bring about the semi-granulated condition in which soft candy is used. Any one who considers cream of tartar superfluous should try his hand at candy-making without that ingredient. Syrup, on the other hand, needs an acetic acid to keep it in condition.

A. H. (North Bucks).—*Glass Covers, and Non-Porous Quilts*.—1. We used the words "There is no analogy between glass covers for frame-tops and non-porous coverings of American cloth," because the former are not laid *close* on the frame-tops, but raised above them, thus allowing the bees a free passage-way over the frames at will. 2. In reply to your question, "What becomes of the condensed moisture?" we may say that the experience of our correspondent "W. R. N." (who first gave prominence to the method of using glass covers), goes to prove that if the glass be warmly covered as directed, no moisture condenses on the underside. 3. We requested "A. H." (on page 60 of our issue for February 11)—after some futile searching on our part—to mention the page in "Guide Book" whereon—according to himself—certain misleading statements appear. In response to this request, we are referred, not to the "Guide Book" or to any other work of Mr. Cowan's, but to "Modern Bee-Keeping," a book issued by the B.B.K.A. Surely we may, without offence, ask that "A. H." will save us needless trouble by being himself a little more accurate in his statements.

G. O'BY (Littlehampton).—*Candy Making*.—Raw, unrefined sugar, whether pure cane or not, is entirely unsuitable for candy making. The sample of flour-candy sent is unfit for bee food, for several reasons. The pea-flour is so "cooked" into the candy as to make it too hard for the bees' use. If the instructions in "Guide Book" are carefully and accurately followed an excellent candy will result. But we should add no flour so early in the season as this.

H. GILPATRICK, JUNR. (co. Durham).—*Using Hives in which Bees have Died*.—It is impossible for us to tell what has caused the death of the bees from the few particulars given. Nor can we make out what is meant by "worms and eggs" found in the combs, on which the bees perished. Try and get some bee-keeper to examine them, and tell you if they are fit for hiving swarms on to in the coming season.

J. LIVELY (Pinner).—*Queen Killed*.—Bee sent is sure enough a queen, and her being found dead outside plainly accounts for the "agitation" noticed outside the hive. The dead bee seems to have been ruptured by some means, from the appearance of damage between the fifth and sixth ventral plates of the abdomen. Have you been examining the combs of late?

CONSTANT SUBSCRIBER (Birmingham).—*Experts' Certificates*.—The books recommended by the B.B.K.A. for use in preparing for exams. are Cowan's *Guide Book*, and the same author's *Honey Bee, Modern Bee-Keeping*, and Root's *A B C of Apiculture*. The first named three books may be had from the BEE JOURNAL Office at prices advertised in that paper, and the *A B C* may be got to order from America. For full particulars as to experts' exams., write to the Secretary, B.B.K.A., Mr. E. H. Young, 12, Hanover-square, London.

JESSIE ROWLANDS (Blundellsands).—Bees sent are hybrid Carniolans. They are generally regarded as mild-tempered and easily-handled bees. So long as the carbolic cloth suffices to keep them quiet in your hands, we should not try smoking. The bees received are evidently of this season's hatching.

E. P. GOLDING (Worthing).—Text Book, "The British Bee-keepers' Guide Book," post free, is sufficiently comprehensive to meet every requirement, from beginner to expert. It may be had from this office for 1s. 8d. post free; or 2s. 8d. bound in cloth gilt.

PERCY WILKINS (Wantage).—*Photos of Apiaries*.—We will be very pleased to receive photo of your apiary for inclusion in the "Homes of the Honey Bee."

W. P. (Derby).—*Moving Bees*.—If hives are carried carefully on a hand-barrow—or a pair of poles by two carriers—they may be removed at once without danger or loss.

LANCASHIRE AND CHESHIRE B.K.A.

Appointment of Expert.

The Committee wish to APPOINT an EXPERT to work one of the Counties. Salary £5 per month, with 1s. bonus per visit to all Members subscribing above 1s., and 6d. per visit bonus on Cottage Members subscribing 1s. only. Above to include all travelling and other expenses. Applications from Certificated Experts (including "Foul Brood" Exam.) to reach me, with testimonials, not later than SATURDAY, 13th inst.

BENJ. E. JONES, Hon. Sec.

The Apiary, Freckleton, near Preston.

Editorial, Notices, &c.

BRITISH BEE-KEEPERS' ASSOCIATION.

The monthly meeting of the Council was held on Friday, March 12th, at 17, King William-street, Strand, W.C. Present:—Mr. E. D. Till (in the chair), Major Fair, Messrs. H. W. Brice, W. B. Carr, H. Jonas, T. I. Weston, R. Hamlyn-Harris, and J. M. Hooker (*ex officio*), and the Secretary.

The minutes of the previous meeting were read and confirmed.

The following new members were duly elected:—

Miss E. A. Fisher, Heath End Farm, Loudwater.

Mr. Geo. Fisher, 2, Orchard-terrace, Newport, Barnstaple.

Mr. W. E. Nutley, Dalton, Thirsk.

Mr. Archibald Seth - Smith, Silvermere, Cobham.

Rev. Sidney Smith, Wheldrake Rectory, York.

Mrs. C. E. S. Watson, Bothenhampton Vicarage, Bridport.

Mr. W. North Row, Cove House, Tiverton.

The report of the Finance Committee, as presented by the Chairman, Mr. H. Jonas, being considered satisfactory, was adopted.

The Education Committee's report stated that a number of applications had already been received in regard to examinations during the coming season, the arrangements for which would be in the hands of the Committee just coming into office.

Mr. Till presented the proof schedule of prizes for the honey department of the R.C.A.S. show at Reading, as drawn up by the Exhibitions Committee, and this was approved. The Committee had had under consideration the advisability of promoting an exhibit illustrative of old and new systems of bee-keeping, at the forthcoming Victorian Era Exhibition at Earl's Court, but on the ground of the heavy expense which would necessarily be entailed by such a venture, and the difficulties attendant upon successful management during the whole period in which the Exhibition will be open, they were unable to recommend the proposal for adoption.

Correspondence between the Secretary and the Secretary of the Lincs B.K.A. was read to the meeting. The Committee of the County Association having resolved not to support the "trophy" class at Manchester, the matter had been taken in hand by bee-keepers, acting independently of the Committee, with the gratifying result that Lincolnshire would be represented by a "trophy" at the "Royal" show. The report of the Committee was unanimously adopted.

After making final arrangements for the annual general meeting of members fixed for

four o'clock on the same day, the proceedings terminated.

A meeting of the new Council was held later in the day for the election of Chairman, Vice-chairman, and Committees for the ensuing year. Council meetings were fixed for the first Friday in each month except May and October, when the dates will be Thursday, May 6, and Thursday, October 21. Conversations of members will also be held on these two occasions.

ANNUAL MEETING.

The annual general meeting of members was held on Friday, 12th inst., at 105, Jermy-nstreet, S.W., under the presidency of Mr. E. D. Till (Vice-Chairman of the Council). Among those present were:—Sir Thos. D. Gibson-Carmichael, Bart., M.P., Major Fair, Rev. W. E. Burkitt, Miss Gayton, Messrs. S. J. Baldwin, W. B. Carr, W. Dixon, R. Hamlyn-Harris, G. D. Haviland, J. M. Hooker, H. Jonas, R. Ness, P. Scattergood, jun., W. J. Sheppard, E. H. Taylor, Chas. Tite, T. I. Weston, F. B. White, and the Secretary (Edwin H. Young).

Letters of apology for non-attendance were read from the President (the Baroness Burdett-Coutts), the Hon. and Rev. Henry Bligh, Mr. W. Lees McClure, Mr. W. H. Harris, Mr. Wilfrid Gutch, Miss Dawe, Mr. W. P. Meadows, Mr. J. H. New, and others.

In moving "that the report and balance-sheet issued for the year 1896 be received and adopted," Mr. Till characterised it as the best that the Association had been able to issue during his connection with the Society. There was, he said, only one paragraph to cause the slightest feeling of regret, viz., that referring to the loss sustained by the Association, and bee-keepers generally, by the death of Mr. Walter Martin, of Wainfleet.

The motion was seconded by Mr. T. I. Weston, who congratulated the Association upon the success attending their efforts to extend bee-keeping. Mr. Jonas, Chairman of the Finance Committee, called attention to the improved finances, the revenue having increased in nearly all departments. The outlook was, he said, exceedingly hopeful, and if members continued to manifest a lively interest in the affairs of the Society, he had little doubt that the report for 1897 would be even more favourable.

The report was unanimously adopted.

After a vote of thanks to the retiring Council and officers had been proposed and carried, along with a similar vote to the Council of the Royal Society for the Prevention of Cruelty to Animals, for the gratuitous use of their board room for committee and other meetings, the election of officers took place, in accordance with the rules, and resulted as follows:—President: the Baroness Burdett-Coutts; Vice-Presidents: Sir James Whitehead, and the presidents of affiliated associa-

tions; Treasurer: Mr. W. O'B. Glennie; Auditor: Rev. R. Errington; Analyst: Mr. Otto Hehner.

The scrutineers' report showed that the gentlemen elected to serve as members of the Council for the ensuing year were:—Mr. R. T. Andrews, Rev. G. W. Bancks, Hon. and Rev. Henry Bligh, Mr. H. W. Brice, Sir Thos. T. D. Gibson-Carmichael, Mr. W. B. Carr, Mr. T. W. Cowan, Major Fair, Messrs. W. H. Harris, J. M. Hooker, H. Jonas, J. H. New, W. J. Sheppard, E. D. Till, and T. I. Weston.

A suggestion was made by several members that it would be more convenient if the conversaciones could be held on Thursdays instead of Fridays as heretofore, and it was resolved to recommend the suggestion to the favourable consideration of the Council.

A discussion ensued relative to the proposed measure for the better prevention of bee pest, and some valuable hints and suggestions were given by Sir Thomas D. Gibson-Carmichael as to the method of procedure most likely to work for a successful introduction of the "Bill." Eventually the following resolution was carried unanimously, on the motion of the Chairman: "That as the very existence of bee-keeping is dependent upon obtaining legislation for the better prevention of bee pest, it is desirable that the County Associations be impressed with the importance of collecting the information asked for."

(Report of Conversazione in our next issue.)

LINCOLNSHIRE B.K.A.

The annual meeting of the Lincolnshire B.K.A. was held in the Guildhall, Lincoln, on February 20, the following members and others being present:—G. J. Young, Esq., J.P., Miss Brewster, Miss Thornton, D. E. Downs, C. F. Foster, J. Emerson, A. F. Blackburn, H. Linley, H. J. Banks, G. Atkinson, J. Mablethorpe, J. Mills, J. Mastin, W. Cooke, Dr. Carline, Dr. Sharp, F. J. Cribb, and R. Godson, hon. sec. In the absence of the President (the Earl of Winchilsea), who is abroad, the chair was taken by G. J. Young, Esq., Vice-President. The Annual Report which was read stated, among other matters, that there has been a very large increase of members during the year, the membership now reaching a total of 480. The receipts for the year, including balance brought forward from 1895, amounted to £156. 19s. After all accounts had been paid, the sum of £28. 12s. 4d. remains to be carried forward to 1897 account. Monetary assistance had been given to sixteen local Horticultural Shows to increase prizes for honey, and new honey-extractors had also been sent to eight districts for the use of members, while four new ones had been purchased to replace those worn out. Referring to the autumn expert's tour, which was unavoidably shortened by the continued wet weather, the report stated that foul brood was on the increase in some districts, and in

cases where only one hive was affected it was promptly destroyed. The County Council for the parts of Lindsey had again renewed their grant of £25 for lecturing purposes, which lectures had been well attended and appreciated. It was announced that the management of the bee and honey department of the Lincolnshire Agricultural Society, at Sleaford, on July 15 and 16 next, would be under the management of the Association.

The report and balance-sheet were adopted.

Dr. Carline then proposed the following resolution: "That all stocks of bees affected with foul brood should be destroyed compulsorily, and that suitable compensation be made to the owner. That, with the object of stamping out this disease, we approve of the principle of the Draft Bill prepared by the British B.K.A., whom we urge to take the necessary steps for bringing it before Parliament as soon as practicable. That a copy of this resolution be forwarded to the British B.K.A. and the Board of Agriculture."

This resolution was seconded by Mr. F. J. Cribb, and carried unanimously.

Dr. Percy Sharp then gave an interesting and instructive lecture on the "Anatomy of the Honey-bee," illustrated by new lantern slides from photos taken by himself, shown by means of a powerful oxy-hydrogen lantern lent by Mr. W. R. Lilly and manipulated by that gentleman. The lecture was much appreciated by all present, Dr. Sharp and Mr. Lilly receiving hearty votes of thanks at the conclusion. The meeting closed with the usual votes of thanks. A portion of those present at the meeting afterwards partook of refreshments at the Lindun Restaurant.—R. GODSON, *Hon. Sec. L.B.K.A., Tothill, Alford, Lincs.*

Correspondence.

The Editors do not hold themselves responsible for the opinions expressed by correspondents. No notice will be taken of anonymous communications, and correspondents are requested to write on one side of the paper only and give their real names and addresses, not necessarily for publication, but as a guarantee of good faith. Illustrations should be drawn on separate pieces of paper. We do not undertake to return rejected communications.

** In order to facilitate reference, Correspondents, when speaking of any letter or query previously inserted, will oblige by mentioning the number of the letter, as well as the page on which it appears.*

NOTES BY THE WAY.

[2815.] The month of March so far has proved very boisterous and wet, preventing the tilling of land and sowing of seed for the coming year's crop. We ought to be now getting nearly twelve hours' sun, and with longer days there is a desire to make a start with outside work in the apiary. Paths want putting in order; hives need painting; seed for our bee-flowers requires sowing, and everything done to make the apiary look spic and span for the coming bee season. A spell of fine, warm

weather is also desirable, so that we can overhaul hives and clean out the *débris* from the floorboards, and reduce or enlarge the brood nest to the size and requirements of the colony. The past month has been fairly mild and brood nests have expanded considerably. I was surprised on taking a peep at the stores of a few hives the other day to see such progress.

I notice our American brethren in the craft are still trying to push forward in the matter of foundation making. Mr. Weed—of foundation fame—has been endeavouring to produce foundation with cells $\frac{1}{4}$ to $\frac{1}{2}$ in. deep, and the product is very favourably spoken of.

Having received some inquiries as to my experience about bees refusing foundation in 1896, I may say after giving the "Weed Foundation" a trial last year, I was well pleased with the result, though I had very few sections refused with any kind of foundation of last year's make. I have no doubt but it is clarifying the wax to get it a good pale colour that has much to do with making foundation obnoxious to the bees, coupled with the lubricant used in some cases, but I hope with the improved process these grumbles will become things of the past. If stocks are found queenless I advise uniting with other colonies near, or bringing the two it is desired to unite a little nearer every day when bees are flying. Don't waste money on queens for queenless, broodless colonies at this period of the year. If the combs are clean and fairly new, preserve them, and get an early swarm to replace the defunct colony. This will give a good return, if managed properly, the first season, whereas a weak colony will only build up in time to keep themselves in ordinary seasons.—W. WOODLEY, *Beeton, Newbury.*

THE "WELLS" SYSTEM.

WITH A WORD ON TITS AND FLY-CATCHERS.

[2816.] I was glad to see your correspondent "Bruen" (2787, p. 68) asking for the experiences of those who have tried the "Wells" system, and hoped to have seen more replies either for or against it. I certainly think that if all those who have tried the system and failed with it were to comply with his request, the Editors would be puzzled to find space for them.

The "Wells" system has probably proved a good thing for the hive manufacturers, but it is open to question whether it has to the average bee-keeper. Moving a good deal among bee-keepers, I know of many "Wells" hives either standing empty or used for single stocks only, owing to the difficulties and repeated failures experienced by the owners. My own experience (commenced in 1892) with the double-queen (or double-stock) system has certainly not been a failure in the strict sense of the term, as I have never had them swarm or lose their queens, while the bees have always been up to full average strength. My hive (a home-

made one) takes ten frames on each side of dummy with one entrance in front and one at end. I put on standard frames for extracting, and I have had some splendid takes of honey from it, but only once, in '94, have I ever taken more honey from this hive than from any two of my single stocks of equal strength. I therefore fail to see anything in the system to pay for the extra care and trouble required to work it, and my advice to the inexperienced is always—"Let the 'Wells' system severely alone."

Tits and Fly-catchers.—Turning to another subject, I notice in this week's JOURNAL Mr. Crisp's plea for the blue tit (2809, page 93). My experience has been that little or no mischief is done by these birds during the winter months; but at this time of year, when bees are flying freely in the sunshine—with a keen and sometimes strong wind blowing, bringing many returning bees to the ground—I must say it is difficult to gaze with equanimity at about half-a-dozen blue tits hopping around the hives. This has been my experience lately, and I have felt constrained to reduce their number. I would not ruthlessly advise the destruction of insect-feeding birds, but am convinced that at times—and if sufficiently numerous—some at least of them must be classed among the worst enemies of bees. For instance, I have before me as I write a letter from a Warwickshire bee-keeper (written about a week ago), who says, "I should be sorry to prefer a general indictment against the fly-catcher as habitually a bee-feeder, but that it most certainly is has been unmistakably my individual experience. Those whose apiaries are in open situations away from the close neighbourhood of trees will not be troubled with the fly-catcher, it being of strictly arboreal habits. You may remember that my garden is a miniature forest of fruit-trees where these birds have exactly the habitat congenial to them. They perch on some branch near to one of the hives and make sudden darts after the bees in their flight, returning to devour the bee after they have killed it. They also feed the young in the nest with the captured bees." I may add that this gentleman is seriously contemplating giving up bee-keeping owing to his non-success through the depopulation of his hives by these birds, and his inability to get rid of them.—GEO. FRANKLIN, *Kenilworth.*

COMB FOUNDATION.

[2817.] In reference to your correspondent's article on comb foundation (2807, page 87), I believe the subject to be an exceedingly interesting one. My experience coincides with his, and I think all bee-keepers do not lay the necessary stress on this important matter. But the almost incessant complaint from beginners that bees will not take to the supers is, in my mind, chiefly due to the fact

that the bees are not ready or strong enough to avail themselves of the extra room. In the uncertainty of our English climate and the shortness of the honey flow, I believe we ought to assist our bees more than we do—by building them up to a fit strength to take advantage of the early fruit blossoms.

Though apple and pear blossom honey is not of a very fine flavour, it is not to be despised. Yet full many a blossom

“Is born to blush unseen,

And waste its sweetness on the desert air.”

And why? Simply because our stocks are not strong enough to fully avail themselves of the secreted nectar. In order, therefore, that these ends may be attained, it is necessary that the hives be crowded with workers at least a month earlier than the usual honey glut.

A step in the right direction has been taken by our American cousins in the manufacture and introduction of the new “Weed” foundation, which must necessarily mean a saving of time and labour to the industrious insects: and experience has taught us that where drawn-comb is used bees commence work much sooner. The “Weed” foundation will be especially useful in comb honey production.—R. HAMLYN-HARRIS, *Bristol, March 5.*

BEEES IN WEST CORNWALL.

[2818.] On March 7 the bees came out in great numbers and very strong on the wing. The weather here for last month has been very mild, the thermometer on most days registering fifty in the shade. Bees are carrying in a lot of pollen, most of the incomers being laden with it. I have two lots of driven bees on five frames (each lot), and on turning back the quilt of one hive to-day I found it very warm, the hive seeming full of bees, although there were so many out on the wing. This being my first attempt at the hobby I seem to be getting on very well, thanks to the B.B.J. I don't mind letting you know what I went through the other day. I bought a skep off the old dame from whom I got the driven bees, and on going to fetch it on Friday last I fastened the bees in and got an old saw (which never saw a file), and tried to saw through the post on which the skep stood. While doing so I found the bottom board was loose, so I gave it a gentle wrench, when lo! the skep tumbled over and fell to the ground with a bang, leaving the board in my hand! I suddenly thought it time to retreat, and made for the house followed by hundreds of infuriated bees! Having no veil I could not go near the hive, but my friend offered to put them to rights. She went a part of the way, but quickly returned, exclaiming, “How savage they are; I can't get near them.”

Not wishing to loose my bees, I braced up my nerves, made a rush for it, turned the skep over on the board, and, after a time, I got the

bees tied up and home all right. As I turned the skep over one comb fell out; will the bees put it all right, or what can I do? By the bye, should I give the other five frames to the hive in which the bees are at present only on five frames!—E. T., *Falmouth, March 7.*

[1. If the broken-down comb contains brood, we advise its being left alone; but if a side comb and broodless, remove it. 2. If the frames are fitted with full sheets of foundation, one may be inserted in centre of those now in the frame-hive. Ten days later insert another, and if the bees cover the added frames well, the remainder may be given at intervals of a few days.—Eos.]

STARTING A BEE-FARM IN SCOTLAND.

[2819.] Referring to a query put by “Novice,” on p. 7 of BEE JOURNAL for January 7 last, as to a suitable district on the west coast of Scotland for starting a bee-farm, I would say Argyle is, according to my idea, about the best place, owing to the large amount of alsyke and white clover grown on each farm under cultivation in that part of the country. I also think it would be difficult to locate a hive of bees where it would not be within reach of heather in Argyleshire.—DONALD MCGEACHY, *Pennyfair, Oban, N.B., March 10.*

COUNTY ASSOCIATIONS AND THEIR WORK.

[2820.] Referring to the letter of Mr. West in last week's issue (2811, p. 94), I must first thank you for so clearly emphasising the only construction that could reasonably be put upon my suggestion, and also for your approval of the idea. Surely no one wishing well to the craft could object to such a simple regulation? The only objection that I can see would come from bee-keepers who have something to conceal.

Regarding the expert's visit mentioned by your correspondent, I may say that May 19 last was one of the most beautiful days of the week the expert spent in this district. Reference to my diary tells me that the temperature at 8 a.m. was 50° Fahr., max. (in the shade) 75°, and during the following night the mercury did not fall below 46°. Mr. Russell West was visited before sundown, and though declining to have his bees inspected, he thanked the expert for calling; nor has any complaint reached me as to the hour he was visited. Moreover, the expert whom we employed has had for a considerable period over a hundred hives under his control, and has been manager for one of the most famous bee-keepers in the United Kingdom. Need I say more as to a “practical bee-keeper” of less than two years' standing teaching such a man his work?

(Continued on page 106.)

HOMES OF THE HONEY BEE.

THE APIARIES OF OUR READERS.

The term "bee-garden" would hardly be considered an appropriate one to apply to the apiary shown in the illustration this week. The surroundings are too entirely matter-of-fact to convey any idea of a garden, while they exactly fit the appellation commonly used in America when describing an apiary, viz., "a bee-yard." None the less, however, does the picture admirably serve to show what may be done, so far as keeping bees profitably, with less of the rural seclusion deemed by many absolutely necessary for success. The apiary shown is that of Mr. Jno. Berry, Llanrwst, North Wales. With perhaps some appropriateness, it is situated in a "street" of that town, and,

keeping in 1882 with one stock in a skep, his first interest being aroused by seeing a book on bees. He started in April of that year, at once determining to have his bees in frame hives, and made one to the Woodbury pattern described in the book. This was fifteen years ago, and, concerning the place, illustrated as it now stands, Mr. Berry says:—"The photograph shows part of my apiary, and was taken in November last. It contains in all forty-seven stocks of bees—though we could not get all into the view—and, although not an extensive apiary, mine is believed to be the largest in North Wales." He then goes on to say:—"My bee-space is 17 yds. by $5\frac{1}{2}$ yds., the hives facing all four points of the compass. Some of those shown have been in constant use for fourteen or fifteen years. All the hives were



MR. JOHN BERRY'S APIARY, LLANRWST, NORTH WALES.

though hardly comparable to an ordinary street—as the term is understood by dwellers in large towns—the close proximity of houses is plainly shown. But the apiary seen is a remarkable one in many respects, and—our curiosity being aroused by the interesting, though few and very brief, details concerning its history sent along with the photo—we resolved to make an effort to get some amplification of the text for the benefit of readers. We succeeded fairly well in this, notwithstanding the diffidence which impelled the writer to add a postscript, saying "I don't expect you will make use of all this, what some would call 'trash,' about ourselves." How many will so term the very interesting—and useful—details sent, readers will judge.

We learn, then, that Mr. Berry began bee-

made by myself from old packing-cases and sugar-boxes of various kinds, the B.B.K.A. standard frame being used throughout. Many of them are simply four sides and a roof, the latter being rendered waterproof by pasting on the outside a sheet of stout brown paper, and giving it two good coats of oil-paint. In the building at back of hives we do the extracting, while in another part is done the hive-making, jobbing, and preparing surplus chambers for putting on hives, besides providing storage room for all appliances not in actual use."

In such simple home-made hives as are shown Mr. Berry keeps his bees in health by care and good management; and, closely packed as they necessarily are, he only knows one case of a young queen missing her hive after a mating trip. Nor has he ever had a

stock entirely destroyed by robbing. It might also be supposed that so large a number of hives kept among so many houses would cause complaints from neighbours, and it speaks volumes for the bee-keeper when such is not the case. Of late years Mr. Berry has worked mainly for extracted honey, and the prevention of swarming. In the latter respect he succeeds, so far as usually having only two or three swarms in a season. This result is attained by alternating frames (fitted with starters only) between hanging dummies of wood, same size as frames, placed so that the bees are not inclined to work on the "starters" of foundation until cramped for room. Then, when at length they do build combs, they are mostly filled with honey, the space between the dummies being too narrow for drone-rearing.

Our inquiry as to his best season's "honey takes," Mr. Berry answers by referring to the accounts, published in the *Record* for 1887 (page 211), and for 1889 (page 267). In 1887 he secured 842 lb. of honey from his then total of thirteen hives (532 lb. in sections and 310 lb. of extracted). In 1889 he took over 1,400 lb. from his twenty-one hives, or an average of 66½ lb. per stock. He also reports, on page 366 of *B.J.* for 1884, an average profit of £3 per hive, and from his best stock of over £5 in that year.

As may be expected from above results, the district is a good one for honey. In fact, the bee-forage begins early with gorse or furze, followed in succession by sycamore, fruit-bloom, hawthorn, white clover, lime, black-berry, and—not least, if last—heather. The latter, though from a mile to a mile and a half away, yields good results to his bees, especially if the weather is settled and warm while the heather is in bloom.

Mr. Berry then goes on to say:—"I am a working man, labouring away from home from 6 a.m. to 6 p.m. I get a little help in the apiary from one of my boys, but my better half does all the bottling, labelling, and preparing our bee-produce for sale. She also finds a market for all our honey at a fair price." The fact of Mrs. Berry occupying a place in the picture along with her husband, and her fulfilling what some call the difficult task of "marketing," induced us to ask for some further information as to the lady's share in the work among the bees. In this way we persuasively drew forth some most interesting facts tending to show how much a woman may do in honey selling. It appears that Mrs. Berry was the first to take honey in sections and in glass jars to the ancient honey fair held annually in the town of Conway (some twelve miles from Llanrwst). This was in 1883, and now we are told that "nearly every seller of honey attending the same fair has some, if not all, in glass jars; whereas in former years it was ladled out from tin cans holding two or three gallons."

Among other useful facts regarding finding

a market for honey, we also learn that, in addition to the home retail trade, Mrs. Berry has succeeded in creating a good wholesale business among grocers, fruiterers, and others in various towns within a radius of fifteen to twenty miles of her own home. Only one good shop in each town is dealt with, and the vendor makes a point of delivering all produce on to the counter of respective customers with her own hands. She thus ensures "safe delivery," while there is no chance of "wrangles" over the question of quality, &c., that are not answerable by the seller on the spot. Besides this, the sections are every year glassed in the same way, while the jars, labels, and general "get up" is uniform throughout. A sort of "brand" or trade-mark is thus created, which gives confidence to purchasers, and brings repeat orders from tradesmen. Referring to this subject Mr. Berry says:—"My wife finds all the customers, who are entire strangers to myself, and when, from any cause, we want to serve a new shop, she turns into a sort of 'lady commercial,' and finds one; always getting a fair price for the honey."

In view of what to many appears almost insuperable difficulties in the way of profitable bee-keeping, we here have a case of success fully and amply proved. And our readers will, no doubt, agree with us in heartily congratulating Mrs. Berry on the success which has attended her efforts in the way of creating a market for her honey, and in regarding the lady as another ideal "bee-man's wife."

COUNTY ASSOCIATIONS AND THEIR WORK.

(Continued from page 104.)

With regard to not getting value received for his subscription, if ever a member got full value and more for his 2s. 6d. it was Mr. Russell West—as I could abundantly demonstrate if allowed space to give the facts.

I find his name in my diary as often as any one's, and he always received willing and ready help step by step during his novitiate. Referring to members who pay 5s. per year subscription, Mr. Russell West says:—"If experts get 2s. for every member they visit, what becomes of the other 3s.? Well, he has the annual balance-sheet of the Association for '96 before him and can easily ascertain. He will there see that the only paid officials are the experts and bee-tent lecturer. The surplus goes to the general expenses of the Society. Many members pay only 1s. and 2s. 6d. per year, consequently those who pay 5s. and upwards have to bear all the burden of working the Association. A word in conclusion regarding Mr. Russell West's last sentence on p. 94. I ask:—Did it strike this gentleman, when he started bee-keeping, that *he* was going to "compete with" older bee-keepers "and to bring down the price" of *their* honey? Did he not rather receive from perfect strangers help

and encouragement without stint, and with an utter absence on their part of any sordid and selfish dread of injury to their own pockets by his competition?—FREDERICK H. TAYLOR, Local Hon. Sec., L. & C. B. K. A., *Fallowfield, Manchester.*

A WORD FROM THE "EXPERT."

[2821.] As I consider that some reflection is cast upon me by the letter of your correspondent, Mr. West (2811, p. 94), I venture to send a word of explanation to clear myself. As one of the Experts of the L. and C. B. K. A., I called upon Mr. West, in company with a local hon. sec. of the Manchester district and his wife, and, all being cyclists, we rode on our machines. I think Mr. West will bear me out in my statements with regard to that visit.

I find in my diary that instead of the day not being "fit to expose a cat, let alone a tender bee" (*viz.*, May 19), the weather was beautiful for the purpose.

In fact, I had on the same day opened and examined twenty-eight frame-hives, and rode about forty-five miles to do it on my bicycle.

At about 7 o'clock p.m. there came on a thunderstorm, rain falling in torrents for about an hour; after which the stars came out, and it was a splendid night.

With regard to Mr. West being afraid of chilled brood, or teaching an expert the proper time to open a hive, I beg to remind him that he showed us a skep from which a few days previously he had driven the bees to make an artificial swarm for a friend. He had then carried home this hive with brood in combs, and about 200 bees to keep it warm, and was at that time introducing a queen, so that he might build them up into a strong colony. So much for my critic's care against "chilled brood."

Again, as to the questioned advantages of membership. Mr. West's subscription—according to the "list"—is 2s. 6d., not 5s., and if out of this the Association pay the expert 2s.—and postages alone to him costs at least 1d., together with a report costing 2d.—it leaves the large sum of 3d. with which to encourage people to commence bee-keeping and compete against him. But a great many cottage members only pay 1s. Also, where is the money to come from to pay for printing, postages, prize money, lectures, &c. It seems to me that Associations are heavily handicapped in their good work for want of funds. Besides, if every 5s. member receives only the advantage of the expert's visit, that alone is value for his money in numberless cases. Last season I was the means of saving scores of stocks from starvation, their owners not being aware they were short of stores. In other places I found hives affected with foul brood, and succeeded in persuading the owners to destroy them; thus helping to stamp out the disease. I know there are a great many people who do not care to spend 2s. 6d. unless they

can see 15s. return for it, especially if they think it is going to help some one who is not so well off as themselves. Happily we have very few such amongst bee-keepers, as I generally find them generous to a fault.

It would redound more to the credit of your correspondent, if, instead of throwing cold water on the work of Associations and their experts, he would take example from one of his local secretaries, who at a sacrifice of time and money, as I know, renders much assistance to his members. In the course of a year costs him pounds in travelling, let alone loss of time, and his only recompense is the thanks and good wishes of those he helps. Referring to myself, I can honestly say that on no account do I attempt to open a hive unless the member wishes it, and never travel at all on days when the weather is unfit for bee-work.—W. HERROD, Expert to L. & C. B. K. A., *Newark, Notts.*

[2822.] I notice that Mr. W. R. West (2811, p. 94), complains of the work done by County Associations; especially with reference to cottagers does the complaint apply.

The bee-keepers of this district are forming a new Association on progressive lines. We have named it "The Wilts Border Co-Operative Bee-Keepers," and we are hoping it will suit the times. I enclose proofs of rules and objects for your kind perusal and unbiassed criticism. You do not often get items from our county (Wilts) so I hope you will receive our contribution with open arms and a warm heart. I may add we staged over 700 lb. honey at our last little show for competition.—J. W. SPENCER, Hon. Sec.

DAYS OF FEBRUARY.

[2823.] In February the indoor games that have lingered on since Christmas are laid aside, for able-bodied men become as easily tired of chess and whist as able-bodied boys become tired of alley-tors and whip-top. With the hyacinths bursting up out of their water-glasses, and polyanthus narcissi raising cups of most delicious sweetness; with various plants in the garden already out in flower, the strange American witch-hazel, the exquisite blue twin-leaved scilla, golden rows of winter aconite (buttercups with an Elizabethan frill), crocuses from Italy (*c. imperati*), from Greece (*c. sieberi*), from the Crimea (*c. susianus*), from Tuscany (*c. biflorus*), narcissus minutus, the smallest daffodil, from the Pyrenees, the lovely sky-blue snow-glory (*chionodoxa*) from the high and far-famed mountains of Asia Minor; with all manner of plants pushing on one side the ashes, the old saucepan lids, the clay tobacco-pipe stems (with which the previous tenants of my garden fertilised the soil), plants, such as the leopard's bane, the madonna lilies, the goat's-rue, the ox-eye daisies, the larkspurs, &c., all saying plainly enough, "Look

out, you chickweed and groundsel you squitch and mayweed, or I will smother you." With the meadows becoming slowly but surely greener, because of the advancing blades of whole armies of grasses—brome grasses, quaking grasses, tuothy grasses—to say nothing of the leaves of sorrel and burnet and buttercup, and a thousand more. With the sap coming up and swelling out the buds of hawthorn and horse-chestnut and American currant, on whose pendent rosy blossoms our hive bees will soon sit and swing. With all these encouraging signs of spring, who can sit indoors and play "all-fours," or try to check a wooden king? (which is poetry!) Of late years the spring is a month earlier than it was. In this district our bees now swarm in May, and often in April, where we never used to dream of swarms till June. Therefore, we cannot complain of the lingering of the "sweet New Year," as did Tennyson, when he wrote—

"O, sweet New Year delaying long ;
Thou doest expectant nature wrong
Delaying long, delay no more.

Bring orchis, bring the foxglove spire,
The little speedwells darling blue,
Deep tulips dashed with fiery dew,
Laburnums dropping-wells of fire."

Even so early as February the gardener lingers a moment to look in shop-windows at shallots, at parsnip-seed, and early peas (Singster's No. 1), or shall it be William I. or "Earliest-of-all"—thus we think trying to 'make up' our minds. Or when that annual fraud—the man with briars (dog-roses), dug up out of country lanes, and fern-roots without any roots—comes round to our office-doors, instead of kicking him down the steps as we should have done did he call in November we call him in and, after bating him down from eighteenpence (for each gloire-de-dijon and La France) to sixpence we buy six—three gloire-de-dijon and three La France! And then we carefully carry them home and diligently plant and stake them. And then, when they flower in about three years' time and turn out to be the common dog-rose, well, to use a vulgar expression, "it gets your hair off"! especially when the wife sings out—

"Is yer mammy always with yer, Susan Ann?"

I write as though I do this thing! But it is not so. Yet I did once. And what brought it to mind this year is the fact that a friend stopped me in the early days of the month and showed me the gloire-de-dijons he had thus cheaply bought! And—wicked like—I kept my thoughts to myself, so that he went away complacent and in amity with all men, whereas I, as soon as ever I could get round the corner into another street, nearly had an apoplectic fit through immoderate laughter.

I have been writing of the last half of the month. The first half was all rain, fog, and general gloominess. We get no floods here,

being seven or eight hundred feet above the sea level, but we read in the papers how Mr. Hooligan, in order to save the lives of his pig and fowl, had to haul the one upstairs and carry the others, where they had to live with the family till the floods abated. Then there was Mr. Crosbee and a friend wading through water carrying his hives to a place of safety, mentally resolving at the same time that in future he would have the legs made ten feet long and each hive chained to posts.

On February 2 was witnessed the most beautiful fall of snow of the winter. It was not from the clouds—there were no clouds. It was the mist forced together by the intense cold of the upper atmosphere, so that the snow which fell was mist in another form. And how lovely that form was! The air was so still that the minutest twig on every bush and tree carried an inch at least of snow. Not common everyday snow, likely enough made in Germany, but the very best of home manufacture, guaranteed all wool, or rather all eider-down—and there it lay, a great quilt keeping warm the huge body of the world, *i.e.*, a little piece of her.

Late at night I went out and walked by the beehives, keeping to the path, however, that I might not spoil the exquisite snowy cloth laid upon the lawn. More than if there had been cold only, there was a great silence upon the beehives, as if it seemed impossible that they should ever again pant and strain under the heat of July days—days that are now almost unremembered, days that are too far ahead to be anything but a dream.

Slowly the snow melted, and gradually the rains and floods abated, till there came the ninth day of the second month. And this was the first red-letter day of the year, when, on stepping out of doors, the wind came against your cheek with a softness and fragrance as to almost, if not quite, startle you. It was to the face of winter even as bananas are to the parched throat of summer. It was to the bees a holiday such as they had not had for months, and deeply did many Sarah Janes and Susan Anns regret having hung out the clothes to dry on that day! Our Sarah Jane came nearer to swearing than ever before, and her face, truthfully pictured, would have made the fortune of Millais or of Burne-Jones. It was fortunate for me that my neighbour's goat did not jump over the fence on that day, for Sarah would have seen him browse off all my Alpine plants with delight, and never so much as raised a mop!

The fourteenth was the next red-letter day, and after that they became so abundant I lost count. It was delicious to see the snowdrops again, and to look down in the glowing golden cups of crocus. It was delightful to hear again the merry hum of the bees' wings as they flew from one aconite flower to another, or from scilla to scilla. The brightness of the sun and brilliant clearness of the air—washed clean by winter storms—made the blood

course faster through my veins, so that I felt a slight return of my old enthusiasm for the bees. And what is enthusiasm but love in another form? As said Tennyson, "In the Spring a young man's fancy lightly turns to thoughts of love."

"In the Spring a fuller crimson comes upon the robin's breast,
In the Spring the wanton lapwing gets himself another crest.

"In the Spring a livelier iris changes on the burnished dove;

In the Spring a young man's fancy lightly turns to thoughts of love."

LORDSWOOD.

CUTTING FEED HOLES IN GLASS.

[2824.] Being desirous of trying the glass-covers over my bees, I found cutting the hole caused my difficulty. I notice in B.B.J. of January 14, page 17, your correspondent, "Artificers," kindly offers to give all the information wanted. Would he be so kind as to inform me through B.J. where I can get the drill, &c. I should be so delighted to try my hand at drilling the hole, and should feel greatly obliged for the information.—WILLIAM BRIGGS, *Dorking*.

ERYNGIUMS AND PIANOS.

[2825.] In my notes on the *Eryngos* (B. J. March 4, p. 83), I should have stated that the one specially recommended, viz., *E. oliverrianum*, is often sold by nurserymen under the names of *azureum*, *coelestinum*, or more often as *E. amethystinum* (a quite distinct plant). Perhaps in ordering it would be best to order "the most popular sea-holly," for a dozen *E. oliverrianum* are sold to one of any of the others. It seems a pity nurserymen are not more careful with their names. I know several garden plants that have a dozen or more synonyms.

In reply to "A Vice-chairman of a School Board" (2814, p. 95), I should like to say that many Board school children are taught to play the piano, but it is after school hours and by a private tutor.

In reading my notes your readers must add a little sometimes and subtract a good deal very often.—LORDSWOOD.

Queries and Replies.

[1685.] *Preventing Granulation of Honey.*—Will the simple act of placing a jar of honey inside an empty vessel and covering it over, prevent the honey from granulating, and for how long?—JOHN WATTIE, *Neston, Cheshire*.

REPLY.—The "simple act" by means of which you inquire if honey will be prevented from granulating is one we never before heard

of. This fact, of course, prevents us from expressing any authoritative opinion, but we have no hesitation in saying that there is nothing in the treatment mentioned to prevent granulation; moreover, we are confident it will not have the desired effect.

[1686] *Doubling and Storifying.*—Though only a beginner, I am preparing to storify my extracted honey. Referring to "Guide Book" (page 58), I find it says:—"The frames in the lower storeys should be placed $1\frac{1}{4}$ in. from centre to centre, which will prevent the rearing of drone brood. Those in the upper storeys may be placed $1\frac{1}{2}$ in. to $1\frac{3}{4}$ in. from centre to centre. 1. My query, therefore, is:—Which shall it be, $1\frac{1}{2}$ in. or $1\frac{3}{4}$ in. Again, in B. J. of last week, in reply to 1674 (p. 97), referring to a query on doubling for extracted honey, you say:—"We consider thirty standard frames far too many for breeding in, and to have that number spaced at $1\frac{1}{4}$ in. apart will tend to reduce the gross weight of honey obtainable very considerably." 2. I want to get as much honey as possible, and so ask at what distance shall my brood frames (twenty in number, ten in each box) be placed?—W. C. H., *South Devon, March 13*.

REPLY.—Before replying to queries we would observe that the author of "Guide Book" uses the words quoted in describing a plan which has worked successfully with himself, but it by no means follows that it is one quite suited to "a beginner" in bee-keeping. To make our meaning plain, it requires very perfectly-built combs to be able to space them so closely as " $1\frac{1}{4}$ in. from centre to centre," and if the combs are at all irregularly built (as those of most "beginners" are) it may lead to very awkward results if the face of combs are too close, because, if so, the bees will inevitably join them by building brace-combs. This compels us to ask are the combs perfectly level on the face? Again, when the combs are spaced wider apart than $1\frac{1}{2}$ in. it needs to make some special provision for the wider distance if "metal ends" are used. Has this been thought of? Having said this much we reply to query 1 by saying, we advise spacing at the $1\frac{1}{2}$ in. distance. 2. If only twenty frames are used for brood, they may (subject to the conditions named above) be spaced at the $1\frac{1}{4}$ in. distance, but combs intended for storing surplus may be spaced at any distance from $1\frac{1}{2}$ in. to 2 in. apart.

[1687.] *Transferring from Skeps to Frame Hives.*—I bought three skeps in July last and not knowing the best way to deal with them, I ask:—1. Could I safely drive them into frame-hives with full sheets of foundation on Saturday next, 20th inst.? 2. The skeps at present stand on covered shelves in my garden. Could I move them to the ground a distance of about 3 ft. and 5 ft. respectively in front of where now standing?—CYMRO, *London*.

REPLY.—1. As our correspondent is evidently

quite a beginner at bee-keeping we advise his allowing the skeps to swarm and hive them in his frame-hives. He might fit the frames of one hive with full sheets of foundation and set the strongest skep above the frames at beginning of April. If neatly and well done the bees would work down into the frame-hive and transfer the brood nest below as combs were built; but to drive bees from skeps for starting frame-hives on the date named would be the height of folly. 2. If the skeps could be lowered to ground at two moves—half the distance each time—the bees would not be at all upset by the change of position.

LORD ROBERTS ON BEES IN INDIA.

"A curious incident happened at the Alambagh. I was employed inside the enclosure, when all at once I heard a noise and commotion some little distance off. Getting on the roof I looked over the plain, and saw our troops flying in every direction; there was no firing, no enemy in sight, but evidently something was wrong, so I mounted my horse and rode to the scene of confusion, where I found that the ignominious flight of our troops was caused by infuriated bees which had been disturbed by an officer of the 9th Lancers thoughtlessly thrusting a lance into their nest. There were no serious consequences, but the Highlanders were heard to remark on the unsuitability of their dress for an encounter with an enemy of that description."—From "Forty-one Years in India," by Lord Roberts.

Notices to Correspondents & Inquirers.

All queries forwarded will be attended to, and those only of personal interest will be answered in this column.

T. S. SMITH (Louth).—*Preventing Swarms; Swarm Catchers.*—The plan you propose of closing ordinary entrances entirely and cutting doorways, confining queen to brood nest below by zinc excluder, in shallow-frame surplus chambers for entrances, will not act at all well, and we would not advise trial of it. See reply to "Swarm Catcher" on page 98 as to these. 2. It is believed that bees do at times remove eggs, but only under very exceptional circumstances.

"X" (Carlisle).—*Mount Hymettus (?) Honey.*—Whether the honey (?) was gathered on Mount Hymettus or not we cannot pretend to say, but since our opinion is requested as to its flavour, it is difficult to believe that the gentleman who presented the honey to our esteemed correspondent can be serious. Anyway we suggest the neighbourhood of a jam factory or a confectionery works as the most likely place where it was "gathered." We have heard that Mount Hymettus honey is still sold in some countries, though they say no bees at all are now kept on the

famous mountain, and it certainly needs no wild thyme to give the flavour of cooked sugar possessed by the wretched stuff sent as a sample of Mount Hymettus honey.

COTTAGER (Stroud).—*Suspected Foul Brood.*—We are very pleased to say comb sent contains nothing worse than chilled brood. In forwarding samples for our inspection, a cell or two, at least, should be left untouched, as it was in the hive. In this case every cell had its contents poked out before despatching. This remark, of course, applies to correspondents generally.

J. W. SPENCER (Atworth, Wilts).—*Willesden Paper for Hive Floors.*—We do not think this will be found suitable for the purpose proposed. The natural damp of hive floors at certain seasons would, we think, cause the "paper" to swell and "buckle" as it does outside if not kept painted.

A. E. BULPITT (Birmingham).—*Bee Intimidants.*—Personally we use, and prefer, the Bingham Smoker to any form of intimidant when manipulating bees. Other forms of subjugation may be adopted by those who prefer them, and, with care, no damage to honey need follow the use of carbolic acid. In careless hands, however, the honey is sometimes spoiled through its use.

W. B. D. (Darlington).—*Californian Honey.*—Sample received is very dense and of fairly good colour. Its fault, to our mind, is the entire lack of character or true honey-flavour. In fact, it might contain hardly any honey at all so far as flavour and aroma. Only careful examination by dialysis would determine its purity or otherwise.

STITCH IN TIME (Essex).—*Suspected Foul Brood.*—We are very pleased to be favoured with a piece of comb from hive referred to on p. 97. It is, we regret to say, affected, as supposed, with foul brood, though, judging by sample, the disease is not of long standing.

Some letters on "County Associations and their Work" are held over till next week.

Special Prepaid Advertisements.

Situations, Publications, Bee Plants, &c. — Up to Twelve words, Sixpence; for every additional Three words or under, One Penny.

FOR SALE, 70 lb. of HONEY, in 1-lb. bottles, tie-over, of good quality, 8s. per dozen. Address, A. WREN, Summer Hill, Mayfield, Sussex. o 24

FOR SALE, last year's Early SWARM in skep, with Super, 2 Stocks in Bar-frame Hives. All healthy. Miss Cook, High House, Litcham, Swatham, Norfolk. o 23

21ST YEAR. Good STOCKS in straw skeps, 15s. each; in makeshifts, 12s. 6d.; 15s. ALSFORD, Expert, Hamford.

FOR SALE, 2 Strong, Healthy STOCKS of BEES, in good Bar-framed Hives, price 25s. SHARP, Thorpe Lubenham, Market Harborough. o 22

SELLING OFF (leaving neighbourhood), 8 STOCKS in Meadows' "X" Hives, 1 Lignian, 1 Wells. Any reasonable offer accepted. E. BENNEY, Swansea. o 27.

Editorial, Notices, &c.

We already begin to experience the reinvigorating effects of prospective summer-work among the bees, and the pressure it always brings upon the rather limited space at our disposal in the columns devoted to ordinary reading matter. In other words, bee-keepers are rousing themselves—just as are the bees—in response to influences which also reawaken to life such vegetation as affords income to the hives and puts an end to the enforced idleness of their inmates. As a consequence—natural, and, we hope, pleasing to readers along with ourselves—the columns devoted to correspondence and queries are filling to the point of overflowing. We therefore occupy space this week with a good portion of the full report (already in type) of the proceedings at the *Conversazione* of the B.B.K.A., and reserve other matter intended for this issue, but which will take no harm by being held over. It is also our earnest wish to be able to insert a bee-garden picture every fortnight for some weeks yet, but when the full press of summer work is on, we fear it will be necessary to limit this feature to once a month.

BRITISH BEE-KEEPERS' ASSOCIATION.

CONVERSAZIONE.

The first quarterly *Conversazione* for the year 1897 was held at six o'clock on Friday, March 12, in the Board-room of the R.S.P.C.A., 105, Jermyn-street, St. James. Mr. Till occupied the chair, and there was a good attendance, including several ladies. Among those present we noticed Messrs. Henry Jonas, J. M. Hooker, Major Fair, Rev. W. E. Burkiit, W. B. Carr, T. J. Weston, H. W. Brice, J. W. Shepherd, F. B. White, G. D. Haviland, S. J. Baldwin, E. H. Taylor, R. Ness, P. Scattergood, W. Dixon, Jas. Lee, R. Lee, J. Greenhill, G. Newman, R. Dymond, Leonard Evans, Geo. W. Fisher, R. Hamlyn-Harris, J. E. Gunyon, T. E. B. Gunyon, J. Helsby, and others, together with Miss M. E. Gayton, Miss Carr, Miss L. M. Carr, and Edwin H. Young, Secretary, B.B.K.A.

The Chairman, in opening the proceedings, called upon Mr. Haviland to describe the case of foreign bees he had kindly brought for the inspection of the meeting.

Mr. Haviland said that perhaps the most interesting of the bees shown in the case were the larger ones, namely, *apis dorsata*. He

supposed the name *dorsata* was given because of the yellow marks on the back of the bee. Those were the bees from which all the wax imported from the East came. They were migratory, and thought nothing of leaving their nests and moving about from time to time, and flying away. In certain places they built a large number of nests on the same tree; they would come year after year and build combs on every branch of the tree perhaps, choosing the time of year when there was most honey. The natives were in the habit of constructing a ladder against the tree for the purpose of enabling them to reach and cut away the comb from time to time. What would happen if they did not periodically remove the comb he could not say. Those bees produced a huge quantity of wax but not much honey. It would be noticed that the thorax of the queen was much larger than that of the ordinary English bee. They had many enemies, the worst of which was the honey bear, consequently they always built their nests high up from the ground, selecting trees which were most difficult to climb. The next specimens in importance were the *Apis indica*, but these bees are absolutely useless for bee-keeping purposes. Very little honey was obtained from them, and they had a habit of all flying away if the hive were touched. The next species was not described by name, and built only three or four combs, very deep down in the hollows of trees that were shaped properly for their purpose. About 5,000 ft. up a mountain he once came across the distinct marks of bear's claws, the animal having climbed up in search of honey, which it eventually found in the hollow trunk of a tree. Some of the other small bees seen among the specimens he had seen brought from Borneo and Singapore, and were found all over India. The workers were very small, while the drones and the queen were, as would be noticed, much larger. The drone had a very peculiar formation on his hind legs. He had seen any quantity of these bees in Ceylon. The native boys would go to the nests and frighten the bees away, leaving their comb, brood, and honey for the youngsters to carry off and eat!

The Chairman asked what was thought about the introduction of English bees into India. He mentioned this matter because a gentleman he knew, who was returning to a sanatorium in the hills there where the climate was well adapted to bee-keeping, proposed to try and introduce English bees at that place. It seemed strange, considering the large English population in India, if English bees had not already been imported into the country.

Mr. Baldwin said English bees had been introduced there. He himself had packed some for transportation to the Bengal Presidency; and he heard afterwards from the gentleman to whom they were consigned that they were doing very well. He also took out a stock of hives, which he thought of using

for native bees, but he (the speaker) pointed out that the English standard frame would be of no use to them, as they would not build comb that size.

Mr. Carr believed no profit or advantage would result from any attempt to "exploit" the *Apis dorsata* by way of trying to cross it with the bees of this country, and that any attempt to do so would fail.

Mr. Baldwin said that Mr. Frank Benton had some thought of introducing the *Apis dorsata* into the United States for hybridising purposes, but he did not believe the crossing practicable.

Mr. Haviland agreed in thinking there was no chance of carrying out the proposed crossing. He had himself been at some considerable expense in trying to domesticate these bees, and had some special copper wire-netting made of such a size mesh as to allow the workers to pass through but not the queen; but the bees always declined to pass through the wire to their combs, and hung about the bushes till the poor deserted queen died, after which they departed entirely. He tried this plan two or three times with the *Apis dorsata*, and also with the *Floria*, but neither would stand any interference whatever, and always chose the particular trees they liked. The *Apis dorsata* built their comb right out in the open, hanging down sometimes 6 or 10 ft. long, on the face of a cliff, perhaps, or any other apparently inaccessible place, and this comb could be seen nearly half a mile off.

Mr. Carr referred to some correspondence which had taken place in the B.B.J. on the subject of what had been called "glass quilts." Their correspondent, "W. R. N.," who sent "Bee Notes from Sussex," advocated glass coverings for hives, and as Mr. Dixon, of Leeds, informed him that he had been making glass covers for frames for some time past, and had brought one to the meeting, he would ask him to show it. Mr. Dixon showed what he had termed his "Observatory Glass Quilt," which enabled bee-keepers to take a look at the condition of their bees from time to time without creating any disturbance to them as when the ordinary quilt was removed. There was a bee-space between the glass and the frame tops, while the strip of wood dividing the covering into two parts allowed for a feed-hole without the need for cutting one in the glass, and if well packed on top to keep in the warmth, there would be no condensation of moisture on the glass underneath. Provision has also been made for proper ventilation when needed.

Mr. Baldwin said that Mr. Hasluck (a former secretary of an Association) had used a plate-glass covering. He had a bee-space above the tops of the frames, which was necessary, because wherever there was an attachment the bees would propolise.

Mr. Dixon said the cover had worked very well, and had been found advantageous by bee-keepers who used it as often enabling them

to see whether bees had sufficient food without disturbing them.

Mr. Baldwin showed specimens of comb-foundation made by himself on the most approved principles. In reply to questions, he said he thought his was better than the American produce, although he would not have volunteered that opinion without being asked. It could also be produced cheaper here, because Americans paid a higher rate of wages than English employers, while wax was cheaper in this country, and because the freightage from America was saved. In reply to Mr. Brice, Mr. Baldwin said his was not the same as the "Weed" foundation, excepting so far as all wax foundations were necessarily similar to one another.

Mr. E. H. Taylor (of Welwyn) said one recommendation of the "Weed" foundation was that it was now made in England, and was thus a home product, although the machinery came from America.

Mr. Baldwin said he had never seen the "Weed" process thoroughly. Mr. Taylor, whom he met in the States, visited Messrs. Root's place, while he (Mr. Baldwin) did not.

Mr. Jas. Lee exhibited a new section-rack, made with a larger covering surface underneath than such articles usually had. It would fit the top of any ordinary ten-frame hive, so covering the tops of frames that there would be no loss of heat. It was arranged with two adjustable dummies, with loose springs, by means of which more or less sections could be taken in and out while keeping those left in the rack close and rigidly packed together. Mr. Lee next exhibited a new form of hive, adapted for taking to the moors. The hive was securely fixed to the floor-board in a moment by means of two springs, while at the back there was an ingenious arrangement by means of which ample ventilation was afforded, and room given below frames for the bees to cluster during the journey, so as to prevent overheating. There was also space for a rapid-feeder to be fitted in from the back, and the floor-board was movable without allowing bees to escape; thus feeding could be done in any weather, almost without interfering with the stock at all. When the bees were taken to the heather the front entrance is first closed entirely and securely; the sliding floor-board was then drawn out, which gave the bees two or three inches of space to the zinc, and the whole was made safe for travelling in about five minutes.

In reply to questions put by those who examined the hive, Mr. Lee said that the feeder was adapted for top-feeding as well as below.

The hive was favourably criticised and approved of.

Mr. Lee also exhibited a new but simple and effective arrangement for fixing comb-foundation in frames, which met with approval.

At this point the Chairman expressed regret that Mr. R. Ness and Mr. P. Scattergood (who had respectively come from Yorkshire and

Notts to attend the meeting) had been obliged to leave to keep an appointment, as the members of the B.B.K.A. took special interest in the work taken up by the gentlemen named in their own districts, and which commended itself to him as being very useful. He referred to teaching bee-keeping in schools. A good deal might, he was sure, be done to advance bee-keeping by encouraging boys and girls in schools to take it up. Hives had been given and promised to one or two schools with successful results; they were presented to the scholars who by some proof of taste for the industry, or practical work, had proved themselves worthy of the reward. Of course it needed school authorities to take an interest in the matter, or there would be no chance of success.

Mr. Weston stated that the year before last the late Mr. Meggy tried to induce schoolmasters in the county of Essex to help in the cause. Many were willing to take up the matter if they could be assisted with drawings and hives by which to show their children how to manage. Several of the schoolmasters were good bee-keepers themselves, and were naturally glad to follow up the suggestion provided they could receive the necessary aid, which he (the speaker) hoped to give them. Undoubtedly the early education of the young was one of the most effectual means of spreading a knowledge of bee-keeping among the country people who could take advantage of the benefits it conferred.

The Chairman observed that an attempt in the same direction had been made in 1895 at Swanley College, Kent, when a stock of bees in a frame-hive was offered as a prize to the boy who wrote the best paper on bee-keeping and showed the most intelligent appreciation of the teaching imparted on the subject. The boy who won the prize secured 84 lb. of honey from his prize stock the following year. Unfortunately, however, the old plague of foul brood supervened the following season and put a stop to the prosperity of the colony.

A long and animated discussion followed on the question of the best means of stopping the traffic in diseased colonies of bees, sold sometimes in ignorance of their being affected, and sometimes with wilfully careless indifference to the fact of their being known to be diseased. Several gentlemen took part in the discussion, and it was agreed on all sides that on no account should colonies of bees or second-hand hives and appliances be purchased without careful precautions as to their being free from disease. Beginners were especially liable to be made victims of the ignorance, carelessness, or worse, of sellers, and should therefore be cautioned by all who had the opportunity of giving a word of advice on the subject. It was agreed on all hands that a conscientious expert or a thoroughly experienced bee-keeper should be consulted before buying stocks instead of swarms on starting bee-keeping.

(Conclusion next week)

Correspondence.

The Editors do not hold themselves responsible for the opinions expressed by correspondents. No notice will be taken of anonymous communications, and correspondents are requested to write on one side of the paper only and give their real names and addresses, not necessarily for publication, but as a guarantee of good faith. Illustrations should be drawn on separate pieces of paper. We do not undertake to return rejected communications.

** * In order to facilitate reference, Correspondents, when speaking of any letter or query previously inserted will oblige by mentioning the number of the letter, as well as the page on which it appears.*

DOINGS OF THE PAST MONTH.

[2826.] I don't remember a more trying month of March from the bee-man's point of view than the present. Both here and at my out-apiary, matters are practically at a stand still. A cautious examination of a few stocks makes me think that the bees are two or three weeks behind. Stores are getting so short as to need assistance at once. Up to the time of writing syrup-feeding is unsafe, therefore the supply of candy must be seen to and kept up. I have in some cases reduced the frames to as many as the bees cover, but even this needed to be done with expedition, and when a mild spell occurred. Brood there is in all hives, but not to the extent usual in the third week in March. Only on a few occasions since I last wrote have the bees had a flight. The crocuses are about gone, with hardly a visit from the bees. Willows, too, seem loth to break into blossom, while primroses, wood-violets, and anemones seem more shy than usual. The few here which have ventured forth are, from their bedraggled looks, repentant, and wished they had not turned out. However, we must, as usual, be hopeful; the late spring may be a blessing in disguise—who knows? Signs of an improvement are not wanting. Anyway, I am going to leave the bees alone until the atmospheric conditions improve. In fact, I shall not disturb the bees at all, save seeing they do not starve. Already we hear of queens found dead outside hives, and of them being killed accidentally; and queens lost now when they cannot be replaced is bad—very bad. It must be remembered that even if the queen of a strong stock got killed at this season, when queens are not to be bought for money, it is a loss that can hardly be made up. To join stocks up during the late weather would be extremely likely to lead to further complications and loss, besides, it is folly to think about joining up good stocks that would do equally well apart if in normal condition and left alone at critical times such as these. Join up weak stocks by all means as soon as the weather becomes fit, but this requires to be carefully done even then, and the queens at head of weak stocks are rarely worth preserving. Beware of spring dwindling; it may be that, owing to inclement weather, comparatively little brood has been raised to take the

place of bees who will assuredly be found missing so soon as fine weather supervenes. When this happy time arrives our care must be to nurse all stocks into good heart again. Do not, under any circumstances, make a thorough examination until April is well advanced and the temperature over 55 deg.

With regard to the question of the sale and purchase of bees raised at the late conversation of the B.B.K.A. on the 12th inst., it was stated by some one present that steps ought to be taken to stop the sale of stocks of bees on bar-frames and in skeps. Now this, to my mind, is unnecessary and unreasonable. If carried out it would inflict a great hardship, while only in a very small measure providing a remedy for the evil it was intended to prevent, viz., the spread of foul-brood. To put a stop to the sale of bees on frames, would deter the advancement of bee-keeping in many ways. Hundreds of healthy stocks every year change ownership to the mutual advantage of all concerned. I have myself bought considerably in this way in the past, and with proper and simple precautions have not yet had a single diseased stock sent me. That some unscrupulous persons may desire to get rid of diseased stocks must, of course, be admitted; but is the sale of all healthy stocks to be vetoed on this account? The remedy against loss is to have all stocks guaranteed healthy (in writing, if need be) before the bargain is struck. As hon. secretary to one of the largest bee-keepers' associations in the kingdom, I have, perhaps, as much to do with foul brood as the majority of bee-keepers in this country (our Editors excepted, of course). But the very knowledge I have gained is my great safeguard. It also places me in a position to speak on this subject, and I say emphatically that with proper caution in the purchase of bees on frames or in skeps, there is no reason why sales of these should not take place. Teach bee-keepers to know and how to detect the disease and you have the means that will stop the sale of affected stocks. When this is done, and bee-keepers are able to detect the disease in all its phases, then will it really begin to disappear from the land. I never advocate the purchase of second-hand hives, because of deeming them to be the most fruitful source of contagion. New ones are cheap enough, and this does away with risk of any kind. Besides, it is always wise to fight shy of beelless hives unless their history is well known.

The advantages of a stock over swarm in the spring hardly requires discussion, as one means a certain harvest and a return for capital expended, whilst the other may or may not mean any return at all during the first season. In fact, the chances are against them for surplus honey till the following year. That there is less risk to the careless in buying swarms is quite true, but to the careful buyer and an honest seller it is quite otherwise.

In making up one's mind as to the line of

work for the coming season, extracted or comb honey, I have decided to devote the main labour to extracted honey, and have been busy preparing shallow-frame supers, so that all may be ready for putting on when the rush comes. It is a comfortable feeling to know that everything is prepared for any contingency that may arise. I make it a rule not to have to wait my turn for anything, when dealers are sold out or too busy to serve one. It pays better to have everything ready before hand. "Store is no sore," or at any rate, should not be, but, to my mind, it is a great sore when the rush comes to find we cannot secure the harvest because of our state of unpreparedness.—HENRY W. BRICE, *Dale Park, Upper Norwood.*

BEE NOTES FROM SUSSEX.

[2827.] When I read "Lordswood's" dainty and picturesque contributions, and his recent captivating accounts of soft and balmy spring days, it makes my mouth water, and a feeling akin to strong envy comes over me, for ne'er a one have we been favoured with as yet in this usually most mild and early part of the sunny south coast. Yesterday, Sunday, was the first really warm and fine day we have had, and then the wind was chilly. For some three weeks or more the bees have been able to fly nearly every day, in the intervals of downpour, and on most days a few have been bringing in a little pollen; but yesterday was the first occasion on which they have been out in really large numbers, foraging wholesale and most successfully.

The continued rainfall has been most trying. For weeks past, hardly a day has been entirely free from rain, early or late. The amount of water which has fallen must be extraordinary. The whole of this low-lying country just under the South Downs is like an overcharged sponge. Ditches are full to overflowing; there have been 2 ft. of water in my cellar nearly constantly since Christmas; fields are sodden and cannot be worked (it is becoming serious for the farmers). Buds and blossoms are on the very verge of bursting open, and a day or two of warm settled weather would bring about a very speedy appearance of spring. In that case it would still be very early, and the way the bees seem to be preparing for it is remarkable.

Never as yet have I seen colonies so strong and forward. The sudden increase in numbers during the past fortnight is wonderful. In one hive a weak lot, till recently covering only two combs, now fill the whole ten frames, and are my strongest stock: their queen must be a good one. In the autumn they were one poor weak lot driven from a skep, hived on ten empty combs, and fed up rapidly till they had finished them off and filled them up with syrup. One fact is noticeable, and shows how much moisture there must be this spring; as yet I have not seen a single bee using the

water-troughs which stand just in front of the hives. In previous years these have been overthronged at this time.

Crocuses and violets are just going off; hyacinths and daffodils are at their best; anemones and primroses are fast coming on; while the arabis forms great white banks, and the laurustinus spreads its snowy white blossoms to every glint of sunshine. And, so soon as a stray sunbeam appears, the bees are seen rushing out and hurriedly snatching a hasty harvest.

I suppose the great storm of Ash Wednesday will never be forgotten in this district. I have had experience of much rough weather at home and abroad, and have made one or two fearful Channel passages; but never can I remember anything like the force of the gale, for about twenty minutes, towards 11 o'clock on that memorable morning. For ten minutes I stood in a sheltered place to windward of my house watching the lead curling up on the ridges of the roofs, seeing the slates fly like sheets of paper, and expecting every moment that a hole would be made, the wind get in, and the whole structure go. Matters just stopped short of that; in the afternoon I got the lead safely battened and spiked down, and next morning it took the workmen some three hours to repair damages. But the destruction to the trees, especially evergreens, was terrible. It was extraordinary in that awful twenty minutes to watch them going over and turning up their roots all around, struck down by invisible blows. Between a neighbouring railway station and a village about a mile off, forty trees lay stretched across the road; in fact, only one short road in the whole vicinity escaped being blocked for awhile. It is no exaggeration to say that in those few minutes thousands of trees were levelled in this neighbourhood alone, and damage was done which 100 years will not repair. Fortunately, my bees escaped all injury.—W. R. N., *Sussex*, March 22, 1897.

THE "WELLS" SYSTEM.

MY EXPERIENCE OF IT IN WEST CUMBERLAND.

[2828.] In reading accounts of the working of the above-named system by different writers in the BEE JOURNAL, I could not help being struck with the similarity between our individual experiences. In August, 1895, I stocked a "Wells" hive with two fairly strong lots of bees, the front entrances of hive facing north-east, and the ends looking south and west respectively. I used the front, or north-east, entrance for one lot, and west entrance for the other, so that the entrances stood at right angles. Both lots of bees wintered well, building up rapidly till about the middle of April, when I found the south end extremely populous, while the west end was correspondingly weak. On examination of combs the west end was discovered to be queenless,

with very little brood, but plenty of stores; the bees and brood, however, seemed quite healthy. In searching outside hive I found the dead queen, so joined up both lots, after which they did well and gave me 30 lb. or so of surplus, which is considered good for this district.

In August, 1896, I again stocked the empty west compartment of hive, but used only the front, or north-east entrances. Both queens were in their second season, and gave a nice lot of bees before going into winter quarters. On February 7 last I made a slight examination of the hive and found both sides strong for the time of year, with ample stores and a nice patch of brood on centre frames. On February 28, however, I found the dead queen on the flight-board of the west half of hive, and both lots in a similar condition to that of the preceding year.

Now, I have another double-queened hive standing within a few yards of the above-mentioned one, and I find the half looking in a western direction, or towards the sea, is very weak in comparison to the south end, although breeding is going on in both halves. I may mention that the dummies (perforated) in each instance were thoroughly propolised. On inquiry, I find that in this locality it is the general rule to find double stocks queenless in one half more frequently than in the case of single hives. But I am none the less determined to give the system a thorough trial, and hope to stock another double hive during the coming summer, though I shall not have entrances together, but at opposite ends.

I hope to send you my report of working the "Wells" system for 1897, and subsequent experiences, all in good time. My six lots wintered well. I have never had the misfortune to lose a stock during winter; I use good hives, good feed, and plenty of coverings.—J. A. NICHOL, *West Cumberland*.

CUTTING HOLES IN GLASS COVERS.

[2829.] In reply to your correspondent, Mr. Briggs (2824, p. 109), of your last issue, I beg to say the copper tube to make a drill for cutting feed-holes in glass covers can be obtained at J. Mayes, Metal Warehouse, Red Lion-street, Clerkenwell, London; or the drill, ready for use, from J. A. Hitchin, 8, Zetland-terrace, Old Charlton, Kent, price 1s. 3d., postage 3d. I usually get six pieces of glass, cut the size required, and place the wood batten, with guide-hole over the lot, and drill the six sheets of glass at one time. My device to prevent the bees from propolising the glass round the edge, is to paint the border with boiling paraffin wax, which, I find, answers admirably. I have had glass covers on a "Wells" hive this winter, and find that now the bees begin to fly more often, those of one hive desert their queen and take lodgings next door, and *vice versa*, staying a few days in

each place. I have determined this question by dusting one stock with pea flour, and found them an hour or so afterwards with their neighbour. Sometimes this has been carried on to an alarming extent, leaving one queen with only two frames of bees, when there should have been six.—ARTIFICER, *Kent*, March 20.

BEEES IN CO. KILKENNY.

[2830.] My eighteen stocks have come through the winter all right, and so far, I have no loss to report. I never packed the hives so carelessly for winter before, having been called away on duty (in consequence of the dispute in the bacon trade at Waterford) ere I had done all I wanted to attend to before the winter set in. However, I returned home on February 13 after an absence of three months, and was glad on the first fine day to see all stocks answering the roll call by turning out in their thousands. The hives were not contracted in any way, having ten or eleven frames in each. I never cut winter-passages or use any other device for attaining this end; nor do I go in for re-queening, always leaving that to the bees to regulate. No inspection of the hives has been made as yet, further than to give a fresh supply of naphthaline and to satisfy myself that there are sufficient stores in each, but judging from the great numbers of bees taking water on every fine day, I feel quite sure that brood-rearing is going on at a rapid pace. The weather here has been very cold and wet since March came in, vegetation having been completely checked for the present; but I hope we will have plenty of sunshine at the proper time notwithstanding all this bad weather, and that bees and bee-keepers will have a good season in '97 is the wish of M. K., *Piltown, Co. Kilkenny*, March 17, 1897.

COUNTY ASSOCIATIONS AND THEIR WORK.

[2831.] With reference to the letter of Mr. W. Russell West (2811, p. 94), the committee of the Lancashire and Cheshire B. K. A. have instructed me to say that they are perfectly satisfied with the way in which Mr. W. Herrod (expert to the association) conducted the expert work at Northenden in 1896.—BENJ. E. JONES, Hon. Sec., L. and C.B.K.A., *Freckleton, Preston*, March 22.

[2832.] As local honorary secretary for the district of the L. and C.B.K.A., in which your correspondent, Mr. W. Russell West (2811, p. 94), resides, I may be permitted to say a word in reply to that gentleman. I would in all fairness ask Mr. W. Russell West, to allow me to refresh his memory on one or two points connected with his bee-keeping experience, and his refusal to admit that any advantage accrues from membership of an old and honourable association.

Firstly, I would remind him of a certain Spring evening in '95, to wit, April 10 of that year, when, as a novice in the craft, he appealed to a "brother bee-keeper" to help him to transfer a small stock of bees which had just reached him in a box from the sunny south, and which, after a considerable application of "fire and smoke," he had failed to subdue or quieten. Did Mr. West receive any benefit from the Association then?

Secondly, I would ask him to carry his mind back to a July afternoon in the same year when the aid of the assistant local hon. sec. (for at that time I was assistant to my friend, Mr. F. H. Taylor) was called in to secure a swarm which a certain uncertificated expert had laid ineffectual siege to for half the afternoon? Has Mr. West forgotten these evidences of the real help of an Association, or shall I remind him of the valuable advice and tuition he received from my senior throughout the preceding winter months? While that energetic propagandist was devoting time and money to forward the interests of the L. and C.B.K.A., by lecturing, writing, and visiting rich and poor alike who asked for assistance and advice, Mr. W. Russell West will hardly deny that he received considerable courteous attention. Should he not rather give honour to our Bee Associations and those who work disinterestedly for the cause of bee-keeping, instead of writing such epistles as the one under consideration, and thus put a stumbling-block in the path of the teacher by whose instrumentality the foundation of Mr. West's knowledge of bee-keeping was laid?—T. F. HARRISON, Local Hon. Sec. L. and C.B.K.A., *Northenden, Manchester*, March 15.

[2833.] Regarding the Editorial footnote appended to my letter (2811, p. 94), in B.J. of 11th inst. permit me to say because I express an opinion (an opinion which, I believe, has previously been given in your columns) that the spread of the knowledge of bee-keeping must tend, by competition, to bring down the price of honey, it does not necessarily follow that I am opposed to the progress of the industry. Contrariwise, I maintain, and advocate bee-keeping, on the ground that the reduction of prices are *pro bono publico*. I trust you will allow this to appear in the B. J., so that I may not be misunderstood.—WM. RUSSELL WEST, *Northenden, Manchester*, March 16.

HOW TO SECURE WORKER COMBS.

When any colony is so weak that it has no desire to swarm (during or preceding the swarming season or honey-flow), such a colony will invariably build worker comb (so that worker brood may be reared till the colony comes into a prosperous condition), providing they do not have sufficient comb already built. Taking advantage of this fact I use all colonies

which are too weak to store honey to advantage, at the beginning of the honey-flow, treating them thus: Their combs are generally all taken from them; but sometimes I leave one comb partially filled with brood, and always one of honey, giving the combs of brood to other colonies so that they will be still stronger for the honey-harvest. I now put in one, two, and sometimes three frames with starters in them, or frames which are partly filled with comb, just according to the size of the little colony, after I have taken their combs away.

In all cases I see that each one has a frame well filled with honey; for should storms, or cloudy, windy weather come on at this time they would build no comb of any amount, and might starve; while with the frame of honey they will go right on converting that honey into comb, storm or no storm. If the right number of frames are given to suit the size of the little colony they will fill them quickly, especially when honey is coming in from the fields, and each comb will be filled with brood as fast as built. If not too strong they will generally build comb of the worker size of cell till the brood begins to hatch from the eggs first laid in the newly-built combs by the queen; but as soon as many bees hatch they will change to the drone size of cells, or if the little colony is quite strong in bees they may change the size of cells sooner than this. Hence as soon as the first frames I gave them are filled with comb I look to see about how many bees they have, and if they are still well stocked with bees, or are in a shape where I may expect that they may change the size of cell before they reach the bottoms of the frames with worker comb (should I spread those apart which they already have and insert other empty or partially filled frames), I take out the combs they have already built, and thus put them in the same condition they were when I first started. But they will not build combs quite as freely this time as they did before, unless there can be some young bees hatching; so, if I can conveniently, I give them a comb containing mostly honey and a little brood (if they have such a comb it is left with them, which is more often the case than otherwise) from some other colony, when they are ready to work the same as before. In this way a colony can be kept building worker comb all summer, or till the bees are nearly used up from old age, the colony becoming so small as to be unable to build comb to any advantage, under any circumstances. But if just the right amount of brood is left, or given them, so that they stay in about the same condition, they will build worker comb all summer by the apiarist supplying honey or feed when none is coming from the fields. If not so strong but that I think they will still continue to build worker comb, instead of taking the brood away I spread the frames of combs (now built) apart, and insert one or more empty frames between, when these will generally be filled with worker

comb before enough young bees hatch for them to change the size of cell. But *this* is always to be kept in mind, whenever you find them building drone comb. The combs they then have, all except the one mostly filled with honey, are to be taken away so that they may feel their need of worker brood again, when they will build cells of the worker size once more. I have had hundreds of frames built full of worker comb in this way, hundreds completed, and hundreds "patched," where I had cut out small pieces of drone comb, which had gotten in in one way or another. If any one wishes a mutilated comb to be fixed so it will be a surprise to him, just give it to one of these little colonies and see what nice work they can do at "patching" with *all* worker comb.—G. M. DOOLITTLE, in *Gleanings*.

Queries and Replies.

[1688.] *Buying Diseased Stocks of Bees.*—Last December I bought twelve stocks of bees in frame-hives. They were all weak, covering on an average three frames each. During February they decreased in numbers very rapidly, so, taking advantage of a fine day, I joined up eight weak spots into two by uniting. These two stocks are now strong, are raising brood in several frames, and appear to be quite healthy. Yesterday, on looking at the remaining four stocks, I found them in very much the same condition as a month ago, except that there is a patch or two of brood in each exactly similar in condition to the enclosed samples. Is this brood merely chilled through inability of the bees to keep up sufficient warmth to maintain the incubation of the embryo, or is it incipient foul brood? It has no perceptible odour. The separate pieces are from different hives. All have ample stores of sealed honey, but were allowed too many frames for the number of bees. 1. If foul brood, I suppose the treatment is to remove all stores and feed on medicated syrup? Will entirely fresh combs be necessary? 2. What kind of divider is used in the surplus chamber (shallow frame) of a "Wells" hive. 3. Is it usual to tier shallow-frame racks for ripening and complete sealing as is done in the case of sections?—E. H. G.

REPLY.—We print the above query in full in order to show the entire unwisdom of inexperienced bee-keepers spending money on stocks of bees which are immeasurably worse than valueless. The most elementary knowledge of the subject would have revealed the fact of something being radically wrong with twelve stocks of bees, "all weak, and covering on an average three frames each." And so, while sympathising very much with our correspondent in supposing it to be only a case of chilled brood—and so lightly estimating the

real nature of foul brood as to ask if fresh combs will be necessary if bees are diseased—it is certain he will have to acquire some information as to the contagious character of the disease before there is any hope of keeping bees successfully where all the hives he now possesses are affected. In answer to the several queries enumerated we can only reply:—1. All the comb sent is badly affected, consequently not only are fresh combs needed but the hives will need disinfecting before the bees again occupy them and build fresh combs therein. We send by post a copy of the Board of Agriculture leaflet on foul brood, which will be helpful in understanding the nature of the disease. 2. No divider at all is used in surplus chambers of "Wells" hives. The bees work in a super common to both lots. 3. Shallow-frame racks are dealt with much the same as sections, so far as ripening the honey. Personally, we like to leave several storeys of surplus chambers on until all contents are fully ripened.

[1689.] *An Unlucky Stray Swarm.*—In July last a friend, into whose yard a stray swarm of bees had flown, asked me to remove them, and this I did. At that time I knew absolutely nothing of bee-keeping, never before had kept bees, nor taken any interest in them. That I might enlighten myself I borrowed a handbook on the subject from a bee-keeper neighbour, which having perused, I learned a great deal from, and began to take a greater interest in the matter. The skep into which I put my swarm was of inferior make, and one very warm day, when the bees had about half filled it with honey, &c., the heat caused the combs to melt, and down came the whole mass on to the floor-board, killing a large number of the bees. I removed the broken combs, placed the skep once more in position, and allowed the bees to work on in it. I was very much discouraged, and in consequence cared little whether they lived or died. The stock (?) was very weak last autumn, but came through the winter splendidly, and finding it all right, in February I had a frame-hive made with the intention of transferring my bees into it early in summer. Last week, however, there were some terrific storms here, and by one of these my skep was raised right off its stand, all the combs broken and some of the bees killed. Unfortunate bees mine, are they not? Well, to make the best of a bad case I drove the bees into a bucket, afterwards transferring them to the frame-hive, into which I had placed four of the frames—three of them filled with half sheets of foundation, and one with such of the broken comb as contained honey (no brood). I immediately afterwards put on my "feeder," giving syrup as recommended for spring feeding, and also a cake of flour-candy. On examining them to-day I find that they are doing nicely, have drawn out some of the foundation, and are very snug. Now what I want to know from you is—Do you think they will pull through, for they are very weak?

And how do you recommend me to treat them henceforth? Also, do you think they will be any good this coming season? Pray excuse this long "history of my unfortunate hive," with which, I hope, I have not wasted your valuable time.—APIS, *Longford, March 21.*

REPLY.—The hardships undergone by the unlucky swarm, and the fact of your describing the bees as "very weak" in consequence, tends to make the chances none too hopeful; but if the queen is a good and prolific one, they may yet be in good condition before the honey season arrives. It will be needful, however, to keep the feeder going until food can be got outside.

[1690.] *Forming Nuclei.*—To avoid bringing up stocks and losing honey, would the following work out all right? Into a nucleus-box put one comb of brood and eggs and two combs of food, and supply about a quart of bees from another hive; would they raise queens from that? And if so, as soon as made up they would be carried to another apiary for mating?—W. F., *Staffs, March 22.*

REPLY.—The plan proposed will not work at all except to sacrifice the comb of brood and eggs, which would become chilled and lost. Our correspondent loses sight of the fact that if, during the flying season, a hive is moved from one position in an apiary to another stand only a dozen yards away the bees of that hive will return to the old stand, and, failing to find the hive, will be lost, or will enter the nearest hive they can find. In the same way, if a comb of brood and a quart of bees are taken from a hive and put into another a few yards away, as proposed, all the flying bees will return to the parent hive, leaving the brood on the new stand to die, as stated above.

[1691.] *Extracting and Grading Honey.*—Concerning the article "Extracting and Grading Honey," page 353, September 3, 1896, "These first chambers are left next to the brood nest all through the season, the bees feeding from them to a great extent," can you inform me, please (1), if this method is much practised? (2) Supposing this first chamber fully sealed over, and a short spell of cold weather comes, would the bees uncap this sealed honey nearest the brood nest rather than go up to the second super, where I will assume there is some honey not sealed over? (3) Will it not tend to swarming through there being no empty cells between brood nest and honey store?—FREDK. P. SMITH, *Exeter, March 20.*

REPLY.—1. We don't know as to the extent to which it is practised. In the case in question it was useful because the early honey was inferior in quality. 2. The bees used the contents of first super as store food. 3. Yes, but such a condition is not likely to arise.

[1692.] *Suspected Combs.*—I enclose a piece of comb, and would feel much obliged for your opinion of its healthiness or otherwise.

To-day appearing suitable for the purpose, I made a careful examination of my only hive of bees (referred to in Query 1575, p. 428 of B.J. for October 22 last as "the second hive, which seemed perfectly healthy"). I wintered this hive on all the stores gathered last year, as advised by yourselves. The stock seemed fairly strong, and sealed food was plentiful. On one comb were three or four suspicious capped cells. I enclose the piece for your inspection. On a centre comb there was a large patch of sealed brood on both sides, the cappings of which had holes in the centre of them, but were not sunken or shrivelled. Can this be "foul brood"? or were the bees in the act of sealing over? There was a little more sealed brood on the next comb, but I could see nothing more of a suspicious nature anywhere. I saw no eggs or newly-hatched brood, though I may have overlooked some, the two centre combs being so thickly covered with bees. I reduced the hive to seven frames and uncapped some honey. There has been naphthaline in the hive all the winter, also a cake of medicated candy above, which was nearly consumed.—M. W. S.

REPLY.—So far as comb received there is no sign of disease in it; in fact, the cells contained nothing but pollen and honey. We can offer no opinion as to the cells with "holes in centre of cappings" without having a piece to judge from.

[1693.] *Price of Swarms and Bees on Frames.*—Would you allow me to ask if any reader of B.B.J. will help me by kindly stating the average price for swarms per pound for the months of April, May, and June. Also price of bees on standard frames at per frame during the time mentioned.—LITTLEWOOD, Droitwich, March 23.

REPLY.—We have no objection whatever to our correspondent receiving any information which may be volunteered in reply to his question, but would refer him to our advertising pages, wherein may be found the prices at which bees and swarms are sold at all seasons.

[1694.] *Italian Bees.*—I have purchased a pure Italian queen of last year, and find she is most prolific; but her offspring, while flying near the hive, or, it may be, when returning after a flight, fall to the ground and become starved and unable to rise to enter the hive. This occurs chiefly on a sunny day. After they have been picked up and warmed, however, they are all right. Kindly say if this breed is weak, or is it that they cannot stand the cold here? Yet it can hardly be the latter, for the mischief happens while the sun is quite warm. The ordinary English bee gets on all right in the other hives. Can you account for the difference?—A. N., Weaverham, March 17.

REPLY.—We can only suppose that the Italian queen has been stimulated to early breeding, and that her progeny have been tempted outside before strong enough on the

wing. The Italian or Ligurian or Alp bee has the reputation of working earlier and later than the ordinary English bee, but we have ourselves found that, like the Carniolans, the young bees are sometimes found chilled outside the hive in early spring—as in the case of our correspondent—while the young of our common bees were free from any effects of chilling.

Notices to Correspondents & Inquirers.

All queries forwarded will be attended to, and those only of personal interest will be answered in this column.

H. ROWELL (Winchfield).—*Hampshire Heather Honey.*—1. Colour and flavour of sample sent are fairly good; the flavour being much milder than that of high-class heather honey, it might be preferred by consumers who do not care for the more strongly flavoured kind. It is also thin for heather honey; indeed, there would be no difficulty in removing it from the comb by means of the ordinary extractor. In view of the points named we could hardly give an affirmative reply to the question, "Is it good enough for showing?" 2. Thanks for approval of bee-garden pictures, and we shall be very pleased to get photo of your apiary as promised for inclusion in the "Homes of the Honey Bee."

C. H. DYCH (Rugby).—*Appliance Dealers and their Customers.*—We will take note of your letter, for which we are much obliged. There is no justification for the treatment received, but it is out of our power to help you, especially as the dealer referred to has ceased to advertise in our pages.

A. B. C. (Cornwall).—*Suspected Combs.*—We find only the faintest trace of disease in comb sent. The dead larvæ in the cells have perished some time ago—from chill, not disease. By continuing the careful precautions hitherto taken, we think the stock will get on all right in the coming season, if fairly strong now.

R. HAMLYN-HARRIS (Hambrook).—*Unrefined Cane Sugar for Bee-food.*—Sample received, though excellent and no doubt genuine, is not suitable for bee-food in the unrefined condition in which it comes to this country "direct from the estate" as stated. The dark-coloured viscid or uncrystallisable syrup called treacle or molasses needs removal before the sugar is good for bees.

E. E. ROWELL (Essex).—*Bee-farming in New Zealand.*—We are making the inquiry asked for on the subject, and will forward address when available.

ANXIOUS (High Wycombe).—No disease in comb sent, but the queen is evidently a drone-breeder and consequently worthless.

T. CHARLES (Much Marcle).—*Willesden Paper for Hive Roofs.*—This used to be obtainable from Messrs. Spalding & Hodge, 34, Cannon-street, E.C., but we cannot say if they still

supply it. Perhaps some reader will say if they know where it can now be had?

MIDLAND (Kettering).—Suspected Comb; Wax-moth.—1. We have delayed reply expecting that a sample of the suspected comb would reach us in due course, but none has come to hand. Descriptions of contents by correspondents are so often unreliable that we cannot express any opinion as to disease being present or not. 2. Honey from stocks which have died in winter is not a reliable food for giving to bees. 3. The best cure for wax-moth is strong stocks. This point attended to there need be no fear of that bee-enemy in this country.

F. C. (Sussex).—Comb is badly affected with foul brood.

CITY CLERK.—American and Colonial Bee Journals.—The best known of these in the U.S.A., are the *American Bee Journal*, weekly; *Gleanings in Bee-Culture*, semi-monthly; *Bee-Keepers' Review*, monthly; and the *American Bee-Keeper*, monthly. The first-named three are one dollar per annum each, and the last 50 cents. The *Canadian Bee Journal*, monthly, is the only bee-paper of Canada; price one dollar per annum.

ANXIOUS (Surrey).—Suspected Comb.—We find no trace of disease in comb sent.

Special Prepaid Advertisements.

Situations, Publications, Bee Plants, &c. — Up to Twelve words, Sixpence; for every additional Three words or under, One Penny.

PURE Herefordshire HONEY in Screw-top bottles. THOMAS CHARLES, Mueh Marcle, Glos. 0 42

WANTED, young unmarried Man. GROOM GARDENER. H. HAWKER, Longparish, Hants. 0 44

HONEYCOMB DESIGNS for our Queen's Jubilee. Apply C. COX, Brampton, Northants.

FINEST English HONEY, in $\frac{1}{2}$ cwt.s., 7d. per lb., tins free. Sample 2d. Deposit. DUTTON, Terling, Witham, Essex.

TWO Healthy (year-old) SURLPLUS QUEENS, 3s. 6d. each; foul brood unknown. ASHMORE, Holmoyr, Chesterfield. 0 41

SKEPS of BEES, 15s. each. Foul brood unknown. Packed and put on rail. Cash or deposit. G. KNOWLES, Newnham, Ely.

PNEUMATIC CYCLE WANTED in thorough repair. Exchange Hives, Appliances, Kitchen Ranges, Ironmongery. GEORGE ELEY, St. Neots. 0 28

THREE STOCKS of BEES in straw skeps, guaranteed healthy, price 12s. each. F. GAY, Edmondsham, Cranborne, Salisbury. 0 33

FIRST-GRADE HONEY in 16 and 32 lb. tins 6 $\frac{1}{2}$ d. per lb.; 56s. per cwt. Sample 3d. Deposit. H. HAWKER, Longparish. 0 45

STRONGLY-BUILT PNEUMATIC SAFETY, new tyres, sell £5. Part exchange extracted honey. SMITH, 26, Skipworth-street, Leicester. 0 38

FOR SALE.—7 empty HIVES, 30s. Good condition. Mrs. C. TOMLINSON, 23, Strelton-road, Leicester. 0 37

FOR SALE.—4 strong STOCKS of BEES, bar frame Hives, £1. 10s. each. G. WEBB, Station-road, Swinon, Wilts. 0 40

WANTED, experienced BEE-MASTER. Reply, with references, stating salary and qualifications. BAXTER, Sedburgh, R.S.O.

FOR SALE, 2 "WELLS" HIVES. Strong Stocks (96 Queens). MOSS, Station Master, Ravenstonedale. 0 34

FOR SALE.—BEES in Hive with 9 Frames, 20s. J. RHODES, Gardener, Eagle Cliff, Greenhithe.

FOR SALE.—20 STOCKS BEES, in straw hives, 10s. Each packing 1s. Divided to suit customers. Perfectly healthy. LINSTEAD, Garboldisham, Thetford.

FOR SALE very cheap, 2 double and 2 single BAR-FRAME HIVES with Crates, Smokers, &c. The lot 30s. LAMBERT, 18, Harper's-road, Summertown, Oxford.

WANTED.—Strong healthy STOCKS in Skeps, in exchange for a genuine old Violin, value £3. 3s. "D." B.E.J. Office, 17, King William-street, Strand, London. 0 39

FOR SALE, 2 healthy STOCKS BEES; hives first-class condition. Second story, with frames of comb. Price Two Guineas each. Mrs. BURTT, Brandon Lodge, Grantham. 0 29

LIMNANTHES DOUGLASSII.—The finest early Spring-blooming Bee Plant. Autumn-sown strong plants, 120, 1s. 3d., carriage paid, including full particulars of culture. Address, E. H. MATTHEWS, Ranelagh-road, Hereford. 0 30

GUARANTEED Healthy 6-frame STOCKS, 20s. Strong 8-frame ditto, 22s. 6d., packing included. Orders for Swarms of my well-known strain booked now executed strictly in rotation. WHITING, Valley Apiary, Hundon, Clare, Suffolk. 0 36

BAR FRAMES, cheapest in the market, equal to any, standard, 7s. 6d., shallow, 7s. gross. List of Bee Goods, 1 $\frac{1}{2}$ d. I must impress on intending customers to order at once to avoid delay. GARNER, Expert, Dyke, Bourne. 0 35

FOR SALE, "FORD-WELLS" HIVE by Blow. Used one season, in good condition. Neatly painted, three tiers, standard and zinc frames, perforated and solid division boards, shaw queen excluders. Ready for bees. Price 35s. JOHN SHERWEN, Grange, Egremont, Cumberland. 0 31

BEE VAN TO LET, fully furnished, for whole or part of season. ALFRED WATKINS, Herefordshire B.K.A., Hereford. 0 10

HONEY.—1-lb. SECTIONS, 7s. 6d. per dozen; also Extracted, good flavour, 6 $\frac{1}{2}$ d. per lb. in 14-lb. tins. E. LONG, Fulbourn, Cambs. 0 16

WANTED, BEES, from 12 to 20 Stocks, on Frames (no hives), and Early SWARMS. State particulars and lowest prices to JOHN G., c/o Bee Journal Office.

HONEY IN BULK from the Lincs. B.K.A. Honey Depot: 6 $\frac{1}{2}$ d. per lb.; 56s. per cwt. Tins extra. Sample 3d. R. GODSON, Tothill, Alford.

TWENTY-FIRST YEAR.—Good STOCKS in Standard Hives, by first makers, 25s. and 30s. each, on rail; package free. ALSFORD, Expert, Blandford.

WANTED, 1-lb. SECTIONS, clear and good condition, for cash. Apply, MANAGER, Southdown Apiaries, Bexhill, Sussex.

FOR SALE, last year's Early SWARM in skep, with Super, 2 Stocks in Bar-frame Hives. All healthy. MISS COOKE, High House, Litcham, Swaffham, Norfolk. 0 23

21ST YEAR.—Good STOCKS in straw skeps, 15s. each; in makeshifts, 12s. 6d., 15s. ALSFORD, Expert, Blandford.

SELLING OUT (leaving neighbourhood), 8 STOCKS in Meadows "XL" Hives, 1 Ligurian, 1 Wells. Any reasonable offer accepted. E. BUNNEY, Swansea. 0 27

OPPORTUNITY for a Gentleman to Learn practical BEE-KEEPING by accompanying a County Expert on Spring Tour of a first-class County Association. For terms, &c., apply to "BUZZ," c/o British Bee Journal Office.

BEE-TENT FOR SALE, Canvas about 7 yards in diameter, 5 ft. 10 in. in height; passage-roof canvas 5 ft. wide; net to enclose demonstrator 4 yards in diameter. As good as new. Maker, Cooper, Bristol. Cost £12. What offers? Apply, E. W. READ, Hon. Sec. B.K.A., Wotton-under-Edge.

Editorial, Notices, &c.

SENDING LIVE BEES BY POST.

Judicious friends of the bee industry cannot avoid a feeling of regretful irritation at the—no doubt well meant—but altogether misdirected efforts of those who, with every desire to do good, seem to possess the happy knack of knowing only how “not to do it.” It forcibly calls to mind Gilbert’s epigrammatic phrase—“He means well, but he don’t know,” when we read one item (important to bee-keepers only) of the proceedings in the House of Commons a few nights ago. According to the *Times* Sir H. Vincent inquired of the Secretary to the Treasury, as representing the Postmaster-General, why the United Kingdom, alone of countries and colonies within the Postal Union, declined to carry live bees by post if securely fastened; and whether, having regard to the desirability of encouraging every branch of rural industry, the Postmaster-General would reconsider the restrictions placed by his predecessors upon this form of postal traffic, which in the United States and elsewhere appeared not to be attended with any unsatisfactory results.

Mr. Hanbury.—I do not know whether my hon. friend contemplates postal facilities for a single bee or a swarm (laughter), or whether he would also send by post other live specimens of rural industry. He is, however, mistaken in supposing that the United Kingdom stands alone in this matter. On the contrary, many countries and colonies in the Postal Union share this country’s objection to carrying live bees in the ordinary mails. Against the transmission through the mails of anything calculated to injure the mails or the postal officials there is a general prohibition by the Union; live creatures are held by the British Post Office to come within this prohibition, and there seems to be no special ground for excepting live bees. The ordinary mails, it has to be borne in mind, are in this country frequently transferred by apparatus to and from railway trains in motion, a process necessarily attended by shock, and consequent risk of breakage, in the case of anything fragile or not securely enough packed; in the event of such breakage happening to a consignment of live bees, the creatures would almost certainly escape into the mail bag and produce unpleasant results (laughter). It is possible, however, for an expert in packing bees to obtain the consent of the Postmaster-General to their transmission by Parcels Post within the United Kingdom. But such permission is subject to conditions and restrictions, and cannot be extended to cases of transmission to or from places abroad, as parcels arriving from abroad are liable to examination in the Custom House (laughter).

Sir H. Vincent asked if such permission

could be extended to the colonies, as there were breeders of queen bees in Sheffield who were anxious to have this facility.

Mr. Hanbury.—No; I think a great many of the colonies refuse to carry bees by post.

We hope to refer again to this matter next week, but meantime can only feel how much more the end desired would have been served had the question been postponed till it could have been better dealt with.

BRITISH BEE-KEEPERS’ ASSOCIATION.

CONVERSAZIONE.

(Concluded from page 113.)

On the invitation of the Chairman, Mr. Carr then exhibited what he described as a few “oddments,” sent from various parts of the world to the office of the B.B.J. for inspection and editorial opinion, and not with the object of display at that meeting. No doubt they had all heard of the wax-moth, and he was able now, through the kindness of a gentleman who had sent over specimens from Cape Colony, to show those destructive creatures alive, as well as a sample of the ravages they made. [A box containing a matlike mass of cocoons and larvae of the moth in various stages of growth, and a smaller box in which were specimens of the insects alive, were then handed round for inspection.] He (Mr. Carr) next observed that he had often received queries for editorial reply as to queens getting through excluder zinc, and it might therefore be interesting for those present to examine a few queens he had brought with him, which showed how greatly the sizes differed between very diminutive and very large queens. There was also a reputed queen amongst those shown to which he drew particular attention, as accounting for the way in which bee-keepers may be led into errors regarding supposed loss of queens. The gentleman who sent the specimens referred to was quite under the impression that it was the queen of his hive he found dead a short time ago; but he was quite mistaken; it was not a queen at all, but a worker bee suffering from abdominal distension through long confinement to the hive. One could easily see how he had been deceived by the appearance when those examining the specimens had not at once noticed the abnormal worker bee among queens smaller than it was. The absence of wax-pockets in the hind legs of a queen bee was, however, the true guide in such matters, and could never be mistaken. A Cyprian queen preserved in spirits sent by a gentleman from Zanzibar was also among those shown. He (Mr. Carr) then remarked that bee-keepers had often heard of the ravages of mice in hives, and he exhibited what was an extraordinary discovery made by a gentleman, namely, several cleanly-picked skulls of mice worked in amongst the combs of a skep.

Next, he produced a curiosity from Gibraltar, showing how bees had built comb between two laurel leaves.

At the last conversazione, it would be remembered, a discussion took place on the subject of putting up honey for sale by grocers, and he now wished to call attention to a sample jar of New Zealand honey packed by a firm in London, and offered retail in grocers' shops at 8½d. per jar. He thought the labelling and general appearance of the bottle very neat and attractive, wrapped up, as it was, in transparent paper, in which form it was handed to customers. He recommended British bee-keepers to imitate this style of putting up honey for its neatness. He then showed another jar of very fine honey, beautifully put up, and sent by Mr. Cowan for inspection. It had been obtained from the Swiss mountains, at a height of 1,633 metres, and was an exceedingly high-class honey. Only a small quantity of this honey could be secured, and there was no difficulty in selling it at a good price abroad. Consequently, the English market would not be troubled with it in competition. A sample of so-called Mount Hymettus honey, of very questionable character and flavour, was next handed round, and not very favourably commented upon. Continuing, Mr. Carr handed round several samples of super-foundation sent to the B.J. office which had been refused by bees. It was desirable that all should see the class of stuff that ought not to be bought. Mr. T. B. Blow had sent to the B.J. office from Tunis, North Africa—where he was at present engaged assisting a gentleman in fitting up a large apiary there—a small sample of foundation having cells of a size midway between those of the worker and drone. The object supposed to be secured by using such foundation in brood-nests was to obtain a larger and stronger worker bee, by rearing the insect in a cell of greater capacity than the natural one. The foundation referred to was made in Belgium, and Mr. Blow had had the good sense to advise its rejection as unfit for use in the apiary. The sample was sent to the office with the object of securing some editorial confirmation of this view, which there was no hesitation in giving. It was no use, Mr. Carr said, trying to improve upon Nature in this respect; nor was the idea new, for it had been tried, but had only puzzled and mystified the bees without any good result following. The collection of sundries showed by Mr. Carr also included a miscellaneous lot of tin-ware articles for use in the apiary, sent by a maker in Nuremberg, Germany, some of which were novel and interesting, including a sliding entrance, metal racks for keeping frames rigid in travelling, the supports for comb foundation, and various other things, all of which were very cheap, and more or less useful. Our manufacturers here might, perhaps, be disposed to introduce some of the novelties for these benefit of British bee-keepers.

After the various items shown had been examined and commented upon by the company present, the Chairman said that it was worthy of consideration whether it would not be a good thing to leave a space on honey labels for the name and date of the harvest and name of the bee-keeper. The Chairman then invited an expression of opinion as to the best season of the year for giving instruction in bee-keeping, and the best way to impart it. If associations could only afford to have an expert continually going about amongst hives, the cause might be advanced very much. The County Councils were giving lectures in summer and winter, and helping bee-keeping considerably, and he had been reminded by Mr. Young that they were sending round pattern hives for the carpentry classes to make hives from, and were thus indirectly giving further aid.

Mr. Weston, in answer to the Chairman, said that he had something to do with Technical Education Committees, and his experience was that a distinction must be drawn between theoretical and practical instruction. With regard to the former, it was impossible to obtain audiences of village men and lads at the time of year when they could work in their gardens, which formed for them an important means of livelihood. The best time, therefore, for theoretical lectures was from October to about the end of February. Of course, practical information could only be given when the weather was suitable for it. His County Council, in appointing bee-keeping instructors, stipulated that certain outdoor practical work must be done.

The discussion was continued in conversational form by the Chairman, Mr. Carr, Mr. Weston, and Mr. Brice.

Mr. Dixon said that in his district some practical lectures had been given on Saturday afternoons at different bee gardens, when hives were manipulated, and the proceedings were successful up to a certain point; but, unfortunately, the County Council would not go on with the work. His was a manufacturing district, where neither agriculture nor apiculture received much attention.

The debate was further prolonged by the Chairman, Mr. Baldwin, Mr. Hooker, Mr. Brice, and others, and turned on the respective County Council grants and conditions for the promotion of bee-keeping in several counties: the Chairman also explaining the efforts that were being made in his own district of Kent to popularise orchard growing and arboriculture.

A vote of thanks to the Chairman for presiding terminated the proceedings.

PARTHENOGENESIS.

A CORRECTION.

Referring to the letter on the above subject in B.J. of January 21 (2729, p. 25), our correspondent, Mr. A. C. M. Schröder, of Trieste—who we regret to learn has been laid

up with an injury to his arm—writes: "I cannot tell now how I came to say that the Hungarian bee-keeper I referred to held the view that drones are produced from eggs fecundated by the liquid contained in the spermatheca of the queen *without* the addition of any male spermatozoa.

"I ought to have made clear his declared view that 'the liquid in the spermatheca is in itself a fecundating fluid.' Please make this correction in the BEE JOURNAL."

Correspondence.

The Editors do not hold themselves responsible for the opinions expressed by correspondents. No notice will be taken of anonymous communications, and correspondents are requested to write on one side of the paper only and give their real names and addresses, not necessarily for publication, but as a guarantee of good faith. Illustrations should be drawn on separate pieces of paper. We do not undertake to return rejected communications.

** * In order to facilitate reference, Correspondents, when speaking of any letter or query previously inserted will oblige by mentioning the number of the letter, as well as the page on which it appears.*

MARCH WINDS.

[2834.] Who can see this earth rolling onward along that magnificent aerial track round the sun without emotion? Five hundred and eighty-five million miles to be accomplished in 365 days, so that this immense globe must make a daily run of 1,600,000 miles! Then there is our satellite—the moon—every month carrying her lamp round us to light us on our way by night. Then consider the earth making a complete revolution every twenty-four hours, causing the darkness of night when the beams of the sun are gladdening our brethren in New Zealand, and causing the matchless light of day, when this portion of our earth rolls over to bask in the sun's warm rays. Think of the swing with which we go round when, to accomplish this turn, the earth at the equator moves faster than a rifle bullet! And yet all these arrangements of Nature would not give us the changes of the seasons—winter gradually giving place to spring, spring to summer. The climate of England would have been a perpetual spring, or, if you will, a perpetual autumn, and how monotonous this would have been! Nature, however, thought of this and made an arrangement whereby the poles (as it would appear) lean over in their turn towards the sun. Thus, the summer is approaching in the north, and in New Zealand it is now autumn. Think of summer not as a time when Britain is nearer the sun (for a good many millions of miles would make very little difference to the sun's power), but as a time when the north portion of our globe is leaning over towards the sun so that his rays strike Britain more direct than they do now. Think of the sun's

magnificent body—865,000 miles in diameter (the earth is 7,918). Go outside on a clear night and look at the "Great Bear" and "Orion," or the great square of Pegasus, or at Venus, the bright evening star, or at Mars, or Saturn. Again, look at the Milky Way, and remember that all these points of light are suns as great or greater than our own, or worlds lighted up by these suns—worlds as likely to be inhabited, and a score, or a hundred times greater than our own earth. Think of these suns and worlds millions of millions of miles away, and remember that there is no end to space, and that these systems of suns and planets may extend away for ever and ever! No wonder that, as each morning the world rolls over into light, each thinking mind lifts up a heart of thankfulness to the wondrous power that has made all this.

"As o'er each continent and island

The dawn leads on another day,

The voice of prayer is never silent,

Nor dies the strain of praise away.

The sun that bids us rest, is waking

Our brethren 'neath the western sky,

And hour by hour fresh lips are making

Thy wondrous doings heard on high."

It is delightful now to know that in its onward march the earth is gradually bending, as it were, its ancient, hoary head into the sun's warm beams. Lovelier, perhaps, than the summer is the spring, when between stormy days—between March winds—there are delicious breathing times, when the traffic of the air is lulled, when the sun is allowed across the thoroughfare, and comes with a cheery morning call to the beehives, to the birds, and to every living thing.

To the crocuses, which open their sensitive gilded petals in great array; to the sweet wild violets—white and blue—that grow in such profusion on Warwickshire banks, so you may gather a great lapful; to the primroses, which are as grass in Worcestershire meads, and along Worcestershire lanes: in woods, by riversides; to the swinging catkin of alder, ruddy and brown, of hazel, pale green and gold, of lofty poplar and slender birch; to the daffodil, and most sweet-smelling velvet wallflower; to the bright eyes of hepatica and golden stars of celandine, to barren strawberry, to moschatel and humble dog's mercury—to all living things does the sun come, lifting them up out of the grave of winter, dressing them in a fashion which never becomes old, and upon their heads placing crowns of gold, set with many precious gems.

Farmers say a bushel of dust in March is worth a guinea; then, say I, let the farmers have the dust and give me the guineas. As I write, the March winds are sweeping the city streets, so that the dust lies in the gutters to the depth of the curb. Nothing is more to be hated than dust. Dust on your desk, in your

eyes, between your teeth—I feel as if I must take a train out to where the grass grows green, and the hawthorn hedges are being painted and decorated anew. If these March winds would only bring some rain as they did every day for twenty days. Even with a hurricane wind and tempest shaking the house—as on the seventeenth day—it would be better than dust!

Poor hive bees! They dare not venture out except in ones and twos, and these the wind sweeps off their wings directly they get out of shelter of trees and hedges. There were bitter frosty mornings when the daffodil leaves, already 6 in. high, were laid flat upon the ground. There were hailstorms, and fierce winds that tossed the great pear-branches heavy with opening bud, so these buds lay thickly on the grass beneath. With the wind always dinning in the ears, what a relief it is to get one day of calm. When the restive wind is stilled; when you may breathe freely the soft air the steady beams of the sun warms; when the bees at the hive doorways jostle and push one another in their eagerness to make up for lost time; when you see going in baskets piled high with flour from the mills of Crocus Brothers and Messrs. Wallflower & Daffodil—flour that is to be kneaded, and so much honey rubbed in, to make cakes of all kinds and farthing buns for the young bees. When you know for certain the winter has quite gone, for the earth is now turning its northern seas and lands over where the sun may strike hotly, and yet kindly, so that the nightingale comes from afar, preferring our sweet woods in May to the stifling heat of her southern home.

“ When along the northern skies
Routed winter shrieks and flies,
And again the mavis shrills,
Come the dauntless daffodils,
Laughing, as they sway and swing,
At rude March's blustering.
These I gather, and with these
Rosy-white anemones,
Like the coral-shells you wear
Sometimes in your hazel hair;
Primroses loved none the less
For their wilding lavishness;
Honeysuckle, like to you,
To what's near it clinging true;
Violets, surprised in shade,
By their own sweet breath betrayed;
Lagging hawthorn, prized the more
That it long was waited for;
These unto your bower I bring,
Gifts of summer lent to spring.”

Lord'swood.

AUSTIN.

NOTES BY THE WAY.

[2835.] “A month of weather!” is the only report I can send of March. The whole of the month has been extremely rough and boisterous. Wind-storms, with deluges of rain, and, even when fine, the continued hurri-

canes of wind have made it impossible for the bees to labour outside except at a great sacrifice of life. In fact, I think March, '97, may be written down as one of the worst on record from a bee-keeper's point of view. Stocks are now in many instances no stronger than they were a month ago, loss of bee-life from the inclement weather having reduced the numbers faster than young bees have hatched out. Being situate on high ground, we have no great trouble in getting our colonies out of danger from the floods in case of emergency, but for a rough, boisterous position, we are well in the centre of it. No chance has occurred for overhauling any of the hives so far, consequently nothing has been done beyond seeing that all stocks have a supply of candy. When the weather becomes dry and warm, syrup feeding will be started where required. Our watering troughs and straw skeps, with pea-flour sprinkled on a handful of shavings, in sheltered positions, have saved the lives of thousands of bees for us.

We have a fairly good breadth of bee-forage already in blossom, the palm and wild anemones are in full bloom in the woods, also a good sprinkling of the dandelion are bursting into bud ready to open so soon as old Sol deigns to smile on them. In our gardens, too, we have abundance of white arabis and wall-flowers, American currant (*Ribes sanguinea*) all waiting for the busy bee, and in the near future we have the promise of a full crop of horse-chestnut blossom. Given, therefore, an equal supply of real bee weather, there is a good time before us.

(Continued on page 126.)

HOMES OF THE HONEY BEE.

THE APIARIES OF OUR READERS.

Our bee-garden picture this week shows the apiary of Mr. C. N. White, and is situate in the village of Somersham, Hunts, in which place he has resided for the past eighteen years. In response to our request for a few particulars regarding himself and his work to go along with the picture, Mr. White says:—

“My first lessons in bee-keeping were taken from my old friend and schoolmaster, Mr. Winter, of Caistor, Lincs, with whom I lived while apprenticed as pupil-teacher. Here, twenty-eight years ago, I first saw bees kept on a humane principle, for my *bee-master* (though hardly progressive or scientific enough to fairly give him a claim to that distinctive title) preferred an economical as well as humane system of bee-keeping. From 1875, when I left college, to '79, when I settled at Somersham, I was gleaning information on bees, and learnt much from Mr. W. B. Jevons, of Market Rasen, who was then an expert bee-keeper. Here, then, I formed the nucleus of an apiary that eventually became my pride, and did not lack the admiration of friends.

The work and worry inseparable from scholastic duties in a rural school of 250 children at first prevented me from doing very much with the bees, but since I have been able to turn to the hobby in grim earnest, I have by practical work and by the use of my pen endeavoured to show other rurals that bee-keeping is a source of interest and profit, and tends to promote good health and the power to work hard. For myself and the benefits it has conferred in this line the multiplicity of duties I have performed and still attend to fairly well show."

Few will dispute Mr. White's claim to be called a worker when we learn that he is Hon.

my means of recreation from school work," it almost makes one wonder when or during what hours he lies down to rest. Solid testimony to the value of the disinterested services he has for many years past rendered to his neighbours is found in the public recognition of his labours on several occasions, when testimonials have been presented to him by the leading residents of his neighbourhood. It may interest "Masons" to know that Mr. White was installed as Worshipful Master of Socrates Lodge of Freemasons at Huntingdon on January 19 last.

In concluding this brief notice we may mention one event, viz., the public presenta-



MR. C. N. WHITE'S APIARY, SOMERSHAM, HUNTS.

Sec. Hunts. and Cambs. Teachers' Association, and in this capacity has been representative at annual conferences of teachers in London and elsewhere. He is Hon. Sec. Hunts B.K.A. and of the Cambs and Isle of Ely B.K.A., while locally he is secretary to trustees of local charity, Hon. Sec. Technical Education Committee, collector of taxes, church choirmaster, conductor of concerts, is correspondent of five local weekly papers, and writes bee articles for ever so many other papers besides.

Bee-keepers also know that Mr. White has done a very great amount of bee-tent lecturing during his annual holiday from school duties, and when he coolly tells us that "the above are

tion to Mr. White of a gold watch and illuminated address in 1895, on his fortieth birthday, to mark his sixteen years' services to the locality. On this occasion, when returning thanks for the honour done him, he alluded to the fact that "in all his work much of the success he had been able to achieve was due to his good wife, and the possession of a happy home." Sentiments in which we are sure readers will cordially agree.

Mr. White holds the first-class certificate of the B.B.K.A., and frequently officiates as judge at bee and honey shows. Indeed, he may be very fairly classed as one of the public men of the bee-keeping craft.

(Continued from page 124.)

Purchasing Stocks.—I was pleased to notice that this subject received considerable attention at the late conversation of the B.B.K.A., and I indorse the opinions there freely expressed of the inadvisability of new hands in the craft purchasing stocks—very often in skeps, which are practically a sealed book to the purchaser. Exceptions must, of course, be admitted. In some cases, no doubt, owners of stocks wish to sell hives and bees for reasons beyond their control, but I opine the many sell because their bees have not paid, or have not done so well as formerly. This falling off may arise from a variety of causes, chief among which may be named foul brood, and if these stocks are sold to some one who knows nothing of bees, the purchaser may quite innocently introduce the disease amongst the bees in a district hitherto free from the pest. I have myself always advised beginners to start with swarms in new hives, giving as my reasons that, with good management a surplus can be secured the first season, and that the stock would be in the best possible condition for wintering after removal of surplus, as all the combs are new, and consequently not “pollen-clogged” as those perhaps several years old often are. Some may say an established stock will prove the best bargain, but when we know that swarms have secured 50, 60, and as much as 75 lb. of section honey in their first season, and leave a good supply for wintering—as I know for a fact they have done—I feel justified in still advocating that novices start bee-keeping with swarms. I feel sure that if swarms only had been purchased in the past we should not now be striving to obtain an Act giving powers for dealing with foul brood.—W. WOODLEY, *Beedon, Newbury.*

BEE NOTES FROM SUSSEX.

[2836.] *Glass Quilts.*—As these seem to be exciting some little interest just now, I should like to say a few words on three points concerning them.

First, let me repeat what I have urged before, viz.—that there is no earthly reason why, if desired, they should not be placed right on top of the frames. I cannot do this on my own hives, if I would, as the edges of the brood-chamber would then rise above the level of the glass, and I could not get a knife under the glass to free it from propolis, burr-combs, &c. It is a simple matter of taste and convenience. I myself think a bee space between frame tops and underside of glass an advantage. But, of course, I get troublesome burr-combs. If the pane is placed flat on frame tops, it will be propolised; but I always so place it over sections and shallow frames, and do not find it more trouble to remove than from the brood-chambers. The free passage above the brood-frames seems a great comfort to the bees, and I always now leave it below

the excluder zinc; but others may think differently, or their hives may be differently constructed.

Secondly, from my experience of broken panes, I feel certain that several strips of glass would be easier to remove in the spring, and would lend themselves better to any desired examination of hives, besides being less costly than one whole pane. What I mean is this: my own hives have an inside measurement of 17 by 15 in. This will admit of three strips of glass, 17 in. long and 5 in. wide, placed side by side; or of five of 3 in. width; or of three of 4 in. width, and one of 3 in. This last, or any one of the strips, might be of wood, as suggested by Mr. Dixon, and contain the feed hole, which may be of any diameter preferred. In practice, I have found 2 inches a convenient size. I myself shall try and work on this plan in future. It would remove any objection as to the difficulty of handling stocks. Probably, if, after the propolis season were over, the strips were loosened and replaced, they would not again be propolised that winter. Burr-combs are, unfortunately, built both very late and very early in the year.

Thirdly, the advantages and comfort of the glass quilts are so great that I confidently look forward to their use, in the modified form recommended above, becoming general. The one essential is *very* warm packing above. Mine consists of remnants of carpeting felt from wholesale warehouses, which cost next to nothing, and seem to keep in the heat admirably. I can only repeat that there is not a trace of moisture on the underside of the panes, nor of mildew inside my hives.

The Freedom of the Hives.—“Artificer’s” letter (No. 2829, p. 115, March 25) interests me very much. I can not only corroborate what he says about the bees “changing sides” in a Wells hive, but can also state as a fact that at this time of year, at any rate, the bees appear to go in and out of any hive as they please. I have watched them outside, and seen them do this time after time; and looking through the glass quilts into the interior of the hives, I find bees from all my stocks mixed up promiscuously. All signs of fighting have disappeared. Every bee is free of every hive; and the general good temper is such, that I recently did some repainting to the porches of all my hives *in situ*, while the inmates took the liveliest interest in the proceedings, buzzing around and alighting on my (painty) fingers; but not one stinging. They seemed to recognise the beneficial character of the operation, and graciously condoned the intrusion—at least, it seemed so. Probably they were far too busy to trouble themselves.

The Outlook.—Even already, since my last, stocks are decidedly impoverished. The continuance of high winds, together with tempting sunshine, has evidently led to the loss of many bees. Some of my fourteen populations look quite different to what they did a week ago, and I don’t think that anything except

daily inspection through a glass quilt would persuade people what a difference a single week will make just now. Stocks are becoming distinctly backward, and unless some change soon sets in little advantage will be taken of fruit blossoms. Yesterday I saw the first almond tree in full bloom; wallflowers and narcissus are just flowering; fruit buds are everywhere opening on the trees; hedgerows are greening; and one week's sunshine with the present mild weather would put a very different complexion upon things.

But as I write, the south-west wind is howling, a steady drizzle is beating on the window-pane, and spring seems anything but nigh. The hopes of an early harvest are falling slowly but steadily, and the bee-keeper becomes gloomy, morose, and fretful. Meanwhile, for the bees, nearly closed entrances, extra warm coverings, and careful feeding is, or should be, the order of the day.—W. R. N., *Sussex, March 29, 1897.*

APICULTURAL NOTES.

ABOUT "DRIVEN" BEES AND SPRING FEEDING.

[2837.] My bees have wintered well. Old-established stocks are in splendid condition. In the autumn I made up about thirty stocks of driven bees, two-thirds of which look like doing well; the remainder have dwindled, and have either been cleared out by other stocks or have had to be united. There is a great amount of uncertainty about driven bees, the numerical strength of which in the autumn appears to be no guarantee as to how they will come out in the spring. The age of the bees, no doubt, has a great deal to do with the matter, and when we take into account the large quantity of brood which would under ordinary circumstances form the juvenile portion of the community, but which is at the time of driving left in the skep to perish, it becomes quite easy to see that driven stocks contain a large percentage of old and worn-out bees, which are saved from the sulphur-pit only to die a natural death during the winter months. Ready-stored combs are, no doubt, in some respects helpful to driven lots of bees; but I have always found that such lots, hived partly on frames of stores, partly on foundation and fed up, encouraged also thereby to breed, are thus enabled to go into winter quarters with a goodly number of young bees, and come out in spring in very much better condition than lots that are put on already stored combs. In the latter case there is no inducement to carry on breeding. But, after all, the best use to make of driven bees is, in my opinion, to unite them to nuclei headed with young queens that are still laying.

I have ceased making candy for the present. Where food is scarce a supply of syrup is given. I boil 7 lb. of sugar to seven pints of water and pour same on to the 7 lb. of honey not considered good enough to offer for sale. (It is very bad policy to sell inferior honey; it

gets you a bad name, and has an adverse influence on future sales.) A quart of such syrup given over night has, in most cases, been taken down in less than twenty-four hours, when the feeding-bottle has been removed and all quilts packed down snug and warm.

There are some amongst us who think it still too early to give syrup, but whatever may be the grounds for objection on the part of bee-keepers, it is quite certain that the bees do not object to the treatment, and when bees are working vigorously, gathering pollen upon every occasion, whenever we have a warm hour or two during the day, I cannot help thinking that under such circumstances syrup is far and away more suitable than candy. It is certainly less trouble to make and is less expensive.

I have not yet made any very close examination of stocks; the fact that they are supplied with sufficient food for the time being, and, whenever weather permits, are busy carrying in pollen, is all I at present want to know. When the proper time and conditions arrive, a careful examination of all stocks will be made, and any combs that do not contain brood, or that have become aged, or are in any other way objectionable, will be melted down, and foundation used as and when required. This is a practice I have always followed and recommended, and believe that the constant renewal of combs has had a great deal to do with keeping bees in a healthy state.

I have a good number of stocks now on ten frames, but it is not given to many to possess bees that are anything like so prolific as the lot mentioned by "W. R. N.," *Sussex*, in his notes (2827, page 114, *B.J.*, March 25)—"a weak lot," which until recently "covered only two combs," and now (in the third week of March) "fill ten frames." This is one of the most extraordinary cases of prolificness at such a season that I have ever heard of. Is it not possible that bees from other hives have joined them?

I have just visited my Cambridgeshire apiary, where stocks have also wintered well. Some of the strongest lots cover twelve combs, and it is encouraging to learn that within a radius of one mile of said apiary there are upwards of 100 acres of sainfoin, trefoil, and white clover, to say nothing about other honey-producing plants. Weather being favourable, this apiary of forty hives should give a good account of itself.

We had a good deal of wet during the early part of the month. On the 20th the banks of the Ouse overflowed, flooding a good many acres of low-lying land. Sunday, the 21st, was a bright, warm day, and bees had a merry time of it. Since then strong, drying winds have prevailed. The land is now in splendid working condition. Farmers and others are busily engaged in seed-sowing, the weather for that purpose being everything that could be desired.—A. SHARP, *The Apiary, Brampton, Hunts.*

THE BEE SEASON.

[2838.] After reading Mr. Brice's letter in this week's B.J. (2826, p. 113) complaining of the backwardness of the season from a bee point of view, it may be interesting if I state what a difference a distance of about ten miles may make. I find that my hives are in a forward state, and I took my first lot of this season's honey to-day (25th). It was not much, certainly, about one tablespoonful! New comb has been formed in most of the candy-boxes on my hives, and on removing them this morning I pressed out from the new comb the above-mentioned quantity of honey. Is not this very early for such a thing?

While writing I send you my take of honey for last year. I commenced with four old stocks, and at the end of April successfully made two artificial swarms. My yield of honey amounted to 389 lb. 331 lb. in comb, and 58 lb. extracted. One hive gave me 109 lb. and another 105 lb. The honey was, I think, chiefly gathered from raspberry blossoms, and was of very good quality. After the numerous complaints of last year's honey yield, I think the above may be interesting to some of your many readers.—LIONEL BURRELL, *Sidcup, Kent, March 25.*

BUYING SECOND-HAND HIVES.

[2839.] Mr. Brice, in his "Doings of the Past Month" (page 114 of last week's B.J.) says he deems second-hand hives "a fruitful source of disease." I well remember, five years ago, an extremely suspicious-looking second-hand hive—the property of a gentleman in good circumstances, living a few miles out in the country—being exposed for sale in the market place in a large town in this county. The hive did not find a purchaser for some time; eventually, however, it was bought by another gentleman (also in comfortable circumstances, and owning four stocks of bees) for a neighbour of his who wished to start bee-keeping. A swarm—guaranteed healthy—was bought, and hived in the second-hand hive; the bees filled it with comb, and did well for a short time; then they went wrong, and were found to be in the last stages of foul brood. The bees of the neighbour who purchased the hive robbed the diseased stock, and were soon in a bad state with foul brood. The owner refused to do what was necessary, and they were allowed to die and rot on their stands, a hotbed of disease in a previously healthy district.—WM. LOVEDAY, *Hatfield Heath, Essex, March 27.*

DESTROYING WASPS ABOUT HIVES.

[2840.]—Regarding the question of preventing the destruction of weak stocks of bees by wasps, I often have a lot of these destructive insects prancing about my hives, on robbery intent, when feeding driven lots of bees in autumn. I find it a good plan to help

the bees in preventing the wasps from gaining an entrance to the hive by placing a round piece of wood on the alighting-board. Let the end of the wood pass about half an inch inside of entrance. A long roll of stiff clay is then pressed closely round the piece of wood to mould it into shape. The wood is then withdrawn, leaving a tunnel through which the bees pass in and out. By this means a very few bees can keep out a great many robber wasps. I send you this simple idea, thinking it might be useful to those readers who are troubled with the same pest as myself.—W. N., *Bridport, March 22.*

BLUE TITS.

[2841.] The blue tit correspondence has been very interesting to me, because I have been anxiously watching a colony of tits for three seasons, fully expecting to have to exterminate them, but I have not seen them take a *live* bee. May not the conflicting accounts be due to the different localities having more or less supplies of other food which the tit likes?

As bearing on this, one season sparrows took nearly all my red-currant bloom buds. They have not touched them before or since then.—FRED. P. SMITH.

WILLESDEN PAPER FOR HIVE-ROOFS.

[2842.]—I enclose a sample of this material in answer to T. Charles, Much Marcle, on page 119 of B.J. Any one ordering it should ask for sheet of "directions for use," which are important to be observed. Never nail it on the *top*, or it will tear away, but turn it well over the eaves and gables and nail from underneath. Wet it well before laying on, as this makes it quite soft and pliable. It will last five or six years with an occasional coat of paint. I call it the cheapest thing out and easiest to use. I found zinc very apt to "buckle" with a hot sun and cause nails to draw. I only use $\frac{1}{4}$ in. or $\frac{3}{8}$ in. boards under the card in my roofs. I obtain my supply direct from the "Willesden Waterproof Card and Canvas Company, Willesden Junction, London."—W. E. BURKITT, *Buttermere Rectory, Hungerford, March 26.*

[Another correspondent writes to say he is still able to obtain his Willesden Card from the Willesden Paper and Canvas Depot, 34, Cannon-street, E.C.—EDS.]

SWARM - CATCHERS AND SELF-HIVERS.

[2843.] Will some readers of the B.J. kindly give us their experience of the several "swarm-catchers" and "self-hivers?" I believe that Meadows' swarm-catcher and also Holes' self-hiver have been improved by the makers in various ways, but do they fulfil all that is claimed for them, and can they be *relied* on, especially for those who cannot be in attendance during the swarming season, except at long intervals?—J. C., *Barrhill, N.B.*

Queries and Replies.

[1695.] *Wax Extracting.*—I was extracting some wax the other day by means of a potato-steamer, placing the comb in the top over some gauze, and boiling the water in the bottom vessel until it ran through. Three lots turned out well, but another lot, out of which I expected almost half a pound of wax, yielded about a quarter of an ounce, which floated on the top of the water when cold, with a thick coating of about half an inch of light yellow powder underneath. Would this be the wax, and what do you think had happened to it? I boiled the water for about two hours before the steam extracted all the wax. DRAGON, *Birmingham, March 2.*

REPLY.—We should judge that the particular combs referred to were old, and had the cells more or less filled with pollen, which, being light, would ascend to the surface of the water, and lodge beneath the thin cake of wax. Old combs yield a very small proportion of wax.

[1696.] *Are Unfertile Queens of Any Use?*—In thanking you for past favours, I am compelled to trouble you again about my bees. 1. On March 13 I examined all my hives, and found one lot weak and without brood. I searched for queen, and at last found her dead at the bottom of the hive. A week later I was uniting the queenless bees to another stock, and when halfway through the operation I found a living queen, but *no brood*. Supposing she is a young queen and not fertilised, is it any good retaining her till drones are flying, or is she useless? 2. Is the fact of bees carrying in pollen a positive proof that there is a fertile queen and brood in a hive?—W. W. JEFFREY, *Atherstone, Warwick, March 23.*

REPLY.—1. Practically useless, because there is no use hoping that the queen will be fertilised. Probably in a few days she will have started laying, and when this occurs she will make no attempt afterwards to leave the hive for mating. 2. Though usually so regarded, it is by no means a positive proof of the presence of a fertile queen in hive. Bees carry in pollen with only a drone-breeding queen, or even a fertile worker, in the hive.

[1697.] *Wiltshire as a Bee County.*—1. Could you tell me whether Bradford-on-Avon, Wiltshire, is a good locality for bee-keeping, and if many bees are kept in the district? 2. Will you also please say if the bees have access at all times to the space between outer-cases and body-boxes of the "W. B. C." hive? or is the interior portion of the alighting board sometimes bridged over with a piece of board to prevent them getting into the open space?—ALPHA, *Scarboro, March 15.*

REPLY.—1. Not being personally acquainted with the district of Wilts referred to, we cannot advise as to its suitability for bee-

keeping. As it is more than probable, however, that the Hon. Sec. of the Wilts B.K.A. will read these lines, that gentleman may kindly send a line of reply for our next issue. 2. Bees have access to the space between outer case and hive proper during the winter months only, when it is deemed conducive to the health of the colony to have a free current of air all round the "open space" referred to. In the busy season, however, a slip of light wood is laid across the space above the entrance between hive and outer-case to prevent the bees from clustering there in warm weather.

[1698.] *Preventing Swarming.*—1. I should be glad to know how to prevent my bees from swarming, if possible from every hive? I now have five stocks of bees, having three early swarms last year, all of which have wintered well, and are heavy and full of bees. 2. I have three frame-hives and two straw skeps, and wish to know, if I put a full skep over an empty one with queen-excluder between, would the lower one be used by the bees for the surplus honey, which I could take away at the end of the season, and prevent a swarm? I am anxious to make a profitable harvest this year, as the cost of new hives and appliances took all my sale profits last season.—LOUISA KING, *Swinford, March 24.*

REPLY.—1. There is no sure preventive of swarming. Timely room, shade, and ventilation, all tend to that end, but no more can be safely assured. 2. The plan proposed will not do at all. The brood-nest must not be cut off from the entrance proper as surplus chambers are. If the extra skep is placed below to prevent swarming, there must be no excluder zinc between.

TRADE CATALOGUES RECEIVED.

J. H. Howard, Holme, Peterborough.—In addition to his large and fully-illustrated list of bee appliances of all kinds, Mr. Howard—as may be supposed—makes a strong point of having imported a full outfit of machinery for making the "Weed" foundation, and so producing it as a home-made product. Most people here will wish that his enterprise in this direction may be fully and amply rewarded.

T. B. Blow, Welwyn, Herts.—Mr. Blow reissues his comprehensive and well-illustrated catalogue of 76 pp., with such additions as have been made since last year. Among these we note that he has acquired the sole rights of the inventor in "Hole's Self-Hiver," which appliance in future will be made solely at Mr. Blow's works.

J. S. Greenhill, 80, Graham-road, Wimbledon.—Mr. Greenhill's neat little list has been revised for 1897 and some new features introduced. All the hives illustrated are good and useful ones, and his long experience with the firm of Geo. Neighbour & Sons will assure his patrons as to the practical efficiency of the goods sent out.

Notices to Correspondents & Inquirers.

All queries forwarded will be attended to, and those only of personal interest will be answered in this column

GEO. WALL (Harrow Weald).—*Distinguishing between Queens and Worker Bees.*—Bees received are not queens, but ordinary workers which have suffered from abdominal distension before death. A simple way of distinguishing between queens and workers is to examine the hind leg with the help of a strong glass. The second large joint or *tibia* of the leg of a worker bee is seen to be hollowed out in concave form, the hollow being edged with strong incurved hairs. This is the "pollen-basket," and as the queen has no use for this very needful appendage to the foraging expeditions of the worker, it is absent, the same joint of the queen's leg having a somewhat uneven surface, but no fringe of incurved hairs.

ONE IN DOUBT (Sheffield).—We find a very slight trace of foul brood in one cell of comb sent. The others contain chilled brood only. Keep a close watch on the hatching brood for a few weeks to come, and if any fails to hatch out, send another sample; meantime medicate all food given to the bees.

R. C. SALMON (Gloucester).—*Proposed Bee-Association for Gloucestershire.*—We shall be very pleased to make any correction so far as the report which appears on page 91, but as that report was furnished to us by a gentleman who signs himself Secretary, Gloucestershire B.K.A., his communication will appear to be authoritative and reliable. Our correspondent's communication was unfortunately mislaid for a time, or we should have already made inquiry before, but we are now doing so, and will again notice the matter on receipt of a reply.

NORFOLK (Garboldisham).—*Honey of '96 in Straw Supers.*—As the honey will no doubt now be granulated solid, the only way of making it saleable is to liquefy by cutting out the combs, slicing them into an earthenware or tin vessel, and placing the latter into hot water till the combs are melted and the honey made liquid. When the contents are cold the wax is lifted off in a solid cake, and the honey jarred off for sale.

J. JAMESON (Darlington).—Comb is affected with foul brood.

A BEGINNER (Thames Ditton).—*Starting Bee-Keeping.*—The best time to begin is when you can procure an early natural swarm—say end of May. For the rest, it is absolutely necessary to procure a book on bees before success can be hoped for. We cannot pretend to give such particulars as you ask for in our columns. Only a text-book (costing from 6d. to 1s. 6d.) can do this.

C. MARKS (Kingsbridge).—*Suspected Comb.*—No trace of brood at all in comb received. Nothing but a few cells half-filled with pollen, the rest empty.

Special Prepaid Advertisements.

Situations, Publications, Bee Plants, &c.—Up to Twelve words, Sixpence; for every additional Three words or under, One Penny.

HONEYCOMB DESIGNS.—Try Scotch Thistle or Crown 1897. C. COX, Brampton, Northampton. 0 55

FOR SALE.—4 strong STOCKS of BEES, in bar frame Hives, £1. 1s. each. G. WEBB, Station-road, Swindon, Wilts.

FOR SALE.—EIGHT STOCK APIARY (English), guaranteed healthy, Standard-Frames, Shallow-Supering boxes, and Section Crates. Apply, KENT, 36, Oak-street, Abingdon. 0 56

FOR SALE, 6 doz. Heather and Clover SECTIONS, filled. 8s. 6d. doz. HORN, Bedale, Yorks. 0 57

WANTED, WAX EXTRACTOR. Suitable for an apiary of 20 hives. State particulars and lowest price, CADNESS, Chadwell Heath. 0 53

WANTED, one or two good STOCKS BEES on frames. State lowest price. A. DRURY, The Laundry, Knellwood, Farnborough, Hants. 0 50

ONE STRAW SKEP BEES, last year's early swarm, with Super; 2 Stocks in Bar-frame Hives, one with Super. All healthy. £3. MISS COOKE, High House, Litcham, Norfolk. 0 52

WANTED, good forward STOCK of BEES, Standard Frames, Makeshift Hive; will exchange high-class Pouter Pigeons, bred from winners.—BETTS, Willowdale, Wyld Green, Birmingham. 0 60

PNEUMATIC SAFETY BICYCLE, new last season, £7; also Apiary, 3 ft. by 18 in. by 3 ft., 15s. Will exchange for healthy Bees, in skeps or otherwise.—BEES, Melton House, Totterdown, Bristol. 0 59

WANTED, healthy STOCKS, without hives, exchange Martini rook-rabbit Rifle, valued 40s. Approval. —11s, Upper Villiers-street, Wolverhampton. 0 58

ABBOTT'S HONEY RIPENER (new), Crates, Feeding Bottles, &c. Half cost price. All in excellent condition.—ROSE, Feltham. 0 57

HEALTHY STOCKS of BEES FOR SALE; young Queens, good condition, on standard frames. Brood on 6 and 7 bars. 30s. each or 3 stocks for £4. E. PHILPOTT, 18, Bedford-road, Hitchin, Herts.

SEVERAL Strong STOCKS of BEES in good Bar-framed Hives FOR SALE. Guaranteed healthy. J. BARRY, Suffolk-road, Cheltenham. 0 61

K. FAYS & MOORE are now booking orders for their EARLY SWARMS, also Queens, Hives, and Appliances at makers' prices. Bee Farm, Hemel Hempstead, Herts.

40 STRONG CHAPMAN HONEY PLANTS for 1s., post free. Sown last August, will bloom this year. GEO. BREALEY, Greneton, Northampton. 0 61

TO PURCHASERS of my Frames (which are cheapest in market and equal to any) will supply "W.E.C." Ends—Narrow 3s., Wide 4s. gross; Bar-Frames from 6s. 6d. gross. Trial order solicited. Send 1/4d. for Price List, GARNER (Expert), Steam Factory, Dyke, Bourne.

TWENTY-FIRST YEAR.—Good STOCKS in Standard Hives, by first makers, 25s. and 30s. each, on rail; package free. ALSFORD, Expert, Blandford.

WANTED, 1-lb. SECTIONS, clear and good condition, for cash. Apply, MANAGER, Southdown Apiaries, Bexhill, Sussex.

21ST YEAR.—Good STOCKS in straw skeps, 15s. each; in makeshifts, 12s. 6d., 15s. ALSFORD, Expert, Blandford.

SKEPS of BEES, 15s. each. Foul brood unknown. Packed and put on rail. Cash or deposit. G. KNOWLES, Newnham, Ely.

PNEUMATIC CYCLE WANTED in thorough repair. Exchange Hives, Appliances, Kitchen Ranges, Ironmongery. GEORGE EDEY, St. Neots. 0 28

WANTED.—Strong healthy STOCKS in Skeps, in exchange for a genuine old Violin, value £3. 8s. "D." B.B.J. Office, 17, King William-street, Strand, London. 0 39

Editorial, Notices, &c.

BRITISH BEE-KEEPERS' ASSOCIATION.

The monthly meeting of the Council was held at 105, Jermyn-street, S.W., on Friday, April 2, under the presidency of Mr. E. D. Till. There were also present Messrs. R. T. Andrews, H. W. Brice, W. Broughton Carr, W. H. Harris, T. I. Weston, and the secretary. Letters were read from Sir Thomas Gibson-Carmichael, the Hon. and Rev. Henry Bligh, and Mr. H. Jonas, regretting their inability to attend the meeting.

The minutes of the meeting held on March 12 were read and confirmed.

New members were elected as under:—Hon. Clement Coke, Longford, Derby; Miss Margaret J. Dunlop, Embsay Kirk, Skipton-in-Craven; Mr. Wm. Montagu, Kettlestone Rectory, Fakenham; Mrs. Nash, 36, The Avenue, Bedford Park, Chiswick; Mr. A. Watkin, Ropsley, New Malden; North Norfolk B.K. Association secretary, Mr. C. J. Cooke, Edgefield, Melton Constable. An application for the affiliation of the Wilts Border Co-operative Bee-Keepers was considered, and the secretary instructed to communicate with the Wilts B.K. Association, in accordance with Conditions of Affiliation, No. 1. Mr. Weston presented the report of the Finance Committee, showing a balance of £34. 14s. 9d. to the Association's credit on March 31. The committee recommended payments amounting to £18, and the report was unanimously adopted. On behalf of the Education Committee, Mr. Harris stated that arrangements had been made for the preparation of the question papers for the first-class examination to be held on May 6, and that the committee proposed that at future examinations, candidates for first-class expert certificates should be asked to give their opinions upon certain samples of honey to be placed before them. The report was endorsed.

The secretary made a statement in regard to the coming exhibitions at Manchester, Reading, &c., and said that in consequence of the "Trophy" class at the Royal Show, an additional space of 400 feet had been secured for the purpose.

A quantity of correspondence upon various matters, not of general interest, was dealt with by the Council, and the secretary instructed in regard thereto.

Mr. Till further reported upon the work during the past month in respect to foul-brood legislation, after which the proceedings terminated.

* * * We are obliged to hold over "Useful Hints" till next week, and hope that in the meantime the present bitter cold will have changed for more seasonable bee-weather.

SUMMER MANAGEMENT OF BEES.

READ AT THE ANNUAL MEETING OF THE ONTARIO BEE-KEEPERS' ASSOCIATION, DEC., 1896, BY MR. A. E. HOSHALL.

Every art and every science has certain underlying fundamental principles which govern it, and which, under the circumstances, produce unvaryingly the same results. Honey producing is no exception to this rule. If we will but observe various colonies of bees and their methods of working, it will be found that they do so along certain definite lines, or, in other words, in a certain well defined manner in accordance with their instinct, no matter whether they are domiciled in the most approved modern hive, or among the rocks, or even in the carcass of a dead lion. Now, I wish you to observe very carefully, and to thoroughly understand what this general, yet well defined, manner in which they work under these varying circumstances really is.

A colony of bees, when left to itself, will store some of its honey about the sides of its brood-nest, but the great bulk of it will be above; in fact, this latter instinct so predominates that it is generally said among bee-keepers that "bees always store their honey above their brood." Besides, they store it as near the top of the hive as possible, and for consumption use that lowest down and nearest the brood. In breeding, the upper part of the brood-nest is kept immediately next to the honey. When the brood in the upper part of the brood-nest hatches, and the honey flow is sufficient, the bees will fill with honey the cells as they become empty, and thus they continue to work, as it were, to keep connected the brood and honey by filling with honey this shallow space of empty cells continually being created between them through the hatching of brood. The latter is thereby forced downward, keeping the honey at the top, and, if there be not sufficient comb to continue this, compelling them to build more beneath the brood for its accommodation until the hive is filled. To illustrate,



let figs. 1, 2, and 3 represent hives of various sizes and shapes cut perpendicularly in two through the centre, so as to expose the central comb of each. The a a a a will represent in each case about the dividing line between the

brood and the honey. That portion of the hive above this line will be filled with honey, while the brood will be immediately next to and below

it; should there be any unoccupied comb or space in the hive (unless it be unreasonably long or wide in proportion to the strength of

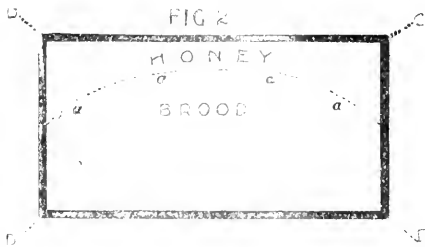

the colony), it will be found between the brood and the bottom of the hive DE. It will be found also that it is in the empty cells, made so by the hatching of the brood, along and nearest the line *aaaa*, that the colony continually stores its honey. Now, from these simple observations of the way in which bees instinctively work, and thoroughly understood in all its bearings, do we learn the fundamental principles of bee-keeping as they relate to summer management, and the adaptation of our hives to the requirements of our colonies, in order that they may work their best for us.

Other things being equal we observe :—

1. That surplus cases should be added above the brood nest, and hence our hives built for top storage.

2. That we should not have our bees travelling over honey at the top or sides of the brood nest to store surplus, thus compelling them to

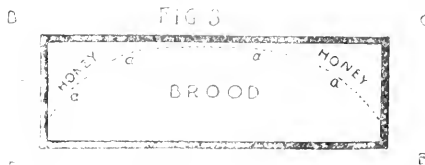

do so at a distance from their brood; hence the dividing line between the brood chamber and surplus apartments of our hives should come right where the brood and honey meet. In Figs. 1, 2 and 3 this should be as seen at *aaaa*. In other words, our management should be such that there will be no honey, or as little as possible, at the top of our brood chamber, whenever we wish our bees to store in the surplus cases above it.

3. That brood should extend underneath the whole surface of the surplus cases; hence, these cases should not extend endwise or side-wise beyond the brood-chamber; neither should there be combs of honey beneath them at the sides of the brood-chamber. It is a fact that the greater the number of combs a brood chamber is in width, the greater the liability of having its outside combs filled with honey, hence, a brood chamber should tend toward the narrow as much as practicable, rather than toward the wide.

4. From principles 2 and 3 we see that any system of management which attempts to fill the brood chamber with honey for winter stores, either before or while the honey harvest is on, does so at the expense of important conditions necessary in developing from our colonies the most work, and accordingly lessens the amount of honey gathered and stored.

5. That when one or more surplus cases have been filled sufficiently to require the addition of another, it should be placed right between the brood and the honey already stored; and, as might be inferred, and which experiment proves true, the shallower the opening which we make for storage between the brood and honey, the stronger the instinct of the bees to connect the brood and honey by filling this

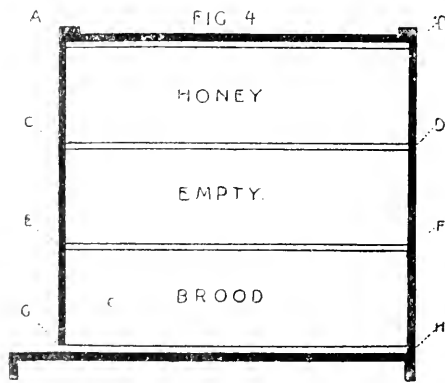

space thus created between them. To illustrate this let fig 4 represent a hive of which EFHG is the brood chamber, filled with brood to its very top EF. ABDC represents a surplus case that has been filled sufficiently by the colony as to require the addition of an empty one CDFE, which, if everything is rightly arranged, can be placed exactly between the brood EFHG, and the honey ABDC, and the shallower the opening made by the addition of this empty case CDFE between the

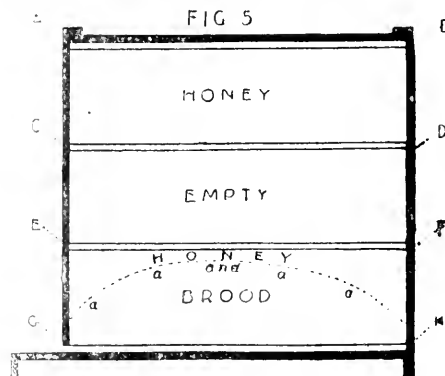

brood and the honey, the stronger the instinct of the bees to fill it. Fig. 5 illustrates a serious mistake, that is made in various ways by many

bee-keepers. ABGH again represents a hive, EFHG being its brood-chamber which is filled with brood and honey *aaaa* being the dividing line between them. ABDC again, as in fig. 4, represents a surplus case which has been sufficiently filled by the colony as to require the addition of an empty one CDFE, which has been added as illustrated, namely, in the midst of the honey, and NOT between the brood and the honey, as in fig. 4. It will be observed now that, in order to store honey in the empty case CDFE, the bees will have to cross the honey in the brood chamber between *aaaa* and EF, which is compelling them to store their honey at a distance from their brood, instead of immediately next to it, as in fig. 4. Now, from our observations as to the distinct, definite manner in which bees instinctively work under varying circumstances, and as already illustrated by figs. 1, 2, and 3, we at once see that this is a mistake. The farther we place our surplus cases from the brood when we wish the bees to fill them, the less inclined, it will be found, are they to do so. No bee-keeper of experience, when adding surplus cases, ever places them above filled ones; experience has taught him, or soon will, that the bees will neglect them. He may not know that it is because they are removed from the brood, and that when he places them above a brood chamber which is filled with honey about the top, he is crossing the honey-storing instinct of his bees in exactly the same way that he does when, in adding an empty surplus case, he places it above a filled one. In either case, he is compelling his bees to store their honey at a distance from their brood, only in the one case the distance is less than in the other, and just in proportion as this distance is increased do we lessen the honey-storing instinct of our bees, and consequently the amount of honey stored.

6. A little reflection shows, and experience proves it true, that the deeper the brood chamber the greater the liability to have honey stored at the top of it by the bees (observe figs. 1, 2, and 3 in this connection), which, in adding surplus cases, prevents them being placed near or immediately next to the brood, as in fig. 4, but removes them from it, as in fig. 5, thereby lessening the honey-storing instinct of our bees.

7. A little mathematical calculation shows, too, that the deeper the brood chamber the less surface there can be above it for top storage, and hence the deeper will the surplus cases have to be in order to have sufficient capacity, in adding which the deeper will be the opening that is made between the brood and the honey, thereby again lessening the instinct of our bees to promptly fill this space.

8. It is a fact that when a brood-chamber is larger than a queen can keep filled with brood, the remaining space will be filled with honey. We see, therefore, that such is a mistake,

where we wish a brood-chamber filled with brood and devoid of honey.

Now, I do not wish it understood that we cannot at times change—to our advantage—the natural conditions under which our colonies work, only that we cannot do it without loss; like in the instances just quoted, when it diverts the instincts of our bees from the end we have in view. The queen excluding honey-board between the brood and surplus apartments, where used, is an unnatural condition, yet it increases both the quantity and quality of our honey. 1. Through preventing the further expansion of the brood-nest when more brood means more bees at a season of the year when they will be consumers instead of gatherers, it diverts, so to speak, the energy of our colonies from unnecessary breeding to honey gathering, and thereby also prevents unnecessary consumption of stores. 2. It enables us to keep our brood chamber in a condition more perfectly in accordance with the principles above enumerated than without it; and (3) by keeping the brood out of the surplus apartment, gives us a better quality of honey, besides all the advantages to be gained in manipulating our hives.

For various reasons we may not always be able to so arrange the conditions of our colonies during the honey flow as to develop their working energy to the fullest extent, but just in proportion as we fail in doing so, we fail in securing the greatest amount of honey from our colonies, and not only this, but also succeed to our own disadvantage, in developing among them the swarming impulse. You will have noticed, as I have already shown, how that bees, when left to themselves, always store their honey above their brood, but build their comb beneath it. In the production of comb honey we partially reverse this order by compelling them to build their comb above it, and this, I claim, is the cause, to a very large extent, of the marked difference there is in results in colonies worked for comb honey, as compared with those worked for extracted, and not that the one has so very much more work to do than the other in the building of comb; it is also the reason why colonies worked for comb honey are so much more liable to swarm than those worked for extracted honey. The first result is but another illustration of failing to develop the working energy of our colonies to the fullest extent through compelling them to work in a manner contrary to their instinct; while the second result is the sequence of it, and a simple, practical illustration of how we can develop the swarming impulse in our bees through failing to develop their working energies. If we wish to retard swarming, if not prevent it altogether, we must work our colonies to their utmost for honey along those lines which tend to develop amongst them their strongest active honey-gathering energy.

Another factor that cannot be overlooked in summer management is the strength of our

colonies and their honey gathering and other qualities. No system of management, however correct in principle and skilfully executed, can atone for a neglect of either of these factors. If we are to have strong colonies, we must see, among other things, that each is supplied the season previous with queens of sufficient vitality and prolificness to keep the brood-chamber of their respective hives full of brood throughout the entire season; not only this, but their progeny must inherit from them the strongest honey gathering instinct, and other qualities that may be desirable. It is a well-known fact among experienced bee-keepers that there is as much difference in the honey gathering and other qualities of bees as there is in the milking qualities of cows, and it is the height of folly to tolerate anything in our apiaries but the best.

In honey production, as in all other lines of production, we strive to obtain the greatest amount with the least expense of time and labour. In conclusion I would ask you to note that with respect to securing our honey with the least expense of time and labour, I have said nothing; I have only mentioned a few of those principles which bear upon how to secure the greatest amount of honey, and which, I trust, will help us to a right understanding of the lines along which we should work, and give us a centre from which to direct our thought, and a basis upon which to build a common-sense and scientific management of our apiaries. The principles which I have set forth I consider fundamental, and that they form the great central sun around which the successful management of our apiaries revolve.

Beamsville, Ontario.

Correspondence.

The Editors do not hold themselves responsible for the opinions expressed by correspondents. No notice will be taken of anonymous communications, and correspondents are requested to write on one side of the paper only and give their real names and addresses, not necessarily for publication, but as a guarantee of good faith. Illustrations should be drawn on separate pieces of paper. We do not undertake to return rejected communications.

"Communications relating to the literary department, reports of Associations, Shows, Meetings, Echoes, Queries, Books for Review, &c., must be addressed only to "The Editors of the 'British Bee Journal,' 17, King William-street, Strand, London, W.C." All business communications relating to Advertisements, &c., must be addressed to "THE MANAGER, 'British Bee Journal' Office, 17, King William-street, Strand, London, W.C."

In order to facilitate reference, Correspondents, when speaking of any letter or query previously inserted, will oblige by mentioning the number of the letter, as well as the page on which it appears.

TARDY SPRING.

[2844.] To-day (March 28) the poor bees have not dared to poke their noses out of doors. My prayer for rain to lay the March dust was

successful, for it has been coming down nearly all the day. The wind—restless, cold, boisterous, March wind—continues unabated. It brings up from the north dark masses of cloud, which seem not only to bring the rain, but the wind too. For as they approach from the horizon the wind freshens perceptibly, and when they are right upon us then it comes fast and furious, and you have to go out and sit on the bee-hive to keep it down. As the cloud passes there is a tugging at the reins, a foot upon the brake, and the wind is stayed. March "came in like a lion," and it bids fair to go out like a lion, *i.e.*, if the going out of that beast is the same as the coming in. Why all this wind? People who have studied the subject will tell you that the sun is at the bottom of it. He it is who warms the land, which in turns warms the air, so that it rises buoyantly. Then the cold air rushes in to supply its place. In doing this the daffodil stems are broken and the golden blossoms lie prone on the emerald grass. The great pear-buds are also lashed from their boughs, and lie scattered where their crimped petals ought soon to have been. This is terrible; young buds and leaves destroyed where only petals should have been! The sun makes the daffodils and pear-buds, and causes the wind which destroys them. Cruel, unthinking, wasteful sun! Perhaps I am too hard on him. The wind has only gathered a handful of the blossoms which gild an acre of this verdant mead. They are only the common wild daffodil (*narcissus pseudo-narcissus*, *i.e.*, a sort of bastard *narcissus*); but, considering them in their thousands, rising from the moist, rich, sweet-scented earth, through blades with a grey bloom upon them, with the dark tangled hedgerow behind, through which rises lordly eims, still dark and leafless, or hawthorn just touched with breadths of green, or blackthorn changing white with opening bud, and sallow lighting up its jets of flame; with the fresh, invigorating air full of sweet song of lark, of piefinch, of thrush and blackbird—the two last already making nests that every boy may see; with the loveliness of the larch—the queen of the woods—dressing herself in the stately presence of the kingly pines, clasping on, among her hair, pink coral cones, reaching down as if to gather shell-like anemone flowers, which now gladden all the woodland; with furze answering the sun's roll call, bluebells, green star fish of the woods, celandine, a satellite of the sun, and on the low hills bilberry wires bursting out in lovely buds—buds which queen bumble bees passionately love: considering all these things, and with the life-blood welling up in every living thing, how much we owe this magnificent orb round whom the earth pursues her unwearied way, year by year, century to century, for millions of millions of years!

Consider the sun with his eight planets—Mercury, Venus, the Earth, Mars, Jupiter, Saturn, Uranus, and Neptune. Consider that four of these are far mightier worlds than our

Earth (Jupiter is 85,000 miles in diameter!) Consider that the outermost planet—Neptune—is 2,780,000,000 miles away from the sun, and yet the latter compels him to circle round just like our earth. Again remember that this group—the sun and his planets—are only a tiny cluster standing away by themselves, isolated in a boundless sea of space. All the stars are suns like our own, isolated from one another at enormous distances apart. And each of these suns may have—indeed is likely to have—his eight or more planets revolving round him. We cannot see these planets even with the greatest telescope, the distance is so stupendous, and the planets have no light of their own. We can only see the suns. If there are planets attendant on these suns—which no one can doubt—then the people on those planets, looking in this direction through their finest telescopes, would see our sun as a star, but they would not see our earth or any of our sister planets! They would see only their own sun, round whom they revolve, their moon or moons, and their sister planets, and the stars like our own stars. Astrologers tell us the sun and his family—the eight planets—live together isolated, as it were, in space. Our nearest neighbour lives a great way off. As to the distance, I will quote Sir Robert Ball, the Astronomer Royal, who says:—

“So important is the subject of star distance, that I am tempted to give one more illustration in order to bring before you some conception of how vast that distance truly is. I shall take the nearest of the stars as known to us at present, and I hope to be forgiven for taking an illustration of a practical and a commercial kind instead of one more purely scientific. I shall suppose that a railway is about to be made from London to Alpha Centauri. The length of that railway I have already stated: it is twenty millions of millions of miles. So I am now going to ask your attention to the question as to the fare which it would be reasonable to charge for the journey. We will arrange to travel at the rate of one hundred miles for every penny. That surely is moderate enough. On these terms, how much do you think the fare from London to this star ought to be? Suppose you went to the station with a cartload of sovereigns, that would not be enough—you would want another cartload; but ten carts, twenty carts, fifty carts would not be enough. You would want five thousand carts before you would have enough to pay the fare. Then when you asked for the ticket, do you think you would get any change back? No doubt some little time would be required to count the money, but, when it was counted, the clerk would tell you that it was not enough, that he must have nearly a hundred millions of pounds more!

That will give some notion of the distance of the nearest star (sun), and we may multiply it by ten, by 100, and even by 1,000, and still

not attain to the distance of some of the more distant stars that the telescope shows us.”

To-day I lifted up the corners of the quilts of the hives to see how the bees fared. I found they had eaten all the candy which I gave them in February, and they seemed happy and contented, as they lounged in the empty space where the candy had been. But when I sought to straighten out the calico quilt—for candy is a terrible maker of creases—they became unhappy and lost their temper; so I was perforce compelled to go and find the smoker and a veil—a by no means light undertaking considering it was the first time they had been wanted for six months. I never was much in love with candy as a bee-food, and in attempting to straighten quilts I mentally resolved to leave the bees an extra dozen pounds of honey in the autumn to carry them well over March, when syrup may be safely given. If I had had glass quilts, these would not have creased, it is true. But I have no glass quilts, nor don't want any! The removal of a glass quilt from a hive, upon which it had been for, say, twelve months, would be something akin to drawing the slides from between the old Stewarton frames! Do you remember, Messrs. Editors, how one bee-man had to get his shoulder again to the hive on the one side, while the other bee-man knocked 'em out with the coal hammer? And what were the bees doing while this was going on? I think if a cobra were to “sting” me now it would have no effect.

The cold, miserable weather continues. Wind due north and snow falling. Yesterday morning the ground was white over with snow. On the 30th there was thick ice on the water. The daffodils, in the early morning, were white with frost, and the great blades and blossoms were flat on the ground. The sun lifted them up again, so that they were uninjured; but the rosy flowers of the Megasea saxifrage still lie with their heads bent. They are bruised and broken by the frost and cannot recover.

Thus it would seem that an early spring is not an unmixt blessing. Better, perhaps, to endure another month of winter and then let the quickening year come, and come to stay. It is ever very hard to retrace one's steps. Hard in autumn or winter; how much more when you know that it is the time of the coming of the cuckoo and swallow, the sweet willow-warbler, and house martin; of the merry hum of bees' wings; of all that glorious time when, as Horace wrote in ancient time:—

“The quickening year dissolves the snow,
And grasses spring and blossoms blow.
Through greener plains the river pours
Its lessening flood by silent shores.
Again th' awakening forests wear
Their pendent wealth of wreathed hair.”

LORDSWOOD.

THE "PEEBLES" HONEY PRESS.

A CORRECTION.

[2845.] While very unwilling to take up your valuable and limited space, I am perforce compelled to ask you to explain to readers of the B.B.J. and *Record* that the "Elevation" (fig. 1) and "central plates" (fig. 5), are reproduced exactly one-third less than the original drawings; consequently, the number 5 should be included in the two parenthetical sentences. If you do this, it will remove what has proved to be a perplexity to a number of your readers who have to tackle the "pressing" of heather honey.

I hadn't the remotest idea the press would have excited so much interest.—ROBERT PEEBLES, *Edinburgh, April 3*

(You will manage the rest, I have no doubt, to the satisfaction of all concerned.)—R. P.

JOTTINGS FROM CHICHESTER.

[2846.] *Early Drones*.—I have had drones plying from one of my hives since March 12. Unfortunately, it is the only one in my apiary that I cannot very easily examine on account of its having fixed combs. I cannot think that the bees are queenless as I have since found a drone larva cast out, and it is a strong colony.

Blue Tits.—Referring to 2841 (p. 128), I have been expecting a more able pen than mine to defend the small blue tit. With me they do no harm. It is the large black-headed tomtit that eats the bees and does a lot of damage to the fruit trees also.

Glass Quilts.—As this subject again comes before your readers (2836, p. 126), may I ask you to make known my plan, which is to cover tops of frames with a one pound section-rack, and lay on flat down in the bottom the $4\frac{1}{2}$ in. by $4\frac{1}{2}$ in. squares of glass that in the ordinary course are used for ends of sections. You can lay twelve of these glasses on the wood rests on which the sections stand when in use, allowing the middle ones to overlap. You have here a bee-space above brood frames with room inside for packing above, and also easy for feeding by using one square of perforated zinc.

Swarming or Returning Swarms.—Should the swarm come from a hive that has started storing in the super, and it is desired to return the swarm while you are not expert in the art of finding the queen, make a box the size of a one-pound super but deeper, put queen excluding zinc at the bottom with bee space under. Stand this on the super of the hive that has swarmed; when dusk shake the bees in and cover over. By morning they will have gone down, leaving the queen, which you can destroy or make a nucleus of. Should they swarm again in eight days repeat. I have used this with great success.—G. FAIRS.

ESSEX BEE-KEEPERS' ASSOCIATION.

[2847.] May I ask you to give publicity in your columns to the changes in our Essex County Association this year. We have lost the valued services of our Hon. Secs., Messrs. E. Durrant and P. Gray, their places being filled by Mr. W. J. Sheppard, of Chingford, who is now engaged in forming a committee to meet in London, thus enabling members from all parts of the county to attend.

Mr. Tunbridge, the expert of 1896, has retired, and Mr. W. Jones Anstey has been appointed for the ensuing season, who, I hope, will find our bees in good order and give satisfaction to all our members.—THOS. I. WESTON *Member of Committee, Wickham Lodge, Gt. Totham, April 2.*

WILTSHIRE AS A BEE COUNTY.

[2848.]—In reply to your correspondent "Alpha" (1697, p. 129), I consider the neighbourhood of Bradford-on-Avon a capital one for bees, and there are not very many kept there. There is an unlimited amount of willows, limes, horse-chestnuts, and other flowering trees; orchards and gardens; sainfoin and clover within easy bee-distance; plenty of shelter from cold winds. Bona is one of the prettiest and most interesting places in Wilts.

If "Alpha" is going to reside there, I hope he will join the "Wilts B.K.A.," and I shall be glad to give him any help.—W. E. BURKITT, *Buttermere Rectory, Hungerford, April 5.*

P.S. *Important*.—I ought to say foul brood is rampant in several districts within four or five miles, and the offending bee-keepers will not allow any inspection since it was discovered four or five years ago.

[2849.]—In reply to your correspondent "Alpha" (1697, p. 129), I should not call Wiltshire a first-class bee county, but the honey is of good quality and fairly heavy returns are made. Bradford-on-Avon is a fairly good district. Wild flowers abound in the valley of the Avon, and there are but few bee-keepers there. We are hoping to push the "gentle craft" in that direction. Salisbury Plain has favourable localities, the honey being of good quality and fine colour. I live within four miles of Bradford-on-Avon. Our county secretary lives forty miles off.—JNO. W. SPENCER, *Hon. Sec., The Wilts Border Co-operative Bee-Keepers, Atworth, near Melksham.*

P.S.—I shall be pleased to have your opinion of our bee society, proofs of rules, &c., of which I sent you a fortnight ago, and which you kindly acknowledged in the JOURNAL.—J. W. S.

[It goes without saying that our heartiest good wishes accompany every legitimate effort to promote the cause of bee-keeping in this

country, and we hope to learn more of the well-meant efforts our correspondent is devoting to this same end. Meantime we must confess to not quite being able to "catch on"—as Americans say—for the reason for the Wilts Border Co-operative Bee-keepers—chopping off the word "Association," which seems to us so necessary for completing the title. Is it an oversight? Or what?—Eds.]

[2850.] Seeing in the B.B.J. the query on page 129 (1697), *re* Bees at Bradford-on-Avon, I beg to say that I have kept bees for the past twenty years and, thanks to the B.B.J., have done very well with them. Of course, it depends upon the season, as our surplus comes from the clover. There are about fifty stocks in Bradford-on-Avon, so far as I know, and I think I am acquainted with all the bee-keepers in this district.—J. TIMS, *Bradford-on-Avon, Wilts, April 5.*

WEATHER REPORT.

WESTBOURNE, SUSSEX, MARCH, 1897.

Rainfall, 4.15 in.	Sunless Days, 3.
Heaviest fall, .80 on 2nd.	Below Average, 10.6 hours.
Rain fell on 22 days.	Mean Maximum, 51.4°.
Above average, 2.12 in.	Mean Minimum, 37.1°.
Maximum Temperature, 57° on 24th.	Mean Temperature, 44.2°.
Minimum Temperature, 25° on 8th.	Above average, 41°.
Minimum on Grass, 21° on 8th.	Maximum Barometer, 30.18° on 20th.
Frosty Nights, 9.	Minimum Barometer, 28.71° on 3rd.
Sunshine, 151.6 hours.	
Brightest Day, 30th, 10.6 hours.	

L. B. BIRKETT.

Queries and Replies.

[1699.] *Driving and Transferring Bees in March.*—Toward the end of February last I bought two skeps of bees. I made a frame-hive, and on March 20 last, following the instructions in the "Guide Book," I drove one lot and hived them successfully—as I thought. I then transferred three combs, with eggs and brood in, and put two other frames with small pieces of worker comb tied in for them to work out. On opening hive nine days later to take tapes off, I was surprised to find three queen cells had been built and capped over, and the bees had built nothing but drone comb around the pieces of worker comb I had put in frames. The frames were spaced at the proper distance of 1½ in. from centre to centre. Upon examination I could not find the queen. I therefore ask:—1. What is the reason of queen-cells

being built? 2. Do they show queenlessness? If so (3) do you advise me to get an experienced bee-keeper to drive the second skep and put some drone-comb in the centre of brood nest, so as to have drones flying to mate the queen when she goes on her wedding flight? I do not want to have to unite the two stocks of bees if it can be avoided, as I don't wish to reduce my number of stocks.—F. R. P., *Tamworth, Staffs, March 29.*

REPLY.—We are sorry to say our correspondent has courted disaster by attempting in the month of March bee operations suitable only for such times as bees are flying and gathering honey daily (see "Guide Book," p. 136). For the rest we reply to queries as enumerated:—1. The queen has undoubtedly been lost or killed during the driving and transferring operations. Hence the building of queen-cells. 2. Yes. 3. We advise deferring any attempt to drive the second stock until the weather is warm and settled (say, a month or five weeks hence). Meantime, the queen-cells might be left on the off-chance (a very slight one) of a young queen getting mated should there be early drones about. If this chance fails—and a drone-breeder results—the bees *may* be utilised (without uniting) by removing the unmated queen, giving the bees a comb with eggs and larvae from the second skep when transferring the latter and letting them raise another queen, which would in due course be safely mated.

Our own plan, however, would be to unite the queenless bees to the second skep; nurse the latter to swarm early, and people the frame-hive with the swarm. This would save much trouble; secure better combs and a better chance of surplus; while if increase is desired the skep may be allowed to cast a second swarm for furnishing a second frame-hive. Thus giving you two stocks in frame-hives and one in the parent skep.

[1700.] *Early Drone Brood.*—On examining my hives one warm day this week, I found all in very fair condition, each containing brood on the centre combs. One hive, however, I am at a loss to understand. It is a pure Italian colony, and the brood in the combs is perfectly level and normal, except in places here and there where some of the cell-cappings are nearly a quarter of an inch higher (or more convex) than the others. My neighbour bee-keepers are also at a loss to understand it. All the foundation given them were worker, no drone comb at all in the hive. Do you think that these cells which are irregular, standing so much above, contain young drones, or is it that the queen is imperfect? Yet the latter can scarcely be, as the bees previously hatched from her eggs were perfect. The queen was only imported in last October. According to the "Guide Book," it is rather early for drones.

REPLY.—If the queen and colony are strong, it may be safely assumed that the early drones

are rather a sign of prosperity than otherwise. We have already had several reports of normal drones being seen on the wing in the month of March last.

[1701.] *Queen Cell in March.—Excess of Food in Brood Combs.*—Towards the close of February I opened one of my hives and found queen and a fair size patch of brood; but when again examining it recently, in the last week of March, I found a queen-cell sealed over but no brood in any other part of the hive. 1. As the colony is rather weak, would you advise me to unite it to another stock or let the queen hatch? 2. On looking at another hive I found the cells nearly all full of honey, consequently the queen had very little room to breed in, and had laid as many as three or four eggs in one cell. I therefore put a frame of empty comb in the middle of brood-nest; have I done right?—ANXIOUS, *Streatham*.

REPLY.—1. It is useless to expect any good from a stock in the condition described; the bees should, therefore, be utilised by uniting. 2. Quite right. It will be also advantageous to uncap a portion of the sealed food in centre-combs at intervals, and substitute another empty comb for a full one in centre of brood-nest.

[1702.] *Doubling and Storifying.*—In B.B.J. for March 18 (1886, p. 109), referring to doubling and storifying, you say, "It requires very perfectly built combs to be able to space them so closely as $1\frac{1}{4}$ in. from centre to centre, and if the combs are at all irregularly built, as those of most beginners are (*mine included*), it may lead to very awkward results," &c.

When preparing for wintering, I spaced the combs at $1\frac{3}{4}$ in. from centre to centre, using bits of wood $\frac{1}{2}$ in. thick between shoulders of the metal ends (see "Guide Book," page 157). On pages 164 and 165 of same book, we are told to "push up the frames until they are about $1\frac{1}{2}$ in. from centre to centre." Yesterday I set to work to do this (so early, and because plums and pears are in bloom here-about), but found the upper parts or faces of the combs so drawn out and full of stores, that there was bare space for the bees between them, and not that in some places.

I removed the bits of wood referred to, but there could be no pushing up of the frames, for the reasons I have stated. I therefore ask, (1) Will the bees as they consume the stores remove the comb that projects beyond the frames? If not, what shall I do? It looks as if $1\frac{1}{4}$ in. spacing was out of the question. (2) Would storifying be attempting too much by one who is only a beginner?—W. C. H., *Newton Abbot, South Devon*.

REPLY.—Does not the onus of failure lie with our correspondent himself? Seeing that while confessedly "a beginner" only, he passes over the simple method at first described in the chapter on doubling and storifying, and

adopts a plan intended to show what the author of the "Guide Book" had "*himself*" successfully practised?

It was to emphasise this fact that we (on page 109) explained that only perfectly formed combs could be dealt with in this particular way. In other words, beginners should be content with simple methods of working, until they understand how to avail themselves of the "finer points" of the craft so advantageous to the bee-master.

The force of this contention is proved by the elementary nature of the queries to which a reply is asked, and which—for the benefit of beginners generally—we gladly make somewhat fuller than usual. 1. At the end of March (see concluding chapter of "Guide Book," p. 164), if weather be favourable, all hives should be examined to ascertain their condition. Where wide-spacing of frames for winter is practised, the frames must be restored to their normal distance of $1\frac{1}{2}$ in. from centre to centre. In the case under notice the bees have evidently been fed after "wide-spacing" took place (hence the lengthening out of the cells in upper part of combs). The obvious and only way of getting over the difficulty is to slice off so much of the face of sealed cells as will permit removal of the "bits of wood" from between the shoulders of metal ends, and allow half an inch of bee-space between the respective comb-faces. 2. If the plan first described in Chapter X. of "Guide Book" is correctly followed, no difficulty will be experienced.

[1703.] *Buying Bees in Frame Hives without Examination.*—I bought three stocks of bees in frame-hives, but could not examine them as to their condition until they arrived at my own home after purchase. I now find that in one case the bees have been so badly covered down at time of hiving that they were able to pass up into the hive roof. This has, in consequence, been filled with comb and honey, and the bees have taken up their abode there and made the roof their brood-nest. There are combs in the frames of hive proper below, but these are all empty. What would you advise me to do in getting the bees to work breeding in the combs below so as to get some sections filled above? A reply will be esteemed.—M. HIDER, *Tunbridge Wells, March 30*.

REPLY.—The best course will be to leave the bees to work down on to the lower frames in their own time. This they will do when breeding-room is needed; and when the queen is well at work laying in lower frames, set a queen-excluder between roof and body-box. Then when brood has hatched out from the combs in roof part, appropriate what honey is left in them and set on surplus chambers in the usual way.

[1704.] *Drone Brood in Worker Cells.*—On examining a hive to-day I found large patches of brood with cappings of various

heights, some normal worker brood and others lengthened, and drones hatching out. 1. What's wrong, and what is the remedy? I assume a fertile worker is doing business. The stock was originally formed by the addition of two weak queenless lots of bees to a weak stock with a good young queen last October. Bees and stores are very plentiful. 2. Would uniting with another colony be the wisest course to pursue? Any help you can give will be thankfully received.—JAMES G. GODWIN, *Withington, Hereford, March 30.*

REPLY.—1. You must be mistaken as to the mother-bee at head of the colony being "a good young queen." It is also an error to suppose that a fertile worker is the cause of the mischief. The remedy is to re-queen, if, as stated, "the bees and stores are very plentiful." 2. In case a prolific queen cannot be got, the only way of utilising the bees is by uniting.

[1705.] *Effect of Bee Stings.*—As an inexperienced beginner in bee-keeping, I beg to ask you if you can tell me of a remedy for bee stings? I bought a stock of bees through an advertisement in your Journal only a month ago, and have already been stung four times. I was stung just above the eye, and though I immediately withdrew the sting and applied ammonia, carbonate of soda, blue-bag, bread poultices, and bathed the wound with hot water all day, yet, notwithstanding all these remedies, my face swelled so much that I could not open my eye the next day, and was obliged to stay away from business in consequence. On another occasion I was stung on the hand; I applied all the things before mentioned, it swelled so much (right up to my elbow) that I could not use my hand for a day or two. The pain from a sting I do not mind at all; but if you know of anything that will stop the swelling I shall be much obliged to you for the information. Thanking you in anticipation.—J. TAYLOR.

REPLY.—Why not try some such remedy as Grimshaw's Apifuge, or Holliday's Carboline? Many persons declare themselves to have been almost entirely freed from such inconvenience and discomfort as is complained of above by the use of these remedies. Of course, a practical bee-keeper of experience never uses preventive remedies against stings, indeed, seldom needs them; but when such serious results follow as are described above, some precautions are absolutely necessary. Then we are inclined to ask why our correspondent does not protect his face with a bee-veil? This is a preventive against stings which a large majority of our most practical men do not venture to dispense with at times. One thing, however, may be noted, and that is, if the sting be immediately scraped out of the wound with the sharp edge of a penknife the less there is of rubbing in and application of blue-bag remedies, poultices, &c., the better, so far as our experience goes.

TRADE CATALOGUES RECEIVED.

Geo. Rose, 50, Great Charlotte-street, Liverpool; Fishergate, Preston; and Market-square, St. Helens.—Mr. Rose, being a seedsman as well as a bee-appliance manufacturer, makes a bold venture in doubling a large illustrated seed-list with his catalogue of bee appliances, but as we see no charge indicated on the well got up book received (not even for postage) the inference is that it goes free to all inquirers. However this may be, the catalogue is not only very fully illustrated but contains in condensed form particulars of every article needed in the apiary and garden, with cultural directions for growing all seeds and plants. We notice that stress is laid on the fact that goods may be had by first train after receipt of cash.

W. R. Garner, jun., Dyke, Bourne, Lincs.—This is a modest four-page list, such as one expects from a "Steam Hive Factory," where a point is made of supplying frames in the flat by the gross or 1,000 and woodwork of all kinds at low prices. Mr. Garner is, however, a certificated expert of the B.B.K.A., so his make of goods ought to be reliable.

Mme. Josephine Chinni, à Praluro e Sasso près Bologne (Italy).—Madame Chinni's price list of pure Ligurian queens is to hand, the charges being same as heretofore. Correspondence may be addressed to her in either French or English.

G. Heidenreich, Sonnenburg (Neum).—This catalogue reaches us from Germany, and deals mainly with tinware for bee-keepers' use, of which Mr. Heidenreich makes a speciality. There are some useful novelties in this line that might with advantage be stocked by dealers in this country.

Notices to Correspondents & Inquirers.

Letters or queries asking for addresses of manufacturers or correspondents, or where appliances can be purchased, or replies giving such information, can only be inserted as advertisements. The space devoted to letters, queries, and replies is meant for the general good of bee-keepers, and not for advertisements. We wish our Correspondents to bear in mind that, as it is necessary for us to go to press in advance of the date of issue, queries cannot always be replied to in the issue immediately following the receipt of their communications.

MARINA.—*Bee Flowers.*—Our correspondent, who dates from St. Leonards-on-Sea, writes: Would any reader tell me the names of flowers (annual or perennial) suitable for planting in a garden for bees? Those that would keep up a succession of honey-flow would be most useful. I am only a novice at bee-keeping, and so do not know what plants for preference to sow.—[Perhaps some of our readers who made a point of sowing or planting for their bees will kindly give the required information.—Eps.]

DAISY (Higginstown, co. Kilkenny).—*Varieties of Bees.*—1. Bees received are the ordinary variety common to the British Isles. 2. Regarding the question, "Are they as good

as Italians?" we think that in this country, at least for all-round purposes, they are superior to the pure Italian bee. 3. Our experience is that no kind of hive-bee works on red clover, so far as the first or full crop of that plant. It is on the second crop (which is usually largely intermixed with alsike and white clover) that bees work in some seasons, and in this direction we think the Italian bee displays more eagerness than the native, but so far as possessing a longer tongue, or working regularly on red clover, it is a statement which no one of experience attaches any value to.

HAROLD PIGOTT (Burton-on-Humber).—*Samples of Honey.*—The request that we should "say what the sample of honey (?) sent is made of," is a very appropriate way of putting the question, for we confess ourselves quite unable to say whether all or any great portion of it is "honey" or not. It is the first sample of granulated honey we have met with which being "granulated" is as free from grain (*i.e.*, granules) as flour-paste; and which, moreover—while as perfectly opaque as any ordinary granulated honey—will run from the jar when the latter is reversed. In a word, we give up the task put upon us; nothing but either dialysis or elaborate chemical analysis would enable us to answer our correspondent's inquiry.

W. RUSSELL WEST (Northenden).—*Experts and their Work.*—After the insertion of two communications from our correspondent, and one each from four other gentlemen concerned, besides the fact that the matter dealt with is largely personal, and devoid of general interest, we think the subject has been sufficiently dealt with in these pages.

W. BURDETT (Leicester).—*Bees Dead in Comb.*—The position in which the bees were found indicates death from starvation. This is by no means an uncommon occurrence, even with plenty of food in the hive, where bees are not properly prepared for wintering. It is probable that the bees left alive will get on all right—now that the weather is warmer—if food is, as stated, plentiful in the hive.

GARDENER (Rotherham).—*Suspected Comb.*—No foul brood in comb received. The dead larvæ has been "chilled."

MIDLAND (Kettering).—Comb is affected with foul brood.

Special Prepaid Advertisements.

Situations, Publications, Bee Plants, &c. — Up to Twelve words, Sixpence; for every additional Three words or under, One Penny.

FOR SALE.—30 lb. PURE HONEY, 7 lb. in tin, free. MAIDMENT, Norbins-road, Glastonbury. 0 67

STOCKS in good Hives. 25s. and 30s. Particulars free. SUTTON, Burston, Diss. 0 71

WANTED.—CARNIOLAN BEES in Frame Hive. F. SMITH, Albert-road, Hyde, Cheshire. 0 68

Prepaid Advertisements (Continued)

WANTED, BEES, from 12 to 20 Stocks, on Frames (no hives), and Early Swarms. State particular and lowest prices to A. B. C., c/o Bee Journal Office.

TO BE SOLD, Cheap, 6 second-hand pitch pin OBSERVATORY HIVES, to hold 4 Bars. Apply, J. COTTERILL, Hydro' Bowden, Cheshire. 0 70

NATURAL SWARMS. Orders now being booked, 12s. each, packages returnable. LINSTEAD, Garboldisham, Thetford. 0 72

SWARM CATCHERS or Self Hivers and Honeycomb Designs. Apply, SEAMARK, Willingham, Cambs. 0 73

WANTED, at once, 2 doz. SECTIONS. Prices to HANLYN-HARRIS, Conifers, Hambrook, Bristol. 0 74

FOR SALE.—200 good clean HEATHER HONEY SECTIONS from the Yorkshire moors, price, £8 the lot. WM. CASS, Pickering, Yorks. 0 76

SAFETY, SOLID, very light, perfect condition, cost £16, take 25s. or exchange Bees. SMITH, Doverstreet, Soho, Birmingham. 0 77

WANTED, COPY of REPORT with names and addresses of Members of the Lincolnshire, Yorkshire, and other Bee Associations. WALTON & Co., Muskharn, Newark. 0 65

VACANCY for JOINERS that understand Bee Appliance making. WALTON & Co., Muskharn, Newark. 0 66

21ST YEAR.—Early SWARMS. Book now, 10s. 6d. 12s. 6d., 15s., packages free on rail. Cash with order. ALSFORD, Expert, Blandford.

WANTED.—TO SMALL BEE-KEEPERS (those living near Loughton, Essex, preferred), I have one Bar Frame Hive. I am WANTING a PERSON to attend to it. State terms, to Mr. ALLEN, 220, Seaford-road, Avenue-road, Lower Tottenham, Middlesex.

TO PURCHASERS of my Frames (which are cheapest in market and equal to any) will supply "W.B.C." Ends—Narrow 3s., Wide 4s. gross; Bar-Frames from 6s. 6d. gross. Beware of bad imitations. Price List 12d. GARNER (Expert), Dyke, Bourne. 0 69

HONEYCOMB DESIGNS.—Try Scotch Thistle or Crown 1897. C. COX, Brampton, Northampton. 0 55

SEVERAL Strong STOCKS of BEES in good Bar-framed Hives FOR SALE. Guaranteed healthy. J. BARRY, Suffolk-road, Cheltenham. 0 61

KEAYS & MOORE are now booking orders for their EARLY SWARMS, also Queens, Hives, and Appliances at makers' prices. Bee Farm, Hemel Hempsted, Herts.

40 STRONG CHAPMAN HONEY PLANTS for 1s., post free. Sown last August, will bloom this year. GEO. BREALEY, Greneton, Northampton. 0 61

SKEPS of BEES, 15s. each. Foul brood unknown. Packed and put on rail. Cash or deposit. G. KNOWLES, Newnham, Ely.

PNEUMATIC CYCLE WANTED in thorough repair. Exchange Hives, Appliances, Kitchen Ranges, Ironmongery. GEORGE EDEY, St. Neots. 0 28

BLAKEY'S BEE FEEDER.

COPY OF LETTER RECEIVED.

"The Apiary, Assich, Fort George.—DEAR SIR, Please send me six Blakey's Feeders and six for a friend, and let me tell you they are the best Feeders I have got, and mind you I have a rare collection of different makes, but Blakey's takes the cake for simplicity, usefulness, and cheapness.—Yours truly, JAS. DAVIDSON."

Price 6d. each. The Postage of one costs 4½d., two 6d., four 9d., six 1s. 18d. To be had of J. M. BALMERA 2 East-parade, Alnwick.

Editorial, Notices, &c.

JUNE 1ST.

The letters, queries, &c., in type and waiting insertion this week compel us to abbreviate "Editorial" matter to its narrowest limits. Nor do we regret this, seeing that we write on June 1, a day supposed to inaugurate a whole month of sunshine by being sunny, and bright, and warm itself, but wasn't! In fact, to use a homely simile, it appeared as if Dame Nature rose early on the last day of May—about 3 a.m. in these parts—with her mind made up for "a good washing day before June came in." And didn't the ruin come down while the "washing" kept on! And didn't the thunder keep the noise going! Result.—The verdure was greener, and lovelier, and everything that Nature calls her own more beautiful than ever. But for the sunshine—well, *that's* to come!

Correspondence.

The Editors do not hold themselves responsible for the opinions expressed by correspondents. No notice will be taken of anonymous communications, and correspondents are requested to write on one side of the paper only and give their real names and addresses, not necessarily for publication, but as a guarantee of good faith. Illustrations should be drawn on separate pieces of paper. We do not undertake to return rejected communications.

Communications relating to the literary department, reports of Associations, Shows, Meetings, Echoes, Queries, Books for Review, &c., must be addressed only to "The EDITORS of the 'British Bee Journal,' 17, King William-street, Strand, London, W.C." All business communications relating to Advertisements, &c., must be addressed to "THE MANAGER, 'British Bee Journal' Office, 17, King William-street, Strand London W.C."

**. In order to facilitate reference, Correspondents, when speaking of any letter or query previously inserted will oblige by mentioning the number of the letter, as well as the page on which it appears.*

HOW FOUL BROOD IS SPREAD.

SELLING INFECTED STOCKS BY AUCTION.

[2908] I am in receipt of your reply anent sample of comb, for which I beg to thank you. I have with great sympathy been watching your efforts to procure legal powers for stamping out foul brood. I hope you will soon succeed. In connection with my own case, it may interest you to know how I think I have got this disease amongst my own bees:—About five years ago a bee-keeper in the neighbouring town died, and his apiary of about fifty hives was sold by public auction. These hives spread far and near over the county. Six stocks from it being bought by three different people, two of whom knew absolutely nothing about bees, and these were placed within half-a-mile of me. Two other hives from the same sale

were bought by a party that never saw the inside of a hive, and these also were put down about one mile from me. I have since been told by some of the purchasers that the bees they bought at the sale had done no good at all; they did not know what was the matter with the bees, but they had simply *rotted away*. I more than suspected what the cause was, having learned in the interval that the apiary sold was badly affected with foul brood. I bought one hive at the sale myself, but the following spring I did not like the look of it and cleared it out sharp. The other hives, however, have been planted round about me ever since. Several of the stocks have died out; and I also know that some people have a trick of forgetting to shut the doors of their hives after the bees die in them. It is heart-breaking to bee-keepers when such things as I have named can happen, and no one made responsible for the damage done and loss incurred. I would not mind clearing out all my hives and starting afresh, but what is the good of it under present conditions? The pest is spread all about us now, and most people do not know their stocks are diseased, and when some die out take no precautions to prevent their neighbours' bees from robbing their beelless hives, and carrying off diseased stores from them into their own "cupboard" to be used in feeding healthy brood. I do not keep many hives (about twelve), but I have been for over twenty years uniformly successful with them until this year. All that I have stated above is capable of proof, and so I enclose name and address (not for publication) and sign myself, A SCOTCH VICTIM, May 27.

BEST METHODS OF WORKING.

SOME PROPOSED NEW METHODS.

[2909.] As an apology for troubling you with the following communication, I may confess my mismanagement during 1896. In the spring of that year I started with the determination of establishing a record take of honey—for, with the exception of a few pounds from the skep, there was no record to "break" in this locality. Hive No. 4 had my special attention. Feeding, brood-spreading, and enlarging were successfully carried out, and the end of June (our honey-flow begins in July) saw No. 4 in "roaring" condition—ten frames, with super above, all crowded with bees. No. 4 must not swarm; so queen cells were cut out once. But there came a day—July 6th—on which a swarm was seen pouring from No. 4; after flying about rather wildly and not properly clustering, the swarm returned to parent hive.

With relieved feelings I concluded that the queen had re-entered the hive, which was opened, and *all* queen cells cut out! The hive was again opened a few days later, but lo! queen cells in abundance, but neither eggs, nor young brood. Then it was that I

learned that the queen had not re-entered the hive, but had been lost, and that I had deprived No. 4 of brood rearing for several weeks. However, it gave me 40 lb. of surplus honey, and with better management would, no doubt, have yielded much more.

Now in order to try and guard against a recurrence of the mistakes, I ask will you kindly say which of the following proposed methods of procedure is best; or make suggestions pointing out where I am wrong? I have four bar-frame hives, and wish them not to swarm; but in the event of their doing so, I want to work to obtain as much honey as possible.

Method No. I.—Given that a hive (A)—containing, say, eight standard frames and a rack of sections wholly or partly worked out—has swarmed, catch the swarm in a skep. Remove parent stock (A) to a new stand, and place an empty hive (C) on old stand. Into C place three frames (fitted either with combs or foundation), with quilt and division board, and shake bees from skep in front. While bees are running in, remove from A two or three frames containing brood, stores, and the best queen-cell, and put these, with adhering bees, into a nucleus hive (B). Place the super removed from A on the ground, with a quilt below, and an empty super above. Take a frame from A, brush the bees on the top of super (some will enter, others join the swarm) cut out all queen-cells and drone brood, draw back the division board and place frame in C. Do the same with the remaining frames in A. Thus C contains the majority of both bees and brood, and will work with the avidity peculiar to swarms. Place super on C, with a quilt between it and frames. Next day remove quilt and substitute excluder-zinc. When super gets nearly filled, place another below it, removing excluder zinc. If hive gets very crowded, and swarming is feared, place a rack of shallow frames—with slits in sides of rack for ventilation—below the brood-chamber. When queen in B gets mated, and begins to breed, add more frames. At end of season B will be fit for wintering, no surplus honey being taken.

Method No. II.—Proceed as in I, but instead of putting bees into super, shake them in front of C among the in-going swarm; or place frames with bees adhering into C before putting in swarm. In this case the swarm will recognise their old home, with little difference, except that their queen-cells are gone. They may at once set about raising more queen-cells, may they not?

Method No. III.—Remove parent stock A to a new location and hive swarm in C on old stand. Wait a day or two till C has established itself as an independent colony. Then insert frames of brood (without bees) from A into C, leaving only what will form a nucleus in A.

In both II and III. do not put on super

till four to seven days after hiving, thus doing away with need for excluder zinc, for the queen will have commenced breeding below, and not likely to pass up into super.—A. H., *Caithness, N.B., May 20.*

[We do not quite approve of any of the methods detailed, and would suggest the following as the better and safer course:—Hive the swarm as a separate colony and leave the parent stock in its old position. After hiving the swarm cut out all queen-cells but the best from swarmed stock and leave it to re-queen. If honey is coming in, place supers on the new stock; if not, feed for the first week. If swarms are not wanted we would also suggest that ten frames be used in original stock, as with a prolific queen eight frames are too few.—Eds.]

BEE NOTES FROM DEVON.

MY FIRST "TAKE" OF HONEY FOR '97.

[2910.] I have seen in the B.B.J. accounts of early swarms reported for the last few weeks, but no takes of honey. Our swarming commenced early in May, but only a few swarms were reported; the 15th, however, seems to have been a record date this year. Every one claims to have had swarms on the 15th, my first coming off on that date, leaving half-filled sections on the hive. I took off a splendidly-filled section on the 20th, and have sealed sections ready for taking on most of my hives. This is ten days later than the '87, Jubilee year. Bees are remarkably strong, helped on by the profusion of fruit bloom; and there is a grand promise of clover judging by the mass of clover to be seen everywhere, and in splendid order. This will soon be in bloom, and I hope, will prove an abundant harvest.—A. GODSLAND, *Bovey Tracey, Devon, May 25.*

BEEES AND ORCHIDS.

[2911.] If possible, will you kindly tell me what is the attachment on the heads of enclosed bees? You will notice between the antennae a yellow, horn-like attachment on the different bees sent, containing from one to five "horns" on each bee's head. If you take hold you can pull them out a half-inch long without breaking. The bees are from a natural swarm of May 15, hived on foundation (only a few of the bees are like this). I caught the bees as they left the hive, and very few return to the hive with it on. At first I thought they were carrying out bits of the foundation.—R. C. SALMON, *Gloucester, May 18.*

[The curious phenomena referred to above is remarkable as showing the wonderful manner in which nature achieves her ends by the aid of insects. Nearly every year, at this season, we have bees sent to us having similar attachments to those described above, and as the true cause or meaning is full of interest,

though not generally known even to bee-keepers, we extract some particulars which appeared in our pages six or seven years ago in reply to a correspondent who sent specimen bees identical with those before us, whereon the "attachments" or horns appear as in the cut Fig. 1.



Fig. 1.

1. These horns are the pollen masses, or pollinia, as they are called, of the *Orchis mascula*, now blooming freely in many of our moist woods and shady places.

Fertilisation is effected in orchids quite differently to what it is in such flowers, for instance, as those of our apple and pear trees. And so, with regard to the former, if we examine an orchis bloom from the front (Fig. 2)

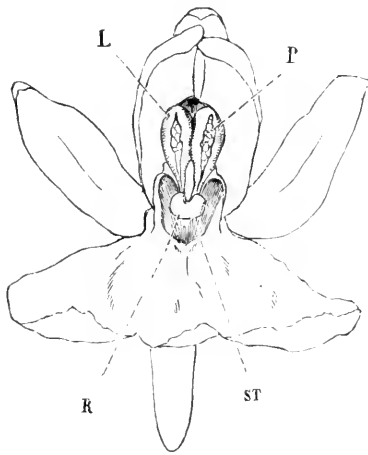

Fig. 2.

we shall get an idea of its structure, Fig. 3 giving a side view of the same flower on rather a smaller scale. The wrinkly stalk is seen in Fig. 3, and just below it, and between R and ST, Fig. 2, is the nectary or tube in which the nectar collects, and down which the bee has to put her tongue in order to reach the nectar.



Fig. 3.

The stigma, ST (Fig. 2), is bilobed, consists of two almost confluent stigmas, and lies just under the pouch-formed rostellum, R. The anther just above it, L, consists of two—one of which, on the opposite side, corresponds to L—widely-separated cells, which are open longitudinally in front, and each cell contains a pollen mass or pollinium, P.

The pollinia removed from these cells, and showing their relative positions, are seen at Fig. 4. Each pollinium consists of a number of packets of pollen-grains united together by

elastic threads. These threads unite at the lower end of each pollen-mass, and form what are termed the *caudicles*, at the bottom of each being attached a viscid disc. Each pollinium has its own separate disc, and the balls of viscid matter constituting these discs lie enclosed together within the rostellum. The rostellum is almost a spherical, somewhat pointed projection overhanging the stigma, and seen in Fig. 3 just over the opening of the tube. Without going into full details of the structure of this complicated organ, we can explain that the pollen-masses are enclosed in two pouches, with the viscid discs downwards, these

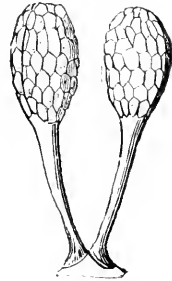

Fig. 4.

being covered by a very delicate membrane whilst in position. To understand how these pollinia get transferred to a bee's head, and fertilisation effected, we must watch a bee; and we shall see her alight on the lower petal or *labellum*, as it is called in orchids, and at once insert her head as far as she can get it into the tube. This is not far, for it is stopped by the projecting rostellum, this act rupturing the thin membrane, and exposing the viscid discs, which now adhere to the bee's head. The viscid matter has the property of becoming hard and dry in a few minutes.

After taking the nectar, when the insect withdraws its head, one or both of the pollinia will be firmly attached to the head, and project like horns. The firmness of the attachment is very important, for if the pollinia were to fall sideways or backwards, they could not fertilise the flowers. Now, the most marvellous contrivance exists by which the pollen-masses are brought into position for touching the stigma. The caudicle has the power of contraction in such a way that it causes the pollinium to sweep through an angle of ninety degrees, but always in the direction towards the proboscis of the insect, in the course of thirty seconds on an average. The time it takes to complete this movement is about sufficient to enable a bee to fly to another plant. On a bee entering the flower from the alighting-place, the thick ends of the pollinia exactly strike the stigmatic surface. This is also viscid, but not so viscid as to pull off the whole of the pollinium from the insect's head. It is sufficiently viscid to break the elastic threads, and leave some of the pollen-grains on the stigma, and in this manner the insect may, by means of one pollen-mass, fertilise several stigmas, until nothing but the caudicles remain. Darwin, in his *Fertilisation of Orchids*, describes how the whole of the process of removing the pollinia may be shown by inserting the point of a pencil into the nectary. The pollinia stand at right angles to the sloping side of the pencil, and if this is held still for

half a minute it will be seen that the pollinia sweep towards the point of the pencil until they lie in a horizontal position (Fig. 5). We

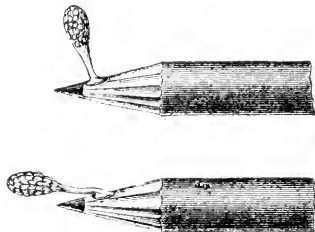

Fig. 5.

have many times used this means of illustration, which has always caused astonishment and admiration of this contrivance for ensuring the fertilisation of these flowers.—EDS.]

SELLING HONEY.

A HINT FOR COTTAGERS.

[2012.] Last season I sent to Mr. Rose, Great Charlotte-street, Liverpool, for one of his transparent window bills, which reads, "Honey from our own Bees on Sale within." I was, however, able to sell my own produce of 1896, and also assist others in selling theirs, so I did not use the bill last year. I now want to say that our cottage is as it were (as the saying goes) "five miles from everywhere," and portorage to the station and carriage by railway is a large item in my expenditure, while the cottage is too far from the road for the bill to be seen on our window. I have, therefore, had it framed like a small picture and hung on a tree in the apiary, adjoining the road, as an experiment, to try and sell more honey at home. The bill has attracted a good deal of attention, and had been in position just a week, when it brought me a customer who was anxious to take the small quantity of last season's Honey I had left. And also gave me orders for the future by which I hope to clear off half this season's produce. If other bee-keepers, especially cottagers, would do likewise, they would sell more of their honey at home, there would be much less trouble to themselves, and there would not be such a glut in the market from July to October, and it would be better for all concerned.—WM. LOVEDAY, *Hatfield Heath, Essex, May 31.*

BEE-TALKS TO MYSELF.

AND SOME MEMS FROM MY NOTE BOOK.

[2013.] April 7, 1896.—No sign of queen cells in any hive. Supered at this date in 1893 and 1894.

April 24, 1896.—Supered two hives out of eleven.

May 2, 1896.—Further supering.

Now for 1897 :—

May 15.—After bitter winds and biting frosts, this is the first really fine bee-day. Several

hives have started queen cells, but in none is there the drawing out of combs along the tops usually indicating time for supering. Yet something must be done. I can't visit the hives again for a week, and must not have swarms. It looks like "the beginning of better days." On go the supers. Oh, bother! This hive, most crowded of all, is a misfit, and there are queen cells right and left; but the outer lift case is an eighth of an inch too small. What is to be done? Why, take out all the brood frames but one, and super another hive with them. But what if this is the only fine day? Why, then the brood will be chilled. What shall I do? I shall risk it. So I do.

May 22.—Hurrah! a glorious week. All the supers filling splendidly. Brood chilled? Not much. I hear the hens cackling; and, by-the-bye, what do the sillies cackle for, when all sensible birds look the other way after laying an egg, in case a law-abiding boy fails to post himself up in the "Birds' Protection Acts"? Well, the hens cackle, and I chuckle. Ah, it serves me right; the next hive is the strong lot left with one comb and six or seven other frames of foundation, instead of five or six in all, as "The Guide-Book" tells me. Yes, it serves me right. The first two are loaded with pollen, and the last with honey, the sensible queen having confined her efforts within a reasonable limit, and packed all the inner combs with brood. Drat those hens. What do they want to cackle for? There are two more of them at it. Very humbly I put in another frame or two of foundation, for the queen *now* wants the room. Thank goodness, I can congratulate myself again. I will have a look at three hives I left out last week. Quite right; they didn't want supering, and two of them are not likely to till Whitsuntide. So can the allotment gardener felicitate himself, when he has a small crop of potatoes, that he will not have so many to wheel home. What a strange season! Both hives had early-prolific queens of 1896, and both had liberal stores given with a view to entire consumption in consequence, and yet they don't get on. Has continuous and late autumn laying impaired the powers of the queens? And, after all, the summer bursts out in one day, and a single week fully justifies all the supering done, when the usual indications for supering were not over abundant. But there, I shall come a cropper at last, if this par. be wound up thusly :—"You were lucky this time; the risk was too great to be run by a wise man"—EDS." Or, worse even, after this manner :—"You wonder why hens cackle; we wonder why some bee-keepers do."—EDS." Please excuse rambling. It is my wedding anniversary (I won't say which, for fear of the cruellest "editorial rejoinder" of all, on age being not always associated with wisdom), and I took my wife with me into the country to see the bees. I haven't told her all that I am telling you.—"J.," *May 22, 1897.*

"ARTIFICIAL" INCREASE, OR DIVIDING COLONIES.

A mania seems to have seized many of those keeping bees, for increase of colonies otherwise than by natural swarming, if my correspondence is any criterion to go by, for, at no time in my bee-keeping life have I had so many inquiries in this matter as during the past three months; therefore, to save so much private correspondence I will give some of the plans which I use successfully, in the *American Bee Journal*, even though it may be, to quite a large extent, matter which I have given before. But, before doing so, I wish to say, that for this locality I prefer natural swarming to any plan of artificial increase, where only one swarm is allowed from each old colony, and where said swarm will issue in time to prepare both old and new colonies in good condition for the honey harvest.

The first plan I will give for artificial increase is what is termed by some as the "nucleus plan." To be of the most value the nucleus should be "forced" eighteen or twenty days before the honey harvest, by having enough bees in it to protect a frame two-thirds full of brood, the larger part of which should hatch during the first four or five days, while said comb should contain some eggs just laid, if possible. Besides this frame of brood and bees, the nucleus should also contain a frame having a pound or two of honey in it, the whole being set in a hive and confined to one side of the same by means of a division-board.

The next day after making, a nearly-mature queen-cell should be given, or a newly-hatched queen introduced. In about ten days, if all proves favourable, the young queen will be laying, when I go to the hive from which I formed the nucleus and select a frame of brood, nearly all of which are gnawing out of the cells, and add this to the nucleus, always putting a frame of comb or comb foundation into the old colony to take the place of the one taken out, otherwise too much drone-comb would be built; for colonies that are allowed to build comb under these conditions nearly always build drone-comb.

I now wait four or five days, when I go to the old colony and take out four frames of brood, from which all the bees were shaken, as they were from the last-mentioned frame, when I carry them to the nucleus. I now fill out each hive with empty comb or comb foundation, and put on the surplus arrangement.

By the above each colony is made of about equal strength, and the brood is so taken out of the old hive that the colony does not have a desire to swarm. The old colony will have the most field bees for the first week or so, but the other will soon make the stronger colony of the two.

My second plan is to make one colony from each old one, on the principle of division of bees instead of division of brood, as in the

above case. In using this plan we must have queen-cells nearly mature by the time our first colonies are preparing to swarm. Having such cells on hand, I go to a colony preparing to swarm, or one that has its hive full of bees and brood, and move it one side of the old location, so as to put a new hive in its place. If a hive is not full of brood and bees, do not touch it; for it is useless to try to increase bees till such is the case.

I now look over the combs till I find the one having the queen on it, when I place that comb in the new hive. I next give them a frame having some honey in it, and then fill out the hive with empty comb or foundation, when about two-thirds of the bees in the old hive are shaken in front of the new hive and allowed to run in. After this I arrange the frames back in the old hive, putting a division-board in place of the frames taken out, when the old hive is carried to a new location where I wish it to remain. After the bees thus removed have become reconciled to their queenless condition, I give them one of the nearly-mature cells, or a virgin queen which will soon be laying. In this way I have secured my new swarm, controlled all after swarming, and introduced my young queen, all to my liking, and with but little trouble.

My third plan is one which I use on the weaker colonies, or those which do not get ready to swarm up to ten days or so before the honey harvest arrives, when I proceed to make colonies from them as follows:—

A hive is filled with frames of empty comb, and placed upon the stand of one of these colonies which have not swarmed, and all the sections are taken off and placed thereon, then all the bees are shaken and brushed off their combs of brood and honey in front of the hive, into which they will run as fast as shaken off. Thus I have a colony that is ready for the honey harvest, as they have the queen, bees, and partly-filled sections all in readiness to work. Previous to this, nuclei have been started, so I have plenty of laying queens to use as I need them.

I next take all the combs of brood from which the bees were brushed except one, arranging them in the hive the bees were shaken out of, and carry them to the stand of another colony which has not swarmed. I next take the comb of brood which was left out, go to one of the nuclei, take out the frame having the laying queen on it, and put the frame of brood in its place. Take the frame—bees, queen and all—and set it in the place left vacant for it when arranging the combs of brood. I now put on the sections, and having all complete, I move the colony to a new stand, and set the prepared hive in its place. Thus I have a laying queen and enough of her own bees to protect her, together with a hive filled with combs of brood, and all the field-bees from the removed colony. The loss of bees to the removed colony stops the swarming impulse, and in about a week they have so

regained their loss that they are ready for the sections again.

In this way I make one colony from two old ones, but have all in the best possible condition to take advantage of the honey harvest which is soon upon us.

These plans all look toward a host of bees in time for the harvest, with no desire to swarm; and thus having them gives an assurance of a large crop of honey.—G. M. DOOLITTLE, in *American Bee Journal*.

Echoes from the Hives.

Hatfield Heath, Harlow, Essex, May 23.—The crocus, snowdrop, petunia, common willow, hazel, and blackthorn flowered well, but the wind and rain and cold spoiled the bees' chance on them. Even the horse-chestnut, apple, and whitethorn are now beautiful with flowers, never better. Field beans, too, are clothed with their tricolour flowers, but it seems as if they too are to waste their sweetness on this withering wind. We are on high ground, without shelters, the wind has been blowing strong generally since last September. Many bees have left home never to return, till uniting became necessary. Now the poor bees leave home and come toiling back within a few inches of the ground, the wind blowing at the rate of twenty miles an hour they endeavour to rise over the 3 ft. high hedge, the wind suddenly blows at seventy-five miles an hour, and they are driven back to try again only to be blown into the adjacent pond, a prey to the ducks. I have supered, but to do it had to put bricks on the quilts to hold them down. The saintinon looks promising, and hope reigns in our breasts.—W. M. LOVEDAY.

Epney, Near Stonehouse, Glos., May 29.—My bees have been gathering well from apple bloom and field beans; it seemed quite a glut this week. To-day we are having some beautiful warm showers, of which we were greatly in need. My stocks are very strong, and I have given a second doubling box to most of them. They are first cross Ligurians, and with me the natives are not in the same street with them. I raise my own queens and re-queen each stock every other year. Pure Ligurians are next to useless, but when mated with our native drones I think they are model bees; at least, that is my experience.—O.K.

Small Lees Mill, Rippondon, May 25.—Bee weather is splendid, but a little cold at night. Farmers are beginning to grumble about the cold dry winds, &c., and are wishing for rain just as they were wanting fine weather not many days ago. Weather is fickle in this country, but man seems more so, for no sooner has he got his wish than he wants something different. It seems part of a man's nature to grumble and especially about the weather.

Some are also grumbling about foul brood legislation, but the few dissatisfied ones only

bring out the strong points of the majority and make their case better in the end.

In this part of Yorkshire the chestnut is only just bursting into flower, fruit trees are covered with bloom, and the dandelion and wild hyacinth forms a nice carpet to the whole, which the bees are brushing and washing, the former to provide next year's bloom and this year's fruit, and the latter for this year's "honeycombs of golden juice." This year I have discarded gloves with good effect; the bees ignore my bare hands. I should be very glad, and so would many readers of the B.B.J., no doubt, if our good editors would give the times of the Demonstration or lectures given at the "Royal" Show, Manchester, and also the day.—JOHN H. PRIESTLEY.

[We will give all the information available on an early day in these pages.—EDS.]

Queries and Replies.

[1738.] *Claiming Swarms.*—I am a novice at bee-keeping, having bought a skep last season and also a frame hive to take my swarm this spring; the skep swarmed on a very windy day this week, and went on to a neighbour's place, and, I believe, went in to a frame hive which he had waiting for the same purpose as myself, to take a swarm from a skep. Will you kindly tell me what the law is on the matter of bees? Is one entitled to follow his bees on to any one else's ground, or is it legal for the owner of the ground where they alight to claim them?—W. Y., *Coleford, May 26.*

REPLY.—The following answer given to a querist in current issue of *Record* is entirely applicable to above case. It reads thus:—"The law of ownership in stray swarms is—according to Blackstone—fairly clear, in that that learned authority says in effect that a swarm remains the property of the person from whose hive it issues so long as it is kept in sight by the owner or some one acting for him, and may be followed on to another person's premises for recovery of same with or without permission.

"If, however, the swarm be lost sight of even for a short time the bees become *fero natura*, or 'wild' in the eye of the law, and are not recoverable. A judge has decided that under this law swarms may be followed into a neighbour's garden for recovery, just as a sheep straying there could."

[1739.] *Transferring Bees to New Hive.*—Kindly give me your advice on the following: Being anxious to transfer my bees from their present hive, where the frames are very old and built into each other, on the 14th of this month I lifted the body-box with bees and frames off the old floor-board and placed it over a new body-box, fitted with ten sheets of "wired" foundation. The entrance in old hive was closed, thus compelling

bees to enter by the lower one and so pass through the lower body-box. This they are now doing freely, but have not yet commenced to draw out the foundation, although the hive is strong. Is there nothing I can do to induce them to work out the foundation and to transfer the brood-nest down? I ask this because the season is advancing and I am anxious to get some honey out of the old frames. As the upper body fits closely over the lower, I do not think the bees refusing to work in lower box can be caused by a draught in same. On Tuesday last I had a fine swarm from one of my best hives. The bees had been working well in the sections for some days before. I fear I shall get no honey from this hive now. The bees are carrying in now a considerable quantity of almost black pollen. Could you tell me where they are getting this? M.C.B.—*Warwick, May 27.*

REPLY.—1. Beyond seeing that the body-boxes are well packed at the junction, so as to exclude cold air entering, and making lower box as snug and warm as possible, nothing can be done to force the bees down; nor is there any need for it. They will work out foundation when cell-room is needed for the queen's egg-laying purpose, and combs above begin to be occupied with honey as vacated by the hatching bees. There is also plenty of time for surplus storing in your county, where it will only have recently begun. 2. There is every prospect of securing surplus from the swarm referred to if weather keeps fine. We should give the unfinished sections to the swarm for completion in course of a week. 3. Dark pollen comes from so many and such various blooms that we cannot name the source without some knowledge of the bee-forest of your district. Perhaps our old friend, Mr. John Walton, as a Warwick bee-keeper, will say where the "almost black pollen" is from at this season?

[1740.] *Queen Cast out of Skep; Dealing with Swarms.*—Being a young hand at bee-keeping I should be greatly obliged if you would kindly inform me (through B.J.) the cause of the enclosed queen being cast out of skep, which swarmed on May 16. I saw her being brought out at midday to-day, and was not quite dead. On the 18th I think two of my skeps must have swarmed and clustered together on a bush close by, which gave way and let them all down to the ground. I placed an empty skep over the swarm, and on going to move them for hiving in the evening I found the skep completely full of bees, and more than it would hold. They weighed 15 lb. I put them in a frame hive and they cover the whole of the ten frames, and appear to want more room. The ten sheets of foundation are almost worked out. As I am anxious to extend my stock, would it be best to allow them to swarm, or would you advise me to place a rack of sections on at once to prevent it? I obtained eight skeps of bees this spring and

am putting all the swarms into bar-frame hives. Four of them have swarmed at present.—W. S., *Esher, May 25.*

REPLY.—Yes, give the sections at once and a second rack if the weather keeps fine. Better "make hay while the sun shines."

[1741.] *Uniting Bees after a Road Journey.*—I will be shortly moving some hives by road for a journey of six hours' duration. I will at the same time have some driven bees with which I should like to strengthen these stocks. I therefore ask, would the jolting caused by the journey to both the driven bees and bees in stocks enable me to unite the driven bees peaceably to the stocks at end of the journey by throwing the driven bees down in front, and at the same time releasing the bees in that hive?—W. E. M. E., *Cambridge.*

REPLY.—Much will depend upon the condition of the stock hive after arrival at the journey's end. And in any case we should see that the bees in "possession" were prepared for the introduction of the driven bees by using such known means of pacification as thin scented syrup, or by dusting the bees on each comb well with flour from a "dredger" before uniting. The driven bees would also need to be dusted or sprinkled when thrown out in front of the stock to which they are added. We may add that the risk, if any, to be guarded against is the temper of the bees in the frame hive at end of a road journey. The driven bees, being homeless and with no stores to defend, would be quiet enough, but we have seen a colony of bees, after a few hours' journey by road in warm weather, so vicious when released as to sting all they could get near. In such a case the driven bees would inevitably be massacred unless great care was exercised.

[1742.] *Using Combs considered "Unsafe" through Disease.*—I have had two lots of last autumn's driven bees die out this spring through dysentery. I have scraped the frames, cut out part of the comb badly messed or "specked," and sprayed combs with a weak solution of carbolic acid and water, shaking off the moisture after and allowing the carbolic smell to pass off by exposure to the air. I have also washed the hives with a stronger solution of carbolic and water. 1. Is it safe to use these combs for swarms this year? 2. I have also some combs on which I hived a small lot of bees which I had given me; but three days after I found out that these bees had had foul brood last year, so I at once killed the lot by placing them over some burning sulphur. The combs and hive I have treated as before mentioned. Shall I be safe in using them again? 3. If I get a good swarm during the next week or so and they go on right, should I be able to divide them into two about the middle of July, so as to increase my stocks?—"TRYON," *Liskeard, May 24.*

REPLY.—1. Quite safe. 2. In this case, also, the precautions taken render danger so

remote that we should not hesitate about using the combs as proposed. 3. You might increase stocks far more safely and suitably by dividing the combs, brood and queen-cells of parent hive, into three nucleus colonies if weather is settled and warm at time of the issue of first swarm.

We add a word to express the satisfaction with which we read of the care exercised by our correspondent in avoiding risk. Would that all would be as careful.

[1743.] *A Cottager's Attempt at Modern Methods.*—I am only a cottager, and beg for a little advice through your valuable journal, which I read with great delight, and am trying to get all my bees into working order on the modern principle. I have now seven stocks—three in frame-hives and four skeps. I have bought two new frame-hives, and want to get bees into them. In carrying out this idea I have placed one of the skeps of bees on top of a new hive, the frames being filled with full sheets of foundation. 1. How long will it be before I can safely remove it? 2. I have one frame-hive queenless, and the bees seem to be sluggish. On taking out the frames I found a sealed queen-cell, and they are now working a little better, some carrying in pollen. Do you think the queen will be of any use this year? There was no brood, but plenty of bees.—STOCKHELM, *Chelmsford*, May 26.

REPLY.—1. The skep may be "safely" removed as soon as it is certain that all the brood has hatched out and queen is breeding in frame-hive below; but if the skep be allowed to remain on, it will be used by the bees for surplus storing, and should be left on till close of the honey season, then remove and have its contents extracted. 2. If queen-cell now hatching contains the normal offspring of the former queen, and is safely mated, there is no reason why she should not be of good use this year.

[1744.] *Buying Diseased Stocks.*—1. Two months ago I bought a stock of bees in skep, and yesterday evening I removed the latter from its stand in order to transfer the bees to a frame-hive by putting the skep over the frames in conformity with the advice given to other inquirers in B.J. In moving the skep from the original wooden bottom, the piece of comb I send you got broken off, as it was fixed to the wooden bottom of the skep. The young grubs appear to me to be healthy enough, but I notice a sticky brownish substance in one or two of the sealed cells, and there is a peculiar smell about one side of the comb especially. Being a novice, however, I should like to be certain this is not a case of foul brood. The stock of bees is very strong, and there have been a good many drones flying from the hive lately. 2. Does the partly-formed queen-cell on comb sent mean anything in particular?

REPLY.—1. The bulk of the larvæ on one side of comb received seems healthy enough, but on the other side are unmistakable signs

of foul brood. Slight, it is true, but nevertheless there. Had not the skep been already fixed above frame-hive, we should have deprecated its being so placed. As it is, we should let it remain, and hope that the stock below will—by reason of its present strength and the constant feeding on freshly-gathered natural food, overcome the "slight attack," which shows the disease to be only in its earliest stage. Use precautions, of course, and watch carefully later on how the brood hatches. 2. The embryo queen-cell has no particular meaning as it does not appear to be of recent formation.

Bee Shows to Come.

June 4 to 8, at **Reading**.—In connection with the Royal Counties Agricultural Society.

June 9 and 10, at **Nottingham**.—In connection with the Notts Agricultural Society, at Colwick Park.

Shows in connection with the Notts B.K.A. will be held as under:—**Hucknall Torkard**, July 29. **Entries close July 16.** **Southwell**, July 22. **Entries close July 5;** and **Moorgreen**, September 7. **Entries close August 27.**

June 23, at **Manchester**.—Royal Agricultural Society's Show. Letters relating to Bee Department to be addressed, E. H. Young, Secretary, B.B.K.A., 12, Hanover-square, W.

July 7 and 8, at **Hanley, Staffs.**—Horticultural Fete. Medals and liberal prizes for honey. Schedules now ready. Apply J. B. Barrow, Town Hall, Hanley.

July 15 and 16 at **Stamford**.—In connection with the Lincolnshire Agricultural Society. Bee Department under the management of the Lincs. B.K.A. Schedules from R. Godson, Hon. Sec., Tothill, Alsford. **Entries Close June 18.**

July 24, at **Fallowfield, L.** and **C. B.K.A.**—In connection with the South Manchester Horticultural Society, schedules from F. H. Taylor, Local Hon. Sec., L. and C. B.K.A., Old Hall-lane, Fallowfield. **Entries close July 8.**

July 21, 22, and 23, at **Harrogate**.—Yorkshire Agricultural Society's Show. Liberal prizes for hives, honey, &c. Schedules to be had from Marshall Stevenson, Secretary, York. **Entries close June 12.**

July 28 at **Henbury**.—Bristol, Somersetshire, and South Gloucestershire Annual Show. For Schedules apply to Miss Hill Dawes, Long Ashton, near Bristol. **Entries close July 21.**

Notices to Correspondents & Inquirers.

All queries forwarded will be attended to, and those only of personal interest will be answered in this column.

J. HUNT (Hampton Wick).—"Homes of the Honey Bee."—The series of bee-garden pictures under this heading began in our issue of December 3, 1896, and have appeared fortnightly in each alternate issue since that time. They will be continued regularly—unless the exigencies of space in the very busy season prevent—until complete. When this will be it is impossible to say, for, thanks to the lively interest taken in the pictures and the collection of beautiful photos we already have been supplied with, the "Homes" will continue to garnish the pages of the B.B.J. for many a long month (we had almost said year) to come.

J. COWIE (Lesmahagow).—*Loss of Queen.*—We see nothing wrong with queen likely

to account for her being found dead outside skep. She is an adult, but not "aged" in the accepted sense, and bears the ordinary appearance of being fertile. If the skep had been handled or knocked about at all, the queen may have been "balled" by her own bees in consequence—as sometimes happens—but this is all we can say, except to ask so far as the bees sent, is your friend sure that food is plentiful in the skep?

Mrs. DAWSON (Mullingar).—*Foul Brood*.—We regret to say the frame of comb received is badly affected with foul brood, and accounts for the failure and subsequent death of the colony. The whole contents of the hive should be at once burnt. So far as the hive itself, and in answer to the inquiry "if it will be fit for another swarm?" we really think that, notwithstanding that it is described as "a very well made one," we think that—judging by frame sent—it is about the worst hive, so far as being practically useful to a bee-keeper, we ever saw. Not of standard size, with top-bar about half as thick as side and bottom bars—both the latter being $\frac{3}{4}$ in. thick—and the frame itself $\frac{1}{2}$ in. "out of square," we think a hive made by a workman so utterly ignorant of what constitutes a workable hive must be a nuisance in an apiary, and if it were ours (especially now that it is so tainted with foul brood) it should go along with the combs—into the fire! This is said entirely in the interest of our correspondent herself.

"SUNFLOWER" (York).—*Suspected Comb*.—So far as the very small sample sent, the brood in cells is "chilled," not foul; but we advise that a careful watch be kept on hatching brood for a few weeks to come.

S. S. (Liskeard).—*How to Treat Foul Brood*. Comb is affected with foul brood. So far as a "remedy," or how to treat the case if diseased? This is very fully dealt with in the chapter on "Diseases," page 142 to 151 of the "Guide Book" (14th edition), which you already seem to possess.

C. M. ANTON (Arbroath, N.B.).—*Using Super Clearers, Excluders, &c.*—1. If it is desired to ensure against risk of sections being spoiled by brood, excluder zinc, between them and brood-nest is indispensable. At same time it is known that some experienced bee-keepers can get sections free from brood without using excluders. But it is "experience" which enables them to do this, and amateurs too often find their sections ruined, to their great disgust, from lack of this knowledge. 2. The super-clearer, fitted with "porter bee-escape," is quite simple in working, and answers the purpose admirably. 3. All projecting bits of comb built on upper side of top bars should be removed before giving a rack of sections.

A TRUE LOVER OF BEES (Mattock Bank).—*Wild Bees*.—1. Insects sent belong to the

genus *Andrena* (variety *Fulva*), a native species of wild bee, commonly called sand bees. They burrow in the ground, forming tunnels 5 in. to 9 in. in length, in which the cells are formed. 2. The danger you would guard against in foul brood legislation is fully provided for.

J. F. GRAY (Herts.).—*Using Suspected Comb*.—1. The cells of comb sent are all full of mildewed pollen. There is no sign of brood, healthy or otherwise, in it. 2. So far as using such combs for a swarm, or "to help a weak lot of bees," as desired, they would be utterly useless, being choked up with hard old pollen covered with mildew. 3. The skep is probably oversupplied with drone-comb, and such hives never yield any profit. The bees are not likely to swarm under such conditions as you describe.

S. G. HOLLOWAY (Walsall).—*Black, shiny bees in hives*.—The presence of these thieves of the hive, as they may be termed, has never been safely accounted for. They are bees who will not work, but, like humans who are thieves by profession, exist on what they can steal. The bees of the hive entered by these marauders naturally defend their stores, and in driving the thieves away give them no rest, and so pull them about as to remove all the hairs which cover the body. That is what gives them the black, shiny appearance noticed.

K. J. (Leyth).—*Using Excluder Zinc below Sections*.—Had we been able to personally inspect the hive and the excluder through which the bees "won't work," it is not improbable that we might have explained matters. As it is, we can only say, if the excluder is a hindrance to the bees working in sections, remove it, and see if the desired result follows.

R. HAMLIN-HARRIS (Hambrook).—*Moulds for Cakes of Bees-wax*.—We do not think there are special moulds made for bees-wax, but suitable shapes are not difficult to get from places where jelly moulds or similar things in confectionery making are obtainable. A tradesman would be the best person to say where they could be got.

HOLMS (Blantyre, N.B.).—*Dead Bees Cast Out*.—There is nothing special in bees to account for death. We have, however, very little doubt they are part of a seam of bees which has got away from the cluster during the winter and died from want of food. The living bees are now clearing them out in the ordinary course of getting combs ready for breeding in. There is little cause for alarm because of this mishap.

J. H. JENKINSON (Rotherham).—*Suspected Comb*.—No trace of foul brood in comb sent. In fact, no trace of any brood at all in cells.

HITCHIN.—*Date for Driving Bees for Wintering*.—1. Salicylic acid used in bee-food as advised in "Guide Book," is a good preventive against infection. 2. We should not

try to establish stocks from driven bees later than the middle of September, and fix a still earlier date if no ready-built combs are on hand to give the driven bees. 3. For particulars as to membership of B.B.K.A. write to the Secretary, Mr. E. H. Young, 12, Hanover-square, London. 4. If queen is safely established and breeding in lower hive, you might set a rack of sections on top of frames—after covering latter with excluder zinc—and place the skep above. But you must be sure that there is no drone brood in skep. Your remark about “wishing the stock to swarm” does not fit in with the giving of surplus room in plenty, seeing that this latter operation tends to prevent swarming. We cannot “blow hot and cold,” you know.

R. HUTCHINSON (Oxon).—An examination of comb received shows that it is affected with foul brood. The disease does not appear to be of long standing, but is rapidly developing.

P. G. (Essex).—Comb is affected with foul brood. We should like to know what “expert” (?) declared it otherwise.

JOHN COLES (Devon).—*Queen Lost in Swarming*.—The queen “found along with a dozen bees” is no doubt the “mother bee” of the hive which swarmed two days previously to the day when she was found (May 23). How she fell to the ground and was lost to the swarm we cannot say as the wings of dead queen received are crushed and broken, but that would no doubt be done afterwards.

R. S. O. —*Extracting Heather Honey*.—1. It is well known by all practical men that heather honey cannot be got from combs by means of the ordinary, or centrifugal, extractor. It requires a Press, and combs are, of course, destroyed—as combs—in the operation. 2. Nothing so effectually prevents “pop-holes” as using full sheets of foundation.

SILVERHILL (Hastings).—*Races of Bees*.—1. The bee sent is a hybrid Carniolan. We do not like the pure Carniolan for this country. It is too much given to swarming. 2. The recipe asked for is salicylic acid and soda borax, 1 oz. each; water, 4 pints. This forms the “solution,” of which 1 oz. is added to 10 lb. of sugar, made into syrup with 7 pints of water. 3. The plan of setting skep over frame-hive and allowing the bees to transfer themselves is far the best.

Special Prepaid Advertisements.

Twelve words, Sixpence; for every additional Three words or under, One Penny.

SPECIAL SILK BEE VEILS, 9d. post free. ABBOTT BROTHERS, Merchants Quay, Dublin. P 46

200 FRUIT BLOSSOM SECTIONS, well filled, ss. 6d. dozen. W. BIRCH, Eastry, via Dover

HONEY.—21lb. in screw-capped bottles. Granulated. 9s. doz. W. LUCAS, East End, Westminster, Petersfield.

Prepaid Advertisements (Continued)

TEN SWARMS BEES WANTED. Young Queens Apply, BELL, Hillside, Langholm, N.B.

GOOD SWARMS of my Superior Bees, 15s. packed. JOHN WALTON, Honey Cott., Weston, Leamington. P 51

WANTED immediately, Good Healthy SWARMS Pure English Bees. MORETON-LOED, Goatley Grange, Northiam, East Sussex. P 49

HONEY (Extracted), 1 cwt. Splendid quality. Deposit Editor. Send empty. 7d. lb. DOWNER, Drayton, Chichester.

FINE 1896 Hatched ENGLISH QUEENS. Good Working Stock, 5s.—BLACKLOCKS, Sycamores, Lydd. P 50

TRICYCLE (Singer's, solid tyres) FOR SALE or EXCHANGE. What offers in Bees? VICAR, Ince, Chester. P 55

A FEW Stones of Pure English HONEY to DISPOSE of, in 28 lb. tins. 6d. per lb., sample 3d. DUBDING, Sabley Rectory, Alford, Lincs. P 53

HEALTHY PLANTS. Limnanthes 1s. 3d. for 50, Borage 1s. 3d. per 100. Proceeds for prizes. TAYLOR, Old Hall-lane, Fallowfield. P 44

WANTED, NEW SECTIONS, first quality; also Bell-glasses Honeycomb. Packages sent. Good price paid and prompt settlement. R. COLE, Southdown Apiaries, Bexhill, Sussex.

SPECIAL OFFER. To introduce our new SECTION (fully patented 1896), and FOUNDATION, we offer to send 24 Sections and Foundation to fit, post free 1s. 6d. ABBOTT BROTHERS, Merchants Quay, Dublin. P 45

SEND FIFTEEN STAMPS for useful (half pound post free) SAMPLES of FOUNDATION, and compare with what you are using. ABBOTT BROTHERS, Merchants Quay, Dublin. P 47

QUANTITY of “ILLUSTRATED LONDON NEWS,” “Graphic,” “Sporting and Dramatic,” “St Pauls,” etc. Recent issues, will exchange for BEES. Send offers to G. WILSON, 21, New Park-road, Brixton Hill, London, S.W. P 48.

TESTED ENGLISH QUEENS, ready in July, 5s. each, in my introducing cage. Bred from stocks selected for gentleness and honey-gathering qualities and under swarming impulse. Postage on telegrams 1s. 6d. at present. W. WOODLEY, Beedon, Newbury.

GARNER'S BEE HIVES and APPLIANCES are the best as well as cheapest. Secretary of Association writes: “I shall certainly recommend what I have seen of yours. They are good value for money.” Steam Factory, Dyke, Bourne. P 54

SUPERIOR QUEENS, Stocks, Nuclei, and Swarms. Address, Rev. C. BRELETON, Fulborough, Sussex.

21 ST YEAR. PURE ENGLISH BEES. Good swarms, 10/6, 12/6, 15/-. Cases 1/, or returned. Tested Queens, 3s. 9d. delivered. Cash with order. ALSFORD, Expert, Blandford.

NATURAL SWARMS. Guaranteed healthy and safe delivery, 3½ to 4 lb. weight, 12s. 6d. each. Box and packing free. A. TWINN, Apiary House, Ridgwell, Halstead, Essex. P 39

To Sheffield, Rotherham, and District Bee-keepers.

BAR-FRAME HIVES, STRAW HIVES, Extractors, Weed Foundation, Sections,

&c. ———
SCREW-CAP HONEY BOTTLES.

16-oz., 12s. 9d. for 10 dozen; 7-oz., 7s. for 6 dozen, can be obtained at

Carnett Brothers, 29, High St., Rotherham.

Editorial, Notices, &c.

USEFUL HINTS.

WEATHER.—The time-worn joke which tells us that British weather consists generally of “samples,” never seemed in a fairer way of establishing itself as a truism than now. June is only eight days old, and, since its advent, samples many and various have been the order day and night. Of course, this is trying both to the patience and perseverance of bee-keepers, to whom fine weather at this time means so much. One writes us yesterday, “No sooner do we have a good day or two than we get damped down again as with a wet blanket.” This column, or to be quite correct, this first page of the B.J. as a rule is left to the last so far as being worked at editorially—hence the elastic nature of its contents—and this time we write at 6 a.m. on the 9th (publishing day), hoping that the sun will illumine our “copy,” but he won’t! A steady down-pour of rain awoke us, and still keeps on, evidently intending to “damp us down” as we wend our way to the village we call Town. Poor bees and bee-keepers!

We should have been tempted to consider ourselves hardly dealt with, but the news of those dreadful storms and floods in France—which, within the last three or four days, have nearly ruined thousands of peasant proprietors who live by the land—steadies us.

THE “ROYAL” SHOW.—Again we have to offer a word of advice or of explanation regarding exhibits at this important Show in response to inquiries from intending exhibitors in the “Trophy” class and other classes for extracted honey. It seems to be the idea of those who write us that honey of previous years must be shown in granulated condition; or, in other words, that reliquefying honey which has become granulated will not be eligible for competition. This is an entire mistake. Honey of previous years may be shown either granulated or in liquid form.

So far, then, as the Trophy class honey gathered previous to '97 will be eligible, whether staged, in solid, or liquid form, and thus will lose none of its original colour or consistency through age. Those who prepare the produce can thus select

samples standing well, so far as colour for reliquefying, and others of darker shade for staging in granulated form. No need, then, for the lament hinted at that “the extracted honey in this class will look like so much paste.”

SWARMS.—Spite of adverse weather, quite a large number of swarms have issued. These will, of course, have to be fed on all days when outdoor work is stopped. A little help in feeding will keep them going, and get the bees in full form for the fine weather when it comes. We don't know if it has been a general feature of this season for swarms to “abscond,” or refuse to stay where put, but a note just to hand from Berks, says:

Several cases have recently come under my notice of swarms absconding after being apparently successfully hived. What can be done to prevent this? Would you advise giving the swarm part of brood nest, or giving frames of foundation and fixing something, say a piece of queen excluder, over entrance until the combs had been built, as queen would then be unable to leave the hive, and having commenced laying would probably stay afterwards; then excluder could be shifted?

In reply to above, we merely add that a frame of brood will effectually retain swarms from flying off after hiving.

Reminder of “Hints” next week.

YORKS AGRICULTURAL SOCIETY.

BEE AND HONEY SHOW AT HARROWGATE.

We beg to remind intending exhibitors that the general entry for the above Society's Show, at Harrogate, closes on the 12th inst.

Entries at double entry fees will be received up to Saturday, June 19.

Correspondence.

The Editors do not hold themselves responsible for the opinions expressed by correspondents. No notice will be taken of anonymous communications, and correspondents are requested to write on one side of the paper only and give their real names and addresses, not necessarily for publication, but as a guarantee of good faith. Illustrations should be drawn on separate pieces of paper. We do not undertake to return rejected communications.

WEIGHT OF HIVES.

[2914.] Probably many of your readers have weighed hives from day to day, but I do not recollect ever seeing a continuous record in your pages. I do not know if a record will interest your readers as much as it interests me. It seems best to weigh the hive, if possible, at 7 p.m., and again at 5 a.m. The hive loses several ounces during the night, chiefly from evaporation; it goes down more

than half a pound lower when the bees fly out to gather, and does not begin to go up again till nearly noon. The following record of the past week was very roughly taken, but it is interesting as showing what a bad week for bees it was here. The hive is a skep with floor-board, containing a swarm of May 21; the swarm weighed a little under 4 lb. :—

	lb. oz.		lb. oz.
May 24, 7 p.m.	9 3	May 28, 7 p.m.	9 12
" 25, "	9 11	" 29, "	9 12
" 26, "	9 9	" 30, "	11 8
" 27, "	10 2	" 31, "	12 3

—G. D. HAVILAND, *Heathfield, Sussex.*

WILD BEES IN HIVE ROOF.

[2915.] A bee, in colour very similar to our hive bee, but rather smaller, has made its nest in the roof of one of my hives, under the board used to weight down the quilts, where there is a hollow space. The cells, formed of mud or clay, are attached to the board, and are nearly filled with pollen. The egg is then laid and attached to the pollen; and, when hatched, the larvæ appear to live upon the pollen only. This "mother bee," like the queen wasp, does an enormous amount of work. Can you name this bee from description? The cells are of the size of our drone-cells.—WM. LOVEDAY, *Hatfield Heath, Harlow, May 23.*

[The insect referred to is, no doubt, the mason bee, genus *Osmia*. It is one of the solitary bees, and constructs its nest of mud and sand in any suitable crevice or corner it can seek out.—EDS.]

QUEEN CEASING TO LAY.

[2916.] I am induced to seek your opinion in an experience that has befallen me since Thursday last. On that day I had a swarm of bees issue from a hive containing ten frames. I knew it was overcrowded, and I had been expecting the swarm for some days; I saw the queen come out, walk along the alighting board and join the swarm—a large one—the bees readily entering the hive prepared for them. The next day I examined them, found the foundation for the most part drawn out, and cells mostly filled with honey; saw the queen, but could not find a single egg. I then gave them two frames from the parent hive, one full of sealed brood on both sides, one with brood and honey. Opened the hive again to-day (Monday) found the brood frames completely covered with bees; saw queen, but not an egg to be seen! A man who discerns quicker and more certainly than I can could not find a single egg. Is not this unusual? it is to me. Can you kindly offer me any suggestion? In the parent hive, now full of bees, there is a ripe queen-cell (and two or three others), but not hatched out up to to-day,

rather a long time after the swarm, is it not?—FREDK. H. L., *Guildford, June 7.*

[We can only suggest that the queen is taking a few days' rest after entering the new home. This is not at all an unfrequent occurrence. No doubt brood will be found by their appearance in frame. If not, we should suspect some damage to the queen in hiving the swarm.—EDS.]

BEES AND HISTORIC DEVICES.

[2917.] The following extract from Mrs. Bary Palliser's "Historic Devices" may interest your readers. It evidently arises from pollen gathering. It says Caro Annibal (1566) bore as a device, "The bee, which, when far from its hive and assailed by the wind, steadies itself with a pebble which it carries in its claws," and a motto ΠΟΝΩ ΠΟΝΩ ΦΕΡΩ—"I bear by toil." Pliny says, "Bees that are employed in carrying of honie, chuse alwaise to have the wind with them if they can. If haply there do arise a tempest or a storm whiles they bee abroad they catch up some little stonie greet to ballaise and poise themselves against the wind. Some say that they take it and lay it upon their shoulders and with all tucy lie low by the ground under the wind when it is against them and keep along the bushes to break the force thereof."

Virgil in Georgics IV., Dryden's Translation, also employs the simile:—

"And oft with pebbles, like a balanced boat
Poised, through the air on even pinions float."

MALTA.

FOUL BROOD.

SUGGESTION FOR A LINE OF TREATMENT FOR STAMPING OUT BEE-PEST.

[2918.] In the literature on the above that I have read I have not seen any up-to-date scientific stamping-out treatment of the disease mentioned. Certainly disinfectants have been used for years, but if what one reads be true, foul brood becomes much more prevalent; this you will doubtless consider due to a not sufficiently universal and intelligent use of such things; and now the great thing appears to be legislation, and, doubtless, if an Act of the nature suggested is passed and can be thoroughly carried out it will be of the greatest benefit. But I fail to see how all the difficulties in the way are to be overcome. It is like muzzling dogs: while muzzled, of course, they cannot bite, but how about those ownerless curs it is so difficult to get hold of? The same with bees; the better class and more advanced bee-keeper will, for his own benefit, do all that it is desired of an Act of Parliament to do to keep down the pest; but the ignorant and antiquated bee-keeper—more especially the skepticist—will be the great difficulty in the way. Legislation and disinfectants are, of course, of great benefit, no doubt; but if our most scientific and long-headed bee-keepers

would turn their attention for a time to an attempt to confer immunity on bees from foul brood I see no reason why they should not succeed and confer upon bee-keepers in general such a benefit as to make foul brood in a few years' time a thing of the past, and legislation quite unnecessary. This may be looked upon as a chimera, but the time will surely come, and I intend trying some experiments, but personally I do not look for much success, it is a Pasteur, a Koch, or a Behring who is required, and did such an one take the matter up I believe success to be almost certain. I do not wish it to be thought from what I have above written that I do not favour legislation, on the contrary, I should welcome the Act as being a check on the disease while the experiments I have proposed are in progress.—F. L. NICHOLLS, *Cambridge, May 23.*

[Any real light that can be thrown on the subject dealt with above will be welcomed in these pages. But we would remind our correspondent that some eminent scientists in Germany, France, and elsewhere, have already devoted much time and research to the investigation of the foul brood bacilli and its ravages among bees. As an instance of what has been done in this line Mr. Nicholls might read Dr. Lortel's article which appears in our issue of January 8, 1891.—EDS.]

WEATHER REPORT.

WESTBOURNE, SUSSEX, MAY, 1897.

Rainfall, 1.44 in.	Sunless Days, 0.
Heaviest fall, .35 on 29th.	Above Average, 4.2 hours.
Rain fell on 15 days.	Mean Maximum, 61°.
Below average, .33 in.	Mean Minimum, 41.2°.
Maximum Temperature, 73° on 18th.	Mean Temperature, 51.1°.
Minimum Temperature, 28° on 13th.	Below average, 0.8°.
Minimum on Grass, 22° on 13th.	Maximum Barometer, 30.45° on 15th.
Frosty Nights, 2.	Minimum Barometer, 29.27° on 28th.
Sunshine, 258.8 hours.	
Brightest Day, 23rd, 14.5 hours.	

L. B. BIRKETT.

SEASONABLE QUESTIONS.

ANSWERED BY G. M. DOOLITTLE.

INCREASE AND EXTRACTED HONEY.

Question.—Which is the better plan when working an apiary for extracted honey—to make the increase by natural swarming or by division? If by division, when is the best time to do it in latitude about forty-one, white clover being the main plant giving surplus.

Answer.—My favourite mode of increase is by natural swarming; and as a general rule I prefer such increase for the reason that I have

found that colonies made by division lose much more time getting ready for work than do the bees when permitted to follow the natural laws of increase. But there are exceptions to all general rules, and this is one of these exceptions. Should we desire, ever so badly, increase by natural swarming, it would be very little we should get if the colonies were worked to the best advantage for extracted honey. A good yield of extracted honey is obtained only by providing the colony with an extra set, or more, of empty combs, putting the same in upper stories at the beginning of the honey-flow, or as soon as the bees have increased sufficiently to receive them without any detriment to their building up the most quickly. Bees do not swarm until the hive is well populated and honey coming in from the fields; hence if we put on combs as above (and we must to secure the best results in extracted honey), these combs go on before any preparation for swarming has been made. Ernest Root never uttered a truer saying than he made when he said that "plenty of empty combs is the best preventive for swarming," and by fixing our bees as we are obliged to secure the best results, we very nearly, if not quite, prevent all increase of a natural kind.

In all of my experience with the extractor I have never had a single colony cast a swarm before the honey harvest was beginning to wane; and not ten per cent. of the colonies thus worked ever offered to cast a swarm at all. Hence we see, if we wish to increase, it must be done in some way other than natural swarming, or we must sacrifice our honey crop quite largely by not putting on the combs till the colonies have swarmed. Hence we have increase by division, where increase is wished, as the only way when working for extracted honey.

Having decided this question, the next thing which confronts us is, "When is that division to be made?" Very many of our most practical apiarists tell us that, where we make increase by division, this should be done a little before the honey harvest, or at its commencement. The *why* of such advice I have never been able to understand. It is argued that, after the division, you would have two queens laying instead of one; and in this there is great gain. But such reasoning as this is mysterious to me, for the bees which hatch from those eggs laid by the two queens after the division can never become honey-gatherers in the white clover-honey harvest, unless said harvest is much more prolonged than it ever is here; so the bees raised from the eggs of the extra queen will only become consumers, without adding one iota to our crop of honey. Yea, more: instead of adding to the crop of honey it will lessen that crop by just the amount that it will take to feed and nurse the brood and the young bees after hatching, which is a clear loss to us.

Then, again, all admit that one *strong* colony will store far more honey when kept together,

it not having the swarming fever, than the same colony would if divided and placed in two separate hives, thus making two weak colonies of it. Hence, by dividing at the commencement of the honey harvest, or a little before, we have two weak colonies to do the gathering, up to about the time the harvest closes, instead of the one very strong one; while after-results from fall flowers are no better for an increase at this time. Still again: By such division we shall have many combs from half to three-fourths full of honey to extract from during the season or at the end thereof, instead of little, if any more, than half the number of chockful combs which will yield bountifully of honey every time we put them in the extractor. Hence we have very much more work in the extracting arising from this division just before the honey harvest.

For these reasons my plan has been to work the colonies, as above given, till very near, or just at the close of the harvest, when I go to work and make what increase I wish by dividing as many of the colonies as I wish increase.

If any happen to swarm near the close of the honey harvest, or at any time during the latter part of the same, I accept their increase as far as they do so, thus lessening the number desired according to the number which swarm. About ten days before the honey harvest will naturally close, I start queen-cells in upper stories (the colonies thus used for cells should have a queen-excluding honey-board between the stories), according to the plan given in "Scientific Queen-rearing," to the needed number, these queen-cells being built without any detriment to our honey crop, as the old queen is still doing duty below; and when these cells are ripe I proceed to divide the required number of colonies by an equal division of brood, bees, and combs, allowing the old queen to remain on the old stand, and giving the nearly mature cell to the part removed, twenty-four hours after removal, when they will readily accept the same without using any precaution against the bees tearing the cell open, and destroying the young queen.

If queen-excluders are used between the two stories of each colony, as I think it well pays to do, then I like this plan a little better: Four days before I expect to make the division I go to the hive and raise the more nearly mature brood to the upper story; and if I see the queen I leave her below; but I take no special pains to look for her. At the end of the four days I take a look at the combs, and if the queen is in the upper story it will be revealed by there being eggs in the combs. If there are no eggs found I insert a queen-cell, and let the hive stand as it is till near sunset, when I take off the upper story and carry it to where I wish it to stand, and the division is made. If eggs are found I hunt out the queen and let her run in at the entrance below, and at night carry the upper story to a new

stand, giving the cell twenty-four hours later, as I did by the first plan, as the bees, having a queen in this upper story, would be likely to destroy the cell if no precaution is taken. If I do not readily find the queen, where one happens to be in an upper story, I either shake off the bees in front of the entrance to the lower hive, or shake the bees off their combs into the upper hive, smoking the bees down through the queen-excluder, when the queen will be easily found trying to get through the zinc. If I wish to catch the queen I use the latter way; but if I only wish to have her in the lower story, the first is the more quickly accomplished.—*Cleanings.*

HOMES OF THE HONEY-BEE.

THE APIARIES OF OUR READERS.

Our bee-garden picture this week carries us into the county of Bedfordshire, and represents the picturesque home and apiary of Mr. Harry Gardner, at Turvey, Beds. Mr. Gardner—who along with his parents are shown in the view—is rather proud than otherwise to call himself a cottager bee-keeper. Being unmarried he resides with his parents, working away from home from 6 a.m. to 6 p.m., and consequently has none too much time to attend to the bees. Nevertheless—and although not a carpenter—all the hives shown in the picture are the work of his own hands, made during the long winter evenings, and, as will be seen, they make a most creditable show, both for type and general appearance. Standing in front of the cottage window to the right of the porch, is seen a hive of uncommon design, being nothing less than an exact model of the cottage itself. This was one of Mr. Gardner's early efforts in hive-making when he only owned a very few stocks, but its interior is arranged quite on the modern plan, and like all the others is made for working shallow frames for extracting, and also for sections, the nature of his honey trade requiring both comb and extracted. In pursuance of our usual inquiries as to how the *business or profit portion* of the apiary works out we learn from Mr. Gardner that his apiary, though not a large one, is about as much as his limited spare time allows him to manage, besides "the district" he says "is not one of the best for honey gathering, but what is got we have very little trouble in selling retail. The hives stand by the side of the main road close to the station, and we have many callers in summer time, most being buyers, but some, of course, to have a chat 'about the bees.' I can get far more money by working for the extractor, but as we have a pretty good demand for sections, we must supply them."

The exigencies of space compel us to leave what we take to be Mr. Gardner's workshop on the left, but he tells us that the small

greenhouse in centre of picture was built by himself more as an extracting-room than for horticultural purposes, and he finds it answer very well with care in keeping out the bees at certain times. "Though some," he says, "may think such a place would be too hot for the purpose, I don't find it so. I shade the glass in summer and put a good thick coat of colouring and this makes it all right, and the honey extracts freely; then when extracting is over, the honey is moved indoors to a cooler place, and my plants occupy the greenhouse till the following season." Mr. Gardner tells us he makes no pretence to the big average "takes" of honey reported by some readers, who live in better bee-districts than himself,

but," he adds, "many cannot help this." Then, and in order to illustrate his point, he mentions the case of a "brother bee-keeper," located in a beautiful district for honey production, but living in a lone cottage right away from the village, and, in consequence, "not able to retail half a dozen pounds of honey in a year from his home." He goes to the shopkeeper, who drives so hard a bargain as to make the bee-man, in its truest sense, "grin and bear it" as best he may. But it only needs to put on a good "business front," and seek out tradesmen whose customers will pay a proper or fair price for a really good article, and no bee-keeper will consider 5*l.* per lb. a fair price for such fine honey as is stated to



MR. HARRY GARDNER'S APIARY, TURVEY, BEDS.

but he is content with a moderate harvest and to take good seasons along with bad. Starting bee-keeping as he said "when quite a lad with a single skep," he chanced to see a friend's bees in a frame-hive and the beautiful honey taken on the modern plan, he "resolved to go in for it, and has never regretted it."

Our friend also tell us that when asked as to the profits to be made by bee-keeping, he always advises inquirers to "start with one hive, and gain experience before they buy more." "I have often noticed in your pages," he says, "that bee-keepers are blamed for rushing their produce on the market and selling at whatever price they are offered;

be sold at this figure by the bee-keeper referred to. We advise the latter to read the B.J. of March 18 last. p. 105, and take a hint on marketing honey therefrom.

Well, we hope our friend Mr. Gardner will be able to lend *his* friend a helping hand in finding a better market for good honey, wherever it is produced, and wish we could see a way to the realisation of his wish, "that all foreign honey should be compelled to be labelled as such." In conclusion, we congratulate him on his neat bee-garden, and hope that his father and mother, along with himself, may long be spared to enjoy its pretty surroundings.

Queries and Replies.

[1745.] *The Disadvantage of a Warm Location.*—I have been keeping bees for two years now, in a very warm, sheltered garden, walled in on all sides, and facing due south. It is always very hot in this garden, even when a northerly gale is blowing outside, and, in consequence, although bees do well in summer they never winter well. The bees also consume a large amount of stores, and then take early and untimely flights, seemingly never to return. I say this because every colony, though strong in flying bees in February, dwindles away later on to a mere handful, in spite of having plenty of stores. 1. Would it not be better to put them in a cold position, after this summer, where they would feel the real temperature going, and probably would not consume so much stores. 2. I have read that dahlias should not be grown where bees are kept, as the honey is a narcotic; is there any truth in this?

REPLY.—1. There can be little doubt that removal to a colder spot would tend to diminish the mischief complained of. On the other hand, it might be possible to do something in the same direction without doing more than keeping the hives lightly covered in cold weather, *i.e.*, removing as many of the usual quilts or wrappings by which, in ordinary situations, hives are protected from cold. 2. No danger to bees need be feared from dahlias growing near or about them. We would remind our correspondent that name and address should be sent with all communications; not necessarily for publication, but as a guarantee of good faith.

[1746.] *Transferring Swarm to Frame-hive after Twelve Days in Skep.*—A lady purchased a swarm of bees last week in a skep, and has since ordered a frame-hive, which she expects to receive in a few days. I have been asked to put the bees into the new hive for her on Saturday next, when it is expected to arrive. The bees will by that time have occupied the skep for ten or twelve days. Will you, therefore, kindly inform me what is the best way to proceed as, no doubt, there will be a quantity of combs built, also honey stored in them, as the weather has been very favourable since the bees were hived in skep.—T. H. B., *Exeter*.

REPLY.—We trust that no one not thoroughly well up in such operations will attempt so difficult a task as transferring bees, combs, and brood, from a skep—in which a swarm has been hived for twelve days past, to a frame-hive. Only a skilled practitioner could hope to do it successfully and without risk of serious damage. To ask—as our correspondent does—for instructions “how to proceed” is quite wide of the mark, because

only a skilled bee-man could manage it, and an amateur would most probably fail entirely. Our advice to the lady—whose only hive we suppose it to be—is to leave the swarm in the skep, where it will now, no doubt, be doing well, breeding fast, and establishing itself as a good stock, and buy another swarm for stocking the frame-hive with. This will be true economy in the end, avoiding risk of disaster, and if well managed ensuring a second stock for next year's work, in case one should perish in the winter of 1897-8. Besides the skep might easily cover its cost by yielding a rack of sections this year.

[1747.] *Uniting Bees.—Why Virgin Queens lay only Drone Eggs.*—I have two stocks of bees, one weak, the other on six frames. The weak one has a nice queen, purchased last year, which I am anxious to keep. I would like to unite these two stocks, but, unfortunately, I have three other hives standing between the two I propose to join up. I therefore ask (1) can I unite with safety by shutting them up for a day or two? Or, could I shift them back in order to get them close together before uniting? 2. Should I cage the queen? My other three stocks are good, and I am glad to say we have no foul brood here; nor do I hear of any in this locality. 3. I had a nice talk on bee matters with friends this last week, and the question arose, “Why does a virgin queen lay drone eggs only?” As we were unable to answer the question, we left it for you to decide, and a reply in E.J. will oblige one who has been a constant reader for years—J. S., *Oakfield*, June 1.

REPLY.—1. Don't try the “shutting up” plan, but move the hives to be operated on either rearward or forward, as most convenient, so as to allow of them being brought gradually near each other—say a couple of feet on each “flying day.” Then unite in the usual way. As no instructions for uniting are asked for, we presume you understand how to unite bees. 2. Yes, cage the queen if it is desired to preserve for forty-eight hours. 3. First, let us say that in printing this query as above, we have reduced the question to its narrowest limits for the sake of clearness and to simplify the matter. As written by our correspondent it was somewhat confusing. To answer the question briefly and simply, we may say a virgin queen produces drone eggs only because of her never having been fecundated—or fertilised—at all. To go fully into this mystery of bee-life would occupy too much space, and bee-keepers whose interest in the subject leads them to go further should read some such work as *The Honey Bee*. We may, however, add that this wonderful power of reproduction without fecundation in some insects, was known to exist for many years before Dzierzon, some half a century ago, discovered the law of Parthenogenesis, as it is called. And by this law, a virgin queen bee—which is known to be

the only perfect female insect in a normal colony—is, though unmated—possessed of ovaries full of eggs, which eggs, through lack of fertilisation, produces drones only.

[1748.] *Queen "Balled" after Swarming.*—Yesterday morning, June 2, about 10.30, a swarm left one of my hives, and after being on the wing for about twenty minutes, returned to the parent hive again. Suspecting something wrong, I hunted about between the potatoes growing in front of the hive, but could find no queen; at last, however, I noticed a ball of bees on the landing board of the next hive, so I got a feather and gently brushed the ball of bees into a skep and placed them in front of the hive that had swarmed; but the bees left one by one until at last one bee only remained in the skep, which I discovered was a dead queen. I send it on for you to see, and should like to know: 1. if it is an old or a young queen? 2. Also how you account for the bees killing her? Since writing the above, I have, this morning, had three swarms. Two of them came from a "Wells" hive, and as they pitched together I put them into a frame hive, with eight frames. The other swarm I also put in a frame hive all right. These are the first swarms I have had for two years, so that all the queens must be old ones, unless they have re-queened themselves. In the meantime, the weather has been very hot to-day—3rd. I did not see the queens when hiving the swarms, and only three drones with all. In the evening, I put a rack of twenty-one sections on the hive. 3. Did I do right in this?—C. M., *Knightsbridge, Devon, June 3.*

REPLY.—1. The dead queen received is an adult, and we have little doubt the "mother bee" of the hive that swarmed. 2. From some cause the queen has been faulty on the wing and, unable to take her place among the flying bees of the swarm, has managed to make her way back to "the next hive" (mistaking it for her own), the bees of which have at once "balled" and killed her. 3. Yes, seeing that the swarm had returned, giving extra room was the best way of securing the eight or ten days honey gathering before the stock swarms again, as it probably will in that time.

[1749] *Hiving Swarm in "Patent Hive."*—I put a swarm of bees into a patent hive, the combs of which run crosswise or parallel with the entrance, and left the division board at end of frames instead of putting it right back, and, in consequence, the bees clustered behind the division board. On finding this out next day, I raised the division board, smoked the bees, and put a bottle of syrup over frames. After some trouble, I managed to get most of the bees out, but they had in the meantime (three days) built two combs as large as my hand, fixed at the bottom, not on to quilt. 1. What am I to do to get them out? I may say that, finding most of the bees out, I again closed the division board and put two pieces of stick so that they could get into the body of hive

over the top of division board. 2. Will you allow me to point out that it would be an advantage if it was stated in E.J. to what name cheques or postals should be made payable.—W. Y., *Coleford, Glos., June 4.*

REPLY.—We confess to some uncertainty as to what is meant by "leaving division-board at end of frames instead of putting it right back," with the result that "the bees clustered behind the division board." Nor do we know what "a patent hive" is. So far, however, as the two pieces of comb built behind the division board, it only needs to drive off the bees with a puff or two of smoke and cut away the combs from whatever they may be attached to. This done, lay a slip of wood on floor of hive to prevent bees from passing below the division board, and allow the bees remaining on the wrong side thereof to fly off and re-enter the hive by the proper doorway in front. 2. We are glad to have attention drawn to the fact that the notice "How to send Money" has been crowded out of its usual place ever since January 28 last. In future it will appear as in the present issue, *i.e.* on inside page of cover.

[1750.] *Loss of Queen—Distance Queens Fly for Mating.*—I have just examined my only stock of bees and find them queenless. The hive is not over-crowded on ten frames, but pretty full. There are five frames of sealed brood, and on them about a dozen queen-cells, most of them containing larvae. The missing queen was two years old, and I cannot even guess the cause of her disappearance, as I saw her three weeks ago. I think she must have been gone about a week; she was laying fast at that time. The stock had been neglected when I bought it in a skep; all the combs run together. I transferred them to a new hive, and on straight combs. I cannot see any drones or drone-cells. 1. What is best to do; will it be of any use to let queen hatch out, or will it only waste time to do so, as there are no bees kept within two miles of this place? 2. How far do queens go to mate?—T. S. (*a working man*), *Pentyrch, Cardiff, June 7.*

REPLY.—1. Your only course is to allow the bees to complete the rearing of a queen to succeed the lost one. Do nothing at all, therefore, until a queen hatches, and we have little doubt but she will be mated all right if weather is favourable for her marital trip. 2. If bees are kept in a radius of four miles all will go well—as a general rule.

[1751.] *Dealing with Foul Brood.*—I am sending a piece of comb for inspection which I fear is badly diseased. If this is so, nearly every stock I have is affected in the same way. I sent some comb last autumn which you at the time declared to be slightly affected. Since then I have used preventives, also cleaned out nearly every hive and painted the same. I had thirty stocks last autumn, ten or twelve of these have since dwindled down to nothing;

the queens not laying, and the bees dying out. Another eight or ten are now weak, while of the remainder some are apparently strong. I really do not know what to do by them. Kindly say in Thursday's B.J. what is the condition of comb sent, so far as foul brood? It is taken from a hive that I built up last autumn from some driven bees.—A. B. C., *Cornwall*.

REPLY.—We regret to say comb sent is affected with foul brood. The condition of our correspondent's apiary as described above is, indeed, a sad one, and shows the need not only for extreme caution in handling stocks—healthy and otherwise—in the apiary, but for prompt drastic measures where a large number of stocks are concerned, and disease has broken out among them. We should at once get the eight or ten weak lots off their combs, join them up into about two or three strong lots and treat them as swarms in clean hives, putting the combs and frames they are now on out of sight for ever by burning. Take the greatest care in handling the stocks now strong, so as to avoid carrying the disease to them by manipulating diseased hives and healthy ones without thorough disinfection. Only by these and similar precautions can a riddance of the disease be hoped for.

[1752.] *Queen and Queen-cells*.—1. Could you tell me why enclosed queen is so very small, she has been dead some time and the body has contracted, still when the bees killed her she was scarcely larger than an ordinary worker? I put a swarm with queen into a weak stock and the next morning found the bees balling this queen, which, I presume, belonged to the weak stock. I also enclose two queen-cells from another hive, from which I had a swarm on the 25th of last month. 2. Is the white matter in one the remains of a grub killed by young queen? There were four queen-cells altogether, two quite empty, one with remains of grub (?), and one still sealed over. In examining combs I saw a young queen in one corner of a frame, but there was only sealed brood in hive, so she has not yet commenced laying. I conclude as two queen-cells were empty a cast must have left hive after the first swarm. Should I remove sealed queen-cell? I was afraid to do so, in case anything should happen to young queen already hatched. I should be greatly obliged if you could answer this question by post. I enclose stamped envelope.—M. E. B., *Warwick, June 5*.

REPLY.—1. Queen sent is not a large one, but still not abnormally small taking time she has been dead into consideration. 2. The "white matter" referred to is "royal jelly," the young larva having been removed by the bees. One cell sent is the one from which the young queen hatched out, the other was evidently destroyed by the bees. The bees will no doubt have removed the remaining queen-cell ere this.

[1753.] *Deferred Mating of Queen*.—I possess a stock of bees which had apparently existed the whole of last winter without a queen. Discovering this, I inserted a frame comb, containing eggs and brood taken from another stock, on April 21. On the 29th I found the bees were raising a queen, then in an advanced larval state; on the 7th inst. she had hatched out. Examining the hive again on the 19th, there was no sign of any eggs being laid. By the way, I had also given them a frame of drone-brood (on April 30), but found that although they had reared most of this, either they had killed the drones or the latter had deserted the hive, for I could not find one mature insect on the combs when last I looked.

1. Is it too soon to expect the queen to lay, or would the cold and windy weather of this month prevent her mating in the regulation time? 2. Would she mate with a strange drone? 3. Is there a possibility of her being malformed? 4. What has happened to drones they have hatched off? (They have plenty of food.) I do not want to unite the bees to another stock if I can avoid it.—EDWIN A. THARP, *Bedford*.

REPLY.—1. Queen has, no doubt, been delayed in mating by the adverse weather. There is no special regulation time. Queens mate usually from the 5th to 14th day. 2. Most probably with a strange drone. 3. We should think not. 4. We cannot exactly say. Most probably the bees have removed them from the hive, although, if the queen was a virgin, they do not generally do this.

[1754.] *Enlarging Brood-nest of Small Hives*.—Would you kindly advise me as to the following:—I have a hive holding only eight "Standard" frames in body-box, hung at right angles to entrance. These are all fully occupied, and the queen's laying capacity makes more brood-frames desirable. Could I increase the brood chamber temporarily by screwing another hive to the present one, and boring a hole about 1½ in. diameter through the walls of both? I would place in the latter say two or three frames of brood from present body-box, substituting frames of foundation, of course, using one entrance only, and covering the other with perforated zinc for ventilation. Lest my description is not sufficiently clear, I have drawn a plan and sectional elevation of proposed alteration. The addition is shown in dotted lines. As winter approaches the bees could be crowded into first body, and the hole stopped with a plug made to fit tightly. Please say if the plan is feasible?—F. MUNTON.

REPLY.—The plan proposed is of course "feasible," but we cannot say it is advisable. The risk is too great of the brood in second chamber being deserted, and left to die on some cold night through "chill." No; our plan would be to prepare a simple box holding same number of frames (8) as present hive, but

taking the "shallow frame" (14 in. by 5½ in.) instead of the "Standard." We would fit these frames with full sheets of brood foundation, and allow the queen free access to them, where she could display her prolificness to the full in any combs built out and not occupied with honey, as the outer ones would probably be. With any further storage room given above the two chambers in use, a queen excluder would, of course, be used. This would, we think, be a better way of dealing with the trouble.

Bee Shows to Come.

June 23 to 29, at Manchester.—Royal Agricultural Society's Show. Letters relating to Bee Department to be addressed, E. H. Young, Secretary, B. B. K. A., 12, Hanover-square, W.

July 7 and 8, at Hanley, Staffs.—Horticultural Fete. Medals and liberal prizes for honey. Schedules now ready. Apply J. E. Barrow, Town Hall, Hanley.

July 15 and 16 at Sleaford.—In connection with the Lincolnshire Agricultural Society. Bee Department under the management of the Lines, B. K. A. Schedules from R. Godson, Hon. Sec., Tothill, Alford. **Entries Close June 18.**

Shows in connection with the Notts B. K. A. will be held as under:—Hucknall Torkard, July 20. **Entries close July 16.** Southwell, July 22. **Entries close July 5;** and Moorgreen, September 7. **Entries close August 27.**

July 24, at Fallowfield, L. and C. B. K. A.—In connection with the South Manchester Horticultural Society, schedules from F. H. Taylor, Local Hon. Sec., L. and C. B. K. A., Old Hall-lane, Fallowfield. **Entries close July 8.**

July 21, 22, and 23, at Harrogate.—Yorkshire Agricultural Society's Show. Liberal prizes for hives, honey, &c. Schedules to be had from Marshall Stevenson, Secretary, York. **Entries close June 12.**

July 28 at Henbury.—Bristol, Somersetshire, and South Gloucestershire Annual Show. For Schedules apply to Miss Hill Dawes, Long Ashton, near Bristol. **Entries close July 21.**

July 28 and 29, at Chester.—In connection with the Great Horticultural Fete. Bee Department under the management of the Lancashire and Cheshire B. K. A. Medals and liberal prizes for honey, &c. Schedules now ready. Apply to Wm. E. Little, 1, East-gate-row, Chester. **Entries close July 19.**

July 27, 28, 29, at Gloucester.—Gloucester B. K. A., in connection with the Gloucester Agricultural Societies' Show. **Eight Open Classes.** Schedules from Dr. Grosvenor, Hon. Sec. G. B. K. A., Clarence-street; or, Mr. E. J. Burt, Assis. Hon. Sec., Stroud-road, Gloucester. **Entries close July 15.**

August 4, at Neston Park, Wilts.—In connection with the Atworth and District Horticultural Show. Two open classes for single 1-lb. section and single 1-lb jar of extracted honey. Schedules now ready. J. P. Inkpen, Secretary.

August 12, at Goole.—Annual Show of Bees and Honey in connection with the Goole and District Agricultural and Horticultural Society. **Six Open Classes,** with good prizes, including 20s. and 10s. for single 1 lb. jar of honey (entry free in this class). Schedules from J. Luddington and H. S. White, Secretaries, Lindum House, Goole. **Entries close August 7.**

September 8 and 9, at Derby.—Sixteenth Annual Show Derbyshire B. K. A., in connection with the Derbyshire Agricultural Society. Nineteen classes and over fifty prizes for bees, honey, and appliances. Schedules from F. Walker, Hon. Sec. D. B. K. A., Cattle Market, Derby. **Entries close August 31.**

Notices to Correspondents & Inquirers.

All queries forwarded will be attended to, and those only of personal interest will be answered in this column.

H. T. ICEINGHELL (Taunton).—*Dead Queen Cast Out.*—The bee received is a young queen, and, but for the "something unusual"

noticed by yourself "at the hive entrance," we should have deemed it only a surplus queen killed on about May 25, and by some accident only now cast out. As it is, we should examine the combs to see that there is still a young queen in the hive. The one sent has been injured on the underside of the abdomen, but whether this just happened now or on the date when the young princesses would be fighting for supremacy, we cannot, of course, determine. She bears no appearance of having mated.

W. S. & Co. (Kilmarnock).—*Wild Bees.*—To avoid repetition please read reply to "A True Lover of Bees" on page 219 last week.

TOM PIPER (Mannington, Essex).—*Distinguishing Used Queen-cells.*—1. A queen-cell from which a queen has recently hatched out may be readily known by its length and the pointed shape at the opening. Those not used or of previous season's make, are not more than half the length of a recently used one. 2. If the hive had a queen trap attached, and no swarm has attempted to issue, we should say the cell you notice has never been occupied, if now empty. 3. Imprisoned drones will do no harm so long as they have access to the "queen trap."

T. B. (Bexhill-on-Sea).—*Foul Brood and the "Bill" for checking it.*—1. Your experience is unfortunately that of many, who, after doing all they can to rid their apiaries of foul brood, find their efforts wasted through what you term "a dirty neighbour's skeps, with which he still keeps infecting the neighbourhood." We charitably suppose it is the "skeps," and not the neighbour, to whom your adjective applies. But it is, as you say, "enough to make one sick of bee-keeping." Nor need any one wonder that you "so hope the Bill will become law, notwithstanding the Rev. D. I. is against it." For the rest, though it is quite easy to kill a stock of diseased bees with a little burning sulphur, there is no other way of getting rid of the combs but burning. 2. If the smell causes annoyance, light the fire late at night; ten minutes watching it will suffice to effectually destroy all mischievous matter. 3. Let the stocks now strong, go on storing in sections till the honey season is over; then get them off the combs and treat as a swarm. 4. No need to have "twelve hives in photo of your bee-garden." Get in all you can.

TOMLOE (Kettering).—*Suspected Comb.*—There are slight traces of foul brood in both pieces of comb sent. The bulk of the dead brood, however, is "chilled" only, not foul. If full name and address is sent on post-card, we will forward a copy of leaflet issued by the Board of Agriculture, on the disease and its treatment.

J. CUNNINGHAM (Alexandria, N.B.).—*How Foundation Should Hang in Frames.*—All the information we can give on this subject

appears in our issue of April 29 last, pp. 164-166.

J. C. (Barrhill, N.B.).—*Feeding to produce combs be fore honey flow.*—If the bees are sufficiently numerous to occupy the added box of shallow-frames fitted with foundation, they will draw out the latter into comb if fed gently and continuously.

CONISTON (Ambleside).—*Suspected Comb.*—Foul brood is rapidly developing in comb sent.

“BOTTLES” (Cardiff).—*Feeding Bottles.*—1. There is no need for trouble as to these. If you cannot procure the one known as the “Nottingham,” buy an ordinary regulating feeder from some of our advertisers, any of which will answer the purpose. 2. Bee sent is of the ordinary native variety.

R. H. (Oxon).—*Honey from Infected Hives.*—There is not the remotest danger to human beings in using honey from infected hives. As the supered hives are—we suppose—strong in bees, we should defer any action until the main honey season is over. Then, if the conditions are favourable, put the bees on frames fitted with full sheets of foundation, and feed with medicated syrup.

A. N. (Weaverham).—*Suspected Comb.*—Only chilled brood in comb received.

F. P. SMITH (*Queen Cast Out Dead*).—There are no means of accurately arriving at age of dead queen bee. The insect sent (a very fine one) might be only a year old by her appearance. No doubt a successor will be in process of maturing in the hive. Sample of 1897 honey is excellent in colour and consistency, but flavour and aroma are poor.

Special Prepaid Advertisements.

Twelve words, Sixpence; for every additional Three words or under, One Penny.

It being impossible for us to guarantee the *bona fides* of Advertisers, it is advisable—in cases where any doubt exists—that intending purchasers should adopt the system of payment by deposit through this Office. (This caution is inserted in consequence of occasional complaints.)

FOR SALE, strong Stocks BEES, in Bar-frame Hives. WATSON, Langhton, Sussex. P 59

NEW HONEY for SALE. Good quality. H. MAY, Kingston, Tetsworth, Oxon. P 61

FEW SWARMS WANTED. Exchange 3 Blow's “Wells” Hives. DR. WALKER, Kirkby-Stephen.

THREE strong Stocks of BEES on 9 Standard frames each. TURNER, Shepherd Villa, Sowerby Bridge. P 60

NEW ENGLISH HONEY, best quality, in 30-lb. tins, 7d. per lb. Tins free. A. TWINN, Apiary House, Ridgwell, Halstead, Essex. P 65

WANTED, 1-lb. Sections NEW HONEY, finest quality. FELL, Bee-keeper, Finsthwaite, Newby-bridge, Ulverston. P 62

STANDARD HIVE, 16 frames, doubling box, 16, section crate, only 10s.; also sundries cheap. WARD, Crownwell Lodge, Malvern.

SECOND SWARMS with Queen, guaranteed from healthy stocks, ss. 6d.; packing case, 6d. Capped Queen-Cells, 1s. 6d. each. Woods, Normandy, Guildford.

Prepaid Advertisements (Continued)

BROTHER BEE-KEEPERS will find comfortable APARTMENTS at Merridale House, 5, Empire-terrace, Empress Drive, Douglas, I.O.M. Terms on application, Mrs. S. J. HORSLEY.

BRICES RELIABLE QUEENS. Well-known strain. B One quality (the best), one price Mated Tested Queens, 5s. 6d. each; Virgins, 3s. each. Post free in my perfected introducing cage; safe arrival guaranteed. Orders executed in rotation. HENRY W. BRICE, Dale Park-road, Upper Norwood.

WOODRUFF, first-class Spring BEE-PLANT, with delightful perfume, 6d. a dozen and postage; plant now. HOREHOUND, most useful bee-plant; makes an appetising beverage; 6d. dozen plants, also seed. FENNEL, 6d. dozen; a few strong, 1d. each; also seed. Also a few strong plants of RUE, 1d. and 2d. each. SAGE, ditto. WM. LOVEDAY, Hatfield Heath, Harlow, Essex. P 63

SPECIAL SILK BEE VEILS, 9d. post free. ABBOTT BROTHERS, Merchants Quay, Dublin. P 46

SUPERIOR QUEENS, Stocks, Nuclei, and Swarms. Address, Rev. C. BRETTON, Fulborough, Sussex.

GOOD SWARMS of my Superior Bees, 15s. packed. JOHN WALTON, Honey Cott., Weston, Leamington. P 51

HEALTHY PLANTS. Limnanthes 1s. 3d. for 50. Borage 1s. 3d. per 100. Proceeds for prizes. TAYLOR, Old Hall-lane, Fallowfield. P 44

WANTED, NEW SECTIONS, first quality; also Bell-glasses Honeycomb. Packages sent. Good price paid and prompt settlement. R. COLE, Southdown Apiaries, Bexhill, Sussex.

SEND FIFTEEN STAMPS for useful (half pound post free) SAMPLES of FOUNDATION, and compare with what you are using. ABBOTT BROTHERS, Merchants Quay, Dublin. P 47

21 ST YEAR. PURE ENGLISH BEES. Good swarms, 10/6, 12/6, 15/-. Cases 1/, or returned. Tested Queens, 3s. 9d. delivered. Cash with order. ALSFORD, Expert, Blandford.

SPECIAL OFFER. To introduce our new SECTION (fully patented 1896.) and FOUNDATION, we offer to send 24 Sections and Foundation to fit, post free 1s. 6d. ABBOTT BROTHERS, Merchants Quay, Dublin. P 45

TESTED ENGLISH QUEENS, ready in July, 5s. each. In my introducing cage. Bred from stocks selected for gentleness and honey-gathering qualities and under swarming impulse. Postage on telegrams 1s. 6d. at present. W. WOODLEY, Beedon, Newbury.

GARNER'S BEE HIVES and APPLIANCES are the best as well as cheapest. Secretary of Association writes: “I shall certainly recommend what I have seen of yours, they are good value for money.” Steam Factory, Dyke, Bourne. P 54

To Sheffield, Rotherham, and District
Bee-keepers

BAR-FRAME HIVES, STRAW HIVES,

Extractors, Weed Foundation, Sections,

—&c.—

SCREW-CAP HONEY BOTTLES,

16-oz., 12s. 9d. for 10 dozen; 7-oz., 7s. for 6 dozen, can be obtained at

Garnett Brothers, 29, High St., Rotherham.

DON'T GET STUNG,

when by using **APIFUGE** you can easily prevent it.

APIFUGE will also be found extremely useful for travellers in foreign countries where insect pests abound. Bottles 1/- post free.

S. E. CRIMSHAW, Beeston Hill, LEEDS.

Editorial, Notices, &c.

USEFUL HINTS.

(Continued from page 221.)

WEATHER.—The bee-keeper who, under present conditions, could refrain from adding a line to the weather par. of "Hints," wouldn't be a bee-keeper in the true sense of the word; and so we heartily congratulate all readers on the complete change in the bee-prospect since our last issue appeared. Within twenty-four hours of the time of writing as despondingly as we dared, on page 221 last week, the rain and the clouds and all that stopped bee-work and nearly drove bee-men to despair, had vanished, and during every day since bees have worked full time and "overtime." It is quite refreshing to think of the tons of honey that will have been stored since the date referred to.

GIVING SURPLUS ROOM.—Not an hour should now be lost in giving surplus room to all strong stocks still unsuppered, and it will need both skill and forethought on the part of bee-keepers to restrain the swarming impulse likely to arise in consequence of the sudden burst of hot summer weather. If, however, the bees are once "trained," as it were, to the fact that plenty of breeding space and storage room may be "had for the asking," they will go on cheerily labouring in the old home and give no thought to "emigrating." This is especially the case when extracted honey is being worked for and a young queen heads the colony. Regarding what we have referred to above as "training," it consists first, of ensuring to the queen not less than ten standard frames of worker comb in proper condition for brood-rearing, *i.e.*, neither pollen-choked nor occupied with stores; and second, giving room enough—not after queen-cells are started, but a little in advance of requirements—until the tendency to swarm has been overcome or checked. It afterwards needs care in the other direction not to overdo the bees with surplus room, or a lot of frames of empty combs may be left on hand in lieu of full ones at the honey season's end.

PRESERVING COMB-HONEY—A correspondent writing from Ticehurst, Sussex,

on the 9th inst., says: "Could you kindly give a 'useful hint' in next issue on the best method of storing comb-honey? Having a quantity raised in straw supers I would like to know how it can be preserved in liquid condition, and stored away for any length of time." On the general question of preserving honey in liquid condition, either in comb or after extracting, it is impossible to name a time when honey will or will not granulate or become solid. That gathered in some seasons will keep liquid for two or more years—whether in comb or jars—if kept in a warm, dry, cupboard. On the other hand, there are seasons when all the honey gathered granulates rapidly, and when it is next to impossible to prevent its becoming solid. We can, therefore, offer no further hint for storing comb-honey than keeping it at a temperature as near to 70 deg. Fahr. as may be, and to let sections stand the same way up as when on the hives.

Regarding the special lot of comb-honey raised from straw supers, our correspondent must keep it in as warm a place as possible, and make a periodical inspection of combs to ascertain when signs of granulation appear; then use or extract without delay.

TO CORRESPONDENTS.—A line or two of this column may be usefully occupied in making clear to correspondents certain particulars which they ought to take notice of when writing, and also the exact time after which queries cannot possibly be answered in current week. On the first point, letters should be properly addressed, *i.e.*, Editorial matter to "Editors" and business matters to "Manager;" in both cases adding the words "BEE JOURNAL" to the usual address. Letters addressed simply, Office, 17, King William-street, cause us no end of trouble and delay, and often reach us with those words only on envelope. Then we get letters intended for B.J. addressed as directed for our monthly, the *Record*, making it impossible for us to tell which paper the answer is expected to appear in. We must also lay stress on the need for crossing postals and cheques sent in payment. Letters containing open postals or postage stamps are liable to be lost in post, and we have no means of tracing them. Some mishaps of this kind are giving us trouble just now.

On the second point, viz., dates. It must be borne in mind that this journal is prepared for press on Tuesday night in each week, and printed on Wednesday a.m., in time for delivery to wholesale agents and for posting to subscribers the same afternoon. It thus becomes obvious that letters reaching us after the Tuesday morning delivery are too late for dealing with in current week's issue. Finally, and to show the need for these few lines, the particular letter which caused them was addressed to the editor of *Record* instead of B.J., posted in Leicester at 8.30 on Wednesday night, with a request for a reply in Thursday's BEE JOURNAL!

BERKSHIRE B.K.A.

SHOW AT READING.

The recent Exhibition of Honey and Bee-keeping Appliances held in connection with the Royal Counties' Agricultural Society's meeting at Reading on June 4 to 8, may be chronicled as the most successful ever held under the auspices of that important and growing Society. The exhibition was under the joint management of the Berkshire and British Bee-keepers' Associations, and undoubtedly proved to be the prettiest of the kind we have seen for some considerable time. A total of one hundred and sixty-six entries were received, and, although one or two of the classes for new honey were not well represented, the exhibits in other departments sufficed to fill the shed placed at disposal for the purpose. A capital display of appliances sent by several well-known manufacturers was ranged on a table running the length of the building, and met with considerable attention from visiting bee-keepers. From end to end, down the centre of the shed, and at the two ends, were staged the numerous exhibits of honey, wax, mead, &c., and these, tastefully ornamented with plants and vases of cut flowers, gave a pleasing and most imposing effect to the show, whilst near to the frontage line, on a dwarf stage, were shown the various hives in competition for prizes. The lecture tent, placed near by, was crowded with attentive listeners on each and every occasion upon which demonstrations were given therein by the expert, Mr. R. Green. It is unnecessary to specially comment upon the various exhibits, except to say they did credit to those who staged them.

Nearly twenty-five thousand persons paid for admission to the show yard on Monday, June 7, on the afternoon of which day Prince Christian, accompanied by Princess Victoria, visited the show, and, after witnessing the parade of horses in the ring, specially honoured

the bee department with a visit. After an introduction to the Secretaries and Committee the Princess graciously accepted a basket containing some of the prize honey, presented on behalf of the Associations concerned, by Miss Egginton, and the Royal party then inspected the exhibits, making a tour of the building, asking numerous questions in regard to the use of the novel appliances, &c. The Prince stated that he was glad to know that the pursuit of bee-keeping was extending among cottagers, whom he thought were likely to largely benefit thereby. Both Princess Christian and himself were sorry to learn of the disease so prevalent amongst bees in the country, and trusted that the efforts now being made by bee-keepers to secure legislation in respect to foul brood would be successful, and in order to aid in this matter they had gladly added their signatures to the form recently submitted them, approving of the principles of the measure to be introduced to Parliament.

The Rev. R. Errington and Messrs. J. M. Hooker and T. I. Weston officiated as judges. The following being their awards:—

Collection of Hives and Appliances.—1st, J. S. Greenhill, Wimbledon; 2nd, T. A. Flood, Reading; v.h.c., Lanaway & Sons, Redhill.

Observatory Hive.—1st, J. S. Greenhill.

Frame Hive.—1st, James Lee & Sons, High Holborn; 2nd, J. S. Greenhill; h.c. and c., Lanaway & Sons; c., C. Redshaw, South Wigton.

Frame Hives for Cottagers' Use.—1st, J. S. Greenhill; 2nd and c., C. Redshaw; h.c., J. Lee & Son.

Twelve Sections of 1896 Honey.—No award.

Three Shallow-frames of 1897 Honey (open).—1st, W. W. Davies, Calcot, Reading; 2nd, G. Wells, Aylesford.

Twelve 1-lb. Jars Granulated Honey, any Year (open).—1st, W. Woodley, Beeton, Newbury; 2nd, H. O. Smith, Louth; 3rd, R. Brown, Somersham.

Twelve 1-lb. Jars Extracted Honey of 1897 (open).—1st, H. W. Seymour, Henley-on-Thames; 2nd, E. C. R. White; 3rd, W. W. Davies.

Twelve 1-lb. Jars Liquid Extracted Honey Gathered Prior to 1897 (open).—1st, H. W. Seymour; 2nd, J. Sopp, Crowmarsh; 3rd and c., W. Loveday; h.c., W. Woodley.

Display of Honey in any Form (open).—1st, W. Woodley; 2nd, A. D. Woodley; 3rd, J. Butler.

Display of Extracted Honey, Liquid or Granulated, any Year (open).—1st, H. W. Seymour.

Bees-wax (open).—1st, R. Brown; 2nd, E. C. R. White; 3rd, W. Loveday.

Useful Invention Connected with Bee-keeping (open).—1st, W. Drew.

Honey in Applied Form, Except Mead and Vinegar (open).—1st, Darvill, Vincent & Co.

Mead (open).—1st and 2nd, H. W. Seymour; 3rd, W. Woodley.

Honey Vinegar (open).—1st, R. Hamlyn-Harris; 2nd, H. W. Seymour.

Educational Exhibit Connected with Bee-keeping (open).—1st, H. W. Seymour; 2nd, Dr. Percy Sharp; 3rd, H. Attfield.

Twelve 1-lb. Sections, any Year (local).—1st, W. Woodley; 2nd, W. Canning; 3rd, J. Sopp.

Six 1-lb. Sections, any Year (local).—1st, W. Canning; 2nd, W. Woodley; 3rd, G. Head.

Twelve 1-lb. Jars Extracted Honey (local).—1st, A. S. Pursey; 2nd, H. W. Seymour; 3rd, M. Shackelford.

Twelve 1-lb. Jars Extracted Honey, any Year (local).—1st, J. Sopp; 2nd, J. W. Painter; 3rd, W. Woodley; h.c., H. W. Seymour.

Six 1-lb. Jars Honey, any Year (local).—1st, J. Sopp; 2nd, H. W. Seymour; 3rd, G. Head.

Six 1-lb. Jars Extracted Honey (local).—1st, H. W. Seymour; 2nd, W. W. Davies; 3rd, M. Shackelford.

Design in Honeycomb (local).—2nd, J. Henderson.

Display of Honey by Agents of B.B.K.A.—1st, F. Paxman, Reading Dairy Company.

Beeswax (local).—1st, A. W. Canning; 2nd, H. W. Seymour; 3rd, G. Head.

Home-made Amateur Hive (local).—1st, A. E. Fry; 2nd, A. Camden.

WORCESTERSHIRE B.K.A.

The annual meeting of this association was held at the Guildhall on the 22nd ult. Mr. C. H. Haynes presided, and the attendance included—the Rev. E. Davenport (assistant secretary), Messrs. A. R. Moreton, T. Smith, L. Higley, A. Thorpe, T. Betts (treasurer), Joseph Davies, A. W. Rollins, J. Jevons, C. Jelfs, T. Carter, A. Moore, Bagster, &c. Apologies for absence were received from the President (the Earl of Coventry) and several of the more prominent members.

The Rev. E. Davenport read the annual report which, among other matters, stated that on account of the unfavourable season it was not deemed wise to hold a public show on a large scale in 1896, and the committee decided to hold a small exhibition, which proved creditable. It was to be regretted that the dreadful bee pest (foul brood) had been and was still so rife in the county. Last year a few stocks were destroyed, but in the early spring of this year it made its appearance in some few places in strong force. In one district upwards of thirty stocks had to be destroyed, and it might be that others would share the same fate. During the year the work had been carried on vigorously, and the bee tent had been kept busy at various shows. Lectures were also given at twelve different centres during the winter. It was intended to hold the annual show in the coming August at Fernhill Heath, in connection with the Ombersley and District Flower Show.

Numerically and financially the association was in a satisfactory condition. Thirty new members had been enrolled, and the membership now was 140.

The report and balance sheet were adopted.

The Earl of Coventry was re-elected president, and the vice-presidents were also re-elected. Mr. Betts was re-elected hon. treas., and Mr. C. H. Haynes hon. sec.

The Rev. E. Davenport was elected to the office of expert and assistant secretary.

The committee was re-elected, Mr. Alfred Baldwin, M.P., and Mr. F. W. Jones being appointed representatives of the Worcestershire C.C.

The following resolution was then put to the meeting and carried *nem. con.*: "That in view of the fearful ravages caused by the rapid spread of foul brood in the county, this meeting desires to urge upon the Council of the B.B.K.A. the importance of securing legislative sanction for the compulsory destruction of infected hives, accompanied by suitable compensation for the loss of such stocks."

Votes of thanks to the Worcestershire C.C. and to the Chairman concluded the meeting.

HONEY IMPORTS.

An account showing the value of honey imported into the United Kingdom during the month of May, 1897, £1,706.—*From a return furnished to the BRITISH BEE JOURNAL, by the Statistical Office, H.M. Customs.*

Correspondence.

The Editors do not hold themselves responsible for the opinions expressed by correspondents: No notice will be taken of anonymous communications, and correspondents are requested to write on one side of the paper only and give their real names and addresses, not necessarily for publication, but as a guarantee of good faith. Illustrations should be drawn on separate pieces of paper. We do not undertake to return rejected communications.

APICULTURAL NOTES.

RENEWING COMBS.—A BRIGHT OUTLOOK FOR HONEY.

[2919.] The wet season, which lasted throughout the whole of the autumn and winter, has been followed by one of the coldest springs that I can remember. For upwards of two months bitter cold winds prevailed, no matter from what quarter it came. Sometimes the sun in the middle of the day would tempt the bees out, but the wind was so cold and strong that many of the wanderers never returned. It was a pitiable sight to see the ground covered with dead bees heavily laden with pollen for yards round the hives. This was a considerable check on increase, and stocks with me had to be fed right up to June. In addition to the cold weather we were without rain for upwards of a month; vegetation was in

consequence at a standstill. Failure seemed to be already stamped on the grass crop, while the young plants of the root crop were being devoured by fly. The bees also made no headway, so that the outlook here a month ago was very gloomy indeed. Our hopes, however, were buoyed up with the recollection that our best honey seasons have always been preceded by cold, unfavourable springs. About three weeks ago the much-needed rain came, and there is now unmistakable signs of abundant crops of all kinds. Just sufficient honey has been coming in to keep the bees breeding, but no surplus appeared. Supers put on a fortnight ago were still unoccupied, the bees preferring to remain thickly clustered in the brood chamber. The weather, also, was too cold to admit of much being done in the way of brood-spreading, but by the judicious use of foundation, weak stocks were kept going. In early spring, all old and objectionable combs were removed and melted down into wax. For several years I have used a wax extractor, and I often doubted whether old combs were worth the trouble of melting down, producing as they did such a small quantity of wax; but this year I determined to give the matter a fair trial. I put twenty-two combs into a very coarse sack, placed the same in a copper with a baking tin turned bottom upwards at the bottom of copper to keep sack from burning. I weighted sack down to keep it under water, and boiled for *six hours*. The result was 3 lb. of wax. I have always been opposed to using old combs, and I have now resolved never to use a comb a second time under any pretence whatever; that is to say, when combs are once removed from a hive they will be melted down, and not saved for future use. I believe this to be one of the best means of keeping the bees healthy, while the rapidity with which stocks are built up by means of foundation well repays the trouble and cost of converting combs into foundation.

About a week ago it looked as though we had entered upon a regular wet season—an incessant downpour for the best part of two days and nights terribly damping our spirits. But all at once the sky cleared and lovely summer weather has now set in; the last three days have been simply perfection for the bees and bee work—warm moonlight nights and bright sunny days. The result is that bees have come on in a most marvellous manner. Stocks that a short time ago looked as though they would not be ready for supering before July, are now boiling over with bees. A few weeks ago my store room contained about 300 standard frames fitted up with foundation most of which are now built out and are filled with honey and brood. In several cases supers have been taken possession of in less than twelve hours from the time of putting on. My Brampton Apiary is surrounded with clover fields on all sides, which

are one mass of blossom. The wind is now in the quarter most favourable for honey production, viz., S.E., and if this glorious weather will continue a few weeks we shall have cause to congratulate ourselves on a good honey season; but all depends now on the weather for the next month.

I am glad that my last "Notes" were the means of bringing about a discussion on the Foul Brood question. That a measure which would affect thousands of persons should be allowed to become law without being fully and freely discussed by those concerned seemed to me a most serious matter, and my main reason for writing what I did was for the purpose of raising a discussion. If the discussion which followed has been in any way detrimental to the interest of bee-keepers, it is myself and not Dr. Bartrum that is to blame. I have read with regret remarks made by several of your correspondents which were in my opinion entirely uncalled for. It does not follow that because one is opposed to legislation he is necessarily opposed to the stamping out of Foul Brood. I am personally acquainted with a large number of bee-keepers who strongly object to any outside interference, but at the same time they would do the utmost that lays in their power to rid the country of the pest of Foul Brood. A representative meeting of Hunts. bee-keepers, held the other week, was pretty equally divided in the matter of legislative interference. But there is no disapproval so far of the principle of the proposed Bill, it is to some of the details to which some object. For the rest, those present would spare neither time nor money for the purpose of stamping out Foul Brood.

If a measure can be framed which would secure the hearty co-operation of all concerned the Foul Brood pest might be reduced, perhaps, to a minimum. But, for myself, I have no faith in it ever being effectually out.—A. SHARP, *The Apiary, Brampton.*

WEIGHT OF HIVES.

[2920.]—The weight of the skep recorded in 2,914 (page 221) has since been as follows:—

	lb.	oz.
June 1, 7 p.m.	12	6
" 2, "	12	5
" 3, "	13	6
" 4, "	14	1
" 5, "	15	12
" 6, "	16	9
" 7, "	16	13
" 8, "	16	3
" 9, "	16	15
" 10, "	16	12
" 11, "	18	8
" 12, "	19	13

You will understand, Messrs. Editors, that these figures are not the only ones taken. The whole of them would scarcely interest your readers, but they enable me to make certain

explanations which are not apparent from those here given.

The greater part of the fall recorded on the 8th took place at night, or, rather, early morning. The day was quite dry and flowers were out in great abundance, but there was a cold north-east wind and scarcely any sun. The thermometer scarcely reached 57 deg. F. all day. Bees were busily bringing in pollen, their pollen-baskets being much more heavily loaded than on a good honey-producing day; so heavily loaded that the balls of pollen frequently tumbled off at the entrance of the hive, and about a dozen could have been picked up from the ground. During the whole day not half-a-pound of bees were ever absent from the hive at one time.

The whole rise of weight on the 9th was due to the skep getting wet during the night. Two other skeps also got wet owing to the partial displacement of their coverings. Each of the three skeps went up a pound in weight in consequence.

The time of day at which the bees go out in great numbers seems to depend almost entirely on the temperature.—G. D. HAVILAND, *Heathfield, Sussex, June 12.*

NOTES FROM THE WEST.

[2921.] During last autumn I gave you particulars of an experiment then being tried, consisting of several lots of driven bees, each lot put on three frames, hived together in a long hive, divided only by a "Wells" dummy board, and said I would let you know result in the spring. For various reasons I could not write you earlier, but am glad to say it proved a complete success. It was simply a make-shift hive, 5 ft. in length, and there were eight lots hived in it, with a piece of excluder zinc immediately above frames; above this, at a $\frac{3}{4}$ distance, was a crown board running the whole length of hive, and over all plenty of packing. The eight lots came through the winter well, and, by being able to get from one section to another, all had plenty of food. In April, I made up eight stocks by placing one frame of brood and queen from, say, lot No. 1, into new hive and with it all the bees which had not begun to fly of lots 1 and 2. This formed a three-frame nucleus which, with careful nursing, has made a good stock. From between lots Nos. 1 and 2, I then removed division board, put in empty comb to fill up vacancy made by removing the comb of brood, and allowed queen of No. 2 the run of the six frames. Nos. 3 and 4, 5 and 6, 7 and 8, were all treated similarly, the four six-frame lots left in long hive were eventually removed into hives proper, and gradually moved into permanent position, and the total result is, I have to-day eight stocks of bees all supered and headed by 1896 queens, each having at least ten standard frames in body box for brood nest.

Yesterday (Whit Monday) I removed a rack of beautifully finished sections from a hive belonging to Rev. G. Jarman, of Knowle, and, to accommodate the large quantity of bees, put on two racks of empty ones. After seeing to and cleaning the sections removed, went back to hive to see how things were proceeding, and to cover up, when, to my surprise, both crates of sections were completely packed with bees. To-day I just had another peep at them, and found sections in top crate nearly half worked out. I reckon in about fourteen days (weather permitting) those two crates can also be replaced with others.

The beautiful rains we have had during the last fortnight have greatly improved matters, and honey is now coming in more freely, even though the white clover is not yet in bloom.

Brood Spreading.—Several of your correspondents have been giving expression to their ideas and experience on this question, but personally my own opinion, which is based on several years' experience and all sorts of experiments, is that this is an exceedingly dangerous practice, especially in the hands of novices, and one calculated to bring about chilled brood, and, in consequence, occasionally even foul brood. The very best way to have strong stocks in the early spring is—to use the words of another—do your spring feeding in the autumn, and, so sure as there are plenty of bees and stores, with young queen, in hive to pack down for winter, so sure that, without any interference whatever—save once, to see if queen is safe—a strong, healthy stock will be the result in spring.—AMATEUR, *Totterdown, Bristol.*

[We have omitted a paragraph in our correspondent's "Notes," having reference to foreign queens, because of his having—inadvertently, no doubt—omitted sending his name and address, and our consequent inability to make any investigation as to the "postcard in German" which is stated to have been sent to this office.—EDS.]

DEALING WITH FOUL BROOD.

[2922.]—I have to-night sent you, under separate cover, a sample of comb, for your opinion as to whether it is affected with foul brood. I should be glad if you would "wire" your views (and enclose stamps and a "form"), because if it is I will put them on clean foundation in a fresh hive to-morrow afternoon. The piece of comb sent is taken from a stock covering eight or nine frames, and was the back comb but one. The two back ones seemed slightly affected, but I could see no trace in the others. I had this stock down from my other apiary near thirty miles away a month back, and think the bees were perfectly healthy then, but should like your opinion on that point—i.e., whether there is disease of old standing—because, if this is so, I must watch

the others up there. I hope I shall be successful in stopping it, having only started bee-keeping last year with one stock (this same), and have now eighteen, which I do not want to lose if I can help it. Unfortunately, I hear that foul brood is very prevalent in this neighbourhood.—ANXIOUS, *Cheltenham*.

[Our reply by wire was:—"Disease only now developing. Act as proposed." At such a favourable time as this for getting bees off diseased combs and treating them as a swarm in a clean hive, that course is, no doubt, far preferable to any "treatment."—Eds.]

DISINFECTING FRAMES.

[2923.] I have doubled up my hives, and put some on clean foundation, &c., as you suggested, but I have not burned the combs as yet, and seeing that I have a large wax extractor, I am induced to ask if you think it would be harmful or unwise if I extract or put them all through the wax extractor instead of burning; then put the frames in a large pan of boiling water mixed with carbolic acid and boil well? There is also a considerable quantity of honey in some frames. If it would not bring danger in putting them through the wax extractor they would make a lot of wax, as I have a hundred frames or more.

My apiary is looking now as if a cyclone or something of that sort had passed over it; instead of the hives being in rows as they used to be, the empty ones are moved away on one side, out of the way, with the entrances stopped up, which makes it look a melancholy sight indeed.—A. B. C., *Cornwall, June 11*.

[So long as the wax is not used for bee-keeping purposes there need be no hesitation in doing as is proposed. The same may be said of the honey in combs; in fact we would not use the wax extractor at all with such combs as contain honey, but slice the latter up into an earthenware jar and place in a pan of water heated sufficiently to melt the wax. Let the water completely surround the jar by raising the latter from pan bottom. After all is melted remove from fire, and when cold the cake of wax can be lifted off in a lump. So far as disinfecting frames, if they are covered entirely with water and boiled for not less than thirty or forty minutes in water to which carbolic acid is added they will be safe for using again.—Eds.]

TOWN AND COUNTRY NOTES.

SWARMING VAGARIES OF '97.

The extraordinary way in which bees show their interest in the post-office this year is remarkable, as the following cases reported in the daily press will show:—

Eynsford, Kent.—On Friday, May 21, a heavy swarm of bees took possession of a capacious letter-box which is fixed in a road-way close under the Maxim rifle range and

butts, about a mile from Eynsford station. The box is built with sloping roof, and is so much the make and size of a beehive that the bees probably were led to enter under a false impression. They doubtless looked on the slot for the letters as made expressly for their entrance. The postman on Saturday morning found himself forestalled. The process of eviction followed in the evening.

Chaffcombe, Somerset.—The unusual event has occurred of a swarm of bees taking up their habitation in a postal letter-box. The swarm was removed by a bee-keeper to more comfortable quarters on Monday, May 29. Fortunately the box is not cleared on Sundays, otherwise the postman entrusted with the work might have had an uncomfortable experience.

Felbrigg, Norfolk.—The inhabitants of Felbrigg were thrown into a state of mild excitement on Monday morning, June 7, by two flights of bees from different cottagers settling in the letter-box which stands upon Felbrigg Green. The would-be "posters" had to acknowledge the supremacy of the usurpers, and go elsewhere, the aperture provided for their missives being effectually blockaded by battalions of bees. The help of the rural postman was invoked, and he was converted for the nonce into a bee-master, armed *cap-à-pie*. When the box was opened it was found to be nearly full of bees. The orthodox white sheet and skep, with its sweet-smelling condiments, was first tried; but the bees stuck tenaciously to the box, and resisted all overtures. Coercion was then attempted, the bees being forcibly swept from their strange tenement. Many of them resisted these attentions, and swarmed back again; and it was not until sulphuric fumes were resorted to that they were eventually dislodged from the home of their choice.

High Wycombe, Berks.—A correspondent dating from Maidenhead, says:—"A friend of mine, while walking in the streets of High Wycombe on Sunday, the 6th inst., at eleven a.m., noticed a swarm of bees, which eventually alighted on a lamp-post, in the Market Place in the High-street. After hanging there for some time they were taken successfully in a box. Being in the heart of a thickly-populated town like High Wycombe, the swarm was seen by a great number of people during the course of the day."

In the London *Daily Telegraph*, the other day, there appeared the following account of what was called "A Curious Find":—"In a truck of hay, consigned to a firm of salesmen at Nine Elms, was found a swarm of bees, which had clustered in the trusses whilst loading at Fullerton Station. The stationmaster telegraphed to Nine Elms, on the South-Western Railway, cautioning the porters to

be careful in handling the hay, and none of the officials appeared anxious to undertake the task of unloading. Some time ago the same firm found a hen and two eggs underneath a sheet covering a truck of straw, and once a live snake from Hampshire in a load of hay, but a swarm of bees is altogether a new experience in their trade."

Another correspondent says:—"I have been struck this season by the persistent way in which recent swarms have refused to stay in the hives after swarming. In one case a swarm was put into the hiving skep three times, and only stayed a few minutes before the bees came out again. Eventually they were got into the frame hive, only to desert it next morning, and they were at last induced to stop in their new home by giving them a frame of brood from the parent hive."

BEE SWARM IN A CHURCH.—A strange incident happened on Sunday morning, the 13th inst., in the old church of Felmersham, Bedfordshire. During the service a swarm of bees appeared inside the building, to the alarm of the congregation, many of whom beat a hasty retreat. One person was severely stung, and several had narrow escapes. The vicar had the tact to use an abbreviated form of service and dispensed with the sermon, the congregation then leaving church with all decent despatch.

Queries and Replies.

[1755.] *Swarms and Undesired Increase.*—I have taken your excellent BEE JOURNAL in for about twelve months, and follow very closely the editorial advice it contains. I started bee-keeping ten years ago, with one hive; but when I had got two, and was nicely getting into the way of managing bees, I was compelled to give them up, my work having failed me in the part of the country in which I then dwelt. However, I have now got back into the country—a grand district—and have recommenced with the hobby. I have four hives, and do not want any swarms this year. If they do come off, what would be the best thing to do? Return them? Or, better still, can I prevent them swarming? An answer to these queries will oblige.—H. J.

REPLY.—Without saying positively that swarming can be prevented, much can be done to attain that end, if desired, by giving timely surplus room (in advance of requirements), with plenty of ventilation and shade from hot sun. It is also easier to prevent swarming in hives worked for extracted honey than where sections are worked for. If swarms do come off, cut out queen-cells and return swarm; but before returning, add an extra surplus chamber next to brood nest, in order to give the swarm some comb-building to do. This

tends to satisfy the bent of their natural inclination after swarming, and lessens the chance of their starting queen-cells anew.

[1756.] *Removing Bees from House Roof.*—*Age of Queens.*—1. A friend of mine has a colony of bees under the tiles of the roof of his house, and wants to know how to get them out while saving the bees, if possible. Can you say how it is to be done? They have been there some years now, and he would rather have them in a hive, if they can be got into one. 2. Is there any way of telling the age of a queen bee? The one in my hive seems thicker in the body now than she was last September, when the bees were given me; but I have no idea as to the age of queen, so I should be glad if you can tell me?—E. P. C., *Evercreech, Bath.*

REPLY.—1. We never feel safe in telling a beginner how bees may be removed from a hive roof. There are so many risks of inexperienced hands "making a mess" of the job that it is most desirable to enlist the help of a bee-keeper who knows how to subdue the bees effectually, while the operation of cutting out the combs and brood goes on. There is also the risk of damage to brood in combs, or loss of queen, and a dozen other things that makes us first ask: can no help of the kind be got? If it can we will supply any information in our power in order to facilitate the work. 2. Queens are usually judged as to age by such signs as jagged wings and the lack of pubescence or "hairyness" on the abdomen; also by the general look of what we might call "wornoutness" which usually accompanies old age. More than this no one can say by way of guiding beginners in "guessing," for that is all it amounts to in their case.

[1757.] *Dealing with Foul Brood.*—You may remember by my previous letters, that I have, during the four years that I have kept bees, had to continually fight against foul brood, losing one or two stocks each year. This has occurred, despite all the knowledge I could gain through studying Cheshire, Cowan, and other authors, and not begrudging any expense in supplying the bees with medicated candy and Syrup, &c. In the latter end of February I had seven stocks of my own saving, and two stocks purchased: when I examined them then two looked weakly, and were promptly destroyed; the others, however, seemed to have a quantity of brood, and I thought were going on fairly well, but to my great disappointment on examining them again last week found the seven stocks so badly diseased that I have had them all destroyed, with frames, combs, &c., leaving only the two purchased ones. One of these is looking well and shows no sign of disease; the other I am afraid is affected. Now, sirs, I love the bees so much that I am still going to keep them, and shall purchase some swarms forthwith; I fear, however, that I must go away from my present

neighbourhood, as I am afraid there are but few bee-keepers within some miles whose stocks have not got the disease more or less. Will you advise me what is the best to do? 1. Is there any necessity to destroy my hives? I can boil them out, having a furnace that will take two or three at once. 2. Do you think gas-water from the gas-holders, which is very full of ammonia, &c., would act instead of carbolic to disinfect them, or had I better destroy the lot, stock, lock and barrel, and begin with new hives? 3. Another thing I should be glad of your advice upon. My garden is right against a river, and only two or three feet above the water-level. Should you think the ground would become contaminated after having bees on it for four years? and in which case do you think it would be better to keep them further off from the river, say 70 or 100 ft., and high up? This I can do if it is likely to be an improvement.—S. H., *Devon*.

REPLY.—1. If the hives are thoroughly disinfected there is no need for destroying them. 2. We should not use water from gas-holders, for washing the hives, but scrub them well with hot water, to which a good quantity of common washing soda has been added. Then boil the hives for a good while, say twenty or thirty minutes. 3. If new ground 100 ft. away is available, we should certainly change the location of the hives. Don't move the stock suspected of being diseased to the new location, and if there are just grounds for believing it to be affected we should get the bees off their present combs and treat them as a swarm in a clean hive.

[1758.] *Removing Skeps from Frame-hive*.—Three weeks ago I placed a strong skep of bees on top of frame hive, with six full sheets of foundation. The combs on skep were very black, and I wish to do away with the skep entirely. Please tell me if it would be safe to remove skep at expiration of four weeks? The hive seems very strong, and a large number of drones flying about entrance.—BLANCHETTE, *Hounslow*.

REPLY.—So far as removal, it is less a matter of "weeks" so much as the bees having taken possession of the lower hive for their brood chamber, and all brood being hatched out of combs in skep. Once the brood is safely out of the old combs, the skep may be taken away at once and the bees have a new chamber given them for storing surplus honey in. Or they may store in the skep, to be extracted later if preferred.

[1759.] *How Bees Gather Pollen*.—Please explain how the bee gathers pollen and by what means it gets it transferred to the pollen baskets on hind legs. Though I have watched often I have never been able to detect the bee in the act of attaching the pollen to its hind legs, nor have I seen any literature on the subject.—NATURALIST, *Tarbolton, Ayrshire*.

REPLY.—The process of pollen gathering, and the various and complex mechanical contrivances by means of which the bee is enabled

to collect pollen, *i.e.*, the fertilising dust of flowers, are only fully described in such large and comprehensive works as the late Mr. Cheshire's "Bees and Bee Keeping" (2 vols.). We may, however, say here in a few simple words that the pollen is brushed or combed—from the hairs which cover the bee's body by the insect itself—into the receptacle known as the pollen baskets. These "baskets" are simply hollows formed in the second large joint of each hind leg. The outer edge of the joint is also fringed with stiff incurved hairs bending towards each other so as to give rise to the name pollen basket. A safe receptacle is thus formed in which the pellets of pollen are carried home to the hive after being kneaded afterwards into a stiff paste by the bee's hind feet, to be deftly transferred into the cells of the comb by the carrier bee which gathers the load.

[1760.] *Working for Surplus and Transferring Bees*.—I should be gratified for your advice as to the best method of dealing with the stocks of a neighbour, the chief object being to obtain a good quantity of surplus honey, if possible, and the next, to get the bees into proper hives. The stocks are six in number—four in skeps (very ancient ones), and two in boxes (one being a large seed box, the other of reasonable size). Two "W.B.C." hives have been bought, and two skeps were placed on these a few weeks ago, so that the bees should work down upon the frames in the body box. The bees have begun to work below, and will soon be ready for driving out of the skep. 1. It will be right, I presume, to do this; put on excluder zinc, replace the skeps, and remove them after twenty-one days? 2. How would it be possible to strengthen these two stocks, so as to ensure their giving surplus honey this summer? Would it do to bring two of the other boxes or skeps alongside, and then remove them on a fine day, and so give the bees which are out at work to the stocks in the "W.B.C." hives? 3. One or two additional frame hives might be procured; if so, what would be the best plan of dealing with the remaining stocks in the skeps and boxes? It would not matter if the number of stocks were reduced, provided that several strong stocks could be made up, and honey secured.—BEEBEE, *Chester*.

REPLY.—1. Yes; or earlier if brood has all hatched out of combs in skeps. 2. You could secure additional foraging bees in the way described without risk if honey was coming in at the time. 3. No plan is more easily worked, or so surely ensures freedom from risk in carrying out, than the one first adopted. The honey season is, however, only starting in Cheshire, so there is plenty of time for surplus storing in frame hives from strong swarms if hived on about six frames fitted with foundation. The stocks in boxes we would allow to swarm, and drive the bees out twenty-one days after, to strengthen stocks at work storing surplus honey above brood nests.

TRADE CATALOGUES RECEIVED.

E. C. Walton & Co., Muskharn Works, Newark.—60 pages. Besides a very full list of bee goods to suit all classes of bee-keepers, Messrs. Walton & Co. devote some 16 pages to poultry houses and the various appliances connected therewith. It may interest poultry breeders to know that Mr. T. Gascoigne, after twenty-five years as poultryman with various gentlemen—who during that time took nearly all before them in the show pen with the various breeds they kept—has now connected himself with the firm of Messrs. Walton & Co. Poultry-keepers living in the neighbourhood who may be requiring advice, will therefore do well to make Mr. Gascoigne's acquaintance. We are informed that he intends taking up judging appointments.

Bee Shows to Come.

June 23 to 29, at Manchester.—Royal Agricultural Society's Show. Letters relating to Bee Department to be addressed, E. H. Young, Secretary, B.B.K.A., 12, Hanover-square, W.

July 7 and 8, at Hanley, Staffs.—Horticultural Fete. Medals and liberal prizes for honey. Schedules now ready. Apply J. B. Barrow, Town Hall, Hanley.

July 15 and 16 at Sleaford.—In connection with the Lincolnshire Agricultural Society. Bee Department under the management of the Lincs. B.K.A. Schedules from R. Godson, Hon. Sec., Tothill, Ailsford. **Entries close June 18.**

Shows in connection with the Notts B.K.A. will be held as under:—**Hucknall Torkard, July 20. Entries close July 16. Southwell, July 22. Entries close July 5; and Moorgreen, September 7. Entries close August 27.**

July 24, at Fallowfield, L. and C. B.K.A.—In connection with the South Manchester Horticultural Society, schedules from F. H. Taylor, Local Hon. Sec., L. and C. B.K.A., Old Hall-lane, Fallowfield. **Entries close July 8.**

July 21, 22, and 23, at Harrogate.—Yorkshire Agricultural Society's Show. Liberal prizes for hives, honey, &c. Schedules to be had from Marshall Stevens, Secretary, York. **Entries close June 12.**

July 28 at Henbury.—Bristol, Somersetshire, and South Gloucestershire Annual Show. For Schedules apply to Miss Hill Davies, Long Ashton, near Bristol. **Entries close July 21.**

July 28 and 29, at Chester.—In connection with the Great Horticultural Fete. Bee Department under the management of the Lancashire and Cheshire B.K.A. Medals and liberal prizes for honey, &c. Schedules now ready. Apply to Wm. E. Little, 1, East-gate-row, Chester. **Entries close July 19.**

July 27, 28, 29, at Gloucester.—Gloucester B.K.A., in connection with the Gloucester Agricultural Societies' Show. **Eight Open Classes.** Schedules from Dr. Grosvenor, Hon. Sec. G.B.K.A., Clarence-street; or, Mr. E. J. Burt, Assis. Hon. Sec., Stroud-road, Gloucester. **Entries close July 15.**

July 31, at Helsby.—Three open classes. Prizes (20s. &c.) for single 1-lb. jar and (10s. &c.) for single 1-lb. section. Apply Dr. Briant, Helsby, Warrington. **Entries close July 24.**

August 4, at Neston Park, Wilts.—In connection with the Atworth and District Horticultural Show. Two open classes for single 1-lb. section and single 1-lb. jar of extracted honey. Schedules now ready. J. P. Inkpen, Secretary.

August 12, at Goole.—Annual Show of Bees and Honey in connection with the Goole and District Agricultural and Horticultural Society. **Six Open Classes,** with good prizes, including 20s. and 10s. for single 1 lb. jar of honey (entry free in this class). Schedules from J. Luddington and H. S. White, Secretaries, Lindum House, Goole. **Entries close August 7.**

August 23 and 24, at Hastings.—Annual Show of the Kent and Sussex Bee-keepers' Association in conjunction with the Sussex County Agricultural

Society. Liberal prizes. Schedules ready shortly from Henry W. Brice, Hon. Secretary, K. and S. B.K.A., Dace Park, Upper Norwood.

September 8 and 9, at Derby.—Sixteenth Annual Show Derbyshire B.K.A., in connection with the Derbyshire Agricultural Society. Nineteen classes and over fifty prizes for bees, honey, and appliances. Schedules from F. Walker, Hon. Sec. D.B.K.A., Cattle Market, Derby. **Entries close August 31.**

Notices to Correspondents & Inquirers.

All queries forwarded will be attended to, and those only of personal interest will be answered in this column.

JAMES MILLER (Oakham).—*Swarming.*—1.

When a first or "top" swarm leaves a hive under normal conditions the bees leave behind them several queen-cells, in which the respective embryo queens are ready for sealing over, but not until from six to eight days have elapsed after the departure of the swarm does the most forward of the young queens hatch out. 2. No fixed date can be given on which a young queen will begin to lay, as under certain conditions, egg-laying may be deferred for several weeks after birth. Ordinarily, however, the young queen takes her marital flight—or mating trip—in three to five days after birth, and usually begins to lay in less than a week afterwards. Read reply to "Surrey" regarding the importance of having a text-book to refer to.

PERPLEXED ONE (Alton, Hants).—*Disinfecting hives.*—If the apiary is only "suspected" of being attacked with foul brood, there is no need for any such drastic measures as destroying combs, bees, &c. Ascertain for certain what the condition of the bees really is, and then resolve upon what is best to be done. Meantime we may say that a couple of coats of good paint, well worked into the corners and crevices of a hive "after removal of everything save the four walls," will serve as a very excellent disinfecting process, and one we know to be effective if thoroughly done. We should spray the rack of sections with soluble phenyle—a half teaspoonful to one quart of water—before using again.

ONWARD (Garforth).—*Queen Rearing.*—Mr. Brice's papers on this subject began in our issue for September 20, 1894, and were continued in the four following issues. These numbers are not out of print, and never have been, so your newsagent is wrong. Back numbers can be had from this office at 1½d. each, post free. Mr. Doolittle's book on Queen Rearing is not sold in this country. We could get it for you from America at a cost of about 5s.

SUSSEX.—*Suspected Combs.*—As the stock is stated to be weak, and our correspondent declares himself "a believer in stamping out disease by destroying all infected stocks," we need only to say there are foul brood spores in the dried up contents of several cells in comb sent.

(Several letters are held over till next issue.)

Special Prepaid Advertisements.

Twelve words, *Sixpence*; for every additional Three words or under, *One Penny*.

It being impossible for us to guarantee the *bona fides* of Advertisers, it is advisable—in cases where any doubt exists—that intending purchasers should adopt the system of payment by deposit through this Office. (This caution is inserted in consequence of occasional complaints.)

WANTED, Modern BEE BOOKS, second-hand, cheap. A. W. SAYLE, Elster Wick, Hull. P 76

FOR SALE or EXCHANGE.—A grand 2 framed OBSERVATORY HIVE. SEAMARK, Willingham, Cambs. P 79

STRONG Healthy NATURAL SWARMS, 3½ to 4 lb. weight, 12s. 6d. Orpington Eggs, Prize Strain, 2s. 6d. doz. E. MIDDLEMASS, Stamford, Althwick. P 78

FOR SALE.—Well-known Bee Plants, BORAGE and CHAPMAN HONEY PLANT, 50 mixed, post free, 1s. 3d. J. T. HICK, Apiary, Sherburn, York. P 72

WANTED, BEES or HIVES. Exchange Holes's Self-Hiver, silver-plated Cornet, cost 90s. GAMBLE, Corn Exchange, Woolston, Carnes. P 74

FINEST NEW ENGLISH HONEY. 7d. per lb. Tins free. A few more Swarms For Sale. A. TWINN, Apiary House, Ridgwell, Halstead, Essex.

TO BE SOLD, Handsome Oak Observatory HIVE. Cost £7. Will take £2. Address, Miss CANE, Weston Rectory, Newark. P 73

FOR SALE, about 60 lbs. EXTRACTED HONEY, 1896, screw caps, 9s. 6d. per dozen. Apply, DAVIES Park House, Wallingford. P 70

SMALL APIARY FOR SALE, 11 strong healthy stocks, all utensils. Owner emigrating. The lot £10, packed free on rail. MEYER, Walkern, Stevenage, Herts. P 69

2-FRAME EXTRACTOR FOR SALE, by Neighbour & Sons, in thorough working order on stand, 12s. Two knives and smoker, 3s. WATKIN BIRD, 23, Priory-street, Huntingdon-road, Cambridge. P 71

FINE 1897 TESTED QUEENS of my well-known strain ready in July. Sent out in my introducing cage. Safe arrival guaranteed. 3s. 6d. each. Strong 3 frame nuclei, 12s. 6d. each. Guaranteed healthy. WHITING, Valley Apiary, Hundon, Clare, Suffolk. P 77

SPECIAL SILK BEE VEILS, 9d. post free. ABBOTT BROTHERS, Merchants Quay, Dublin. P 46

SUPERIOR QUEENS, Stocks, Nuclei, and Swarms. Address, Rev. C. BRERETON, Pulborough, Sussex. P 75

GOOD SWARMS of my Superior Bees, 15s. packed. JOHN WALTON, Honey Cott., Weston, Leamington. P 51

WANTED, 1-lb. Sections NEW HONEY, finest quality. FELL, Bee-keeper, Finsthwaite, Newby-bridge, Ulverston. P 62

WANTED, NEW SECTIONS, first quality; also Bell-glasses Honeycomb. Packages sent. Good price paid and prompt settlement. R. COLE, Southdown Apiaries, Bexhill, Sussex.

SEND FIFTEEN STAMPS for useful (half pound post free) SAMPLES of FOUNDATION, and compare with what you are using. ABBOTT BROTHERS, Merchants Quay, Dublin. P 47

21ST YEAR. PURE ENGLISH BEES. Good swarms, 10/6, 12/6, 15/-. Cases 1/-, or returned. Tested Queens, 3s. 9d. delivered. Cash with order. ALSFORD, Expert, Blandford.

SPECIAL OFFER. To introduce our new SECTION (fully patented 1896.) and FOUNDATION, we offer to send 24 Sections and Foundation to fit, post free 1s. 6d. ABBOTT BROTHERS, Merchants Quay, Dublin. P 45

Prepaid Advertisements (Continued)

TESTED ENGLISH QUEENS, ready in July, 5s. each, in my introducing cage. Bred from stocks selected for gentleness and honey-gathering qualities and under swarming impulse. Portage on telegrams 1s. 6d. at present. W. WOOLLEY, Beedon, Newbury.

BROTHER BEE-KEEPERS visiting the ISLE of MAN will find comfortable APARTMENTS at Merridale House, 5, Empire-terrace, Empress Drive, Douglas. For Terms apply S. J. HORSLEY, as above.

BRICES RELIABLE QUEENS. Well-known strain. One quality (the best), one price. Mated Tested Queens, 5s. 6d. each; Virgins, 3s. each. Post free in my perfected introducing cage; safe arrival guaranteed. Orders executed in rotation. HENRY W. BRICE, Dale Park-road, Upper Norwood.

GARNER'S APPLIANCES

beat all for quality and cheapness. Try my Heather Hive, 12s. and 14s. 6d. Easiest packed. Best ventilated.

Steam Factory, Dyke, Bourne, Lincs.

ROYAL AGRICULTURAL SHOW, MANCHESTER,

July 23-29.

I shall be pleased to meet my friends as I have done at these shows for the past fourteen consecutive years. I have many new and original ideas, also a new Catalogue, the best ever published in the Bee Appliance trade. These may be had gratis at the Show, or sent post free, from here on application.

W. P. MEADOWS, SYSTON, LEICESTER.

THE NORTH RIDING YORKSHIRE BEEKEEPERS'

SUPPLIES.

Straw SKEPS, Bar-FRAME HIVES, the British make "WEED" FOUNDATION, Split-Top SECTIONS, Screw-Cap HONEY BOTTLES, STOCKS, SWARMS, NUCLEI, QUEENS, &c.

Catalogues free.

ROBERT NESS,

Sproxtion Park Apiary, Helmsley, York.

SPECIALITIES, 1897.

Transparent Waxed Paper Section Wrappers, Gilt Section Bands, 1s. per 100. 16-oz. Screw-Top Honey Bottles, 2s. doz. Natural Swarms, 12s. 6d.

LISTER & TAYLOR,

HATHERSAGE, SHEFFIELD.

BEE HIVES AND APPLIANCES,

With all the Latest Improvements, Including the 'Wells' Hive, 'W.B.C.' Hive, &c.

Hives, complete, from 10s. 6d. each.

1896. PRIZES AWARDED DURING 1896

at St. Albans, Longton, Shrewsbury, Moorgreen, and Derby.

Illustrated Catalogue Post Free.

G. H. VARTY, ETWALL, NEAR DERBY.

To Sheffield, Rotherham, and District Bee-keepers.

BAR-FRAME HIVES, STRAW HIVES, Extractors, "Weed" Foundation, Sections,

&c.

SCREW-CAP HONEY BOTTLES,

16-oz., 12s. 9d. for 10 dozen; 7-oz., 7s. for 6 dozen, can be obtained at

Carnett Brothers, 29, High St., Rotherham.

DON'T GET STUNG,

when by using **APIFUGE** you can easily prevent it.

APIFUGE will also be found extremely useful for travellers in foreign countries where insect pests abound. Bottles 1/- post free.

S. E. CRIMSHAW, Beeston Hill, LEEDS.

Editorial, Notices, &c.

THE JUBILEE WEEK.

If any uncertainty existed as to the enormous amount of interest being taken in the People's Great National Thanksgiving for the sixty years of continued progress and prosperity enjoyed by this kingdom and the Empire over which our loved and venerated Sovereign rules; a day in London just now would effectually and completely remove it. The Jubilee week has upset and—as it were—so demoralised the five or six millions of human beings

plete the "copy" for next week's issue. This being so, it is quite possible that the B.J., dated Thursday, the 24th, may be in the hands of readers on the 22nd (Jubilee Day)! We don't know, but we are told by wholesale agents that "unless our paper is out some days in advance, it may not reach readers at all next week."

Then, as a matter of course, it must be a "Jubilee Number," otherwise its readers would be left out in the cold, and bee-keepers especially don't like to be left that way. Thus we find ourselves completing next week's issue from "copy" already in hand, and, leaving out such communications

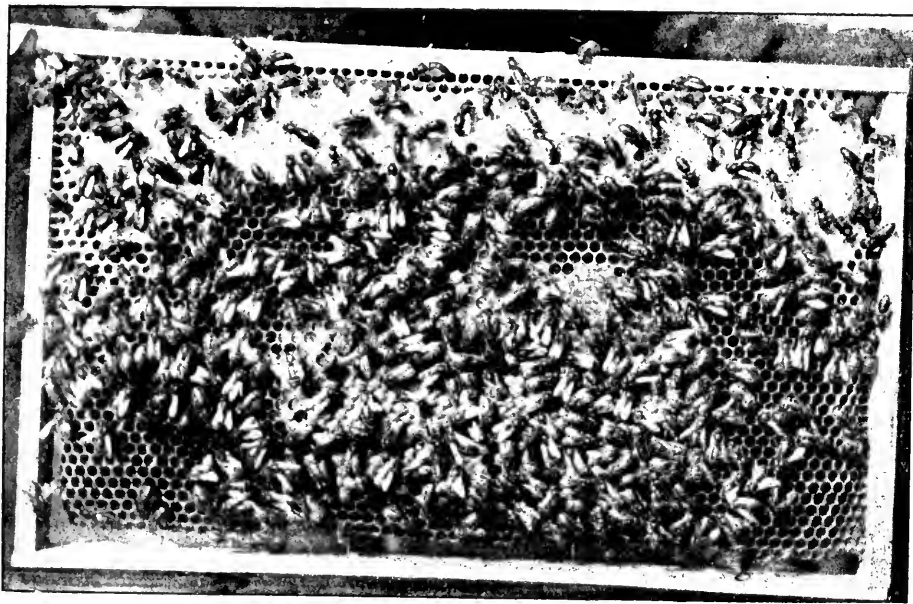

THE QUEEN BEE AND HER LOYAL CHILDREN.

whose lot is cast in the great metropolis, that nothing seems to be in its right place or normal condition. To use a vulgarism, "We don't know where we are"—at least we of the BRITISH BEE JOURNAL don't. These lines would, in the ordinary course, have been written four days hence, and be read on Thursday, the 24th inst.—*i.e.*, after the Jubilee Day. But we find ourselves on Friday, the 18th, scrambling among crowds of people to get through the fifty or sixty yards which separates Charing Cross Station from the B.J. office, full of anxiety to com-

as reach us after the 18th to be dealt with in the following issue. But this is not all; Editors cannot—like Sir Boyle Roche's bird—be in two places at once, and yet, while our Senior is now some thousands of miles away, the Junior, in charge, has received an official intimation worded something like this:—"Judging begins at Manchester 10 a.m. sharp on Wednesday, 23rd." This means a "wrench" in more ways than one to the said Junior, who claims to be so loyal a subject that he *would* have liked to stay in town, and struggle (or pay) like the

rest of the millions, to obtain a sight of our good Queen on the crowning day of her long life.

As a matter of fact, however, he will be engaged trying to find out, by devious courses and much inquiry, if it will be possible to get across London and reach Euston at 2.30 p.m., with thoroughfares blocked and traffic suspended, just in the thick of the great Demonstration which will be taking place at the time. This is what it appears we must do, and very regretfully leave the "sights" unseen.

But, to leave personal and come to more important matters, the five or six millions of London toilers whom, like the poor, we have always with us will be augmented probably by several millions from our own provinces, to say nothing of the scores of thousands of visitors from all parts of the world. One may well wonder how many human beings will be gathered in the metropolitan area on Jubilee Day, 1897. It has been computed at about ten millions! Referring to the occasion and the august lady who is the subject of it the *Standard* says:—

"Virtue, wisdom, judgment, conduct, character do not grow, like the prophet's gourd, in a night. They mature slowly and imperceptibly, and it is only when men and women have attained a certain age that they begin to carry what is called weight. The Queen was raised to a mighty throne when she was an inexperienced girl of eighteen summers. But during sixty years she has gone on ripening and mellowing, till now the wisest statesmen and the greatest rulers regard her as the embodiment of political wisdom. She has lived and learnt—learnt because she longed to learn, because she was conscientious, passionately attached to duty, eager and anxious only to do what is right. It is no derogation to the natural capacity of the Queen to say that almost any man or woman, having as high a sense of duty and as sound instincts, might in sixty long years, if similarly placed, have acquired the difficult art of constitutional government. That is what we mean when we say that time has been on the Queen's side, and on the nation's side, extending to her a long and protracted lease of experience which has enabled her to harvest the wisdom we all revere, and ripen the tenderness of feeling that en-

dears her to the heart of the whole world. It is an unprecedented, an unparalleled position. There has never before been anything like it in history. The reign of Victoria is absolutely unique, and unique in its character will be the great commemoration of Tuesday next. There is a high moral element in the celebration which distinguishes it from all other Royal or national festivities. The Jubilee is not designed to celebrate great victories in the field, great naval triumphs on the ocean, or the domination of one country over others. Its meaning is essentially domestic. It is the festival of the English race, recalling and commemorating their labour, sorrows, successes, energy, and expansion during sixty years under the mild and beneficent sceptre of the most loved and popular Sovereign that ever wore the crown."

Sixty years ago—indeed, at any period of the nation's history—the Diamond Jubilee of our good Queen's memorable reign would have been an event to be remembered for the whole lifetime of those who were privileged to witness the ceremonies connected with it; yet how enormously different are the circumstances of to-day, when every detail can be flashed round the world in the space of a few minutes. Think also how every household in the land may, by the expenditure of a few pence, have the whole proceedings photographed as it were, and the story told with such marvellous fidelity. Why, the humblest cottage can have its portrait of the Queen as she is to-day produced in the very perfection of art, at a merely nominal cost. So numerous and so beautiful are these productions that the B.J. seems to be quite cut off from its contemporaries in that we have no portrait of her Majesty to present to our readers. As a matter of fact, we have been much pressed to introduce such a picture in this issue: but wiser, as we think, than those who so cordially invite us, we deem it best to leave art portraits to journals more fitted to do justice to them than the B.J. makes any pretence to do. At the same time, and without the sacrifice of one jot of the known love for the Queen which is supposed to be the special characteristic of bee-keepers, we are going to have our own picture of "The Queen" (photographed from life) where-

with to embellish this Jubilee number. Thanks to our good friend Dr. Sterry, of Sevenoaks—who is a capital amateur photographer, and a bee-keeper to boot—we are enabled to present readers with a reproduction of what is, in the language of bee-men, the Queen, or mother-bee,

the newly-sealed honey in the upper portion of the comb, the larvæ in the cells in close proximity to the Queen, and the sealed worker-brood lower down. Our Jubilee picture in this way becomes not only interesting, but, we hope, educational also.



A CORNER OF MR. T. H. FRINGLE'S BEE-GARDEN.

surrounded by her loyal children. If the "portrait" cannot be quite characterised as a "speaking likeness," it will, at least, be helpful to those who have difficulty in finding the Queen on a comb; for the merest novice will have no trouble in pointing out her Majesty. Nor will the experienced bee-keeper fail to admire the beautiful accuracy with which is shown

While out of our usual track in this particular issue, and bearing in mind that the "Homes of the Honey Bee" is due this week, we forego to some extent the usual fortnightly bee-garden picture, in so far as presenting a view, not of an apiary proper, but a corner of one—all that can be got into a photo in this case. It, however, serves to show a reader

in the person of Mr. T. H. Pringle at work among the bees. Of himself Mr. Pringle says:—

"I am a bee-keeper in a small way, living in a suburban house such as is referred to in the article on page 498 of B.J. for Dec. 10, 1896, where we do not often expect to find the "Home of the Honey Bee." The locality is between Greenwich and Woolwich, some twenty minutes' train ride from London Bridge, but, owing no doubt to the recent rapid growth of bricks and mortar in this neighbourhood, my "takes" of surplus honey have not been very large. In '96, indeed, it failed altogether; in one hive the bees refused to work in the super at all, and in another only four sections were filled; but each of the two previous years I did very well, though the honey was rather dark in colour, but it has a good flavour. The photo was taken by Mr. Worsley, of Charlton, as I was in the act of examining a comb, and I thought, perhaps, you might find room for it in the collection of "Homes of the Honey Bee." I use the "Gayton," and, for a cheap hive, consider them very satisfactory. I thankfully acknowledge much help from the B.B.J., and am hoping for a good season this year."

Correspondence.

The Editors do not hold themselves responsible for the opinions expressed by correspondents. No notice will be taken of anonymous communications, and correspondents are requested to write on one side of the paper only and give their real names and addresses, not necessarily for publication, but as a guarantee of good faith. Illustrations should be drawn on separate pieces of paper. We do not undertake to return rejected communications.

SWISS BEE-KEEPING AND "ART" HONEY.

[1894.] Having to leave England early last May, I unwillingly supered all my hives on the 6th, gave full width entrances, and having prepared four extra hives for swarms, I left the bees to shift for themselves. In days of old, when Deities were plentiful and an extra one or two easily come by, the Roman bee-keepers took the precaution to appoint a special patron to meet such cases as mine. Just now his name escapes me; but I remember he was reputed to be lame, so that the selection would seem somewhat injudicious. We may be sure, however, he was a "first-class expert," and doubtless in those good old days bees gave less trouble than they sometimes do now. My gardener, now in charge, is not lame, but he is quite a novice. He proudly writes that he has "hived five swarms, and would be glad to know what is to be done with the next one?" So should I. Still the news is cheering; for it makes me believe that in spite of rather gloomy forecasts you are having fair weather at home, with prospects of a good harvest.

Here, in Switzerland, not many miles from Zurich, it has been very hot, and with the meadows full of clover and wild flowers the bees should be doing well. On Derby day, I got our landlord to take me to see a Swiss bee-keeper. His bees were in a picturesque house, six sided, with a pointed roof, tall and well tiled. The eaves came well down; the sides, 8 ft. high by 5½ ft. broad, were faced with small tongue-shaped shingles. Of the six sides three had nine hives each, in three tiers, the exits being by long partitioned slits in the bee-house walls, each entrance numbered to correspond with the inside hive number. Space was used for cupboards, &c. Inside, the effect was that of a collection of lockers, as in a cricket pavilion. On one of these being opened, a framed glass partition was seen, which closed in the bees. The frames were of two kinds. The brood-frames about 12 inches square with a supporting bar two-thirds of the way down; the extracting frames 5 inches shallower. There were twelve brood-frames, with more drone comb than was advisable. All frames were put in from the back, the ¾ in. shoulders resting on strips of wood. They were distanced by wire nails, and were not much propolised. The bee-keeper handled them by means of a long pair of pointed plyers, so that his hands remained unsoiled; wherein, thinking as I did of all the Brookes' soap I have to use and the trouble of it, I envied him; but, of course, it was unhandy. My Swiss friend told me that press of work had caused him to neglect his bees, and judging by his excitement on my pointing out the queen he probably leaves them a good deal to themselves. They were very quiet, and showed traces of Ligurian and Carniolan strains; but he told me that his preference is now for brown bees.

There being only one tier of extracting frames, and that a fixed one, it is not surprising that the yields are small, especially as swarming is not discouraged. Forty pounds is considered very good for any one hive. The record year, as with us, was 1887. Comb honey is not produced in this neighbourhood, nor, I believe, in any quantity in any part of Switzerland. There is a good market for honey, both for table use and by confectioners. Honey cakes of various kinds are constantly on sale abroad, and are much appreciated. Prices seem to be a little better than with us; about 9d. per lb. for pure honey, and a little less in bulk; but here we come upon the question of adulteration, which, as most people know, is very common in Switzerland. Who actually does the trick is a delicate point, but in hotels and such places pure honey is seldom met with, the principal adulterants being sugar-syrup and glucose. Such a mixture, which I have heard delicately described here as "Kunst Honig" (art honey), may not be unwholesome, yet no one who has been used to good English honey can relish it. To me it is very distasteful; on the other hand many

an English traveller is delighted with "art honey," because, as I believe, he has no honey, good or bad, offered to him at home.

The hope for British bee-keepers lies in educating the popular taste. There is room for it. A big hotel near Charing Cross was lately holding out "Honey as in Switzerland" as a temptation to its guests, and for all I know is doing so still. We can produce the best and purest honey in the world. Let us stick to that, and see that the public know it. As a parting hint to our associations, look up the hotel-keeper and wake up the confectioner. —SOUTH DEVON ENTHUSIAST, *Wengen, Switzerland, June 11.*

THE "W. B. C." HIVE.

HOW TO MAKE IT.

[2925.] In answer to the query, "What sort of hive do you use yourself?" you were good enough give in the *Record* for March, 1890, perspective drawings and detailed measurements of what is now known as the "W. B. C." hive. Unfortunately, to begin with (but through no fault of yours), the measurements were not correct, and various queries have been

well and good for him, but there is just the possibility that others of your readers may be in the same dilemma, and who, on reading the reply, containing, as it does, such a formidable array of figures—together with the introduction of other matter not pertinent to the question—may resolve to give up in despair their intention to construct one for themselves. Now, in order if possible to prevent this result and assist those who are willing and able to help themselves, I have prepared a plan and two sections, drawn to the accompanying scale, which, should they merit your approval, will, I believe, place the details and measurements of this most useful hive within the power of any such to comprehend or commit to memory for that part.

Keeping strictly in view your description and illustrations (with one exception), avoiding technicalities and fractional parts of an inch as much as possible, the principal dimensions will, for all practical purposes, be found correct. The tracings are from drawings of my own hives, five of which (as you know) I made in 1892, and the following description applies to them:—

The floor-board, covering of roof, casings,

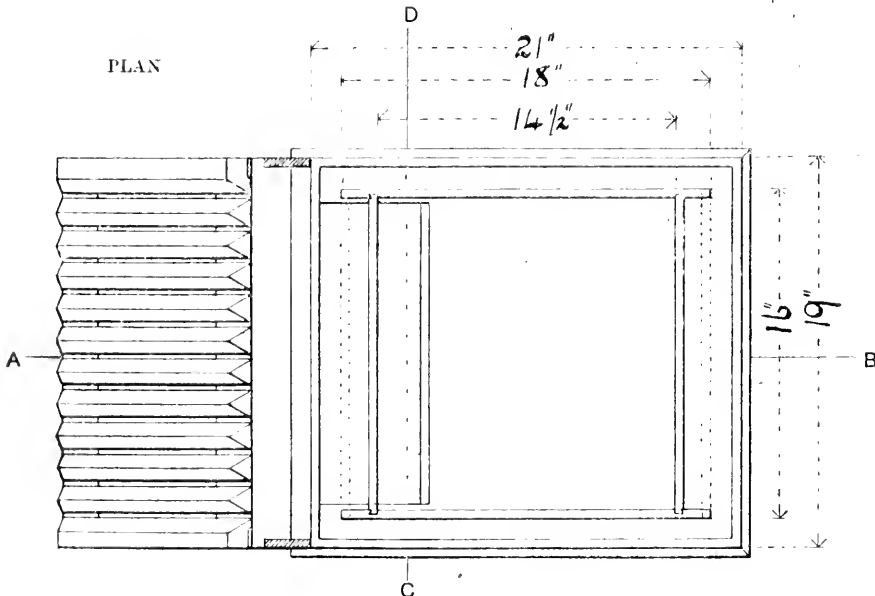

submitted to you from time to time, respecting these and other details which it is unnecessary to recapitulate. The latest of these

body and surplus boxes, are made of selected American yellow pine (or Wancy-board), half an inch thick off the saw, and if cut with the



appeared in the *BEE JOURNAL* of December 17, 1896 (2734, p. 504), as well as a reply thereto. If your querist understands the reply,

perfection of now-a-days, all the dressing required is a skim over with a hand-plane to remove the saw marks. If this is attended to,

it will be found when the hive is put together, that the outside sizes marked on plan tally with the principal inside dimensions given by you.

The frames of the stand and roof, as well as the hive proper, are dovetailed (not simply nailed) together. Where required screws are alone used, and these are previously dipped in paint, the overlaps and plinths are screwed from the inside. Where the wood overlaps it gets two coats of white or red lead and oil previously. There are no hand holes, the plinths of the case and the ledges on boxes filling the requisite. The plinths are bevelled on inside edge as shown. You will observe that the end pieces or kerbs are also half an inch thick; this is necessary for hinging the narrow flaps to—one of which is shown partly open—the other sheet. These flaps are used primarily for covering the exposed ends of top bars, and for keeping the surplus chambers in position.

(Conclusion in our next.)

NOTTINGHAMSHIRE B.K.A.

The annual show of the above association was held in connection with the show of the county agricultural society in Colwick Park, Nottingham, on June 9 and 10. The exhibits were of good quality, and the staging and arrangements in the show-tent reflected great credit on the energetic secretary of the N.B.K.A., Mr. Geo. Hayes, and his staff of willing workers.

Notts bee-keepers are very enthusiastic show-men, and work with commendable energy to make their exhibitions successful. This year the County Agricultural Society, as representing the larger industry, has generously helped the prize fund, and, by so doing, secured what has long been hoped for by the Bee-keepers' Association, viz., the holding of the annual shows of both societies at the same time and place.

Lectures were given in the bee-tent with suitable demonstrations and manipulations during each day by Mr. W. B. Webster, of Binfield, Berks, who also officiated as judge, and made the following awards:—

Collection of Appliances.—1st, G. H. Varty, Etwell, Derby.

Frame Hive.—1st, G. H. Varty.

Amateur-made Hive.—1st, J. McKinnon, Gedling; 2nd, Geo. Hayes, Beeston.

Single 1-lb. Jar of Extracted Honey (open).—1st, J. Sopp, Crowmarsh, Berks; 2nd, J. & W. Herrod, Sutton-on-Trent; 3rd, A. G. Pugh, Beeston.

Single 1-lb. Section (open).—1st, A. Twinn, Ridgewell, Essex; 2nd, J. & W. Herrod; 3rd, W. Loveday, Harlow, Essex.

Honey Trophy.—1st, J. & W. Herrod; 2nd, J. W. Rawson, Selston.

Twelve 1-lb. Jars Extracted Honey (light).—1st, P. Scattergood, jun., Stapleford; 2nd,

H. Merryweather, Southwell; 3rd, J. & W. Herrod.

Twelve 1-lb. Jars Extracted Honey (dark).—1st, W. Hallam, Orston; 2nd, J. & W. Herrod; 3rd, J. W. Rawson.

Sic 1-lb. Sections.—Equal 1st, J. & W. Herrod, and G. Marshall, Norwell.

Sic 1-lb. Jars Granulated Honey.—1st, J. & W. Herrod; 2nd, A. G. Pugh; 3rd, H. Merryweather.

Shallow-Frame of Comb Honey.—1st, P. Scattergood, jun; 2nd, J. & W. Herrod.

Extracted Honey (Novices only).—1st, W. Hallam, Orston.

Honey Vinegar.—1st, P. Scattergood, jun.; 2nd, J. & W. Herrod.

Honey Cake.—1st, J. Wilson, N. Clifton; 2nd, P. Scattergood, jun.

Bees in Observatory Hive.—1st, J. W. Rawson; 2nd, G. Hayes.

Bee-swar.—1st, J. Wilson; 2nd, W. Hallam, 3rd, P. Scattergood, jun.

(Communicated.)

Queries and Replies.

[1761.] *Starting Sections in Brood Frames.*—Some sections which I placed in frames in the body of a hive to be drawn out before being put in the supers were allowed to remain too long, and when removed were found to contain eggs (just laid). 1. Will it be necessary to pick out these eggs before placing the sections in the super? or will it be sufficient to keep the sections a few days, when I presume the eggs would lose their vitality and would be removed by the bees before filling the cells with honey? 2. Some few cells, too, had pollen in them; but, if this is cut out, may I expect that the bees will repair and fill the sections cleanly and satisfactorily?—BURLEY BEACON, *Hants.*

REPLY.—If sections are kept in a cool place for a few days the eggs will "perish" and do no harm. 2. The bees will repair any breakage made by removing pollen, but the sections will most probably be damaged so far as turning out *nice in appearance*. For actual use, however, no great harm will follow. Curiously enough we never took kindly to the plan, either of starting sections, or having them filled in the brood-nest of hives.

[1762.] *Separate Entrances to Supers.*—*Dividing Stocks in Autumn.*—Having commenced bee-keeping this spring with one stock, I began taking your valuable journal, and have received much help and many useful hints given to bee-keepers in it. I am now about to ask for a little information on my own account. 1. My stock of bees covers twelve frames. I gave them a super for extracting on the last day of May, which they are now working in it splendidly. The super has a separate bee-way entrance from outside.

1. Is there any advantage in using this entrance, or should you let the bees work from the bottom doorway? 2. I wish to increase my stocks, and so ask how late in the season will it be safe to defer dividing, so that the young queen may become fertile?—*INQUIRER, Banbury.*

REPLY.—1. No: let the bees use the bottom entrance only. They are rather prone to store pollen too freely in comb if separate entrances to supers are allowed. 2. Dividing should take place at once when the main harvest begins to fail perceptibly, because drones are soon killed off when honey becomes scarce. It is not good practice to "divide" late unless followed up by proper and early preparation for making divided stocks strong for winter. To do this, the middle of July is late enough, and when young queens are reared and mated liberal feeding must follow to keep up breeding as late as it is safe to do so. Comb foundations should also be given, and be built out so that enough combs are provided for wintering on.

[1763.] *Transferring—Skeps for Surplus.*—With the advent of 1897 I became a bee-keeper, owning one skep hive. Two months ago, with the assistance of a friend, I was enabled to put the skep on the top of a ten-frame hive fitted with comb foundation. So far we are all right, but I want the queen to take possession of the hive below and then to put a sheet of queen excluder on the frames so that when all the brood have hatched out the skep will contain nothing but honey. What can I do to get the queen to go down on to the frames?—*GEO. MARTIN, Leicester.*

REPLY.—The time of queen taking possession of lower hive depends largely upon the strength of the colony when skep was set above the frames, and the precautions taken to make the frame-hive as snug and cosy as possible. When the skep becomes crowded and the queen needs laying room, a move will be at once made to the lower chamber, and it will then become the brood nest of the colony. There is no need to put queen excluder between skep and frames. The bees will carry their surplus mainly into the skep, and when the combs are sealed over (if they do become filled) the skep may be removed for extracting. Queen excluder, in this case, would only be likely to conduce to storing below.

[1764.] *Queen Lost after Manipulating Hive.*—1. Will you kindly tell me in *BEE JOURNAL* what race the enclosed queen belongs to, *i.e.*, is she a practically pure "black"? I had a curious thing happen to my stronger hive which I cannot understand. The bees were very strong in numbers and working in the supers, and about three weeks ago I thought something seemed wrong, as they became less industrious. I, therefore, examined them some days after and, to my astonishment, they were queenless; having, apparently, been so for at least eight days. By the age of the queen cells

(there were only two) I could tell that they must have become so some days after I had last opened the hive. 2. What could have become of her. She was a very prolific queen? I then placed in the hive a frame containing three queen-cells due to hatch from last Monday to Wednesday. On Monday evening I found the enclosed queen under the hive; can you account for this? 3. Is she a virgin? On examining I found one queen-cell had hatched out and the others were torn open; the bees are working in the supers all the time and are packed with bees. 4. Can Italian queens get through ordinary excluder zinc?—*B. H., Shrewsbury.*

REPLY.—1. Queen is of the ordinary or native race, which cannot be called "pure black." 2. We fear the mishap has occurred during some manipulating of the hive prior to the examination which showed the stock to be queenless. 3. Though not a virgin we should not have judged her to be a "very prolific" queen. 4. Italian queens can no more get through ordinary excluder zinc than any others.

[1765.] *Transferring Bees.*—I had a stock of bees in a straw skep, which I placed over a frame-hive. They have now been in that position for a month, and have drawn out the ten frames of comb in lower hive, and each is now full of brood and honey. On Saturday last (12th inst.) I took off skep and placed on a stand by itself alongside of the old hive. I looked for the Queen in the latter but was unable to find her, so concluded she was in skep. The bees in frame-hive are working all right, but those in skep are very quiet and do not go out to work, only a few showing themselves at the entrance. The combs in skep seem fairly covered with bees, and this morning (Monday) there are several dead ones at entrance. 1. Under the circumstances, which hive would you suppose Queen to be in? If not in skep, do you think there is a possibility of bees in skep raising for themselves a new queen? I can't see any signs of brood in the skep, as bees cover the combs completely. The drone-cells at bottom of combs are open, no sign of brood. 2. If you think the bees in skep will be unable to raise a new queen, would it matter if I put skep on to frame-hive again, with excluder between? And in that case should I have to prepare bees as in "Guide Book" (uniting). Awaiting your esteemed reply.—*C. EYLES, Southsea.*

REPLY.—1. In frame-hive. 2. The probability is, that the skep will now contain only honey and some sealed brood. We should therefore return it to its place on the frame-hive, until fairly heavy with honey, then remove it for extracting.

[1766.] *Transferring Bees from Skeps to Frame-Hives.*—I have two skeps of bees, and wishing to transfer them into frame-hives, I took your advice with one by setting the skep over a frame-hive. The bees are now working

hard and doing well in the latter. I purpose allowing the other skep to swarm and then hive them in frame-hive, but I see no sign of them swarming as yet. 1. What is best for me to do in the event of no swarm coming off this month? 2. My next door neighbour has several hives and has been expecting a swarm from one of them daily, but to his great surprise, on going to look at them this morning, he found a dead queen on the flight-board, which I send on to you. He is very anxious to know what can be the cause, and wishes me to ask you to kindly give your opinion as to what can have been the matter and what must he do? 3. Is it a young queen!—WM SMITH, *Helensburgh, N.B.*

REPLY.—1. If the skep is at present full of bees and in normal condition for swarming, you might drive a swarm just now while the weather is so favourable for the purpose; but first assure yourself as to the queen's prolificness, because it is no use peopling the frame-hive with a driven swarm having a poor queen at its head. 2. Your neighbour must judge whether or not the skep has swarmed unknown to him and returned to the hive. If it has—and the queen been killed through some accident—"piping" will be heard in seven or eight days from the time the swarm returned. This is all we can say from the meagre details furnished. 3. The queen sent is an adult.

[1767.] *Utilising Driven Bees.*—I am a beginner in bee-keeping, and have no means of acquiring information on the subject except by reading the "Guide-book," and also the B.B.J., which I take each week. A good many cottagers keep bees in skeps around here, and sulphur them when they wish to take the honey. I have tried my hand at driving, and have been fairly successful, and now I think of driving the cottagers' bees which I can have for the purpose of strengthening and increasing my own stocks in frame-hives. I should have to take a day and go round with a horse and trap to do the driving, and should not be home until too late to unite them the same night. I therefore ask:—1. Would the bees be vicious in the morning after remaining in the driving skep all night? 2. Can I unite by simply throwing the bees on to a sheet in front of frame-hive and dusting both lots well with flour? 3. Will driven bees do well if put into a frame-hive without any combs but simply filled with foundation? 4. If so, how many lots should I unite in order to make a successful stock next season?—S. GROVES, *Somerset.*

REPLY.—1. No; they will be very quiet. 2. Some bee-keepers, who have a good many lots to drive, do the uniting at the time of driving, running two or more lots into one "carrying-skep" or box in order to reduce the number of parcels. This will be your best plan, but let the driven bees have plenty of ventilation on the home journey. If preferred, you can, of course, "unite" at home, but

on the first-named plan you can regulate the quantity of bees for each frame-hive beforehand, and have them "fraternising" all night. So no flour will be needed when running them in. 3. Yes, if the driving is done early in September and each new-formed colony is fed well while building out combs. 4. This will, of course, depend on the strength of stocks driven. If very strong, join up only two lots; if weak, three or four.

[1768.] *Bees Refusing to Enter Surplus-Chamber.*—I have a strong stock of bees covering ten frames. When I saw that they were extending the cells in brood-chamber I placed on a crate of shallow-frames fitted with full sheets of foundation. I examined this several days after and found that they had not touched it, and did not seem anxious to. I then placed on a bottle of syrup to induce them to come up, but after leaving it on five days examined again and found that they had not even touched the syrup. 1. Why is this? Honey seemed to me to be coming in pretty well; anyhow, the bees seemed very busy. 2. I added a little naphthol beta in syrup when making it, as advised in "Cowan's Guide Book." Do you think that the smell of the disinfectant is obnoxious? I keep them well covered up with about three layers of thick felt, and they are situated near the town. 3. Kindly advise me in this week's B.J., if possible, what to do to get the bees at work comb-building.—A. E. S., *Leicester.*

REPLY.—1. Judging by dates and the time intervening between putting on the surplus-chamber and the second examination made, it would appear as if the adverse weather at beginning of June caused the bees to refuse the storage room offered them. Many scores of stocks in which bees had started work storing in supers during the warm spell in May deserted the surplus-chambers at the time referred to. If the stock is really strong in bees, we have little doubt they will be working out the foundation by the time these lines are read. In any case, readers must bear in mind that unless weather is warm and favourable for brood-raising and honey is to be had outside, even strong stocks will crowd close on to the hatching-brood and refuse to enter supers. 2. There is no perceptible smell about syrup medicated with naphthol beta. 3. Your query reached us on the 10th, when the current week's issue was already printed and in the hands of readers

Bee Shows to Come.

June 23 to 29, at Manchester.—Royal Agricultural Society's Show. Letters relating to Bee Department to be addressed, E. H. Young, Secretary, B.B.K.A., Bee Department, Royal Agricultural Show.

July 7 and 8, at Hanley, Staffs.—Horticultural Fete. Medals and liberal prizes for honey. Schedules now ready. Apply J. B. Barrow, Town Hall, Hanley.

July 15 and 16 at Steaford.—In connection with the Lincolnshire Agricultural Society. Bee Department under the management of the Lincs. B.K.A.

Shows in connection with the Notts B.K.A. will be held as under:—**Hucknall Torkard**, July 20. **Entries close July 16.** **Southwell**, July 22. **Entries close July 5;** and **Moorgreen**, September 7. **Entries close August 27.**
July 24, at Fallowfield, L. and C. B.K.A.—In connection with the South Manchester Horticultural Society, schedules from F. H. Taylor, Local Hon. Sec., L. and C. B.K.A., Old Hall-lane, Fallowfield. **Entries close July 8.**

July 21, 22, and 23, at Harrogate,—Yorkshire Agricultural Society's Show. Liberal prizes for hives, honey, &c. **Entries closed.**

July 28 at Henbury,—Bristol, Somersetshire, and South Gloucestershire Annual Show. For Schedules apply to Miss Hill Dawes, Long Ashton, near Bristol. **Entries close July 21.**

July 28 and 29, at Chester.—In connection with the Great Horticultural Fête. Bee Department under the management of the Lancashire and Cheshire B.K.A. Medals and liberal prizes for honey, &c. Schedules now ready. Apply to Wm. E. Little, 1, East-gate-row, Chester. **Entries close July 19.**

July 27, 28, 29, at Gloucester.—Gloucester B.K.A., in connection with the Gloucester Agricultural Societies' Show. **Eight Open Classes.** Schedules from Dr. Grosvenor, Hon. Sec. G.B.K.A., Clarence-street; or, Mr. E. J. Burt, Assis. Hon. Sec., Stroud-road, Gloucester. **Entries close July 15.**

July 31 at Helsby.—Three open classes. Prizes (20s. &c.) for single 1-lb. jar and (10s., &c.) for single 1-lb. section. Apply Dr. Briant, Helsby, Warrington. **Entries close July 24.**

August 4, at Neston Park, Wilts.—In connection with the Atworth and District Horticultural Show. Two open classes for single 1-lb. section and single 1-lb. jar of extracted honey. Schedules now ready. J. P. Inkpen, Secretary.

August 12, at Goole.—Annual Show of Bees and Honey in connection with the Goole and District Agricultural and Horticultural Society. **Six Open Classes**, with good prizes, including 20s. and 10s. for single 1-lb. jar of honey (entry free in this class). Schedules from J. Luddington and H. S. White, Secretaries, Lindum House, Goole. **Entries close August 7.**

August 24 and 25, at Hastings.—Annual Show of the Kent and Sussex Bee-keepers' Association in conjunction with the Sussex County Agricultural Society. Liberal prizes. Schedules ready shortly from Henry W. Brice, Hon. Secretary, K. and S. B.K.A., Dale Park, Upper Norwood.

September 6 and 9, at Derby.—Sixteenth Annual Show Derbyshire B.K.A., in connection with the Derbyshire Agricultural Society. Nineteen classes and over fifty prizes for bees, honey, and appliances. Schedules from F. Walker, Hon. Sec. D.B.K.A., Cattle Market, Derby. **Entries close August 31.**

Notices to Correspondents & Inquirers.

All queries forwarded will be attended to, and those only of personal interest will be answered in this column.

JOHN H. PRIESTLEY (Ripponden).—*Bee Tent Lectures at "Royal" Show.*—In fulfilment of promise made on page 216 of B.J. for June 3, we beg to say the lectures and demonstration with bees will begin at noon on each day of the show, and be given at frequent intervals during the afternoon.

CHEW STOKE (Bristol).—*Young Queens cast out of Nucleus Hive.*—Queens sent are only just hatched, one of them has not hatched out at all, but been pulled out of cell and killed by the first hatched queen in nucleus.

M. P. (Lanarkshire).—*Drone Breeding Queen.*—The stock of bees from whose hive comb was cut is headed by a drone-breeding queen. It is not a case of a worn-out queen or a fertile worker, but unmated drone-breeder pure and simple. This is shown by every worker cell being occupied

by drone larvæ. The stock is worthless, and should be destroyed.

SURREY (Tunbridge Wells).—*Artificial Swarm.*—1. "Removing queen and quantity of bees from a strong stock," is practically making an artificial swarm, and, if properly done, the bees left in the hive will raise a queen from the young larvæ in the parent hive. 2. "The cause of very strong stocks of bees—although not supered, refusing to swarm"—as the question is put to us—might be explained readily enough after inspection, but it is not easy to make it clear to one who evidently has not the most elementary knowledge of bee-keeping. Our correspondent should certainly invest a few pence in procuring some sort of guide-book on the subject before he can hope to succeed with bees; besides, it is utterly impossible for us to furnish all the information needed in the limited space of query and reply column. 3. The B.B.J. is in the hands of readers on Thursday in each week, and obviously must be printed the day previous; therefore no amount of "urgency" will make it possible for us to reply "in this week's paper" to a query we receive on Thursday morning.

E. JENKIN (Swansea).—*Transferring Cross-Built Combs.*—The task of transferring combs "built completely into each other"—as stated—from one hive to another, is, we fear, quite beyond the powers of an amateur bee-keeper—especially a lady—in fact, none other than a skilled bee-keeper could hope to do it successfully, and we do not advise the attempt. If the hive could be set above another properly prepared with full sheets of foundation, the bees would, if strong, soon work their way down into the hive at this season, and thus transfer themselves and their brood-nest below. Then the cross-built combs would become the store chamber for surplus honey, and could be removed with its contents at end of season. The box of shallow frames now on would have to be removed of course.

S. E. GRIMSHAW (Leeds).—Mr. J. Martin's address is Orange Grove, Blue Cliff, Uitenhage, S. Africa.

ROGER (Pontypool).—*Suspected Comb.*—Though only a few of the unsealed larvæ show the unmistakable symptoms denoting disease, it is plainly a case of recent outbreak, judging by comb sent. You can only take the usual precaution so far as your own stocks; don't disturb the supers now being worked in, and endeavour to induce your friend to get his own bees off their present combs (the season being favourable for that operation) and give them a new start in a clean hive.

A. J. R. (Petersfield).—Foul brood in developing in comb sent, though the disease appears to have but recently broken out. We very heartily wish you a successful

journey on what you term "the road to a discovery with regard to it (foul brood) that will be of value to bee-keepers." Is it too much to hope that we shall be informed of such progress as is made?

J. McM. (Whiting Bay).—The mass of brood in comb to hand is chilled, but we find just a trace of disease, that makes it a case for careful watching.

GRANTA (Cambs.).—There is foul brood of old standing in comb sent.

(We must specially apologise for holding over so many letters, &c., till next week, the reason being fully explained in our Leader on page 241.)

Special Prepaid Advertisements.

Twelve words, Sixpence; for every additional Three words or under, One Penny.

It being impossible for us to guarantee the *bona fides* of Advertisers, it is advisable—in cases where any doubt exists—that intending purchasers should adopt the system of payment by Deposit through this Office. (This caution is inserted in consequence of occasional complaints.)

BEEES FOR SALE, in skeps and Bar-frames. **WATSON**, Laughton, Sussex. P 84

FEW good 1896 ENGLISH QUEENS, 4s., healthy and prolific. **BLACKLOCKS**, Sycamores, Lydd. P 81

FOR SALE, guaranteed healthy SWARMS, 11s. 6d.; '97 Queens, 3s. 6d. each. **W. HORSLEY**, Scarborough-road, Norton, Malton. P 82

HONEYCOMB DESIGNS.—"1897," 7s.; "V.R.," 4s. 6d.; "Crown," 12s. Cash with order. **C. COX**, Brampton, Northamptonshire. P 83

EXCHANGE for two good SWARMS, 21 Parts of Fairbairn's Imperial Bible Dictionary, good condition, 2s. parts. **B. WRIGHT**, Netherton, Dudley.

FOR SALE, Stocks of BEES on Bar frames; Hive, complete, 20s., 25s. Cash wanted. **JOHN GIDDY**, Brough, Yorks.

SPECIAL SILK BEE VEILS, 9d. post free. **ABBOTT BROTHERS**, Merchants Quay, Dublin. P 46

SUPERIOR QUEENS, Stocks, Nuclei, and Swarms. Address, **REV. C. BRERETON**, Pulborough, Sussex.

GOOD SWARMS of my Superior Bees, 15s. packed. **JOHN WALTON**, Honey Cott., Weston, Leamington. P 51

TO BE SOLD, Handsome Oak Observatory HIVE. Cost £7. Will take £2. Address, **MISS CANE**, Weston Rectory, Newark. P 73

STRONG Healthy NATURAL SWARMS, $\frac{3}{4}$ to 4 lb. weight, 12s. 6d. Orpington Eggs, Prize Strain, 2s. 6d. doz. **E. MIDDLEMASS**, Stamford, Abwick. P 78

FOR SALE.—Well-known Bee Plants, BORAGE and CHAPMAN HONEY PLANT, 50 mixed, post free, 1s. 3d. **J. T. HECK**, Apiary, Sherburn, York. P 72

WANTED, NEW SECTIONS, first quality; also Bell-glasses Honeycomb. Packages sent. Good price paid and prompt settlement. **R. COLE**, Southdown Apiaries, Bexhill, Sussex.

SEND FIFTEEN STAMPS for useful (half pound post free) SAMPLES of FOUNDATION, and compare with what you are using. **ABBOTT BROTHERS**, Merchants Quay, Dublin. P 47

SPECIAL OFFER. To introduce our new SECTION (fully patented 1896) and FOUNDATION, we offer to send 24 Sections and Foundation to fit, post free 1s. 6d. **ABBOTT BROTHERS**, Merchants Quay, Dublin. P 45

Prepaid Advertisements (Continued)

21ST YEAR. PURE ENGLISH BEES. Good swarms, 10/6, 12/6, 15/-. Cases 1/-, or returned. Tested Queens, 3s. 9d. delivered. Cash with order. **ALSFORD**, Expert, Islandford.

BROTHER BEE-KEEPERS visiting the ISLE of MAN will find comfortable APARTMENTS at Merridale House, 5, Empire-terrace, Empress Drive, Douglas. For terms apply **S. J. HORSLEY**, as above.

TESTED ENGLISH QUEENS, ready in July, 5s. each. In my introducing cage. Bred from stocks selected for gentleness and honey-gathering qualities and under swarming impulse. Portage on telegrams 1s. 6d. at present. **W. WOODLEY**, Beedon, Newbury.

BRICE'S RELIABLE QUEENS. Well-known strain. One quality (the best), one price. Mated Tested Queens, 5s. 6d. each; Virgins, 3s. each. Post free in my perfected introducing cage; safe arrival guaranteed. Orders executed in rotation. **HENRY W. BRICE**, Dale Park-road, Upper Norwood.

ROYAL AGRICULTURAL SHOW, MANCHESTER, July 23—29.

I shall be pleased to meet my friends as I have done at these shows for the past fourteen consecutive years. I have many new and original ideas, also a new Catalogue, the best ever published in the Bee Appliance trade. These may be had gratis at the Show, or sent post free, from here on application.

W. P. MEADOWS, SYSTON, LEICESTER.

THE NORTH RIDING YORKSHIRE BEEKEEPERS' SUPPLIES.

Straw SKEPS, Bar-Frame HIVES, the British make "WEED" FOUNDATION, Spit-Top SECTIONS, Screw-Cap HONEY BOTTLES, STOCKS, SWARMS, NUCLEI, QUEENS, &c.

Catalogues Free.

ROBERT NESS,

Sproxtton Park Apiary, Helmsley, York.

SPECIALITIES, 1897.

Transparent Waxed Paper Section Wrappers, Gilt Section Bands, 1s. per 100. 16-oz. Screw-Top Honey Bottles, 2s. doz. Natural Swarms, 12s. 6d.

LISTER & TAYLOR,

HATHERSAGE, SHEFFIELD.

BEE HIVES AND APPLIANCES.

With all the Latest Improvements, Including the 'Wells' Hive, 'W.B.C.' Hive, &c.

Hives, complete, from 10s. 6d. each.

1896. PRIZES AWARDED DURING 1896

at St. Albans, Longton, Shrewsbury, Moorgreen, and Derby.

Illustrated Catalogue Post Free.

G. H. VARTY, ETWALL, NEAR DERBY.

To Sheffield, Rotherham, and District Bee-keepers.

BAR-FRAME HIVES, STRAW HIVES,

Extractors, "Weed" Foundation, Sections, &c.

SCREW-CAP HONEY BOTTLES,

16-oz., 12s. 9d. for 10 dozen; 7-oz., 7s. for 6 dozen, can be obtained at

Carnett Brothers, 29, High St., Rotherham.

BEE-HIVES And Up-to-Date BEE-APPLIANCES.

Illustrated Catalogue Free.

E. J. BURTT, MANUFACTURER, CLOSTER.

Editorial, Notices, &c.

JUDGING AT SHOWS.

We learn that the question of judging at the more important shows connected with live stock and produce is, like so many other things at the present time, undergoing a process of evolution. All things—except, we suppose, the laws of the Medes and Persians—change, and the different conditions of to-day compel many old customs either to move on or be left behind. Thus it is that, as we understand, a change is being brought about gradually in the matter of “judging.” In other words, the task of awarding prizes is being relegated to single individuals instead of groups. In this way one judge acts in one section of the show, and the awards are his alone. There is thus no sharing of responsibility, and the decision arrived at becomes perforce unanimous.

We confess to having had no great liking for this new order of things. We always stood by the wise saying, “In the multitude of counsellors there is wisdom.” Moreover, it seemed to us a better and more satisfactory arrangement for all concerned if everything in the shape of individual predilections, or whatever there may chance to be, which tends to more or less bias one man’s mind, might have the sobering effect of another opinion to bring about the necessary “balance,” as it were. In theory this cannot be denied; in practice, however, it is not so good; and the fact of our beginning to see wisdom in the new arrangement is what has caused these lines to be written. We yield to no one in upholding the just and proper principle of yielding loyally to the verdict of a majority; thus accepting responsibility for a verdict which may possibly not be quite in accord with one’s own views. On the other hand, we cannot deny the force of the argument which says, “That verdict, then, is not yours, but some one else’s.” But, in the present case, the difficulties of the position are very greatly increased because of the fact that one of the Editors of this journal has imposed upon him a sort of double individuality; and in the honest exercise of two distinct offices compels him, so to speak, as seem-

ing to blow hot and cold with the same breath!

In other words, we feel it to be due to ourself that we should take this means of clearing up what would be an altogether anomalous position—from which our esteemed colleagues are entirely free—in that our duty to readers compels us to report on the various exhibits and give our honest opinion regarding them. If in fulfilling this duty we chance in a few instances to be speaking one way, as it were, and voting another, we trust that no one will either charge us with inconsistency, or with endeavouring to question the justice of the awards from the judges’ standpoint, according to which full responsibility is accepted by all for the verdict of the majority. Their decision carries the day, and it is perfectly right that it should do so; but, as we have said, it may, in so rare a case as ours, need a word of explanation, which we are perfectly sure none of our colleagues on the occasion referred to would for a moment deny to us.

That the situation is an awkward one we confess, but it has not been of our making; for while accepting the office of judge, we cannot rid ourself of the editorial responsibility which may, perhaps, compel us to speak somewhat adversely of one or two awards which were largely our own. But having said this much, we conclude by again expressing our firm conviction that none would refuse us the right of free comment on the various exhibits staged at the recent “Royal” show, to which we need hardly say this article refers.

ROYAL AGRICULTURAL SOCIETY.

MANCHESTER MEETING.

The Fifty-eighth Annual Meeting of the Premier Agricultural Society of England took place at Trafford Park, Manchester, in the Diamond Jubilee week, amidst splendid weather and the most favourable surroundings. Contrary to the usual custom of opening the show on Monday and closing on the following Friday, those in charge of the arrangements met the convenience of the large working-class population by making Wednesday, the 23rd, the opening day, and continuing the exhibition until Tuesday evening of the following week. The result was eminently satisfactory, for, as we go to press, a telegram informs us that the total number of visitors up to Monday evening reached the enormous

number of 195,359. With Tuesday's attendance added thereto no doubt the aggregate will be very nearly, if not quite, a record one. The extent of ground enclosed for the purposes of the Show may be gathered from the fact of bee-keepers having to walk a full mile from the entrance before reaching the Bee Department. Once there, however, a goodly display awaited their inspection. The extent of shedding occupied by honey, hives, and appliances was 120 ft. in length, the total superficial area occupied by the exhibits being 2,400 ft.

It was felt that the backward spring would somewhat lessen the number of exhibitors, but notwithstanding adverse weather for several weeks before the Show, the total entries numbered 258. The main attraction of the Show was, of course, the Special County Trophy class, in which nine exhibits were staged, five at one end of the tent and four at the other. In this class the prizes were exceptionally liberal; more valuable, we believe, than at any previous bee exhibition held in this country. The counties represented were Berkshire, Gloucestershire, Huntingdon, Kent, Lancashire, Nottingham, Somerset, Sussex, and Yorkshire. Three other entries were made—Lincolnshire, Derbyshire, and Leicestershire—but for some reason these exhibits were not staged.

Taking the display as a whole, it reflected the utmost credit on all concerned, and none will question its general merit. Notwithstanding the very moderate season up to the time of removing surplus for showing, good honey of 1897 was staged, and in very satisfactory quantity, both of comb and extracted. For the rest, space forbids us dwelling further on the exhibits as a whole; there being a good deal to say of the leading ones owing to the very special and exceptionally important nature of the whole show.

Following the order of the schedule with regard to the exhibits, we come first to the TROPHY CLASS; and here let us say it would have pleased us better to see the exhibits in a continuous line, or in a double line, with no long stage full of various exhibits between, as was the case at Manchester. The difficulty of direct comparison would thus have lessened and the general effect, to our mind, heightened. This by the way.

Coming to the first prize Trophy, *i.e.*, Notts, it formed a very pretty display, arranged in the form of a square pyramid, so placed on the table-space that the corners of the pyramid came in centre as it faced the onlooker and left a clear space at the corners of the table, on which were arranged four small groups or pyramids of sections and jars, four tiers high, each surmounted by a vase of flowers. The main or centre portion was six tiers high, each tier being supported by stages of bevelled plate glass, while the apex of the whole was surmounted by a tasteful arrangement of flags and flowers, intermingled with an abundance

of maidenhair ferns. The foundation of the stand was draped with lace and flags. The contents of the whole stand was as follows:—Sixty-four 1-lb. sections, two shallow frames of comb-honey, about 200 lb. of extracted honey in various-sized screw-cap jars, about 14 lb. wax (in cakes and large moulds), $\frac{1}{2}$ gallon mead, and $\frac{1}{4}$ gallon vinegar. The total weight of honey was about 298 lb.

Next in order comes the second prize one, *viz.*, that of Yorkshire. This was a far more imposing display, the ground plan being similar to that of Notts, but larger in size. Here the central pyramid was nine stories high (including one tier of very tall jars), those at the corners being each seven tiers high. In the front was a very neat honeycomb design suited to the Jubilee occasion, *viz.*, the letters "V.R." and "1897" above. Along with the first prize one a good deal of the honey here was of dark colour; nevertheless the Yorks Trophy well deserved its prize, and, but for what seemed to us a great mistake in overloading the several groups of honey, especially the centre one, we think the position of Notts and Yorks would have been reversed. Curiously enough, the very *overweight* which we thought did the whole arrangement so much damage—so far as tasteful effect is concerned—was made a subject of complaint by other exhibitors as an infringement of the schedule. Anyway, to our mind, the removal of sixty pounds of honey from the stand would have greatly improved the trophy. Without having been furnished with a list of contents in this case, we are told that the honey weighed about 290 lb., and the rest of the contents included wax, mead, and vinegar. Flowers were less abundant here, but such as were shown looked well and very tastefully arranged.

Third in order follows Berks. This, to our mind, was a perfect Honey Trophy. Of decoration there was practically none. And we thought all the more of the display on that account. In form the ground plan was that of the four arms of a cross, extending to each corner of the stage, and the whole four walls of the cross, seven tiers high, was composed entirely of 1-lb. sections; and such sections as we have never seen in a single group before! They rested simply on edge, and on each other, over 169 of them, and all as good as sections could be. Starting with a simple platform of silvered glass, with which the stand was covered, the trophy had no extraneous staging; it was a trophy built up of the sections of honey which formed it; in fact, its four extending arms were simply walls of beautiful sections set on edge, and bordered with a fringe of small globe-shaped jars of light-coloured extracted honey. Every item on the stand was in the best taste, the elegant cut-glass bottles of mead and vinegar well keeping up the character of the whole. The same with the extracted honey. All of one colour and excellent in quality, but left—alas! as it turned out—to take its chance unadorned. The total weight of

honey was about 300 lb. It seems quite certain that those who set up this stand left out decoration advisedly, and certainly, as it turned out, unfortunately; for we cannot think that any bee-keeper could look on the honey staged on it without feeling that Berks was in its wrong place, so far as awards.

Fourth in order stands Kent, somewhat differing in form from those already mentioned. The honey here was arranged on a nicely constructed wooden stand enamelled white, the whole structure or pyramid being hexagonal in form with rounded corners. On each face of the hexagon appeared sections in tiers, diminishing in size upwards, some tiers having shallow frames of comb-honey along their fronts. The higher tiers were of extracted honey only, interspersed among which were bottles of mead and vinegar, along with wax in moulded cakes, a large cake of this surmounting the whole. While the honey on this stand was scarcely up to the usual Kent standard, it was by no means bad, especially that in comb. There was also a reminder of old days in the shape of a glass super on a dish—not quite a bell glass, but one with a flat top—filled with nice comb-honey. The few flowers used here were very tastefully placed.

The fifth prize trophy hails from Sussex, the dual county which, along with Kent, comprises the Kent and Sussex B.K.A. Excepting that the senior half of this Association had the best of it in comb-honey, these two trophies ran each other very close. The design in that under notice was square, arranged in ten tiers: sections, shallow-frames of comb and jars of extracted honey alternating on five of the platforms, the others being filled with jars of extracted honey. There were also several dozen nice cakes of wax arranged wherever a vacancy was seen. A neat display of flowers, tastefully disposed among the items on the several stages, completed the whole, and there was quite as much decoration as we should deem necessary. The total weight of honey was 314 lb., and, excepting about one dozen pounds, the whole was, we understand, of this year's gathering.

The only remaining exhibit singled out for recognition is Hunts, which was Very Highly Commended. This was a well thought-out and very creditable show as a honey trophy. There was, perhaps, a little too much wax in evidence, although the way in which it was applied for decorative purposes was ingenious and well done. Sheet wax formed the background for a single tier of sections placed diagonally and resting on their corners. A single row of sections, forty in all, ran round the four sides of the platform, and these, too, were bordered top and bottom with narrow strips of sheet wax. The same material, also, appeared on the four pillars supporting the top tier of sections, &c. Finally, a full-sized Royal crown, 1 ft. in diameter, also of wax, surmounted the whole. Nor was the occasion of the Royal Jubilee lost sight of here, for each

front of the trophy had a good-sized bust of the Queen in plaster overlaid with wax. This latter innovation, unfortunately, made the exhibit lose favour with the judges, some of whom were much disappointed on it being shown that the busts of her Majesty were only plaster of Paris overlaid with wax! For the rest, the Hunts trophy looked exceedingly well, and would no doubt have been placed higher up, but for the defects we have mentioned. The contents of this stand were 100 1-lb. sections, 8 2-lb. ditto; 45 2-lb., 68 1-lb., and 16 8-oz. jars extracted honey. Altogether about 282 lb. of honey, in nearly equal portions of new and old, 6 quarts honey vinegar, and 2 gallons mead. The other trophies will be mentioned in our next.

Messrs. W. Broughton Carr, J. M. Hooker, Henry Jonas, and E. G. Parker undertook the duties of judging, and made the following awards:—

HONEY.

SPECIAL COUNTY HONEY TROPHY COMPETITION.

Class 375. Best and most attractive display of *Comb* and *Extracted Honey*, and such *Honey* products as *Wax*, *Mead*, and *Vinegar*, arranged in Trophy form on a space not exceeding 4 ft. 6 in. square, by 5 ft. in height. The gross weight of the *Honey* (which may be in any form and of any year) must approximate 300 lb. (12 Entries).

First prize (£15 and silver medal), Notts B.K.A.
2nd (£10 and bronze medal), Yorks B.K.A.
3rd (£5 and bronze medal), Berks B.K.A.
4th (£3 and bronze medal), Kent B.K.A.
5th (£2 and bronze medal), Sussex B.K.A.
Very highly commended, Hunts B.K.A.

Class 376. *Twelve 1-lb. Sections* (21 entries). 1st, William Woodley, Newbury, Berks; 2nd H. W. Seymour, Henley-on-Thames; 3rd, Miss Ada Bostock, Colwyn Bay, N. Wales. V.H.C., R. Brown, Somersham, Hunts; H.C. John Stone, Cubley, Sudbury.

Class 377. *Six 1-lb. Sections* (22 entries). 1st, William Woodley; 2nd, Albert Twinn, Ridgewell, Halstead; 3rd, R. Brown. V.H.C., H. W. Seymour.

Class 378. *Twelve Sections of '96 or any previous year* (6 entries). 1st, William Woodley; 2nd, Rev. T. J. Evans, Tarvin Vicarage, Chester; 3rd, Jabez Sopp, Crowmarsh, Wallingford.

Class 379. *Twelve Sections Heather Honey* (1 entry). T. Walker, Ambleside.

Class 380. *Three Shallow Frames Comb Honey for Extracting* (18 entries). 1st, Geo. Wells, Aylesford; 2nd, John Stone; 3rd, R. Brown.

Class 381. *Twelve lb. Extracted (light) Honey in Jars* (24 entries). 1st, Jabez Sopp; 2nd, Lieut. Hawker, Longparish, Hants; 3rd, Wm. Woodley; V.H.C., Albert Twinn; H.C., Wm. Loveday, Hatfield Heath; and Wm. Pether

Henley-on-Thames; C., Miss S. J. Cooper, Leicester.

Class 382. *Twelve lb. extracted (dark) Honey in Glass Jars* (13 entries). 1st, H. W. Seymour; 2nd, E. C. R. White, Holbury Mills, Romsey; 3rd, A. J. Carter, Billingham, Sussex.

Class 383. *Twelve lb. Extracted Heather Honey of '96 in Glass Jars* (8 entries).—1st, Wm. Drinkall; 2nd, John Berry, Llanrwst; 3rd, Robt. Ness, Sproxton, Helmsley; V.H.C., R. Ness.

Class 384. *Twelve lb. Granulated Honey—any year—in Glass Jars* (25 entries).—1st, Wm. Woodley; 2nd, Lieut. Hawker; 3rd, R. Brown; V.H.C., J. H. Howard, Holme, Peterboro'; and T. Walker, jun., Howden; H.C., T. Walker, jun.; C., Jabez Sopp.

MISCELLANEOUS.

Class 385. *Bees-wax—not under 3 lb.—(17 entries).*—1st, W. H. Woods, Hemingford Grey, St. Ives; 2nd, Tom Sells, Uffington, Stamford; 3rd, R. Brown; V.H.C., T. Walker, jun.; C., E. C. R. White and J. Wilton, Newark.

Class 386. *Useful Inventions connected with Bee-keeping* (13 entries).—1st, John Howard, *British Made "Weed" Comb Foundation and Sheeted Wax*; 2nd, Jas. Lee & Son, *Improved Non-Swarming Hive*; 3rd, W. P. Meadows, *Honey Ripener and Liquefier*; H.C., Geo. Rose, Liverpool, *Transparent Honey Labels for Windows*.

Class 387. *Honey Vinegar* (6 entries).—1st, H. W. Seymour; 2nd, Rev. G. W. Bancks, Dartford, Kent; 3rd, P. Scattergood, Stapleford, Notts.

Class 388. *Mead* (8 entries).—1st, H. W. Seymour; 2nd, W. Pether; 3rd, A. Sharp, Brampton, Hunts; C., Rev. R. M. Lamb, Burton Pidsea Rectory, Hull.

Class 389. *Interesting and Instructive Exhibits connected with Bee Culture* (8 entries).—1st, W. S. Nettleton, Southport, *Aerated Water flavoured with Honey*; 2nd, Joseph Hyde, Middleton, Lancs, *Lantern Slides, Photos, &c., with Stand*; 3rd, Dr. Percy Sharp, Brant Broughton, Newark, *Lantern Slides*; H.C., Wm. Dixon, Beckett-street, Leeds, *Design in Honey-Comb*.

BEEES, HIVES, AND APPLIANCES.

Class 390. *Collection of Hives and Appliances* (6 entries).—1st and 2nd, W. P. Meadows, Syston, Leicester; 3rd, Geo. Rose, Liverpool; V.H.C., G. H. Varty, Etwall, Derby.

Class 391. *Observatory Hive with Bees and Queen* (6 entries).—1st, Thos. Richards, Church Gresley; 2nd, Wm. Dixon; H.C., Jas. Chadderton, Old Trafford, and R. Hamlyn-Harris, Hambrook, Bristol.

Class 392. *Most Complete Frame-Hive* (14 entries).—1st and 2nd, Jas. Lee & Son, High Holborn, London; 3rd, J. S. Greenhill, Wimbledon, Surrey; V.H.C., T. Lanaway & Son, Redhill, Surrey.

Class 393. *Frame-Hive for Cottagers' Use* (9 entries).—1st, T. Lanaway & Son; 2nd and V.H.C., W. P. Meadows; 3rd, G. H. Varty.

Class 394. *Honey Extractor* (7 entries). 1st and 2nd, V.H.C., and C., W. P. Meadows.

Correspondence.

The Editors do not hold themselves responsible for the opinions expressed by correspondents. No notice will be taken of anonymous communications, and correspondents are requested to write on one side of the paper only and give their real names and addresses, not necessarily for publication, but as a guarantee of good faith. Illustrations should be drawn on separate pieces of paper. We do not undertake to return rejected communications.

Communications relating to the literary department, reports of Associations, Shows, Meetings, Echoes, Queries, Books for Review, &c., must be addressed only to "The Editors of the 'British Bee Journal,' 17, King William-street, Strand, London, W.C." All business communications relating to Advertisements, &c., must be addressed to "THE MANAGER, 'British Bee Journal' Office, 17, King William-street, Strand, London, W.C."

** * * In order to facilitate reference, Correspondents, when speaking of any letter or query previously inserted will oblige by mentioning the number of the letter, as well as the page on which it appears.*

WEIGHT OF HIVES.

[2926.] The first column, headed A, gives the recent weight of the skep recorded in 2920 (page 234). The second column, headed B, gives the weight of a second skep. It is useful for comparison:—

	A.	B.
	lb. oz.	lb. oz.
June 13, 7 p.m. ...	20 14	11 10
" 14 " ...	21 15	12 7
" 15 " ...	22 13	13 6
" 16 " ...	21 14	12 15
" 17 " ...	21 10	12 15
" 18 " ...	21 7	12 12
" 19 " ...	21 6	12 14
" 20 " ...	21 1	12 12
" 21 " ...	22 0	13 15
" 22 " ...	24 6	15 15
" 23 " ...	25 12	17 9
" 24 " ...	26 13	19 7
" 25 " ...	26 9	19 4
" 26 " ...	28 6	21 1
" 27 " ...	28 3	21 2
" 28 " ...	30 3	23 1

The skep A being quite full of bees and comb, I placed an empty skep beneath it on the 14th, allowing the bees to enter both above and below; but the weight of this under skep does not appear in the figures, having been subtracted to make comparison with the previous figures more easy. On the 24th the upper entrance was stopped up with a rag dipped in carbolic solution. The reason was that the bees were clustering at the upper entrance instead of working freely. I could hear the bees working in the lower skep, but feared that the queen had not gone down. At any rate, I dislike to see bees idling outside a hive. There has been no more clustering outside, but the laden workers have lost a little

time in flying to the closed entrance and then climbing down to the lower one.

Skep B is close to skep A; it contains a swarm of June 3; on the 5th it weighed 8 lb. 5 oz.

A word—if you can find space, Messrs. Editors—about the utility of measurements. The daily record of the weight of a hive does not take up much time, and gives a knowledge about the honey flow which amply repays for it. More frequent observations take up too much time, yet, if made on occasional days, will teach enough to pay for the trouble spent on them. How interesting might be a comparison of numerous daily records made by different bee-keepers in various districts.—G. D. HAVILAND, *Warbleton, Sussex.*

SWARMING VAGARIES OF 1897.

[2927.] Shall I be trespassing on your generosity by sending you the enclosed?

I thought perhaps it would interest some of your many readers, especially those who happen to be railway men:—

A most singular experience befel a night porter on Monday, June 14, on the Midland Railway. When going on his rounds (situate between Elford and Tamworth) relamping, to his astonishment he found one of his starter signal lamps occupied by a strong swarm of bees.

Calling to some platelayers working some little distance off, a consultation was held how best to get rid of the unwelcome occupants. All of them were quite ignorant of apiculture, so were at their wits' end. Several suggestions were made and tried, but failed to accomplish the end in view. At last a happy thought (?) struck one. Being supplied with the usual cotton waste, it was dipped in the lamp oil and ignited it.

The bees were completely destroyed.

During the time of operations the signalling was done by flags in the usual way when obstructions occur.—A. A. WALKER, *Tamworth, June 21.*

THE SWARMING PROPENSITY.

[2928.] As a subscriber to your paper, I should like some information on the following:—My bees are in Langstroth hives. Notwithstanding I gave them plenty of room, shade, and full sheets of worker foundation, they cast many after-swarms. My scheme, in future, is to catch the first after-swarm, then put it right alongside the hive from which it issued, and place an "Alley" queen-trap in front of the hive from which it issued. The consequence will be that no more after-swarms will come off. The chances are that any queens which may hatch out in that hive will perish, or not become fecundated. But the bees will stay six days after the first after-swarm issued. Take the hive from which it issued, and if any queen should be still in

that hive, kill her, and unite the bees with the first after-swarm, having by this time in all probability a laying queen.

I have tried the plan of cutting out all queen cells but the best, but always seem to overlook some, as piping and quacking came in regular course, and pesky small after-swarms were the result.

Would this plan work? What are the objections, apart from having hives without laying queens?—F. DE HAAN, *Holland.*

[We do not think any queen-trap would entirely meet the case, as virgin queens have been known to pass through excluder zinc. Hives without laying queens will not answer. We should try the following:—After the issue of the prime swarm and first cast, cut out as far as possible all queen-cells and drone brood, and return the cast to the hive after twenty-four hours. We have known this to be effective. Perhaps some of our readers have had experience in this direction, and we will be glad to publish anything likely to help our correspondent.—EDS.]

Queries and Replies.

[1769.] *Queen Thrown Out after Hiving Double Swarms.*—On Jubilee day I had two swarms of bees which I succeeded in hiving in separate skeps as soon as clustered. Not requiring the two swarms I united them in the evening, placing them in a bar-framed hive. During this process I endeavoured to find one of the queens, but without success, so I left the white cloth in front of hive as per your "Guide Book." This evening (Thursday) I found the enclosed bee cast out. 1. Is this one of the queens? 2. Also what species of bee does it belong to?—E. CLEWS.

REPLY.—The queen sent is an old one, and shows evidence of being balled. It is no doubt one of the queens which accompanied the swarm. The common or native species.

[1770.] *Dealing with Skep after Swarming.*—In the second week in May I placed a skep which was well filled with bees over a hive of ten frames fitted with half-sheets of foundation. On June 12 I opened the hive and found the frames covered with bees, so I put three other frames in thinking this would be sure to prevent their swarming, but last Wednesday, to my surprise, they gave off a good swarm. I now want to know if it would be safe to remove the skep for the sake of the honey; if so, would it do to put the skep in a large box having a bee-escape in the side. If you can reply in next B.B.J. I shall be much obliged.—F. B. THOMPSON, *Boston.*

REPLY.—Seeing the possibility of some brood being still in the skep we should allow it to remain till the young queen is mated and

laying in the frame-hive; then remove the skep. To remove the latter now is to run the risk of leaving the frame-hive queenless, because it is not stated whether the latter has young brood in it or not. The condition of both skep and frame-hive should be exactly ascertained and action taken accordingly. When the skep contains nothing but honey the box with bee-escape may be used.

[1771.] *Sending Bees by Parcels Post.*—Can you, or any of your readers, kindly inform me whether it is allowed to send bees by parcel post; and, if so, subject to what regulations?—*APICULTURIST, Oxford, June 28.*

REPLY.—The Chairman of the B.B.K.A. (Mr. T. W. Cowan) waited on the postal authorities in March, 1892, for the purpose of ascertaining if bees could be sent by post, and was informed that, if securely packed, they might be sent by Parcels Post at usual rate.

THE "W.B.C." HIVE.

HOW TO MAKE IT.

(*Concluded from page 246.*)

In a recent number of the *BEE JOURNAL* or *Record*, I forget which, you were asked,

this was certainly a mistake, because by so doing the principle of ventilation without draught, which is one of the main features of the hive, would be destroyed. Am I right? * I have not found it necessary as yet to push the hive forward, never having been troubled with the bees in rushing up. Observe also that the ends of the body box and the surplus chamber are flush, this (as you recently inferred) is sometimes necessary to prevent the bees rushing up inside when manipulating body-box, by simply pushing it forward against the case. The hives are painted three coats light stone colour, the stands being dark green, and are as perfect as on the day they left the workshop. Allow me to state that to make a variation in the thickness of the wood, for the sake of a trifling difference in the size and weight, is of little moment, and is more than compensated for in having the wood of a uniform and obtainable thickness.

I have, therefore, had very great pleasure indeed in preparing these tracings and description for your personal consideration and for the benefit of your readers; and if you see anything in the tracings requiring alteration I will be very pleased to do whatever you may think



THE "W. B. C." HIVE.

With Mr. Peebles's Improved Alighting Board.

"if the hive could be pushed hard up to the outer case to prevent the bees rushing up?" and your reply was that they could be so utilised, but that some manufacturers had a piece of wood fixed across the sunk entrance for that purpose. I thought at the time that

necessary in the way of improvement, so as to make everything simple and easy to understand by an amateur joiner of ordinary intelli-

* Quite right so far as winter, but in summer it is needful to use the strip to keep bees from clustering in the space.—Eids.

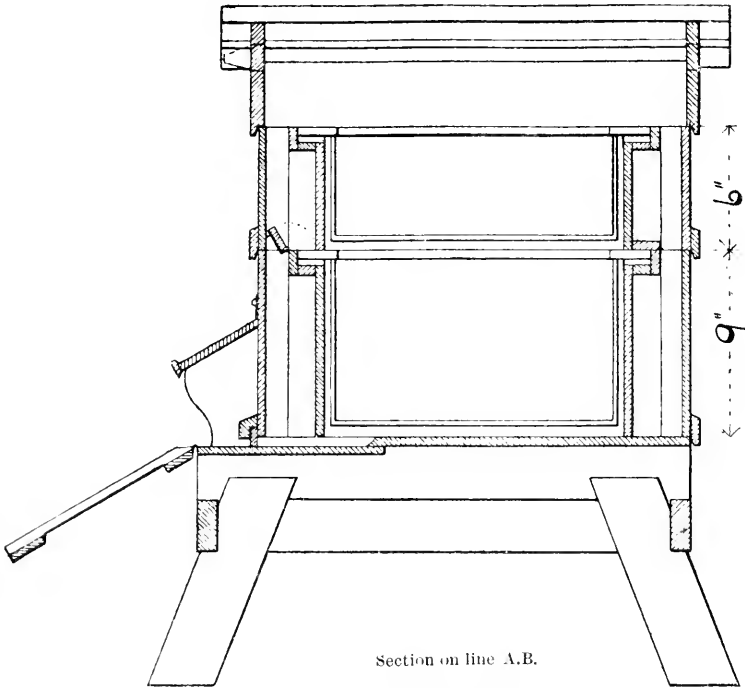

Section on line A.B.

gence. For myself, I will grudge no labour of mine thrown away, if it will help to make the

throughout the world are so various that, unless accompanied by detailed plans, mistakes will always occur. When the description and drawings of this hive were first given in the *Record*, I at once found mistakes in the measurements, not of much consequence certainly to a practical tradesman, one who could make allowance for such and also rectify them, so as to carry out the idea which you well describe in your introduction. Had you just stopped there all would have been well, but you wanted sectional drawings to explain it without the measurements, &c., in such detail, in the same way as the "Cowan" hive is illustrated in the "Guide Book." I had often the idea of supplying you with them, but was afraid to venture. The continued inquiries about it, however, and also the corresponding alterations in the measurements and details, at last fairly made me risk it, believing that after your honest confession of inability to deal with these "technical details," you would willingly give me all the assistance in your power, so that conjointly we might supply all that was necessary in the way of illustration.

Why cannot the "W. B. C." hive be made as plain as A.B.C.? *It shall!* — ROBERT PEEBLES, *India-street, Edinburgh.*

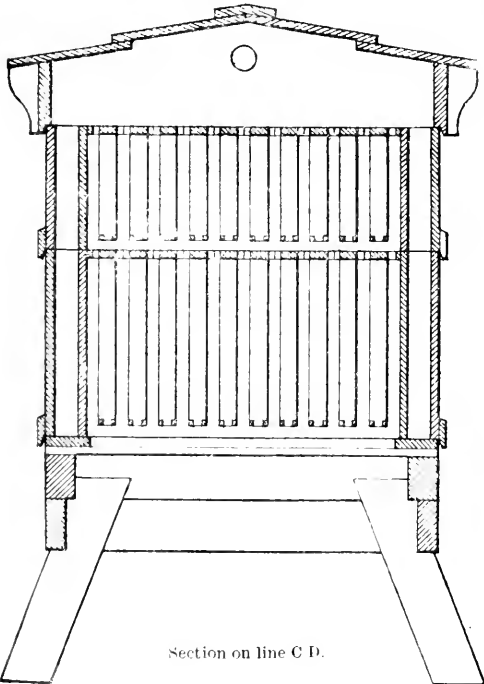

Section on line C.D.

"W. B. C." hive properly and easily understood. The technical terms used by the trade

A DOZEN QUESTIONS ON BEES.

ANSWERED BY DR. C. C. MILLER.

A young bee-keeper puts the following questions to Dr. Miller in a recent number of the *American Bee Journal*, to which we

append the Doctor's replies as given in the same paper:—

1. If a ripe queen-cell is inserted in a hive that has just cast a swarm, will the bees tear it down, or will the queen-cell hatch and the young queen tear down the remaining cells?

2. Are pure Italian drones any differently marked than hybrid drones?

3. Are drones reared from the daughter of a pure Italian queen that has mated with a hybrid drone as good as those reared from a purely-mated Italian queen?

4. How would it work to have queen-cells started in a queenless colony, and have them finished in the upper story of a colony containing a laying queen below, with a queen-excluding honey-board between, and not under the swarming impulse, as per Mr. Doolittle's plan?

5. Would a virgin queen be accepted in a colony that has just cast a swarm?

6. Is there any safe way to introduce a virgin queen to a full colony or nucleus? If so, how can I do it?

7. Are the bees of queens brought from the North to the South any more apt to be hardy than those brought from the South to the North?

8. Which will produce the best results, natural swarming or artificial?

9. Will the bees be just as gentle, as good workers, and as hardy if pure Italian leather-coloured bees are crossed with pure yellow three-banded stock or five-banded stock, as either race would be if alone?

10. Does it improve the stock to buy Italian queens from different breeders and mix them with pure Italians?

11. How can I determine as to whether a queen is bred from a purely-mated mother when she is mated with a hybrid drone?

12. Are drones bred from the daughter of a pure Italian queen that has mated with a hybrid drone as pure as those reared from a purely-mated Italian queen?—F. C., *Galt, Mich.*

ANSWERS.—1. Bees are somewhat freaky, and sometimes tear down cells of their own starting, while others are allowed to stand, but, as a rule, if you insert a queen-cell in a hive from which a swarm has just issued, it will be allowed to go on to maturity, providing it is older than any other in the hive. Whether the young queen which emerges from the cell of your inserting is allowed to kill all her rivals or be forced to issue with a swarm, depends upon circumstances, chiefly the strength of the colony. The main point in the question is that the bees will treat the cell you insert about in the same way as if it had been one of their own construction, but probably it will not be quite so sure of being undisturbed as if it had been present from the start.

2. They are likely to have more yellow on

them, but the marking of drones is not as constant as that of workers.

3. The drone is practically of the same blood as his mother, no matter what the mating may have been.

4. Sometimes all right, and sometimes all wrong. The chances of success may be increased by making the separation from the brood-nest greater. Lay a cloth or a piece of tin over the excluder, merely allowing the bees to go up through the outside perforations, or else have three or four stories, and have the cell in the upper story.

5. Generally. Perhaps always, if the "princess," as the English call her, is young enough. Indeed, a young queen just out of the cell will be accepted in any colony, even if a laying queen be present, but she will likely be killed when she is a few days old if a laying queen is present.

6. Simply take one just out of the cell, and place it right on the brood-comb among the bees. You may also succeed with one of any age, in the following manner: Make sure that there has been no unsealed brood in the hive for forty-eight hours; go to the hive just after bees have stopped flying in the evening, and quietly drop the queen on top of the frames, allowing her to crawl down.

7. The probability is that there is no difference noticeable.

8. That's a question for each one to settle for himself. On page 291 Professor Cook says: "We used to hear a good deal about dividing bees, or artificial swarming, but in these latter days I think very few attempt any increase except by natural swarming." Apparently the good Professor thinks, because little is said about it nowadays, it is little practised, a conclusion that is hardly warranted. We used to hear much about the advantage of moveable-frame hives, and nowadays little is said about it, but it does not follow that "very few" use such hives. On the very next page C. Davenport, who produces honey on a large scale, says: "In producing comb honey, instead of allowing natural swarming, I prefer dividing, or artificial swarming, and I can by this means obtain better results with less work," but he thinks the inexperienced may do better with natural swarming. Last year I made an increase of 121, and had only two or three natural swarms, one of which sailed away while I was trying to get it into the hive. Neither do I think Mr. Davenport and myself are alone in this matter. But some of our best bee-keepers prefer natural swarming.

9. I think likely, but I don't know.

10. Yes, providing you don't get inferior stock.

11. You can't do it at all.

12. If this is the same as question 3, you have the answer there. If you mean drones from a queen whose mother was impurely mated, then the drones are not pure.

Bee Shows to Come.

July 7 and 8, at Hanley, Staffs.—Horticultural Fete. Medals and liberal prizes for honey. Schedules now ready. Apply J. B. Barrow, Town Hall, Hanley.

July 15 and 16 at Sleaford.—In connection with the Lincolnshire Agricultural Society. Bee Department under the management of the Lincs. B.K.A.

Shows in connection with the Notts B.K.A. will be held as under:—**Hucknall Torkard, July 20. Entries close July 16. Southwell, July 22. Entries close July 5; and Moorgreen, September 7. Entries close August 27.**

July 24, at Fallowfield, L. and C. B.K.A.—In connection with the South Manchester Horticultural Society, schedules from F. H. Taylor, Local Hon. Sec., L. and C. B.K.A., Old Hall-lane, Fallowfield. **Entries close July 8.**

July 21, 22, and 23, at Harrogate.—Yorkshire Agricultural Society's Show. Liberal prizes for hives, honey, &c. **Entries closed.**

July 28 at Henbury.—Bristol, Somersetshire, and South Gloucestershire Annual Show. For Schedules apply to Miss Hill Dawes, Long Ashton, near Bristol. **Entries close July 21.**

July 28 and 29, at Chester.—In connection with the Great Horticultural Fete. Bee Department under the management of the Lancashire and Cheshire B.K.A. Medals and liberal prizes for honey, &c. Schedules now ready. Apply to Wm. E. Little, 1, East-gate-row, Chester. **Entries close July 19.**

July 27, 28, 29, at Gloucester.—Gloucester B.K.A., in connection with the Gloucester Agricultural Societies' Show. **Eight Open Classes.** Schedules from Dr. Grosvenor, Hon. Sec. G.B.K.A., Clarence-street; or, Mr. E. J. Burt, Assis. Hon. Sec., Stroud-road, Gloucester. **Entries close July 15.**

July 31, at Helsby.—Three open classes. Prizes (20s. &c.) for single 1-lb. jar and (10s. &c.) for single 1-lb. section. Apply Dr. Briant, Helsby, Warrington. **Entries close July 24.**

August 4, at Neston Park, Wilts.—In connection with the Atworth and District Horticultural Show. Two open classes for single 1-lb. section and single 1-lb. jar of extracted honey. Schedules now ready. J. P. Inkpen, Secretary.

August 12, at Gooles.—Annual Show of Bees and Honey in connection with the Gooles and District Agricultural and Horticultural Society. **Six Open Classes.** with good prizes, including 20s. and 10s. for single 1 lb. jar of honey (entry free in this class). Schedules from J. Luddington and H. S. White, Secretaries, Lindum House, Gooles. **Entries close August 7.**

August 13 and 14, at Dumfries.—S.S.B.K.A. Jubilee classes open to the world; schedules from Jas. Kerr, Douglas-terrace, Dumfries.

August 24 and 25, at Hastings.—Annual Show of the Kent and Sussex Bee-keepers' Association in conjunction with the Sussex County Agricultural Society. Liberal prizes. Schedules ready shortly from Henry W. Brice, Hon. Secretary, K. and S. B.K.A., Dale Park, Upper Norwood.

September 8 and 9, at Derby.—Sixteenth Annual Show Derbyshire B.K.A., in connection with the Derbyshire Agricultural Society. Nineteen classes and over fifty prizes for bees, honey, and appliances. Schedules from F. Walker, Hon. Sec. D.B.K.A., Cattle Market, Derby. **Entries close August 31.**

TRADE CATALOGUES RECEIVED.

W. P. Meadows, Syston, Leicester.—44 pages. Mr. Meadows is this year somewhat late in issuing No. 18 of his long list of catalogues. The delay is caused no doubt by a desire to introduce several useful novelties for which new engravings were required. Any-

way it is now ready, and will be found to contain everything a bee-keeper needs at prices suitable for every class. The illustrations are numerous and well executed, several being from photos, and altogether it forms a most useful list to keep for reference.

Notices to Correspondents & Inquirers.

All queries forwarded will be attended to, and those only of personal interest will be answered in this column.

A. R. H. (Winchester).—*Repeated Swarming of Swarm.*—Many cases of swarms reissuing have come to our notice this season, and we cannot account for same. It sometimes happens in the case of casts, or second swarms, that, the young queen being unmated, bees leave their hive when she goes out to meet the drones.

GEO. C. (Boarhills).—*Age of Queen.*—It is advisable to supersede queens after they reach their second year. Young queens accompanying second swarms sometimes mate at the time of swarming, but as a rule afterwards.

T. A. (St. F., N.B.).—*Signs of Age in Queen.*—1. The only signs are the general bare appearance of the insect and ragged conditions of wings, and want of pubescence. Two or three eggs in a cell is far from a sign that a queen is failing, rather the contrary, and that she is cramped for laying room. 2. The book in question is an American publication, and it can only be had of the author or from some one in America who keeps such books. The series of articles referred to appeared in these columns in 1894-5, and may be had from this office at the usual price.

F. H. K. (Rocca Green).—*Suspected Comb and Wax Moth.*—No disease in comb sent. Insect to hand is the wax-moth in the larval stage.

WILD ROSE (Govell).—*Quality of Foundation.*—The sample of foundation sent appears to us to be very good. As you say your bees have practically deserted the supers, we should suspect that they have swarmed. This should be ascertained, as there is nothing in the foundation that would, in our opinion, cause them to act as you say they have done. Bees would travel two miles from their hives to collect honey.

G. MUNDAY (Aylestone).—*Delay by Dealers in Executing Order.*—We are surprised at the contents of your letter, and regret that the dealers in questions have not executed your order more promptly.

W. B. (Herts.).—Comb is badly affected, and as "bees are weak," we advise burning the whole contents of the hive at once, with thorough disinfection of the latter before again using.

A correspondent (who gives no name), signing himself "A Working Man," is desirous of finding a good honey district within twenty miles of Charing Cross. Can any reader oblige him?

H. H. (Chippenham), A. M. K. (Midlothian), J. G. R. (Abingdon), A LOVER OF BEES (Newbury), H. V. H. (Wootton Bassett), A. W. (Cheddaw), J. H. (Heddington), T. F. B. (Loddiswell).—Samples of combs sent in the above cases were all badly affected with foul brood, and steps should be at once taken to eradicate same.

. Copies of B.B.J. for May 20 and 27 (evidently sent by some reader to a friend for perusal), have reached us through the "Returned Letter Office," marked "Not known at Wyld Green." If this meets the eye of sender it will account for non-delivery.—[EDS.]

[Referring to the large number of letters awaiting reply, we ask the indulgence of correspondents under the trying circumstances of nearly a week's absence from town at the "Royal" show. As many replies as possible will be sent by post and be received in course of a day or two.—EDS.]

Special Prepaid Advertisements.

Twelve words, Sixpence; for every additional Three words or under, One Penny.

It being impossible for us to guarantee the *bona fides* of Advertisers, it is advisable—in cases where any doubt exists—that intending purchasers should adopt the system of payment by Deposit through this Office. (This caution is inserted in consequence of occasional complaints.)

WALLFLOWERS, strong plants, 50 for 1s., post-free. HIPWELL, Woodside, Hatfield, Herts.

STRONG NATURAL SWARMS, in straw skeps, 15s. each. C. SMITH, Wheatacre, Beccles. P 96

A FEW good strain '97 English QUEENS, Fertile, 3s. 3d. free. HIGLEY, Rushock, near Droitwich. P 94

FOR SALE, 10 SWARMS, at 10s. per Swarm; packing 1s. each. A. HUNT, High-street, Ringwood, Hants. P 91

JOINERS WANTED, Bee Appliance. Constant work to good men winter and summer. WALTON, Muskham, Newark. P 92

PURE WILTSHIRE HONEY for SALE at 7d. per lb. Tins free. Sample on application to WILLIAM GEO. KNIGHT, Chisledon, Swindon. P 95

FOR SALE, "WELLS" HIVE, good as new, newly painted, cheap. MOSS, St. Master, Ravenstone-dale. P 90

SITUATION WANTED as an ASSISTANT by a young Man on a Poultry or Bee Farm. SHORT, St. Stephen's-road, Saltash, Cornwall. P 95

GIVING UP BEE-KEEPING.—Five Stocks, 2 Swarms, and Appliances, including Bee House, FOR SALE. Apply R. EMBSON, Sutton Grange, Masham. P 89

NEW ENGLISH HONEY, good quality, 7d. per lb. Tins free. 1-lb. Tie-over Bottles, 8s. 6d. doz Samples 3d. H. MAY, Kingston, Tetworth, Oxon. P 87

Prepaid Advertisements (Continued)

FINEST NEW ENGLISH HONEY, 7d. lb.; cheaper per cwt. Strong 3-frame Nuclei, 10s. 6d. Guaranteed healthy. A. TWINN, Apiary House, Ridgwell, Halstead. P 86

A FEW Healthy SWARMS to spare, 3½ to 5lb., at 3s. per lb. Also 3 "Wells" Hives, in use two seasons (foul brood unknown), with or without Bees. R. NESS, Sproxton Park Apiary, Helmsley, Yorks. P 86

FINE TESTED 1897 QUEENS of my well-known strain, 8s. 6d. each. Strong 3-frame Nuclei, with Queen, 12s. 6d. A few Swarms at 12s. 6d. each. All guaranteed healthy, and safe arrival. C. WHITING, Valley Apiary, Hundon, Clare, Suffolk. P 97

STRONG NATURAL SWARMS, English, with good '96 Queens, 12s. 6d.; packing 1s. Good Second Swarms, with young '97 Queen, 8s. 6d.; packing 6d. All guaranteed from perfectly healthy stocks. WOODS, Normandy, Guildford. P 93

SCARCE BEE BOOKS FOR SALE, all Clean and Perfect.—"Purchas on Bees," 1657, 10s. 6d.; "The Monarchy of Bees," 1721-2, by Joseph Warder, 8s. 6d.; "Thorley's History of Bees," 1743, 5s. 6d.; "Management of Bees," by Thomas Wildman, 1778, 6s. 6d.; "The Natural History of Bees," from the French, 1744, 5s.; "The Honey Bee," by Edward Bevan, 1827, 4s. 6d.; "Nutt on the Management of Bees," 1832, 3s. 6d.—THOMAS LEE, Bunker's Hill, Macclesfield. P 88

SPECIAL SILK BEE VEILS, 9d. post free. ABBOTT BROTHERS, Merchants Quay, Dublin. P 46

SUPERIOR QUEENS, Stocks, Nuclei, and Swarms. Address, Rev. C. BRERETON, Pulborough, Sussex.

WANTED, NEW SECTIONS, first quality; also Bell-glasses Honeycomb. Packages sent. Good price paid and prompt settlement. R. COLE, Southdown Apiaries, Bexhill, Sussex.

SEND FIFTEEN STAMPS for useful (half pound post free) SAMPLES of FOUNDATION, and compare with what you are using. ABBOTT BROTHERS, Merchants Quay, Dublin. P 47

21ST YEAR. PURE ENGLISH BEES. Good swarms, 10/6, 12/6, 15/-. Cases 1/-, or returned. Tested Queens, 3s. 9d. delivered. Cash with order. ALSFORD, Expert, Blandford.

BROTHER BEE-KEEPERS visiting the ISLE of MAN will find comfortable APARTMENTS at Merridale House, 5, Empire-terrace, Empress Drive, Douglas. For terms apply S. J. HORSLEY, as above.

SPECIAL OFFER. To introduce our new SECTION (fully patented 1896.) and FOUNDATION, we offer to send 24 Sections and Foundation to fit, post free 1s. 6d. ABBOTT BROTHERS, Merchants Quay, Dublin. P 45

TESTED ENGLISH QUEENS, ready in July, 5s. each, in my introducing cage. Bred from stocks selected for gentleness and honey-gathering qualities and under swarming impulse. Portage on telegrams 1s. 6d. at present. W. WOOLLEY, Beedon, Newbury.

BRICE'S RELIABLE QUEENS. Well-known strain. One quality (the best), one price. Mated Tested Queens, 5s. 6d. each; Virgins, 3s. each. Post free in my perfected introducing cage; safe arrival guaranteed. Orders executed in rotation. HENRY W. BRICE, Dale Park-road, Upper Norwood.

Highland and Agricultural Societies Show, Glasgow, July 6-9.

At Stand No. 138,

R. STEELE, Gauldry, Dundee,

Will Exhibit HIVES and BEE-KEEPING APPLIANCES, and solicits a call from all bee-keepers visiting the Show.

To effect a clearance reduced prices will be accepted during the Show week.

Editorial, Notices, &c.

THE "ROYAL" SHOW.

(Continued from page 254.)

Resuming our remarks on the exhibits in the County Honey Trophy class, we come to the three displays which received no official recognition at the hands of the judges: viz., Gloucester, Lancashire, and Somerset. The first of these, *i.e.*, Gloucester, was, so far as its form, intended to represent a sort of Grecian temple, but it bore signs of lacking the full quantity and also the quality of honey to carry out the idea properly. No doubt the bad season had something to do with this. As a matter of fact, however, we think designs of this sort never work out well. Honey in sections and glass jars, wax cakes, with honey and mead in bottles, are but poor material for shaping an architectural design, and we consider it an error of judgment to so employ them. May we be allowed to mention as an instance of this, the roofing of a temple with sheets of comb foundation as looking somewhat incongruous.

Lancashire's trophy consisted of a square upright glazed show-case, about a foot wide in each front. In this case were shown sections and jars of honey on shelves in the usual way. From each corner of the square and extending down to the extreme four corners of the stand were fixed six tiers of shelves, on which were staged extracted honey in jars, similar to the county trophy shown on page 52 of our issue of February 11 this year. Here again the honey season of 1896 and the spring of 1897 told heavily against Lancashire bee-keepers, compelling them to stage honey of such quality as gave but little chance of a prize.

Somerset only remains to be noticed, and here the design of the trophy—though very appropriate to the Jubilee occasion—was not a "taking" one. The centre of the stand was occupied by an immense Royal crown, the outline of which was formed of sections of honey laid on edge; but here, as with Gloucester, the material used did not work out well, affording another instance, if we may be pardoned for saying so, of a mistake in trying to adapt honey to an end for which it is unsuited.

This terminates our review of the Special "County Trophy Class" of 1897, and we gladly conclude a somewhat invidious task by thanking our stars that the County Trophy class does not recur every year.

Classes 376 and 377 were for sections of 1897, and, notwithstanding the untoward weather during the time earlier sections ought to have been filling, the classes for twelve and six 1 lb. sections respectively made an excellent show; all the prize ones, and several besides, being capably-finished sections for such a season.

Class 378, for twelve 1-lb. sections of any

year had only six entries. Mr. Woodley still leading as in the first-named classes.

There is as yet not much encouragement for retaining the class for heather sections at the "Royal." Why our Scotch and Northern friends don't think it worth while to save a dozen sections over a year to win such prizes as were offered here is a mystery. Anyway, Mr. Walker, of Ambleside, need not regret sending the only exhibit staged in the class (379), and carrying off the 1st prize for it.

Class 380.—*Three Shallow Frames of Comb* did not make a very noticeable show, though it had eighteen entries. The prize exhibits were fair, but not such as will be seen later on in the season.

Class 381.—*12 lb. Extracted Honey* (light coloured).—This was a good class, there being some fine samples among the twenty-four entries. Besides the three prize lots, four others received notice at the hands of the judges—a result which proves the excellence of the whole class.

Class 382.—*12 lb. Extracted Honey* (dark coloured).—The honey here was not so good all round as the previous class, none but the three prize lots receiving awards.

Class 383.—*12 lb. Extracted Heather Honey.*—This was again an easy win for the prize exhibits.

Class 384.—*12-lb. Granulated Honey.*—With twenty-five entries, this formed an excellent class, and included some first-rate samples. We think, however, that some clearer definition of what is meant by "Granulated honey of any year" is needed in order that bee-keepers—whether exhibitors or not—may know what to look for in an exhibit staged in this class. Personally, we look for honey of more remote gathering than that of the current season in a show held in the month of June. Yet, unless we are much mistaken, the second prize lot was of this year's gathering. Moreover—although granulating—it was so far liquid as to pour out of the jar in liquid form with very little difficulty, and it certainly seemed not to have lost much of the colour it had when first gathered. Anyway, we do not question the justice of the award, but only name the need for a clearer definition—as we have said—of what is meant by granulated honey?

Bee-keepers generally look for honey which has entirely lost its original colour and liquidity; in fact, which has become white and solid, and if this is proclaimed to be the view of the great majority of practical men, we feel quite sure there will be no difficulty in their having the schedule so worded that the prizes will be awarded on strictly practical lines, without reference to the chemical or scientific view of the question.

(Space compels us to hold over the notice of the remaining classes till next week.)

ERRATA.—The weight of Yorks trophy, as stated on page 252, was an error. According to the card shown on stage (which card we did not see), the weight was about 368 lb.—EDS.]

Correspondence.

The Editors do not hold themselves responsible for the opinions expressed by correspondents. No notice will be taken of anonymous communications, and correspondents are requested to write on one side of the paper only and give their real names and addresses, not necessarily for publication, but as a guarantee of good faith. Illustrations should be drawn on separate pieces of paper. We do not undertake to return rejected communications.

** * In order to facilitate reference, Correspondents, when speaking of any letter or query previously inserted will oblige by mentioning the number of the letter, as well as the page on which it appears.*

JUDGING AT THE ROYAL AGRICULTURAL SHOW.

[2929.] SIR,—I regret exceedingly that your remarks as to judging generally in your editorial, and your criticism of the awards in the trophy class, render it necessary that some reply should be made to the same.

"The change (which you say) is being brought about gradually in the matter of judging" single-handed would, no doubt, expedite matters, but whether the awards would give more general satisfaction is a great question of doubt.

You "confess to having had no great liking for" it, preferring to believe in the old adage, "In a multitude of counsellors there is wisdom," and that "individual predilections" "tend to more or less bias one man's mind"; in this all will agree. It would appear, however, that "in practice" when you find yourself in a minority you begin to see wisdom in the new arrangement of having only one judge.

It is difficult to understand how you are "upholding the just and proper principle of yielding loyally to the verdict of a majority" (in this case of three to one) when you proclaim to your readers, as you do in your criticism of a certain exhibit, that you "cannot think that any bee-keeper could look on the honey staged on it without feeling that it was in its wrong place so far as awards." Surely it would have been better taste, and more loyal, if you, having acted as one of the judges, had left out this paragraph.

The wording of the schedule is as follows:—"Class 375. Best and most attractive display of comb and extracted honey, and such honey products as wax, mead and vinegar arranged in a trophy form on a space not exceeding 4 ft. 6 in. square by 5 ft. in height. The gross weight of honey (which may be of any form and of any year) must approximate 300 lb."

When the schedule was being prepared by the Council of the B.B.K.A., it was felt that if honey alone was to decide the merits of the trophy class, the southern counties would have undue advantages, as they would be able to stage a larger quantity of this season's honey than the northern counties, and it was a question whether being thus handicapped they would enter the competition; the schedule was framed

to meet this, and the exhibits judged accordingly.

I understand that a series of photographs of the various exhibits were taken at Manchester with the object of being reproduced in the B.B.J., and I have little doubt when the pictures appear the verdict of the majority of the judges will be endorsed by your readers.—JOHN M. HOOKER, *Bedford Court Mansions, London, W.C., July 5.*

[We gladly give insertion to the above as requested "without alteration," and, we may add, without comment; except so far as gently reminding our esteemed correspondent that he is a little "too previous"—as the phrase goes—in his assumption as to the series of photographs taken at Manchester. Every one is glad to see friend Dixon with his Camera at all Shows, and we were very pleased when he presented us with photos of most of the trophies, but so far as any undertaking to reproduce them in the BEE JOURNAL there is none.

If, however, an incentive were needed to decide us to publish illustrations—of the winning trophies at least—our correspondent's reference furnishes it, and it is, therefore, more than probable that in due time they will appear in our pages.—EDS.]

"ROYAL" SHOW AT MANCHESTER.

A PROTEST TO THE COUNTY TROPHY CLASS.

[2930.] I feel, after the stand I myself, along with others interested in the County Trophy class, took on the show-ground in protesting against the decision of the judges, that some further explanation is due to both parties interested (I mean the judges and the exhibitors). The Notts exhibit was found to be nearly 20 per cent. under the requirements of the schedule, and the Yorks exhibit was 20 per cent. over the prescribed limit—a full 40 per cent. of difference between the two. These wide discrepancies from the approximate quantity required by the schedule ought to have disqualified both exhibits, if the stewards of the department had attended to their duties. Moreover, in the case of the exhibit awarded second prize, this flagrant case of overweight was marked on the card. I give due credit to the Yorks staging committee that they honestly marked down their quantity; but when we consider those in charge of the Notts trophy certifying that their stand contained a larger quantity of honey than it actually did, they must either have been lax in their counting or they certified to a deliberate lie, to screen themselves, with an insufficient quantity. The Yorks quantity, however, being before the judges' eyes, they have no excuse in this matter, and by every rule of justice to the other exhibitors, the exhibit ought to have been disqualified as a flagrant breach of the rules of the schedule.

When we remember that the finest and best exhibits at a previous "Royal" Show were disqualified, and by at least one of the judges on the present occasion, because the regulation had been exceeded by only the eighth of an inch, I was astounded to find that such flagrant breaches of the regulations should, at this meeting, be allowed to pass, and not only so, but awarded the first and second prizes! Was ever judgment more perverted? Was ever honey of the finest quality the country produces relegated to a back position in favour of a handful of maiden-hair fern before this show? The veteran judge himself told me that *quality of honey did not count!* Fancy that, ye bee-keepers! and at a "Royal" honey show, where the first word in the schedule referring to this class is the word "Best." I write from Berks, I write for Berks, and I contend that the Berks exhibit contained the grandest display of first prize honey ever staged on a 4 ft. 6 in. square table! It was the cream of cream quality.

It is evident to my mind that the judges had either neglected to read the schedule relating to the trophy classes, or failed to rise to the occasion in refusing to estimate the value of first quality honey. Ours is not the only county who have just cause to grumble, and to call on the committee and judges to disqualify the counties proved to have broken the rules and regulation of the schedule, and thus bring others into their rightful position.—
WM. WOODLEY, *Beeton, Newbury, June 26.*

WEIGHT OF HIVES.

[2931.] White clover is in full flower, and the hay is being cut and carried. Last week should have been the best of the year in this locality. The following are the weights of the hives continued from 2926 (page 254).

	A	B
	lb. oz.	lb. oz.
June 29, 7 p.m.	30 0 ...	23 2
" 30, "	32 9 ...	25 10
July 1, "	35 1 ...	27 9
" 2, "	33 8 ...	26 5
" 3, "	36 0 ...	28 5
" 4, "	37 3 ...	28 12
" 5, "	36 6 ...	28 3

July 2 was the most noticeable day; there was no rain, no sun, and scarcely any wind. The minimum thermometer the night before and the night after registered 58 Fahr., the maximum thermometer registered 62 Fahr. The bees stayed at home and hung in clusters at the entrance. In skep A not more than 3 oz. of bees were away at any one time; in skep B about 5 oz. of bees were away between 2 and 3 p.m.

The clustering outside was so great that it was clear the bees did not stay at home to keep up the temperature of the hive, nor can I believe that they stayed at home for fear of rain. I suppose that they thought the flowers

were not secreting nectar, and if this was the case, was it want of heat, or want of sunshine, which made the flowers sulky? The great loss of weight—1½ lb. in A, and 1¼ lb. in B—I attribute to the ripening by evaporation of the honey collected in the previous days.—G. D. HAVILAND, *Warbleton, Sussex, July 5.*

MAKING ARTIFICIAL SWARMS

FROM DISEASED COLONIES.

[2932.] I send you by same post a piece of comb. I shall be glad if you will inform me through the B.J. if infected by foul brood?

In the hive this was taken from, June 3, I found, on examination, what I believed to be foul brood. Knowing the queen to be three years old, I made an artificial swarm from it, with the intention of raising a young queen and letting the brood hatch out, then take the old queen away and unite. I put swarm on clean foundation and have fed with naphthol beta, putting naphthaline in both hives. The brood and young queen have all hatched out with the exception of one or two cells, as piece of comb sent. My object in writing is to be sure that I am doing right. There are still plenty of bees in the old stock, and I find to-day two combs filled with eggs and a third with the young hatched out. The swarm having now filled out ten frames of comb, I do not care to interfere by uniting, and if mistaken in my surmise as to foul brood, I should prefer to leave the old stock as it is.

The artificial swarm made	..	June 10
The young queen out	..	June 24 or 25
The eggs hatched out on one frame	..	July 3

—J. M., *Herts, July 3.*

[Comb received is undoubtedly affected with foul brood, though only, as stated, in a very few cells. In view, therefore, of what you have done and are still doing in the continuous use of preventives, we should let both the old stock and the swarm made from it continue working as they are till an opportunity is afforded of judging how the brood now being reared hatches out. This done, write us again and we will advise you further.—EDS.]

THE ABUSE OF FOUNDATION.

THE NEED FOR DRONE CELLS IN BROOD CHAMBERS.

[2933.] In these days of the wholesale use of foundation, a word seems necessary cautioning bee-men against using full sheets of foundation in all the frames in the brood-nest, thus apparently doing away with all drone comb.

In such hives drone eggs may be laid—more especially in the spring of the year—in cells intended for workers, and not only will the drones raised in these be under-developed

but the cells will be misshapen, and much annoyance is caused in operating such combs, as the projecting drone-caps, distributed here and there, are likely to be rubbed against adjoining prominent combs.

To deny the utility of drones in the hive is almost on a par with condemning frame hives, and the best drones can only be reared in regularly built drone comb.

If half a sheet of foundation be put into a frame in a hive where all the other frames contain worker comb or foundation, the lower part of this frame will be filled with drone comb in which sufficient drones will be reared for ordinary purposes. Space this particular frame wider apart by using "wide ends," placing it next to the dummy, and it will be found that there will be no bruising of brood or honey-capping in lifting the frame out, also the drones will be reared only at the season of the year when most required. If a taste of early sycamore honey is desired it can be extracted from the upper part of the comb before the supers are even put on.

I find that a full sheet of drone foundation wired into the last frame of a ten-frame hive does not produce too many drones, and I like to see that any colony, the strain of which I wish to perpetuate, has it. It is a good plan to paint the projecting shoulder of a frame containing drone comb, black, but wide ends, if used, would mark it sufficiently.

This matter is, perhaps, of more importance than might appear, and one which might affect not only individual bee-keepers, but the craft at large, for should our queens learn to lay worker and drone eggs promiscuously in worker cells, as the British wasps do—*Apis dorsata* is also said to do it—foundation would lose one of its chief uses, namely, the regulation of the production of drones in a hive—a very important check which we should be sorry to give up.—F. W. L. SLADEN, *Ripple Court, Ringwood, Dover, June 24.*

[There can, of course, be no great harm in allowing bees one half of a single frame in each brood chamber for drone rearing as suggested, but, seeing that a half-inch of space is usually allowed between the lower edge of the full sheet of foundation and bottom bar of frame, it is generally considered that this is a sufficient space for allowing the bees to follow their natural tendency to have some drone cells in their brood chamber.—EDS.]

SWARMS DESERTING THEIR HIVES.

[2934.] During the last forty-eight hours I have had what I think must be a unique experience in the bee-keeping line. I bought a swarm, which arrived in a wooden tub; net weight of bees, 4 lb. I transferred them on arrival to a bar-framed hive, fitted with full sheets of foundation, the centre frame being full of brood taken from another hive. In less

than half an hour the bees all cleared out, and swarmed in two or three bunches on a neighbouring plum-tree. I shook them off into a straw skep, and again attempted to hive them, but they again absconded, and, to make a long story short, they have been doing the same thing six times during the last two days. My idea is that they are without a queen; so, acting upon this theory, I gathered up the remnants (about 3 lb.) this evening, and, with a plentiful dredging of flour, united them to my weakest hive, in which I knew "Her Majesty" was present. I have since heard that a neighbour of mine has had a somewhat similar experience, but, less fortunate than myself, after hiving the swarm three times they took themselves off, and were "lost to sight and memory dear." I should be glad if you could tell me whether you think I am right in supposing that these swarms were without a queen, or whether "Her Majesty," if present, was suffering from temporary insanity.—ROBERT KING, *June 30, 1897.*

P.S., July 1.—The bees united last evening are all right this morning.

[The natural inference is that the swarm was queenless. It is a remarkable peculiarity of the present season that swarms have nearly everywhere shown a quite unusual unwillingness to settle down in the hives given them. Never before do we remember so many instances of this having occurred. Perhaps other readers may have had similar experiences. If so, it would be useful to have them recorded.—EDS.]

(Correspondence continued on p. 266).

HOMES OF THE HONEY BEE.

THE APIARIES OF OUR READERS.

From Beds to the Isle of Man is a long flight, even in a bee-line, and this week we present the unpretending little apiary of Mr. Thos. Faragher, situated partly within the boundary of Douglas, Isle of Man. The place will be known to visitors to the island as Faragher's Strawberry Gardens, on the Peel-road. Mr. Faragher, whose figure is seen in the picture, followed the business of a market-gardener, and had his shop at the entrance to his gardens, where, along with fruit and flowers, he disposed of the produce of the apiary; and, as he says, "I never had trouble in selling my honey; in fact, I always had orders beforehand for the greater part of it." This is but another case proving how the possession of a little business aptitude helps those who help themselves—in bee-keeping anyway. And this is how Mr. Faragher does it. He says:—"I was always careful about my honey; never extracting till the combs were sealed over. I also used one shape of tie-over jar with a simple label. A few jars of honey were shown in my window, and a card which read: 'Pure honey from the hives in these gardens.'" In view of the neat appearance of

the few hives shown in the photo., we may say they are all made by our bee-keeper himself, as were the supers and section-racks, though only an amateur joiner. Placed close under the hill, seen rising in the background of the picture, with the honey and work-room partly cut off on the right, the whole shows just the neatness and trimness which bespeaks the true bee-man.

Mr. Farragher furnishes us with a few particulars regarding himself as follows:—

“I began to keep bees in the year 1883, and have been fairly successful with them. Without keeping any accurate record I have been perfectly satisfied with the general results. I have secured surplus up to 100 lb. off one hive

rasps, apple trees, are grown in plenty. There are also plane trees about, and the fields are at times yellow with “charlock,” or wild rape. I think that every market gardener ought to keep a few hives if only for the sake of his fruit trees. My gooseberries never failed to have a fine crop unless it was damaged by the frost.”

He further goes on to say:—“When I began to keep bees, I bought a skep and sent for Cowan’s “Guide Book,” and from the instructions in it made two frame hives. When the bees in skep swarmed, I put the first in one frame hive; and after the second swarm had issued I cut the skep in two, cut out the combs, and tied them in the frames with tapes



MR. THOS. FARRAGHER'S APIARY, DOUGLAS, ISLE OF MAN.

in one season. This is considered very good for the Isle of Man. I generally kept about eight or ten stocks, and worked the best one for sections; running the others for extracted honey. I never sold any other honey save that gathered by my own bees. In this way I have sold £16 worth in a season, to say nothing of a liberal use of honey at home and for giving away to workers and friends. I considered that was a very nice little thing towards expenses for seed, &c., in my gardens. I sold at 1s. per single jar, or 10s. per dozen, sections same price. The chief source of honey in the district is white clover, and the many small gardens close to where gooseberries,

and placed them in the second hive I had made. They did fairly well and gave me some surplus honey. The following winter I made other three hives, and gradually increased my stock by making more as the chance offered. I never had many swarms, for as soon as I found the tops of the combs getting white I put on supers. I never had a swarm come off to my knowledge after the surplus chambers were put on. There are always some wet days in the winter when it is a real pleasure to have a little joinering to do, and this is what made me my own hive maker. I made fifteen hives in all, but the highest number of stocks I kept was eleven at one time, because, as my

gardens were open to the public a large apiary would have been inconvenient.

"I would not recommend a beginner to go in for keeping many hives at first until he has gained experience with bees. All the information I possess about bees, such as it is, is due to the *B.B. JOURNAL* and Cowan's 'Guide Book.'

"I was thirty-seven years old when I began bee-keeping, so that younger men need not be frightened at starting late in life. I believe in everything about bees being well done. I have often been amused about leaky roofs—never having had any such."

CORRESPONDENCE.

(Continued from page 264.)

BELL-GLASSES ON SKEPS.

[2935.] Having cut a hole in the crown of my skeps and stood on each a bell-glass, I now find the bees are building their comb from out of the hole I cut in the skep up into the centre of the glasses, instead of commencing from the crown of the glasses as I intended they should. I fixed some strips of comb foundation across the crown of each glass by means of strips of wood, but the bees have taken no notice of this. In one instance they have not started comb-building in the glass at all, although it has been on since June 26 (the stocks appear strong and heavy). Is it too much to ask for your help in advising me so that I can get some glasses nicely filled with honey? And how long ought they to be filling a glass holding 10lb.?—*"STRAW," Kent, July 3.*

[Bell-glasses worked on straw skeps (especially dome-topped ones) should always be set on a platform of thin board cut to size of glass. These "adaptors," as they are called, enable the bee-keeper to remove the glass when full without breaking the combs; and, unless used in this kind of bee-work, all kinds of mischief follows at times. It is not uncommon for bees to carry the combs upward as described above, but if the bell-glass is covered by a warm "cosy," such as is used to keep the teapot warm, the bees will take full possession of the glass and soon find the guide-comb fixed above for them to build from. June 26 however, is too late to place bell-glasses on skeps in Kent. They should have been put on at least a month earlier. We have known a 10-lb. bell-glass to be filled in four or five days, or less in a good season.—*EDS.*]

SWARMING VAGARIES OF 1897.

[2936.] Referring to your correspondent Mr. Walker's description of "Swarming vagaries" (2927, p. 255) in last week's *B.B.J.*, you may be interested to hear that about a fortnight ago, two swarms took refuge in signal lamps on the Midland railway, distant about a quarter of a mile from each other, between Bedford and

Oakley stations. I was informed that they were both destroyed by the aid of sulphur fumes after some difficulty, there being no bee-keeper at hand to hive them in a proper manner.

Another (rather amusing?) incident occurred on June 25 in a private house in this town:—A gentleman was taking an afternoon nap in his bedroom when he was suddenly awoken by a smarting pain in one of his toes (I presume he had his boots off). Glancing round the room he found it to be full of bees. On getting up he discovered that a swarm had taken possession of the chimney. Having obtained assistance he proceeded to destroy the lot with the aid of brimstone. You may imagine my disgust on hearing of this destruction of the poor bees, as I am an enthusiastic bee-keeper myself and anxious to increase my apiary.—*E. THARP, Bedford, July 3.*

WEATHER REPORT.

WESTBOURNE, SUSSEX, JUNE, 1897.

Rainfall, 3.23 in.	Sunless Days, 2.
Heaviest fall, .77 on 9th.	Below Average, 19.7 hours.
Rain fell on 14 days.	Mean Maximum, 65.8°.
Above average, 1.55 in.	Mean Minimum, 51.5°.
Maximum Temperature, 77° on 24th.	Mean Temperature, 58.6°.
Minimum Temperature, 42° on 19th.	Above average, 0.9°.
Minimum on Grass, 37° on 2nd.	Maximum Barometer, 30.43° on 11th.
Frosty Nights, 0.	Minimum Barometer, 29.57° on 18th.
Sunshine, 206.6 hours.	
Brightest Day, 13th, 15.2 hours.	

The honey crop so far has been only moderate, but we have great hopes from the limes, which promise well.

L. B. BIRKETT.

Queries and Replies.

[1772.] *Queen Killed in Manipulating Frames. — Packing Bees for Rail Transit.*—I made an artificial swarm on June 3 from a strong colony of bees. I left the parent hive to rear its own queen, which they did, and, on examining the combs on June 26, I found she had commenced to lay. Yesterday (July 3) I examined the hive again, and, to my horror, could see no sign of a queen. There was one frame at the back partially covered with sealed brood, and that was all I could find. From this I conclude the queen must have disappeared some days ago. In all probability I killed her accidentally on the 26th. 1. Is it too late in the season for them to rear a queen, so that the hive would have enough bees in it through the winter; or would it be better to

introduce a fertile queen? 2. Who is the best dealer to get one from? In the meantime, I have supplied the hive with a frame of comb containing eggs. I am leaving this district at the end of September. 3. Could you tell me the best way to travel stocks of bees by rail?—E. A. T., *Bedford, July 4.*

REPLY.—1. Not too late, but for the future well-doing of the colony it would be far better to introduce a fertile queen at once, unless the bees are raising a queen from eggs given. 2. Our rule is not to recommend special dealers. Consult our advertising pages, and use your own discretion. 3. Our monthly, the *Record* of May last, contains very full instructions on packing bees for travelling by rail, and will be sent post-free for 2½d. in stamps.

[1773.] *Hybridising or Cross-breeding among Bees—Brood in Sections.*—Would you kindly answer the problems below in your excellent paper. 1. How can I prevent my bees from becoming hybridised, or in other words, how can I keep my Ligurians pure? Three years ago I invested in a pure Ligurian swarm from a good firm, and gave 25s. for it. This year I am selling swarms to the same firm, and on receipt of my first swarm they told me the bees were no longer pure, but twice crossed with English bees, and their value gone down in proportion. I am told the virgin queens left in hive to hatch out after a swarm leaves, mate with any drone they meet on their marital flight. 2. Why do they not mate with pure Ligurian drones in the same apiary, in hives all round them, and how can I cause them to do so? Could I insert drone comb on the verge of hatching in their hive, or could I hatch out queen-cells in nucleus hive, and then introduce drones? I can find no help in bee books on this subject of hybridising. 4. How do the big bee breeders keep all their varieties pure, running, as they do, about five kinds of bees in the same apiary? Now I have never kept any but Italians (Ligurians), and have taken all the swarms myself. 5. If I breed my own queens, how am I to get them purely fertilised? Should I re-queen all this autumn? Hints on queen-raising, or names of useful books, would be gratefully received. 6. This year I find in four of my hives quite half of the sections are filled with drone-brood. What is wrong? They have ten brood-frames, and the bees were fed in the spring, about 5 lb. syrup being given to each hive. Has the queen got crowded out? What course should I pursue to prevent this, and what shall I do with the spoilt sections? The bees have never done this in any former year. They were late in swarming.—L. M. C., *Heathfield.*

REPLY.—1. There are no means of keeping races of bees pure in this country. What you were told regarding virgin queens mating is quite true. 2. The natural tendency is to seek a mate from an alien colony, thus reducing the risk of deterioration by in-breeding. This is

one of the wise provisions of nature. 3. None of the plans proposed above for keeping your Ligurians pure will be of any use whatever, and bee books afford no help in the matter because no help is possible. 4. Reliable firms who supply pure bees breed only from pure imported queens or "mother bees." 5. The only way of supplying swarms of pure Italians will be to re-queen all stocks kept for swarms with pure imported queens. 6. It is often said that queen-excluder is not needed when working for section honey, but this year's experience has proved to many readers—who have had the same complaint—that to be quite safe from brood the queen must be prevented from entering sections by excluder zinc. The building of drone-comb in sections is sometimes an irresistible attraction to the queen in her anxiety to produce drones on the approach of the swarming season. 7. The only sure preventive against brood in sections is excluder zinc. So far as the spoilt sections, the comb filled with drone brood should be burnt, unless the larvæ can be given to chickens as food.

[1774.] *Foul-brood and Swarming.*—I write to ask if you will kindly give me your opinion concerning one of my stocks of bees. It is in the centre of a row of seven equally strong stocks, and is in a frame-hive. On June 3 it threw off a very strong swarm while the hive was supered with a rack of 21 1-lb. sections nearly full. I examined the brood-chamber on June 22 and find there is foul-brood very bad on five frames. I also saw one queen-cell ready for hatching out, but I can find no brood whatever besides. Do you think it advisable to try to cure the stock, as the bees are very strong at present? or had I better make away with them? I am only a cottager with a few stocks and wish to do the right thing. I cannot understand the stock having only one queen-cell and no other brood whatever on the hive?—C. H., *Droitwich.*

REPLY.—The length of time (nineteen days) intervening between date of swarm issuing and the finding of a sealed queen-cell on June 22 makes it certain that the cell was either empty or contained a dead larva. It also quite accounts for there being no young brood in the hive. We would, however, much like to see a sample of the dead brood in comb supposed to be "badly affected" with foul-brood. Nothing short of this will afford us a chance of advising properly as to what is best to be done. By the time this appears in print there will either be a young queen in the hive or the stock is queenless; no great harm, therefore, will be done by allowing the bees—stated to be very strong in numbers—to finish the lack of sections before being dealt with as a diseased colony. We therefore hope to have a sample of comb sent by early post.

[1775.] *Swarm Working Down from Skep into Frame-Hive.*—I have just hived a swarm of bees—purchased in a straw skep—by placing

the skep above frames of brood-chamber in a frame-hive, with a quilt having a hole in it between. My intention is to allow the bees to establish themselves in the brood-chamber of the frame-hive and then drive them down from the skep into the hive below by perforating the top of same and smoking them. When the bees are driven down I propose to put sheet of excluder zinc between bar-frames and the skep, so that the bees may go up and hatch out the brood, and then fill with honey. (1) Kindly advise me how long you consider the bees should take to work out the foundation in brood-chamber ready for the queen? and (2) if the method of driving them down from the skep is feasible? My knowledge of the management of bees is purely theoretical, and culled from Cowan's very explicit "British Bee-keepers' Guide-book.—D. G., *Ulmster*, June 24.

REPLY.—Before answering query No. 1, we suppose it to be presumed that the swarm had been several days in the skep when purchased; otherwise, we cannot account for not hiving the swarm into the frame-hive in the usual way. This being so, it is impossible to name a date when the bees may be expected to have worked out the foundation in lower hive ready for the queen. If the season be not a very good one in the district where our correspondent is located, it is quite probable that the swarm may not take full possession of the frame-hive at all this year, so far as making it their brood-chamber. It is not at all uncommon for a swarm—hived when June is more than half over—to do no more than fill its skep with comb, &c., the first year. Hence our uncertainty as to what may follow. 2. If the bees really do need room and work down below they may do so, but on no account do we advise smoking them down and setting on excluder to prevent the queen from re-entering her present brood-chamber, *i.e.*, the skep. Leave on the skep, therefore, just as it is, and see how matters stand a fortnight hence, then write us again.

[1776.] *Bees Refusing Section and Swarming.*—On May 29 last I placed a section rack on my hive, which at the time was very strong both in bees and stores. They not only refused to work in sections, but to my great surprise turned out a very large healthy swarm at mid-day to day. Can you explain this? The section rack was perfectly new, clean, and fitted with comb foundation.—A. B., *Stetchford*.

REPLY.—Bees will at times act as in the above case, and it is utterly impossible to give the why and wherefore of their so acting. The point to be aimed at in giving surplus-chambers is to make them as attractive to the bees as possible in order to induce them to take possession and start work therein. In other words, they need to be well covered with warm material, and every chink—by which cold air can get in from the outside—carefully stopp'd up. A cold, draughty surplus-chamber

will often be avoided by bees even when they are quite strong enough in numbers to take immediate possession of a cosy warm one.

[1777.] *Bees Transferring Themselves from Skep to Frame-Hive.*—Many thanks for your reply on p. 237 of B.J. of June 17. I do not think help can be got in the neighbourhood, so I expect the bees in roof referred to will be destroyed. On May 1 I put a skep over the top bars of a frame-hive in order to allow the bees to transfer themselves to the hive below, and I thought to allow them to store their surplus honey in the skep, and so ask:—How long should I leave it on, in view of the fact that the bees are clustering about the entrance on warm days and sometimes hang in a great bunch underneath the alighting board? Do you think the bees require more room? They have ten frames, all drawn out, but the stock in the skep seemed a very strong one. Would you kindly tell me what I had better do, as I don't want a swarm?—E. P. C., *Evercrech, Bath*.

REPLY.—The fact of the bees clustering outside, as stated, in warm weather makes it probable that some ventilation is needed, as well as tending to show that another surplus chamber may be required. We should lift off the skep and see to the condition of combs in lower hive without delay, taking such measures as may be deemed needful after inspection. If more storing room is required and honey is still coming in, set a box of shallow-frames between skep and lower hive.

[1778.] *Swarm Repeatedly Leaving Hive.*—Will you kindly inform me in your next issue the cause of bees swarming last Saturday, the 26th inst., and again twice yesterday, Sunday, the 27th inst., out of a bar-framed hive; and also if I did right in taking the two queens away and letting them go back again to the hive?—W. P. J., *Saebly*, June 28.

REPLY.—Without your having stated that the stock referred to had already thrown off a top swarm eight or nine days prior to June 26, we should suppose—from what took place afterwards—that it had done so. Consequently the swarm which came off on the date named was a second swarm, and that of the 27th a third swarm or cast. In any case, so long as there was a young queen left behind there could be no more harm in taking away young queens, and allowing bees to return to the parent hive, than the risk of your having removed a better queen than the one left. In order to do away with this risk, it would have been better to hive the swarm and return it very early next morning, leaving the young queens to fight it out among themselves for supremacy, thus securing the survival of the fittest.

[1779.] *Honey from Diseased Stock.—Utilising Driven Bees.*—1. What can be done with honey from a stock believed to be affected with foul brood? The bees in this

hive are very strong, and cover ten frames. Can it be used for feeding bees if boiled, or is it wholesome for human consumption? 2. Can you tell me an easy way for a cottager to take a rack of sections off a hive without bees in them? 3. I can get a lot of driven bees in autumn, and so I ask—Is there any advantage in uniting them with good stocks? Would they be stronger in the spring?—D. D., *Tiverton*.

REPLY.—1. As the honey is quite suitable for general household use, we would not risk giving it back to bees as food, even if boiled. 2. Use a super clearer. 3. If queens need renewing, and young queens can be got with driven lots, it is a good plan to utilise driven bees as proposed. Otherwise, we hardly think the results are sufficiently advantageous to make it worth the trouble involved.

Bee Shows to Come.

July 15 and 16 at *Sleaford*.—In connection with the Lincolnshire Agricultural Society. Bee Department under the management of the Lincs. B.K.A.

Shows in connection with the Notts B.K.A. will be held as under:—*Hucknall, Torkard*, July 20. Entries close July 16. *Southwell*, July 22. Entries close July 5; and *Moorgreen*, September 7. Entries close August 27.

July 24, at *Fallowfield, L. and C. B.K.A.*—In connection with the South Manchester Horticultural Society.

July 21, 22, and 23, at *Harrogate*.—Yorkshire Agricultural Society's Show.

July 28 at *Henbury*.—Bristol, Somersetshire, and South Gloucestershire Annual Show. For Schedules apply to Miss Hill Dawes, Long Ashton, near Bristol. Entries close July 21.

July 28 and 29, at *Chester*.—In connection with the Great Horticultural Fete. Bee Department under the management of the Lancashire and Cheshire B.K.A. Medals and liberal prizes for honey, &c. Schedules now ready. Apply to Wm. E. Little, 1, East-gate-row, Chester. Entries close July 19.

July 27, 28, 29, at *Gloucester*.—Gloucester B.K.A., in connection with the Gloucester Agricultural Societies' Show. Eight Open Classes. Schedules from Dr. Grosvenor, Hon. Sec. G.B.K.A., Clarence-street; or, Mr. E. J. Burt, Assis. Hon. Sec., Stroud-road, Gloucester. Entries close July 15.

July 31, at *Helmsby*.—Three open classes. Prizes (20s. &c.) for single 1-lb. jar and (10s. &c.) for single 1-lb. section. Apply Dr. Briant, Helmsby, Warrington. Entries close July 24.

August 2 and 3, at *Swansea*.—Glamorgan B.K.A., in connection with the Glamorganshire General Agricultural Society. Schedules from E. Thornton, Hon. Sec., Bridgend, Glam. Entries close July 12. The annual general meeting of the G.B.K.A. will be held in show grounds, on August 3.

August 4, at *Neston Park, Wilts*.—In connection with the Atworth and District Horticultural Show. Two open classes for single 1-lb. section and single 1-lb. jar of extracted honey. Schedules now ready. J. P. Inkpen, Secretary, Atworth, Wilts.

August 10 and 11 at *Burton-on-Trent*.—Staffs. B.K.A. In conjunction with the Staffordshire Agricultural Society. For full particulars see advertisement on page 270. Schedules from Ellis E. Crisp, Secretary S.B.K.A., Meaford Cottage, The Hough, Stafford. Entries close July 17.

August 12, at *Goole*.—Annual Show of Bees and Honey in connection with the Goole and District Agricultural and Horticultural Society. Six Open Classes, with good prizes, including 20s. and 10s. for single 1 lb. jar of honey (entry free in this class). Schedules from J. Luddington and H. S. White, Secretaries, Lindum House, Goole. Entries close August 7.

August 13 and 14, at *Dumfries*.—S.S.B.K.A. Jubilee classes open to the world. Schedules from Jas. Kerr, Douglas-terrace, Dumfries.

August 24 and 25, at *Hastings*.—Annual Show of the Kent and Sussex Bee-Keepers' Association in conjunction with the Sussex County Agricultural Society. Liberal prizes. Schedules from Henry W. Brice, Hon. Secretary, K. and S. B.K.A., Dale Park, Upper Norwood.

September 8 and 9, at *Derby*.—Sixteenth Annual Show Derbyshire B.K.A., in connection with the Derbyshire Agricultural Society. Nineteen classes and over fifty prizes for bees, honey, and appliances. Schedules from F. Walker, Hon. Sec. D.B.K.A., Cattle Market, Derby. Entries close August 31.

Notices to Correspondents & Inquirers.

All queries forwarded will be attended to, and those only of personal interest will be answered in this column.

EDWD. WILLIAMS.—1. A swarm is not a swarm without a queen accompanying the bees. 2. If the hive is in condition for supering, and honey is so abundant, as stated, give a rack of sections at once. You cannot have both increase and honey from a swarm in its first year.

M. M. (High Wycombe).—1. Your sample of comb must have missed in post. We have no trace of it. 2. Extracted honey for exhibition should, where possible, be of pale golden colour. To be of thick consistency is a strong point in its favour rather than a defect.

E. THARP (Bedford).—*Supposed Dead Queen Cast Out*.—The queen sent is a fine one, and was not dead, as you supposed; in fact, the application of a little warmth, by holding her between our warm hands, caused her to revive sufficiently to stand on her legs. We cannot see any outward marks of damage, but there may be some internal injury not perceptible by the eye. Nor can we be sure that she would have revived if attended to. However, as we chanced to have a dozen or so of live bees in a cage—sent for inspection—we “introduced” your queen to them, and she was “accepted” by the queenless ones quite kindly.

W. R. (Newport).—*Bees Refusing Foundation*.—There is nothing in foundation received which should make bees refuse to work on it. We rather think the cause must be attributed to lack of honey income, bees not numerous enough, or some fault in management, such as the want of warm packing enough to make the surplus chamber attractive to the bees as a store room.

J. HERROD (Sutton-on-Trent).—We have made the desired alteration, as will seen in “Shows to Come” this week.

M. B. (Bishop's Stortford).—No. 1 is chilled brood only. Nos. 2 and 3 have each slight but distinct signs of foul brood.

S. DANIEL (Wymondham).—Comb contains nothing worse than newly-gathered pollen and a little honey.

YOUNG DEVON and E. THOMAS.—Foul-brood just developing in comb sent.

J. K. T. (Woodland), T. PUTTEN, and “WIS-TONIAN.”—All three samples are affected with foul brood, and we are glad to know that in the two last ones the bees have been burnt. We hope J. K. T. will do likewise.

Special Prepaid Advertisements.

Twelve words, Sixpence; for every additional Three words or under, One Penny.

HEALTHY QUEENS, 3s. 6d.; Nuclei, with Queens, 5s. 6d. BEETAL, 80, Northhill, Highgate, London. R 9

WANTED, CYLINDER HONEY EXTRACTOR. State price, make, &c. A. BAYLEY, Worsley, Stour-bridge. R 7

STRONG HEALTHY 3-frame (wired) Nuclei, with Queen, 12s. 6d. Safe arrival. GAMBRILL, Bagshot-road, Ascot. R 6

FOR SECTION HONEY, finest quality, perfectly worked. Apply E. PHILPOTT, Bedford-road Apiary, Hitchin, Herts. R 2

FOR SALE, HEALTHY STOCK, in Frame Hive, also Jubilee Swarm. W. BURGESS, Stanley Villa, Sutton, Surrey. R 2

SPLENDID NEW HONEY 6d. per lb. carriage paid, This returnable. Sample free. For cash. A. COE, Ridgewell, Halstead. R 4

FOR SALE, guaranteed healthy SWARMS, 11s. 6d.; 1897 Queens, 3s. 6d. each. W. HORSLEY, Scarborough, Norton, Malton. R 4

FINE TESTED 1897 QUEENS of my well-known strain, 3s. 6d. each. Strong 3-frame Nuclei, with Queen, 12s. 6d. Guaranteed healthy, and safe arrival. C. WHITING, Valley Apiary, Hundon, Clare, Suffolk. R 3

QUEENS reared under the swarming impulse from imported Italian mothers, and mated to native drones, 4s. post-free. 3-frame Nuclei, with Queen, 10s.; prompt despatch. All stocks guaranteed healthy, SALMON, 2nd Class Expert, Hardwicke, Gloucester. Stamp for enquiries. R 8

WALLEFLOWERS, strong plants, 50 for 1s., post-free. HIPWELL, Woodside, Hatfield, Herts. R 4

SPECIAL SILK BEE VEILS, 9d. post free. ABBOTT BROTHERS, Merchants Quay, Dublin. P 46

SUPERIOR QUEENS, Stocks, Nuclei, and Swarms. Address, Rev. C. BRERETON, Pulborough, Sussex. R 4

FINEST NEW ENGLISH HONEY, 7d. lb.; cheaper per cwt. Strong 3-frame Nuclei, 10s. 6d. Guaranteed healthy. A. TWINN, Apiary House, Ridgewell, Halstead. R 1

WANTED, NEW SECTIONS, first quality; also Bell-glasses Honeycomb. Packages sent. Good price paid and prompt settlement. R. COLE, Southdown Apiaries, Bexhill, Sussex. R 4

SEND FIFTEEN STAMPS for useful (half pound post free) SAMPLES of FOUNDATION, and compare with what you are using. ABBOTT BROTHERS, Merchants Quay, Dublin. P 47

21ST YEAR. PURE ENGLISH BEES. Good swarms, 10/6, 12/6, 15/-. Cases 1/4, or returned. Tested Queens, 3s. 9d. delivered. Cash with order. ALSFORD, Expert, Blandford. R 4

BROTHER BEE-KEEPERS visiting the ISLE OF MAN will find comfortable APARTMENTS at Merridale House, 5, Empire-terrace, Empress Drive, Douglas. For terms apply S. J. HORSLEY, as above. R 4

SPECIAL OFFER. To introduce our new SECTION (fully patented 1896.) and FOUNDATION, we offer to send 24 Sections and Foundation to fit, post free 1s. 6d. ABBOTT BROTHERS, Merchants Quay, Dublin. P 45

TESTED ENGLISH QUEENS, ready in July, 5s. each, in my introducing cage. Bred from stocks selected for gentleness and honey-gathering qualities and under swarming impulse. Postage on telegrams 1s. 6d. at present. W. WOODLEY, Beedon, Newbury. R 4

BRICE'S RELIABLE QUEENS. Well-known strain. One quality (the best), one price. Mated Tested Queens, 5s. 6d. each; Virgins, 3s each. Post free in my perfected introducing cage; safe arrival guaranteed. Orders executed in rotation. HENRY W. BRICE, Dale Park-road, Upper Norwood. R 4

THE NORTH RIDING YORKSHIRE BEEKEEPERS' SUPPLIES.

Straw SKEPS, Bar-Frame HIVES, the British make "WEED" FOUNDATION, Split-Top SECTIONS, Screw-Cap HONEY BOTTLES, STOCKS, SWARMS, NUCLEI, QUEENS, &c.

Catalogues free.

ROBERT NESS,
Sproxtton Park Apiary, Helmsley, York.

AUGUST 10th and 11th, at BURTON-ON-TRENT.

ANNUAL SHOW OF THE STAFFORDSHIRE B.K.A.
IN CONJUNCTION WITH THE STAFFORDSHIRE AGRICULTURAL SOCIETY.

COLD, SILVER, AND BRONZE MEDALS, AND LIBERAL MONEY PRIZES.
16 Classes, including Open Classes for SECTIONS and EXTRACTED HONEY.

Schedules from ELLIS E. CRISP, Secretary S.B.K.A. Meaford Cottage, The Hough, Stafford.

Entries Close July 17th.

SPECIALITIES, 1897.

Transparent Waxed Paper Section Wrappers, Gilt Section Bands, 1s. per 100.
16-oz. Screw-Top Honey Bottles, 2s. doz.
Natural Swarms, 12s. 6d.

LISTER & TAYLOR,

HATHERSAGE, SHEFFIELD.

To Sheffield, Rotherham, and District Bee-keepers.

BAR-FRAME HIVES, STRAW HIVES, Extractors, "Weed" Foundation, Sections, &c.

SCREW-CAP HONEY BOTTLES,
16-oz., 12s. 9d. for 10 dozen; 7-oz., 7s. for 6 dozen can be obtained at

Garnett Brothers, 29, High St., Rotherham.

BEE HIVES AND APPLIANCES,

With all the Latest Improvements,
Including the 'Wells' Hive, 'W.B.C.' Hive, &c.
Hives, complete, from 10s. 6d. each.

1896. PRIZES AWARDED DURING 1896
at St. Albans, Longton, Shrewsbury, Moorgreen, and Derby.

Illustrated Catalogue Post Free.

G. H. VARTY, ETWALL, NEAR DERBY.

WEBB BROS., BEE + HIVE + MANUFACTURERS, MAIDENHEAD, BERKS.

SPECIAL HIVE, 10s. 6d. Cottager's Hive, 6/6; in the flat, 5/6.
Section Racks with Metal Dividers, and 2 or 4-way Sections, 1s. 9d. each.

Shallow Frame Crates, with 8 Frames, wide ends, 2s. 6d. each.
Standard or Shallow Frames 7s. per gross; made up and fitted with "W.B.C." Ends, 9s. per 1-gross.

Everything of the best material and workmanship.

SPECIAL TERMS FOR QUANTITIES.

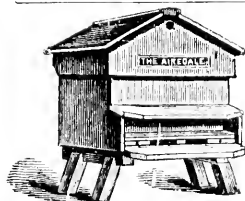

THE YORKSHIRE Bee-keepers' Supplies. WILLIAM DIXON, 5, Beckett St., Leeds.
Hives, Extractors, Smokers, Feeders, 'Weed' Foundation, &c.
Prizes Awarded, Gold, Silver, & Bronze Medals.
Catalogue post free.

Editorial, Notices, &c.

BRITISH BEE-KEEPERS' ASSOCIATION.

The monthly meeting of the Council was held at 105, Jermyn-street, S.W., on Friday, the 9th inst., Mr. Till occupying the chair. There were also present Messrs. R. T. Andrews, H. W. Brice, W. Broughton Carr, J. M. Hooker, J. H. New, and the Secretary.

The minutes of the previous meeting were read and confirmed.

Three new members were elected as under :—Mr. Wm. Fothergill, Birchwood, Romsey, Hants; Mr. Geo. Hayes, Mona-street, Beeston; Mr. Wm. Herrod, Sutton-on-Trent.

Mr. Till presented the Report of the Finance Committee recommending payment of prize and other accounts relating to the recent shows. The report was adopted.

The Education Committee reported that they had made numerous appointments of judges and examiners in response to applications from affiliated associations, and the appointments were endorsed by the Council. Reports were presented giving results of examinations for third-class certificates at the Reading and Manchester shows. The advisability of centralising the examinations was suggested, and after a lengthened discussion, it was resolved to refer the matter to the Education Committee for a full report.

The Chairman stated that the show committee had revised the schedule for the honey classes at the coming Dairy Show, and, subject to approval by the Council of the British Dairy Farmers' Association, classes would be added for "Beeswax," and for "Non-Returnable Parcel Post Packages for Honey."

The Council then adjourned till September 3.

THE "ROYAL" SHOW.

(Continued from page 261.)

Class 385.—*Beeswax* (not less than 3 lb.)—In this class six of the seventeen entries were noticed by the judges, a fact which testifies to the general excellence of the exhibits. Two samples—numbered 4,183 and 4,188 respectively—were each excellent, but, in the opinion of the judges, lost "points" through being artificially perfumed—presumably with attar of roses. We mention this in order that exhibitors—with no intention to deceive—may at least, keep roses and beeswax apart when showing for prizes.

Class 386.—*New Inventions Connected with*

Bee-keeping.—Several very useful, if minor, things were shown in this class, evidencing the fact that bee-keepers and appliance dealers are alive to the need for progress in all things. Far ahead of all others, however, in importance to the craft of bee-keeping, was Mr. J. H. Howard's exhibit of sheeted wax and finished comb-foundation, made by him by the new "Weed" process. We are relieved from the necessity for saying anything further as to this "Invention" by the illustration on page 277 of this issue and the particulars there given regarding it—except to add that Mr. Howard's exhibit well earned the premier award in the class. Next in importance came Messrs. Lee & Son's latest attempt to solve a knotty problem by means of their new "non-swarming hive," which took second prize. Space forbids us going into full details regarding this hive—indeed, we would need the full "specification" to enable us to do so—but we hope the principles on which it is based will receive full trial in due time, and be appreciated accordingly.

Mr. Meadows never seems to tire of "thinking things out," so far as bee-appliances, and well earned his third prize for his combined honey-ripener and hot-water tank for reliquefying granulated honey. It is a capital thing in its way, and will no doubt be appreciated by those for whose use it is intended.

The classes for Honey Vinegar and Mead (387 and 8) may be dealt with together, by saying that these honey products are now receiving proper attention as articles of commercial value, and future profit to beekeepers, not dreamed of until a year or two ago. The prize samples both of vinegar and mead were excellent, and we need only criticise the non-winning exhibits by observing that "sweetness is *not* a desideratum in good mead.

Class 389.—*Interesting and Instructive Exhibits connected with Bee Culture.*—It well illustrates the difficulty of making the wording of schedules quite consistent when read along with the awards in this class, nor is the difficulty easily overcome; here we had an aerated water of excellent quality, staged presumably by a mineral water manufacturer, who just gives it a "dash" of honey flavour, and there-with quite fairly and justly carries off the first prize, while a studious bee expert, who happens to be also an excellent amateur photographer, spends may be days and nights in preparing lantern slides—for the use of lecturers on bee-keeping—illustrating, among other things, the wax-moth and the ravages its larvæ works out as a bee enemy; yet this exhibit has to be content with a third place in the prize list.

With the five classes for *Bee Appliances* still to deal with, we are reluctantly compelled by press of matter this week to hold over the conclusion of our report till next issue.

Correspondence.

The Editors do not hold themselves responsible for the opinions expressed by correspondents. No notice will be taken of anonymous communications, and correspondents are requested to write on one side of the paper only and give their real names and addresses, not necessarily for publication, but as a guarantee of good faith. Illustrations should be drawn on separate pieces of paper. We do not undertake to return rejected communications.

Communications relating to the literary department, reports of Associations, Shows, Meetings, Echoes, Queries, Books for Review, &c., must be addressed only to "The Editors of the 'British Bee Journal,' 17, King William-street, Strand, London, W.C." All business communications relating to Advertisements, &c., must be addressed to "THE MANAGER, 'British Bee Journal' Office, 17, King William-street, Strand, London, W.C."

JUDGING AT THE "ROYAL" SHOW.

[2937.] It was with the utmost regret that I perused your editorial on "Judging at Shows" (page 251) and the subsequent letters (2929 and 2930) in last week's issue; especially that of Mr. John M. Hooker on page 262.

As a member of the Council of the B.B.K.A., upon which body lies full responsibility with regard to the appointment of judges and others who hold office at shows held by the Association, permit me to say that never before in my experience have I seen what I regard as so complete a misappropriation of awards as was seen in the Trophy Class at the "Royal" last month. Mr. Hooker's letter last week and the overbearing attitude he chose to take up at the Show, taken along with his *vidé voce* statements—heard by most of us—made it quite clear where the *force* lay so far as being in evidence and well to the fore. I was present at the Show when this question was discussed. I am also well acquainted with three of the four judges, but, along with practically all the other exhibitors, including the representative of the Notts Association, was never more surprised in my life than when the awards were made known, so difficult was it to believe that any one of the judges could be guilty of what was generally regarded as a great error of judgment.

Mr. Hooker in his letter (2929) attempts to justify the verdict of what he calls the "majority, in this case, of three to one" (the italics are mine). There is thus no difficulty in locating the dominant factor in the "majority" to which he refers, and we know where we are in dealing with the matter. He then goes on to say: "When the schedule was being prepared by the Council of the B.B.K.A. it was felt that if honey alone was to decide the merits of the Trophy Class, the southern counties would have undue advantages." He then adds: "The schedule was framed to meet this, and the exhibits judged accordingly." I beg to differ from Mr. Hooker's view, which is, to my mind, erroneous and misleading. I also aver that the Council of the B.B.K.A. "felt" nothing of the kind. It *was* mentioned on the occasion referred to—as I recollect quite well—that

certain counties would, no doubt, be able to stage some of the current year's produce, while others would fail in this respect; but it was also "felt"—and the feeling was given expression to—that the honey staged should stand on its merits without consideration as to its being of the "current" or any other year's gathering. Consequently, when comparing early honey of 1897 (*i.e.*, that from southern counties) with the best of that gathered in 1896—the latter being carefully liquefied for the purpose of staging—the opinion was expressed that the "points" for quality would be in favour of 1896 honey.

How this can be twisted into a declaration that northern counties would be "handicapped" and "southern counties have undue advantages," as Mr. Hooker states, I am at a loss to understand.

The question of the Notts and Yorks trophies not being in accordance with the regulations contained in schedule is a matter which rests entirely with the officials of the Show, whose duty it is to see that every exhibit is in conformity with the schedule, and does not affect the judges at all. The attention of the steward was drawn to certain infringements of the regulations before the awards were published, and after consultation with the judges (or majority of the judges) I, with others, was informed that "it was useless protesting; the judges knew all about it, and had made their awards. We had better, therefore, not waste our money, as we should certainly do if a protest was lodged." Needless to say, in the face of this we did not "waste our money." I also asked the steward whether the quality of the honey had any weight with the judges in making their awards, and after again consulting with the "majority," I was informed that the "quality of the honey staged had *nothing at all* to do with the awards"! In my surprise at this I then remarked, "We might have put on the trophies any rubbish then?" and the reply I got was, "Quite so."

Bearing in mind that the main object of this and all other shows is for improving the quality of honey and honey products, when we are told, as in this case, that the medals of the B.B.K.A. are to be awarded for glass jars filled, it may be, with golden syrup—for all the majority of the judges knew or cared—it is hard to believe that such a condition of things could really exist. The Bee Department at the "Royal" was a honey show, advertised as such, and, I ask, are prizes to be given for inferior produce or for the best? The judges, if asked this question, would, I am sure, at once say, emphatically, for the best, yet their awards in the class in question belie their words. The fact is, the prizes were not given for honey at all, and we have the repeatedly spoken words of Mr. J. M. Hooker that this is so. It thus becomes clear that the medals and prizes were awarded for displays of flowers, ferns, banners, earthenware

jars, and drapery; objects quite outside the province of the B.B.K.A. and our department of the Show. It may be argued that the schedule said the "best and most attractive display." Yes, but, I ask, of what? Read on, and we come to the words "of comb and extracted honey." Not a word about extraneous matters. The schedule is headed "Prize list for honey, hives, &c." The "best," therefore, must mean the *best honey*, and "most attractive display" can only be construed to mean a display of the best honey in an attractive form. Whether or not the prizes were awarded in faithful regard to these words I leave any ordinary reasonable man to say.

What I cannot but regard as a misconception on the part of the judges has undoubtedly wrought a serious injustice, and one past remedying now, of course; but it will do good, as this question of judging must receive attention at the hands of the B.B.K.A. Another "experience" such as that at the "Royal" of 1897 will assuredly so shake the confidence of exhibitors that instead of this being an encouragement for future trophy classes, or indeed for shows generally, it will turn out to be a most discouraging event for all concerned. To my mind the most important points to consider are these:—1. Is the quality of the honey and the condition in which it is harvested to be the principal object aimed for at our shows? 2. Are exhibitors to be bound by the rules and regulations laid down in the schedules or are they to be utterly disregarded? If these questions are answered in the affirmative, then a more flagrant miscarriage of justice was never enacted than the so-called judging at the late "Royal" Show at Manchester in the honey department.

I hope, Messrs. Editors, it is not too much to ask, as in Mr. Hooker's letter, that this may be inserted unaltered.—HENRY W. BRICE, Dale Park, Upper Norwood, July 9.

[2935.] I write from "Notts," and, along with Mr. Hooker (2929, p. 262), regret exceedingly the remarks in your editorial and review of the trophy class in the issue of B.B.J. of July 1; and shall I say that, in common with a number of leading Notts beemen, I think they are a "wee bit" one-sided. Their tone shows a little disappointment on your part as one of the judges, and, to say the least of it, the article is none too friendly to our Notts trophy. On this point many of us think we have just cause for complaint, especially in view of the fact stated by Mr. Hooker, that "Honey alone was not to decide the merits of the trophy." I could say much more on this point, but refrain, as in the main I think it is a matter for those who made the awards, and not for me, to defend their action. But, when we come to the "exhibition of temper" (for I cannot call it anything else) shown by Mr. W. Woodley, not only in the B.B.J., but also on the Show ground when the

awards were made known, it is a different matter, and I must say I was much surprised and pained, and, but for the credit of our Notts trophy, and our Association, and the integrity of the Committee, I would have passed over such an outburst of egotism and bad temper with the contempt it deserves.

Sirs, we in "Notts," are not guilty of *deliberate lying*, and the Committee who had charge of the trophy, of whom I am one (and without egotism, please), are all men of honour and integrity quite as much so as Mr. Woodley; while our Secretary is not, as a rule, *lax* in anything. I do not intend to satisfy Mr. Woodley at present as to the actual weight of the trophy. I will say this, however, that he is a long way out in his percentage of what he pleases to call "the requirements of the schedule;" but I suppose this is the point at issue, and one reads "approximate" to mean one thing and Mr. W. another.

I am afraid that Mr. W. is a bad loser, and a disappointed man; while his exhibit—disqualified several years ago—which appears to *stick*, has no bearing whatever on the case in point. A trophy exhibit and a section exhibit are under quite different conditions, and his remarks, *re* perversion of judgment, are uncalled for and ungentlemanly, and I must say I gave Mr. W. credit for having more manliness and common sense. His sneer, too, about a "handful of maidenhair fern" being accepted before his "cream of cream" quality of honey, and the "grandest display," &c., is in keeping with the outburst of egotism and temper before named, and are hardly worth consideration.

Mr. W., and those who were dissatisfied had their remedy. They might, if they had so wished, lodged a protest, and done the matter in a straightforward, honourable, and manly form; but, instead of this, he, Mr. W., rushes into print and calls on judges and committee to disqualify the Notts and Yorks exhibits, and, of course, place his (Berks) exhibit first.

He well knows this is too late now, but if it could be done, it might satisfy a spoilt child, and that child Mr. Wm. Woodley.—P. SCATTERGOOD, JUNR., Stapleford, Notts, July 10.

[For some reason—not quite clear to us—both the foregoing communications contain a request for its insertion "without alteration;" and thus, having complied in one case (2929, p. 262) it is difficult to refuse in another. But, while loth to stifle the free expression of opinion on a subject of immediate interest and importance, like the one under discussion, we must ask correspondents to kindly understand that personalities—of whatever kind—are carefully deleted from all communications appearing in this journal; and to this rule no exception can be made.

But for the exceptional circumstances surrounding the case in point, we should certainly have "softened off" some of the expressions used by our several correspondents, who, in

favouring us with their views, have gone very near the line to which objection is taken. No good can follow the use of unnecessarily strong language; we therefore beg that such may not be adopted in writing for print. We also hope that those who are good enough to express their views will be content to do so in a single communication and then be done with it. Retort is easily provoked, but it only "makes more" of what a very little is often enough and to spare.—EDS.]

[2939.] I had not intended to trouble your readers with my views of the judging in the trophy class at Manchester, your own editorial and the letters of other contributors to your columns having been so trenchant and straightforward; but Mr. John M. Hooker's extraordinary letter on page 262 of your last issue has raised such important points, involving matters of principle, that the question cannot be allowed to remain where it is, but in the interest of the whole craft must be thrashed out.

Leaving aside the honourable position you have taken in this matter—which Mr. Hooker calls in question—to be dealt with by yourselves, I would just add that it would be a sorry day for your readers if, when acting as judge, you must lose your individuality as editors, and be thereby debarred from free and fair criticism as journalists. At the same time I feel sure that it must be a glaring miscarriage of justice which causes you to speak so plainly under the circumstances.

Not having had the pleasure of visiting the show at Manchester, but as representing the Berks Association whose exhibit in the trophy class seems to have caused this outburst of indignation—not confined to ourselves but almost as unanimous among all the bee-keepers and people present who were able to form an opinion on the subject—I do not wish to intrude my own personal views of the merits of our exhibit, except to say that almost every ounce of honey shown on our stand had already been awarded first prizes at previous shows, most of which were in "open classes." It must, therefore, be plain that an immense amount of trouble and expense had been incurred in getting together the best the county could produce. Yet we are now told that this was simply wasted labour; that all we had to do was to send anything in the shape of bee produce which came to hand and trust to ornate decoration for the prize. This is what Mr. Hooker practically tells us in his letter on page 262. I am also informed that he has publicly made the same statement in still stronger term, viz., that "southern counties were to lose points in judging owing to their having an advantage in honey production." How were the judges to know from which counties the trophies came?

He implies in his letter that he had the authority of the Council of the B.B.K.A. for such action, and I shall be glad to know if

such was the case? Moreover, if this is so, why was not this condition stated in the schedule, and upon what precedent was such a condition based? Mr. Hooker has thrown the responsibility upon the British B.K.A., and from them we have to expect an explanation. Why did they not call it a "handicap" instead of a "competition" and state the conditions in the schedule?

What are the facts? If we take precedents we have but one, viz., the South Kensington Competition, when (I believe) the first prize was awarded to Lancashire and Cheshire! So much for the advantages of southern counties. I believe our exhibit had in it almost the least proportion of new season's honey in the competition.

With regard to the staging and the promise of our Editors' footnote on page 262, I am looking forward to seeing the various trophies in the pages of the BEE JOURNAL, and from what I can gather, there is not much fear that the wider circle of bee-keepers who read your paper will arrive at the same conclusion as I am told those who saw it at Manchester did, viz., that "the Berks trophy was head and shoulders above anything else there."

The question of approximate weight in the Yorks and Notts exhibits referred to in 2930 (page 262), if it stood alone, would not be so important, but taken along with the other matters referred to above, it is extremely difficult to explain how the judges arrived at their conclusions. Personally, I am strongly in favour of exhibitors loyally accepting the decisions of judges, however much they may differ from them; but in this case such a strong and general opinion has been expressed from all sides that the judging was unfair, that we have called a meeting of the Council of the Berks B.K.A. to take the matter into consideration, and upon their decision we shall act.—A. D. WOODLEY, *Hon. Sec. Berks B.K.A.*, 17, Market-place, Reading, July 12.

WEIGHT OF HIVES.

[2940] Last week was a good one here. The following are the weights of the hives, continued from 2931 (page 263):—

	A	B
	lb. oz.	lb. oz.
July 6, 7 p.m.	35 14 ...	28 4
" 7, "	37 9 ...	28 15
" 8, "	41 4 ...	30 9
" 9, "	42 14 ...	31 9
" 10, "	44 15 ...	32 10
" 11, "	47 5 ...	33 11
" 12, "	49 0 ...	34 11

It will be noticed that three weeks ago hive B was slowly gaining on hive A, but that now it is quite the other way. In the latter the queen is doubtless in the under skep and the brood continually hatching in the upper skep leaves plenty of room to store the honey in. In the former there is not the same storage room, and the bees are engaged in

comb-building. I supered it with an ordinary skep long ago, but the bees would not take to the super, and I did not want to interfere with the weight by putting comb in to draw them up. However, I was obliged to on the 7th; I fastened 7 oz. of comb with a little newly-gathered honey in the super, and they at once went up, and are now building hard, but I fear the delay has lost me several pounds of honey. The 7 oz. do not appear in the figures given, but is deducted.

The 10th was a day I have been looking out for; one of those days on which the bees think it is going to rain, and come hurrying home. I, too, thought it was going to rain, but it did not; there was not much fall of temperature, nor was the sun altogether hidden, but there was a heavy black cloud in the east at 3.15, and in a quarter of an hour "Hive A" had gone up 1 lb. and 10 oz., practically all the bees had come home. The cloud cleared away, and the sun was out most of the rest of the afternoon, but scarcely a couple of ounces of bees went out again.—G. D. HAVILAND, *Warbleton, Sussex, July 12.*

SWARMS DESERTING HIVES.

[2941.] While sending to the B.J. office on another matter, I will mention, as perhaps possessing some interest for readers, a curious occurrence in bee life I have just experienced, as follows:—Yesterday (Sunday) a swarm issued from a frame-hive and alighted on the branch of an ash-tree near about 8.30 a.m. I shook them into a straw skep and placed them underneath the tree. As I am about to remove from my present residence to one about five minutes walk away, I carried a bar-frame hive to the garden of the latter between two and three in the afternoon, to be ready for the swarm to be transferred in the evening when they were settled quietly in the skep. About 6 p.m. they issued from the skep, and thinking they were off, my neighbour, who saw them, followed, and, to his surprise, they went straight to the hive I had prepared in the other garden for them about three hours before. The curious part to me is that they should have discovered this new home so quickly after it was placed there.—ALFRED BROWN, *Barnstaple, July 12.*

[2942.] You ask on page 104 for your readers' experiences as to swarms this season. I give you mine:—I have four hives, three of which are very strong. One swarmed, but returned to the hive before I could be fetched to hive it. I cut out the queen cells and ventilated the hive, and have had no further trouble with it. The next hive swarmed and returned in a precisely similar way and, as a precaution, I put on a swarm a queen-catcher for three days. Whilst this was on, the hive swarmed again, but the queen never left the hive and the swarm returned. I then made an

artificial swarm on a somewhat novel principle, by removing four frames of brood with bees to a new stand, one frame having a ripe queen cell, in which I heard the young queen piping. I did this because, unfortunately, I could not find the old queen. This hive appears to be going on all right though I have not seen the young queen, nor signs of her fertility in the shape of eggs. There was quite a swarming fever in this neighbourhood on or about Jubilee day.—G. O. N., *Market Harborough.*

DAYS OF JUNE.

[2943.] Last year about this time the earth was dry as dust, the daffodil leaves entirely withered away, the plants of our gardens standing with flagged and dusty foliage. There was the earth, but of what use is solid food if there is no cool, sparkling water to allay the thirst of meadow sweet, of valerian, of blue-flowered wild geranium? To those of us who saw their cherished plants perceptibly dying day by day—for water could not be spared for them—the contrast between this year and last is quite startling. The wet winter and spring; the deluges of warm rain in the greenhouse temperature of June, have amassed a wealth of foliage delightful to see. The ladyferns that grow in such masses along those rocky roads that have been hewn out of the fell sides in Westmoreland and Cumberland—such roads as the Kirkstone Pass, or between Conistone and the Langdales—are worth going all the way from London town to see. There are lady ferns in London, too, and hosts of them in Kent and Surrey and Warwickshire (I know them well), but compared to those that unfurl their lovely fronds in the sweet, pure atmosphere of the fells, within sight, maybe, of Helvellyn or Blencathra, they are poor, miserable, bedraggled, leaden things, not worthy of the name of ferns. And what is true of the lady ferns is true of the other ferns that have their home there, too. Male ferns with fronds 6 ft. long! Soft shields and prickly shields; blechnums in their thousands; parsley fern so abundant that if there were no rock among it you might mow it down with a scythe; great beds of oak and beech fern drooping over beck* sides, sometimes—indeed, often—with their tips in hissing, raging, milk-white water; cysopteris fragilis, lastrea montana (loveliest, perhaps, of all mountain ferns), polypodiums, spleenworts, and bracken. If you want to see all these at their best, in tropical luxuriance, then go to the English Lakes in June and take your fill. But take not either trowel or satchel to make prisoners, for they will speedily die in the florid, choky atmosphere of the south.

On the lower slopes of these mighty butresses of rock that support the giant fells, who

* A beck is a stream, often in fine weather a mere chain of deep, rocky pools, but in times of rain a foaming, impassable torrent.

lie back yonder in grim, silent majesty amongst the clouds, there are a thousand acres of bracken—one sunny expanse of pale green unfurling fronds, scenting all the air for miles. Against these legions of pirate ferns man fights in vain. No smiling fields of corn or oats or pleasant grass will ever be seen upon these rocky slopes. Only wiry mountain grass, on which subsist a flock of ever-bleating, half-starved mountain sheep, some juniper, some tormentil, heath-bed straw, a little wild thyme, parsley fern, and always the bracken, vigorous and as tall as a man at the beck sides, gradually decreasing in stature as it nears the edge of the clouds. In August you may see the dalesmen reaping this—their harvest—tossing and gathering it as we do hay; and very sweet does it smell then as it browns under the hot August sun. The scent comes to me now, after all those years, and although I am 200 miles away! Comes to me, even through a thick atmosphere of goats, so thick that you might almost cut it with a knife. With it, also, I can detect an aromatic whiff of juniper and—yes, that was bog-mint; and, ah! let this stay the longest, for it is indeed bog-myrtle. And as I write these names so a thousand other darling plants come crowding up for mention—bog pimpernel and asphodel, and grass of Parnassus, cranberry and crowberry (brave crowberry, 3,000 ft. high on the fell tops!), yellow-flowered saxifrage and sundews, alpine ladies' mantle, violet-like, white-throated butterworts, lovely pink-flowered bird's-eye primroses, and you bravest of all brave flowers, stemless campion and purple-flowered saxifrage, decorating the cold, wet rock in the dreariest, most desolate, most awful acre of English ground. Half your life spent amidst the clouds, high up, half-way between Heaven and earth; on the hottest day in summer, cold, with icy water always dripping from the black precipices above you, and hissing down amongst those below you. The wind howling around you ever, and your only visitors a screaming buzzard, or maybe a peregrine falcon, or, least likely perhaps of all, a desperately enthusiastic botanist, who tears you from your rocky home and hurries back again to his inn at Seathwaite or Lodore. And then—believe me, ye bee-keepers, for I know—it is a wondrous delight to sit on the rudest rush-bottomed chair in that inn while you study the map, and listen to a noise wonderfully like ham and eggs frizzling somewhere round the back, to say nothing of a smell of best "Mocha" or chicory—you know not which, neither do you care.

The higher fells that are grouped in such magnificence about Helvellyn and Sca Fell have few flowers to tempt the honey bees to climb their breathless slopes. There is no ling or heather upon them—no thyme to speak of, nor birdsfoot trefoil, clover, or horseshoe vetch, or those dozens of sweet plants that grow in such profusion on our lower chalk hills. To see the heather you must go to the lower fells,

and there it is, indeed, worth going to see, especially in August, when the sun goes down behind the Langdale pikes. Then it is that you see things which make you wonder why on earth you are satisfied to dwell all your days in a smoky city, where one decent sunset every six months is the rule. No wonder that Wordsworth and Coleridge wrote poetry! The wonder to me is that every man, woman, and child who lives always amongst those changeful scenes of splendour is not a poet! Probably they are, but, fortunately, do not seek to write down their thoughts, and so our heads are saved much bewilderment. Upon the lower fells also there is much wild thyme and white clover—very dwarf, as bees like it—heath-bedstraw, pinkish white stonecrop, cow-wheat in great yellow patches, eye-bright, tormentil, and lovely little patches of blue sheep-bit. Where the vales, too, expand widely, and much land has been redeemed from rock and bracken, you will meet with the most charming meadows, surrounded always with a rocky wall, perhaps half hidden in flourishing thickets of raspberry, and usually with some mounds of rock cropping out, set with thyme and field veronica, in grey-blue patches. The road is generally a ledge in these mountainous districts, sloping more or less steeply down on the one hand and upwards on the other, so the verge of the meadow is on or above the level of your eyes. Used always to the flat fields of the midlands, where you look down on the flowers, it is a new and delightful experience to look upwards and see the myriad stems and petals of the meadow flowers—ox-eye daisy, and red sorrel and buttercups, hop trefoil and hawkweed, and slender grasses—against the blue dome of heaven, or the great grey summit of some far off fell. Often enough the walls that hold up the meadow from the road are veritable little "rock gardens" themselves. Sometimes you see great cushions of yellow lotus glowing like the sun itself on their tops, and huge hairbells leaning over. Or ruddy heads of the orpine, or golden stonecrop mossed over and fairly brown with honey bees. Or perhaps there will be a hundred yards of polypodium fern or black spleenwort in every crevice, and a colony of the little blue Alpine heartsease on the top. And at the bases of these cool, grey, rock walls what wild gardens there are! Bracken and masses of male and lady fern seeming as if they had had gold dust sifted over them. Bell-heather and bog-heather, and ling, sweet smelling juniper and delightful bog-myrtle, meadowsweet, in one of whose plumes is a whole rick full of new mown hay; cascades of wild roses, in whose opening buds lies all our hearts desire; wreathed honeysuckle, and foxgloves—twice ten thousand spires; yellow poppies, whose faces are radiant with the light of love. Ah me! ye dwellers in the hot and choky south, come here in June and cool your fervent lips!—LORDSWOOD.

(To be continued.)

IRISH BEE-KEEPERS' ASSOCIATION.

The Committee met on 8th inst. Present, Mr. Read, in the chair, Mr. O'Eryen, Mr. Watson, and Mr. Chenevix (hon. sec.).

Preliminary arrangements were made for giving lectures in the bee tent at various places in the country.

NOVELTIES FOR 1897.

HOWARD'S BRITISH MADE "WEED" FOUNDATION.

Referring to the illustration below, and kindly supplied by Mr. Howard (reproduced from a photo, which shows the foundation factory at Holme) Mr. H. says: "The

HONEY IMPORTS.

An account showing the value of honey imported into the United Kingdom during the month of June, 1897, £1,921.—From a return furnished to the BRITISH BEE JOURNAL, by the Statistical Office, H.M. Customs.

this claim the first prize of the late 'Royal Show confirms.

"As an instance of the superiority of the Howard-Weed foundation: I was asked early on in the year to explain in what way the new process gave a superior article. Well, I did explain, and sent samples of my own make in both 'dipped' and new 'sheeted' wax. I got

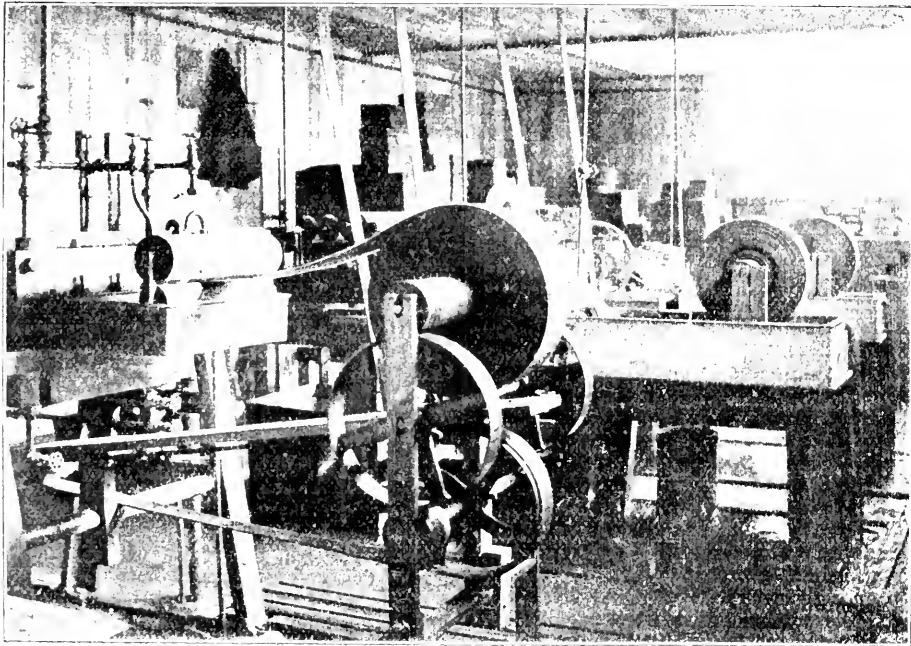

MR. J. H. HOWARD'S "WEED" FOUNDATION MACHINE SHOP.

'sheeting machine' is seen in the foreground. This machine will sheet pure beeswax only, and it is, I think—to bee-keepers at least—worth a visit here, to see how readily the molten wax is picked upon one side of the machine and delivered out at the other a perfect sheet of wax. These sheets are then cell-impresed, cut to required lengths, and packed by the machinery shown in background."

Mr. Howard further says: "I make no claim as inventor on the machinery depicted, but as introducer and manufacturer of a new make of comb-foundation—which is found to outstrip all other makes on the old lines of 'dipped wax' sheets—I claim to possess the most 'useful invention' of the year. And

this reply: 'Old dipped sheeting resembles cast iron, new sheeting, wrought steel!' More I might say," he adds, "but it would savour too strongly of 'puff' if here written."

We understand that Mr. Howard is open to receive a visit from any bee-keeper interested in the subject and anxious to see for himself. Among many visitors this year to view the machines and factory have been several from the Continent; one a German bee-master of no small repute, who, we are told, on leaving Holme on Saturday last, heartily congratulated Mr. Howard on his comb-foundation, and the successful manner in which he has fixed up the necessary machinery for the work.

Queries and Replies.

[1780.] *Utilising Driven Bees.*—Like your correspondent, Mr. Groves, (1767, p. 248), I am intending to collect bees from the people who annually destroy them to procure the honey. I am thinking of making a long hive like a terrace, as described by "Amateur" (2921, p. 235), in the June 17 number of B.B.J., and should be glad of a few hints regarding same. 1. Will it be necessary to unite different lots when they are hived in a hive common to all? Would it do to delay uniting till the spring, in order to then make up as many good colonies as possible by uniting? 2. When running the bees into the second compartment of the terrace hive, will it be necessary to entirely shut in those in the first one? Or would it be sufficient to provide an extra large movable porch with projecting sides, so that it could be temporarily attached to each hive during the "running in" process? 3. I presume the "eke" referred to on p. 44 of the "Guide Book" (14th edition) would be as equally advantageous in this instance for wintering—in which case I should make the dummies with an extension to reach to the floor-board. Is this so? 4. Should the frames be placed further apart than during breeding season to allow better clustering, at the time of running the bees in (which would be before feeding up), or after they have sealed all their stores? Perhaps your correspondent "Amateur," Tottenham, Bristol, will favour us with his experiences on these points?—D. G., *Iminster.*

REPLY.—Probably the correspondent referred to will see the above and forward a few lines of reply as requested.

[1781.] *Transferring from Skep to Frame Hive*—I have a stock of bees in a straw skep (a last year's swarm), I want to transfer the bees to a frame-hive. Is it too late to put the skep and bees over a set of frames fitted with full sheets of foundation? or, would it be better to unite the bees with one of my other stocks?—HALTON, *Leeds, July 8.*

REPLY.—It is now too late for any hope that the bees in skep would take possession of the lower hive as a brood-chamber this season. April or May are the best months for that method of transferring, though June will often answer. If it is necessary to do away with the skep we should defer driving the bees till end of August, so that as many young bees as possible may be added to the stock it is intended to unite the bees to.

[1782.] *A Bad Start with Bees.*—The "Wells" System.—I began bee-keeping this spring, after thirty years' absence in the East, and was imposed upon with a stock which, when the first warm day came, I found to be queenless, and containing fertile workers with drone-brood in worker-cells. I have introduced a queen, who is doing good work,

though the colony is still very weak. Will you oblige me with information where I can procure full particulars of the "Wells" system?—E. C., *Fife, N.B.*

REPLY.—Mr. Wells has himself published a pamphlet on his "system." It can be had for sixpence by addressing "George Wells, Aylesford, Kent." You have made a bad start in bee-keeping, according to the facts detailed above, and we would advise caution with regard to the "Wells" system till a little experience has been acquired in handling and managing bees. The double-queen system is scarcely suited for beginners.

[1783.] *Queen Laying Two Eggs in One Cell.*—I should be glad if you would kindly inform me, through the BEE JOURNAL, why a queen should lay two eggs in one cell? I have a "Wells" hive, and on looking into same on June 27 I found the bees in one compartment fairly good, and the other had a queen, but not more than one frame covered with bees. I therefore put two frames of brood and bees from the strong into the weak side of the hive. I examined them again on July 5, and found that the queen with the small quantity of bees had commenced to lay in a frame not covered with bees, but in several cases had put two eggs in one cell. Why is this?—VINDOMORA, *Exchester, July 6.*

REPLY.—Weak colonies often have not sufficient surface of comb covered with bees to furnish a prolific queen with enough cells for her purpose, hence she either drops the eggs about the surface of the combs, or perforce deposits several in one cell.

[1784.] *Queen-Raising.*—1. What is the best method of raising a number of queens for the forming of nucleus stocks? After having removed the queen, I have tried inserting a frame of eggs in the centre of brood-nest, having first cut a few small openings in the comb as is often recommended, but invariably find I have not more than one, or at the most two, queen cells raised at one time, which is galling when you need a quantity. 2. I have two hives of bees standing in a hot sheltered place, enclosed on three sides by high hedges. During the summer time they are extremely angry, it being almost impossible to work with them, besides being given to excessive swarming. The place is also badly infested with flies, which seem to trouble them. Am I right in attributing their temper and excessive swarming propensity to their location?—J. J. K., *Appleby, July 8.*

REPLY.—1. The method described should succeed in producing some queens, but the number of cells produced depends very much upon the race and condition of bees used for the purpose. As to the best method, choose a strong stock with plenty of young bees, and unless stores are coming in fast, feed, and, when sufficient cells are obtained,

divide for nuclei, giving each a sealed queen-cell. 2. No doubt the heat and confined situation in a great measure affect the bees in the way indicated. More ventilation and judicious shading should be tried, or bees removed into a more open spot.

[1785.] *Bees Accompanying Queen on Her Mating Trip.*—I have a stock of bees which is queenless; the bees have now, however, constructed some queen-cells, but by the time the queen is ready to take her mating trip there will be no uncapped brood in the hive. I therefore ask, when the queen goes forth to meet the drone, will the bees follow her or will they stay in the hive?—W. F. HOSEGOOD, *South Croydon.*

REPLY.—If you have another stock from which a comb of young brood can be taken it will be well to insert it. It is not, however, at all certain that the bees will follow the queen when she leaves the hive for the purpose stated, and you will have to take the risk mentioned failing a comb of brood.

Bee Shows to Come.

July 15 and 16 at Bleasford.—In connection with the Lincolnshire Agricultural Society. Bee Department under the management of the Lincs. B.K.A.

Shows in connection with the Notts B.K.A. will be held as under:—**Hucknall Torkard, July 20. Entries close July 16. Southwell, July 22. Entries closed; and Moorgreen, September 7. Entries close August 27.**

July 21, 22, and 23, at Harrogate.—Yorkshire Agricultural Society's Show.

July 24, at Fallowfield, L. and C.B.K.A.—In connection with the South Manchester Horticultural Society, schedules from F. H. Taylor, Local Hon. Sec., L. and C.B.K.A., Old Hall-lane, Fallowfield. **Entries close July 17.**

July 28 at Henbury.—Bristol, Somersetshire, and South Gloucestershire Annual Show. For Schedules apply to Miss Hill Dawes, Long Ashton, near Bristol. **Entries close July 21.**

July 28 and 29, at Chester.—In connection with the Great Horticultural Fête. Bee Department under the management of the Lancashire and Cheshire B.K.A. Medals and liberal prizes for honey, &c. Schedules now ready. Apply to Wm. E. Little, 1, East-gate-row, Chester. **Entries close July 19.**

July 27, 28, 29, at Gloucester.—Gloucester B.K.A., in connection with the Gloucester Agricultural Societies' Show. **Eight Open Classes.**

July 31, at Helaby.—Three open classes. Prizes (20s. &c.) for single 1-lb. jar and (10s., &c.) for single 1-lb. section. Apply Dr. Briant, Helaby, Warrington. **Entries close July 24.**

August 2, in Melton Constable Park. North Norfolk B.K.A. Annual Show. B.K.A. medals and liberal prizes for honey. Schedules from C. J. Cooke, Hon. Sec. N.N.B.K.A., Edgfield, Melton Constable. **Entries close July 28.**

August 2 and 3, at Swansea.—Glamorgan B.K.A., in connection with the Glamorganshire General Agricultural Society. The annual general meeting of the G.B.K.A. will be held in show grounds, on August 3.

August 2 and 3, at Northampton.—Northants B.K.A. Sixteen classes (six of them open to all), with good prizes for honey and beeswax. Schedules from Robt. Illeford, Hon. Sec., Kingsthorpe, Northampton. **Entries close July 25.**

August 4, at Neston Park, Wilts.—In connection with the Atworth and District Horticultural Show. Two open classes for single 1-lb. section and single 1-lb. jar of extracted honey. Schedules now ready. J. P. Inkpen, Secretary, Atworth, Wilts.

August 10 and 11 at Burton-on-Trent.—Staffs. B.K.A. In conjunction with the Staffordshire Agricultural Society. For full particulars see advertisement

on page v. Schedules from Ellis E. Crisp, Secretary S.B.K.A., Meaford Cottage, The Hough, Stafford. **Entries close July 17.**

August 12, at Goole.—Annual Show of Bees and Honey in connection with the Goole and District Agricultural and Horticultural Society. **Six Open Classes**, with good prizes, including 20s. and 10s. for single 1 lb. jar of honey (entry free in this class). Schedules from J. Luddington and H. S. White, Secretaries, Lindum House, Goole. **Entries close August 7.**

August 13 and 14, at Dumfries.—S.S.B.K.A. Jubilee classes open to the world. Schedules from Jas. Kerr, Douglas-terrace, Dumfries.

August 19, 20, 21, at Hastings-in-Furness.—In connection with the Royal Lancashire Agricultural Society. Six classes, with liberal prizes for honey. Schedules from Jas. Birch, Secretary, 34, Castle-street, Liverpool. **Entries close July 31.** For fuller particulars see advertisement on page 111.

August 24 and 25, at Hastings.—Annual Show of the Kent and Sussex Bee-keepers' Association in conjunction with the Sussex County Agricultural Society. Liberal prizes. Schedules from Henry W. Brice, Hon. Secretary, K. and S. B.K.A., Dale Park, Upper Norwood. **Entries close August 14.**

September 8 and 9, at Derby.—Sixteenth Annual Show Derbyshire B.K.A., in connection with the Derbyshire Agricultural Society. Nineteen classes and over fifty prizes for bees, honey, and appliances. Schedules from F. Walker, Hon. Sec. D.B.K.A., Cattle Market, Derby. **Entries close August 31.**

Notices to Correspondents & Inquirers.

All queries forwarded will be attended to, and those only of personal interest will be answered in this column.

L. HIGLEY (Droitwich).—*Bees Refusing Foundation.*—White, flat-bottomed foundation, such as sample received, has nearly always a "tallow" smell, and bees frequently refuse to work on it. Super foundation—to be attractive to bees—should be pale-yellow in colour, and possess a pleasant odour, personally we never use that made from white wax.

W. H. STOPPARD (Sparkbrook).—*Examinations for Experts' Certificates.*—Full particulars as to these may be obtained from Mr. E. H. Young, Secretary, B.B.K.A., 12, Hanover Square, London.

LILLEWOOD (Droitwich).—*Bees Refusing Comb Foundation of White Wax.*—See reply to L. Higley.

IGNO (Lydbrook).—*Vicious Hybrid Bees.*—Box with bees were received on the 9th inst., but sample of comb sent by parcels post on 1st has not reached us at all. Regarding bees, they are either Ligurian or Cyprian hybrids. Nothing can be done to "cure" their temper except re-queening the colony.

J. S. (Leigh, Lancs.).—Foul brood is just developing in comb sent out; as there are so few bees left to deal with, we advise "burning the lot" without delay.

S. W. (Dulwich).—Foul brood is developing. The stock, as described, is not worth attempting to save or cure.

APIS (Hepscott).—Bad case of foul brood. Stock from whence comb was taken should be at once burnt.

F. B. THOMPSON (Lincs).—*Immature Larvæ Cast Out after Swarming.*—The white, immature bees and dead larvæ cast out need cause no alarm. It is merely the result of

the removal of so many bees in swarming, and lack of income through depleting the hive of the bulk of the honey gatherers, which mainly constitute the swarm.

H. H. (Chippenham).—Comb is badly affected with foul brood.

C. C. A. (Dorset).—1. Bulk of brood in comb is chilled, but there are signs of disease in one or two cells that cannot be mistaken. Remove the comb from which sample was cut, and any other containing chilled brood, and feed the stock with medicated food while bees are building out the foundation. 2. Zinc will not injure the honey while sections are being filled.

T. W. TOWNSEND.—So far as we can see it is only a case of chilled brood. The six pieces of comb sent were in a sad mess when received. If any further suspicious signs are seen after the honey season is over, send another sample; but only one piece, and let it be just as cut from the frame, dry and not crushed up at all.

FAIR OAK (Bishopstoke).—*Subduing Bees*.—The best implement for subduing bees is the *Bee Smoker*, with a roll of any material that will smoulder readily and give off a good volume of smoke. Some bee-keepers use carbolic cloths, *i.e.*, a square of calico sprinkled with a strong solution of Calvert's carbolic acid. This is laid over tops of frames before manipulation, and caused the bees to retreat below. Others use a fumigator or bellows, in which is placed a sponge saturated with carbolic acid, together with a small quantity of creosote. Our preference, however, is for the smoker (Bingham pattern) as first mentioned.

A. H. R. (Winchester).—*Erratic Swarming*.—We are glad to hear that the "cast," after re-issuing, was safely hived. The "going back" after swarming was simply caused by the absence of a queen, which either did not come off with the bees or got lost before "the clustering" took place.

E. A. CRISP (Charlton).—*Queen Cast Out*.—Insect sent is not a virgin queen, as supposed, but an adult.

S. W. (West Dulwich).—*Bees Dwindling*.—A hive which now contains "only about one quarter the number of bees" (and very little brood) "compared with what it had early in the season" needs examining without delay. One of two things is certain—*viz.*, either the queen is old and worthless or the bees are diseased. If a sample of the brood is sent, we may decide for you so far as the latter point, and if the bees are healthy, the fault must be in the queen. In any case, the few old bees remaining are hardly worth re-queening at this season.

C. C. JAMES (Diss).—We cannot yet trace the nomenclature of insect and plant sent, but hope to give it in this column soon.

* * Letters from *Quintilis*, E. A. Tharp, H. Livermore, and Woldbee, and several Queries are in type, and will appear next week.

Special Prepaid Advertisements.

Twelve words, Sixpence; for every additional Three words or under, One Penny.

It being impossible for us to guarantee the *bona fides* of Advertisers, it is advisable—in cases where any doubt exists—that intending purchasers should adopt the system of payment by Deposit through this Office. (This caution is inserted in consequence of occasional complaints.)

HEALTHY YOUNG QUEENS, 2s. 6d.; Laying, 4s. cash. BEETAL, 89, Northill, Highgate, London. R 18

WANTED, Quantity good '97 HONEY, Comb or Extracted. S. CRAWFORD, Lisnacloon, Castleberg. R 15

HEALTHY DRIVEN BEES in August, 1s. 6d. per lb. Rotation. C. H. HAYNES, Hanley Castle, Worcester. R 13

TWO Strong Three-frame NUCLEI, 12s. 6d. each. Also "Little Wonder" Extractor, 6s. DYMOND, Ferny House, Southgate, N. R 14

DRIVEN BEES, in lots with Queens. End of July and August. 5s. Boxes returnable. A. R. MORETON, Bransford, Worcester. R 21

EXTRACTED HONEY. "Superb," 7d. Hungerford G.W.R. Sample 3d. Tins returnable. PULLEN, Ramsbury, Hungerford. R 19

LADY wishes thoroughly practical Instruction in Bee-keeping. Scotland. Address "P," c/o "Bee Journal" Office, 17, King William-street, Strand, London.

FINEST NEW ENGLISH HONEY, 7d. lb.; cheaper per cwt. Strong 3-frame Nuclei, with young Fertile Queen, 10s. 6d. Guaranteed healthy. A. TWINN, Apiary House, Ridgwell, Halthead. R 1

FOR SALE, 1 Blow's "Wells" Hive, 1 "Ford-Wells" Ditto, 4 Meadow's "XL-All," and 6 Lee's New Non-swarming Hives, all nearly new and well painted. Each Hive is crowded with splendid stocks of Bees, and working well in supers. Guaranteed free from Foul Brood. J. GEARY, New-street, Barwell, Hinchley. R 17

WALLFLOWERS, strong plants, 50 for 1s., post-free. HIPWELL, Woodside, Hatfield, Herts.

SPECIAL SILK BEE VEILS, 9d. post free. ABBOTT BROTHERS, Merchants Quay, Dublin. P 46

SUPERIOR QUEENS, Stocks, Nuclei, and Swarms. Address, Rev. C. BRERETON, Pulborough, Sussex.

WANTED, NEW SECTIONS, first quality; also Bell-glasses Honeycomb. Packages sent. Good price paid and prompt settlement. R. COLE, Southdown Apiaries, Bexhill, Sussex.

SEND FIFTEEN STAMPS for useful (half pound post free) SAMPLES of FOUNDATION, and compare with what you are using. ABBOTT BROTHERS, Merchants Quay, Dublin. P 47

21ST YEAR, PURE ENGLISH BEES. Good swarms, 10/6, 12/6, 15/-. Cases 1/, or returned. Tested Queens, 3s. 9d. delivered. Cash with order. ALSFORD, Expert, Blandford.

BROTHER BEE-KEEPERS visiting the ISLE of MAN will find comfortable APARTMENTS at Merridale House, 5, Empire-terrace, Empress Drive, Douglas. For terms apply S. J. HORSLEY, as above.

FINE TESTED 1897 QUEENS of my well-known strain, 3s. 6d. each. Strong 3-frame Nuclei, with Queen, 12s. 6d. Guaranteed healthy, and safe arrival. C. WHITING, Valley Apiary, Hundon, Clare, Suffolk. R 3

SPECIAL OFFER. To introduce our new SECTION (fully patented 1896,) and FOUNDATION, we offer to send 24 Sections and Foundation to fit, post free 1s. 6d. ABBOTT BROTHERS, Merchants Quay, Dublin. P 45

Editorial, Notices, &c.

MIDDLESEX B.K.A.

ANNUAL SHOW.

The above association held its County Honey Show (Southern Province) on Wednesday, July 7, at Hampton, in connection with the Hampton and Hampton Hill Horticultural and Cottage Garden Society, in the grounds of the Manor House, by permission of J. P. Kitchin, Esq. The weather was all that could be desired, consequently the attendance was large.

In spite of the schedule being an inviting one, the entries were not so numerous as was hoped for. This was partly accounted for by the fact that owing to the coldness of the spring, and consequent failure of fruit blossom, little early surplus honey was stored by the bees, while the date of the fixture was too early for the gathering from lime-blossom, which is the chief source of honey in most districts of the Southern Province.

The display in the honey tent was attractive, and reflected credit on those bee-keepers who endeavoured to make the show a success. Free lectures and manipulations with bees were given by Mr. Roland Green, expert, B.B.K.A., in the bee-tent.

The Princess Frederica of Hanover visited the honey exhibits, and also the bee-tent, and heard Mr. Green lecture. Her Royal Highness, who appeared to take much interest in the manipulations, saw a frame hive opened, was shown the combs with adhering bees, and had the queen bee pointed out to her. Her Royal Highness put several questions to the hon. secretary (Major Fair), and also to the expert as to the economy of the hive, and herself incidentally related an interesting experience of her early childhood in connection with a swarm of bees.

Mr. W. H. Harris, B.Sc., of Ealing, judged the exhibits, and examined one candidate for third-class expert's certificate. The following being the awards:—

Twelve 1-lb. Sections.—1st, A. Curtis, Hanworth; 2nd, E. Basley, Ealing; 3rd, P. Taylor, Ealing.

Twelve 1-lb. Jars Extracted Honey.—1st, A. Curtis; 2nd, E. Basley.

Exhibit of Comb and Extracted Honey (Southern Province only).—No entries.

Twelve 1-lb. Sections (District only).—1st, A. Curtis, Hanworth; 2nd, Mrs. Luscombe, Teddington.

Exhibit of Honey.—1st, A. Curtis; 2nd, Mrs. Luscombe.

Collection of Bee Appliances (open).—1st, J. S. Greenhill, Wimbledon; 2nd, R. Green, Rainham.

THE "ROYAL" SHOW.

(Continued from page 271.)

Class 390.—Collection of Hives and Appliances.—This class, though making a goodly show with six large collections of up-to-date appliances, was practically reduced to five competitors, Mr. W. P. Meadows taking 1st and 2nd, with good and complete collections so nearly synonymous as to almost claim equal 1st. Mr. Rose's 3rd prize exhibit had in it some very good hives, but a little uneven perhaps in quality. The V.H.C. exhibit had the same fault, though a very fair collection.

Class 391.—Observatory Hive.—Besides the 1st and 2nd prize hives of Mr. Richards and Mr. W. Dixon both good (the 1st prize one especially so), Messrs. Hamlyn-Harris and J. Chaddiston got a H.C. in a class of six entries, which made a very creditable display on the whole.

Class 392.—Most Complete Frame-Hive for General Use.—Messrs. Lee & Son secured 1st and 2nd prizes in this class. The 1st for a non-swarming hive, a counterpart of the one staged by them in Class 386, and for which they were also awarded 2nd prize. Mr. Greenhill taking 3rd with a good hive of useful type.

Several hives in this class outside those receiving awards were good in their way. One staged by Mr. Geo. Lambert, for instance, if strength, weight, and solidity were of more practical importance in hive making than they really are, would have stood well in the prize list. The labour of lifting such weighty hives about in hot weather, however, tells much against their merits. In the same way, hives priced 12s. 6d. each—of which there were several staged—are palpably outclassed when competing as the "Best and Most Complete Hive," no limit being stated as to price.

Class 393.—Frame-hive for Cottager's Use (price not to exceed 10s. 6d.)—This class affords a good illustration of what is possible in hive-making for a moderate sum; and Messrs. Lanaway's exhibit, which secured first prize, included body-box, rack of twenty-one sections, with roof-raising lifts enough to cover a full season's surplus-gathering. It was quite a complete "fit out" in shape of a hive, and only priced at 10s. Mr. Meadows took second prize for an admirable little hive especially adapted for heather work. We never before saw more complete and efficient arrangements for ventilation and security on the journey, and for preventing any possible risk of disaster when removing bees to the moors, in a high-priced hive fitted for the same object, yet this was valued at only 10s. 6d. Mr. Varty's third prize was also a good and useful hive, priced at 10s. 6d.

The only remaining class is that for Honey Extractors. Here Mr. Meadows fairly swept the board, taking, first, second, v.h.c., and h.c., for his four exhibits out of the seven staged.

We conclude our notice of the "Royal" in

the Jubilee year by stating that in point of attendance the show was a record one, exceeding the previous highest by nearly 29,000. The total number of visitors who paid for admission was 217,980.

Correspondence.

NOTES BY THE WAY.

[2944.] *The Honey Season of '97.*—The fact that we are nearing the end of July puts us in a position to judge what the season will be, so far as the South of England. I except, of course, the few heather districts where the season is prolonged somewhat. In my own immediate district we have no heather within reach of our bees, and no large breadths of this source of supply to tempt us into "carrying our bees to the moors." From inquiries made I cannot place the average results for '97 in this district higher than a two-thirds crop; and in many apiaries swarming will have greatly reduced the "take," in fact, I don't think there will be more than half a crop compared with last year. In my own apiaries we have not much to complain of, spite of our having lost nearly a whole week in the best of the honey harvest, just as the bees had started stinging in good earnest. Then, later on, we had a cold spell, lasting nearly a week. Still, though results will not equal those of '96, we have, by dint of management and real hard work, secured a good quantity of excellent honey, chiefly in sections.

The New Deep-cell "Weed" Foundation.—Our American brethren are still to the fore with "Inventions" in the matter of artificial comb, for a well-known dealer in American goods kindly sent me a sample of the new deep-cell foundation, which I consider is a beautiful production, equal in every respect to the natural product of the bee. In fact, if the cell bases were natural shape instead of flat, it would take a practical apiarist to distinguish between the natural and the artificial product. The cells are a $\frac{1}{4}$ in. deep, thus making the artificial comb—as sent out— $\frac{1}{2}$ in. thick. The main objection I find in it is the small size of the pieces in which it is made for sale. It takes more than two to fill a 1 lb. section; I have, however, little doubt that it will be eventually found possible to make each piece 4 by 4, and thus fit the 1-lb. section without cutting. I showed a sample of the foundation referred to at the Reading Show, and every bee-keeper who saw it, was astonished to see how near the artificial was to the real comb. And now a word on the British "Weed" foundation. This, too, is a great stride forward. The wax is cleansed from impurities in the process, so that all objectionable matter is removed, and, in no single instance have I found the bees refuse to work it, in fact I

never remember my bees taking to the sections so promptly as they did to those filled with British "Weed" this season.

The Royal Show.—I have no desire to prolong the controversy on the Manchester Show, except to thank Mr. Brice for his exhaustive *resumé* (2937, p. 272), which, in a great measure, replies to Mr. Scattergood's attack on myself, which follows on p. 273. For the rest I am content to be judged by your readers, but especially those readers who were also exhibitors present at the Show seeing and hearing all that took place, when the awards were made known.—W. WOODLEY, *Beeton, Newbury.*

SWARMS DESERTING HIVES.

[2945.] In B.J. of July 8 (page 264), you invite bee-keepers to relate 1897 experience of swarms reluctant to occupy hives assigned to them.

On June 10 I reached my out-apiary (my only one) to find a swarm had issued, and clustered, partly in the hedge and, in larger part, on a board set edgewise in the ground close by. As I suspected two swarms to be there, one an after-swarm, I hived them in separate skeps, and had a good look through the smaller lot for a virgin queen to take her away, but could not find her. I then ran the two into one. On the next day I removed the old stock and prepared a new hive to take its place, fitted with combs and foundation. Then I threw the swarm in from the top, but they boiled over and occupied all sides but the inside. Smoke, feathers, and fingers were of no avail, and presently they took wing. I then removed the hive temporarily to the garden-path for convenience of operation, and put in a frame of young brood, while the bees clustered again in the hedge, but like a double bunch of grapes. With care I hived in two skeps again and looked for the queen of the smaller lot, with the same negative result as before. Then both were run in under the hive together. Again they bolted and clustered in two parts, twenty yards apart, to be again taken in two skeps. Here I intended to let them stay till evening, an hour or two later on, but hunted once more in the smaller lot for a queen, only to find the bees slowly disappearing and no queen. But they appeared to be settling in the hive in the garden-path. The larger lot was successfully hived with them in the evening, and no queen was found thrown out. *Per contra*, on June 3 I went out and was informed that No. 5 had swarmed. So I made up a fresh hive and, acting upon the information given, put this on the old stand under two heavy supers already there, removing the old stock. This was quite successful, but a day or two after I found No. 5 had not swarmed at all, but No. 7. What an escape from a battle with, perhaps, 40,000 bees on each side! But honey was

coming in with a rush, and the fraternisation was complete.

I have noticed a pretty phenomenon which seems to be almost uniform. On turning a skep mouth downwards to put it on the ground just after hiving a large swarm, the tumbled-out bees run off in all directions. Very soon, and at one instant, they all seem to make a discovery, and, quicker than you can say "Jack Robinson," they are marching the other way—to the hive. You may be so sure of seeing this that it is worth turning the hive down with a very little carelessness to make the effect more noticeable. It looks as though the hearing of the sound in the hive is the cause of the change.

A very similar thing was noticed under somewhat different circumstances on April 20. A strong hive consisted of two storeys, all the brood being in the upper one, and it was desired to put this below. The top storey was lifted off to the flat surface of the roof, placed on the ground, and the work was done, the queen and brood being placed below excluder zinc. The top part was replaced at more leisure, so that bees had fair time to discover loss of queen. The roof was left on the ground some minutes longer, and there were still a score or two of bees scattered over it. The roof was then lifted, and set level with the alighting-board, with the result that there was an instantaneous and simultaneous fronting of all bees to the entrance, and wing vibration was set up. This, being unexpected, was most striking, and I could only be fully convinced that hearing was the cause of what occurred.

Another experience puzzles me, unless bees carry drone eggs. On June 3 I closed a top storey of deep-frames to the queen by excluder zinc, and on June 23 found six fine drone larvæ, unsealed, close together, three and three, surrounded by honey in drone comb in the upper storey. There was no other brood in the top, but the lower storey had abundance of brood. Yet another experience is a nuisance. The top of the cage in my extractor is about flush with the top of the extractor. The gossamer web flies all round the machine when one gets up a good revolution. I didn't know better when I bought that extractor for a guinea. I do now. No thank you, Mr. Appliance-Maker, no more of that sort.—S. JORDAN, *Bristol*.

QUEENS REARED FROM DRONE EGGS.

[2946.] The wonders and ever-occurring mysteries of the bee-hive are endless, and I have taken a lively interest in the habits of its inmates for more than seven years. The following experience may be of interest to some of your readers:—

I made an artificial swarm from one of my hives on June 3; the parent hive reared its queen satisfactorily, but lost her by some acci-

dent about the 27th. During her existence she had covered one comb with eggs. These were reared, and became sealed over without the bees attempting to raise queens. I therefore gave them on the 3rd inst. a frame of comb containing eggs; but still they showed no signs of producing a common mother, allowing the eggs to hatch and continue their development as worker grubs. This was naturally a great disappointment to me; but, examining the hive again on the 10th inst., I discovered, to my astonishment, some drone comb containing larvæ of various ages (laid by the workers, I presume), and no less than eight queen-cells partially drawn out on these cells. They were the usual cup shape, the bases being rather larger than an ordinary Royal cell.

Through my impetuosity, I destroyed them with a pen-knife, not wishing to have any monstrosities produced in my hives. But, on further meditation, it has struck me as being very strange, and the basis of a subject leading to most interesting results, if one had the opportunity for carrying it out.

I do not know if you or any of your readers have had the same experience, and should be glad to get opinions on the subject. If those drone-larvæ had been allowed to develop, fed on "Royal" food throughout the larval state, and reared in a queen-cell, what would they eventually become? Abnormally large drones, or would they possess any female peculiarities at all?—EDEN A. THARP, *Bedford, July 12*.

NOTES FROM THE WEST.

[2947.] *Wintering Driven Bees*.—In your last issue a correspondent, "D.G.," 1780 (page 278), asks various queries re my experiment in this matter and how I managed with "hiving," &c.? I must say at once mine was simply an experiment, and as such open to question and improvement, and I should not like any one inexperienced in the ordinary habits of bees to follow me, and, failing in his attempt, be liable to censure me afterward. I merely gave my experience for what it was worth, in the hope that it might be tried by others and reported upon. So far, however, mine has been successful, and, with slight variations, I shall adopt it again in the ensuing autumn. The hiving and getting settled down is the greatest difficulty to grapple with, and as the entrances were only about 6 in. apart, the bees are very apt to get mixed up and kill some of the queens in their excitement. My method was, all were hived in single lots on three or four worked-out combs each (or full sheets of foundation, wired), one of which contained brood and taken out of another hive. I did not let them run in at entrance, but, after propping up dummy of No. 1 about an inch, threw bees into hive, and, with the aid of smoker, drove them in under the dummy ("Wells"); when this was finished, fasten down dummy, cover up, and proceed in like manner with No. 2,

and so on to the end. When all were in, I set on crownboard a large "rapid feeder" of food, and the bees, coming up through the two cut holes, easily took down from 20 lb. to 30 lb. per day. Of course, the roof was deep enough to admit of such feeder, and fitted so that no robber bees could get in. The combs were all set the natural distance apart. The inner walls were 9 in. deep instead of 8½ in., so as to give an air space.

Taking Honey.—I have been busy the last fortnight taking honey, and in one instance had a remarkable experience. On July 9 I took two crates of shallow frames, all filled from one of my (driven) stocks, there being 41 lb. net weight of honey from the extractor. On July 16, a week later, I noticed bees in same hive were beginning to get idle, and on examination found both supers again full, which I forthwith removed and extracted, there being this time 47½ lb. Is not this somewhat of a record quantity; for this neighbourhood, anyway? Altogether my bees have done well this year, but we need a day's good rain to bring up more young clover, otherwise the season is now over.—AMATEUR, *Totterdown, Bristol, July 17.*

1. FEW BEE NOTES FROM OXFORD.

[2948.] The honey season in these parts would have been good were it not for the absence of clover, which was killed last year by the intense drought soon after it had taken root. Bees therefore have to collect what surplus they can find from the sainfoin. Unfortunately, however, this crop was cut directly it came into flower, so there was only left beans, vetches, charlock, &c. It will be a short supply, I consider. Owing, as I believe also, to last summer's drought, I noticed in the autumn a particularly unusual absence of brood in the hives. My stocks, each wintered on 20 to 25 lb. of natural stores with a 2 lb. cake of candy and six quilts on, seemed all strong and healthy in February, but during the cold rough winds of spring they dwindled terribly. I lost several stocks in spite of stimulative feeding, and I am now convinced that some one's rather paradoxical advice to "do one's spring feeding in the autumn" is sound economy.

Swarms in this district have been exceedingly erratic, many settling on the tops of trees and in the roofs of houses. I do not believe that a large surplus will be gathered, except in districts where the clover survived last year's ten weeks' scorching drought.—APIARIST, *Fairspeir, Wychwood, Oxford.*

SWARMING VAGARIES.

COMBS BUILT ON BRANCHES OF A TREE.

[2949.] A swarm having issued from one end of a "Wells hive" while I was away at a bazaar in our village on the 8th inst.; the bees hung clustered in an apple tree

till next morning. After I had shaken them all into the skep and carried to where they were to stay, on going back to see if flyers had gone back, to my astonishment I found there was quite a nice lot of comb built, 2½ in. deep and about 4 in. wide; on three branches, just a little comb on each. Is this not rather unusual in this country?

This season my bees have shown quite an inclination to swarm, due partly to the changeable weather we have had and to the fact that I did not re-queen at all last year. A few of my strongest and earliest stocks have stored very nicely, but the yield this year is, I fear, going to fall short of '96 in these parts, when my best colony gave me 112 lb. of extracted honey, and my best, worked for comb, yielded 66 finished sections, some of which weighed 18 to 19 oz.

In making mead, does it ferment best in a wooden tub, or would it do in an earthenware pot, with a hole for a tap at the bottom as well as a cork-hole?—C. B., *Elmhurst, Hon. Sec. Knaresboro' and District B.K.A.*

[An earthenware vessel is more convenient for making mead, but when the liquor is prepared, a wooden barrel is best for managing the process of fermentation.—EDS.]

[Correspondence continued on page 286.]

HOMES OF THE HONEY BEE.

THE APIARIES OF OUR READERS.

The apiary which forms our bee-garden picture this week is one of the largest in the Kingdom; Mr. W. B. Webster, its proprietor, is a well-known expert, holding the first-class certificate of the B.B.K.A., and actively engaged in the bee business in all its branches, not excepting its literature, for he is the author of the "Book of Bee-keeping," a contributor on bee subjects to several periodicals, and known to our readers as the writer of a chatty and practical article in each issue of our monthly, *The Record*. Mr. Webster has also done a great deal of spring and autumn touring in the exercise of his calling as a county expert for some years past, and thus has seen as much as most men of bees and bee-keepers at their own homes among the bees. In addition, he has also "toured" in Scotland and Wales, and does a large business in queens, bees, honey, hives, and appliances.

We asked Mr. Webster for a few particulars regarding his apiary, and he wrote in reply:—"I don't exactly know how the picture of my bee-garden will turn out, but the 'photo' itself was not what I should term 'good.' However, if it's a fair illustration I shall appreciate the skill of the 'half-tone block' producer. Well, I'm expected to give a description of the same; but, as it's my own apiary, I may, as so frequently happens, fall into the error of extolling my belongings more than is justifiable; but I'll curb my

feelings and give, as nearly as possible, an 'unvarnished tale.' The number of my hives for 1897, 'spring count,' was one hundred and thirty-seven. With so large a number it would be utterly impossible to keep a record in one's mind of the condition of each colony. On looking very closely at the illustration a tablet of zinc will be noticed hanging on the back of each body-box; upon these I write, with a lead pencil, all that has, and is, going on within the hive. These pencil marks will, upon the material of the tablet, last from one year until the next. They are then turned round and the next season's business is written on the other side, so a record is kept of two seasons' doings. Right in the middle of the

also the milk providers of our establishment; and to the right, the proprietor with his dog, whose predilection (not the proprietor's in this case) for honey, and his knowledge of when there is a chance to get some, is remarkable. That dog is always at my heels, except when I am packing bees or queens, in which case he is careful to take a safe berth outside the apiary, but well in sight of his master. But if honey is the quest, my heels, or, rather, the proximity of some odd pieces of comb honey, overcomes this somewhat retiring disposition. My 'first hive' (it was made out of a match case) is hidden, but still it is there, grown, like the proprietor, 'a bit moaly' in the service. It will be seen that



MR. W. B. WEBSTER'S APIARY, BINFIELD, BERKS.

illustration—it doesn't look exactly in the middle, as the apiary slopes to those willow trees on the north side, so quite a number of the hives are hidden—is what I call the 'apiary house.' I name it thus in contradistinction to the usual term 'honey house,' for the simple reason of its being used only for packing queens and the various jobs incidental to raising bees—not honey. Around the outside of this house are seen three tiers of shelves, and upon these shelves nuclei are kept during the season. As it was winter when the picture was taken, I simply put the nucleus hives on the end shelves, to show how they stand in the working season. In the foreground, to the left of the centre, will be noticed a pollen feeder,

we are surrounded with woods on the north and west sides. On the east—at my back—is my other 'garden,' devoted to apples and chickens. This orchard garden protects the apiary from the east winds, and from the north the willows afford similar protection. All the winds I have to fear are those from the south-west. When such are blowing freely there's a general hunt around afterwards for roofs. On the south and west sides a barbed-wire fence protects the hives from any familiarity on the part of cattle or horses. All the hives, except three or four, are made for 'tiering up,' long combination hives being conspicuous by their absence. My creosoted platforms are not discernible—as, being black,

they are merged in the grass. Each hive, however, stands on one of these, and the grass is kept mown close around them. The apiary house is quite a unique structure, being in seven parts, and can, by simply removing four stout iron bolts, be taken to pieces. It has also double walls and roof, packed between with sawdust; thus I get an equable temperature within, of considerable service in the summer time, as when a consignment of queens arrive they can be left in there all night in safety. In this house also is usually written, in the summer time, to the accompaniment of a very busy hum, my monthly notes 'Among the Bees.'

CORRESPONDENCE.

(Continued from page 284)

SWARM-CATCHERS.

[2950.] It may be of interest to many bee-keepers to know that there is a swarm-catcher that answers to its name.

Three years ago I purchased one, the invention of Mr. Hole, and I must admit that until Saturday last I looked upon it as simply a superior drone-trap, as hitherto it has answered admirably for that purpose only, and has doubtless deterred the bees from swarming. However, last Saturday, the 10th inst., it secured, for the first time, a large swarm from one of my strongest hives, and I was particularly gratified as on the same day I lost a fine swarm, during my absence from home, from another stock unprovided with a swarm-catcher.

The "Hiver" had been in position for the last six weeks or more, and I am bound to say that I have noticed no apparent difficulty to the bees in coming and going.

I have, for years past, anxiously searched the columns of the JOURNAL, week after week, for tidings of a satisfactory swarm-catcher, which is so desirable for bee-keepers who are obliged to leave their bees throughout the day more or less to the mercy of circumstances. I know now what to do, and in future shall expect to lose no swarms.

I need hardly add that my personal interest in this appliance is *nil*, so far as £ s. d., and I write simply as a bee-keeper in the interest of bee-keepers.—H. LIVERMORE, *Enfield*.

BUYING HONEY FOR EXHIBITING:

A PRACTICE THAT NEEDS REMEDYING.

[2951.] I enclose for your inspection a letter I received a few days ago. The writer, as you will see, wishes to purchase honey from me for exhibition. I am bringing this matter forward as I have reason to believe that there is a good deal of this sort of thing going on at the expense of honest bee-keepers. When a bee-keeper makes his motto "honour at any cost" stoops to buy or borrow honey to

exhibit as the produce of his own apiary, and signs the usual certificate to that effect, I think all honour and manliness has left him, and such practices have a demoralising effect.

A few months ago it came to my knowledge that a bee-keeper, and, as such, a leader of men and much respected, who has secured many honours at county and Royal Shows, had for years purchased his honey for exhibition. The mere knowledge now to others that these honours were secured by dishonesty removes them from his head, and he falls in the estimation of those by whom he was respected.

Exhibitions of honey and beeswax do much good, not only by bringing our produce to the notice of the public, but the good done to the craft from an educational point of view is greater.

Unfortunately a feeling of rivalry—not always friendly—is harboured by a few exhibitors. I think it is only those who are honest, and who, while hoping to be successful exhibitors themselves, still hope the prizes will only be awarded to the best exhibits, that can have real enjoyment in any success or position to which they may attain.—WM. LOVE-DAY, *Hatfield Heath, Essex, July 19*.

[There can be but one opinion on such conduct as is recorded above. We will make further inquiry into the matter.—EDS.]

WEIGHT OF HIVES.

[2952.] In the figures given in 2940 (page 274) I have made a slip. The weight for A on July 12 should be 48 and not 49 lb. The following are the weights since then:—

	A		B	
	lb.	oz.	lb.	oz.
July 13, 7 p.m.	51	2	36	0
" 14, "	53	13	38	5
" 15, "	56	1	40	9
" 16, "	57	12	43	3
" 17, "	59	1	45	4
" 18, "	60	15	48	0
" 19, "	61	0	48	9

It will be seen that since the 15th, hive A has been increasing less rapidly than hive B. On that day the bees were hanging in great clusters outside hive A, so at 4 p.m. I put an empty skep underneath it, raising the skep from the floor-boards by bits of broken tiles, so that there was free ventilation all round. I then closed the upper entrance, and now have the satisfaction of seeing only obviously empty bees just stop to brush their antennae and then fly off, and obviously full bees come hurrying back. All the other bees are out of sight, but I can hear them building in their new skep. This is their third skep, its weight, as that of the second, does not appear in the figures, but has been deducted.

As to the causes of the lessened rate of increase, I am, Messrs. Editors, in much doubt. I hope it is chiefly due to increased comb-building, but the new conditions may have lessened

their eagerness to collect, and of course the bees have further to climb when they come home. Perhaps not quite so many ounces of bees leave the hive in the morning as did before the change, but the difference is not great enough to be sure of.—G. D. HAVILAND, *Warbleton, July 19.*

DURATION OF THE HONEY-FLOW.

HIVES ON SCALES.

[2953.] Readers of the BEE JOURNAL are, I am sure, very much indebted to Dr. Haviland for the trouble he has taken to record his observations at Warbleton and for communicating the same for the information of your readers. I hope the example will be imitated in other parts of the Kingdom. If it is, I am quite confident that bee-keeping will gain, and although for the present year it will be no longer possible to record much *increase* of stores, the autumn and winter will afford an opportunity for showing the rate at which stores are depleted. It would also be interesting to see the difference as regards consumption of food between a hive exposed all the winter and another esconced snugly in a bee-house. External and internal temperature, as well as weather conditions, should also be recorded. I am tempted to ask, would not Dr. Percy Sharp, of Brant Broughton, be willing to co-operate with Dr. Haviland.

It is interesting to notice the conduct of the bees now the honey-flow in the hives is over in my district of Kent. They do not appear to seek the blooms of the white clover in the meadows. The second bloom probably is not of much value. I see them now on garden plants. For instance, the American black-berry the asparagus blossom, also on the large spikes of the sumach. When bees do not range, but seek for such sparse sources of supply close home, it seems to point, at this late period of the season, to the southern honey-flow being over.—"T," *July 16.*

THE SWARMING PROPENSITY.

[2954] Since you invite readers to give their experience in reply to Mr. F. de Haan (2928, p. 255), I beg to say I think your plan is far better than that suggested by your correspondent. As soon as the second swarm had issued he should have examined the parent hive, removed dummy—if space permits—to end of hive; if not, remove two or three of the first frames and place them in a nucleus box or empty hive, and cover them over. Then draw back the next frame midway in empty space of hive and with a long stiff feather brush off the bees; then by taking it out quick he will be able to see every queen-cell it contains, and of these he must destroy every one. This done, put it back close to dummy, or hive wall, as the case may be; then slide

back the next frame and treat in like manner, and so on another till all are gone through. He then should slide all the frames back to front of hive, as they were at first. Now take the frames one at a time from nucleus-box if so placed, and brush the bees off on the top of frames in parent hive. If they contain no brood they need not be returned; indeed, more frames might be removed according to the strength of the colony so as to crowd the bees up into a super, if this be the object in view. The best super for such a colony would be a box of shallow frames with ready-built combs just large enough to cover the brood combs below.

HAVING made sure of every queen-cell, the swarm may be returned the same evening. I think this will be sufficient to insure success in most cases under the conditions referred to.

I consider that I have quite mastered the swarming impulse in bees and so venture to put my views in print.—J. FAIRALL, *Hellingly.*

SWARMING FEVER IN 1897.

[2955.] I have this year suffered from a visitation of swarming fever amongst my bees such as has beaten all previous records in this direction. I began the season with eight stocks which came through the winter badly. With feeding and care they nursed up into good colonies, and as they seemed to require it I put in supers. Swarming, however, set in, and I have had thirteen swarms, including casts, from six of the above hives. The casts were as large as big swarms. I begin to cry, Hold, enough! The remarkable point is that one of the most persistent swarms has been a stock in the largest hive in fifteen frames, supered with shallow frames. While one of the two which has not swarmed at all is a skep which is working well into a large bell-glass super. This looks like being a year of increase rather than of harvest. Yet I cannot perceive that there has been any variation in my treatment of the bees from the method pursued in other years. Has the cold ungenial May discouraged the workers and led them to throw the onus upon the queen? Or is it sympathy with the Jubilee year, and a determination to keep the queen before the public? Anyhow it is quite phenomenal as far as my experience goes. Are bee-keepers as a rule *satisfied* with this season? It seems to me that very little super honey is being stored. Of two large swarms hived in the first week in June neither has yet entered the super. Cutting out queen-cells has not been effectual in keeping the bees at home after swarming. I am inclined to think that there is not an abundant nectar flow in the clover this year. But it would be great satisfaction to me, and perhaps to others, if Mr. Lamb and other North country bee-keepers would give us the benefit of their experience as regards the season.—"WORLD-BEE," *Beverley, Yorks.*

Echoes from the Hives.

Ipswich, July 7.—Honey has been first-rate in quality hereabouts this season. All my hives have swarmed, although I worked them entirely with a view to prevent it. I have only worked one hive for sections, and have up to date taken sixty-six sections from this hive. Later on I will send you, as I have other years, list of my total takings. Have just heard that I have taken first prize at Deal show for extracted honey.—GEORGE B. FOX.

Ripponden, July 12.—Up to July 2 we had some dreadful weather here for nearly a fortnight, dull, cold, and showery. A look at the hives almost made one think that it was winter, so seldom did the bees come out. The larder was almost empty, prospects of honey bad, and it brought to mind that doggerel rhyme—

How doth the little busy bee,
Delight to bark and bite;
And gather honey all the day,
And eat it in the night!

The second and fourth lines seemed all that was appropriate to the weather. However, on the 3rd inst., out came old Sol, and with him all the bees, who speedily replenished the stores. Even the dumbledore and "buzzy" drones condescended to come forth, and all seemed mad with delight. Briar roses, black-berry, limes, and foxgloves speedily burst into bloom, and everything and everybody seemed to enjoy the regulation July weather. Our poor newspaper editors will have to look round for something else to talk about than the American "hot wave," as they will be put in the shade, for now—as the babies say—"we's all happy cos we's got it;" at least I hope so. Our farmers are getting in the hay, bees are getting in the honey, and now we bee-keepers shan't be much behind, if the bees can only "keep it going." Hoping all readers of B.J. will soon be bottling and labelling "pure English honey" and plenty of it.—JOHN H. PRIESTLEY.

Queries and Replies.

[1786.] *Swarming Vagaries—Loss of Queen.*
—I am the possessor of only two hives of bees, which I will call A and B. A threw off a swarm on June 21 last, which swarm I hived all right, but the bees took wing and flew off next day, being lost, of course. A swarmed again on the 26th (which swarm I lost also), and a third time on 27th. This time I secured the swarm and returned to the hive at night by throwing the bees on to top of the frames. They swarmed again next day, however (on the 28th), and I gave away the swarm to a friend. I found a small swarm on July 2 in a signal-lamp in a remote country district, the bees

probably coming from a straw skep close by. They had been in the signal-lamp about a week, apparently, when I found them. This lot—which I shall call B—were put in a plain wooden box about 12 in. square; they worked very well up till yesterday when I noticed they seemed to be rather idle, and later in the day I could not see one outside the hive. A, on the contrary, was very busy, but about 1.30 p.m. I noticed a few bees clustering on a flower about a foot away. On examination I found a queen among them; her wings seemed very short and were a bit damaged; there was also an indentation on her abdomen below the waist as if she had been crushed. I cut off the flower and put it on the alighting-board of A, when the queen immediately disappeared. About twenty minutes later I saw a similar cluster on a twig close to the alighting-board, and, as I examined them, the queen dropped on the board and ran into the hive, nor have I seen her since. All yesterday, however, up till a late hour, and again early this morning, the bees were running to and fro in a very excited way as if looking for something, and hive B, on the other hand, seems to have strack work altogether. Will you please give me your opinion of the case and advise me what I should do?—C. CAMPBELL, *Denbigh, July 12.*

REPLY.—It seems clearly apparent that the queen of A has received some damage or injury, which damage, as we think, can only be accounted for by supposing that two young queens issued along with the cast on June 27. Then—following up our diagnosis—when returning the cast, by throwing the bees on to the tops of frames, we fancy one of the young queens received the injury to her abdomen, and, owing to this, was unable to fly well, consequently only one of the two queens came out with cast on the 28th, leaving the damaged one behind. This we take to be the queen found on the flower bloom after herself leaving the hive, as injured bees so often do, to die. Her again entering the hive with your help in carrying her to it only deferred her end, as she was sure to die. Our advice, under the circumstances, is to examine the frames of A, and if—as is almost certain—the bees are queenless, it will be necessary to procure one or the bees will come to grief.

[1787.] *Transferring Bees from Skeps.*—
In April last I came into possession of eleven stocks of bees in skeps, all well filled with brood and some little honey. I have purchased modern frame-hives, and have gradually transferred each skep colony to them by the method known as "open driving." One skep I placed on the top of a frame-hive, hoping the bees would transfer themselves by taking possession of the hive below. 1. It is nearly a month since this occurred, and I should like your advice as to when I may safely conclude that the bees have accepted their new quarters for a brood-chamber. The skeps are of the

most primitive kind—made of osiers, and covered with cow-dung, with another outside covering of plaited straw. 2. Would you advise me to put a sheet of queen-excluder zinc between the skep and frame-hive? It is but lately that I have subscribed to your journal, and very possibly my question may have been answered before, but I have not so far seen a reply which is applicable to my case. 3. Can you tell me what kind of bee we have in these parts?—BURDETT MASON, *præs Bayonne, Basses Pyrénées, France, July 10.*

REPLY.—1. Not having any personal experience of your part of France, we do not feel competent to name a time when bees are likely to have transferred their brood-nest from a skep to a frame-hive placed below. Our senior Editor could no doubt have advised on the subject, but he is abroad, and his view not available in consequence. However, it is a simple operation to lift the skep off for a few moments while the frames of lower hive are examined and their condition ascertained. 2. No; we do not advise the use of a queen-excluder in your case. If the bees have built out combs in the frames, and they are occupied with brood, the skep may be allowed to remain where it is. After all brood in it has hatched out, the combs will be filled with honey if the season holds out. Then, at the close, the skep may be removed and its contents appropriated. 3. We will communicate with Mr. Cowan on this point, and reply in due course, merely adding here that, as our message and reply will have to travel some 12,000 miles to and fro, it will take several weeks before reply appears.

Bee Shows to Come.

July 24, at Fallowfield, L. and C.B.K.A.—In connection with the South Manchester Horticultural Society.

July 28 at Henbury.—Bristol, Somersetshire, and South Gloucestershire Annual Show.

July 28 and 29, at Chester.—In connection with the Great Horticultural Fête. Bee Department under the management of the Lancashire and Cheshire B.K.A. Medals and liberal prizes for honey, &c.

July 27, 28, 29, at Gloucester.—Gloucester B.K.A., in connection with the Gloucester Agricultural Societies' Show. Eight Open Classes.

July 31, at Helsby.—Three open classes. Prizes (20s. &c.) for single 1-lb. jar and (10s. &c.) for single 1-lb. section. Apply Dr. Briant, Helsby, Warrington. Entries close July 24.

August 2, in Melton Constable Park. North Norfolk B.K.A. Annual Show. B.K.A. medals and liberal prizes for honey. Schedules from C. J. Cooke, Hon. Sec. N.N.B.K.A., Edgefield, Melton Constable. Entries close July 28.

August 2 and 3, at Swansea.—Glamorgan B.K.A., in connection with the Glamorganshire General Agricultural Society. The annual general meeting of the G.B.K.A. will be held in show grounds, on August 3.

August 2 and 3, at Northampton.—Northants B.K.A. Sixteen classes (six of them open to all), with good prizes for honey and beeswax. Schedules from Robt. Hefford, Hon. Sec., Kingsthorpe, Northampton. Entries close July 25.

August 4, at Neston Park, Wilts.—In connection with the Atworth and District Horticultural Show. Two open classes for single 1-lb. section and single 1-lb. jar of extracted honey. Schedules now ready. J. P. Inkpen, Secretary, Atworth, Wilts.

August 5, in Keele Park.—Honey Show in connection with the Keele Agricultural Society. For full particulars see advt. on page 290.

August 10 and 11 at Burton-on-Trent.—Staffs. B.K.A. In conjunction with the Staffordshire Agricultural Society.

August 12, at Goole.—Annual Show of Bees and Honey in connection with the Goole and District Agricultural and Horticultural Society. Six Open Classes, with good prizes, including 20s. and 10s. for single 1-lb. jar of honey (entry free in this class). Schedules from J. Luddington and H. S. White, Secretaries, Lindum House, Goole. Entries close August 7.

August 13 and 14, at Dumfries.—S.S.R.K.A. Jubilee classes open to the world. Schedules from Jas. Kerr, Douglas-terrace, Dumfries.

August 18 and 19, in the Quarry, Shrewsbury.—Schedules from T. Whittingham, Colum Cottage, Shrewsbury. Entries close, August 5. See advt. on page ii.

August 19, 20, 21, at Barrow-in-Furness.—In connection with the Royal Lancashire Agricultural Society. Six classes, with liberal prizes for honey. Schedules from Jas. Birch, Secretary, 34, Castle-street, Liverpool. Entries close July 31. For fuller particulars see advertisement on page iii.

August 24 and 25, at Hastings.—Annual Show of the Kent and Sussex Bee-Keepers' Association in conjunction with the Sussex County Agricultural Society. Liberal prizes. Schedules from Henry W. Brice, Hon. Secretary, K. and S. B.K.A., Dale Park, Upper Norwood. Entries close August 14.

September 4, at Bramhall Hall.—Lancashire and Cheshire B.K.A., in connection with Bramhall and Woodford Horticultural Society. Annual show of honey. Open to district and members of the L. and C. B. K. Association only. Schedules from Secretary, J. Bell, Davenport, Stockport.

September 8 and 9, at Derby.—Sixteenth Annual Show Derbyshire B.K.A., in connection with the Derbyshire Agricultural Society. Nineteen classes and over fifty prizes for bees, honey, and appliances. Schedules from F. Walker, Hon. Sec. D.B.K.A., Cattle Market, Derby. Entries close August 31.

September 25, in the Corn Exchange, Jedburgh.— Roxburghshire B.K.A. Annual Honey Show. Twenty-six classes for honey, wax, and sundries. All open. A single entry fee of 2s. covers all classes. Schedules from Thos. Clark, Pleasants Schoolhouse, Jedburgh, N.B. Entries close September 21.

Notices to Correspondents & Inquirers.

All queries forwarded will be attended to, and those only of personal interest will be answered in this column.

JOHN M. HOOKER.—*Judging at the "Royal" Show.*—Our correspondent's communication on the above subject—received too late for insertion this week—throws no new light whatever upon the discussion. In fact, it consists mainly of personal remarks addressed to one who does not care to make any reply. We therefore see no possible good that can come of its insertion. Mr. Hooker had his full "say" on the question on page 262, and the various comments he now makes on the criticism provoked by himself makes it clear that, in common fairness, those he criticises should have space for further reply. As this cannot be, we trust all our friends will agree to accept the limitation made in our footnote on page 273, and confine their observations to a single letter.

BEGINNER (Guildford).—*Vicious Bees. Capturing Queens.*—1. It is just possible that you have done something to upset the temper of the bees when transferring comb and bees from skep a month ago. At same time, we have many reports about bees being more

than usually irascible this year. If carefully managed they will, no doubt, quieten down in a short time. As a rule, beginners should not readily undertake such operations as *transferring*. 2. Only practice will enable you to capture the queen when driving bees. But if two driven lots are united, the queens may be left to settle between themselves the question of the "survival of the fittest."

W. F. (Paull).—*Pamphlets on Mead and Vinegar-Making*.—The pamphlets published by the Rev. G. W. Bancks, Durham House, Dartford, Kent, price 2½d. And the same author's "Honey and Its Uses," 3s. 6d. per 100, are the only ones we know of.

H. C. (Ilkeston).—*Medicated Bee Food*.—1. Syrup medicated with Naphthol Beta has no perceptible taste or smell beyond that of syrup not medicated at all. Phenol, on the other hand, is so distasteful to bees that it is at times very difficult to get them to touch it. 2. For preventing swarming there is no panacea. Shade, ventilation, and room in advance of requirements is all that can be done in effecting the desired end. 3. Can you not give us some indication of how long ago it was since names of Carniolan queen raisers were given? "About two years ago" is too indefinite to help us much.

J. H. H. (Bedale), M. DIXON (I. o. M.), and A. R. M. (Bransford).—In all these cases samples of comb received are affected with foul brood.

* * * *We again regret to be compelled to hold over till next week several interesting letters and queries from lack of space.*

Special Prepaid Advertisements.

Twelve words, Sixpence; for every additional Three words or under, One Penny.

FEW PROLIFIC QUEENS LEFT, 2s. 6d. to clear. BEETAL, 80, Northill, Highgate, London.

STRONG STOCKS, 25s.; Swarms, 5s.; Sections, 8s. Particulars free. SUTTON, Burston Diss. R 30

FOR SALE, Healthy Stock Hives, cheap. B. 7, Routh-road, Wandsworth Common. R 22

WANTED, Choice CLOVER HONEY. Sample and price to E. LOWE, Helsby, Cheshire. R 27

FINEST SECTION HONEY, perfectly worked, beautiful colour, from prize crates. E. PHILPOT, Bedford-road Apiary, Hitchin, Herts. R 23

WANTED, several lots DRIVEN BEES, earliest date possible. MACDONALD, Schoolhouse, Morinsh, Ballindalloch. R 24

HONEY. Finest White Clover and Heather wanted. Post samples and lowest prices, stating quantities. SPRING & Co., Brigg, Lincs.

WANTED, GARSTANG PRESS and HONEY (no rubbish). Exchange good Cushion Bicycle, ball bearings, or sell, £3. Woods, Normandy, Guildford. R 33

HEALTHY DRIVEN BEES, 1s. 4d. lb.; order now, deliver early in August. Boxes returnable. Extracted Honey in bulk, 1 lb. sample, 3d. LAWRENCE, 11, Princess-street, Cheltenham. R 32

LIGURIAN QUEENS. The consignments from Italy are coming in very regularly, so I can send by return post, price, July, 6s. 6d. W. B. WEBSTER, Binfield, Berks. R 25

Prepaid Advertisements (Continued)

WHAT OFFERS? Four Fine STOCKS BEES in bar-frame Hives, with Honey and Appliances. Buyer fetch. Apply, Miss SNOWBALL, "Fairholm," Brougham-road, Acton, Middlesex. R 26

DRIVEN BEES, July and August lots with Queens, 5s.; two, 9s.; per lb., 1s. 6d. Rotation as orders received. Boxes returnable. CROFT, Highcliffe, Winchester, Hants. R 23

QUEENS reared under swarming impulse from imported Italian mothers and mated to native drones, 4s. each; 3-frame Nuclei with queen, 10s. packing free. Native Queens, 3s. each. All stocks guaranteed healthy by first class expert. Stamp for inquires. SALMON, Hardwicke, Gloucester.

DRIVEN BEES! DRIVEN BEES! Guaranteed healthy, 1s. 3d. per lb. Ready in August; 3d. per lb. returned to all that return empties paid to Horse-bridge Station. OWEN BROWNING, King's Somborne, Stockbridge, Hants. Remittance must accompany all orders. R 29

STRONG STOCK OF ITALIANS with year-old imported Queen, with or without combs and hive. Smoker, Cylinder Extractor; catalogued 40s.; only used one season; 500 best white sections, 1s. 9d. per 100. Foul Brood unknown. E. ASHMORE, Holymoore-side, Chesterfield. R 31

FINE TESTED 1897 FERTILE QUEENS of my well-known strain, 3s. 6d. each. Strong 3-frame Nuclei, with Queen, 12s. 6d. Guaranteed healthy, and safe arrival. Bees 1s. 6d. per lb., for 5 lb. lots or over with Queen. Ready in August. Packages to be returned WHITING, Valley Apiary, Hundon, Clare, Suffolk.

WANTED, Quantity good '97 HONEY, Comb or Extracted. S. CRAWFORD, Lisnacloog, Castlederg. R 15

SPECIAL SILK BEE VEILS, 9d. post free. ABBOTT BROTHERS, Merchants Quay, Dublin. P 46

SUPERIOR QUEENS, Stocks, Nuclei, and Swarms. Address, Rev. C. BRERETON, Pulborough, Sussex.

DRIVEN BEES, in lots with Queens. End of July and August. 5s. Boxes returnable. A. R. MORETON, Bransford, Worcester. R 21

SEND FIFTEEN STAMPS for useful (half pound post free) SAMPLES of FOUNDATION, and compare with what you are using. ABBOTT BROTHERS, Merchants Quay, Dublin. P 47

21ST YEAR. PURE ENGLISH BEES. Good swarms, 10/6, 12/6, 15/-. Cases 1/-, or returned. Tested Queens, 3s. 9d. delivered. Cash with order. ALSFORD, Expert, Blandford.

LACE PAPER for GLAZING SECTIONS. 100 strips, 7d., 200, 1s. 2d., 300, 1s. 6d., 500, 2s. 3d., 1,000, 4s. Post free. Best quality. Neat patterns. W. WOODLEY, Beedon, Newbury.

SPECIAL OFFER. To introduce our new SECTION (fully patented 1896.) and FOUNDATION, we offer to send 24 Sections and Foundation to fit, post free 1s. 6d. ABBOTT BROTHERS, Merchants Quay, Dublin. P 45

BRICE'S RELIABLE QUEENS. Well-known strain. One quality (the best), one price. Mated Tested Queens, 5s. 6d. each. Post free in my perfected introducing case; safe arrival guaranteed. Orders executed in rotation. HENRY W. BRICE, Dale Park-road, Upper Norwood.

SPECIALITIES, 1897.

Transparent Waxed Paper Section Wrappers, Gilt Section Bands, 1s. per 100. Postage 3d.
16-oz. SCREW-TOP HONEY BOTTLES, 2s. dozen.
LISTER & TAYLOR, HATHERSAGE, SHEFFIELD.

Keele Agricultural & Horticultural Society.

SHOWS in KEELE PARK, THURSDAY, AUGUST 5th, 1897.

OPEN AND LOCAL CLASSES. £700 in PRIZES.

Agricultural, Horticultural, BEES & HONEY, Pit Ponies, Dogs, and Poultry.

Entries close July 19th; double fees to 26th.
W. A. BENSON, Secretary, Silverdale, Staffordshire.

Editorial, Notices, &c.

LINCOLNSHIRE B.K.A.

ANNUAL SHOW AT SLEAFORD.

The annual show was held in connection with that of the Linc. Agricultural Society at Sleaford on July 15 and 16. This year, for the first time, the Bee department was entirely under the management of the L.B.K.A., with the result that nearly double the number of entries of previous years were made. The weather during the show was superb, but unfortunately it had been otherwise at a time when the filling of supers was sorely needed by exhibitors.

The arrangements were ably carried out by Mr. Godson, the indefatigable hon. sec., while the bee-tent was made a centre of attraction by the manipulations and lectures given by Messrs. F. J. Cribb, and H. O. Smith.

Though the weather was responsible for the absence of a few entries, there was no lack of fine samples of honey, but the fact of no entries being made in the class for a display of honey was ample testimony that the season and not lack of energy on the part of bee-keepers was responsible for the absence of such an interesting section of a honey show. Sections also, for the same reason, did not make a very good show, still, they were a creditable class. The extracted honey classes contained several samples of dark honey, some of fine flavour, but owing to its being classed along with clover and sainfoin it had to be passed over. Another year, doubtless, the committee will see their way to making a special class for dark honey.

In the appliance classes, Mr. Meadows was an easy first, though in the classes for single hives there were several really meritorious exhibits.

The judges were Mr. C. N. White and Mr. R. Thorpe.

LIST OF AWARDS.

Collection of Honey (No Competition).—Special prize, E. Elcombe, Sleaford, for super of honey.

Twelve 1-lb. Sections.—1st, H. O. Smith, Louth; 2nd, W. Patchett, Thoresway; 3rd, R. Godson, Tothill.

Twelve 1-lb. Jars Extracted Honey.—1st, H. O. Smith; 2nd, A. W. Weatherhogg, Willoughton; 3rd, R. Brown, Somersham.

Twelve 1-lb. Jars Extracted Honey (County only).—1st, A. W. Weatherhogg; 2nd, W. Patchett; 3rd, R. Godson; 4th, J. R. Herbert Bonby.

Six 1-lb. Jars Extracted Honey (Cottagers only).—1st, T. Holdsworth, Kirton-in-Lindsey; 2nd, W. Patchett; 3rd, W. J. Coulson, Hibaldstow.

Bees' Wac.—1st, R. Godson; 2nd, J. R. Herbert; 3rd, R. Brown.

Two Shallow Frames of Comb.—1st, R.

Brown; 2nd, R. Godson; 3rd, F. S. Smith, Louth.

Observatory Hive.—1st, R. Godson; 2nd, Dr. Sharp, Brant Broughton.

Collection of Bee Appliances.—1st, W. P. Meadows, Syston; 2nd, W. R. Garner, jun., Dyke, Bourne.

Hive not Exceeding 25s.—1st, W. R. Garner; 2nd, W. P. Meadows; 3rd, C. Redshaw, South Wigston.

Hive not Exceeding 12s. 6d.—1st and 3rd, C. Redshaw; 2nd, W. R. Garner; h.c., W. P. Meadows.

Special prize to Dr. Sharp for a fine set of lantern slides.

NOTTINGHAMSHIRE B.K.A.

SHOWS AT HUCKNALL AND SOUTHWELL.

The show at Hucknall, on the 20th inst., in connection with the Local Horticultural Society, was a very fair one, some splendid honey in sections and bottles being staged. The first prize extracted honey was of excellent quality.

Mr. P. Scattergood (first-class expert) officiated as judge, and also gave some well attended and interesting demonstrative lectures in the bee tent.

The following is the list of awards:—

Twelve 1-lb. Sections.—1st, J. & W. Herrod, Sutton-on-Trent.

Twelve 1-lb. Jars Extracted Honey.—1st, H. Wiggett, Hucknall; 2nd, Mrs. Hind, Papplewick Grange; 3rd, J. T. Faulconbridge, Bulwell Wood; 4th, H. Cartledge, Hucknall.

Bees in Observatory Hive.—1st, G. Hayes, Beeston; 2nd, H. Wiggett; 3rd, H. Merryweather, Southwell.

The SOUTHWELL SHOW was held in connection with the Horticultural Society, at Southwell, on the 22nd inst. The entries in all six classes were numerous, and the general quality of the honey staged excellent, especially the sections. Mr. P. Scattergood (in the absence of Mr. Pugh) officiated as judge, and his awards were as follows:—

Shallow-Frame of Comb.—1st, W. Lee, Southwell; 2nd, J. & W. Herrod, Sutton-on-Trent; 3rd, T. Marshall, Sutton-on-Trent.

Six 1-lb. Jars Granulated Honey.—1st, W. Lee; 2nd, H. Merryweather, Southwell; 3rd, G. Wood, Apperstone.

Six 1-lb. Sections.—1st, J. & W. Herrod; 2nd, T. Marshall; 3rd, H. Merryweather.

Six 1-lb. Jars Extracted Honey.—1st, J. T. Faulconbridge, Bulwell; 2nd, H. Merryweather; 3rd, G. Marshall, Norwell; 4th, W. Lee.

Bees in Observatory Hive.—1st, G. Hayes, Beeston; 2nd, G. Marshall; 3rd, W. Lee; 4th, J. & W. Herrod.

Single 1-lb. Jar of Extracted Honey (local).—1st, H. Merryweather; 2nd, W. Lee; 3rd, J. Holmes, Southwell.

(Communicated.)

Correspondence.

The Editors do not hold themselves responsible for the opinions expressed by correspondents. No notice will be taken of anonymous communications, and correspondents are requested to write on one side of the paper only and give their real names and addresses, not necessarily for publication, but as a guarantee of good faith. Illustrations should be drawn on separate pieces of paper. We do not undertake to return rejected communications.

MISCELLANEOUS BEE ITEMS.

[2956.] *Bell-glasses on Skeps.*—Your correspondent "Straw" (2935, page 266), would, perhaps, like to know how I manage with my bell-glasses. I therefore write to say: Rather late in the autumn of 1894 I purchased three lots of driven bees joined together in an old skep for 2s. 6d. Owing to date on which the bees came into my possession, and fearing robbing whilst this lot was storing syrup, I determined to try to keep it in an attic, and accordingly removed a pane of glass from the attic window and in its stead fixed a stout piece of cardboard, having in the centre a hole 3 in. in diameter. I then placed an empty honey-jar crate near to the window, and upon it placed the skep of driven bees. I then got a large glass lamp-chimney about 13 in. in length and 3 in. in diameter at top, placing one end of it in the hole in cardboard and cementing the other end to the entrance of the skep. I fixed nothing for the bees to alight upon before entering their "tunnel." I gave this stock about 24 lb. of syrup. In April the following year, 1895, I gave these bees 10 lb. of syrup, and in May placed over the hole in flat roof of skep an adaptor. This was a circular piece of wood 14 in. in diameter, having a 4 in. hole in centre covered with queen-excluder zinc. I packed the space between the skep and adaptor with a layer of mortar so as to conserve the heat and ensure the bell-glass—a fairly good sized one—standing perfectly level. When completed in July I found the net weight of the contents of the glass was fully 28 lb. Previous to putting the bell-glass on I fixed in it three small pieces of drawn-out comb. This super of honey was awarded first prize at the annual show of the W.B.K.A. This stock had no feeding in the autumn, because of its stock on hand being sufficient. The bees wintered well. In the following April I gave a few pounds of syrup, and again placed the bell-glass on in May, 1896. Result: a super fairly well filled, but not so well as in 1895. Again secured a first prize at the annual show. Although I had twenty stocks in 1896, my attic colony was the only one that gave me any surplus. I broke up the contents of bell-glass this last March, and to my surprise found it was not in the least granulated. Early this spring, wishing to examine the combs, &c., of this stock, I removed the glass chimney, and having no cement or mortar, I was unable to

refix it, so the bees have now a direct flight from the skep through the window. I gave about 3 lb. syrup this spring, and in May again put on bell-glass, which I am hoping will be ready for removal by the end of this week. I might add that the small pieces of drawn out section-comb I fixed in bell-glass last year, and this year fell down before the bees could work upon them, so the combs were built upwards instead of downwards. Whilst the bell-glass is on, I cover it up warmly with an old mackintosh day and night. These are elementary details of no value to the bee-keepers of experience, but of course my experience may perhaps interest beginners.

Chickens Stung to Death.—A friend of mine kept a brood of chicks in a small pen about a dozen yards from his hives. He one day found four of the chickens stung to death, as many as twenty stings being found in the body of one, and nearly as many in the others. He at the same time found the remainder of the brood with a few stings, but these eventually recovered.

Drones returning to their Hives.—I had no idea until recently that these gentlemen were given to keeping late hours. Whilst watching the late workers returning to their homes the other evening just before 9 o'clock, to my surprise I observed a drone arrive and enter. I watched him closely to see if he appeared any the worse for leading so gay a life, but I must own his gait was steady, and he at once passed through the portal, no fumbling about for the latch-key, &c.—I mean the entrance. I concluded he had been out Jubileeing, but I do not think he had either seen or met her Majesty, for his physical powers did not seem to be in the least enervated. Unusually late for this young spark to be out, was it not? I am afraid he comes of a vicious strain.

The Limes.—Happy is the *Bee-ist* whose stocks are situated within easy distance of the limes, for this season the few trees in this neighbourhood are literally bending down with the profusion of bloom. As early as 5.30 in the morning and late on in the evening have these trees been all alive with their joyful visitants; at least, the owners of the bees were joyful, if the bees themselves were not.

What a pleasure it is to inhale the delicious perfume when passing, although now not so great as it was a few days ago, after a nice shower. The country generally has now a parched appearance owing to the very hot winds lately blowing.

The Clover.—How I envy the bee-keepers in Cheshire and other counties where white clover is largely grown! What little Dutch (or white) clover grown about here was this year in A1 condition, and helped us on.

I must ask you, dear Messrs. Editors, to pardon my verbosity. It is now several months since I wrote you last, that now I have again started I have a trouble to come to a stop.—PERCY LEIGH, *Beemount, Stoke Prior, near Bromsgrove, July 15, 1897.*

A DOZEN QUESTIONS ON BEES :

AS ANSWERED BY DR. C. C. MILLER.

[2957.] I have read with much interest the B.B.J. of July 1 (p. 257) the twelve questions on bees and the answers to them as given therein, but I think Dr. Miller is scarcely consistent in the replies given to Nos. 3 and 11. His answer to question 3 is "that the drone is practically of the same blood as the mother irrespective of the mating of the queen." Question 11 is, "How can I determine as to whether a queen is bred from a purely mated mother, when she is mated with a hybrid drone?" and is answered, "You can't do it at all." Now, assuming the reply to question 3 to be correct, this can easily be determined, as a queen bred from a purely-mated mother must breed pure drones. I was discussing the above with an old bee-keeper, but he said he had never given this point much attention, and, on suggesting that we might test the question by purchasing a Ligurian queen on the probability of a black queen mating with one of her drones, he told me he remembered having a Ligurian hive that never swarmed, and while he had it he gave a neighbour a swarm of black bees. Asking this neighbour some time afterwards how his hive was progressing he was told it was doing well, but that half of the bees were Ligurians. Do you not think this black queen must have mated with a Ligurian drone—her drones being pure and the workers hybrid! Can you give me any information regarding the markings of hybrid workers? For instance, a black queen is mated with a Ligurian drone, or a Ligurian queen with a black drone, would the worker in either case take the markings more distinctly from the queen or the drone? Your early reply in the BEE JOURNAL would be much esteemed.—NOVICE, *Minishant, by Mayhole, N.B.*

[Will reply next week.—EDS.]

SWARMING VAGARIES IN 1897 :

WITH SOME PERSONAL BEE NOTES.

[2958.] I notice a letter (2936, page 266) in B.J. of July 8 on "Swarming Vagaries of 1897." But I think one which came under my notice beats that of Mr. E. Tharp, and so I send on particulars. A friend of mine was called in to look at a frame-hive in the early part of June, and found seven queen-cells capped over, the whole of which he cut out. He then gave the bees three more frames and a rack of sections. In spite of all this additional room the hive swarmed again two days later, and the swarm entered a neighbour's frame-hive, which was not only queenless but very weak. My friend removed his swarm from the neighbour's hive into a skep, but next day they came out again and re-entered the same hive. They were this time put into a skep, where they settled down for nine days, nearly filling the skep with comb and some brood. Yet after all this they again

swarmed, and of themselves again went into the frame-hive. Once more they were put back into the skep, with the comb and brood in it; but this did not satisfy them, for they simply repeated the operation just as before, and as my friend happened to have a frame-hive of his own not in use, he put the errant swarm in it, and set the skep and contents on top of frames. There they have remained ever since, doing well.

My own bees have also done very well this year. At end of '96 I had six frame-hives, all headed by young queens, but two of them became queenless in spring. One of these I made into a splendid stock by taking a swarm out of an old ash tree where they had been for several years; the other I left on the off chance of getting a swarm myself. A stray swarm, however, made love to the queenless bees one Saturday night quite late, and saved me further trouble by joining forces with them—they are now a good stock. I have not, so far, had any swarms from my own hives, all of which are doing first class. I account for this by the fact that I give plenty of air top and bottom; I also shade them with some thin wrapping stretched on sticks. I also soak the wrapping in water on hot days, which keeps the bees cool. One thing, however, I don't understand, and that is why the bees all round here this last fortnight are such perfect demons for stinging. They use their "tail-end" on any or no provocation. This, of course, makes it "hot work" for one's neighbours to be continually on the run for shelter, as one cannot make them understand to be quite still, and they consign the owner and the bees to that place which is said to be well—hotter even than the weather. It is no unusual sight to see one or more eyes that remind one of the "P.R." results after a tough battle. I close with best wishes for you and your charming paper.—T. ADAMS, *Carliff.*

QUEEN'S "MATING TRIPS."

[2959.] As there are often questions asked relating to this matter, perhaps some kind friend will give us the benefit of his experience. It has been said that bees take little notice of a virgin queen, so why should a swarm follow her on these occasions? And, again, would not the height to which the wedding trip is taken somewhat debar the throng from following? In such a case they would surely return to the hive as in the case of a lost or damaged queen. It is frequently impossible, especially with people only possessing one hive, to provide a frame of unsealed brood about the period of such flight. Again, when does she fly, and at what age (in days) does she commence to lay on an average? If I am right in supposing an allowance of twenty days to be made during which a young queen must become fertilised, it would require a great deal of attention and examination and more than one supply of unsealed brood (supposing such to be neces-

sary, which I doubt) to keep the hive safe if the full limit of the twenty days is taken.

This is all referring to movable frame-hives, but what could be done in the case of a skep? It occurs to me that the bees have arranged these little matters very satisfactorily for a long time under the old conditions, and possibly there was not always a ten or twelve days' old embryo queen at the time of swarming. Some light might be thrown upon the vagaries and re-issuing of swarms, not necessarily from an overcrowded hive. I have myself seen swarms boil out of hives time after time, both in the case of a young mated laying queen being present, and also when they have had only a virgin. In these cases the queen has been almost the last to issue, and, on being caught and caged, the swarm have quietly returned to their quarters.—“*BETAL*,” *Highgate, London, July 16.*

DAYS OF JUNE.

(Continued from page 276.)

[2960.] There is no place like the Fells. This morning there is not a ripple on Rhydal Lake. The Scars of Loughrigg, with its encircling woods, are reflected in the clear water as in a mirror. The sun is hot, and the little heath butterfly revels in his beams. The hot air rises, and the cold fell tops turn it into clouds which drag along the higher summits and dry away as they drift out into the blue. Not a cloud anywhere except on the fells. The short, wiry mountain sward is wet beneath them. The water is ever percolating through the best of all filters—rock—and this one fell alone has a thousand springs bubbling up, always full and brimming over. Do you see those silver streaks high up on yon dark fell that flash and shimmer under the summer sun? Those are the ghylls* descending steeply into the dales. You cannot go many hundred yards without crossing one of these noisy young becks, and you cannot have a better morning's task than to trace one of them up to its source, for there you will find the best of the mountain flowers congregated together—alpine meadow-rue, mossy saxifrages, bird's-eye primroses, and splendid tufts of stag's horn moss—and perhaps you may see two or three buzzards soaring thousands of feet above the summit of the fell, or hear larks singing sweetly in the profound solitude which always reigns up there.

Ye dwellers in the arid places of the world, what would not ye give if you had some becks and ghylls like these? Ye toilers under the murky skies that lie between Wigan and Warrington, or between Wolverhampton and Birmingham, what would ye not give if you might wander of an evening under the rocky shoulders of Loughrigg by the delicious moun-

tain stream—the Rothay—that comes rushing down from the Rydal fells and the glorious lakes of Rydal and Grasmere? Cold, sparkling, leaping water of the becks and ghylls, distilled through rock and roots of bird's-eye primroses and butterworts and sundews, let down from one ledge to another by ropes of yellow-flowered, rich green-leaved crimson-stemmed saxifrage, was there ever water like you since the world began?

Ye heathy wastes unmix'd with reedy fens;

Ye mossy streams, with sedge and rushes stored;

Ye rugged cliffs, o'erhanging dreary gleens—

To you I fly, ye with my soul accord.—BURNS.

Perhaps of all June days, the one on which I wended my way to the “Royal” Show will be remembered the longest. It was one of those glowing, electrical days when the sun fortunately plunges through the clouds but seldom. On those occasions there was nothing for it but to immediately sink down on the grass and go to sleep, or, in the case of bees, to swarm; and swarm they did. One of the observatory hives sent off a contingent which settled on a crate, and in the evening when we returned home there was a fine swarm awaiting us.

We sauntered to the Show ground by that magnificent artificial waterway, the Ship Canal, on whose fair—and yet not very fair—bosom reposed some merchantmen from who knows what sunny clime? And one great convict ship that tried to lure us by promising a sight of several convicts, made in wax, murdering their guards! As we were making a bee-line for the honey tent we reluctantly had to forego this treat. On we went and then we got into the Show ground, and thereupon our troubles began. Where was that bee-tent? The fact is we went too early! It was eight o'clock a.m. and the blinds were not yet drawn up. We met a hostler rubbing his eyes. Had he seen the bee-tent? Nay, nor ever heard o'n't! We stumbled about over sleepers (wooden ones) and through arcades of machinery and pigs; and then we struck a vein of goats and had to make a long detour. At last we came across a farmer in a pair of breeches evidently constructed in honour of the Diamond Jubilee. They clasped his legs very tightly nearly to the top and then suddenly bulged out into a very decent balloon. The farmer filled the upper portion very successfully, so that we were lost in admiration of his spindly (by comparison) legs which managed to carry so great a weight. We mustered up courage to speak to so great a personage, and asked him, “Did he know where the bees were?” He gazed down at us sadly and spoke with a voice which came from the depths of his boots, saying, “Dun I know weer th' bees am? Nay, I dunna. But I knowst weer thou'rd ocht to be, and that's abed!” And then my brother would have gone for him had I not caught him by the coat collar and dragged him away. After we had wandered a few more miles through

* Ghylls are the smaller streams that run into the becks. Descending the steep fell sides, almost perpendicularly, they are ever impetuous, rushing little torrents.

exhibits of all kinds, we sat down and wondered how far the show extended, and whether we should ever find that bee-tent. At last a man passed us with larger buttons on his coat than are usual on an ordinary man, so we at once ran to him, and, as no one seemed to have ever heard of bees, we asked him if he knew where the honey exhibits were. "No," said he, "at least, not as I knows on. Wait a bit,

in, and all other portions of that mighty show knew us no more!

For here was honey of every kind. From clover and sainfoin, from ling and wild thyme, from apple-blossom and linden flowers. Honey of all colours and of all degrees. Dark browns and light browns, amber, Allsopp's pale ale, Bass' bitter, even to the colour of the clearest cowslip wine. Honey in mead and

□ COUNTY HONEY TROPHIES AT "ROYAL" SHOW, 1897. (No. 1.)



FIRST PRIZE, NOTTINGHAMSHIRE B.K.A.

though. Is honey like hair oil?" This took our breath away, but at last we managed to stammer that it had something of the same appearance. "Then," said he, pointing to the horizon, "you'll find it right over by yon elm trees, between they and that red flag, what you can see there on the left." And right over by those elm trees, in the course of time, we did find it, and then we plunged headlong

metheglin. Honey crystallized, fine in the grain as alabaster. Honey in combs, delicate as Indian azalia blossoms. Honey in trophies piled up high, and on tables that groaned under the weight. Honey, food of the gods! (Would that we could see you again the food of men! On the tables of the rich and on the "pieces" of the poor.) Honey as food; not as medicine. A teaspoonful with lemon juice

when you have a cough, forsooth! Say, rather, a tablespoonful with every meal. And for this desirable consummation of our hopes we must work year by year, and from early morning far into the silent watches of the night. Writing and arguing, taking children by the hand, and shewing what the bees can do for them; by making these exhibits in every town and village and hamlet, if needful, without hope of a prize or other reward; even as the worker bees of the hive labour, not for themselves, but for the generations of bees yet unborn. "Freely have we received, therefore freely must we give."

When we had feasted our eyes long enough with the sight of honey, we turned to the hives and extractors and appliances of all kinds. Many hours did we spend thinking out this piece of tin and that piece of perforated zinc, this mysterious shutter and that puzzling slide; and, when completely baffled, there was Mr. Howard, with his shirt sleeves rolled up—doubtless to enforce his arguments if necessary—Mr. Till, and other well-known bee-men, ready and willing to find a solution of the difficulty—if they could.

They must be enthusiastic, hardy bee-men—those who stayed at the Show all the week. One day only did we spend there, and in the afternoon glad indeed were we to escape from the heat, the noise of machinery, the thousands who thronged in to see the Show or gaze at one another—I know not which! After a cup of refreshing tea we went a stroll in the long twilight—which is the rich heritage of those who dwell in northern lands—along the glorious aisles of Dunham Park, beneath a massive canopy of beauteous foliage—of lime, oak, and beech—a canopy supported by the gigantic limbs and bodies of these trees—trees worth going all the way from London town to see—so great, so calm and enduring, even as in the days when the Druids worshipped under their mighty branches. Cool were the long shadows aslant the sanded pathway; cool the short sward where the deer browsed—sward apple-green in the open spaces, dark as myrtle where the leaves pile shadow upon shadow; very satisfying again to see the wavy masses of bracken, to have the scent of it in your nostrils, the feel of it in your hand. Happy bees! thrice happy bees! those of you who are within reach of Dunham Park.—LORDS-WOOD.

THE STANDARD FRAME.

[2961.] Would it not be a boon to hive makers if the length of the top bar of the standard frame were shortened $\frac{1}{2}$ in.? This would make no difference in handling frames, nor would it matter in the manufacture of frames, which are made in quantities, with machinery and gauges easily adapted to a length of $16\frac{1}{2}$. But a bar of this length would go freely into a space just 17 in. long, while a bar 17 inches long requires a space of

$17\frac{1}{2}$ in. The space that accommodates the top bar of frames is the base of many measurements in the hive. If this base were just 17 in. long it would simplify many calculations, and facilitate many measurements. It would also conduce to a uniformity in the space for top bars which is not always found, but is very desirable. The $14\frac{1}{2}$ in. space is always observed with uniformity, and perhaps a 17 in. space would be equally definite with $14\frac{1}{2}$ in.—INVESTIGATOR, *Oxford*, July 18.

[In view of the many thousands of standard frames in use and the hives made to fit them, our correspondent can hardly have considered the full meaning of making any alteration in its measurements. We quite agree there would be no difficulty in decreasing the length of top-bar, so far as manufacturing, but on the other hand it seems to us that the amateur joiner can, by making his space 17 in. "full" (as the trade term goes) overcome the mischief complained of, with a minimum of trouble to himself.—EDS.]

RECORDING OBSERVATIONS ON BEES.

[2962.] I have been much interested in Mr. Haviland's reports concerning the "weights of hives" at various times, and have admired the careful and exact manner in which his observations have been recorded. I see that your correspondent "T.," on page 287 of last week's JOURNAL, suggests that I should cooperate with Mr. Haviland in further investigations on the same lines during the coming winter. I certainly think that such winter observations will be of more practical value than those already undertaken, and hope that Mr. Haviland will be able to continue his work. Should he desire comparative observations to be made, say, in this district, he will, perhaps, communicate with me.—PERCY SHARP, 1st class expert, B.B.K.A., *Brant Broughton, Newark-on-Trent*.

BEES BUILDING COMBS ON TREES.

[2963.] I write a hurried line to tell you of what to me seems a most remarkable occurrence. On one of the branches of my fir trees a swarm of bees has settled—not in a hollow at all, but simply hanging from the bough, unprotected from attack on all sides. There can be no question of their not meaning to stay, for they must have been there ten days at least, having built comb enough to fill an ordinary-sized skep. What do you advise my doing? The tree is too valuable to cut off the branch. I should be greatly obliged if you would advise me what to do?—A. A. O., *Woking*, July 18.

[There is but one course, since the tree cannot be damaged by removing the branches; but it will need one with some little experience to perform the operation successfully. First,

then, procure a frame-hive and set it down on the ground close under where the swarm has made its home. With the aid of a little gentle smoking clear the bees from an outside comb, and then sever the latter from the branch with a sharp knife. Tie this comb securely into one frame and hang it in the hive, repeat the proceeding with a second comb; then, if bees remain quiet, the third comb may be removed with the bees on it, and laid gently on the alighting board of the hive, and they will soon run in. Once the bees have left the comb, tie it into a frame as before, and so on till the combs and bees are all in the frame-hive, where they will soon settle down if queen is got safely in.—EDS.]

Queries and Replies.

[1788.] *Surplus Queens thrown out after Swarming.*—I am a comparative novice in the bee-keeping business, all I know being learnt from the B.B.J. and Cowan's "Guide Book," and I sometimes meet with things I do not understand. Here is one: I have been a bee-keeper about four years, and have now eight fairly strong colonies, all working in surplus chambers. One stock has already filled me a rack of twenty-one sections, and had nearly filled a second rack, when on Friday, June 25, it sent off a large swarm. Yesterday (July 14), on looking over the ground in front of my hives, I found the enclosed four bees under the alighting-board in front of that hive. Believing them queens, I would ask—1. Is it usual to find more than one queen hatched out after swarming? And, 2, will it be necessary to remove the rack of sections and search the hive to see if there is still a queen left therein?—R. T. P., *Plympton*.

REPLY.—1. It is not very uncommon to see six or eight young queens thrown out after a second swarm has issued from a hive. With some foreign races of bees any number of surplus queens are thrown out up to scores—indeed, we may say hundreds in rare cases. 2. No need to disturb the rack of sections unless you could give them to a stock more likely to finish them off than one which has swarmed twice.

[1789.] *Dividing Stocks after Swarming.*—This morning (June 28), from a strong colony covering ten frames—with rack of sections on and filled with bees—a swarm issued, but after clustering for a few minutes returned to parent hive. As I am away from home during the day, I am afraid they will shortly swarm again. I to-night attempted to divide them into two colonies, as advised in the "Guide Book," but although I carefully searched both sides of the frames, and used a feather to separate the little clusters, I was quite unable to find the queen; I therefore placed four frames full of sealed brood and stores in the empty hive, and filled up with

frames of foundation. There were several queen-cells on frames, and one very large one. I placed new hive in position occupied by parent hive, and set bees which clustered on alighting board of (parent) hive flying, so that the new hive has a good number of bees.

1. Will the artificial swarm I have made, although I fancy without the old queen, raise one from one of the queen-cells? I am, of course, feeding them, but, being only a beginner, am afraid that I have made rather a muddle by dividing them without finding the queen, although one more experienced than myself might have been excused, as the floor-board and sides of hive were also a mass of bees. If possible, I should be glad of an answer in this week's JOURNAL. Hoping that you will be able to understand my long statement, I am,—J. P., *Upper Norwood*.

REPLY.—If the queen-cells referred to are in the queenless part of the divided stock, it will be all right; but if in the part containing the queen they should be cut out at once.

[1790.] *Swarm of Bees Suffocated.*—I shall feel obliged if you will kindly give me your opinion in the B.B.J. on the following:—Yesterday at noon a gentleman sent to ask if I would go and give him a swarm of bees. I went and successfully hived them in a skep. The bees had swarmed from a frame-hive with a rack of partly filled sections on, and the gentleman's desire being to have these sections completed, he left it to me how best to act so as to secure this result, not understanding much about bees himself. The clover is part over here and the limes coming in, so it was necessary to keep the colony as strong as possible, and I felt sure if I cut out all queen cells and returned the bees at once, they would swarm again, so decided to cut out queen cells and defer returning the bees till first thing this morning. I therefore tied up the swarm in the skep (a new one), the cloth used was old and not very close, so that the bees would have plenty of air, and put them in a stable, which is used as a carpenter's workshop. I put them on a work bench in the ordinary position *i.e.*, open end of skep downwards, but with each side resting on the raised side of work bench, so that the whole of the mouth of skep was open to the air. At 5.30 p.m. the gentleman came to tell me the bees were escaping, but, being unable to accompany him at the time, I advised opening the window to allow the escaped bees to return to the hive, also to stop up the hole in the cloth through which the bees were escaping from the skep. This morning I went to return the swarm to the parent hive, and to my surprise found nearly every bee dead. There was a good cluster in the window that had escaped, but all of these were in a stupefied state. Can you help me as to the cause of this, as I am certain the cloth was sufficiently porous to allow them air?

The gentleman seems to think I ought to

have left them with the open end of the skep upwards. I certainly should have done so had I been carrying them any distance or sending them by rail, but I considered it quite safe to leave them as I did, and I feel sure it had nothing to do with the bees being suffocated. The gentleman's son being down with fever just now, I am led to ask:—1. If the cloth had had on it disinfectants and was afterwards washed, would this have caused it? I noticed nothing when I put it on the bees. 2. Or, supposing the gentleman, when stopping up the hole in the cloth, shook them down on to the cloth, might this result in the death of the bees?

I think myself it must either have been the cloth or some smell in the stable that overpowered them, but should like your opinion, if you will kindly give it?—"SURPRISED," *Great Haywood*.

REPLY.—There is little doubt that the mishap was caused by leaving the swarm for so many hours in the position stated. It should have been borne in mind that a closed stable is not quite like the open air—so far as assisting ventilation—and we fear the cloth has been of too close a material to allow of proper admission of air under the circumstances. Again, bees, when swarming, fill their honey sacs with food, but, if distressed for want of air, they discharge the contents of their sacs, and are found literally drowned in honey. If the skep had been covered with a piece of coarse cheese-cloth, or, better still, of strong net, and left bottom upward, it is quite safe to say no harm would have resulted; because, even if the swarm had been accidentally dislodged and caused to fall down in a mass, there would be no lack of ventilation above.

[1791.] *Returning Casts.*—*Signs of Queen Mating.*—On June 26 a cast (or what looked like two casts close together) came off fourteen days after the issue of a first swarm from one of my hives. I opened the hive, cut out five queen-cells, which were empty, and put the casts back, and they settled down all right. Being in a hurry at the time, I did not look for dead queens on ground after, but have since been in vain expecting to see some thrown out. I have, however, found two drones below floor-boards with their nether organs hanging from their abdomen by a membrane, as we sometimes see a worker in appearance with its sting hanging. I therefore ask: 1. Is it usual for a drone to return to the hive after its mating trip? And 2. Is this a sign of a mated queen? 3. Are the killed surplus-queens likely to be in the hive yet? A few drones have been thrown out. 4. I recently caught a bright gold and green glittering fly, with a very long sting, which was always about a warm wall of a boiler-house when the sun is hot. A specimen I have seen like it is ticketed in a museum:—Of the order Hymenoptera, and divisioned Chrysididae. Underneath the specimens are the words "Chrysis

ignita." Is it of the ant-fly, or bee family? It seems to have a sting the length of its body, which latter is very hard.—J. H. P., *Ripponden*.

REPLY.—1. Drones would, no doubt, endeavour to return to their hives, and as assuredly be thrown out again. 2. It by no means follows that the queen in question was mated with one of the drones found. 3. No; the casting out of drones points strongly to only one queen, and that the bees have now settled down. 4. We should hardly like to designate this insect without seeing a specimen.

[1792.] *A Cottager's Notes and Queries.*—Just a line to let you know how my bees have got on this year. As a cottager I thank you very much for the valuable advice you give me through the B.J. I had seven stocks (two in frame-hives, five in skeps), to start with this spring, and bought two new frame-hives to be ready when wanted. On one I placed a skep, after filling the frames with foundation, and in the other hived a swarm on June 5. I examined both to-day, and found the swarm had all frames filled with honey, so I put a rack of sections on. In the other hive I found the bees had worked from skep down into the body-box, and the frames of the latter were all filled with brood and honey. But on examining the skep found it just the same, and also saw the queen in it. So I drove the bees, caught queen, put her below, and put on excluder zinc. I then put the skep back in its old position. 1. How long must I let it remain there? 2. Would I do any harm in taking two or three frames of honey from the swarm, or would it injure them for another year? Bees seem to be doing very well about this part of Essex now; white clover has been very plentiful, and honey seems to come in fast, and we are, you see, not all "disappointed cottagers," but are still hoping that '97 will yield us the best harvest for several years.—ONE WHO LIKES THE BEES, *Stockholm, Chelmsford*.

REPLY.—1. It takes three weeks for all brood to hatch out. 2. Far better leave all stores in body-box alone, unless the queen is cramped for room, which is unlikely in your case.

Bee Shows to Come.

July 31, at *Helsby*.—Three open classes. Prizes (20s. &c.) for single 1-lb. jar and (10s. &c.) for single 1-lb. section. Apply Dr. Briant, *Helsby, Warrington*. Entries closed.

August 2, in *Melton Constable Park*. North Norfolk B.K.A. Annual Show. B.K.A. medals and liberal prizes for honey.

August 2 and 3, at *Swansea*.—Glamorgan B.K.A., in connection with the Glamorganshire General Agricultural Society. The annual general meeting of the G.B.K.A. will be held in show grounds, on August 3.

August 2 and 3, at *Northampton*.—Northants B.K.A. Sixteen classes (six of them open to all), with good prizes for honey and beeswax.

August 4, at *Neston Park, Wilts.*—In connection with the Atworth and District Horticultural

Show. Two open classes for single 1-lb. section and single 1-lb. jar of extracted honey. Schedules now ready. J. P. Inkpen, Secretary, Atworth, Wilts.

August 5, in Keele Park.—Honey Show in connection with the Keele Agricultural Society.

August 10 and 11 at Burton-on-Trent.—Staffs. B.K.A. In conjunction with the Staffordshire Agricultural Society.

August 12, at Goole.—Annual Show of Bees and Honey in connection with the Goole and District Agricultural and Horticultural Society. **Six Open Classes**, with good prizes, including 20s. and 10s. for single 1 lb. jar of honey (entry free in this class). Schedules from J. Luddington and H. S. White, Secretaries, Lindum House, Goole. **Entries close August 7.**

August 13 and 14, at Dumfries.—S.S.B.K.A. Jubilee classes open to the world. Schedules from Jas. Kerr, Douglas-terrace, Dumfries.

August 18 and 19, in the Quarry, Shrewsbury.—Schedules from T. Whittingham, Colum Cottage, Shrewsbury. **Entries close, August 5.** See advt. on page ii.

August 19, 20, 21, at Barrow-in-Furness.—In connection with the Royal Lancashire Agricultural Society. Six classes, with liberal prizes for honey. Schedules from Jas. Birch, Secretary, 34, Castle-street, Liverpool. **Entries close July 31.**

August 24 and 25, at Hastings.—Annual Show of the Kent and Sussex Bee-Keepers' Association in conjunction with the Sussex County Agricultural Society. Liberal prizes. Schedules from Henry W. Brice, Hon. Secretary, K. and S. B.K.A., Dale Park, Upper Norwood. **Entries close August 14.**

August 28, Corn Exchange, Biggar.—In connection with the Horticultural Society's Show. Annual Open Exhibition of Bees, Honey, Wax, &c. Prize lists from W. Ormiston, Sec., Fernbank, Biggar, N.B.

September 4, at Bramhall Hall.—Lancashire and Cheshire B.K.A., in connection with Bramhall and Woodford Horticultural Society. Annual show of honey. Open to district and members of the L. and C. B. K. Association only. Schedules from Secretary, J. Bell, Davenport, Stockport.

September 8 and 9, at Derby.—Sixteenth Annual Show Derbyshire B.K.A., in connection with the Derbyshire Agricultural Society. Nineteen classes and over fifty prizes for bees, honey, and appliances. Schedules from F. Walker, Hon. Sec. D.B.K.A., Cattle Market, Derby. **Entries close August 31.**

September 25, in the Corn Exchange, Jedburgh.— Roxburghshire B.K.A. Annual Honey Show. Twenty-six classes for honey, wax, and sundries. All open. A single entry fee of 2s. covers all classes. Schedules from Thos. Clark, Pleasants Schoolhouse, Jedburgh, N.B. **Entries close September 21.**

Notices to Correspondents & Inquirers.

All queries forwarded will be attended to, and those only of personal interest will be answered in this column.

INVESTIGATOR (Oxford).—*The "W.B.U. Hive."*—Seeing that the admirable article on this hive was mainly written with the object of rendering its construction easy to the amateur joiner, we think it advisable that our correspondent should refer to B.J. of June 1 and July 8, and read the article for himself. The one with which "Investigator" deals (which appeared in B.J. of February, 1894) called forth that of a few weeks ago; and if the details therein given are mastered we will reply to the other questions as they arise.

FREDK. H. LEMARE.—*Cane Sugar for Bee Food.*—The sample sent is, no doubt, cane sugar, but being raw, or unrefined, it is unsuitable for bee food. Very pleased to hear that the queen suspected of having ceased laying is now doing well.

J. B. (Kirkby Stephen).—*Queens "Piping."*—It is not usual to hear piping for so long as

four days after the issue of a second swarm. If you are quite certain that the sound heard really is that of "queens piping," the probability is that a very small after-cast will come off; but we cannot say for certain that it will do so.

CHAS. C. TURNER (Beds).—Pray dispel your anxiety about "robbing." We hope to keep it down, though not with the "carbolic cloth." That subjugator generally causes bees to buzz most energetically and run about a good deal. We must keep our bees quiet, you see.

A BEE IGNORAMUS (Wendover).—*Suspected Case of Foul Brood.*—From details given we suspect the stock is diseased, but cannot offer any decided opinion without seeing a sample of comb containing dead brood, which you can send as suggested.

H. A. C. (Wickham Market).—*Unripe Honey for Showing.*—1. Both queens received are of the ordinary or native variety. One is a very fine queen. 2. Honey extracted before being sealed over is unripe and, consequently, not fit for showing. The fact of its being, as stated, "nearly as thin as water" would quite destroy its chance of any prize.

G. F. D.—*Hole's Swarm-Catchers.*—See Mr. Livermore's letter on page 286 for reply.

FRED. J. BROWN (Smethwick).—*Bees Unable to Fly.*—It is not uncommon to see young bees outside hives, as stated, in early spring, but there should be no recurrence of the mischief in the present warm weather. Let us know how the progeny of the newly introduced queens gets on, when we will reply further.

E. S. (Stevenage).—*Bees Killing Drones after Swarming.*—1. There is nothing wrong in drones being killed off. It merely indicates that the young queen in skep is safely mated. 2. Bees in skeps usually desert supers after sending off swarms. 3. Use naphthaline as directed on the package in which it is supplied. 4. Bees in "Wells" hives work in a super common to both compartments. Only the queens are kept apart. 5. Opinions are divided as to the merits of the "Wells" system.

H. J. MASON (Lewisham).—*Uniting Queenless Stock with Swarm.*—If the stock has been long queenless, or if the bees are few in number, we should not trouble to unite the swarm to them. To use a common phrase, "the game is not worth the candle," so we should establish the swarm in frame-hive, and set it on the old stand, moving the queenless lot to another place, and allowing them to gradually join the swarm by flying back to the old location.

W. B. (Hereford).—*Establishing Stocks from Driven Bees.*—Driven bees, if in strong lots—i.e., two or more joined together—will work out combs from full sheets of foundation up to mid-August, or even later if crowded on only as many frames as they

will cover thickly, and fed well. The point is to keep them warm while comb-building and sealing the newly-stored food over for winter.

DEVONIENSIS (Newton Abbott).—*Dealing with Foul Brood*.—We are sending by post the leaflet issued by the Board of Agriculture on the subject as containing all the information needed.

S. R. V. (Handsworth, Staffs.).—*Brood in Sections*.—*Duration of Honey Flow*.—1. In view of the date when you write (July 22), we should leave the sections containing brood where they are, and regard them as "spoiled ones." It is no use removing and replacing them with empty ones this year with any hope of the latter being filled. 2. Unless you have some heather within reach, it is more than probable that the honey season will be now about closing in Staffordshire; the last source of supply—the limes—being nearly over.

L. C. C. (Ravenstone).—*Foul Brood*.—Comb received is so badly affected with foul brood that the "weak stock" from which it was taken should be promptly burnt. There is not the slightest use in trying to save the bees; in fact, the stock is utterly worthless.

CYMRÆAS (Anglesea).—*Queen Unable to Fly*.—The bee received has all the appearance of a young virgin queen. Are you sure the stock has not swarmed previously? However this may be, the queen found, having left the hive along with the swarm and "being unable," as you say, "to fly," has fallen to the ground, unnoticed by any but the few bees surrounding her. Consequently the swarm returned to the parent hive. You should examine the frames to see if there are queen cells on combs sealed or unsealed. In the meantime the sixty or seventy pounds of surplus honey should be ready for removal. 2. We should certainly not buy swarms at this season unless very cheap indeed, as they would need prompt feeding to get them ready for wintering.

C. HOWES (Bristol).—We are given to understand that last season M. Ambrozie was very unfortunate in queen-rearing, and could not fill his orders. We are told, however, that he is now sending queens out ordered last year. You should, therefore, write him with regard to yours.

KUNJA B. BARAK (Calcutta).—*Hives Suitable for India*.—We are posting you a couple of BEE JOURNALS in which is described a hive which will give an idea of what we think to be a suitable one for your hot climate.

A LADY BEE-KEEPER (Taunton).—*Living Swarm*.—It was a great mistake not to cover the tops of frames close down when hiving swarm. Having now hived the swarm in a skep after the bees had deserted and placed the skep above top bars of the frame-hive, they should certainly be got out of their present domicile into the latter.

Can you not enlist the help of some bee-keeper in performing this operation? It is almost too much for a lady bee-keeper unless experienced.

WM. DUNCAN (Ayrshire).—*Young Bees and Swarm*.—The time occupied in transforming an egg into a worker bee is twenty-one days. You may therefore be on the look out for baby bees among those of the newly-hived swarm in twenty-three days from date of hiving.

BEGINNER (Lanio-road, R.S.O.).—The very first thing a "beginner" should do on starting to keep bees in frame-hives is to buy a copy of a good text book on bees. Without such he cannot hope to succeed. With half a dozen frame-hives in possession and no means of knowing anything of the management of such it is courting failure not to have an instruction book. We can supply such from this office for 1s. 8d. post free.

[We ask the indulgence of correspondents for holding over many letters—including Mr. Haviland's on "Weight of Hives"—and queries which should, in the ordinary course, have appeared this week. We do this for two reasons:—(1) Our pages will only hold just as many columns as fills them, and we can this week plead *embarras de riches* in this respect; and (2) having perforce to leave town—in the performance of public work for the craft which we cannot ignore—on the 27th, our issue of 29th requires to be made up a day earlier.—EDS.]

Special Prepaid Advertisements.

Twelve words, Sixpence; for every additional Three words or under, One Penny.

It being impossible for us to guarantee the *bona fides* of Advertisers, it is advisable—in cases where any doubt exists—that intending purchasers should adopt the system of payment by Deposit through this Office. (This caution is inserted in consequence of occasional complaints.)

WANTED, a few late SWARMS, cheap. E. BROCK, Lundsford, Etchingham. R 45

DRIVEN BEES, one shilling per lb. Boxes returned. W. MARTIN, Well Cottage, Downley, High Wycombe. R 46

TWO Strong, Healthy June SWARMS in flat-top skeps, 12s. 6d. each. RIX, Twyford Lodge, Winchester. R 42

IGURIAN QUEENS (imported). Consignments arriving freely. Queens by return. August price, 5s. 6d. each. W. B. WEBSTER, Binfield, Berks. R 39

WANTED, English HONEY, 1-lb. Sections, and Extracted. Trade. Apply, D. BROADBENT, Scarisbrick-avenue, Southport. R 37

HEALTHY DRIVEN BEES. 5-lb. lots, with 1897 Queen, 1s. 3d. 1b. Packages free. Order early. BROOKS, Ashleworth, Gloucester. R 38

BEAUTIFUL White Clover HONEY, 7d. lb., including tins. Sections, well filled, 8s. dozen. Rectory, Bowers Gifford, Essex. R 40

TWENTY-FIRST YEAR. — Pure Blacks Tested Queens, 3s. 9d. delivered, with swarm 5s. Case 6d. or returned. Cash with order. ALSFORD, Expert, Bladford.

WANTED, a few lots of Healthy Driven Bees, with Queens, delivered in Penzance second week in August. HARBORNE, c/o JOHN JACKSON, Porthgwarra, Treen R.S.O., Cornwall. R 44

Editorial, Notices, &c.

HONEY SHOW AT CHESTER.

FLORAL AND HORTICULTURAL SHOW AND
FÊTE ON THE ROODEE.

The second exhibition of hives, honey, &c., held under the auspices of the Lancashire and Cheshire B.K.A. took place in connection with the above on July 28 and 29. The interest of BEE JOURNAL readers, of course, centres on the bee department, which was a very conspicuous success, as shown by the fact that the entries more than doubled those of last year, while the number of classes was increased from six in 1896 to eleven in 1897. The number and value of the prizes was also proportionately extended. The main cause for congratulation, however, was the very high quality of the bee-produce shown. Certainly no better display of first-class honey—both comb and extracted—has been seen this season. A glance at the awards will prove this, while the number of entries in many of the classes shows how strong was the competition. Among so much that was good we hardly care to single out for special mention, and so content ourselves by saying it was a keen contest, and to lose in such a competition meant no discredit so long as exhibits got a notice.

The large marquee was well laid out, and the whole arrangements reflected much credit on Mr. W. E. Little and the Rev. T. J. Evans, who between them managed the bee department.

Dr. B. E. Jones had charge of the bee-tent, and lectured at intervals.

Mr. W. Broughton Carr, London, and the Rev. J. F. Euckler, Bidston Vicarage, judged the exhibits, the following being their awards:—

Collection of Hives and Appliances.—1st, James Lee & Son, London; 2nd, W. P. Meadows, Syston, Leicester; special, George Rose, Liverpool.

Complete Frame Hive for General Use.—1st and v.h.c., J. Lee & Son; 2nd and h.c., W. P. Meadows; 3rd, H. W. Lanaway, Redhill.

Frame Hive for Cottager's Use.—1st and 3rd, W. P. Meadows; 2nd, H. W. Lanaway; v.h.c., G. H. Varty, Etwell, Derby.

Twelve 1-lb. Jars Extracted Honey (28 entries).—1st, J. Sopp, Wallingford; 2nd, George Jeffs, Great Barrow; 3rd, William Woodley, Beedon, Newbury; v.h.c., Richard Dodd, Willington, Joseph Cunnah, Marford; W. H. Woods, Hemingford Grey, Hunts; H. Edwards, Rossett; and R. Bithell, Great Saughall; h.c., W. Huxley, Churton; B. Thomas, Market Drayton; and S. Cartwright, Shrewsbury.

Twelve 1-lb. Sections (12 entries).—1st, William Woodley; 2nd, Rev. T. J. Evans,

Tarvin Vicarage; 3rd, J. Stone, Cubley; h.c., R. Barlow, Colwyn Bay, and W. H. Woods.

Two Shallow Frames Comb Honey (13 entries).—1st, W. Pether, Henley-on-Thames; 2nd, J. Wynne, Waverton; 3rd, Rev. E. Charley; h.c., F. Dresser, Chorlton Hall, and G. Jones, Hargreave; c., T. Moore, Hartford.

Six 1-lb. Jars Dark Extracted Honey (15 entries).—1st, J. Cunnah; 2nd, S. Eaton, Audlem; 3rd, W. H. Seymour, Henley-on-Thames.

Beeswar (14 entries).—1st, S. Eaton; 2nd, W. H. Woods; 3rd, A. Thomas, Frodsham; h.c., H. W. Seymour and J. Cunnah; c., Rev. E. Charley.

Twelve 1-lb. Jars Extracted Honey (32 entries).—1st, Richard Dodd; 2nd, W. Crellin, Barnston; 3rd, J. Wrench, Hartford; v.h.c., E. P. Hinde, Heswall; Mrs. E. Jones, Plemstall; and S. Eaton; h.c., Owen Dutton, Bridge, Trafford; W. Forrester, Huyton; and J. Wynne, Waverton; c., J. Hughes, Great Mollington; J. M. Harnaman, Alvanley; and T. Evans, Saughall.

Twelve 1-lb. Sections (12 entries).—1st and 2nd, with silver and bronze medals, Rev. T. J. Evans; 3rd, F. Dutton, Huxley; v.h.c., Richard Dodd; h.c., Owen Roberts and Philip H. Rawson, Market Drayton; c., Rev. E. Charley.

Single 1-lb. Jar Extracted Honey (42 entries).—1st, Rev. A. G. Glenn, Barnston Vicarage, Birkenhead; 2nd, W. H. Woods; 3rd, S. Cartwright; 4th, Rev. T. J. Evans.

LINCOLNSHIRE B.K.A.

SHOW OF BEES AND HONEY.

The Blankney Horticultural Society held its annual exhibition on Wednesday, July 28, and, as usual, was attended by a large number of visitors, quite 15,000 people paying admission. The honey department was a great success, both as to number of the exhibits and the quality of the honey, several "old stagers" declaring they never before saw such a splendid collection. The bee-tent was in the charge of Dr. P. Sharp, the Association's junior expert, and he gave two lectures to large audiences. Dr. Sharp also examined one candidate for the third class experts' certificate of the E.B.K.A. Mr. R. Thorpe, Swineshead, acted as judge, and made the following awards:—

Observatory Hive.—1st, Dr. Percy Sharp, Brant Broughton; 2nd, R. Godson, Totbill; 3rd, J. Emerson, Lincoln; 4th, F. S. Smith, Louth.

Twelve 1-lb. Sections (10 Exhibits).—1st, W. Patchett, Thoresway; 2nd, H. O. Smith, Louth; 3rd, R. Godson; 4th, J. Emerson.

Twelve 1-lb. Jars Extracted Honey (18 Exhibits).—1st, H. O. Smith; 2nd, F. S. Smith; 3rd, T. Coulson, Scopwick; 4th, T. Sells, Uffington.

Six 1-lb. Sections (Cottagers).—1st, W.

Patchett; 2nd, A. Barnes, Scothorne; 3rd, W. W. Phillips.

Six 1-lb. Jars Extracted Honey (Cottagers).—1st, T. Coulson; 2nd, W. Patchett; 3rd, F. G. Davey, Legbourne; 4th, Mrs. Hawley, Blankney.

Bell-Glass of Honey.—1st, B. C. Blackburn, Billingham; 2nd, F. Lumsden, Bloxholm; 3rd, T. Sells.

Beeswax (10 Exhibits).—1st, W. Phillips; 2nd, W. Paulger, Scothorne; 3rd, W. Kettleboro', Washinboro'; 4th, J. Emerson.

Two Shallow Frames (6 Exhibits).—1st, R. Godson; 2nd, A. Barnes; 3rd, T. Sells.—(Communicated.)

SURREY BEE-KEEPERS' ASSOCIATION.

ANNUAL SHOW.

The second annual exhibition of the Surrey B.B.K.A. was held in connection with the Woking and District Horticultural Society's Show, at Woking, on July 28 and 29, and was in every way a decided success. Notwithstanding the difficulty in selecting a point in the county convenient to all the members, this exhibition attracted no less than ninety-four entries in the nine different classes for competition.

In the classes for twelve and six 1-lb. sections, there were thirteen entries in the former and twenty-one in the latter, the quality of the exhibits in both classes being very good, and the competition close in consequence.

Upwards of thirty separate competitors staged attractive exhibits of extracted honey, and the shallow-frames of comb and beeswax also made a good show.

The prize-winner in class for "Best Display of Honey" staged some of fine quality, weighing about 100 lb, most tastefully arranged.

Messrs. Jas. Lee & Son, J. S. Greenhill, and C. J. Overton staged capital collections of appliances.

Mr. J. W. Jacomb-Hood (now of Exeter) and Mr. J. H. Evans, Wimbledon, judged the exhibits, and made the following awards:—

Twelve 1-lb. Sections.—1st, A. H. Miller, Egham; 2nd, Mr. Killick, Cranleigh; 3rd, Mr. Wollaston, Reigate; h.c., Mr. Newman, Petersfield; Mr. Watkin, New Malden.

Six 1-lb. Sections.—1st, H. Sayers, Chessington; 2nd, Mr. Trussler, Cranleigh; 3rd, Rev. H. Wilder, Sutton; h.c., Mr. Wollaston; Mr. Watkin; Mr. Gilbert; c., Mr. Giles, Guildford.

Three Shallow Frames of Honey.—1st, F. B. White, Redhill; 2nd, R. C. Blundell, Horley; 3rd, T. Welham, New Malden.

Twelve 1-lb. Jars Extracted Honey.—1st, Mr. Ketcher, Cranleigh; 2nd, Mr. Aubry, Woking; 3rd, Mr. Davis, Cranleigh; h.c., R. C. Blundell and Mr. Killick.

Six 1-lb. Jars Extracted Honey.—1st, Mr. Davis; 2nd, Mr. Gilbert; 3rd, Mr. Cooper,

Addlestone; h.c., Messrs. Goddard and Hinson; c., Messrs. Miller and Blundell.

Twelve 1-lb. Jars Granulated Honey.—1st, not awarded; 2nd, Mr. Ketcher; 3rd, Mr. Goddard, Addlestone.

Display of Honey in any form.—1st, F. B. White.

Beeswax.—1st, H. Sayers, Chessington; 2nd, Mr. Killick.

Collection of Appliances.—1st, Jas. Lee & Son, High Holborn; 2nd, J. S. Greenhill, Wimbledon.

The whole of the arrangements for the carrying out of the show were admirably made, and reflect the greatest credit on the Hon. Secretary, Mr. F. B. White, Redhill, whose indefatigable labours contributed largely to the success of the show.—(Communicated.)

YORKSHIRE AGRICULTURAL SOCIETY.

SHOW AT HARROGATE.

The annual exhibition of the above society took place on July 21, 22, and 23, at Harrogate. As usual, there was a bee and honey department. The lateness of the season for honey accounted for the fact that the show in this section was not so large nor competition so strong as was the case last year. Moreover, the prize-money offered in this section of the show was not so large as to tempt south-country exhibitors to come north. The honey staged, however, was very good indeed, and altogether, with the lectures on bee-keeping, this was a very interesting corner of the show. The bee-tent of the Yorkshire B.B.K.A. was on the ground. The lecturer was Mr. W. Dixon, assisted by Mr. A. C. Jemison. In the competitions Mr. W. Dixon swept the board, securing first place in all four classes. His display of honey and comb was very tempting, including heather, clover, and fruit honey, and a number of devices in combs. Mr. R. A. H. Grimshaw, of Leeds, was the judge, and made the following awards:—

Collection of Bee Appliances and Honey.—1st, W. Dixon, Leeds; 2nd, A. C. Jemison, York.

Complete Frame Hive.—1st, W. Dixon; 2nd, A. Jemison.

Observatory Hive.—1st, W. Dixon; 2nd, A. C. Jemison.

Display of Honey.—1st, W. Dixon; 2nd, Miss S. Cooper, Leicester.

Twelve 1-lb. Sections.—1st, C. Atkinson, Tockwith; 2nd, J. Atkinson, Kirk Hamerton; v.h.c., A. W. Weatherlogg, Lincoln.

Twelve 1-lb. Jars Extracted Honey.—1st, W. H. Seymour, Henley-on-Thames; 2nd, W. Dixon; v.h.c. J. Atkinson, Kirk Hamerton, York.

Beeswax.—1st and 2nd, Rev. S. Smith, Wetherdale Rectory; 3rd, T. Walker, ju.

Correspondence.

The Editors do not hold themselves responsible for the opinions expressed by correspondents. No notice will be taken of anonymous communications, and correspondents are requested to write on one side of the paper only and give their real names and addresses, not necessarily for publication, but as a guarantee of good faith. Illustrations should be drawn on separate pieces of paper. We do not undertake to return rejected communications.

Communications relating to the literary department, reports of Associations, Shows, Meetings, Echoes, Queries, Books for Review, &c., must be addressed only to "THE EDITORS of the 'British Bee Journal,' 17, King William-street, Strand, London, W.C." All business communications relating to Advertisements, &c., must be addressed to "THE MANAGER, 'British Bee Journal' Office, 17, King William-street, Strand, London, W.C."

EXPERT VIEWS ON IMPORTANT POINTS.

WHEN DOCTORS DIFFER.

[1894.] Having a strong feeling that the privilege of putting questions in the B.J. ought not to be abused, and thinking it possible that as to some of the questions I have lately sent it might be reasonable to answer to this effect: "If the questioner reads the literature of the subject he will find that different views prevail in different quarters, among persons equally qualified by experience to deal with the matter; where this is the case it is not possible to give an analysis of the said literature by way of reply in the B.J., and the best course for the questioner is to try the different courses supported by equal authority, and then decide for himself which he prefers." This answer would be final, if the questioner was seeking to elicit a dogmatic statement of some supposed to be and only correct view or method. For my part, where there are, say, three courses, each supported by equally expert authority, I do not assume that one of them must be right and the rest wrong, and ask to be told which is *the* right one; nor do I desire to try all three and select for myself; nor do I ask to have all three exhaustively discussed for my edification in the B.J.; but I *do* wish to avoid the risk of drifting, through ignorance, into some fourth course of my own which is pretty certain to be wrong; I also seek through the B.J. for a statement (without reasons) of *one* course resting on expert authority, and if I may venture to say so, I attach special value to what is preferred in doubtful cases by "W. B. C.," because, without wishing to depreciate in the slightest degree the experience, talents, and judgment of other eminent experts, I may confess that I cannot feel more confidence in any expert than in the person to whom we are indebted for the "W. B. C." hive and the "W. B. C." metal end. The "Guide Book" is a truly admirable treatise, and where there is just one correct course, indicates it; and where there is more than one it states alternatives with proper impartiality, and it contains all that is needful, no doubt. In some cases, however, the practice of dealers causes difficulty. Thus

not long since I wrote to a dealer (a first-class one) to send me frames with a top-bar $\frac{3}{8}$ -in. thick, as set down in the "Guide Book." In reply he said he was ready to send them, but strongly recommended top-bars $\frac{1}{2}$ in. thick as preferable. My feeling, thereupon, was to get to know (1) which bar "W. B. C." prefers? apart from any question of cost. On another occasion a dealer showed me what he said was a "W. B. C." hive. I said the legs seemed to me rather short. He then chattered about "heavily-laden bees," and the desirability of having the hive close to the ground. After that I felt no confidence in him. For a bee who cannot use his wings, and has to walk, can no more rise 6 in. into the air by walking than he can rise 6 ft., and if a gangway is to be provided its length is immaterial, while the convenience of getting at the hive for manipulating is very material indeed to the bee-keeper. The dealer referred to conveyed the idea that the pattern he showed me was intended to satisfy two classes of customers, viz., those who approved of legs for hives, and those who used legs, but very short ones. So I ask (2) what is the best height for a hive for the general convenience of the bee-keeper? (3.) As regards the space under frames, between bottom-bar and floor, the "Guide Book" indicates $\frac{3}{8}$ in., which, no doubt, is excellent. But my own preference would be for $\frac{1}{2}$ in. rather than $\frac{3}{8}$ in., and unless I am mistaken the space is $\frac{1}{2}$ in. in the "W. B. C." hive, properly so called—is it not? I should not have referred to the point as to contracting the nest, except that I did mention it to the dealer above referred to, and asked if blocks were used in front, and his answer was that they were unnecessary, and that "it was an advantage for the bees to have access to the spaces beyond the division boards, because when they built combs in those spaces it showed you that the nest was getting too narrow, and should be enlarged." This also did not increase my confidence in the dealer's judgment, although I do not doubt that he is an intelligent and absolutely honest man. Some dealers, however, certainly advocate things which *a priori* seem objectionable, and one wonders whether it can be otherwise in practice? For instance, to place bars of wood $\frac{3}{8}$ in. thick and $\frac{7}{8}$ in. wide, with $\frac{1}{2}$ in. spaces between, across a span of $14\frac{1}{2}$ in. from bearing to bearing, and then to put a weight of 2 or 3 lb. in a bottle-feeder on a space a few inches square in the centre, seems to me vicious and a certain way of making them bend downwards. One dealer is so wedded to the bottle-feeder that he supplies one holding between 7 and 10 lb. when full. (4.) Has the plan of covering roofs of the "W. B. C." hive with one board of best quality $\frac{3}{8}$ in. thick, on each side of the ridge proved a failure in practice, so as to necessitate the substitution of double boards? (5.) Is one hole at each end of the roof as useful as three, so far as ventilation? (6.) Has the plain alighting

board shown in the earlier "W. B. C." hive proved objectionable at all? 7. How wide should entrances be left open in winter?—*Novus, July 31.*

[We have inserted the above here instead of in our query column, because the communication reached us in two parts, one for each department, but each containing what are practically queries. Our replies to the questions put are as follows:— 1. We (*i.e.*, "W. B. C.") prefer and use only the "Standard frame" the top bar of which is $\frac{3}{8}$ in. thick. 2. Our hive-stands raise floor boards about 10 in. from the ground. 3. Yes. We like a $\frac{1}{2}$ in. space between bottom bars of frames and floors of brood-nests, and $\frac{3}{8}$ in. below frames of surplus chambers. 4. If sound best quality yellow pine be chosen, the single $\frac{1}{2}$ in. board (reduced to $\frac{3}{8}$ in. planing) is both durable and watertight when painted yearly. We have used such roofs for over fifteen years without a leak. It is far better than a step-roof in every way. 5. One hole at each end $1\frac{1}{4}$ in. diameter—with a cone inserted—is all we use in roofs. 6. Not to any appreciable extent; but Mr. Peeble's improved flight-board (shown on page 256) has undoubted advantages such as affording a sure foothold to tired bees on alighting thereon in cold, high winds, &c. 7. Width of entrances in winter must be subject to conditions at the time. When impervious coverings are used and hives not exposed to cold winds, 4 in. is not too wide, but we often find ourselves reducing the width to 1 in. or less when conditions require it. The "W. B. C." hive admits of a very narrow entrance to the *outside* and yet allows a full width one after passing the outer case to the hive proper within.

WEIGHT OF HIVES.

[2965.] The following are the weights of the hives continued from 2952 (page 286):—

	A		B	
	lb.	oz.	lb.	oz.
July 20, 7 p.m.	62	11	...	51 13
" 21, "	62	9	...	51 14
" 22, "	62	13	...	52 10
" 23, "	64	1	...	54 11
" 24, "	64	14	...	56 4
" 25, "	64	8	...	55 13
" 26, "	64	3	...	55 6

It will be seen that hive B has been increasing twice as fast as hive A. The bees of the former cannot now all find room in the hive at night, and it is certain that several ounces more of bees go out to collect from this than from hive A.

I have already said what I believed would be the use to a bee-keeper of putting one of his hives on scales and making a daily record of its weight. The letter of Mr. "T." (2953, page 287), leads me to say more on the utility of observation. In every colony of bees it is the business of a small percentage of the workers to explore new places for fresh sources

of supply. If any of these return home laden, the others somehow find out where they have been and go there. So, Messrs. Editors, it should be with us bee-keepers—there should be a minority who make it their labour to explore. The work must, for the most part, be done by single individuals; but our ability to organise our work, so that it be done with the least amount of waste, should be greater than in bees. If the British Bee-keepers' Association would organise the work so much the better; but, failing that, those willing to do such work might communicate together and organise their plans.

I do not intend, Messrs. Editors, to tire your readers with figures when the hives have ceased to gain, but I hope to follow Mr. "T.'s" advice and keep hives on scales throughout the winter, and am looking forward to the advice and co-operation of others of your readers. It seems most important to bee-keepers to be able to measure the effects of circumstances on their stocks, and the rate of the honey flow, and to weigh hives seems the best way of measuring these, though, of course, it is a far from perfect way. I have a good number of observations on the variations in weight during the day, which I hope will be of interest to the B.B.K.A., and a guidance in planning future observations.

Temperature seems to have a great effect on bees, and the effects of different temperatures urgently wants careful examination. I should feel happier if I saw the charge of brood-spreading, made against experts sent round by associations in the spring, flatly contradicted.

I should like to thank "Amateur" (2947, page 283), for the information he has given on wintering many colonies in one hive. At the time of his previous letter (2921, page 235), I had just such a hive as he describes, in which I had placed four swarms. It seems safer to give the disadvantages than the advantages of new experimental methods, and so I will venture to remind "D. G." that to winter eight driven colonies in one big hive is to challenge foul brood under the most disadvantageous circumstances possible, and that it is impossible to get young queens fertilised from such hives that they are sure to return to a wrong entrance. As far as I have seen, a common dummy is quite equivalent to a "Wells" dummy; at any rate the conditions of several colonies in one hive wants further exploration even if it may prove a barren field.—G. D. HAVILAND, *Warbleton, Sussex, July 26.*

[Correspondence continued on page 306.]

HOMES OF THE HONEY BEE.

THE APIARIES OF OUR READERS.

Few readers, knowing the reputation of Manchester for dirt and smoke, will believe that the picturesque cottage and garden we depict this week stands within three miles of the Exchange. Indeed, until quite recently

people living a few minutes' walk were ignorant of it. But district secretarial work of the L. and C. B. K. A., and the numerous bee-meetings held at the "Cottage," have made it a household word with numbers of enthusiastic bee-keepers, who soon make themselves at home there. Mr. Taylor welcomes all and any who love the honey bee, and spring, summer, and autumn the place is the rendezvous of those wishing to learn of bees and of bee-keeping.

Writing us on the honey production of the district, Mr. Taylor says:—"One cannot expect great results so near a large city as Manchester, yet I make the bees pay well. In 1894, four hives gave me 225 lb. of honey

the Honey-bee." The late Mr. Pettigrew of "big skep" fame kept his bees within a quarter of a mile from the apiary which is the subject of the present notice; but, as stated in his "Handy Book" on bee-keeping, he found it a poor neighbourhood for bees. "They can barely keep themselves in ordinary seasons," he says. Seeing, then, that Mr. Pettigrew failed with his famous skeps, it says much for modern management when so much better results are obtained by the intelligent use of frame-hives.

The apiary now numbers eighteen hives—sixteen frame hives and two skeps—scattered all over the garden, as seen in the photo. The hives are built on modern principles, and the



MR. F. H. TAYLOR'S APIARY, FALLOWFIELD, NEAR MANCHESTER.

and five swarms. The largest "take" from a single hive was 82½ lb. of honey and one swarm, which latter yielded 28½ lb. of honey and a virgin swarm. Even in such poor seasons as 1895 and 1896 the average was over 20 lb. per hive."

On undertaking the duties of local hon. secretary to the L. and C. B. K. A. three years ago Mr. Taylor began with three members. There are now sixty on his list. Birch Fold Cottage in spring has been compared to a very "Paradise," and though the encroaching hand of the builder is visible around, we hope its present occupier will for years be enabled to retain the quaint old place as a "Home for

influence of this apiary extends far beyond its own district, which, of itself, is extensive, for we learn that its owner has correspondence with bee-keepers so far away as Palestine in the east, to Brazil in the west.

Birch Fold Cottage stands in a large old-fashioned garden, nearly an acre in extent, and plentifully supplied with fruit trees of every kind and an abundance of flowers all through the year when blooming is possible. Crocus first appear, succeeded later with limnanthes. Borage grown in great masses causes keen delight. Then in autumn there are giant balsams—grown by hundreds—indeed, the place is sometimes called "Balsam Forest."

They frequently attain here a height of 13 ft. Besides his enthusiasm for bees, Mr. Taylor is a grower of the queen of garden flowers, the rose, and all the better varieties of hybrid perennials are found in his rosarium. Indeed, it is to be doubted whether the roses in their season do not attract more visitors than the bees.

We trust Mr. Taylor will continue his active interest in the craft for long years to come.

CORRESPONDENCE.

(Continued from page 304.)

BERKSHIRE B.K.A.

THE COUNTY HONEY TROPHY COMPETITION.

[2966.] I enclose herewith copy of resolution passed at our last Council meeting on July 19, and will be obliged if you will publish it in next issue of the BEE JOURNAL.—A. D. WOODLEY, *Hon. Sec., Berks B.K.A., 17, Market-place, Reading* :—

At a meeting of the Berks Beekeepers' Association, held at 17, Market-place, Reading, on Monday, July 19, 1897, the following resolution was unanimously carried :—"That having regard to the general expression of opinion that the judging of the Trophy Class at the Manchester Show was most unsatisfactory, and also the public statements of some of the judges that points were taken from the southern counties exhibits in favour of the northern counties, the Secretary is instructed to bring the matter before the British Beekeepers' Association, and if necessary the Royal Agricultural Society, with a view to ascertain whether they endorse this action; and if so, on what grounds such instructions were based, and why it was not stated in the schedule."

WHITE CLOVER AT END OF JULY.

[2967.] I beg to thank you for your kind and prompt verdict respecting the specimen of comb sent you for inspection. The comb was not taken from my apiary, but was brought to me by a brother in the craft, distant about two miles from here. I was sure what your decision would be, but considered it more satisfactory to the party to have your opinion, so that he might read for himself. I am glad to inform you that foul brood is unknown in our little hamlet, though we can number upwards of fifty colonies. So far we have done fairly well. I never remember seeing the white clover so abundant, the fields are literally white with it. The farmers about here attribute this largely to a liberal supply of super-phosphates as a top dressing. We are looking forward to the heather season, to which point we have to convey our bees about sixteen miles. If acceptable, I may send you an account of how the hives do at the moors further on.—"ROMAN WALL," *Haltwhistle, July 26th.*

[You are exceptionally fortunate in having

fields white with clover blossom so late as end of July. By all means let us know how the bees get on at the heather.—EDS.]

HEDGEHOGS AND BEES.

A GOOD COLONY "EATEN UP."

[2968.] I have a few words for insertion in the JOURNAL concerning hedgehogs, which may possess some interest for bee-keepers. One of these interesting animals (?) has completely spoiled my best stocks by the simple process of eating the bees. I had five hives to start the season with, and they had all swarmed with this particular one. A fortnight ago it was so full of bees that I hardly knew what to do with it, in order to secure full ventilation. I had got it tiered up with shallow-frames, and a rack of sections on top of these; but, as stated above, for the last two weeks the bees have been so gradually but continually diminishing in numbers that there are now but a few left in the shallow-frames at all. I began to think the stock had become diseased, but could not be sure. However, on the evening of the 15th inst., while pulling up weeds from around the hive, I noticed that a hedgehog had been there. I therefore made a thorough inspection next day, and while examining the alighting board of this particular hive, I noticed where its claws had scratched the paint off in scrambling on to the alighting-board for a regular feast of bees at the entrance every night. That Friday night's feast was its last, for I set a trap, and catching the gentleman in the act, soon put an end to his existence.—A. BARBER, *Camb.*

EULOGY OF THE LINDEN-TREE.

[2969.] To describe the linden-tree to beekeepers would be a wanton waste of ink, for every one of us knows full well its graceful, drooping boughs, covered with foliage of a pale "glad" green; its pendent racemes of creamy blossoms, so abundant that sometimes the leaves are almost hidden from sight entirely, and the whole tree is one great bower of honey-laden blossoms, amongst which revel a host of bees singing as they work. If you gather a few sprays, they will fill a room with the odour of honey. Think, then, of the scent that is drifting away from these mighty trees! The soft, warm July air moves on loaded with the odour. It comes in great massive drifts miles wide and miles high, sweeter than the breath of roses, of gardenia, of hyacinths, of white-petalled crimson-eyed narcissus. Sweeter than the leaf of miles of clover, or sainfoin, or even melilotus, more precious than the spices of Arabia, and yet free for all who come. Such grandeur of generosity, such divine liberality, such godlike openness of hand! Does it not make us ashamed of our own selfishness, avarice, niggardliness? If men would but give like the

linden-tree, careless of praise or reward, then Heaven would not be so very far away.

When the linden blossoms open—sometimes in June, but more often in the radiant warmth of July—see that you have the supers piled up high, the thoroughfares of the hives clear, the doorways wide open. For then the ordinary rules and regulations of traffic are set aside. So lavish is the supply of honey that the bees become dazed with mad enthusiasm; crowding and colliding this way and that; working with such fierce energy that the whole atmosphere seems full of rushing, swirling, frenzied bees. Bees tumbling over the guards, and choking the entrances—entrances fourteen inches wide and half an inch high. Bees covering the whole alighting board, and hanging in knots and clusters about the porches and doorways—bees heated and perspiring, satiated with honey. Bees—a thousand of them—battling with the fiery heat inside; melting combs, suffocation, death in there, if they cease for a moment driving in broad volumes of cool air. Bees—dear, busy bees—if we could but work with the forgetfulness of self (without pay or hope of reward) as you, how happy might we be.

I entreat of all beekeepers who may have occasion to plant trees, either on their own ground or on that belonging to other people, to plant all the linden trees they can. We reap now the seed that was sown fifty or a hundred years ago. Let us therefore plant freely, so that the beekeepers of a hundred years hence may have a bounteous harvest too.—LORDSWOOD.

BEES IN THE MALAY ARCHIPELAGO.

AN EXPERIENCE WITH HIVE BEES IN SUMATRA.

[2970.] It was in April, 1884, that I made my first attempt to introduce hive-bees into Sumatra for the better fertilisation of the coffee plantations. Going out then for the first time, I took two stocks of Italians with me, packed in a double frame-hive. On boardship the bees were placed in the ice-cellar, and, after a four weeks' artificial winter, they were landed in good order at Deli, Sumatra.

Although things looked well at first, the experiment was in the end unsuccessful. There were difficulties to contend against. My duties took me from one estate to another, and I had to take the bees long journeys both by land and water, so that they suffered greatly from the heat when I had no means of protecting them. One colony lost its queen. The other was attacked by an army of big black ants, which fell upon the hive when I was away working in the jungle, and dealt so hardly with the bees that, after much loss, the survivors swarmed out of the hive and clustered on a high tree, too high for me to catch them again. Thus both my stocks were lost.

Then I returned to Europe for my health,

and in October, 1892, I came out again with two more Italian colonies—one in a straw skep, the other in a frame-hive. I gave the bees a flight at Marseilles before putting them into the ice room, and in about twenty-seven days they were landed at Singapore, where, having business at Borneo, I was obliged to leave them for two months. On my return I found the skep colony strong and well, but the frame-hive was deserted. By hanging the hives from trees I had saved them from the attacks of the ants, but I had overlooked the large frogs, which I found out, too late, were nimble enough to jump on to the alighting boards. One evening I found three of them eating bees, and I think that during my two months' absence they must have done much harm.

After this I took the straw hive colony with me to Sumatra. There was no ice-house in the little ship, and I had to keep the bees in my cabin. It was very hot, and several times I put water into the hive. On landing at Deli the bees were placed in the hotel garden. They worked hard and all seemed well, till after two months two small swarms were thrown off; perhaps the old queen had died. I joined these two and placed them in a straw hive of native make. It was not well made, and one hot morning the bees abandoned it after having made a hand's-breadth of comb. I was away at the time, and lost them. Now, the old hive seemed to be getting weak, and the bees had become lazy. I then noticed that some handsome green birds, shaped like a swallow, were hawking round the hive and catching the bees, and I concluded that one of these had caught the young queen on her wedding flight, for the stock gradually died out, and I was once more bee-less.

Soon after this I heard from a native of three colonies of wild bees living in a hollow tree. I secured them, hiving one in the old skep, and the other two in frame hives which I got made for me. These bees are smaller than Italians, especially the drones, but are of the same colour, except that both workers and drones have two red spots on their backs. They are quick, and fly right into the hives, and sting very readily. When I smoked them rather severely they left the hive altogether, and clustered on a cocos leaf, but in about ten minutes they all came back again. The queen is brown and very nimble, taking wing as soon as you try to catch her. One time I tied a fine thread to one of these queens' legs, and so got all the swarm to follow me.

These wild bees worked very well in my hives. Those in the old skep took kindly to the combs which the Italians had left, although the cells were decidedly bigger than those they build for themselves, and it seemed to me at the time that the bees bred in this hive were bigger than their fellows.

Then came a big storm, and some of the cocos-trees fell on to the little house in which my bees were hanging. That night the natives

came and made a fire close by, so that the bees were scared, or flew into it, and were burned. Then the Malays took out the brood combs, which they consider a great dainty, and devoured them, and this was the end of my bee-keeping in Sumatra. For the third time I was bee-less.

There is yet another kind of wild bee in Sumatra, coloured like Italians, but a good deal bigger. Fortunately they are gentle, for their stings are long. The queen is just the size and colour of a black queen. I never saw any drones. These bees build their combs in the open, on the branches of a big tree called Twaalang, sometimes there are ten or more nests on one tree. Of this kind, too, I took home a colony, and put them into a straw hive, but after two days they went away. They would not work in darkness, and preferred another place in the open air.—N. C. L. HOLTJUS. (*Communicated by "South Devon Enthusiast," July 25.*)

A PROBLEM.

DOUBLE v. SINGLE-WALLED HIVES.

[2971.] Is a double-walled hive really cooler in summer than a single-walled one? No doubt the sun shining on the outer surface of the single wall heats this surface, and this heated surface heats the outside air in contact with it; but on the other hand this air is the free open air, which is always in motion (as any one soon discovers who tries to photograph trees), and the hot air is always moving off to be replaced by cooler air. The wooden wall of the hive is too non-conducting to act like a metal plate, and to heat the air inside. As far as I can judge from observation and experiment it is quite impossible for the sun shining on a board $\frac{3}{4}$ in. thick, to heat the inner face of the board, and thereby to heat the air on the inner side of the board. And the cooling influence of the open air on the outer surface from its constant motion and free circulation, and the endless flow of cooler air to replace the heated air is enormous. A double-walled hive with "dead" air between the walls is likely to be hotter than a single-walled one, because it will be more retentive of heat generated by the bees inside their hive, and will be less affected by the cooling influence of the open air outside. Of course, matters may be so arranged as to permit a current of air between the walls, but will the cooling influence of a current of this restricted kind be equal to that of the open air circulating freely round a single walled hive? And is there any gain from the double wall as against the heating of the air inside the hive by the sun? In other words, where there is a double wall, is the inner face of the outer wall sensibly hotter than the inner face of the inner wall? And is the inner face of this inner wall sensibly cooler than the inner face of the single wall, when there is only one wall? It seems to me that if there is a difference it is

in favour of the single wall, which may be due to the cooling influence of the open air outside affecting it more.

Under certain circumstances the air inside a hive becomes untearably hot to the bees, and this occurs just the same in a double as in a single-walled hive. The bees then create an artificial circulation of air in the hive by fanning with their wings. Ventilation of this sort is of course free from any danger of being carried to excess, and unduly chilling the hive. But any attempt to permanently establish a draught, running through the interior of the hive, seems to be attended with danger, and, moreover, is pretty certain to be defeated by the bees blocking up the ventilators. Provision may be made for the escape of hot air at the top of the hive, through a quilt of texture sufficiently porous for the purpose, and permitting to some extent ventilation without draught. But this is just as possible in a single as in a double-walled hive. My observation has not been extensive, but so far as it has gone, I cannot discern that the double-walled hive is cooler in summer than the single-walled, but rather the other way. I should be glad to know the views of yourself and readers about the above question.—QUINCTILIS, *Oxford.*

METEOROLOGICAL OBSERVATIONS

For week ending Sunday, August 1, taken at
Rosslyn Castle, N.B.

Mean Height of Barometer	29.977
Mean Temperature	64°
Highest Point of Thermometer (August 1)	79°
Lowest do. (July 27)	47°
Mean Dew Point of Temperature.....	57°
Solar Radiation	95.9
Terrestrial Radiation	44.6
Rainfall in One Day08
General Direction of Wind	W.

H. MARRS.

Queries and Replies.

[1793.] *Drone-breeding Queens.*—I started this season with six hives and have now only two left owing to failure of the queens. They started breeding all right in the spring but then turned into drone-breeders. You might kindly give me your opinion of the queen enclosed in box. The hive this queen was in was near swarming about end of May. But it gradually began to dwindle from that time. I drove the bees to-day (July 28) and joined them on to another stock from which I took queen. There was nothing but drone brood in worker cells. Your reply in B.J. will much oblige?—DISAPPOINTED, *Stonehouse, N.B., July 28.*

REPLY.—Beyond saying that the queen sent is a rather fine adult with no signs of ragged

age about her we cannot even make a reliable guess why four queens out of six should turn drone-breeders in one year. There must surely be some explanation of so extraordinary a state of things which would make itself plain to an experienced bee-keeper. Can you not obtain the assistance of such a man who could examine the hives?

[1794.] *De-Queening hive—Dealing with foul brood.*—Will you please give me advice how to proceed in the following case: On June 16, the county expert examined a hive of mine. I was unfortunately away at the time, but he left word that the bees had foul brood, and killed the queen. He then said the colony would swarm in a few days (there were five or six queen-cells sealed over at the time). I don't quite see myself why the bees should swarm as they had no old queen left; at any rate, they haven't swarmed to my knowledge. I did not notice any diminution of numbers in the hive when examining them several times, till Saturday the 24th, when I found the bees much fewer, but there are two patches of unsealed brood now. 1. Even on the 26th was the expert's advice correct? 2. As all the frames in brood chamber are full of honey except for the brood mentioned. I want to get the bees into a skep and confine them for forty-eight hours previous to rehiving them in a healthy hive; how can this be done? Will shaking and brushing manage it?—C. M. W., *Kidderminster July, 26.*

REPLY.—Yes, the plan followed by the expert was quite right under the circumstances. The idea was, no doubt, to get rid of the old queen—and as the bees were evidently preparing to swarm when examined—it gave a chance to hive the bulk of the bees in the usual way, after keeping the swarm for forty-eight hours in the hiving skep. Twenty-one days later—when all brood would be hatched out—the bees (as we suppose) would have been got off the affected combs and treated as another swarm hiving them in due course in a clean frame-hive. The diseased combs would then be burnt. 2. Bees can be easily shaken of frames of comb—on to a board or platform—by a downward jerk, or brush them gently off with a feather. When shaken off they readily run into any hive prepared for them.

[1795.] *Wax Extracting.*—By following the instructions pp. 85 and 86 of "Guide Book" I have extracted some wax of a beautiful colour, but not quite free from impurities which adhere to the bottom of the cake. How can I get rid of this? 2. There is nothing said in the instructions as to how the basket, which is full of refuse, is to be cleaned before being used again.—S. E., *Farningham, Kent, July 26.*

REPLY.—The usual ready way of getting over the fault complained of is to cut away the discoloured portion from underside of cake and remelt the wax. But if wax is in-

tended for exhibition it is found useful to add a teaspoonful of sulphuric acid (vitriol) to two gallons of water used. 2. After emptying the débris. The comb-basket is cleaned by steaming in the boiler for a time.

Echoes from the Hives.

Honey Cott, Weston, Leamington, July 29.
—The season here has not been what we bee-keepers call a good one, nor can we truly call it a bad one, such as I have known more than once; but it has been indeed a Jubilee year for swarming; "Jubilee day" capping it all in this respect—five big swarms out almost simultaneously, and they all joined together at the top of a plum tree, 8 ft. high. You know, Messrs. Editors, I am not given to exaggerating, but there were at the least 30 lbs. of bees in that cluster! I mounted a ladder and fetched them down in skepsful till I had got them all down, and eventually got them settled into three skeps, and one lot weighed about 12 lb. As a matter of course some of the queens got "balled." Regarding the honey crop, although the weather has been so variable, sometimes very hot and then very cold, However, for myself, I see no reason to grumble, having got my share, so far as the season has gone. Indeed, I think it more than probable we may have a little more yet, seeing that second crop white clover is just coming out, and the recent rain has started it blooming again. I often wonder if Mr. Cowan will be sending a few lines to the *Journal* telling us how he is getting on with the bees in America.—JOHN WALTON.

Bee Shows to Come.

August 10 and 11 at Burton-on-Trent.—Staffs. B. K. A. In conjunction with the Staffordshire Agricultural Society.

August 12, at Goole.—Annual Show of Bees and Honey in connection with the Goole and District Agricultural and Horticultural Society. **Six Open Classes**, with good prizes, including 20s. and 10s. for single 1 lb. jar of honey (entry free in this class). Schedules from J. Luddington and H. S. White, Secretaries, Lindum House, Goole. **Entries close August 7.**

August 13 and 14, at Dumfries.—S.S.B.K.A. Jubilee classes open to the world. Schedules from Jas. Kerr, Douglas-terrace, Dumfries.

August 14, at Stoke Prior.—Honey exhibition in connection with Horticultural Show. Cash prizes and medals (including a good open entry, without entrance fee). Catalogues free. Percy Leigh, Lee Mount, Stoke Prior, Worcestershire.

August 18 and 19, in the Quarry, Shrewsbury.—Schedules from T. Whittingham, Colum Cottage, Shrewsbury. **Entries close, August 5.** See advt. on page iv.

August 19, 20, 21, at Barrow-in-Furness.—In connection with the Royal Lancashire Agricultural Society. Six classes, with liberal prizes for honey. Schedules from Jas. Birch, Secretary, 31, Castle-street, Liverpool.

August 24 and 25, at Hastings.—Annual Show of the Kent and Sussex Bee-Keepers' Association in conjunction with the Sussex County Agricultural

Society. Liberal prizes. Schedules from Henry W. Brice, Hon. Secretary, K. and S. B.K.A., Dale Park, Upper Norwood. **Entries close August 14.**

August 25, at Fleetwood.—Honey Show, under the auspices of the Lancashire and Cheshire B.K.A., in conjunction with Floral and Horticultural Society. Cash prizes of 20s., 10s., and 5s. in each class for twelve sections, and twelve jars extracted honey. Schedules from E. H. Wilson, Hon. Sec., 9, Queen's-terrace, Fleetwood. **Entries close August 11.**

August 28, at Fairfield, near Manchester.—Exhibition of Bees, Honey, &c., in connection with the Manchester and District Branch of the L. and C.B.K.A. For particulars apply F. H. Taylor, Local Hon. Sec., Birch Fold Cottage, Fallowfield, Manchester. **Entries close August 21.**

August 28, Corn Exchange, Biggar.—In connection with the Horticultural Society's Show. Annual Open Exhibition of Bees, Honey, Wax, &c. Prize lists from W. Orniston, Sec., Fernbank, Biggar, N.B.

September 1, at Hereford.—The Thirtieth Annual Show and Honey Fair of the Hereford B.K.A. will be held in the Butter Market, Hereford, as above, when consignments of honey for sale are solicited. Schedules from the Hon. Sec., Mr. A. Watkins, Imperial Mills, Hereford. **Entries close August 27.**

September 2, at Castle Douglas, N.B.—Annual show of the Galloway Horticultural and Honey Society. Open classes, with liberal prizes, for three 1-lb. jars extracted honey, and for three 1-lb. sections. Schedules from Thos. Myers, Hon. Sec., Gowandea, Castle Douglas. **Entries close August 31.**

September 4, at Bramhall Hall.—Lancashire and Cheshire B.K.A., in connection with Bramhall and Woodford Horticultural Society. Annual show of honey. Open to district and members of the L. and C. B. K. Association only. Schedules from Secretary, J. Bell, Davenport, Stockport.

September 8 and 9, at Derby.—Sixteenth Annual Show Derbyshire B.K.A., in connection with the Derbyshire Agricultural Society. Nineteen classes and over fifty prizes for bees, honey, and appliances. Schedules from F. Walker, Hon. Sec. D.B.K.A., Cattle Market, Derby. **Entries close August 31.**

September 25, in the Corn Exchange, Jedburgh.— Roxburghshire B.K.A. Annual Honey Show. Twenty-six classes for honey, wax, and sundries. **All open.** A single entry fee of 2s. covers all classes. Schedules from Thos. Clark, Pleasant Schoolhouse, Jedburgh, N.B. **Entries close September 21.**

Notices to Correspondents & Inquirers.

All queries forwarded will be attended to, and those only of personal interest will be answered in this column.

G. BENFORD (Hants).—*Appliance Dealers and their Customers.*—Our correspondent, in complaining about the unfair business treatment he alleges against certain appliance dealers, concludes his letter by asking, "Cannot you show them up in the BEE JOURNAL? By so doing you will oblige many bee-keepers." But he forgets that there are two sides to every question, and many reliable accounts of unfair treatment of dealers by customers have been sent to this office which equal, if not surpass, anything we have knowledge of on the other side. This being so, it only remains for both buyers and sellers alike to take such needful precautions as they can, and don't deal a second time where there is cause for complaint on either side.

T. J. R. (Cupar Fife).—*Suspected Comb.*—The sample of comb received contains nothing worse than hard pollen along with a few earwigs. There is no disease about it.

S. HARBORNE (Birmingham).—*Moving Bees in Frame Hives.*—Since you have choice of time for removal let the hives remain where they now are till cold weather sets in, and bees have been kept indoors for a week or two in consequence,

J. W.—*Preventing Granulation.*—If the honey is already granulating, insert the jars (uncovered) in a vessel of warm water; heat it gradually to about 100 deg. Fahr., leaving it at that temperature till the honey becomes quite clear and bright. Keep it afterwards in a warm place till wanted for showing.

J. S. N.—*Sections for Exhibition.*—We are sorry to say the section was too much damaged in post for us to accurately judge its merits for the show bench, but with beautifully white capping, full weight, and excellence of the honey, and—so far as we could see—well-sealed, admirably clean, and well got up, a dozen sections like the one sent would make a very good attempt for prize winning.

F. C. (co. Down).—*Bees Refusing Foundation.*—1. We see no reason to question the quality of foundation sent. It seems of good quality. Stocks that have sent out swarms frequently refuse to work in supers the same season. 2. Honey that is fully ripe when extracted does not need keeping "air tight." Keep it in a warm, dry place, and it will be all right if covered down or in jars. 3. Unsealed (*i.e.*, unripe) honey is very liable to fermentation, unless it is artificially ripened by keeping it at a high temperature for several days.

CHAS. BROWN (Hants).—*Mead-Making.*—The Rev. G. W. Bancks, Durham House, Dartford, Kent, has published an excellent pamphlet on mead-making. There is also a good recipe "100 years old" in our issue of February 28, 1895, which may be had from the office for 1½d. in stamps.

A. H. R. (Hants).—*Packing Bees in Skeps for Travelling.*—Travelling boxes for bees may be bought from any appliance dealer. So far as sending stocks of bees in skeps on long journeys, unless the skeps are "sticked," *i.e.*, have two or three sticks run through the combs and straw of skeps, they are not safe to travel in any but cold weather. The skeps must also be sent bottom upwards and fixed up in a box, or in a light wood frame, so that they will not fall over when set on the ground mouth upward. The skep must also be covered with strong net or with very coarse scrim or cheese cloth securely tied on. They must also be labelled, "*Bees, with care.*"

D. G. (Ilminster).—*Sugar for Bee Syrup.*—The yellow crystals (Demerara) are quite suitable for spring feeding, but for winter food refined or white crystals—cane sugar—should be used.

MISS E. S. H. (N. Devon).—*Bees Killing Drones in July.*—It is not at all uncommon for bees to kill drones in July if outside food is failing.

J. HELSBY (Herts).—*Uniting Bees.*—Under the circumstances, and bearing in mind the doubtful advantage to be derived from uniting, we should advise selling the stock hived in skep as it stands, if it is not desired to keep it.

Editorial, Notices, &c.

USEFUL HINTS.

WEATHER.—That the weather on the whole has for the last six or seven weeks past been what bee-keepers would call perfect, goes without saying; in fact, ever since the Jubilee week there have been but few days other than those of sunshine and warmth, so that wherever forage bloomed bees have worked on it continuously, and gathered honey of extra fine quality. This is about all we need say on the weather topic, which occupies first place in this column.

PREPARATION FOR WINTERING.—We lay stress on this point just now because by far the best of the season has this year come late—so late, indeed, that those located in early districts have by no means received their fair share of the good things gathered in the north, seeing that the honey income has continued without intermission right up to the end of the bloom that yielded it. Consequently—wherever surplus storing has been properly managed by the bee-man—the whole of the honey has been carried “upstairs,” and when upper chambers are taken off the storage-room in brood-nest below will be represented mainly by empty combs. Experienced bee-keepers don’t forget this, but, unfortunately, all are not old hands, and we therefore urge those who have already appropriated a good share of the results of their willing workers’ labour for the year to be content; and bearing in mind the future, to remove their already sealed supers at once, allowing the bees to carry the “unsealed stuff” below as their share of the year’s sweet spoil. Feeding up well later on is good, we admit; but “the stocks that come out best next year” are so often those left with plenty of natural stores that the point is well worth thinking about. It is a wise if somewhat paradoxical bee-saying which declares that “bee-work for next year begins in this,” and those who regard it as true show their wisdom as bee-keepers.

BUYING HONEY FOR SHOWING.—The regard which honest men should have for strict integrity and straightforwardness in all their dealings compels us to revert to a matter which it would have been more pleasant never to have heard

of at all. We refer to the letter in our issue of the 22nd ult. (2951, page 286). Along with the communication there printed was enclosed for our inspection a letter—received by the writer thereof—from a bee-keeper, whose way of looking at things may be regarded as somewhat “warped,” seeing that without any beating about the bush or concealment whatever he wrote to ask if the recipient of his inquiry “would kindly sell him a dozen jars of extracted honey same as you had at the show.” Then follow words which in one sense attest the writer’s honesty from his own point of view, for he adds: “I want to show it at the — show, at —, this month, so let me know as soon as you can.”

Of course, the request to sell was declined, and the matter coming to our knowledge we, in a footnote on page 268, promised to inquire into it. In the end the authorities at the show referred to disqualified several exhibits—not questioned as to their genuineness—entered and staged by the person referred to above, who was thus justly penalised for an offence not actually committed, but about which the intention to stage a fraudulent exhibit was clearly proved under the writer’s own hand.

In consequence of this action, the individual most concerned was very indignant with our correspondent, Mr. Loveday, and wrote him so strongly condemning his conduct that the latter felt constrained to send for publication in our pages the following letter:—

“SIRS,—Referring to the matter that I brought to notice in B.J. of July 22 (2951, page 286), and the action I took in fulfilment of what I felt to be my duty in the true interests of the craft, I may say I took the only course open to me if honest showing is to mean anything. I have received the enclosed letter with a request to forward it to you as I did the other one from the same party. While it would hurt me to know that I was doing a fellow-man an injury, I have no qualms of conscience in having taken the only course open to any honest man.”

Well, now, without for one moment attempting to justify the real offender in this business, we are quite anxious to do him justice, and, in so doing, would point out the strange obliquity of vision by which a man—who is, in his own opinion, perfectly well-meaning and honest—cannot “see himself as others see him.” We print as much of a long and very irate

letter as is needed to illustrate our point, and this is how he "talks" to Mr. Loveday:—

"I must write and tell you what I think of your unkind treatment of me. Had you replied to my letter and said you didn't think it right, I would have thanked you and considered you a gentleman; but now I call it base. If I had bought your honey and showed it you might have acted as you have."

Here follows an extraordinary bit of logic, for the writer goes on to observe:—

"I don't say the thing is right, but I know, and you admit in B.J., that it is regularly practised, and that is why an honest exhibitor like myself, unless he follows the same rule, has no chance at all."

How "an honest exhibitor" can obtain his chance by following a "rule" which is "dishonest," it is rather hard to see. This point, however, is evidently overlooked, for the writer, after stating that "he has kept bees all his life, and exhibited many times," quite solemnly declares—"I have never showed any honey in my life but my own, and if you think me an impostor and a cheat, you are under a great delusion. You have done me a great injury here, as I am blamed for doing what I am innocent of, my honey and wax being disqualified," &c. Of course, buying honey makes it "my own" in the Gilbertian sense, but schedules usually state very distinctly that the honey must be gathered by the exhibitor's "own bees": this being the fraud committed when honey is bought for show purposes.

That the writer of the letter we are dealing with is, from his own point of view, perfectly sincere, we do not doubt for a moment, seeing that he boldly challenges inquiry into his character "among neighbours who have known him for years." He says—"You will find no unfair dealings on my part." Then he very truly observes—"If every man was an honest exhibitor, then honest men would have a fair chance, but who can prove that they are?" This last proposition is a poser, though most readers will incline to the view that Mr. Loveday is doing his share in giving honest men the very chance desired. The writer, however—in the perversity of vision to which we have already referred—sees only good in himself and evil on the other side. This is fully proved in the letter before us, which concludes with

an "exhortation" containing the *crux* of the whole question. However oblivious the writer may be to joke so far as its obvious application, he says:—"I don't wish to hurt your feelings, but it should teach you to do to others as you would be done by, remembering that with what measure you mete it shall be measured to you again."

A postscript asks that the letter be forwarded to us as the other was, and we trust we have dealt not harshly or unfairly in giving it prominence as above.

(Remainder of Hints next week.)

LEICESTERSHIRE B.K.A.

The fifteenth annual exhibition of bees, honey, and appliances was held in Victoria Park, on July 28 and 29, in connection with the Leicestershire Agricultural Society.

The Association is to be congratulated on the large number of exhibits staged and the success of the honey department generally. The arrangements were all that could be desired and reflect much credit on the Hon. Sec. Mr. J. Waterfield. Lectures were given in the Bee-tent by Mr. H. M. Riley, and apparently much appreciated by a large number of spectators.

Mr. J. M. Hooker judged the exhibits and made the following awards:—

Observatory Hive.—1st, H. Hill, Ambaston; 2nd, J. Cooper, Leicester.

Three Frames of Comb Honey (17 entries).—1st, W. Bent, Groby; 2nd, J. Waterfield, Kibworth; 3rd, W. Parkinson, Groby.

Twenty-four 1-lb. Jars Extracted Honey (10 entries).—1st, Mrs. A. Parry, Melton; 2nd, F. Pickersgill, Witcote; 3rd, Miss Chester, Waltham.

Twelve 1-lb. Sections (19 entries).—1st, F. Pickersgill; 2nd, J. W. Smith, Ashby Folville; 3rd, J. Fewkes, Great Glen.

Twelve 1-lb. Jars Extracted Honey (29 entries).—1st, Miss S. J. Cooper, Leicester; 2nd, Mrs. A. Parry; 3rd, W. C. Lowe, Rothley Plain.

Display of Honey.—1st, J. Waterfield; 2nd, Miss S. J. Cooper; 3rd, Miss A. Shrosby, Leicester; 4th, Miss Chester.

Six 1-lb. Jars Extracted Honey (9 entries). novices only.—1st, H. Hayward, Great Glen; 2nd, G. O. Nicholson, Market Harborough.

Six 1-lb. Sections (5 entries).—1st, A. H. Peach, Oadby; 2nd, G. O. Nicholson.

An exhibition of honey bees, &c., under the management of the above Association, was also held in connection with the Abbey Park Flower Show, on Aug 1st 3 and 4 at Leicester. The honey department was again in charge of the Hon. Sec., Mr. J. Waterfield, and proved beyond doubt a great attraction to visitors, the tent being crowded to excess nearly the whole

of the time the show was open. The entries numbering upwards of ninety, and for quality the exhibits were highly extolled by the judge.

Mr. R. Brown, Somersham, officiated as judge and made the following awards:—

Observatory Hive.—1st, J. Cooper, Leicester; 2nd, H. Hill, Ambaston.

Twelve 1-lb. Sections (19 entries).—1st, W. P. Meadows; 2nd, F. Pickersgill, Withcote.

Twelve 1-lb. Jars Extracted Honey (29 entries).—1st, J. Waterfield, Ribworth; 2nd, Miss Chester, Waltham; 3rd, A. W. Garner, Waltham; 4th, F. Pickersgill, Withcote, v.h.c. A. Parry and W. Godby.

Display of Honey.—1st, J. Waterfield; equal 2nd, W. P. Meadows and S. J. Cooper; 3rd, Miss A. Throsby, Leicester.

Twelve 1-lb. Jars Granulated Honey.—1st, J. Waterfield; 2nd, F. Pickersgill.

Six 1-lb. Jars Extracted Honey (novices only).—1st, Hy. Smith, Melton; 2nd, A. W. Garner.

Single 1-lb. Jar Extracted Honey.—1st, J. Waterfield; 2nd, Miss Chester.—(*Communicated*.)

LANCASHIRE AND CHESHIRE B.K.A.

SHOW AT FALLOWFIELD.

In connection with the South Manchester Horticultural Society a bee and honey exhibition was held at Fallowfield on July 24, under the auspices of the Manchester and District branch of the L. and C. B.K.A.

A beautiful day brought numerous visitors, and the honey and bee tents were centres of attraction for crowds from the opening to the close of the exhibition.

The lectures were given by Mr. F. H. Taylor, first-class expert and local hon. sec., while Mr. T. F. Harrison, of Northenden, and Mr. Hall, of Salle, rendered valuable service in the exhibition tent, explaining the very instructive and unique exhibition, which carried off the first prize in class for interesting exhibits.

For so early a date the entries were very fair, considering this was only a tentative effort, but having proved a success will be greatly extended next year.

Dr. B. E. Jones, Hon. Sec. L. & C. B.K.A., was the judge, and made the following awards—

Six 1-lb. Jars Extracted Honey (light).—1st, R. Dodd, Millington, Tarporley; 2nd, Rev. E. Charley, Ince Vicarage, Chester; 3rd, T. F. Harrison, Northenden; v.h.c., J. Chadderton, Old Trafford; h.c., Horton Bros., Flixton.

Six 1-lb. Jars Extracted Honey (dark).—1st, J. Yarwood, Sale; 2nd, Horton Bros.; 3rd, Miss B. Smith, Cheadle.

Six 1-lb. Sections.—1st, R. Dodd; 2nd, Rev. E. Charley; 3rd, C. A. Ingham, Ashton-on-Mersey; h.c., W. Bradbury, Sale.

Bees Wac.—1st, Rev. E. Charley; 2nd, W. Forrester, Huyton; h.c., F. H. Taylor.

Instructive and Interesting Exhibits.—1st, F. H. Taylor, Fallowfield; 2nd, John Warburton, Withington; 3rd, J. Chadderton.—(*Communicated*).

NORTHAMPTONSHIRE B.K.A.

The annual show of the above Association was held in connection with the Horticultural Society's Exhibition in Delapre Park, Northampton, on August 2 (Bank Holiday) and following day. The exhibits were this year staged in a more commodious tent, tastefully decorated for the occasion. In some classes the entries were not up to the average of previous years, but the quality was excellent.

A new class was this year arranged for the best cake sweetened with honey, which proved of considerable interest to exhibitors and visitors, Messrs. Lawrence and Adams, of Northampton, kindly placing the awards in this class. Mr. W. H. Harris, M.A., B.Sc., Ealing Dean, W., was appointed judge of the honey exhibits, and made the following awards:—

Twelve 1-lb. Sections.—1st, Thomas Salmon, Brackley; 2nd, W. Winterton, Wellingborough; 3rd, James Adams, West Haddon; 4th, Joseph Pollard, Tingewick, Bucks.

Twelve 1-lb. Jars Extracted Honey.—1st, L. Jordan, Holdenby; 2nd, W. Litchfield, Weedon; 3rd, O. Orland, Flore; 4th, C. Wells, Oxendon; 5th, W. Manning, Northampton; h.c., James Adams.

Six 1-lb. Jars Granulated Honey.—1st, L. Jordan; 2nd, James Adams; 3rd, W. Manning; commended, L. Jordan.

Three Shallow-Frames of Honey.—1st, C. Wells; 2nd, J. Adams; 3rd, L. Jordan.

Beeswax.—1st, A. Williams, Overstone; 2nd, James Adams; 3rd, T. Reynolds, Overstone.

Classes F, G, and H (open to non-prize winners at previous shows).

(F) *Six 1-lb. Sections*.—1st, A. Brayshaw, Glasgow; 2nd, G. Page, Halcot.

(G) *Six 1-lb. Jars Extracted Honey*.—1st, C. Wells; 2nd, H. Williams; 3rd, J. Pollard; 4th, Mrs. Reynolds.

(H) *Super of Comb Honey*.—1st, H. Williams; 2nd, H. England, Overstone.

SPECIAL PRIZES.

(Open to United Kingdom.)

(a) *Single 1-lb. Jar Extracted Honey*.—1st, R. Dodd, Tarporley; 2nd, O. Orland; 3rd, J. Pollard; 4th, W. Tustain, Farthinghoe; 5th, W. Manning; 6th, Mrs. Prideaux-Brune, Gosport.

(b) *Single 1-lb. Jar Extracted Honey*.—1st, A. Hamer, Llandilo Bridge, S.W.; 2nd, L. Jordan; 3rd, W. Litchfield.

(Northants only.)

(c) *Single 1-lb. Jar Extracted Honey*.—1st, W. Litchfield; 2nd, W. Manning; 3rd, C. Wells; 4th, W. Tustain; 5th, O. Orland.

(Open.)

(d) *Single 1-lb. Section*.—1st, H. O. Smith, Louth; h.c., A. Hamer; c., W. Manning.

(e) *Beeswax*.—1st, C. Wells; 2nd, W. Loveday, Harlow; 3rd, L. Jordan.

(f) *Honey Cake*.—1st, Mrs. James; 2nd, Mrs. Wells; 3rd, Mrs. Hifford; 4th, Miss Perry.

H.C. for Trophy of Honey.—W. T. Mann, Northampton.—(Communicated.)

HONEY SHOW AT HELSBY.

The second annual exhibition of honey in connection with the local flower show was held on the 31st ult., and was a distinct success, the number of entries being larger than in the previous year. The classes, with one exception, being open, visitors had an opportunity of seeing specimens of honey gathered in various parts of the kingdom. Some splendid exhibits were staged in the extracted honey classes, and the contest was consequently keen, Cheshire exhibitors being well to the front. Dr. B. E. Jones acted as judge, and also lectured in the bee tent in the afternoon.

AWARDS.

Sic 1-lb. Jars Extracted Honey (open).—1st, S. Woodward, Kingsley; 2nd, P. Crellin, Barnston; 3rd, J. Acton, Runcorn; v.h.c., Owen Roberts, Tarporley, Richard Dodd, Tarporley; h.c., J. M. Harnaman, Alvanley; c., G. Fairs, Chichester.

Beeswax (open).—1st, A. Thomas, Frodsham; 2nd and v.h.c., Rev. E. Charley, Ince; c., J. Oultram, Kingsley.

Three 1-lb. Jars Granulated Honey (open).—1st, W. Loveday, Harlow, Essex; 2nd, S. Woodward; v.h.c., H. W. Seymour, Henley-on-Thames.

Local Class.—1st, A. Newstead, Ince; 2nd, J. M. Harnaman; 3rd, W. H. Gerrard.

Single 1-lb. Jar Extracted Honey (thirty-seven entries).—1st, A. Thomas; 2nd, Mrs. Park Yates, Chester; 3rd, J. M. Harnaman; 4th, Owen Roberts; v.h.c., Thomas Blake; h.c., Miss Ada Bostock, H. W. Seymour.

Single 1-lb. Section.—1st, Rev. T. J. Evans, Tarvin; 2nd, R. Barlow, Colwyn Bay; 3rd, Owen Roberts; 4th, Miss F. E. Smith, Lichfield; h.c., J. Sopp; c., H. W. Seymour.—(Communicated.)

Correspondence.

The Editors do not hold themselves responsible for the opinions expressed by correspondents. No notice will be taken of anonymous communications, and correspondents are requested to write on one side of the paper only and give their real names and addresses, not necessarily for publication, but as a guarantee of good faith. Illustrations should be drawn on separate pieces of paper. We do not undertake to return rejected communications.

NOTES BY THE WAY.

[2972.] August is once more with us, and we feel that the honey season is over in the South of England. Our interest at present is,

therefore, centred in the "takes." How have the bees done? What sort of a season has it been? Got much honey this year?—and similar questions greet one, according to the idea of the questioner. And to each question so put to myself the reply has been, "Season not so good as in 1896, though the early honey was and is superior in quality to the honey gathered in the corresponding period of '96."

In the work of removing surplus—whether racks of sections or boxes of shallow combs for extracting—no appliance invented during the last decade has so added to the comfort of the bee-keeper as the "super-clearer." With this simple article honey can be removed from the hives almost without trouble or stings. More than half my harvest has been taken from the hives without the use of a veil, all the work of taking off honey being done with the aid of the carbolised cloth.

This matter of the "cloth" raises another thought. I have always recommended a piece of unbleached calico, but this season I have used an old piece of "strainer cloth" for my carbolised sheet, and find it a deal more effective than the closer texture of unbleached calico. I think this is because the bees set up a rapid fanning, which induces a greater current of the carbolised air to circulate amongst the inmates of the brood nest. The work of removing the honey may be done when the bees' labour is over for the day, and by putting on the clearers one evening and taking off the surplus the next one, no disturbance of the bees will follow. I rarely use a smoker in putting on or taking off honey, simply the carbolised cloth. The smoker, however, suits me best in work connected with queen-rearing, as the time one requires to have the hives open is too long for the use of the cloth.

In poor districts and in some hives in good districts feeding will have to be done to put the stocks into good order for the winter months, and August is the best month in which to attend to this necessary work. Begin feeding gently, say $\frac{1}{2}$ lb. food for a few nights to induce the queen to deposit eggs. Then, after a few combs have fair sized patches of brood, give the required quantity rapidly. This enables colonies to go into winter quarters in the best possible form, with a goodly number of young bees and a clear brood-nest with abundance of sealed food for their future wants. The best food next to honey for winter consumption, according to my experience, is syrup made with pure cane sugar. In practice I always use granulated cane sugar in syrup, made by simply pouring boiling water on the sugar and stirring till dissolved. I add a little salt but no vinegar. I have not used vinegar in syrup for the last ten years.

Sending Queen Bees by Post.—This is a subject which it is to be hoped will be taken up by the parent association. Here in this year of "Diamond Jubilee," we bee-keepers

are charged by the Postmaster-General 200 per cent. more for a sample of bees than any other industrial sample. Why is this? Why, I ask, is our small industry handicapped thus? Has any consignment of bees through the mails ever caused an injury either to the officials or to the accompanying muter in ransit with the bees? If so, let us know who sent the consignment and then we will try and

"CONDEMNED" BEES.

[2973.] In the years gone by, at this season we used to go round with pony and carriage rescuing condemned bees. That was when we were young and energetic, and had visions of a garden (day-dreams) with fifty hives down one side of it and fifty down the other. The garden is there right enough, but somehow the bees never increased beyond twenty hives;

COUNTY HONEY TROPHIES AT "ROYAL" SHOW, 1897. (No. 2)

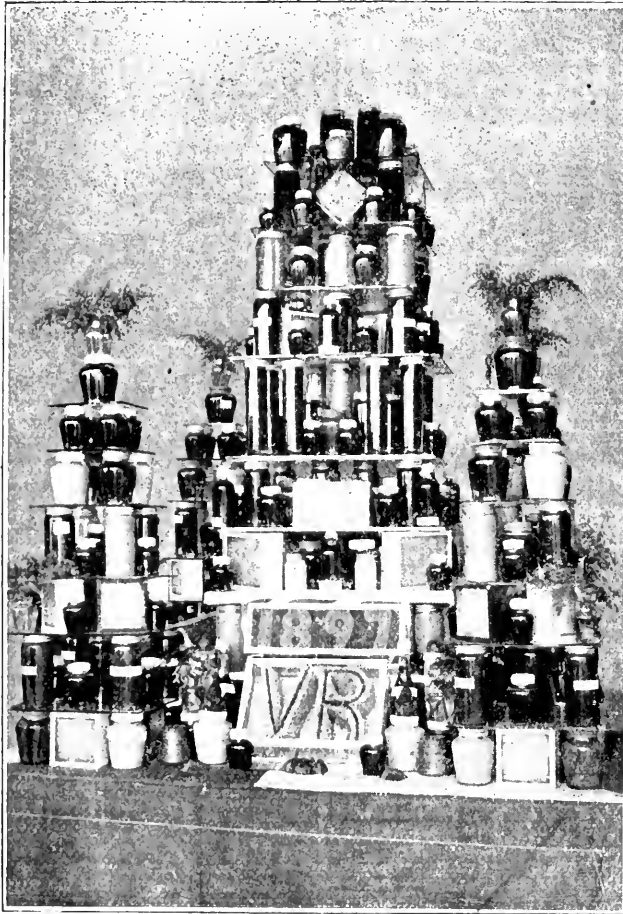

SECOND PRIZE, YORKSHIRE B.K.A.

instruct him how to send queens without the slightest risk of any escape of bees, even if her Majesty's mails should get wrecked. This subject affects only a minority of bee-keepers, yet I think it worthy the serious attention of the British Bee-keepers' Association. Who will start the cause!—W. WOODLEY, *Beeton, Newbury.*

or, if they did, some one came along and made us a tempting offer, and so the bees went. Bees in these parts do not swarm very readily. If you super early they rarely swarm at all, so to increase the apiary it is necessary to artificially divide or make extra stock in the autumn with condemned bees. In those days we were young and inexperienced, conse-

quently the bees (and ourselves) suffered untold agonies. We tried to make our stocks, that were strong enough as they were, extraordinary powerful by joining a peck or so of bees to them. We put a cloth up to the entrances, and threw down heaps of homeless bees, scenting them with peppermint as they tried to run in. The rightful owners, however, would not have them at any price, scented or otherwise. As fast as they bundled in the rightful owners chucked them out again, and on the morrow there were what looked like millions of bees dead and dying before the entrances. When all was over, I think the stocks were weaker than before we commenced to strengthen them, and only the ground profited through being fertilised with the bones of the dead bees. That was our first "driving" experience. The next year we tried a different plan. We secured the condemned bees (condemned by the cottager, and, as it turned out, "condemned" also by ourselves), and upon our arrival home, late at night, proceeded to open the hives by moonlight! Not weakly hives, but powerful colonies, in which the bees were packed like herrings in a barrel, for the supers had been taken off, and all the bees were forced into the breeding compartment, consequently no sooner did you drag off the quilts than the bees boiled over the frame-ends, up the roof, and hung in festoons over the sides. Still we wanted at least 160 lb. surplus from each colony next year (see Mr. Pettigrew's book on bees), and so we proceeded to strengthen them. The hives were opened, as I have said, by moonlight, and the frames were drawn apart. At that time we had not that absolute control of our nerves so necessary for successful bee-keeping. Our knees *would* knock together, and our hands *would* shake alarmingly, especially when we had had a little formic acid injected with the neatest of all syringes into the end of each finger and thumb. The frames were drawn apart; then a skep was lifted, inverted, and the poor, condemned bees dosed with scented syrup till they were black in the face and body. Then they were thrown mercilessly into the boiling cauldron of bees, seven times heated, and the quilts thrown on, loosely, so that all the bees might go in if they felt so inclined.

Each of the hives were thus dosed with bees, while the world of men (unhappy non-bee-keepers) slept, and several night-jars (cats) became wakeful and sang sweetly on the slates, which, no doubt, were cool to their feet. The moon shone serenely, calm, and unmoved, as though she knew nothing of the ways of men, but amongst the constellations I thought I saw some eyes that were lit up with the semblance of a smile. Towards the dawn, say three of the clock, when we had succeeded in ridding ourselves of the last bee, for, be it known (and well remembered) that condemned bees are infinitely worse than your own (to use a pigeon-fancier's phrase) "stout" bees. The latter have a home to go back to if they feel

so disposed, but condemned bees are "strays," that want no whistling to make them come to you, nor even the rattling of Indian corn in a tin. I do not mean to say they are vicious. Certainly not. They are, in fact, too amiable—like flies of a drowsy August evening. They settle gently down on your eyelid and in your ear, and say, "Here, my dear fellow, I am going to stay, and if you knock me off a thousand times I shall fly back again. Your only remedy is to kill me, and you can do that if you like, for life isn't all buttercups and daisies and honey." I am afraid we did have to kill a few, sadly and with tears at the back of our eyes, and then we crept in the small, still hours of the early dawn as quietly as we could—the more you try the more noise you usually make—up to our beds, where in time, through exhaustion, we fell into troubled sleep. I would dream that the bees were thickly spread all over the pillow, so that I must hold my head perfectly rigid lest I should pinch a row of bees and make them sting! This was tedious work, holding your head so still; but when the bees began to climb over my face and cover my eyes and mouth, so I could only breathe with a half-smothered feeling, it became terrible. What could I do? Shout I dare not. It would be the signal for a thousand stings. The bees were getting thicker and thicker, now pressing their heads in between my lips, now digging their heels into my eyes! I could feel their soft, warm bodies palpitating, and see the drops of poison held out on the ends of their stings; and then they crowded over my nose till I could endure it no longer. So I took a wild leap into the air, shouting Murder! Police! And then I fell back on to the chest of my brother, who thereupon jumped up and shook me till the tears came from the back of my eyes into the front. Under this vigorous treatment I soon awoke, and very pleasant it was to get back between the sheets and lay my aching head on the pillow. Never before (only on similar occasions!) had a bed seemed to me such a noble invention. I even pitied the poor angels, who, of course, have none of these luxuries.—LORDSWOOD.

(Conclusion next week.)

TRANSFERRING BEES TO FRAME HIVES.

[2974.] In accordance with your suggestion in reply to my query (1775, p. 267) I have to-day examined the hive referred to therein and now give the result. First, as to your remark on my not hiving the swarm straight off into frame-hive, I may say the swarm had been in the skep about a fortnight before I got them, and I, therefore, concluded that to drive them from skep into the frame-hive then would throw them back somewhat. To-day, I find the skep is full of honey (weight 29 lb.) and contains very few bees. Of the eight frames in lower hive six had full sheets and two half-

sheets of foundation, and five of the centre ones are fully now worked out on both sides, the remains partly being worked out. In the top corners of the five centre frames is stored a quantity of honey sealed over. In the centre of four frames on each side is sealed brood surrounded by plenty of larvæ. I failed to detect the queen owing to the number of bees. I could see no brood in the skep. I am much obliged to "Amateur," Totterdown, for reply to my queries on page 283, and although I mean to try that plan and may fail, I shall not blame him on that account.—D.G., *Ulmminster*.

EXCESSIVE SWARMING.

[2975.] A swarm issued from a frame-hive with a three-year-old queen on May 24, partly clustered, and then returned itself. On June 3 a second swarm appeared, which was returned the same evening after every visible queen-cell had been cut out, some sixteen altogether. A third swarm came off on June 6, but never clustered, and shortly went back of its own accord. On June 10 the fourth and last swarm was dealt with in a similar manner to that of the 3rd. Since the final swarm the colony has been greatly reduced in numbers, but now seems to be picking up again and finishing the two racks of sections, which were well advanced before. There has been a change of queen apparently, but when did it occur? [We should say the old queen was lost on May 24.—Eds.] My four hives have given off no less than eighteen swarms this year, including the two already mentioned which returned themselves. One hive swarmed six times, and another five, though every sign of a queen-cell was removed before returning. Notwithstanding all this commotion there has been and will be a fair show of honey.—F. C., *Hants*.

WHEN DOCTORS DIFFER.

[2976.] Your correspondent "Novus" (2964, p. 303) asks for information respecting frames and hives. It is now several years since the size of the standard frame was settled, and I think there are very few old and experienced bee-keepers that are not satisfied with the decision of those appointed to settle the matter. As one of that committee, several of whom, I am sorry to say, have passed away, I would say the size of the standard frame was not decided without several meetings and much consideration; well known bee-keepers throughout Great Britain were consulted before arriving at a decision. One of the chief objects in making the frame $8\frac{1}{2}$ in. deep was that the hive or body box could be made from the usual size of deals, which are 9 in. deep, that size being cheaper than the 11 in. planks. It will be seen that after planing the rough edges of the top and bottom of a 9 in. boards it would be reduced, at the least, an $\frac{1}{4}$ or $\frac{1}{16}$ of an inch, so that the frame being $8\frac{1}{2}$ in. deep, it

will be impossible to leave $\frac{1}{2}$ in. under the frame, unless wider and more expensive stuff is used. I notice in a footnote you say the roof should be made of $\frac{1}{2}$ -in. "sound, best quality, yellow pine." If this is well seasoned, and painted before any moisture gets at it, and has at least two coats of paint every succeeding year it will last for years; but this quality of pine is far too expensive for use in hives made at present prices, and if wide boards of cheaper, or unseasoned wood are used, being nailed, when shrinkage takes place they will crack and leak, paint as you will. It is therefore a question whether it will not be safer, better, and cheaper to make the roofs slope, as in the Cowan hive, of ordinary wood, and cover it with thin tin or zinc; this must, of course, be painted.—JOHN M. HOOKER.

[In writing replies (not a "footnote," as our correspondent terms it), to "Novus," we simply gave the information asked for, i.e., the opinion of "W. B. C." himself on the various questions put, and we have, perhaps, inexcusably erred in supposing that no other person's views were invited. However, since our correspondent chooses to question the practical value of our opinion as to the best form of roof for the "W. B. C." hive—owing to the extra cost of the one we prefer—it is but right to say here that we shall be very pleased to supply the names of several manufacturers who make, and will gladly undertake to supply the "W. B. C." hive as the writer prefers it, without any extra charge whatever.—EDS.]

PLANTING FOR BEES.

[2977.] Can any of your correspondents recommend me a plant suitable for sowing for bee-keeping purposes. I happen to have a considerable plot of ground adjoining my hives that is not put to any particular purpose, and generally requires a good deal of cleaning to keep tidy.

If sown with some suitable flowering plant of easy culture and strong growth, both bees and ground would benefit thereby. Some hardy perennial I should prefer to an annual plant, if there be one acceptable to the bees, and one that would flower steadily throughout the summer.

Borage I have tried, but the plants require cleaning, and have no covering properties. Tares (veitches) make a very dense growth, but I am not sure if the bees work on them.—L. F., *Ashby-de-la-Zouch*.

HOW FOUL BROOD IS SPREAD.

[2978.] It has recently transpired that a beekeeper residing in this village lost his three or four stocks of bees at the end of last year, and the hives and combs still remain on their stands. His neighbour across the road, who had six frame hives and six skeps of bees, also lost some stocks last autumn and they have kept dying off since until there are now only

two small weak stocks in skeps left. Here again the hives and combs were left, as in the former case, and I have suspected foul brood as the cause in both instances. In fact, I told the owner so, and wanted to inspect the hives, but he has kept procrastinating and putting me off from time to time. At last, however, he fixed to-day for the inspection, and I have seen them, and cut out three pieces of comb from separate hives—two being cut from bar frames in which the bees were dead, and the other with grubs from a skep with living bees. These samples are sent for your inspection and decision, please. The first named owner, whose bees died last autumn, says that a new swarm has come into an old hive of his, the bees of which died some time ago, but the swarm are working in it. I told him I thought it the hive was foul broody, and expressed a wish to examine them, but he did not give me permission. Is it not high time that some legislation was obtained on this matter as I could see diseased hives being robbed by other bees? And we soon shall not have a healthy stock in the parish. I send my name and address for your information, and sign myself A TROUBLED BEE-KEEPER.

[The combs sent were all badly affected with foul brood.—EDS.]

IRISH BEE-KEEPERS' ASSOCIATION.

The Committee met on the 5th inst. Present: Mr. Farrelly (in the Chair), Mr. Jenkins, Mr. Drought, and Mr. Chenevix (Hon. Sec., 15, Morehampton-road, Dublin).

It was resolved to offer prizes for honey exhibited by members at the Kerry Agricultural Society's Show to be held on September 2, in Tralee.

WEATHER REPORT.

WESTBOURNE, SUSSEX, JULY, 1897.

Rainfall, '67 in.	Above Average, 57·2
Heaviest fall, '53 on 21st.	hours.
Rain fell on 8 days.	Mean Maximum,
Below average, 2·41 in.	69·3°.
Maximum Temperature, 80° on 16th.	Mean Minimum,
Minimum Temperature, 43° on 8th.	53·2°.
Frosty Nights, 0.	Mean Temperature,
Sunshine, 263·7 hours.	61·2°.
Brightest Day, 13th, 15·50 hours.	Above average, 1·9°.
Sunless Days, 1.	Maximum Barometer,
	30·47° on 11th.
	Minimum Barometer,
	29·67° on 20th.

L. B. BIRKETT.

Queries and Replies.

[1796.] *Queens reared from eggs laid by ten-days-old mother.*—One of my hives swarmed on June 27, and on July 4 I heard the young queen "piping"; but wet days kept the second swarm from issuing till the 9th. I

then immediately cut out all remaining queen-cells (seven in number), and returned the swarm in the evening. Two days afterwards the weather became very warm and the bees were hanging out until July 15, when they swarmed again. Will the queen raised from the egg laid by so young a queen be likely to be a fit mother for the colony?—T. LOVE, *Kirvennie, Wigtown, N.B.*

REPLY.—Your letter reached us four days later than date when written and since then reply has been unavoidably delayed. If, however, the young left eggs behind in the old hive, the queen reared therefrom will be all right so far as her progeny is concerned. We should, however, look over the combs in order to make sure that normal queen-cells are there and occupied.

[1797.] *A Beginner's Queries.*—Will you kindly advise me in following matter? I started bee-keeping in April last with a colony on nine frames. Not having had any previous experience, I did not super early enough, and, in consequence, the bees swarmed about June 2. The swarm is now doing well, but on looking at parent stock a few weeks ago, I found they were not working in super which was put on after the swarm was hived. On further examining them, I found a very large number of drones and very ill-filled frames. A neighbour advised me to kill the drones as they went in and out of the hive; this I did on two occasions, and destroyed about a thousand drones in this way. I have not since examined the hive interior, but the stock seems very feeble compared to the swarm. Will you kindly say whether it was a right proceeding to kill the drones, and what you think likely to be the cause of the apparent dwindling? For the past four or five days, since killing the drones, I have been feeding bees on syrup. When examining the hive I failed to identify the queen, but saw some larvæ, and I also notice that there is a little pollen being carried in by the bees. What is the right course to pursue?—IGNORAMUS, *Tiverton.*

REPLY.—The "right course" at the present juncture is to remove the super given to the parent stock after issue of the swarm and allow the bees to gather as much food for winter as is available to them. It was a mistake to super after swarming, but no serious harm was done. Regarding the massacre of the unfortunate "thousand" drones, the only harm done—beyond inflicting a gruesome job upon yourself—was the removal of so great a body of heat producers, as the unfortunate drones undoubtedly were; this would detain at home a large number of worker bees for the purpose of keeping the brood warm, which said workers would otherwise have been free for honey gathering.

[1798.] *Transferring from Skep to Frame-hive.*—Can you give me any advice on the following:—A friend of mine had a swarm

given him a few weeks ago which worked so hard that in a short time they were crowded out of skep and clustered underneath hive. I advised the purchase of a frame-hive, which arrived about a fortnight afterwards, and I at once got the bees into it by "driving." I then cut out combs of brood and tied them into five of the frames; the remainder I filled with full sheets of comb-foundation. I took care to leave plenty of honey with brood. Judge of my surprise at night to find more than half of the bees clustering under bottom of new hive. I drove them in again with smoke, but only to find them return to the same place. After again driving them off, I sprinkled the place with a solution of carbolic acid, but, in spite of all, the bees will persist in clustering under the hive porch, which they completely fill. Do you think that the fact of the bees inside having been separated for so long from the outside cluster that they have become two colonies? But the outside lot, having no brood, cannot raise a queen, and, therefore, have not swarmed off or gone away. (Can this be so?—A PERPLEXED ONE, *Beechworth*.)

P.S.—I have again driven the bees into the hive on two evenings since writing above, but they persist in again coming out.

REPLY.—First let us say it was not quite a wise thing—under the conditions stated—to break up the colony in skep and transfer the contents to a frame-hive. It would have been better to set the skep above frames of new hive when the latter was received, and let the bees work down into it. This they would have readily done if frames were fitted with full sheets of foundation, and skep could have been removed at close of season as a super of honey. Regarding the refusal of bees to enter the frame-hive, the obvious course is to examine the combs and ascertain the cause of refusal; then determine on your action in accordance with the condition of things, which only inspection can make clear. There is no fear whatever of the bees becoming "two colonies," as you suggest.

[1799.] *Uniting Bees*.—Your kind replies to previous questions embolden me to ask for help once more. 1. Can I re-queen by uniting a second swarm to an old stock in a frame-hive? Will the young, unfertilised queen at head of the swarm get the best of the battle? I can seldom find queens, so should not be able to kill the queen in old stock before uniting. Of course, I should only re-queen if the old one was getting past her best. 2. Can driven bees be united to old stocks by simply dusting both lots with flour, and throwing the driven bees down in front, as in hiving a swarm? 3. What quantity of driven bees should I put into a skep in order to make a successful stock next season? Would three-quarters of a peck be sufficient? 4. What quantity of syrup would be required to feed up driven bees in order to go safely through the winter?

REPLY.—1 and 2. The method of re-queen-

ing suggested is not advisable. Better reduce the old stock to the condition of the swarm; then join the *two* swarms in the skep, and run them into the frame-hive. It would be better, however, to destroy the old queen. 3. Three ordinary lots of driven bees, if well fed, will make a successful stock next season. 4. 25 lb. If a letter is sent here we will address as desired.

Echoes from the Hives.

Betley, near Crewe, August 7, 1897.—This is a record season for honey in this district. I have had every frame and section box in use. Yesterday I took off one hive twelve standard and twenty-four shallow frames solid slabs of sealed honey—I guess about 140 lb. weight. Do you know average weight of standard and shallow frames when well filled? If possible, I will gross and tare this lot, and let you know later the result, also average "take," for publication in B.B.J. if you care to have the information.—F. W. P.

[It is hardly possible to name an "average weight" for frames of honey in comb. We have had "standards" weighing 6½ lb., and "shallows" of 5 lb. each, but only in exceptional cases. We will be very pleased to print your average "take" for '97.—EDS.]

Bee Shows to Come.

August 12, at Goole.—Annual Show of Bees and Honey in connection with the Goole and District Agricultural and Horticultural Society.

August 13 and 14, at Dumfries.—S.S.B.K.A. Jubilee classes open to the world. Schedules from Jas. Kerr, Douglas-terrace, Dumfries.

August 14, at Stoke Prior.—Honey exhibition in connection with Horticultural Show. Cash prizes and medals (including a good open entry, without entrance fee). Catalogues free. Percy Leigh, Lee Mount, Stoke Prior, Worcestershire.

August 18 and 19, in the Quarry, Shrewsbury. Entries closed.

August 19, 20, 21, at Barrow-in-Furness.—In connection with the Royal Lancashire Agricultural Society.

August 24 and 25, at Hastings.—Annual Show of the Kent and Sussex Bee-Keepers' Association in conjunction with the Sussex County Agricultural Society. Liberal prizes. Schedules from Henry W. Brice, Hon. Secretary, K. and S. B.K.A., Dale Park, Upper Norwood. Entries close August 14.

August 25, at Fleetwood.—Honey Show, under the auspices of the Lancashire and Cheshire B.K.A., in conjunction with Floral and Horticultural Society.

August 28, at Fairfield, near Manchester.—Exhibition of Bees, Honey, &c., in connection with the Manchester and District Branch of the L. and C.B.K.A. For particulars apply F. H. Taylor, Local Hon. Sec., Birch Fold Cottage, Fallowfield, Manchester. Entries close August 21.

August 28, Corn Exchange, Biggar.—In connection with the Horticultural Society's Show. Annual Open Exhibition of Bees, Honey, Wax, &c. Prize lists from W. Ormiston, Sec., Fernbank, Biggar, N.B.

September 1, at Hereford.—The Thirteenth Annual Show and Honey Fair of the Hereford B.K.A. will be held in the Butter Market, Hereford, as above, when consignments of honey for sale are solicited. Schedules from the Hon. Sec., Mr. A. Watkins, Imperial Mills, Hereford. Entries close August 27.

September 2, at Castle Douglas, N.B.—Annual show of the Galloway Horticultural and Honey

Society. Open classes, with liberal prizes, for three 1-lb. jars extracted honey, and for three 1-lb. sections. Schedules from Thos. Myers, Hon. Sec., Gowanlea, Castle Douglas. **Entries close August 31.**

September 4, at Bramhall Hall.—Lancashire and Cheshire B.K.A., in connection with Bramhall and Woodford Horticultural Society. Annual show of honey. Open to district and members of the L. and C. B. K. Association only. Schedules from Secretary, J. Bell, Davenport, Stockport.

September 8 and 9, at Derby.—Sixteenth Annual Show Derbyshire B.K.A., in connection with the Derbyshire Agricultural Society. Nineteen classes and over fifty prizes for bees, honey, and appliances. Schedules from F. Walker, Hon. Sec. D.B.K.A., Cattle Market, Derby. **Entries close August 31.**

September 25, in the Corn Exchange, Jedburgh.—Roxburghshire B.K.A. Annual Honey Show. Twenty-six classes for honey, wax, and sundries. **All open.** A single entry fee of 2s. covers all classes. Schedules from Thos. Clark, Pleasants Schoolhouse, Jedburgh, N.B. **Entries close September 21.**

Notices to Correspondents & Inquirers.

All queries forwarded will be attended to, and those only of personal interest will be answered in this column.

M. W. SULLIVAN (Slough).—*Races of Bees.*—

Drones sent are the ordinary or native bee of this country.

FREDK. A. L. (Guilford).—*Sugar for Syrup*

Making.—Sample received is "Demerara Crystals," and will be very good for spring bee-food, but for the winter supply it is better to use "refined" sugar (*i.e.*, white crystals). Your sample is yellow, and contains more or less of the molasses which makes it less suitable as a winter bee-food.

F. W. PLACE (Crewe).—*Honey Extractors.*—

Mr. Meadow's Extractors are so well known, that to have given a full description in our report of "Royal" Show would be deemed superfluous by readers. Chain gearing is, of course, an improvement on the simple shaft and cogs, but the latter does its work very well.

G. S. W. (Moniave).—We have given the

"gentle hint" as desired, and trust the delay has been satisfactorily accounted for.

F. COCKETT (Battle).—*Recipe for Mead.*—The

address asked for is "Rev. G. E. Bancks, Durham House, Dartford, Kent."

J. L. P. (Biggar).—*Suspected Comb.*—We find

a slight trace of foul brood in the very small piece of comb sent. It would, however, have been helpful to us in deciding as to this if a larger piece, cut from suspected comb, with unsealed larvae in it, had been forwarded.

A. P. T. (Saffron Walden).—*Disease or Queen-*

lessness.—There is nothing more than honey and pollen in comb received. As the hive contains "very few bees," it is probably queenless, as suspected. We should not care to trouble about uniting so small a lot of old bees; they will do no good.

J. L. (Boothstown).—*Queen-Cells and Swarmed*

Hives.—The four empty queen-cells found after issue of second swarm—fourteen days subsequent to the top swarm of Jubilee day—will, no doubt, have had young queens reared in them, while the sealed one will

have been an aborted or useless cell. We cannot, however, understand a cast coming off from the parent hive five days after the second swarm left. This is *very unusual*, and needs an examination on the spot to determine the "why and wherefore" of it. The sealed drone-brood may be from eggs laid by the parent queen just before the top-swarm issued on June 22. If the queen of second swarm has mated safely brood should be found several days before these lines are in print, as reply has been unavoidably delayed.

J. C. H. (Wellington, Som.).—*Honey Samples.*

—Honey as samples will be quite suitable for showing. No. 1 is good; No. 2 very good clover honey; and No. 3 is also very good.

C. HOPKINS (Droitwich).—We are glad to

learn that the hive is now in good condition for becoming a populous colony before winter sets in. The queen-cells sent have been torn down by the bees after the queen first hatched out has been accepted as the "mother" of the hive.

W. A. (Okehampton).—*Honey from Limes*

and Heather.—It is safe to say that no honey more will be got from limes in Devon this year. The heather harvest, however, should only now be starting, so there is plenty of time to get a rack of sections filled if it yields well.

A. S. T. (Northampton).—*Inspected Comb.*—

The comb sent looks suspicious; there is no foul brood in it. Can you not send further particulars regarding the state of the hive from whence it was taken.

SIGNALMAN (Glais, Swansea).—*Driving Bees*

to Strengthen Second Swarm.—1. The error you made was in not allowing the full twenty-one days from issue of first swarm to elapse before driving the bees from skep to unite to second swarm. Had this been done, all the brood left by the old queen would have been hatched out. You did the next best thing in setting the skep with unhatched brood on top of a frame-hive till the young bees had all come forth. The tendency to fighting is only the natural mischief in that line which usually occurs when no honey is coming in.

T. X. (Alton, Hants).—*Working Bees for*

Profit.—1. We prefer to use shallow frames for extracted honey and hanging-frames for sections. The relative proportion of comb and extracted honey should be regulated by the demand in district where bees are kept. 2. The only available returns as to profit are those recorded from time to time in our pages. 3. The first week in September is a good time to get driven bees for building into stocks this autumn.

H. J. (Wolsingham).—*Queen Cast Out.*—We

can only say that queen sent is a full-sized adult, and has evidently been a fertile one.

. Several letters and queries are unavoidably held over till next week.

Editorial, Notices, &c.

USEFUL HINTS.

(Continued from page 312.)

WEATHER.—Since writing last week a considerable amount of rain has fallen, and, although the weather keeps warm when fine, the wet will have put a stop to late honey-gathering. This means the prompt removal of surplus chambers—in all but heather districts—and an immediate glance into the condition of stores in body boxes; followed by making early arrangements for such joining up of weak colonies and preparations for re-queening where advisable. It is just the season for taking a general look around the apiary with the view of deciding where driven bees may be useful, and where they are not needed. There is plenty of time for all these things if the necessary work entailed be not put off; but to get bees in good order for winter, and seeing to all requirements needed, there is nothing like taking time by the forelock.

REPORTS OF SHOWS.—It goes without saying that we are at all times pleased when the properly appointed officials of shows—or, better still, when the hon. sec. of the B.K.A. concerned—are good enough to forward to us for publication reports of the various Bee Shows held throughout the Kingdom. This is particularly the case when important exhibitions which have been advertised in our pages are in question. We cannot—for many reasons—be expected to send representatives long distances to furnish special reports; indeed, it is not necessary to do so, seeing that the local newspapers invariably have reporters present, and the latter are only too glad to be helped in preparing “copy” by some one who knows all about the bees. This fact usually ensures a fairly good and accurate account in print which the secretary of the B.K.A. concerned is seldom slow to avail himself of as supplying the material for the B.J. report.

In some cases, however, the hon. official named is not sufficiently interested in the matter to trouble about reporting his show in our pages, and, in consequence, some more actively interested

bee-keeper—an exhibitor himself maybe—cuts out the report from the local paper and forwards it to this office, and, with such condensation as our limited space demands, we don't hesitate to print it with thanks to the sender. This is exactly what occurred with regard to the Yorkshire Show held at Harrogate on July 21 and two following days. We got no report of the show from the Yorks B.K.A.—nor did we last year—but nearly a fortnight after the show took place a correspondent (not an exhibitor this time) sent a cutting from the local paper, and, following our ordinary course, we printed it on p. 302 of our issue of the 5th inst.

So far, so good; but on Monday, the 16th, we received a rather long letter for publication from Mr. A. C. Jemeison, Hon. Organising Sec. of the Yorks B.K.A., disclaiming responsibility for the report on p. 302, which he terms “misleading, partial, and inaccurate.” After our explanatory remarks printed above there is no need either for our printing Mr. Jemeison's letter or for saying anything beyond reminding that gentleman that if those who assisted in making the bee department of the Yorks Show a success are not credited with a fair and proper share of notice in the report in question the fault is not ours. Moreover, his complaint would surely have been more appropriately addressed to the newspaper from which it was taken.

When Mr. Jemeison writes of the report on p. 302 that it “attempts the glorification of one individual only to the exclusion of everybody else,” on reference to the page quoted it is curious to see along with the name of what we suppose to be the “one individual” referred to that of Mr. A. C. Jemeison himself; the only difference being that the latter comes second in each case.

NORTH NORFOLK B.K.A.

The annual show of the above Association was held in connection with the Horticultural Society in Melton Constable Park, on August 2, when a quarter of a ton of bee produce was staged in a most creditable manner by the committee in charge of the arrangements. The general quality of the honey was hardly so good as last year on account of the very changeable season, yet, in all classes, some very fine samples were

exhibited. The list of awards are as follows:—

Members Classes.

Collection of Honey.—1st, S. Fisher, Briston; 2nd, H. W. Woolsey, Edgefield; 3rd, C. Cage, Melton Constable.

Twelve 1-lb. Sections.—1st, A. Chestney, Bale; 2nd, W. J. Norman, Harpley; 3rd, J. Hammond, Bale.

Twelve 1-lb. Jars Extracted Honey.—1st, J. Carr, Briston; 2nd, H. T. Stimpson, Briston; 3rd, W. J. Norman.

Open Classes.

Twelve 1-lb. Sections.—1st, W. H. Woods, Hemingford Grey; 2nd, W. Towler, Edgefield; 3rd, W. J. Norman.

Twelve 1-lb. Jars Extracted Honey.—1st, W. H. Woods; 2nd, H. T. Stimpson; 3rd, W. J. Norman.

Single 1-lb. Jar Extracted Honey.—1st, W. Loveday, Hatfield Heath; 2nd, J. Carr; 3rd, W. Stendall, Rodbaston; 4th, H. W. Woolsey.

Bee Driving Competition.—1st, A. Chestney, Bale; 2nd, C. Cage, Melton Constable.—(Communicated.)

HONEY SHOW AT KINGSBRIDGE.

An interesting show of bee-produce took place at the third annual exhibition of the Kingsbridge Cottage Garden Horticultural Society on the 12th inst. The show was held in the Archery Field, at the head of the town, and was a great success, some very excellent samples of honey being staged. During the afternoon the Rev. W. T. Adey gave short lectures on bees and bee-keeping, which were attentively listened to by a large number of visitors to the show.

The Rev. T. F. Boulton judged the honey exhibits, and made the following awards:—

Twelve 1-lb. Sections.—1st, C. Marks, Frogmore; 2nd, W. Patey, Chillington.

Six 1-lb. Sections.—1st, C. Marks; 2nd, A. Pepperell, Aveton Gifford.

Six 1-lb. Jars Extracted Honey.—1st, J. Parkhouse, Kingsbridge; 2nd, C. Marks.

Collection of Honey.—1st, C. Marks; 2nd, W. Patey.

Bee-wax.—1st, W. Patey; 2nd, C. Marks.—(Communicated.)

AGRICULTURAL SHOW AT WELBECK.

AN UNREHEARSED INCIDENT.

At the invitation of his Grace the Duke of Portland, Messrs. P. Scattergood, jun., and A. G. Pugh visited the show of the Welbeck Tenants' Agricultural Society, annually held in the grounds of Welbeck Abbey, to lecture on bee-keeping and to give demonstrations with the bees. The Society was established eight years ago for the tenants on the various estates belonging to the Duke of Portland, and

the annual show has become a very popular one, being looked forward to by many besides tenants with great pleasure. The meeting under notice took place on the 3rd inst., and was no exception to the rule, as seen in the fact that over ten thousand persons visited the show ground during the day.

When the bee-tent had been set up a rather novel incident happened, as follows:—The bees intended for use in driving and manipulating had been conveyed from Nottingham in a skep, and the weather being very hot at the time, they were liberated as quickly as convenient after arrival on the ground; instead, however, of settling down quietly the bees swarmed. This put the two lecturers in a bit of a fix, seeing that the Duke and Duchess and the house party from the Abbey had intimated their desire to hear the lectures and witness the manipulations with the bees. By the time the distinguished visitors had arrived at the tent the swarm had nicely settled on the branch of a lime tree about thirty yards away, and so, after explaining the position of affairs, it was suggested that the party should proceed to the spot and watch the hiving of a swarm. This was agreed to, and skep in hand Mr. Scattergood mounted a box and had soon successfully hived the swarm, amidst the applause of those present, numbering several hundreds. The bees were then thrown down in front of the frame-hive and soon ran in, thus affording a practical object-lesson in housing a swarm in a frame-hive, all of which details were explained to the company.

This is the first time that representatives of the Notts Bee-keepers' Association have been invited to take a part in the proceedings at this show, and judging from the large numbers gathered round the bee-tent at the three subsequent lectures much good and many new members must accrue—at least, we hope so.—(Communicated.)

Correspondence.

The Editors do not hold themselves responsible for the opinions expressed by correspondents. No notice will be taken of anonymous communications, and correspondents are requested to write on one side of the paper only and give their real names and addresses, not necessarily for publication, but as a guarantee of good faith. Illustrations should be drawn on separate pieces of paper. We do not undertake to return rejected communications.

** * In order to facilitate reference, Correspondents, when speaking of any letter or query previously inserted will oblige by mentioning the number of the letter, as well as the page on which it appears.*

SENDING BEES BY POST.

[2979.] My letter is suggested by Mr. Woodley's "Notes by the Way," p. 314, in this week's B.J. His paragraph about sending queen bees by post needs the serious consideration of the British Bee-keepers' Association. I do not know if it be the want of vigour in the B.B.K.A., but it does seem that

such a reasonable demand as transmitting queens by post would only need wise and persistent effort to bring about an alteration. Could the Editor say if anything has been done in approaching, in the last year or two, the Postmaster-General on the particular subject? If not, could not a deputation be appointed? Would a long list of signatures of bee-keepers in all parts of the country strengthen the hands of our representatives; or, failing this, could we not all write at the appointed time to the Postmaster-General? This would show we were keenly alive to the need of reform, and that bee-keepers were more intelligent than the authorities would otherwise allow. I have been given clearly to understand that at all post-offices the assistants are to refuse any live creature, and of course to reason of the harmlessness of the queen to the officials is out of the question when the orders to forbid are issued. A queen may be securely packed, and there be not the slightest risk of damage to officials or parcel. On what grounds is a queen refused? I have never been able to discover. Can any one tell?

While writing of what might be done I should like to join my voice with others in the urgent and persevering call for legislation upon "Foul Brood." This should come first, and be kept first, on our programme for reform. May I thank Mr. Woodley for his suggestion as to the "strainer cloth" being more quick in its action, and to say that I always use carbolic, and find it, for general purposes, the most comfortable and convenient administrator. The smoker is not so certain, and often needs another pair of hands when much over-hauling is to be done. May I give a suggestion I have found of great comfort this year. I came across a lavender bottle, tube-like in shape, about seven inches long and two inches in circumference. It had a cork with a leaden bolt and screw embedded. The little screw would be taken off and a tiny drop of lavender water could be shaken through upon the handkerchief. When I saw it I thought it would make an admirable little bottle to mix up carbolic and its quantity of water, and as it would screw on or off easily the same mixture would last for several days. So I lovingly pleaded for it, and won. It goes into the trousers pocket easily and one mixing would carry you through action with twenty stocks; but as that number would mean an exceptional quantity to deal with in one afternoon, the mixture will be just as strong, because screwed in, for a week afterwards. I spread the cloth out, and then, taking off the screw, shake out what is required, and re-adjusting the screw I put the little bottle in my pocket in safety and strength until further dosing is required. An appliance dealer might take this hint and incorporate it in his next year's catalogue. I would give one shilling for a similar bottle for the comfort it brings in manipulating.

With me the year has been abundant in swarms and in honey. Thank you, sir, for your

high moral tone on "Buying Honey for Showing" in last week's paper.—REV. GEORGE JARVIS, *Coleford, Glos.*

[If our rev. correspondent will refer to B.J. of April 1 last (p. 121), he will find an official statement of the "grounds" on which the transmission of live bees by post are refused.—EDS.]

"CAT'S CLAW HONEY" (?)

[2980.] In conversation with a gentleman recently returned from the neighbourhood of Colorado territory—where he has been many years—I learned from him that the honey which bees obtain from a particular wild shrub or low bush growing there called "Cat's Claw," has a very fine flavour indeed and fetches a good price, but it is not often or easily obtainable pure; that is to say, the honey is usually mixed with honey gathered from other sources. He tells me that when walking through bushes of this so-called "Cat's Claw," the scent is exactly like that which would be given off by deliciously ripe fruit, and the honey partakes of same character. Perhaps some correspondents of yours in the United States may be able to give further information hereon?—"T."

"CONDEMNED" BEES.

(Concluded from page 316.)

In the morning, when the sun had climbed a full mile—an Irish mile—into the sky, we dressed and hurried into the garden—where we found a pandemonium indeed. The stocks were killing all the bees we had introduced! There were heaps under the alighting boards, and, worse still, all those stocks that had had no bees joined to them were robbing one another in all directions. Never was such turmoil, such slaughter of the innocents. By evening every bee had been condemned, executed, and thrown outside the city gates, and again the garden was fertilised with the bones of busy bees. Again we felt broken bee merchants, forlorn and sad. All our labour was in vain. But as the years came and went, so we persevered, until we had mastered the problem of joining bees to bees. The solution of the problem is a simple one. You must make all the bees *homeless* waifs and strays. They will then unite and be as happy as doves, or as the days are long.

My experience teaches me that condemned bees are valuable for increase. If you can give them some frames of comb and honey, then feed gently for a time, they usually make splendid stocks. I would, however, urge that it is a mistake to join them to stocks that are in good heart, such as swarms of the current year and the stocks that gave these swarms. Rather join them to hives that have old failing queens, queenless colonies, or very late casts. I have half a dozen or more casts, which came off in June, in such excellent condition at the present time, that it would be

sheer madness to attempt to strengthen them with condemned bees. Again I would urge beginners, if not old hands, to leave condemned bees severely alone by daylight. They settle about everywhere, and thousands are lost. If you wish to join them to a hive, shake the bees off the frames into a skep just before dusk. Then at dusk throw these bees on to a board in front of the hive; previously opening the entrance full width or propping up the hive front, if possible. Sprinkle the bees a very little with flour, then, as they commence to run in, shake on to them the condemned bees; sprinkle as before and they will all run in together, without any bees flying and without any fighting. If you wish to form a new colony take a frame of comb and honey from several of your stocks that can spare them, or, failing these, fit up your hive with frames full of foundation and wired. Prop up the dummy so that bees can run under, but do not space the frames wider apart.

Open the entrance full width and lean a board or cloth up to it. Then go and fetch your bees and a good large cloth that will fall over the outside of hive on all sides (I use a dust-sheet, but don't mention this to the mater, please!). When nearly dark, or even after dark, uncover your skep or box and lift it gently on to the tops of frames. Now shake the bees out in the usual way on to the frames and immediately let your assistant throw the "dust-sheet" over so that it hangs completely over on all sides. An hour after put on the roof and in the morning take off the sheet and put on a calico quilt, &c. This is a much better plan than running them in through the entrance, for the latter is a tedious job, and often in cool evenings many bees are chilled or wet may come and drown a lot. The main thing is to get the cloth over the mass of bees before they have time to spread to the sides of hive.

Never examine the bees for several days after, *i.e.*, not till they have had a flight and marked their location. Never attempt to hive them or an ordinary swarm in this way in the day time but always after dark, and never feed swarms, or condemned, or any bees whilst in their travelling skeps or boxes. *Experientia docet.*—LORDSWOOD.

UNITING BEES.

[2981.] I am quite a novice in the art of bee-keeping, and after having read several of the best books on bees must confess that I cannot grasp their contents as to uniting stocks. The directions are, no doubt, plain enough to any one who has once seen the operation performed, but perhaps I am not the only novice who, living at a distance from some experienced bee-keeper, hesitates to do what seems so simple a matter to the initiated. My chief difficulty is this:—The directions say, "Put the frames in alternately." Now, when you

have a hive which only holds ten frames, it is evident that only five frames from each hive can be so placed. What is to be done with the remaining ten frames, which may be partly full of brood? Again, one writer says, "Place the frames at some distance apart, or so that they do not touch." It would be impossible to do this in a ten-frame hive if all ten frames were inserted. Would some reader of this be so kind as to put himself in the position of a novice, perhaps a stupid one, and give a description of the proceedings with as many details as possible.—C. H., *Skipton, Yorks, July 31.*

METEOROLOGICAL OBSERVATIONS

Taken at the Mid-Lothian Asylum, Rosslyn Castle, for week ending August 8.

Mean Height of Barometer	29.848
Mean Temperature	66°
Highest Point of Thermometer (2nd)	80°
Lowest do. (8th)	47°
Mean Dew Point of Temperature.....	61.4
Solar Radiation	100.6
Terrestrial Radiation	46.6
Rainfall in Three Days	1.06
General Direction of Wind	W.

H. MARRS.

(Above should have appeared in our last issue.)

Taken at the Mid-Lothian Asylum, Rosslyn Castle, for week ending August 15.

Mean Height of Barometer	29.755
Mean Temperature.....	63°
Highest Point of Thermometer (9th)	70°
Lowest do. (10th)	44°
Mean Dew Point of Temperature.....	56°
Solar Radiation	88.7
Terrestrial Radiation.....	42.4
Rainfall in Five Days	1.68
General Direction of Wind	S.W.

H. MARRS.

HONEY IMPORTS.

An account showing the value of honey imported into the United Kingdom during the month of July, 1897, £5,791.—From a return furnished to the BRITISH BEE JOURNAL by the Statistical Office, H.M. Customs.

HOMES OF THE HONEY BEE.

THE APIARIES OF OUR READERS.

Our illustration this week carries us to a Yorkshire apiary, that of Mr. Robt. Ness, and is situate at Sproxton Park, Helmsley. During the three years which have elapsed since Mr. Ness returned from Australia to take charge of his father's farm he has been actively interested in the bees, as shown by his taking a third-class certificate of the B.B.K.A., and, mainly by personal effort, estab-

lishing a prosperous and successful Bee Association for Helmsley and District, of which he is the Hon. Secretary and expert.

We asked for some particulars to go along with the picture, and, in response, Mr. Ness says :

"My present apiary was established by the purchase of three skeps of bees in March, 1894 (this was a recommencement of bee-keeping on returning home from Australia). Not caring for the skep system, I had three 'Wells' hives made ready to receive the swarms, which issued early in June. I put a swarm in one end of each of the three double hives ; twenty-one days later I transferred bees and best of the combs from the skeps into

front to back, there follows the three 'Wells' hives, after which are four of the 'Conqueror' pattern ; these answer fairly well, but are a nuisance in manipulating. Most of the older hives are made with a hinged alighting board, with an aperture cut through, $1\frac{1}{2}$ in. by 10 in., covered with perforated zinc for ventilation ; this board doubles up and fastens with a thumbscrew, and is a very handy arrangement when preparing for sending hives to the heather, as the bees can be fastened up in a moment. They are also ventilated for the moor journey through the floorboard. All my various patterns of hives take ten standard frames, with one exception ; but about one-half have the $15\frac{1}{2}$ in. top-bar, and the remainder



MR. ROBT. NESS'S APIARY, SPRINGTON PARK, HELMSLEY.

the empty compartments of the 'Wells' hives. In 1895 I increased to twelve stocks, and all wintered safe, again doubled the number of my colonies for 1896 by artificial swarming, driven stocks, and a few by purchase. The first four hives on left of the picture are Messrs. Lee's new 'Heather hives.' Next to these (in the corner) is a 'W.B.C.' hive, which I like best for all purposes ; then follow two of Lee's waterproof hives, which justify their title to the letter. Adjoining is a strong old-fashioned hive, made to take fourteen frames, which though in use about ten years, is as good as new owing to the roof being covered with zinc, and the hive having a coat of paint every year. After the small hive with roof sloping from

17 in I am gradually working round to the latter, or proper 'standard' size. My dog has 'got his eye' on the camera, no doubt wondering what it is ; but though a bit dubious about going near the hives, I wanted him in the picture, as on several occasions he has assisted me in hiving swarms, not always to his own comfort, and he now considers discretion the better part of valour. I need hardly say that the figure behind the hives is that of the owner of the apiary. This is in a very bleak situation ; so I built up a wind break on the west side, which protects the hives very much. The hives are at present not more than 15 in. apart, but they will be spread out to at least a yard this summer."

Queries and Replies.

[1800.] *Dividing Colony in a "Wells" Hive.*—You may remember my writing to tell you that I had a hive which became queenless six or eight weeks ago. There were no drones or drone cells in the hive at the time, but on examining the hive about fourteen days later, I found that a queen had been reared, and was evidently mated, for I saw an abundance of brood in the combs. To my surprise, there were also at least a hundred drones among the bees. 1. Will workers allow strange drones to establish themselves in the hive at such a time? Or, if not, how did the drones get there? The bees are now increasing quite fast, thirteen standard frames being fully occupied with brood and honey, and they are working well in a rack of twenty-one 1-lb. sections. 2. I lost two colonies of bees last spring, and wish to increase my stocks either this autumn or next spring; I should therefore like your advice on the following plan:—I propose to use my fifteen-frame hive on the "Wells" system by putting a queen-excluder in the centre and making another entrance into one compartment at the back. I would keep the queen now in the hive at one end, and introduce an Italian queen at the other end, and let them all work in one super next year. Has this been done, and, if so, was it a success? I also wish you would give me the name and address of the secretary of the (Glamorgan B.K.A.—A WORKING MAN, Cardiff (Glam.).

REPLY.—1. Whenever bees are raising queens in a hive they will welcome drones from whatever quarter the latter may come. The drones also are either attracted to or seek out such hives and take up their quarters therein. This is in fulfilment of a natural law easily understood. 2. We have not heard of the plan proposed being tried before, and although it looks simple and feasible on the face of it, we fear it won't work out so well as it looks on paper. In the first place, when dividing the combs between the two compartments of the "Wells" hive, it must be borne in mind (a) that in order to get the bees to accept a second queen, a solid dummy must divide the two lots; (b) that the flying bees of the back—or new entrance—compartment will nearly all enter by the *front* doorway, and so cause a considerable diminution in the number of adult bees in that compartment. This will need watching, and young bees should be given to the latter—if the brood is not well covered by bees—to prevent "chilling." It will be safer to try the plan this autumn than next spring. 3. Mr. E. Thornton, Bridgend, Glam., is Hon. Secretary of the Association named.

[1801.] *Spacing Frames at $\frac{1}{2}$ -in. Distance.*—Will you kindly reply in BEE JOURNAL, saying which is the correct way to work the

"W. B. C." hive? I take it that the hive is designed for those who prefer close spacing of frames which will allow ample room for dummy-board, and also that if frames are spaced at full distance of half an inch between combs, not more than nine frames should be used so as to allow room for the dummy board? I ask the latter question because of my supposing that the dummy-board should not be dispensed with in any hive; while if the hive be filled with ten frames it allows no space for manipulation. For clearness and brevity I therefore put my questions thus:—1. When ten frames are used in "W. B. C." hive, should they be placed $\frac{1}{2}$ -in. apart with dummy-board at side? 2. If frames are spaced at the usual distance of $\frac{1}{2}$ -in. apart, is it best to use only nine frames and dummy-board? 3. Should any hive be filled up with the whole ten frames, thus leaving no room to manipulate until a frame has been lifted out?—W. MORRIS, Bristol.

REPLY.—1. No. The frames are never spaced at the $\frac{1}{2}$ -in. distance, except for the purpose of preventing bees from building drone-comb in cases where a swarm is hived on "starters" only instead of full sheets of foundation. Even in the latter case the $\frac{1}{2}$ -in. distance is only retained until combs are fully built out with worker cells. This done, the "metal ends" are set at normal or $\frac{1}{2}$ -in. spacing. 2. In our own practice (*i.e.*, that of "W. B. C.") ten frames are used during the working season; the dummy occupying the space in rear between hive and outer case, until packing for winter. 3. The removal of the $\frac{1}{2}$ -in. strips of wood at *outsides* of frames on each side of hive gives all the lateral space needed for manipulation.

[1802.] *Re-queening in August.—Finding Queens on Combs.*—One of my hives was queenless about a fortnight ago, and I then inserted a frame containing eggs and brood from another colony. Queen-cells were at once commenced, and they are now hatching out; there were about a dozen cells formed on the single frame, and the bees have cast out several queens just in front of the hive. I saw one worker dragging a young queen out which was quite alive, but could scarcely stand up properly. 1. What does this show? 2. Is it not too late in season for queens to become fertilised? There are a few dozen drones in the hive. 3. Which is the best way to find the queen in a frame-hive? Does she usually run down to the bottom of the frame when raising one up? Although possessing eight or nine hives I have never been able to find the queen when I tried. I did, accidentally, see the queen once, and that when not looking for her.—H. F. MATTHEWS, Herts., August 6.

REPLY.—1. The casting out of a maimed and nearly killed queen is quite natural. 2. As there are still drones in the hive, it is more than probable that the young queen will be successfully mated. 3. The "best way"

is to stand by while a practical man shows you how the queen is found. She has, however, no set form of proceeding when being sought for. If combs are quietly and carefully raised, the queen will often proceed with her maternal duties without any running about at all. It is impossible to lay down rules for finding queens. Practice and a sharp eye teach how to do it readily; some, however, are much quicker than others at the task.

[1803.] *Transferring Bees to Frame Hives.*

—I am exceedingly obliged for your prompt answer in the B.B.J. to my questions, and venture to trespass once more upon your courtesy, as under: I have six well-filled primitive skeps of bees, and wish to transfer the occupants to frame-hives. Upon examination, looking far up into the hives, I find a large amount of brood, with little or no honey. Our season here has been rainy and dull. 1. Would you advise me to transfer these bees now, or in the autumn, or, perhaps, not until next spring? Our climate here is such that bees might easily be out flying until December, though I fancy what they would gather would be finished in early November. I have just sown a good bit of white clover for my bees, hoping to have a late harvest. 2. Is it necessary to feed the bees after being transferred? 3. In arranging a skep upon a board with "Porter Bee Escape" I found the following day that quantities of dead bees obstructed the passages, while apparently none had passed out. I used the board as it had been sent to me from the English makers, and am much disappointed at its failure. Can you explain the matter?—BURDETT MASON, *Basses Pyréennes, France, August 7.*

REPLY.—1. Judging by present conditions, as stated above, the present time would be best for transferring. It is most helpful to have "little or no honey" in combs when transferring from skeps to frame hives. We cannot, however, conceal from our correspondent that we strongly deprecate transferring combs unless they are fairly new and straight. Black, old, and crooked combs built in skeps are altogether unfit for tying into frames if comfort in handling is of any account. Besides, in these days of full sheets of foundation, we consider it far better to set the skeps above frame-hives, and let the bees work down into the latter in their own good time, *i.e.*, when breeding room is needed. 2. If—as it appears—food is not too plentiful in the district just now, feeding will help the bees very much. 3. The super-clearer, or "Porter Bee Escape" must have been faulty in construction to cause the trouble. There should be no difficulty in bees leaving supers if the escape is properly made and used.

[1804.] *Dividing Stocks of Bees in August.*

—On June 12 I had a very strong swarm, which I hived in a flat-topped skep, and let them remain on a stand, not having a frame-hive ready at the time. The bees very soon

filled the skep, and I then put another skep on the top of first one as a super, but without using any excluder zinc between. I examined them the other day and found the super filled with honey and a considerable quantity of brood. This gave me the idea of making two stocks from them, and the lower skep having the most brood, I removed it to a new stand, and put the upper one, or super, on the old stand. This being the present condition of the two portions of the divided colony, I ask, is it too late for whichever lot is without a queen to raise one? I think the queen is with the lower skep. Thanking you for all the information given in B.B.J.—F. B., *Canterbury, August 11.*

REPLY.—The chances are decidedly against a successful ending to your dividing operation. It is, of course, possible that a queen may be raised by the bees left on the old stand, and if there are flying drones left alive at her mating-time all may turn out well; but we doubt it. Anyway, the stock alluded to as a "super" should be examined to see if queen-cells are formed, and if these are seen, the chances of mating taken into account by observing if drones are flying. Finally, if a queen is hatched and turns out a drone-breeder, she should be destroyed, and the bees united to the skep from which they were removed.

[1805.] *Buying Second-hand Hives.*—I believe I have troubled you but once before during the many years I have taken your journal, from which I have derived very great help with my bees. I have, however, within the last few days purchased the whole outfit of a neighbour giving up bee-keeping, and the hives are in very dirty condition. There are only two stocks of bees, but things were left lying about in untidy fashion. The enclosed sample of comb was taken from a hive in which the bees either died or left entirely. There were no dead bees found in it; but you will notice there has been brood in the combs, which are now full of wax-moth. I did not like to just burn combs and use the other things without ascertaining, if possible, whether foul brood had been in the hive. I have never yet seen foul brood, and don't want to. Your opinion will be valued. The past history of the hive, however, I cannot say anything about.—H. G. R., *Street, Som.*

REPLY.—There is no sign of disease in comb sent, but it is only fit for burning. We also advise thorough disinfection of hives before using, and would either burn or well "bake" all quilts and loose things that have been in use. It is so desirable to keep foul brood away from places where it has so far never been seen that every precaution should be taken to avoid acquaintance with an insidious enemy, often introduced along with second-hand appliances sold by untidy and unsuccessful bee-keepers.

[1806.] *Curious Effect of Bee Stings.*—On July 23 one of my two hives sent off a swarm which I successfully hived. On the 29th I examined the parent hive and found several queen-cells, which I attempted to cut out to prevent a second swarm. The bees were, however, so vicious that I had to give up the task after receiving six or eight stings on my hands, which were rather painful at first, and then swelled very much. But the strangest part of the business was that before I could fix the hive and bees up a strange feeling came over me, and I had to go into the house, when I began to feel sick, and shortly afterwards vomited. This peculiar feeling went all over my body, and got up into my head; when it got to my head I was quite dazed, and became very faint. I was quite conscious, but it appeared to go dark, and I seemed to have no control over my hands, which kept jerking. I remained in this state for about fifteen minutes, I was then all right, only feeling a little dazed. On August 1st I had another swarm from the same hive, and when hiving I saw what seemed to be a virgin queen. I am feeding both swarms. The first swarm appears to be doing well, having plenty of brood on three combs. The second swarm is doing likewise, but I could not find queen, or see any signs of brood. Will you kindly say—1. Have you heard of a similar case through bee stings? 2. In cutting out queen-cells should I first brush all bees off? 3. Am I right in feeding the swarms to make them strong for wintering? 4. Should I put a comb of brood in hive with second swarm, as I fear the queen must be lost?—NOVICE, *Tottington, nr. Bury.*

REPLY.—1. Somewhat similar effects have been reported to us, but such cases are not at all common. Judging, however, from the details given above, we fear that our correspondent is too much given to knocking his bees about. There is no need at all for overhauling recently hived swarms, it being quite easy to see from the outside if bees are doing well, and a good bee-man always prefers to let well alone in this case. 2. Yes. 3. Quite right. 4. It will be less trouble to first examine the central combs of second swarm, when, if queen is all right, eggs and young larvae will be seen.

[1807.] *Using "Swarm-catchers."*—I bought a stock of bees last year—supposed to be in movable frame hive. On arrival I found honey running out at entrance, which latter was choked up with bees. The combs were also built into each other, and quite immovable, while some of the frames were close up together and others were askew. I first raked the entrance clear of bees and honey and then left the colony to pull themselves together during the summer, which they did. I put on a "swarm-catcher" (Taylor's) early in the summer, but failed to secure swarm, as the bees did not get up into box with frames in, which is supposed to secure the swarm. I thought they had swarmed on two occasions

when a big cluster of bees were found hanging under box. I therefore moved the "catcher" away, bees and all, and placed it at the entrance of another hive prepared for swarm, thinking I had my swarm all right, but queen evidently was not there on each occasion. The second time I moved then I examined the "catcher," turning it upside down to try and find queen, but failed to do so. I therefore ask:—1. Do you think the queen might have been deposed, as, owing to the "catcher" being in position for about eight weeks, and the old queen not having come off with a swarm, the queen excluder on "catcher" not allowing her to pass through or the virgin queen either to go on her mating trips? (Hence my doubt as to deposition of old queen in returning to or not leaving hive—and also a doubt, if such were the case of the young queen not being fertilised). 2. Would you re-queen on off-chance of the old stock being queenless? 3. Can I drive the bees out of the old box hive, as I wish to do away with same, and would Saturday afternoon be a good time? What would be the best thing to put over the frames to drive them into? I ask this because of having neighbours all round, and must regard their safety from stings! 4. As an alternative plan, could I remove stock and make a nucleus of flying bees by giving them a queen and a comb of brood from another hive? I might then feed them up, and next season place old stock over fitted frames, and let the bees work down into it.—H. S. L., *Ilford.*

REPLY.—1. We see no reason for supposing that there was any deposing of queen in the circumstances as detailed. But so far as the failure to secure the queen in "swarm-catcher," we suppose that the bees—after clustering in the catcher and being removed therein to a new hive—found themselves minus the queen, and consequently returned to the parent hive. Is this so? We ask because if the bees did not go back, but remained where put, the inference is that the queen was with the swarm. Your description does not make this point clear. 2. No. 3. We don't advise you trying to drive bees from fixed frames in a box under the circumstances stated. Our advice is to leave bees as they are till April next, then set the box of fixed frames above a properly-prepared frame hive, and let the bees work down into the latter. This will save time, trouble, and risk. 4. The proposed plan of forming a nucleus colony will not work at all.

EXCESSIVE SWARMING.

We are informed that Mr. John Rawlinson, of Wellknowe, Cartmel, Westmoreland, commenced the season with four hives, first of which swarmed May 20, the second on the 22nd, and the last on July 21. Besides the four original stocks he has now twenty additional hives, which have swarmed and reswarmed.

NOVELTIES FOR 1897.

THE JUBILEE HONEY JAR.

Mr. T. B. Blow of Welwyn, who is introducing this jar to the notice of bee-keepers, sends us the following particulars regarding it:—

"This glass jar has been designed for honey and fruit, in consequence of complaints that the old screw-cap jars leaked. By the use of this jar, with its simple cap, all trouble in the way of leakage is done away with. The neck is fitted with a rubber ring, and when the cap



is placed on this ring, the top part—fitted with a patent screw—is put on the top and then given a half turn; this pressing the cap on to rubber ring makes the bottle absolutely air and water tight. The jar also answers splendidly for fruit preserving, and the caps, being made of very hard metal, can be used over and over again without damage. This gives them a great advantage over the ordinary screw cap, which cannot generally be used a second time."

Bee Shows to Come.

August 19, 20, 21, at Barrow-in-Furness.—In connection with the Royal Lancashire Agricultural Society.

August 24 and 25, at Hastings.—Annual Show of the Kent and Sussex Bee-Keepers' Association in conjunction with the Sussex Agricultural Society.

August 25, at Fleetwood.—Honey Show, under the auspices of the Lancashire and Cheshire B.K.A., in conjunction with Floral and Horticultural Society.

August 28, at Fairfield, near Manchester.—Exhibition of Bees, Honey, &c., in connection with the Manchester and District Branch of the L. and C.B.K.A. For particulars apply F. H. Taylor, Local Hon. Sec., Birch Fold Cottage, Fallowfield, Manchester. **Entries close August 21.**

August 28, Corn Exchange, Biggar.—In connection with the Horticultural Society's Show. Annual Open Exhibition of Bees, Honey, Wax, &c. Prize list from W. Ormiston, Sec., Fernbank, Biggar, N.B.

September 1, at Hereford.—The Thirteenth Annual Show and Honey Fair of the Hereford B.K.A. will be held in the Butter Market, Hereford, as above, when consignments of honey for sale are solicited. Schedules from the Hon. Sec., Mr. A. Watkins, Imperial Mills, Hereford. **Entries close August 27.**

September 2, at Castle Douglas, N.B.—Annual show of the Galloway Horticultural and Honey Society. Open classes, with liberal prizes, for three 1-lb. jars extracted honey, and for three 1-lb. sections. Schedules from Thos. Myers, Hon. Sec., Gowandea, Castle Douglas. **Entries close August 31.**

September 4, at Bramhall Hall.—Lancashire and Cheshire B.K.A., in connection with Bramhall and Woodford Horticultural Society. Annual show of honey. Open to district and members of the L. and C. B. K. Association only. Schedules from Secretary, J. Bell, Davenport, Stockport.

September 8 and 9, at Derby.—Sixteenth Annual Show Derbyshire B.K.A., in connection with the Derbyshire Agricultural Society. Nineteen classes and over fifty prizes for bees, honey, and appliances. Schedules from F. Walker, Hon. Sec. D.B.K.A., Cattle Market, Derby. **Entries close August 31.**

September 25, in the Corn Exchange, Jedburgh.— Roxburghshire B.K.A. Annual Honey Show. Twenty-six classes for honey, wax, and sundries. **All open.** A single entry fee of 2s. covers all classes. Schedules from Thos. Clark, Pleasant Schoolhouse, Jedburgh, N.B. **Entries close September 21.**

Notices to Correspondents & Inquirers.

Letters or queries asking for addresses of manufacturers or correspondents, or where appliances can be purchased, or replies giving such information, can only be inserted as advertisements. The space devoted to letters, queries, and replies is meant for the general good of bee-keepers, and not for advertisements. We wish our Correspondents to bear in mind that, as it is necessary for us to go to press in advance of the date of issue, queries cannot always be replied to in the issue immediately following the receipt of their communications.

All queries forwarded will be attended to, and those only of personal interest will be answered in this column.

A. RAYNER (Colchester).—*Bees in a Railway Lamp.*—It is rarely safe to take as gospel statements made in popular and non-technical papers, so far as bees are concerned. We have readers at Nuneaton who might, perhaps, confirm or refute the statement made in cutting sent which declares that "the lamp that lights up the goods yard at Nuneaton Station (L. and N.W.R.)" has been occupied by a swarm of bees which retain possession, and, "although lit up at night, has become a veritable bee-hive."

G. CHEETHAM (Fife, N.B.).—*Queen Refusing to Leave with Swarm.*—Queens rarely show any objection to leave the hive along with a swarm unless—through some wing defect or other damage—she is unable to fly. It is not at all uncommon, moreover, for a queen to fall to the ground on attempting to take wing, and, in many cases of this kind, the queen gets lost while the swarm returns to the hive. The queen, of which mention is made in your letter, will need watching next year or some mishap like this may occur to her.

H. MARRS (Rosewell).—Much obliged for your favour, which you will see has been utilised in this week's issue.

THOS. G. B. (Milverton, Som.)—*Driving Bees*.—See reply to T. X. on page 320. But, so far as skeps being "free from brood" when driven, you cannot wait till breeding has ceased for the season and bees hatched out, seeing that it will be impossible to safely winter driven bees unless there is time to build out combs and seal over the winter stores before cold weather sets in.

C. HOWES (Bristol).—*Carniolan Queen-raisers*.—We have addressed your post-card as desired. The names of the two Carniolan queen-raisers referred to appear in B.J. of August 27 last year, and are as follows:—(1) Mr. R. Ruffly, Delamont, Jura Verneis, Switzerland; (2) M. Ambrosic, Moistrana, Carniola, Austria. Letters addressed to the latter should, if possible, be written in German. We cannot undertake translations from foreign languages (except French) in the absence abroad of our senior Editor.

EUSTACE (Co. Kildare).—*Dysentery Bees in August*.—The symptoms described are those of dysentery; but it is a most unusual thing to hear of this bee-trouble occurring in the month of August. It is essentially a winter and early spring malady, caused by ill-made or fermenting food, or by badly ventilated, damp hives. The remedy is a clean, warm hive, and good, wholesome food. In your case it needs to examine the hive interior, and judge if there is anything there to account for the abnormal condition of the bees.

C. R. W. (Folkestone).—*Removing Queens for Exhibition in Observatory Hives*.—In removing two combs for exhibition in observatory hive, your first care, of course, will be to pick out the comb on which the queen is found. Be careful, therefore, to open the hive and lift out combs as gently and with as little disturbance as possible, so as not to start either bees or queen "running," as the phrase goes. After securing the desired comb, select another thickly covered with bees; the more bees the better for a show, and for keeping the brood warm while away from the parent hive. Don't be alarmed at the excitement which will, no doubt, be seen at the old hive when the bees find out that their "mother" has been carried off; they will run about a good deal, but no further harm follows, and when the removed combs are returned, peace and contentment will be visible at once. Mind and push up frames before closing the hive down after removal, and, when returning, let the combs occupy their original positions with regard to the other frames.

NOVIS (Stockton-on-Tees).—Bad case of foul brood. We should not hesitate about prompt destruction of the stock.

J. T. WILSON (Carlisle).—*Preventing Swelling when Stung by Bees*.—There is no known remedy for preventing swelling when stung,

though the immediate application of an alkali, such as common washing-soda, will, in some cases, stop swelling. A little ammonia applied to the spot at once is also effective at times, especially if the rim of a key is pressed on the wound caused by the bee's sting.

F. B. (Canterbury).—*Dealing with Foul Brood*.—If the piece of new comb sent is from the skep in which the bees are working it is useless to let them remain as now, for there is unmistakable foul brood in two of the cells. The queen appears to be prolific, for there are eggs in every cell. When you say, "I am using the honey contained in the frames," are we to understand that the honey from the diseased hive is being used as bee-food? If so, it accounts for the diseased larvae. In any case, unless the bees in skep are a fairly strong lot, we would not attempt to build them up for winter, but, bearing in mind the six healthy stocks alongside, we would do away with the bees in skep altogether.

H. J. SKELDING (Glam.).—Heather, as sprig sent (*i.e.*, *Erica vulgaris*), is a good honey plant.

NOVICE (Rochester).—*Using Honey for Bee-food*.—Granulated sections must be melted in a vessel immersed in hot water, the wax being lifted off in a cake when cool. Honey thus dealt with requires diluting with hot water to the consistency of ordinary beesyrup for use as bee-food.

W. WESTLAKE (Glos.).—*Allowing Bees to Transfer Themselves*.—1. If the skep was strong in bees when placed above frame-hive and set on in good time, they would have taken possession of lower hive before the month of July. It is, however, no use trying that method of transferring with weak stocks not likely to swarm, or not needing additional breeding space in May or June. 2. See B. J. of July 22, p. 286, on "Swarm Catchers."

T. R. M. (Llandudno).—*Destroying a Vagrant Swarm*.—We can suggest no means of destroying the bees except by either closing up the crevices, by which they get under the lead-covered roof, or by using cyanide of potassium. The latter would be the more merciful course if the deadly fumes of the agent used can be got into the space where the bees are. Great care will, however, be needed in using so dangerous a poison.

J. V. (Collooney) asks: *Why are Virgin Swarms so called?*—In reply, we regard the term as somewhat of a misnomer, when applied as it usually is by bee-keepers; nor can we say how it first arose. Practically, a "virgin swarm" is one that issues from a swarm hived in the current year.

* * * We hope to get all overdue Letters and Queries in our next issue.

Editorial, Notices, &c.

SHALLOW FRAMES FOR EXTRACTING.

It would appear that some little uncertainty exists on a question which has just been put to us by a correspondent who asks: "To whom must be credited the introduction of the shallow-frame now so popular in working for extracted honey?" And it is not quite easy to reply thus: "Well, we consider that *we* have had some share in the matter." In view, therefore, of removing anything which may savour of egotism or contentious argument, we have thought it well to reprint an article penned by the writer some eleven years ago, which appeared in our monthly, the RECORD, of February, 1886, which will serve the purpose of reply, and may also possess some interest at the present day. It reads as follows:—

"There seems to be a very general inclination just now on the part of those who keep bees more or less for profit, to favour a system of working for extracted honey in preference to that where the produce is intended to be sold in the comb. A good many reasons have contributed to bring about this feeling, but no doubt the low price obtainable for fine comb honey and the difficulty of finding a market for it last season have been the main causes of complaint. Sections (if they are to be secured in fine condition and quality) are not easily got; a good deal of care and trouble is involved in their production, and when the bee-keeper, after all his expenditure of time and labour, is offered perhaps less than one half the price he counted on, he is apt to feel discouraged, and inclined to cast about for a remedy for what is to him a very unsatisfactory state of things. We have been brought into communication in various ways with a goodly number of bee-keepers, and there seems to be but one opinion as to the way in which an improvement can be effected. In other words, they are 'going in for *extracting*,' either wholly or as nearly so as to make comb honey a very minor point with them. This being so, it behoves us to follow the bent of public opinion, and, although it may be thought early in the season to give advice now, we deem it useful to say a few words to those who are already maturing their plans for another year. The main point for consideration being the very perceptible fall in the value of British honey, experienced in the autumn of 1885, it becomes necessary to consider by what means the largest amount of the product may be obtained at the smallest outlay of time and money, in order to secure such an equivalent in quantity as will counterbalance lower prices.

"The method of working for extracted honey

has already been treated of in our volume for 1885, and we hope at a more seasonable time to recur to it again. We shall, therefore, at present confine our remarks to the preparations needful for the forthcoming campaign. There are many necessities to provide, and it is important that all appliances, whether made at home or purchased, should be of the right kind and most likely to serve the purpose for which they are intended. With regard to these appliances, and the method of working with them, there will always be differences of opinion even among men equally experienced, as to the best means of bringing about the desired result, whichever system may be adopted. The honey producing capabilities of certain localities, the amount of spare time at the disposal of the bee-keeper, together with other minor details of management, have a deal to do with what each one may consider of importance in the method of working, and so, while describing our individual preferences, we leave it to our readers to adopt such hints as they may think most suited to their surroundings. There is now less need than formerly to dilate on the many evils which resulted from the extracting system when carelessly or injudiciously carried out. Among these evils, none were more disastrous than the mischief done to brood by extracting from combs containing quantities of larvæ in all stages of growth. It is now generally admitted that no combs with brood—sealed or unsealed—should ever be placed in the extractor, and if this precaution is carefully observed—as we have all along contended it should be, extracting will be more in favour in the future than it has been in the past.

"We do not purpose considering here which is the best form of hive for honey producing, and by no means wish to 'fix' our readers to any particular hive. Good hives are plentiful enough in all conscience, and there are scores of makers whose productions are all excellent in their way, but, while we agree with many of the advantages claimed for the Standard frame, it is, in our opinion, a mistake to 'tier up' with a second hive of equal capacity to that which holds the stock. It may be very well in some districts, or in exceptionally good seasons to do so, but as a rule it would never do with us, and we consider our apiary fully up to the average in point of situation. We want to give additional room as early in the season as it is required, but by no means desire so great an enlargement of our hive's capacity at one time as an addition of say ten or eleven Standard frames give.

"The main point in favour of the well-known and celebrated 'Stewarton' hive, and that which contributed so much to its deserved popularity in bygone times was its success as a 'tiering up' hive; its 6 in. body boxes and 4 in. honey boxes were just the sort of addition to make on the storifying principle. Each box was usually found 'full up' with either brood or honey—as the case might be—and

not that half and half of each so often seen on deeper frames of comb. But for its octagonal shape and the immobility of the combs, we twenty years ago considered it the best hive out for successful bee work, and we have ever since favoured a shallow frame, for both stock hives and tiering boxes. Our present purpose, however, is to treat of the hives most in use, viz. :—those containing the ordinary standard frame, and we advise that they be ‘tiered up’ with boxes, 6 in. deep, made to hold nine or ten frames $5\frac{1}{2}$ in. deep, and of the same length as the standard frame. Each of these will—when well filled—hold 35 lb. to 40 lb. of honey; quite enough storage room to give at one time in the best of seasons, and certainly enough to hold the whole surplus from one hive in a poor one.

“To work successfully by the ‘extracting’ method, a good supply of surplus combs or frames will be required, and there is no reason why these should not be of the most convenient size for ‘tiering up’ with, and kept solely for that special purpose. Nor do we see how there can be any great objection to their use for *that* purpose even by those who consider the standard frame the most suitable for the brood nest.

“Our point is this :—Judging from the signs of the times, it may be assumed that by far the greater portion of our surplus honey will, in the future, be got by tiering or ‘storifying,’ and we are quite sure that any bee-keeper (who knew what he was about) having his choice between a box of combs $5\frac{1}{2}$ in. deep, and a similar box in which they were $8\frac{1}{2}$ in. deep, would unhesitatingly choose the former for tiering up with. Having used these shallow frames many years for storing surplus honey intended for slinging, we greatly prefer them to deeper ones. The combs are not so easily fractured in the extractor; they are more quickly sealed over by the bees; more readily uncapped; we get our frames more solidly filled with honey; and by the judicious use of foundation we get at least 80 per cent. of them worked with comb down to, and all along the bottom bar. Other obvious advantages will suggest themselves to the bee-keeper without our specifying them in detail. If standard frames be purchased in the flat, they are readily reduced to our ideal of a ‘tiering’ frame by sawing off 3 in. of the side-bars before nailing up.

“Another point we would emphasise, and that is the imperative need for the use of excluder zinc when tiering. Many object to this because it hinders a free passage to and fro on the part of the bees, but after testing hives side by side, with and without zinc, we find the difference in the amount of honey gathered to be infinitesimal. Now, if the expenditure of time and labour is to be minimised, we must keep our surplus boxes free from brood—we don’t want to be ‘always anxious’ as to whether the queen has got into them or not—and as to queens pushing their way through

the zinc, the chances, according to our personal experience, are so much against it, that we never give a thought to such a contingency. At all events, we can safely say that not 5 per cent. of ordinary normal queens will deposit brood in surplus boxes if zinc be used.

“It is certain that extracted honey in bulk is in a commercial sense a more valuable commodity to have left on hand, than that which is stored in the comb; indeed, we may say the latter is almost unsaleable—after it has crystallised or become solid—unless we go to the trouble of melting it down and extracting the wax from it. Those who have a quantity of each kind by them, will readily realise the difference. The bee-keeper can keep his extracted honey till prices improve; it may be in good demand before the present year is out, at a much higher figure than it would fetch if sold now, and it will take no harm by keeping providing it was fully ripe when extracted.

“One of the advantages of ‘tiering’ with shallow-frames is their suitability for regulating the amount of storage room as the honey income fluctuates. It’s an exceptionally poor season in which we cannot secure one box of fully sealed combs, and if, after adding a second box under the first, the income suddenly fails, leaving the latter only partly filled, the contents may be extracted or left for the bees’ own consumption at the pleasure of the bee-keeper, while the first box is found in prime condition. Since it is of importance to economise time and labour in every possible direction to enable us to produce our honey cheaply, we do not advocate the constant or even frequent use of the extractor in the height of the working season. It’s hard work, and a July temperature, coupled with the excitement inseparable from it, makes it *hot* work, while the evils resulting from a rough and tumble method of doing it may be better imagined than described. Besides, if surplus honey is safe (that is, if it is sealed over) it is far best left in that finest of all places for ripening it, *i.e.*, the top of the hive where it has been gathered. As the season closes, these boxes full of ripe honey can be taken indoors to be extracted *en bloc* or as required. We used to think that honey would not pay the producer if sold for less than 1s. per lb., and the only way to make it remunerative at present prices is to reduce in every possible way the labour and cost of securing it.”

SHROPSHIRE B.K.A.

ANNUAL SHOW AT SHREWSBURY.

The above Association’s annual show and honey fair was held, as usual, in connection with the Shropshire Horticultural Society’s Fête in the famous “Quarry” at Shrewsbury on August 18 and 19, and was in every respect a conspicuous success. In view of the Jubilee year the co-operation of the Royal Horticultural Society was secured, and as a result a

considerable amount of interest was displayed in the event by leading horticulturists of the kingdom. It was also gratifying to those whose special interest centred in the bee and honey section of the show to see a display worthy of the occasion, for certainly it is a question if so large or fine an exhibition of bee-produce has been seen this year.

The entries reached the high figure of 258, and bearing in mind the fact that in the principal classes, both for comb and extracted honey, each entry requires twenty-four sections, or 24 lb. of extracted honey—instead of the usual 12 lb.—together with seven excellent exhibits in the trophy class, the total weight of honey staged must have weighed tons. Consequently, the labour of judging was no small one.

With so many samples of high excellence to deal with, it is impossible in our limited space to say more than that the winning exhibits (and not a few of the non-winners) were very fine indeed. This was especially the case with the extracted honey classes, which involved so much labour in making the awards that the Rev. Mr. Evans assisted his colleague in completing his heavy task. It is little less than a marvel to us, how so large an amount of interest is maintained in this show by members of the association and by leading exhibitors outside the county. It speaks volumes for the "management" which can succeed in bringing together so excellent a display as the one in question, because the prizes are not large. Anyway, every one must congratulate the active members of the executive committee (with the indefatigable hon. sec. and treasurer, Miss M. Eyton, at their head) who take upon themselves so large a share of the arduous work involved, and it must be a source of satisfaction to them when their labours are, as in this case, rewarded by complete all-round success.

The judges were Mr. W. Broughton Carr, the Rev. T. J. Evans, Tarvin Vicarage, and Mr. P. Scattergood, jun., Stapleford, Notts. The first-named taking the classes for appliances and the various miscellaneous classes, while Mr. Evans judged the honey in comb, and Mr. Scattergood the extracted honey. All three gentlemen taking the trophy classes. The following awards were made:—

HONEY CLASSES (OPEN).

Twenty-four 1-lb. Sections.—1st, S. Cartwright, Shrewsbury; 2nd, T. R. Horton, Much Wenlock; h.c., Phil Jones.

Twelve 1-lb. Sections.—1st, A. Hamer, Llanarthney; 2nd, M. Meadham, Hereford; h.c., Phil Jones.

Twenty-four 1-lb. Jars Extracted Honey.—1st, W. Crellin, Barnston; 2nd, R. Dodd, Tarpoley; 3rd, A. Burton, Barnston; 4th, T. J. Tetley-Nickels, Day House, Shrewsbury.

Twelve 1-lb. Jars Extracted Honey.—1st, S. Cartwright; 2nd, A. Burton; 3rd, Rev. E. Hutton; 4th, W. Crellin; h.c., B. Thomas

(3rd and 4th in above two classes were given as extra prizes).

Twenty-four 1-lb. Jars Granulated Honey.—1st, F. W. Morris.

Collection of Extracted Honey from Various Sources (named).—1st, A. Beale; 2nd, A. W. Rollins; h.c., J. Bradley.

(MEMBERS ONLY.)

Twenty-four 1-lb. Sections.—1st, P. Jones; 2nd, S. Cartwright, h.c., T. R. Horton.

Twelve 1-lb. Sections.—1st, S. Cartwright; 2nd, A. Hamer; h.c., T. R. Horton.

Single 1-lb. Section.—1st, S. Cartwright; 2nd, T. R. Horton.

Twenty-four 1-lb. Jars Extracted Honey.—1st, S. Cartwright; 2nd, Jno. Palmer, Ludlow; 3rd, G. Croxton; 4th, P. Jones.

Twelve 1-lb. Jars Extracted Honey.—1st, S. Cartwright; 2nd, T. J. Nickels; 3rd, Miss Bullock; 4th, B. G. Brocklehurst; h.c., J. Hammonds; c., P. Graham (3rd and 4th in above two classes are extra prizes).

Twenty-four 1-lb. Jars Dark Honey.—1st, J. Palmer; 2nd, B. G. Brocklehurst; h.c., E. Oakes; c., Mr. Clark.

ARTISANS' CLASSES.

Twenty-four 1-lb. Sections.—1st, P. Jones; 2nd, T. Pritchard; h.c., G. Cliff and J. T. Croxton.

Twelve 1-lb. Sections.—1st, V. Graham; 2nd, T. Pritchard; h.c., M. Price.

Twenty-four 1-lb. Jars Extracted Honey.—1st, J. Hammonds; 2nd, J. Shuker; 3rd, P. Jones; 4th, Mr. Morris, h.c., V. Graham (3rd and 4th are extra prizes).

Super of Comb Honey.—1st, R. Hill; 2nd, Mr. Oakes, jun.

COTTAGERS ONLY.

Twelve 1-lb. Sections.—1st, J. T. Croxton; 2nd, Mr. Gough.

Twelve 1-lb. Jars Extracted Honey.—1st, J. T. Croxton; 2nd, J. Carver; 3rd, Mr. Lewis; h.c., Mr. Blower. (Third extra prize).

Six 1-lb. Sections.—1st, J. T. Croxton; 2nd, G. Croxton; h.c., Jno. Jones.

Six 1-lb. Jars Extracted Honey.—1st, J. Carver; 2nd, Mr. Gough; 3rd, Mr. Blower.

Honey Cake.—1st, Mrs. G. Lloyd.

Single 1-lb. Jar Extracted Honey.—1st, G. Croxton; 2nd, Mr. Blower; h.c., Mr. Lewis.

Single 1-lb. Section.—1st, G. Croxton; 2nd, J. Hammonds.

Honey Trophy (open).—1st, W. P. Meadows; 2nd, J. Tetley-Nickels; 3rd, A. W. Rollins; h.c., A. Beale and A. Bradley; c., T. Pritchard, and A. Hamer.

HIVES AND APPLIANCES (OPEN).

Collection of Appliances.—1st, Jas. Lee & Son, Holborn, London. (Extra prizes were given by the Hon. Sec. to Messrs. Meadows and Varty, whose respective collections could not be judged owing to an informality in entry).

Frame Hive (price not over 15s.).—1st

T. Lanaway & Son, Redhill; 2nd, W. P. Meadows; v.h.c., Jas. Lee & Son.

Frame Hive (price not limited).—1st, Jas. Lee & Son; 2nd, W. P. Meadows; h.c., T. Lanaway & Son.

MISCELLANEOUS CLASSES (OPEN).

Mead.—1st, W. H. Seymour, Henley-on-Thames; h.c., A. Hamer.

Honey Vinegar.—1st, H. W. Seymour; h.c., Mrs. Bullock.

Fruit Preserved in Honey.—1st, Mrs. G. Lloyd.

Beeswax.—1st, J. Carver; v.h.c., V. Graham; h.c., E. Oakes; c., A. Beale.

Collection of Bee Flowers.—1st, J. Bradley; 2nd, G. Lloyd; 3rd, A. Beale; h.c., R. Hill.

Observatory Hive with Bees (Salop only).—1st, R. A. Price; 2nd, R. Hill.

The prizes were distributed at the close of show by Lady Ashburnham.

STAFFORDSHIRE B.K.A.

ANNUAL SHOW AT BURTON-ON-TRENT.

The annual show of the S.B.K.A. was held at Burton-on-Trent, in conjunction with the Staffs. Agricultural Society's meeting, on August 10 and 11. The present honey season in the county of Staffs., unlike that of 1896, has been an excellent one for bees, and this was reflected in the very creditable display made by the S.B.K.A. of honey exhibited in the various attractive forms known to the modern bee-keeper.

With respect to honeycomb in sections, a rule of the Association states that the paper-lace edging shall not exceed three-eighths of an inch in breadth over surface of the comb used in glazing sections. The infringement of this rule led to the disqualification of one or two of the exhibits in every class for comb-honey. This was notably the case in Class 1, for displays of honey in any form, where a very fine collection of 100 sections exhibited by Mr. W. Ford would undoubtedly have taken the first prize but for a disregard of this rule. The other entries in this class were very good, and the well-known names of W. Williams, J. R. Critchlow, and E. Clowes were to the fore in the order named. The first prize was a gold medal given by Lady Burton. The class for 12 1-lb. sections of comb-honey was a very good one. The class for 12 1-lb. jars extracted honey was also a very excellent and large one. The prizes offered to labourers do not seem to be appreciated by those for whom they are intended, the class for sections attracting no entries. There were some excellent exhibits in the class for three frames comb-honey. One of the best entries in the class, that of Mr. H. Wilks, was, however, passed over by the judges for having cotton-wool placed along the bottom of the frames. The class for bees in

observatory hives attracted a good entry. In the classes open for 12 1-lb. sections and 12 1-lb. jars extracted honey some of the entries were of exceptional merit. The collections of hives and appliances were very interesting, all being good, the first prize one especially so. Mr. Cock gave lectures on bee-keeping in the bee-tent, the show and the lectures being well attended.

The Rev. J. F. Buckler, Bidston Rectory, and Mr. W. Lees M'Clure, Lytham, judged the exhibits, and made the following awards:—

Honey in any form, not exceeding 100 lb.—1, W. Williams, Lichfield; 2, J. R. Critchlow, Maer Farm, Newcastle; 3, Elihu Clowes, Blackbrook; 4, J. Beach, Burntwood, Lichfield.

Twelve 1-lb. Sections.—1, P. H. Rawson, Market Drayton; 2, J. Stone, Cubly, Sudbury; 3, A. W. Rollins, Stourbridge; 4, J. R. Critchlow; h.c., Miss F. E. Smith, Lichfield.

Six 1-lb. Sections.—1, P. H. Rawson; 2, A. W. Rollins; 3, Miss F. E. Smith.

Twelve 1-lb. Jars Extracted Honey.—1, P. H. Rawson; 2, E. Clowes; 3, W. Ford, Wolverhampton; 4, J. R. Critchlow; h.c., S. B. Fox, Maer, and W. H. Scarlett, Stafford; c., F. Bridgett, Cheadle.

Twelve 1-lb. Jars Dark Honey.—1, J. R. Critchlow; 2, F. J. Hall, Lichfield; 3, Miss M. J. Fox, Maer.

Six 1-lb. Jars Granulated Honey.—1, F. Harper, Uttoxeter; 2, Mrs. R. P. Cooper, Lichfield; 3, J. R. Critchlow.

Three Frames of Comb Honey.—1, E. Clowes; 2, A. W. Rollins; 3, J. Wallis, Keele Hall Gardens; h.c., J. R. Critchlow.

Twelve 1-lb. Jars Extracted Honey.—1, G. F. Dale, Little Haywood, Stafford; 2, F. Bridgett; 3, C. Sharman, Fradley, near Lichfield.

Six 1-lb. Jars Extracted Honey.—1, G. F. Dale; 2, F. Bridgett; 3, C. Sharman.

OPEN CLASSES.

Twelve 1-lb. Sections.—1, W. H. Woods, Hemingford Grey; 2, H. W. Seymour, Henley-on-Thames; 3, J. and W. Herrod, Sutton-on-Trent; h.c., Mrs. Salt, Stafford, and J. R. Critchlow; c., Miss Ada Bostock, Colwyn Bay.

Twelve 1-lb. Jars Extracted Honey.—1, W. H. Woods; 2, S. Cartwright, Shawbury, Shrewsbury; 3, B. Thomas, Market Drayton; h.c., W. H. Scarlett.

Observatory Hive.—1, A. W. Rollins; 2, G. F. Dale; 3, J. R. Critchlow; c., J. Beach.

Beeswax.—1, J. Stone; 2, J. R. Critchlow; 3, A. W. Rollins; h.c., S. B. Fox.

Single 1-lb. Section and Glass Jar.—1, J. R. Critchlow; 2, E. Clowes; 3, Miss M. J. Fox; h.c., G. H. Varty, Etwahl, Derby.

Hives and Appliances.—1, G. H. Varty; 2, Thomson & Co., Birmingham; h.c., T. Walmsley, jun., Lichfield. —(Communicated.)

GLOUCESTER B.K.A.

The above Association held their show in connection with that of the Gloucester Agricultural Society on the 27th, 28th, and 29th ult., when an excellent display of honey was staged, the entries numbering about eighty. There were in the show two noteworthy devices worked out in honey-comb by Mr.

Twelve 1-lb. Sections.—1st, R. C. Salmon; 2nd, John Butler, Newbury; 3rd, R. J. Morse.

Twelve 1-lb. Jars Extracted Honey.—1st, R. C. Salmon; 2nd, H. Rhys, Redbrook-on-Wye; 3rd, E. Witchell, Quedgeley.

Six 1-lb. Sections.—1st, James Butler; 2nd, John Playsted, Newnham; 3rd, R. C. Salmon.

COUNTY HONEY TROPHIES AT "ROYAL" SHOW, 1897. (No. 3.)

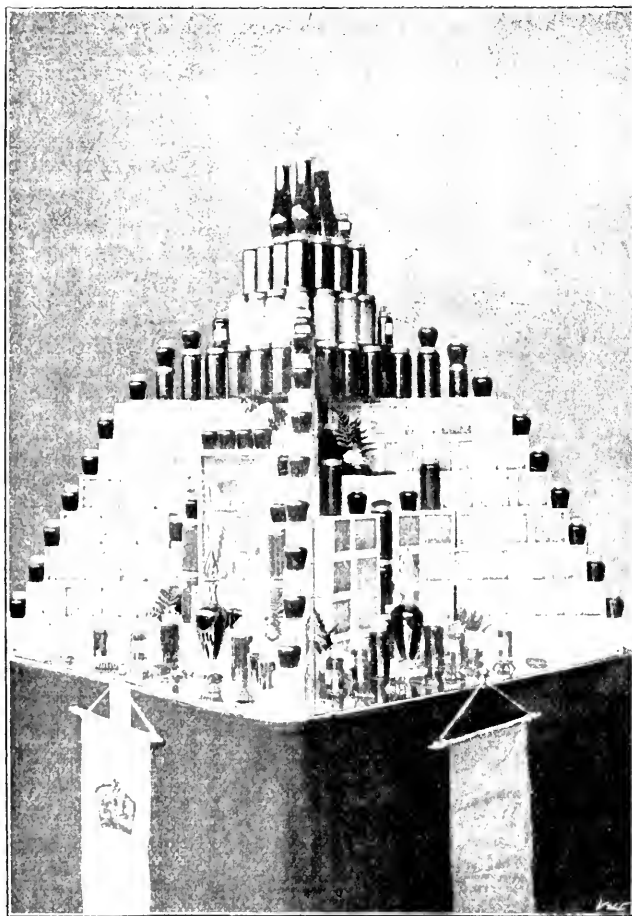

THIRD PRIZE, BERKSHIRE B.K.A.

R. J. Morse, Hardwicke, and Mr. A. J. Brown, Wotton-under-Edge.

Mr. J. Hutchinson, of The Poole, Hereford, judged the exhibits, and made the following awards:—

Best and Most Attractive Display of Honey.
—1st, R. J. Morse, Hardwicke; 2nd, R. C. Salmon, Hardwicke.

Six 1-lb. Jars Extracted Honey.—1st, H. Rhys; 2nd, R. Hamlyn-Harris, Hambrook, Bristol; 3rd, R. C. Salmon.

Super of Comb Honey.—1st, A. J. Brown, Wotton-under-Edge.

Three Frames of Honey.—1st, Mrs. Coombs, Gloucester; 2nd, R. J. Morse; 3rd, George Hunt, Chaxhill.

Single 1-lb. Jar Extracted Honey.—1st, R. J. Morse; 2nd, Mrs. Jane Till, Wotton-under-Edge; 3rd, H. Rhys.

Six 1-lb. Sections.—1st, G. Hunt; 2nd, A. Jones, Gloucester; 3rd, Mrs. Hewlett, Barnwood.

Six 1-lb. Jars Extracted Honey.—1st, R. J. Morse; 3rd, G. Hunt. No second awarded.—(Communicated.)

BEE AND HONEY SHOW IN DORSET.

The Yetminster County Council District Beekeepers' Association held their fifth annual show of bees and honey on Thursday, August 12, at Bradford Abbas, on the Vicarage lawn (by kind permission of the Rev. Gordon Wickham).

The committee are to be congratulated on the success which attended their efforts, the exhibits, in quality and number, far exceeding those of previous years. About 700 lb. of honey were shown in the nine classes, and the judges (S. Smith, Esq., of Charlton Horethorne, and the Rev. F. W. Crick, of Little Cheney) had some difficulty in arriving at their decisions, so keen was the competition.

AWARDS.

Standard Size-Frame of Honey.—1st, Rev. Gordon Wickham, Bradford Abbas; 2nd, T. Gabe, Thornford; 3rd, G. Leeding, Bradford Abbas; 4th, T. Groves, Chetnole.

Shallow-Frame of Honey.—1st, J. Andrews, Thornford; 2nd, J. Lang, Bradford Abbas; 3rd, T. Gabe; 4th, T. Groves.

Four 1-lb. Sections.—1st, F. Trott, Leigh; 2nd, T. Gabe; 3rd, Miss Ffooks, Leigh; 4th, Rev. G. Wickham.

Bell Glass (over 10 lbs.).—1st, Rev. G. Wickham; 2nd, W. Lang, Bradford Abbas; 3rd, J. Lang.

Bell Glass (under 10 lbs.).—1st, G. Leeding; 2nd, J. Andrews; 3rd, Rev. G. Wickham.

Four 1-lb. Jars Extracted Honey (Dark).—1st, Rev. G. Wickham, 2nd, W. Lang, 3rd, J. Lang; 4th, C. Smith, Bradford Abbas.

Four 1-lb. Jars Extracted Honey (Light).—1st, W. Lang; 2nd, C. Smith; 3rd, E. T. Caines, Leigh; 4th, J. Lang.

Bees Wax.—1st, G. Leeding; 2nd, F. Trott; 3rd, J. Lang; 4th, T. Groves.

Collection of Honey and Wax.—1st, G. Leeding; 2nd, J. Andrews; 3rd, F. Trott; 4th, W. Lang.

Bedding-Contest.—1st, G. Leeding; 2nd, T. Hitchcock.

A number of bee-appliances were shown (not for competition) by Messrs. J. B. Pether & Son, of Yeovil.

The exhibition was well attended during the afternoon and evening, considerable interest being taken in the bee demonstrations carried out under the direction of Mr. H. M. Tilley (Lecturer and Instructor appointed by the Dorset County Council).

The prizes were presented by Mrs. Goodden, wife of Colonel Goodden, President of the Association.

The flowers for the occasion were kindly lent by Mrs. Clayton.—(Communicated.)

SOUTH OF SCOTLAND B.K.A.

ANNUAL SHOW AT DUMFRIES.

Under the auspices of the South of Scotland B.K.A. the annual show of honey was held at Castledykes Park on August 13 and 14. The exhibits occupied a prominent place in the marquee, and along with the horticultural display made up an attractive show.

The comb honey is hardly up to last year's standard of excellence; supers, on the other hand, show well, while the honey is excellent. Altogether, the show is superior to the display a year ago, both in regard to numbers and quality.

The silver cup presented by Mr. Wm. Wilson for two 1-lb. bottles extracted honey was awarded to Mr. James Kerr, secretary of the Association. The cup requires to be won three times before it becomes the property of any competitor.

These excellent displays should act as a stimulus in extending the cultivation of bees and making the pursuit more popular.

Mr. Thos. Tennant was appointed judge of the honey section, and Mr. James Kerr, the secretary, is to be congratulated on having got together such a good all-round display. The following is the prize list:—

Three 1-lb. Jars Extracted Honey (open class).—1st, J. Sopp, Wallingford; 2nd, John Ross, Dumfries; 3rd, R. M'Naught, Burnhead, Auldirth.

Three 1-lb. Sections.—1st, J. M'Donald, Lochrutton; 2nd, J. Ross; 3rd, John White, Toddington; v.h.c., K. R. Horton, Much Wenlock, Salop.

Super of Honey (Scotland only).—1st, J. M'Donald; 2nd, M'Vie & Fraser, Dumfries.

Glass Super of Honey.—1st, J. Richardson, Trailflat; 2nd, T. Hyslop, Auldirth; 3rd, R. Grierson, Lochrutton.

Six 1-lb. Sections.—1st, J. Ross; 2nd, M'Vie & Fraser.

Six 2-lb. Sections.—1st, M'Vie & Fraser; 2nd, J. Richardson.

Three 2-lb. Sections.—1st, J. Richardson; 2nd, M'Vie & Fraser.

Six 1-lb. Jars Extracted Honey.—1st, J. Ross; 2nd, R. M'Naught.

Two 1-lb. Jars Extracted Honey.—1st, Jas. Kerr, Dumfries; 2nd, J. Ross.

Six 1-lb. Sections (members owning not more than six hives)—1st, J. Kerr; 2nd, Henderson & Brown, Dumfries.

Three 2-lb. Sections.—1st, Henderson & Brown; 2nd, M'Vie & Fraser.

Super (over 10 lb.).—1st, Peter Jeffrey, Dumfries; 2nd, M'Vie & Fraser.

Super (under 10 lb.)—1st, J. McDonald; 2nd, J. Kerr.

Six 1-lb. Jars Extracted Honey.—1st, Peter Jeffrey; 2nd, J. T. Hyslop.—(Communicated).

SCOTTISH B.K.A.

ANNUAL MEETING.

At the annual meeting of the S.B.K.A., held in M'Innes' Hotel, Hutcheson-street, Glasgow, there was a fair attendance of members, and Mr. James Johnstone, Touch, Stirling, was called to the chair. The hon. secretary, the Rev. Robert McClelland, The Manse, Inchinnan, Renfrew, read the annual report, which stated that the resuscitated society was making slow but steady progress. There were about seventy members on the roll, with three affiliated societies, making in all about 120. The financial statement was most satisfactory, the subscriptions from individual members averaging between 5s. and 6s. each. It was obvious that if all Scottish bee-keepers now rallied round this useful institution its success was assured. It was agreed to use every endeavour to have a honey show, either in connection with the Royal Caledonian Horticultural Society or the Chrysanthemum Show in Edinburgh.—(Communicated).

Correspondence.

The Editors do not hold themselves responsible for the opinions expressed by correspondents. No notice will be taken of anonymous communications, and correspondents are requested to write on one side of the paper only and give their real names and addresses, not necessarily for publication, but as a guarantee of good faith. Illustrations should be drawn on separate pieces of paper. We do not undertake to return rejected communications.

. *In order to facilitate reference, Correspondents, when speaking of any letter or query previously inserted will oblige by mentioning the number of the letter, as well as the page on which it appears.*

HOW FOUL BROOD IS SPREAD.

[2982] The BEE JOURNAL of the 12th inst. contained a letter on "How Foul Brood is Spread" (2978, p. 317). The method described in it was the robbing of diseased stocks. Here is another:—A advertises for guaranteed healthy bees. B replies stating that his bees are strong and healthy. The bargain is struck. The bees are in due time received and examined. What is the result? The stocks are found to be very badly diseased. On complaint being made, B denies all knowledge of the existence of the disease and directs the destruction of the stocks. A bonfire worthy of Jubilee Day immediately follows! Fortunately in this case the receiver of the bees had sufficient knowledge to detect the disease, but, had it been otherwise, the results might have been—possibly are—disastrous.

A's advice to his brother bee-keepers is to

buy only from recognised and trustworthy dealers, and to avoid second-hand hives. "A" will be—**WARY FOR THE FUTURE**, *Chester*, Aug. 21.

DEQUEENING HIVES, &c.

[2983.] Under the above heading I noticed a question in query column of BEE JOURNAL (1794, p. 309), whether the expert was right or not in killing a queen in a foul-broody hive that had queen-cells sealed over; and told the party that the hive would swarm in a few days, as the queen hatched out. The idea apparently was that the bees would hatch a young queen and swarm (a very unlikely thing to happen after the old queen was destroyed), and so on till the end of twenty-one days, when the remaining bees could be swept off the old combs and the combs burnt.

Now, in my opinion, the expert was wrong in killing the old queen, because he at once reduced the stock to a queenless colony; in that case the bees would simply hatch a young queen (requeen themselves) that would destroy the remaining queen-cells, thus leaving your correspondent with a foul-broody hive in a worse position than before, his stock of bees weaker, and more progress made by disease. Under ordinary circumstances the hive would have swarmed, but killing the queen would prevent the desired result. If a hive of bees swarm (first swarm) and lose the old queen, the bees return to the parent hive. They are then queenless, and there are odds against them swarming again. They will simply requeen themselves. At least, that is my experience.—T. HASTWELL, *August 17.*

BEE PLANTS.

[2984.] Referring to the request of your correspondent "L. F." (2977, page 317), if he sends me his address on stamped envelope, I will forward him some seed of melilotus, which grows here to a height of 7 ft. 6 in. This plant is well worked by hive bees, though very few humble bees seem to visit it. I can also supply (free) seed of French honeysuckle.—J. GRAY, 1, *East-street, Long Eaton, R.S.O.*, *August 16.*

PLANTING FOR BEES.

[2985.] Your correspondent "L. F." (p. 317) asks for the name of a suitable plant to grow on a piece of ground adjoining his hives. To limit myself to one particular plant only, I should prefer *Arabis alpina*. It is a valuable plant to grow for bees, blooming early in the spring, and continuing through the summer. Now is a good time to sow the seed, and when large enough plant in permanent places 1 ft. apart each way, or sow in drills 1 ft. apart, where they are to remain, and thin out, leaving each plant the above distance apart. I should advise "L. F." to plant more of a selection of

bee-flowers, which will prove a great attraction for his bees, such as crocus, Arabis, wallflower, *Limnanthes Douglasi*. These spring-blooming plants, I think, ought to be grown by every bee-keeper, they coming in bloom when bee-forage is scarce, and the bees certainly pay these plants great attention in the spring of the year. For the autumn, nothing beats giant balsam, Chapman honey plant, and *Echinops nivalis*, the latter proving an ideal honey-producing plant.—C. GOULD, *Guernsey*, August 15.

Queries and Replies.

[1808.] *Bees Dying Behind Queen-Excluder in Combination Hives*.—1. Would insufficient ventilation account for bees dying behind the excluder where worked for extracting and also on top of excluder where worked for sections? 2. I make my own hives and frames; will you kindly tell me if you consider I am working properly. My hives are on the combination principle, with double walls all round. I work, say, ten or eleven frames for brood-nest, then a queen-excluder frame, behind which I fill up with combs for extracting. When working for comb-honey I put a rack of sections on top with or without excluder—I have had no breeding in sections this season, but swarming has been quite the fashion—indeed one swarm (not a very early one) has thrown off three swarms, the third returning to the parent hive. 3. I have been taking out any well-filled combs from the brood-nest, extracting their contents, and placing the empty combs in centre of brood-nest. Am I doing right? 4. I find more honey in brood-nest than is desirable; how can I avoid this in future? I considered I had given plenty of surplus room, and given it in good time. I see one writer in B. B. J. speaks of “pollen-choked combs.” 5. Would a comb quarter part filled with pollen be considered pollen-choked and unfit for use? 6. I find a larger quantity of pollen than usual in my hives this year. Am I right in taking it as a sign of health when there is plenty of pollen and propolis?—AMATEUR, *West Cornwall*.

REPLY.—1. No. Ventilation will have had no part in causing the death of bees; the fault is probably in the excluder zinc itself. 2. Our personal preference is for hives in which the surplus honey is stored above the brood-chamber, not on same level in the rear of brood-combs; this avoids the necessity for disturbing brood-nests as stated. 3. If brood-combs are well filled with honey, it is quite right to remove it, and so allow the combs so filled to be put to their legitimate use of brood-rearing. 4. The very trouble you wish to avoid is one of the objections to the system you practice. Try working a hive or two on

the storeyfeeding system next season, and compare results. 5. Not at all, but if the one-fourth pollen gets hard and useless to the bees, the cells so occupied are, of course, “unfit for use” until such time as the hard pellets are removed either by bee or bee-keeper. 6. It is always a sign of health when bees work hard in gathering, but if queen is prolific and brood-raising proceeds apace, it helps to keep down surplus pollen storing.

[1809.] *Wintering Driven Bees in an Empty Room*.—Will you kindly tell me if temporary hives of driven bees—placed on combs, and fed with syrup—could be safely wintered in an empty room? One window faces south, and the other west. 2. Should the windows be left open, or any special arrangement made for them?—C. J. WADEY, *Dorset*, August 21.

REPLY.—1. Very well indeed, if an aperture be cut in lower edge of window frame to form an entrance. A small alighting-board should also be provided, and if much exposed to wind, a porch is helpful. 2. No; the only thing needed is an entrance for the bees, and as little outside disturbance as possible during the winter months.

[1810.] *Permanent Observatory Hive for Indoor Work*.—What do you consider the best observatory hive for observing bees in a room without disturbing them at their work? A hive with glass walls round a brood nest reveals little of what is going on in the nest, while a uncomb hive conceals nothing, but seems to break up the brood nest. What would you recommend?—INVESTIGATOR, *Oxford*.

REPLY.—The only really efficient hive for such observations as are mentioned above is one with glass on all sides and on top, the frames of which are movable laterally without disturbing the coverings. By this means each comb may be examined on both sides. The bees, to winter properly, must be on frames just as in an ordinary body-box.

[1811.] *Unfinished Heather Sections—Making Honey Crates*.—1. At the close of season, are uncapped heather sections quite good for the table? 2. Can partly-drawn and filled heather sections be given back in a box to the bees, placed over feed hole, for them to take down for winter stores, and the combs used again next year? 3. What should be done with uncapped heather combs in body-box on finally packing up the bees for the winter? 4. Is stimulative feeding advisable in a heather district after a good flow? It makes it late to get capping done after rapid feeding, should the weather turn out wet and cold, as it often does here in September. 5. When rapid feeding is necessary, should the frames be reduced to size of stock before or after feeding? In fig. 31 (storing crate) of “Guide Book” is the weight of the upper sections supported by the lower, or on ledges? Would it be

too much to ask for working drawings of this crate? It would be of use to many, or an article on making market crates would also be much appreciated.—G. M. S., *Keswick, August 8.*

REPLY.—1. Yes. 2. If the weather is favourable and the partly-filled sections are given not too late in the year the bees will carry the contents below into body-box. It is, however, sometimes necessary to cover the box in which sections are overed, with only a single quilt of light material to keep it cool, or the bees will not remove their contents. 3. Leave them where they are. 4. No; if sufficient stores are on hand no feeding is required so late as that. 5. Before feeding is begun. 6. The sections rest upon each other. 7. Seeing that what our correspondent asks for would cost several pounds, and that the end aimed at will be better secured by the expenditure of a couple of shillings for a pattern crate to work from, we advise the latter course.

[1812.] *Storing Pollen Combs.*—I have one or two questions I should like to ask you, answers to which would be acceptable through the columns of your valuable little weekly. Firstly, I would express my regret that none of your readers have taken up the question of "queen-cells being drawn out on drone comb," a description of which I sent you and you kindly inserted in a recent issue of the B.B.J. 1. Can you tell me what sort of honey country is immediately north of London? I am leaving my present location next month and going to live at Mill Hill, and am, of course, taking my bees with me. I am therefore anxious to know if that locality is good for bees. 2. I have about twenty Standard frames of comb I extracted honey from. They were taken from the body of the hives, and some contain a good deal of pollen. What is the best way to store these through the winter, so as to keep pollen from going mouldy? 3. I am thinking of purchasing one or two stocks in straw skeps, also of getting some driven bees. How do you recommend my uniting them to my colonies in frame hives? The honey season has been very poor here. From seven stocks I have only managed to get about five section-boxes filled: they would not work in them. I have ordered one of the "W.B.C." hives to be sent to me, and am looking forward to giving it a trial next season.—EDEN A. THARP, *Beds, August 14.*

REPLY.—1. Some parts north of London are good for bees, but we cannot speak for Mill Hill; perhaps some reader will supply the information sought. 2. Pollen in comb if not covered with honey by the bees never keeps well outside the hives. It is almost impossible to prevent it becoming hard or mildewed, and so quite useless for the bees. 3. We advise using driven bees at this season for building up weak stocks, but not otherwise; strong stocks are not improved as a rule by adding driven bees to them.

METEOROLOGICAL OBSERVATIONS

Taken at the Mid-Lothian Asylum, Rosslyn Castle, for the week ending Sunday, August 22, 1897:—

Mean Height of Barometer	29.471
Mean Temperature.....	60°
Highest Point of Thermometer (20th)	65.5
Lowest Point of Thermometer (19th)	42°
Mean Dew Point of Temperature ...	53.6
Solar Radiation	85.7
Terrestrial Radiation.....	40.1
Rainfall in Five Days93
General Direction of Wind	W.

Bee Shows to Come.

August 28, at Fairfield, near Manchester.—Exhibition of Bees, Honey, &c., in connection with the Manchester and District Branch of the L. and C.B.K.A. For particulars apply F. H. Taylor, Local Hon. Sec., Birch Fold Cottage, Fallowfield, Manchester.

August 28, Corn Exchange, Biggar.—In connection with the Horticultural Society's Show. Annual Open Exhibition of Bees, Honey, Wax, &c. Prize list from W. Ormiston, Sec., Fernbank, Biggar, N.B.

September 1, at Hereford.—The Thirteenth Annual Show and Honey Fair of the Hereford B.K.A. will be held in the Butter Market, Hereford, as above, when consignments of honey for sale are solicited. Schedules from the Hon. Sec., Mr. A. Watkins, Imperial Mills, Hereford. Entries close August 27.

September 2, at Castle Douglas, N.B.—Annual show of the Galloway Horticultural and Honey Society. Open classes, with liberal prizes, for three 1-lb. jars extracted honey, and for three 1-lb. sections. Schedules from Thos. Myers, Hon. Sec., Gowandale, Castle Douglas. Entries close August 31.

September 4, at Bramhall Hall.—Lancashire and Cheshire B.K.A., in connection with Bramhall and Woodford Horticultural Society. Annual show of honey. Open to district and members of the L. and C. B. K. Association only. Schedules from Secretary, J. Bell, Davenport, Stockport.

September 8 and 9, at Derby.—Sixteenth Annual Show Derbyshire B.K.A., in connection with the Derbyshire Agricultural Society. Nineteen classes and over fifty prizes for bees, honey, and appliances. Schedules from F. Walker, Hon. Sec. D.B.K.A., Cattle Market, Derby. Entries close August 31.

September 25, in the Corn Exchange, Jedburgh.—Roxburghshire B.K.A. Annual Honey Show. Twenty-six classes for honey, wax, and sundries. All open. A single entry fee of 2s. covers all classes. Schedules from Thos. Clark, Pleasants Schoolhouse, Jedburgh, N.B. Entries close September 21.

Notices to Correspondents & Inquirers.

Letters or queries asking for addresses of manufacturers or correspondents, or where appliances can be purchased, or replies giving such information, can only be inserted as advertisements. The space devoted to letters, queries, and replies is meant for the general good of bee-keepers, and not for advertisements. We wish our Correspondents to bear in mind that, as it is necessary for us to go to press in advance of the date of issue, queries cannot always be replied to in the issue immediately following the receipt of their communications.

All queries forwarded will be attended to, and those only of personal interest will be answered in this column.

DRAGOON (Wylde Green).—Honey for Showing.—The sample is a good honey for flavour, and if the judge would accept it as eligible for the "Dark Honey" class it should stand well on the show bench. It is difficult for us to judge of its colour when less than an ounce or so is sent in a long,

- thin, glass tube or sample phial. The predominating flavour is from lime blossom.
- H. J. SKELDING (Glam.)—*Honey for Showing*.—If you will get rid of the air-bubbles (of which sample received is full) the honey would do credit to the show bench. It is from white clover, and save for being a little thin is a very good sample.
- C. HOYLE (Cornwall).—*Removing Surplus Honey and Feeding for Winter*.—1. Reference to "Guide Book" (page 111) will show that about 30 lb. of sealed stores should be left for wintering on. You do not state if stores now in the hives—weighing 45 lb., 35 lb., and 25 lb. respectively—are in the body-boxes or in surplus chambers. If in the latter, we advise removal at once, and giving back sufficient sugar-syrup to make up stores already in body-box to the weight specified or thereabouts. 2. Far better to winter bees in their present skep home and let them transfer themselves to the frame-hive about April next, as has been so frequently explained in our pages of late.
- A. C. JEMIESON (York).—*Show at Harrogate*.—We regret to say that our correspondent's letter dated 21st inst. is not suitable for publication as written, but if a report of the show referred to is sent by him as secretary of the Association concerned we will be very pleased to find room for it in our pages.
- J. L. S. (Berkeley, Glos.).—*Bee-fool for Autumn*.—No food other than honey is suitable for autumn feeding, but syrup made from sugar and water in the ordinary way. Stocks of bees should not be "weak" at this season, unless they are either late swarms or in hives which have sent off several swarms this year.
- A. AIKMAN BLAIR (Edinburgh).—*Beginning Bee-keeping*.—1. Bees which have only begun to take to supers in mid-August after swarming are not likely to do much in them this year even so far north as Edinburgh. 2. Had a fertile queen been introduced—instead of waiting for the bees to rear one—a deal of time would, of course, have been saved, and better results probable; but this is the worst that can be said so long as young queen is now doing well. 3. The queen-cell sent has not been occupied. 4. You have done fairly well, but must not allow too much drone comb in any hive.
- L. FOSBROKE (Ashby-de-la-Zouch).—*Bee Plants*.—If you wish it, and will send a stamped envelope, we will forward a printed list of bee plants.
- J. JEAL (Surrey).—*Cane Sugar for Bee Food*.—The price-list appears in this issue. No. 7 (or small white crystals) is the best kind for autumn use.
- "SHOW" (High Wycombe).—*Honey for Showing*.—Sample received is excellent in colour and good in flavour, but the small particles of wax must be strained from it, or it will not stand well as a fine sample for exhibition.
- A. BEGINNER (Thames Ditton).—Pure cane sugar may be had in all forms, from the raw unrefined article to lump sugar. None but refined crystals are suitable for autumn bee food, and it is an entire mistake to say that pure cane sugar can only be had in the raw or unrefined state.
- S. SHAPCOTT (Devon).—*Dealing with Foul Brood*.—We have not been able to look up your letters of some time ago, but will deal with the questions now sent, in our next issue.
- JAS. STOKES.—*Sugar for Bee Food*.—See reply to J. Jeal.
- B. J. (Aylesbury).—*Storing Honey*.—A warm dry room is the best place for storing honey after removal from the hives.
- J. STUBBS (Cheshire).—*Honey Samples*.—The honey sent is very good in colour, aroma, and flavour. Its consistency might be a little more dense, but otherwise it is a very good sample.
- "H." (Atherstone).—*Do Bees make Wax?*—Beeswax is a secretion produced in the body of the bee—not gathered—and it is calculated that, in order to produce 1 lb. of wax, the bee requires to gather from 13 lb. to 20 lb. of honey. Regarding the argument as to bees "possibly losing the power of secreting wax, if they continue to be supplied with comb-foundation on which to build their combs," you could "fix" those who use such an argument by asking where the comb-foundation is to come from if bees forget how to secrete wax?
- J. R. (Winchfield), F. R. P. (Staffs.), C. F. (Mon.), and A. M. (Wycombe), whose letter we regret to say has been mislaid.—All samples sent by the above are more or less affected with foul brood. We will send each a copy of the leaflet issued by the Board of Agriculture if an addressed envelope is sent to this office.
- A. BEGINNER (Cambridge).—*Swarms Return-ing*.—When swarms return to the parent hive after having been put in a new home, it is usually because the queen has not been hived with the swarm. Various causes may account for this; sometimes the queen is unable to fly, and falls to the ground unseen by the bees, and thus gets lost; at other times she fails to take wing along with the bees, which return sooner or later to the parent hive.
- S. CRAWFORD (Castleberg).—*Buying Honey*.—We are very pleased to learn that your advertisement in our pages enabled you to buy all the honey needed. We are quite sure, however, that all who sent samples will not expect you to write them, nor need we do more than mention the fact here as above.

Editorial, Notices, &c.

BEE AND HONEY SHOW AT BARROW.

The annual show of the North Lancashire Agricultural Society took place at Barrow-in-Furness on August 19, 20, and 21. And in connection therewith a section of the exhibition was set apart for bees and bee-produce.

The honey staged in the open classes, both comb and extracted, was extremely fine, and consequently a keen competition took place. In the county classes, however, the entries were less satisfactory, and it is matter for regret that a show at which such good prizes are offered should not meet with more liberal support from the county palate. In the class for instruction exhibits a most interesting display was made, the winning exhibits attracting the close attention of large numbers of visitors.

At the last moment it transpired that the gentleman appointed as judge wired his inability to attend, and in the emergency Mr. F. H. Taylor—first-class expert B.B.K.A.—who was present at the show in the capacity of lecturer, withdrew his own exhibits in the honey classes from competition, and undertook the duty of judging these. Mr. J. J. Astley, Ambleside, awarding the remaining prizes.

AWARDS.

Twelve 1-lb. Sections (open).—1st, Rev. T. J. Evans, Tarvin, near Chester; 2nd, Wm. Woodley, Beedon, Newbury; 3rd, F. Postlethwaite, Rampside-by-Barrow; v.h.c., P. H. Rawson, Market Drayton.

Twelve 1-lb. Jars Extracted Honey (open).—1st, H. W. Seymour, Henley-on-Thames; 2nd, R. Dodd, Tarporley; 3rd, W. Woodley; v.h.c., J. & W. Herrod, Sutton-on-Trent; h.c., P. H. Rawson and Robert Cooper, Huyton; c., Rev. T. J. Evans.

Twelve 1-lb. Jars Extracted Honey (County only).—1st, G. P. Mulock, Fleetwood; 2nd, Robt. Cooper; 3rd, W. Forrester, Huyton; v.h.c., W. Redhead, Ulverston; h.c., T. Smallbone, Poulton.

Twelve 1-lb. Sections (County only).—1st, F. Postlethwaite; 2nd, A. J. Kendall, Kirkby-in-Furness; 3rd, Mrs. John Boulton, Ulverston.

Interesting and Instructive Exhibits connected with Bee Culture.—1st (Silver Medal), F. H. Taylor, Fallowfield, Manchester; 2nd (Bronze Medal), H. W. Morris, Doncaster; c. H. W. Seymour.

Trophy of Honey.—1st (Silver Medal), F. H. Taylor. (Communicated.)

HONEY SHOW AT GOOLE.

The annual show of the Goole and District Agricultural and Horticultural Society was held at Goole on August 12, and proved to be one of the finest exhibitions in the North of England.

It required four large marquees to accommodate the exhibits of plants, cut blooms, fruit, vegetables, honey, poultry, rabbits, dogs, &c., whilst the splendid exhibition of horses, &c., was held in the open. The display of honey was the best the Society have ever had, and was staged in one of the large tents under the direction of Mr. A. Woodhead, Hon. Sec. G.B.K.A., and a staff of assistants. Mr. J. H. Howard, of Holme, judged this section of the show, his awards being as follows:—

Six 1-lb. Sections (open) (9 entries).—1st, G. Remmer, Knedlington; 2nd, W. Patchett, Thorsway; v.h.c., W. H. Woods, St. Ives; h.c., J. Butters, Beedon.

Twelve 1-lb. Jars Extracted Honey (14 entries).—1st, J. Giddy, Wilton; 2nd, W. H. Woods; v.h.c., Miss Laurence, Leeds; h.c., A. Phillips, Leeds.

Two Frames of Comb Honey (6 entries).—1st, J. Giddy; 2nd, Dr. Arbuckle, Thorne; c., R. Brown, Somersham.

Observatory Hive.—1st, Dr. Percy Sharp, Brant Broughton; 2nd, J. Giddy.

Interesting Exhibits connected with Bee-Keeping (10 entries).—1st, Dr. Percy Sharp; 2nd, J. Giddy; v.h.c., H. W. Morris, Doncaster; c., A. Woodhead, Goole.

Single 1-lb. Jar Extracted Honey (25 entries).—1st, W. Dunning; 2nd, O. Roberts, Tarporley; v.h.c., W. Patchett; h.c., Wm. Love-day, Harlow; c., Thos. Blake, Broughton.

MEMBERS' CLASSES.

Three 1-lb. Sections (3 entries).—1st, G. Remmer; 2nd, J. Giddy; 3rd, W. Ramsey, Skelton.

Six 1-lb. Jars Extracted Honey (Light) (7 entries).—1st, G. Remmer; 2nd, W. Chester, Goole; 3rd, W. Ramsey; v.h.c., J. Giddy; c., T. Earl, Rawcliffe.

Six 1-lb. Jars Extracted Honey (Dark) (8 entries).—1st and 2nd, W. Chester; 3rd, G. Remmer; v.h.c., A. Woodhead.

Three 1-lb. Jars Granulated Honey (5 entries).—1st, E. Wainman; 2nd, Dr. Arbuckle; h.c., J. Giddy; c., G. Remmer.

Super of Comb Honey (3 entries).—1st, J. Giddy; 2nd, W. Chester.

Beeswax (7 entries).—1st and 3rd, G. Remmer; 2nd, W. Ramsey; h.c., Dr. Arbuckle and A. Woodhead. (Communicated.)

MIDLOTHIAN B.K.A.

The fourth annual exhibition of the Midlothian Bee-keepers' Association was held at Juniper Green on Saturday, August 21, in conjunction with the flower show, and proved the most successful yet held, in spite of the fact that no heather honey was staged.

The entries numbered 98, the honey staged about 690 lb., as compared with 96 entries and 670 lb. of honey in Penicuik last year, when heather entries swelled the totals.

The judges were the Rev. R. McClelland, Inchinnan, Renfrew; and Mr. W. Wilson,

Galashiels; and their awards were as follows:—

Twelve 1-lb. Sections.—1st, H. Marrs, Whitehill, Rosewell; 2nd, Mr. Weir, Heriot; 3rd, Mr. Craik, Dalkeith.

Six 1-lb. Sections.—1st, W. Hogg, Penicuik; 2nd, Mr. Headridge, Eskbridge; 3rd, Mr. Craik.

Three 2-lb. Sections.—1st, H. Marrs; 2nd, Mr. Craik; 3rd, Mr. Brindle, Whitehill.

Six 1-lb. Jars Extracted Honey.—1st, Mr. Brindle; 2nd, Rev. J. W. Blake, Temple; 3rd, H. Marrs.

Three 1-lb. Jars Extracted Honey.—1st, Mr. Brindle; 2nd, Rev. J. W. Blake; 3rd, H. Marrs.

Non-sectional Super.—1st, Mr. Weir; 2nd, Mr. Craik; 3rd, H. Marrs.

Design in Honeycomb.—1st, Mr. Craik; 2nd, Mr. Weir.

Beginners owning not over Three Hives.

Three 1-lb. Sections.—1st, B. Huth, Bonnyrigg; 2nd, P. Smith, Heriot; 3rd, W. Herkes, Heriot.

Three 1-lb. Jars Extracted Honey.—1st, D. Young, Roslynlee Cottages; 2nd, W. Herkes; 3rd, Mr. Melrose, Currie.

Special Classes.

Display of Honey (not over 40 lb.).—1st, Mr. Weir; 2nd, Mr. Craik; 3rd, H. Marrs.

Six 1-lb. Sections.—1st, Mr. McIntyre, East Calder; 2nd, Mr. Welsh, Penicuik; 3rd, Mr. Smith, Oxenfoord.

Straw Super.—1st, Mr. Craik; 2nd, Miss Stewart, Geenbrock, Balerno; 3rd, H. Marrs.

Bell Glass.—1st, Mr. Craik.

Beehive.—1st, Mr. Martin, Colinton; 2nd, Mr. Craik; 3rd, Mr. Brindle.

Three Shallow Frames for Extraction.—1st, Mr. Craik; 2nd, Mr. Marrs; 3rd, Mr. Young.

Honey Wine or Mead.—1st, H. Marrs.

Honey Cake.—1st, Mrs. Brindle; 2nd, Mrs. Weir; 3rd, Mrs. Mattison, Curriehill.

Bar-Frame Hive made by Amateur.—1st, Mr. Young; 2nd, Mr. Brindle.

Special Prizes.

Best Exhibit in Show.—1st, Mr. Weir (Lady Carmichael Medal); 2nd, Mr. Craik (Steele's Set of Appliances).

Most Points in Open Classes.—1st, Mr. Craik (Lady Carmichael Medal); 2nd, H. Marrs (Raitt's Set of Appliances).

Highland Society's Medal.—H. Marrs (for sections); Mr. Brindle (for extracted honey).

Silver Brooch, by Mrs. Craik.—Mrs. Brindle (for honey cake).—(Communicated.)

SHOW AT NORTHENDEN.

The first exhibition of honey, wax, &c., in connection with the Northenden Horticultural Society, was held at Northenden on Saturday, August 28, and proved a great success.

Mr. Geo. Roberts, of Liverpool, kindly acted

as judge, and delivered a lucid discourse on Bee-management, he also (assisted by Messrs. W. Russell West and R. Worstencroft) gave a practical lesson in driving to an exceedingly interested audience.

The awards were as follows:—

Three 1-lb. Jars Extracted Honey.—1st, W. J. Robertson; 2nd, W. Russell West.

Three 1-lb. Sections.—1st, Miss J. Shuttleworth; 2nd, W. J. Robertson.

One Single 1-lb. Jar Extracted Honey.—1st, T. F. Harrison; 2nd, E. Johnson.

Single 1-lb. Section.—1st, W. Russell West; 2nd, R. Worstencroft.

Frame of Honey in Comb.—1st, W. Russell West; 2nd, W. J. Robertson.

Best Exhibit of Bees Wax.—1st, R. Worstencroft; 2nd, W. Russell West.—(Communicated.)

BIGGAR B.K.A.

ANNUAL SHOW.

The fifth annual show under the auspices of this Association was held in the committee-room of the Corn Exchange, Biggar, in connection with the Horticultural Society's show, on Saturday, August 28.

Notwithstanding the scarcity of heather honey, this show breaks the record of previous years by about forty entries, the total number of which was 133. The room was tastefully decorated, and the quality and general get-up of the exhibits reflected great credit on the exhibitors in all classes.

Altogether, the show was a decided success, and ought to give a strong impetus to the bee-keeping industry in the district, which is undoubtedly a splendid honey-producing one. Owing to a misunderstanding one of the judges did not turn up in time, and his place was very kindly taken by Mr. G. C. Murray, Carnwath.

The judges appointed were Mr. Gray, Carluke, and Mr. Wishart, Peebles.

The following were the awards made:—

Six 1-lb. Sections.—1st, R. B. Forrest, Coulter; 2nd, W. Ormiston, Biggar; 3rd, A. Brownlee, Symington.

Six 1-lb. Sections (Heather Honey).—1st, R. B. Forrest; 2nd, John Lawrie, Brownsbank; 3rd, Danl. Brown, Symington.

Single 1-lb. Section.—1st, Jas. Brown, Carstairs Village; 2nd, Robt. Clarkson, Cormiston; 3rd, Adam Proudfoot, Skirling.

Single 1-lb. Section (Heather Honey).—1st, R. B. Forrest; 2nd, Alex. Brownlee; 3rd, Wm. Ormiston.

Three 1-lb. Jars Extracted Honey.—1st, Geo. C. Murray, Carnwath; 2nd, Andrew Boa, Biggar; 3rd, John Eunson, Biggar.

Three 1-lb. Jars Extracted Heather Honey.—1st, Michael Rae, Biggar; 2nd, John Lawrie; 3rd, Walter Rae, Biggar.

Super Honey (under 12 lb.).—1st, Andrew Boa; 2nd, John Clark, Liberton; 3rd, Wm. Ormiston.

Super Heather Honey (under 12 lb.).—1st, Walter Rae.

Display of Honey.—1st, Michael Rae; 2nd, Walter Rae; 3rd, John Clark.

Bees Wax.—1st, John Tweedie, Biggar Park; 2nd, Andrew Boa; 3rd, James Brown.

Honey Cake.—1st, Miss Mysie Rae, Biggar; 2nd, Miss May Rae, Biggar; 3rd, Mrs. Lawson, Stone.

Shallow Frame of Comb Honey.—1st, Michael Rae; 2nd, Andrew Boa; 3rd, Wm. Ormiston.

Four 1-lb. Sections (two each of flower and heather honey).—1st, John Lawson.

Super Honey (under 8 lb.).—1st, John Lawson.

Non-winning Exhibit in Foregoing Classes.—1st, Wm. Ormiston.

Bee Candy.—1st, Michael Rae; 2nd, John Eunson; 3rd, Wm. Ormiston.

Super of Honey (under 7 lb.).—1st, John Clark; 2nd, Andrew Boa; 3rd, Wm. Ormiston.—(Communicated).

LANCASHIRE AND CHESHIRE B.K.A. SHOW AT FAIRFIELD, NEAR MANCHESTER.

In connection with the Fairfield Horticultural Society the district branch of the above Association held a very creditable show of bees and honey on Saturday, the 28th ult. The honey in the classes for light extracted and sections was beautiful, and the competition very close; Cheshire honey, which has done so well this season, carrying off the honours.

The greatest interest was aroused by the Educational Exhibits and the Trophy. The judge was Mr. T. D. Schofield, of Alderley Edge, hon. treasurer of the L. & C.B.K.A. Lectures on "Modern Bee-keeping," and the "Habits and Instincts of the Honey Bee" were given in the Bee Tent by Mr. F. H. Taylor, local hon. sec., who manipulated bees at the close of each lecture.

AWARDS:—

Six 1-lb. Jars Extracted Honey (light).—1st, O. Roberts, Tarporley; 2nd, R. Dodd, Tarporley; 3rd, J. Wrench, Hartford; h.c., W. Forrester, Huyton, and G. H. Mulock, Fleetwood; c., T. F. Harrison, Northenden, and R. Cooper, Huyton.

Six 1-lb. Jars Extracted Honey (dark).—1st, Miss B. Smith, Cheadle; 2nd, Horton Bros., Flixton; 3rd, John Sanwood, Sale, Cheshire.

Two Shallow-Frames Comb Honey.—1st, Rev. E. Chanley, Chester; 2nd, T. F. Harrison; 3rd, F. H. Taylor, Fallowfield.

Six 1-lb. Sections.—1st, O. Roberts; 2nd, F. Postlethwaite, Barrow-in-Furness; 3rd, R. Dodd; c., C. A. Ingham, Sale.

Best Beeswax.—1st, Rev. E. Chanley; 2nd, W. Forrester; 3rd, F. H. Taylor.

Interesting and Instructive Exhibit connected with Bee Culture.—1st, F. H. Taylor (educational exhibit); 2nd, F. H. Taylor (honey trophy); 3rd, T. Mottram, Heaton Chapel (design in honey comb).—(Communicated).

YORKS. AGRICULTURAL SOCIETY.

The annual county show of the above Society was held at Harrogate on July 21, 22, and 23, ample space being, as usual, afforded for the exhibition of honey and bee appliances. The bee tent of the Yorkshire B.K.A. was in attendance and lectures on bee management delivered therein on each day of the show, Mr. W. Dixon and Mr. F. A. Pay occupying the tent as lecturers the first day; the latter gentleman, assisted by Mr. R. King, lecturing also on the last two days, as also did Mr. A. C. Jemison, organising secretary of the Y.B.K.A. The lectures were well attended and evidently aroused much interest among hearers.

The Rev. R. M. Lamb, of Burton Pidsea, was again to the front with his glass-sided extracting house, by means of which onlookers were able to observe how pure English honey is extracted from the combs, drained, and bottled ready for use or sale. The show of hives and bee appliances was limited to entries filled by two exhibitors only. The collections were nevertheless very complete and up to date.

Owing to the dry season in the Yorkshire district the exhibits in the honey classes were not so numerous as usual. The quality of honey staged was, however, excellent.—ARTHUR C. JEMISON, Hon. Organising Secretary Y.B.K.A.

[We have pleasure in inserting the above somewhat extended report, by request, to supplement that on page 302 of our issue for August 5, where the prize list already appears.—EDS.]

Correspondence.

The Editors do not hold themselves responsible for the opinions expressed by correspondents. No notice will be taken of anonymous communications, and correspondents are requested to write on one side of the paper only and give their real names and addresses, not necessarily for publication, but as a guarantee of good faith. Illustrations should be drawn on separate pieces of paper. We do not undertake to return rejected communications.

**.* In order to facilitate reference, Correspondents when speaking of any letter or query previously inserted will oblige by mentioning the number of the letter, as well as the page on which it appears.*

TRANSFERRING DIFFICULTIES IN GETTING BEES FROM SKEPS TO FRAME-HIVE.

[2986.] About the middle of July I brought home two skeps of bees from Dundrum, a place situate about forty miles from Belfast. I had no opportunity of examining the bees before packing, the day being wet; I also had to pack them in the middle of the day. One of the skeps (A) was a swarm hived in June last; the other (B) a stock two or three years old. When unpacked after arrival here I found all the combs in (A) detached, and so, to

save the bees, I drove them the same evening into a frame-hive fitted with six frames of foundation, and fed them on thick syrup. The queen not being found among the dead bees, I judged she was saved, together with about three-fourths of the bees. I also put the other skep (B) on the top of a frame-hive, and packed all round, thinking the bees would work down as the honey season was then in full swing. But, after a week had elapsed, they had built no comb on the foundation, and, in fact, I could see no bees coming in or out of the hive at all. A friend then told me there must be something the matter with the queen, and advised me to unite the bees to swarm (A) by placing the skep on the top of the hive where swarm (A) was located. I therefore drove the bees of (B) into an empty skep, smoked the bees of (A) and threw the bees of (B) out at the entrance of the latter, the two lots uniting without the least fighting and apparently without the death of one bee. Swarm (A) had built out a good deal of comb and filled it with syrup. I next placed the skep from which the bees had been driven on the top of the frames of hive (A). The skep contained about ten combs, six being well filled with healthy looking grubs. There were no queen-cells. I packed carefully the space around the skep and covered all in with the roof of the frame-hive. They were left there for three weeks, in order that the brood in combs might all hatch out. Four days ago I examined them and found, to my surprise, that all the bees had betaken themselves to the skep overhead, nor was any more comb built in the frames below. Moreover, the bees seemed to have taken permanent possession of the skep and had no intention of deserting it. I certainly thought that when the swarm (A) had started the combs they would finish them. Now, Sirs, what course would you advise me to pursue? In other words I ask:—(1) When would the brood be all hatched out? (2) Will the bees leave the skep at all? (3) What could I do with the combs of honey, &c., in the skep after removal if taken away as soon as the brood was hatched? (4) Would you advise transferring them to the bars frame hive? (5) Do you think the queen is all right?

I should like to have them settled up this autumn, not having much spare time in the spring. I must apologise for acquainting you with all these details; but they may be of interest to some of your readers who may have had a similar experience, as well as helping you to give advice to one inexperienced but anxious to learn.—H. M. JOHNSTON, *Belfast*, August 25.

[The natural inference is that the hive (A) was queenless, otherwise you would have noticed brood in the combs as well as syrup when the frames were inspected. This being so the queenless bees were only too glad to join on to the brood combs above. The proper course will be to drive all the bees and

queen from skep and set on a queen-excluder above frames; then replace the skep on this and return the bees to frame-hive. The only risk attendant on this course of procedure is the chance of all the bees passing through the excluder up to the brood-combs in skep and leaving the queen to perish below; but this contingency can be guarded against by ascertaining if any bees are on the newly-built combs along with the queen a few hours after excluder is set on. If there are plenty of bees, however, the risk is nil.—Eus.]

MEAD.

[2987.] Since writing you asking for a recipe for making mead, I have been turning up some old numbers of the B.B.J., and came across a few recipes, but they all differ from one another, and most of them advise adding ginger, cloves, &c., which will, one would think, give the mead a flavour not its own. This is what I want to avoid. I want to make the real, genuine article, with the true flavour of honey, and, as I am going to make as much as will fill a wine-cask (about 30 gals.), you can imagine why I am anxious to get the proper recipe. I think even yeast would give it a foreign flavour.

In the B.B.J., December 1, 1879, page 153, there is a recipe by the then editor which seems good, and I think his plan of leaving the mead alone and letting it make itself is very good; it only means waiting longer for fermentation.

I should like to know if this method was ever tried on a large scale, and if it is necessary to add yeast, and also after how long should it be bottled.

I think an article on mead in the B.B.J. would interest many readers besides myself.—JOHN L. TITHERLEY, *Wallasey, Cheshire*, August 20.

[In view of the prominence given to mead at many of the important exhibitions of bee-produce of late years, and the progress that has been made in the manufacture of mead in recent years, we do not think that any one who contemplates making mead can do better than try the recipe published in the pamphlet on mead-making by the Rev. G. W. Bancks, of Dartford. Mr. Bancks has gone very thoroughly into the matter, and has consulted all the old recipes available. As a result, the mead he produces is as good as any we have ever tasted. Nor is there any need to wait several years in order to have the beverage well matured and fit for use.—EDS.]

HOMES OF THE HONEY BEE.

THE APIARIES OF OUR READERS.

The bee-garden picture we present this week represents the Yorkshire apiary of Mr. Wm. Crisp—who may be classed as belonging to the older school of bee-keepers—and as

will be seen, it is located alongside the railway. Mr. Crisp is now, and has for some time past been, the appointed lecturer on bee-keeping to the Technical Instruction Committee of the Durham County Council. In response to our request for some particulars as to himself and his bee experiences, Mr. Crisp writes as follows :—

“Many years ago my brother bought a hive of bees and solicited my help to bring them home. He paid for them with the proverbial ‘gold’ without which the vendor assured us no luck would follow. The straw skep—suspended on a pole—was carried carefully as eggs. Arrived at home, we talked bees,

hives and the Italian or ‘Golden Bees,’ as so described by bee-men. ‘Golden’ they certainly were so far as price. Of course we took the BEE JOURNAL from commencement, and then came bee-keeping in earnest. During a honey-glut I at once saw the utility of the then just introduced extractor, designed one, and had it made (one of those 20 h.p. affairs warranted to extract everything!) However, it did good work for us. Many were the bee adventures experienced in those long gone days. After being well stung people used to think I had got erysipelas. However, I have got over all that years ago, and after leaving home the bees still remained a hobby, with me, form-

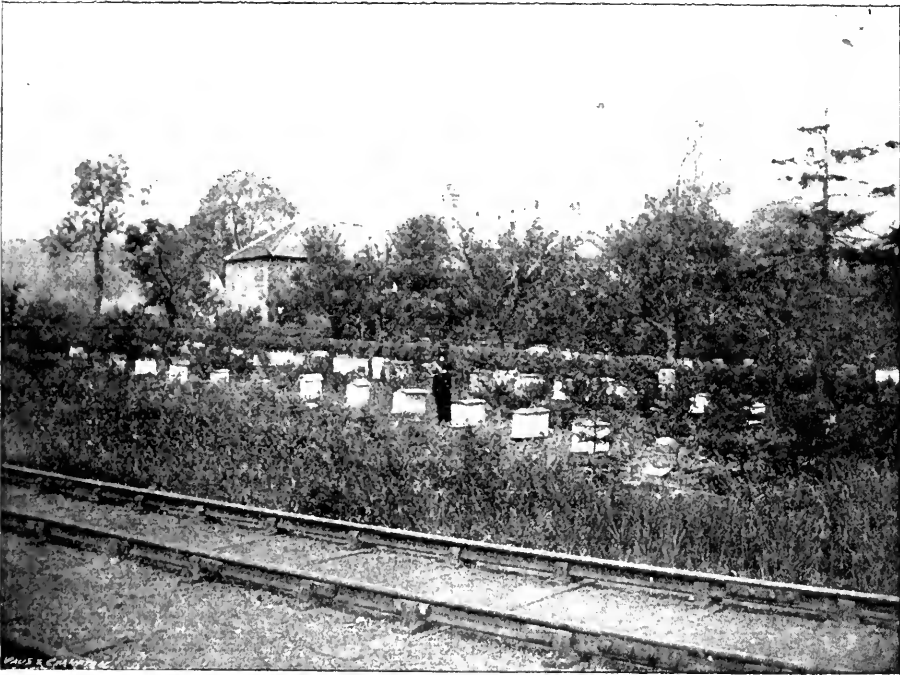

MR. WM. CRISP'S APIARY, YORKSHIRE.

hunted for bee-books, procured ‘Huish’ on bees, next ‘Huber,’ then Hunter’s Manual, and as our ideas expanded so did our apiary. Then came the making of a frame-hive from Hunter’s instructions—after making our first frame-hive from our own ideas alone, which left much to be desired. However, the following summer we supered it with small frames $4\frac{1}{2}$ ” deep, and it was the only hive in our apiary that gave a good return of honey; but when we proceeded to remove the latter it was so propolised together that it had to be turned out en masse from the case. We were, however, now in love with the new system and in consequence next came Abbott’s improved

ing a strong incentive to remain in the country, though it is not always easy to obtain a place where you can build up a large apiary. The apiary represented in the photo we had to leave, the house and garden being required for a resident farmer. It will be noticed our hives nearly all have flat roofs covered with zinc, but this is not their only peculiarity differing from hives of the present day: the frames are wedge-shaped, thus allowing free manipulation without crushing the bees. The frames, too, are 11 in. in depth, each hive containing at least ten frames. I was amongst the first to work double and treble hives tiered above each other, but found there was so much ten-

dency for the stock of one end to join the other placed above that I gave them up. I still use the hive as a single one with a dummy, and often used glass covers under the ordinary one of felt. I believe I was also the first to make a set of lantern-slides to illustrate my lectures on bees, and have kept adding to them ever since. Though I do not adopt all the new-fangled ideas of bee manufacturers, I hope to see many improvements in apiculture. Like many others in your "Homes of the Honey Bee" my wife and family are all keen bee-keepers. We have our good and bad seasons, with ups and downs, the relation of which always proves interesting to my audiences at the Technical Education Lectures on bee culture for the Durham County Council, and for Durham bee-keepers whom I meet in social converse, who, like all men who get together with a hobby, soon chum up and become friends."

NORTHAMPTONSHIRE B.K.A.

PRESENTATION TO MR. R. HEFFORD,
HON. SEC.

On Tuesday evening, August 9, a few members of the committee and friends assembled by invitation at the house of the hon. treasurer, Mr. G. E. Atkins, Kingsley Park, Northampton, and after being hospitably entertained Mr. James Francis, one of the oldest members of the Association, and who had formerly been hon. treasurer for several years, stated when the committee heard of the marriage of Mr. Hefford they decided that the occasion would afford a suitable opportunity for making some acknowledgement of the services he had rendered the Association. When Mr. Hefford took over the secretaryship the Association was heavily in debt, but largely through his exertions, and careful management, the debt had not only been cleared off, but a balance remained in hand at the close of the past few years. In the course of his observations Mr. Francis observed that no one but the committee knew the amount of work which fell upon the shoulders of their secretary in arranging the shows and carrying on the correspondence, and also in many cases giving practical assistance to bee-keepers. He then, on behalf of the committee, asked Mr. Hefford to accept the present before them, consisting of a sugar basin, cream jug, and sugar tongs in sterling silver, the former bear the inscription "Presented to Mr. Robert Hefford by his Bee-keeping Friends on the occasion of his marriage, May, 1897." Mr. Francis, in conclusion, hoped their friend might live long to enjoy the use of them, and also continue to occupy the position of secretary which he had so well filled for many years.

Mr. Hefford, in returning thanks, expressed the very great pleasure it gave him to accept their handsome present, and said if words failed him in conveying his thanks, it was not

that he did not value the gift, but because he was no speaker. He, however, fully appreciated the good feeling which had prompted it, and heartily thanked them all, and as long as he lived should value their beautiful gift as one of his greatest treasures.

Thanks were passed to Mr. and Mrs. Atkins, and a most enjoyable evening brought to a close in the usual way.

Queries and Replies.

[1813.] *Destroying Bees in Diseased Hive.*—

1. Will you kindly tell me how to destroy the bees of a diseased stock in a wooden hive so as to preserve the combs from which to extract the honey and wax? I have kept bees many years, and have never had to "burn" them; but as two of my stocks have done nothing for the past year or so, and I suspect foul brood, I have determined to clear them out and not run the risk of contaminating a fresh hive. The other stocks I mean to doctor if infected. Another day I will enclose you a sample of their comb for inspection, as I should be grateful if you will tell me whether I am correct or not. 2. There seems no expert in this locality. I sometimes have wished that the names and addresses of experts and of those counties in connection with the Association were given in the magazines or guide books. The bee industry is on the increase, and beginners might often be glad to know where to apply for help. 3. I notice that W. Woodley speaks of honey being stored in self-opening tins, but is it quite safe to use tin for fear of the acid in honey coming in contact with tin and so producing poison? Of course the gain over glass breakages and the comfort in packing must be delightful.—M., *Devon*, Aug. 23.

REPLY.—1. A tablespoonful of powdered sulphur set in the shallow lid of an old mustard tin, with a red-hot cinder dropped in before slipping it under the frame, will destroy the bees in two minutes if the hive entrance be closed. 2. We could not well occupy space in our journal with names, &c., of experts. 3. Honey does not become injurious if stored in tins.

[1814.] *Materials for Packing Bees in Transit.*—

1. I enclose samples of green gauze (used for bee-veils), black mosquito net, buttercloth, and "scrim," and beg to ask which of them, if any, is suitable for giving ventilation to bees when travelling? The buttercloth I have used, but the bees work through it. I have not risked the "scrim," as I find that a little water getting on it dissolves the sizing, causing it to open, and I am afraid the same would apply to the green. The mosquito is the strongest, and could not unravel, being real netting, but are not the holes rather large? I cannot obtain cheesecloth here in stock, but of course I could get it

elsewhere, if you think it most suitable. Would not some bees gnaw through almost any woven material if of a cotton nature? I had a lively time with some this summer. 2. When removing sections with super-clearer, after placing on the latter, should I put the usual quilts on to the rack to be removed, or only one light one? I was afraid that if the latter I might chill the body-box by heat escaping through the Porter escape. 3. When using a box with funnel to clear bees from sections, would the bees start fighting if I put in several "W. B. C." hanging-frames with sections, with their bees on, from different hives at the same time? It would be sometimes convenient to do this. Of course I mean after brushing off all bees one can get at; but some will stay behind the separators. 4. I have heard it stated that supplying bees with foundation is likely to gradually harm the bees; in what way was not suggested, but I suppose by losing their power of secreting wax. Is there any possibility of this? 5. When taking hives to the heather, why is it usual to fix on crates before instead of after arriving there? It makes them so bulky. 6. My hives are all of the "W. B. C." pattern, which kind I would like to keep to entirely, unless you think that it would be advisable to have special heather hives to transfer the bees into for taking them to the heather, re-transferring into the "W. B. C." on their return? If not, could you give me hints on securing the outer cases and body-box, &c., together? Reading of Mr. Robert Ness's apiary, he says he likes the "W. B. C." best for all purposes. Perhaps he would also kindly state his method of securing this hive?—G. M. S., *Keswick*, August 28.

REPLY.—1. Notwithstanding your objection, we do not hesitate in saying that, although the "mosquito net" (which is really the net used for bee-tents) will answer very well; we should use the "scrim" as being better and cheaper for the purpose than the black net. 2. The quilts are not disturbed at all when removing honey. 3. If the exit "funnel" is some distance away we should not suppose fighting will occur, but it is not quite wise to mix bees from different hives indiscriminately in that way, unless, as in your case, very few are put together. 4. Take no notice of these alarmist stories, there is a possibility of many evils occurring, and which, in every-day life, we must ignore. 5. It saves time and trouble if hives are suitable. 6. It goes without saying that hives specially made for taking to the heather are preferable to those not so prepared, but we have found no great difficulty in sending the hive you use safely to the moors by using the "eke," covered with "scrim," as an overhead ventilator.

[1815]. *Uniting Driven Bees*.—I would thank you for advice on the following questions:—1. Would it be best to drive bees from old skeps now and put them into frame-

hives, with full sheets foundation? or wait until next spring, and put them on top of frame-hives then? 2. If driven now how many lots will it be advisable to put on nine frames? 3. How much sugar should I require to feed up each colony established in this for winter? I notice that reference is often made in BEE JOURNAL about smoke *versus* carbolic acid for quietening bees. I [use carbolic acid and glycerine in equal parts sprinkled on a cloth and kept rolled up in a tin-box. It will last thus for several days. For smoker fuel I use dry-rot ash wood. I gave a brother bee-keeper some of this, and he was delighted with it. I would like to send you some to try, so that you may express your opinion about it.—G. V., *Broadway, Wor.*, August 26.

REPLY.—1. The question of transferring bees from skeps to frame-hives *versus* allowing the bees to transfer themselves has been dealt with several times in our pages of late and our views on the matter can be readily got by reference. See also reply to "G. J. P. (Lincs.);" on page 350. 2. Two or three lots according to size. 3. About 20 lb. of sugar made into syrup will be needed if the driven bees have to build out new combs in September.

[1816] *Stimulative Feeding and Feeding Bees in Autumn*.—Will you kindly tell me:—1. Why should stimulating syrup not be as thick as autumn food? 2. In feeding up second swarms which I have in "Wells" hives, would it not be as well to give them each, say, 1 lb. per day until they have enough for the winter? I have found that thin syrup is apt to ferment, and, if it is only a question of cost, I would always give it thick enough to store. My syrup is all coloured with cochineal, so I cannot mistake it for honey in the comb.—E. C., *Kenley Green, Fife*, August 27.

REPLY.—1. In considering this question it must be borne in mind the entirely different objects in view. Stimulative feeding is undertaken for the purpose of inducing bees to breed well at a time when, without the artificial income given by the bee-keeper, they would remain comparatively quiet because of there being no natural food obtainable. We also know that bees, when breeding is going on rapidly in early spring, carry in large quantities of water for use in thinning down the thick-stored food for nursing purposes, going long distances and undergoing many risks in order to obtain it. Stimulating syrup is, therefore, made thin to fill the above requirements, and in order to save loss of bee-life in water carrying. Autumn food, on the other hand, is made thick for the exactly opposite reason of saving the bees labour in evaporating the excess of moisture so necessary in winter bee-food. 2. All feeding up for winter should be got through as speedily as possible once the month of September is reached. It saves risks of robbing, and the sooner bees quiet down after the season is over the better. Young bees that have to undergo

two or three weeks' hard and wearying labour, defending their hives from robbers this month, are comparatively old and worn out so far as next year's work.

Echoes from the Hives.

Hutfield Heath, Essex.—We have not had an average season here from the "quantity" point of view, but apiaries in sheltered situations in this district have done rather better. The whole of the honey taken is of good quality. This has been the longest honey season I have ever recorded, though only for three days had we anything like a real good inflow. Honey came in dribbles from the first week in May till August 17. I have never before had sections filled in August, and never before experienced such persistent swarming, nor ever found so many abortive queen cells. I have had the greatest difficulty in getting combs finished this season; many combs given in supers or built in have dragged on unfinished, and remaining unsealed till late in July. My stocks had killed off most of the drones by the first week in July, but those hatched later have been given a fresh lease of life, and are still present in large numbers in several hives. A queen, too, hatched in a nucleus on August 6, has mated, and is laying well. This is unusually late for this district, as no artificial means were taken to preserve drones in the hives. My bees have been very good-tempered right through this year, all things considered. The spring was wet, with a piercing wind and fitful gleams of sunshine, and it was some trouble to get stocks strong. One result of the late cold spring was a large number of dwarfed drones reared in workers' cells. Rough winds and gales prevailed from September last till the end of June. June was intensely hot and stormy, and many swarms, on being returned a second time, killed the old queen and raised a batch of queen cells from larvae of all ages. Three queen cells I found on opening contained nothing better than a worker bee. Honey having come in slowly, only enough has been placed in the brood-combs for winter.

— WM. LOVEDAY, August 23.

METEOROLOGICAL OBSERVATIONS

Taken at the Mid-Lothian Asylum, Rosslyn Castle, for the week ending Sunday, August 29, 1897:—

Mean Height of Barometer	29.613
Mean Temperature	61°
Highest Point of Thermometer (26th)	68°
Lowest do. (24th)	42°
Mean Dew Point of Temperature	55.1
Solar Radiation	85.3
Terrestrial Radiation	38.4
Rainfall in Five Days	1.4
General Direction of Wind	S.W.

HONEY HARVEST IN FIFESHIRE.

Notwithstanding the very inclement nature of the weather in the early summer months, the honey season all over has not been so disappointing as was at first predicted. On the contrary, in most localities the yield is more than the average. Early summer honey is principally obtained from furze and broom flowers, which in their season were very luxuriant, so that—although when the trefoil bloom was at its best the bees could not venture abroad for wind and cold—apiarians who devote a considerable portion of their time to this section of the year's crop have secured a pretty good harvest. Bees have swarmed very freely, although almost a month later than usual, but this season may rightfully be designated "the year of double swarms." A few bee-keepers have also had peculiar experiences with their bees in 1897. Mr. Balfour, Scots-craig, Tayport, had from one of his hives a swarm thrown off on June 2, which was secured, and from it a virgin swarm was got on July 26, and another on August 8; an occurrence which few apiarians remember as having ever happened in all their experiences. The same rare event also took place at the Dovecot, Auchtermuchty, where the first, cast off on June 11, was succeeded by two virgin swarms about five weeks later. Splendid colonies were obtained in Cupar, Kilrenny, Gaudry, and Markinch districts, the genial weather of July materially helping the young bees. Full supers were being removed and frames extracted long before this time last year, but apiarians have, as a rule, no reason to complain, as honey is being stored in large quantities. A fortnight ago Mr. D. M. Reid, Auchtermuchty, took off 96 lb. of honey from a couple of skeps—an unusually large supply. Last week, however, this was thoroughly eclipsed in the Stratheden district by Mr. Wm. Sellars, Ladybank, who from a similar number of hives removed 130 lb. "Takes" from hives already vary from 20 lb. to 60 lb. per stock. Apiarians are now earnestly turning their attention towards the heather honey harvest, which is so much sought after and always finds a ready market, and, given fine weather, bee-keepers in the vicinity of the uplands and moorlands, where the luscious nectar is garnered principally from heather flowers, anticipate that they will be able to store up a good supply of surplus honey.

(Communicated.)

SEASONABLE QUESTIONS.

ANSWERED BY G. M. DOOLITTLE.

FEEDING BACK EXTRACTED HONEY.

Question.—I have read somewhere that, if I were to run an apiary for extracting honey, during the harvest of white honey, and feed the same back to the bees to put into sections, said extracted honey would sell in the section

form for enough more to give me a big profit. Is this a fact? If so, how and when should extracted honey be fed back in order to procure comb honey?

Answer.—The feeding of extracted honey in order that comb honey may be obtained is something that has been tried by very many of our best apiarists, and still remains an unsolved problem with some of those who have tried it. Some have reported success and others a failure; but, if I am correct, those who consider the thing a failure far outnumber those who consider it a success. From my experience in the matter, I should say if any one must feed extracted honey to his bees in order that comb honey may be produced, it should be fed in the spring, in order to hasten brood-rearing, thus securing multitudes of bees in time for the honey harvest; then, by putting on the sections at the right time, a large crop of comb honey may be secured, if the flowers do not fail to bloom or yield honey. My experience has also led me to think that it is better to secure the honey in the sections in the first place, rather than have it stored in combs, and then thrown out with the extractor that we and the bees may go through with much labour and stickiness to secure the same thing which we might have secured without all this trouble. The practice of feeding back is on the principle of producing two crops to get one, and no one will argue that such a course would pay in the long run. Even under the most favourable circumstances, to finish nearly completed combs of honey, I cannot make it pay if I count my time as anything. At the close of certain seasons, when I would have a large number of unfinished sections, many of which were so nearly completed that a few ounces of honey would apparently finish them, it seemed that it might pay to feed a little extracted honey to finish such; but after a careful trial of the matter, covering a period of ten or more years, I finally gave it up as a bad job, and have not fed back a pound of honey during the past six years. If any one should wish to satisfy himself that feeding back will not pay, he can get the best results by feeding the extracted honey right at the close of the early white-honey harvest, so that the bees are kept active. It is thought best by some to take away all combs except those which have brood in them, when preparing the colony for feeding back; but if all combs are filled with sealed honey, except that which the brood occupies, there is no advantage in taking away the combs, that I can see. The extracted honey should be thinned to a consistency of raw nectar, by adding the necessary amount of warm water, thinning only the amount needed for one feeding at a time; for if the thinned honey is allowed to stand long in warm weather, it is quite liable to sour and spoil.

Then there is another item against feeding back, which is that, from some reason or other, this fed-back honey is far more likely to candy

or become hard in the comb than is that put in the comb at the time it is gathered from the field. When first taken from the hive it looks very nice and attractive; but when cool weather comes on in the fall it assumes a dull, unattractive appearance, thus showing that the honey has hardened in the cells; while comb honey produced in the ordinary way is still liquid, and will keep so for from one to three months after the fed-back article has become almost unsaleable.

COMBS OF HONEY FOR NEXT SEASON.

Question.—I have on my hives about 200 combs, very full of honey, which I wish to use for next year's increase. I am at a loss to know what to do, so ask if it would be advisable to throw the honey out with the extractor and use the empty combs, or would it be best to use the full combs of honey? I expect to make my increase by natural swarming.

Answer.—If extracted honey brings a good price in your market, and the honey in the 200 combs is of good quality, then my advice would be to extract the honey and sell it; for the old saying, "A bird in hand is worth two in the bush," is generally correct. If, on the other hand, extracted honey drags heavily, at a price hardly above the cost of production, or the honey in the combs is of a quality not fit for market, then I would store the combs of honey away till spring (allowing the bees to protect them till there was no danger of damage from the larva of the wax moth), when I would use these combs for building up colonies in the spring, by exchanging them with the colonies for combs that they might have which were empty, or nearly so. In this way you will get this honey converted into brood, which brood, when hatched into bees, will store for you large quantities of honey. If the colonies in the spring had no need for this honey, then I would use the combs of honey something as you propose, hiving new swarms on them. If the combs are only from one-third to one-half full of honey, then you may secure the best results by hiving your swarms on the full number of frames and putting the sections on at the time of hiving. But if completely full from bottom to top, it will be better to use only from four to six combs to the hive when hiving the swarms; for, if given a full hive of full combs of honey, the bees may not carry much of the honey to the sections, as they generally will do with the whole where only a few are used. If the bees do not immediately start to carrying the honey from these full combs, the result will be little or no honey in the sections, and little brood and few bees in the hive in the fall. But should the honey in the 200 combs be of inferior quality or of dark colour, or both, then the only thing to do with it is to extract, or use it for spring feeding; for if such inferior honey is given at swarming time, more or less of it will find its way into the sections, thus injuring the sale of the honey, and giving yourself a bad reputation.—*Gleanings (American).*

Bee Shows to Come.

September 2, at Castle Douglas, N.B.—Annual show of the Galloway Horticultural and Honey Society. Open classes, with liberal prizes, for three 1-lb. jars extracted honey, and for three 1-lb. sections. Schedules from Thos. Myers, Hon. Sec., Gowanlea, Castle Douglas. **Entries closed.**

September 4, at Bramhall Hall.—Lancashire and Cheshire B.K.A., in connection with Bramhall and Woodford Horticultural Society. Annual show of honey. Open to district and members of the L. and C. B. K. Association only. Schedules from Secretary, J. Bell, Davenport, Stockport.

September 8 and 9, at Derby.—Sixteenth Annual Show Derbyshire B.K.A., in connection with the Derbyshire Agricultural Society. Nineteen classes and over fifty prizes for bees, honey, and appliances. Schedules from F. Walker, Hon. Sec. D.B.K.A., Cattle Market, Derby. **Entries closed.**

September 25, in the Corn Exchange, Jedburgh.—Roxburghshire B.K.A. Annual Honey Show. Twenty-six classes for honey, wax, and sundries. **All open.** A single entry fee of 2s. covers all classes. Schedules from Thos. Clark, Pleasants Schoolhouse, Jedburgh, N.B. **Entries close September 21.**

UNITING BEES.

Referring to the request conveyed by our correspondent "C. H." in B.J. of August 19, Mr. W. Hamilton, 5, Smitherds-street, Keighley, writes:—"If C. H., Skipton, Yorks. (2981, p. 324), will communicate with me I shall be very pleased to give him practical assistance."

Notices to Correspondents & Inquirers.

All queries forwarded will be attended to, and those only of personal interest will be answered in this column.

G. J. P. (Lincs.)—*Starting Bee-keeping and Utilising Driven Bees.*—1. If two or more lots of driven bees are united and a good young queen secured, they will frequently make excellent stocks the succeeding year. They should, however, be secured early this month, and started comb building on full sheets of foundation and fed continuously until the combs are built out and the required quantity of syrup is stored and sealed over for winter. Be careful also to only give the driven bees as many frames as they will cover thickly, otherwise the combs will not be built of equal and proper thickness. 2. It would certainly vary your experience as a beginner if a couple of stocks in skeps are purchased for wintering as they stand, and let them transfer themselves to frame-hives next spring. We must, however, strongly advise you not to start with too many hives. Two or three at most are quite enough until some experience in their management is gained. Nothing but failure confronts a beginner in bee-keeping if he sets off with a dozen hives to manage before he knows properly how to manage one.

J. B. (Aylesbury.)—*Storing Empty Combs.*—We read your inquiry as referring to honey, "supers and combs"—without the word "empty"—being so often meant as such in our correspondence. We now beg to say

the empty combs may very well be kept above body boxes in winter if protected from mice, moths, spiders, and insect pests generally.

H. J. SKELDING (Glam.)—*Honey for Showing.*

—Honey must be covered with vegetable parchment when shown in tie-over jars. Otherwise those known as screw-cap jars are used. We could not report a show in our pages with only one class for honey.

"LINCOLNSHIRE."—Comb is affected with foul brood of old standing. We have forwarded the Board of Agriculture leaflet for your information as to treatment.

B. W. (Kirky Stephen.)—*Hive for the Heather.*—The hive shown at the "Royal" in June by Mr. W. P. Meadows is admirably suited for heather going. Reference to this hive is made in report of the Show on p. 281 of our issue for July 22 last.

H. O. L. (Ilford.)—*Giving Combs with Dead Larvæ.*—Foul brood cannot be "created"—to use your own term—by giving a comb (in which a few larvæ have died) from a healthy stock to another colony. The bees of the latter will clean out the cells before using.

G. V. (Handsworth, Birmingham.)—*Dark Honey in Sections.*—It is impossible to regulate the colour of honey brought into hives; that is entirely for the bees. The honey seems to be from the bramble or blackberry bloom.

W. BRIGGS (Dorking.)—*Colour of Honey.*—The dark golden-coloured sample is from *Trifolium incarnatum*, which is always dark yellow in colour and of not very good flavour. The second sample has the ordinary light colour of honey from white clover. It is, however, by no means specially thin in consistency.

W. B. VAN H. (Consett.)—*Varieties of Honey.*—We cannot fix the taste for all palates. So that a honey preferred by one will sometimes be considered "vile" by another. Your remark about "supposing heather to be best and white clover next" will be agreed to by a good many, no doubt, but we fear a large majority would differ on the point. So each must be allowed to have their own preferences. Personally we prefer white clover honey mixed with sainfoin for flavour.

A. A. BLAIR (Edinburgh.)—The few sealed cells in comb are unmistakably affected with foul brood.

D. C. Z. (Roseneath.)—*Suspected Comb.*—The comb received containing only drone-brood in worker-cells, it is apparent that the queen is a drone-breeder. This is all we can gather from sample of comb sent. If a piece of comb containing worker brood or old sealed cells in it is sent, we may be able to pronounce as to the trouble, but otherwise we cannot possibly do so.

Several letters and queries are held over till our next issue.

Editorial, Notices, &c.

USEFUL HINTS.

WEATHER.—It will need a good stretch of memory to recall so unfortunate a time for the holding of bee and honey shows, or for outdoor gatherings of any kind, as the past month of August has been. Reports have appeared in which, owing entirely to the most wretched weather conditions, agricultural, horticultural, and apicultural societies have sustained serious financial loss in the comparative failure of what would otherwise have been eminently successful exhibitions, simply because the continuous descent of torrents of rain kept thousands of intending visitors to the show at home to escape a drenching. On two occasions during the latter half of the month, at important honey shows held in succeeding weeks, we had personal experiences of a very trying kind in this way. For two or three hours at a stretch, honey judges were glad to pursue their labours under canvas roofs, with a deluge of rain outside, while their less fortunate colleagues in other departments judged horses and cattle in mackintoshes, leggings, and rain! On one day a very violent thunderstorm, lasting for a long time, broke over the ground, and its effects may be better imagined than described: suffice it to say that only a few hardy enthusiasts ventured near the show ground, which was, for a time, in many places ankle-deep in water.

It makes one sad to see so much praiseworthy effort on the part of those constituting the executive of such affairs, involving months, may be, of arduous labour—to see their efforts rendered nugatory at last by elements entirely beyond human control. We fear some serious financial deficits from this cause will have to be met this year by a few agricultural and kindred societies, and it is to be hoped that some of those who—fortunately for themselves—were spared the actual labour and anxieties inseparable from immediate participation in executive duties of this kind will not stand aloof, but loosen their purse-strings when adverse balances have to be faced.

Bee-keepers, too, who are perforce compelled to rely mainly on an autumn

harvest, must also be sincerely condoled with, so unpromising is the present outlook for the heather honey season. In fact, it would be hard to find a class of producers so completely at the mercy of the weather as those of our craft whose bees are just now kept in enforced idleness just when they ought to be storing up their owners' profits for the year by busy outdoor labour.

AUTUMN FEEDING.—Bad luck through bad weather, though it may be deplored, must not, however, make us unmindful of what is needful for our bees' welfare in the time to come. It is known that as the season's natural income begins to fail the queen or mother-bee of the hive gradually slackens off in ovipositing. This means practically a period of rest so far as her work of egg laying is concerned. Later on she will resume her maternal labours, but only in a very limited degree. Prolific queens may, however, be encouraged to increase very considerably the size of the brood-nest in autumn by judicious stimulative feeding with somewhat thin syrup at this time; and for a couple of weeks to come, gentle, but continuous, feeding will have a very beneficial effect, strengthening the colony by bringing into existence some thousands of young bees, which otherwise would never have seen the light of day.

No one who keeps bees on intelligent lines will deny the important advantages of such an array of lusty young workers for next season's labours. This result secured there will be still a week left for rapid feeding—where needed—and getting winter stores sealed over by the end of the month. After which the sooner bees are packed down for winter the better. In saying this, we do not for a moment wish to minimise the fact that colonies with a full supply of natural stores on hand at this time are best left severely alone in autumn, as regards feeding, but where really required it is obviously advantageous to the bee-keeper if his autumn feeding is carried out in the light of present-day knowledge, as against slipshod methods having no particular object in view other than staying off starvation.

SUITABLE SUGARS FOR BEE-FOOD.—It is now generally admitted that bee-food should be made from pure cane

sugar. The raw, unrefined product of the sugar-cane is, however, quite unsuited for bees' use, because of its containing the molasses or treacle, which, if not removed, tends to cause the disease known as dysentery among bees when wintered on laxative food. Common sense teaches that insects requiring food daily, yet unable for weeks at a time to take a cleansing flight, must suffer in this way if improper food be given. Refined sugar is therefore the only proper kind; some prefer it in loaf or lump form, but we think small white crystals gently boiled for a minute or so do very well in making syrup for winter stores. Nor have we found any bad result from using large yellow crystals for spring and summer food. The point is to ensure that the sugar used is pure cane. This has for some years past been obtainable through the B.J. office, and it will now be seen by our advertising pages that bee-keepers located in distant parts of the kingdom can procure through any grocer a kind known as "Glebe," which is stated to be a pure cane sugar; so that cost of carriage need not be a bar to the purchase of even small quantities. But, whatever is done, we simply lay stress on the fact that beet sugars are not suitable for bee-food.

HOMES OF THE HONEY BEE.—In order to remove the uncertainty which we find exists in the minds of a few readers who have been good enough to send photos of their bee-gardens for inclusion in the series now appearing in our columns—it has been decided to send a *proof* of each plate (as finished by the engravers) to every one whose apiary will sooner or later be depicted in our papers. This course is rendered necessary because of our having had very natural inquiries at times whether the photos forwarded are suitable or not for reproduction, seeing that so long a time has elapsed since they were sent to us.

We also propose making some deviation from the order in which the pictures have up to now appeared. Hitherto each issue of our monthly, the *Record*, has been illustrated by two pictures from the preceding issues of the BEE JOURNAL. In future, however, this order will not be strictly followed, though in the end all the views will be given in both our journals. We shall thus ensure more

variety at the time, and secure a shorter "wait" for the pictures now on hand and ready for insertion. The most gratifying result of our effort to place on permanent record this series of British bee-garden pictures has been the hearty way in which the project has been taken up by readers. We have at present by us a sufficient number of engraved plates to occupy us till well on in next year, and so goodly a number of charming views on hand waiting reproduction—with promises of more to come—as to ensure that the series, when complete, will form ample material for a large and handsome volume, which we hope will some day see the light. The beautiful half-tone engravings will then have proper and full justice done them by the aid of art paper and the high-class printing, which cannot be expected in our journals. The work promises to be not only unique in its way, but historical for all time to come, as faithfully representing the "Homes of the Honey Bee" in this kingdom in the nineteenth century.

BRITISH BEE-KEEPERS' ASSOCIATION.

A meeting of the Council was held at 105, Jermyn-street, S.W., on Friday, 3rd inst., under the presidency of the Baroness Burdett-Coutts. There were also present Major Fair, Messrs. W. B. Carr, W. H. Harris, J. H. New, E. D. Till, T. I. Weston, and the Secretary.

The minutes of the previous meeting were read and confirmed.

New members were elected as under:—Mr. A. C. Clements, Solheim, Overbury-avenue, Beckenham; Mr. W. A. Hardy, Mill View, The Greenway, Uxbridge.

The Finance Committee reported that since the last meeting the accounts relating to prizes and sales at the late shows had been paid, and they recommended further payments amounting to £21. 10s. 4d., subject to approval by the Council. The report was endorsed.

A report presented on behalf of the Education Committee gave results attending the examination of candidates for third-class expert certificates at Navenby, Hampton, Sleaford, Hereford, Henbury, Leicester, Barnetby, Blankney, Northampton, Horley, and Hastings. The recommendations of the various examiners were approved by the adoption of the report.

The following resolution of the Berks B.K.A. was then brought forward for consideration:—"That, having regard to the expression of opinion that the judging of the Trophy class at the Manchester Show was

most unsatisfactory, and also the public statements of some of the judges that points were taken from the southern counties exhibits in favour of the northern counties, the Secretary is instructed to bring the matter before the British Bee-keepers' Association, and, if necessary, the Royal Agricultural Society, with a view to ascertain whether they endorse this, and if so, on what grounds such instructions were based, and why it was not stated in the schedule."

The Secretary having read the letters and resolution of the Berks B.K.A. *re* the Manchester Trophy judging, the Council came to the unanimous decision "That, as no protest was made by the Berks B.K.A. at the time of the judging of the trophies, it is impossible for the Council of the B.B.K.A. to now enter on any discussion of the subject."

The President thought considerable advantage would accrue if an article calling attention to the importance of the bee-keeping industry could be inserted in some one or more of the leading magazines, and Mr. W. H. Harris, with the support of the Baroness Burdett-Coutts, kindly undertook to endeavour to carry out the suggestion.

Attention was directed to a case recently tried before his Honour Judge Sir W. L. Selge, at the Romney County Court, the plaintiff claiming £25 for misrepresentation, or, in the alternative, for breach of warranty, in connection with the sale and purchase of bees found to be unhealthy. The result being considered of great importance to bee-keepers, it was resolved to, if possible, obtain a *verbatim* report of the evidence, together with a copy of the judge's notes.

A vote of thanks to the Baroness Burdett-Coutts for presiding, and suitably acknowledged, concluded the business.

IRISH BEE-KEEPERS' ASSOCIATION.

The Committee met on 2nd inst. Present: Mr. Farrelly (in the chair), Mr. Read, Mr. O'Bryen, Mr. Jenkins, Mr. Watson, and Mr. Chenevix (Hon. Sec., 15, Morehampton-road, Dublin). In accordance with a resolution passed at this meeting, the season for lectures at the Apiary, Model Farm, Glasnevin, will close about the middle of October. A certificate of competency as expert was granted to Mrs. Cronin, of Kilgarvan, co. Kerry.

THE COMING DAIRY SHOW.

We have now received the schedule of prizes to be offered for honey and bee-products at the Twenty-Second Annual Dairy Show, to be held at the Royal Agricultural Hall, London, on October 19, and three following days. It will be seen that the Dairy Farmers' Association are cordially supporting the B.B.K.A. so far as the section of their important annual exhibition specially devoted

to the bee industry. Liberal money prizes are offered in the ten classes for bee produce, and this year, for the first time, it is our pleasing duty to mention that the president, Sir James Blyth, Bart., is giving a "Champion prize" (value £2), for the best exhibit in the several classes, embracing extracted honey in jars, and comb honey in sections.

It will, no doubt, also be satisfactory to exhibitors, judges, and all concerned, to note that one item in the schedule on which opinions in past years have somewhat differed, is now altered. We allude to the class for extracted honey in bulk, which will this year be judged as honey alone. Another and separate class has, however, been added for "non-returnable packages," in which honey is sent by "parcels post." This class is not only a new and very important one to bee-keepers, but, as arranged, the exhibits will each undergo the best of all tests as to their efficiency, in that they will each be sent to the Show by parcels post, and be opened in the presence of the judges.

In view of the growing importance of this annual and only metropolitan exhibition of bee produce, there need be little doubt that the Show will receive the hearty support of our readers, and bee-keepers throughout the kingdom. We must not close without drawing attention to the date on which entries close, viz, Monday, the 20th inst.

KENT AND SUSSEX B.K.A.

ANNUAL SHOW AT HASTINGS.

The above Association held its annual exhibition at Hastings on August 24 and 25, in connection with the Sussex County Agricultural Society's Show.

There were 177 entries, including six trophies, and the quality of the exhibits was unusually fine, consequently competition was keen in all classes. The trophies were erected in a most tasteful manner, forming a first-rate exhibition of honey in themselves, several containing some 300 lb.; indeed, we believe the whole show was the most creditable display ever staged on behalf of the Association, and it promised to be an unexampled success; unfortunately, however, on both days of the show thunderstorms and downpours of rain kept away many visitors. The effect of the unfavourable weather was such that comparatively few visited the show, and, in consequence, what would have been an exceptionally favourable opportunity for disposing of the fine collection of honey to visitors—with whom the favourite watering-places of Hastings and St. Leonards were thronged—was unfortunately lost.

On the second day of the show an examination of candidates for third-class certificates of the B.B.K.A. was held, Mr. W. Broughton Carr being the examiner. Six candidates presented themselves.

Messrs. W. Broughton Carr, R. Hamlyn-Harris, and E. H. Young undertook the duties of judging, and made the following awards:—

Observatory Hive, with Bees.—1st, J. S. Greenhill, Wimbledon; 2nd, Arnold King, St. Leonards; 3rd, G. C. Lyon, Hastings.

Twelve 1-lb. Sections.—1st, J. Moreton Lord, Northiam; 2nd, A. Hounson, Bosham; 3rd, E. Longhurst, Longfield; v.h.c., G. Maule, Westfield; h.c., Rev. W. R. Nightingale, Worthing; c., Miss Winifred A. Parkes, Ashford.

Twelve 1-lb. Jars Extracted Honey.—1st, E. Longhurst; 2nd, J. H. Seabrook, Longfield; 3rd, H. Dobell, Marden; h.c., Thos. Shipley, Folkington; c., Miss W. A. Parkes.

Three Frames of Comb Honey.—1st (and silver medal K. and S.B.K.A.), A. J. Carter, Billingham; 2nd, Miss W. A. Parkes; 3rd, E. Longhurst; v.h.c., Geo. Wells, Eccles, and G. W. Tompkins, Marden; c., D. E. Shortell, St. Leonards.

Twelve 1-lb. Jars Extracted Honey (open).—1st, G. Dew, Hawkhurst; 2nd, J. Fairall, Hellingly; 3rd, W. Robinson, Rye; v.h.c., Rev. W. R. Nightingale and J. Moreton Lord; h.c., R. Matthews, jun., Polegate.

Honey Trophies (weight not limited).—1st (and silver medal B.B.K.A.), J. Moreton Lord; 2nd (and bronze medal B.B.K.A.), E. Longhurst; 3rd (and certificate B.B.K.A.), Arnold A. King; v.h.c., G. C. Lyon; h.c., H. F. Neve, Heathfield.

Six 1-lb. Sections (Cottagers).—1st, A. Hounson; 2nd, J. Playford, Staplehurst; 3rd, H. Dobell.

Six 1-lb. Jars Extracted Honey.—1st, W. Loveday, Harlow; 2nd, J. Playford; 3rd, G. Dew; h.c., J. Bailey, Staplehurst; c., G. Fairs, Mundham.

Super of Honey.—1st, G. Dew.

Single 1-lb. Jar Extracted Honey.—1st, W. Loveday; v.h.c., J. H. Seabrook, J. Bailey, J. Moreton Lord, J. Fairall, E. D. Till, W. Robinson, T. Evershead, G. Dew, and Rev. W. R. Nightingale; h.c., H. J. Blacklock.

Single 1-lb. Section.—1st, H. Crowther, Pembury; v.h.c., M. Kilner, Billingham; G. Fairs; A. Chapman, Pembury; and A. Hounson; c., G. Dew.

Beeswax.—1st, J. Fairall; 2nd, E. Longhurst; v.h.c., W. Loveday.

Mead.—1st, E. Longhurst; 2nd, Will Pether, Henley.

Collection of Appliances.—1st, Jas. Lee & Son, Holborn, London; 2nd, J. S. Greenhill, Wimbledon; 3rd, T. Lanaway & Son, Redhill.

Complete Frame Hive.—1st, Jas. Lee & Son; 2nd, J. S. Greenhill; 3rd, Jas. Lee & Son; c., T. Lanaway & Son.

Frame Hive (cost not over 10s.).—1st, T. Lanaway & Son; 2nd, Jas. Lee & Son; 3rd, J. S. Greenhill.

New and Useful Objects of Interest.—Silver medal, Jas. Lee & Son; certificate, Miss Baden Powell, Hyde Park, W.

WILTS BORDER CO-OPERATIVE

B.K.A.

SHOW AT NESTON.

In conjunction with the annual Neston Flower Show, held, as usual, in the beautiful park of J. P. Fuller, Esq., on the 4th ult., the Wilts Border Co-operative Bee-keepers' Association held a capital exhibition of bees and honey. The bee department has grown so much that this year a separate tent was occupied by the apicultural exhibits, the marked improvements in which testified to the success with which the Association has laboured to promote bee-keeping on the best principles.

Mr. E. Martin and Mr. Cameron judged the honey exhibits, and made the following awards:—

Observatory Hive.—1st, T. Owen; 2nd, J. W. Spencer.

Twelve 1-lb. Sections.—1st, T. Owen; 2nd, H. Frankham; 3rd, F. Lodge.

Six 1-lb. Sections.—1st, Joseph Barnett; 2nd, F. Sheppard; 3rd, Tom Clark.

Twelve 1-lb. Jars Extracted Honey.—1st, T. Owen; 2nd, F. Lodge; 3rd, H. Frankham.

Six 1-lb. Jars Extracted Honey.—1st, Joseph Barnett; 2nd, F. Sheppard; 3rd, E. J. Brown.

Collection of Honey Arranged for Effect.—1st, H. Frankham; 2nd, T. Owen.

Super of Honey.—1st, H. Frankham; 2nd, Tom Clark; 3rd, George White.

Frame of Comb Honey.—1st, Tom Owen; 2nd, Joseph Barnett; 3rd, H. Frankham.

Honey Comb (above 4-lb.).—1st, H. Frankham; 2nd, T. Owen; 3rd, Joseph Barnett.

Extracted Honey.—1st, T. Owen; 2nd, F. G. Brown; 3rd, F. Lodge.

Wax.—1st, F. Lodge; 2nd, T. Owen; 3rd, H. Frankham.

One-pound Section.—1st, Joseph Barnett; 2nd, T. Owen; 3rd, H. Frankham.

Greatest Number of Queen Wasps.—1st, H. Hulbert; 2nd, F. Rogers; 3rd, F. K. Rogers.

Mrs. Fuller's Prize to the Most Efficient Student in Mr. Spencer's Bee Class.—Tom Clark.

Ornamental Design in Beeswax.—1st, T. Owen; 2nd, H. Frankham; 3rd, J. W. Spencer.—(Communicated.)

Correspondence.

The Editors do not hold themselves responsible for the opinions expressed by correspondents. No notice will be taken of anonymous communications, and correspondents are requested to write on one side of the paper only and give their real names and addresses, not necessarily for publication, but as a guarantee of good faith. Illustrations should be drawn on separate pieces of paper. We do not undertake to return rejected communications.

NOTES BY THE WAY.

[2988.] We are now drawing near to the close of the bee season of 1897, and our aim should be to get our stocks into condition suitable for

their prosperity during the autumn and winter months. First see that every stock has a prolific queen, next that the hive contains a good supply of stores, and if any colony requires feeding to make up the required quantity the food should be given at once, and in such quantities as the bees will take down during the night. The best time to feed,

queen, then sprinkle the bees in the hive with flour, also those to be joined to them; then shake the driven lot on the top of frames, which must be spaced a little distance apart. Next lay on a single quilt, not heavy enough to injure the bees. Replace the frames when the bees have quieted down. Flour is a wonderful pacifier of bees, and "uniting"

COUNTY HONEY TROPHIES AT "ROYAL" SHOW, 1897. (No. 4.)



FOURTH PRIZE, KENT B.K.A.

according to my experience, is in the evening, after the bees have become quiet for the day. If only two or three hives are kept there is little danger of robbing, but in larger apiaries robbing, once started, is difficult to quell, and oftentimes results in the loss of the stock attacked. Those of our fraternity who build up stocks, or replenish weak ones with driven bees at this period, should first capture the

is done without the loss of a single bee from fighting.

I have used flour three or four times this season with direct introduction of virgin queens into queenless colonies. This saves trouble and time, not only to the bee-keeper, but also to the bees. I hope to give the matter further trial next year.

Marketing Honey.—I am asked how to pre-

pare honey for sale, how to sell it when prepared, and how to pack it so that it may travel safely by rail. To the first I say glaze sections in clean white paper. Get a roll of white paper from the paperhanger, and cut with a sharp knife on a board with a "straight-edge" to the desired width. Or if a more ornamental style is desired, get some laced-edged paper as advertised in the B.B.J., and by bringing the lace part little less than half-an-inch over the glass on front of each section, it adds greatly to the saleable appearance of the honey.

How to sell and where to find a market or name a price for produce one has not seen is a difficult matter. I find that prices vary considerably in different parts of the country, one can sell readily at 1s. or 1s. 3d. per section, while in another district only 6d. or 8d. per section is realised. I have not noticed the familiar advt. of "H." in your pages this season. Is there any special reason for this omission? [We regret to say the advertiser referred to died some months ago.—Eds.]

Then as to packing honey: I still use grocers' "empties," cube-sugar boxes, for five or six dozen, Sunlight Soap boxes for five dozen, Price's candle boxes for three or three and a half dozen sections, all of which are tied in parcels of six or twelve as required by the dimensions of the box. First put cord handles at each end of box for the larger quantities and pack in hay or barley straw: first a layer of hay, next a layer of parcels, then another layer of honey, and hay over the top. Nail securely down and you will rarely get a breakage.—W. WOODLEY, *Beeton, Newbury.*

MEAD.

[2989.] I see that the subject of mead is again cropping up in to-day's issue of your *Journal*, and as there must be many of your readers, besides Mr. Titherley (2987, p. 344) anxious to know the best materials to use in its manufacture, the following remarks may at least interest them.

I have read Mr. Banck's most instructive pamphlet, and agree in the main with his suggestions.

From the biological point of view, the main conditions necessary to produce the best article are:—

1. Sterilisation of the saccharine fluids and of all the utensils (not forgetting the bottles and even the corks).

2. The introduction of a pure yeast culture.

The first of these conditions is accomplished by carrying out Mr. Banck's instructions in pouring boiling water into all surfaces that may come in contact with the liquor, and by keeping the mash out of contact with air as far as possible; also by boiling the liquors before addition of yeast. If bisulphite of lime is used for sterilising the containing vessels, I should advise a subsequent washing with boiling water.

The second condition (use of pure yeast culture), is in practice more difficult to accomplish.

Ordinary yeast varies so much in quality that I strongly recommend the mead brewer to spare no pains in securing the best that can be made. I know of no better way than to obtain it from a large brewery where an efficient chemist has the control of this department. This chemist could—and doubtless would—supply a fresh yeast, practically free from those foreign organisms which not only produce inferior malt liquors, but very inferior mead.

The addition of ginger, cloves, &c., is a matter of taste; but if used in other than very minute quantity masks the true flavour and distinctive character of mead.—J. H. LESTER, M.Sc., F.I.C., *September 2.*

PARASITES ON BEES.

[2990.] I thank you for reply to my last. May I trouble you again? Having sought for and found the queen once, it is now quite an easy matter to pick her out, but some of my queens (and workers too) are very much infested with little parasites, which cling to their backs and sides. One queen I saw had quite half-a-dozen of them on her. They are of reddish appearance, and small spider-shaped. Do they do any harm to the bees, and, if so, can they be got rid of by placing something in the hive, such as camphor or naphthaline, and how much should I put in so as not to injure the bees? In one of my hives some of the brood is only partly sealed over, and the white pupae can be seen. What is the cause of this?—H. F. M., *Stevenage, August 27.*

[1. The parasite referred to is that of the Braula Coeca or blind louse. For particulars regarding this bee-pest refer to our issue of October 8, 1896, page 408. 2. The appearance noted death of the larvae before being sealed over. We cannot judge why death should so take place unless a piece of comb, with dead brood in it, is forwarded for inspection.—Eds.]

GOSFORTH AGRICULTURAL SOCIETY.

A BEE ASSOCIATION WANTED FOR CUMBERLAND.

[2991.] Will you kindly allow me space in the BEE JOURNAL to say a word on the wonderful amount of interest taken in the honey section of the above society's annual show at Gosforth? This is only the second year in which bee-keepers have had a chance of coming to the front, and it is in this case owing to the generosity of Mr. Miles Postlethwaite (who gave five guineas for prizes in the first three classes) and Mr. B. Matterson (who gave two guineas in the other classes) that the prizes could be offered; but it shows how great a pity it is that we have no bee-

keepers' association for West Cumberland. I feel sure that if once a start were made it would get on well. I enclose the prize list from local newspaper for your inspection.—*J. B., West Cumberland, September 6.*

[We are very pleased to give insertion to above, together with prize list, which follows.—Eds.]

Class 1. *Observatory Hive*.—1st, Jon. Branthwaite, Rowrah; 2nd, James Finlay, Hensingham.

Class 2. *Collection of Appliances*.—1st, Joseph J. Cowan, Egremont.

Class 3. *Display of Extracted Honey*.—1st, James Finlay; 2nd, Joseph Key, Arlecdon Parks; 3rd, Jon. Branthwaite.

Class 4. *Best and Most Complete Hive Made by an Amateur*.—1st, J. J. Cowan; 2nd, W. Townson, Ravenglass; 3rd, J. Finlay.

Class 5. *Twelve 1-lb. Sections*.—1st, Jos. Key; 2nd, J. Finlay; 3rd, Jon. Branthwaite.

Queries and Replies.

[1817.] *Uniting Driven Bees*.—Would you kindly answer the following query? I am by no means a novice at bee-keeping, but the problem has never occurred to me before, and is not solved in any book I have. Bearing in mind then that weather and distance, however, absolutely forbid collecting all the driven bees at once, my query reads thus:—Several lots—some very small—of driven bees are run into a frame-hive but not enough to make a good stock; some days later more are obtained. What is the best method of uniting them to those previously got? To run them in would probably result in fighting, and yet to put them into a frame-hive on sheets of foundation and then unite is round about, and would cause unnecessary comb to be built and take it out of the bees. The first lot, having seven frames only partly built, could hardly spare any for the newcomers.—D. D. B.

REPLY.—In uniting it will need careful handling of the partly built-out combs to avoid a breakdown, but for the rest proceed as follows:—Uncover a few frames, lift out one and brush the bees gently off the comb (with a feather) on to the flight board, as they run in dust them with flour from a dredger; then replace the comb. Do the same with a second frame, and as the bees run in throw on to them one of the lots of driven bees, dusting them also, and allowing the whole to run in together, no fighting will follow.

[1818.] *Dealing with Foul Brood*.—I should feel obliged if you could advise me on the following:—I have six swarms in hives which has had foul brood very bad through the summer. I reported this to you for advice, and you referred me to the "Guide Book" which I had in my possession at the time. In the early summer, after finding that I had foul brood in my apiary, I had eleven lots of bees;

so I united and fed on medicated syrup until honey was coming in freely. I then put on sections and shallow-frames in supers, and the result has been a very good harvest, ranging from 40 lb. to 70 lb. of comb and honey per hive. Our honey harvest being now over I examined them quite recently and got them reduced to ten frames for each stock, and found there were still signs of the disease in hives, but the larvae were looking quite healthy and white, very few turning yellow as they do in first instance. Would you advise me to get them on full sheets of foundation and feed them with medicated food, and put them into clean disinfected hives now, or in the following spring? I have a bee-house 20 ft. long; a rather warm place by day inside now, and having a lot of driven bees offered me, would it be advisable to unite one lot of these to each of my stocks? Or would you make separate stocks of them? Also will bees unite when driving into the skep without sprinkling flour or scented syrup over them?—S. SHARFOTT, Cornwall.

REPLY.—1. Cut out the few affected cells, and medicate all food given. 2. Don't add driven bees except to weak lots. 3. Yes.

[1819.] *Extracting from Skep Covers*.—In accordance with the instructions given in your journal, I placed a skep on a frame hive in the month of April last, and removed it last week. There was no brood in it, and the whole weighed 40 lb. I find, however, that it is not so easy to extract the honey. I have uncapped the combs, and broken them up into small pieces, which I have placed in the drainer of a honey-ripeners. Will this be sufficient? If not, how could it be squeezed? 2. Is there any objection to leaving unfinished shallow frames over the hive during the winter months?—G. G., Honiton, August 27.

REPLY.—1. It may be necessary to stand the "ripeners" before the fire before the honey will drain out. The extractor would have removed it much easier if uncapped neatly and combs not crushed. 2. If partly filled with honey, we should not leave the frames over the hive for winter unless the bees had access to them.

WEATHER REPORT.

WESTBOURNE, SUSSEX, AUGUST, 1897.

Rainfall, 4.39 in.	Above Average, 8.4 hours.
Heaviest fall, .95 on 26th.	Mean Maximum,
Rain fell on 20 days.	66°.
Above average, 1.91 in.	Mean Minimum,
Maximum Temperature, 80° on 4th.	53.1°.
Minimum Temperature, 46° on 26th.	Mean Temperature,
Frosty Nights, 0.	59.5°.
Sunshine, 206.8 hours.	Above average, .5°.
Brightest Day, 4th, 13.5 hours.	Maximum Barometer,
Sunless Days, 1.	30.31° on 3rd.
	Minimum Barometer,
	29.60° on 21st.

L. B. BIRKETT.

METEOROLOGICAL OBSERVATIONS.

Taken at the Mid-Lothian Asylum, Rosslyn Castle, for the week ending Sunday, September 5, 1897:—

Mean Height of Barometer	29.531
Mean Temperature.....	57.
Highest Point of Thermometer (August 31)	65.
Lowest Point of Thermometer (September 4).....	34.
Mean Dew Point of Temperature ...	49.4
Solar Radiation	71.6
Terrestrial Radiation.....	36.7
Rainfall in Seven Days.....	1.43
General Direction of Wind	W.

NOVELTIES FOR 1897.

THE NEW "RAITT HONEY PRESS."

(Patent applied for.)

Mr. Meadows, who has just introduced the above novelty to the notice of bee-keepers, writes of it as under:—"This is an entirely new departure in honey presses, and without doubt the simplest and best ever made. The honey is squeezed out between perforated corrugated plates, the pressure commencing at the bottom, the honey being gradually forced through the perforations in its upward movement.

"A shallow-frame as taken from the hive can be placed intact into the press; the comb and honey is taken out by pressure, leaving the frame whole and free from either honey or wax. During the 'pressing' the honey is allowed to run into the tin receiver, after which a loose perforated drainer slides under the press to receive the wax, &c., upon the press being opened. When this is done the wax is scraped off the plates with a serrated scraper (sent with each press), the tray again slides back, and the press is again ready for use.

"This appliance is the result of very exhaustive trials, and is guaranteed to answer all that is claimed for it."

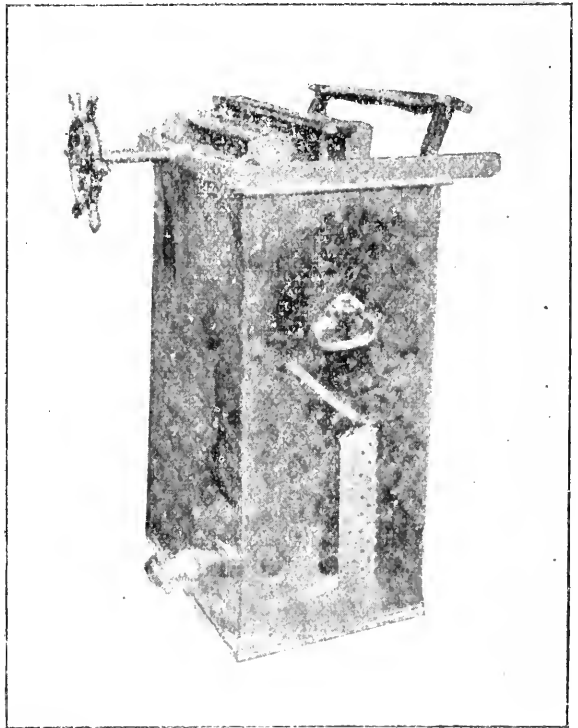

PREPARING HONEY FOR MARKET.

In this locality, the crop of white honey will all be off the hive by the middle of August, when we are ready to commence to prepare it for market. In order that the honey may be ripening and growing better every day after it leaves the hive, the honey-room should be kept at a temperature of from 85 deg. to 90 deg.

if possible, for with this temperature the honey will be thickening and growing better in the cells, which will give it a fine appearance, instead of that watery, unattractive look which will soon come to comb honey that is stored in a cellar, or other damp, cool place.

Some bee-keepers work hard all the season to secure a crop of honey, then store it in such an unsuitable place that when it reaches market they do not get nearly so much for their labour as they would did they spend more thought on having their product reach the market in attractive shape. If the proper temperature in the honey-room cannot be kept up otherwise, an oil-stove will be found an excellent thing to do it with, as the flame can be so regulated by a proper manipulation of the wicks, that the desired temperature can be maintained at all times.

Many of our Eastern bee-keepers store their honey in an upper room, or attic to the house; and where this can be done without too much lugging and lifting, there is no better place to

store honey. The hot noon-day sun heats this upper room and thoroughly dries every part of it, thus causing the pile of honey to become very warm before the sun sinks behind the western hills, while the heated pile of honey keeps the temperature of the room up till well toward morning, thus keeping an even temperature of a high degree, which will cause even the honey in the unsealed cells next the sides

of the sections to become ripened to a degree sufficient to keep it from running out, which otherwise would be the case. All know how annoying it is to pick up a section of honey and have the honey from the few unsealed cells drip about the floor, and on the hands and clothing, as it always will do if the section is left a few days in a damp place.

Having the honey stored in so high a temperature as is necessary for its thorough ripening, causes the eggs of the wax-moth to hatch on the combs, should there happen to be any such eggs on them; therefore it is best to look at the honey often so as to detect these worms as soon as possible after they hatch from the egg. If little flour-like lines are seen on many of the combs, this shows that the larva has commenced its work, and the honey should be sulphured, as I directed in a former number of the *American Bee Journal*.

In two or three weeks' time the honey will be thoroughly ripened, when we are ready to go about preparing it for market. All propolis or bee-glue should be carefully removed from each section. This is best done with an old table or other knife which has its blade broken or cut off within one or two inches of the handle, when by filing or grinding the portion left at right angles, we have square corners on all sides, which seem to be just right for taking off the bee-glue without cutting into the wood. Have your crate by your side, and as fast as a section is cleaned, pack it nicely away in the crate, keeping on till it is full.

In crating honey it is always proper to put the most perfect side of the sections out where they will be seen, the same as in doing up wool, putting fruit on a fruit-stand, &c. I once knew a man to tie up his wool with the dark or outside ends out, and he could hardly sell it at any price. Why? Not because the wool was not just as good, but because it did not look as well. Just so with a crate of honey. Market men, or any customers, want the best side out; but don't make the mistake some do, and fill up the centre of the crate with dark or inferior honey.

Grade the honey, making three or more grades of it, and then put the best side of each grade out, where it will be in sight. In No. 1 put nothing but strictly white honey, or what is termed by some "fancy" honey. In No. 2 put such white honey as may have combs slightly coloured, or those having an uneven surface, or a few unsealed cells. In No. 3 that which is still more inferior. Then have a grade for dark honey, &c.; but keep an eye out that none of an inferior grade finds place in any crate bearing a more perfect number.

When the crate is full, if you wish to have it "gilt-edged," put on the cover with bright round-headed screws. This gives the crate a nice appearance, does not tend to break the honey by driving nails, and the cost is but a trifle more. To make still more attractive, sandpaper off the sharp corners and top of the

crate, when it is ready to pack nicely away for shipment, when a sale is made, or to show to purchasers, or any company who may chance to call in.

Bear in mind, comb honey sells from looks more than anything else, and the nicer the appearance the better price it will bring.—G. M. DOOLITTLE, in *American Bee Journal*.

Bee Shows to Come.

September 8 and 9, at Derby.—Sixteenth Annual Show Derbyshire B.K.A., in connection with the Derbyshire Agricultural Society. Nineteen classes and over fifty prizes for bees, honey, and appliances. Schedules from F. Walker, Hon. Sec. D.B.K.A., Cattle Market, Derby. **Entries closed.**

September 25, in the Corn Exchange, Jedburgh.— Roxburghshire B.K.A. Annual Honey Show. Twenty-six classes for honey, wax, and sundries. **All open.** A single entry fee of 2s. covers all classes. Schedules from Thos. Clark, Pleasants Schoolhouse, Jedburgh, N.B. **Entries close September 21.**

October 19, 20, 21, and 22, at the Agricultural Hall, London.—Show of Honey and Bee Products in connection with the British Dairy Farmers' Association. Over 40 prizes (including the President's "Champion" Prize, value £2, for the best exhibit of honey). Schedules (now ready) from Mr. C. Young, Sec., 12, Hanover-square, London, W. **Entries close September 20.**

November 18, 19, and 20, at the Waverley Market, Edinburgh.—In connection with Chrysanthemum Exhibition Show, the Scottish B.K.A. will hold a Honey show as above, at which very liberal prizes will be offered (see advertisement on page v). Schedules from Rev. R. McClelland, Hon. Sec., The Mause, Inchman, Renfrew.

HONEY SHOW AT BRAMHALL.

The annual show of the Bramhall and Woodford District Horticultural Society was held on Saturday, the 4th inst., in the grounds of Bramhall Hall, and in connection therewith a section was set apart for honey and wax, confined to a radius of twelve miles and members of the Lancashire and Cheshire Bee-keepers' Association.

There was a very satisfactory entry for extracted honey and wax; nineteen entries of the former, and six for wax. The entries for sections of comb honey were less satisfactory, a result, no doubt, attributable to the unfavourable season in the district.

The quality of the honey was excellent, and the competition very keen. Dr. B. E. Jones, Secretary of the L. and C.B.K.A., acted as judge, and made the following awards:—

Twelve 1-lb. Jars Extracted Honey.—1st, S. Woodward, Kingsley; 2nd, P. H. Rawson, Market Drayton; 3rd, W. Forrester, Huyton; v.h.c., Richard Dodd, Tarporley, and Owen Roberts, Tarporley; h.c., Percy Hinde, Liverpool, and Josh. Wrench, Hartford.

Twelve 1-lb. Sections.—1st, Richard Dodd.

Beeswax.—1st, Robert Chappel, Mottram, St. Andrew; 2nd, A. Horton, Alderley.—(Communicated).

Notices to Correspondents & Inquirers.

All queries forwarded will be attended to, and those only of personal interest will be answered in this column.

Referring to reply to "Burdett Mason (*Basses Pyrénées*)," page 289 of B.J. for July 22 last, our senior editor writes from California, U.S.A.:—"The bees alluded to are the ordinary brown bee of France, and similar to the common bees of the British Isles."

G. F. D.—*Making Observatory Hive*.—1. A space of half an inch should be allowed between face of comb and the glass of an observatory hive for show purposes. Nothing looks worse than to see bees crushed and imprisoned between glass and comb on the show-bench. 2. Wax made entirely from cappings cannot turn out "nearly black" in colour if the vessel used was clean. We cannot explain discolouration. 3. Only an experienced eye can make a safe guess at age of queens. Old ones usually have ragged wings, and a good deal of the pubescence rubbed off the abdomen, but not always.

H. R. (Monmouth).—*Dark Honey*.—The sample sent is certainly dark in colour, but by no means so bad as our correspondent seems to regard it. If kept till it granulates, the colour will not tell against it, and as the flavour is fairly good, we should advise keeping it on hand till winter or spring. Then put it on the market.

INQUIRER (Little Haywood).—*Source of Honey Supply*.—The honey sent is sufficiently characteristic in flavour to be called "sainfoin honey," but there is no sound reason for maintaining that it is from that plant only. In fact, it is seldom that an unmixed sample of honey from one plant only can be had.

EDNOR (Whalley Range).—*Honey Samples*.—The honey sent is fairly good in flavour, and is, we think, mainly from lime blossom. It is, however, suggestive of the bramble or blackberry bloom. There is no ground for the suggestion of the "forage being dirty." Though its colour will tell against it for sale purposes it is not at all a bad sample for household use.

A. B. (Didsbury).—*Kinds of Bees in a Hive*.—It is an error to speak of the several kinds of bees in a hive as queen, drones, workers, and neuters. The workers *are* neuters. In other words, a neuter is an undeveloped female, *i.e.*, a worker bee.

A. B. B. (Burton-on-Trent).—*Quality of Honey*.—1. Honey as sample sent is only fit for leaving in the hive as food for the bees. 2. Lime honey is fairly light in colour, and usually has a greenish tinge. It is classed among light honey's, unless the colour be spoiled by honey-dew.

J. B. S. K. Y. (Notts).—*Number of Frames for Wintering on*.—1. If the bees are sufficiently numerous—when packing down for winter—to cover the whole eleven frames

they may certainly be left in the hive, but if not we advise removal of all not so covered. Those taken away and containing honey may be given in early spring as food is needed. 2. If combs are as stated, "half filled with honey," eight or nine of them would contain ample stores for winter.

H. ROBERTS (Bridgewater).—*Suspected Comb*.—There is nothing worse than pollen in comb received: no sign of any brood at all. It is, however, very old, and sadly needs renewing.

JOHN RANDALL (Surrey).—Through being wrongly addressed, reply to your queries has been delayed for a good many days. 1. It is rarely of much use giving racks of sections for filling to skeps which have already swarmed this year; nor is there now the slightest chance of them being worked in. We should remove sections at once, and if the skeps are well supplied with food for winter, pack down and let them remain as they are till spring, when they may be set above frame-hives, as proposed, and allowed to transfer themselves below. The skeps should weigh at least 25 lb. each now, to be safe for winter; 30 lb. will be better.

W. J. T. (Matton).—*Candy for Driven Bees*.—1. You will find full particulars for candy-making in *Guide Book*. 2. Candy is not suitable for driven bees when first hived. It will be far better to give them a large bottle of syrup, holding seven or eight pounds, if you cannot attend to the bees for some days after hiving.

DRAGON (Birmingham).—*Packing between Outer Case and Hive in the "W.B.C." Hive*.—Personally we do not fill in the space referred to at all in winter. We have sometimes, in early spring, used old newspapers to fill up the vacuum when breeding was just starting in earnest, but it is not essential if stocks are fairly strong.

AQUARIUS (Oxon).—*Preserving Legs of Hive Stands*.—We usually hold each leg in the flame of a wood fire till well scorched, but *not burnt*.

C. H. (Droitwich).—*Transferring Bees from Skeps*.—Considering the lateness of the season, leave the skeps as they are and place them on bar frame-hive as before early next spring. If bees in the one already on frame-hive have not worked down, remove frame-hive and place skep in its position, and treat as advised above. See that the bees have abundant supplies.

T. A. (Perthshire).—*Two Queen Larva in One Cell*.—The cell received is the first instance which has come under our notice where two queen larva have so nearly developed in one cell. It is a very rare occurrence.

J. P. (Folkestone).—*Hives for a Bee-House*.—Shallow boxes have been tried, and discarded in favour of hives holding standard frames for brood chambers. We advise light single-walled hives of full size for use in the bee-house.

Editorial, Notices, &c.

DERBYSHIRE B.K.A.

ANNUAL SHOW.

The annual show of the above Association was held in the grounds of the Derbyshire Agricultural Society on September 8 and 9. The number of exhibits was greater than last year, and the competition most keen. Honey in the comb was scarcely up to the usual standard of excellence, but the run honey was exceptionally fine, especially in the open classes. The eight exhibits specially mentioned in Class 13 were excellent samples, and secured the closest attention from the many connoisseurs who inspected them. In the class for display of honey in any form, Mr. Stone eclipsed all competitors by the neatness and beauty of his display, although the other six exhibits reflected the greatest credit upon their owners. A special feature of the show was the trophy staged by Mr. F. Walker (hon. sec.), which received a special prize (silver medal). Inability to secure honey sufficiently early prevented this trophy being exhibited at the Royal Show at Manchester. The classes for bees in observatory hives were well filled, twelve exhibits being staged. The arrangements of the tent were planned and carried out by Mr. F. Walker, to whom great credit is due, as the thousands who visited the tent during the two days of the show could inspect the exhibits without discomfort. Mr. C. N. White, Somersham, judged the local exhibits; Messrs. R. Giles and T. W. Jones, Etwell, awarding the prizes in the open classes.

The awards were as follows:—

Bees in Observatory Hive (with or without super).—1st, J. Pearman, Derby; 2nd, H. C. Jacques, Burton-on-Trent; 3rd, T. Richards.

Bees in Observatory Hive.—1st, T. Richards; 2nd, H. Hill, Ambaston.

Display of Honey in any Form.—1st, and gold medal, J. Stone, C'ubley; 2nd, and silver medal, G. H. Varty, Burnaston; 3rd, and bronze medal, H. Hill; 4th, T. Richards.

Beeswax.—1st, H. Meakin; 2nd, J. Kirkland; 3rd, J. Stone; 4th, H. Hill.

Twelve 1-lb. Sections (members only).—1st, and silver medal, W. G. Sale, Ashby-de-la-Zouch; 2nd, J. Meynell; 3rd, J. Stone; 4th, H. West.

Twelve 1-lb. Jars Extracted Honey.—1st, and silver medal, J. R. Bridges, Chesterfield; 2nd, and bronze medal, J. Stone; 3rd, H. C. Jacques; 4th, J. Pearman.

Honey Products.—1st, H. Hill.

Comb Honey, not exceeding 15 lb. (labourers only).—1st, and bronze medal, G. N. Foster.

Extracted Honey, not exceeding 15 lb. (labourers only).—1st, and bronze medal, H. West; 2nd, G. Thornhill; 3rd, G. N. Foster.

Six 1-lb. (Blow's) Sections.—1st, T. Walker.

Six 1-lb. Jars Extracted Honey, in Blow's Bottles.—1st, T. Walker.

OPEN CLASSES.

Twelve 1-lb. Sections.—1st, J. Berry, Llanrwst; 2nd, P. H. Rawson, Market Drayton; 3rd, H. O. Smith, Louth; v.h.c., W. Patchett, Thorsway; h.c., E. Lloyd, Llanwrda; and R. Brown, Somersham.

Twelve 1-lb. Jars Extracted Honey.—1st, W. H. Woods, St. Ives; 2nd, P. H. Rawson; 3rd, W. Loveday, Harlow, Essex; 4th, R. Dodd, Tarporley; v.h.c., H. W. Seymour, Henley-on-Thames; h.c., T. B. Osborne, Hunts; H. O. Smith; and W. J. Norman, Bridport.

Twelve 1-lb. Jars Granulated Honey.—1st, R. Brown; 2nd, W. Lee; v.h.c., H. W. Seymour.

Single 1-lb. Section.—1st, J. H. Rawson; 2nd, H. O. Smith; 3rd, G. H. Varty.

Single 1-lb. Jar Extracted Honey.—1st, J. H. Rawson; 2nd, W. Loveday; 3rd, W. Patchett.

Collection of Appliances.—1st, G. H. Varty.
CONSOLATION PRIZES. (GIVEN BY MR. G. H. VARTY.)

Six 1-lb. Sections.—1st, S. Poulson; 2nd, T. Haynes; 3rd, H. J. Morris.

Six 1-lb. Jars Extracted Honey.—1st, T. Haynes; 2nd, W. Loveday; 3rd, W. Glover.—(Communicated.)

HONEY IMPORTS.

An account showing the value of honey imported into the United Kingdom during the month of August, 1897, £1,987.—From a return furnished to the BRITISH BEE JOURNAL by the Statistical Office, H.M. Customs.

Correspondence.

The Editors do not hold themselves responsible for the opinions expressed by correspondents. No notice will be taken of anonymous communications, and correspondents are requested to write on one side of the paper only and give their real names and addresses, not necessarily for publication, but as a guarantee of good faith. Illustrations should be drawn on separate pieces of paper. We do not undertake to return rejected communications.

THE BRITISH B.K.A.

AND ITS AFFILIATED ASSOCIATIONS.

[2992.] You very kindly opened your columns a few weeks since to discuss the question of judging in the Trophy Class at the Royal Show, Manchester, the result of which revealed differences of opinion in the minds of the judges, so much so that a good many people who have interested themselves in the matter came to the conclusion that some of those who undertook the responsible post of judge at that show, did so with strangely

erroneous ideas as to this particular class. Without in any way wishing to upset or disturb the decision of the judges, but rather with the hope of preventing a repetition, the Council of the Berks B.K.A. passed the resolution quoted on page 352 in your last issue, with the result, as there stated, that the British B.K.A. treat the question in a way that can hardly be called courteous to our Association. Now, sirs, if this is the way the Council of the B.B.K.A. propose to further the cause of bee-keeping and to retain the confidence of its members, it will not be wondered at if they do not receive that cordial support which its objects entitle it to, and which every well-wisher of our cause is anxious to give it. With your permission I will briefly state the leading—and strict—facts of the case :—

The Manchester local committee offer prizes for the "Best and most attractive Display of comb and extracted honey, &c., &c."

The British B.K.A. frame the schedule and lay down the conditions of the competition. You, yourselves, Messrs. Editors, took considerable trouble in your columns from time to time to make those conditions clear, and, I believe, each one of the counties who entered knew perfectly well what they were, and, I believe, kept to them. The result of the judging I need not now dwell upon further than stating that while deeply disappointed as the Berks Association were, they had decided to accept the decision of the judges as final. But, arising out of the controversy, one of the judges put forward in your issue of July 8 (page 262) the following astounding statement :—

"When the schedule was being prepared by the Council of the B.B.K.A. it was felt that if honey alone was to decide the merits of the Trophy class the southern counties would have undue advantage, as they would be able to stage a larger quantity of this season's honey than the northern counties, and it was a question whether, being thus handicapped, they would enter the competition; the schedule was framed to meet this, and the exhibits judged accordingly."

On page 272 of B.B.J. Mr. H. W. Brice denies this statement as follows :—"I beg to differ from Mr. Hooker's view, which is, to my mind, erroneous and misleading. I also aver that the Council of the B.B.K.A. 'felt' nothing of the kind; it was mentioned on the occasion referred to (as I recollect quite well), that certain counties would be able to stage some of the current year's produce, while others fail in this respect; but it was also 'felt,' and the feeling was given expression to, that the honey staged should stand on its merits without consideration as to its being of the 'current' or any year's gathering."

It was upon the marked difference in these two statements that the resolution of the Berks B.K.A. was based, and it was felt that they had a right to expect a satisfactory

answer, failing which my instructions were to refer the matter to the Royal Agricultural Society. We are as anxious as any one that our differences shall be kept within our own circle; but is the B.B.K.A. helping us to do so by their action? It amounts to taking refuge in a technical omission (which does not affect the case) to gloss over a grave scandal which will tend to destroy all confidence in the judging of the future. They practically say: no matter how erroneous may have been the ideas of the judges we will support them whether they are right or wrong. This may be very heroic, but not calculated to gain respect. Better far to have fairly met the matter and told us Mr. Hooker was either right or wrong, and if right, to have stated why the condition was not mentioned in the schedule. Their position would then have been logical, and no one would wish to condone a mistake to which all are liable when frankly admitted; and it is with the hope that we may yet get the matter cleared up that before taking further action in the matter, I ask you to find room in your columns for this letter.—A. D. WOODLEY, Hon. Sec. Berks B.K.A., 17, Market-place, Reading, September 13.

[While freely giving insertion to the above communication, we cannot help expressing our personal opinion that it would have been well if the Association Mr. A. D. Woodley represents as Hon. Sec. had realised the fact that the Council of the B.B.K.A. had really no other course open to them than dealing with the resolution of the Berks B.K.A. as reported in our issue of last week. Questions involving differences of opinion—either among judges or members of the B.B.K.A. Council—though proper subjects for discussion when considering a duly lodged protest, made at the time, cannot be entered upon after awards are made and the whole matter done with from the official standpoint.]

So far as the future, however, it is quite another thing, and the Annual Meeting of the Members of the B.B.K.A. seems to us a suitable opportunity for any further discussion on the subject which may be desirable. It is then open to any one to propose changes which seem to them necessary for increasing the usefulness of the parent association, and the whole body of the members can accept or reject such proposals by voting according to their discretion.—EDS.]

BEEES IN CUMBERLAND.

A RECORD HONEY SEASON.

[2993.] Perhaps it will not be uninteresting to hear how the bees have been doing in this part of Cumberland (twenty miles west of Carlisle). To begin, we have the oft-repeated story of a cold, backward, and disappointing season until well on in June, then a week of warm sunny weather, but followed by a sudden return

to cold as before, lasting till the second week of July, when we had such summer heat as has not been felt for many years. Bees which had been stimulated judiciously to encourage breeding soon repaid us for any trouble and the little expense involved. And I may say for all bee-keepers about here, who so cared for their bees, it has been a Jubilee record season, and will long be remembered as such. For a time we feared that the tremendous swarming mania evinced was going to spoil our "honey take," but our fears proved groundless, for the bees worked splendidly in spite of swarming, and we had about three weeks of glorious weather, with white clover in flower all the time. In fact, bee-keepers about here do not remember honey coming in so fast, or so plentifully, as it did during the time stated. One man took 120 lb. from a small hive, another puts his average at 67 lb., and a beginner with only one hive, after losing his first swarm from it, secured the second and third, and got 31 lb. of surplus honey.

I had seven hives in spring, and, notwithstanding that I did everything I knew of to prevent swarming, my hives were soon doubled in number. And as a final result, I have taken 217 well-filled sections and 414 lb. of extracted honey, a total of 631 lb., or an average of fully 90 lb. per hive, taking spring count. Although the surplus-chambers and racks of sections were so rapidly filled, I was astonished when going over the hives after removal of surplus, in order to see what syrup was required for winter, to find the brood-chamber of most of them so well supplied. In several cases I had to remove a few brood-combs filled from top to bottom and substitute empty combs to allow for autumn breeding. The honey flow was so abundant during the cessation from breeding—while the young queens were hatching and mating—that the cells were filled with honey as fast as the brood hatched out.

One or two bee-keepers have not done so well as the rest of us, but the reason can generally be traced to their want of having the bees "fit" (as we say in Cumberland) when the honey flow came, or having too many pollen-clogged combs in their hives. This last reason is so detrimental to all chance of getting the hives into proper condition for work, that it should receive far more attention than it does. Such combs are worse than useless; in fact, one might almost as well put in a few dummies and expect the bees to work on them. Some bee-keepers are most careful in observing the rule never to tolerate queens more than two years old, but if they would look more to renewing combs by removing the worst every year and replacing with new ones, they might with advantage leave the renewal of the queen to the bees themselves. Last year, after the honey flow was over, and also during the early part of this summer, when there was no honey to be had, the bees seemed to have stored more pollen than usual, some

frames I have seen this autumn being from half to two-thirds full of it.—J. T., *Baggrow Aspatria, Cumberland, September 10.*

CURRENT TOPICS.

RENEWING QUEENS.

[2994.] The season of 1897 has, I fear, been one of disappointment to the majority of bee-keepers in the south. A few brief but warm weeks of summer followed a cold, damp spring, and now that the close is at hand, dreary and wet weather is the order of the day, with a temperature varying from ten to twenty degrees below the average. The harvest, so far as I am concerned, is about half a crop. From a few districts I hear of good takes, but in the main the crop is small, though of better quality than last year. Most stocks in which brood-chambers have not been interfered with are, however, well provided with stores, and the bees are at present strong in numbers, breeding still going on in all normal colonies. Especially is this noticeable with stocks possessing young queens. Bee-keepers make no greater mistake than that of tolerating queens above two years old. It may seem contrary to common sense to destroy a queen now laying well, but it too often happens that six months hence such queens will fail to respond to the call on her ovipositing powers which will take place early in the coming year. The result, so far as such stocks are concerned, will be another season lost. So great, to my mind, is the advantage of young queens, that at the head of colonies worked for surplus I invariably have queens of the previous year's growth, and, as illustrative of the thoroughness with which this idea is carried out, I may say that in all my hives (numbering close upon 100) there is not at the date of writing a queen over four months old! It has been said that everything relating to bee-keeping centres in the queen. I would alter this somewhat and say, "everything in successful bee-keeping centres in having young queens at the head of all colonies."

It is very satisfactory to be able to record the fact authoritatively that foul brood is less rampant here in the south-eastern counties than for several years past. And I believe the question of young queens has a distinct bearing on the matter, seeing that one of the most important remedial measures in dealing with this bee disease is the introduction of new blood into our colonies from apiaries known to be free from infection. In this matter of the introduction of new blood, some bee-keepers in the north and in Ireland have for some years past shown their wisdom by systematically introducing fresh blood from a distance and in having only young queens at the head of their colonies. When the weather is kind, the published results of this plan of working speak for themselves. Having practically done with queen-rearing for the season of 1897, it cannot be said that in giving prominence to this plan I

am seeking a free advertisement. In fact, I have been requested to bring this question of introduction of fresh blood into our apiaries, and its bearing on the bee-keeping industry so far as assisting in ridding the country of foul brood, to the front. It seems to me quite clear that to successfully combat foul brood, and to obtain the highest and most profitable results for our bee-labours, young queens are an absolute necessity in our hives, and these should be obtained from a distance, and only from hives and districts known to be untaunted. It cannot be denied that it is expensive to purchase queens for each hive every year, or even in alternate years, but there is no reason why a system of exchange of queens between friends having apiaries far apart should not be adopted. Or, if this is not feasible or convenient, one or two queens could be purchased annually early in the summer, and a supply raised therefrom sufficient to stock all hives having old queens.

This has been frequently spoken of as a season of swarms, yet not a single stock has attempted even to rear queen-cells on their own account in any of my apiaries. This immunity from swarms has not been shared by bee-keepers located near me, and I attribute it mainly to my having young queens free from Carniolan blood, and to the use of any swarm appliance described in your pages (I neither make nor sell these). By means of this contrivance I am able to clear the hives of all the flying drones at intervals, and it is well known that colonies of bees without drones seldom swarm. I have only had one swarm issue in two years, and this was successfully secured. Nearly all the swarms I have been called upon to hive for friends or neighbours have been either of the Carniolan race or Carniolan cross.

Birds and Bees.—Birds this year have been very troublesome about my hives, eating a large number of bees. The remains thereof found on rail posts and on hive roofs have testified to this fact. In June and July the culprit was the butcher-bird, or red-backed shrike. These birds hunt in pairs, and their appetite for bees seems insatiable. They appear to me to be eating all day and every day. Now, and since August, I find the blue tit (*Parus ceruleus*) in force and most destructive in the apiary. In fact, it has become so serious a matter that I intend either to mend their manners or summarily end their depredations.

Storing Combs.—The question of preserving store-combs for future use after they have been through the extractor is an important one; personally I think nothing equals a cupboard fitted with wooden runners for the combs to hang upon. Any spare corner in a dry room or outhouse is suitable, and the cupboard can be built according to the bee-keeper's requirements. The convenience of such a place for combs when out of use cannot be over-rated; their condition may be noted at a glance; a little sulphur burnt therein three or four

times during the winter preserves the combs from moth or damp, while destroying all fungoid growths, without the risk of damaging them by frequent handling in the cold weather when they are most brittle. If the number of frames be not sufficient to warrant the building of a cupboard, a "cube-sugar" box, or any suitable-sized package, may with very little trouble make an excellent substitute by fitting runners to hold the frames, pasting the cracks over with stout brown paper, and making a door for same. It will then answer the purpose as well as the best.—HENRY W. BRICE, *Dole Park, Upper Norwood.*

A SUGGESTED BEE CLUB.

[2995.] There are several bee-keepers in this district who feel that a bee club for "Wellington (Salop) and district" would be very advantageous to the craft, and it has been suggested to me that such a club could be founded, without in any way clashing with the Shropshire Bee-keepers' Association, whose shows at Shrewsbury are so well known. I shall be much obliged if you will kindly allow me to draw the attention of your readers to this and ask all who are willing to join as members, or who will assist us, to communicate with me, when, if there appears to be any general desire that a club shall be started, I will call a meeting at an early date to discuss the subject.—R. HOLLAND, *Haygate-road, Wellington, Salop, September 13, 1897.*

[Correspondence continued on page 366.]

HOMES OF THE HONEY BEE.

THE APIARIES OF OUR READERS.

The illustration opposite shows a portion of Mr. F. A. Goodall's Tame Valley apiary, near Tamworth, Warwickshire. It will scarcely strike the reader as being other than a neat little apiary of well-made hives somewhat after the "Cowan" type so far as outward appearance. And yet, with one exception, the hives shown are home-made from old bacon-boxes costing a shilling each! We should, perhaps, have been a little more delicate in thus describing Mr. Goodall's hives, were it not that he rather prides himself than otherwise on the bacon-box part of the description; and few will venture to assert that the hives don't look well in the picture. They also—as we learn—serve their purpose as bee domiciles admirably, and are said to be hard to beat for doubling, and also for wintering the bees safely. Writing a few lines of text to go with the photo Mr. Goodall says:—
"In your issue of January 16, 1896, there appeared an account of the hives as made and used myself, and I thought, probably, some of your readers who are in need of a good and

cheap hive would be pleased to see a photograph of some of these hives reproduced among the 'Homes of the Honey Bee.' I have pleasure, therefore, in enclosing a photograph from my own camera, my better half knocking the others out. So I called it the 'Knockout Hive,' but the winter of 1896 proved that it was badly named. In fact, it is a failure compared with its neighbours. So I have called these latter the "Goodall" hives, as, after being an ardent bee-keeper for many

and I also hold a diploma and gold medal for inventions, and an honorary member of the Parisian Inventors' Academy."

It affords an opportune occasion for reprinting the description referred to, written by Mr. Goodall, with the accompanying sketch as follows:—

"I first procure from my grocer a bacon-box (cost, one shilling). Standing it on end, I sweep out all salt; then, after drawing nails, knock out the top and place it at the back B as in sketch, and nail in position. Draw lines from C to D on both sides the box, and saw off top pieces, which come in for firewood.

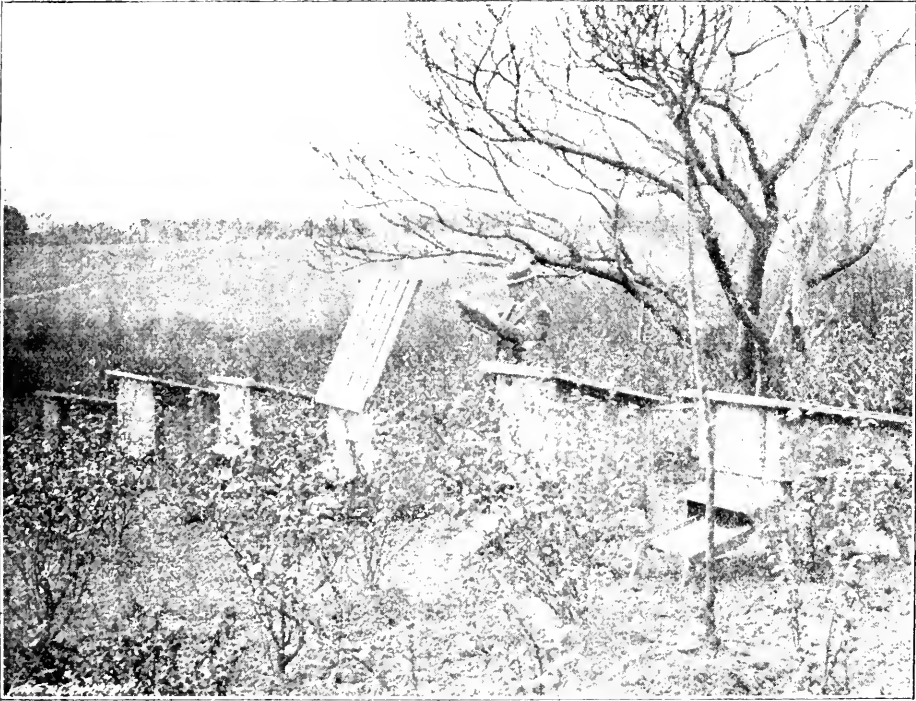

MR. F. A. GOODALL'S TAME VALLEY APIARY, TAMWORTH.

years, and having tried nearly all types of hives, I have proved them to be "good all-round" hives, so far as good "takes" of honey can make them so. Equally suitable also for the gentleman's garden or that of the cottager, and certainly within easy reach of the latter, as they cost but little more than the time-honoured skep. The hive is described in the B.J. referred to, and full instructions given for making it.

"A designer by profession I have kept bees for about twelve years. I have also manipulated at our local shows. I am an amateur photographer, and I find that this latter hobby runs very well side by side with bee-keeping,

Next take the lid—which B has taken the place of—and nail it together by means of two strips of wood about three inches wide. This makes a very good roof, C D. Should you prefer the roof to project a little, insert an extra piece of wood of similar thickness about six inches wide before nailing together. To make this joint waterproof, take a sheet of brown paper, give it a coat of paint on each side, and while wet place it on, fastening it down with tacks, using small bits of cardboard or gum wads to prevent the tacks from tearing the paper. When dry, give it another coat of paint, using plenty of oil, as the paper will absorb it all, but it will be as tough as leather.

"Two roof-hinges are fixed at the top, E F, the roof being fastened down at G with a small hook. This completes a good sound outer case at a cost of about 1s. 6d. For the hive body or brood-chamber I use 9 in. by $\frac{7}{8}$ in. board for back and front, and plane the same size timber down to $8\frac{1}{2}$ for the sides, so that the frame tops are flush with the front and back when placed in position; cut out an entrance about 6 in. by $\frac{3}{8}$ in. and make a similar hole in the outer casing at front to correspond. Next nail on the floor-board, leaving about $1\frac{1}{2}$ in. projection in front, which keeps it away from the outer-case, placing over the cavity a strip of wood on two small blocks so that the bees cannot gain access to the space between hive and

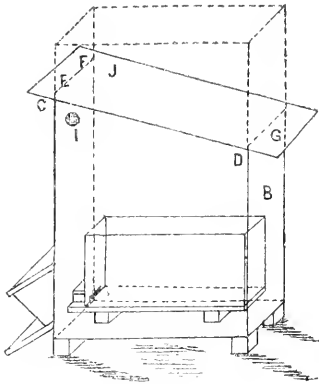

outer-case. Set the whole on four bricks and rear a piece of timber against the front for an alighting board; or it may be nailed in a slanting position and a porch added if preferred. Bore two holes at I J about 1 in. in diameter, and nail perforated zinc over ventilators, place the hive-body on two strips of wood opposite the outer entrance, and nail in position. There will be about 3 in. to spare on either side, which may be filled in with cork dust, and then we have a perfect frame-hive suitable for any purpose whatever at an outlay of about 2s. 6d. or 3s. Three bacon-boxes will supply timber to make two hives throughout similar to above, but I prefer to use new timber for the hive bodies."

CORRESPONDENCE.

(Continued from page 364.)

A PENDING BEE CASE.

[2006.] A case interesting to bee-keepers will be tried in the County Court shortly, and I should be very glad to have your opinion on its merits. The facts are these:—

A farmer granted permission to locate a number of hives on his holding (hill grazing) in August. There does not seem to be any prohibitory clause in his lease or in estate

regulations. Nor, so far as is presently known, has there ever been any exception taken to having bees put there for the heather season. There have been hives taken to the hills in this locality beyond the memory of the oldest inhabitant; but the proprietor, on behalf of the shooting tenant, seeks interdict against the farmer.

So far as is presently known, this is the first case of the kind in this county, or in any county in Scotland. Are you aware of any decision in a similar case, and what is your opinion on its merits? We bee-keepers here are much interested in the case, and intend to do something to assist the farmer, if need be. — A KINCARDINESHIRE BEE-KEEPER, *Laurenockirk, N.B.*

[We shall in no way infringe the just and proper rule—observed by respectable journalists—of withholding our opinion on the merits of a case which is still *sub judice*, in saying that the points in English law would probably turn first on the question as to subletting, and second, establishing a danger or nuisance to neighbours or others passing by the hives. We are aware of no exactly analogous case likely to form a precedent, and will be glad if some of our Scotch readers can afford any information likely to assist our correspondent.—EDS.]

Queries and Replies.

[1820.] *Carbolic Acid and Surplus Honey.*—In removing my shallow-frames of surplus honey this year, I was unable to fix the super-clearer properly, so I brushed the bees off the frames with a feather, which had been dipped in diluted carbolic acid. Now, however, after extracting the contents of these frames I find that my whole harvest of extracted honey has a slight flavour of carbolic acid. I therefore ask: is there any way in which I can get rid of this, as several of my customers notice it. Would it go off by exposing the honey to the air? If you can help me I shall feel obliged.—B. MORELAND.

REPLY.—We do not know of any means by which honey may be freed from the flavour complained of. Notwithstanding the fact that some of our most experienced bee-keepers use carbolic acid pretty freely about their hives, with no ill effects, we never recommend it to any who may be classed as beginners. The flavour of carbolic acid is so destructive to honey, so far as table use, that we deprecate its use generally in removing surplus.

[1821.] *Queens Ceasing to Lay in Autumn.*—I examined my four hives to-day, with results that I am at a loss to account for. In no one of the four could I detect the presence of a single egg or of any brood unsealed. There were small patches of sealed brood in all four hives. Three of the queens are th

year's (one I introduced successfully August 28), the fourth is a last year's queen. All four hives are fairly strong. They are all turning out the drones and have abundance of sealed stores in the brood chamber, though the frames are not choked with honey. The weather has been very bad for the last five weeks. I should feel much obliged if you would inform me through your most useful paper:—1. Whether this is an unusual state of things? 2. If I ought to do anything to induce the queens to lay?—RYLSTONE, *Skipton-in-Craven, Yorks, September 9.*

REPLY.—1. It is quite usual for queens to almost cease laying at this season for a short time as stated. See our remarks on "Autumn Feeding" in "Useful Hints," last week (p. 351), which deal with this subject. 2. Feed gently for ten days.

[1822.] *Using Carbolised Cloths.*—In "Notes by the Way" for August 12 Mr. Woodley mentions the "super-clearer" as an article than the introduction of which no invention of the past decade has so added to the comfort of the bee-keeper. May I ask for further information about the method of using carbolised cloth as a super-clearer? I have this season returned to the ranks of bee-keepers, after dropping the hobby for ten years, so that I am out of touch with the latest developments of the craft.—W. F. D., *Cumberland, September 2.*

REPLY.—We rather think that our correspondent, Mr. W. Woodley—when testifying to the value of the "super-clearer" as a new "appliance for removing bees from supers"—does not refer to the "carbolised cloth," but to the clearer in which the Porter bee-escape is fixed. He uses the "cloth" at times, as stated, and will, perhaps, give the method adopted in his next "Notes."

[1823.] *An Awkward Bee-possession.*—I have just become possessed of a straw skep of bees (untouched for three or four years) from near the Botanical Gardens, Regent's Park. On going to fetch them last week, I found the skep had been standing upside down, and upon it was a "Neighbour's" cottage observatory hive surmounted by a straw cap or cover, all communicating by centre holes. The outlets for the bees were a hole in the centre of the bottom skep, another half-way up, with a third entrance at the bottom of the observatory hive. I have taken them (just as they stood) down into the country and set the hives on a stand as they were, except that I have removed the straw cap, which contained a little empty comb with a number of drones clustered in it. I stopped the top and bottom centre holes with mortar and covered all with a roof. It weighs between sixty and seventy pounds, and seems full of bees and dark honey, and I am at a loss to know (1) if I should stop one of the side holes, if so, which, and (2) if they require any other preparation for wintering? I see they

are now carrying in pollen and that there are young bees working, but they do not seem very energetic since removal.—J. L. W.

REPLY.—1. Stop up all entrances but the lowest one. 2. If the stock is so heavy as sixty or seventy pounds and full of bees as stated, we advise nothing more than protecting it from wet or severe frost, allowing the bees to swarm next year. If it is intended to adopt frame-hives for future use you can either do away with the skeps as now fixed up or keep the cottage observatory as a single hive on a proper floorboard.

[1824.] *Railway Companies and Damaged Sections.*—1. I should be very pleased if you would let me have your opinion in next journal as to the following case:—I exhibited a dozen 1-lb. sections at Derby Show last week, and with them took first prize. On arriving back nine of the twelve were smashed. Can I claim for damage against the railway company? The parcel travelled on two companies lines by passenger train. One of my children told me before I opened the box that the porter handled it very roughly, and let it drop with a jerk on the road in delivering. I went straight off to the station-master (who is also a bee-keeper) and informed him about them; I also wanted him to call and see their condition; I then told him how valuable these particular sections were to me, as they had won prizes both times when shown, and that I intended them for the Dairy Show. The station-master declined to inspect the sections, saying that he believed what I said. He however, thought I had no claim for damage, as they were booked as an ordinary parcel. I will be greatly obliged for your opinion on the matter. 2. What is the best way of packing sections for sending to shows?—JNO. BERRY, *Llanrwst, September 13.*

REPLY.—1. Your claim for damage must turn upon the way the sections were packed for travelling from the show. It is not easy to prove negligence on the part of the railway companies, but you might at least send a claim in and mention the fact of inviting your station-master to inspect the damage as soon as discovered. 2. Our views on the best way of packing honey exhibits for shows appears in "Guide Book," page 87. It is always safest to send valuable exhibits of sections in spring-crates, which are made to avoid risk from a sudden jerk, such as the one referred to by our correspondent.

[1825.] *Honey Comb Devices.*—I should feel obliged if you or any reader of your journal could inform me how the above devices are arranged in order to get them worked out in the comb. I have seen them represented in the trophies in your journal, as shown at the various shows—such as the letters "V.R." and the figures "1897." Any information on the above will be gladly received.—W. P., *Ticehurst, Sussex, September 13.*

REPLY.—Full instructions (with illustrations) for making designs appeared in our monthly, the RECORD, of May last year, and may be had post free for 2½d.

[1826.] *Amount of Food for Winter*.—I am writing to ask your advice on a subject that I feel must interest many other novices besides myself, viz., (1) the amount of stores required, (2) and the average number of frames needed to successfully winter a stock of bees upon. Authorities seem to differ very much on these important points. One says 20 lb. of stores and six or seven frames, another recommends "six square feet of sealed comb (including both sides), and if more so much the better." Now I calculate that this would mean eight and a half standard frames full of stores alone, or about 43 lb. net weight of food. To particularise, I have a stock on sixteen standard frames in two body-boxes each holding eight frames, all partly filled, and a June swarm on ten frames also well filled. These latter are all in one body-box. If you will kindly answer the above questions I shall feel grateful. 3. Also is there any way of removing honey from combs, other than by the extractor, without destroying the combs, for my surplus will be so small that it hardly warrants my investing in one this year? I purchased a stock on six frames in the middle of May, and the bees swarmed three times. I joined the two last swarms that issued, and returned first swarm with the eight frames that they were hived upon to old stock after the last "cast" issued, previously cutting out queen cells. I have taken seventeen sections weighing 15½ lb. from the stock, and one frame that was a solid block of honey weighing 6 lb. when extracted, by destroying comb. The bees have drawn out the comb again and partly filled it. The stock and swarm now cover sixteen and ten frames respectively, all well filled. 4. Do you think they have done well considering that Shepherd's Bush is a busy suburb of London?—F. M.

REPLY.—1. 20 lb. of sealed stores *at least*. 2. Give as many frames as the bees can cover and no more, and have the food stored now as rapidly as possible. 3. No other practical method. 4. We have no knowledge of the honey resources of the neighbourhood in question, but the bees have done well.

[1827.] *Utilising Driven Bees in Autumn*.—Will you kindly say in next issue of journal:—1. Is brass wire in a strainer injurious to honey? 2. Would this week be too late for driven bees (say Saturday the 18th inst.) to put on frames with full sheets of foundation, or to add to weak stocks in bar frame hive?—PERSEVERANCE, Bath, September 11.

REPLY.—1. No. 2. If well fed and cared for before finally packing for winter, it is a good time for the purpose.

[1828.] *Uniting Bees*.—I see in the last issue of B.B. Journal a reply of yours to a correspondent (1817, p. 357) who asks for

information as to joining driven bees to those which have been before united and, in a way, would be established stocks. Would you kindly say, in next issue, whether this same plan, *i.e.*, taking out two frames and dusting the bees with flour, and then running the new bees in altogether with the others, will do for old established stocks, which are being put up for the winter, to strengthen them up a little; and (2) if removing one queen is absolutely necessary.—"GEORGE," Beaminster, Dorset, September 13.

REPLY.—1. Yes; dusting both lots of bees with flour answers equally well with stocks as with driven bees. 2. It is usual to remove the least valuable queen, but is not absolutely necessary.

Echoes from the Hives.

Lancaster.—The season for clover honey in Lancaster district this year is the best we have had since 1887. The quality is very fine, and many have secured as much as 100 lb. from single hives, though we got little till July. The heather crop will, however, be small, as the weather has been cold and unsettled. Bees are working on the "Giant Balsam," and come in white as millers.—W. L., September 4.

FACTORS INFLUENCING SWARMING.

Forty-five years ago Mr. Quinby in his first edition of "Mysteries of Kee-Keeping Explained," assigned three requisites as constituting the cause of swarming, I quote from page 189:—"The combs must be crowded with bees; they must contain a numerous brood advancing from the egg to maturity; the bees must be obtaining honey, either being fed or from the flowers. Being crowded with bees in a scarce time of honey is insufficient to bring out the swarm, neither is an abundance sufficient without the bees and brood. The period that all these requisites happen together, and remain long enough, will vary with different colonies, and many times do not happen at all through the season with some."

I cannot refrain here from giving expression to the wonderful accuracy of Mr. Quinby's investigations. In discovering the three requisites he was unaided¹ by the movable-comb hive. With the advantages of movable combs, other minor factors present themselves to the investigating mind. By careful and comparative investigation with a number of swarming colonies, we find certain factors, trivial in themselves, entering into, and constituting a force bending to a common end—swarming.

Although it is generally conceded that the three factors given by Quinby are the requisites which induce swarming, I shall name one as the prime cause, with factors which I shall hereinafter refer to, acting in conjunction, constituting a force to hasten or retard the impulse, proportionally as they are present. I will here state for the benefit of those concerned, that all my experiments the last five or six years have been based upon the foregoing fact.

The first or prime cause of swarming is, *bees*. As Mr. Quinby gave it, a crowded condition. All the other factors may be present, but without a crowded condition, no swarms will be forthcoming. Of all the adjunct requisites a honey-yield is the strongest factor, and with the natural increase of maturing bees, which tends to a crowded condition, a large brood is usually present. Still, with a crowded condition, although the flowers may yield no nectar, swarms will occasionally issue, which is evidence that an abundance of bees constitutes the strongest or prime factor. A crowded condition renders their abode somewhat untenable, and it also interferes with the duties of the queen. It is a well-known fact that temperature is an important factor in influencing the swarming impulse. A number of colonies located in a pent-up atmosphere, subjected to the burning rays of the sun, will swarm much sooner than a like number equally strong, but protected by shade. Ventilation also governs largely in the matter; and its necessity becomes more apparent with hives exposed to the sun's rays than otherwise. In a previous article under the head, "Drones as a Factor in Swarming," I alluded to my experiments with artificial comb, by which I proved them to be a factor in swarming; they being necessary in reproduction.

In numerous experiments I have also found that a removal of the combs containing pollen retarded swarming. This I have proved by comparison with an equal number of colonies from which the pollen was not removed. As already alluded to, honey is undoubtedly the strongest factor influencing the crowded condition. With combs well supplied, a failure in the sources will not always prevent the issue of swarms. This is particularly true when colonies have been confined to the hives by unfavourable weather after a good honey-flow. We frequently see swarms issue a week or ten days following fruit-bloom, when they have been confined by cold or rainy weather. Having begun preparations under the influence of a honey yield, an intensely crowded condition by reason of confinement, during which time a failure of the honey-yield is not realised by the colony, swarming is almost certain to occur when honey is plentiful in the hive.

With an aggregation of colonies under the control of man, we also find another factor which does not present itself where colonies are isolated as in a state of nature. I refer to the swarming impulse as being contagious. I have known it to manifest itself under certain

circumstances and in certain seasons favouring the circumstances to an excessive degree. These circumstances include some of the factors already named, such as heat, want of ventilation, honey-yield, &c. This contagion spreads by reason of bees entering neighbouring hives. We find another factor in the inherent tendency, or sensitiveness of some colonies to the foregoing factors. The Carniolans are a notable example of a variety in which both bees and queens are extremely nervous and susceptible to outside influence. I have already intimated that the queen is impeded in her work of laying by reason of a crowded condition of the colony. It is barely possible that queen-cells are then constructed under circumstances similar to supersedure; the queen being unable to fulfil the requirements of the colony. I have frequently observed many empty portions of comb-cells under such circumstances. I have also noticed that swarming frequently takes place in case of supersedure, when the colonies are overflowing with bees. In such case the queen is liable to succumb the following winter. I had such an occurrence the past season.

As a summary we have as the prime cause of swarming—Bees, and some eight or nine factors: Temperature, ventilation, drones, pollen, honey, the influence of a honey-yield extending into a failure of the honey-sources, the swarming impulse, the inherent tendency, and, lastly, that under the circumstances of supersedure. With a crowded condition, one or more of these factors influence the issue of swarms proportionally as they are present.—L. A. ASPINWALL, in *Bee-keepers' Review* (American).

Bee Shows to Come.

September 25, in the Corn Exchange, Jedburgh.—Roxburghshire B.K.A. Annual Honey Show. Twenty-six classes for honey, wax, and sundries. All open. A single entry fee of 2s. covers all classes. Schedules from Thos. Clark, Pleasants Schoolhouse, Jedburgh, N.B. Entries close **September 21**.

October 2, in the Town Hall, Hamilton, N.B.—Annual Show of the County of Lanark B.K.A. **Thirty-seven classes** (open and confined) and **120 prizes** for Bees, Honey, and Bee Appliances. Schedules, &c., from the Secretary, John Cassells, Solicitor, Cadzow-buildings, Hamilton, N.B. Entries close **September 25**.

October 19, 20, 21, and 22, at the Agricultural Hall, London.—Show of Honey and Bee Products in connection with the British Dairy Farmers' Association. Over 40 prizes (including the President's "Champion" Prize, value £2, for the best exhibit of honey). Schedules (now ready) from Mr. C. Young, Sec., 12, Hanover-square, London, W. Entries close **September 20**.

November 18, 19, and 20, at the Waverley Market, Edinburgh.—In connection with Chrysanthemum Exhibition Show, the Scottish B.K.A. will hold a Honey show as above, at which very liberal prizes will be offered (see advertisement on page v.). Schedules from Rev. R. McClelland, Hon. Sec., The Manse, Luchinman, Renfrew.

Notices to Correspondents & Inquirers.

Letters or queries asking for addresses of manufacturers or correspondents, or where appliances can be purchased, or replies giving such information, can only be inserted as advertisements. The space devoted to letters, queries, and replies is meant for the general good of bee-keepers, and not for advertisements. We wish our Correspondents to bear in mind that, as it is necessary for us to go to press in advance of the date of issue, queries cannot always be replied to in the issue immediately following the receipt of their communications.

All queries forwarded will be attended to, and those only of personal interest will be answered in this column.

D. M. (Alness).—*Bee Notes from the North.*—We will be very pleased to have a few lines on bee-keeping in your "trans-Grampian savage wilds." Pray have no fears as to the "sensitive ears of southern readers." A few of your "barbaric ideas" will perhaps give us some useful enlightenment. Anyway, we hope you will send on a few bee-notes for insertion in an early number. We will also be glad to send the missing numbers of B.J. if you will specify them on post-card.

J. W. N. (Westmoreland).—*Granulation of Honey.*—1. To keep extracted honey from granulating is, in some seasons, impossible, but it may usually be kept liquid by storing in a dry, warm cupboard (next to a fire if possible) at a temperature of about 60 to 75 deg. Fahr. 2. The same may be said of comb honey in shallow frames. We cannot say "how long it will be safe to let it remain" for the reasons stated above. We have had it in fine condition for over a year from some seasons' gathering, and at other times it will granulate solid in a couple of months after removal. 3. "Good quality English honey" may be "bought in London" at times very cheap, no doubt, as it can in other places; but we do not know of it being regularly sold here "at 9d. per 1 lb. jar," as you have heard.

A. B. (Stechford, Birmingham).—*Bees Dying in Winter; Suspected Comb.*—Comb contains nothing worse than pollen. We should suppose the weight of such combs has deceived your friend as to the amount of honey in store; consequently the bees have probably died of starvation.

W. ALSFORD.—*Jubilee Design.*—We are much obliged for photo of the Jubilee design worked by your bees, which is a very good piece of bee-work, and will be an interesting addition to our "collection." The fact of her Majesty the Queen having graciously accepted a design in honey-comb, consisting of the word "Jubilee," worked by your bees, ten years ago is worth remembering, and we are very pleased to record the fact in our pages. The "extra" photo will be returned by post as desired, with thanks for the opportunity given us of inspecting it.

F. B. (Market Rasen).—*Varieties of Heather.*—No. 1 is the "Bell Heather" (*Erica cinerea*). No. 2 *E. tetralix*, No. 3 being the true "ling," *E. vulgaris*. The last-named is by far the best bee-plant. See B.J. of Sept. 10 last year for illustrations and full particulars of these varieties of heather.

A. H. M. (Dore).—*Syrup for Autumn Bee-fool.*—The proper proportions are 10 lb. refined cane sugar to five pints of water. Boil for about one minute, and, before removal from fire, stir in a couple of table-spoonfuls of vinegar and $\frac{1}{2}$ oz. of salt. Medicate, if needed, with solution as advised in "Guide Book," p. 163.

H. V. HUMPHRIES (Wilts).—*Introducing Alien Queens.*—Twelve hours after removal of old queen, an alien one may be introduced by observing the usual precaution of caging for twenty-four hours.

A. S. (Parracombe).—*Disqualifying Exhibits.* If a schedule expressly prohibits covering more than three-eighths of an inch of face of comb in sections with lace paper, and an exhibitor infringes this rule, he cannot justly complain if disqualified. On the other hand, if no limit as to width of edging appears in schedule, an exhibitor cannot legally be penalised or disqualified in this respect.

R. S. O. (S. Wales).—*Suspected Comb.*—Comb sent contains no trace of brood in cells at all; only pollen.

ALBERT LEWIS (Devon).—*Taking Humble Bees Nests — Sending Queens by Post — Hive Roofs, &c.*—1. The humble bee has a sting, and uses it on mischievous boys who destroy the poor insects' nests. If there is a real necessity for destruction, the fumes of burning brimstone will soon "quieten" the bees. 2. Experienced judges of honey can readily tell the predominating source of many honeys by the characteristic flavour or aroma of each. 3. White clover and raspberry, very light-coloured honeys, sainfoin being golden coloured. 4. Queen's are often sent by letter-post, though it is not in strict conformity with postal regulations to do so. They may, however, be sent by parcels post without infringing rules. 5. Thin zinc makes the best covering for "shakey" hive-roofs.

C. J. F. G. (Herts).—The larva sent is that of the wax-moth (*Galleria alvearia*).

NEMO (Manchester).—*Suspected Comb.*—We find no foul brood in comb sent.

R. L. G. P. (Tonbridge).—*Specimen Copies for Free Distribution.* We are at all times glad to forward a few specimen copies of our journals for distribution, carriage forward, and will send some on receipt of post-card, giving railway address.

Editorial, Notices, &c.

USEFUL HINTS.

WEATHER.—Bee-keepers need not be told how unusually cold and uncongenial has been the past three weeks of September. An odd mild day or two have certainly intervened, just to make one realise what ordinary autumn weather should feel like at this season, but on the whole it will be set down as a cold and wet time generally. Feeding, and “packing down” for winter will, therefore, probably be in arrear with many of our readers. Not that much mischief need be apprehended in consequence, because, judging by the reports which reach us, brood-chambers are, as a rule, fairly well stocked with natural stores, to the mutual advantage of both bees and bee-keepers.

WINTER PREPARATION.—The importance of completing without delay the needful preparation of all colonies of bees for withstanding the rigours of a long and hard winter in safety cannot be too emphatically expressed or enforced. It is little better than wasting time to pack up stocks in which there are at the end of September fewer bees than will thickly cover five or six frames of comb, and expect them to winter well and safely. We do not forget that there are odd times when small colonies winter well and do excellent work the following season; but these merely are the exception which prove the rule, just as it sometimes happens when stocks of bees, wintered under the most adverse conditions it is possible to imagine, will safely tide over all the risks supposed to be inseparable from such conditions, and make splendid colonies the next year. Isolated instances like these don't alter established facts, and one of these latter is “plenty of bees for insuring safe wintering,” then add on “plenty of natural stores,” and we make assurance doubly sure. When the late William Raitt said, “the best winter packing for bees is *bees*,” he gave utterance to a truism which commends itself to all practical bee-keepers; and referring above to the essential need for five or six frames being well covered with bees, it should go without saying that if ten or eleven

frames are so covered, all the better. So far as safe wintering, the question of joining up or uniting weak stocks at this season is an important one, seeing that at least 70 or 80 per cent. of such stocks as are packed for winter, with only a few bees to maintain the necessary warmth for sustaining bee-life, will assuredly succumb before the rigour of a hard and long continued frost.

SELLING HONEY.—It is with some regret that we have perforce been compelled to admit our inability to help readers in finding a market for their honey. In all sincerity we here add, would it were otherwise; but the three or four correspondents who—within the last few days—have sent the inquiries to which reference is made will surely, after a moment's reflection, be able to see how impossible it is for us to help them in the direction sought? We get a note worded thus:—“Please give me the names of two or three London firms who buy honey wholesale. I have a few ewts. to sell this autumn, and will send samples and prices if you will let me know what to charge?” Now, nothing would afford us greater satisfaction than being able to send a dozen or two names of buyers from which the producer could tick off the “two or three” needed; but—even if we could comply with all the requests so made—a single season would do all the “placing” needed for some years to come, so easily counted are the firms open to deal, and not already fixed in the matter of supply.

As a matter of fact, bee-keepers have to rely largely upon themselves for creating a demand for their produce, and in this very important detail the methods of the individual and his aptness, both for production and the disposal of the product when secured, are as divergent as the poles are apart. A rather notable case in point came under our personal notice within the past few days. A bee-keeper who labours under difficulties—so far as having his apiary located seven miles away from his regular business—told us that, notwithstanding this drawback, he had now no difficulty at all in finding a market for his produce. Then, in response to our further inquiries as to how he managed this, he answered that it was simply because he had

"established for himself a name for uniform good quality, which sells the stuff." This consists of from ten to fifteen hundred sections annually; and the customers to whom he "wholesale's" it say their trade in comb-honey is now reliable and regular because of dealing with one whose produce commends itself. We inquire still further as to the particular method followed, and learn that our friend "never sells a section weighing less than 16 oz. often 18 oz., but none below 16 oz." Nor does he ever crate a section in which the comb is not attached to the wood on all sides and fully sealed over. All not up to his "standard" are broken up, strained, and the honey "jarred off" for sale as extracted. To ensure perfect success, we need hardly add that our informant's bees are in a capital district for good honey, and when we learn that he takes an active share in all the work both of production and preparing the produce for sale, in addition to seeking out his "market," the secret of success is so plain that those who run may read. In other words, efforts so well directed and so thoroughly carried out are sure to succeed; and no practical man will fail to see the reasonableness of our declaration that it can hardly be otherwise. Some day we hope to give a picture of the bee-garden in which the work referred to is done.

SPARING OUR CONTRIBUTORS.—We some time ago had occasion to remark on the question of "Sparing the Editors," and we now find it necessary to offer a word in the same direction on behalf of contributors. The "sparing" in the latter case, however, takes a somewhat different shape, and it may save further explanation if we print a brief note recently received from our esteemed correspondent, Mr. Robert Peebles, whose articles in our pages descriptive of the "Peebles Heather Honey Press," and more recently on the "W.B.C. Hive: How to make it," have aroused considerable interest among readers. The interest is, of course, very gratifying, as affording testimony to the value of the information contained in the articles mentioned; but when it comes to an assumption on the part of those who read that the articles were written with trade purposes in view, and when, in consequence, all sorts of inquiries about prices, quali-

ties, and bargainings are made, needing time and trouble to reply to, it gets beyond good nature to put up with them, and our correspondent at last declares it to be quite past bearing. Mr. Peebles therefore writes us to say:—"Will you kindly insert a notice in BEE JOURNAL to the effect that I am neither a dealer in, nor a maker of, bee appliances, and that communications concerning the 'W.B.C.' hive or the 'Peebles' heather honey press must be sent to your office in future. It is becoming quite unbearable."

We feel sure that the above will have the desired effect; and while on the subject we may add a line on our own behalf, as being frequently asked to send catalogues or prices of bee goods to which the name or initials of one or other of the Editors of this Journal are appended. We therefore beg to say that we neither make, sell, or deal in hives nor appliances of any kind whatever, nor have we the remotest monetary interest in their sale.

HEREFORDSHIRE B.K.A.

ANNUAL HONEY FAIR.

The seventeenth annual honey fair of the Hereford Bee-keepers' Association was held in the Butter-market, Hereford, on Wednesday, Sept. 1, and, judging from the display of honey staged, it was a marked success. The object of the show is in a great measure to encourage the keeping of bees, and as a consequence the number of skilful apiarians is gradually increasing in the district. Mr. James Rankin, M.P., is the President of the Bee-keepers' Association. The show of honey was never excelled, and there were some twenty-four entries in one class; in all there were about eighty-one entries. In the extracted honey classes the quality on the whole was especially good, a decided advance on the previous years' exhibits, the prize exhibits being of excellent flavour and delicate colour, just what judges delight to see. The sections, however, lacked colour and fulness owing to the season. Notwithstanding this slight drawback of the dry summer, most of the prize exhibits were exceptionally meritorious, and the quality of the honey good all round. The judges were the Rev. E. Davenport, of Worcester, and Mr. J. Palmer, of Ludlow, and the hon. secretary Mr. Alfred Watkins, Imperial Mills, Hereford, who, as usual, efficiently carried out the duties entrusted to him.

There were some large consignments of honey offered for sale, which met with ready purchasers at the following prices, viz.:

Extracted honey from 8d. to 10d.; superior quality, 1s. to 1s. 3d. per lb.; 1-lb. sections, 10d. to 1s. 3d. Dark honey was not much in request.

The following were the awards:—
Members of the H.B.K.A. only ("Champion" Class excepted).

Best Exhibit of Honey (not exceeding 100 lb.)—1st, R. Grindrod, Whitfield; 2nd, W. Williams; 3rd, T. Meadham, Huntington.

Best Exhibit of Honey (not exceeding 50 lb.) (Novices only).—1st, F. Mailes, Hampton Bishop; 2nd, R. Wood, Thruxton.

Twelve 1-lb. Jars Extracted Honey.—1st, E. Edwards, Logaston; 2nd, T. Meadham; 3rd, R. Pearce, Stoke Prior; v.h.c. W. James, W. Williams, Thomas Pritchard, W. J. Spencer; h.c., Mrs. Blashill and J. Thomas.

Six 1-lb. Jars Extracted Honey (Novices only).—1st, C. Edwards; 2nd, R. Pearce; 3rd, R. Farr, Dewchurch; v.h.c., W. Williams, A. B. Farr, W. G. Lewis, W. J. Spencer.

Twelve 1-lb. Sections.—1st, Thomas Pritchard, Bricknall; 2nd, T. Meadham; 3rd, W. Tomkins, Burghill.

Six 1-lb. Sections.—1st, C. Edwards; 2nd, G. Fox, Garnons; 3rd, Miss Wooton, Byford.

Three Shallow Frames Comb Honey.—1st, C. Edwards; 2nd, J. Mailes.

Exhibit of Honey in any Shape.—1st, G. Griffiths, Hampton Bishop; 2nd, Thomas Pewtress, Bishopston; 3rd, Mrs. Anning, Birch.

Champion Prize: Exhibit of Honey, not exceeding 12 lb., jars or 1-lb. Sections (open to previous prize winners only).—W. Williams, Canon Froome.—(Communicated).

LEICESTERSHIRE B.K.A.

This Association held its third annual exhibition of honey, &c, in connection with the Loughborough Agricultural Society, on September 15, in the beautiful grounds of Southfield Park, kindly lent by W. B. Paget, Esq. The number of entries for bee-produce did not quite equal those of previous years, but the honey shown was of very excellent quality. Short lectures on the management of bees were given at intervals in a special tent, and the modern methods of manipulating bees were shown by Mr. P. Scattergood, Stapleford, Notts, who also acted as judge, and made the following awards:—

Twelve 1-lb. Sections.—1st, J. Waterfield, Kibworth; 2nd, J. Fewkes, Great Glen.

Twelve 1-lb. Jars Extracted Honey.—Equal, J. Waterfield and H. Hayward, Great Glen; 3rd, A. H. Peach, Oadby.

Display of Honey.—1st, J. Waterfield.

Twelve 1-lb. Sections (Novices only).—1st, J. E. Woolley, Barrowcliffe, Loughborough; 2nd, J. E. Barker, Loughborough.

Twelve 1-lb. Jars Extracted Honey.—1st, J. H. Topley, Walton-on-the-Wolds; 2nd, A. Brown, Forest-road, Loughborough.—(Communicated by the Hon. Secretary.)

PERTSHIRE B.K.A.

The fourteenth show of honey in connection with the Perthshire Bee-Keepers' Association was held in the hall of the Perth Cafe on the 28th ult. Though a small body, the Association is possessed of considerable energy, and the display on Saturday was among the best yet seen. Mr. D. Morrison and the members of the committee are entitled to great credit for their excellent arrangements. The following is the prize-list:—

Display of Honey (not less than 30 or over 50 lb.): 1st, Charles Cross, Luncarty; 2nd, Duncan Stewart.

Six 2-lb. Sections: 1st, Peter M'Whannel, Bridgend; 2nd, Charles Cross; 3rd, Duncan Stewart.

Six 1½-lb. Sections: 1st, Peter M'Whannel; 2nd, Charles Cross; 3rd, Duncan Stewart.

Twelve 1-lb. Sections: 1st, Charles Cross; 2nd, William Logie, Luncarty; 3rd, Peter M'Whannel.

Four 1-lb. Sections (Heather Honey): 1st, William Duncan, Bridgend; 2nd, Peter M'Whannel; 3rd, Charles Cross.

Four 1½-lb. Sections (Heather Honey): 1st, Peter M'Whannel; 2nd, William Duncan.

Four 2-lb. Sections (Heather Honey): 1st, Peter M'Whannel; 2nd, William Duncan; 3rd, Charles Cross.

Super (any weight): 1st, Peter M'Whannel; 2nd, William Duncan; 3rd, Duncan Stewart.

Six 1-lb. Sections in Show Glass: 1st, Robert Ewing, Jeanfield; 2nd, Peter M'Whannel; 3rd, Charles Cross.

Six 1-lb. Jars Extracted Honey: 1st, Peter M'Whannel; 2nd, William Duncan; 3rd, Duncan Stewart.

Bee's Wax: 1st, Charles Cross; 2nd, Peter M'Whannel; 3rd, Duncan Stewart.

Silver medal awarded to the most successful competitor—Peter M'Whannel.—(Communicated.)

DALRY BEE-KEEPERS' ASSOCIATION.

TECHNICAL INSTRUCTION IN SCOTLAND.

Last winter the Dalry Bee-keepers' Association instituted a series of public lectures on bee-keeping, which resulted in a large accession to its membership. Their efforts were aided by a grant from the County Council Technical Education Committee, and they were fortunate in securing the services of the Rev. Robert McClelland, of Inchinnan. This season the association has taken up the matter in the same practical spirit, and yesterday Mr. McClelland delivered at noon a public lecture in a field in the vicinity of the town, which was well attended. The lecture was illustrated by a demonstration exhibiting the methods of removing bees from the hive in order to procure the honey. In the evening Mr. McClelland lectured in the Lesser Public Hall to a large company.—(Communicated.)

Correspondence.

The Editors do not hold themselves responsible for the opinions expressed by correspondents. No notice will be taken of anonymous communications, and correspondents are requested to write on one side of the paper only and give their real names and addresses, not necessarily for publication, but as a guarantee of good faith. Illustrations should be drawn on separate pieces of paper. We do not undertake to return rejected communications.

Communications relating to the literary department: reports of Associations, Shows, Meetings, Echoes, Queries, Books for Review, &c., must be addressed only to "THE EDITORS of the 'British Bee Journal,' 17, King William-street, Strand, London, W.C." All business communications relating to Advertisements, &c., must be addressed to "THE MANAGER, 'British Bee Journal' Office, 17, King William-street, Strand, London, W.C."

**.* In order to facilitate reference, Correspondents, when speaking of any letter or query previously inserted will oblige by mentioning the number of the letter, as well as the page on which it appears.*

NOTES BY THE WAY,

[2997.] We have had here a week of fine weather, followed by cold storms and a much lower temperature since Friday, the 17th inst. With an eye to business in the future I have, therefore, been on the outlook to note the condition of the growing crops of forage, from which our bees gather the harvest of honey. I am thus glad to say that the young plant is satisfactory, also that good breadths of vetches or tares are being sown by the farmers. I observe, too, several fields of trifolium are just coming up after being sown in the "stubble" and harrowed in. These items make for hope in the prospective future.

The Dairy Show.—I am glad to note on page 353 the Executive of the B.B.K.A. have seen their way to give the prize to the honey and not to the package in the class for extracted honey in bulk. The "package" in which honey may be sent cheaply and safely by rail I venture to think ought to form a class by itself. The same may be said of the "Parcels' Post Package," which, from the schedule is, I opine, for the "best and safest package" for conveying honey in bottles by post. The quality of the honey I suppose will not count in points, so that I take it the prizes will go to the best packages? There is just one other item, which it seems to me will require some discrimination in making the awards, and that is to which class will the Champion Prize be given. Will it go to the light or dark extracted honey (there will be first prize exhibits in both classes), or will it go to the Section Classes, and, if so, to which—flower, honey, or that from heather?

[We rather think the several matters mentioned above will have to be left to the discretion of the Judges.—EDS.]

Super Clearers.—I notice your request that I should say a word in reply to Query 1822 (p. 367) on my reference (p. 314, Aug. 12) to the use of carbolised cloths as "super clearers" when

removing honey. On the question generally let me say I have super-clearers fitted with the Meadows "Bee off" and also with the "Porter Escape." The "Meadows" have exits at both ends, while the "Porter" has one exit only, and from extended practice I can say that the one exit equals if it does not exceed in rapidity of action in clearing supers of bees. My own escape boards are made the size of an ordinary rack of twenty-one sections, with a strip of wood nailed all round both top and bottom sides. This allows a space over the frames and also below the bottom of sections, and answers two important points—in preventing crushing of bees and allowing them the chance of clearing up any honey that may be found in the brace combs.

The carbolised cloth, as mentioned by me in "Notes" on page 314, is a useful adjunct in putting the clearer on and taking it off the hive. I use it for this purpose as follows:—Take a piece of calico or a piece of strainer or cheese cloth which has been previously washed. Procure a modern scent-bottle with a "patent stopper," which only allows a minute portion of acid to escape at a time; or failing that get a small phial, cut a notch in the cork and use this as the distributor of your carbolic acid (but not as a store bottle). Spread the cloth out and drop a few drops of Calvert's No. 5 carbolic acid on it, roll up tight, and put it in a mustard tin or any suitable tin box. It is then ready when required. After using give a few more drops of the acid and put it away in the tin. For myself I like a dry cloth better than a wet one, and when using for putting on clearers I place the super-clearer on a box or stool, or on the top of the next hive, remove the cover and wraps, except the carpet, take your carbolised cloth and hang it over the side of the hive furthest away from you; now, by holding two of the corners in your hands as you lift off the super the cloth drops on the bees, who rush pell-mell away from it, and your super is placed on before a bee has escaped. The cloth is then picked off and the super and clearer returned to the hive. Do this in the morning, and at night the sections will be cleared of bees, except in cases where the queen has deposited eggs and there is brood in the sections. In the latter case, a few bees will remain to nurse the brood.—W. WOODLEY, *Beeton, Newbury.*

PRICES OF HONEY.

[2998.] Solomon said, "It is not good to eat much honey" (Prov. xxv., 27); and in another place (Prov. xxiv., 13) he says, "My son, eat thou honey because it is good!" There is no contradiction here; the one qualifies the other. Our common saying about "eating too much of a good thing" is intended as well as to avoid the neglect of what is good. I fear in this (southern) part of England honey is greatly neglected as an article of diet, and there is too little attention paid to the con-

sumption of honey as a daily food. There is an idea that honey is a luxury—*i.e.*, beyond the reach of the masses. Whose fault is it that such an impression exists? I say it is the fault of our bee-keepers to a very large extent. Honey at a shilling a pound is very well for those who can sell it at that price, but few can dispose of very much at a shilling unless super-excellent in quality, and there is some

BEEES IN NORTH PEMBROKE.

[2999.] I am sending report of how my bees have done this season. I am very well pleased with them indeed. I started with seven stocks, and they gave me no swarms, the only one that came off being near the end of the honey flow. They settled on the top of a high oak tree, out of my reach, and remained there from 2.30 p.m. till

COUNTY HONEY TROPHIES AT "ROYAL" SHOW, 1897. (No. 5.)



FIFTH PRIZE, SUSSEX B.K.A.

honey worth more than a shilling. I am afraid I shall be called a heretic, but I consider honey ought to be obtainable retail at 7d. or 8d. a pound, even of tip-top quality, and our Associations should stir themselves to bring honey more to public notice, so as to make it more popular, and the British product into common use by all classes. Do vegetarians advocate the use of honey in their dietary?—A KENT BEE-KEEPER.

10.30 next morning, and then cruelly bade me adieu. I worked entirely for extracted honey, with the exception of one rack of 21-lb. sections. I took 969 lb. in all, or an average of 138 lb. per hive. My best hive gave me 185 lb. I consider this very good, as I never had any knowledge except what I gathered from your "Guide-book" and the *Record*. My hives are ten-frame, standard size. After removing surplus, I have left them ample stores in the

brood-nest, not extracting any from that compartment of the hives. All the honey was gathered from white clover in the short space of three weeks, viz., the last week in June, and up to the middle of July. During the last week of the flow the bees were storing at the rate of about 10 lb. per hive per day. I had a stray swarm come to me on June 3. I hived them on eight half-sheets of foundation, and they gave me fifty lovely sections, making my grand total reach 1,019 lb., with hives well supplied with stores for winter. I have sold all my honey at a fair price, so that I can sit by the fire during the winter nights, and talk of the pleasures and profits of bee-keeping. Wishing all a successful season in 1898.—A. TRANSPLANTED THISTLE, *Boncath, September 15.*

FOUL BROOD.

THE NEED FOR LEGISLATION.

[3000.] For the past three years my bees have been suffering badly from foul brood, the number of my stocks having gradually decreased from eleven to two. This rapid diminution follows because, in every case as discovered, I have immediately destroyed the bees with a view to stamping it out. The hives used have been thoroughly disinfected by burning and painting well inside and out. There seems little doubt, therefore, that the constant recurrence of the disease is owing to infection which results from the presence of affected stocks of bees in the neighbourhood. On overhauling my hives to-day before preparing them for winter, I find one of the remaining stocks—which, when last examined in the spring, was apparently perfectly healthy—is now badly affected. It was very strong in bees in the spring and early summer, but fell off considerably later on, and has in consequence not given more than 20 lb. of surplus. As there are plenty of bees in the hive at the present time, would you advise any attempt to effect a cure at this season by reducing them to the condition of a swarm, or will it be better to at once destroy them?

The other hive appears to be healthy, with plenty of bees, but very little store. This lot I am feeding up for the winter. They have been weak throughout the year, and have done very little.

Judging by my own experience, the season here has been a poor one, very few sections having been properly finished, but the quality of honey gathered has been better than last year. I hope the proposed foul-brood legislation will soon be obtained, and be the means of saving bee-keepers from such discouragement as I have experienced these last three years.—W. W. C., *Torquay, September 16.*

[The discouragement experienced by bee-keepers—located in districts where diseased colonies of bees are persistently kept to the injury of neighbours—can only be realised by those who are themselves sufferers. We have

had frequent occasion to notice how complete a change comes over the opponents of legislation for obtaining compulsory powers for dealing with such cases as are referred to above when they find themselves in direct touch with the evil, and we venture to say that such small opposition as is offered to the proposed "Foul Brood Bill" would rapidly disappear after a personal experience like that of our correspondent.—Eds.]

SEASONABLE QUESTIONS.

ANSWERED BY G. M. DOOLITTLE.

LONG HIVES *v.* TIERING UP.

Question.—Why do not those working for extracted honey use a long hive, holding the same number of frames that they wish to use in one story, instead of tiering up several hives, one on top of the other, as is advised in our bee-papers, and quite generally practised? I am of the opinion that a long hive would be more convenient, and that less time would be consumed in the manipulation of it.

Answer.—The above brings to my mind what happened years ago; and as it will serve to answer the correspondent's question I will speak of it here.

Some twenty or twenty-five years ago Mr. D. L. Adair, of Kentucky, was quite a prominent bee-keeper and writer for our bee-papers. He used and advocated a long hive, to be used on the principle of spreading frames out horizontally, instead of tiering one hive above the other, claiming that, thereby, a colony of bees could be kept in a normal condition, and while in said condition no swarming would be the result. This he termed the "Long-idea" hive. Being always ready to test all "new ideas," I made two hives, each four feet long, during the next winter. One of these I worked for extracted, and the other for comb honey, on the Adair plan. The one worked for comb honey swarmed, either because the "idea" was faulty, or because I did not know how to fully manage such a hive, or both; so after repeated trials to keep them at work in the four-foot hive I let them have their own way, when they had swarmed after being returned the fourth time.

The one worked for extracted honey did splendidly; but another, worked on the tiering-up plan, did nearly or quite as well; and by practical knowledge I learned that I could work a two or three storey hive much more easily than I could this long one. To take the frames out, the person's back must be bent just enough to make it the hardest kind of work; and the bees which were shaken off the combs would crawl all over the sides and top of the hive in such numbers as to make it almost impossible to close it again without taking much valuable time. With the two-story hive the bees could be shaken on top of the frames in the lower hive, with but very

few taking wing, when they would crawl below till the hive was closed; and the operator could stand erect, or nearly so, while doing the work.

But the worst thing about it was that I lost both colonies during the next winter, and during every succeeding winter that I tried to winter bees in them. So far as I could see they were prepared for winter as well as any of the other hives which came through the winter in good condition. I tried these hives for honey several years, putting colonies from other hives in them in the spring, as often as those in them died, but with no better success than at first; and finally, becoming disgusted with them, I tore them to pieces and made the lumber into other hives. For extracted honey, I know of nothing better than using any of the ordinary hives two and three stories high, according to the populousness of the colony being worked.

ITALIAN BEES NOT WORKING IN SECTIONS.

Question.—I have had Italian bees for the past two seasons, and they have made no surplus honey, while from my blacks I have had fair returns in section honey. What do you suppose is the cause of this? and what course shall I pursue to remedy the matter.

Answer.—As the writer gives no information as to the number of colonies he keeps, it is hardly possible to tell exactly what course should be pursued in the matter. If he has ten or more colonies that persist in not entering the sections, it is something I never knew of happening before; but if there is only one or two colonies which act that way it would not be very strange. One important point in the construction of a hive for comb honey where Italian bees are used should not be overlooked; and that is, the brood-chamber should not be too large. If the questioner has a brood-chamber of from 2,500 to 3,000 cubic inches, I should not wonder at the action of the Italian bees; for Italians are more prone to store honey in the brood-chamber than the blacks. Especially do they show a preference towards storing in the brood-combs over the sections if the queen does not have the combs occupied with brood when the honey season commences; and if they have room to store from 30 to 40 lb. of honey in the combs below they will very likely not go into the sections at all. If bees refuse to work in sections, there are various methods of coaxing them to go to work. I will give two or three which are usually successful.

If a section, or several of them, are taken from a hive where the bees are at work nicely in them, and placed on the hive where the bees are loath to enter the sections, carrying the bees that adhere to the sections with them, it will usually incite the non-working colony to go to work in the sections also. If this does not work, fit a piece of drone comb, containing small larvae, into one or two sections, when the bees will at once commence to work

in the surrounding sections. Or you can drum or shake from the frames the larger part of the bees and the queen from such colony as will not work in sections, and put them into an empty box or hive; and when they get to building comb nicely, put them back where they came from. Where this plan has been used I never knew them to fail to work, going right to the sections and building comb in them at once. In drumming out the bees, do not drive too close, as bees enough must be left to fully protect the brood. The nice white comb that the drummed colony build while in the box should be placed in the sections for "baits," for there is no greater incentive to commence work than new white comb containing a little new honey. Of course, all of this is given on the supposition that our questioner's bees were strong enough as to numbers to work in sections, and still refused to do so, when the honey harvest was on. Where any hive is not filled with bees it is useless to attempt to make them work in sections. Many are deceived in this way, and I think that this has something to do with our friend's bees not working. Italian bees do not breed quite as rapidly early in the season as do black bees; but if attended to as they should be they will have more brood in field the right time to give us labourers in our field just when we wish them than will the others. That Italian bees are inferior to black bees for comb honey, if properly managed, I never could see, even in a good season; which fact is now generally conceded by nearly all of our best bee-keepers; while in a poor season they certainly show great superiority over the latter to the amount of quite a surplus, while the black bees scarcely make a living.—*Gleanings* (American).

Queries and Replies.

[1829.] *Wintering Hives in Rooms.*—1. I intend placing twelve hives in a room, close against the window frame. Will one long entrance do for all, or will each hive require a separate doorway? 2. Should a porch and alighting board run the whole length of the window frame? 3. Will it be safe for me to feed them in room after the first week in October?—*Broadstone, Dorset, September 17.*

REPLY.—1 and 2. We can scarcely imagine the window frame of a room long enough to have twelve hives close against it. However, as no details are given or any explanation why the hives are to be so placed, we need only say that each hive should have a separate entrance, and it would also be helpful if each had its own porch and alighting board. 3. We have known a couple of stocks of bees successfully kept winter and summer against a window looking on to a stair landing, and they were fed with soft candy the whole

winter through. We cannot, however, quite approve of the idea of so many as a dozen hives being kept in a room of a dwelling house, for many reasons.

[1830.] *Driven Bees Deserting Hives.*—I hived a lot of driven bees, all of which went in the hive all right, but came out later on and clustered outside under the porch during the night. I put them back again next morning, but they keep going in and out in a very restless way. Next day I hived four lots of driven bees in four separate hives, and no sooner had I got the last lot in than the bees began pouring out of the four hives, and all joined together in the air and eventually hived themselves in the hive from which the last lot had departed. All these bees displayed the same restlessness as the first lot mentioned above. Is not this owing to their having no queens? At all events, none was seen when hiving any of the lots, though a sharp look-out was kept, but no queens were seen. How could I now fill the four hives? It is very disappointing to have them all go into one, and it seems clear that the bees were sent away without queens.—A. N., *Stockport*.

REPLY.—The action of the driven bees certainly indicates queenlessness, except in the one case. By this time you will know how the united lots are doing, and should examine the combs for eggs or brood. So far as furnishing the empty hives, there is no other course than getting more driven bees, and making sure they have queens when purchasing.

[1831.] *Does Tin cause Discolouration of Honey?*—I have some honey that has turned quite dark in colour through standing in a tin can. At least I think it is the tin that has done it, because some spots on the surface of the can are turned black where it has had drops of honey on it. Is the honey of any use, or would it hurt the bees if given back to them as food? It is not like dark honey, but looks nearly black when in bulk, and very dark brown in bottles. You will be able to judge of it by sample sent herewith.—E. P. C., *Bath*, September 15.

REPLY.—We cannot say what the action of honey would be on the particular "tin can" used, but it is quite certain that an ordinary tin vessel is (next to glass or earthenware) the most suitable receptacle for storing honey in. This is shown by the general use of tin in the manufacture of extractors, ripeners, travelling cans, and all the various things used in connection with honey. The honey sent is very poor in quality and shows signs of fermentation, but it would do for bee-food if prepared the same as sugar syrup, adding a little water, and boiling for a minute or two.

[1832.] *Sterile Queen.*—I have two stocks of bees, one of which is now doing very well, with good fertile queen in same. The other—although I keep on feeding to induce the queen to start laying—shows no signs of brood.

This queen was raised about the beginning of August last, but has not yet produced a single egg. 1. Is it possible that she was not properly fertilised? I am sure that there were drones in the hive at time of her birth. 2. Is it advisable to kill queen and introduce another?—W. F. HOSEGOOD, *Croydon*, September 18.

REPLY.—1. There must be something wrong with the ovaries of the young queen, otherwise she would have started laying ere this whether fertilised or not. 2. If the bees are sufficiently numerous to be worth re-queening, you should introduce a fertile queen at once, after killing the sterile one.

[1833.] *Making Soft Bee Candy.*—After transferring my stocks from primitive skeps to frame-hives, as we have before us, to all appearance in this part of Europe, a dull, rainy season. 1. Will you kindly give me the recipe for making the necessary soft bee candy which will serve as food for the bees during the winter? 2. During what months are the bees hibernating, *i.e.*, not feeding?—BURDETT-MASON, *Basses Pyrénées (près Bayonne)*, September 6.

REPLY.—1. The following recipe for soft candy is from a former issue of *B. B. J.*: 1. Use preferably a brass jelly or preserve pan, otherwise an enamelled iron or plain iron one. 2. Put in 10 lb. of white granulated sugar at 2d. or 2½d. per pound, two pints imperial of cold water, and half a teaspoonful of cream of tartar. 3. Set on or hang over a brisk fire and stir gently now and then till the sugar is all melted. This should require about fifteen minutes. 4. Almost immediately afterwards the whole will reach the boiling point, at first throwing up a deal of froth. The fire may be moderated or the pan withdrawn a little at this stage, when the foamy boil will settle down to a clear crackling one. This boiling should only occupy about two minutes. 5. Now try a drop let fall on a cold surface, withdrawing the pan from the fire in the meantime. If the drop at once begins to set, so that in a few seconds it will draw out as a thread when touched with the finger, the mass is cooked enough. If not, boil a few seconds longer and try again. 6. Remove the pan from the fire and set it in a trough of cold water. It may be left there for a few minutes while the moulds (flat or soup plates will do) are being set ready, each with a thin sheet of paper rather larger than the mould laid in. Returning to the pan, commence and continue to stir briskly until the mass begins first to get dim in colour from incipient granulation and then to thicken to the consistency of thin porridge. Then pour into the moulds, warming any remainder slightly to get it to leave the pan. This cooling and stirring process should take about fifteen minutes more. 7. Thus in about thirty-two minutes we finish the whole process, with the result that we have twelve pounds of candy from ten pounds of sugar. The cakes should set within an

hour, so as to be safely turned out of the moulds. When quite cold they should still be soft enough to be easily scratched into with the finger-nail, and to melt in the mouth with a soft grain. 2. Bees never hibernate in the full sense of the term. They will be found, even in the most severe frost, ready to move as soon as light is shed on them.

[1834.] *Feeding Driven Bees.*—Would you, through the medium of your valuable journal, tell me the best way to feed driven bees? I drove some twelve or thirteen skeps of bees about the second week in August, and have hived them in frame-hives fitted with foundation, and fed with medicated syrup as advised in "Guide-book"; but I cannot understand if I am to keep them constantly supplied with bottle of syrup (over the frames), night and day (as I have been doing, and find they do away with a large quantity of syrup), and for how long? They seem to be making a good deal of comb. Can any reader tell me how to make a "block" for nailing-up frames? I make hives, &c., but find it difficult to get the frames true.—"ONE IN DOUBT," *Newton, Suffolk, September 20.*

REPLY.—There should be no need for feeding driven bees for so long a time as stated above (over five weeks) if food was given freely, as it should be at this season. You do not say what quantity of syrup has been given to each. However, in any case the combs should be examined without delay, and the general condition of bees, combs, and brood noted. If each colony has sufficient stores (say 20 lb. to 25 lb.), feeding should stop at once, and all other conditions being favourable, the sooner the bees are packed for winter the better. Referring to "frame-block" our advice is to get one made by a reliable man, accustomed to such work. It would only cost a couple of shillings or less, and that sum will be well spent in securing a reliable "block."

[1835.] *Clearing Honey for Exhibition.*—I have some honey which I intend to send to the Dairy Show. I fear, however, that I shall lose points for "cloudiness" through the presence of air-bubbles. I think this is due to the great density of the honey, seeing that, though not at all granulated, I can invert the bottle for ten seconds without the honey running as far as the edge (less than $\frac{1}{2}$ in.) Is there any method by which I can improve its appearance? (I have already tried keeping it at a high temperature for some time previous to bottling.) If so I shall be glad if you will give the information in your next issue.—"SILVERHILL," *St. Leonards-on-Sea, September 20.*

REPLY.—The air-bubbles may be forced to the surface by heating in water to a sufficient temperature—say 80 deg. or 90 deg. Fahr. Once on the top the "bubbles" can be skimmed. Do not overheat the honey, or the aroma will leave it, and the flavour be more or less spoiled.

[1836.] *Bee-syrup made Two Years Ago.*—Herewith I send a sample of some autumn food which I made according to recipe in the "Guide-book," two years ago. I now find that it has gone off, or become a little "mildewy." Having about a gallon of it, I shall be much obliged if you would inform me if it is still suitable for bee food.—A. E. R., *Bristolington, September 14.*

REPLY.—Syrup, as sample, will be perfectly fit for use if boiled for a minute or two, in order to thicken it somewhat and to get rid of the very slight signs of mould or mildew, which we suppose gathered on the surface of the liquid through keeping so long.

[1837.] *Wintering Skep above Frame-hive.*—I have a straw skep (a swarm of this year) which I purpose placing over top bars of a frame-hive, more for the sake of keeping the bees snug through the winter than anything else. I presume no harm would be likely to result from this? The bees, if wintering well and strong enough, will begin working down into the frames of lower hive in spring.—J. C., *Barhill, N.E.*

REPLY.—If bees in skep are now strong in numbers they will take no harm treated as above. If not strong, we would set a square of American cloth (glazed side down), having a 4-in. hole cut in centre, above the frame tops, and set the skep over all and pack warmly. This would help in keeping the bees "snug," and at the same time lessen the chance of moths getting among the outer combs of skep.

[1838.] *Transferring Bees from Old Hives.*—I should be very glad if you would kindly tell me what to do with two hives whose bodies are falling to pieces. They are very old, and have had no attention for years, and do not look like standing another winter. I looked into one of them a few days since, and they are a solid block of comb and honey, the comb running zigzag through the frames. It would be quite impossible to take out a frame. Both hives swarmed last year, and at the present moment one looks like swarming again.—BUSY BEE, *Bletchley, September 15.*

REPLY.—Without seeing the actual condition of the hives and bees we are unable to advise what to do, considering the lateness of the season and the serious difficulties of the task involved. If the hives and bees can be preserved till next spring a better chance of success will be afforded. In the meantime our correspondent may find some one competent to assist in the necessary work.

[1839.] *Robbing.*—I am a constant reader of your journal, and have to thank you for my success so far, this being my second season as a bee-keeper. This autumn "robbing" has set in, and I have tried closing hives till sunset some days, only allowing a bee-space to the entrance, and painting alighting boards and round entrances with carbolic solution, but all

to no purpose, and my bees are always fighting. Can I do anything else? Kindly tell me the proportions of pure carbolic and water I ought to use in trying to stop robbing? I am supplying pea-candy.—L. T., *Merioneth*, September 15.

REPLY.—We should disturb the bees as little as possible and stop feeding for a time. This will tend to remedy the evil complained of. In using carbolic acid for the purpose in question prepare a weak solution of about $\frac{1}{2}$ oz. of the crude acid to 20 oz. of warm water, and well shaken.

[1840.] *Miscellaneous*.—Would you kindly answer the following in next BEE JOURNAL:—(1) Is it advisable to mortar round the bottoms of skeps in the winter in a garden with four high walls round? (2) How can one keep a frame-hive free from earwigs without injury to bees? (3) What is the earliest time in the spring, after an average winter, when frame hives can safely be inspected without risk of chilling brood?—W. J. R., *Crieklade*, September 15.

REPLY.—(1) No. In fact skeps should not be attached to their floorboards by any material whatever. (2) Only by trapping them as do gardeners when they become a nuisance. (3) Hives should not be opened when the temperature is below 50 or 55 Fahr., and then combs must be returned as quickly as possible after examining.

Echoes from the Hives.

Kirkby Lonsdale, Cumberland, September 18.—This has not been a particularly good season in this locality. During the clover the bees were so inclined to swarming that little surplus was gathered, and last month, when we should have been reaping the heather, the weather was cold and wet; scarcely a day during the whole month but it rained some part of the day—W. M. W.

Bee Shows to Come.

September 25, in the Corn Exchange, *Jedburgh*, h.—*Roxburghshire B.K.A. Annual Honey Show*. Twenty-six classes for honey, wax, and sundries. All open. A single entry fee of 2s. covers all classes. Schedules from Thos. Clark, Pleasants Schoolhouse, *Jedburgh*, N.B. Entries closed.

October 2, in the Town Hall, *Hamilton*, N.B.—*Annual Show of the County of Lanark B.K.A. Thirty-seven classes* (open and confined) and 120 prizes for Bees, Honey, and Bee Appliances. Schedules, &c., from the Secretary, John Cassells, Solicitor, *Cadzow-buildings*, *Hamilton*, N.B. Entries close September 25.

October 19, 20, 21, and 22, at the Agricultural Hall, *London*.—*Show of Honey and Bee Products* in connection with the British Dairy Farmers Association. Over 40 prizes (including the President's

"Champion" Prize, value £2, for the best exhibit of honey).

November 18, 19, and 20, at the *Waverley Market, Edinburgh*.—In connection with *Chrysanthemum Exhibition Show*, the *Scottish B.K.A.* will hold a *Honey Show* as above, at which very liberal prizes will be offered (see advertisement on page v). Schedules from Rev. R. McClelland, Hon. Sec., *The Manse Inchinnan, Renfrew*.

Notices to Correspondents & Inquirers.

Letters or queries asking for addresses of manufacturers or correspondents, or where appliances can be purchased, or replies giving such information, can only be inserted as advertisements. The space devoted to letters, queries, and replies is meant for the general good of bee-keepers, and not for advertisements. We wish our Correspondents to bear in mind that, as it is necessary for us to go to press in advance of the date of issue, queries cannot always be replied to in the issue immediately following the receipt of their communications.

. *Jubilee Designs in Honey-comb*.—Referring to the notice on page 370 last week, Mr. Alsford requests us to "avoid any chance of a wrong impression on the part of readers by printing the name, &c., by which he is known in the bee-world, viz., "Alsford, Expert, Blandford"; the design mentioned having been worked by his bees.—EDS.

GEO. MITCHELL (*Guildford*).—"Bee Case" at *New Romney*.—We are not losing sight of the importance to bee-keepers of this case, and in due time hope to have something to say regarding it. Some dozens of press-cuttings referring to it have been forwarded to this office by interested readers, who will please take above reply as an acknowledgment of their courtesy in sending them on.

A. H. M. (*Sheffield*).—"Medicating Bee Food".—There need be no hesitation in medicating all food given to bees with naphthol beta. It is perfectly innocuous if given as directed.

J. DAGLEY (*Oxon*).—"Honey for Showing".—Sample of honey sent, though fairly good, is not up to exhibition standard. It is dark in colour, and already begins to show signs of granulation, which gives it a cloudy appearance.

W. J. (*Royston, Herts*).—"Suspected Comb".—Comb received contains only honey and pollen. No trace of any brood at all.

W. M. W. (*Kirkby Lonsdale*).—"Source of Honey".—The comb in section reached us in a state of pulp. Regarding the source from whence the honey was gathered, we should say it is from the bramble or blackberry, unless it comes from some such shrubs as bilberry or cranberry. The flavour is poor and colour very dark. It will no doubt be quite good for home use if its poor flavour be not objected to.

ERRATA.—In Mr. Brice's article last week (2nd par. on page 364) the words "any swarm appliance" should read "my swarm appliance."

Editorial, Notices, &c.

A NEW BEE CLUB

FOR WELLINGTON (SALOP) AND DISTRICT.

In response to a special invitation to consider the advisability of forming a Bee Club for Wellington and district, a large number of bee-keepers attended at the Central Temperance Hotel on Saturday evening, the 25th inst. Mr. Jno. Palmer, of Ludlow,—who rode over on his bicycle specially to attend the meeting—was unanimously voted to the chair. Mr. Holland explained his reason for calling the meeting, and thought from the goodly number who had replied to his invitation that there was promise of a very strong club being formed. He considered that in a strong bee-county like Shropshire it was somewhat of a reproach that no expert was regularly employed, and he would like to see one in connection with a Wellington organisation. He thought that a show should also be arranged, and worked somewhat on the same lines as those in previous years. Other advantages were briefly touched upon, and he then asked for an expression of opinion from those present.

The Chairman, in a very able speech, strongly supported the idea, and showed that with a powerful body of bee-keepers, such as they ought to form, so many more advantages could be obtained than by single individuals. If the funds permitted of an expert being engaged, it would give new life to the whole of the bee-keepers in the district, and he predicted that with efficient officers willing to throw their whole energies into the business, a most prosperous and useful Bee Club would result.

It was then resolved that a club be formed, which shall be styled the "Wellington and District Bee Club," Mr. Holland being elected Hon. Secretary.

The Hon. Secretary then reported that he had received many letters of apology from gentlemen all over the district for non-attendance, every one of whom very strongly supported the cause, and promises of help were forthcoming from all quarters. Among the letters received were the following:—Miss M. E. Eyton, Hon. Sec. Shropshire B.K.A., who offered every assistance in forming the Club; the Vicar of Wellington, the Rev. H. M. Marsh-Edwards; the Rev. J. A. Panter, St. George's; Mr. T. R. Horton, Harley Tower; Mr. John Greene, Shifnal; Mr. R. Hill, Donnington; Mr. J. Bradley, Yockleton; Mr. A. Beale, Mr. R. A. Newill, and many others.

A provisional committee was elected to draw up rules, nominate officers, &c., and report to a meeting of the members, which will be called as early as possible.

A general discussion ensued as to the best

and most efficient methods to pursue, which the Committee promised to consider, the meeting terminating with a very hearty vote of thanks to the Chairman for coming so long a journey to be present with them and for presiding.

The Hon. Secretary (Mr. R. Holland, Haygate-road, Wellington) trusts that all bee-keepers and friends in the district will at once join the Club, and advise him of their intention to do so at as early a date as possible.

THE HONEY HARVEST IN ATHOLL.

Now that the honey season is over, says the *Dundee Advertiser*, both bees and bee-keepers are settling down for the winter, and, although 1897 cannot be recorded as a failure, yet it almost borders upon that unenviable state. To the bee-keepers of North Perthshire, who are situated on the high hills, August is looked forward to as the month of their honey harvest. Unfortunately, however, the past month of August has been one of the worst on record. Opening with a severe thunder-storm, followed by incessant rain, the heather bloom was literally washed away. With the barometer hovering about 29 in. and the rainfall varying between 7 in. at Blair Atholl to 9 in. at Dalnaspidal, it is surprising that the bee-keepers' returns do not read "nil." Undoubtedly such would have been the case had not the heather been early, and the bees able to take advantage of the fine weather of the last few days of July. During that short time the bees gathered about all the season's surplus, which cannot be more than about 15 lb. or 18 lb. on an average per colony. Nevertheless, some bee-men have done really well—one fortunate apiarian, Mr. P. Robertson, Garryside, taking 81 lb. from a single hive, a phenomenal return for a bad season, and also showing what "apis mellifica" could do, given a "congenial environment." Although this district is far removed from the orchards and gardens of England, yet Mr. Wells, of Kent, has an enthusiastic follower who has been running a two-queened hive for the last few seasons with indifferent success. The system is certainly good for rapidly bringing the bees to full strength, especially in the earlier part of the season; but the great tendency to swarm counteracts the good otherwise accomplished. No doubt in skilful hands the system has proved veritable "wells" of honey, but such has not been the experience of the Atholl "Wells." Notwithstanding the wet weather, the quality of the honey is fully up to the ordinary average. This is probably due to the fact that most of it was gathered in the short spell of heat during the latter end of July. Although the supply has fallen 60 per cent. compared with last year, yet, happily for consumers, there has been no advance in price, "clover and heather blend" going at 1s. per lb., while well-finished sections of "pure heather" still command 1s. 6d. per lb.

Correspondence.

The Editors do not hold themselves responsible for the opinions expressed by correspondents. No notice will be taken of anonymous communications, and correspondents are requested to write on one side of the paper only and give their real names and addresses, not necessarily for publication, but as a guarantee of good faith. Illustrations should be drawn on separate pieces of paper. We do not undertake to return rejected communications.

Communications relating to the literary department, reports of Associations, Shows, Meetings, Echoes, Queries, Books for Review, &c., must be addressed only to "The Editors of the 'British Bee Journal,' 17, King William-street, Strand, London, W.C." All business communications relating to Advertisements, &c., must be addressed to "THE MANAGER, 'British Bee Journal' Office, 17, King William-street, Strand, London, W.C."

** In order to facilitate reference, Correspondents, when speaking of any letter or query previously inserted will oblige by mentioning the number of the letter, as well as the page on which it appears.*

JULY DAYS.

[3001.] It is a well-known fact amongst amateur gardeners that we may grow a plant in our gardens from some foreign clime for five, or it may be, ten years, without seeing it really flourishing, or even without seeing a flower upon it at all. This is owing to our peculiar climate. Most of us, however, instead of rooting the plant up keep on coddling it from year to year with the hope of having an extraordinary fine season; and rarely are we disappointed if we have patience to wait long enough. Some year it will thrust itself up and flourish like—I was going to say "a green bay tree," but on second thoughts I will say "like a privet." To give examples I may mention the *Eremuri* and *Tritomas*.

And so, likewise, to some extent, is it with our bees. In this district the years go by, and each recurring spring the apple blossom falls and the bees have only gained a fair living. The farmers forget to plant beans for us, the clover fails, the lindens (limes) blossom, but just at the time there are bitter cold winds, and not a bee will go near them; consequently we take off the section rack, and if there are a dozen filled and these not "honeydew" we feel delighted, and at once spend a few pounds buying the best cane sugar to feed our stock up for winter.

In this district it would be sheer madness to keep an account to find out how many bright sovereigns you have made by keeping bees. The best plan is to forget what you spend, but remember what you receive for honey, swarms, &c.

In bee-keeping, however, as in gardening, there comes a time that repays one tenfold for the years of weary waiting. And such a time is here now! Glorious July days, placid and calm, or stirred by grateful breeze. Days filled with exultant strength of heat and light—life to the bees, life to the butterflies, life to every living thing. The days that we have yearned for, hoped for, lived for, are here now! The unfathomable sky, clear to its deepest

depths; the sun's rays coming through like a search-light blazing full upon the earth. So great, so marvellous, such profound splendour of light; is it any wonder that the sun was worshipped in olden time—may still be worshipped now? And to know that the same light illuminates our sister planets—bright Venus and Mars, Mercury and Saturn—and is wasted (?) in all the immensity of space between and beyond. Does it not make sun-worshippers of us, too? Such divine overfilling of the measure of light!

The regret of autumn, the hope of winter, the promise of spring—these days! These July days. How ought we to enjoy them after all those months filled with expectation and desire!

If we could but conquer our worldly-mindedness for a month, and spend our whole time drinking in the beauty of these summer days. I wish we had time to walk in the early morning—while the dew is still upon the grass—about these meadows, lavender blue with the countless flowers of scabious, or fight our way in the tangled thickets of the forest, where the hazel nuts hang in clusters—young faces in "mob" caps; where are the crimped blossoms, pink and white of the bramble, beds of strawberries, St. John's wort, bladder campions, sweet wild thyme; where there is ling beginning to open, and lowly bed-straw, and fox-gloves; to struggle through fern and heather; to wrestle with bracken, now level with your shoulders; to watch the crimson burnet flying from ox-eye daisy to hawkweed, and silver-washed fritillaries floating by on resplendent wing, and the purple hair-streak about the oak tree leaves. I wish we could spare the time to go and see these things, but we cannot. We must keep our hand to the plough, let our heart beat as it may, or our eyes become almost sightless, or our lips crack with thirst. Therefore, the zenith of summer passes by, and we must be satisfied with a morning and an evening glance at the bee-hives and the linden trees. We are chained, like Prometheus, to the rock of duty, and worldly-mindedness is forced upon us by circumstance.

Since July 9 what a time the bees have had! Warm nights and bright delightful days; clover yielding well and the lindens bowers of honey! Never was there such a time! In a few days the supers were full and the bees were crowded out; hanging in bunches or scattered in crowds about the fronts of hives and entrances. We gave them more room—empty racks under full ones, racks over shallow frames, shallow frames over deep frames—anything that we could rig up to hold honey. We opened entrances full width, fourteen inches; we watched them in the morning working with a splendour of energy never seen before. We listened to them in the dusk of evening and far on into the night, when the stars came out and blazed brightly above, and the white lilies and roses and sweet peas filled the garden with grateful odour;

when the eyelids of the day-flowers were closed, heads drooping, but night-flowers opened wide their petals for ghost-like moths. To listen to the teeming, heated hives, a roar like to the sea beating on the beach, or as the wind drawing through a million pine needles, or even as the dreamy music of the harp. To see the entrances dark with laborious bees drumming the cool air in with a million wing-beats, tireless, restless, unwearied, uncomplaining! To see, in imagination, the tender honeycomb, white and sweet as lily blossoms, becoming broad and heavy—the honey glistening in the open cells. To feel it in your hand (as in the old days), the honey bursting out under the pressure of your fingers, to hear the air crackling, to see the honey-spout under the strainer. To stand in the fragrant stream of air that comes welling up after its passage by ten thousand cells and all the by-ways between—air sweeter than attar of roses, air more delicious than that scented by the flora of the Alps. Does it not fill us with love and gratitude? Gratitude to the powers that are? Love for the wide, blue sky; the great generous earth, the mountains of cloud sweeping over, the sun for ever burning! The bees soon filled the extra room given and were building comb behind the dummies and lying out over the whole entrance, so that the fanners were hard pressed to get sufficient air through the blocked passages. What was to be done? Bright idea. Go down the cellar and sort out the discarded frames, glass and wooden supers that make our hair stand on end just to remember. And, gingerly, down the cellar we went, and soon the spiders and blackbeetles were going helter-skelter behind ambushes of porter-bottles and marine stores of all kinds. There is an old saying that “a man never knows what he is worth till he moves,” and as a parody of this I may say, “a bee-keeper never knows what he is worth till he goes down the cellar.” There we found frames, in the flat, enough to work a Californian bee-ranch, and all sorts of strange and mysterious appliances, amongst which we noticed a thing of wood and springs to carry hundreds of sections round the world in safety. What offers, fair readers, for this handy appliance, which we have had fourteen years and never used?

With some of these things we built a new wing to the hives, and again the bees were happy, till the linden trees blossomed no more. Then the rain came down amain, and the parched fields grew green as before the mowing, and pale autumn crocuses (our native “flower of the west wind”) pushed up mysteriously and purpled all the meadows and the hard ground between the hazels in the woods. And the farmers looked lugubriously at the sky and the sodden corn beneath it, at the flocks of sparrows, at their empty purses—and still the rain fell relentlessly day by day, until, in low-lying places, the shocks stood up to their waists in the

water of the flooded streams and rivers; or, in places that were high, the grains of wheat sprouted in the husks, and grew also where it had been scattered by the sparrows. Who would be a farmer? But the bee-keepers staggered like drunken men under the weight of their “supers” of honey, while their arms felt fit to drop out of their sockets with continuous turning of the ungeared extractor, or the “Little Wonder.” And the eldest lads shaved off the cappings, and the eldest lassies handed the combs to and fro between father and brother, and the wives washed the bottles, &c., and the Sarah Janes saw to the tea and supper things. And one and all continuously sampled the honey with their fingers, and declared that they never tasted anything like it—so delicious, so clear, so thick, such an aroma. And then the fathers’ hearts swelled, and they saw the rush of rain and the grey sunless skies, and the strange quiet of the hives; but these things troubled them not. One said, “We shall have some watercress after this;” another said, “Won’t there be some mushrooms! I do like mushrooms;” and another, “I notice the white clover is growing well, as also the sainfoin.” And not one of them troubled a jot, so full their hearts were of the memory of July days.—LORDSWOOD.

IRISH EXHIBITS AT SCOTCH SHOWS.

AN IRISH BEE-KEEPER'S COMPLAINT.

[3002.] After a period of ten years, it is not too soon to complain of the treatment I have received at the hands of those connected with Scotch bee-shows; nor can my action be considered as wanting due deliberation. I have been an exhibitor at most of the important honey shows in Scotland, but with little success, for which reason it seems to me as if Irish exhibits are mostly consigned to a remote corner before the prizes are awarded. This is not a random assertion, but a supposition backed by what I consider as sufficient proof to justify my asking you to allow me space for putting it in print.

I have been badly beaten at a Scotch show by Scotchmen, while with the same honey and against the same exhibitors English judges have given me the prize. The practical inference to be drawn from this is, that I must either suppose that fair play has not been given me in Scotland, or that the English judges are ignorant of the duties they undertake to perform. Perhaps the following will show which supposition is correct: Last year I asked an exhibitor who had beaten me in Scotland to oblige me with a sample of his honey; this request was refused, perhaps for reasons known to the exhibitor himself. Further, I am informed by a person who was present at a Scotch show a few years ago that he heard judge A say to judge B: “This exhibit is best” pointing to mine, “but it

would never do to give the Irish exhibit first prize" I hope to be pardoned for causing the blushes which will, no doubt, suffuse the respective countenances of Messrs. A and B on reading this, and I would spare them, but bare justice to myself and to others demands that such proceedings should be made known to exhibitors and readers of our journals. I have been at a good deal of expense, and have suffered much chiding of my friends for my foolishness in sending honey to Scotland. Against both of these I persevered, however, with what appears like the vain hope that merit would sometimes be rewarded. I have also thought it curious to note how very few open classes are included in Scotch prize schedules, and would ask, Why should Scotland exclude Irishmen from her shows?

In other words, Why cannot the Irish shamrock produce as good honey as the thistle of Scotland?—W. J. ANDERSON, *Ards, Caledon, Ireland, September 23.*

[We cannot, of course, offer any objection to the insertion in our columns of the above complaint—made openly and over the name and address of the writer—but too much confidence should not be placed upon what is known as "mere hearsay evidence," such as that quoted regarding certain Scotch judges not named. Indeed, we find it difficult to believe in the possibility of its truth. The British Bee-keepers' Association has for years past been foremost in advertising open classes for honey wherever possible, and the old system of giving all the prizes to local men is far less prevalent in consequence.

On the other hand, and in reply to our correspondent's query, "Why does Scotland exclude Irishmen from her shows?" we rather think that any such exclusion will apply to Welsh and English bee-keepers equally with Irishmen.

We are, however, pleased—and amused—to note that with characteristic humour Mr. Anderson concludes his complaint with a good joke in humorously comparing honey produced from the "Irish shamrock" with that from the "Scotch thistle!" We might be pardoned for adding a line to say the dwellers in the four quarters of the British Isles are unfortunate in their national emblems so far as honey. Irish shamrock, Scotch thistle, Welsh leek and English rose are equally worthless as honey producers. In fact, we may aptly quote the wise saying, "One is as bad as the other, and a good deal worse!"—EDS.]

BERKSHIRE B.K.A. AND THE "ROYAL" SHOW.

[3003.] Permit me to correct an error in my letter (2,992), which probably arose from bad penmanship. In the last paragraph on page 362 the sentence in which the word "condone" appears should read "no one would wish to condemn a mistake (to which all are liable) when frankly admitted."

Referring to your courteous footnote, I would respectfully point out that the action, upon which the resolution of our Association is chiefly based, took place subsequent to the Show, as was stated in my letter referred to, and also pointed out to the secretary of the British B.K.A. before the meeting on the 3rd inst., I therefore feel that it was a question with which they were fully justified in dealing, and that promptly. It is obvious that in view of the rules of the Royal Agricultural Society with regard to protests, the matter is to be shelved, and we shall doubtless be met with the same difficulty should the question be raised at the annual meeting. I have no doubt, however, that if the British B.K.A. will give us the necessary assistance and prefer to deal with the matter in this way, our Association will be quite willing to hand in a protest to the Royal Agricultural Society, but I had hoped that they would have rather kept the matter within their own circle.—A. D. WOODLEY, *Hon. Sec. Berks B.K.A., 17, Market-place, Reading.*

BUYING DISEASED BEES.

[3004.] To-day I went to examine four stocks of bees not far from here, with a view to purchase, and found them reeking with foul brood, as per samples of comb sent herewith, but in order to confirm what I say, and as a warning to other bee-keepers in the place, I shall be glad to have your opinion publicly expressed in B.J. The owner has decided on total destruction if he finds what I say is correct and endorsed by you.—CHAS. HOWES, *Bristol, September 25.*

[We are very pleased to hear of the owner's willingness to destroy the bees referred to, for a worse case of foul brood than that of the hive from which comb received was taken cannot well be imagined. The thanks of bee-keepers everywhere are due to those who so readily acquiesce in the only safe and sensible course in such cases, viz., that of "total destruction," as stated.—EDS.]

[Correspondence continued on page 386.]

HOMES OF THE HONEY BEE.

THE APIARIES OF OUR READERS.

Just fourteen years ago the site of the apiary pictured in the illustration was an uncared-for and waste corner of land in Holme, near Peterborough, Mr. Howard at that time leaving his native town of Huntingdon, and taking up his residence there, to serve as builder, &c., to the late W. Wells, Esq., then owner of the extensive Holme Wood estate. We understand the "squire" gave much encouragement to Mr. Howard, and when the latter had fully equipped his apiary with hives, bees, and manipulating house—besides planting the spare ground with fruit-trees and flowers, frequent visits were paid to the apiary by Mr. and

Lady Louisa Wells, and their numerous visitors and friends. The late William Raitt, after visiting most of the more important British apiaries, on seeing Mr. Howard's place, at once named it "The Model Apiary"—a designation its owner is justly proud of, as coming from the well-known Scotch bee-master. The rather exceptional nature of Mr. Howard's surroundings—and need we say "the bees"—has also placed him in touch, as it were, with some of the best families in the country, an advantage he has put to good use in forwarding the general interests of the craft. In order to thus secure the patronage of influential people—whose position in country districts enables them to render so

being so arranged that I can enter direct from any path in the apiary. All windows swing on their centre, so that bees finding their way into the house may be turned outside at once. The hive-fronts face south-east and south-west. The view being taken looking from east to west.

"In the Jubilee year I secured 160 one-pound sections from the single hive seen third from the end of the centre row, immediately in front of where I stand in photo."

Among particulars as to his past and present bee-work Mr. Howard says:—"Before the manufacturing business pressed heavily on me, as it now does, I went about a good deal showing products from my apiary which have



MR. J. H. HOWARD'S APIARY, HOLME, NEAR PETERBORO'.

much help—modern bee-keeping has at all times been demonstrated with live bees and their work at the "model" apiary, and impromptu lectures, given on many occasions by Mr. Howard to select companies of ladies and gentlemen interested in the subject. In fact, the manipulating house was designed and built by Mr. Howard with a front of glass, so that a good-sized and safe auditory within could witness the opening of a modern frame-hive, and see the bees and their work, as shown and explained by him from the outside.

In giving us some detailed particulars regarding his apiary, Mr. Howard writes:—"The manipulating house faces due south. Doors

won me not a few medals and prizes. Here also I have gained and am still gaining that practical experience which is so necessary to guide the teacher and the taught aright in giving advice asked for by my many correspondents."

Mr. Howard then characteristically adds:—"So far as the picture of my bee-garden, I may say that in the view and opposite to 'Churchwarden' Howard stands the 'Parish Clerk, fork in hand. This is the 'official' who, directed by his superior officer, attends to the apiary garden and the other garden adjoining my house. For at 'Holme' not only bees, but flowers, fruits, and vegetables get attention." And we add, domestic animals also, each and

all in their turn well cared for, and Mr. Howard admits they help to fill to the brim the happiness of one who is a lover of Nature in all her varied forms.

"In the centre of the model 'apiary,'" our friend continues, "you will note Mrs. Howard has ventured—note also how carefully she has marked out her line of retreat!—for somehow bees always leave such 'well-marked' evidence of any close attention they may pay her that this bee-master's 'model' wife prefers confining her bee-work to apiary products and putting them up for show and market rather than coming in close 'touch' with the bees. Still my better half is now more in sympathy with bee-life than when she first became Mrs. H., and thought that 'bees had no mission but to sting!' My foreman, standing after a manipulation hard by the manipulating house, completes the figures in the picture."

With the multitude of things to be seen to daily and the many public offices he fills, Mr. H. is a less frequent operator in the apiary now than formerly, especially during the past season of 1897. For, having purchased and imported special machinery, he has had personally to see to the work of turning some tons of beeswax into comb foundation by the "Weed" process, for which he is sole patentee and manufacturer in Great Britain.

In concluding our notice we are very pleased at being authorised to say that Mrs. and Mr. Howard extend a hearty invitation to any readers desiring to know more of the "Holme" Apiary, and that they "offer a bee-keeper's welcome to all who pay a passing call, or choose to spend a night under their 'Roof Tree.'"

CORRESPONDENCE.

(Continued from page 384.)

QUEEN REARING.

[3005.] I write you this letter in order to lead up to one or two questions I shall be grateful to have an answer to in B.B.J., and if you think it worth printing, or likely to lead to any profitable discussion, it might appear in type; but use it just as you think best.

I had a batch of nine queen-cells due to hatch on August 5. From every one a good-looking queen hatched out. All were sealed over within a few hours of each other. As I had selected the larvae as carefully as I possibly could, I was most anxious about them, as they were from a queen which on June 22 had twenty-three combs packed with bees; viz., eleven combs in the brood nest, and two supers holding six combs in each, all standard size. I, therefore, thought her worth breeding from.

The stock swarmed on June 22. I put the bees back again after cutting out all queen-cells, as honey was coming in, and I wanted some of it. I started to rear queens later on,

and, as already said, they hatched out on August 5. Then my troubles began. One queen—along with bees—went off altogether, I don't know how, or when. Another began to lay at twenty-three days old, a third at twenty-six days, and a fourth not till she was thirty-three days old, and the last-named one has bothered me very much, for she laid only a few eggs, then stopped. I thought she might possibly be all right, but, unfortunately for me, these eggs never came to anything, and were, in fact, never sealed over, and on September 18 I looked again and found a few more eggs, but I think there is something wrong or abnormal about them. None are erect in the cells, and they look flaccid. August, after the first week, has been a bad month for getting queens mated; it has been wet and windy and cold, with only a few not too fine days. I had plenty of drones in July, and even later, so that is not the cause.

These are some of my difficulties, but my bee experience is not all quite so bad as this. I am going into winter with ten stocks, nine of which have laying queens all hatched in July and August. The one remaining stock of the ten is to carry over my champion queen for next season's rearing of queens; that is, if some of her daughters don't beat her in the egg-laying line.

Now, sirs, having detailed my troubles as above, I ask—1. Can you indicate where I missed my way in this business? 2. How long is it wise, or what is the usual length of time our leading queen-rearers (that is, experts at this work) keep on queens that don't begin to lay? 3. In contracting my stocks ready for winter I have a lot of combs partly stored with pollen. What is best to do with them? If left in the hive there will be too many for the bees to cover, and if stored the pollen goes hard, and is of no use, and spoils the comb. 4. Do queens ever lay eggs that produce neither drones nor workers?—"QUEEN," *Southport, September 20.*

[Regarding above questions, we suppose—1. It is assumed each of the nine queens, when hatched, were in separate colonies. If so, such stocks should have been provided with some brood, otherwise queen and bees are apt to go off when the former leaves the hive for mating purposes. 2. About thirty days is the limit within which a queen can be successfully mated and laying. 3. If the combs have a superabundance of pollen in them, *i.e.*, are "pollen-clogged," it is best to remove it with a blunt knife, scraping the walls of the cells down to the midrib if necessary in removing the pollen. 4. We have never known queens to lay barren eggs, but it is not uncommon for bees to eat eggs and then remove the empty coverings, and especially will this be done when the bees in the hive are all aged ones and the queen begins to lay out of season. Hundreds of eggs are so treated in every hive without the bee-keeper being aware of it. —Eds.]

BLOCK FOR MAKING FRAMES.

[3006.] In reply to "One in Doubt" (1834, p. 379), let him first get a frame that is "true" when nailed up; lay it on a bench, then get a bit of $\frac{3}{4}$ -in. wood, and cut it so that it fits true inside the frame. See that both frame and block are flat on the bench, and then nail the frame to block. This done, all frames made on the top of the one attached to the block are sure to be true, because the block inside the frame is your "guide" for making them so.—J. PEARMAN, *Derby, September 25.*

SELLING HONEY.

[3007.] Referring to your editorial remarks in September 23rd issue *re* "Selling Honey," we should be grateful for any assistance in obtaining either large or small supplies of good honey. We are open to buy large quantity, and by giving us the names of people who have good honey to sell, you would greatly oblige.—H. N. B., *Solbergh, September 27.*

[In addition to the above, we have received another communication from a buyer, offering to purchase small lots of honey. Offers to either buyer sent to this office will be forwarded if enclosed in a stamped envelope.—EDS.]

Queries and Replies.

[1841.] *Drones in Autumn.*—I should like your opinion on the following facts:—A fortnight ago I began to suspect queenlessness in one of my stocks, first, from the cessation of work; second, from the absence of brood; and third, from the presence of a good many drones. Not caring to make a thorough search for the queen, for several good reasons, I determined to get a small stock of driven bees with queen guaranteed. This I did, and a week ago I united the new comers with the old colony. Robbing was to some extent set up, through my using syrup instead of flour for sprinkling both lots, and many strangers with some drones were killed. In a few days matters quieted down, and now plenty of work is going on when the weather is suitable, and pollen is being carried in, but still a good many drones are spared. Why is this do you think? With the two satisfactory signs of activity and pollen carrying, I hardly think it worth while to disturb the stock by a thorough search for the queen, especially after the attack of "robbers" last week. What say you?—W. H. H., *Ealing Dean, September 21.*

REPLY.—We do not think the sparing of drones for a short time means more than that the original bees of the hive have not yet quite realised the fact of there being a fertile queen

at their head. The drones will soon be turned out when brood-rearing advances.

[1842.] *Dead Bees Found on Floor-boards.*—On examining my hives to-day, prior to removal of surplus honey from the body-boxes, I found an enormous quantity of dead bees lying on the floor-boards. In one hive especially there was a complete cushion of dead bees, on which the frames rested. A brother bee-keeper, who assisted in lifting the body-boxes off the stands to enable me to sweep away the dead bees, said that he could not account for the great mortality. I don't think there has been any fighting, which would have been noticed either by myself or my gardener. Notwithstanding all these deaths, the hives are full of live bees. Can you enlighten me on the subject.—S. E., *Farningham, Kent, September 21.*

REPLY.—It is impossible to give a reliable or satisfactory reply by way of accounting for the death of so many bees without examination of the hives and appliances used. We might hazard a guess, but the chances are that personal inspection would entirely change our views. The only thing certain is that a "cushion of dead bees" on floor-boards is neither natural nor inevitable except under conditions which we believe to be avoidable in experienced hands. Can you not get some expert opinion on the spot as to the cause of the mischief?

[1843.] *Cleaning-up Boxes of Shallow Frames.*—I am glad to say my bees have done well this year. After extracting the honey a fortnight ago I put the boxes of shallow frames on the hives for the bees to clean up, and yesterday went, intending to remove them for storing away clean and dry. I intended at the same time to see what stores they had in body-box, but I found the bees were busy storing honey in the shallow frames. There was not, however, a single cell capped over. Will you kindly say in next issue of B.J. what I am to do in this difficulty? Is it advisable to leave the ten shallow frames where they now are for the winter, and pack them warmly? If it is best to take them off, what can I do with them, or how to keep them for use in the spring!—CYMRAES, *Anglesey, September 15.*

REPLY.—We should pack the shallow frames warmly up as they now stand, and leave them on the hives where they now are.

[1844.] *Bees Fighting Among Themselves.*—I have a hive from which I obtained about 20 lb. of honey this season. After removing the surplus honey I gave the bees stimulating syrup, and on inspecting them later on I found the bees covered nine frames; I also calculated they would have about 16 lb. of food. I gave them 12 lb. of thick syrup about three weeks ago, and they killed the drones in the usual course. On fine days, however, during the last fortnight the workers have been killing

each other! I thought at first it was a case of "robbing," and took all the usual precautions to put a stop to the supposed attack. I even removed the hive to a dark room and kept the bees closed in for thirty-six hours. They were then put outside again, after which wet weather came on. Now, to-day, they have again been at the same work of killing one another without mercy. Two bees usually come out of the hive, one after the other (the entrance only allows one bee to pass at a time), and they immediately tackle one another, and in a few seconds both drop from the board, one or both either maimed or killed. They cluster on the alighting board, and are not active, hardly flying at all. I have another stock situated 6 ft. from the above, the bees of which behave quite differently. I have questioned all the local bee-keepers and two of them have inspected the hive, but they can suggest no solution to the mystery. I am sure that you will be able to clear it up. When I raised up the edge of the quilt to-day the bees hardly cover seven frames, but when I inspected the hive before feeding up they were much more numerous. The queen, too, seemed all right, as I had a good view of her.

REPLY.—The curious anomaly of bees fighting among themselves without any visible reason, fortunately only occurs at rare intervals. It has been supposed at times that scented syrup has caused the mischief, but no reliable explanation has yet been afforded. Particulars of a few similar cases have been reported in our pages, the last, we think, about two years ago.

[1845.] *Working for Heather Honey.*—1. As flower or clover honey is not easily disposed of in this district compared with heather honey, I have been thinking whether it would answer to buy an extractor and extract the clover honey, and then use the sections when the bees go to the moors. What is your opinion on the point? 2. I use hanging-frames for sections so that they are very clean when taken from the hives, but would it soil them in extracting the clover honey? Also, what make of extractor would you prefer for that purpose, and could I extract the honey without taking the sections from the frame?—T. F., *Bishop Auckland.*

REPLY.—1. It is not at all uncommon to extract clover honey from unsealed sections, and send them—along with partly filled ones—to the moors for completion. Clover and heather honey mixed is a delicious combination. 2. If carefully handled there need be little or no soiling. There are several extractors specially adapted for sections. See our advertising pages. The sections would need removal from hanging frames for extracting.

[1846.] *Extracting Honey.*—Referring to this question, I beg to ask:—1. Is there any difference between extracting from shallow frames and from sections, and will the same

kind of machine answer in each case? 2. Is it really necessary to use a machine at all in order to obtain honey in good condition and without loss? If a machine is not necessary, how should I proceed to extract honey from sections? 3. In a work on bees by Mr. G. Gordon Samson he states that "more honey is obtained by using shallow frames than by using sections, but that section honey commands a higher price." As a beginner, it is rather puzzling to know how section honey can be superior to shallow-frame honey, if queen excluder zinc is used in each case. 4. Can I increase stocks by putting a double box containing standard frames above brood box: lifting a couple of frames of brood into doubling box, and substituting two standard frames in centre of brood nest fitted with full sheets of foundation, and feeding up rapidly?—ANOTHER BEGINNER.

REPLY.—1. You will find considerable difference after a trial of the two. Plainly put, shallow frames are intended for extracting; sections are not: though at times the beekeeper is compelled to extract from the latter for various reasons. Some extractors are adapted for extracting sections, but not all, though they may all be used for the purpose, at a pinch. 2. Only if it is desirable to preserve the combs for future use. Our forefathers cut the honeycomb up and strained it through muslin or cheese-cloth, to remove the honey from the wax. 3. Sections are supposed to bring a higher price than jars of extracted honey, by reason of their being more suited for table use among the better class of buyers, but the honey in them is not superior to the extracted. 4. We advise you to gain some experience before attempting to increase stock other than by natural swarming. The plan suggested will not do at all.

[1847.] *How Combs should Run in Surplus Chambers.*—1. Will you kindly inform me which is the correct way to place on supers of shallow frames? Do the frames run the same way as those in the body-box, or should the combs run across the top bars? I want to know now because I am trying to build my own hives and supers both for shallow frames and sections. 2. Also whether in tiering up with racks of sections they are to run parallel to combs below, or should the sections in separate racks cross each other?—G. K., *Horsey, September 24.*

REPLY.—1. Some authorities advise the "crossing" plan to avoid brace combs, but we have never seen any disadvantage in the combs of all surplus chambers running parallel. Besides, section racks and shallow frame boxes are not exactly square so they cannot be put on "either way" unless specially constructed. We therefore advise the parallel plan. 2. The same remark applies here.

[1848.] *Brace Combs in Sections.*—1. Can you kindly tell me why a great many of my

sections this year have been spoilt by being built on to the separators? The latter are tin and the sections are worked in the ordinary section rack. 2. Is there any objection to wintering bees with the excluder on and feeding up through it?—G. S. W., *Moniace*, September 25.

REPLY.—1. There must be some fault in "fixing up" the section or else in the make of the rack. If the foundation is accurately fixed and the hive is set level, care being taken to see that the separators are in proper position, very few combs will be attached to them. This is proved by the infrequency of such mishaps in experienced hands. 2. The only objection to leaving on excluder is the bother of removing should it be found necessary to examine combs below. Otherwise the bees may be "fed up" for winter through the excluder zinc" as desired.

[1849.] *Extracted Honey as Bee-food*.—1. Will you kindly tell me the best way of using extracted honey for bee-food? 2. Can it be diluted with water, or will it be best to mix with the ordinary autumn food, and if so will it require less sugar?—F. M., *Ewell, Epsom*.

REPLY.—1. Extracted honey needs no diluting when used as autumn bee-food, unless it is very thick indeed, in that case a quart of hot water may be stirred into a dozen or more pounds of honey. 2. If mixed with sugar-syrup stir in the honey while syrup is hot, but unless—as already said—the honey is very thick, we should not use less sugar than usual in making the syrup.

[1850.] *Thin v. Extra-thin Super Foundation*.—1. Will you kindly inform me whether the bees take practically the same time when drawing out sections from full sheets of foundation if the ordinary *thin super* is used, or that sold as *extra-thin*? 2. Could you give me any hints on ascertaining when a hive is queenless? At this time of the year breeding seems to have quite ceased, and on looking through my hives to make sure that they had queens, I failed to find them in two hives crowded with bees (only a very few drones), by examining the combs. I have just been "rapid feeding," so that I would like to avoid brushing the bees off on to a board in front, as the syrup would attract robbers. I have to record a failure to introduce a fertile pure Italian queen by the "swarming method," after removing the existing queen, which is well spoken of in the "Guide Book" and elsewhere. The attendant bees were thrown out within an hour, and the queen on the second day, the hive being in the meantime quite undisturbed.—G. M. S., *Keswick*, September 25.

REPLY.—1. We do not think there will be any appreciable difference in the time taken up. 2. It is next to impossible to convey in words the various signs by which the experienced eye guesses not at actual queenlessness,

but that "something is wrong," from the outside. Only observation and practice can do it. Our correspondent must just observe when a particular hive "behaves" differently from the rest, and then examine combs in order to settle the point. There is no "rule of thumb" in this matter, and, as is well known, one man will see at a glance what another will be perfectly oblivious to.

Bee Shows to Come.

October 2, in the Town Hall, Hamilton, N.B.—Annual Show of the County of Lanark B.K.A. Thirty-seven classes (open and confined) and 120 prizes for Bees, Honey, and Bee Appliances.

October 19, 20, 21, and 22, at the Agricultural Hall, London.—Show of Honey and Bee Products in connection with the British Dairy Farmers' Association. Over 40 prizes (including the President's "Champion" Prize, value £2, for the best exhibit of honey).

November 18, 19, and 20, at the Waverley Market, Edinburgh.—In connection with Chrysanthemum Exhibition Show, the Scottish B.K.A. will hold a Honey show as above, at which very liberal prizes will be offered (see advertisement on page v). Schedules from Rev. R. McClelland, Hon. Sec., The Manse Inchinnan, Renfrew.

Notices to Correspondents & Inquirers.

Letters or queries asking for addresses of manufacturers or correspondents, or where appliances can be purchased, or replies giving such information, can only be inserted as advertisements. The space devoted to letters, queries, and replies is meant for the general good of bee-keepers, and not for advertisements. We wish our Correspondents to bear in mind that, as it is necessary for us to go to press in advance of the date of issue, queries cannot always be replied to in the issue immediately following the receipt of their communications.

All queries forwarded will be attended to, and those only of personal interest will be answered in this column.

EXON (St. David's).—*Inspecting Hives and Detecting Disease*.—1. It is a serious drawback to the chances of success in modern bee-keeping where either the effects of a sting, or the dread of it, makes inspection of hives a matter of serious consideration before venturing on opening a hive. We think if our correspondent could manage to see a practical bee-man at work a few times it would help him considerably both in avoiding stings and managing to bear with an "odd prod" occasionally without "immediately applying" any remedy at all. We say this much on account of "Exon's" own remark about not looking "very deeply" into his only hive "because of getting stung." Had he done so the piece of comb sent would no doubt have reached us sooner, for we are sorry to say it is affected with foul brood, in addition to being so old and black as to have badly needed renewing even if healthy. We are thus regretfully compelled to advise neither re-queening or renewing of

combs in reply to queries on these points. There is a good deal of dead brood in comb, and, being diseased, it is no use in recommending at this season any other course than destroying the stock outright, burning the combs and disinfecting the hive before using again. It is idle to talk about making bees "pay" when the only colony possessed is diseased. If, therefore, our correspondent would defer any new start in bee-keeping till next year, and, meantime, read up the subject, we venture to say he will get on better and be more prepared to give a fair chance to the profitable side of the pursuit.

2. There is no Bee Association in Devon, though there are some active and enthusiastic bee-keepers near to Exeter.

A. NOVICE (Salisbury).—*How to Treat Honey after Removal from Hives.*—1. If honey is properly ripe when taken off, it needs no "treating" beyond removing it from the combs by means of an extractor, straining, and careful "jarring off." We do not understand what is meant by "letting it work itself before being bottled?" 2. Comb honey needs to be kept in a warm room to retard granulation, and must be sold before it becomes solid in the comb. If our correspondent has never seen a text-book on modern methods of bee-keeping, he would do well to procure one. See latter portion of reply to "Exon."

E. A. M. (Kidderminster).—*Varieties of Heather.*—The botanical name of heather received is *Erica vulgaris*. It is the common "ling," and best of all the heathers as a bee-plant. See reply to F. B. on page 370 of B.J. of September 16.

COLONIST (Nottingham).—*Packing Hives for Transit Abroad.*—Our correspondent will find full details on the subject of his inquiry in the June issue of our monthly, the *Record*, which may be had from this office for 2½d. in stamps. We have no knowledge of bee-keeping in South America beyond the fact of knowing that large imports of honey and wax are received here from that quarter of the world.

F. DYER (Wilts).—*Buying Diseased Bees.*—The question of claiming damages against persons for an alleged fraud in selling diseased bees as healthy ones can only be decided by the judge who tries the case after hearing the evidence *pro* and *con*. It is entirely beyond our power to state what chance there is of recovery of value or damages after hearing one side only, and even to express an opinion might mislead. We therefore prefer not to say, but our correspondent will soon have an opportunity of reading particulars of a recent case in point which will help him.

S. V. (Birmingham).—*How Long Naphthol Beta Remains Fit for Use.*—1. This is a question we have never thought it necessary to go into, seeing that it will remain

good for a year or two if kept in a bottle or carefully packed away. 2. We do not think there is any cause for alarm in the bees "crowding in the entrance and appearing excited" so long as it is certain that robbing has not started. It might be well, however, to lift a frame or two and make sure the queen is all right by looking for eggs or very young larvæ in the cells.

D. W. E. R. (Lanio-road, South Wales).—*Wintering Bees in Garret.*—It is "possible" to winter bees as stated, but we do not quite understand what is meant by the words "where the hives will have plenty of room." There could not well be room for more than two hives at a garret window. If, however, the bees are now located on outside stands we strongly advise leaving them there.

J. M. (Middlewich).—*Honey Sample.*—The honey received is very good in colour, flavour, and aroma.

J. E. (North Wales).—*Varieties of Bees.*—Bees received are a cross between ligurians and carniolans. Your complaint of them being "the most vicious bees I ever handled" is one often made against this particular cross; though, at times, they are just the opposite, and very quiet under "handling."

R. B. (Colwyn Bay).—*Joining the B.B.K.A.*—Full particulars of membership may be had from the secretary, Mr. E. H. Young, 12, Hanover-square, London, W.

GEO. HEAD (Windsor).—*Quality of Honey Samples.*—Of the seven samples sent we consider 1, 2, 4 and 6 very good in colour; 3, 5 and 7 not quite so good. For aroma and flavour we prefer 2, 3 and 4; the others being only moderate. All are fairly good in consistency, but for condition and appearance 1, 2, 3 and 4 are much the best. None of the samples could be classed as dark honey, all being distinctly light in colour. The best are quite good enough for staging at an ordinary show.

L. A. H. (Burry Port).—See reply to "C. J. F. G." on page 370 last week.

R. E. P. (Lincs.).—The few immature bees sent have failed to hatch out through being "chilled." They are quite free from foul brood.

PRESTON (Guildford).—*Drone-breeding Queen.*—There is no foul brood in comb sent, but queen is evidently a drone-breeder.

Sugar Cake (Pangbourne); *Making Candy.*—Full particulars appear on page 378.

R. JACKSON (Bentham).—*Queen Smashed in Post.*—The dead queen reached us so completely smashed out of shape as to be unrecognisable. Now that 4 oz. will go by letter post for a penny, there is no reason why bees should not always be enclosed in some sort of box for protection.

Editorial, Notices, &c.

BUYING DISEASED BEES.

IMPORTANT DECISION AS AFFECTING BEE-KEEPERS.

A case of considerable interest to beekeepers was heard before His Honour Judge Sir W. L. Selge, at the County Court, Romney, Kent, on August 19 last, in which the plaintiff, Mr. O. W. Cookson, of Blean, Canterbury, sued the Rev. G. H. Samson, New Romney, for damages for misrepresentation, or in the alternative, for breach of warranty. Mr. Percy Maylam, solicitor, Canterbury, represented the plaintiff; and Mr. G. F. Drury, barrister, instructed by Mr. Bracher, of Maidstone, defended.

In view of its importance to the bee industry generally, and the more or less conflicting reports of the case given in the daily Press, we have been at some trouble to secure a special and reliable account of the proceedings (from the reporter's notes) for the benefit of our readers, which will be found below. This explanation is made in order to account for the delay in publishing particulars, not from lack of interest, but as affording a reason why we did not acknowledge the scores of Press cuttings kindly sent by various readers for insertion in our pages.

In opening the plaintiff's case, Mr. Maylam stated that plaintiff had purchased of defendant twelve stocks of bees, which defendant had advertised for sale in the BRITISH BEE JOURNAL for October 22, 1896, as being "strong stocks of healthy, selected strain, Black Bees"; the amount of purchase money for the twelve stocks and certain bee-keeping accessories being £16. The plaintiff had bought the bees on the strength of the representation that they were "healthy," as stated in the advertisement, and confirmed by subsequent verbal statements; whereas they were infested with foul brood, a bee disease of a very serious kind, as being extremely destructive and infectious. Mr. Maylam explained the nature of the disease, and quoted from the leaflet issued by the Board of Agriculture on the subject. As a consequence, the whole of the stocks bought had died a short time after the purchase, having previously infected with the disease bees which had belonged to the plaintiff, and were healthy before the purchase in question from the defendant. He submitted that the defendant was liable, in the first instance, in contract, as the advertisement and representations amounted to a warranty, and argued that a bare representation or assertion as to the quality of goods might amount to a warranty. Secondly, he (Mr. Maylam) submitted that the defendant was liable *in tort* for misrepresentation on the ground that, being a certificated expert, he must have been aware of the state

of the bees when he represented them as healthy, and evidence would be produced to show that he had been warned that foul brood existed among his bees before the sale took place.

The plaintiff, examined by Mr. Maylam, stated that after reading the advertisement (produced) he went down to the defendant's place early in November, and—after the price (£18) had been named—expressed a wish to look at the bees; the defendant, however, objected to their being disturbed unless there was some prospect of coming to terms. They were then described as strong and healthy. After a general conversation, defendant said, "I have never had a case of foul brood amongst my bees." The plaintiff explained his ignorance of the disease called foul brood, but having noticed while in the bee-house one or two combs that had a peculiar appearance, he drew defendant's attention to them, but the latter declared it to be only "chilled brood." He also added: "I had a person down here the other day who was afraid it looked like foul brood, but if he had known anything about it he would have been aware that foul brood had an offensive smell." He then held up a comb and said, "You will find there is none whatever about that." He further added that he had kept bees ever since he was eight years of age, and he was a second-class expert of the B.B.K.A. Eventually the plaintiff did not purchase—deeming the price too high—but took time to consider it. He subsequently wrote offering £20 for twenty-one Combination hives (twelve containing bees) and two hundred frames of comb, provided that the bees did not cover less than seven frames in each hive. This offer was accepted, and, in consequence, plaintiff went down to inspect the bees again about the end of November. As the weather was cold, defendant suggested that it would be sufficient to draw back the quilts to see how many seams of bees appeared below, and on finding only four seams instead of seven in each hive, expressed surprise that the bees were so weak in numbers, but explained that it had been a bad season for brood-raising. Plaintiff, however, declined to purchase, but eventually wrote offering £16, which offer was accepted and a deposit of £1 paid. In the first week of January, 1897, plaintiff went to fetch his purchase, and on arriving found the hives already packed. He therefore did not see the bees. He, however, paid the balance and took them away. About a month afterwards on inspection he found the bees had decreased in numbers, and brood-rearing had not begun. Subsequent inspections showed a still further decrease, until, on examining in March, evidence was seen which caused plaintiff to cut out and forward a piece of comb to the office of the BRITISH BEE JOURNAL, and received a reply that it was affected with foul brood. The plaintiff gave further details of his action with regard to the matter, culminating in his taking

proceedings for the recovery of £25 damages for loss incurred.

In cross-examination by Mr. Drury, plaintiff said at the time of purchase he "did not inspect the bees further than stated." He did not remember being told to "satisfy himself before purchasing," but admitted defendant's leaving him in the bee-house and saying, "You can see anything you like." He might have spent three-quarters of an hour in the garden, but not a single comb was lifted out of the hives for him to see.

Mr. R. Hamlyn-Harris, examined by Mr. Maylam: I reside at Hambrook, near Bristol, and am chairman of the Bristol Bee-keepers' Association, which is in affiliation with the British Bee-keepers' Association. I am a certificated expert of the latter association, and have passed the examination on foul brood. I am also a member of the Council of the B.B.K.A. I saw the advertisement in October last in the BRITISH BEE JOURNAL, and after writing to defendant regarding it, made an appointment with him. In pursuance of this appointment, I went to see the defendant in October last at his house at New Romney. I arrived at 12.30 and was shown into his apiary, defendant inviting me to look round. In further examination witness said he expressed a wish to examine the bees, but defendant declined, saying, he "did not want the bees looked at unless I was about to purchase." To this Mr. Harris replied, "I should not have come all the way from Bristol without such an intention." He afterwards, while examining the bee-house accessories in the absence of defendant, took out some combs that had been removed from the hives, and in them found foul brood in the most advanced and final stage. In consequence of the discovery he came to the conclusion that foul brood must have existed among the bees, and that probably the whole apiary was more or less infected. He did not therefore consider it necessary to do anything further, but at once went to the house and told defendant that he had found foul brood in the combs in his bee-house, and could not tell where it would end. The defendant said "he was very sorry, but he had never known foul brood in his apiary." He, however, did not deny it. The witness then went on to say he had communicated with the editors of the BRITISH BEE JOURNAL, informing them that defendant was trying to sell a foul broody apiary, and asking that the advertisement be withdrawn in consequence. This was done.

The witness further stated that "he should think it was impossible for any certificated expert not to have known of the existence of foul brood among his bees when present in such a pronounced form."

In cross-examination by Mr. Drury: Witness said "it was a rare thing for brood to be raised in November or December. There would be no brood to be attacked, and besides,

at the stage in which he found the diseased combs, no smell is emitted; an inexperienced person might certainly mistake "chilled" for foul brood. If the hives were healthy £16 would be a very good price. No person with any understanding would put bees into a hive that had held a diseased stock without first disinfecting. Witness concluded his evidence by stating that when he informed defendant that he had got foul brood in his apiary he did not reply that "it was chilled brood only."

Wm. A. Withycombe, examined by Mr. Maylam, said he resided at Bridgwater, Somerset, and was the official expert of the Kent and Sussex Bee-keepers' Association, and of the Bristol and Gloucester Associations. His duties were to travel through the various counties, and examine the hives of members. In this way he examined plaintiff's bees on the 3rd of May, 1897, and on that occasion was shown the hives and bees purchased from defendant. "Mr. Cookson," he said, "showed me six stocks of his own, which he possessed prior to the purchase from defendant. I found the stocks of bees so purchased simply rotten with foul brood; in fact, it was the worst case I had ever seen, and I reported it to the Association as such. In most of the combs there was disease of the previous year. I inspected over 4,000 hives this year. I corroborate all Mr. Hamlyn-Harris has stated as to the nature of the disease, and think he was wise in declining to have anything to do with the defendant's apiary."

Cross-examined by Mr. Drury, the witness said he found the hives originally belonging to the plaintiff were slightly affected, or in the first stages of the disease. He advised him to get rid of them, and told plaintiff that defendant's bees had infected his. He had also warned a neighbouring bee-keeper of the danger of infection. The witness further stated in the third-class examination a person must possess a thorough practical knowledge of bees. "Chilled brood" is not generally prevalent in hives in the autumn months, but is usually found in the spring of the year.

The defendant, the Rev. G. H. Samson, examined by Mr. Drury, said he did not agree with plaintiff's account of what took place. He had given him carte-blanche to look at and examine everything, and left him alone on his first visit to see for himself. The bee-house was a large room, which contained all the bee paraphernalia. When the bees were packed up for the plaintiff they were in the exact state in which he (defendant) had advertised them. The witness, Mr. Hamlyn-Harris—when he came and made his examination—said, "I have had foul brood myself, and your bees have too much the appearance of it for me to tackle it." He then added, "What time does the next train start for London?" Continuing his evidence, the witness said: "On the occasion of his first visit he (plaintiff) picked up a piece of comb and remarked that 'it looked like foul brood;' but I said it was

‘chilled brood, not foul.’ In reply to further questions of counsel, witness stated that plaintiff on his second visit “carefully inspected the hives, in course of which inspection he made me remove the quilts and raise the combs—as he has stated. I had to pack up the bees when he came.” In conclusion, witness declared that “he sold the bees, believing them to be healthy.”

Cross-examined by Mr. Maylam, defendant added: “Notwithstanding the warning I received from Mr. Hamlyn-Harris, I felt justified in selling the bees and hives to the plaintiff. I considered my opinion was as good as that of Mr. Hamlyn-Harris, and it was plaintiff’s own look out.” The defendant further stated that he had passed the British Bee-keepers’ Association examination in foul brood, in addition to being a certificated expert of that Association.

Mr. Drury submitted that the sale had not taken place on the strength of the advertisement, as there had been subsequent negotiations. He further argued that the advertisement did not amount to a warranty, the statement being descriptive merely, and only amounting to the ordinary puff of a vendor.

Plaintiff’s solicitor, Mr. Maylam, replied on the whole case, and argued that the word “healthy” in the advertisement was not descriptive merely, but was a distinct representation of condition amounting to a warranty, and that the defendant, after the warning given by Mr. Hamlyn-Harris, ought to have satisfied himself as to the state of his bees before selling them as healthy.

His Honour, the Judge, in giving his decision, said: I am of opinion that no case of misrepresentation has been made out, and am surprised that it has been brought. It appears that the defendant had no knowledge that the bees were infected with foul brood, and being an expert, he considered his opinion as good as that of Mr. Hamlyn-Harris. With regard to the question of warranty, it is plain that the bees were described as healthy in the advertisement, and we have the statement of the plaintiff that they were described as healthy to him, and that he bought them relying on that assurance. On the first occasion the plaintiff did not examine; on the second occasion he did, but only to the extent of ascertaining how many frames were covered with bees. It appears to me that the defendant did sell them as healthy bees, and that the plaintiff relied on the representation of the defendant that the bees were healthy; therefore, there has been a warranty. Now we have seen that they were seriously infected; therefore, there has been a breach of warranty, and the verdict will be for the plaintiff for the amount claimed, with costs.

ROXBURGHSHIRE B.K.A.

The annual autumn honey show of the above Association was held in the Corn Exchange, Jedburgh, on Saturday, September 25, and

was eminently successful. The large number of classes were fully filled, and scarcely any inferior honey seen. Where the heather honey came from in a season like that of '97 was a mystery. In extracted granulated honey, both liquid and granulated, some rare specimens were tabled, and the “displays” of honey were a sight to cheer a bee-man’s heart. A few of the sections in quality and get-up were simply perfect, and the supers numerous and highly acceptable to those exhibitors who staged them. There were no entries in the class for new inventions connected with bee-keeping.

The Rev. R. McClelland, Inchinnan, and Mr. George Wilson, Kelso, officiated as judges in the honey classes, and made the following awards:—

COMB HONEY (Sections).

Twelve 1-lb. Sections.—1st, Alexander Anderson, Minto; 2nd, Donald McGeachy, Oban.

Twelve 1-lb. Sections (Heather Honey).—1st, George Ormiston, Knowesouth; 2nd, Walter Oliver, Jedburgh.

Six 1-lb. Sections.—1st, James Whillans, Camptown; 2nd, Alexander Anderson; v.h.c., H. Marrs, Rosewell.

Six 1-lb. Sections (Heather Honey).—1st, David Welsh, Jedburgh; 2nd, James Whillans; v.h.c., Thomas Ellis, Jedburgh.

Five 1-lb. Sections (Gift Class).—1st, Alexander Anderson; 2nd, J. Whillans.

Single 1-lb. Section.—1st, A. Anderson; 2nd, J. Whillans,

Standard Frame of Comb-Honey.—1st, G. Ormiston; 2nd, G. Yellowlees, Jedburgh.

Two 1-lb. Sections (Gift Class).—1st, J. Whillans; 2nd, A. Anderson; 3rd, William Swanston, Jedburgh.

Super (any Weight).—1st, William Weir, Heriot; 2nd, G. Ormiston; v.h.c., Thomas Pate, Milnathort; h.c., A. Anderson.

Super (7 lb. to 10 lb.).—1st, Alexander Brownlee, Jedburgh; 2nd, Thomas Dodds, Hardenpeel; h.c., W. Sinton, Jedburgh.

Super (5 lb. to 7 lb.).—1st, Thos. Mabon, Jedburgh; 2nd, G. Ormiston.

Super of Heather Honey (any weight).—1st, W. Swanston; 2nd, J. Whillans; c., D. McGeachy.

Super of Heather Honey (7 lb. to 10 lb.).—1st, W. Swanston; 2nd and v.h.c., Adam Telfer, Jedburgh; v.h.c., Thos. Ellis.

Super (not under 10 lb.).—1st, W. Swanston; 2nd, W. Sinton; v.h.c., G. Ormiston.

Glass Super of Honey (any design).—1st, Wm. Weir; 2nd, A. Anderson; v.h.c., W. Swanston.

EXTRACTED HONEY.

Six lbs. Extracted Honey.—1st, T. Pate; 2nd, R. J. Brindle, Rosewell; v.h.c., Wm. Loveday, Harlow, Essex.

Six 1-lb. Jars Extracted Honey.—1st, R. McAudie, Edgerston; 2nd, H. Marrs; v.h.c., Wm. Loveday.

Six 1-lb. Jars Extracted Heather Honey.—

1st, Thos. Clark; 2nd, Adam Oliver, Jedburgh.

Six 1-lb. Jars Extracted Honey—1st, A. Teller; 2nd, T. Dodds; c., G. Yellowlees.

Single 1-lb Jar Extracted Honey.—1st, T. Clark; 2nd, G. Ormiston.

Six 1-lb. Jars Granulated Honey.—1st, Wm. Loveday; 2nd, J. K. Young, Jedburgh.

Display of Honey (60 lb. to 100 lb. in weight).—1st, Thos. Clark, Pleasants.

Display of Honey (not over 50 lb.).—1st, T. Clark; 2nd, J. Whillans; v.h.c., Jas. Kerr, Chatto, and Thos. Pate.

Beeswax.—1st and 2nd, G. Ormiston.

Observatory Hive (stocked with bees).—1st, Adam Oliver.

Bar-frame Hive.—1st, A. Oliver; 2nd, and v.h.c., John Cranston, Jedburgh.—(Communicated).

HONEY TROPHY PHOTOGRAPHS.

The illustration on page 395 completes the series of pictures from photos of County Honey Trophies which received awards of the "Royal" Show held at Manchester in June last. We are requested to say that direct copies of the several photos from which our tone-blocks were reproduced may be had mounted on cards, 10 by 8, price 1s. each, from Mr. W. Dixon, 5, Beckett-street, Leeds; as may also copies of the group of bee-keepers taken at same time and place.

Correspondence.

The Editors do not hold themselves responsible for the opinions expressed by correspondents. No notice will be taken of anonymous communications, and correspondents are requested to write on one side of the paper only and give their real names and addresses, not necessarily for publication, but as a guarantee of good faith. Illustrations should be drawn on separate pieces of paper. We do not undertake to return rejected communications.

** * * In order to facilitate reference, Correspondents, when speaking of any letter or query previously inserted will oblige by mentioning the number of the letter, as well as the page on which it appears.*

IRISH EXHIBITS AT SCOTCH SHOWS.

[3008.] Referring to Mr. Anderson's complaint (3002, p. 383) in last week's journal, I cannot allow his remarks anent Scotch shows to pass without a word in defence.

First—and regarding myself—I am a Scotchman, a bee-keeper, a honey judge, and have in days gone by been one of Scotland's largest exhibitors at honey shows. I have also been the promoter of five Bee-Associations in different parts of Scotland, and have kept bees as a hobby for twelve years, having had in my apiary sixty stocks at one time. During these years bee and honey-shows have been one of my pet schemes, and in every district in which I have been resident my best endeavours have been directed to their en-

couragement. As an instance of this, let me say I have in the past year subscribed upwards of £10 to our local flower show solely for honey prizes.

On this matter of judging, then, in the first place, I do not know a single honey show in Scotland where the judges can know whether the honey they have before them belongs to English, Scotch, or Irish exhibitors, that being known only to the secretary till after the prizes have been awarded. Therefore, how the judges in the case Mr. Anderson mentions knew his was Irish honey puzzles me. Your correspondent also complains of the Scotch prize schedules excluding Irishmen, but I cannot call to mind a single instance of any important Scotch show where either English or Irish exhibitors are excluded from showing. On the other hand, I could name a dozen Scotch shows which are open to the world on payment of entry fees.

Three seasons ago I was hon. sec. for the South of Scotland Bee-keepers' Association, when they held a very large honey show at Dumfries, at which I was not myself exhibiting, but we had exhibits from England, Scotland, and Ireland, and I had the pleasure of seeing Mr. Anderson's honey among the other exhibits staged. The Rev. R. McClelland, Renfrew (who is considered one of our best judges), awarded the prizes, and I am glad to say the first prize for both sections and extracted honey went to English exhibits at the show in question. Mr. Anderson's honey was not among the prize winners on that occasion for a good reason, as, in my opinion, it was a long way behind in order of merit; indeed, if all the honey Mr. Anderson sends to important Scotch shows is like the samples he then staged, he will never get a first prize in Scotland.

I remember taking particular notice of Mr. Anderson's honey in comparison with the beautiful samples of Irish honey the late John D. McNally used to send to our Scotch shows, and which was generally about the top of the prize list.

It is not for me to say why the Scotch bee-keeper referred to refused to let Mr. Anderson have a sample of the honey which had beaten his, but if the latter would send a sample section and a sample jar of his Irish honey to the Editors of the BEE JOURNAL, I would be very pleased to send a similar quantity of Scotch clover honey, and our Editors could perhaps tell us which is best; or I will be pleased to send same to Mr. Anderson for his inspection and comparison.

In conclusion, I must, as a lover of fair play, and one who has attended most Scotch shows either as judge, exhibitor, or onlooker, express my opinion that all honey, whether from Scotland, England, or Ireland, shown at our Scotch shows are put on a level, and the best in the opinion of the judge always wins.—WILLIAM WILSON, *Galashiels, N.B.*, October 2.

A HINT FOR WINTERING.

[3009.] Winter is not far ahead, and before long the candy-pot will be bubbling in many a bee-keeper's kitchen. But those of us who, like the writer, are bound to keep their apiary within moderate limits must have been obliged after this swarming summer to join up stocks, and will now perhaps possess more

quantity is no objection, the comb itself must be such as you would care to retain in your hive brood-nest.

Take two empty frames; call them top and bottom respectively. Tack a piece or pieces of thin board to the side bars of the top frame, so that one face is quite or pretty nearly covered over. Put the bottom frame flat on a table; then the comb-frame accurately on the

COUNTY HONEY TROPHIES AT "ROYAL" SHOW, 1897. (No. 6)

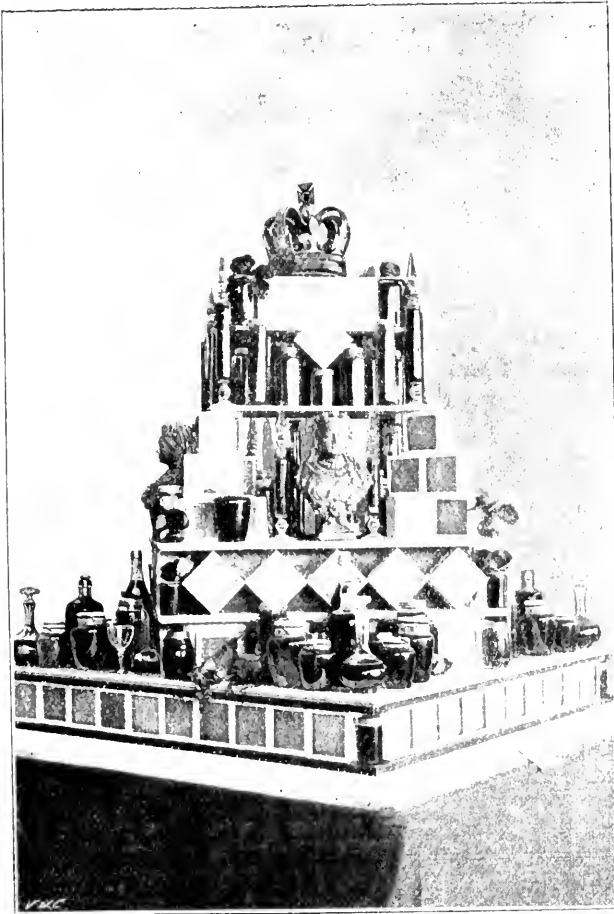

HIGHLY COMMENDED, HUNTS B.K.A.

stored combs than they care to keep through the winter, useful as a few such combs will be to them next spring. In that case candy is not wanted, seeing that as good, if not better, results can be got by using the spare combs in a manner I will now describe, mentioning, however, as a proviso, that, although the quality of the honey is of small consequence, and the presence of pollen in the cells in reasonable

top of it, and on the top of that again the top frame, boarding upwards. Twist bits of thin frame-wire round the frame ends and bottom bars so that the frame, will keep in position. Here, then, is a snug honey-box with stores in the middle and a winter passage below, so that the bees can move about or cluster as they will. Place it over the brood-nest, and cover with soft quilting material of any kind

available. If the brood-nest is very big the honey-box can be placed transversely; but probably it will be better to place it so that frame ends cover frame ends, to which there is no practical objection if the quilting be properly seen to.

Having done this last winter, I left the hive alone till the middle of March. On inspection I found that the honey had been consumed, while the comb contained brood on both sides. Three snips of a big pair of scissors set the brood-frame free, and it was at once lowered into place at the back of the brood-nest, which still contained a good supply of stores. After results quite justify me in recommending this method of wintering to such as have combs at their disposal.

One thing puzzled me at the time, and does so still. How is it that brood can be reared in cells that open downwards? What keeps the cell contents from yielding to the force of gravity after the hatching of the larvæ? It is true that queen cells often point downwards, but their pear-like shape even before sealing would be probably sufficient to hold the contents in place, although even then the arrangement strikes me as uncomfortable. I should be glad of a satisfactory explanation.—SOUTH DEVON ENTHUSIAST, *October 3, 1897.*

BEEES IN THE FAR NORTH.

[3010.] The season of 1897 may be classed as a good one for bee-keeping in this far away part of Scotland. The weather in spring and early summer was not favourable to bee-work, but towards the end of June sunshine and warmth set in abundantly, and continued with little interruption until well on in August, when a change for the worse took place. While the good weather lasted the bees worked with a will and filled the surplus chambers rapidly. The pleasant smile observable on most bee-keepers' faces when the conversation turned to bees, showed better than words how well pleased they were with the way matters were progressing in their apiaries. The honey crop from the clover was a good way above the average of former years and the quality was excellent. The heather did not yield so largely as expected, owing to the prevalence of cold winds and rain.

Taking this district as a whole, the average yield of honey for the season may be taken at 40 lb. per hive. According to a local print, one or two apiarists in the "Black Isle" took as much as 200 lb. off one hive. This large result is abnormal for the district and must be taken with some reserve. I did not take less than 40 lb. off any of my hives, while from three or four I got ninety sections of splendid honey, most of them weighing 1 lb. 3 oz. Sections were unusually well filled this year. The results obtained from bee-keeping have given general satisfaction here, but grumblers are not entirely wanting whose non-success is due to bad management; not that the bees nor

the weather. None who worked their apiaries on anything like modern principles have failed to take honey of some sort. A skeptic of my acquaintance, whose ideas of bee management are of the most antiquated kind, gives expression to his grievance in this way:—"The dirty *bastes* didn't give me a single grain of honey. They wouldn't work either above the skep or below, although I put as *bonnie boxies* on them as ever you saw." The poor fellow did not know his queens were worn out with old age, and his stocks so weak that they had quite enough to do to keep themselves alive.

Another unfortunate says his bees are run out and he must get a "red queen"—meaning an Italian—next year, as the black bees are such lazy brutes; they won't do anything but sleep and eat. Some old-fashioned bee-keepers hereabout have very funny notions indeed.

To tell another person how many stocks one has is sure to bring mischief on the bees. No one must know how much honey is taken off the bees; otherwise some evil will come to them. To suffer another bee-keeper to count your hives is certain destruction to your apiary. Hives near water won't thrive. To sell or give away a stock of bees is very "unlucky." One skeptic declares he lost more than half his apiary through this cause.

Runaway swarms were common in this quarter last season. These were due in several instances to the laxity of the bee-keepers. The evil of runaway swarms could be prevented if queen-clipping were resorted to. Some soft-hearted people consider this a cruel practice and detrimental to the laying powers of the queen, but the apiarist who wishes to profit by his bees cannot afford to be too humane.

The "Wells" system has been tried in a few apiaries here, but with what success has not transpired. I suppose the game was not worth the candle. I have not tried it myself because I have doubts as to its utility. The idea of two colonies of bees working together in the same super is, to my mind, a little against nature. The system consists in nothing more than two stocks working in partnership, and it is difficult to realise how bees could gather more honey in this way than when working in separate hives. The real secret of successful bee-keeping lies I believe, in having young prolific queens at the head of all stocks. I never keep a queen beyond her second year, because after that she ceases to be profitable.

My apiary at present consists of the insignificant number of forty hives. I use both single and double walled hives, but I prefer the latter as being undoubtedly more comfortable in severe weather.

Any packing between the inner and outer cases is more injurious than useful. My bees are all packed up for winter with abundance of natural stores. I make it a rule to give the hives a good coating of paint before winter sets in so as to make them proof against the wet.

There were very nice displays of honey at

Strathpeffer, Tain, and Novar Flower Shows, and reflected great credit on local bee-keepers. The honey department at Novar Show was the largest ever seen there, but the exhibitors have a good deal to learn in the way of staging their honey. The principle prize takers at Strathpeffer were Mr. McVemish, Beauly, and Mr. A. Paterson, Delny. The latter gentleman is a shining light amongst the bee-keeping fraternity of his own district.

A great, if not the chief difficulty bee-keepers here have to contend with is how to find a market for their produce. This is due in a great measure to the sparseness of the population and the absence of large towns.—D. M., *Atness, N.B., September 18.*

HELPING TO STAMP OUT FOUL BROOD.

[3011.] Referring to your answer to "Exon" (St. David's) on page 389 of B.B.J., September 30, I may say we have had foul brood around Exeter for some years, and had an experience of it myself two or three seasons back, but am pleased to say my eleven stocks are quite free of it now.

If I could have "Exon's" name and address I would call upon him to see if he is willing to help in stamping out the disease from this district, and if he is in poor circumstances, I know of bee-keepers who will be willing to compensate for the destruction of his diseased stock.

We hope during the coming winter months to do away with the reproach conveyed in your answer No. 2, by having a Bee Association for Exeter and district to be in touch with the B.B.K.A.—T. H. B., *Exeter, October 4.*

[The very practical remarks of our correspondent are in themselves most commendable, and we trust they will not escape the notice of the "enthusiastic bee-keepers" to whom we referred in our reply on page 300. A communication from one of these latter gentlemen appears on page 395 of this issue. We will also draw the attention of "Exon," St. David's, to the above, and have little doubt but he will avail himself of the practical help offered.—Eds.]

JACK BANNELL TO "LORDSWOOD."

[3012.] Dere Mister burter (Bertie) ples xcoose mi nott ritin to yu last weak i adent no oppertunety as i waz hup at farebanxhis elpin um kill 2 piggs i am verry sorry as I could nott dew as i Promesd yu but I shud if I cud of dun so with mutch Plesur as i am verry sorry as my wurd his Broke an ope yu wil xcoose as hit waz quiet unempossible we 'av add sum specements of wethwer sence i sid yu larst weak bes am dewin nuthink tu spake on i azent fedd um as i Promesd as i av a heep of Hasturs in blough allso jeranys an a fu ricklizzies so i thinks as thaerl du weart. Won progged 'er on (Mrs. Bannel I suppose t) ther

ibrough day arter yu cum, yude orter seed er marx. ther nough, 'er sez wate til i siz im oil gee im sum appells an arter sellin im neerly a cut of unny to an feedin they bes ther leetel xcoose me a writin of it in print the unny is a runnin outen ther sells send sum bottells as i asnt got enuf i sharnt waist enny rite me annie time yu kan run hover on Biysickell yure wellkum tu shelltur in my umbell cott, weem rugfh an rheady as yu no add diffekultea hin getin postle hodr kasht as thay sed yud orter sined hit. were am they fillbirds yu raxkall yu am know mor unemprvd than wen i ized tu droive yu tu skule we tommy. those waz daze you did leed me darnse never fourgivd you yet speshly that day yu kiddid me hintwo pickin wite viletts and then drovd on 3 moil weart me yu raxkall i minds yu wel i spose lads hull be lads ast saain his i ope guvner is al rit hi ham al rit. "ers" al rit sept begrog marx ther yit. wisht bin hon er tong. ples send sum envlups ope youer muther is al rit. yud orter sid er i arter bede progged er. maid you larf yuer touley, JACK BANNELL.

BLOCKS FOR MAKING FRAMES.

[3013.] Permit me to correct an error referring to above in my letter of last week, which (3,006, p. 387) should read $1\frac{3}{4}$ in. wood, not " $\frac{3}{4}$ in." This $1\frac{3}{4}$ leaving space to make the frame round the block.—J. PEARMAN, *Derby, October 2, 1897.*

THE SEASON IN SCOTLAND.

[3014.] I enclose a cutting from the *Scotsman* newspaper. My own experience in Dumfriesshire (five miles north of Gretna) is quite the same, except as regards swarming, which in some districts has been very troublesome. I will, however, shortly write a separate account of the hive which I wrote about in the spring when the queen stopped laying owing to the winter wrappings being taken off too soon.—FREDERIC MCCONNELL, *Ecclefechan.*

[The cutting referred to reads as follows.—Eds.] :—

The flower and clover honey season having just closed, bee-keepers are gathering in the yield of honey from these sources. The yield is more abundant than was promised in the spring and early summer, when the conditions and outlook were exceedingly unfavourable. Owing to the comparative mildness of the season, the stocks came through the winter in fairly good condition, but the spring being cold, little progress was then made, and only such stocks as were carefully attended to were in good condition at the beginning of June, the usual month for the beginning of the honey flow season in Berwickshire. June is usually a good honey month, but this season it was exceedingly disappointing. The weather throughout was dull, windy, and cold, conditions in which bees do little storing. In the

beginning of July, however, when the hopes of bee-keepers were at zero, the weather suddenly altered and became everything that they could wish. The cold spring and the dull weather in June having delayed the blooming of the clover in that month, the sudden and full development of it in July was such that the bees revelled in it, and extracted honey without let or hindrance, and quickly stored up. It was one of the best clover honey flows that has been for many years. Clover bloom generally fades about July 20, but this year it continued about ten days in August, when the last of it was washed away by a heavy rain. One noticeable feature of this bee season is the small amount of swarming. June is usually the swarming month, but this year there was little of it, and what there was was late in the month. These stocks having made preparations for swarming were prevented from carrying it out by the character of the weather, and they swarmed later, having young queens, the old queens being superseded by the bees, the result of being arrested when ready for swarming. The result of the clover season is good all round, quite beyond expectation. Good stocks have gathered in three weeks from 50 lb. to 80 lb. of super honey each, and from 48 lb. to 60 lb. have been widely realised. The contrast of this clover season with the last is quite special. Last year the spring weather was so fine that honey was well stored in May, supers having to be put on, a most unusual thing, and many were filled by the end of the month. The price sought by bee-keepers is 10d. per lb. It is not considered, however, that that price can be maintained, as the supply is so plentiful. The stocks are now being removed to the heather, which is getting well into bloom and promises well.

Queries and Replies.

[1851.] *Effect of Tin on Honey.*—In reference to your reply to "E. P. C., Bath" (p. 378), on the effect of tin on honey, I was just going to ask you whether there might not be some risk in using any odd tin cans, &c., for storing syrup in? Some little time ago I remember reading an account of how—in order to keep down prices on cheap tinned goods—cans were being put on the market not coated with *pure tin*, but with a mixture of two of tin to one of *lead*, called "terne metal." What would be the effect of lead on syrup or honey, and how could one test tin for lead?—GEORGE M. SAUNDERS, *Keswick*.

REPLY.—We have never seen or heard of "terne metal," and cannot say what its effect on honey would be. If bee-keepers will but be careful to use the ordinary "lever-up" tins

for storing honey in, there need be no fear of any bad effect. Zinc is known to be detrimental to honey, as is also galvanised iron, but tin is perfectly safe.

[1852.] *Pollen Carrying in October.*—There are about ten acres of mustard, together with four or five acres of "charlock," in full bloom, about a mile from my bee-garden, and about eleven o'clock to-day (October 4) the bees of all my twenty-two colonies were carrying in pollen quite briskly, though some carried much more than others. 1. Is this a good sign for this season of the year? 2. Is there likely to be any honey in the aforesaid bloom so late as this?—W. E., *Wills, October 4*.

REPLY.—1. The activity of the bees shows that the abundant forage has given an impetus to late breeding. 2. No doubt the bees are getting honey as well as pollen from the bloom referred to on warm days.

[1853.] *Wax-moth in Skep.*—*Recipe for Bee-syrup.*—I am a beginner with bees, and am in a fix. I therefore solicit a little help from you or from some reader of the B.J. willing to advise me under the following circumstances:—Last week I examined a straw skep of mine, and got well stung for my pains. I stuck to them (the bees, not the stings), and saw all I wanted before putting them back on the stand. I found the skep contained wax-moths, but not much store, and only a little brood. The bees, however, are still carrying in pollen. 1. What shall I do to get rid of the wax-moth? 2. Should I leave it alone till the next spring before taking any steps to banish the intruders? 3. What sort of sugar should I give the bees, and where can it be got? 4. Does the syrup require boiling, and for how long?—G. T. J., *Spalding, October 4*.

REPLY.—1 and 2. If the larvæ or grubs of the wax-moth are only found between the bottom "round" of the skep and the floorboard, it will suffice to brush all traces of them off with a stiff brush. Should the larvæ have obtained a lodgment in the combs, you can do nothing towards remedying the mischief. If the bees get fairly strong in early spring, they will keep the moths down. 3. Refined pure cane sugar (white crystals) is the proper kind for making bee-syrup at this season. It can be had from any grocer who will guarantee its being "pure cane." 4. Follow this recipe in making bee-syrup:—10 lb. cane sugar (refined crystals) to five pints water. Boil gently for a minute, and on removal from fire stir in 1 oz. vinegar and $\frac{1}{2}$ oz. salt. Medicate the syrup if there is foul brood in your district.

[1854.] *Dealing with Diseased Stocks in Autumn.*—I send you herewith three combs taken from middle of brood nest which I fear shows foul brood. You might examine them and, if possible, kindly reply in first issue of journal. I first noticed the traces (as indi-

cated in Guide Book) when extracting from comb taken from body-box, and shall be pleased to have my suspicions confirmed or dissipated, as the case may be; also, what would be the best course to pursue at this time. The bees are numerous and well looking, and I should be sorry to destroy them.—J. S., *September 30.*

REPLY.—We are sorry to say that all three pieces are affected with *foul brood*. It is very late for taking effective measures or attempting to cure; but if you possess a few frames of *healthy combs*, we would advise getting the bees off their present diseased ones and joining up the three lots into one (or two, if plenty of bees), and feeding up rapidly with medicated syrup. It is not much use wintering stocks known to be diseased, seeing how great is the risk of worry and disappointment in spring in having diseased colonies of bees to handle in curing, and the consequent danger of infecting healthy ones. Better to deal with them now on *clean combs*, and watch carefully how the brood hatches out in the early spring of '98.

[1855.] *Late Feeding under Difficulties.*—I keep my bees about three miles away from home, and can only attend to them once a week. On examining the hives a few days ago, I found that none of them have enough stores to last the winter. Kindly say, through the BEE JOURNAL, if I can feed them up with dry Porto Rico sugar supplied in hollow dummies; or will candy do? I cannot possibly manage the usual syrup-feeding on account of the distance and want of time.—S. M., *Sheffield.*

REPLY.—If you can obtain *genuine* Porto Rico sugar, and so prepare the "hollow dummies" that the sugar will not run out during the winter if it deliquesces, the dry sugar may answer; but, personally, we do not like it as a winter food for bees. It is far too laxative to be wholesome. It is also very difficult indeed to get genuine Porto Rico sugar. On the other hand, a good-sized cake (say 4 lb.) of soft candy, if properly made, will last the bees for a good many weeks, and may be renewed as needed.

[1856.] *Making Frame Blocks.*—In the B.B. for September 30 Mr. J. Pearman, Derby, in his reply to "One in Doubt" (p. 387) advises how to make up frames true; but if I understand his instructions correctly, the frames made by his method will all be too large, *i.e.*, the inside will be as large as the outside ought to be, and will be larger than standard size. Further it will not go into a hive made to take standard frames.—QUEEN, *Southport, October 4.*

REPLY.—Please refer to Mr. Pearman's communication on page 397 of this issue.

[1857.] *"When Doctors Differ."*—Kindly give me your opinion of the enclosed comb.

In the spring an expert said it was a grand stock. Now I find every comb more or less like this one, and another expert says it is foul brood. Which is right?—LADY BEE-KEEPER, *Eccles, September 29.*

REPLY.—The hive from which comb received was taken is decidedly suffering from foul brood. But this fact does not impugn the accuracy of both experts referred to. There are now many stocks of bees badly affected with the disease in question, which in the spring of '97 were "grand stocks." This being so, both experts may be right in describing the hive at two different periods of the same year.

BEE-KEEPING IN THE ISLE OF MAN.

A correspondent residing at Lezayre, Isle of Man, writes:—

"The enclosed cutting is taken from *Mona's Herald and Isle of Man Advertiser*, dated September 29. I should like to have, through your JOURNAL, an opinion as to whether this will establish a record? I may add the Isle of Man is only some seventy miles from Liverpool, and consequently nowhere near the U.S.A.":—

"In our last issue we questioned the following statement which was made at the Laxey Fruit and Flower Show by Mr. Egbert Rydings, who spoke on the profit to be derived from bee-keeping:—

"I may tell you that from one hive this year Mr. Lancelot Quayle, of Glenmoye, has taken 334 lb. of honey. He has seven hives, and if they will make anything like, he will make about £100 a year profit out of bee-keeping. Now, where can we find a Manx farmer who will come up to that out of an outlay of £12 capital? Now, that can be done."

"This statement seemed to us so remarkable that we considered it our duty to call public attention to it on the following grounds:—(1) If bee-keeping be really so profitable we should induce others to follow Mr. Quayle's example. 2. If the aspects are not so rosy as here painted, we should warn the public against rushing wildly to bee-keeping on Mr. Ryding's authority only. We do not profess to be expert bee-keepers, and in the public interest we therefore consulted three prominent Douglas gentlemen who have devoted much time and thought to bee culture. These gentlemen ridiculed the statement, stating it was impossible; and on the face of it it does seem incredible that 3 cwt. of honey should be extracted from one hive by one colony of bees in a single season!

"Since our last issue we have had a communication from Mr. Rydings, in which he adheres to his former statements. We accordingly sent a representative to interview Mr. Quayle.

Our representative states that Mr. Quayle very kindly showed him his hives and explained the different processes by which he obtained such startling results. Mr. Quayle, we must confess, satisfied our representative, who, by the way, is not an expert bee-keeper, that his bees have done all that Mr. Rydings has claimed for them.

"Our representative further states that Mr. Quayle admitted that the yield was an exceptional one. The highest yield ever taken from one hive in the British Isles, of which he had previous knowledge, was 235 lb., although 400 lb., from a single hive, it is stated, is often taken in America. Mr. Quayle is confident that had the weather during the last three weeks of August been favourable this particular hive would have reached that amount! For four consecutive weeks he obtained 70 lb. weekly on an average from it.

"Mr. Quayle, who is a son of the late Mr. John Quayle, M.H.K., for Glenfaba, is thoroughly conversant with the habits of bees, having studied the subject in all its bearings. He devotes unremitting attention to his stock, and regulates his work on the latest scientific principles. In his opinion 500 tons of honey are lost to the Island annually owing to our supineness in bee culture. Our columns are open to Mr. Quayle, and we sincerely hope that at an early date he will give his fellow-countrymen the benefit of his experience."—*Mona's Herald, September 29.*

A "FIND" OF HONEY.

For several years bees have been noticed to travel through a hole in the wall on the north of Mr. Diment's house at Roses Farm, Buckland St. Mary. On sawing away part of the floor of the bedroom the other day it was found that over a hundredweight of honey had accumulated, which proved to be of excellent quality.—(*Communicated.*)

Bee Shows to Come.

October 19, 20, 21, and 22, at the Agricultural Hall, London.—Show of Honey and Bee Products in connection with the British Dairy Farmers' Association. Over 40 prizes (including the President's "Champion" Prize, value £2, for the best exhibit of honey).

November 11, at the Town Hall, Ludlow, Salop.—In connection with Chrysanthemum and Fruit Society's Exhibition. Two open classes for "Sixes." Schedules from Mr. Jno. Palmer, 17, Brandlane, Ludlow, Salop. Entries close November 4.

November 18, 19, and 20, at the Waverley Market, Edinburgh.—In connection with Chrysanthemum Exhibition Show, the Scottish B.K.A. will hold a Honey show as above, at which very liberal prizes will be offered (see advertisement on page v). Schedules from Rev. R. McClelland, Hon. Sec., The Manse, Inchinnan, Renfrew.

Notices to Correspondents & Inquirers.

Letters or queries asking for addresses of manufacturers or correspondents, or where appliances can be purchased, or replies giving such information, can only be inserted as advertisements. The space devoted to letters, queries, and replies is meant for the general good of bee-keepers, and not for advertisements. We wish our Correspondents to bear in mind that, as it is necessary for us to go to press in advance of the date of issue, queries cannot always be replied to in the issue immediately following the receipt of their communications.

All queries forwarded will be attended to, and those only of personal interest will be answered in this column

CORDENS (Chadlington).—*Experts' Certificated.*—Mr. E. H. Young, Sec. B.B.K.A., 12, Hanover-square, London, will furnish the necessary information required by intending candidates.

G. R. R. (Newent, Glos.).—1. Comb sent is badly affected with foul brood. 2. In view of the healthy colonies contiguous to the diseased one, we advise entire destruction of all combs in the latter by burning. If bees are—as stated—very strong, and you can spare a few combs of food from the healthy colonies, you might try the well-known plan of dealing with the bees as a swarm, and hiving them on the healthy combs in a clean hive, after keeping them confined indoors in an old skep for twenty-four or thirty hours. If, however, the bees were our own we should destroy the lot and so put an end to all risk.

J. S. N. (Saundersfoot).—*Honey Samples.*—The sample of honey received is from more or less mixed sources. We rather think the predominating flavour is from *trifolium incarnatum*, or crimson clover.

E. M. DOLBY (Blackburn).—*Buying Honey.*—We are forwarding letter of inquiry on to "Kent Bee-keeper," who will doubtless reply to it.

F. DYER (Wilts.).—*Buying Diseased Bees.*—See report on page 391.

H. E. (Worcester).—*Making Roofs Water-tight.*—There are many means of securing this very desirable feature of a really efficient hive, all more or less effectual. It would, however, be difficult to find anything more easily applied, and more "absolutely rain-proof" than a covering of thin zinc, turned in and nailed to the underside of the wood.

W. R. BRIDGE (Lancs.).—*Moving Hives.*—If removal is deferred until such time as several weeks' frost has kept the bees indoors, no harm will follow changing the hives' present position to one 200 yards away. The hard candy may be used when syrup-making in spring, provided it has not been burnt in preparing it as candy.

J. S. (D.).—*Foul Brood.*—We regret to say all three pieces of comb sent are diseased.

Editorial, Notices, &c.

THE DAIRY SHOW, AND QUARTERLY CONVERSAZIONE OF THE B.B.K.A.

The announcement on front page of this issue will serve to remind readers of the Annual Show of the Dairy Farmers' Association, which takes place next week at the Agricultural Hall, London. The honey department of this popular exhibition grows in its relative importance to the bee industry, and we are very pleased to see its popularity increasing among bee-keepers generally as years go by. We have before now commented on the favourable opportunity so important a gathering offers for the disposal of honey in bulk, and this fact alone should not be lost sight of by those who have still bee produce left on hand for which they desire to find a market. One is led also to inquire why the occasion should not be highly valued as affording an exceptionally favourable opportunity for impromptu conferences among those attending the show on subjects of such mutual interest as prices of honey; markets for same; methods of packing honey for transit, etc. Regarding this latter item, the class for "non-returnable packages by parcels post," if well filled, should serve as a valuable object lesson to all who send honey by post.

We learn that the entries for next week's Show, though not greatly in excess of last year, nevertheless *do* exceed those of '96, thus getting beyond the highest previous record. It is safe, therefore, to say that a fine show of honey and bee-products will be staged, and a goodly number of our best known bee-keepers present to inspect the same. The popular or favourite day for a visit to the Show will, no doubt, be Thursday, the 21st inst., seeing that the railway companies select this day for the dispatch of cheap trains to London from nearly all parts of the kingdom.

This fact has not been lost sight of by the Council of the B.B.K.A., who have arranged to hold their last quarterly conversazione for the year at five o'clock on Thursday, the meeting being held, as usual, in the commodious board-room of the R.S.P.C.A., 105, Jermyn-street, St. James's.

The Council tender a cordial invitation to all bee-keepers and friends able to avail themselves of the opportunity of participating in this pleasant social gathering, and hope to see a good number present. Appliance manufacturers and others are also invited to bring or send on for exhibition at Jermyn-street any novelty in bee goods or appliances devoted to bee purposes they may desire to bring before the meeting.

We are requested to state that the bee department of the Show will be located, as last year, in the New Annexe on the ground floor of the building.

For the information of strangers to London we may state that 'buses pass the main entrance to the Agricultural Hall every ten minutes; and by taking the omnibus to Holborn, then changing to another 'bus for Piccadilly-circus, they may be set down close to Jermyn-street, at a cost of threepence, the journey occupying thirty minutes. The conversazione begins at five o'clock.

USEFUL HINTS.

WEATHER AND LATE FEEDING.—Notwithstanding the fact of the second week in October being here, there are, as we well know, a good many readers who will be only too glad to have a few more days of the recent mild weather in which to complete feeding up needy stocks that should have been packed for winter weeks ago. The "unavoidable circumstances" constantly occurring to bee-keepers exceptionally situated, afford a sufficient reason for sparing them the usual homily on the evils of procrastination in bee matters, and so it only remains for us to give such advice as we can as to the best course to follow under the circumstances. To begin with, then, it must be borne in mind that in the usual course bees will not seal over or cap the cells of comb in which they are storing food given in October. We must also remember that bees cannot by any chance be expected to winter well on combs filled, or half-filled it may be, with unsealed syrup. This being so, some plan must be adopted by means of which a degree of warmth similar to that of September may be realised: by crowding the bees thickly on a few frames of comb; by raising the temperature of the

hives' interior by means of hot bricks—wrapped in warm material—laid on top of the quilts covering the body-box; and by preparing good thick syrup (made by using more sugar and less water than ordinary and by boiling for a few minutes) then giving it warm and plentifully to the bees. This is the only possible chance of guarding against the prospective mischief and danger to stocks in passing through the rigours of the coming winter in a state of unpreparedness brought about by delay. And it depends on the care with which the plan indicated is carried out for success or failure.

SELLING HONEY.—This (to bee-keepers) very important question has aroused a good deal of interest among our readers since the remarks on page 371 appeared, and some useful information has resulted. We are, however, as far off as ever from arriving at anything in the way of uniformity in prices. Nor do we think it necessary—in view of the conflicting interests and opinions involved—to do anything beyond referring to our “pre-paid advertisements” column for so much of “current prices” as can be gathered therefrom. We hear of a reader in Ireland having sold 1,000 first-class sections at 9s. per dozen, and he has still another 1,000 for sale, the whole being this season's produce. Another reader in county Limerick has 800 good sections for sale to finish the year's crop, so that Irish bee-keepers have apparently done well in 1897. It is also known that some exceedingly fine honey is gathered in many parts of the Green Isle.

A RECORD “HONEY TAKE.”—The extraordinary yield of 334 lb. of honey, recorded on page 399 last week as having been secured from a single hive in the Isle of Man, has been received with some amount of incredulity among our readers, to judge by private comments thereon reaching us from various sources. Nor need there be any surprise at this, seeing how completely all previous records for this country have been left behind. We are, however, hoping to get from the bee-keeper referred to, *i.e.* Mr. Lancelot Quayle, of Glenmaye, Isle of Man, full particulars of his “take” for publication in our pages, with dates of putting on and removal of the surplus-chambers from which the honey was taken.

BEES IN JAPAN.

Mr. T. B. Blow, under date October 7, writes:—“I have much pleasure in enclosing for use in the *E.B.J.* and *Record* a report that I have written on bee-keeping in Japan, which, I think, will be of interest to many of your readers”:—

REPORT ON MODERN BEE-KEEPING IN JAPAN.

BY THOMAS B. BLOW, F.L.S., &C.

TO THE RIGHT HONBLE. VISCOUNT ENOMOTTO,
Minister of Agriculture and Commerce,
Tokyo, Japan.

Section I.—Honey-yielding Plants.

I have carefully observed the various honey-yielding plants on my way through Japan from Nagasaki to as far north as Nikko, during the months of April, May, and June. I saw only the remains of the spring flowering tree blossoms, but that was enough to convince me that a very large amount of honey would be obtained from the plum and cherry bloom. This early harvest of honey would compare to the fruit blossom harvest in England, which we consider to be of the highest importance, as it gives the bees the chance of getting strong in numbers (owing to the abundant food supply) and in good condition for the next honey flow, which usually yields the main surplus. In England a surplus is *sometimes* obtained from the fruit blossom harvest, but in Japan a surplus from the plum and cherry bloom should be a certainty, owing to the better weather at this time and the enormous abundance of the blossoms. The maples, too, should yield a great quantity of honey, they being very abundant, and also the azalia, though the quality of this honey may be doubtful.

The next crop of honey-yielding flowers that I particularly noticed was the oil-yielding plant of the natural order of Cruciferae (probably rape). In view of the immense acreage of this, and its most abundant yield of honey—so soon after the hives have been well filled from the plum and cherry bloom—I have no hesitation in saying that *this alone* should always yield a splendid surplus, and still leave enough in the hives for the needs of the bees for the remainder of the year. We have similar plants (mustard, &c.) grown in the Fen districts of Lincoln and Cambridge, and in these districts enormous crops of honey are gained from these plants alone; but the acreage of these plants in Japan is far larger than in England. At about the same time that the rape is in bloom you have also many species of leguminiferous plants (beans, peas, and such) grown in considerable quantities, all of which are honey-yielding.

In the mountain districts, especially around Fiji, there is a great wealth of bloom, most of which will be honey-yielding; and I have no doubt that later in the year you will have many other honey-yielding plants, especially

among the trees, many of which appear to be late summer blooming.

Section II.—Bees.

I regret that I cannot report very favourably on your native bees. They form very small colonies, and thus are not well calculated to gather any very large quantity of honey per colony. They appear, too, to possess in a very great degree the migratory instinct which shows itself in the bees deserting their hives on slight provocation, or if at all roughly handled. They swarm very freely, giving off a number of small swarms. I do not think that with this race of bees any great results can be hoped for, and though doubtless their defects can be amended by judicious crossing, yet it may be advisable to start the operations with foreign bees altogether in order to get an accurate judgment of the capabilities of the country from a honey-yielding point of view. Great care, however, must be taken to avoid importing foul brood with the foreign bees, it being widespread in Europe and America. So far I have not observed it in Japan.

Section III.—Suggestions.

1. I would propose that in the first instance experimental apiaries be established in about three places in Japan—say, each consisting of about twelve colonies.

2. That hives of the English standard size be used, this being, in my judgment, the size best suited for the needs of the country. Drawings of a hive that I have designed expressly are sent.

3. That queens of the best English, American, and Italian strains be imported, and the results (in the shape of honey-yield), both of the pure races, the crosses, and of the native race be ascertained and compared. In this way in a very short time an accurate idea of the capacity of Japan as a honey-yielding country can be ascertained. As the spring in Japan is an early one, I think the best plan will be to get stocks of Japanese bees together in one place to the number of about fifty; to get these transferred into hives of the correct size, and to introduce the foreign queen to these stocks in the summer of 1897; then in the spring to distribute these to the three chosen localities, and at the same time to prepare to raise the crosses in quantity for future supply. I think by adopting this plan it could be seen at the end of the first year whether it would be advisable to go on with the matter on a larger scale.

4. I shall be very glad to aid you in any way in my power, and could devote any time up to one year in carrying out the experiments and instructing some of your people so that they could be continued on a larger scale if thought desirable. I will be glad to get you suitable pattern hives, &c., made and sent on to Japan, and would arrange for a supply of the best strains of bees from England, America, and Italy, as I am personally acquainted with all the best queen-raisers in all these countries,

and I could arrange to come to Japan in the summer of next year to begin the operations.

5. I am quite of opinion that a large and good-paying industry could be built up in a few years in Japan, just as has been done in both England and America, but that it would be done more rapidly, as your people appear to be able to grasp new ideas more quickly than we do; and they, too, have the advantage of the ideas in a perfected condition—the result of our twenty years of experiment.

THOMAS B. BLOW.

*The Chub, Welwyn, England,
October 7, 1897.*

Correspondence.

The Editors do not hold themselves responsible for the opinions expressed by correspondents. No notice will be taken of anonymous communications, and correspondents are requested to write on one side of the paper only and give their real names and addresses, not necessarily for publication, but as a guarantee of good faith. Illustrations should be drawn on separate pieces of paper. We do not undertake to return rejected communications.

** In order to facilitate reference, Correspondents, when speaking of any letter or query previously inserted will oblige by mentioning the number of the letter, as well as the page on which it appears.*

NOTES BY THE WAY.

[3015.] *Selling the Crop*—It is very pleasing to hear of our brethren in the north having secured a good harvest of honey this year. The spring was cold and backward, and the honey-flow came late, yet the season has finished well for them. Now, having secured a good harvest, it behoves them to market the same to their own advantage. The tendency of producers on a small scale is to rush the whole of their crop on the market at about the same time; this demoralises the market-price and the natural consequence follows, *i.e.*, prices go down; moreover, when once down there is great difficulty in getting an advance to previous rates. There are, of course, many diverse causes why bee-keepers may wish to sell out; one has no convenience to store his crop; another cannot be bothered with storing for the sake of 1d. more per lb.; a third wants the cash to meet some call on his purse, and so on. But these are often the parties who—without intending it—glut the market and lower the price. The question therefore arises, how can these bee-keepers who want a prompt sale be dealt with so that their produce does not affect the general market-price of our commodity? It was thought several years ago that a honey company would meet the want by buying up all the produce of small bee-keepers and distributing the same as required to the retailer. But after trial this method of trading was found wanting, and the honey company perforce went to the wall and the promoters and shareholders dropped some cash they had invested in the venture. Then we had the individual trader coming to the front with the same object in view. The Rev. W.

Handcock, of Hampton-hill, came to the rescue and relieved many a bee-keeper of his burden in finding a market for his honey. I have myself referred many inquirers to him ; some direct, and calling the attention of others to his familiar advertisement in the pages of B.J. for honey over the initial "H." I was indeed sorry to learn of the rev. gentleman's death from our Editors. Possibly, however, some one may be carrying on the business, as he told me about a year ago that he had secured a good connection, chiefly among grocers. If the business connection has not been given up it would, I think, be well to make it known.

There is, however, nearly always a market for honey in one's own neighbourhood if it is worked up in the proper way. Many persons will buy a jar or a tin of honey for consumption during the winter. The practice of keeping bees in straw skeps is fast dying out, and those who produce honey in modern frame-hives should see to it that the practice of eating honey does not die out with skep bee-keeping. It will be many years before we Britishers can hope or wish to successfully compete with the foreign supply, owing largely to the immense crops secured abroad. I read in an American bee journal of a Mr. Mendelsohn, of Ventura, California, having recently lost three tons of honey through a faucet coming out of one of his honey tanks, yet he still had 50 tons left to ship somewhere. How can we hope to compete with such large outputs as these when we consider our short honey season ?

Rendering Wax.—The honey crop being stored or sold our next job is rendering the wax, and this requires some amount of care. First, it is a good practice to grade your combs and scraps before beginning to melt them up (we always take care of every bit of scrap wax all through the season). The old-fashioned way of rendering wax is by putting the combs into a bag made of strainer or cheese cloth, and dipping the bag into boiling water in a copper boiler (iron boilers are liable to spoil the colour of wax); then squeezing the contents on a board skanting into a pan of cold water. This plan makes some mess, but you get all the wax out of the dross by repeated dipping and squeezings. After the wax is removed from the combs it should be carefully melted in a skillet (*don't boil it*). If wanted in moulds a second melting will have to be made, but first removing all the dross after the wax has become cold. If the cake required is a large one, cover the pan or vessel up warm so that it cools gradually; this will prevent cracked edges.—W. WOODL Y, *Beeton, Newbury.*

BEEES IN COUNTY KILKENNY.

MY RECORD HONEY HARVEST.

[3016.] Now that the busy time is over and bees are settling down for the winter, it may not be out of place to give a short account of my bee-keeping for '97, which, with me, has

been a record year. After uniting, doubling, and doing away with diseased stocks, I commenced the season with fifteen colonies, three of which were run for swarms, and therefore not supered. The spring proved wet and cold, so I did not tamper with a single hive until about the middle of May, being satisfied that the bees had plenty of natural stores left from the previous year. The weather continued unfavourable, consequently we had no honey flow in May, and very little in June. Thus things were looking very gloomy, and each bee-keeper one met hung his head rather dolefully at the prospect before us, when a change for the better came, and with it honey gathering commenced in real earnest. Not only so, but it continued without interruption up to about August 10, later than I ever remember it before. The clover did not remain in bloom all the time, but the bees gathered late honey in abundance from other sources, such as what is called here the black-button (*scenus*), which yielded very freely. This honey is of deeper colour than that gathered earlier in the season.

About the end of May I secured a vagrant swarm from outside, and had a new hive with full sheets of foundation fitted up to receive them; but the bees refused to accept the home I offered them, and, contrary to my wishes, united themselves to the next stock (a very strong one) without the loss of a bee. This made up an enormous colony, but it did not swarm during the season. And for honey storing I think it breaks the record for this country. It gave me twenty-one standard frames of honey filled and sealed over from top to bottom, and 63 1-lb. sections fit for any show bench. The bees also built two large combs 2 in. thick under the alighting board. I calculate the surplus honey taken from this stock to be over 170 lb., besides leaving a well-filled brood-chamber of eleven frames.

Swarming commenced early in July with the honey-flow, and continued all through the month. I never had any great trouble from excessive swarming before, but this year I might as well try to keep back the tide with a broom as prevent swarms coming off once the fever set in. I therefore turned my attention to the prevention of second and after swarms, which I did with a fair amount of success. Of my fifteen hives, all swarmed except four, and in one case a swarm issued from a swarm. My apiary has thus increased from fifteen—spring count—to twenty-nine on July 31. In the case of one of the stocks I ran for swarms, a second swarm issued, and I hived it on the stand of the parent stock, removing the latter to another stand some distance away, thereby depriving it of all its flying bees. It will give readers some idea of the good time the bees had here when I state that this particular hive, after giving two swarms and being deprived of all its flying bees, built up rapidly, and filled a dozen fine sections before the season closed.

[*Correspondence continued on page 406.*]

HOMES OF THE HONEY BEE.

THE APIARIES OF OUR READERS.

Our illustration this week represents the modest little apiary of Mr. S. Brooks, who stands on the left in picture, the other figure being that of a neighbouring bee-keeper who got his first hive and his first lessons with bees from the apiary seen, and has since become a very successful bee-man himself.

Mr. Brooks has some substantial claim to be considered a teacher in bee-craft, having had as pupils among others several of the nuns at Abbot Lea, Abbotskirkwell, and under his supervision these ladies are managing a success-

Accordingly, he went—accompanied by a bee-keeper of more matured experience and years than himself—a couple of days later, and was told on arrival that two swarms had come off and he could take his choice. This he did, as that other boy did who said, “I don’t want to be greedy, so I’ll take the heaviest.”

From this small beginning he began the following year to make frame-hives, after buying one as a pattern, and got a friend to teach him “the ways of modern bee-keeping.” He then, in writing us particulars, goes on to say “I have at present twelve hives, including skeps, which I keep for supplying swarms. I have taken the BEE JOURNAL for years, and



MR. S. BROOKS'S APIARY, NEWTON ABBOT, DEVON.

ful apiary of their own. In the same way we understand he is recognised as the bee-expert of the locality, and is frequently called to the residences of the gentry in the neighbourhood on work connected with the bees. All the frame-hives seen in the photo are the work of his own hands.

We learn from Mr. Brooks that he has been a bee-keeper nearly twenty years, his first start being brought about by seeing some straw skeps at a farmhouse he had occasion to visit. Though only a boy of fifteen at the time he bargained with the old dame who owned the skeps to pay her 10s. for a swarm which she said would be coming off in two or three days.

learnt a good deal of what I know from it. The district around here is fairly good for honey, as we have plenty of orchards and fruit trees about. My own crops are not very large compared with some whose bees are kept further out in the country. I average about 40 lb. per colony yearly, and as an exhibitor at local shows have taken several first prizes. Nor have I ever experienced any difficulty in selling my crop; in fact, in some years I have to buy to keep my regular customers supplied." In concluding his remarks Mr Brooks says, "I am a ropemaker by trade and work with my father, so that, being on the spot, I am always at hand in case of swarms."

CORRESPONDENCE.

(Continued from page 404.)

My take of honey this year from stocks and swarms is 470 sections and 530 lb. of extracted honey, or a total of 1,000 lb., with well-filled brood-chambers and a fine cake of first quality wax, weighing 14 lb.

I could have secured far more honey had I been able to attend more thoroughly to the hives worked for extracted honey by using the extractor, and emptying the combs as they were filled; but, having only my limited leisure hours in which to get through all bee-work, it was impossible for me to do more than remove the frames when I got the chance, take off the excluders, and put on sections.—M. K., *Piltown, Co. Kilkenny, October 9.*

VEGETARIANS AND HONEY.

[3017.] In your issue of September 23 (2998, page 374), a "Kent Bee-keeper" asks "Do vegetarians advocate the use of honey in their dietary?" Without even intending to be sarcastic towards our Kentish friend, I may say that, in spite of their name, vegetarians do not live entirely on grass. Vegetarians are divided into sects like other bodies of people. While all are agreed not to consume the corpse of any animal as food, most of us have no great objections to using animal products, such as butter, cheese, &c., and I suppose honey must be considered as partly an animal product. But most vegetarians consider that, while there is some risk incurred in consuming infected milk or butter, there is very little danger, if any, attached to the use of honey. The primary article of our dietetic creed is not to kill an animal for food, and, obeying that cardinal principle, we are free to eat anything beside which we consider wholesome. Most of us are very fond of honey in moderation, and if there were more vegetarians there would, I think, be more gardeners and bee-keepers, and fewer persons condemned to follow the unpleasant calling of a butcher. I may say in conclusion that meat is a very innutritious food, and, besides, contains much injurious matter, which, apart from all sentimental considerations, excludes it from the dietary of food reformers; while honey is, on the contrary, of sound dietetic value.—W. J. FARMER, *a Bee-keeper and Member of the Vegetarian Society.*

BEES IN DUMFRIESSHIRE.

A GOOD YIELD FROM A SINGLE HIVE.

[3018.] On page 397 of the BEE JOURNAL of October 7, I promised to give an account of a hive whose queen ceased to lay for ten days, because I removed its winter wrappings too soon. I found this out by an examination of the hive, and I replaced all the wrappings and fed more rapidly. At that time the hive was located in the outskirts of Carlisle. On June I removed it to Dumfriesshire, after which the

population rapidly increased. It was a large hive, holding fifteen frames; I had transferred the bees to it. The bees only fully occupied ten frames, the other five were either empty combs or foundation. I did this to prevent swarming. In a day or two I perceived a disagreeable and sour smell, for which I never fully accounted. It may have been something in some candy-cakes I had used; however, I transferred the bees and combs to a clean hive, and the unpleasant smell disappeared. The hive, which I will call (No. 1), was placed on the same site, in a bee-house. The bees flew right into a long entrance, and another empty hive (No. 2) with foundation was placed opposite to it, 18 inches away. Glass was placed above these entrances, so that I could see what took place. The bees increased very rapidly, and many went into No. 2, going straight in from their flight. One afternoon, a few days later, a large number went across, as if swarming, and they there remained in, all night. No. 1 hive was crowded with bees, and in consequence I put No. 2 on the top of No. 1, but as the population seemed so great, I finally put a super of shallow-frames on the top of No. 2, with excluder zinc between. It was only on July 11, however, that the bees went in force into the super, and then they seemed to go in with some sudden impulse, probably a very hot day. Many of the incoming bees remembered the position where No. 2 had formerly stood, and, more or less, ever since they have evinced a desire to go into it, but I have had the entrance closed with a slide. On June 27 I took off the super; it contained 40 lb. of clover honey, well sealed, gathered in sixteen days. The population was tremendous, and in order to find more room I put on another hive filled with empty combs and a frame or two of foundation. At the end of August I removed the latter and got from it another 40 lb., leaving the brood hive No. 1 and No. 2 behind. On October 1 I removed No. 2 and took 25 lb. of honey from it. The wasps and robber bees then began trying to get in, showing that the supply of outside food was coming to an end. The super last taken had been partially used by the queen for breeding, and the cells were partly filled with heather-mixed honey. From the above you will see that this hive has done well; it is now full of bees, all the drones are killed, and the queen apparently has ceased to lay. She is taking a well-earned rest, and I am now feeding; but I cannot even approach the take of your Isle of Man bee-keeper, who, as reported on page 399, got 344 lb. from one hive.—FREDERIC McCONNEL, *Beekefchan, N.B., October 8.*

THE B.B.K.A. CONVERSAZIONE

AND NEXT WEEK'S DAIRY SHOW.

[3019.] May I, as a "home county" bee-keeper, express the hope, in your columns, that we shall have the pleasure, for which we annually look forward, of once more meeting

many of our brother (*and* sister) bee-keepers from north, south, east, and west next week at the Agricultural Hall, and *particularly* at *Jermyn-street*? There is one great advantage which these two metropolitan opportunities possess—they are independent of weather! At some shows this year we have been well-nigh baked, and our specially choice granulated samples have come back “perspiring,” like ourselves, under the influence of a broiling sun. At other shows, and at not a few, our section cases, and we, too, have gone through a gratuitous course of hydropathic treatment with very bad effect on sales and show finances. But we must “take things as they come.” So our provincials and north country men of the craft should take this coming opportunity to meet their brother and sister bee-keepers, and a warm “WELCOME.”—*October 9.*

RACK V. CRATE.

[3020.] Of the two I have a decided leaning to the last word as best describing the receptacle in which the bees store their surplus. I note, however, that most contributors to the *JOURNAL* invariably use the former. The word *crate* exactly describes the article used. It is an open article of woodwork in which are laid the sections about to be filled. In this crate we carry our full sections into the manipulating house, or transport them where we please. The word *rack*, to my mind, does not convey the same meaning. If it were applied to an open piece of woodwork in our honey store where we could lay the successive crates piled up, or lying in a row ready for future disposal, I could the better appreciate its use.

I am willing to be corrected, but I affirm that the term is not used in any similar case, that it is not a correct use of the word, and that crate is the better and more expressive term.—F. E. J. S., *October 8.*

[Concerning the frequency with which the word “rack”—as applied to the bee-appliance in which empty sections are placed on hives for filling—is used in our pages, it is mainly attributable to ourselves, as Editors of a technical paper supposed to be fairly correct in the terms used. It thus happens that a large number of readers, when writing of a section-rack, use the word *crate*, having, no doubt, in mind the term they are most familiar with in the catalogues of bee-appliance manufacturers, nearly all of whom print the word “section-crate.” But a rack is not a crate, and *vice versa*; the two things are distinct, and each is used for a distinct and separate purpose. Hence the absolute need for each having a distinguishing name for itself.

The B.B.K.A. show their appreciation of this need by including the terms “rack” and “crate” in the printed questions put to candidates for experts’ certificates, and we have not seldom, when officiating as an examiner, been amused at the nonplussed look of a candidate, after describing a “crate” as the appliance

“in which sections are put on hives for filling,” when he is asked what a rack is?

Practically, then, a crate is the box in which sections are crated for sale, or transit, or the market, or for carrying them about in any way needed. We never use a “rack” for these several purposes, but only for “filling” the sections on the hives by the bees. And we trust all will agree that, admitting the need for two words, we cannot do better than keep to the terms “rack” and “crate” each for its respective purpose.—EBS.]

IMPORTS OF BEESWAX.

[3021.] I think it is about a year ago since you made a promise that you would endeavour to ascertain if statistics are obtainable showing the value of imports of beeswax. Have you been able to get any information on the subject?

The last report of value of imports of beeswax given in the B.B.J. was ten years ago. The report was for the then previous year, eleven years ago, and showed that in the year referred to we imported beeswax to the value of £119,927 from our colonies and possessions, and foreign countries. If we could have a more recent report I am sure it will be interesting, as there appears to be an increasing demand for good English beeswax. In the report mentioned above, English wax is not under consideration, but of foreign wax Turkish is said to be the best and most expensive, and of bright red colour.

Vetches are said to produce red wax. Last year there was a field of vetches a quarter of a mile from my apiary, and the wax from comb made at the time the vetches were in bloom was of a beautiful red colour.

I have taken a good deal of trouble in the production of wax during the last few years, and the great demand I have for beeswax again this year prompts me to renew my inquiry of you as above. Last year I purchased from bee-keepers in this county 50 lb. of wax, and would have taken more if I could have got it. With the exception of 4 lb., the whole of the 50 lb. was resold in this county. This year I have even more orders for beeswax. A large quantity of beeswax is wasted when it might be turned into money. In some apiaries one sees the odd pieces of comb thrown about, and combs of a previous season may be seen rotting in the corners. Some bee-keepers do not attempt rendering wax, but throw away, bury, or trample underfoot the odds and ends that should be turned into pence.—WM. LOVE-DAY, *Hatfield Heath, Essex, October 9.*

[For some reason our effort failed last year, but we will try again.—EBS.]

QUERY FOR ENTOMOLOGISTS.

[3022.] What is the name and life history of a dipterous (?) fly, seen on sunny days just now in great numbers along with the wasp and

the bee on the ivy bloom? It is a bit larger than a bee—at a distance might be taken for one, being much the same colour—but it has very shiny wings and body.—“T.,” October 9.

WEATHER REPORT.

WESTBOURNE, SUSSEX, SEPTEMBER, 1897.

Rainfall, 2.60 in.	Sunless Days, 3.
Heaviest fall, .60 on 5th.	Below Average, 13.8 hours.
Rain fell on 18 days.	Mean Maximum, 59.2°.
Above average, .09 in.	Mean Minimum, 47.4°.
Maximum Temperature, 64° on 26th.	Mean Temperature, 53.3°.
Minimum Temperature, 37° on 19th.	Below average, 1.4°.
Minimum on Grass, 32° on 19th.	Maximum Barometer, 30.60° on 12th.
Frosty Nights, 0.	Minimum Barometer, 29.45° on 1st.
Sunshine, 155 hours.	
Brightest Day, 12th, 10.7 hours.	

L. B. BIRKETT.

Queries and Replies.

[1858.] *Unsealed Syrup in Combs for Wintering on.*—I have been unavoidably late with rapid feeding, and circumstances necessitate my packing the bees up finally for winter without delay, yet the syrup is not being sealed over at all, and many cells only half full. Now if syrup is analogous to honey, I suppose these half-filled cells would not be sealed under any circumstances, unless the bees removed it from some cells to quite fill up others. 1. Is this so? 2. I wrote in advance as to what I should do if the above occurred, and your reply in the B.J. was to leave the uncapped combs where they are for the winter. 3. I do not quite understand if you mean me to leave the ten combs in each hive, just as they are now, or whether to crowd the bees on to six or eight combs, with a division board, and then leave the spare combs on the outside of it? If the latter, could I not remove the spare ones into the house, keeping them in a warm, or cool (whichever best), dry place? They would then be handier to give back to the bees in the spring, after being warmed up. 4. Could I get the bees to cap over the syrup by putting hot-water tins between the quilts for three or four days now, before raising the body boxes on ekes? In reference to using hot-water tins for this and other purposes I am never certain as to how much quilting should be between the bees and hot water. The tins I use are 8 in. by 8 in., by 2½ in. deep? 5. Supposing, then, that they are filled with boiling water, is an American cloth quilt and two thicknesses ordinary carpet quilting sufficient protection to the bees from the heat? I made some experiments with an empty body box (with no

entrance) placing thermometers at different distances from the quilts, and with one American cloth and one carpet quilt, at ¼ in. distant from American cloth the highest temperature was 105 deg., while half an inch away it was 90 deg. The American cloth got quite warm and soft, which would be at a still higher temperature. But with bees inside, causing ventilation, it is difficult to form a correct estimate from experiment. 6. In dealing with such material as I have mentioned, can you tell me the number of quilts to use?—G. M. S., *Keswick*, October 5.

REPLY.—1. Bees will certainly not use the syrup from half-filled cells to facilitate the complete filling up and sealing over of other unfilled cells, in autumn feeding. 2. Please refer us to page of B.J. where this reply appears; we cannot find it. 3. The capping over of cells will be considerably facilitated by crowding the bees on to fewer combs, and increasing the warmth by artificial means as proposed. 4. Yes. The hot-water tins and warm syrup should, however, be given in the evening, when the excitement consequent on feeding and extra warmth will not entice the bees out. 5. Quite sufficient, but there is no need for having the tins filled with “boiling water.” We should not heat above 150 or 175 deg. F. 6. A couple of thicknesses of carpet would be ample protection.

[1859.] *Some Bee-Driving and Other Experiences.*—I hived three lots of driven bees on six sheets of foundation in September. As all seemed well, I did not look inside for some time, when, to my horror, I found two inside and alternate sheets had fallen from frames, and that the bees had joined both to foundation on each side, had then drawn out all the foundation, and commenced combs of their own in empty parts of frames, and placed the syrup I was feeding them on in the entire mass of prostrate and erect comb. 1. What is to be done? I should feel deeply grateful for your advice. May I ask—2. I have purchased a colony on old black badly worked-out combs. How can I best get them on to a new set without sacrificing brood, as, of course, the middle combs are always full of brood during the open season? 3. Two of the combs of a skep I was driving fell out as I was overturning the hive, what course ought I to have pursued? I managed the job in a blundering sort of way, but was positively terrified at the time, as horses were passing along the high road within 5 yards of me, and bees were, of course, furious. The bees of another skep refused to be driven, and stung me so, from time of overturning till my graceful though rapid retirement, that I was again bewildered as to my course of action, but eventually managed, by placing an empty skep on top of the bees, and tying carbolised cloth round the junction of the two hives. Could I have done better, as, besides horses, children were handy this time, and my carbolised was four miles away, involv-

ing half an hour's hard riding, during which time the bees cleared the country in their immediate neighbourhood of all living things capable of feeling pain? I might add I am not a novice at driving, having operated for the last two years without experiencing any difficulty. According to guide books, driving is quite an easy, monotonous performance. I beg to differ.—A BEWILDERED READER, *Cheltenham*.

REPLY.—Beyond saying that the bees will need subduing and "keeping down" while the misshapen combs are removed and utilised by tying into the frames, we can only add that all depends on the aptness of the operator. 2. Do not attempt to get the bees on to new combs so late in the season as this; defer operations till the bees have safely got over the winter. 3. The best reply we can offer is to be more careful next time. It is hardly fair to blame guide books for the mishaps detailed above, seeing that until this time our correspondent had no difficulty in driving. As the "books" say, it "is quite easy" when properly done.

[1860.] *Wintering Bees on Unsealed Stores.*—*Suspected Foul Brood.*—The county expert visited me on September 17 and reported my bees as healthy, but said that four or five of the stocks required feeding. That I have now attended to; but on examining before packing for winter, I found what I think is foul brood. Not having seen the disease in combs before, I shall be glad if you will give me your opinion on samples sent by this post? If diseased, please advise me what to do. I began keeping bees in September, 1895, with three driven lots in skeps, and have since been working for increase of stock rather than honey, and my apiary now consists of twenty-two colonies. I only started frame-hives this last May, since which time I have got fourteen lots on frames. Of these I find three with combs like samples sent. There was only a few cells with cappings on and dead brood inside, as in comb forwarded for your inspection. Every comb in my frame-hives has been built on foundation given since May 20 last. If you think I can save the stocks I shall be glad. I have cut out all sealed cells and removed combs with same in frames of the worst lot, as I feel sure that it is the pest, although I have never seen it before. Could bees have been healthy on September 17 *past*.—E. W. C., Jun., *Bodmin*, October 11.

REPLY.—We are glad to report our correspondent's fears as groundless. The comb sent contains chilled brood only—not foul. It is, however, so well to err on the safe side that he has done well to be prompt in dealing with the suspected combs. What we do fear is that (judging by comb sent) the bees will be wintering on unsealed food owing to late feeding. This should be seen to (vide "Useful Hints," page 401), as the bees cannot come out strong and well in spring if now on combs with half-filled cells of syrup.

[1861.] *Bees Superseding Queen in October.*—To-day (October 9) at about 11.30 I was surprised to see a young queen return to and enter one of my hives, which I knew to be in possession of a fertile and prolific queen about the middle of September. On subsequent examination I found, on lifting out the second frame, a queen-cell recently vacated, and also saw the old queen—her wings being slightly ragged—who was not so dark as the young one seen. There was, for the time of year, a good deal of capped and uncapped brood, but no eggs that I could see. The weather being unfavourable, I did not search further. Is it not strange for the two queens to be alive in the same hive? Should the young queen be removed, as she cannot become fertilised now?—GAVENNY, *Abergavenny, N. Wales*, October 9.

REPLY.—So many remarkably late cases of queen-mating have been reported this autumn that we would not set the young queen down as a virgin till we had again examined the combs for eggs. We know of a young queen being mated four days prior to the date given above.

CLOSE OF THE BEE SEASON.

QUEEN MATING—AUTUMN FEEDING.

Irrespective of climatic conditions, the wheels of time move onward, and with our best efforts we fail to keep pace with its inevitable trend. Most of us plan in excess of our ability to accomplish, both as regards the things attempted and the time occupied. I fully intended to clip all virgin queens in my yard the present season, but the opening of a rich honey flow intercepted my plans.

Although the season has been variable in extremes of temperature, still, bee-keepers in Michigan have experienced an old-time honey yield; and although a single season cannot fully compensate for the failure of many in succession, still, I am thankful that nature has not exhausted her resources, and hopeful that a cycle of good years has returned.

The temperature of late has been rather low for rapid storage of honey; however, there is ample time for an abundance of buckwheat and autumn flowers, if accompanied by warm nights, which are likely to follow the cool spell. In the meantime, these periods of rest will be productive of a larger force of workers, and will fully compensate for the present inactivity. Such was the condition previous to white clover bloom in June. The cool weather served to increase the number of field bees by reason of inactivity. These periods of rest are furnished by nature to all her creatures, otherwise constant wear would detract from any advantage that might be gained.

Towards the close of a season it is but natural to take a retrospective view. In looking back I see where I failed in neglecting to clip the wings of all my virgin queens. For some unaccountable reason more than the

usual number have mismated. It is probably due to a natural increase of the surrounding bees in good seasons, 1896 being favourable to such a result.

The mismated queens in my yard among the unclipped averaged one in every four. The results attendant upon clipping are highly satisfactory; the mismates averaging but two in every twenty four, or one in twelve. With a larger number the results might have been still more satisfactory.

It is also satisfactory to note that none were lost in the marital flight; particularly so as many had more than one-sixteenth of an inch clipped from their wings. It may be well to note that great accuracy was observed in clipping to maintain a uniform length, and preserve the balancing power requisite in flight.

With September comes the removal of all sections. I usually employ a few strong colonies to complete all unfinished ones as the supers are emptied. The best will often contain a few, possibly one or two at the corners, particularly so if the weather has been cool. Working on this plan, I had no unfinished ones from white clover. However, the chances are less favourable towards the close of the season.

The passing of the honey season confronts us with preparations for winter. Readers of the *Review* are aware that I am an advocate for leaving bees abundant stores, and believe such preparation in autumn is a requisite to success the following season. There are those who contend that an excess of winter stores is objectionable and liable to contaminate the comb honey when not consumed for breeding purposes. Inasmuch as colonies differ in the amount consumed, no rule as to a limited amount can be given. I therefore prefer to occupy the sure ground of an abundance. Furthermore, breeding is pushed forward more rapidly in the spring with resources at hand. Even if a few sections contain a little old or dark honey, it is clear gain, taking into consideration the increased production which accrues from strong colonies. I will state that sugar syrup used in feeding is generally consumed first, being stored in the central combs, so that little or none remains until the general honey flow, hence will find no place in the surplus departments.

Believing as I do that a full supply should be provided for all colonies, the matter of feeding should receive careful consideration. Successful wintering depends largely upon location of the stores; an abundance in the outside combs will not compensate for any deficiency in the central ones where the food is most required. Such an expedient as Hill's device as a makeshift will answer in the south or for cellar wintering, but for outdoor wintering it serves no purpose whatever, aside from affording space which is usually soiled with excrement.

In consideration of the foregoing facts, I invariably defer feeding until all the brood has

matured, thus giving place for storage accessible to the cluster. We should bear in mind that the central combs, which usually contain the least honey, are occupied by the greatest number of bees.—L. A. ASPINWALL.

(Conclusion next week.)

Bee Shows to Come.

October 19, 20, 21, and 22, at the Agricultural Hall, London.—Show of Honey and Bee Products in connection with the British Dairy Farmers' Association. Over 40 prizes (including the President's "Champion" Prize, value £2, for the best exhibit of honey).

November 11, at the Town Hall, Ludlow, Salop.—In connection with Chrysanthemum and Fruit Society's Exhibition. Two open classes for "Sixes." Schedules from Mr. Jno. Palmer, 17, Brand-lane, Ludlow, Salop. Entries close November 4.

November 18, 19, and 20, at the Waverley Market, Edinburgh.—In connection with Chrysanthemum Exhibition Show, the Scottish B.K.A. will hold a Honey show as above, at which very liberal prizes will be offered (see advertisement on page v). Schedules from Rev. R. McClelland, Hon. Sec., The Manse, Inchinnan, Renfrew.

Notices to Correspondents & Inquirers.

All queries forwarded will be attended to, and those only of personal interest will be answered in this column.

J. C. H. (Wellington, Som.).—*Honey for Showing*.—We cannot, for obvious reasons, adjudicate on the samples of honey sent, seeing that it will devolve upon us to officiate as judge at the show in question. We may, however, say—without having tasted the sample—that No. 1 is excellent in colour and consistency. Of the other three samples all are too light in colour for the dark honey class, though No. 4 would probably pass as a dark honey when shown in a full-sized jar. It is not easy to "fix" the colour from a sample sent in so small a bottle. We advise exhibitors not to put labels on jars of liquid extracted honey, though the rules only prohibit names, or anything that identifies the exhibit.

G. M. S. (Keswick).—*Keeping Combs of Unsealed Food over Winter*.—1. We should prefer a dry and moderately warm place for these. A "kitchen cupboard" would answer the purpose very well. 2. Both samples of candy are very good. They will naturally set harder when in such thin cakes as those sent than when moulded into 2-lb. cakes, because of the extra bulk of moisture in the latter, as well as the smaller surface exposed to the air.

J. W. C. (Isle of Wight).—No. 1 sample of comb is affected with foul brood of old standing. No. 3 is not diseased, the cells containing chilled brood only.

Editorial, Notices, &c.

A RECORD "TAKE" OF HONEY.

334 POUNDS FROM A SINGLE HIVE IN 1897.

Referring to the remarkable—and, as we think, unprecedented in this Kingdom—harvest of 334 lb. of surplus honey taken from a single hive of bees in one season, which was reported on page 399 of our issue of the 7th inst., we are now enabled to place on record reliable and fully detailed particulars of the extraordinary ingathering from the pen of the bee-keeper himself. So many and conflicting were the Press accounts of this record honey "take," that we gladly availed ourselves of the fact that Mr. Lancelot Quayle was a regular reader of our journals, and invited him to favour us with a correct version of the facts of the case in order that practical bee-men might be made acquainted with the method of working followed, and have the details first-hand from the owner of the bees that achieved so splendid a result. In reply, Mr. Quayle promptly wrote us as follows:—

"In response to your request for full particulars regarding what you call my 'remarkable take of honey,' I now send an account of the management of the hive during the season, with dates of extracting and weights extracted.

"Owing to pressure of other work during the fall of 1896 the hive referred to was allowed to go into winter with scarcely sufficient stores, but as very little frost followed, and our apiary is situated in a snug valley, the bees came through all right.

"In the spring, care was taken to supply the bees with candy, and when brood raising had well begun I found that stores were very scanty, so the colony was kept regularly supplied with syrup. In this way the brood-nest was gradually extended until the body-box—containing twelve frames—was filled with bees and brood. I was very careful to give the bees only just sufficient for their daily wants, so as to prevent storing, and by this means reserved every possible cell for the raising of brood. I was nearly going too far in following out this precaution, for I remember that towards the end of May, upon neglecting to feed this stock for a day or two, they began to cast out young immature brood. Resolving to profit by this 'hint' from the bees, the feeding was subsequently carefully continued until the second week of June.

"About this time, as the hive was becoming well crowded with bees, and fearing lest they should commence preparations for swarming, I fixed above the top bars of brood-nest a sheet of queen excluder zinc, and on this placed a super of shallow frames fitted with half sheets of foundation. I may here say this queen excluder remained on till the honey season was over. These frames the bees soon filled with comb, and towards the end of June I removed the shallow surplus chamber, and in its place

put a 9-in. deep chamber containing ten standard frames of built-out comb spaced about $1\frac{1}{4}$ in. from centre to centre. Then, when the honey flow commenced in such earnest, I used two 9-in. surplus chambers, same as above, for storing. My plan was to remove the uppermost chamber and at once extract the honey, after which the empty combs—wet with honey—were returned to the hive by raising up the lower surplus chamber, setting the empty combs next to brood-nest, and then replacing the partly-filled surplus chamber on top. This process was repeated as top box became filled, and continued as long as the honey flow lasted.

"My method of weighing the honey was as follows:—I first weighed the full combs of honey; then, after extraction, the empty combs were weighed, and the difference gave the weight of honey extracted. To be exact, I may say no allowance was made for the wax 'cappings,' but I feel sure that the cappings for the season would not amount to more than between 1 lb. and 2 lb. at most. To counter-balance this, no reckoning was made of the small amount of honey extracted from the shallow frames, first removed, nor of the honey contained in a few frames which were taken from the brood-chamber when contracted for wintering.

"The following is a record of the various extractings:—July 13, 42 lb.; July 19, 45½ lb.; July 26, 46½ lb.; August 3, 53 lb.; August 5, 48 lb.; August 9, 42 lb.; August 16, 39 lb.; September 1, 18 lb. Total, 334 lb.

"This hive, along with seven others, is placed on a platform above the roof of a shed, at a distance of 10 ft. or 12 ft. from the ground. The aspect is S.W., and I find that my hives with this aspect usually do the best. I have never given that attention to queen-raising and re-queening which I think these subjects deserve, and do not usually re-queen, except in the case of queenlessness; consequently, I do not know the age of the particular queen which heads the colony dealt with.

"My highest previous takes from single hives were 190 lb. in 1894 and 180 lb. in 1893; but I know that, previous to this year, I never bestowed such assiduous attention upon spring stimulative feeding. To this circumstance, then, and a very good queen, I chiefly attribute my unprecedented success in 1897. Of the 334 lb. of honey extracted from this hive, only the last 18 lb. was from the heather.

"During the last three weeks of August we had very bad bee weather in the island; so bad that bees were compelled to remain indoors most of that time. Had the glorious weather of July continued to the end of August, I feel confident that this colony would have stored at least another 100 lb. of honey. In conclusion, let me say the bees, as far as I am aware, are a pure strain of natives, and the supply of bee forage in this locality throughout the season is varied and abundant.—LANCLOTT QUAYLE, *Glenmay, Isle of Man, October 11.*"

HELMESLEY AND DISTRICT B.K.A.

The second annual show of this Association was held in the Low Schools, Helmsley, on Saturday, October 9, and attracted considerable public attention. The Earl of Feversham, who takes much interest in the Society, is president, the Hon. H. Duncombe, M.P., and E. W. Beckett, Esq., M.P., being vice-presidents. The exhibition room had been nicely decorated with flowers by Miss Spencer, the schoolmistress; Mr. D. Williams, head gardener at Duncombe Park, kindly supplying flowers for the purpose. The management of the show devolved upon a committee, who, along with the hon. sec. of the Association, Mr. R. Ness, Helmsley, ably carried out their duties to the apparent satisfaction of all parties concerned. Mr. Rymer, of Levisham Station, N.E.R., officiated as judge, and made the following awards:—

Six 1-lb. Sections (Heather Honey).—1st, Miss Spencer; 2nd, W. Baldwin; 3rd, J. Russell; all of Helmsley.

Six 1-lb. Jars Extracted Heather Honey.—1st, W. Baldwin; 2nd, G. Simpson.

Two 1-lb. Jars Extracted Honey (Beginners only).—1st and 2nd, J. Russell; 3rd, J. Johnson.

Rack of Sections, as taken from the Hive.—1st, J. Russell; 2nd, R. Ness; 3rd, W. Baldwin.

Three Frames of Comb Honey.—1st, R. Ness; 2nd, Miss Spencer; 3rd, W. Dunning. *Beeswax.*—1st, R. Ness; 2nd, — Bowes, Nawton; 3rd, W. Dunning.

Altogether, the show was a very creditable one, all the winning exhibits being very good indeed, and the Society deserves the congratulations which the executive received. We may add that some of the principal prizes were given by the noble President of the Society, the Rev. C. N. Gray, Mrs. Punshon, Dr. F. Collins (of Wanstead, Essex), and Mr. E. W. Beckett, M.P.—(Communicated.)

CLAIM FOR SWARM OF BEES.

At the Middlesbrough County Court recently, before his Honour Judge Turner, James Leng, of Old Ormesby, sued Robert Wood, also of Old Ormesby, for damages for having converted to his own use a swarm of bees, the value of the swarm being estimated at £1. 1s. Mr. Barnley, on behalf of the plaintiff, said that both parties were employed on Mr. Pennyman's estate, and kept hives near to each other. The hive from which the bees came was expected to swarm soon, and plaintiff's wife saw the bees leave their own hive, and settle on an empty hive in the defendant's garden. Charlotte Leng, wife of plaintiff, said that on June 11 she had been watching the bees, and saw them go into a hive in defendant's garden. She immediately ran and told Mr. Wood that the bees were swarming and going into his hive. The defendant went round to the hive and

said to her, "They are going in hard enough; it's a bad job." In reply to Mr. Stubbs, for the defence, witness said she could swear that the bees were from their hive. Wood stated that he offered to toss plaintiff for the bees, but he refused, and also declined an offer of 10s. Cross-examined by Mr. Stubbs, witness said the bees would not go into a hive in which there were bees already. Judgment was entered for plaintiff for 21s., including costs.—*North Eastern Daily Gazette.*

HONEY IMPORTS.

An account showing the value of honey imported into the United Kingdom during the month of September, 1897, £1,852.—*From a return furnished to the BRITISH BEE JOURNAL by the Statistical Office, H.M. Customs.*

CLOSE OF THE BEE SEASON.

QUEEN MATING—AUTUMN FEEDING.

(Concluded from page 410.)

The delay of feeding until breeding is over usually brings the work into October for Michigan latitude, which, with thick syrup, necessitates a better feeder than either the "Miller" or "Heddon." Feeders upon that principle compel a distance of travel for the bees, favourable to warm weather only, and at a season when least required. Although not a manufacturer of feeders, I have constructed and used one for several years which supplies the food directly above the cluster. It is atmospheric, and holds about 12 lb.

I am also an advocate for thick syrup. The bees instinctively prepare their stores by evaporating all the moisture or watery portion previous to sealing the cells. Possibly a trace may be left, as honey, even after being sealed, improves with age unless exposed to dampness. Let us bear in mind that honey is primarily the food of bees, and that water is not. We shall then be better able to understand the cause of losses attendant upon out-door wintering. We appropriate the early and well-ripened stores of our bees leaving the late and unripe for them, and wonder why so much fatality occurs in wintering. Pure honey, fully ripe, is almost entirely appropriated by the system of the bee; water cannot be appropriated in any quantity, consequently must be voided, necessitating many unseasonable cleansing flights.

In making syrup I prefer to use about twelve or fourteen pounds of refined crystal sugar to a quart of water, bringing it to a boiling point for two or three minutes, at which time I add less than a half-teaspoonful of tartaric acid dissolved in a little water to prevent granulation. Vinegar will not answer. I know many who have followed the old beaten path will contend that such syrup is too thick, and in the next breath recommend candy for wintering. While I have no use for

candy, I do recommend the feeding of syrup just as thick as can possibly be used. It tends to concentrate the food, also the storage of it, by reason of which the colony remains more compact, conserving its vitality. Colonies prepared as before stated for out-door wintering, in properly-constructed hives, will furnish abundant evidence of its success, not only the following spring, but throughout the season. With abundant stores of concentrated food, accessible to the cluster, I would just as quickly insure a colony in properly constructed hives against loss in winters as any other live stock.

With the failure of honey a tendency to rob is often manifested. I scarcely believe the tendency is inherent, but has been developed by the careless exposure of honey for generations. Bees are susceptible of lasting impressions. This is evinced by their ability to combat the bee-moth, which upon its first appearance in this country was much more destructive than in later years. The bees patrol the hive entrance each evening to prevent their inroads. The exposure of honey also makes an impression, which they not only remember during life, but by some means transmit to the younger ones.

I have never experienced any trouble from robbing. I leave no honey or sweets exposed in any form. All colonies are maintained strong. All entrances are contracted according to the strength of the colonies.—L. A. ASPINWALL, in *Bee-keepers' Review* (American).

Correspondence.

The Editors do not hold themselves responsible for the opinions expressed by correspondents. No notice will be taken of anonymous communications, and correspondents are requested to write on one side of the paper only and give their real names and addresses, not necessarily for publication, but as a guarantee of good faith. Illustrations should be drawn on separate pieces of paper. We do not undertake to return rejected communications.

In order to facilitate reference, Correspondents, when speaking of any letter or query previously inserted will oblige by mentioning the number of the letter, as well as the page on which it appears.

NORTHERN NOTES.

[3023.] *Skeps*.—I generally do a good deal of driving during my holidays, and the results for years made me rather sceptical of the stories of large takes from skeps reported by ancient bee-men. I invariably found them yield only the most moderate returns. Frequently 10 to 20 lb. represented the accumulated stores, and rarely did they exceed 30 lb. This season has, however, converted me into a believer. I drove six skeps in neighbouring gardens which would have averaged 60 lb. It was a cosy nook in the middle of clover fields, and in the near proximity of heather.

Inside Open-air Feeding.—When our honey harvest comes to an abrupt conclusion owing

to the supply being suddenly cut off, as was the case this and several former years, many of our queens cease ovipositing, and consequently fewer young bees than is at all desirable go into winter quarters. Feeding or even stimulating inside hives is a thing that for many reasons I have dispensed with for years. I have discarded feeders, and have relegated them to the bee museum, unless when driven bees have to be fed up. Still, something to keep the queens laying has been a desideratum. In visiting a brother bee-keeper lately I saw a contrivance admirably suited for such a purpose which seems too good to keep to myself. He had a large glass bottle with a very wide mouth hung from the rafters of his bee-shed. The bees had free access through the open windows, and in their exits and entrance they seemed to take it as coolly as if simply on business bent. No hurry or jostling occurred, and no signs of fighting were to be seen. No idea of robbing seemed to enter into their wise little heads, for all movements were made leisurely and steadily. Being under cover, cloud or sunshine was all the same to them, and it mattered not whether it was wet or dry for all the distance they had to travel. The consequence was that these bees showed large patches of brood after my hives had little or none. As a corollary, spring should show a large proportion of young bees ready to meet any emergency. Judiciously done, the idea seems to be one worthy of imitation. I trust some will try this system (which I would dub *Inside Open-air Feeding*), and give us their opinions and results.

A Scotch Show.—The S.B.K.A. has at last been galvanised into life. True, it gave some spasmodic gasps during the past year, showing that it was not quite defunct, but it has been in a species of trance for over two years—not dead, but sleeping. Now we are to have a show in the Waverley Market, Edinburgh, once more. Highlander and Lowlander, shoulder to shoulder, and make it in every way a complete success. Anything like a failure means annihilation, and this must not be. Could not our Association go in for granting certificates, and have experts' first, second, and third class? Could not it have regular meetings somewhere to keep up the enthusiasm, and recruit the ranks? Could not we even have a Scotch bee paper? The B.B. JOURNAL is admirable and indispensable, but I have a grievance to ventilate against it. It is British only in name! A Scotch contribution is a *rara avis*. Since writing the above sentence I have had the curiosity to examine the back numbers for this year, and, with the exception of an Edinburgh gentleman, who has "improved" your already perfect hive, and invented a new honey press, the name of a Scotsman will scarcely appear in your index. Why, our country might be away beyond Nansen's "Further North"—some Greenland or Ice-land for any notice taken of it by the

BRITISH BEE JOURNAL. Weather is unpropitious, and as I write (17th) snow covers the hill tops, and at times shows white down to the bee-hives. Owing to the early break in the weather, my young queen referred to in last "Notes" never got fertilised, and the stock, much reduced by then, had to be joined on to a near neighbour. Late queen-rearing won't pay here.—D. M. M., *Banffshire, N.E., October 16.*

[We accept with proper humility *our* share of what justification there is for the above good-natured "thrust" at the absence of Scotch names at the foot of our correspondence columns. It needs, however, but a few others to join "D. M. M." in the ranks of contributors in order to remove all grounds of complaint so far as the B.B.J. is concerned.—Eds.]

THE DRONE FLY

(ERISTALIS TENAX).

[3024.] Your correspondent "T." (3022, page 407) asks for information about a fly which, from his description, is, no doubt, the insect named above. This name was given to it by entomologists for their own convenience. They capture, kill, set, mount, and arrange in their cabinets a few specimens, and they must have a name to distinguish it from other species of eristalis. It does not follow that this is its proper name. If the drone fly could talk he would very likely inform us that his proper name is *Montmorency Vera de Vere*, and that he is engaged in studying the genus *Homo baldedensis*!

In replying to your querist, I hope he will not infer that I am an entomologist. Once upon a time I was. I could spend a week in the heart of a forest, with a net and a few boxes in a satchel, with the greatest delight. Nothing pleased me more than to drop a choice specimen of *miniata* or *albicillata* into a cyanide bottle, and watch him flutter into the next world, and then pin him on to a setting board, and gently spread his wings out, and body, and antennae, and legs into the rightful positions. Aye, it was grand! Counted by hours I must have spent years "setting out" specimens alone! I wonder whether that was wasted time? In some good book it says, if I remember aright, "Lay not up for yourselves moths and butterflies on earth, where rust and dust doth corrupt, &c." Be that as it may, I believe, but for a diabolical combination of untoward circumstances, I should be an entomologist now. Who can hunt for butterflies in city streets or suburban thoroughfares? I am chained like Prometheus to the rock, and my weekly intellectual food is the BRITISH BEE JOURNAL and bricks!

The drone-fly is one of the attributes of summer. The hotter the day the more life pulsates through his tiny veins. When the sun shines he is poised like a hawk over the stifling rides and passages between the enclosure of the forest or woods. Like a hawk

or falcon, and yet in the matchless throb of his wings, and magnificent rushes to and fro and sudden stops, he is a thousand times the falcon's superior! He is the humming-bird of the woods, twanging his lute all day long for his sweethearts' cars—the flowers. He is a protégé of the sun, and basks only in his smile. Does the sun sink below the horizon, or even go behind a cloud, and the drone fly settles on a leaf to await his return.

In the autumn, when wild flowers are scarce, he bids farewell to the woods and visits more the gardens, being especially fond of the flowers of golden-rod (*Solidago*) and Michaelmas daisies (asters). He is a very different creature now that the sun's power is on the wane. Cold nights and often wet, sunless days take his energy away, and he becomes a very drone fly indeed. And now I come to the most unpleasant (to us) part of his career. For I have to tell you that in his young days he wallows in all the most terrible stuff imaginable, the same as other dipterous larvae. He is then an ugly-looking maggot with a rat tail; the tail being really an air-tube, so that he can dive down for oysters amongst mud or excrementitious matter and keep his air-tube held up at the surface, so that he may breathe contentedly below. Let us not, however, call him ill names for his early mode of life. He is one of our most useful scavengers, and follows mankind wherever he goes, so that it is impossible to say to what country he belongs.

May he live long to hover as a hawk and sing as a humming-bird along the glades of our English woods, and crowd on the flowers of golden-rod and ivy, and perchance remind us of our entomological days, is the wish of—
LORDSWOOD.

BEE-KEEPING AND COUNTY COUNCILS.

REPORT OF BEE-WORK DONE BY MEANS OF A GRANT FROM THE WILTS COUNTY COUNCIL DURING 1897.

[3025.] This spring the Wilts County Council made a grant of £55 for the encouragement of bee-keeping, and appointed three well-qualified gentlemen to work the whole county with me simultaneously, my portion taking in the eastern portion from Swindon in the north to Salisbury in the south; but, unfortunately, arrangements were not completed till the middle of June. As far as possible each centre was to be visited twice.

I always had to pay for hire of a trap, and very often for bed and board. The cost of twenty-eight visits and 759 miles of travelling was £12. 6s. 9d. During the day-time I drove round to neighbouring villages for bee-work.

I held twenty-eight out-door meetings in bee-keepers' gardens (of course, admission free), visiting ninety apiaries, consisting altogether of 602 bar-frame hives and 611 skeps—total, 1,213—and travelled 759 miles. I was wel-

comed at every place, and was not once refused permission to examine hives, except (very properly) when they had been packed for winter. I received much hospitality and many requests to come again.

My plan has been on leaving the train to hire a trap (being no cyclist), and take a few of the most simple and useful appliances with me (not for sale) and show their use, reaching the appointed place as early in the day as possible, visiting and helping bee-keepers generally, if at home, holding an outdoor meeting, and giving demonstrations at 6 p.m. or 7 p.m. (or earlier as days closed in), and then adjourn for an hour or so for "bee-chat" over a pipe, or sometimes, if wet, a homely lecture in the school-room. Sleeping at the place, I was able to start at 5.30 or 6 a.m. and help cottagers before they went to their work. This was much appreciated, and "the old woman" always had a cup of tea ready for the "bee-man." I was thus able many times to do from ten to fourteen hours' bee-work in the day, and thoroughly enjoy it. When twilight stopped out-door bee-work, before cottagers could attend, I have, at their request, seen to their bees and shown some of the family how to do the work, and then got all together for bee-talk later on.

The two things which most pleased *labouring* men, were working skeps for super honey and the use of "super clearers" and "bee escapes" — inexpensive contrivances which often suit their pockets and intelligence better than the really far superior bar-frame hives, of which, if left entirely to *their own devices*, they often make a mess.

A decided improvement was noticed almost everywhere at my second visit. Many cottagers who attended my first lectures had successfully driven their skeps and united the bees; while some had made them up into carefully fed stocks in bar-frame hives. Another proof that these visits were appreciated is, that twenty-five new members, of whom fifteen were cottagers, joined the "Wilts Bee-keepers' Association" in my districts, to ensure the expert's help and another year's course if the "C. C." made no grant.

I hope the other three experts who have been working, as I have, for the "County Council" will send you a report for the rest of Wilts. — W. E. BURKITT, *Hon. Sec. W.B.K.A.*

P.S.—Though always on the look out, I only found "foul brood" in one apiary—the owner, a cottager, at once burnt all the infected stocks; and I shall keep an eye on him.

THE SEASON IN IRELAND.

240 LB. FROM A SINGLE HIVE.

[3026.] I have been reading about record and other takes of honey in different parts of the kingdom, and it has struck me that my experience might be of some interest. I live in the centre of co. Louth, Ireland, and there

is not an advanced bee-keeper within many miles. I began the season with eight hives, off which I have taken 800 lb. of good extracted honey. The bees are hybrid carniolans, and have upheld their reputation for swarming. Seven of the eight hives swarmed, some more than once. I was unfortunate enough to lose several (one established itself near in a hollow tree). However, by putting sometimes as many as three swarms together, I managed to average 100 lb. per hive. The hive that did not swarm gave 240 lb., and this might have come up to Mr. Lancelot Quayle's record mentioned, if I had given full sheets of foundation in the supers, but I did not do so, as I ran short. Then, of course, the lost swarms if hived would have increased the "take." Last year there was no difficulty in disposing of honey in jars, but this year all the buyers over here seem to be overstocked, and I have nearly 700 1-lb. jars still in stock, as well as some in bulk. I send you a sample, and would be glad if you would give me your opinion of its quality.—L. DORAN, *co. Louth, Ireland, Oct. 15.*

[Sample sent is excellent in colour and flavour. It is rather thin so far as consistency is concerned, and needs straining to remove the tiny particles of wax, which tend much to spoil its appearance and quality for market; but it is a very good honey.—EDS.]

VIRGIN QUEEN v. PRINCESS.

[3027.] Several Americans have expressed their preference for the term of Princess as applied to a young queen, whether heading a colony or nucleus until she has been fertilised, and they have backed up their use of the word by stating that it is the one favoured by British apiarists. I take exception to both the term and the statement. It is seldom, if ever, used by bee-men at home. Further, I hold it is a misnomer. No princess performs the functions analogous to that which a virgin queen does in a colony of bees. She is always a secondary individual. A queen never is. A princess has no paramount power or authority, and the idea of queenship or headship is never associated with her. A queen, married or single, is always a queen. A young queen bee, fertilised or not, is always a queen, and from her earliest infancy is recognised as the bond that knits the colony into one homogeneous whole. Before she can ever perform the functions of a mother she is decidedly a queen bee. A virgin queen exactly expresses what she is.—F. E. J. S., *Ballinaculloch, N.E., October 16.*

IRISH EXHIBITORS AT SCOTCH SHOWS.

[3028.] Some of your readers may perhaps suppose that Mr. Wilson's letter (3008, p. 394) has squeezed me into a screw-cap jar when I did not speak out in reply to his crusher of last week. True, I must no doubt look small in

the eyes of some with the weight of his "sixty stocks" over me, but, however, it has not been quite sufficient for the operation. You see it was not my bees but my acres that demanded my attention, these being more in number than Mr. Wilson's stocks, and I have little time for correspondence. However, I think, a gentleman who describes himself as "a Scotchman, a bee-keeper, a honey judge," and "one of Scotland's largest exhibitors," should be a little more careful in his assertions as to the honey shows of his own country. Mr. Wilson says he cannot call to mind a single instance of any important Scotch show where either English or Irish exhibitors are excluded from showing. He, no doubt, remembers being secretary of the South of Scotland Bee-keepers' Association three seasons ago, but seems to be ignorant of the doings of that Association in the following year, for there lies before me a prize schedule of the Dumfries Show in 1895, and in it I read that this show is "open to the members of the South of Scotland Bee-keepers' Association only." Surely this excludes Ireland. I regret this did not happen at Dumfries when Mr. Wilson was secretary, but confining the show to "members only" the following year looks as if my honey—which Mr. Wilson "remembers taking particular notice" of—had given them a hint which they took to heart, and closed the door against invaders in 1895.

I am, however, glad that judging is now carried on so fairly. Perhaps my informant mistook the secretary for "Judge A" mentioned in my letter on page 385. Mr. Wilson cites the late John D. McNally as an ideal exhibitor, who "was generally about the top of the prize list," and compares his "beautiful samples of Irish honey" with mine. Now, Mr. McNally was a personal friend of mine, and one whom I admired and respected for his whole-souled liberality. He was a Scotchman by birth, but before his lamented death became an Irishman by adoption. We often met as rival exhibitors in Ireland, and again in the great "National Competition" at Reading, 1892; and on these occasions, with one exception, Mr. McNally good-humouredly "permitted" me to get first prizes in Ireland, and at Reading I got second when he himself failed to score, though he entered in the same classes. Speaking of this event in B.J. of October 27, 1892 (page 420), he says:—"I congratulate my personal friend Mr. Anderson in obtaining second place. In so big a competition such a victory goes to prove what Ireland can do if she has a mind."

Now, sir, if Mr. Nally was generally at the top of the list, where should his friend Anderson be, who was able to beat him? In conclusion, let me say a severe illness kept me from seeing to my bees this year, for which reason I am not at high-water mark in 1897; but if I am spared to next year, I will show what Ireland can do when she has a mind.

While sorry for trespassing so much upon your space, I think these letters will refresh some minds and dispel the mists which seem to hang over others.—W. J. ANDERSON, *Ards, Caledon, Ireland, October 14.*

BEEES IN COUNTY DOWN.

CURIOS EXPERIENCE WITH A "WELLS" HIVE.

[3029.] I began the season with six old stocks, and during June and July I got five swarms from them, which I put into empty hives. I have now taken off 600 lb. of honey from the lot, which is sold at from 6d. to 9d. per lb. Would you call 54 lb. per hive a good average yield from my whole stock, seeing that three of these were July swarms?

I am much puzzled about my "Wells" hive. I put a swarm into one compartment of it the first week in June, and this swarm did very well. I also put a July swarm into the other side, and these bees worked fairly well; but I never could find any eggs in any of the combs, nor could I see the queen, though I sought for her several times. I afterwards added a second and a third swarm to the same side, but with no better results. I even put frames of brood from other hives, but the bees never attempted to raise any queens. Has any reader had a similar experience? The two compartments of the hive were worked separately. In the end I joined them to the other side. I may say they filled all the brood-frames and eight shallow-frames besides with honey.—F. C., *County Down.*

WELLINGTON AND DISTRICT B.K.A.

Referring to the above recently formed Association, we are requested to state that a meeting of bee-keepers and friends will be held at the Central Temperance Hotel, New-street, Wellington, on Saturday, October 23. BUSINESS:—To pass rules; to elect President, Vice-Presidents, and officers; to elect members, and other business.

The Rev. H. M. Marsh-Edwards has kindly consented to take the chair at 6.30 p.m., prompt.

Bee-keepers and other ladies and gentlemen interested in the craft, are invited to join the Association. Those who cannot attend the meeting will greatly oblige by giving in their names to the undersigned, on or before the 23rd.—R. HOLLAND, *Hon. Sec., Haygate-road, Wellington, Salop.*

Queries and Replies.

[1862.] *Comb v. Extracted Honey for Profit. —Dividing for Increase.—Queen-rearing.*—1. Which do you consider, working for sections or with frames for extracting, the most profit-

able, the source of honey in the locality being principally white clover? 2. I intend supering twelve of my colonies next year with standard frames, with a view to increasing the number of my stocks at the end of the season, on the following plan:—On August 1 I will extract all surplus honey from every hive. This done, I then propose to divide the bees of any of the hives that have not swarmed into two parts, utilising for this purpose the empty frames of comb, and giving each five frames of brood and five of empty comb. Fertile queens will then be introduced to the queenless lots. What is your opinion of this method of increase? 3. I understand that bees supered with full-sized frames seldom swarm. Is this so? 4. What do you think of the following method by which I intend rearing queens next year? About June 1 I will divide one of my strongest hives into four small nucleus stocks, and let each of these rear a queen for itself. As soon as the first of the young queens hatches out, I will form four more nuclei from the parent hive, and into each put one of the newly-reared queens, leaving the first-formed nuclei to hatch out a second queen each, which I presume will be just matured at the time. 5. What is the best method of packing queens for transit by rail about 100 miles? 6. When introducing queen in perforated zinc cage between the frames, is there any danger of her dying from hunger during incarceration, or will the bees feed her? 7. When introducing a queen, would it be well to have some of the bees from her own hive in the cage with her? 8. Is honey taken from combs by means of the new honey press likely to bring as good a price as if extracted, and will it press out the honey from the combs of skeps?—“SKEP,” *Co. Kilkenny, October 15.*

REPLY.—1. It is simply a question of demand and supply. A good deal more weight of honey is got on the extracting method, but some prefer to work for sections as being more saleable with them, and *vice versa*. 2. Far better and safer methods of increasing stocks will be found in any reliable guide-book, without the help of which you cannot hope to succeed in such bee-operations as those proposed. 3. The tendency to swarm is lessened by giving large frames, but two boxes of shallow frames will more than answer the same purpose. 4. Your method of queen-rearing is faulty, and will never succeed. Follow the advice given in reply to query No. 2. 5. Queens need not be sent by rail; parcel post is a better and cheaper mode of transit. Pack in the ordinary travelling queen-cage, with food and bees, as per guide-book. Replying to queries 6, 7, and 8, we may say briefly—6. In the more modern introducing cages, queens are supplied with food in a compartment of the cage. 7. Some bees are always sent along with the queens to feed her and maintain the necessary warmth. 8. The “honey press” is used for

extracting heather honey only. Ordinary honey should always be got from combs by means of the cylinder extractor.

[1863.] *A Beginner's Queries.*—*The Need for a Text Book.*—I am just starting bee-keeping with a new 15-frame combination hive, into which I had a driven lot of bees with queen put in the middle of last month (September). The bees were lived on three frames of empty comb and two frames full of honey, but they only seem to cover the frames of honey well. I gave them some syrup in a plate first, but have now got a tin rapid-feeder, but the bees won't use it. What shall I have to do to make them take the food from the feeder? I am also ignorant of the amount of supplies to be put into the hive to carry the bees over winter, and whether it should be syrup only or candy? There are no sentinels inside the entrance in the evenings, and I have to tap the hive half a dozen times before a bee appears. Is this right? Wasps, too, keep on worrying the bees, and several times when lifting out a frame to examine I have seen bees fighting with wasps on the combs. Consequently, the entrance has been reduced to a very small space. The bees, however, still fly out foraging and bring in pollen. I will be grateful if you will answer the following questions:—1. Is it necessary to use either a piece of calico wrung out in the carbolic solution or a smoker when one wants to examine a hive and lift out the frames to inspect? 2. When driven bees are put into a new hive (middle of September) does the queen begin to lay eggs then or does she wait till the spring? 3. What is the meaning of nuclei, and how does one set to work to form one?—*GRENADINE, Worcester, October 14.*

REPLY.—We could, of course, have summarised the above communication, and replied in a few words, without printing the questions or other particulars at all. But more good will be done, as we think, by inserting it in full, in order to show how vain it is to start keeping bees on such conditions, with even a moderate chance of success. It is like groping about in the dark for any one to buy a frame hive, stock it with “a driven lot” at a time of the year when bees should have been already fed up and snugly packed for winter. And all this, too, without the help of a reliable guide-book, from which some knowledge of the subject could be acquired. We, therefore, advise our correspondent to make a large cake of soft candy, weighing four pounds or so, and set it above the two frames of food on which the bees are now clustering. There is little good endeavouring to induce bees to take syrup-feeding when November is close at hand. But, above all things, we say buy a book on bees, and the questions asked above will be found answered therein with more detail than we could attempt in our reply column.

[1864.] *What Plants Yield the Best Honey?*
—I am sending a sample of honey just taken

off one of my hives in sections. The appearance before extracting is good, light-coloured honey, fair consistency, and "cappings" very white; but the taste is very peculiar, and as I took it off hive without the aid of either smoke or carbolic, it certainly has no extraneous flavour added to it. The sections—fitted with foundation only—were placed on hive July 27. Six out of the nine have been completed. As there have been fields of mustard in flower, I think the honey must have been gathered from this source. 1. I should be much obliged if you would let me know your opinion, and whether honey from mustard is known to have this peculiar taste. Also your opinion as to the quality of the honey. 2. I have often seen it stated that honey from clover or sainfoin is about the best. My idea is that honey from sainfoin, though very rich in colour and good flavour, does not come up in richness of flavour to honey culled from a varied selection of choice flowers. I tasted a section this year—not from my apiary, but, I believe, produced in Kent—which was about perfection. It tasted of the sweetness of all the most delicious flowers one had ever smelt. I should like the bees to have told me where they got that from. Should you say probably from a choice selection?—M. W. B. O., *Goodnestone, Dover, October 11.*

REPLY.—1. The honey sent is not, in our opinion, from "mustard," nor are we conscious of the "peculiar taste" our correspondent mentions. The sample is to us a fairly good flavoured honey, from mixed sources. It is rather thin but of good colour, and not at all of poor flavour. 2. It seems to be generally admitted that a white clover honey, with a good dash of that from sainfoin mixed with it is equal to any, if not the best of the light honeys produced in this country.

[1865.] *Mead Making from Granulated Honey.*—Having some very nice 1896 and 1897 honey comb, with perhaps a dozen pounds of honey therein, also a few 1896 sections which are granulated, I thought of making a nine-gallon cask of mead from this, and sent for Rev. G. W. Bancks' pamphlet, but finding that the mead is to be made from pure run or extracted honey, I am at a loss what to do with the honey comb. Would it be injurious to boil mead in galvanised iron furnace? Could I get any receipt for making mead from honey in comb from any reader through your valuable paper?—EGRUB, *Castle Cary, Somerset, October 18, 1897.*

REPLY.—We should not use a galvanised iron vessel in mead making. Nor will it be well to get the honey from the wax by melting the whole and removing wax from top when cold. The best plan will be to dissolve the granulated honey in warm water and let the wax rise to the top, when it may be skimmed off preparatory to melting.

[1866.] *Pigeons and Bees.—Split-top v. Plain Sections.*—1. Can you say whether pigeons would do harm to bees, if kept in a large number in an apiary? 2. Do you think there is much gain in split-top sections, over plain ones with foundation waxed in; the latter are I think neater looking. 3. Also in fitting foundation into a large number of sections, would not the waxing be a quicker method? 4. Would they be as secure when filled for travelling as the split?—G. M. S., *Keswick, October 16.*

REPLY.—1. We never knew any harm to follow the keeping of pigeons near an apiary. 2. and 3. There is certainly a gain in both time and efficiency when the split-top and a proper block for using it is adopted. 4. The split-top attaches the foundation more securely than melted wax, and the section is quite as strong.

[1867.] *Salted Pilchards as Bee Food.*—I have just removed here from Birmingham and find bees in this district are mostly kept in skeps (called butts). It is usual, I am told, in the early part of the year to give the bees salted pilchards if they are short of food. Will you kindly give your opinion on this kind of "bee food"?—S. H. S., *S. Buryan, Cornwall, October 7.*

REPLY.—We know that bees at times visit rather disagreeable spots in seeking for the saline moisture found there, but never knew of them evincing any liking for fish salted or otherwise. Perhaps some Cornish reader may be able to say something on the custom referred to, &c.

SEASONABLE QUESTIONS.

ANSWERED BY G. M. DOOLITTLE.

SUGAR SYRUP FOR BEES—HOW MADE.

Question.—Will you please tell us in the next issue of *Gleanings* how to make sugar syrup for winter stores for bees? I think you have given your recipe for syrup for winter feeding in some of the bee-papers before, but I cannot turn to it just now. The season did not turn out as well as we were promised at first, and hence many of us will have to feed.

Answer.—Years ago we were told of many plans to make a feed of sugar that would answer for winter stores for the bees; but, upon using most of the plans, I found them to be failures along certain lines, the ones most common being that the syrup would crystallise in the feeders and in the cells after being fed. Not being satisfied, I went to experimenting in different ways; and, while studying over this matter, it occurred to me that years before, during some experiments made to prevent honey from granulating, I had used sugar in one of these experiments, which syrup had accomplished the desired end, that of keeping the honey liquid when cold weather came. I

said to myself that, if sugar syrup would keep honey from granulating, why would not honey keep sugar syrup from crystallising? So the next batch of syrup was made as follows:—

Fifteen pounds of water was weighed out and put into a tin vessel of suitable size. This vessel was then put over the fire till the water was brought to a boil, when 30 lb. of granulated sugar was poured in, stirring the same briskly while putting in, so that it would not settle and burn, as such sugar is sometimes liable to do if not stirred. The stirring was kept up till the sugar was partially dissolved, when it was left over the fire till it boiled again, when it was skimmed if impurities arose. It was then taken from the fire, when 5 lb. of good thick honey was poured in and stirred for a moment or two, so that the whole should be mixed thoroughly. This honey proved to be just what was needed, for syrup thus made remained liquid day after day, when not fed to the bees immediately, although with this formula the syrup was nearly, if not quite, as thick as the best honey. And I found that, after keeping it for several months by way of experiment, it proved as good as ever, not crystallising or souring at all. Thus I had a food that was easily made, and that would remain good whether in the hive or out; and after years have passed I use the same whenever the season has been so poor that I am obliged to feed in the fall.

The honey first used was extracted basswood honey; but of late years I have used that which has accumulated from the wax-extractor, no matter how badly mixed or of what colour. I find that honey coming from the solar wax-extractor, by way of a little honey being in the bits of comb and wax placed there for melting, is always the nicest kind for any manner of feeding, no matter what the colour may be, for the heat of the sun so ripens and thickens it that it is always prime for winter stores. If no honey can otherwise be had, that from partly-filled sections will answer.

PREVENTING SWARMS IN AN OUT-APIARY.

Question.—If you were going to run an out-apiary for comb-honey, how would you manage to prevent swarming?

Answer.—Well, as I have an out-apiary that is run for comb-honey, perhaps I can answer this by telling what I do at that out-apiary each year. If I wish any increase I proceed as follows: Placing a hive all rigged with frames filled with foundation or empty combs on the stand of one of the populous colonies which I think may be getting ready to swarm, I next set the sections from the old hive on the new, when I proceed to shake all of the bees off their combs and out of the hive, letting them run into the hive I set on their former stand. I now place the combs of brood back in the hive again, and carry the whole to the stand of another populous colony, setting this last colony on a new stand from 10 ft. to 100 ft. distant. The sections are now put on the

hive of brood, into which the bees returning from the field are now pouring. When they find that this is not their old home they are somewhat homesick; and if their old home is nearer than 10 ft. many of these bees will find it, and, setting up the joyous hum of "home is found!" will call most of the bees away from the brood, which is not a desirable thing; hence I place the removed hive 25 ft. or more away if it is possible to do so. I generally carry along with me some nearly mature queen-cells and give this made colony one of these in a queen-cell protector. This protector keeps the bees from destroying the cell till they realise their queenless condition, which happens a little before the cell hatches, so that, when the queen emerges, she is kindly received, and in due time becomes the head of the colony. In this way one new colony is made from two old ones; all desire for swarming is broken up, unless the season of surplus honey is long drawn out, while all three are in the best possible condition to store surplus, after a week or so has elapsed. If I wish no increase I usually cage the queen just before the bees think of swarming, leaving her caged for ten days, when the hive is opened, the bees shaken from every frame, so as not to miss any queen-cells, when all such cells are cut off, which makes the colony hopelessly queenless, except for the queen in the cage. If this queen is a good one I use her; if not, I give them a young one, brought with me from my queen-rearing yard, or obtained elsewhere. But no matter what queen is used, I proceed as follows:—After removing the stopper from the cage containing the queen I wish the colony to have, I insert another, this latter one having been prepared beforehand by boring a $\frac{3}{8}$ hole through it. Into this hole is stuffed all the candy (such as is used in shipping queens that it will hold, and the hole should not be less than 1 in. long. Having the queen and cage thus fixed, the cage is placed in some frame having a little vacant space free from comb, near the bottom; or if none such is found, I make a place large enough, when the hive is closed. To eat through this candy takes about five days, or the colony is without a laying queen for fifteen days, which time I find amply sufficient to stop all desire to swarm. While no eggs are being laid for the fifteen days, still the colony has a queen all the time, and so far as I can see, work goes on in the sections nearly or quite as well as if the queen were out at liberty.—*Gleanings.*

Echoes from the Hives.

Great Totham, Essex, October 12, 1897.—This has been a medium season—better for the bees than the bee-keeper. The winter and early spring were most favourable, inducing early breeding, so having had no winter losses and nearly all strong stocks the outlook was most promising. A cold and windy May spoilt

the prospect of early sections. The honey crop from the fruit blossom, which this year was profuse, was very light, so sections this year with us are below average. Stocks worked for extracted honey have done fairly well, and the quality is good. The fine August enabled the bees to glean from the hedgerows and brambles a good supply with which to store the brood-combs for winter. I have rarely seen brood-nests better supplied with stores, so with warm, dry packing and sound roofs, the coming winter can be entered on with little anxiety. I noticed that brood-rearing ceased very early this autumn, the weather seemed hardly such as would account for it; is it possible that the large amount of brood raised in early spring has impoverished the queens causing them to cease laying earlier than they otherwise would have done? Hives that swarmed and have young queens have been carrying in pollen every fine day till quite lately, which rather reinforces the argument as to the impoverishment of the older queens. An observatory hive purchased this year has given me many opportunities of watching the domestic ways of our little friends. One point about the building of brace-comb may be new to some readers as it was to me. I had considered that the bees built it after using up the other available space—but I find that in my observatory hive (which is a six-frame one having two tiers of three frames each) where the space between the bottom of one frame and the top bar of the next below exceeded a bee space, the bees built brace-comb to join them together, giving themselves an easy ladder from one to the next before they built the combs out. Wise little workers!

—T. I. WESTON.

[The usual cause of queens ceasing breeding in early autumn is the stoppage of honey-income. If, however, stimulative feeding is kept up for a week or so, egg-laying will usually be re-started.—EDS.]

Rosslynlee, Midlothian, October 16, 1897.—I started 1897 with two frame-hives and one skep which have yielded me 90 lb. of honey and four swarms. I put the four swarms into a "Wells" hive holding twenty standard frames, which are now well stocked with winter stores. I have not taken any honey from the brood-nest of the "Wells" as yet, but intend taking three frames from each side in the spring of 1898. I will then put frames with foundation to prevent swarming, and try my skill with "Wells" favourite. The rest of my stocks have plenty of winter food and will require no artificial feeding until spring. As an amateur bee-keeper I am well pleased with my season's result, looking to the fact that the heather in this district was a failure. I am much indebted to the district secretary of the Midlothian Bee-keepers' Association for valuable assistance and advice. Indeed, I believe that my more than average success is very much due to the help I have received from him.—D. Y.

Bee Shows to Come.

October 19, 20, 21, and 22, at the Agricultural Hall, London.—Show of Honey and Bee Products in connection with the British Dairy Farmers' Association. Over 40 prizes (including the President's "Champion" Prize, value £2, for the best exhibit of honey).

November 11, at the Town Hall, Ludlow, Salop.—In connection with Chrysanthemum and Fruit Society's Exhibition. Two open classes for "Sixes." Schedules from Mr. Jno. Palmer, 17, Brand Lane, Ludlow, Salop. Entries close November 4.

November 18, 19, and 20, at the Waverley Market, Edinburgh.—In connection with Chrysanthemum Exhibition Show, the Scottish B.K.A. will hold a Honey show as above, at which very liberal prizes will be offered (see advertisement on page v). Schedules from Rev. R. McClelland, Hon. Sec., The Mause, Inchinnan, Renfrew.

Notices to Correspondents & Inquirers.

All queries forwarded will be attended to, and those only of personal interest will be answered in this column.

E. W. (Hemyock).—*Transferring Bees to Clean Hives.*—There will be no risk of queen being balled in transferring frames of comb and bees if ordinary care is observed in the operation; in fact, by proceeding quietly the bees need hardly be disturbed at all.

F. G. (South Ealing).—*Old Bee Books.*—"Wildman Treatise on Bees, dated 1765," is not so scarce as to be very valuable; in fact, we have seen a copy which was bought for a couple of shillings.

R. B. (Colwyn Bay).—*Extracting from Brood Chambers in October.*—*Renewing Combs.*—

1. It is not good bee-keeping to be extracting from brood chambers so late as October 8, and your neighbours are unwise bee-keepers to practice it; in fact, we deprecate extracting from brood-chambers at all except under very exceptional circumstances. 2. To renew brood-combs, two or three each year in hives, is an excellent plan to follow; by its means all faulty combs are weeded out, and all kept in good working order. It also tends to the health of colonies in many ways.

SPIDER (Heathfield).—*Suspected Comb.*—A "small tin box," such as is mentioned in your note dated 7th inst., reached us on the 8th, but with no name attached or anything in the way of letter within. The box had a label on it with the words "Cigarettes Egyptian;" and, if this was yours, we may say the comb contained nothing worse than pollen and honey, or syrup, which latter had been freely running out into the mail-bags, much to the annoyance of the postal authorities.

F. S. H. (Surrey).—*Race of Bees.*—From description given we should say the bees are Ligurians. A specimen bee or two would, however, enable us to speak with greater certainty as to their race.

Editorial, Notices, &c.

BRITISH BEE-KEEPERS' ASSOCIATION.

The monthly meeting of the Council was held on Thursday, October 21, at 105, Jermyn-street, under the presidency of Mr. E. D. Till. There were also present the Hon. and Rev. Henry Bligh, Major Fair, Messrs. H. W. Brice, W. Broughton Carr, R. Hamlyn-Harris, W. H. Harris, H. Jonas, W. J. Sheppard, T. I. Weston, Rev. W. E. Burkitt (Wilts), and the Secretary.

The minutes of the previous meeting were read and confirmed.

Four new members were elected as under:—
Miss L. A. Dunnington, West Mount, Guildford.

Mr. J. H. Roper, Hanover-street, Keighley.
Mr. W. T. Tarr, 42, North-road, St. Andrews, Bristol.

Mrs. A. H. Venables-Williams, Llandrillo Vicarage, Colwyn Bay, North Wales.

The Finance Committee's Report, presented by Mr. Weston, stated that the Secretary's receipts since the last meeting had been checked by the Committee, and compared with the payments to the Association's bankers. Bills amounting to £24. 10s. 6d. were brought forward for payment, and the report endorsed.

Messrs. W. B. Carr and W. H. Harris were asked to prepare the Question Papers for the forthcoming Second Class Examination on November 12 and 13, for which a number of candidates have already entered.

The time having arrived for the commencement of the *Conversazione*, it was found necessary to postpone several matters for consideration at the next meeting (November 5).

CONVERSAZIONE.

At the commencement of the proceedings, at five p.m., the board-room of the R.S.P.C.A. was crowded by an audience which included bee-keepers from nearly all parts of the kingdom, among those present being the following:—Messrs. R. T. Andrews, H. Attfield, J. R. Aubrey, W. J. Anstey and Miss Anstey, Hon. and Rev. H. Bligh, Rev. W. E. Burkitt, H. W. Brice, G. W. Brown, E. Bontoft, G. J. Buller, Richard C. Blundell, Richard Brown, E. Bishop, C. J. Cooke (Norfolk), W. Broughton Carr and Miss L. M. Carr, E. H. Durrant, Major Fair, F. S. Fletcher, W. Ford (Wolverhampton), W. Forrester Huyton (Liverpool), J. Fewkes (Leicester), R. Hamlyn-Harris (Bristol), Geo. Hayes (Notts), W. H. Harris, G. D. Haviland, W. A. Hardy, Miss Ing, Henry Jonas, G. F. Jones (Bristol), A. Jones, Rev. R. M. Lamb (Yorks), Geo. Ledger, R. C. Lyon, A. J. Macey (Devon), S. H. Miles, H. G. Morris, H. J. B. Moreland, J. H. New, A. G. Pugh (Notts), R. Peters, Rev. J. E. Rambo (Damoh, C.P., India), W. J. Sheppard, P. Scattergood, jun., A. Sharp

(Hunts), Geo. Sawyer (Bucks), Ned Swain and Mrs. Swain, F. W. L. Sladen, H. W. Seymour, E. D. Till, E. H. Taylor, Lawrence Taylor (Sheffield), J. Waterfield and Mrs. Waterfield (Leicester), E. Walker, A. D. Woodley, F. B. White, T. I. Weston, W. H. Woods, and others.

Mr. Henry Jonas was voted to the chair, and after briefly opening the proceedings, invited those among the company present who had kindly brought objects of interest to show, if they would explain them to the meeting.

Mr. Weston said he had been asked to bring to their notice an adaptation of an ordinary rapid-feeder for serving the purpose of a solar wax-extractor. His friend, Mr. W. J. Sheppard, was entitled to any credit which might attach to the appliance before them so far as the latter purpose to which it had been applied, but he had himself tried it in use and found it answer admirably, through the months of June, July, and August. The great advantages were the entire absence of over-heating the wax, the purity of the product, and the clean simplicity of the whole plan of working. A piece of muslin in the tray is desirable before filling with combs, and the dross can then be completely removed after each "charging" without any difficulty.

The Chairman said the meeting was greatly indebted to Mr. Sheppard for his experiment, and to Mr. Weston for explaining it.

Mr. Weston next exhibited a specimen of what was called "Drew's (of Winchester) Patent Self-Hiving, Swarm-Retaining Frame-Hive." The hive, he said, was rather long, so as to receive a box somewhat similar in construction to the "swarm-catchers" or self-hivers usually placed *outside* the hive, whereas in this case the catcher, with frames on which the swarm would cluster, was inside the hive and in front of the brood-frames. After fully explaining, the hive was examined, and some pertinent questions put by those present regarding the efficacy of swarm-catchers.

Mr. Carr, in reply, said in fairness he ought to say that at least a dozen letters had been received at the B.J. office from bee-keepers who had been quite successful with Mr. Hole's swarm-catcher.

Mr. Brown, of Appleby, Yorks, had sent a bottle of honey-vinegar made by his brother, a railway engineer at San Caterina, in Brazil. This was the result of advocating the making of honey-vinegar in the *RECORD* some four years ago. Mr. Seymour and others present considered this Brazilian sample good, but not quite strong enough. It was, he said, superior to the vinegar awarded first prize at Reading show.

Mr. Till stated that there was now a manufactory of honey vinegar in Kent under the name of "Melligar." He was sorry none of this had been exhibited at the Dairy Show; it created much interest at Manchester. Mr. Till brought to the meeting a sample of honey purchased on his way to Jermyn-street from

an Islington chemist, who kindly told him that honey found much sale in pennyworths, and it is retailed at a penny an ounce—the particular sample was Chilian honey, without doubt genuine, wholesale price, 35s. per cwt.; but as it certainly is not *half* as good as ordinary British, our bee-keepers need not be alarmed.

Mr. Carr said they had a gentleman present whom he would have pleasure in introducing to the meeting, viz., the Rev. J. M. Rambo, an American missionary, who was sailing to India on the following day, to take charge of a training school for destitute native boys at Dahmo, C.P. Mr. Rambo had undertaken to do his best so far as determining the question as to the possibility of cultivating the native bee known as *Apis dorsata* in ordinary frame-hives on his arrival in India, and to communicate the result of his experiments for the benefit of American bee-keepers in particular, but in the interest of bee-keeping generally. Personally he (Mr. Carr) had no faith in the success of the experiment, though all would, of course, wish it to succeed.

Mr. Rambo, who received a very hearty welcome from those present, said he felt great pleasure in being present at that meeting. When in India, his attention had not been called to the matter referred to, and it was a great many years since he had much to do with bees. He was brought up on a farm with his brother, who kept bees, and now he was going out again to India to organise an industrial school. A great deal of interest has been evoked concerning *Apis dorsata*, and the question has been discussed as to sending a special commission from the Government of the U.S.A. to India for the purpose of obtaining that variety. The experiment, he thought, would be too expensive, and as failure was perhaps most likely, it would be no doubt better to get some one on the ground to see what could be done in the matter, and report. He could not help thinking that the experiment would fail. He was, however, willing to undertake the investigation because it was connected with gardening and farming and the teaching of these subjects. If the mission did not succeed, perhaps it would open out other possibilities of usefulness, and that was the idea which animated him. He would do his best. He had stolen an hour from his last day in this country before sailing to attend their meeting, and was pleased to see so many present, and gratified by the reception accorded him. He hoped to send some account of his work to the B.B.J. from time to time.

Mr. Till remarked that there were bee-keepers in Egypt, Brazil, Minorca, Palestine, and other places abroad who communicated most interesting particulars to the BRITISH BEE JOURNAL, and he was sure the Editors would be pleased to welcome contributions from new fields.

(Remainder of report next week).

THE DAIRY SHOW.

The British Dairy Farmers' Association held their twenty-second annual exhibition of stock, produce, and implements in the Royal Agricultural Hall, Islington, the show opening on Tuesday, October 19, and closing on Friday, the 22nd. Bearing in mind that the entries for 1896 exceeded those of any former year by more than 1,400, it needed a sanguine temperament to venture a speculation that the record then established would be passed in 1897. But so it turned out, the total entries for last week's show reaching 7,973 as against 7,541 in the previous year. And as the weather was in every way propitious, the entire exhibition was a conspicuous success.

The bee-department—with which our readers are more especially concerned—was again located in the new Minor Hall on the ground floor of the building, though less favourably placed than before with regard to the light. It is, we think, imperatively necessary to remember the important bearing this particular point of light has in a display of bee-produce, especially when arranging a position for an exceptionally large exhibit of liquid honey in glass jars, as in Class 64. In this class the attractive appearance of the honey staged—which same attractions include colour and transparency—is very seriously marred if the staging on which the honey is displayed be not well lighted, or if the jars are placed in a bad light against an opaque background such as a brick wall. We are not without hope that some improvement will be possible another year in this small but, to bee-keepers, important matter. The position assigned to the bee-produce is an admirable one, and if, without the sacrifice of any interest, our suggestion could be adopted, the attractiveness of the honey department will, we are sure, be considerably enhanced in the eyes of those very important persons—the general public who visit the show.

So far as the classes into which the schedule was divided, there were in all 173 entries—six more than last year. Very little change, too, was observable in the arrangement from that of 1896. The class for extracted honey in commercial packages was, however, omitted, and instead we had one class for 28 lb. in 7-lb., 14-lb., or 28-lb. packages, the package not counting, and a new class for any quantity up to 12 lb. liquid honey in non-returnable packages, suitable for parcels post. This latter class produced eight exhibits—quite as many as we expected to see in a class calling for the exercise of so little effort or ingenuity as the schedule demanded. A non-returnable package really means nothing beyond a light wooden box—costing as little over a penny as possible—and a bit of corrugated paper, value about one farthing. If in a package like this honey can reach the show intact as it leaves the sender, we have all the requirements of the schedule complied

with; and neat little boxes or wicker-work hampers, which contained most toothsome displays of pretty jars of honey within, had perforce to be passed over because—while admirable for such a purpose as sending a present of honey to a friend, or for a Christmas hamper of bee-produce—of not being in strict conformity with the wording of the schedule. Let us hope that in 1898 this class will be altered into a non-returnable package for *comb-honey* by parcels post. There would be some room for ingenuity here, and, if successful, a long-felt want filled. It is easy enough to get extracted honey safely along by post or rail, but a safe comb-honey package of the kind mentioned is still lacking.

We cannot afford space for more than a brief reference to the various classes enumerated seriatim in schedule, beginning with that for twelve 1-lb. jars light coloured liquid honey (Class 64). Here were 48 entries of remarkably fine produce; indeed, it may be safely said that at no other exhibition of the year are there so many choice samples staged in competition as at the Dairy Show. Most of the exhibits have been shown before, and it naturally follows that most have been awarded prizes; so that a "win" at the "Dairy Show" may well be esteemed highly. Nor need there be any wonder that so large a proportion of the exhibits at this show receive recognition after the actual cash prizes have been "placed." Taking the whole class, it was a display of British honey so good as to fully maintain the high character claimed for our native bee-produce when compared with that gathered in any quarter of the world.

The class for dark-coloured liquid honey (Class 65) was a decided improvement on last year as regards quality; but, judging by the exhibits staged, the schedule needs defining a little more clearly in order to keep heather honey out of this class. When writing a year ago (page 431, vol. 24), with reference to this class, as to the schedule "specially providing that dark-coloured honey and heather honey should each stand on their own merits," we had no idea of heather being staged in the same class as dark-coloured honey; but it was last week, and, moreover, it won—as win it will if eligible to compete. And it cannot be excluded unless the words "*other than heather*" are printed in schedule. This course is adopted in Scotland, and will, no doubt, be followed at future Dairy Shows.

Class 66.—Twelve 1-lb. jars extracted heather honey, produced eleven entries. This too was a good deal better class all round than in '96, and the samples receiving awards were very meritorious, notwithstanding the fact that the heather season of '97 has been notably a poor one. The force of our objection (mentioned above) to the inclusion of heather honey in class 65 will be seen, when what was obviously the same honey took 1st prize in both classes.

Twelve 1-lb. Sections (Class 67).—Though not

remarkable as a whole in point of excellence, the exhibits to which awards were given included some very fine sections. Notable among these was the 1st prize lot which were very good indeed. They formed a great contrast in colour to those taking 2nd prize, the latter being from sainfoin, and consequently having the usual yellow capping to the combs, while the cappings of the highest placed sections were beautifully white. We were told that the dozen sections referred to had been shown six times this season, previous to their appearance at the "Dairy," taking 1st prize on each occasion; so that with their success last week—which gained them Sir James Blyth's champion prize value £2, the 1st prize of £1 5s., and the silver medal of the B.B.K.A., the exhibitor needs but to sell them at a good price to claim for that particular bit of bee-work a very profitable season.

We were sorry to see so poor a show (seven entries) in the class for heather sections. A result no doubt attributable to the bad weather prevailing in August and September.

There was again a capital lot of granulated honey in class 69. Not so large an entry as last year, but the quality was very good indeed, as shown by the large percentage of exhibits noticed by the judges beyond the prize samples. The President's prize and the silver medal of the B.B.K.A. were awarded as above stated; the bronze medal going to the 1st prize exhibit in Class 64, and the certificate to Mr. Seymour's exhibit in Class 73.

Mr. W. Broughton Carr, London, and Mr. Mr. T. D. Schofield, Alderley Edge, Lancs., were the appointed judges.

AWARDS.

Twelve 1-lb. Jars Light-Coloured Extracted Honey (48 entries).—1st, S. Cartwright, Shawbury, Shrewsbury; 2nd, W. H. Woods, Hemingford Grey, Hunts; 3rd, Jabez Sopp, Crowmarsh, Wallingford, Berks; 4th, Jas. Cragg, Garstang, Lancs; 5th, Mrs. E. Sopp, Wallingford; Reserve No. and v.h.c., S. Woodward, Kingsley; v.h.c., T. Colyer, Good Easter, Essex; Wm. Woodley, Beedon, Newbury; J. M. Lord, Northiam, Sussex; R. Dodd, Tarporley, Cheshire; Mrs. W. Woodley, Beedon; H. O. Smith, Louth, Lincs; P. H. Rawson, Market Drayton; A. E. Rowell, Saffron Walden; H. W. Seymour, Henley-on-Thames; and Owen Roberts, Tarporley; h.c., Wm. Dixon, Leeds; and H. Hayward, Leicester; c., Jesse Garratt, Meopham, Kent; S.E. Agricultural College, Wye, Kent; E. C. R. White, Romsey; F. Chapman, Wells, Som.; E. Ainsley, Bishops Waltham, Hunts; F. Harper, Uttoxeter; and J. Hookway, Wellington, Som.

Twelve 1-lb. Jars Dark-Coloured Extracted Honey (28 entries).—1st, T. Walker, Esthwaite, Hawkshead; 2nd, John Berry, Llanrwst, N. Wales; 3rd, H. Attfield, Ascot, Berks; 4th, J. R. Aubry, Woking; 5th, E. C. R. White; h.c., H. W. Morris, Don-

caster; A. J. Carter, Billingham, Sussex; J. Hookway; and R. Brown, Somersham, Hunts; c., F. Harper; J. D. Wilcox, Bedminster; and B. G. Brocklehurst, East Hamlet, Ludlow.

Twelve 1-lb. Jars Extracted Heather Honey (11 entries).—1st, Thos. Walker; 2nd, T. and H. Thompson, Grafton, Yorks; 3rd, Jno. Berry; v.h.c. and Reserve No., H. Attfield; v.h.c., D. McGeachey, Oban, N.B.; h.c., R. Ness, Helmsley, Yorks; J. M. Balmбра, Alnwick; G. F. Dale, Little Haywood, Staffs; and J. R. Aubrey.

Twelve 1-lb. Sections (20 entries).—1st, F. Chapman; 2nd, W. Woodley; 3rd, Mrs. W. Woodley; 4th, J. Moreton Lord; v.h.c. and Reserve No., Jno. Berry; v.h.c., Jesse Garratt, S.E. Agricultural College, and Jabez Sopp; c., H. W. Seymour.

Twelve 1-lb. Sections (Heather Honey) (7 entries).—1st, J. McDonald, Kingussie, N.B.; 2nd, E. Middlemass, Alnwick.

Twelve 1-lb. Jars Granulated Honey (13 entries).—1st, R. Brown, Somersham; 2nd, T. Colyer; 3rd, W. Woodley; 4th, H. W. Seymour; v.h.c. and Reserve No., H. Merryweather, Southwell, Notts; v.h.c., E. D. Till, Eynsford, and H. and O. Smith; h.c., T. and H. Thomson; c., Mrs. Woodley, and W. Lee, Southwell, Notts.

Extracted Honey in Bulk, not less than 28 lb. (9 entries).—1st, W. H. Woods, 2nd, W. Woodley; 3rd, H. W. Seymour; c., E. C. R. White.

Non-Returnable Packages for Sending by Parcels Post (8 entries).—1st, Wm. Dixon; 2nd, A. J. Carter; v.h.c., H. W. Seymour.

Beehive (17 entries).—1st, W. H. Woods; 2nd, G. J. Buller, Hitchin, Herts; 3rd, T. J. Weston, Great Totham, Essex; v.h.c. and Reserve No., Rev. Sidney Smith, Wheldrake, Yorks; v.h.c., J. Berry; h.c., E. C. R. White.

Interesting and Instructive Exhibits (12 entries).—1st, H. W. Seymour; 2nd, H. W. Morris; 3rd, Dr. Percy Sharp; v.h.c., J. and W. S. Nettleton, Southport.

HONEY SHOW IN GLASGOW.

The Annual Grand Scottish Co-operative Floral Festival and Honey Show was held in St. Andrew's Hall, Glasgow, on September 10 and 11.

In the honey section some of the classes had as many as seventeen entries staged, one exhibitor accomplishing the unusual feat of securing first prize in each of the eight classes open for competition.

The same gentleman also had a tastefully-arranged trophy of honey for exhibition, which was much admired.

The Rev. Robt. McLelland, Inchinnan, Renfrew, officiated as judge, and made the following awards:—

Best Super (12 lb.).—1st, Sydney Roebuck, Dumfries; 2nd, John Walker, sen., Kilmaurs; 3rd, John Walker, jun., Kilmaurs.

Four 1 lb. Sections.—1st, S. Roebuck; 2nd,

Jas. Kirkpatrick, Selkirk; 3rd, Wm. Keggie, Dunfermline.

Single Super.—1st, S. Roebuck; 2nd, J. Greenshields, Lurkhal; 3rd, James Kemp, Selkirk.

Four 1-lb. Jars Extracted Honey.—1st, S. Roebuck; 2nd, Wm. Keggie, Dunfermline; 3rd, Wm. Laird, Kilmarock.

Best Super (10 lb.).—1st, S. Roebuck; 2nd, Jas. Kemp; 3rd, R. Fairbairn, Innerleithen.

Six 1-lb. Sections.—1st, S. Roebuck; 2nd, Jas. Kirkpatrick; 3rd, Jas. Kemp.

Six 2-lb. Sections.—1st, S. Roebuck; 2nd, J. Greenshields; 3rd, Jas. Kemp.

Six 1-lb. Jars Extracted Honey.—1st, S. Roebuck; 2nd, Peter Lamont, Kilmaurs; 3rd, J. D. Hannah, Bonnybridge.

(Communicated.)

PICKERING AND DISTRICT B.K.A.

In April last an Association was formed for this district under title "The Pickering and District Bee-Keepers' Association." The work of the Association was commenced in May by a lecture on the "A.B.C. of Apiculture," by Mr. Robert Ness, of Helmsley, Yorks, who was engaged by the Technical Instruction Committee of the North Riding of Yorkshire County Council. Much interest was centred in the lecture by nearly all the leading bee-keepers of the district, as well as by a large number of the general public. As a result of the lecture, a desire was expressed that Mr. Ness should give a bee demonstration at Pickering Gala on August 4. The Technical Instruction Committee readily granted this second application from the new Association, and the vicinity of the bee tent was crowded during the exhibition, which was ably carried out by Mr. Ness. Prizes were also offered on the occasion for members of the Association by Mr. T. Mitchelson, president, Mr. W. Cooper, and Mr. W. Scoby. The awards were as follows:—

Three 1-lb. Jars of Dark-coloured Extracted Honey.—1st, E. Baker; 2nd, W. Cass; 3rd, E. Baker.

Three 1-lb. Jars of Light-coloured Extracted Honey.—1st, J. A. Snowden.

Three 1-lb. Sections.—1st, W. Cass; 2nd, E. Baker; 3rd, J. A. Snowden.

The members of the Association being desirous that the winter months should pass without something more being done to increase its usefulness, made a third application to the Technical Instruction Committee for a further course of two lectures, and as a result two more lectures will be given by Mr. Ness, on dates yet to be fixed.

The thanks of the Association are due to the Technical Instruction Committee of the County Council, who have rendered such valuable help in our efforts to promote the bee industry in the county.

The Association consists of thirty-four members.—J. P. W. LIGHTFOOT, *hon. sec.*

HOMES OF THE HONEY BEE.

THE APIARIES OF OUR READERS.

We present on this page a view of Mr. C. Atkinson's apiary at Tockwith, near York, with the owner seen in the background. Mr. Atkinson being a well-known Yorkshire bee-keeper and honey-producer on a comparatively large scale, we were desirous that readers should know a little as to himself and his apiaries, and consequently made bold to express this much in asking for a few particulars. In response, Mr. Atkinson kindly wrote as follows:—

"Yes, I have served a decently long apprenticeship; it must be twenty years since I

moors for heather-honey, but that was when the 'fever' ran high, but I still retain pleasant recollections of the former outings.

"My average take per stock for the last four or five years is between 50 lb. and 60 lb. 'Do I favour the "Wells" system?' Yes; but the bee-keeper must know his work, or he'll often find one end of his hive minus a queen. I invariably work those long combination hives—seen in front of the sun-dial in picture—as twin hives. Being compelled to economise space, I never disturb two single stocks in order to establish them in a 'Wells' hive; but for working up small stocks (nuclei of the previous season with young queens) I find the system work well and the result satis-

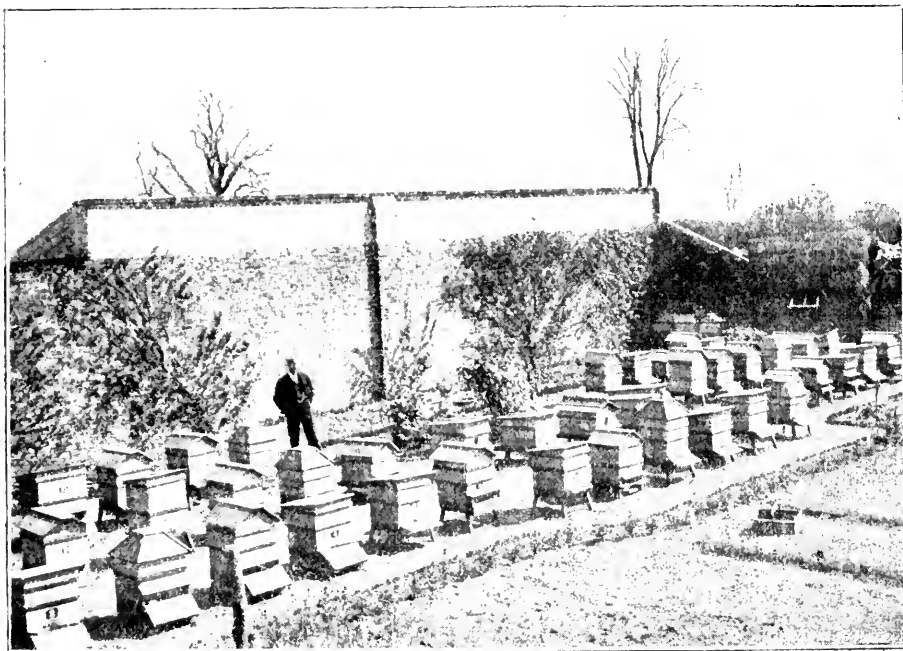

MR. CHAS. ATKINSON'S APIARY, TOCKWITH, YORKS.

first became part owner of a stock of bees in a skep. At present I have between fifty and sixty colonies in frame-hives, and for a few years the number has varied little. I first caught the 'bee fever' after hearing the expert lecture in the bee-tent at the 'Royal' Show held at York, and for some years my bee-enthusiasm gave a quietus to nearly all my other summer hobbies. One needs to be in real earnest, though, to become a good bee-keeper, and without close attention, and a fair knowledge of the subject, success is seldom attained. In our neighbourhood little else than clover honey is gathered, but few districts are better for this particular bee-forage. Years ago I used to go twenty-five miles to the

factory. My dummies always become blocked with propolis, but I don't trouble, having little fear of the bees disagreeing if both lots are allowed access to super at the same time when honey is coming in.

"I never have many swarms, but, in order to have young queens, I usually get my cells from the few stocks that do swarm, and find this a convenient way of getting the necessary young queens, and I think queens raised in this way compare favourably with those bred on advanced and approved lines. I don't like pure foreign bees for Yorkshire, but nearly every hive in my apiary shows the Italian cross. Foul brood I've had no experience with, nor do I wish to have any.

"I run my hives mostly for extracted honey, and I think 180 lb. is the most I ever took from one colony. In recent years, however, I have not troubled with a separate account. 'Have I much trouble in disposing of my honey?' No, not a great deal, and, as a rule, I keep over each year about a quarter of a ton, and then, if the crop is a failure, as it is apt to be some seasons, I am still able to supply my most regular customers.

"I have, of course, my favourite hive (my own invention, you may be sure); the bees, perhaps, are not so conscious of its many 'points.' Anyway, the result doesn't show it off much more favourably than it does some of the other patterns."

Correspondence.

The Editors do not hold themselves responsible for the opinions expressed by correspondents. No notice will be taken of anonymous communications, and correspondents are requested to write on one side of the paper only and give their real names and addresses, not necessarily for publication, but as a guarantee of good faith. Illustrations should be drawn on separate pieces of paper. We do not undertake to return rejected communications.

** * In order to facilitate reference, Correspondents, when speaking of any letter or query previously inserted will oblige by mentioning the number of the letter, as well as the page on which it appears.*

CARNIOLAN QUEEN-BREEDERS

AND NON-DELIVERY OF QUEENS BY POST.

[3030.] I have had lately some inquiries and complaints from British bee-keepers regarding the supposed negligence of the proprietors of some of our Carniolan bee-establishments. My correspondents stating they had sent their money but had received no queens in return, I at once wrote to the queen-breeders complained of, asking for an explanation of the affair, and I have received the following information in reply :—

Queens, they say, were duly posted, but, for some reason not given, the postal authorities sent them back without giving any notification as to the reason. Others were delivered all right, much to the surprise of the breeders themselves. One of same (I do not give names for obvious reasons) wrote a long letter to me, begging that I would use my influence in overcoming the difficulty with the British Post-office authorities in England. It seems so curious why queen-bees should not be forwarded the same as our post does here, and as is done in nearly every country in the civilised world. Of course, personally I can do nothing. I see, however, that the British Post-office will forward queens in the year 1899 or 1900, in carrying out the new contract of the Postal Union. This being so, perhaps the British B.K.A. might by a little extra effort induce your postal authorities to anticipate this decision a little. I myself secured a similar concession in Austro-Hungary many years ago, though it was at first refused for the reason

that the bees would die for want of air. However, on my contending that primarily the Post-office was not responsible for the life of queen-bees, and could not be held responsible for any loss of such, there was no logical reason for refusing to take queens by post so long as the risk of loss in transport was the bee-keeper's risk only.

In the next place I reminded them that as the transport of queens was made entirely with the object of improving the various strains of bees such an object should enlist the help and not the hostility of a wise Government. In the end, I am glad to say, my request was granted fully and freely to forward even nucleus colonies of bees by mail, and my success was published in most of the European bee-papers.

Without saying that equal success will attend your efforts in England you may by my publishing these lines in the B.B.J. give British bee-keepers an opportunity to see that if their orders for queens were not promptly filled, the fault was not that of our Carniolan bee-establishments.

At the same time I beg to make it clearly understood that I do not sell bees, nor have any interest in their sale by others. Neither do I recommend customers to any one of our queen-breeders. I only wish my British bee brethren to understand how matters stand with regard to bees by post. I will also publish any information appearing in the B.B.J. on the subject in our bee-papers in this country for the information of all concerned.—ALEX. SCHRODER, Trieste, Austria, October 16.

NOTES FROM MIDLOTHIAN.

[3031.] I was pleased to see Mr. W. Wilson's letter (3008, page 394) in defence of Scotch judges, or perhaps I should say, judging at Scotch shows, because I think that both our editors and other Southern county judges come this way to judge sometimes. I am quite sure from what I have seen of shows that no partiality is shown, such as is suggested by Mr. Anderson on page 383. The judges are not aware who the honey belongs to till their decision is given, unless the secretary points it out to them, which I do not think any secretary would do.

The season here for clover honey has been a short but very good one. Bees were very backward in spring, and in June it was thought that the season would be a failure. But the cold, backward weather of that month was followed by beautiful sunshine and warmth in July, during which time bees did well. My average was 40 lb. per colony. Several other beemen did well about here; but one or two of the old school got no surplus at all, their bees just becoming strong in numbers when honey flow was past. I had only one swarm from a skep, whilst a friend close by was bothered terribly in this line. He hived one swarm six or seven times. Speaking

of swarming leads me to say that I think the aspect of a hive has a great influence on swarming.

My bees during the last five seasons have stood facing N.E. for no particular reason except that it is the most convenient place in the garden for them. During that time I have had no more than two swarms other than those I wanted to come off, and two hives which I look after standing in a garden adjoining mine have not swarmed for the last three seasons. The sun strikes the hives early in the morning starting the bees off to work. I might mention, by the way, that the sun strikes *my hives* at the same time, but not with the same result, for the hives are in the shade by midday. Perhaps I sleep sounder than the bees. I work on the tiering system with hives not wanted to swarm, and this helps to reduce swarming; nevertheless, I think the aspect has more to do with swarm-preventing than the tiering; of course, hives that do not swarm for two years are requeened.

It may be thought that my bees are longer in building up, and in consequence I have to put up with a poor harvest. Such is not the case. I have averaged 40 lb. per hive for the last five seasons, which will compare favourably with any one's take in this locality. I should like to learn if any one has had similar experience to mine as regards swarming with hives standing north-east?

We are having beautiful mild weather just at present, and bees are carrying pollen freely. They seem to be prying into each other's affairs a little more than I like to see, so hope the weather will soon get cooler and keep them quiet.

I almost forgot to say that the heather was a failure about here, although I think little feeding has been required.—H. MARRS, *Local Secretary M.B.K. Association.*

THE "RECORD TAKE" OF HONEY.

THE BEE-KEEPER'S PARADISE.

[3032.] Mr. Lancelot Quayle's phenomenal success will, no doubt, set the thoughts of his brother bee-men in less favoured districts towards the Isle of Man as towards another promised land, and soon, perhaps, we shall see another "exodus" from this Egypt of England, not across the Red Sea this time, but that yeleft the Irish, to seek a bee-keeper's millennium amidst the beauties of Glenmay. What a vista of Paradise is opened out to us by the joyful news this new Joshua tells us! Here we may find a haven of content at last! Here may we set up our nest while the busy bees gather in the sparkling nectar by the ton! What an ideal life may then be led by the devoted apiarist! "Far from the madding crowds," "The world's ignoble strife," away from bustle and worry of commercial or mechanical drudgery and toil, "we may fleet the time carelessly as they did in the Golden Age." There arises in my mind's eye the

realisation of my life's dreams. A bee-farm of 100 hives spread about an acre of land well planted with bee-flowers. A model bee-man's cottage—with workshop and store-room, and laboratory for scientific purposes, and all the latest up-to-date microscopical accessories—stands in the midst thereof. A wife and children, of course, fill up the complement of this day dream. But through all this there keeps running in my head—I cannot drive it away—whenever I re-read, and I do so often whenever I think of this "famous take," back comes to my mind these words, "Were there not ten lepers cleansed. Where are the nine?" "Where are the nine"? And so the refrain follows me about, "Where are the nine?" Were there not seven hives? Mr. Quayle has told us of one. What has he to say about the other six? Yes, Mr. Quayle might easily make £100 per annum from seven hives if they all yielded as much as the one. But what have they yielded? This, Mr. Editor, is a point I would like to hear about. Then there arises just another thought about the age of the queen. Mr. Quayle says he does not know the age of the particular queen of this colony. Well, he might say whether this stock was a swarm of the previous season, whether it swarmed at all, or whether it was the young queen left in the hive after the swarm or swarms had "gone off." We might then have some data as to the age of this particular right-down regular royal queen.

I congratulate Mr. Quayle most heartily, and wish him all success in the future, and trust that every season may be as good as this one; nay, that he may eventually obtain the height of his ambition with a 400 lb. single-colony take.—EXCALIBUR, *Manchester, October 23.*

THE DRONE FLY.

[3033.] Your correspondent's query (3022, p. 407) is, I think, easily answered. His description of the fly he saw on the ivy, though rather vague, suits the well-known drone fly, *Eristalis* (tenax or pertinax), as both species are common. The rat-tailed larvæ of this species are found in stagnant water; often in drains and cattle yards. An allied species, *Volucella bombylans*, which in appearance closely mimics small worker humble bees of our common species—sometimes having the end of the abdomen red, as in *Bombus lapidarius*; and sometimes white, as in *Bombus terrestris*—is parasitic upon the larvæ of these species, and has been bred in great numbers from the nests of these bees. This species appears about June and July.—ALFRED THORNLEY, M.A., F.L.S., *Lincoln, October 22.*

STORING HONEY IN TIN VESSELS.

[3034.] On page 398 of the B. B. JOURNAL (No. 1851) *re* effects of tin on honey, there are tons of terne metal used because of it being

much cheaper than tin. I have not the least doubt if honey or syrup is kept in any time it will contain lead used in the fixing process. If I were a judge I would not give a prize for honey that has been kept in tin vessels. In fact, the honey should be taken out of such receptacles as soon as possible or the flavours of the honey will be spoiled. I would not buy any for my own use that has been long in tin cans. I know several who have kept honey in them but they say "never again."—*MORNING CLOUD, Wolverhampton, October 19.*

CARRYING DRIVEN BEES.

[3035.] Recently, in view of a bee-driving expedition, I made an attachment for my bicycle, whereby I was enabled to carry three skeps of bees and an additional skep containing smoker, &c.

If you think it would interest BEE JOURNAL readers, I shall have much pleasure in sending you a photo and drawing of same. By its aid I was enabled to bring home seventeen lots, which would have cost me something considerable in trap hire.—*D. G. T., Ilminster, October 18.*

[We will be very pleased to receive a photo and particulars regarding the above if our correspondent will kindly send them on.—*E.*]

THE "WELLS" SYSTEM.

[3036.] I have not yet had many reports of the "Wells" in the JOURNAL this season. Will some friends who have used them kindly oblige with reports to their "takes," &c.? I am rather interested in them.—*W. J. FARMER.*

Queries and Replies.

[1868.] *Transferring from Skeps to frame-hives.*—I have five skeps of bees, swarms this year, and I am very desirous to do so with the skeps and substitute frame-hives. Would you advise me to purchase the same now and transfer bees to them? If so, would it be advisable to unite, say, two skeps into the bar-hive, or would it be best to winter them in present skeps, if you advise transferring, kindly say how to feed during winter, and whether I must destroy or separate, and thus leave only one queen to each frame-hive?—*CONSTANT READER, Chichester.*

REPLY.—October is altogether too late in the season for successfully transferring bees and combs from skeps to frame-hives, and we very strongly advise wintering the bees in the skeps they now occupy. April of next year will be the proper time to transfer, if at all. But unless the combs are straight, clean, and good ones, we should set each skep above a frame-hive, and let the bees transfer them-

selves. By this course, better and more workable combs will be got in the frames, and the prosperity of the bees not interfered with.

[1869.] *Requeening Experiences.*—Being a beginner, I am rather at a loss to understand one or two things in connection with my bees. 1. On July 31 an expert said the queen of my hive was very old, and advised requeening. I therefore removed her on August 9, and next day introduced young queen by means of a pipe-cover cage. On opening hive to liberate her on the 12th, I found she had already been liberated by workers and a few eggs were to be seen. I then gave thin syrup for a few days, afterwards going away from home for a fortnight, during which time the weather became wet and cold. On returning I gave more thin syrup and examined hive first opportunity, expecting to find eggs and brood, but neither were to be seen, nor was I then able to find the queen on combs, but did so afterwards. 2. On September 14 I thought I saw a queen bee alight on board and enter hive, and was confirmed in this by again seeing her leave the hive on Sunday the 31st, take wing, and, after wheeling round once or twice, she alighted and re-entered the hive. With regard to query No. 1, do you think the eggs referred to would be those of the young queen or the old one? or is it more probable that the queen I introduced was not accepted by the workers, and that they reared another? This might account for my seeing a queen as mentioned in second query, when she would, perhaps, be taking a marital trip. I made the hive snug for winter on Saturday the 2nd inst., after feeding up on thick syrup, and put cake of candy over frames. There does not appear to be any drones in the hive.—*B. E. J., Stockport.*

REPLY.—1. It is quite possible that the few eggs were those of the old queen, supposing that the young queen introduced was only a virgin. 2. As to the bees having refused the alien queen first given, that point should be settled by the appearance of queen-cells on combs. The matter would be much easier cleared up if we knew whether or not the queen given on August 12 was mated or not, because, if a virgin, it is very unlikely that she would be taking a mating trip on September 31. It is, however, so probable that you may be mistaken that we would leave matters as they are till spring.

[1870.] *Superabundant Bee Books.*—1. I have your books, also "Cheshire's" and Webster's." Could you tell me of other books which are also practical for everyday use, and up to date? 2. Has Mr. A. J. Root written more than one? There are advertisements of his at different prices, and names such as "Root's A B C," and "Root's Manual." I am the strength of one of your correspondent's commending their material for carbolic combs, a short time ago, I have tried butter-cloth for this purpose, and find it much

handier and more effective than calico. It has also the advantage that one can see the bees through it, and also use the fumigator (or smoker) through it, if a specially strong dose is needed.—G. M. S., *Keswick*.

REPLY.—1. If our correspondent is about to form a library of bee-books, it would not be difficult to name many volumes of suitable books for inclusion therein, but for all practical purposes the works mentioned cover the whole ground, and embrace every known want of the practical bee-keeper of to-day. 2. We know of no "Root's Manual," nor do we think Mr. Root has ever written a book bearing that title. Is it not "Cook's Manual" that is meant? Root's "A B C of Bee Culture" is a distinct work, and the only one of its particular kind.

[1871.] *Wintering Bees in Conservatory under Artificial Heat*.—I shall be greatly obliged if you will kindly give your opinion and experience of wintering bees under artificial heat on the following plan. I propose to place one of my strong stocks in the corner of a small conservatory, and to warm the latter with a hot-water circulation throughout the winter up to about 60 deg. During the whole time I also propose to give the bees the full run of the conservatory, and furnish them with a judicious system of feeding and food *ad lib*. Will the bees be content to work under these conditions?—J. P., *Folkestone*, October 21.

REPLY.—Without being able to give our personal experience of the above method of wintering bees, we are perfectly certain it will fail completely. This being so, our advice is, not to waste a stock of bees, strong or otherwise, in making the experiment. In the first place, whatever chance there might be of the bees enduring a temperature inside the hive warm enough to tempt them out when the outside temperature was altogether unfit for bee-flights, this chance would be completely destroyed by any attempt to confine their flight to a small conservatory, and the bees would perish in hundreds beating against the glass in the vain attempt to reach the open air. It has been proved beyond dispute that if bees are properly prepared for wintering in this country they are far best when left on their summer stands, with entrances open all the year round.

a bright, genial day, and scores of bees from this particular hive were sporting in front of the entrance for several hours, while others were busy carrying in water.—C. H. H.

Huntly, Aberdeenshire, October 18.—In spite of a very cold and backward spring, this has been the best season I have ever had with my bees. All my stocks swarmed, and I was successful in returning only one of them; after giving the bees of the swarm two days to cool down in a large hiving skep, I then returned them, and they were content to remain in the parent hive. I have taken 267 lb. of extracted honey from this stock, while leaving enough stores to winter on. The others swarmed excessively, even when I had returned second swarms. After leaving them over night in a skep several of them came off in a day or two. I have not had time to sum up an average, but my worst stock has given me 90 lb. of honey. I got 80 lb. from one swarm, and 90 lb. from another, but both were double swarms, and both have enough left to winter them. Very little was done at the heather; I only got about 40 lb. of heather honey from ten hives. Some northern bee-keepers recommend getting queens from the south, or even foreign races, but I doubt if they would do better than my own. Most of my neighbours' bees have done very well this year, especially those worked in frame-hives, and that were well attended to.—J. E.

Salisbury, October 20.—"Good, better, best." This is my third complete year of bee-keeping, and my average has been:—1895, 58 lb.; 1896, 66½ lb.; 1897, 100 lb. This year I commenced with five stocks, of which only one swarmed, and that one with the swarm gave me 145 sections. My take per hive was as follows:—No. 1, 85¾ lb. extracted; No. 2, 145 sections; No. 3, 88 lb. extracted; No. 4, 101¾ lb. extracted; No. 5, 80½ lb. extracted; total, 500¾ lb. No. 5 was very weak all the spring, and on June 2, when all the others were supered, the bees covered six frames only, but afterwards they came on splendidly. In addition to all this honey, the bees built out forty-five shallow frames, which with those I had before, they have now nicely scrubbed and dusted out ready for next spring. Am I right in reckoning my average? Should it be five or six stocks? A friend (who hasn't done so well as I have) says six; I thought it was reckoned from "spring count."—S. P. D.

Echoes from the Hives.

Woodhouse, near Leeds, October 20.—You may be interested to know that I have a hive of driven bees which are already busy on the fruit blossom. In a neighbouring garden a pear-tree is covered with an abnormal second crop of white bloom, and the bees are working on it, for I notice that some of them are carrying in pollen. Last Sunday (October 17) was

Bee Shows to Come.

November 11, at the Town Hall, Ludlow, Salop.—In connection with Chrysanthemum and Fruit Society's Exhibition. Two open classes for "Sixes." Schedules from Mr. Jno. Palmer, 17, Brand-lane, Ludlow, Salop. Entries close November 4.

November 19, 19, and 20, at the Waverley Market, Edinburgh.—In connection with Chrysanthemum Exhibition Show, the Scottish B.K.A. will hold a Honey show as above, at which very liberal prizes will be offered (see advertisement on page v). Schedules from Rev. R. McClelland, Hon. Sec., The Manse, Inchinnan, Renfrew.

Notices to Correspondents & Inquirers.

All queries forwarded will be attended to, and those only of personal interest will be answered in this column.

- C. H. H. (Leeds).—*American Bee Journals*.—
1. We supply *Gleanings in Bee Culture* from this office at 6s. 6d. per annum (post free). 2. The *American Bee Journal* is issued weekly, and could also be had, by ordering from us, at same price as above. 3. "Queen Rearing" may be had from the author, G. M. Doolittle, Borodino, New York, U.S.A., price 4s., and postage. 4. The *Australian Bee Bulletin* is still published. 5. We think you would like *Gleanings* best.
- G. F. (Sussex).—*Rack v. Crate*.—1. If our correspondent will point out the page in "Guide Book" where "a rack is called a crate, and *vice versa*" we will be very pleased to notice his correction. 2. The word "case" is not used at all on page 53 of the latest, or 14th, edition.
- R. C. S. (Biggar).—*Unmated Queen*.—The fact of drone brood only being found in worker cells, and the very appearance of dead queen received renders a post-mortem quite unnecessary, and we do not hesitate in declaring it a case of non-mated queen.
- J. L. (Boothstown).—*Hives near Public Road*.—The question of safety to passers-by—owing to hives being located "about five yards from a public road"—depends very much upon the bee-keeper who has control of the hives. In careful hands there would be no danger, but if convenient to set up a piece of trellis-work five or six feet high, two yards in front of the hives, the risk (if any) would be entirely avoided.
- J. SPITAL (Blairadam).—Queen has all the appearance of a virgin, but it is impossible to say for certain, as the body is too dry and shrunken for microscopical examination of the ovaries. As to her race or breed she has the appearance of an ordinary or native bee.
- C. ANGLESEA (Amlwch).—*Suspected Queenlessness*.—Being only "a beginner with bees and too timid to examine the combs," it is not easy to advise you how to proceed with regard to queenlessness. If full name and address is sent here we may possibly get some bee-keeper near to render the help needed. There is no use buying a queen for introduction, unless it is certain the old one is gone.
- W. B. J. (Broadclyst).—1. While thanking you very much for kindly offering help, we think the correspondent referred to will have already had some assistance in the way indicated. 2. So far as the Association we hope to see started in the county, the matter is not being lost sight of, and when any tangible result becomes visible the fact will no doubt be published in our pages.

G. M. S. (Dowthwaite).—*Misshapen Combs*.—
1. If combs are found bulged or misshapen, and require paring down or repairing in any way, the first thing must perforce be to shake or brush the bees off the comb back into the hive; then go to work with knife, tapes, or clips, as may be needed, to get all put straight. The bees are sure to build brace combs if there is less than $\frac{1}{2}$ in. space between the face of combs. 2. If combs are built out more than $\frac{1}{2}$ in. from septum or midrib, the bees will reduce the cells to that depth when using them for brood-raising.

G. N. (Middlesex).—*Wintering Bees in Greenhouse*.—1. It has been proved that bees properly prepared for winter, and housed in sound, dry hives, will come out far better in spring when left outside on their ordinary stands than if kept in greenhouses where an artificial temperature is maintained. 2. On no account should bees be kept confined to their hives for the winter months. They should have liberty to fly abroad on fine days, and stay indoors when too cold for flight.

GREYSHOTT (Surrey).—*Suspected Combs*.—In one cell of comb sent there are distinct traces of foul brood, but without a larger piece of comb, with dead larvæ in a few cells, we cannot offer an opinion as to the mildness or otherwise of the attack.

NOVICE (Guisborough).—*Feeding Driven Bees*.—1. The feeding should be continued till they have about 20 to 25 lb. of food stored; but as it is now too late for syrup feeding, any deficiency of stores should be made good by a cake of soft candy placed above the cluster. 2. We are at all times willing to forward spare copies of our journals for free distribution on payment of carriage.

T. H. B. B. (Exeter).—*Honey Samples*.—No. 1 is poor in flavour and dark in colour, such as we have seen gathered from blossoms of dwarf beans, but we cannot say if sample is from this source. No. 2. Good colour and fair in flavour, little or no aroma. No. 3. Very good colour, and is probably from clover, but some other forage—not definable—has rather spoiled the true clover flavour. No. 4 is thin and has no character about its flavour. None of the samples would win on the show bench, we think.

M. B. (Bishop's Stortford).—*Suspected Comb*.—No. 1 is badly affected with foul brood. No. 2, not quite so bad; but both lots are bad enough for advising destruction.

LINCS. (Grantham).—There is no foul brood in comb sent; but, seeing how small a sample was forwarded, it is hardly a fair test, if there is much dead brood in hive and good grounds for suspecting disease.

* * * Several letters and replies to correspondents are unavoidably held over till next week.

Editorial, Notices, &c.

BRITISH BEE-KEEPERS' ASSOCIATION.

CONVERSAZIONE.—Continued from p. 422.

Upon the invitation of the Chairman, Mr. Haviland narrated his personal experience of bees in India, especially with regard to *apis dorsata*. The worker of that species, he said, was as large as an English queen. The queen has a very large thorax, much larger than the worker. He thought, from the habits of those bees, there would be no possibility of domesticating them. They always established their home in the open, building their combs either on the boughs of trees high up in the jungle, or on the rocks. Bears were very fond of honey, and, being good bee-hunters, climbed boldly up the trees for it; and the object of the *Apis dorsata* bee apparently was to build their combs where bears could not reach them. It was obvious that building as they did in the open air, they would be unable to stand a cold climate, and any attempt to introduce them to one would be sure to fail. These bees also readily deserted their nests when disturbed, but that occurred in India even with bees that could be induced to build in a hive. But it was far more difficult to restrain the *Apis dorsata*, as he had himself proved by experiment, and unless the queen's wings were clipped she would probably be lost. In their natural habitat the *Apis dorsata* build combs 5 or 6 ft. in length and 2 or 3 ft. in depth. The natives know the kind of trees and rocks where they may be found, and it is no uncommon thing—after an hour's climb—to find bears "tracks" in the same direction. These bees migrate according to the honey flow. When the honey is there and the natives (who, like the bears, are expert tree-climbers) want to take it, they go after dark, and, with the aid of a torch, cut down the combs. They always ate the larvae or grubs, which they relish far better than the honey. In fact, they usually sold the honey and wax if they could find a buyer. Asked as to the effect of being stung by this bee, Mr. Haviland said fortunately he was never stung by them, but there was no doubt their sting was very severe; and as the whole of the comb was exposed in the open air any victim of their wrath would be attacked not merely by two or three bees, but by the whole colony. He did not think there was the slightest possibility of crossing them with European bees. The latter were closely allied to a species found in Northern India, and yet these never crossed with *Apis dorsata*.

Mr. Sladen exhibited specimens of *Apis dorsata*, *Apis indica*, and many other kinds of bees collected by him during a recent visit to India, which were passed round the audience and examined with much interest. He also

showed a piece of comb and cappings of brood of *Apis florea*.

Mr. Weston observed that there must be parts of the Southern States of America where the objection on the ground of cold climate did not exist.

Mr. Carr and Mr. Haviland said that the principal obstacle to domestication and crossing was the habits of the *Apis dorsata*, not the climate.

Mr. Sladen, while in India, went to Darjeeling and saw some ligurians there, but he never heard of a cross having been effected. He believed that a cross might be obtained with the Himalayan bee, but did not think it possible with *Apis dorsata*. He saw forty or fifty hives of black Himalayans at the gaol at Darjeeling. The honey extractor was in use there, and the whole business was looked after by the prisoners. They use wooden frames for the combs, and generally keep the bees on the modern system. He intended to bring some bees home from India, and started with three colonies of Himalayans from Calcutta; but, before reaching England, two had died, and in the third the bees had dwindled so much that it was useless as an effective colony. He therefore united the queen with a home stock, but she was killed by the British bees, and so his importation came to naught. He did not think it possible or desirable that *Apis dorsata* should be crossed with English bees, for several reasons. He was particularly struck when catching *Apis dorsata* on the wing with the heaviness of its flight. It flew very much like a drone, flapping its wings comparatively slowly and making considerable noise. It was also slow in its general movements, and would settle on a leaf to rest, as it were, besides visiting flowers in a heavy and lackadaisical manner. *Apis indica*, on the other hand, was very similar to European bees.

Mr. Sladen afterwards exhibited his slit section, and in describing its use said: The opening on three sides was not new, but the V-shaped slot was, he believed. This slot was made on three sides, and there was a groove on the fourth side. When operating, the section was placed in a block, the slit opened, and a piece of foundation dropped into the groove at the bottom, when the plastic nature of the wax fixed the two parts of the section together. Unfortunately for him, the section could not be patented, because, as he had said, the ordinary saw cut on three sides was covered by an older invention, although the V-shaped slot he claimed as his own idea. He (Mr. Sladen) gave several illustrations of the rapidity with which foundation could be fixed in sections, and was much applauded on account of the neatness, speediness, and efficacy of the work.

Mr. G. Buller asked whether the experiment had been tried of sending these sections out in hot weather, with the foundation fitted as shown, and if so, in what condition had they arrived?

Mr. Carr replied that he believed Mr. Jas.

Abbott, of Dublin, who made a section very similar to Mr. Sladen's, sent them out so, and had no complaints; but there was no need for sending sections out fitted up, they travelled so much better in the flat.

The Chairman said they were all much indebted to Mr. Sladen for exhibiting his collection of bees, and also his improved section, and method of fixing foundation therein. The plan was exceedingly simple, and he had no doubt that ladies and gentlemen would take a delight in putting in foundation themselves. Mr. Till, having devoted considerable time to the Dairy Show, had been getting out statistics regarding entries or exhibits from different counties, and would give the meeting the benefit of them.

Mr. Till said the figures were as follows:— Berks heads the list with 22 entries; Yorkshire was second, with 17; Oxfordshire, 15; Hants, 15; Kent, 10; Hunts, 9; Surrey, 9; Sussex, 8; Essex, 8; Somersetshire, 6 (but, with a small entry, she carried off the Champion Prize, given by Sir Jas. Blyth); Middlesex, 5; Lancashire, 5; Staffordshire, 4; Nottingham, 4; Gloucester, 4; Northumberland, 3; Cumberland, 3 (the last two counties had not appeared before); Shropshire, 2; Leicester, 2; Beds, 2; Cheshire, 2; Norfolk, 1; Wilts, 1; Hereford, 1; Herts, 1; Dorset, 1; total, 164 in 24 counties. That was a great improvement in the number of entries, which were also more widely distributed than last year. Wales, as before, had 5, and Scotland 4, so that the total for Great Britain was 173 entries——

The Chairman apologised for interrupting Mr. Till, but seeing that the Rev. Mr. Rambo, through press of business, was obliged to leave the meeting, he desired before that gentleman left to tender him, on behalf of those present, a hearty welcome to that meeting of representative British bee-keepers, and to wish him and his family a safe journey, good health, and success in the mission he was about to undertake.

The Rev. Mr. Rambo, while regretting that time compelled him to leave them, expressed his thanks for their kindness to an entire stranger like himself, and retired amid cheers.

Mr. Till, continuing his remarks on the Dairy Show, observed that, generally, the Show was an extremely good one. It would have been undoubtedly better if the bottles could have been staged on a central table, so that the light might pass through them. Much interest was evinced in the exhibition by the immense number of bee-keepers and others present, among whom were the representative of the *Times* and Sir John Thorold, who was particularly anxious to get some hydromel, and hear all about it. Besides this, they received a visit from their President, the Baroness Burdett-Coutts, who was accompanied by a lady friend.

The Baroness asked many questions, proving her interest in the proceedings, staying some

time inspecting the bee-exhibits, and requested that samples of Mr. Seymour's honey-vinegar and mead might be sent to her.

Mr. Till made some humorous observations with reference to his experiences as an exhibitor in the class for parcels-post packages, at the conclusion of which the President, the Baroness Burdett-Coutts, was announced, and a few moments later her ladyship, accompanied by Miss Astor, entered the board-room, and was escorted to the chair, the audience rising to greet her.

Mr. Jonas, in inviting the President to take the chair, briefly explained to the Baroness the proceedings of the meeting previous to her arrival, especially with reference to the Rev. Mr. Rambo, and his mission to India. Mr. Till also gave a short account of the Brazilian honey-vinegar; and Mr. Sladen showed her ladyship his collection of foreign bees, adding a short description of each.

Mr. Carr, continuing the ordinary business of the conversazione, explained that he was always anxious to make the most of these occasions so far as affording an opportunity for discussing matters of practical interest to them as bee-keepers, and with this view he had brought that evening some specimens of honey selected from a great many sent to the BEE JOURNAL office for editorial opinion thereon. To these he had added some few special samples sent at his request from good friends of many present specially for them to see on that table, and thus afford an opportunity for inspecting and sampling representative honeys from all four quarters of the kingdom.

The speaker then passed quite a number of samples of honey round the table, each having written upon it the district from whence it came. Among them was a section of English heather honey from the apiary of Mr. Robert Ness. This did credit to the moors of Yorkshire, as did a jar of extracted Scotch heather honey sent by Mr. William McNally, Glencuce, to the high reputation Scotland holds for heather produce. There was also a jar of capital Scotch flower honey, kindly forwarded by Mr. W. Wilson, of Galashiels, whose letter on Scotch *v.* Irish honey appears in the B.J. of October 7. Of English samples there was a fine one sent by the Rev. A. Jollye from Norfolk, and good specimens from Essex, Cumberland, and several other parts of England. Irish honey was represented by a sample from co. Kerry, and was thought highly of, so far as the excellence of its flavour, by those who tasted it.

Among the Welsh samples was one from heather. Some few dark and inferior honeys were included, among the latter being a specimen from blackberry bloom from Pateley Bridge, Yorks. This was shown mainly to illustrate the difference between honey-dew and honey from the bramble or blackberry, which it so much resembles as to deceive the inexperienced.

Mr. Carr wound up his list of honey samples by producing what he termed a "curiosity." This was a couple of sections of the comb-honey from the great Canadian exhibit shown at the "Colinderies" eleven years ago. The glazed case—which contained two of the well-known 1½-in. sections—was, Mr. Carr said, exactly as he had received it from the hands of the late Mr. S. Corneil at South Kensington in 1886, and had not even been opened since that time.

Sampling the various honeys, and the animated discussion which followed, occupied some time, but appeared to be interesting to all present.

Among the other items of interest shown by Mr. Carr were samples of the new drawn-out "Weed" foundation, with cells almost of full depth. These were examined closely, and created much interest as to the time when the new product was ready to put on the market, and afford a fair and full test as to its value.

Mr. Jonas, addressing the President, said he had a rather interesting announcement to make, viz., that in compliance with the wish expressed by her ladyship some time ago, that the Association should endeavour to get an interesting article on bee-keeping written for insertion in the public journals, a gentleman well known to them had kindly undertaken to prepare such paper, which would be entitled "Honey and Honey Products."

Mr. Till added that the gentleman in question would be very pleased if bee-keepers generally would send brief hints on subjects they thought it desirable to include in the article, to Mr. Young, Secretary to the Association, 12, Hanover-square.

The Baroness Burdett-Coutts agreed that the composition in question should speak the united voice of many.

(Conclusion of Report next week.)

Death of M. Georges de Layens.

We have just received a communication from our esteemed correspondent M. P. J. Baldensperger conveying the sorrowful news of the sudden death at Nice of the above-named gentleman, from an apoplectic seizure, on October 23. M. Baldensperger writes as follows:—

"DEAR MESSRS. EDITORS,—I was much astonished to read this morning in our local paper here of the death of M. Georges de Layens. Proceeding at once to the residence indicated, I found the news true enough, and that the eminent French bee-keeper—who, by his work and writings, has been one of the chief means of extending the pursuit of apiculture throughout France—had really passed away. I had never seen him alive, and it was thus my sad privilege to become acquainted with his features for the first time as he lay unchanged in death. M. de Layens died here yesterday from an apoplectic stroke.

"He now rests from his labours, but his works will outlive him.—Very truly yours,

"P. J. BALDENSBERGER.

"Nice, October 24, 1897."

The mournful information conveyed in the above has been forwarded to California (where our senior Editor is still staying), and we hope in due time to receive from Mr. Cowan—who was on terms of the most intimate friendship with the distinguished French bee-master—a few biographical notes regarding him for publication. Meantime, our readers will, we are sure, join us in expressing sincere sympathy with all who mourn his sudden death.

FARNHAM DISTRICT, SURREY B.K.A.

Our first local Honey Show, held here last week in connection with the Cottagers' Garden Show, quite exceeded anticipations (we had twenty-six entries), considering the short notice we could give of holding a show. Besides, the season has been a tad one here. By starting earlier, however, we hope to have a much larger exhibition next season. Prize list follows.—WHITE LEWIS, *Hon. Sec.*, *Show Committee, Farnham, November 1.*

Awards in Honey Classes.

Of the honey awards the following went to cottagers residing in Farnham parish:—

Six 1-lb. Sections.—2nd, John Chandler, Heath End; 3rd, W. Brant, Farnham.

Best Super.—2nd, A. Brockenhurst, Farnham; 3rd, Mrs. Knight, Compton.

Four 1-lb. Jars Extracted Honey.—1st, H. Mills, Frensham; 2nd, W. Brant.

Prizes to members of the Surrey B.K.A. resident within four miles of Farnham, and in the county of Surrey:—

Eight 1-lb. Sections.—1st, Rev. C. H. Keable, Wrecclesham; 2nd, E. Clapshaw, Farnham; 3rd, R. Arkwright; h.c., J. Clarke; c., C. Winslade.

Four 1-lb. Sections.—1st, Rev. C. H. Keable; 2nd, E. Clapshaw; 3rd, J. Clarke; h.c., Miss Paget, Lowlands; c., H. Dowding.

Six 1-lb. Jars Extracted Honey.—1st, G. Langrish; 2nd, Miss Paget; 3rd, Miss Newman, Churt; h.c., Miss Poulton, Frensham; c., H. Dowding.

Correspondence.

The Editors do not hold themselves responsible for the opinions expressed by correspondents. No notice will be taken of anonymous communications, and correspondents are requested to write on one side of the paper only and give their real names and addresses, not necessarily for publication, but as a guarantee of good faith. Illustrations should be drawn on separate pieces of paper. We do not undertake to return rejected communications.

QUEEN-RAISING IN CANADA.

[3037.] Some subscribers to your journal, whose names I see on its pages, may remember me as the first lady exhibitor and prize.

winner at the bee shows held under the auspices of the late Rev. Herbert Peel, between the years 1876 and 1885, and may therefore read with some interest an account of a visit I have paid to the great Queen-bee Raising Apiary of Toronto. Mr. McArthur has devoted twelve years to apiculture with the most marvellous success. He has several apiaries in and around Toronto, but that which he uses for queen-raising is situated on Hanlon's Island, about a mile and a half across the Bay of Toronto. Here he has isolated forty hives of Carniolan bees of a lovely yellow colour, perfectly pure, bred from queens mated with yellow Carniolan drones, all the progeny bearing the distinctive marks of the race having been raised from the original queen imported from Carniola. He has had, at various times, bees from all parts of the world—Liguria, Cyprus, Egypt, and the Holy Land; also the old English bee. His experience shows that of all these, those of his present colony are naturally of the mildest temperament, and by inbreeding secured by isolation, this disposition has increased to the extent that they are now mild and inoffensive to a positive degree, allowing horses to work close to their hives and children to play baseball in their midst with impunity. He opened all the hives for me to see the queens therein, of all ages and sizes; he waved the frames over his head and round in all directions, without a bee flying or appearing at all discomposed, even when he breathed upon them repeatedly, which our English bees generally resent. No smoke or narcotic was used, and he told me that he never scents his bees before uniting; indeed, he had just united a nucleus to a large stock which was evidently quite undisturbed by the presence of the strangers. My own bee-keeping experience led me to feel nervous at such close proximity without veil or skirt, but I found his assurance correct that I should sustain no harm. I had paid him a visit the night previous, when he offered to show me a queen he was about to send to Texas. He fetched the hive into the sitting-room and took the frames out close to a brilliant lamp; no bee left them, although they were busily moving in all directions. Mr. McArthur tells me that some time back he had a queen, mated with a yellow drone, both of pure Carniolan descent, who laid worker eggs in all the drone-cells, raising only a few (some eight or ten) drones and only one queen. This peculiarity she transmitted to her offspring, and it has been handed down to the present time through seventeen generations, the result of this heredity being that the worker-bees are all larger, have longer probosci, and are proportionately stronger. Mr. McArthur exhibited some hives at the meeting of the British Association held here in August last, and I hear he is invited to attend the next meeting, to be held in Brussels in 1898. It would be well if the British Bee Association could prevail upon him to go by way of England, and exhibit

there these beautiful bees, to whom he devotes himself so closely. He is too modest to extol his own methods, but I feel sure, if English bee-keepers could see the results he has produced by careful selection and attention to the laws of Nature, they would gladly follow in his footsteps; and, by so doing, would ameliorate the pugnacity of our British bees. This enthusiastic bee-master has greatly improved the island-home of his queen-raising colony. Ten years ago it was simply a sand-bank. He commenced sowing seeds of many honey-bearing plants, and it is now carpeted with a profusion of lovely flowers, the most noticeable being the Golden Rod, the single and double Blue Gentian, and *Phystigia Virginiana*, or False Dragon-head. Besides these, the *Mellilotus alba*, or sweet clover (from Bokhara and Afghanistan), and the *Mellilotus officinalis*, or yellow clover. Both of these are excellent, not only for bees, but for cattle fodder; the former bears three crops in the year, the two first being cut as our English clover-hay, whilst the third is allowed to seed itself. He has sown it all round the country-side, on waste lands and stony places, and has turned his care for bee-pasture into a lasting benefit to agriculturists. I walked with him to see a patch of waste ground a mile in extent, where he had sown this seed, and found it covered with blossoms, on which, although the hour was late, the bees were thickly crowded. I send herewith a blossom for your inspection.

I believe Mr. McArthur's queens would be a good cross for our English bees, softening their natures and increasing their powers of production, as he gets on an average 250 lb. of honey from each hive. Time and space fail me to recapitulate other matters of interest, which he would be pleased to impart to others as to myself; indeed, I must apologise for writing at such length. But, although I am unable to keep bees as of yore, my interest in them is undiminished, and I would like to see my bee-keeping friends in England profiting, as I would gladly do, by Mr. McArthur's experience and culture.—(Mrs.) P. R. LEIGH SPENCER, *Toronto, Canada, October 15, 1897.*

THE "WELLS" SYSTEM.

[3038.] Your correspondent, Mr. W. J. Farmer (3036, p. 428) asks for reports from bee-keepers who have adopted the "Wells" system.

The more experience I have of this system, the more I am convinced that it cannot be generally adopted. It is only the bee-keeper who is within easy call of home during the swarming season (as I believe Mr. Wells is) that can hope for good results from this system. I, too, am perforce (unfortunately for myself) never far from the apiary. This season (not an average one here), the quantity I have taken by the double-queen plan is one

"Wells" hive to three single ones. This has been exactly my average, comparing the two systems for four seasons; but the labour involved by the double-queen plan is more in proportion, that is, one "Wells" hive makes quite as much work as three single-queened ones. Bees swarm, do what you will, if worked on the "Wells" live system. If the bees in one end swarm, those in the other compartment follow suit at once and join them, even if no preparation has been made by last-named lot for swarming. The result is, you have a swarm weighing from nine to twelve pounds to hive, or return if you wish; and this may have to be gone through three times in as many weeks. If the bee-keeper can afford to have an empty "Wells" hive ready to hive the double swarm into, placing the new hive on the old stand, this will allay the swarming fever, for a time at least. My experience is that the swarms invariably unite, and if one wishes to continue working on the "Wells" system, this enormous mass of bees and the queens have to be divided. This season I tried a solid dummy placed in between the two stocks before supering, but this had not the desired effect.

On the other hand, if it is desired to work up two weak colonies for the honey flow, the "Wells" system has none to equal it. If nuclei be wanted, have a few "Wells" hives stocked, and nuclei may be formed by the dozen during the swarming season.—WM. LOVEDAY, *Hatfield Heath, Essex, November 1.*

DOMESTICATING *APIS DORSATA*.

COUNTY ENTRIES AT THE DAIRY SHOW.

[3039.] The analysis of the Dairy Show entries published in the *Times*, Oct. 22, were announced at the Jermyn-street Conversation, but they are worth repetition.

Berks is a good first this year, and wins by far more than "a length," but if non-competitive sale honey sent by Kent and Sussex were reckoned, those two counties would be far ahead in point of quantity staged. I deem this annual analysis very interesting, as it shows how exhibitors are distributed over the kingdom, and it will be seen that the area of distribution is much wider than formerly and better spread. This is a good sign. Bee-keeping is greatly indebted to our exhibitors, and to one and all thanks are due, for it is an immense help towards popularising honey.

The *Times* also said:—"A new feature deserving notice is the occupation of stands by the Kent and Sussex Bee-keepers' Association for the sale of honey sent by their members. Close upon a ton has been forwarded to the hall and finds a ready sale, thus aiding the object in view, which is to popularise British honey as an article of food."

What I consider a very satisfactory incident in connection with the show and the Jermyn-street meeting is the offer of £20, which I

learn has been received from an anonymous but patriotic lover of the craft, to aid research in a field hitherto very much neglected—that of *Apis dorsata*. We shall not, therefore, be behind the United States, after all, in this interesting question. I beg to say I will add a sovereign to make it twenty guineas. I hope other friends will come in to swell the sum.—NEMO, *Kent, November 1.*

[The analysis referred to appears in our report on p. 432 of this issue.—EDS.]

QUEEN BEES BY POST.

CARNIOLAN QUEEN-BREEDERS AND NON-DELIVERY.

[3040.] Referring to the letter from Mr. A. Schroder on this subject as contained in your last issue (3030, p. 426), may I be allowed to say I am one of those who wrote him on the subject, having been treated in a most unbusiness-like manner by some of these dealers. My experience of one of them is as follows:—Early in September, 1896, I sent order and cash for carniolans, 1st grade, and heard no more—though I sent two or three cards of inquiry—until November 18th, when I received a post-card in German, which was at once posted to BEE JOURNAL for translation, but inasmuch as the Senior editor was away, I heard no more of that either. Early in this year I wrote again, and getting no answer, repeated my inquiry four times before receiving any reply whatever, and then only after threatened action. In October of this year I received a long letter (in German), which, when translated, gave me particulars of the difficulties with our postal authorities, and saying he would try again in a few days. On the 24th ult. a queen came safely to hand, but in the most ugly and ill-designed cage I ever saw, and I at once said, no wonder the Post refuses such things; they are sufficient to arouse the suspicions of the most careless. This is one case; the other is similar, but with the difference that I have never heard anything, even of receipt of cheque, which, however, was duly passed through bank about a week after date. I am in full sympathy with the subject-matter of our friend Mr. Schroder's letter; but surely we deserve better treatment from these men.—AMATEUR, *Totterdown, Bristol, November 1.*

NEXT DAIRY SHOW PROGRAMME.

SOME IMPORTANT SUGGESTIONS.

[3041.] Now is the time to begin our plans for next year's show, and bee-men will oblige by at once stating concisely what they have to suggest by way of improvement. If we wait until next year to consider our programme, we shall have forgotten much that is now fresh in memory as the fruit of our recent experience. One thing is absolutely necessary; that is, a special salesman in the honey department

expressly to deal with the competitive honey. Who cares to go through the ordeal of waiting one's turn, with twenty more, at the B. D. F. A. office before one can even find out whether exhibits are for sale, and, if so, the price? One lot I could have sold for a Hampshire man at the last hour of the show, but it meant the loss of a midnight train if I had attempted it. I pitied that exhibitor. He sent a box of lovely sections which came to the show smashed to atoms, but I could have sold the lot, and his bottles too. It is, I think, a great mistake to send more than 12 lb. in a package; the railway company must have let this lot fall from a height. In addition to a special salesman (who must be a bee-man and understand honey), every exhibitor should be compelled to price his honey the same as in the poultry section; 'then the price appears in the catalogue. If not for sale, make the price so high as to protect it. But, in future, every entry must be priced.—E. D. TILL, *Eynsford, Oct. 29.*

ASPECT OF HIVE ENTRANCES,

SO FAR AS AFFECTING NATURAL SWARMING.

[3042.] In reference to "Notes from Midlothian," on page 426 of the issue of the BEE JOURNAL of October 28, I wish to bring the following facts to notice. During the summer of the present year, I kept thirty hives for natural swarming, all facing the south-east; of these hives only three swarmed naturally on May 15 and June 24 and June 30 respectively. One of these swarms weighed 7 lb. 2 oz., and, for the remainder, although in many of them the bees were hanging out for weeks together, not one swarmed by June 11. Between this date and the 22nd I made six artificial swarms, but the other twenty-one hives altogether failed to swarm, yet they were all strong, healthy, and free from foul brood.—E. PARSONS, *Tunbridge Wells, October 30.*

BUYING DRIVEN BEES BY WEIGHT.

[3043.] I should like to ask a question which, perhaps, may possess interest for very many bee-keepers besides myself:—You buy, say, 10 lb. of bees (driven), and pay for them at, say, 1s. 3d. per lb. After having weighed bees and box before the former are removed, and the latter when empty, you find that instead of 10 lb. you have only 8½ lb.! This is what has happened in my own case. Now I do not for a moment question but that the bees weighed 10 lb. when dispatched, but they lost 1½ lb. by evaporation. I have let the matter drop, but I contend that I have paid for 1½ lb. of bees which I have *never had!* Of course, as you will see, sirs, there are several things to be taken into consideration, but still, for all that, it would be an interesting matter for a legal debate. We know, for instance, *in re* sugar (moist), tobacco, &c., but I believe

there have been no laws passed in the interest of bee-keepers since Alfred the Great.—A COUNTRY RECTOR, *Bungay, October, 1897.*

[We invite the attention of sellers of driven bees to the above communication, which has much force in it from the buyers' point of view and should be answered.—EDS.]

WAX EXTRACTING.

[3044.] In reporting the proceedings at Jermyn-street on the 21st (page 421 of last week's B.J.), where an interesting discussion arose on the subject of "Wax Extracting and Solar Extractors," you omit what was said about the importance of using *earthenware* in preference to metal vessels as receptacles for holding the wax. One who is a "dab hand" at the work uses a big pie dish: iron, tin, and copper have a bad effect on the colour of the wax.—ONE WHO WAS PRESENT, *Kent, October 28.*

MEAD MAKING.

[3045.] Seeing that your correspondent "Egrub" (1865, page 418), asks for a receipt for making mead from honey-comb, I send a description of the way we make ours:—Cut the comb up in small pieces about the size of a walnut. Place in a clean washing-pan; cover with warm water no hotter than you can bear your hand in comfortably. Let it soak half an hour, then add a little more warm water, and then squeeze the comb up with your hand. It will break all to pieces. Next tie a cheese-cloth over another pan, and pour the contents of the first pan on the cloth. When the liquid portion has run through, pour it back again into the empty pan, and add more warm water, and squeeze the whole again well. Next add as much water as will make up the quantity of mead required. Strain again through the cloth, and when all has drained through the cloth, squeeze the latter to get the whole out, and pour into a clean boiler. It does not matter whether it is a galvanised boiler or not, just for the boiling, but the liquor must not stand in a galvanised vessel for any length of time. While in the boiler drop a fresh egg in, and if the egg shows itself nearly half its size above the top of the liquor, you will have some real strong mead by the time it has been kept about twelve months. If the egg goes to the bottom your liquor will be small beer. In the latter case, to make it the desired strength more honey or sugar must be added till the egg will rise to the proper height. It is, however, no use adding honey or sugar unless you have the liquor warm enough to melt it. When made right let it boil half an hour steadily. While boiling put ½ lb. hard ginger, tied up in thin rag, also ¼ lb. cloves, to each nine gallons. When taken from the fire put it outside to cool, but before quite cold toast a bit of bread, and put a small quantity of yeast

on it to start it fermenting. Next day put it in your barrel, but don't cork it up tight for some time, and put the ginger and cloves in the barrel with the mead.

This is how we have made our mead for the last forty-five years, and I do not remember ever having any spoiled. We have made it in iron boilers and in galvanised ones, but never found any difference. There is no fear if it is done right.—W. B., *Hilts, October 26.*

P.S.—When the water has drained from the combs the second time put them into an empty vessel. The wax should be dealt with the same day or the next, and it will be good if properly extracted.

STAMPING OUT FOUL BROOD.

[3046.] Referring to your note in B.J. of October 7 (p. 397), *re* helping to stamp out foul brood, I am very sorry I have not answered yours before, owing to having been busy and working late. I am extremely obliged to you for your assistance, but, curious to relate, I happened to fancy as to whom the initials "T. H. B." belonged, and, on calling on him, I was lucky to find him the individual himself, so by his assistance and your first aid I hope next year to make a fresh start.—EXON, *St. David's.*

WEATHER REPORT.

WESTBOURNE, SUSSEX, OCTOBER, 1897.

Rainfall, 45 in.	Sunless Days, 1.
Heaviest fall, 13 on 2nd.	Above Average, 45 5/8 hours.
Rain fell on 9 days.	Mean Maximum, 56°.
Below average, 3.77 in.	Mean Minimum, 43.7°.
Maximum Temperature, 64° on 19th.	Mean Temperature, 49.8°.
Minimum Temperature, 30° on 13th.	Above average, 3.4°.
Minimum on Grass, 27° on 13th.	Maximum Barometer, 30.64° on 21st.
Frosty Nights, 1.	Minimum Barometer, 29.48° on 15th.
Sunshine, 166.8 hours.	
Brightest Day, 3rd, 9.5 hours.	

L. B. BIRKETT.

Queries and Replies.

[1872.] *A Comb-rack suitable for Fumigating Combs for Destroying Wax Moths.*—I wish to fumigate my surplus-store combs with brimstone, as I notice there are a few larvæ of the wax-moth in them. How should I proceed, seeing that I have nowhere to do this than the small room where I store all my honey and bee-keeping ecceteras? This is the first time I have found it necessary to fumigate, but somehow a large female moth got

into my room this autumn. Previously I have used naphthaline liberally, and this has proved sufficient; naphthaline certainly is, in my opinion, one of the most useful things recently introduced to bee-keepers.—WM. LOVEDAY, *Harlow, October 30.*

REPLY.—The most useful reply we can give our correspondent is to describe a simple, home-made rack for holding store combs, which is admirably adapted for fumigating. It is so simply made, and by using an old used box or packing-case, costing a few pence, that any one capable of using a saw and hammer can make it.

The "body box" (fig. 1) is 9 in. deep, 14 1/2 in. from front to back, and 32 in. long,

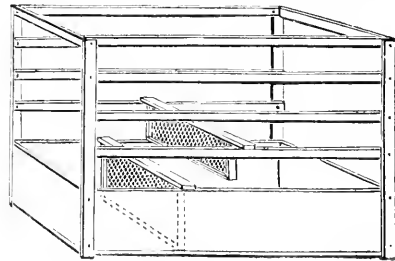

Fig. 1.

inside measure. So that, if needed, standard size combs may be stored therein. Three-quarter-inch or even 1/2-in. board is quite strong enough for the sides and floor of the body box. The uprights at each corner are 33 in. long, 2 in. wide, and 1/2 in. thick, nailed on to the outside of body box. Four light rails—slaters' laths answer well for these—front and back form the runners on which the frames hang; they are nailed on the inside of uprights with their top edges 6 in. apart, the top rails only being continuous. This rack when complete is very light, and will comfortably hold 100 frames.

The sketch (fig. 2) represents the frame of cover, and is made of very light laths, the

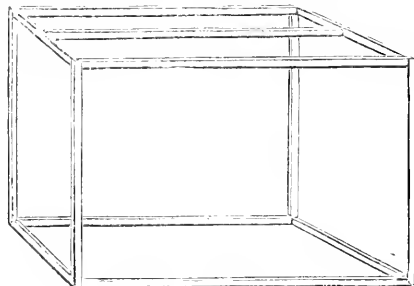

Fig. 2.

uprights being 34 in. long, and the internal dimensions of just sufficient length and width to slip easily over the "rack" when the latter

is full of frames of comb. When nailed up, this frame has a covering of several thicknesses of strong paper pasted together, and the whole is then complete. The cover fits down over all quite close to the ground, and we find that no moths or spiders, &c., ever attempt to enter at the bottom edges. A few pieces of naphthaline are placed in the body box, and the fumes will permeate the whole of the combs and stop mischief. For fumigation of combs with sulphur, space is allowed in body box for holding the burning brimstone in an old tin lid, and when a hot coal is put in, the cover is placed over the whole, and keeps in the fumes.

[1873.] *Feeding Driven Bees.*—During the last week in September I drove two stocks of bees (neither of them very strong), placing one lot in each compartment of a "Wells" hive on seven frames. I have been feeding them since on syrup, and they have had about 30 lb. in all. Examining them to-day, October 18, I find each lot has filled about half the space with sealed comb beautifully white, and were apparently still sealing over the food given, but in view of your remarks *re* feeding in last issue. I have discontinued syrup feeding, and given each a cake of soft candy. Can the bees liquify this to store in the cells and make comb of it? I ask because, in spite of the cold, they still seem able to continue comb-building, and the bees, though not numerous, are very active. Breeding is also going on, pollen being carried in abundance. They refuse artificial pollen.—W. J. T., *Malton, Yorks, October 18.*

REPLY.—We rather think that by the time this reply is read, the bees will have given up comb-building, and, this being so, soft candy is the most suitable food for this season of the year. The bees will store a certain portion of the candy when the weather enables them to find water for liquefying it.

[1874.] *Syrup v. Candy and Queen Rearing.*—Please answer the following:—1. What advantage is there in giving bees syrup rather than candy in autumn? (*Vide* G. M. Doolittle, B.J., October 21, p. 418). 2. Do you consider the following plan of artificial queen-raising a good one:—Put two three-inch starters into your best hive with the two centre combs between them, and contract the entrance. When the eggs begin to hatch put them into a new hive on the stand of another stock, and add brood when the queen-cells are sealed. Remove one of the starters to form another stock with the flying bees of a third hive, after they have had a couple of days on a frame of brood? I ask the latter question as I find it works, but as it is not mentioned in any of the books, I am afraid it may be faulty, though it saves an amateur like myself from cutting out and fixing queen-cells.—G. S. W., *Moniave, N.B., October 26.*

REPLY.—1. In this country everything depends upon the time feeding takes place. Syrup

is suitable in autumn, say, up to beginning of October; after that date candy is used here. In fact, bees will often refuse syrup if the weather is cold. Climatic conditions are so different here to what they are in America. 2. Assuming bees of the "new hive" have no queen, cells would be raised, and, so far as we can understand your method, we think, with attention, the plan would answer, but it is not better than that described in "Guide Book," care in both cases being, of course, taken to get the queens raised on larvæ of the right age.

Echoes from the Hives.

Chichester, October 30.—Splendid weather during this month. Bees carrying pollen freely. I cannot remember such a mild season as the present autumn; whether it will cause the bees to consume more stores than usual remains to be seen. They will, however, want careful watching early in spring where not fed up to full amounts during this autumn. My average for 1897 has been about 30 lb. per hive.—JOHN DANIELS.

BEEES AND SPORTSMEN.

THE RIGHTS OF AGRICULTURAL TENANTS.

Two or three weeks ago we related an encounter where a bee-man and his bees proved more than a match for a sportsman and his keeper, armed with breechloaders and assisted by two dogs, and when last seen they were in full flight down the hillside with more speed than dignity. Whether stung into retaliation by the action of the bee-man or the bees, more has been heard of the incident, and, indeed, it promises to lead to important consequences, and has raised the question in the Howe of the Mearns of the respective rights of shooting and agricultural tenants.

The factor has interviewed the farmer, who, like the man of mettle that he is, let his position be known without any dubiety, and assured the factor that he resented the interference, stood on his rights, and intended to have double the number of hives on his ground next season if he could get them.

The lease, it seems, is very general in its terms, and has no mention of such small deer as those in question. The ground game is the farmer's if he chooses, the winged is not; but he hardly includes the creatures who have caused the trouble in the category of "game." No doubt bees, like grouse, live on heather, and an attempt might be made by the owner of the grouse to set up a case for damage on this account. But, on the other hand, it is certainly not the same parts of the heather that is used by bees and grouse, and if there is any truth in the theory of the fertilisation of

plants by insects the bees may reasonably be credited with at least earning their board in return for their services in this very respect.

The birkie in the kilt has also visited the bee-man to learn more definitely his story so effectively interrupted at their last interview, and he complained that the hills were so crowded with bees that the shooters were getting stung by them. Our bee-man replied with spirit that he had in his time been game-keeper as well as bee-man, and had never had any experience such as that, and had too good an opinion of his bees to know that they had other matters in their heads when gathering their honey than care a straw for sportsmen, or dogs, or grouse, and while so engaged that stinging was the very last thing they thought of doing or could do.

The latest development of the incident is a threatened interdict against the farmer or the bee-man or both, and if it comes on it promises some entertaining features.—*People's Journal*, October 9.

HEREFORDSHIRE B.K.A.

EXAMS. FOR EXPERTS' CERTIFICATES.

In July last an examination was held at Hereford for the third class expert's certificate of the British Bee-Keepers' Association. Mr. W. Broughton Carr (editor of the *BRITISH BEE JOURNAL* and *Bee Keepers' Record*) was the examiner, and each candidate was put through a somewhat severe test, including the driving and manipulation of hives, and close questioning on practical details. The examiner devoted at least one hour and a half to each of the nine candidates who presented themselves. A series of seven classes had been held in May and June, under grant from the Herefordshire County Council, as a preparation for the examination. Mr. Alfred Watkins filled the office of honorary teacher, and covered the whole subject of practical bee-keeping, with the aid of lantern diagrams and pictures, practical manipulation also entering into the course. The result of the examination has just been made known. Six candidates have gained the experts' certificates, this being regarded as a high average. The names are: Rev. J. Beard, Messrs. A. Hill, J. G. Godwin, R. Grindrod, T. P. Warner, and J. H. Wootton. It is probable that a similar class may be again organised next season by the Herefordshire Bee-keepers' Association.

(Communicated.)

SPECIALISED DEVELOPMENT IN BEES.

Since the demonstration of the fact of the evolution of animals and plants from lower forms, men have everywhere been studying specialised organs, and, no wonder, for it brings to us a wonderland unsurpassed. Every naturalist knows that organs are more or less

modified, depending upon their use. The functional use of organs depends largely upon the varied habits of the animal or plants. A plant or animal that does much will give us the most interesting examples of modified organs and varied functions.

To all students of the common honey-bee the fact of their marvellously varied functions is well known. The bee gathers honey, which it digests and stores. It gathers pollen, which it digests, regurgitates and feeds to the brood, and also the queen and drones. They also gather wax by means of which they glue their combs to the hive, and cover over offensive matter in the hive. They also use this to stop up cracks, and smooth over rough places. They secrete wax, which is very interesting in its make-up, transfer it from the under side of their abdomen, where it is secreted, to the mouth, where it is kneaded and fashioned into the most wonderful mechanism known to the animal kingdom—the beautiful, matchless, honey-comb.

Thus, we see that bees really perform a variety of operations which are hardly excelled even by man himself. We have always supposed, indeed, that the wonderful honey-comb could not be duplicated even by all the ingenuity of man. If Mr. Weed does succeed in fashioning an article equal to the natural comb, he will indeed do a wonderful piece of work. Even then he has to get the wax from the bees. I doubt if man will ever succeed in making an article so thin and delicate as is the natural honey-comb.

Every naturalist believes that modified function, and modified structure, have always gone hand in hand. Thus we see that bees must have wonderful structural modifications and it is to these that I wish to direct the attention in this and succeeding articles that will appear in the *American Bee Journal*.

I will first call attention to the wonderful developments in the legs of bees, referring to and describing the marvellous antennæ-cleaners on the four legs. In order to do this the more satisfactorily, we will have to discover, if we may, the use of the antennæ. These horn-like organs, which are appended to the head of all insects, must be very important. They are as prominent in the insect as is the nose to the man. We have discovered of late, indeed, that they have exactly the same function. I think we may safely say that the antennæ are more than nose, that they combine three organs in one—nose, ears, and touch organs. That a tactile or touch sense exists in the antennæ is very patent to any one who carefully observes this insect, as it seems to feel its way, oftentimes, by the use of these organs. There is also some reason to believe that the antennæ are answers as ears, or at least that they detect vibrations, and thus are practically the same as hearing organs.

That the antennæ are olfactory organs, or used to detect odour, there is hardly any difference of opinions among scientists. There

are little pits which contain projections, all lined or covered with very sensitive membranes in the antennæ of most insects. These are much more numerous and better developed in insects like bees, which have to search for their food, and are probably directed toward it through the sense of smell. Thus we are not surprised that drones, queens, and workers among bees have these antennæ pits greatly developed. The workers have to find the nectar in the flowers; the drone as he flies forth to mate must search for the queen, and the queen in turn is eager to find the drone. It is therefore probable that each of these kinds of bees is directed through the antennæ.

Wasps, also, in searching for insects to store, their cells, that their young may have food doubtless use their antennæ in the same manner as the bee. The bee rushes into a flower in search of nectar, and is almost certain to get its antennæ dusted with pollen—or, in other words, to get its nose dirty. Thus we see that the bee, as well as the boy, may need to wipe its nose. It has no regulation pocket-handkerchief, but instead possesses a much more novel and interesting arrangement by which to perform this important work, viz., the antennæ-cleaner on the foreleg. At the base of the first tarsal joint (the tarsi are the last five joints on the leg of the bee), there is a concavity—more than a hemi-cylinder—lined with the most delicate hairs, and just the size of the antennæ. Projecting from the lower end of the tibia (the joint of the leg next above the tarsi), is a spur which may, at the will of the bee, close directly over the groove already mentioned. The inner face of this spur consists of a membrane more delicate than the finest chamois skin.

Now, we are prepared to note just how the bee wipes its nose, or rather cleans its antennæ. It throws its front leg forward, and receives the base of its antennæ in this groove, closes down the spur, and draws the antennæ through.

The brush and chamois-skin-like membrane removes every particle of pollen, which now rests on the side of the antennæ-cleaner very much as the scraping of the shoe or boot rests on the foot-scraper beside the door. There is this difference, however, the dirt on the boot-scraper is only good to be pushed one side. Pollen, on the other hand, is valuable food, and the bee wishes to save it.

The bee next draws the part of the foreleg mentioned through between the first two joints of the tarsi of the middle legs, and thus all pollen is gathered on the brushes of the middle legs. The bee next takes each middle leg, and rubs it over the outside of the pollen-basket on the hind legs, and thus the pollen is packed, ready to be conveyed to the hive.

The wasp collects mud to build the brood-cell, and so besmears its antennæ, not with useful pollen, but with annoying dirt. But before seeking insects or spiders wherewith to people its mud-cell as store for its young, the wasp

must clean antennæ; and this it does in similar fashion to the bee. I will describe it in my next article.—PROFESSOR A. J. COOK, in *American Bee Journal*

Bee Shows to Come.

November 11, at the Town Hall, Ludlow, Salop.—In connection with Chrysanthemum and Fruit Society's Exhibition. Two open classes for "Sixes." Schedules from Mr. Jno. Palmer, 17, Brand-lane, Ludlow, Salop. **Entries close November 4.**

November 18, 19, and 20, at the Waverley Market, Edinburgh.—In connection with Chrysanthemum Exhibition Show, the Scottish B.K.A. will hold a Honey show as above, at which very liberal prizes will be offered (see advertisement on page v). Schedules from Rev. R. McClelland, Hon. Sec., The Manse, Inchinnan, Renfrew.

Notices to Correspondents & Inquirers.

Letters or queries asking for addresses of manufacturers or correspondents, or where appliances can be purchased, or replies giving such information, can only be inserted as advertisements. The space devoted to letters, queries, and replies is meant for the general good of bee-keepers, and not for advertisements. We wish our Correspondents to bear in mind that, as it is necessary for us to go to press in advance of the date of issue, queries cannot always be replied to in the issue immediately following the receipt of their communications.

All queries forwarded will be attended to, and those only of personal interest will be answered in this column.

G. F. (Sussex).—It is evident from extracts sent that the book you have is an edition several years old. The alterations have been made in the last three editions issued.

R. B. (Godalming).—*Bleaching Beeswax.*—The only method we know of without spoiling the wax is to expose same to sunlight in thin sheets

BEVERLAC (Norwood).—*Queen Balled. Old Used-up Combs.*—1. From description it is clear the queen was being "balled." We cannot, however, without examination, tell what the "scales" can be. 2. In comb sent, though very old and looking suspicious, there is no distinct trace of disease. As you say "the hive is very dirty, and bees not strong," we advise careful watching of this stock in spring, when, if all is satisfactory, the bees should be transferred to a clean hive.

ERRATA.—Referring to the meeting of the Council of the B.B.K.A. on the 21st ult., reported on page 421, the name of the Hon. and Rev. H. Bligh should be substituted for that of Mr. E. D. Till as presiding on the occasion. Mr. Till did not reach Jermyn-street till later in the evening.

* * WANTED: Copies of the *Bee-Keepers' Record* for January and February, 1895. The Editors will be glad to pay full price and postage for a few clean copies sent to this office. Wanted to complete volumes for that year.

Editorial, Notices, &c.

BRITISH BEE-KEEPERS' ASSOCIATION.

The monthly meeting of the Council was held at 105, Jermyn-street, S.W., on Friday, November 5, under the presidency of the Baroness Burdett-Coutts. There were also present the Hon. and Rev. Henry Bligh, Messrs. W. B. Carr, W. O'B. Glennie, W. H. Harris, J. H. New, E. W. Till, T. J. Weston, and the Secretary.

The minutes of the previous meeting were read and confirmed. A new member was elected in the person of Mr. R. Westlake, jun., Springfield, Swaythling, Southampton. The Finance Committee reported that the accounts for the month of October had been examined and were duly certified as correct. Mr. W. H. Harris stated, on behalf of the Education Committee, that arrangements had been completed for the forthcoming examination of candidates for second-class certificates, and the various "supervisors" nominated by the County Associations approved by the Committee. On the recommendation of the examiners, it was resolved to award third-class certificates to two candidates examined at Derby and Hampton, respectively. A number of suggested alterations in the rules governing the examinations were detailed by Mr. Harris, and it was resolved to incorporate the Committee's recommendations in a circular to be issued to members and affiliated Associations prior to arrangements for examinations in 1898.

As an outcome of the discussion on the subject of *Apis dorsata* at the recent *Conversazione* of members, Mr. Till read a letter from a gentleman generously offering an anonymous contribution of £20 if the B.B.K.A. would devise or organise a scheme whereby our knowledge of the *Apis dorsata* might be extended or improved. On the motion of the Baroness Burdett-Coutts, who very kindly offered to augment the fund, seconded by Mr. T. J. Weston, it was decided to refer the matter to a Select Committee, and Mr. Till was authorised to convey the thanks of the Council to the anonymous donor.

A question having reference to the provision of honey labels by the B.B.K.A., for the use of members residing in localities where no affiliated Associations exist was referred to the Committee for consideration.

It being understood that the R.A.S.E. had abandoned their intention of holding a show at Maidstone in 1898, the drafting of the prize schedule for the Bee Department was postponed. A vote of thanks to the Baroness for presiding terminated the proceedings.

CONVERSAZIONE (*Concluded from p. 433*).

Reverting to the subject of the recent Dairy Show, Mr. Carr thought they should make an

appeal to the Council of the Dairy Farmers' Association for a little relaxation of their rules in order to allow bee-keepers a trifle more liberty in the display of their wares. The show was a good one, as Mr. Till had said, but full justice was not done to the exhibits so far as making them look well. It was always unfortunate for show purposes to have extracted honey placed against a wall, as it took away half of its good looks. If the Council of the D.F.A. would allow a few of the officials of the B.B.K.A. to assist in the arrangement of the honey exhibits it would tend very much to the excellence of the display. If it were possible to put up a trophy or two, that would also enhance the interest and attraction of the show. These trophies might be non-competitive, and if this were permitted many would engage the space necessary to show them. Of course they must conform to the rules, but, perhaps a little relaxation of them might be obtained under the special circumstances, and that was what he thought they should address themselves to. Then the addition of tastefully displayed plants and flowers would be an enormous advantage. The judges had to make a report and suggestions, and—having acted in this capacity—he was anxious to back up these suggestions with an expression of the opinion of that meeting. If space could be allotted for a simple erection where the whole operation of honey-extracting could be witnessed by the public, it would create an interest in native honey unobtainable by any other means.

Mr. Till said that two years ago their noble President was kind enough to make the honey display attractive by the loan of plants. Last year a similar offer was made, but as it clashed with the regulations of the show they were obliged to decline it. If they had had permission to put up a few decorative plants and flowers he was quite sure that, in the hands of their Secretary, the result would have been far more gratifying.

Mr. Young (Secretary B.B.K.A.) explained the varying rules and regulations of the Dairy Show in regard to the display of articles for competition as distinguished from those applying to articles "*for sale*."

Some further discussion then took place with regard to various items in the schedule which it was thought needed amendment, after which Mr. Jonas—as the President was about to leave—desired to express to the Baroness Burdett-Coutts the pleasure they all felt to see her at that meeting, and also to pass a vote of thanks to her for kindly presiding on that occasion. They were delighted to hear of her visit to the Dairy Show, and of the extreme interest she took in all that related to bee-culture; but they had hardly expected to be honoured and favoured by her presence that evening.

The vote was passed with general acclamation.

The Baroness Burdett-Coutts then said: I will not detain the meeting any longer, but I

should like to thank you for the cordial way in which you have received the kind words just expressed. It is a very great pleasure for me to be present at this conversazione. It does not often happen that I am able to attend these highly-interesting meetings. I am not always in London at this time of year, besides which, I have many calls on my time, as you are, no doubt, aware. I have derived the greatest pleasure in being with you to-night, because it has given me an opportunity of meeting friends whom I do not see on other occasions, also because I am much gratified in noting what I consider to be a manifest onward step in the progress of this useful Association. There are various proofs of this, which will naturally occur to your mind immediately. There has been, I am given to understand, a much larger quantity of honey exhibited this year than before, whether of an equal quality I cannot say; but the very fact of so much honey being shown indicates a rise in its utility, and that a more general interest in the production of it has been excited. Then there is the constant improvement in bee-appliances, which one cannot fail to notice. I am sure you will agree with me that all these gratifying circumstances are due to the exertions of many whom I need not name, but whose sympathies and interests are bound up with the occupations and pursuits of country life. I quite recognise the desirability of improving our show, and earnestly hope that everything possible will be done towards that end, although if we succeed in getting all the honey and the flowers placed as we should like to see them arranged, I am afraid other exhibitors will become extremely jealous of us. (Laughter.) At any rate we must not relax our energy on behalf of the cause even if we only win our way by slow degrees. Let me again thank you, and wish you good night and every prosperity. (Loud cheers, amid which her ladyship retired.)

Mr. Jonas then resumed the chair.

Mr. Geo. Wells then desired to urge upon those present, and on bee-keepers generally, the advantage of planting for bees a few of such flowers as would help to fill up gaps when little or no honey or pollen could be got. He specially recommended for this purpose the *Melilotus alba*, or, as some termed it, Bokhara clover. [In America it is generally known as sweet clover.—Eds.] It would grow anywhere, and he had that day gathered a bunch of it (to show them at the meeting) growing in a claypit by his house. The plants were 8 ft. high. They began to bloom in July last, and were in flower at the end of October, as they could see.

After describing the best method of growing, and the great advantage his own bees derived from it, Mr. Wells went on to say that he had last year given away about two barrels full of seed, and was always glad to supply some if a stamped envelope were sent to him. Several gentlemen then gave their experience of

Melilotus, referring to its effect on the flavour of honey, and its use or non-use as a forage plant for bees and cattle.

Mr. A. Sharp, of Brampton—being invited, as a large honey-producer, to give his experience of the past bee season—said he had had a very uncommon experience this year, for, after removing the racks of unfinished sections from all his hives—supposing that the season's income was over, and that anything already stored overhead would be carried below if left on longer—the weather improved, and he had put on the surplus-chambers again, and by thus doing had increased his total harvest by about 1,000 pounds' weight of honey.

The value of the late gathering was also testified to by others present.

A general desultory conversation followed, and several suggestions were made, including the desirability of introducing classes for bee-candy at honey shows; and prizes for essays on different branches of bee-keeping.

A very successful meeting—probably a record one so far as attendance—was brought to a close by the passing of a resolution that a cordial greeting be sent to Mr. Cowan (now on a visit to America), and expressing the pleasure all bee-keepers would feel in seeing, on his return, an account of his experiences in the BEE JOURNAL. This resolution, with a vote of thanks to the chairman, brought the proceedings to a close.

SURREY BEE-KEEPERS' ASSOCIATION.

An examination for third-class expert certificates was held on August 21 last, at Mr. R. C. Blundell's, Benhams, Horley, whose kindness in giving the use of his apiary for the purpose, and the hospitality of Mr. and Mrs. Blundell on the occasion, made the day a very pleasant one. Mr. W. Broughton Carr was the examiner, and the following candidates passed the examination, and have obtained certificates, namely: Mr. W. F. Reid, Fieldside, Addlestone; Mr. A. H. Miller, Rusham-road, Egham; Mr. G. C. Halahan, Sydenhurst, Chiddingfold; Mr. W. Hogsden, Flexford House, Hog's Back, Guildford; Mr. A. Caffyn and Mr. E. Bontoff, both of Beechwood-road, Caterham Valley. Next year it is hoped that a third-class expert examination will again be held in the county of Surrey, and any members wishing to enter should give notice to the Hon. Secretary as early in the year as possible of their intention to offer themselves. Candidates having gained a third-class certificate are eligible to compete for a second-class certificate. It is very desirable that more expert certificates should be obtained by members of this Association, as the Executive Council would naturally prefer the services of an expert who is a member and resident in the county of Surrey, when expert work is required.

ESSEX BEE-KEEPERS' ASSOCIATION.

A meeting of this Association was held on Friday, October 29, when the Committee decided to hold a show of honey in connection with the Essex Agricultural Society next year if a sufficient grant is made towards the expenses and prize fund from the Society and the local Show Committee. The Hon. Secretary reported that fifty-six new members had joined the Association this year, and that over 2,000 of the new county honey labels had been sold to members. Application for membership should be made to the Hon. Secretary, Essex Bee-keepers' Association, King's Head-hill, Chingford.—(Communicated.)

Correspondence.

The Editors do not hold themselves responsible for the opinions expressed by correspondents. No notice will be taken of anonymous communications, and correspondents are requested to write on one side of the paper only and give their real names and addresses, not necessarily for publication, but as a guarantee of good faith. Illustrations should be drawn on separate pieces of paper. We do not undertake to return rejected communications.

BEE-KEEPING IN THE ISLE OF MAN.

A VISIT TO MR. LANCELOT QUAYLE.

[3047.] Being obliged to recuperate after illness in the Isle of Man, and staying within two miles of Glen May, I took the opportunity of calling on Mr. Lancelot Quayle and making myself known to him. His apiary is perched on the top of an annexe to his house, and perfectly safe so far as withstanding the stormy winds which blow up the Glen from the Irish Sea. Although within a few days of November when I saw them, the bees were flying freely. The hedges covered with wild flowers, the blossoms on the blackberry bushes being remarkably fine. On the hill behind, a large field of what looked like wild mustard was in full flower.

I was received very kindly by Mr. Quayle, and over a cup of tea talked bees and bee-keeping, especially in relation to "The Island." Of course, the "record take" was discussed, and from the books kept for the purpose I saw the account of his "takings." It appears that the number of stocks Mr. Quayle actually started the year 1897 with was three, and his average from these (which includes the one that yielded 334 lb.) was 216 lb. per hive, and two swarms, or 334 lb., 164 lb., and 150 lb. respectively from each; the total being 648 lb. from three hives. But this does not cover the whole of Mr. Quayle's harvest, for in June he imported a number of stocks from England which have amply repaid his outlay. Among them was a late swarm, which arrived without a queen. A few days afterwards one of Mr. Quayle's hives swarming, he united this to the queenless one, but, unfortunately, the queen was "balled." A week or so later another stock swarmed, and of their own

accord joined the queenless hive. July was well under weigh when work began in this "three-barrelled" lot of bees, yet he obtained the marvellous return of 180 lb. of honey from it.

Now, it may be asked "How does Mr. Quayle obtain such results?" Well, in the first place, he is an intelligent man and an out-and-out practical bee-keeper. From the start he has studied the best books on bee-keeping and carefully *thought out* the rest. He is not one of those individuals who—liking honey either for its own sake or the pecuniary returns to be had from its production, and having a "fancy for bees about the place"—invests in hives, bees, &c., looks up the nearest local hon. sec. or expert, promises a subscription, and then expects the said hon. sec. or expert to devote the whole of his time to his particular stock, and cares nothing for the bees or the welfare of any one else. On the contrary, Mr. Quayle knows his business, and for the rest nature must be thanked. Whenever you go about the district where Glen May is situated evidences of white clover abounds. Most of the hedges are banks of mud or "sods," and these are also profusely covered with it. The road sides and the cart tracks are themselves abundant forage grounds. Then the mud-banks are surmounted with blackberry brambles without end. The hills are masses of heather. But, over and above all these, within a quarter of a mile Mr. Quayle has another source of bee pasturage. When he told me of this any doubts that might have been left in my mind vanished. Between the clover and heather bloom for a full fortnight, day after day, his stocks were hard at work on scores of acres of wild *mountain sage*. The hills, he says, are covered with it. This is the flower which produces the celebrated Californian honey, and in the Holy Land also the bees work hard on it. Its flavour is excellent, and I sampled a blend of "sage and heather honey" which was delicious. Mr. Quayle gave me permission to send these particulars and also supplemented them with further information which follows, and which I had confirmed from other sources. It would seem that we have here struck upon a "bee-keeper's paradise," but—and as Eden had its "serpent," there is a *but* which, like a hydra-headed serpent, rises in this land so blessed with milk and honey. Foul brood stalks through it, north, south, east, and west, and as most bees are kept in skeps by old-fashioned methods and old customs and superstitions abound, bee-keeping on a large scale would be extremely risky. A commission has been appointed by the Governor to inquire into minor insular industries, and Mr. Quayle asked to give evidence before it on bee-keeping. This he willingly consented to do, but at the same time he pointed out that the dark side of the picture would have to be dealt with in his evidence. He stated he was quite willing to help in the movement, but before anything could be done

efforts should first be made to stamp out the disease all over the island, which disease, he felt sure, was of very long standing. From farmers who keep or have kept bees in the district (in skeps), I heard only of disappointment. Their bees get nothing, or the bees die, and they "can't make it out," for there was plenty of honey in the combs. Bees are still "sulphured," and for the average Manx cottager "Modern Bee-keeping" would be as impossible as speaking Greek.

I would like to have said something about the natural beauties of the place, but no doubt next year many "pilgrimages" will be made to this now noted bee place, so the practical has conquered the rhetorical.—FREDK. H. TAYLOR, *Birch Fold Cottage, Fallowfield, November 8.*

NORTHERN NOTES.

[3048.] *An Indian Summer.*—What delightful weather we have had since mid-October. Bright sunshine has been the rule all day long, and it has shone with a real summer heat in an unclouded sky. Rarely even at night has the temperature sunk much, and all over it has been 5 deg. higher than the average. For fully three weeks no single shower of rain has fallen, and the rainfall from the beginning of October has been under 2 inches compared with 7 and 10 inches the two previous years. A croaker now and again is encountered who declares we are to pay for it later on, or, leaving the regions of prophecy, he protests it is not seasonable. Well, I say enjoy it and all the other good things the gods provide, and remember that sufficient unto the day is the weather thereof. I know my bees enjoy it. What a hurly-burly there often is at mid-day. What attempts at robbing have I seen, beholding them, too, with the greatest equanimity, for I know they are but futile attempts, as all my stocks are strong and uniformly so. Formerly I used to dread these predatory excursionists, as the slaughter was often very great, but now I have found a specific cure. Keep stocks strong! Never a dead bee is now to be seen on front of hives, as all would-be depredators know the fate which awaits too familiar meddling with a neighbour's property, and they wisely keep out of range of rival stings. I remember, however, that all this waste of energy cannot take place without a commensurate waste of provisions, so all this merry-making must reduce stores very considerably. Breeding seems to be all but discontinued, and even on the finest days little pollen was being taken in, unless in the case of driven bees, and the amount they collected was a marvel.

Re-queening.—I take it that a dictum of our Editor's is, like an axiom in Euclid, self-evident and requiring no proof, as far as bee-keeping is concerned. Acting on this belief, and wishing "more light," I have, while remembering that you believe out and out in

young queens being a *sine qua non*, tried the contrary. During the past few years I have repeatedly changed my queens, with one exception. Succinctly put, your advice was, "When a queen is doing specially well, 'Hands off!'" In some of my former "Notes" I recorded that my best hive in '95 and '96 contained, so far as I knew, a queen of '93, and at the same time I noted my resolve that she should be allowed to reign another year. Well, this season again she all but tops the list, for this is my second best colony. It gave seventy-two, eighty-three, and eighty-seven sections during the past three years, and this year by weight its surplus counted 101 lb., with two heavy spare frames given to a driven lot. Again I repeat your cry "Hands off!" and let such an excellent queen reign as long as she or her bees choose. The colony has not swarmed since '93.

Bees Smothered in Transit.—Not often have I heard of swarms from the south being smothered in transit, but I had a case of it this season. With ordinary care it should not happen, as bees will come out of their boxes lively and bright after four or five days' confinement. In the case which came under my observation, it must have been the fault of some railway servant, who injudiciously covered them up, perhaps with the erroneous notion that they required to be kept warm. Out of three lots, that in the largest and best ventilated box succumbed—a proof of carelessness in some quarters.

Broom Honey.—I noticed a paragraph in the *Scotsman* newspaper describing the bee forage during the early summer in Fifeshire, and amongst other sources of supply *broom* was named as a honey plant. I have grave doubts of the accuracy of including it in such a category. Personally I never remember to have seen any appreciable quantity gathered from it. It is an excellent pollen-bearing plant, however, and old bee-men, when they saw their young bees at an early date come in coated yellow with it, felt the colony was safe to do some good that season.—D. M. M., *Banffshire, N.B., November 8.*

[Correspondence continued on page 446.]

HOMES OF THE HONEY BEE.

THE APIARIES OF OUR READERS.

We this week present the first illustration in our series so far of an apiary owned and managed by a lady. Miss Helen Laurence, of Clitheroe House, East Keswick, is a bee-keeper essentially of the active school; not one of those who reserve their knowledge to themselves, or are too retiring by nature to say a word when occasion offers for the extending of the bee craft. The genial manner and hearty enthusiasm of Miss Laurence at shows where she happens to be present has a marked effect on those who hear her pleasant but pertinent remarks on bees and bee-keeping,

and she seldom loses an opportunity of expatiating on the benefits which may accrue to cottagers and cottagers' wives from keeping a few stocks of bees and managing them well.

We learn with regret that a rather severe illness has incapacitated her from active work during a great part of the honey season this year, and postponed her intention of trying to secure the third-class experts' certificate of the B.B.K.A., which we hope some day she will gain.

In reply to our usual request for some particulars regarding her bee experiences, Miss Laurence writes:—

“I really have not much to say about my

forage in the early spring. We have also a little heather about a mile and a half away, along with an abundance of blackberry bloom, which latter helps to supply the bees in the autumn and for winter store.

“I work my hives mostly with shallow frames, because sections do not sell well here, and I think are not the most profitable crop, as you get a much larger quantity of extracted honey in the time from the same number of stocks. I put my honey up in 1 lb. tall jars, and usually get 10s. and 11s. a dozen for them, according to quality.

“The picture shows a few straw skeps, but I have since done away with these, as causing

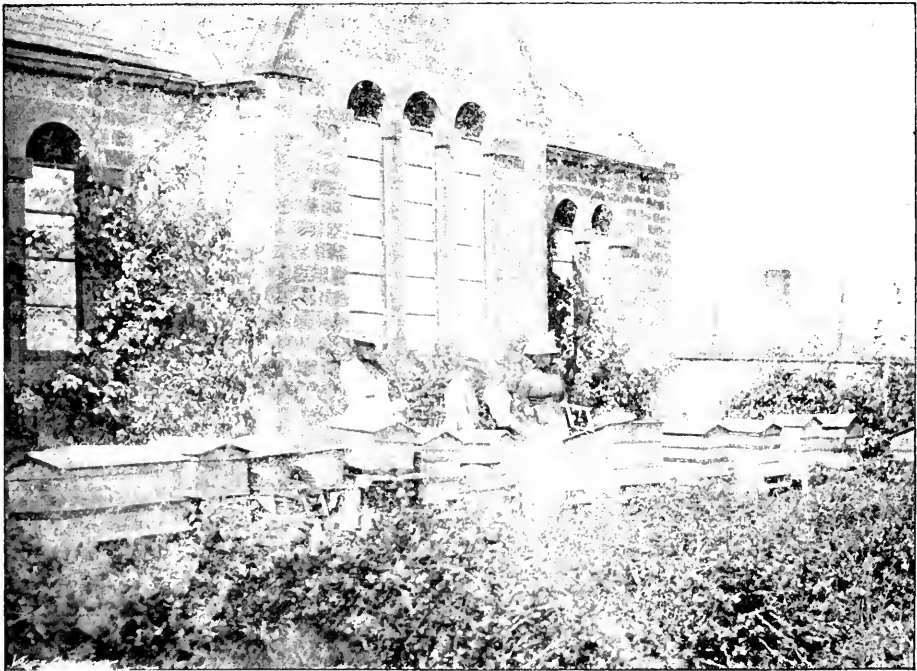

MISS HELEN LAURENCE'S APIARY, EAST KESWICK, NEAR LEEDS.

early bee-keeping experience beyond what has already appeared in the *JOURNAL* for April 5, 1894. I commenced bee-keeping in July, 1891, a perfect novice in the craft, with one swarm of bees, and was taken in hand by the Yorkshire Bee-keepers' Association and instructed how to proceed, in order to secure the best results, by Mr. W. Dixon, of Leeds. I may say it is to his advice and help that my success is mainly due. I am fortunate in living in a good district for bees; a good deal of the land about here is pasture, and grows a quantity of white clover. There are also several large market gardens near, where a quantity of rasps and strawberries, as well as stone fruit, is grown, so that we get plenty of

too much mess and dirt for the quantity of honey you get from them. I greatly prefer frame-hives, they are so much cleaner and better to manage. Skeps are all right if you want a little honey, no trouble with manipulating, and are not very particular about quantity. But then you have to destroy so much brood in appropriating your share of the bees' labours."

Beginning, as stated above, in '91 with a single swarm, Miss Laurence increased her stock to seven the following year, and, like so many others, added a "Wells" hive to the list. All of these stocks she wintered safely, and in 1893 secured from them 450 lb. of honey and ten swarms—a capital result under

all the circumstances, as our readers will agree. The writer then goes on to say:—"The photo (taken in 1893) was, of course, not done with any idea of its appearing in the pages of the BEE JOURNAL, but shows us after a busy day extracting in our old bee-hats and print dresses as worn at work. I am standing to the right of my gardener, who is giving a puff of smoke to the bees prior to opening a hive. Next is a young relative come to see the process, and my sister stands to the left with carbolic bottle. She is not 'bee mad,' but helps on 'extracting' days. Behind is the old schoolroom (East Keswick College), where so many boys were taught the three R.'s, and in front of the hives are seen a row of rose bushes. Since the above was taken I have moved my bees to the bottom of the garden, as we have divided the house into two since we gave up the school.

"I had intended going in for queen-raising, and for my third-class expert exam. this year, but my long illness has prevented me for the present. While confined to my bedroom from the end of January to first week of June this year the bees amused me at times, probably not with the avowed intention of paying a morning visit, but entering by the bedroom window instead of flying over the house, and up the hill, to their forage ground. Anyway, they gave me pleasure by evidencing their good health and capacity for work, which I was, alas! unable to join in."

Our readers will, we are sure, join us in hoping that the coming season of 1898 will find Miss Laurence restored to health and the capacity for work among the bees she so thoroughly enjoys.

CORRESPONDENCE.

(Continued from page 444.)

BUILDING UP STOCKS FROM NUCLEI.

[3049.] I think I have seen it stated in the B.J. at times that you would welcome articles from fresh contributors, and as I come under that definition, if what I am herewith sending you be worth publication, you are at liberty to do so with it. The little "experience" I write of concerns what I take to be an exceptionally prolific queen. To begin, I may say that late last summer I made a couple of two-frame nuclei, which for convenience I will number one and two. I gave a queen-cell to each. No. 2 hatched out all right, but I could not get a queen to hatch in No. 1 at all. I tried it with two or three cells in succession, the fault being—as I think—owing to my having got too few bees in the little stock. At the beginning of August, therefore, I sent to a queen-rearer for a young fertile queen, which arrived on 10th of that month, and was introduced same day. Four weeks later (*i.e.*, September 7) the young bees began to fly, but the increase was very slow

during that month, consequent on there being so few bees to hatch brood. I now began to fear there was no chance of No. 1 surviving the winter, so concluded to destroy queen of No. 2 and unite both lots. On examining, however, I found the queen of No. 2 so prolific that I could not see my way to destroy her, and would not destroy No. 1. In this fix I decided to make a miniature "Wells" of a 10-frame hive by cutting an entrance in the side, and placing the two nuclei stocks in it with a perforated dummy between, so that they might keep each other warm. The bees in No. 1 covered a little more than two frames on September 30, but I gave them also three frames of foundation, a strange proceeding, you will say, but I had a reason for it. I put on box feeder, and gave as much syrup as they would take. They now began to increase at a rapid rate, carrying in a considerable amount of pollen. On October 19, when examined, they had not only drawn out the sheets of foundation, but all three combs were completely filled and sealed over. I therefore removed the feeder, gave a box of candy, and packed for winter. As the bees still kept on working hard, I looked in again on the 26th, and found the candy gone and a comb built in the box! This told me the bees were short of room. I then had to contract brood chamber of No. 2 to give them another sheet of foundation, which they are now busy drawing out, and if the weather continues fine for another week or two like it has been in October, it looks very like as if I shall have to put on a super to give more room! The bees are working morning, noon, and night, carrying in more stuff than all my other ten stocks put together. In fact, they are in full swing in the morning before any of the others have come downstairs, and work on after the latter have retired to bed at night. Judging from appearances they are now the strongest working stock I have. Bearing in mind that on August 10 the bees did not more than cover one frame, and all eggs laid and hatched since that date, it seems wonderful, though quite true. You may think that I disturb them by examining them so often, but that is not so, as I use glass quilts, and can see how they are going on by merely lifting the top cover. Is not this rather a remarkable case for this late period of the year? Should any reader feel disposed to dispute anything herein written, and be in the locality, they are at liberty to come and see for themselves. The facts can also be borne out by a brother bee-keeper, both of us members of the Lancashire and Cheshire B.K.A.—W. T. P., Sale, Cheshire, November 2.

THE "WELLS" SYSTEM.

[3050.] May I be allowed to say a word on the "other side," in answer to your correspondent Wm. Loveday (3038, p. 434). I have never had the discouraging experiences described in his letter, after working bees on

the double-queen principle, or "Wells system," ever since it first came into vogue. Nor have I been unfortunate enough to lose a stock in a "Wells" hive during the whole time. Working this present year with twenty-one double-queened and forty single-queened colonies, not one of the latter have approached the "Wells" stocks for quantity of surplus honey. I also labour under the disadvantage Mr. Loveday mentions, for I have three out-apiaries, the farthest away being eighteen miles from home, and, so far as the bees in this spot are concerned, I only see them about once a fortnight during the honey-flow; yet one "Wells" located there was tiered-up this summer with three boxes of shallow frames, twelve in each, and after extracting and returning these thirty-six frames, half of them were filled again, notwithstanding our short and very moderate season in Hunts. I am quite within the mark in saying that my good single stocks this year on eleven frames have not yielded anything like in proportion to the small stocks worked out on the "Wells" system.

All my other double-queened hives have done equally well, so far as giving best returns. A most remarkable thing is, I have never had a swarm from a "Wells" hive yet. My principle is to give the bees plenty of work in advance, without reducing the internal heat of the hive, and so long as I am a bee-keeper, I shall continue this principle. I think a great deal of gratitude is due to Mr. Wells for introducing his double-queen system. In conclusion, I may state there was not convenience for me to weigh the honey got from my "Wells" stocks; but the approximate weight would be about 200 lb. per hive.—R. BROWN, *Flora Apiary, Somersham, Hunts, November 6.*

PERSISTENT SWARMING IN '97.

ONE HUNDRED AND EIGHTEEN QUEEN-CELLS
RAISED IN ONE HIVE.

[3051.] It may be interesting to some readers if I record my experience this year of a case of persistent swarming in spite of all my efforts to prevent it. The colony in question first swarmed on May 31, when, after cutting out twelve queen-cells, I returned the swarm. I examined again on June 5, and removed thirty-nine more cells. The queen seemed at the time all right and active, but the bees took the law into their own hands and deposed her. They must have done this at once, for, noticing that the bees were not working, I examined again on June 10. No queen could be found, and no eggs had been laid since the 5th, but I found fifty-five queen-cells in various stages. I cut out the whole of these, and gave a ripe cell from a nucleus, taking care to protect it for a short time. The queen (a very fine one) was allowed to hatch from this cell, but another batch of a dozen queen-cells was started, none of the brood being less than five days old. I had given no thought to such a condition of things being

possible, as the bees started working in the super, and I hoped they had given up all idea of swarming. Nevertheless, out they came again on June 21, headed by the queen from the cell I had given them.

On opening the hive, I found the queens from the dozen cells mentioned above already hatching out. Three of them (all small ones) had left their cells; they were so diminutive that I had some trouble to find them. This stock had raised, to various stages, 118 queen-cells in four weeks, and when my other stocks found nothing to do in August, this one filled me some sections from red clover.

I might mention that the parent queen of this colony was two years old (the only queen in my apiary aged more than one year), and very prolific. So prolific, indeed, that in 1896 I used eleven frames of her brood to strengthen other stocks, and she still so maintained the strength of the hive that I had a very considerable surplus from it.

Most of my hives have of necessity to be arranged along the bank of a pond; owing to this I lose many hundreds of bees in spring by drowning; consequently I have to make up my stocks by combs of brood, usually exhausting one stock for this purpose.—WM. LOVEDAY, *Hatfield Heath, Essex, November 2.*

BUYING DRIVEN BEES BY WEIGHT.

[3052.] In complying with the Editorial request for an answer to "Rector" (Bungay) (3043, p. 436) on above subject, the enigma may appear difficult to your reverend correspondent, but I hope the explanation will prove to him that my assertion is true. On despatch of driven bees per rail—as all bee-keepers understand—they may be quite up to the weight purchased when sent off. During transit, however, and confinement, say from twenty-four to forty-eight hours, maybe, travelling any distance up to 200 miles, the bees will have exhausted much of their vital energy and doubly drawn upon the food supply; but if the same bees after being released are fed up—we'll say with a quart of good syrup, costing very little—you would have the same weight and number as when despatched. It is estimated that 1 lb. avoirdupois is equal in weight to 4,000 bees in normal condition; but in a state of semi-starvation it will take 5,000, at least, to weigh a pound, seeing that they are like so many "wind-bags." Permit me to cite a case in point:—

Only last winter a friend of mine had neglected a very strong lot of driven bees, numbering probably 20,000. They were lived and then fed for a few nights, after which nothing else was done to them. In the middle of December I had occasion to look at these bees, and found they had not a particle of food, the bees lying in an inert mass on the floor-board, with scarcely a sign of life left. As I gathered them together in my hand, they appeared lighter than cork-dust, and probably reduced

in number by 8,000 or 10,000 bees. I do not think they weighed 1 lb. avoidupois. I quickly remedied it by warming a couple of bricks on the kitchen range, then getting made about a quart of syrup. I went to the hive, placed the warm bricks on the floor-board, and with both hands heaped up the bees on the bricks. In a short time I had the pleasant satisfaction of seeing that life was not extinct, and after I had sprinkled a little warm syrup on the mass they in a few minutes entirely recovered. I set the remaining syrup on the top and left the bees singing, "Oh, what a happy place is England!" The stock in question gave a good return to my friend this summer.—NIL DESPERANDUM, *November 8.*

THE DAIRY SHOW OF 1898.

ANOTHER SUGGESTION.

[3053.] I should like to suggest that in future there be a "steward" appointed for the honey department *alone*—one who not only can give advice and help in matters immediately connected with the show, but some one who could help practically in drawing public attention to the importance of the bee-industry, and thus interest them in British honey as an article of food.

There are crowds of people who visit the Dairy Show, who would be delighted to be shown round and to have things explained to them in connection with the honey bee and *its products*. Now, although Mr. Till was good enough to be in attendance nearly every day to help, naturally there were times when he could not be present.

I also take this opportunity of saying that bee-keepers and others have every reason to be very grateful indeed to Mr. Till for his untiring efforts in the cause of bee-keeping.

I think Mr. Till's difficulty expressed in his letter in last B.J. (3041, p. 435) would be overcome if attention is paid to the matter of a reliable steward in this department.—R. HAMLYN HARRIS, *Humbrook, Bristol, Nov. 4.*

MY FIRST YEAR WITH BEES.

A BEGINNER'S BALANCE-SHEET AND REPORT.

[3054.] Having derived pleasure and advantage from reading "reports" in the BEE JOURNAL, I thought it possible that some interest might be aroused in the experiences of a beginner, which, considering the circumstances, I don't consider unsatisfactory. Below I therefore give the result of my first year's work with bees. Notwithstanding a strong desire to keep bees, I was unable to do so till last year, when I left the region of bricks and mortar for the haunts of the hive bee. My first bee-book was called "British Bee Farming," by James Robinson, Frodsham, Cheshire, a work which, though now out of date, is interesting reading (curiously enough my first swarm of bees was purchased from another Mr. James

Robinson). The book strongly advocates hives about 12 in. square, and I made two of these. They have the merit of convenience in handling, being of small size and suitable for sectioning. I have since made a double-walled "Wells" hive, taking seven standard frames on each side. On June 12 I purchased my first swarm and by July 14 the body was pretty well filled, and as the bees seemed to contemplate swarming instead of taking to the sections given them, I cut out six queen-cells, all of which contained embryo queens. Two days afterwards the bees entered the sections with a rush, but for several days it was not safe to go near them, they seemed so savage at having their swarming intentions frustrated. The honey-flow during the following month was very poor; consequently on August 10 I removed the rack containing five finished and three imperfect sections.

On September 17 I drove five skeps at a neighbouring village, keeping two lots for myself. With these I have stocked the "Wells" hive, and though not very strong in bees, they stand a fair chance of wintering. Each has three frames of sealed syrup and 2 lb. of soft candy over the frames.

My first balance-sheet shows a gross expenditure of £2. 17s. for materials for hive-making, bees, appliances, books, sugar for feeding, &c. On the credit side I value my assets at £3. 17s. 5d., which gives £1. 0s. 5d. to the good.

Assuming, however, that my stock of bees, hives, and materials are only worth the £2. 17s. spent, it still leaves me with 5s. 5d. for honey taken, which is clear profit.

This shows a net gain of £1. 0s. 5d., but even assuming that the stock on hand is not worth more, say, than £2s. 17s., it will still represent about 10 per cent. interest on outlay, and I value the pleasure of the hobby as nil. In concluding, let me add a word to say what great help and pleasure I have got from reading the BEE JOURNAL. In handling bees I have found little need for using a veil. My bees are the ordinary sort, domesticated in the district for a couple of generations, in the same family, though this is practically their first experience in frame-hives.—W. J. FARMER, *Yorks, November 1.*

[We advise our correspondent to confine his experience of hives made to hold other than standard frames to the one already possessed, or he will have to value them as very low indeed in his assets.—EDS.]

PATCHED-UP COMBS.

[3055.] In an article reproduced from the *American Bee Journal* in your pages some little time back, the writer—Mr. G. M. Doolittle—dealt with the subject of patching up combs by cutting out drone cells and substituting worker comb, also making up frames of worker comb with odd pieces cut from

various hives, and gave his early experiences in this direction, to which I add my own as strengthening his case. I have now two combs which I know to be, at least, ten years old. They are black, but as clean as any in my apiary. These two combs were made up by cutting out small pieces of suitable comb and fitting them together so as to fill the frame. But after much trouble in carefully fixing, it is, of course, next to impossible to make a good straight frame of comb in this way. I will remember buying the stock to which the combs used on the occasion belonged from the agent of the owner. It was on May 8, 1887, and the gentleman had left the house and garden unoccupied, save for the bees, for a year. The stock had wintered well with no other covering above the brood nest than a sheet of glass well propolised to the frames. I remember, too, that, after operating on the combs as stated above, the stock gave me 30 lb. of surplus honey that season.—W. L., *Essex*, Nov. 2.

BEEES IN A RECTORY HOUSE.

EXTRAORDINARY "TAKE" OF HONEY.

For the last two or three years the inmates of Holcott Rectory, near Northampton, have observed numbers of bees very busy at the front entrance of the house, the door of which is flanked by two cylindrical columns over 8 ft. in height and 9 in. in diameter. Bees have often been seen to enter the left-hand column, about half-way up, through a small orifice, and during last summer the humming noise within the column was so loud and frequent that it became evident there must be an accumulation of honey inside. In order to ascertain the real state of the case, the Rector (the Rev. John Gooch) consulted Mr. George Page (a well-known bee-keeper in the village) on the matter, and on Tuesday afternoon last (November 2), with the assistance of Mr. Hefford, secretary of the Northants B.K.A., an examination of the column took place. A portion of the pillar (the latter being hollow) was removed, when it was discovered that right from its top the pillar was filled with a series of vertical honeycombs 5 ft. 6 in. in length, presenting a very beautiful appearance. It occupied some hours to clear the pillar of its contents, which was effectually done by Messrs. Hefford and Page, with the assistance of Mr. R. Green, and by the judicious use of a little smoke from brown paper the clusters of bees inside were far more frightened than the spectators. Mr. Hefford lifted the bees out in handfuls, and they quickly ran into an empty skep, and were conveyed to a neighbouring village for uniting to a weak stock. The total weight of the honeycombs taken was 66 lb.—(*Communicated*).

Queries and Replies.

[1875.] *Selecting Queens.*—*Hive Entrances in Winter.*—I shall be greatly obliged if you will tell me:—1. Is a small queen ever so good as a large one? 2. Which do you prefer, a small young queen (fertile) to a larger and good-looking one of uncertain age? 3. In March last, I sowed some Chapman honey-plant seed. It has made big strong plants, but has scarcely bloomed at all. Will it stand the winter and bloom next year? 4. Can you tell me how to preserve insects (more especially bees) after death? 5. Why should hive-entrances be opened to their full width when robbing is no longer going on? And when does "robbing" stop? Not being home till dark at this season I cannot judge for myself on this point.—W. J., *Atherstone*, November 3.

REPLY.—1. Frequently better. 2. This is a matter we could only decide after inspection, and on comparing the two. 3. The Chapman honey-plant is a perennial, and when fully established may be propagated by division of the roots in spring. 4. Different insects require different treatment. The best course is to buy a small handbook on the subject for a few pence. 5. The wide entrance in winter is to afford a good supply of fresh air to the bees. Robbing usually stops when the bees have settled down for winter, and have given up foraging for the year.

[1876.] *Price of Honey.*—*Sections as "Christmas Cards."*—1. Is it safe to send 1-lb. sections by post? 2. What is the best method of packing a single section for post. I am thinking of sending a few to friends at Christmas, instead of the usual "cards," which will, to my mind, be a good way of turning honey into use. There seems to be little demand about here for honey generally, although I have myself got rid of a good deal direct to the consumers, who have been much pleased with it. Trying to sell wholesale is of no use here; we do not get enough honey per hive to justify us in selling at the ridiculous price of 5½d. or 6d. per lb.; 10d. per lb. is what I have realised for all mine yet, and when I have to sell for a less price I shall then give bee-keeping up, as it would then not pay in this part. I had the pleasure of seeing the honey at the Dairy Show: it appeared very good. The light-coloured honey especially attracted my notice: it appeared so extremely pale in colour. The wax, too, was very good.—A. BEGINNER, *Hinckley*, November 5.

REPLY.—1. No. 2. To minimise the risk, select sections the combs of which are attached to the wood on all four sides. Pack with any soft substance that will soften off a sudden jar or shake. For the rest, trust to "p. p. p.," which bee-keepers must perforce translate "providence and parcels post."

[1877.] *Colour of Comb Cappings.*—Will you please tell me :—1. What kinds of flowers bees work upon for amber, or pale straw-coloured cappings to their combs? 2. For white and dark cappings? 3. How and by what means is honey adulterated? 4. Does the B.B.K.A. publish any pamphlet on the adulteration of honey? If so, what is the price?—M. A., *Handboro', Oxon, November 5.*

REPLY.—1. The straw-coloured cappings to combs are characteristic of honey from sainfoin. 2. The whitest of all capping is seen on first-class sections of heather honey. 3. We have no experience as to methods of adulterating honey, beyond saying that the adulterant chiefly used is the glucose of commerce, a substance which may be described as starch-sugar. It is of very little value. 4. Yes. The title is "Adulteration of Honey," by Otto Hehner, F.C.S., price 6½d., post free, from this office.

[1878.] *Judging Wax and Granulated Honey.*—Reading in B.J. that you judged the exhibits at the Dairy Show, I am making bold to ask if you recollect my exhibit of beeswax, which was awarded a v.h.c. I sent two cakes weighing about 3½ lb. each, one a little lighter in colour than the other, but I think the darker sample was better in aroma. I could not decide which was best, so I sent both. 1. Was there any difference in quality, and did one lose any marks to the other? I only ask for future information, just to know which was the best. 2. In dealing with granulated honey, can anything be done to keep it from showing *white marks* on the sides of the glass jars, besides keeping them in warm and dry places? Or is there any way of packing the honey away for winter which will prevent the marks from showing in the running of it into the jars? I never have my honey free from these white patches in jars after granulation.—J.N.O. BERRY, *Llanrust, November 4.*

REPLY.—1. With so many exhibits to judge we cannot carry in mind all the various factors which influenced the award referred to, except, if our memory serves us rightly, that the lighter coloured cake of wax was best. Aroma is a strong point in a sample of beeswax, and this would, no doubt, help to get you the v.h.c. with both samples. 2. The only thing we know of that will assist in preventing the white patches referred to is using perfectly clean, dry jars, and not allowing the honey to run into the jar too fast.

[1879.] *Division Boards in "W.B.C." Hives.*—Is it necessary to use division boards with "W.B.C." hives? I bought two early in August, and at about the middle of month put bees and brood and the greater part of the honey from three straw skeps into them. I then gave the two stocks over 30 lb. of sugar syrup between them. The bees thickly cover seven frames in each hive, and have stored food in nine of the combs. I examined them about the middle of October and found

the two centre combs in each hive almost full of brood from top to bottom, both sealed and unsealed, the bees carrying in large quantities of pollen at the time, and so late as the 25th ult. I was watching them, and saw several go in pollen-laden. I shall be very glad to know about the division boards as none came with my purchase. It is my first attempt with frame-hives. I have well packed with chaff the space between the outer case and the brood-chamber, and have made a thick chaff-cushion to go on top of frames.—THAMES DATTON.

REPLY :—Division boards should always go along with hives; but, though most useful, they are not absolutely indispensable except when forming nucleus colonies. The ordinary "W.B.C." hive is made to take ten frames only in brood-chamber with no provision for division board therein. In fact the latter lies at back between the outer-case and body-box except when used in contracting the hive. By not providing space for it at all seasons, the hive is reduced in size or bulk.

Bee Show to Come.

November 18, 19, and 20, at the Waverley Market, Edinburgh.—In connection with Chrysanthemum Exhibition Show, the Scottish B.K.A. will hold a Honey show as above, at which very liberal prizes will be offered (see advertisement on page v). Schedules from Rev. R. McClelland, Hon. Sec., The Manse, Inchinnan, Renfrew.

Notices to Correspondents & Inquirers.

Letters or queries asking for addresses of manufacturers or correspondents, or where appliances can be purchased, or replies giving such information, can only be inserted as advertisements. The space devoted to letters, queries, and replies is meant for the general good of bee-keepers, and not for advertisements. We wish our Correspondents to bear in mind that, as it is necessary for us to go to press in advance of the date of issue, queries cannot always be replied to in the issue immediately following the receipt of their communications.

All queries forwarded will be attended to, and those only of personal interest will be answered in this column.

"W." (Hants).—*Honey Samples.*—The most pronounced flavour of honey sent is from heather. We cannot detect anything savouring of red clover at all.

S. J. SMITH (Waltbamstow).—*Fermenting Honey.*—The fermentation is caused by the honey not being fully ripe when stored. It may also have been badly kept since its gathering in 1896, which would develop fermentation.

. *Dairy Show Prize List.*—The name of G. J. Buller was printed on page 424 in mistake for that of John D. Willcox, Bedminster, Bristol, who was awarded the 2nd prize for beeswax.

Several Letters and Queries are in type and will appear next week.

Editorial, Notices, &c.

FOUL BROOD LEGISLATION.

THE THIN END OF THE WEDGE.

THE letter of our correspondent Mr. F. H. Taylor, on page 443 of last week's issue, suggests the reflection whether—in considering the question of legislation for dealing with foul brood among bees—the Isle of Man would not afford an exceptionally favourable opportunity for putting to a practical test the usefulness and general advantage to the bee industry of a law conveying the possession of such legal powers as are being sought for in the interests of the British bee-keepers at the hands of the British House of Commons.

Isolated from the mainland, as it is, by many miles of water, and small enough to be controlled from the bee-keepers' standpoint by a single expert, the Isle of Man is unique so far as offering a chance of doing on a small scale everything that we have hitherto in vain been endeavouring to accomplish in England on a large scale. There, no big stumbling block bars the way in shape of a House of Commons, with work on its hands (probably considered of far greater importance than a "Bill" about bees) sufficient to occupy it for many sessions to come. The Island has its own House of Keys, tantamount to our Commons, and its equivalent to our Lords in the persons of the Governor and Council. Now, when we are told, on page 443 last week, that "a Commission has been appointed by the Governor to inquire into minor insular industries, and Mr. Quayle asked to give evidence before it on bee-keeping," it needs but to read between the lines in order to see what appears to us a splendid opportunity for getting in the thin end of the wedge, which may ere long act as a powerful lever in securing the attention of our Imperial Parliament.

Bee-keepers outside the Isle of Man will regard with peculiar interest any further steps which may be taken by our neighbours, because of Mr. Quayle's specially referred to intention of "pointing out" to the members of the Commission how vain would be any effort to promote bee-keeping unless foul brood—which, as we learn, "stalks through the whole island"—is stamped out. While,

therefore, wishing all success to our Manx brethren, there is also to British bee-keepers the additional point on which we lay stress, and which has prompted the writing of these lines—viz., how far will the effort be successful in the smaller area to which it would be confined if our friends should succeed in obtaining a Bill for stamping-out foul brood? It will need judicious care on the part of those who undertake the work, and we can promise on behalf of the British Bee-keepers' Association every assistance in their power, not only for our friends' sakes, but because it is possible that a success in the Isle of Man may bring into view a means of bridging over the many difficulties which beset us in our efforts in the same direction with the larger authority we have to deal with in the British House of Parliament.

USEFUL HINTS.

WEATHER.—November, the month of fogs—here in London said to be "thick enough to cut with a knife"—is now more than half over, and we have, so far, experienced only two or three morning mists; nothing that a true cockney would condescend to call a fog. The generally dry autumn will no doubt be the main cause of our present comparatively clear atmosphere at a time when quite the opposite is expected, and, as we write, a spell of unnaturally warm weather seems to have set in. This means daily flights for bees, and will, of course, tend to reduce stores, a fact not to be lost sight of where scarcity exists. Writing of the weather, the *Standard*, in its always interesting monthly article on "Agriculture at Home and Abroad," says:—"The drought, which, for October, was the most severe for sixty-three years, continued until Monday, November 8, which must have rendered it almost or quite a 'record' for the season of the year. In many parts of the east and south of England less than an inch of rain had fallen since the end of September, and in some districts not much over half an inch. In such places water was short, and the land so dry and hard that farmers had not been able to complete the sowing of wheat. Stiff soils for two or three weeks had been quite impervious to the harrows, and on

light soils, where wheat was put in, it was literally sown in dust. The nearest approach to such a state of affairs within the last twenty years occurred in 1879, when rain held off until November 5, and a large proportion of the wheat crop was not sown until after that date."

NEGLECTED BEE-WORK.—We continue to receive from inexperienced readers requests for help or advice in cases where, from various causes, bee-work, which should have been attended to in September, remains still undone. To such queries we can only reply that fertile queens wanted for placing at the head of motherless colonies are not on sale in November, consequently queenless bees—if worth saving—must be joined to those of contiguous hives. The same may be said of weak lots; if healthy join up; if unhealthy, burn bees and combs. Stocks, too, with insufficient stores at this late season, to be safely wintered must either have frames of sealed food given from stocks over-provided, or be supplied with a large cake of soft candy, to be renewed as often as needed. This much has been said over and over again in our pages this autumn, and we can do no more now than repeat advice already given. It's no use at all supplying bees with bottles of syrup-food at the end of November and expect them to come out well next year. As the old bee-man said: "It's agen natur an' can't be did."

QUEEN BEES FROM ABROAD.—Referring to the letter on the difficulty in dealing with foreign queen-raisers who do not correspond in English (*vide* B.J. of the 4th inst., page 435), we are very pleased to receive an offer of help, as will be gathered from the following letter:—

"Having several times noticed difficulties on the part of your readers as to German correspondence, and having myself spent about eight years in Germany, I beg to offer my assistance in translating any letters sent to me in the absence of our senior editor, Mr. Cowan. If of any service you might state this in the B.B.J.

"R. HAMLYN HARRIS.

"The Conifers, Hambrook, Bristol."

CHEAP COVERS FOR SECTIONS.—At the conversazione of the B.B.K.A. on the 21st ult., we showed a sample of a cheap cardboard cover for protecting sections of

comb honey sold over the counter, and promised to get some further information as to where they might be obtained by bee-keepers desiring to use them. In pursuance of this promise we have taken the necessary steps, and expect they will be put on the market for use next season.

WAX IMPORTS.—In reply to a correspondent, we some time ago promised to try and obtain information as to the annual importation of wax into the United Kingdom. So far as we can gather, the quantity of wax of all kinds imported from all foreign countries during 1896 was 38,064 cwt., valued at £162,023. While from British colonies and possessions, during the same period, the weight was 5,104 cwt., valued at £32,607. We are not quite certain whether or not the above return includes wax of all kinds, or only beeswax; but we hope to be able to clear the point up before the year is out.

HONEY IMPORTS.

An account showing the value of honey imported into the United Kingdom during the month of October, 1897, £2,123.—*From a return furnished to the BRITISH BEE JOURNAL, by the Statistical Office, H.M. Customs.*

HONEY SHOW AT LUDLOW.

LUDLOW CHRYSANTHEMUM AND FRUIT SHOW.

The third annual exhibition was held in the Town Hall and Market on the 11th inst., and was a most successful show from every point of view. Chrysanthemums, fruit, and vegetables were of the very best, and competition was exceedingly keen. In the honey section there was an increase not only in the numbers of entries but also an improvement in the quality. The six jars extracted was a capital class of eighteen entries, with scarcely a second-rate sample staged. The six sections were also especially good, the whole eight entries being very good.

Mr. John Palmer officiated as judge, and made the following awards:—

Six 1-lb. Jars Extracted Honey.—1st, E. Middlemass, Stamford, Alnwick; 2nd, R. A. Price, Shrewsbury; 3rd, T. Lloyd, Builth, Brecon; v.h.c., S. Woodward, Kingsley; h.c., H. W. Seymour, Henley-on-Thames, and Jabez Sopp, Crommarsh, Wallingford; c., P. Scott, Broseley.

Six 1-lb. Sections.—1st, R. A. Price; 2nd, T. Pritchard, Bucknell, Salop; 3rd, T. Salter, Shrewsbury; v.h.c., Jabez Sopp; h.c., J. H. Wootton, Byford, Hereford; c., E. Middlemass.—(*Communicated.*)

Correspondence.

The Editors do not hold themselves responsible for the opinions expressed by correspondents. No notice will be taken of anonymous communications, and correspondents are requested to write on one side of the paper only and give their real names and addresses, not necessarily for publication, but as a guarantee of good faith. Illustrations should be drawn on separate pieces of paper. We do not undertake to return rejected communications.

Communications relating to the literary department, reports of Associations, Shows, Meetings, Echoes, Queries, Books for Review, &c., must be addressed only to "The Editors of the 'British Bee Journal,' 17, King William-street, Strand, London, W.C." All business communications relating to Advertisements, &c., must be addressed to "THE MANAGER, 'British Bee Journal' Office, 17, King William-street, Strand, London, W.C."

NOTES BY THE WAY.

[3056.] Here we are in the third week of November still enjoying exceptionally fine, mild weather. It has certainly been a phenomenal autumn, and bees have been on the wing nearly every day; last week I saw a fine humble bee careering among the flowers of the white nettle, and a few stray wasps were with us till the end of October, while the bees carried in pollen at the same time. The closing show of the year has been held, and bee-keepers will now begin to plan for 1898. The most enthusiastic in our ranks will, of course, want something on which to expend their latent energies, and I would suggest hive construction as one of the most useful of the many forms in which to spend the spare hours during the long winter evenings, thus preparing receptacles for next year's swarms. One is able to devote more time to jobs of this kind in winter compared to the busy days in spring, when perhaps there is a garden as well as bees to attend to; better work being put into the hive, and also of a more ornate style of finish. The most important item in hive-construction for the amateur to remember is to have the standard size frame for the brood-nest; all other items may be left to the ingenuity of the bee-keeper, whether it takes the model of a cube or the ornamental chalet.

The Dairy Show and meeting of bee-keepers at Jermyn-street which followed are amongst the most interesting events of the bee year, and will always make a successful wind up of the work. Press of business outside bee-keeping prevented me staying in town on the 21st, though had I known that my old friend, the veteran John Walton, intended being present at the conversazione, I should have endeavoured to postpone my previous engagement and be in London for the meeting.

The Show has been commented on in your pages, and as I had a hand in staging the exhibits I may be allowed to add a few further comments. The gentleman who officiated as steward of the bee-keepers' section had never before been to a honey show, though he was fully posted up in all matters connected with technical instruction for country districts, and was most willing to explain the best method of diffusing such knowledge; but this qualifica-

tion, though very valuable in its way, was far less advantageous to a steward who had the superintending, arranging, and staging honey exhibits than experience of the work in hand would have been. I, at least, venture to think so.

Then the grandmotherly solicitude of the L.C.C. that the cheese should not be converted into Welsh rabbits, nor the crystallised honey be relinquished by fire, culminated in their insisting at the last moment that the calico coverings of the tables should be rendered *fireproof* by being dipped in some solution. This meant loss of time, and, our department being in the annexe, we had to wait till last, or nearly so, for both cloths and staging. Then there were exhibits sent, some in one style of package and some in another; some single, some double, some triplets, and one or two quadruple, if not quintuple. These are very—to say the least—unhandy methods of packing honey for a show. The respective classes are often staged on different tables, and when several exhibits are packed in one case it is most inconvenient for those staging to have to carry the case about from place to place. Then how much more it adds to the inconvenience of repacking after the show is over. This applies to exhibits which have to be returned, and it is even worse in the case of exhibits which may be sold, with no receptacle in which to pack them, as so often happens. If more than one is packed in a box I should strongly advise the Council of the B.B.K.A. to include in next year's schedule a rule that each exhibit shall be packed in a separate box. The extra cost of carriage will be nominal. Consider, too, the help it will be to those who do the staging, besides the extra security afforded to exhibitors' honey; to say nothing of the enormous help it will be in repacking at the close of the show, to have each package under the table opposite the exhibit. I would also impress on exhibitors the necessity of using a box deep enough to allow for a good springy "bed" on the bottom of the box for the honey to rest upon. It may be steel springs or a few inches thickness of hay or straw; but if sections are to be staged in good condition some such provision must be made for their safe transit.—W. WOODLEY, *Beeton, Newbury.*

THE "WELLS" SYSTEM.

HOW I MAKE IT SUCCESSFUL.

[3057.] In response to your correspondent W. J. Farmer (3036, p. 428), at first I could not see my way clear to write, because you will understand how difficult it is for an amateur to extol a system that seems to have failed in the hands of so many "old hands" in the craft. On reading Mr. Loveday's experience, however (3038, p. 434), and Mr. Brice's remarks *re* "Wells" system in the November *Record* (p. 164), I concluded, in all fairness to the introducer of the system, that I should

give my experience with the "Wells" system, and let readers see that at least there is one in this remote part of Yorkshire who has made the system a very great success.

My experience entirely differs from that of both gentlemen referred to above. I adopted the "system" at the time Mr. Wells was giving us his splendid report in the B.B.J. some years ago. I now possess nine "Wells" hives, and have never yet known the bees to leave one side and all join up together in the other compartment. During the last heather season I had the misfortune to lose a queen in one of my "Wells" hives, and as honey was coming in I decided to leave it alone and note result. This hive stood four weeks without a queen at one side, and yet the bees did not join up with their next-door neighbours; they continued storing in the supers, and at the end of the time stated the only difference I could see was that the brood-nest was completely filled up with pollen. As to swarming, well, I should be quite surprised to have a swarm from my "Wells" hives, seeing that, for the last three years, not one of them has swarmed. The honey returns, too, from these hives have always averaged as much as any four of my single-queened stocks; and so far as the "Wells" system is looked upon by the members of the Association I belong to (the Pickering B.K.A.) is not due to any trouble in working, but solely to one cause, viz.—they are too large to cart to and from the moors. I induced a friend to try one on the moors in 1895, and it gave him 13½ stones of heather honey. My own "Wells" hives in that year gave me 196 lb. each, about 50 lb. each of this being clover, while my single hives for the same year gave me 41½ lb. each, and, as I said before, it takes about four of my single hives in the best of seasons to compete with one of my "Wells." I also carry my "Wells" system further than the production of honey by raising a few more young queens during the summer than I require at the end of the season for requeening. These spare queens are packed up for winter in ordinary single hives with a perforated division board in the centre, with one queen and bees on each side, and just as many frames as they can cover (usually about four frames, but I have wintered such lots on three frames each). We are usually told to unite such lots at the end of the season, but the queens are too valuable to me, consequently I prefer uniting on the "Wells" system; I may want them the following March or April. Those who wish to preserve a few spare queens in winter will find that putting them up for winter as stated above will prove that when wanted in spring they will be *there*, and you will have a hive in the best possible condition for future work. I really think that in the case of failure in this system, there is something wrong, either in the management or in the make of hive, or both. If Mr. Wells' teachings are strictly adhered to I cannot see

how the system can fail. I, at least, am satisfied with it, and I only wish others could make it a success, for without doubt a great deal better returns in honey are got; but for those that make a trade of selling swarms or working entirely for sections the "Wells" system is no use whatever.—J. RYMER, *Levisham, Yorks.*

VITALITY OF THE BEE'S EGG.

[3058.] In the days of my novitiate I used to make experiments to prove the accuracy, or otherwise, of what I read in books on bees. I accepted, however, all that was written of the extreme frailty of the bee's egg, and the tenderness, so to speak, of the larvæ, without hesitation, and was, in consequence, much surprised to find that there is far greater vitality in a bee's egg than I had previously believed it to be possessed of. About mid-June of this year one of my queens managed to creep through at an unprotected corner of the excluder placed above the brood nest of a supered hive, and having occasion to examine the stock at this time, I found newly-laid eggs in nearly all the shallow combs of the super. I returned the queen to her proper place in the brood-chamber below, and substituted fresh combs for those in super containing eggs. The latter being new and good combs, my idea was to allow the eggs to become chilled or spoiled, so that the bees would remove them. With this view the combs were placed in a cool place, where there is a through draught of cold air at the back of my cottage. I left them so all that day, giving them the protection of an outhouse at night, and the following morning placing the combs outside again. These eggs were subjected to this treatment for thirty hours, when, as I had hive waiting for a second super, I used the combs containing them, naturally supposing that the chilled eggs (as I fully believed them to be), would be removed by the bees. Six days later, I found that 50 per cent. of the eggs had hatched, and the larvæ were now approaching the pupa stage.—W. LOVEDAY, *Hatfield Heath, Essex.*

STORING HONEY IN TIN VESSELS.

RECEPTACLES FOR HONEY USED IN VARIOUS COUNTRIES.

[3059.] Referring to the question of receptacles for honey, I may say French beekeepers put their honey in wooden barrels as a rule, as is done, I believe, in most countries on the Continent, except Turkey and Greece. In the last-named countries honey is stored away in goatskins, those different kinds of receptacles being obviously chosen for the good reason that wood was found more easily in some countries and skins in others. In Syria and Palestine earthenware jars are used for the same purpose, apparently for the reason that clay is plentiful and more easily got than

either timber or skins. For myself I do not like wooden barrels for first-rate extracted honey, because, however clean the barrels at first, when once honey has been in them they retain a small quantity of acid in the joints, and honey cannot be kept stored for many months in barrels without the disagreeable result of finding an inch or more of liquid—and more or less soured—honey on top, though the bulk below may be perfectly granulated. The mischief this may cause I leave to everybody's good sense to judge of. This is my experience with wood barrels.

The goatskins which are utilised in Greece and the islands I also have a great dislike for. They give a peculiar and not agreeable flavour to honey. Butter is transported in skins in Palestine, and whoever knows anything of this peculiar flavour discards such butter at once. The unglazed pottery of Syria and Palestine, although better than skins, is defective, because honey penetrates the pores, and in consequence the same jars cannot be used for storing honey a second time. The Palestinians use them again for storing both edible oil and honey, but when so used the contents have a disagreeable flavour to any refined taste. The oil readily becomes rancid, and honey gets this *strong*, disagreeable flavour. Over the north of Africa the same earthenware pottery is adopted. In Algeria, however, glazed pots are used, which are a great improvement; but there remains the drawback of exceeding fragility in transportation to be considered. These same receptacles have, however, been in use for thousands of years. Americans, I believe, largely use barrels as being cheap and strong, at least in the eastern and northern States, whilst in California tin cans are adopted.

Personally, I have always used tin cans (not expressly made for honey), during the whole of the time when I lived in Palestine. Petroleum was formerly imported there largely from America, but is now almost exclusively got from Batoum in the Black Sea, on account of being cheaper. These square petroleum cans can be bought for 3d. to 5d. each, they hold a little over 50 lb. of honey, and are easily cleaned, either by simply exposing them to the sun for a fortnight or washing them with "lye," and, when well dried, a few drops of spirits spread over the surface and ignited with a match, and the can becomes as clean as new, without the slightest trace of petroleum flavour. As long as I followed the pursuit of bee-keeping in the Orient, and furnished honey to Cairo, Alexandria, Beyrouth, Constantinople, or Algeria and Europe, I always sent it in these washed petroleum tin cans, and never had a single complaint of objection to the tin. H.M. the Sultan of Turkey yearly received a supply of our orange-blossom honey in these same tin receptacles, whilst I also sent several washed tin cans containing honey to Yidliz Kiosk.

Here in France, although wooden barrels

are generally used, I have always served my customers in specially made tin cans, and this is the sixth year that the same clients are taking honey from us. Several bee-keepers here have also adopted the tin cans through my example. Again, tin packages are cheaper and less fragile than either earthenware or glass for sending by parcels post or by rail. A tin vessel of 10 or 20 lb. capacity, weighs only from 1 to 1½ lb. Glass or earthenware vessels are far heavier, besides needing the protection of a wooden box, all this being dead weight. A postal package in France may be of 3, 5, and 10 kilos in weight, and is delivered for 85 centimes, 1 franc 5 centimes, or 1 franc 50 centimes respectively, according to the weight at the house (in English this is 6½ lb., 10½ lb., and 21 lb., for 8d., 10d., and 1s. 2½d.), of buyers in any part of France, provided there is a railway station. Olive oil is also sent in tin cans without any protection, thus lessening dead weight. Besides this wholesale business in which I have sold thousands of pounds of honey—my brothers in Palestine still do the same as far as packages. I also retail honey here in Nice in tin receptacles of ½ lb., 1 lb., and 2 lb. Glass jars are certainly better looking, but the cost is more than double that of tins, and customers generally do not care to pay for the package, which necessarily they must do directly or indirectly. Many of my retail clients here are English, and they usually prefer tin to glass.

In conclusion, and with regard to storing honey in bulk, I use large tin cylinders holding about 500 lb. each, all extractors are made of tin, as are the honey ripeners also. I think if tin were as cheap in France as in England, it would also be used more extensively, and as I have not had a single complaint after seventeen years using it for honey, I hope this experience will continue to prove its value for the purpose.—*PIL. J. BALDENSPERGER, Avenue Malacoussa, Nice, November, 1897.*

THE SHAMROCK.

IS IT A HONEY PLANT?

[3060.] In a footnote to the letter of an Irish correspondent you say (on page 384 of B.B.J. for September 30) the Irish shamrock is worthless as a honey producer; but, according to the dictionary, shamrock is white clover. Is the dictionary wrong, or is white clover not a honey plant in Ireland?—*C. C. MILLER, Marengo, Ill., U.S.A., October 28, 1897.*

[We cannot help thinking that our genial friend, Dr. Miller, when penning the above had in mind his "Stray Straws" column of *Gleanings*, wherein one often sees just such sly thrusts at editorial shortcomings. But, however the worthy doctor may poke fun with his pen, his humorous thrusts never wound; and his editor "taps back" in equally pleasant fashion. In this case we can fancy Mr. Root

saying:—"Look here, Doctor, just get that dictionary down again, and read on a bit. There, now, don't you see that shamrock is white honeysuckle? And do you call that a honey plant?"

For ourselves, however—and seriously—let us say the shamrock, or trefoil, accepted by Irishmen as the national emblem and described by their poet as:—

"The chosen leaf of bard and chief—
Old Erin's native shamrock,"

is not the white clover of the bee-man at all but the simple, tiny-leaved wood sorrel (*Oxalis Acetosella*), bunches of which are worn in the button-hole of patriotic Irishmen on every St. Patrick's day.—Ebs.]

BEEES NEAR LONDON.

[3061.] I send you the account of my "take" of honey for the past season, which shows, I think, that there is plenty to be obtained within a distance of eleven miles from London Bridge. I commenced the season with five hives. On April 27 I made an artificial swarm. Altogether I have taken 537 lb. of honey—335 lb. in sections and 202 lb. extracted. Thus my average is a little over 107 lb. per hive (spring count). The largest amount taken from one hive was 118 lb. From the artificial swarm I took 84 lb., and from the old stock 35 lb. So together these gave me 1 lb. more than my best hive. I had only two natural swarms, both of which I returned, after cutting out all queen cells, and I had no more trouble from swarming.

Should any of your readers, unfortunately, require to destroy a hive of bees, they will find the following a very easy way. Dip a piece of rag in molten brimstone, and place the same when cold in smoker. Then light and insert the nozzle in narrowed entrance to hive with cloth round to make nearly air tight; a few puffs will quickly kill all bees in hive. Of course this should be done late in the evening, and it should be seen no sulphur is left in the smoker before using it in the ordinary way.—LIONEL BURRELL, *Sidcup*, November 12.

BUILDING UP STOCKS FROM NUCLEI.

[3062.] Under the above heading your correspondent "W. T. P." on page 446, gives an interesting account of a very prolific queen. While I am aware it would be against the rules of B.B.J. Office to publish name of the raiser of queen in question, it must be gratifying to that gentleman to know of the extraordinary working propensity of this stock. It would, however, be of more benefit to the craft generally had "W. T. P." named whether queen was a native, hybrid, or Italian. Having experimented a little in this direction, I give my vote in favour of "natives," hybrids

being too much given to thieving.—W. CLARK, *Grange-over-Sands*, November 13.

THE "RECORD" TAKE.

[3063.] I am glad to see Mr. Taylor's letter on this subject on page 443, and trust it may satisfy all bee-keepers whose envy or bile has been excited by Mr. Quayle's success. Allow me to give my own observations on the matter. I was at the Isle of Man in the middle of October just past, and noticed everywhere bees working most industriously on an abundance of flowers and clover in full bloom. As Mr. Taylor remarks, the blackberry bushes are most abundant, many of them still flowering; but this is hardly surprising when bearing in mind the fact that frost is almost unknown in the island. Contrast this with the short season at home, and one can then see the possibilities of what is undoubtedly a most genial climate and lovely splendid country for bees.—F. W. PEARSON, *Sheffield*, November 12.

PREVENTING SWARMING.

GIVING BEES WORK IN ADVANCE.

[3064.] I write for the purpose of inquiry and explanation. Your correspondent, Mr. R. Brown (3050, page 446) in B.J. for November 11, advocates the principle of "plenty of work in advance, without reducing the internal heat of the hive, and has such faith in this principle that he means to continue it. Now, this very principle, or the idea contained in it, is one that for years I have been trying to solve. I believe if Mr. Brown will give his methods in this direction, it will be greatly appreciated by many bee-keepers and a great boon to one whom so far 'plenty' of work in advance has always meant 'reducing the internal heat.'—ROBIN HOOD, *November 12*.

COMPULSORY BEE-KEEPING.

[3065.] In the *Illustrated London News* last week I was interested in reading that at Abo, in Finland, bee-keeping used to be enforced on all the citizens, or flogging was the penalty.

I also learn that bees are now kept to such an extent round Abo as to be troublesome to the traveller.—E. J., *Tunbridge Wells*, November 13.

BEEES AND THE GARDEN.

The ruthlessness of his occupation is a recurring grief to the amateur gardener. So much must be killed before the simplest plant can grow. If he hoe in the morning after a rainy night, with every weed that comes away he halves a writhing worm. The weeds themselves have done their best to spring gaily from the soil, and yet here must they now lie, on this rubbish heap where the sun will dry their sap, and, through no fault of their own, they will perish. Like David, the gardener kills his tens of thousands. The predatory bird is

the despair of the tender-hearted; the robins that sit on a convenient bough watching with ironical eyes the patient horticulturalist, whose back aches as he bends over the little trough of earth in which the sweet peas are to be sown, and, if he only knew it, sown to no purpose. It is characteristic of the amateur gardener's wife that she expects the appearance of leaves the morning after the seeds are sown, just as if Flora were an Indian conjuror. "Are the sweet peas showing yet?" she asks, as her husband returns from his tour of the garden before breakfast on the following day. "No, my dear, but there are some absurdly fat robins staggering about"—that is the disconsolate reply. And yet who can kill robins? Snails one can throw over the next wall without a pang, blight one can drown cheerfully in insecticide; but birds? The bird is too beautiful, too conscious a creature for death. Let him have the next sweet peas if he wants them. Let him have enough to make himself ill (which he never does). That is the attitude of the amateur gardener, and the worst of it is the bird knows it.

This particular garden is the abode of birds and bees. The birds belong to the universe; the bees are Mrs. Peters', whose garden is divided from the one under consideration only by a path, and whose husband (it must be confessed by an effort) does all the real work in both, in spite of the continual object lesson which his wife's bees afford his neighbour. But to be busy because a bee is busy postulates weakness. It is no credit to a bee to go booming about the world in search of work. Industry is its hobby, and perpetual successful pursuit of honey must be very pleasant. Mrs. Peters has several hives. "I like horses and I like dogs," she once said, "but of all animals I think I like bees best." She cares for them like a mother. One afternoon in the winter she came into her neighbour's sitting-room, which opens directly on the garden, and, after moving mysteriously about by the window for a while, "I've come for one of my bees," she explained; "I want to put him back in the hive again," and so saying, she picked up the little brown body from a corner of the pane, and bore it away. Could there be a prettier instance of solicitude? Mrs. Peters' bees make excellent honey, dark—for there is heather on the common close by—and very sweet. Last year she brewed some mead, which is to be ready for drinking this winter, and is going to impart to all who taste it an Early-Briton content, and, possibly, exaltation. Mr. Peters affects to be out of patience with his wife's bees, because of the frustration which they bring upon his horticulture. "They will cross the greens," he says, although this spring he has succeeded, greatly to his delight, in preserving two roots of kail against them. These are now 6 ft. tall, with a mass of yellow flower to each. "So I shall have some of the true seed again," he remarked; "it's an old favourite of mine, that kail."

More interesting than the ordinary proceedings of bees are the extraordinary ones. The other morning, for example, when gardening, as it often does, gave place to reading, the sound of strumming, rather like one of the Cingalese tom-toms at the Indian Exhibition, came through the hum of bees and the rustle of the wind, the whistling of the birds, and all the other music that mates with a fine May morning. Looking round, there was Mrs. Peters standing beside her pear-tree beating a tin. "The bees are swarming," she cried; "come and look!" On arriving beside her, Mrs. Peters was found to be gazing very earnestly at a little black snowstorm that was raging about the tree. She motioned that spectators were to stand still, and then explained with some haste, in order to be beforehand with criticism, that it was her neighbour's saucepan lid which she was using, and that she was "ringing" the bees to keep them at home. Ringing, it seems, stupefies them somewhat, and has the effect of curbing ambition to roam. It was pleasant to think that one's own saucepan lid was being used for this intimate purpose; it gave one a personal interest in the swarm. The "ringing," or strumming, went on. Every moment the storm abated a little, and by peering through the leaves one could see a solid and increasing mass of bees hanging from one of the branches. When all the flakes had at last settled, Mrs. Peters, in the absence of Mr. Peters, sent for Mr. Cronk. Mr. Cronk lives close by, and is also a bee-master, and meanwhile she bustled about the kitchen making a mixture of cold tea and sugar. This being for the refreshment of the swarm, it was spread on the inside of a straw hive.

Mr. Cronk came at once armed with a net, which he placed over his head. It made him look like a diver, and he laughed hugely when the comparison was made, and the water-butt offered to him for an experimental descent. Mr. Cronk's hands were bare, although he had the offer of a pair of gloves. Bees couldn't sting through his hands, he said, and it was not difficult to believe him. The man who invented the saying, "There's nothing like leather," had never seen Mr. Cronk's hands. Mr. Cronk placed a ladder carefully against a pear-tree, and then, taking the hive in his arm, he climbed up. He held the hive with one hand immediately under the cluster of bees, and with the other he shook the branch. At once they fell in, and he hastened down and turned the hive over upon a piece of matting. The bees buzzed furiously within, while stragglers flew all around Mr. Cronk's head and body, and many settled on him. But he heeded nothing; all he did was to kneel beside the hive and place his ear first on one side, and then the other, straining to hear if the queen bee was within. "I think she is," he said at length, "although," he added, looking up into the tree again, "she may be there." Following his glance, one saw that another cluster of

bees was forming on the branch. "I'll get them down directly," said Mr. Cronk, who was now closely examining the bees that were entering the hive by the little hole. "You've got a lot of crossbred ones, Mrs. Peters," he said. "I've got a tidy few, but you've got more than me. I mean these with only one gold band round 'em. The true bred ones has two gold bands." Then Mr. Cronk went into the tree again, and collected the second subsidiary swarm, which he added to the others. "There must be a couple o' pounds o' bees," he said thoughtfully, and it seemed odd to hear him compute them by weight. So the excitement ended.

A day or so afterwards another hive swarmed, but this time in a gooseberry bush, so low down that they could not be taken in the usual way, and it was necessary to place a hive over the bush and leave the bees to rise into it. Mr. Peters performed the necessary duties, prowling round the bush in a thin sheet, like a leper or a ghost. Just now the busiest humming sounds among the raspberry blossoms; but those bees that rove from home make for a field a quarter of a mile away on the hill, half of which is purple with pansies. Little wild pansies they are, and there are millions of them, all turning their glowing faces to the sun, and quivering in the breeze. The field has been christened *The Field of Thoughts*. Stooping one's head near the ground, it is easy to believe oneself a new Gulliver in the midst of a little purple people, kindly and innocent. When the wind comes across the field towards one, it brings the delicate sweetness of the pansies with it. Great flocks of doves feed there. It is the abode of peace.—*The Globe*.

EXPERIMENTS WITH NON-SWARMERS.

The continuous hum of bees for more than three weeks during oppressively warm weather had a semblance of the monotonous roar which characterises that of Niagara, and added to the monotone was the inability to keep pace with our bees in removing and supplying supers.

The season has been extraordinary in many respects, and the honey-yield phenomenal; never have I known its equal. The yield appears still more wonderful, when but eighteen months ago bee-keepers were bemoaning the condition which seemed to indicate that our honey-sources were being obliterated by the woodman's axe, and a succession of extremely dry seasons. But following these conditions comes the present season with an unprecedented amount of white clover. Where none was visible last season it completely covered the ground. This has led me to consider how, in the face of apparent death, comes such an abundance. Surely, Nature is founded in wisdom, and her resources are indestructible. Has not the seed accumulated during the past

five or six years of drouth, and the requisite amount of moisture necessary to its germination and extension by the rooting tendrils given us more than could have been expected; and has not Nature more than ever before displayed her marvellous stores?

In connection with, or rather preceding, this extraordinary condition, the weather was unseasonably cold and unfavourable to the flight of the bees. My hives having been well packed until a few days preceding the honey-flow—which opened suddenly with warm weather on June 10—were overflowing with bees, even in my large hives (although supplied with dummies), which place them again in the condition of swarming colonies. I became extremely anxious as to the situation, wondering if it were possible to keep them from swarming with such a sudden change of temperature, accompanied by the great flow of nectar. There was in them, also, an unusual proportion of field-bees with perfect or unworn wings (by reason of non-use) compared with the middle-aged or comb-building bees, which would naturally carry honey to the latter faster than their ability to care for it, clogging the hive and increasing the tendency to swarm.

Swarming was, however, greatly retarded by use of the dummies, and late compared with my neighbours, most of the swarms issuing between June 20 and 30, some of the parent colonies having stored upwards of 40 lb. previous to swarming. At first thought I attributed the failure to new dummies which I substituted for those of last season, but, upon reflection, seeing that my hives were too small and the season unusually favourable to swarming, I concluded that possibly it was not in the dummy, but a return of the crowded condition like that of swarming hives. My hives have a capacity for but eleven frames, and upon careful consideration I have concluded that with a space for fifteen or sixteen, a little less than half of which could be occupied with dummies, better results might be obtained.

I am really surprised that the additional room for three frames (occupied by dummies) should have produced such satisfactory results heretofore, and to have retarded swarming to the extent it did this season, all things taken into consideration. There was, however, a noticeable fact presented which has given me great encouragement for the future non-swarmers. It was the unusual number of bees which remained with the parent colonies almost without exception. So strong were they that the storage of honey in the supers was continued or resumed in two or three days, and has given me an average of about 60 lb. per colony, with about 40 lb. more in prospect.

Although the flow tended to fill the bee-keeper with enthusiasm, still the brood-chambers are clogged with honey, to the exclusion of brood. This, of course, is unfavour-

able to the best results just at present; still, with a favourable season at the close, although not in a basswood locality, I should look for at least 100 lb. per colony.

I learn that the intensely warm weather has ruined a few colonies by breaking down of combs in this and doubtless many other localities; still, none of mine have suffered. The dummies favour ventilation, and should one comb soften and drop from the top-bar, the dummies would prevent further disaster by holding it partly in place. Three or four years ago I had several hives in which a single comb became detached while the others remained intact by reason of the dummies.

Another advantage derived from the use of dummies is alluded to above, in affording more perfect ventilation, and the additional room prevents the bees from clustering on the outside during warm weather. The result is that no loafing colonies are found in my apiary. There is a marked difference in the aggregate amount of honey stored when every colony in the yard is doing something. Of course, the equalisation of colonies during the month of May, as set forth in a previous article, is the prime essential to such a result.—L. A. ASPINWALL, in *Bee-keepers' Review* (American).

Queries and Replies.

[1880.] *Spacing Frames in Surplus Chambers*.—In supering the "W. B. C." hive (or any other hive) with shallow frames, some bee-keepers use ten frames spaced 1 $\frac{1}{2}$ ", while others use eight frames spaced 1 $\frac{1}{4}$ ". Has it been proved which method is preferable, and if there is any difference in the quantity of honey gathered? The latter is, of course, the main point to be aimed at, but I do not remember ever having seen this subject discussed in the JOURNAL.—T. H. B. BURGESS, *Ecetor*, November 2.

REPLY.—We don't think there can be any doubt as to the obvious advantage of using fewer combs to fill the same surplus-chamber. There are fewer bee-passages, all of which occupy space, and fewer combs, involving, of course, less labour in extracting, with the "waste" which accompanies it. If the same gross weight of contents is dealt with, eight combs must show a better net result in honey must follow after deducting the tare, in shape of wet combs, &c.

[1881.] *Spacing Frames, &c.*—1. If I put sticks across frames under the quilt to allow bees to pass, is it also necessary to cut passages in combs? 2. If I put on candy cakes (as sold)—these will cover three or four frames—will the bees not eat their own way through combs to the candy? 3. The "Guide Book" says (p. 157):—"Distance 1 $\frac{1}{2}$ " from centre to centre," but my combs are as close as the

metal ends will allow them to be; therefore, about 1 in. from centre of one frame to centre of next frame. Should I take one or two frames away and contract with dummies to the required distance? Time of year, according to "Guide Book," is very late, but I have been absent from home and the weather has been phenomenally mild, so I don't think it yet too late. My four stocks are all in bar-framed hives, new this year. 4. Is it necessary to uncap stores?—*Ruhtra, Rousey*.

REPLY.—1. No. 2. Yes. 3. Notwithstanding what our correspondent says, it is too late now to carry out any manipulations such as spacing frames for winter. In any event, whatever has to be done must be done at once. If bees are strong and have plenty of stores, be content only to remove such outside frames as are not covered with bees, and do not disturb the cluster. The "Guide Book" can be depended upon in what it states when work is carried out in season. 4. No.

SEASONABLE QUESTIONS,

ANSWERED BY G. M. DOOLITTLE.

WINTER PASSAGES NOT NECESSARY.

Question.—I see in one of my papers one writer claims that old age can be set down as the reason for bees dying in winter without apparent cause; and asserts that the cause of the loss of many colonies lies in the fact that the same was composed mostly of bees already old at the approach of cold weather. This may have caused some of the loss; but I think (where bees are wintered on their summer stands in the open air) the loss is more often caused from chill, or the impression from cold of those occupying outer ranges of comb during sudden changes from warm to very cold weather. The loss especially is very considerable from this source where the comb-passages are deficient, as they generally are where large frames are used, as in such case the detached clusters are unable to readily join the main cluster, and are not in sufficient numbers to maintain the requisite degree of heat, and are thus lost. Considering these facts, do you not think it well to make winter passages through the combs, near the centre, for the bees to pass through?

Answer.—The above brings up a subject which was discussed at length several years ago, when there was a "craze," as it were, for "winter passage-ways" through the combs. The argument then brought forth was, that on the first cold spell the cluster of bees is obliged to contract in order to maintain the necessary degree of heat required; and in doing so those occupying the outer ranges of comb, being in a sluggish state from the influence of the cold, failed to pass up and around the combs quick enough to keep up with the receding cluster; hence were left to perish with the cold. To obviate this loss,

winter passage-ways through the centre of combs were recommended, made by boring holes through them, or by having a curled shaving (painted on the inside) suspended in each frame when the swarm was hived, so that the bees would of themselves leave such passage-ways when constructing their combs. By this means the outer bees had direct communication with the cluster, so that, even though partly stiffened with the cold, they could easily recede so as to keep up with the main cluster. The painting of the inside of the shaving was said to keep the bees from building comb in these holes; but, notwithstanding, the bees would as a rule fill up these winter passage-ways each summer whenever there was a good yield of honey, so it was found quite a job to see that they were opened again each fall. This led some one to propose boring a hole in the side of the hive, at the proper place, so that with a square stick, pointed at one end, which was to be slowly "wormed" (in order to avoid killing the bees) through to the opposite side of the hive, thus making a passage through all of the combs at one operation, thus making quite a saving as to labour. Many of my older hives have such a hole in the sides, with a button to turn over it when not in use; and where such passage-ways are desired, there is no better way of securing them than this last.

However, it was soon found that the bees would remain and die within half an inch of these holes in the combs; and as said holes were quite a damage to the combs (the bees filling them with comb having the drone size of cells the next season, or, if left open, it allowed a place for the bees to stay in when they were being brushed off for extracting or any other purpose), the making of such passage-ways has been generally given up, I believe. Some who still cling to the idea use what is known as the "Hill device" above the combs, as a sort of compromise; but after careful experiments with all of the above the writer has discarded the whole of them, believing there is not enough gained to compensate for the trouble. That the bees would die within an inch or less of such passage-ways, as spoken of above, and that such death of bees rarely occurred except during the first heavy freeze each fall, led me to investigate the matter closely, said investigation proving to my mind that these bees died from lack of vitality (or old age), rather than from the cause assigned. Usually we have much cool cloudy weather from two to four weeks before the first severe cold, so that old bees do not leave the hive to any extent to die, as they do all through the summer months, so that the number of dead bees dying from this cause would be considerable, providing none were chilled. But instead of dying at once, at this time of the year, these old bees seem to linger along for a chance to get out of the hive to die, the same as they do at all times when they can fly freely, and so gather in little

clusters of three, six, twelve, or more, in a place where they remain in a half-dormant state till caught by extreme cold, or a chance is offered for a flight.

I find, by referring to an old diary that was in writing at the time I was conducting experiments along this line, that one year, when a fine warm day occurred just before the first very cold weather, on which day the bees all flew finely, owing to their being confined to their hives from cool rainy weather for two weeks preceding, I found multitudes of sluggish bees clinging to the sides of the hives, on the grass, fences, &c., near the evening of that day. On touching them they had life enough to thrust out the sting, but none would fly or even crawl; and when the next morning came with a temperature of only 15 degrees above zero these bees were frozen stiff, remaining where they were the night before. This was a surprise to me, and I was led to believe, which belief still clings to me, that I had discovered the real cause of the trouble. A look into the hive after this cold wave had passed brought to light no dead bees on the combs as are usually found where the bees have no chance to fly for some time before the first extreme cold, and very few were found at any time during the winter, all getting clustered compactly for winter without passage-ways.

Then, again, I have often noticed that these little knots of bees were found, dead or otherwise, only with the first contraction of the cluster, as afterwards no gain in dead bees between the outer ranges of combs was noticed with each expansion and contraction. Therefore I do not pay any attention to passage-ways for bees during winter at the present time.—*Gleanings (American)*.

Notices to Correspondents & Inquirers.

All queries forwarded will be attended to, and those only of personal interest will be answered in this column.

A. BULLITT (Birmingham).—*How to Make an Extractor*.—The pamphlet on this subject is now out of print.

T. E. PAICE (Pewsey).—"Bees for Object Lessons."—We will be very pleased to forward a queen for the purpose mentioned, but first we are endeavouring to procure you a live drone, as desired. It is, however, altogether out of season for live drones, and the only chance is where they have been preserved for a purpose.

C. J. WADEY (Broadstone).—*Bee Candy*.—You may utilise the "squeezed honey" as candy by adopting the plan followed in making "Good's" candy, *i.e.*, by working into the honey as much icing sugar as will form a very stiff paste. This is given to bees just as ordinary candy.

G. M. S. (Keswick).—The fact of the hive mentioned being the only one made by the firm referred to which does not fit the appliance, explains the mischief complained of

Editorial, Notices, &c.

UNREPORTED BEE-TALKS.

HOW THEY DO THINGS IN AMERICA.

Among the desultory conversations at the *Conversazione* of the B.B.K.A. last month were heard many suggestions for the improvement of the bee-industry generally. The questions discussed included such matters as "finding a home-market for bee-produce"; bringing prices down in order to popularise the use of honey, on the one hand, and keeping up prices for the same to a "paying" figure on the other. There were also quiet personal chats as to the relative profits of "wholesaling" compared with selling retail; and at what price per lb. honey could be sold while leaving a fair return for the labour and capital involved. In view also of these various items of interest, together with the requirements needed in order to make things better for all, there were not wanting suggestions directly affecting ourselves as regards the policy of the Journals issued from this office. Nothing, however, of a very revolutionary character was contained in the latter proposals, our good friends merely suggesting that we should meet the "up-to-date" spirit of the time by offering prizes for papers or essays on bee-subjects, and by issuing a special Christmas number of the BEE JOURNAL annually.

All of the well-meant suggestions advanced during these informal bee-talks must and do contain more or less of what is useful and good, but apart from the broader and more important issues first mentioned, and concerning what merely affects ourselves—the one thing overlooked is the cost of carrying them out. No doubt our friends have in mind the ever-increasing tendency of late years by a certain class of periodicals—penny weeklies as a rule—to offer, in every imaginable sort of competition, prizes varying in value from a few shillings to cheques for a thousand pounds. There is no need to explain why these desirable things are far and away beyond *our* reach, except saying that where so much as a hundred pounds per page is got for advertising in the papers referred to, it accounts for generosity in the giving-away line undreamt of by technical journals of neces-

sarily limited circulation. While to make a puny attempt at imitating that sort of thing would be as ridiculous as undignified. We, therefore, content ourselves with the reassuring words of a speaker at the meeting referred to, which was to the effect that "British bee-keepers get a good and all-sufficient pennyworth in their weekly JOURNAL," and we take this to mean that enough is as good as a feast.

On the other hand, and with special reference to the question of finding a home market for bee-produce, we have been much interested, and not a little amused, while perusing in the current number of *Gleanings* a couple of articles on the subject alluded to. They are worth reproducing, not as affording an example easy to follow on this side of the Atlantic, because of the widely different conditions existing in the two countries—but to show how they do things in America. The first article reads as under:—

PEDDLING MADE EASY.

By Dan White.

I told you in my last article that I had about 7,000 lb. of extracted honey, and expected to sell every pound of it near home, and promised to report later on how I got along, so I will tell you about my experience in new territory.

You see I must reach out further than ever before, so I decided to try a place twenty miles away—a place of about five thousand people; so one morning I packed my grip and took two 12-lb. cans of honey, and started out. About all I had in my grip was a good supply of those leaflets published by the A. I. Root Co.; then fifty postal cards addressed to myself.

I got into the town just before dinner-time; and after eating a good meal at a boarding-house I filled my pockets with leaflets and took one honey-can and commenced business. I started down a street and did not miss calling at every house. After ringing the bell, or rapping, a lady would open the door and look at me with more or less suspicion. I would say, "I made the call to ask you if your family were fond of honey."

They generally answered yes, but believed they would not buy any.

"Well," I would answer, "but I am not selling honey to-day. I am giving it away, and should be glad to give you some in a sauce-dish."

Some would look astonished, others would smile, and say, "That's funny," but in every instance I was invited in. I would pour out the honey, then hand out a leaflet, telling them

to read every word of it. "You will find it very interesting; it will tell you all about honey—how and why we extract it, &c. Then here is a postal addressed to me; and should you decide to want a 12-lb. can, put your name, street, and number on the card, drop it in the office, and when I deliver in about ten days you will get a can of honey."

Well there were enough cards put in the mail within five days to take thirty cans of honey. I promptly made the delivery on time, taking along twenty extra cans that sold about as fast as I could hand them out; and since then I have received orders for fifty more cans from the same town. I tell you it has got all over town that a honey-man had been there, selling *real* honey 12 lb. for one dollar. I am certain this one place will take over 2,000 lb., all in one-gallon cans. Now, then, 18 lb. of honey given away from house to house, fifty postal cards, 200 leaflets left at houses and handed to people on the street, and one day walking over a very small portion of the town, has found a place for at least 2,000 lb. of honey. Then think what I can do next season should I secure a good crop? All I shall have to do is to take a big load and go up there and hand it out. By the way, the honey sold there was thrown out of clean white combs, over every inch of whose surface the uncapping-knife had to go. It weighed strong 12 lb. to the gallon, just as good as the best comb honey, *only* it was out of the combs. Of course, I can go back just as often as I choose; yes, and the people will all be glad to see me.

We read about the trouble in grading comb honey, and just how to get it in the market to the best advantage; but I want to ask, what would happen with comb-honey producers if the bees could only be influenced to fill the section combs one day and cap over ready for market the next day? I imagine there are some who would favour this very thing. Yes, sir, some would advertise a strain of bees that could be controlled in that direction easier than any other strain. Others would say, "Hold on! my bees must go on in the good old way, and not cap over any honey until it is ripe and wholesome to eat." We will call the latter class honest men who can build up an honest trade for their honey, and then hold it if the former class would just keep away. Now, sir, I shall call the former class dishonest, not only to their customers, but dishonest to themselves especially, if they expect to continue in the business. Then they would be dishonest because they would do a great injury to the honey market in general, and this is the very worst thing of it all. Don't forget that *very few* people get tired of good, first-class honey; and, above all, remember that almost any one will tire of poor, thin, unripe honey.

One thing we must always expect, and that is, some of these fellows who have only a few colonies of bees will annoy us by extracting

poor honey, and finding some one to buy it because they call it honey, and often find customers because they make a price below any thing heard of. This class, of course, don't care, as they care nothing for a reputation. Some seasons they have a little to dispose of, and other seasons they make a failure. Thank fortune for their failures! But what can we say to bee-keepers who handle large apiaries, to convince *them* they are doing wrong? I personally know several who are scattering this unripe honey over the country. This makes me believe there are just lots of these fellows, because my acquaintance does not reach out very far over this broad land.

I am saying more than I want to about this, but I am in earnest, and wish I could influence some or all to see as I do, and then see how easy it will be to dispose of our honey.

Only last season a man called on one of my customers who annually buys from 50 to 75 lb. of me. Being out of honey, he was influenced to take 50 lb. of *his* honey. One reason he bought of him was because the price was lower than he had ever had it offered. You see, this was two or three weeks earlier than I could get any *good* honey for my customers. I found this out when I did call, and told him he had made a mistake. Now, here is the secret of all this. When I called on this family this season with some *good* honey, they had plenty left over from last season's supply. What must I now do? Well, I will tell you. Start all over new; call for a dish, and give them some to renew that taste for honey. It worked just like a charm, for it was only a day or so when I got an order for 20 lb., and, later on, 40 lb.

I could enumerate several places where this energetic hustling bee-keeper caused this same trouble. Now, is it surprising that we hear so much about poor honey markets, especially extracted honey? I don't want any one to think I am worrying about the sale of my own honey, because they will be very much mistaken. My aim is to see if I can't fix it so these fellows who want to sell and market their honey can feel as good about it as I do.

I have said enough for one time, and will close after telling one thing more that I candidly believe to be true. Now listen, if the people in Ohio were properly supplied, or eating what honey they would eat if it were put before them in the right shape, the supply would not equal the demand, even if every State joining should depend on Ohio for a market. Use your customers right. Look up your own territory right; peddle no better than I do, and you will believe as I do.—*New London, Ohio.*

[I have spoken highly of our friend Dan White before; but the more I see of him, and read what he has to say, the more I believe he is chock full of good hard common sense.

Peddling seems to be very distasteful to many; yet the most disagreeable feature of it is removed by the method proposed. To knock

at the front door and try to *force* a sale is something that nine-tenths of us will not do; but to tell the lady of the house that you are not selling anything to-day, and that you would like to *give* her a sample of nice honey—why, it seems to me that would be easy. Then the idea of letting the honey-leaflet and the postal card do the talking, and take the order afterward—well, it is the best idea that has yet been proposed.

I hope every reader will take pains to read this article. Try the scheme, and then report. You may not all be as successful as was our friend Dan, with his honest-looking face and general appearance of one who earns his bread and butter and honey by the sweat of his brow. I tell you it is worth a good deal to have an honest heart inside; for in a short time it will blazon itself in big letters all over the man. I am going to ask Dan to send us a photo of himself.—ED. *Gleanings*.]

It will be admitted that the above plan is original, thoroughly American, and, we venture to say, one which few bee-keepers would ever dream of putting into practice here. They may, however, gather not a few useful hints from it.

The article in our contemporary immediately following that quoted above is by Mr. Geo. L. Vinal, who, to use an American phrase, "goes one better." It, too, deals with the same subject, and is thoroughly interesting reading, as showing the different customs prevailing in the old country and the new.

DEVELOPING THE HOME MARKET.

By Geo. L. Vinal.

In all the literature on bees and honey, we are urged to develop the home market. Acting on the advice after I had travelled over my regular route this fall I went into an entirely new locality. After enjoying the scenery and the sunlight for about a five-mile drive I called at a farmhouse and inquired of the good lady if she would like some honey.

"Well, yes. I should like some, but I have no money."

Seeing some ducks, I offered to trade honey for ducks; and for a pair I gave four pint jars of honey.

Calling at another house, I sold 2 dols. worth for cash; and while I was talking with the man one of the ducks gave a quack, which led to an inquiry as to what I had. I told him I had traded honey for ducks.

"Well, now, look here: can't I trade you some hens for some honey?"

I traded for half a dozen, and made the children, I hope, happy (I was). In this way I passed the day, and on my drive home I was trying to figure out my profits.

I had disposed of two gross of pint jars, and 120 lb. of comb honey. For the pint jars I received 25 cents; also 25 cents each for the

sections of comb. I had had a royal day's sport; and as I listened to the quack of the ducks and geese, the cackle of the hens, and squeal of the pigs, and looked at the large box of eggs that I had in the wagon, I thought I would have to send for some of Dr. Mason's egg-preservative.

After getting home I took account of stock. I had 54.40 dols. cash, 108 dozen eggs, 8 ducks, 1 goose, 2 pigs, 24 hens, and 1 bull pup. (The pup is for sale.)—*Charlton City, Mass.*

The relation of what our American friend calls his "Royal day's sport" is—in its quiet humour—worthy of Mark Twain: especially the "stock taking" and the sly "free ad." at the close. It makes one quite curious to know what that bull pup will fetch in cash or "kind."

SCOTTISH BEE-KEEPERS' ASSOCIATION.

SHOW AT EDINBURGH.

The Royal Diamond Jubilee Show of the Scottish Bee-Keepers' Association was held in the Waverley Market, Edinburgh, on November 18, 19, and 20, in connection with the Chrysanthemum Exhibition. The weather was most favourable, and, considering the lateness of the season in the North, the number of entries was unprecedentedly large; in fact, it is doubtful if ever such a large amount of the finest British honey was brought together in Scotland before. The whole *tout ensemble* of the exhibition of honey, &c., had an imposing and pleasing appearance, and was one of the most attractive corners of the market. The following gentlemen officiated as judges:—Comb honey: Sir T. D. Gibson Carnichael, Bart., M.P., and Messrs. H. Stevens, Alexandria, and G. Symington, Coodham; honey in jars: Col. Bennett, Alloway Park, and Messrs. A. Pearson and J. Johnstone. Their awards were given after the most painstaking trials, and gave general satisfaction.

The success of the Scottish Bee-Keepers' Association is now absolutely secured, and it only remains for the bee-men of Caledonia to rally round the Scottish standard; not only to hold their own in honey production but to carry a friendly warfare into competitions south of the Tweed.

AWARDS.

Display of Honey.—1st, T. Clark, Jedburgh; 2nd, J. Ross, Dumfries; 3rd, J. Clark, Carnwath.

Twelve 1-lb. Sections.—1st, F. Chapman, Wells, Somerset; 2nd, A. Anderson, Minto; 3rd, Mrs. Ross, Dumfries.

Twelve 1-lb. Sections (Heather Honey).—1st, Mrs. F. B. Williams, Bargrennan; 2nd, J. McDonald, Kingussie; 3rd, J. Ross.

Twelve 1-lb. Jars Extracted Honey.—1st, J. Ross; 2nd, R. McNaught, Auldgrith; 3rd, Mrs. Ross.

Six 1-lb. Jars Granulated Honey.—1st, W. Hogg, Castle Douglas; 2nd, T. Clark; 3rd, J. W. Nelson, Appleby.

Six 2-lb. Sections.—1st, J. Ross; 2nd, S. Roebuck, Dumfries; 3rd, R. McNaught.

Twelve 1-lb. Jars Heather Honey.—1st, J. McDonald; 2nd, A. Boa, Biggar; 3rd, H. Attfield, Ascot, Berks.

Non-Sectional Super.—1st, S. Roebuck; 2nd, R. Weir, Carnwath; 3rd, J. Clark, Carnwath.

Beeswax.—1st, Charles Jaffy, St. Ninians; 2nd, J. H. Howard, Holme, Peterborough; 3rd, S. Roebuck.

Honey Cake.—1st, W. Weir, Heriot; 2nd, R. Colthart, Abington; 3rd, S. Roebuck.

Cottager's Hive, and for Heather.—1st, J. Allan, Stewarton.

Comb Foundation (Brood and Super).—1st, J. Allan; 2nd, A. Boa.

Three 1-lb. Sections and Three 1-lb. Jars Extracted Honey (Cottagers only).—1st, H. Myers, Castle Douglas; 2nd, R. Hogg, Galashiels; 3rd, R. McNaught.

Three 1-lb. Sections (Sweepstakes Competition)—1st, Mrs. Ross; 2nd, J. Ross; 3rd, W. Hogg.

Three 1-lb. Jars Extracted Honey (Sweepstakes Competition).—1st, W. Hogg; 2nd, Mrs. Ross; 3rd, J. Ross.

In addition to the valuable money prizes and silver medals, a number of certificates of commendation were granted to meritorious exhibitors in all the above classes. The Show was a pronounced success, and augurs well for the next exhibition, which is to be held in the Waverley Market, Edinburgh, in connection with the Horticultural Society's Show of 1898.

I append a few brief notes on the various classes staged at the Show:—

Display of Honey.—Great taste shown in the different styles of erection. Grand collections. The first three admirable. *Twelve 1-lb. Sections.*—Keenest competition. The honours went South, but Scotchmen ran up close. *Twelve Sections Heather Honey.*—Considering the season, a wonderful display. *Twelve 1-lb. Jars.*—A huge class, very difficult to judge; towards thirty entries; Dumfries well to the front. *Six 1-lb. Jars Granulated Honey.*—Some of the finest ever shown. *Six 2-lb. Sections.*—Grand sections; but 2-lb. sections dying out. *Twelve Jars Heather Honey.*—A few very fine ones; but judges complained of thin and mixed honeys. Cause—Bad season. *Non-Sectional Supers.*—A fine lot. In the North this class is still popular, though waning. *Beeswax.*—Large number of entries; Mr. Howard well to the front. *Honey Cake.*—Very first-rate, and toothsome. *Cottagers' Hive.*—Naturally a weak class at this season. *Comb Foundation.*—Some fine specimens of the new "Weed." *Cottagers' Classes for Honey.*—Interesting, but weak. *Three 1-lb. Sections (Sweepstakes).*—Good, but few. *Three 1-lb. Jars (Sweepstakes).*—Grandest lot in the Show. R. McC., Hon. Sec. and Treas.

Correspondence.

The Editors do not hold themselves responsible for the opinions expressed by correspondents. No notice will be taken of anonymous communications, and correspondents are requested to write on one side of the paper only and give their real names and addresses, not necessarily for publication, but as a guarantee of good faith. Illustrations should be drawn on separate pieces of paper. We do not undertake to return rejected communications.

THREE-SIDE-CUT SECTIONS.

THE IDEA NOT A NEW ONE.

[3066.] In your issue of November 4 (p. 431) it is reported that at the last conversation of the British Bee-keepers' Association Mr. F. W. L. Sladen exhibited his section cut through on three sides. It may interest Mr. Sladen and others of your readers to know that I have had such sections in use since 1887, and believed the idea was original with myself. I have so far seen no claim dating back to that time.

There can be no advantage in the groove cut in bottom of the section, seeing that it is only possible to use so-called full sheets of foundation when they do not reach the bottom by about $\frac{1}{4}$ in., otherwise the sheet will usually warp. The question was raised at the meeting referred to whether the experiment had been tried of sending these sections out in hot weather, with the foundation fitted in such sections. I may say that the experimental stage has long since been passed, and that since the date named I have sent out many hundreds of sections cut through on three sides, with full sheets of foundation fitted in, and I have received no complaints, though sent as part of complete hives by goods train.

I may further state that in 1889 I first adopted a section completely divided through the centre, placing a whole sheet of super-foundation right into the three sections at once; perhaps the most expeditious plan ever devised for furnishing sections. In this case each set of three halved sections is held in a $\frac{3}{4}$ in. frame or holder; the foundation laid across one half set, with the other frame and its three halves pressed directly upon it.

The object of this development was that the foundation might be started or partly worked before inserting between the halved sections. The three-side-cut sections are also adapted to these twin $\frac{3}{4}$ in. holders, allowing the full length sheet to be dropped into all three at one operation.—SAM'L. SIMMINS.

[Correspondence continued on page 466.]

HOMES OF THE HONEY BEE.

THE APIARIES OF OUR READERS.

Mr. John Lee, a portion of whose apiary appears in the illustration on opposite page, is an old reader of the BEE JOURNAL, and, as we learn, located in a good honey district of Bedfordshire. There are in the apiary shown something over forty colonies, but, as will be seen,

the bee-house behind the tree in centre of the picture divides the hives into two lots, save where a few of those on the far side are visible through the opening between the two buildings. The figures shown are those of Mr. Lee and his son, who assists in the apiarian work. In writing us a few lines about himself as a bee-keeper, Mr. Lee says: "I have been very much interested in bees ever since I was a boy: and as soon as I left school, I bought one stock. But my father, being strongly opposed to my keeping bees, would not allow of my purchase being set down in our own home garden. A neighbour, however, living close by, kindly permitted me to fix up

time, he says, "there were several in the village who kept bees in skeps on a fairly large scale, but they and the bees have now 'gone the way of all flesh'; but their bees and bee-doings were of great interest to me; indeed, all through my life, work among the bees has been to me a source of pleasure and delight." Nor as a man, now over fifty, does his interest in the pursuit slacken. Last winter he brought every one of his forty stocks through in good condition, without loss of any kind.

Assisted by his son he has, we are told, packed and sent away thousands of sections, and finds them safe in transit if combs are

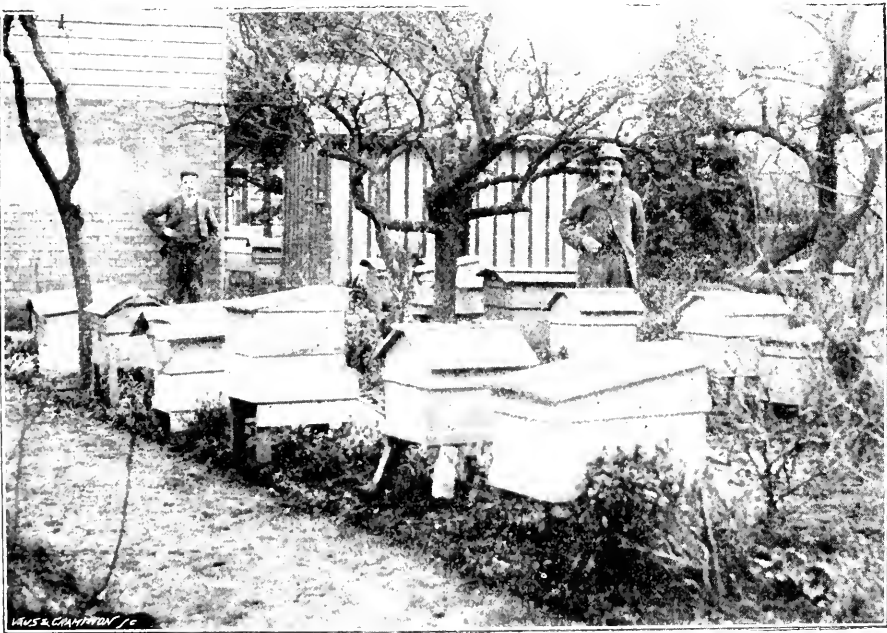

MR. JOHN LEE'S APIARY, DUNTUN, BIGGLESWADE, BEDS.

my purchase in her garden, and I kept them there for some years, in fact, up to the death of my father. I then commenced bee-keeping on a larger scale, not only for pleasure, but for profit also, and I have received a very fair and satisfactory share of profit, seeing that two years ago it was enough to enable me to have built the large and commodious bee-house in which to work in, and to keep all my appliances, seen in the photo. It was erected for me by Mr. Blow, of Welwyn."

Mr. Lee relates how, as a boy, he never missed an opportunity of slipping away from home to hive swarms of bees for the neighbours. This was nearly forty years ago, at which

properly built to the wood and reasonable care is exercised in packing. This, however, is the experience of most bee-men who have large quantities of honey to sell. Practice—and the need for safe delivery—makes perfect. We need not add more to the very brief particulars furnished to us beyond saying that Mr. Lee is one of those who love the bees, and is so satisfied that they are a paying hobby that he says in conclusion: "I often think what a mistake young people who live in the country make in not having a hive or two of their own. They would find 'pocket money' in it, and it would add to their happiness while young and after they become old."

(Correspondence continued from page 464.)

CURRENT TOPICS.

[3067.] *Winter Stores.*—Up to the date of writing autumn and early winter has left little for the bee-man to grumble at. Bees have had exceptionally fine weather, in which, with the help of their owners, to put their houses in order, and ample time has been afforded for supplying additional stores wherever required. To do a little extra feeding in such mild weather as we have had shows but a wise precaution, for none know what is to come in the shape of bad weather. Many will remember how woefully short of food colonies of bees were found early in the season of '97, owing to the protracted and inclement spring; a past experience which—taken along with the drain upon stores incurred through the late mild autumn—should be sufficient to induce some augmentation of the supply already within by a little from without, in the shape of a cake of soft candy. It will do no harm and may be exceedingly helpful later on.

Mating of Queens.—Taken altogether, the late season has afforded, to myself, a remarkable experience in queen-raising. Out of a very large number I only lost six young queens on their mating trips, and considering the fact that I am rearing queens almost continuously from May to September (five months), 1897 is with me a record. The last five queens reared in my apiaries were mated between October 3 and 5, which is unusually late even here in the south. But if any virgins had been still left on hand, their fertilisation would have been not only possible but very probable for ten days later, seeing that pollen was carried into the hives plentifully up to quite the middle of the month.

Foul Brood.—It has been quite a relief to take up either our *JOURNAL* or *Record* during the last few weeks and find that this plague has not been much to the fore. We had a long spell of it, both the literature on the subject and accounts of direct experience of the disease itself in the respective counties where my own and other of your readers' apiaries are located. Judging by reports received by myself as a county secretary, it seems pretty evident that the thorough rousing-up of all concerned with the craft to the threatened danger has had a salutary effect; not that our enemy is thoroughly "scotched," to say nothing of killing, but the results show that foul brood is perceptibly less prevalent of late.

It would, of course, be absurd for us to suppose that the disease has to any great extent been mastered. It will require years of persistent effort before this desideratum is realised, but to have some control over the enemy is an important point gained. It is, in my opinion, epidemic in a great measure, but if we keep on the alert and always watchful, it is certain that patient effort will be rewarded, and we may hear much less of it than formerly.

To take immediate steps for its extermination directly the first trace is seen is half winning the battle.

Using Tin Vessels for Honey and Wax.—Referring to the discussion which has been raised in the *BEE JOURNAL* on the suitability or otherwise of tin vessels for storing honey and rendering wax, my own experience is that after keeping honey in tins for months there has been no detrimental effect on its flavour whatever. In fact, all my honey is ripened in a tin vessel that has been in use many years. With regard to wax-extracting, I have used a solar extractor, but have abandoned it, chiefly because of the very short time in which there is sufficient sun-power to make the thing work effectually; and when it does act well, it comes just when one has most other things apicultural to see to. In other words, I prefer to leave the rendering of wax until time is of less value than at the height of the bee-season. Hence I have to be content with an extractor of the Gerster type, made of the usual tin-plate. The wax resulting from this is excellent both as to quality and colour. The appliance is also, in my view, more convenient to use than the solar arrangement. Of course, the wax is graded before being melted down; nor must we mix brood-combs with cappings. As your correspondent "Morning Cloud" mentions on page 427, we have tin-ware made from metal coated with what is only sham tin, so made because of cheapening the vessels manufactured from it. The moral is to get the right article, and not that coated with an inferior amalgam, known as "terne metal," so called because of its consisting of three metals, viz., a thin plate of sheet-iron, coated with tin and lead combined, lead predominating in the commoner article. The best goods, on the contrary, are made from the iron plate coated with tin only, the latter being a metal not readily oxidisable under ordinary conditions, and, in my opinion, having regard to the very minute quantity of acid contained in honey, perfectly harmless when used for either of the purposes in question.—HENRY W. BRICE, Dale Park-road, Upper Norwood.

WAX IMPORTS.

USES OF BEESWAX.

[3068.] I was pleased to see in this week's *B.J.* that your efforts to obtain information as to our annual imports of wax have been successful, and thank you for the trouble you have taken to get those figures. If it can be ascertained whether or no all this £194,000 worth of wax was beeswax, additional interest will attach to these figures. Can some *B.J.* readers tell us of some uses to which beeswax is applied beyond those generally known? I am sure it will be interesting to know what becomes of this enormous quantity of wax. A comparatively small portion of the imported wax is, I know, re-exported, and apart from

the many tons of *beeswax* used in the manufacture of comb foundation, wax is used in the preparation of such compositions as "dubbin." The best firms of saddlers use a good deal of beeswax, and chemists all use more or less of the same. The best quality of wax candles, I believe, are also made from beeswax, while the commoner kinds are manufactured from mineral waxes. We are also told that the demand for beeswax is now much less than formerly, and looking back to the eighties I find that our imports of wax were then less each succeeding year. In 1885 the value of imported wax was £149,253. In 1886 it came down to £126,377, and in 1887 decreased to £119,927. From that time, however, our imports of wax appear to have been increasing considerably, and the figures quoted on page 452 show that the quantity of wax imported during the year 1896 was 43,168 cwt., value £194,630. Coming down to small figures, and concerning myself only, the orders that I have received for beeswax have increased very perceptibly. This year, after buying up all the native beeswax I can—which with my own produce will only fill half my orders—I have to divide this among my customers, and what more they require they will of necessity have to buy from the foreigner.

There are many bee-keepers who do nothing towards reducing our imports of beeswax, but habitually throw away their old pieces of comb, which should be melted down for wax, for which there is such a great demand. At the present time even wax of dark colour sells readily.—W. M. LOVEDAY, *Hatfield Heath, Harlow, Essex, November 20.*

VARIOUS BEE NOTES FROM YORKS.

[3069.] *The "Wells" System.*—I desire to express my thanks to your correspondents, Messrs. W. Loveday, R. Brown, and J. Rymer, for so kindly and fully responding to my desire for "experiences" with the "Wells" system. Their several accounts gave me great interest, and, no doubt, readers along with myself will be much obliged to them.

The Shamrock.—Having lived in Ireland for nineteen years, I am able to endorse your statement regarding the shamrock. Throughout the greater part of the country the plant, commonly known by this name, is a very tiny one, with leaves very much smaller than those of the white clover, and of a purply-green colour. It grows almost everywhere—

"It thrives thro' the brake, thro' bog and the mireland,
For it is the dear LITTLE shamrock of Ireland."

In a few benighted places I have found people adopting white clover as the shamrock, and in other places various varieties of the trefoil are occasionally used as the national emblem; but the plant generally known and adopted is, as stated, a very tiny one indeed.

I am ignorant of its botanical name, but should a sample of the genuine thing possess any interest I will get one forwarded to you from distant co. Kerry. I never saw it in flower, but it may bloom for all that, as, unless about St. Patrick's day, I never took much notice of it when growing.

Packing Honey for Post.—Many of your readers seem to have great trouble in sending honey safely by post, especially in sections. I have sent several lots by post this season (not my own) and without mishaps, by merely placing a thin piece of wood, about $\frac{1}{8}$ " thick, on each side, cut to exact size of the section, and wrapping all up in one fold of paper. The sections were, of course, all well sealed. When forwarding two sections in one package I merely placed one of the thin boards between the two and one at each end, tightly packing all in paper and tying as before. It is not necessary to put wood over the *sides* of sections; they are quite strong enough to bear all the pressure they are likely to be subjected to in that direction. If packed tightly, so as not to allow of them shaking about, they will go quite safely. In fact, this is the essence of all packing. I have sent bottles of chemicals a couple of hundred miles with no packing whatever beyond pressing the bottles so tightly together that they could not shift and break each other. If this be thought unsafe, a fold of newspaper round each, just once or twice, is absolute protection. I am often the reverse of pleased when parties sending me goods find it necessary to send with them a lot of hay, straw, and litter of all sorts, making it a labour to find the goods themselves in the medley, when the same goods, if packed on the "can't shift their position" plan, might come much handier, and at less expense of time, money, and comfort. Of course, articles too fragile to bear pressure must be packed in hay or other soft springy substance, but sections well sealed travel quite safely if the comb be protected by pieces of wood placed to cover the ends of the sections.—W. J. FARMER, *Yorks.*

THE SHAMROCK.

IS IT A HONEY PLANT?

[3070.] In reply to Dr. Miller (page 455) you say in a footnote that the shamrock accepted by Irishmen is the wood sorrel (*Oxalis Acetosella*). Allow me to say that there is as much difference between *Oxalis* and the "chosen leaf" as there is between a wild rose and the moss-rose. It is more than fifty years since I wore my first shamrock, and I never once knew the *Oxalis* to be worn. The shamrock bears a yellow, not a white, flower, and its leaf is much smaller than clover; it is known as *Trifolium minimum*, or *T. major*—the former preferably.—AN IRISH READER.

[While only too pleased to allow an Irish reader to have his "say" on a subject about which an Irishman ought to know something, we are afraid our correspondent's botany is a

little at fault. Anyway, we cannot find in Nicholson's "Dictionary of Gardening" (a standard text-book on the subject) any mention either of *Trifolium minimum* or *T. major*. Moreover, although we had not consulted "Nicholson" when our footnote on page 456 was written, we have since done so, and find the following on page 427:—"Shamrock.—In some districts of Ireland, this name is applied to one or more species of clover; in England the wood sorrel is generally supposed to be the shamrock." To this we can add the fact that Irishmen seem to accept the wood sorrel, too, as the shamrock, so far as wearing it on St. Patrick's Day in England is concerned.—EDS.]

HUMBLE BEES FOR AUSTRALIA.

[3071.] A luminous article in leader type appears in to-day's *Bristol Mercury* on the possible dangers of introducing the humble bee to Australia from New Zealand to fertilise red clover. "There is no reason," says the writer, "why these New Zealand bees should not take after the rabbits. They may likewise increase in size, and not only become a nuisance, but distinctly dangerous." But the writer seems to forget that if the bees increased in size, and "made for" the rabbits, they may be a great blessing to the colonies. Our editors wisely use the blue pencil and give the "cut direct" to any reference to politics in our JOURNAL; and so I can only venture a word to say how remarkable it is that so great a dread of armed forces in the shape of the "humble" (worker) bee should come from a paper so ultra-democratic as the *Mercury*. Why, the poor *Bombus* may apparently become bloated aristocrats, unless they are kept down,—nay, keep them out from the very first.

The article does not speak directly of Providence, though it exalts Nature to the throne of intelligent direction of affairs in keeping the bees out of Australia up to the present time. "No doubt," it says, "Nature has a good reason for the total absence, or scarcity, of bees in this Colony," and "Nature does not like to be unduly corrected." One can imagine the writer's smug contentment with Nature's allotment of prescience, which allows the inditing of such an absurd article. And one is afraid it is better to acquiesce in Nature's dole to the journalist than to try to improve his knowledge.

The writer's natural history is about on a par with his natural religion. "Not being an expert in matters botanical," he does not know "the direction in which the peculiar properties—whatever they may be—of fertilised red clover are applied." Well, many of our farmers know as little of botany—but that is saying a great deal—as the writer, but they know a good crop of succulent red clover, or the first-class dry fodder it makes, and they know that to get the crop they must have the seed, and its fertility is a peculiar property of

the perfected product of red clover. We may remind the writer, too, that if the humble bees develop themselves enormously, it will be no good for "the Agricultural Department eventually to import sparrows to kill the bees." The writer allows that "the presence of these magnified bees may be all right so far as honey is concerned." It really seems hard to rob him of his one consolation, but it must be done. We do not get our honey from the humble bees.—READER, *Bristol*, November 22, 1897.

EXPERIMENTS WITH NON-SWARMERS.

THE USE OF DUMMIES FOR PREVENTING SWARMS.

[3072.] Referring to Mr. L. A. Aspinwall's article on non-swarmers, in B.J. of last week (p. 458), the writer does not say how the dummies are used. Reading between the lines, however, I take it that a thin dummy is placed between each frame or comb within the hive. Is this so?—ROBIN HOOD, *November 19*.

[We hope to print some further particulars regarding the dummies used by Mr. Aspinwall in an early issue.—EDS.]

STARTING HONEY SHOWS.

[3073.] As a reader of the B.B.J. of some years standing, I have taken the liberty of sending you a schedule of our annual fanciers' show at Basingstoke on December 8 and 9. As you will see, we have this year two classes for honey, and I hope it will be a success, as I have been trying for a long time to get some classes for honey, but could not do so till this year. Knowing the great interest you take in bee-keeping, I write to ask if you would kindly insert the date of our show in "Shows to Come." By doing so it will help us in our first attempt, and also aid in getting more classes next year. Thanking you in advance.—GEORGE SLATER, *Basingstoke*, November 16.

[We gladly give publicity to the above request, and hope some readers will help to give our bee-keeping friend's venture a good "send off," by entering an exhibit or two on occasion. See page 470 for particulars.—EDS.]

NOVEMBER HONEY.

[3074.] I venture to enclose a small sample of honey, the source of which it would be interesting, if possible, to know. I have good reason to believe it has been gathered almost entirely in the last three weeks. Surely this is a record for November? About a month ago I drove some bees from between the walls of a neighbour's granary, where they had stored some 40 lb. of honey; leaving the honey, as agreed, I successfully removed the bees clustered on five frames to which I had tied empty comb. By-the-by, I was unable to find

a trace of brood. To this stock I united two other driven colonies, filling up the hive with combs from which the honey had been extracted. I was, from one cause or another, unable to attend to the important matter of supplying the bees with their winter's store of sealed frames until yesterday, when, to my surprise, I discovered that all the combs had more or less honey in them; and I have extracted the sample from them. For some days the weather has been unseasonably mild, and we have not had a severe frost since September went out, so that many summer and autumn flowers are still making a brave show. Close by my garden is a field yellow with "charlock." Is that the happy hunting-ground of the gatherers of this November honey?—N. HAMPSHIRE, November 18.

[There is little doubt the honey comes from the charlock. It is, of course, abnormally thin, as it may well be at this season of the year; but it will do fairly well for wintering the bees on. The only source from which honey is gathered in appreciable quantities during the months of October and November is the ivy, which at odd times yields pretty freely for a few days.—EDS.]

THE "WELLS" SYSTEM.

[3075.] Your correspondent, W. J. Farmer, who wrote, on page 428, asking for reports on the "Wells system," does not seem to be getting many, which I cannot understand, seeing how numerous are the readers who are trying Mr. Wells's plan. Mr. W. Loveday's experience (p. 434) differs altogether from my own, as I have had a "Wells" occupied for three years without a swarm from it. What I have seen about these hives compares most favourably with the single queen stocks. The first year my "Wells" was occupied I was using very thin foundation for supers, which the bees utterly refused to work out, and not finding out the reason till too late, I got no surplus in consequence. The next year, with fresh foundation, the bees set to work with a will; but a bad year followed, and I only got 40 lb. of honey from the double-queened lot; but from my single hives I got nothing. This year I took 100 lb. from the "Wells" hive, in addition to having four supers of worked-out comb to start next season with. My single-queened hives only yielded about 9 lb. each. Two of them, however, were swarms and two artificial swarms. The "Wells," therefore, compares very favourably with these. I ought, however, to say that I do not strictly follow Mr. Wells's method; never taking the division board out to remove the propolis from perforations of dummy, yet the bees never fight when allowed to work together. If novices adopt this plan, and do not follow it out carefully, it is unfair to lay the blame on Mr. Wells.

I have set up one more double-queened stock this autumn, and intend ordering a third

"Wells" hive from the makers, feeling confident that they are the best to use. I hope, however, that other readers will give us their views either for or against.

The weather here is very open, bees bringing in pollen daily; this points to late breeding and young bees for the spring. I have sold nearly all my honey in single jars at 11d. per lb. retail, a little cheaper for larger quantities, only about 50 lb. of my crop being left on hand.—S. H. TOLLINGTON, *Leicester*, Nov. 18.

P.S.—If your correspondent, "A. Bullpitt," who writes on page 460, will send me seven penny stamps addressed to c/o the B.J. office, I will send him the book "How to Make Extractor."

Queries and Replies.

[1882.] *Dividing Stocks in Spring.*—Will you kindly answer the following:—1. How soon can a stock be divided in spring? Can it be done with a fair chance of success, say, the first week in May, if the weather be fine and warm, and the stock strong and in good condition? 2. Would there be any chance of success in trying to raise queen-cells so early as the first week in May; and, 3, if so, in dividing, would it do to place frame containing queen-cells with other frames of brood in new hive; or only cut out one for transfer to new hive? 4. After dividing, are frames of foundation to take the place of frames of brood from the stock hive, or do you close up remaining frames and then fill with new ones? I have two stocks, one in a frame-hive the other in a skep. I propose in early spring to place the skep above the frames of a new hive, and as soon as possible after divide the stock in the frame-hive by taking half the combs containing brood (brushing bees back) and placing them in a new hive. Then place this latter on the stand now occupied by the skep in frame-hive, which by this time should have got fairly strong. If I can get queen-cells started on frame of brood in this new hive, it would save a lot of time. If these operations can be successfully performed by the first week in May, would they all be in good condition for the start of the honey flow about June 1? I crave your indulgence for this long string of questions, and my excuse is that I am anxious to succeed with bees as well as it is possible in this district, and therefore I must get the whole routine by heart beforehand, so that I shall know what to do in case of emergency.—G. KRICHELDORFF, *Hornsey, N.*, November 18.

REPLY.—1. Stocks may be divided successfully in May if bees are strong and weather fine and warm as stated. 2. Yes. 3. Cut out queen-cells and place where required. 4. Do not add any frames, either of foundation or comb, until bees have a laying-queen and are strong enough to cover same. Simply

reduce space by closing the frames up. As to stocks so dealt with being in "good condition" for the honey-flow about June 1, such a thing is impossible. You must either be content with increase only, or gather the harvest first and divide afterwards. In a district so near to London we should advise care in carrying out such operations as are proposed; far better to keep stocks at full strength than divide them to any great extent.

[1883.] *Keeping Sections over Winter.—Distributing Foul Brood Samples.*—1. I have a quantity of sections filled this year, but, as the price is low at present, I am induced to ask, if I keep them over till springtime, will the honey become candied? And if so, would they be as saleable in this state as in the liquid condition? 2. If I send cost of postage will you forward me a piece of comb affected with foul brood, so that I may be able to detect the disease immediately if it ever appears amongst my own bees?—"ANXIETY," *co. Kilkenny*, November 18.

REPLY.—1. Unless the sections can be kept at a warm temperature, (about 55 deg. to 65 deg. Fahr.), the honey will granulate, and in this condition be unsaleable as comb honey. 2. On no account could we undertake to send samples of diseased combs about the country as desired; therefore, while commending our correspondent's expressed anxiety to guard against risk to his own bees, he should be content to gather from print such knowledge as will enable him to detect the disease, while keeping any direct contact with foul brood as far from his apiary as possible.

Echoes from the Hives.

Brightlingsea, November 14.—I cannot let this day (November 14) pass without an "echo." I have been watching my bees with great pleasure. I am not quite thinking of putting on sections yet, but to see the bees come home laden with pollen, and such a day as this in November, makes me wish it was February instead of the last month of the year. In fact, to-day here has been like to a May day. Wherever do the bees find forage now? I cannot imagine. The only flowers in bloom to my knowledge are the chrysanthemums and violets, a few strawberry and very few raspberry blooms, which are very weak. I gathered two ripe raspberries on November 5. I have taken several colonies from trees and houses this year. In one old farm-house close to where I took about 50 lb. of honey and bees, I found a nest of comb which has cells so abnormally large that I cannot understand it. Nor do I know what sort of bees built it. My own stocks have not done much this year, but I have got three friends to start bee-keeping since I wrote you

last. I have only a small apiary now, but hope to be able to send you a photo of large one some day.—A. BAGLEY.

Bee Show to Come.

December 8 and 9, at Basingstoke.—Annual Show of the Basingstoke and District Fanciers' Association. Classes for **Twelve 1-lb Sections** and **Twelve 1-lb. Jars Extracted Honey**. Bronze Medal of the Hants and Isle of Wight B.K.A. for best honey exhibit. Schedules from W. B. Cannon, Hon. Sec., 5, London-street, Basingstoke. **Entries close November 27.**

Notices to Correspondents & Inquirers.

All queries forwarded will be attended to, and those only of personal interest will be answered in this column.

J. S. R. (A Beginner).—*Making a "Wells" Hive.*—After saying that we do not consider the "Wells" hive or system at all suitable for a beginner in bee-keeping, we advise our correspondent to procure Mr. Wells' pamphlet on his method of working on the double-queen plan. This may be had from the author, G. Wells, Aylesford, Kent, for 6½d. He will no doubt be able to gather from it all the information needed.

W. T. P. (Cheshire).—We are entirely at a loss to understand your extraordinary letter dated 20th inst. The contents are, however, unsuitable for publication in our pages, and we therefore acknowledge its receipt without further observation.

E. B. (Horsham).—*Using Honey from Diseased Hives as Bee Food.*—1. The comb sent is affected with foul brood, and it would be the height of folly to use the honey in the hive as bee food. Sprinkling the honey with a disinfectant will not remove the danger at all, and so long as it can be safely used for household purposes we should not let the bees taste it, no matter how "very full of honey" the combs may be. *Danger of Lending Honey Extractors.*—2. It is a risky thing to lend honey extractors at any time, but to allow its use in a district where foul brood exists is courting danger. We should on no account do any such thing. The bees suspected of robbing the diseased lot must be carefully watched in the early spring of '98.

J. S. (Downham Market).—*Preparing Driven Bees for Winter.*—1. If the bees have "seven frames fairly well filled with sealed food," they should take no harm between now and March next. 2. The excitement among the bees noticed just now is no doubt caused by the candy recently given. The particles they carry out are granules of the candy too dry for the bees to consume as food. No harm will follow. 3. Leave the zinc at entrance till warm weather returns, and bees need door-room.

Editorial, Notices, &c.

USEFUL HINTS.

WEATHER.—The prolonged mildness of the weather which has made the autumn of 1897 memorable to bee-keepers was roughly ended by the arrival on our shores of disastrous gales and rain storms, beginning on the evening of the 28th, and culminating on the following night in a storm of great intensity (with showers of hail, snow, and rain) which extended over the entire kingdom. Floods and unprecedentedly high tides around the Kentish coast and in the valley of the Thames have done great damage by water, and the gale, which sorely tried the stability of ships, will have tested the stability and thoroughness of the arrangements made by bee-keepers for protecting their hives. It is, therefore, safe to assume that many stocks will have been unroofed, some, mayhap, submerged in water, and hives blown over. By way of repairing damage of this kind, the first thing will be to substitute dry coverings for wet ones, and dry hives if needed. Leaving out of view then, without overlooking the more serious consequences in loss of life and the extensive damage caused by storms of such violence, we may point out to readers that prompt attention to mishaps in the apiary is at this season absolutely necessary in order to minimise the mischief. Advantage should also be taken when inspecting hives to judge how stores are holding out, because of the continued activity of the bees for so long a time after the normal date of their going into winter quarters.

THE SHAMROCK.—Only those who have read the correspondence resulting from an amusing remark in our issue of the 18th inst. (p. 455), by Dr. Miller, of Marengo, Illinois, U.S.A., who asked, "Is white clover not a honey plant in Ireland?" will understand the reason of our taking up the shamrock in this column. It is gratifying to note how readily readers evince interest in subjects outside bee-keeping, and report what they know or what they can acquire by reading on questions like this. Dr. Miller also, when he reads his B.B.J., will readily acknowledge that his question has not been asked in vain. The several letters in

this issue lend additional interest to those already printed, though not getting us very much "farrarder," so far as settling the question is concerned. Our correspondents "G. F." (Sussex) and W. J. Farmer, who write on page 475, of this issue, both become practical, each sending a specimen of the plant they refer to. "G. F." encloses rooted plants of "what the people in his part call shamrock." Those received, we may inform "G. F.," are the genuine wood-sorrel (*Oxalis acetosella*); and, with regard to it, we incline to agree with the antiquarians he quotes, in contending that "the Saint probably selected a leaf of wood-sorrel as illustrating the doctrine of the Trinity." On the other hand, we have the testimony of Mr. Farmer on the same page that Irishmen all over Ireland wear the plant of which he kindly sends a specimen, and we confess to having frequently seen this same plant in the buttonholes of Irishmen; but this is not a trifolium at all, but belongs to the genus *Medicago*, its true name being black medic (*Medicago lupulina*). The leaf is trifoliate, and, being very plentiful in the country, and looking its best on March 17 (St. Patrick's Day), it is usefully employed as a buttonhole-plant which keeps its freshness well for a whole day. Hence, probably, its adoption for the purpose: for the rest, and as further uninformed opinion, however interesting, will not usefully add to what has been said, we may close the discussion with a line from the Dictionary of Dr. Miller's great countryman, Noah Webster, who says of the shamrock:—"The original plant was probably a kind of wood-sorrel (*Oxalis acetosella*), but now the name is given to the white clover (*Trifolium repens*) and the black medic (*Medicago lupulina*)." It is certain that while authorities are so divided on the subject, we must "agree to differ," and let each select his own shamrock, of course giving our Irish friends first choice.

PACKING HONEY.—We are glad to notice that the question of packing honey has been once more mentioned as a subject for discussion: Mr. W. Woodley, in this issue, continuing his remarks began on page 453, while our Scotch contributor, Mr. W. McNally, devotes the whole of his monthly article in the

Record to the same question. It is also gratifying to find practical men like both of the above in, we may say, perfect accord with the views expressed by ourselves some half-dozen years ago in one of the series of "Bee-papers for Winter Reading." The article to which we refer appeared under the heading "Packing Honey" in the BEE JOURNAL of February, 12, 1891, and was written in compliance with the strongly expressed wish of the late John Huckle, than whom no man had greater experience so far as it applied to packing honey for sending to shows. He had felt more than any one of his time the force of what Mr. Woodley puts in his notes on page 472, how those who stage honey can be assisted by exhibitors who will take trouble to do things properly; and Mr. Huckle's words on first seeing the original "cut," which we reproduce

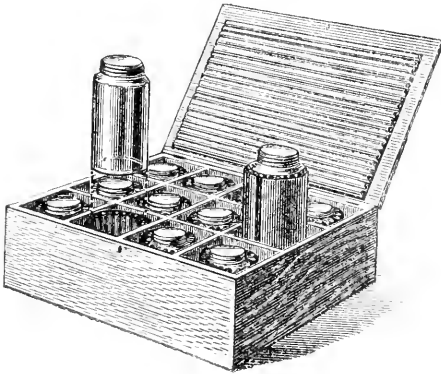

here, of a box for sending a dozen jars of honey to shows, were: "That's just the thing we've wanted for years." Of course, this applies only to those exhibitors who form the large majority of showmen, and need an appliance for show purposes which does duty for years. The one illustrated can be made by any handy man for an outlay of little over a shilling, or purchased ready-made for 2s. Sections in the same way can be sent in single dozens to shows with more safety if packed in a spring crate, which should also be included in the exhibitor's outfit.

With regard to exhibits intended to be "sold," the methods now detailed are known by practical men to be safe, economical, and efficient, and the words now written by Mr. Woodley confirm

what was said in our own article in 1891. Let us have discussion by all means, but let it be in the full light of what has already appeared in print.

Correspondence.

The Editors do not hold themselves responsible for the opinions expressed by correspondents. No notice will be taken of anonymous communications, and correspondents are requested to write on one side of the paper only and give their real names and addresses, not necessarily for publication, but as a guarantee of good faith. Illustrations should be drawn on separate pieces of paper. We do not undertake to return rejected communications.

*** In order to facilitate reference, Correspondents, when speaking of any letter or query previously inserted will oblige by mentioning the number of the letter, as well as the page on which it appears.*

NOTES BY THE WAY.

[3076.] We have now reached the last month in the year—a time of rest for our erstwhile busy workers, and a period when we can ourselves review the past, and think over the worries and the disappointments of the season. By the aid of another year's experiences, and the knowledge we have gained, we may earmark our shortcomings and classify our errors, so that another season we may start better equipped to secure a fuller share of the harvest. Nor must we forget the successes we have achieved on the show-bench. They may have been won from competitors nearly equalling our best endeavours; yet how much lustre is added to the prize when won in a contest with "foemen worthy of our steel." To those who have failed in prize winning during the past year I would say, "Don't be discouraged; let 'try again' be your motto." Another year the white clover fields, in sight of your apiary, may pour forth a flow of nectar just in the nick of time, and secure you highest honours by bringing your sections up to "first prize" standard. Or with a week or two of ideal bee-weather your "extracted" may carry all before it in consistency and flavour.

In my last "notes" I made some remarks on "shows," to which, with your permission, I will add a word or two here. I trust that others who are interested in the subject will also give their ideas on the subject, and point out my mistakes and criticise my ideas, if they consider them erroneous. The packing for bottles or jars of honey may be of the simplest nature; some of the exhibits at the Dairy Show were packed—or rather stood—one in each compartment of a wood-divided box without packing of any kind, and no wraps. These travelled safe by rail, and were quickly staged. Then perhaps the next exhibit unpacked was surrounded by a lot of hay, with each jar wrapped in two or three pieces of paper. This rolling up in paper necessitates the bottle being held on its side while unfolding the paper, and this often means "messy" bottles, with honey down the outside after-

wards. Again, when a dozen bottles and a dozen sections—or, it may be, two dozen bottles for two separate exhibits—are sent in one case, the trouble of staging is considerably increased, besides the added chances of breakage on clearing the tables at the close of the show. Some exhibitors, too, have lock and key to their travelling cases; the key perhaps is missing or the person in whose care it is placed is not at hand or possibly has not arrived. I consider locks useless appendages to travelling cases, as in more than one instance at the "Dairy" we opened the case by removing the screws that held the flap to the lid. A lock and key are no security, while they add to staging troubles. A hinged lid and two or three screws to hold it down in transit saves running about inquiring for keys, &c.

The package, in my opinion, best suited for the purpose of sending a dozen jars of honey to a show is a small grocer's butter-box; this can often be had for asking, but where a continual demand is made for them, as in my case, the charge is 2d. An inch in depth of hay laid on the bottom of box, then a piece of corrugated paper around each jar, fitting loosely, so that the latter can be easily lifted out, completes the package, so far as material. Stand the bottles in their cases in the middle of box, pack the sides with hay or odd paper, and add a piece of corrugated paper over the top. The cost of the whole would not be more than 3d or 4d., and if the exhibit is entered for sale, the very fact that the box for packing is included would often induce a purchaser to secure the exhibit. Then, when the clearance comes, the dozen bottles can be returned to the dozen cases and the boxed nailed or screwed down. Every exhibit entered for competition ought also to be entered "for sale." If the owner does not want to sell he may put on a prohibitive price. I know my suggestion is not helpful to the appliance makers, but to those who prefer a better style of box, have it simple and plain as regards the unpacking and repacking, and don't forget to have a handle of some kind, so that the porters may handle it easily. Again, have a good-sized label for your cases (mine are the size of a half-sheet of foolscap) marked in red ink: "Don't Jar! Honey in Comb. This Side Up."—W. WOODLEY, *Bedon, Newbury.*

DOES HONEY-PRODUCING PAY?

[3077.] I do not wish to start a discussion on the question, "Do bees pay?" There was one in your columns not very long ago, and on that occasion a number of small bee-keepers kindly furnished statements as to the profits which they had gained. These results were, for the most part, quite satisfactory. But my point at present is this—does it pay to produce honey in quantity and sell it at the present (low) wholesale price? It would be interesting if some of those who have large

apiaries would give their opinions. I am aware the question is rather a difficult one to answer with exactness, because most bee-keepers dispose of a portion at least of their crop at retail price, and because large bee-keepers are also engaged in selling swarms, queens, &c. Still, the views of those who produce the article in considerable quantities, and dispose of a lot of it in bulk or fair-sized consignments of jars or sections, would be valuable. With such contributors as Messrs. Woodley, A. Sharp, W. McNally, H. W. Brice, and many others, all owning large apiaries, we ought surely to secure a satisfactory answer to the question. The wholesale price is, I suppose, about 6½d. per lb. for good honey in bulk, and 8s. 6d. or 9s per dozen for 1-lb. jars or sections. At these figures or thereabouts, does the bee-keeper reap a reward worthy of his labours? No doubt opinions may differ as to the rate of profit which should be looked for. The expectations of some persons may be too high; but in putting the question I would ask for the profit to be considered at a fair and reasonable rate of return for capital and labour expended. One of your correspondents a fortnight ago stated that he had realised 10d. per lb. for all his honey this year, and that he should give up bee-keeping when he had to sell at a lower price. He is a fortunate man, but I am afraid that there is a likelihood of his dropping out of the ranks, unless he is specially favoured in regard to his market or can dispose of all his crop direct to the consumer. He will be lucky, even in the latter event, if he can sell a large quantity without going below the minimum price which he has stated. Another recent correspondent said that he calculated that his honey cost him 4d. per lb. to produce. Would he be good enough to say how he arrived at this conclusion? I should like to mention another matter, if I am not trespassing too much on your space. There is a movement at the present time to bring the producer of "home produce" and the consumer into closer contact. This, no doubt, is to the injury of the middleman. But has he not brought upon himself any disadvantage which he may suffer? As regards honey, 50 per cent. seems frequently, if not usually, to be expected by the retailer. Somewhat too large this would seem to be, seeing that honey is not a perishable article. Some dealers look for more. Mr. Woodley once mentioned in your columns that he had seen sections of his on sale at a cent. for cent. increase in price.

In this way the producer does not get his fair proportion of profit—the consumer probably pays too much—the market is restricted in extent. The remedy is for the producer to supply the consumer direct to a greater amount than he does now. Why is this not done as much as it might be? One reason seems to me to be the difficulty of obtaining suitable receptacles in which to pack the honey. This applies to all the forms in which honey is put

up, but especially to sections. The man who would make small boxes suitable for carrying say one, three, or six sections, or the same number of 1 lb. jars, and offer them at a reasonable price would, I doubt not, reap his due reward, and confer a great benefit upon many bee-keepers. Such boxes having been obtained, an advertisement offering small quantities of honey at a price rather lower than that quoted in shops would, particularly about Christmas time, in all probability bring in numerous orders.

If any of your readers know where suitable boxes can be procured they would be doing others a kindness by giving the name and address of the firm which supplies them. The material used in making the boxes should be light, yet strong enough to bear the risks of travelling by post or rail.

You, Mr. Editor, say we must trust to "p.p.p." (providence and parcel post), but I venture to remark that the hands of "p. and p." meaning "porters and postmen," are—what shall I say?—well, somewhat unreliable, when breakable articles are in transit.

May I add just one word more as to the value of honey as a cure for chilblains. I met a boy one day last winter whose hands were covered with chilblains. Next day I sent a bottle of honey to his father, and I afterwards heard that two applications were sufficient to make a perfect cure.—ENQUIRER, *Chester*, November 29.

FOR THE BEE'S SAKE.

[3078.] For the bee's sake I live in Suburbia, or rather *roost* in Suburbia; the City's throbbing heart claims me all day. There I struggle for myself and for the lives of others—the one is egoism, the other altruism. The one is selfishness, the other unselfishness. Of which do I possess the most? I dare not trust myself in the scales with altruism! It is fully three miles from my office to my home—three long, weary, British miles, up streets and down streets, and round corners. Along long roads, dusty in summer and dirty in winter, until you come to real hawthorn hedges and patient privet. Here dwell retired tradespeople in mansions standing in gloomy grounds thickly besprinkled with laurel and privet, and speckled aucuba. You can tell they are retired tradespeople, because they have a plate fixed on the back door with this inscription—"Tradesmen's Entrance."

I am walking about all day, week in and week out. I get worn out and tottery like an old man of eighty, and yet, in addition, I trudge the three weary miles night and morning, from and to Suburbia, for the bee's sake.

Every morning and evening for seventeen years, think of it! Think of the pairs of boots ground to powder, and the energy expended in that weary business of putting one leg before another leg, and all for the bee's sake!

I know every blade of grass, every plant of shepherd's purse, every stone; I know the

hedges inch by inch, and all the boughs and twigs of the trees. Many were mere nursery youngsters when I knew them first, and now they are great in bough and leaf, immense dark hollies (or variegated with gold and silver), and great towering limes, weeping elm, and birch. But what were fields are now desirable residential properties, replete with every convenience, guaranteed not to tumble down within twenty years. There are rows and rows of them, hundreds of exactly one kind, so that the resident can only tell his own home by the number on the gate. They spring up like mushrooms almost in a night, and in a month or two you forget the fresh young grass and the sweet clover the bees loved that grew where they now stand. Soon I shall have to move farther afield. Neither I nor the bees can stand this great strong tide of bricks. My ancestors were tillers of the soil, bee-keepers, huntsmen, lovers of the country always; and the bees' ancestors, were they not ever passionate lovers of the flowers?

We will haste away ten miles out, where there is ling and heather, and where the banks are covered with the sweet wood sage. There we will sow our wallflowers and mignonette, and plant our roses. *Félicité Perpetue* shall clamber over our roof, and *L'Idéal* peep in at us through the windows, and *Rêve d'Or* (dream of gold) gild our garden beds.

A kindly train will carry us swiftly to and from the City. Sometimes it will be an hour late (generally when we have had a good run to catch it); sometimes we shall miss it by ten seconds; often we shall oversleep ourselves, and have to rush off without any breakfast. We shall suffer terribly with indigestion, and contract heart disease, and get low and dispirited through eating cookshop dinners, and weak and ill through hauling grocery, &c., home from the City. But we will suffer all this, and more also. We will cut ourselves adrift from society, from balls and soirées. Concerts, music-halls, and theatres will know us no more. Out of the swirl of the City, into the train and out of the train, to grope along dark country lanes in blinding rain, or through 3 ft. of snow. That is what we shall do for the bee's sake!—LORDSWOOD.

THREE-SIDE-CUT SECTIONS.

ABBOTT'S 1896 PATENT.

[3079.] My name having been mentioned in the last conversation as having sent out these sections, I beg to state that during last summer I distributed about 40,000 of them amongst nearly 500 bee-keepers, and the result of their use has been an unqualified success. Some of these sections were sent out with foundation fixed complete, and in no case did the sheets come loose. They were enclosed in ordinary section racks, and kept in position by springs. Possibly, if sent other than in racks, or without careful packing, some of the foundations might be displaced, though I think not; but as the foundation can be fixed so quickly by any one

I see no reason for sending them out that way, no appliance whatever being required. I have received most favourable reports from those who have used the sections, and nothing whatever against them, all repeat orders being for the "new kind;" consequently I believe they have "come to stay."

There seems to be a difference of opinion on the question of novelty. When I designed the section—early in 1896—I had not heard of its being used before, and proceeded to patent it. Shortly after doing so, I discovered that Mr. Sladen had taken the preliminary steps to patenting the same idea a few months before; but as he did not proceed with it, I did, and have since been granted letters patent for it.

The adage, "there is nothing new under the sun," is true of bee-keeping, as with all other things. It is next to impossible to find anything absolutely new, or that some one has not tried at some time or other, and I do not wish in any way to discredit Mr. Simmins; but one thing is quite certain, viz., the sections were never extensively used or advertised until I introduced them, and, to avoid future misunderstanding, I may state that I am advised by the best authorities that, though having no power to restrain those who have previously used or sold them, my patent is perfectly valid against all who did not use them previous to June 24, 1896 (the date of my completed patent).

Mr. Simmins erroneously claims originality for a section completely divided in 1889. I believe the first sections ever made in Great Britain (or anywhere else as far as we knew at the time) were made by myself, under my father's directions, just about twenty-three years ago. In the first instance, each section was only "half a one," and it was intended to insert a sheet of foundation between the two halves. However, foundation was not as perfect then as now, and on further consideration the top only was divided for insertion of a narrow strip of foundation. One-piece sections were not then thought of. This is all described in B.B.J. for April, 1875, p. 202, in an editorial by my late father, twelve years before Mr. Simmins used it.

The perfection to which super-foundation has now been brought enables whole sheets to be used without detriment, though this was hardly possible even so late as 1889. I have found little disadvantage from using sheets right down to the bottom. The sheet certainly sometimes buckles a little, but that only affects the midrib of the comb, as the separators straighten the outside; but I prefer to use the foundation one-eighth of an inch from the bottom. The section, however, admits of narrow strips being used on all three sides, and, no doubt, the very nicest honey will be so produced; but for profit there can be no question of the value of the whole sheet.—JAS. A. ABBOTT, *Merchant's Quay, Dublin, November 28.*

SPLIT SECTIONS.

[3080.] I notice on last issue of B.J. (3066, p. 464), that Mr. S. Simmins says he used split sections in 1889. Will you allow me to say, that I used such in the seventies. My plan was to cut the section in halves with a sharp knife. I then placed one-half in a block—to hold it square—and laid the pieces of comb foundation (cut to full size) right over it. The other half of section was next put on, and a few gentle taps with a hammer made wax and wood hold the section as if in one piece, while the foundation did not sag at all.—J. R. TRUSS, *Ufford Heath, Stamford, November 27.*

THE SHAMROCK.

IS IT A HONEY PLANT?

[3081.] I am sending you some leaves and roots of what the people of this part call shamrock. I do not wish to enter into the discussion now going on in your pages on the subject, but from a work called "Flowers of the Field," I find oxalis quoted as "an elegant little plant, with clover-like leaves and white and lilac veined flowers." This plant is supposed by many to be the true shamrock which was used by St. Patrick. The same work also says of *Trifolium repens*, "In a variety commonly cultivated in gardens under the name of shamrock, nearly the whole of the centre of each leaflet is tinged with dark purple." Much discussion about the identity of the shamrock might, I think, have been saved by recollecting the fact that St. Patrick's-day falls at a season when the botanical characteristics of the trefoils are scarcely developed. Besides, the devotees of that saint can scarcely be expected to be all possessed of much botanical knowledge. Some antiquarians contend that, as Ireland was a well-wooded country in St. Patrick's time, the saint probably selected a leaf of wood sorrel (*Oxalis acetosella*) to illustrate the doctrine of the Trinity.—G. F. Süsser.

[3082.] The question as to the identity of the shamrock appears to be of interest to many readers; therefore I have thought well to forward you a specimen of the plant accepted by nine-tenths of the Irish people as the "rue shamrock," and my experience of Ireland is not confined to one locality, but extends from Tralee to Belfast. I do not know what plant is known as the "wood sorrel," perhaps the one I send is so called in England. If so, then wood sorrel and shamrock are the same plant and the one to which I refer.

"An Irish Reader" says he never knew the wood sorrel to be worn as the shamrock, but the difference may arise from a misconception of what plant is meant by the sorrel. In Ireland the plant called "sorrel" is a large-leaved sour-tasted plant, the leaves being somewhat like those of the plantain in shape,

but not so large and smoother in texture. Your correspondent refers to a plant bearing yellow flowers as the shamrock. I have noticed the plant to which I think he refers. It so closely resembles the plant which I enclose that I have myself thought it might be the same plant when in flower, but the flowering plant does not run on the ground as does the plant which I enclose; it, on the contrary, grows somewhat erect. I cannot positively state they are not the same in different stages of growth. My own opinion is that the real shamrock does not flower; anyway it certainly does not about the time of year when St. Patrick's Day comes round.

Our editors might decide the matter from the bee-keepers' point of view by informing us on the natural history of the plant.—W. J. FARMER, *Yorks, November 27.*

[3083.] Your reply to Dr. Miller (page 455) led me to look up one or two authorities, and I was surprised to find that the shamrock has been often discussed before and never decided on. Chambers' Encyclopædia seems rather to favour the white clover, but concludes that any leaf with three leaflets may be shamrock. Sowerby's English Botany refers in the index of English names to the Black Medick (*Medicago lupulina*), but under *Oxalis Actosella* the matter is discussed at length, and this plant (wood sorrel) is favoured. Your two correspondents "An Irish Reader" and Mr. W. J. Farmer (page 467) seem to refer to *Trifolium minus* Sm., sometimes known as *T. procumbens* Huds. or *T. filiforme* L. (see Hooker's "Students' Flora, page 99).—G. D. HAVILAND, *Warbleton, November 26.*

[3084.] The question of the "true shamrock" is not more likely to be settled than that of the "true whitethroat" or "true blackcap." Although a national emblem, Irishmen differ among themselves as to the plant. Some Irish people I know consider the *Oxalis actosella* (wood-sorrel) as the plant, but by far the greater number use *Trifolium minus*, and it is highly probable that this is the plant which St. Patrick used to illustrate his doctrine. I have cultivated the plant more than once given to me by Irishmen themselves. *Trifolium procumbens* and *filiforme* are so closely allied to it that botanists are scarcely agreed as to the limits of the species *minus*. *Medicago lupulina* is also very similar, differing essentially in its fruit. Nicholson mentions *minus*, but he gives *Trifolium repens* (the Dutch clover) as the shamrock. This we know is our best honey-yielding plant, but I have not observed the bees to work on any of the small yellow-flowered species mentioned above. The wood-sorrel belongs to a different natural order, and bears but little resemblance to the clovers.—Geo. WALL, *Grym's Dyke, Harrow Weald, November 25.*

(Above correspondence is referred to in "Useful Hints.")

FREE SEEDS OF CHAPMAN HONEY PLANT.

[3085.] I have a quantity of seeds of Chapman's honey plant which I am willing to distribute amongst bee-keepers who wish to grow it, on their sending me an addressed, stamped envelope. Will you kindly make this known?—J. QUARTERMAIN, *Tenby, November 19.*

TEACHING BEE-KEEPING.

COPIES OF JOURNALS FOR FREE DISTRIBUTION.

[3086.] For some time past I have been trying to get our Parish Council (being clerk to the Council) to adopt bee-keeping as a subject for technical education, but have not yet succeeded, other subjects hitherto having a preference, though the Council do not regard my project with disfavour. However, I am contemplating giving some "bee talks" myself after Christmas, and with a view to this asked the School Board (being also their clerk) to grant me the free loan of the schoolroom for this purpose, to which they unanimously agreed. Should I do so, of course, it will only be some information on the practical side of bee-keeping, showing various appliances with their uses. I have had several years' experience with bees, and been a reader of your excellent and helpful journal for a number of years, and this being a good district with a number of persons desirous of learning something of bee-keeping, my object is to impart what little knowledge I have gained.

My chief aim in writing you is to know if I could obtain a number of old copies of the JOURNAL for distribution free, or if they could not be supplied thus, at what cost? Also, could I obtain some copies of "Modern Bee-keeping" and the "British Bee-keepers' Guide Book" for sale, and any unsold copies to be returnable? Would you kindly state terms, if this is possible? Perhaps you could also tell me whether I could obtain any diagrams of bees, and at what cost?—H. W. E., *November 27.*

[We are at all times willing to supply surplus copies of our paper a few weeks old gratis to lecturers on payment of carriage. The Guide Book and modern bee-keeping are supplied at the usual "trade rate" of 25 per cent. off published price; but it is difficult to manage the "sale or return" conditions through risk of frequent soiled or slightly damaged copies returned unsold at times. Cost of carriage to and fro (borne by lecturer) is also a serious item. The safest plan is to take two or three samples copies only. When these are sold, take orders for delivery of extra copies by post from this office. Accounts being balanced on original terms. The diagrams published by the B.K.A. cost 4s. per set.—EDS.]

(Correspondence continued on page 478.)

SKETCHES BY A ROVING BEE-KEEPER.

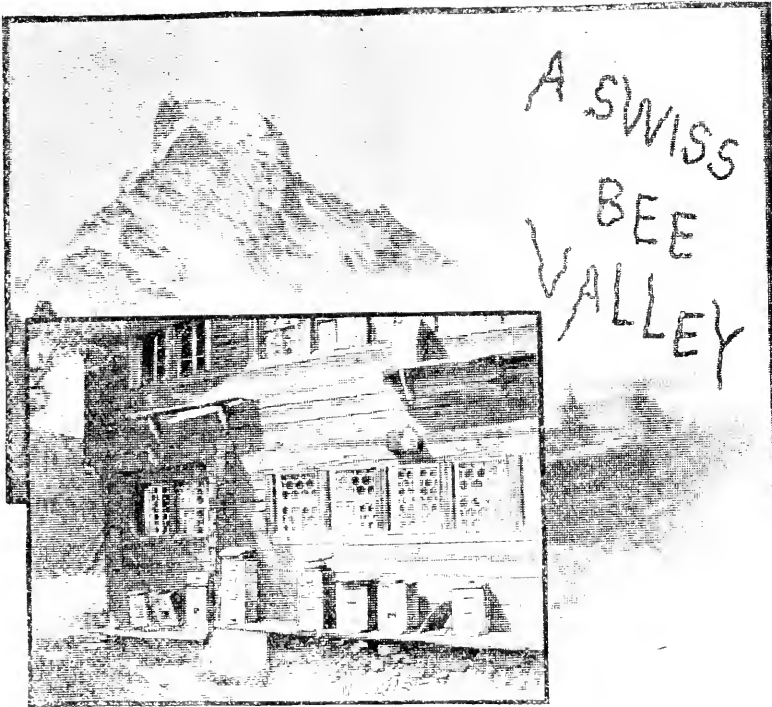

BY ALFRED WATKINS.

Travellers who have visited Switzerland, either for the purpose of restoring health, or the more pleasurable occupation of viewing those wonderful sights which have made the Alpine region so famous, will have no difficulty in recalling to mind the great valley of the Rhone which runs through the heart of the Swiss Alpine district, and the little towns dotted along its course—close and oppressive as they always seem after the pure freshness and clear snows of the Upper Alps—and how, on either side, branching valleys ascend towards the more lofty peaks, forming the roads by which the tourist travels on his way to his headquarters for climbing work.

We had rested the night at the little town of Visp, and our day's walk was towards Zermatt, the headquarters of the Monte Rosa district. How vividly that tramp in the Visp Thal comes back to mind! The early start, long before six, in the cool morning; the carriage road up the centre of the valley, among vineyards and chestnut groves; the glimpses now and then, in the distance, of the pack mules bearing, among other luggage, our knapsacks, sent on by post the night before; the little village of Stalden, clinging to a hill-side so steep, the saying goes, that "even the hens must be iron-shod to keep a footing in

Stalden." Then the more placid valley of St. Nicholas, not rich with vineyards and fruit trees, being on higher ground, but with groves of fir trees, stretching from the bare rocks above, down among the hayfields and bee pastures.

How can we but think of the bees as we look at the feast around—myriads of, to us, unknown flowers, with clover among the bottom growth, and familiar wild thyme on the banks. We can realise that when this luxuriant growth is laid in swathes by the scythe and carried into the chalet-like hay-barns which make the valley so picturesque, the hay will be made up, not so much of blades of grass, as of flowers, their leaves, and stems.

And the bees kept for the feast! We had seen them in hives of all kinds and shapes; in the Hasli Thal (under the eaves of a rich brown-coloured chalet), glimpses of long low boxes with wide sides and entrance to the front. At Liddes, similar boxes, but with two entrances cut in the narrow end; and here the honey was taken by cutting out from the back. Near Lenk, placed upright against some of the chalets, were log-hives made of hollow chestnut trees; and in many places large flat-topped straw hives, some of them with supers on.

The road had long since degenerated into a mule-track—Zermatt not being far off—when, opposite a roadside chapel, where the congregation had overflowed into the graveyard, we saw, under the windows of a pretty chalet, a row of hives, which fill us with special interest, for we had hardly expected to see examples of the Stewarton system in Switzerland; and yet here were hives made and used on that plan, only that the boxes were square and not octagonal.

We here decide to take a photograph, and as we stand in the good bee-man's garden, cannot help wondering whether he had copied the pattern of the hexagonal panes of glass for his windows from his little teachers the bees, and whether the square tin funnel on the shelf above is used for hiving swarms into the boxes it so exactly seems to fit. But no one being near to give information, we finish our picture—part of which is reproduced in the illustration given above—pack up our traps, and, leaving worshippers and bees behind, travel on until, turning a corner, the village of Zermatt comes into sight, with glaciers creeping down to meet it from mighty snowfields, thousands of feet above; while, towering high above all, and standing like a gigantic obelisk in defiance of time, the Matterhorn—now first seen—takes possession of the mind and drives away all other thoughts.

At Zermatt we examined more of the storifying hives. They are dove-tailed at the corners, 11 in. square inside, and from 5 in. to 8 in. deep, fitted with bars across the top, but not at the proper comb distance. At the same place we saw some rudely-made bar frame-hives, with close-fitting top bars and wooden crown boards. The owner told us the season was very short and the harvest of honey very small in these high latitudes. All the bees seen in this district were black ones.

[The above was written a few years ago for our monthly, the *Record*, by Mr. Watkins, Hon. Sec. of the Herefordshire B.K.A., and will afford an interesting variety to the series of bee-garden pictures now appearing fortnightly in our pages. We shall insert another "Roving Sketch" on December 16, the "Homes of the Honey Bee" occupying its usual place next week.—EDS.]

CORRESPONDENCE.

(Continued from page 476.)

NOVEMBER HONEY.

[3087.] I can fully agree with your correspondent, 'N.' (Hampshire), (3,074, p. 468) as to the gathering of November honey. In my own apiary the bees have been having a grand time of it up to the 20th of the month, and I have been noticing them capping over some honey, which, no doubt, they have got from "charlock" (two acres) and ivy, of which there is a large quantity handy. Do they gather honey from ivy? [In some seasons the ivy yields honey freely.—EDS.] I fancied it

yielded pollen only. It is to be feared that the bees will be left with a large quantity of unsealed stores through late gathering. Whether this will be hurtful to them or not in winter, spring will prove. Drones have been flying from my hives almost daily; on November 19 and 20 the bees were turning them out, but I have seen none since. I hope there are not many bee-keepers like your correspondent. To take the honey and leave the poor bees on empty combs for one month at this season is hard on them. In this case they have survived; but I fear if others try it they will not be so lucky. If I had no time to feed my bees I should sulphur them.—G. F., *Sussex*, November 27.

BEE SWAX AND ITS USES.

[3088.] I was very pleased and interested in the statement on page 466 of last week's B.J. about beeswax, and only wish we were as fortunate as Mr. Wm. Loveday in selling our wax. Could Mr. Loveday or any reader tell me how to bleach and make white wax? as I think if I can do it I can sell the wax got from my bees more freely. Ours is a very poor district for selling honey in. I always send mine to London, as I can make more of it wholesale there than retail in the town.—D. J. C., *King's Lynn*, November 27.

LECTURE ON APICULTURE.

In connection with the Clutton and District Flower Show, which is now so well known in the district, the first of two lectures on apiculture was given in the British School-room, Clutton, on Tuesday, the 16th inst., by Mr. R. Hamlyn Harris (Chairman of the Bristol, Somerset, and South Gloucester B.K.A.), the title of the lecture being "Bees: Their Ways and Habits." Dr. T. Martin was in the chair. After introducing the lecturer, the Chairman read a letter received from the Countess of Warwick desiring him to express to the meeting and to Mr. Hamlyn Harris her regret at being unable to be present at the lecture. Her Ladyship also said that she was quite sure that the subject would be as interesting as ever, and that the cottager had still a great deal to learn with regard to the more profitable use of his hives, so that such a lecture was sure to be appreciated. The lecturer spoke first of the numerous different varieties of bees found in England and in foreign countries, and afterwards dealt more particularly with the anatomy and management of the honey bee. The room was crowded, and, judging from the applause, it was evident that the lecture was much appreciated. The lecture was illustrated with a large number of slides, shown, by the oxy-hydrogen lantern, by Mr. M. W. Dunscombe, Bristol. The second

lecture by the same gentleman will be held at High Littleton early next month, and will also be illustrated by the oxy-hydrogen lantern. The subject will be "The Progress of Apiculture during the Victorian Era."—(*Communicated*)

PREPARING BEES FOR WINTER.

Although having been uniformly successful when wintering bees in special repositories, still, with properly-constructed hives and the requisite amount of food for each colony, I am persuaded that outdoor wintering far transcends any or all methods heretofore advised.

Although success may attend our efforts in the beaten paths, still in some new way a degree of perfection may be reached which will far overshadow the past. Such has been the result during forty-five years of progress in bee-keeping. Most methods of the ushering in of those years are now almost obsolete.

With a successful outdoor method of wintering unrestricted flight is maintained, the desirableness of which can only be appreciated when contrasted with the restless roar of bees confined in cellars during warm winters, especially towards spring. Furthermore, bees wintered in the open air require absolutely no care, and the machinery of its success obviates the necessity of further brain effort.

In this paper I shall endeavour to outline a simple arrangement favourable to successful outdoor wintering in the ordinary single-wall frame-hive. It will, however, be imperfect compared with hives made specially for the purpose (including closed end frames); still, will insure reasonably good success.

To obtain a more intelligent understanding of the wintering problem, let us consider a few facts relative thereto, and the circumstances which necessitate slight changes in the arrangements. First of all, it is a well-established fact that single walls are insufficient for protection against the cold of our Northern States; hence something equivalent to about 2 in. of packing on the bottom, sides, and ends must be included as a requisite to successful wintering. Above the frames I would recommend about 4 in. to 6 in. of packing for protection. The warmth of the colony naturally ascending necessitates a greater thickness above to prevent its radiation. With hives well packed on the bottom, ends, and sides, a tray of sawdust about 6 in. deep will conserve most of the heat generated by an average colony. Preferably, the tray should have a muslin bottom, which, when filled with sawdust, will conform to and fill the shallow bee space above the frames.

With no packing at the bottom or sides, the thin walls allow a constant radiation of heat generated by the colony, and when the temperature becomes sufficiently low we find a

consequent condensation of moisture. Under such circumstances a slow upward current is necessary to carry it off. In order to accomplish it planer shavings or chaff should be used in the tray instead of sawdust. The reader will readily comprehend that an upward current can only be obtained at an expense of the vitality of a colony, and in consequence the bees must draw largely upon their stores in order to maintain the requisite degree of warmth. This explains why the consumption of food is greater in outdoor wintering than in cellars or special repositories. Let us bear in mind that the converse is also true with a perfect system of outdoor wintering. Never in all my life experience with special repositories or cellars has the consumption of food been less than with hives properly prepared for open-air wintering.

With sufficient packing on all sides and bottom, together with suitable entrance protection, the warmth of the colony is almost wholly conserved. A hive without entrance protection may be compared to a house with suitable warming appliances and having the door left open. I often have wondered why so many have attempted to construct warm hives and yet leave the front door wide open. Of course, to contract the entrance of an ordinary hive without first constructing some anti-clogging arrangement would prove disastrous—the result would be suffocation.

Without packing, an increased amount of food is consumed, necessitating an undue number of cleansing flights, which is one cause of dysentery.

I have found three essentials prominent in successful outdoor wintering. Outside packing, entrance protection, and a small chamber or box below the entrance to receive all dead bees and debris carried there during warm spells. This prevents the clogging which is so common with an ordinary entrance.

Having given the three requisites in hive construction for successful outdoor wintering, let us endeavour to approximate the combination, using the ordinary hive. Of course it will be imperfect compared with hives made especially for the purpose. First of all, let us make—composed of slats 2 in. wide, set 2 in. apart, perpendicular to each other—a crate, in size, when completed, 4 in. larger inside measurement than the hive, and about 6 in. or 8 in. deeper. At the bottom two cleats, 2 in. wide, are set edgewise to support a bottom board $\frac{1}{2}$ in. thick, of the same length and width as the hive. At the entrance end an opening should be cut 2 in. wide by 3 in. long for the dead bees to drop through into the vestibule to be placed at the front, as will be described in another paragraph. To give room for this opening the front cleat should be set 2 in. from the end of the bottom board. It will be found best to nail the cleats to the bottom board first, then put them together into the crate, using a nail

or two to secure in position after packing underneath the same.

The vestibule entrance may be a small box made of $\frac{1}{2}$ in. lumber 2 in. deep, about 8 in. square. It should be placed with the open side against the hive front, and a 2 in. by $\frac{1}{2}$ in. opening or entrance, cut half way up, opening between two slats of the crate. From this entrance to the one proper a 2 in. slat should incline for the bees to travel. It may be secured by nailing to a block bevelled on the top and nailed to the front of the vestibule box. The inclination prevents all tendency to become clogged with dead bees. No alighting board is required to this small entrance. The tendency to clog with snow makes it objectionable.

A simple cover for the crate should be made which will fit over all with a roof inclined sufficiently to allow the water to run off. A slatted roof will answer, provided the slates run downwards, and are covered with oilcloth nailed on the outside edges. Oilcloth makes a good winter roof if left undisturbed, as it cracks very easily when cold. The heat of summer softens and destroys it. With the vestibule or box entrance placed at the bottom of the crate, which is 2 in. lower than the hive, the whole may be packed with leaves and straw. The leaves should be placed underneath the bottom board and straw at the sides. A piece of burlap or muslin (the latter is preferable) should be placed over the frames, and leaves or chaff over all. The cover should be secured in place with a nail or two as security against strong winds. No fears need be entertained as to the sides getting water-soaked, the hive being sufficient protection against moisture. Even if the packing becomes somewhat wet, it still greatly serves to maintain the warmth of the colony. Preferably the crate and hive should set 10 in. or 12 in. from the ground, which will obviate the necessity of keeping the entrance free from snow.

Although there is an air of cheapness in this structure which will answer as a makeshift, still with hives made to combine summer and winter requisites the expense will be greater, and withal far more durable.

In considering the importance of complete outdoor wintering attachments, the first cost should be counted included for many years of service. With bees properly wintered, the loss ought not to exceed a teacupful. Naturally the remaining ones will be physically stronger and better able to serve as nurses and honey gatherers; so that the first season ought to pay something towards the extra expense of wintering.

In further considering the preparations for wintering, the matter of food should also receive special attention. This part of our subject, however, I discussed at some length in the September issue, and it fully covers all that is requisite to that end.—L. A. ASPINWALL, in *Bee-keepers' Review* (American.)

Notices to Correspondents & Inquirers.

Letters or queries asking for addresses of manufacturers or correspondents, or where appliances can be purchased, or replies giving such information, can only be inserted as advertisements. The space devoted to letters, queries, and replies is meant for the general good of bee-keepers, and not for advertisements. We wish our Correspondents to bear in mind that, as it is necessary for us to go to press in advance of the date of issue, queries cannot always be replied to in the issue immediately following the receipt of their communications.

All queries forwarded will be attended to, and those only of personal interest will be answered in this column.

H. W. E. (Devon).—*Fermenting Honey.*—1.

The honey, as sample, has been unripe when extracted, and fermentation has started in consequence. It is not fit for table use in its present state, and will get worse as time passes, unless dealt with. It may be used as food if boiled, skimmed, and has about 40 grains salicylic acid stirred into each quart of honey while boiling. 2. As to the tradesman to whom the honey has been supplied, your position with regard to him is, we think, to take the honey back, if future orders are expected without any friction. It is not "good business" to sell unripe honey for retailing.

WILLIAM R. BRIDGE (Bolton).—*Bought Honey for Feeding Bees.*—1.

The only objection to using honey bought from an unknown source is the risk of its coming from other than healthy hives. If this is guarded against, the honey should have worked into it as much "icing sugar" as will form a very stiff paste. Place a couple of pounds of it, so prepared, on top of frames, as is done with ordinary bee-candy, and renew as required. A glazed box will be useful for laying over the food, so as to know when a further supply is needed. 2. If stocks are weak in autumn, joining up is necessary; not otherwise. 3. A hive with only two seams of bees in November is decidedly "weak."

J. EVANS.—*Samples of Honey.*—Reply to this will appear next week. We regret the delay.

NOTICE.—*Home-made Hives.*—1. There can be little difficulty in adapting hive—used hitherto for surplus comb-honey only—to working for extracted honey. We should make the surplus-boxes same size as brood-chambers. The depth of "invertible covers" or lifts are of no moment, since they only serve to raise the roof to accommodate surplus-boxes. 2. You will act unwisely in departing from the correct standard frame which has a 17-in. top-bar. 3. The question of using "wide ends" in working for surplus is one on which opinions differ; try both, and make your own choice.

(Several Letters and Queries are in type and will appear next week.)

Editorial, Notices, &c.

BRITISH BEE-KEEPERS' ASSOCIATION.

The monthly meeting of the Council was held on Friday the 3rd inst., at 105, Jernyn-street, S.W. Present: Mr. E. D. Till (in the chair), the Hon. and Rev. Henry Bligh, Major Fair, Messrs. W. Broughton Carr, W. O'B. Glennie, W. H. Harris, H. Jonas, J. H. New, T. J. Weston, and the Secretary.

The minutes of the previous meeting were read and confirmed.

The following new members were elected, viz.:—John Horsfall, 98, Market-street, Hebdon Bridge; W. Douglas Jones, Alderley House, Hoylake, Cheshire.

Mr. Weston, on behalf of the Finance Committee, presented the statement of accounts for the month of November. This, with the recommendations of the Committee as to payments, was duly approved.

The Council proceeded to consider, in detail, the proposals of the Education Committee in respect to future 3rd class examinations, and the conditions under which they may be held, and it was thought well to await the Committee's complete report before endorsement of any portion of the regulations by the Council.

For the "Royal" Show to be held at Birmingham in the month of June, 1898, the prize schedule for the bee and honey department was revised for presentation to the R.A.S.E. Amongst other alterations, additional classes have been provided for "The most suitable Outfit for a Beginner in Bee-Keeping," price not to exceed £1. 10s., and for "Extracted Honey Gathered in 1897 or any Previous Year." The class for "Attractive Displays of Honey" by individual bee-keepers, absent from the 1897 schedule, has once more been included. Messrs. Carr, Harris, Till, and Weston were appointed as a sub-committee to arrange details of a scheme to further our acquaintance with the habits and value of *Apis dorsata* as a honey and wax-producing insect, in conformity with the wishes of the anonymous donor of £20 for such purpose.

ROYAL AGRICULTURAL SOCIETY.

SHOW AT BIRMINGHAM IN 1898.

We are requested to state that the fifty-ninth annual exhibition of the Royal Agricultural Society of England will be held at Four Oaks Park, Birmingham, from Monday, June 20, to Friday, June 24, 1898.

The prize schedule for the Bee and Honey Section is now being prepared by the Council of the B.B.K.A. for submitting to the Council of the Royal Agricultural Society, and will be printed in our first issue after it is finally settled.

THE "HUCKLE MEMORIAL" FUND.

"The Committee herewith beg to submit the cash statement of the Memorial Fund.

The amount subscribed being insufficient for the erection of a drinking-fountain in addition to the tombstone, it was considered advisable to present the balance to Mrs. Huckle. A cheque for £24 has accordingly been handed to her by the Treasurer.

Total subscriptions	£41 18 5
Payments:—Tombstone, gilding, fees, and in- cidental expenses ...	19 10 0
Printing, stationery, and stamps.....	1 8 5
	<hr/>
	20 18 5

Balance..... £24 0 0

Signed, F. C. FISHER, Treasurer.
EDWARD TOMS, Hon. Sec.

King's Langley, Nov., 1897."

[We have just received a copy of the above circular, and insert it here for the information of those who subscribed to the fund through this journal.—EDS.]

HELPING IRISH BEE KEEPERS,

LARGE SALE OF HONEY.

The following communication, which appears in the *Irish Times* of the 30th ult., has been sent to us for publication:—

"Two or three years ago the Congested Districts Board for Ireland sent an instructor in bee-keeping throughout the congested districts, and by his advice made loans to numerous residents there, to enable them to purchase hives and stocks of bees. Last year it was seen by the Board that in order to make the keeping of bees a profitable occupation for people in remote parts of the country it would be necessary, for the first couple of years at all events, to market the honey of any bee-keepers who were themselves unable to find a purchaser. The Board accordingly issued a circular to those who had obtained hives and stocks of bees from them, stating that they were prepared to purchase any honey that might be offered for sale, and special boxes were also provided for sending the honey to Dublin, where a building with suitable fittings was prepared for storing the honey pending re-sale.

"The Board, while ready if necessary to sell the honey in small lots, decided in the first instance to endeavour to dispose of it to some purchaser who would take as large a quantity as possible. At a meeting of the Board held in October last, at which Mr. Gerald W. Balfour, M.P., Chief Secretary for Ireland, was in the chair, a letter was sent to Mr. Lipton, the well-known purveyor, explaining to him the Board's position in the matter, and asking if he would purchase any of the honey at a

stated price, which was just sufficient to reimburse the Board for their outlay. Mr. Lipton at once replied, offering to take at the price quoted all the section honey the Board could let him have, subject to an inspection as to the quality of the honey. His agent and packers accordingly visited the Board's store, and after a careful inspection, did not find it necessary to reject a single section, either as regards the quality of the honey or on account of the manner in which the sections were filled. The greater part of the honey is white clover, but a large proportion of it is most fragrant heather honey from the moors and mountains of Donegal, Mayo, Galway, and Kerry. It was a considerable relief to the Board to have their entire stock taken off their hands in one lot, and to be spared the trouble and risk of disposing of thousands of such fragile and perishable articles as sections of honey. Mr. Lipton's action in the matter will be of much service to bee-keepers in the west of Ireland, and it is hoped that his cheerfully undertaken experiment will be sufficiently satisfactory from a financial point of view to justify him in continuing to buy in future years on commercial principles apart from a benevolent motive."

TO DEVONSHIRE BEE-KEEPERS.

AN ASSOCIATION FOR DEVON AND EXETER.

A representative meeting of those interested in bee-keeping was held in the Market Hall, Exeter, on the afternoon of Saturday, December 4, to consider the advisability of forming an Association for Devon and Exeter, to be affiliated to the B.B.K.A. It was decided unanimously that an Association ought to be formed, and a provisional committee was elected to draw up rules for presentation at a public meeting to be held on an early date. Mr. T. H. Burgess, Guinea-street, Exeter, was appointed Hon. Secretary, *pro tem*.

Correspondence.

The Editors do not hold themselves responsible for the opinions expressed by correspondents. No notice will be taken of anonymous communications, and correspondents are requested to write on one side of the paper only and give their real names and addresses, not necessarily for publication, but as a guarantee of good faith. Illustrations should be drawn on separate pieces of paper. We do not undertake to return rejected communications.

**.* In order to facilitate reference, Correspondents, when speaking of any letter or query previously inserted will oblige by mentioning the number of the letter, as well as the page on which it appears.*

FOUL BROOD AND ITS REMEDY.

[3089.] I have read with much interest the correspondence in the *Western Daily Press* on foul brood and its remedy. The contributors are Miss Hill-Dawe, Mr. S. Jordan, Mr. Chas. Howes, and Mr. R. Hamlyn-Harris, and "Gloucestershire Bee-keeper."

I do not know that it throws much new light on the subject, but it emphasises the importance of dealing radically with the mischief, and thus fully supports the action of the British B.K.A. in their endeavour to "stay the plague." Mr. Chas. Howes seems to have started the correspondence. The others reply. Mr. Howes seems to think that county B.K.A.s could accomplish the work. Undoubtedly they can do much in the right direction—indeed, they *are* doing so where there are earnest men or women at the helm—but, do what Associations will, there are always selfish and ignorant as well as careless bee-keepers, who have not the smallest scruple in doing wrong to their neighbour (love doeth no ill to his neighbour, so they are offenders, some, of course, unintentionally, against the highest law I know), and with such *nothing* but compulsory powers will avail. The proverb says that "Money answereth all things," and possibly these men could be "bought." But where is the *money* to come from?

Mr. Howes maintains that "*spirited action on the part of any individual or society seldom is allowed to go unrewarded when the public sees its reward is well merited.*" Mr. Howes has much to learn, but if he can tell me the secret by which we can open the "*public eye,*" I, for one, shall be *very* much obliged to him. He has, I am convinced, but small experience in that line, or of the almost insuperable difficulty of getting an *adequate* income to work a county B.K.A. on anything like efficient lines. If all bee-keepers were public-spirited like Mr. Harris or Miss Dawe and others, who give their time and money ungrudgingly, it would be simple enough; but one so frequently meets with the mean spirit among bee-keepers, that at times I almost despair. I don't despair, because "*all things come in time to those who know how to wait,*" and if we cultivate the spirit of patience and perseverance, we shall win the day. Mr. Elliot, at the Board of Agriculture, told the Council of the B.B.K.A. that he had been *years* getting statutory powers for dealing with the diseases to which live stock are incident, and therefore it is not to be expected that bee-keepers are to jump into success in a moment. Meantime, let B.K.A.s do all in their power—and even beyond their power, so to speak—and in aiming at "much" they will at least accomplish a little.

In Kent and in Surrey, as well as in Sussex, the County Councils encourage bee-keeping by liberal grants, but only for lectures. I am thankful for this, but if some of the money were devoted (as in Surrey) to the Kent and Sussex B.K.A. it would be of immense assistance. The Kent and Sussex B.K.A. now numbers over 500 members, and if individual members of the Council did not supplement the funds to a considerable extent, as well as give much of their time and personal attention to the county work it could not do what it does. What the Kent County Council grants for lectures would

keep an expert going *all the year round*, and if it was only to say that part of the money should be devoted to the eradication of foul brood, every ten pounds so expended would be worth a hundred to county bee-keeping; but hard as it is to "open the public eye," it's harder far to "open the eye" of a *County Councillor!*

The Kent and Sussex B.K.A. have never touched one single farthing of County Council money, though they freely admit the bee-keeping industry has been greatly encouraged by technical instruction. Even £50 a year for two or three years (Kent spends from £100 to £150, and Surrey probably more; Sussex spends less in bee-keeping instruction) would wonderfully diminish foul brood, but unaided B.K.A.'s *cannot* do what they wish. The County Councils should make their efforts simultaneously, otherwise foul brood might be attacked in Surrey—say, for example, at Kingston—and the disease allowed free course over the river at Hampton Wick. That is why an Imperial enactment compulsory over every county is so important. I have great hopes that we shall be able to carry out a scheme for the Isle of Man, sea girt as it is, and sufficiently far from the mainland. The task if attempted on proper lines could not fail to be successful.

Mr. Howes suggests that *self-interest* would contribute to the eradication of foul brood, but does he realise how many bee-keepers are as ignorant and careless about their "interests" as they are ignorant of symptoms of foul brood when they see them? No doubt if a district could be pronounced practically clear of disease, the resident bee-keepers would get better sale for their stocks, but Mr. Howes forgets that bee-keepers reckon in their ranks the unscrupulous as well as the careless and the ignorant.

The recent important action of Cookson *versus* Sampson, mainly brought about through the instrumentality of the K. and S.B.K.A., stands now as the leading case and precedent protecting bee-keepers from unscrupulous dealing.

I am afraid my letter has transgressed the bounds of editorial indulgence, but I could not express what I desire in less space without sacrificing clearness. I have said sufficient to show that while we are waiting for Imperial powers, earnest individual exertion and earnest Association effort are being slowly but surely directed towards the desired end.—E. D. TILL, *Eynsford, Kent, December 6.*

APICULTURAL NOTES.

THE BEE SEASON OF 1897.

[3090.] It is a long time since I sent my last "Notes," and several readers of the JOURNAL have been asking if I had forgotten how to write. The fact is I have had 150 colonies of bees of my own to manage entirely single-

handed, in addition to other work, which has taken up a considerable amount of time. Regarding this "other work," let me say that I have bought and sold the whole of the produce of several large honey producers, both in Hunts and Cambs, most of which has been packed and taken to the station by myself. I think this will fully explain my somewhat long silence. The time of year has now come, however, when it is not quite so necessary—as it was a short time back—to work from eighteen to twenty hours a day, consequently I can find more time for writing, and I assure those of our brother bee-keepers who at the Dairy Show expressed a wish for the continuation of "Apicultural Notes," that, whenever I have anything to tell that is likely to benefit or in any way interest readers of the JOURNAL, I shall have pleasure in telling it.

The year 1897 has been one of the most peculiar bee-seasons I have ever experienced, made up, so to speak, of hope and despair—the two have reigned alternately in somewhat quick succession. At one time we have been on the mountain-top of prosperity, where everything has appeared bright and encouraging; then, all of a sudden, we have been tumbled down to the bottom of the valley of despair. But, while bewailing our ill-luck, sunshine and honey has come, and up we have gone again, only to take another dive down, as one does on a switchback railway.

The day on which my last "Notes" were written (June 13) was one of the most perfect bee-days I ever saw—a bright, warm morning, not a single cloud to be seen, a balmy south-east breeze, which always means abundant income of honey. After passing through eight months of most trying weather for both bees and bee-keepers, during which drenching autumn and winter was followed by a cold, dry spring, failure seemed to be stamped on everything around. But just when almost ready to give up hoping, warm weather set in; the much-needed rains came in abundance, causing a complete transformation of the whole face of the earth. What had looked like a barren wilderness was now turned into a fruitful land, where everything was so full of promise as to gladden the hearts of farmers, gardeners, and bee-keepers alike. In fact, everything and everybody seemed to rejoice. Crops which had only the appearance of miserable failure soon showed unmistakable sign of an abundant yield, and yield abundantly they did with me. A heavier crop of hay or such magnificent roots (rabis) I never had before, and when I carted the latter home through the village I, of course, didn't forget to put the least at the bottom of my cart, and the very finest ones on the top, to be admired and talked about by all I met on the way. Some of us bee-keepers, you know, put our very best "takes" of honey right on top of everything, and carefully keep "reports" of those hives that have done little or nothing out of sight. What a queer thing human nature is! Yes, it was indeed a

charming day. The sweet songs of the birds showed how they appreciated the delightful change, and the merry hum of the bees helped to swell a chorus which was music to the bee-keeper's ear. Stocks that had for a long time been mere nuclei now developed into populous colonies with a rapidity astonishing even to a bee-keeper of upwards of twenty years' standing. Frames of foundation, by the hundred, were built out and filled with brood and honey like magic! While watching for swarms, wanted for experimental purposes, I had more than once to walk from one end to the other of the long rows of hives to satisfy myself whether or not the bees were really swarming, so busy were the hundreds of thousands of workers. There were clover fields in full flower on all four sides of the apiary. Foundation in sections, put on only the night before, was next morning being rapidly drawn-out, and honey was literally pouring into the hives. Nor was there any signs of change in the weather, and ten days of that glorious state of things meant an abundant honey-harvest. If such an outlook didn't gladden the heart of the most gloomy bee-man, and put him on good terms with himself and all the world besides, I don't know what would. "This is a glorious world," said I. We always say or think thus when all goes well and bears a rosy tint. "It is good to be here," we say; "my lines have fallen in pleasant places." There sprang up in one's breast an involuntary and irresistible feeling of deepest gratitude to the Great Giver of all good things. We were on the mountain top, and there I will leave my readers to the full enjoyment of the beautiful picture! Next week I will tell them what followed.—ALLEN SHARP, *Brampton, Huntingdon, December 4.*

QUEEN-REARING IN CANADA.

[3091.] Under the above heading an article appears on page 433 of the *BRITISH BEE JOURNAL* for November 4. The pride and interest I take in Canadian Apiculture would give me the greatest pleasure could I credit the statements said to have been made by Mr. McArthur, and reported by your correspondent, Mrs. R. P. Leigh Spencer. I think, however, that, knowing something of Mr. McArthur's reputation, it is my duty to put British bee-keepers on their guard, be that duty never so unpleasant. In this country we do not know Mr. McArthur as a successful bee-keeper; he may be one, but I have personally met men who, after sending him money, have with the greatest difficulty obtained queens in return. Unless it has been paid very recently, I know of him owing bee-keepers sums which would reach fully 100 dols. As to the remarkable "records" he may have them, but, I ask, can he show that any one after buying his queens, has had anything like similar results? No doubt his bees handle well; they are gentle, but the experience of

many is that these very gentle bees lack honey-gathering qualities; call it energy or what you will. If all that is reported in the *BRITISH BEE JOURNAL* is true, we are not doing justice to Mr. McArthur here, and I think it would be well for him to attend our provincial and county conventions to induce bee-keepers to take him at his real value. I have no desire to do more than as already said, put British bee-keepers on their guard, and so I refrain from saying more.—R. F. HOLTERMANN, Editor, *Canadian Bee Journal, Brantford, Canada, November 15.*

STORING HONEY IN TIN VESSELS.

[3092.] I note some remarks on the above subject in *B.J.* of November 25 (p. 466) by your contributor, Mr. H. W. Brice, and am surprised that one of the well-known writers in your pages should advocate keeping honey in tins for months. I cannot, however, agree with Mr. Brice, because I consider honey should be kept either in glass or earthenware vessels. Tin does affect the flavour without doubt, and although it is less injurious when the best tin is used, the order of the day is for cheap articles, and for these "terne metal" is used. As sure as honey is put into vessels made from this metal, and allowed to remain in them for any length of time, it will contain lead.

To show what is done in works where terne metal is made, I may say the masters supply soap, brushes, hot and cold water, and towels for the use of workmen employed, and they have to wash themselves before partaking of meals, or are fined £2 for refusing or neglecting this precaution.—MORNING CLOUD, *Wolverhampton, December 4.*

(Correspondence continued on page 486.)

HOMES OF THE HONEY BEE.

THE APIARIES OF OUR READERS.

The bee-garden shown in the accompanying illustration will at once strike readers as "out of the common," as the phrase goes. Nor is the term misapplied, for British bee-keepers will, no doubt, regard it as a very uncommon bee-garden picture indeed. It, however, represents the apiary—situated at Trieste, Austria—of an old reader and esteemed contributor to the pages of this journal—M. Alex. Schröder—who is seen at the open lattice window of his bee-house and workshop, on the left. Several contributions from M. Schröder's pen appear in this year's volume of the *B.J.*, and he has been long known among Continental bee-keepers as an enthusiast in the craft.

In view of the comparatively small space occupied by the hives in the photo, it will perhaps surprise readers to know that there are nearly fifty colonies of bees located in the garden, most of them being arranged in tiers,

as seen behind the large tree in the foreground. Some few are located in the substantial beehouse wherein M. Schröder stands, several flight-boards being visible there; but the bulk of the hives are evidently stacked up, in true Continental fashion, in the shed further away.

It forms an interesting contrast to the apiaries hitherto shown, and we trust it will not be the last sent for inclusion in the

"Apiaries of our Readers" who may be located in distant parts.

M. Schröder sends a few "notes" regarding himself and his bee-keeping, which we quote

foreign queens for breeding from, and Count Kolowrat, to my knowledge, while certainly selling some, used to rear Cyprian queens by the score, and give them away as presents to his friends. I had received from these two gentlemen (who were 'first importers and breeders' of the Cyprian bees in Europe) written instructions on bee-keeping, along with some books on the same subject. This was my first bee-lesson, and I got quite enthusiastic about the bees. Count Kolowrat also presented me with various hives and implements for bee-keeping, among them

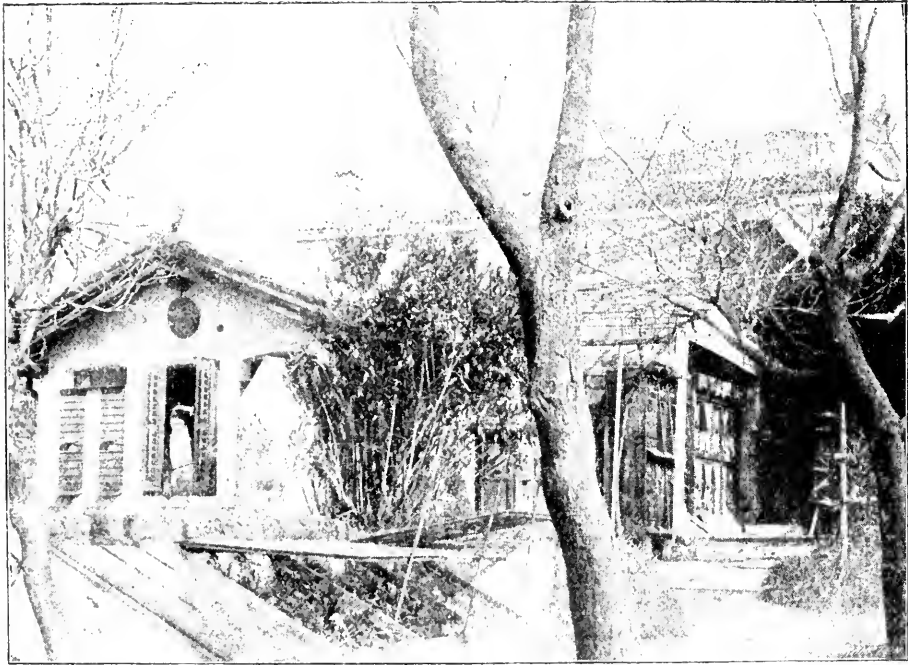

M. ALEX. SCHRODER'S APIARY, TRIESTE, AUSTRIA.

here as descriptive of the picture, &c. He says:—

"I enclose a photo (taken by my brother-in-law in February last) of my apiary which was started in the year 1874 with three hives presented to me by an English lady who left Trieste for another domicile. My interest in bees at the time had become strong owing to the import of foreign races from various parts, including Cyprus, brought here for Count Kolowrat and Mr. Cori, in Bohemia. These gentlemen had for several years been endeavouring to find a thoroughly-defined yellow race of bees, and finally did so in the Cyprian. At that time the transport of bees was not so easy as now. More than twenty years ago it was risky and expensive to get

straw and wooden hives, which are still among those shown in the picture, and in good working condition. In a little time I got on fairly with the bees, enlarging my 'bee-sheds,' and eventually got my present 'bee-house' (reduced to its present size) made from a large poultry and pigeon house. The bee-house referred to contains one room in each flat, and has four hives arranged along the gable wall, two of which are seen in the picture. Each of these hives can contain either a gigantic single colony or two strong ordinary colonies, there being room in each hive for forty frames. The lower apartment is my extracting and general workroom. In the upper one I keep all the necessaries (and unnecessary) of bee-keeping. There is also

plenty of storage room for empty and full combs, together with the 'curiosities' gathered in my over twenty-three years of bee-keeping. I have now usually between forty and fifty stocks to winter each year (in the winter of 1896 and 1897 I brought safely through forty-four hives and four nuclei) uniting in the autumn any excess of this figure, or selling swarms and hives at the original cost to beginners in the pursuit. I shall always be grateful to my dear friends, Count Kolowrat and the late Mrs. Cori, as well as to the lately deceased Mrs. Georgina Williamson Martin Lowell, seeing that I owe them so much of purest pleasures which apiculture and the study of the bee affords to its votaries. By chance I became enrolled as a correspondent of bee journals, and I still devote some of my spare time to writing on bees, though I have not too much leisure at my disposal.

"Bee-keeping is not very remunerative here, the country being stony; the average surplus of the last ten years was about 10 lb. of honey per colony, autumn count. An average of 20 lb. is about the maximum yield in one year, and 7 lb. average the minimum. The most I ever got from one hive was 84 lb. from my hive called 'Count Kolowrat, No. 2.' I sell my extracted honey at about 10d. (one Austrian crown fix price) in nicely got up glass jars; so does my friend, ex-pupil, now colleague, Mr. Rathborne, from his 'Plavia' apiary. My wax I get all by the solar extractor, which I introduced into Austria, Hungary, and Germany, and which, if well made, produces the cleanest and best wax obtainable. I have read that the solar extractor is largely used in the United States, but never heard a word of its being used in Great Britain, except once in the *Apiculture* of Milan, by Dr. Dubini."

CORRESPONDENCE.

(Continued from page 484.)

VILLAGE BEE-KEEPERS' ASSOCIATIONS.

[3093.] I would like to ask if any of the readers of the B.J. have had experience of the working of a village bee-keepers' association? I think it might be possible to form cottagers into an association for purchasing foundation, &c., in large quantities and with such expensive apparatus, as an extractor for the use of members, in fact, the principle of co-operation applied to bee-keeping, much as the Danes and Swedes have applied it to butter-making and captured the English market.—ALPHA, *Hull, December 1.*

TEACHING BEE-KEEPING.

[3094.] Referring to the letter of your correspondent, H. W. E. (3086, p. 476), I think he is wrong in applying to the "Parish Council" *in re* technical classes. They, as

"Parish Council," have no power in the matter, they have no funds to apply to technical education, nor can they use any money from the rates for that purpose. So that, unless the members of the Parish Council are also the members of the Technical Education Committee, H. W. E. has applied to the wrong authority. He must apply to the Technical Education Committee, or, if there is none for his district, to the County Council.—D. G., *Ilminster, December 3.*

THREE SIDE-CUT SECTIONS.

THE VALIDITY OF PATENTS.

[3095.] I can endorse what your correspondent, Mr. J. R. Truss says in 3080 (page 475). Mr. Truss was one of the first practical bee-keepers I met in my then new location at Holme. Aye, and didn't we talk out the best of every thing. The three side-cut sections I used and sold prior to Mr. Simmins' illustrating of same in his "Modera Bee-Farm" (published in 1887). But these three side-defaced sections found no great favour, and, to my mind, rather evidenced slipshod bee-keeping. It was not till 1886 that I decided in my own mind the superiority of having the three sides grooved and a split top-bar, so far as it being by far the best method, and causing the least defacing a section for full sheet for fixing. For this invention I got a silver medal award.

But how, in view of the evidence as to three side-cut sections and the illustration shown on page 73 of "Modern Bee-Farm" (1887 issue), a patent can be granted in 1896 and held to be valid, I am at a loss to understand. Surely it is so stated from want of knowledge of the "best authorities," and not the fault of the British Patent Laws, much as these require amendment? Any way, if three side-split sections are wanted, I say they can be had from any one without infringing any one else's "valid" patent.—JOHN H. HOWARD, *Holme, Peterborough, December 3.*

SLADEN'S V-SLIT SECTION.

[3096.] Referring to the mention made of my name in connection with a section cut through on three sides on page 464 in your issue of November 25, by Mr. S. Simmins, I think I explained to those who saw my sections at the *conversazione* of the B.B.K.A. in October last, that I do not wish to claim originality for the idea of cutting a section through on three sides, and I mentioned that such a section was, in fact, described by Mr. Simmins in 1887. I worked out the idea, however, independently a year or two ago, not being then aware that it was already known. As a result of further experiment, I was led to think of what I have called my V-slit section, in which I believe that the V-shape of the cut (similar to the V-cut of the corners, but in a longitudinal, not transverse, direction), and

the presence of a groove cut on the inside of the bottom bar, together with the form of guide-block used for fixing foundation, are all original ideas of mine. Many friends who have tried the section declare it to be a distinct advance on a section having only a plain saw-cut down three sides.

The accompanying illustration will help to make the idea clear to those of your readers who did not see the sections at the *conversation*. It shows one of the V-slit sections—which has been folded together and placed in the guide-block—having its slit opened to receive the sheet of foundation which is dropped into it from above. The foundation, which should be tough ("Weed" foundation answers the purpose admirably), is

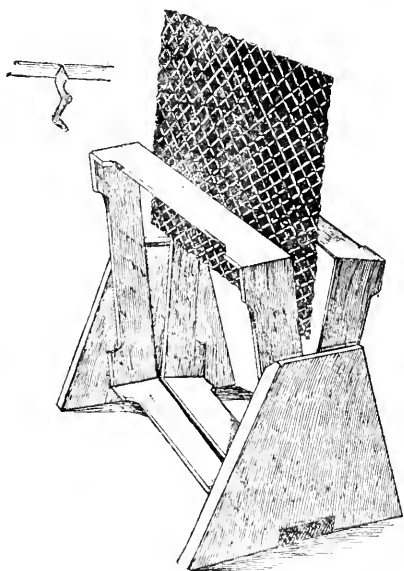

cut to a size of nearly $\frac{1}{4}$ in. square (for a 1-lb. section).

The guide-block keeps the section quite square, and directs the course of the foundation until its bottom edge rests in the groove in the bottom bar. The slit is then firmly closed on the foundation. Owing to the adhering nature of bees'-wax under pressure, the two halves of the section thus brought together cannot easily come apart, and the foundation is firmly embedded between them along the top, as well as down the ends, of the section.

I cannot follow Mr. Simmins' reason for saying on page 464 "there can be no advantage in the groove cut in bottom of the section." Without it, the bottom edge of a full sheet of foundation might warp to a considerable extent, but when it rests in the groove it cannot warp beyond the edges.

The advantage of the V-shaped slit over a "square" (parallel-sided) slit lies in the fact that the one makes a thoroughly effective job, and the other one less so, and this, as most bee-

keepers know, in the case of fitting foundation, may make all the difference between success and failure. In the V-slit, increase of pressure causes the foundation to spread itself out in the slit, as is shown in section in a somewhat diagrammatic way at the left hand top corner of the illustration. When the process is completed, the two halves of the section are cemented together by an almost solid mass of wax, which fills the slit, while on the outside the edges of the wood meet, so that in a completed section close observation would be necessary to detect the slit at all. In a parallel-sided slit the two halves of the section cannot easily be brought quite together, except by the application of great pressure: in this case the foundation becomes more or less detached from the section.

To succeed with the V-slit section the foundation must not, of course, be in a brittle state; and the best results are got in a somewhat high temperature, such as would be found in a honey room on an ordinary summer's day. With good foundation and a little practice, at the right temperature, I have been able to fix the foundation into my slit section so firmly that one could throw it up into the air and catch it again without fear of the slit opening or of the foundation becoming loose, and scores of sections were fitted up just as securely, as fast as I could fold them, open the slits, and drop the foundation in, with no apparatus beyond the simple guide-block shown in the sketch.

I need hardly say that combs built in sections fitted in this way with full sheets of foundation are even, and well attached to the wood; indeed, were it not for the propensity that some bees have of nibbling "pop-holes" through the foundation during a slow honey flow, "pop-holes" could not exist, since the foundation is made to fill the entire section.

Those who object to full sheets of foundation on the ground of expense or "fish-bone," may close the slit when the foundation is only a part of the way down the slit, such as where it is in the sketch, cutting off the remaining piece of foundation to be fitted into another section in the same way. In this case the uprights of the guide block should extend to the top of the section in order to guide the sheet of foundation from the start. I shall be pleased to give further particulars regarding it to any who are interested.—F. W. L. SLADEN, *Ripple Court, Ringwood, Dover.*

BEESWAX AND ITS USES.

BLEACHING WAX.

[3097.] In reply to the question put by your correspondent "D. J. C." (King's Lynn), on page 478 of B.B.J., December 2, my own experience is that beeswax cannot be bleached without taking away quality along with the colour. In my opinion bleached beeswax is for general purposes of less value than good

wax of any colour. To succeed in producing good wax, the cappings and odd pieces of comb must be graded, just as different qualities of honey are. I always make three grades of comb before rendering wax, viz., white comb and cappings, stained comb, and very dark comb. Wax may be bleached by exposing thin cakes to strong sunlight for some time.

"D. J. C." describes his as a poor district for selling the produce of his apiary. Surely it is not worse than my district in this respect? This is one of the largest and poorest parishes in Essex, and we are seven miles from a town. Did "D. J. C." read the extracts from the American bee journal on "Peddling Made Easy," in your issue of the 25th ult.? Every bee-keeper, to be successful, has to resort to "peddling" in one or other of its various forms. I have done a good deal of peddling in my time, but never traded for a "pig," or a "bull-pup," but always for hard cash. Through the autumn and winter season I have, after returning home in the evening, started out with a few sections and jars of honey many a night, and I remember one season in the eighties, when we had a poor honey harvest, I sold all my surplus honey at one house at 1s. 3d. a pound! Every bee-keeper should sell as much as possible of his honey at home. This keeps the market clear and open.

The best way to advertise our produce is to make a few presents of honey to friends at Christmas. This is a taking advertisement, and pays to do well. A representative parcel may be made up of one section of comb-honey, one jar each of clear and granulated honey, and a neat ball of beeswax. If "D. J. C." cannot sell his wax I can dispose of 20 lb. for him if clean and guaranteed pure. One of my best customers recently bought a quantity of wax elsewhere, and found afterwards, to his cost, that it was adulterated. Frequently wax is badly strained, or not at all; this spoils the sale. I have found bees' heads, and even whole bees in a cake of wax.—WM. LOVEDAY, *Hatfield Heath, Essex, December 6.*

DOES HONEY PRODUCING PAY?

[3098.] Your correspondent, "Enquirer" (3077, p. 473), in the last issue of B.J., asks if in the opinion of owners of large apiaries it pays to produce honey to sell at present wholesale prices? which he quotes fairly accurately. I think he may, without doubt, be answered in the affirmative, though we all should be glad to receive the better price of years ago. The lesson taught by a consideration of the "Apiaries of our Readers" is that the large apiaries—illustrated in your pages—have gradually been built up by men having a natural aptitude for handling bees, combined in many instances with handiness in the use of tools. Under these conditions cost of appliances has been reduced to the lowest point, and time economised to the utmost in the necessary manipulation of a

large number of hives. Thus the product in honey or wax is placed on the market at less cost than that of the average small bee-keeper. The next point to note is the need of business aptitude in disposing of the produce. It is all to the interest of the large producer to keep up the price, and to keep together the business connection built up by continued uniform good quality over a series of years. The man who spoils prices is the unmethodical and slipshod one who disposes of his second-class honey at the first offer he can get, which is usually very small.

Then, at what rate should we value the time occupied in bee-keeping? Bee-keeping is certainly one of the minor branches of agriculture, and should, therefore, be paid for at agricultural rates, i.e., about 3d. per hour, and the intelligent, shrewd country cottager is the most suitable person to carry it on. The fancy rates per hour of the oppressed engineer or artisan are not for the humble bee-keeper. As regards the bringing of the consumer and producer into contact, I think we shall find that the self-closing tin containing 4 lb., 7 lb., or 14 lb., the best and cheapest package. Brown paper and string are all it requires to fit it for journeying by post or rail in perfect safety, and in using tinware we shall but be following the example set us by the syrup makers, who now use it. Hoping these few remarks may meet with your approval.—T. I. W., *Great Totham, Essex, December 5.*

SUCCESS IN "SHOWING."

[3099.] With your permission, I will say a few words on Mr. W. Woodley's "Notes by the Way" in B.B.J. for December 2 (page 472). Mr. Woodley speaks of the "lustre" attached to "success on the show-bench." In my opinion this is a feeling which should be discouraged. Unfortunately, in many districts rivalry on the exhibition table is the reverse of friendly, and no sort of encouragement should be given to a feeling of having added lustre to one's own name by winning prizes from others. Those who exhibit should do so to assist the show, at the same time hoping to get some return for the trouble involved, not solely for glory and gain, as is sometimes the case; then there would be less disappointment. I have known a disappointed exhibitor to watch for an opportunity, pocket his exhibit, and leave the exhibition by a back door, that his friends might not know that he was an unsuccessful exhibitor. I regard shows as a first-class educational medium, and being under an obligation to the B.B.K.A., I exhibit a good deal to assist the various shows, keeping in mind the idea of educating the younger members of the craft and the public. Exhibitors who fail to win prizes may learn much, and see why they are left behind by examining the winning exhibits. I have never attended a show without learning something.

Mr. Woodley has several times, during the

last few months, mentioned in print that a number of persons have joined our ranks through bee-keeping having been "boomed" in the papers; thus reducing the price of honey by increasing the supply. While we are paying the foreigner about £200,000 a year for honey and beeswax there is plenty of room for more bee-keepers, and while many tons of golden nectar are wasted every year for the want of bees to gather it, there is foraging room for more bees. I think we should look forward to the time when the working man, as the term is generally understood, can have a dish of good honey on his table, and not allow honey to continue to be regarded as a luxury for the well-to-do only. I believe good honey will continue to command a paying price, and the lower quality honey helps to keep out the foreigner.—WM. LOVEDAY, *Hatfield Heath, Essex, December 6.*

USES OF BEESWAX.

[3100.] In reply to query in B. J., November 25 (p. 466), I beg to state that beeswax is a good deal used in this neighbourhood by plasterers for moulding, &c.

In last week's B. J. I also observe that "D. J. C." (p. 478) finds some difficulty in disposing of his beeswax. I only wish my bees would produce as much of that commodity as they do of honey. This year I had only 9 lb., which I sold to a party who asked for "one ton," or, say, 2,240 lb. Of course, I looked somewhat small under the circumstances when I told him how much I had.

The great difficulty lies with some in not knowing the proper parties to apply to who really want the home article (not foreign) and in quantity. Buyers, on the other hand, appear to be as much at a loss where to get it. Of course, they know there are hundreds of bee-keepers throughout the country, but where are they to find their addresses? This is a common difficulty with all who are not acquainted with the proper dealers in any article.—HENRY A. WEBSTER, *Gourrock, N. B., December 4.*

WEAK COLONIES FOR WINTER.

Question.—"I wish to ask for a little advice. I have 200 colonies of bees, and the honey-flow failed about October 1 on account of drought. I have just been looking into my hives (November 8), and I find not enough bees to cover two or three combs, with no brood, either sealed or unsealed. But all have plenty of stores. What can I do to save those bees? If I unite them will the bees not be too old to stand the winter? How can I stimulate brood-rearing at this time of the year?—T. McD., Gallatin Co., Ill."

Answer.—It is rather late to give feed to bees to incite breeding, yet an attempt of this kind cannot be injurious, even if it is not

successful. It is well known to bee-keepers that bees will breed most when there is a flow of honey, especially if the flow is not strong enough to cause them to fill the brood-cells. The queen has to eat a great deal in order to lay eggs in such large quantities as she usually lays, and her appetite is excited by food being constantly offered to her by the workers that go about with a full honey-sac. If we can produce these circumstances artificially, we can undoubtedly incite her to lay eggs, although at this season we encounter the resistance of their natural habits, which are opposed to the object in view.

By feeding warm honey, slightly thinned with water, in small quantities, but at often repeated intervals, we will create more or less excitement in the hive, the queen will be offered food oftener, and the result will certainly be an increase in the laying of eggs. Whether this laying can be induced in a sufficient amount to supply a force of bees adequate to the requirements is a question that can only be solved by the actual experiment, but if we were to try to breed up as desired we should feed each colony, say a couple of tablespoonfuls each evening for a week or two, and we should take pains to scatter this food about the combs, to give them as much labour as possible in gathering it up. We would feed in the evening, and not at any other time for fear of robbing. The excitement caused by this would subside by morning. If it was found that the quantity fed caused too much of an increase in the stores, we would reduce it according to the circumstances.

When we feed bees for a winter supply in seasons when they are short, we take especial pains to feed as quickly as possible in as large quantities as practicable, because we wish to shorten the period of excitement; but in this case it is necessary to lengthen it as much as convenient, since we seek production of bees and not supplies. In hives that were too plentifully supplied with stores, and had too few bees to winter, we have often seen the practice of slightly cutting into the sealed combs at the back, and as near the bottom of the frames as possible. The honey thus exposed acts in a similar way to the feeding which we recommended above. It causes the bees to transport it in order to repair the comb, and creates an excitement which will lead to breeding. If the questioner tries this method we would like to know his experience at the end of the season.

We advise the use of warm, thin food, because it thus more nearly resembles a spring harvest, and also because watery honey is best for larvæ food; but such food, if given in unnecessary quantities, would prove injurious, as it might be stored for winter.

If the colonies are exceedingly weak, and the winter near at hand, with stormy days and cold nights, it would be of no use to try this method, which can be successful at best only when there is a chance for the bees to take

flight during the day. On the other hand, as pollen is needed, if there is none in the hives, the experiment would be sure to prove a failure, for there are no blossoms at this season, and we doubt whether the bees could be induced to take artificial pollen in the shape of flour or meal.

In such a case, nothing is left to be done but uniting several of the colonies into one. This requires a great deal of care, and is not always successful, and rather than attempt it on a large scale we would risk wintering all those colonies that were worth it by placing them in the cellar at the opening of the coldest weather. When cellar-wintering is carried on in favourable circumstances a smaller colony may be wintered in this way than out of doors.

It has been a question with many bee-keepers whether a hive containing no young bees could winter as well as one containing both young and old bees, and from discussions on this subject the fact has been elicited that the old bees would winter fully as well as the young, but that they were not so well fitted to rear brood as the young bees were. It appears that the glands which help them in the process of making the larval food or jelly, become atrophied or shrunken with age, so as to render them unable to produce it.

But it is not astonishing that bee-keepers generally should have become distrustful of colonies containing only old bees for winter, for the appearances are against them. Taking two colonies of apparently equal strength, the one with brood, the other with none, the conditions are evidently not equal, as the one has an advantage in the expected increase which places it in much more satisfactory circumstances than the other. But at this season of the year there is but little brood in the hive. And, to speak plainly, in our opinion it is a mistake to mistrust hives that have only old bees, if conditions are otherwise satisfactory. Aside from the fact that they are less able to take care of the brood, they are otherwise fitted to go through winter fully as well as the young bees. Their bowels do not so readily become distended with discharges as those of the young bees, for they eat less.—C. P. DADANT, in *American Bee Journal*.

IRISH BEE-KEEPERS' ASSOCIATION.

The Committee of the above Association met on 2nd inst. President, Mr. Read, in the chair, Mr. Farrelly, Mr. T. O'Bryen, Mr. Drought, Mr. Watson, Mr. Jenkins, and Mr. Henry Chenevix (Hon. Sec., 15, Morehampton-road, Dublin). Certificates of prizes won at the Co. Kerry Society's Show were signed for by Mr. Eugene O'Connor, of Castleisland. A list of names of school teachers to be certified to the Commissioners' of National Education as competent to instruct children was submitted and approved.

Notices to Correspondents & Inquirers.

All queries forwarded will be attended to, and those only of personal interest will be answered in this column.

(Mrs.) B. C. J. (Milnthorpe).—*Drones in November*.—1. As a general rule the presence of drones in hives in November may be taken as a sign either of queenlessness, or else that a queen in abnormal condition is at the head of the stock. 2. There can be no re-queening until spring at which time the colony will have dwindled considerably in numbers, and only be of use (if worth the trouble) for uniting to a weak lot with fertile queen at its head. 3. Mr. Wells' address is Aylesford, Kent. 4. Bees sent are the ordinary brown variety.

H. N. B. (Sedburgh).—*Packing Hive-sides for Winter*.—If the space between hives and outer-cases is packed with chaff, or any other littersy substance, the strip of wood—usually sent along with hives—used for bridging over the entrance in summer, is fixed in position before the chaff is put in, personally, however, we do not pack the space at all, and find no appreciable difference in wintering stocks so.

CYMRUS (Anglesea).—*Dealing with Queenless Bees*.—We regret delay in reply, but if you have not already united the queenless bees to the small stock offered by a friend, it should be done the first fine day. Use flour for dusting the bees when uniting.

J. H. (Cardiff).—*Starting Bee-Keeping in a large Town*.—To "start bee-keeping in a large town half a mile from the open country," and then, "ask whether I can make them pay?" is to meet trouble half-way, and invite us to reply in the negative. In fact, it would be next to impossible to make bees pay under such circumstances.

J. W. NELSON (Westmoreland).—*Spring Travelling-Crates for Sections*.—1. Those who have had experience of properly made spring-crates for sections, know so well that they are entirely effective for the purpose, that we must look for the cause of your failure somewhere else than in the crate we recommend. Besides, the maker you name is so generally credited with knowing his business, that it would only be bare justice to hear his side of the story before publishing names.

H. J. W. (Cambs).—*Dealing with Honey "Out of Condition"*.—We have deferred reply, deeming it advisable to wait till we saw if the honey would "set" well after melting, and show more plainly its subsequent chance of keeping. It has now re-granulated well, and although, when liquid, there were signs of fermentation, these seem to have now disappeared, and we consider it quite in marketable condition, and such as the tradesman should readily take back for sale.

S. E. (Farningham).—*Wooden Dummies*.—See reply to "Robin Hood" in B.J. of November 25 (3072, p. 468).

Editorial, Notices, &c.

COUNTY OF LANARK B.K.A.

ANNUAL HONEY SHOW.

By way of accounting for the very late appearance in our pages of a report of the above show, which took place some time ago, we append a letter received from the Hon. Secretary of the County of Lanark Bee-keepers' Association which explains itself. For ourselves, it needs but to add that the account of the show forwarded some time ago must have missed in post, as it did not reach us. We are, however, even thus late in the day, very glad to make good the lapsus through the courtesy of Mr. Cassells, who writes as under:—

"DEAR SIRS,—I enclose herewith to you copy of the *Hamilton Advertiser* of October 9, 1897, containing report of the annual show of the County of Lanark Bee-keepers' Association. A number of the members of the association, who are readers of THE BRITISH BEE JOURNAL, have called my attention to its non-appearance in the official organ of British bee-keepers. Some time ago I sent another copy of this paper, with the particular part marked, but possibly amid your many communications it has gone astray. On behalf of our association, I shall thank you to give it notice in your next issue. I think I may safely say that it was the Scottish honey show of the present year. Thanking you in anticipation,—Yours truly, JOHN CASSELLS, Secretary, *Hamilton, N.B., December 9.*"

The third annual honey show of this association was held in the Town Hall, Hamilton. There were 520 entries as compared with 200 last year, and the show was most interesting, the display of honey being the largest and best that has ever been seen in Scotland. Most of the honey-producing districts of Scotland and England were represented, and from the high quality of the exhibits the competition was throughout keen and close.

The arrangements throughout were very complete, and reflected much credit on the secretary, Mr. John Cassells, solicitor, and the active committee by whom he was ably assisted. The judges were:—Rev. R. McClelland, Messrs. Gordon, Dunn, Jamieson, and McMillan. Awards:—

Display of Comb and Extracted Honey (open classes).—1st, William Hogg, Castle Douglas; 2nd, Walter Rae, Biggar.

Display of Honey (not to exceed 100 lb.).—1st, W. Hogg.

Honeycomb Design.—1st, J. Greenshields, Larkhall; 2nd, Walter Rae.

Non-Sectional Super (not exceeding 25 lb.).—(County only).—1st and 2nd, J. Clark, Carnwath; 3rd, J. Brown, Carstairs.

Non-Sectional Super (Heather Honey) (not exceeding 25 lb.).—1st, R. Weir, Carnwath; 2nd, J. Clark; 3rd, R. Colthart, Abington.

Non-Sectional Super (not exceeding 10 lb.).—1st, R. Weir; 2nd, J. Thomson, Bothwell; 3rd, J. Clark.

Super (not exceeding 15 lb.).—1st, J. Clark; 2nd, A. Thomson, Larkhall; 3rd, J. Thomson.

Non-Sectional Super (not exceeding 8 lb.).—1st, J. Clark; 2nd, R. Weir; 3rd, W. Rae.

Non-Sectional Super (Heather Honey) (not exceeding 8 lb.).—1st, J. Clark; 2nd, J. F. Frame; 3rd, J. Park, Crossford.

Six 1-lb. Sections.—1st, J. Thomson; 2nd, D. B. M'Nab, Bothwell; 3rd, A. Boa, Biggar.

Six 1-lb. Sections (Heather Honey).—1st, A. Boa; 2nd, W. Ormiston, Biggar; 3rd, R. Colthart.

2-lb. Section.—1st, J. Thomson.

1-lb. Section.—1st, J. Thomson.

Bell Glass of Comb Honey (not over 5 lb.).—1st, W. Rae; 2nd, James Cowie, Lesmahagow.

Display of Comb and Extracted Honey.—1st, J. Clark; 2nd, M. Rae, Biggar; 3rd, D. B. M'Nab.

Twelve 1-lb. Jars Extracted Honey.—1st, Thomas Pate, Milnathort; 2nd, A. Boa; 3rd, J. Brown.

Three 1-lb. Jars Extracted Honey.—1st, W. Ormiston; 2nd, Thomas Pate; 3rd, D. B. M'Nab.

Three 1-lb. Jars Extracted Heather Honey.—1st, A. Boa; 2nd, T. Pate; 3rd, W. Cowie, Lesmahagow.

Six 1-lb. Jars Granulated Honey.—1st and 2nd, Walter Rae; 3rd, William Loveday, Harlow, Essex.

BEGINNERS' CLASSES.

Three 1-lb. Sections.—1st and 2nd, D. B. M'Nab; 3rd, J. Cassells, Hamilton.

Three 1-lb. Jars Extracted Honey.—1st, A. Hunter, Abington; 2nd, J. Cowie; 3rd, A. Thomson.

Three 1-lb. Jars Extracted Clover Honey.—1st, D. B. M'Nab; 2nd, A. Walker, Uddingston; 3rd, George Stronach, Uddingston.

Three 1-lb. Jars Extracted Heather Honey.—1st, J. Cowie; 2nd and 3rd, W. Brown, Strathaven.

One Super each of Clover and Heather Honey; *1-lb. Section and 1-lb. Jar each of Clover and Heather Honey*.—1st, W. Hogg; 2nd, R. Weir; 3rd, J. Clark.

Super Heather Honey.—1st, J. Clark.

Super (not exceeding 10 lb.).—1st and 2nd, W. Hogg; 3rd, D. B. M'Nab.

Three Shallow-Frames Comb Honey.—1st, W. Ormiston; 2nd, W. Hogg; 3rd, J. Cowie.

Four Bars Comb Honey.—1st, A. Thomson; 2nd, A. Brown, Blantyre; 3rd, J. Robertson, Blantyre.

Bees Wax.—1st and 2nd, T. Platt, Larkhall; 3rd, A. Thomson.

Observatory Hive.—1st, J. Thomson.

Complete Frame Hive.—1st, Messrs Lee & Son, London; 2nd, R. Black, Rutherglen.

Hive Suitable for Heather.—1st, Lee & Son; 2nd, R. Black.

Standard Frame Hive (amateurs only).—1st, A. Nisbet, Auchinheath; 2nd, W. Ormiston; 3rd, J. Stevenson, Larkhall.

New Invention.—1st, W. P. Meadows, Leicester; 2nd and 3rd, Lee & Son.

Collection of Bee Appliances.—Austin & M'Anslin, Glasgow.

Most Successful Exhibitor.—J. Clark.

HONEY SHOW AT BASINGSTOKE.

I again thank you for kindly publishing notice of our Show in B. J. of the 25th ult.

The Show, as a whole, was a grand one, there being 1,150 entries altogether, including exhibits from the most important poultry and bird shows in the kingdom.

With regard to the bee-keepers' section of the exhibition, the entries were very satisfactory for a first start with honey exhibits, the class for sections including Mr. F. Chapman's winning exhibit at the Dairy Show and Mr. Moreton Lord's fourth prize sections at the same Show. All the entries in the class for extracted honey were capital samples, and much of it sold.

Mr. Milson and Dr. S. Andrews officiated as judges of the honey, and made the following awards:—

Twelve 1-lb. Sections.—1st (special and medal), F. Chapman, Wells, Somerset; 2nd, J. Moreton Lord, Northiam, Sussex; 3rd, Mr. Boyce, Odiham, Hants; v.h.c., G. Slater, Basingstoke; h.c., H. Rowell, Hook, Winchfield, Hants.

Twelve 1-lb. Jars Extracted Honey.—1st, Jabez Sopp, Crowmarsh, Wallingford; 2nd, J. Moreton Lord; 3rd, G. Slater; v.h.c., H. W. Seymour, Henley-on-Thames; and E. C. R. White, Romsey; h.c., E. C. R. White and J. W. Lewis, Farham, Surrey.—(GEORGE SLATER, Basingstoke, December 13.

Correspondence.

The Editors do not hold themselves responsible for the opinions expressed by correspondents. No notice will be taken of anonymous communications, and correspondents are requested to write on one side of the paper only and give their real names and addresses, not necessarily for publication, but as a guarantee of good faith. Illustrations should be drawn on separate pieces of paper. We do not undertake to return rejected communications.

*. In order to facilitate reference, Correspondents, when speaking of any letter or query previously inserted will oblige by mentioning the number of the letter, as well as the page on which it appears.

NOTES BY THE WAY.

[3101.] There is a measure of sadness in nearing the end of another volume and in writing about the end of the year. The latter event induces one to take a retrospective view on many subjects not admissible in these columns, but there are some subjects which

we can, however, discuss in the B. J. with considerable help to ourselves and, it may be, service to those who are novices in bee-keeping. The ostensible object of spreading a knowledge of the craft according to improved methods amongst cottagers and the labouring poor in country districts was the praiseworthy motive that called bee-keepers' associations into being some twenty years ago. It was hoped that the cottager would adopt the more humane and profitable system of keeping his bees in movable frame-hives. This hope, I fear, has not been realised in many cases in this district of West Berks, whatever it may have done in other parts of the country. There are many places where cottage bee-keepers could be counted by the score twenty years ago, and the number had dwindled by quite one-half in the following ten years, and the decrease still goes on. Old bee-keepers die off as time passes, and their sons will not trouble themselves much with bees. The majority are too poor to purchase frame-hives, nor would they trouble to learn how to manage them on profitable lines. I have had practical experience of this in cases where, a few years back, after starting some in this district, and giving advice and help (or, rather, doing the practical work for them), I found, when left to themselves, their interest flagged, and the bees were left to take their chance. And unless one continues to help and help, all along, their interest seems to die out. I used to say I didn't expect to be always wheeling them out in a perambulator; they should learn to manage to walk alone, without depending constantly on a teacher. Looking back to those would-be bee-keepers who will take no trouble at all on themselves, the only consolation is the fact of having helped some to have that pot of honey on his table, of whom Mr. Loveday writes in last week's B. J. [3099, p. 488] I am glad that Mr. L. has called attention to my note on "showing," and trust others who habitually stage exhibits on the show-bench will give us their motive in showing honey. The chances are that most of us compete in the hope of winning; there may be a few who are so blessed with an overplus of this world's goods and spare cash that they can go on year after year exhibiting at every honey show in Great Britain simply to help in making a show by filling the classes. This is of course commendable, but to the majority of showmen "winning" is the prime motive which induces them to enter the lists. I admit having had the educational side in view when sending my own exhibits to some shows, but I always sent honey which I hoped would make its mark in the eyes of the judges. The educational side is giving exhibitors a practical lesson on how to put up section honey in the best form for market. I may also add that my idea is to show—where one's own labour is not a bar—how to put up sections in the cheapest and most efficient style for market. These facts being constantly displayed before the public

and bee-keepers in particular at all the important honey shows has, I trust, done somewhat towards popularizing comb honey. For myself, I can say that every year my trade is extending and, further, I shall not be able to supply my customers' orders till honey of 1898 is ready. Good honey put up in saleable packages commands a market, and repeat orders from the same firms year after year in increasing quantities tells its own tale.

In closing my "Notes" for the year I take the opportunity of wishing all bee-keeping friends a merry Christmastide.—W. WOODLEY, *Beedon, Newbury.*

APICULTURAL NOTES.

THE SEASON OF 1897.

(Continued from page 484)

[3102.] The brilliant and encouraging outlook mentioned in my "notes" last week was suddenly changed into one of gloom and despair. The delightful weather which had prevailed for several days came to a temporary close on the evening of June 13. Then came a week of the most wretched bee weather imaginable. Supers which had been crowded with bees were suddenly left bee-less. Not a bee was to be seen on wing, and many of the hive entrances were deserted as in midwinter, while every stock in the apiary looked as though it had swarmed. I was quite afraid that swarms really had come off in many cases, and for the moment became very anxious to ascertain if it really was so. The weather, however, was so cold that it was positively unsafe to open hives; therefore nothing could be done but patiently wait to see if there would be a return of favourable weather. While thus waiting, several queen-cells which I was anxious to save were, of course, lost. What had looked like being the most profitable week of the whole year turned out to be one of absolute idleness, not a drop of honey being gathered during the whole time, whereas with seven more days of the favourable weather many hundreds of sections would have been filled in my own apiary. It was the very best part of the year, and every day lost meant a good sum in cash lost too, for bee-men with large apiaries. The many hives, supers, &c., which had been prepared during the winter looked like remaining so much dead stock for another twelve months, and the prospects of a satisfactory return for the liberal feeding and unstinted labour and attention that had been bestowed on the bees was daily becoming more remote. The tuneful strains which had rejoiced our hearts the week before was now turned, so to speak, into a doleful song of lamentation, and the outlook was gloomy indeed. Everything seemed to betoken "vanity and vexation of spirit." The evening of June 20 was so cold that I was glad to close the door of our domicile, and seek the comfort of the

fireside. The very early part of next morning indicated a pouring wet day, but the temperature rose, and so did the bees. My first swarm was out by eight o'clock. The sun did not break through until nearly mid-day, but by that time I had hived about a dozen swarms, and before the day was over the number which came off and were hived was twenty. How many absconded I am unable to say. "Swarming Fever" in no way describes the bees' behaviour. They were simply "mad." It just looked as though the whole lot had made up their minds to swarm simultaneously, and that they were all determined to upset the adage that "unity is strength." About half-a-dozen huge swarms formed one big cluster, and it took me all my time to prevent another like number "joining-up" in the same way. In several cases swarms settled on the alighting-boards of other hives, and in trying to effect an entrance a battle royal ensued. Altogether it was the warmest day's work I had had for a long time. As stated in my last "notes," I wanted some natural swarms for experimental purposes. I had, therefore, done nothing to prevent swarming, but had rather encouraged it, with the intention of reversing matters so soon as sufficient swarms had issued. The first real swarming day, however, had given me enough and a good many to spare. I therefore took immediate steps to put a stop to it. Having decided over night what I would do the next day, I took time by the forelock, and so did the bees. I started work at 4 a.m.; they started swarming at 7, and kept up the game during greater part of the day. Several swarms which had been hived the previous day on full sheets of foundation—which they partly worked out—re-swarmed. Many of the prime swarms were accompanied with several queens, which, no doubt, accounted for a great deal of trouble that followed. For prime swarms to be accompanied with three or four queens is no doubt unusual—but not unaccountable. Many of the stocks were on swarming point when the cold weather set in, and on the return of warm weather young queens were just ready to hatch. At last the bees were quieted down, but not until the majority of the stocks in my home apiaries had swarmed. Before the swarms had become well established there was another return of unfavourable weather, and we began to wonder how much sugar it would take to feed up our 150 colonies for winter. But we were soon relieved of that anxiety; another spell of fine weather set in, and sent both swarms and stocks up into supers, where they worked well for a short time, but another cessation in the honey-flow occurred, which we regarded as final. We had now got to the middle of July—and it is very rarely that we get honey in this district after that date—unsealed honey was taken down by the bees, and all sections thus emptied were removed and stored away for next year's use. I then left home for a few days, and on my return, to my great surprise, every section left on was full

up with honey, some of which weighed 18 oz. Many of the sections taken off empty had to be put on again, and were quickly filled, removed, and others put in their place, which were also filled. I got quite a lot of sections filled in August, a thing I never knew to happen in this locality before. Altogether I got, as I stated at the *Conversazione*, about 1,000 lb. of honey after I had concluded the honey season was over. The whole 150 colonies have abundance of honey to carry them well through winter and spring, and I have not had to buy a single pound of sugar for winter feeding. Twenty of the stocks were sold to one customer, leaving me about 130. My out apiary, worked for run honey, gave me very little trouble. Only two swarms came off, both of which would have been prevented but for a slight oversight on my part.—ALLEN SHARR, *The Apiary, Brampton.*

THE BEE SEASON OF 1897.

A HAMPSHIRE BEE-KEEPER'S EXPERIENCE OF IT.

[3103.] Last season was for some bee-keepers in this county the best they have ever had; for others the worst. The bees swarmed like mad things, and those who did not put the swarms back took but little honey. My own swarms were always returned, though it was impossible in all cases to keep the bees from coming out again. Out of twelve hives eleven swarmed, and some of them came out six times. One morning, when they persisted in swarming, and I had six swarms hanging in different parts of the garden at the same time. I verily believe that any one who had come along might have got all my bees for the asking, on condition of carrying them off at once out of my sight. I tried a "Conqueror" hive; but it did not conquer the bees. It swarmed thrice. But the principle of the thing seemed to work successfully—the sliding chambers and the safety chamber beneath the brood nest, where the bees built out the wax foundation, as I found at the end of the season, but had reared no brood. The yield of the hive, too, was on the whole good. Besides, it acts as an unrivalled *mouse-trap* during the winter. They (the mice) gnaw away the entrance, run up the hollow sides of the hive, and make a nest in the quilts. Then, with the help of a dog at the mouth of the hive, they can be caught.

This hive gave me one curious experience. It swarmed, and I returned the swarm. Six days afterwards, on opening the hive, I found one bee by itself on the top of the quilts. At once it began to fly, and feeling sure it was a queen I snatched at it and caught it. It proved to be a queen, so I put it in a cage, and gave it to a queenless nucleus, and when released her majesty was well received. I suppose it was a young queen who had fled away from the old queen, and had escaped up the sides of the hive.

I am still waiting for some one to discover a remedy for swarming? When I lived in a neighbouring county I had no trouble with it; a hive would not on an average swarm more than once in ten years. But when the bees were brought to this spot, though they are in the same hives and treated in the same way, a hive swarms nine years out of ten. Perhaps the earliness of the season here is the cause, or, may be, charlock is a stimulative diet for bees. I noticed the bees working on one variety of willow on February 28, on another variety on April 28. Willows of one kind or another were in flower all that time, but there were not more than two or three days in which the bees could work on them.

My hives needed no autumn feeding this year, and, I suppose in consequence, looked almost as if they were uninhabited in September. On fine days there was sometimes hardly a bee flying, but by now, some of the hives have begun breeding; for on a still day when standing near the pond, I can hear them and see them fetching water.

In examining a "Wells" hive in March, I found that a piece of wood had warped and, in consequence, the bees were walking past the "Wells" dummy from one side to the other. Yet there was no fighting, and a queen breeding each side. Is not this contrary to regulations?

Has any one tried a "Wells" hive with a solid dummy? Mine are so sealed up that they are practically solid dummies; and bees mix so readily in spring when honey is coming in, that I expect they would work in a common super, even though they were strangers.—With best Christmas wishes, H. S., *Winchfield, December 11.*

SUNDRY BEE NOTES.

[3104.] *Stowing Honey in Tin Vessels.*—The thanks of bee-keepers are due to "Morning Cloud" (3092, page 484) for bringing forward what he considers a danger, from his knowledge of the process of manufacture of cheap tin in which "terne metal" is used. But I do not think there is much cause for alarm, as good tin does not act upon honey, nor honey upon the tin. It is only those bee-keepers who have a tendency to buy the cheapest of everything (the dearest in the end) who are likely to get served with "terne metal." The only complaint I have is, that the dealers will not take sufficient care of the tins, as frequently, when delivered to bee-keepers, numerous spots of rust are to be seen inside the tins. I have proved that with *good* tin. The honey does not act upon the metal, even where the rust spots were.

Hornets.—I have just learned that a nest of hornets were destroyed this autumn within two miles from here. I have not seen a hornet or heard of a nest, previous to this, for twenty years.

(Continued on page 496.)

SKETCHES BY A ROVING BEE-KEEPER.—No. II.

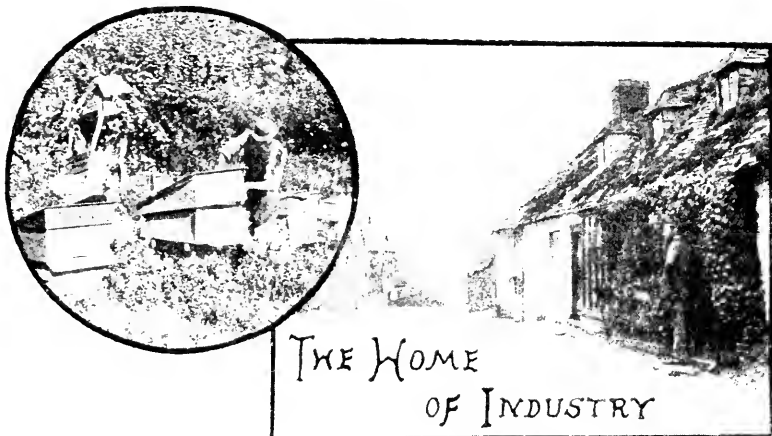

BY ALFRED WATKINS.

At an early part of the course of the river Wye, soon after coming down from its mountain birth-place on the slopes of Plinlimmon, it forms the border line between two Welsh counties; and at one point Nature seems to have placed an impassible barrier of rock in its course. But centuries of effort have carved out a narrow chasm for the mountain stream; and so, before falling over a natural weir, it forms a deep and placid pool where the lads of the place bathe on summer mornings, and even dive into it from the single arch bridge which spans from rock to rock just at this point.

Up from the bridge, the houses of a little town line each side of a steep road, until a more level space is gained where four streets meet at the old market house. One small cottage in the street wears an appearance somewhat different from the rest; in the summer time the little front is bright with canariensis and nasturtium, with perhaps a lily planted in the window box; and then, later on, the window panes are lined with honey in bottles and sections exposed for sale, for visitors often come to the little town from an inland watering place not far off. The street door opens into the one room, with stone floor and low ceiling; but arranged on shelves and against the wall are many signs of the owner's taste—a prize cup from the horticultural show, one of many prizes gained for garden produce; a few mounted butterflies; a book or two on natural history; and, most valued of all, the silver medal of the British Bee-keepers' Association, gained one year for the best collection of honey at the county show.

We often visited the town, and that magnetism which draws bee-keepers together brought us to John Williams, the shoemaker,

who lived there. He at once took us to his bees, at that time (some few years ago) in boxes made after instructions in that old standard book "Bevan on the Bee," and ranged in a neat bee house which bore the sign (cut out in white paper letters), "The Home of Industry."

John was used to working supers and glasses, but knew nothing of bar frame hives; yet such was his eagerness to learn that the help we were able to give in the course of successive visits quickly bore fruit. And very pleasant these periodical visits grew to both; always the same eager face and smiling greeting from wife and children; the great talk on bee matters; the frame hive or hives made since the last time to be shown; or stocks to be overhauled, supers examined, and grand consultations as to this queenless, or that weak, stock to be made.

And in a season or two a new colony of hives was established among fragrant mignonette, near the nut-tree hedge at the top of the garden, all frame-hives of John's own making, some constructed from Indian tea chests (and capital working hives they were) at a total cost of half-a-crown, and some of the simple storifying pattern we use ourselves. Then there were the walks we took together among the hills, and the exploration of the beautiful valley where the ravens build; the joint scheme we carried out for taking a couple of lives up among the heather-clad hills, John tying a couple of ropes across the top of a gambriel (country cart) on which the hives rode in perfect safety. It was a sad September day when we went up among the wet heather to visit them, and we were able to take only a very few sections of the fragrant heather honey back to our own clover district.

John is the bee-man of the district, and

every bee-keeper near is glad of his help and advice. The man who keeps the little shop next door had noted, over the hedge which divides the gardens, how many bright sections of honey and well-stored combs come from the well-managed stocks of bees, and so he has set up a couple of hives; but, says John, "He neglects them shameful, and when he gets into a mess with 'em I have to go and put 'em to rights." Sad complaints he makes of the carelessness of his bee neighbours, "for indeed they will let you do any amount of work in driving bees and taking honey for them, but indeed they will never try to help themselves." And to two of his eldest children a hive apiece was assigned, in which they took great interest, and Jim was saving up his pennies to buy sugar to feed the bees for the winter, but Tommy didn't see why the bees couldn't take care of themselves.

It was a little sad to notice our friend's hollow cough and narrow chest, the result of years of indoor work; and he often spoke of the wholesomeness of his bee-work in the open air, and wished he could make it his chief occupation. We found him a little expert work to do for the Association, but bee-keepers in that thinly-populated district are widely scattered and have gradually ceased membership. A season ago our friend had a sad loss. He prepared his bees for winter as usual, and took care they had plenty of stores; and yet in the spring three-fourths of them were dead, leaving honey in the hives. The good bee-keeping Colonel who calls upon John now and again thought they might have been packed up too carefully, not leaving enough ventilation in the hive.

We have not seen our friend for three years, and sadly miss his tall figure and eager, sensitive, almost refined face. He writes now and again, once sending a balance-sheet showing he was some two or three pounds better off as a result of his bee year, and always giving a good account of his season's work, especially since, by going shares with the police-sergeant over the way, and a little outside help, he has become joint owner of a good extractor.

CORRESPONDENCE.

(Continued from page 494.)

Do hornets still exist to any considerable extent in the United Kingdom? I never heard of hornets as enemies of bees in this country, but I notice that they are most destructive to bees in Egypt.

Queen-Cells Built on Drone-Combs.—A correspondent of the B.B.J. some time back wrote mentioning, that he had queen-cells built on drone-comb in one of his hives, and that he was expecting something out of the common from them. I had last season sixteen queen-cells built around the edge of a piece of drone-comb in one of my hives, but we have yet to hear of so intelligent a creature as the

queen bee laying drone eggs in queen-cells, her object being to perpetuate her species.
—WM. LOVEDAY, *Hatfield Heath, Dec. 9.*

STORING HONEY IN TIN VESSELS.

[3105.] I think the remarks and suggestions made by some of your correspondents on the subject of tin vessels for storing honey are not only very wide of the mark, but calculated to do much harm. No large honey producer wants to be bothered with earthenware vessels, with their innumerable drawbacks, breakage and weight being the worst.

We make more honey tins and tins for various purposes than most people, and have never found honey damaged either in flavour or colour by using our tins. As to terne-coated sheets, with all my experience I have never seen a vessel made of this material used, and I venture to assert your correspondent who writes on p. 484 (3092) has not.

The principal use of these sheets is for lining packing-cases for the export trade; they are occasionally used for oil-drums, but very seldom.

If good charcoal tin plates are used, no scare need be put before readers of the B.B.J.—the evils there assumed will never occur.—W. P. MEADOWS, *Syston, December 10.*

[We are glad to have in the above letter the view of one so largely engaged in the manufacture of tin-work for use in bee appliances as Mr. Meadows is known to be; and, by way of closing the correspondence, we append the views of Mr. Otto Hehner, President of the Society of Analysts, who some years ago wrote in our pages as follows:—EDS.]

"In the BEE JOURNAL of November 1, Mr. W. Crisp warns against the employment of tin canisters for the storing of honey, and states that 'honey that has been stored in tin is not fit for food, as the action of the acid contained in the honey on the tin makes it more or less poisonous, and, if tinned for a long time, highly dangerous. See the poison in tinned fruits—honey is much worse!'

"As I believe I was the first to make an extended series of observations on the action of food matters on tin, and physiological experiments as to the effect of the metal on the animal body (published in the *Analyst*, 1880), a few remarks on the subject may not be unwelcome to the readers of the *Journal*.

"I examined the following articles, obtained at random at various shops: French and American asparagus, peas, tomatoes, peaches (3 brands), pineapple (2), cherries (2), marmalade, corned beef (5), ox-cheek, ox-tongue (3), collared head, tripe, oysters, sardines, salmon (2), lobsters, shrimps, curried fowl (2), boiled rabbit, boiled mutton, roast chicken, roast turkey, ox-cheek soup, gravy soup, sausages, condensed milk (3).

"With the exception of the sausages, the whole of these samples contained more or less tin. The amount in the vegetable products

was, in some cases, exceedingly large, the tins being positively corroded; in the animal products the tin was present only in very small amounts, or traces even.

"After reading Mr. Crisp's answer I obtained from Mr. Huckle two samples of honey that had been in contact with tin for several months. They showed no deterioration as to quality as far as taste and aroma were concerned. On analysis they were found to be practically free from tin, the slightest possible traces only being detectable.

"And here I may say that owing to the exceedingly slight acidity of pure honey—much slighter than is generally supposed—not any notable action of honey upon tin was to be expected. The action is proportional to the acidity; hence pine-apple, tomatoes, peaches, &c., corrode the metal strongly; animal substances but to an insignificant extent; and honey may in this respect safely be classed with animal matters. Mr. W. Crisp's warning notwithstanding, I can see not any more objection to the storing of honey in tins than in the case of sardines or shrimps.

"I am no advocate for the use of tin for any food matter whatever, and strongly object to it for the storing of fruits or other acid vegetables, and I would welcome any new process of keeping preserved provisions in a non-metallic vessel; but no adequate or convenient substitute has yet been devised. Glass or china are breakable and bulky, though otherwise perfect. But I do deprecate any alarm being raised and a prejudice being created without necessity.

"Tin is not innocuous; in some forms it is positively poisonous, but considering the enormous consumption of canned goods, especially in America, cases of illness arising from their use are very rare, and then may generally be traced, not to the injurious effect of the tin itself, but to the presence in the tin of lead or of soldering fluid, or to the fact that diseased and poisonous animals can not always be excluded from the millions that are preserved in canisters.

"I would say, therefore, by all means use tins for the storing of honey. The method is not perfect. Mr. Crisp should devise a better one; a fortune would surely await him.

"OTTO HEHNER."

FOUL BROOD AND ITS REMEDY.

[3106.] Mr. Till writes a very good, common-sense article (3089, p. 482) in last B.J. But he fails to touch on certain points which, I think, are equally as important.

The individual to whom he refers is a member of the Bristol S. and S. Gloucester B.K.A. Committee, and as such he takes upon himself the responsibility of censuring in a public newspaper the actions and work of the latter Association. Nor has he, as far as I can see, said one word tending to give the idea that the society in question has done its best.

On the other hand, the same person tells the public that "foul brood" has an effect on honey which may prove injurious.

What, I ask, is the use of discussing such a subject in this way? Surely it can only prejudice the public mind against buying honey at all, lest unhappily they might be infected with "foul brood" themselves! Nor must we overlook the fact that there are plenty of people quite ready to believe such nonsense—through ignorance, of course. The exposure of such manifestations of ignorance, with many others too nonsensical to mention, called forth the remarks as follows:—"When I inserted that extremely sensible letter of Mr. Howes, I did not think that it would have the effect of overturning the bee skeps of the B.B.K.A.; but it did, and revealed an amount of weakness that it was scarcely supposed could exist."

The writer of the article further goes on to state that "an expert visit once in six months is bad enough, but the lack of funds which causes it is much worse."

I leave the sensible readers of the B.J. to judge as to the accuracy of these remarks, among many others equally absurd. But I only wish to draw your attention to one more, where we read:—"But, if a society or an association will not assert itself, can it justly expect the funds to come in to maintain it in an efficient state of masterly inactivity? Let the B.B.K.A. show that it really exists?" This seems to me the crowning point of all!

I should like to ask the Editors of the BRITISH BEE JOURNAL if they have ever heard of bees "coming out in about eight days," or if they have ever known the disease "affect the brood only" and *not* "the older bees," as we are told.

Whilst the idea of "foul brood" being "attributed by some to mice, &c." may *eventually* throw some light on the subject of "foul-broody honey," which Mr. Howes tells us is *certainly endangered*.

But I have done, and request you, sirs, in the interests of "right and justice," to kindly allow me space for this letter.—R. HAMLIN HARRIS, *Chairman Bristol S. & S.G. B.K.A., Hambrook, Bristol, December 9.*

DIVIDED SECTIONS.

[3107.] I have no wish to dispute Mr. Abbott's statements (3079, page 474) as to his early attempts at a completely divided section; but, seeing that his halved four-piece section was dropped without being brought to a successful issue, and that I have myself made the American halved section an accomplished fact by introducing it in connection with my divided holder; and such combination being the only possible means of its being accepted as a practical development, I fear he has no case in attempting to detract from the originality of my combined invention. Seeing also that Mr. Abbott's object was to be able to

use a single-section sheet of foundation, while my own perfected device provides for a sheet about 13 in. in length, filling three sections at once. Certainly these points are original with myself, and had I thought it worth while, a sound patent could have been secured, as nothing of the kind had been published or advertised in connection with the American section.

Personally, I do not consider that any patented section will repay the cost of protection. The question at issue, however, simply resolves itself into this: should the halved American section come into general use, will it be because of Mr. Abbott's undeveloped, and for long-forgotten, idea? or will it prove to be for the reason that I have for several years past advertised, distributed, and published my own practical development? I leave it for the future to decide.

THREE-SIDE-CUT SECTIONS.

Mr. Abbott must be sadly in error when he states that these sections were never extensively used or advertised before he introduced them, considering that they have been sent out since 1887 by thousands, and have been largely advertised since I then introduced them, by private circular, and have also been noticed by hundreds of readers of "A Modern Bee-Farm," wherein they are fully illustrated, as shown in the following "cuts" from that work.



Three-Side-Cut Section. Introduced 1887.

I am glad to notice Mr. Abbott admits he has no restraining power over those who used this section before he procured a patent on it; but under the circumstances I fully believe he will not attempt to exercise a questionable control over any one who may choose to adopt this style of section.

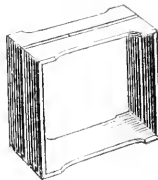

The same folded.



Completely-Divided Section. Introduced 1889.

GROOVED SECTIONS AND SLIT TOP RAIL.

Since writing the preceding I have noticed Mr. Howard's remarks in your last issue (No. 3095) and do not see that we have much to disagree about. It appears we both started off on similar lines, and while I persisted with the three-side-cut section he discontinued it. I should, however, state that I

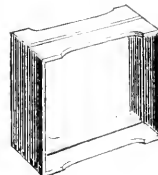

The same folded.

at no time made or claimed any originality as to a V-slit, regarding it as unsuitable from a manufacturing point of view, and not so certain in its hold as the square-cut. A score of sections are cut with the square slit while a single one is prepared by any grooving process; and as sections are covered before being offered for sale, there can be nothing unsightly in the joint holding the wax.

Mr. Howard will be interested to hear that I used grooved sections with slit top rail from

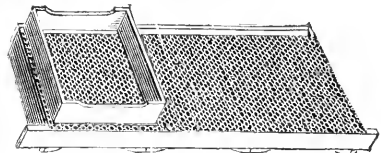

Simmins' Divided Section Holder.

about 1878, and discontinued the grooves when adopting the more suitable three-side-cut sections.

In conclusion, while thanking your several correspondents for helping to bring additional facts to light, I think we may safely leave the matter for the guidance of other hopeful inventors who may think they have discovered some new feature in the construction or adaptation of sections.—SAM'L. SIMMINS.

PATENT RIGHTS IN SECTIONS.

[3108.] I agree with your correspondent, Mr. Howard (3095, p. 486), that there is not a "valid" patent in existence for three-side-slit sections. We have supplied a few of this kind of section each year for the last ten or twelve years. They have not, however, been favourably taken up by bee-keepers until the one shown by Mr. Sladen at the last *Conversazione*, which seems to have caused quite a stir. Perhaps it was the want of knowledge amongst bee-keepers generally that these sections could be procured that has caused their not coming more to the front. I think nearly every one who, along with myself, saw the one shown by Mr. Sladen, is agreed that it is simple, effective, and an expeditious way of fitting sections, with either half or whole sheets of foundation. Finally, bee-keepers can get three-sided split sections when they choose, regardless of such called patents on them.—EDWD. H. TAYLOR, *W'clwyn, Herts, December 9.*

BEE'S ECCLESIASTICAL.

3109.] The paragraph that has gone the round of the papers as to an invasion of bees, which made the parson "fly" from the pulpit

and the people skedaddle, has probably not lacked journalistic colouring. Possibly a bee-keeper belonging to the locality of Bishopstone can oblige you with a correct version. According to one paper, the churchwardens "trod the burning deck" as long as they dared, and the bees bivouacked on the field of battle. The Church register goes back more than four centuries; it would be extremely interesting to know if parsons have previously "flown" from a similar cause.

A correspondent in the *Record* recommends the parson to become a bee-keeper and lay the Bishopstone bees under contribution for something better than stings. The same correspondent further suggests that rural clergymen who are suffering from *impecuniosis* should make bees to take "tithes" of abundant nectar, and thus augment their income. He, at the same time, quotes the example of a worthy octogenarian clergyman of the Irish Church, who cannot have cleared less than £100 from his apiary this year.

In cycling some time since from Salisbury to Stonehenge by way of the "fords," I came across lots of skeps; and at one point on the Avon, a blacksmith, who was also inn-keeper and bee-keeper—his small garden was literally covered with skeps. One of his bees "had" me in a moment on the tip of my nose! Very unceremonious for a Wiltshire bee! thus to welcome a stranger. The writer in the *Record* thinks that bee-keeping in the county (I suppose he means from an "Association" point of view) is in a *somnolent* condition, for he speaks of Wilts needing to wake up! Has not Wilts a B.K.A.?—B. K. P. R., July 13.

DOES HONEY PRODUCING PAY?

[3110.] I am not a very large producer of honey, but as a cottager I find bee-keeping pays, and according to my experience, no other of our minor industries give an equal return with judicious expenditure. I say this, moreover, in view of the fact that my bees are kept under most adverse conditions it is easy to imagine; and I have never kept bees under really good conditions.

So many bee-keepers commence with their enthusiasm far too nearly at boiling point; in fact, I have known many to court failure by starting with ten or twelve hives before they know to manage one properly, and when they get their first good stinging the enthusiasm drops down to zero. Then the next time one asks after the bees, its "Oh, they were a failure," and you learn that goat-keeping is his "hobby" now. Next season you will probably hear that the goats were also a failure, and that fowls, or something else, now claims his attention. To be a successful bee-keeper, and make honey-producing pay, the aspirant must possess an enthusiasm that will remain and carry him unabated through "thick and thin" until he learns how to manage his bees well. As Mr. Weston says (3098, page 488),

it is the unmethodical and slipshod bee-keeper who spoils prices, and with his second-grade honey he prevents the consumer knowing what good honey is. I have had some experience in this direction during the past season. I gave quotations to a customer which were accepted, and I bought a gross of jars of a particular pattern purposely for this customer. A gentleman a few miles away keeps bees for a hobby, mixes his honey, and offers it to my customer at half my price. This practically took bread from my mouth, but I lost nothing in the end, as all my honey was bespoke by mid-September. It would greatly help some bee-keepers, who, like myself, almost entirely depend upon their few hives of bees for a living, if such help as is given to bee-keepers in Ireland could be extended to those of us in England, who, for the need of capital, find it very difficult to get the necessary appliances. To such, I say, a loan free of interest would be a boon. I refer to the loans to Irish bee-keepers mentioned in B.E.J. for December 9, on page 48. Then to hear that the Congested Districts Board actually sell their produce for them. Well is it that our brethren in the sister isle clamour for what they want, and "won't be happy till they get it!" If this be so we, too, must agitate, and then maybe our turn will come.—WM. LOVEDAY, *Hatfield Heath, Essex, December 9.*

Queries and Replies.

[1884.] *Disinfecting Store Combs.*—Will you kindly advise me what would be best to do in the following case:—After extracting the honey from my shallow frames (about 100 in number) last season, I found one of my hives badly affected with foul brood. But I had at that time already packed all my store-combs away for the winter. I am unable to pick out the frames that came off the foul-broody hives, as I mixed them altogether. Can I disinfect the lot in any way, so that they will be safe to use next season? I shall suffer a great loss if they must be destroyed, as they are all good, clean combs, most of them built out last season. I have also mixed the queen-excluders altogether. Can I disinfect them, too? Am about to destroy the foul-broody hive by setting fire to it.—"SAROS," *Lines, December 10.*

REPLY.—So long as no brood has been reared in the combs it will be fairly safe to use the combs again if well sprayed with salicylic acid solution, and, after drying, fumigated with fumes of burning brimstone. The queen-excluders may be also washed with the solution.

[1885.] *A Beginner's Plans for '98.*—Seeing that beginners in bee-keeping all fly to you in their troubles for advice, and how patiently you bear with them, I venture to tax your

patience with a few queries. I commenced bee-keeping last spring, buying one stock in a skep (a swarm of previous year). This stock gave a swarm on July 12, and I hived them in a frame-hive on ten frames with strips of foundation. I examined the hive on August 24 and found one of the "strips," through insecure fastening, had fallen down. I removed the strip as well as I could, but the bees had built comb fastening two frames together, and all the frames except one were filled with comb to the bottom. The unfinished comb I put in centre, then covered up warm, and left them. After the skep, or parent hive, had swarmed I placed on a straw super, and, when removed, the latter was full of honey. I got no honey from the swarm, however. After studying the "Guide Book" and JOURNAL I have formed the following plan for '98, which I should like you to criticise: First, examine frame-hive end of March; spread brood and feed when necessary with frames of candy. Get brood-combs worked out when strong, also super foundation in frames (see fig. 38, "Guide Book"). Feed skep with candy to get early swarm; put swarm where skep stood in frame-hive. Eight days after swarming drive bees from skep, transferring combs to frames, cutting out drone-comb; put frames in two nuclei with queen-cell to each on "Wells" system (see BEE JOURNAL, November 11). Shake driven bees on the frames as equally as possible, close up with division boards, cover up warm, and feed. When queens are laying, introduce one to frame-hive having old queen after removing the latter. Then unite the two nuclei closing one entrance. Insert combs as required in nuclei. Is it necessary to introduce frame of brood before queen flies to meet drones in this case? My expenses in bee-keeping amounted to 18s. The assets I estimate at £2. 10s.; leaving a balance of £1. 12s., which I think is extremely satisfactory. I may state that I knew absolutely nothing about bees when I commenced, except that they made honey and wax, and that they were always ready for a fight when interfered with.—W.M. P., *Fore, N.B.*, December 6.

REPLY.—Though we do not like to debar any one from carrying out operations on new lines, yet experience tells us that with beginners such experiments are best left alone until greater knowledge has been acquired. Spreading brood must be done with great care, and, when it can be safely carried out, it is better to feed slowly with syrup and not with candy. The latter is used only when it is inadvisable to give syrup.

HONEY IMPORTS.

An account showing the value of honey imported into the United Kingdom during the month of November, 1897, £656.—From a return furnished to the BRITISH BEE JOURNAL by the Statistical Office, H.M. Customs.

Notices to Correspondents & Inquirers.

All queries forwarded will be attended to, and those only of personal interest will be answered in this column.

J. E. (North Wales).—*Welsh Honey*.—The samples were shown at the conversazione of the B.B.K.A. in October last, and by some means were lost sight of, and have not since been recovered. No. 3 was mainly from heather, and decidedly best of the three samples. None were, however, quite up to show-standard for quality.

GEORGE PLESTER (Beds.).—*Chapman Honey Plants*.—You will have no difficulty in getting plants at a very cheap rate in spring; but we know of no one who has plants at this season.

A. HAIGH (Wakefield).—*Suspected Comb*.—The partly-built comb has never been bred in at all, the "substance" seen at bottom of cells being only pollen.

H. N. B. (Sedburgh).—*Comb Foundation and Honey Samples*.—1. The brood-foundation is of fair quality but dark in colour. On the other hand the super is too light in colour (*i.e.*, bleached) to be very acceptable to bees. Pale yellow super foundation is much superior. 2. Honey sent is fermenting.

G. B. (Herts).—*Renewing Combs*.—1. This is best done in early spring when weather has become settled and night frosts are gone, a full sheet of foundation being substituted in centre of brood-nest for a frame of comb which from some cause or other needs renewing. A week later a second frame may be given, and in cases where combs are very faulty or old, other combs may be renewed in the same way as the season goes on. 2. The "happy noise" mentioned would only be the humming of the bees' wings in ventilating the hive. 3. The book named is interesting reading, but the rev. author was not himself a practical bee-keeper.

IGNORAMUS (Manchester).—*Loose Stands for Hives*.—The advantages of loose stands are manifold and so obvious that we feel it only needs our correspondent to obtain a little experience to make the fact plain beyond dispute. We know of few bee-keepers who do not regard fixed legs to hives or to floor-boards as a nuisance.

YOUNG BEGINNER (Grinstead).—*Bees Dying*.—There is nothing in queen sent to account for her death or that of the bees. Surely with "plenty of sealed honey in the hive," as stated, it can only have been through paucity of bees and consequent death from cold. We can offer no other explanation while only being able to judge from the few details sent.

H. J. H. (Worthing).—*A Flowering Ampelopsis*.—We do not know the plant referred to, nor have we heard of a flowering ampelopsis useful to bees.

Editorial, Notices, &c.

THE LATE M. GEORGES DE LAYENS.

M. G. de Layens, whose death we announced on page 433 of B.B.J. for November 4 last, was born in 1834, and in 1862 he attended a course of lectures that were given by the late M. Hamet, the editor of the *Apiculteur*, at the gardens of the Luxembourg in Paris.

In the following year M. Layens asked M. Hamet's permission to take the swarms in an apiary which belonged to him at Meudon, near Paris. There were sixty hives in this apiary, and it was here that M. Layens had his first experience with bees. At this time frame-hives were hardly known in France, and those which were recommended to M. de Layens appeared to him hardly practicable.

In 1865 M. Thierry-Mieg exhibited a horizontal hive, and on his recommendation M. Layens adopted this style, considerably enlarging the frames and the hive, and increasing the number of frames to twenty, which he considered generally sufficient in the best honey-producing districts.

In 1869 he went to the Dauphiné Alps, where he established an apiary. He remained here till 1874, and had apiaries at an elevation of 1750 mètres and 1460 mètres. Up to this time he was not acquainted with foul brood, and consequently did not take the precautions necessary to guard against it. He gave his bees combs taken from an apiary where foul brood existed, and as a result he lost all his hives but three.

About this time he wrote the first edition of his book, "Elevage des Abeilles par les procédés modernes." This book was awarded a prize of 300 francs by the Société d'Acclimatation, and the Société Centrale d'Apiculture presented him with the Abeille d'Honneur. He found that a book did not give sufficient publicity to rapidly propagate modern methods of bee-keeping. He therefore published "Lettres à un Ami sur la culture moderne des Abeilles," which appeared in several horticultural and bee papers in Switzerland, and also in several political and other papers in different parts of France.

The second edition of his work, "Les Abeilles," which appeared some years afterwards, is a reproduction of these letters, arranged as practical lessons. This work, which is quite different from the first, was awarded a prize of 200 francs by the Société d'Acclimatation.

In 1877 family circumstances obliged him to return to the neighbourhood of Paris, and at this period he established an apiary at Louye, in Eure. It was at this place that M. Gaston Bonnier made his observations on bees and flowers, and wrote his famous work "Les Nectaires," in 1878.

In 1879, he commenced a series of obser-

vations and experiments on ventilation by bees; water collected by bees, &c. All these observations have been published in the *Revue Internationale*, to which M. Layens was a contributor from its commencement, until after the death of M. Hamet, when he commenced to write for the *Apiculteur*.

M. Layens wrote a number of pamphlets, and quite recently published, conjointly with M. Bonnier, a book entitled "Cours Complet d'Apiculture." He was President of the Fédération of French Bee-keepers' Societies, which has adopted three standard frames; and it is strange that a man so practical in his ideas as M. Layens, and one who had done so much to popularise the frame-hive in France, should have been induced to advocate the adoption of such a number of different frames as standards—particularly as his object was to simplify as much as possible the culture of bees, as well as the appliances, so as to put bee-keeping on modern principles within the reach of small cultivators.

Besides his interest in bee-keeping, M. Layens has devoted much time to botany, and, in conjunction with M. Bonnier, has published several volumes on the flora of France, viz., "Nouvelle Flore des Environs de Paris," "Flore du Nord de la France," "Flore de la Belgique," and "Flore Complète de la France," the last by the auspices of the Ministre de l'Instruction Publique. He was engaged on a work on the "Botanical Geography of France," and was for the benefit of his health spending the winter in Nice, where he died of apoplexy on October 23 last. The death of M. Layens is a great loss to bee-keeping, especially to those of France, as he has for many years taken a leading part in promoting and popularising the industry. We made several trips with him in conjunction with M. Ed. Bertrand; the last one, "Amongst the Bee-keepers of Savoy," described in vol. xix. of B.B.J. It is just twelve months since we received a very complimentary letter from him on the appearance of the last edition of "Guide Book." All bee-keepers will mourn his loss, and sympathise with his sorrowing relatives.

HONEY SHOW AT DUBLIN.

ROYAL DUBLIN SOCIETY'S WINTER SHOW,
DECEMBER 7, 8, AND 9.

The display of honey at the above show was very attractive, owing partly to the variety of ways in which it was staged, the sections sometimes quite plain, or glazed with lace paper, sometimes in show cases or small glazed boxes, the extracted honey in jars of different shapes, and in one instance on an ornamental stand. The number of exhibits staged was thirty-three, exactly the same as last year. Of these, twenty-eight were sent by members of the Irish Bee-keepers' Association, amongst which were six of the eight prize exhibits, and all

the four which were "highly commended." The prize list is as follows:—

Twelve 1-lb. Sections.—1st, Peter Brock; 2nd, Miss L. de Blaquiére; h.c., Patrick Henebery.

Six 1-lb. Sections.—1st, Thos. A. Govan; 2nd, Peter Brock; h.c., J. A. Aiken and Edgar B. Drought.

Six 1-lb. Sections (Heather or Dark Honey).—1st, Miss Montizambert; 2nd, Mrs. Power.

Twelve 1-lb. Jars Extracted Honey.—1st, Thos. A. Govan; 2nd, Wm. J. Anderson; h.c., J. A. Aiken.

There was also a class for *Twelve 1-lb. Jars of Heather or Dark Honey*, but, with only one exhibit, no prize was awarded.—(*Communicated.*)

SCOTTISH B.K.A.

THE JUBILEE SHOW AT EDINBURGH.

May I be allowed to add a word of additional note to my report on page 464 of B.J. for the 25th ult., to say that Lady Gibson-Carmichael not only graciously gave her presence and patronage, but also acted as judge in the class for "*Tea Cakes containing Honey?*" Lady Carmichael has given two handsome and valuable silver medals as prizes. In the class for "Best Foundation, Brood and Super," Mr. Howard, of Holme, Peterborough, made by far the finest display; but as his name was printed on the sheets the judge declined to award it the prize. The same remark applies in a lesser degree to the fine exhibit of Mr. Raitt, Blairgowrie.—R. McCLELLAN, Hon. Sec. and Treas., *Inchinnan, Paisley.*

"CHRISTMASTIDE."

What an age is this! In the hurry and the rush we do not notice the flight of time. The months are no longer than a week was when we were young, and the weeks are now days! I cannot realise that it is the shortest day, and that to-morrow the daylight will be lengthening. Saturday—Christmas Day? Surely I must be dreaming!

A sight of the market, however, dispels any doubt. Crates of mistletoe and holly are being rushed hither and thither. Evergreens of all kinds have turned the market into a new Arcadia. There are flowers innumerable—jonquils, tulips, chrysanthus, carnations, lilies of the valley, azalias, Maréchal Niel roses, Roman hyacinths. Beneath and amongst them is the glitter and the glint of an array of fruit that would have made the gods' eyes water! It is as if the fairies had been arranging a most gorgeous feast for mankind, or as though Orpheus had appeared with his lute and raised the seeming dead of winter to the most glorious noon of summer! But it is not the fairies or gentle Orpheus. You see these huge heaps of apples from America and California? These oranges from Spain and Jaffa? These pine-

apples, dates and figs, nuts and grapes, bananas and pears, from Italy, from Madeira, from Turkey, from every sunny clime? They are conjured here by the alchemic power of gold! The hard, stern northerner has suddenly made up his mind to enjoy himself, he unbends but seldom, he works with such fiery energy and endurance that the angels, witnessing it, weep in heaven; he turns the sweet bosom of earth into a barren wilderness of ash and slag, fiery furnaces belch out lurid flames, the sky glows red at night time as above Vesuvius, his white-hot iron puts out the feeble lights of Orion and Sirius and Cassiopeia. He is of the Goths and Romans, and like the Goths and Romans, after the battle is the feast. His halls are now decked in evergreens and flowers. Bring hither the harp and the brass instruments, and send the music swirling into the fastnesses of the hills! Bring hither the Spanish wines and let the walls ring with laughter and applause. Bring roast beef and geese and turkeys, and let us be merry while we may!

The whole world is ransacked for the merry-making. Huge ships plunge hitherward with a speed that would have made the stoutest Viking of ancient time quiver in his shoes. Laden trains come leaping across the plains and bursting out of the mountains with a rush and a throb that would have made the bravest earl of old grow cold with terror, and sent him scampering off to get behind the nearest tree! What an age is this! How happy we ought to be, but are not!

In comparison to the gay appearance of the town at this festive season, the country is very lonesome and dreary. A cold white mist hangs about the fields, and the remaining leaves shiver in the searching wind. Our native flowers have deserted us, every one, and in this there is bitterness of spirit, for they are like friends that desert us when adversity threatens. We need not search amongst our own kith and kin when frost and fog are here. The only friends that will stand by us now are strangers—foreigners. Chinese winter-sweet gladdens us with its fragrance; Japanese jessamine is dearer to us than the memory of June roses; and the pure white cups of St. Bridgid Christmas rose—the *Helleborus niger* of the Austrian woods—is the best bad-weather friend we have; whatever the weather may be—frost or fog, snow or rain—he pushes up his sturdy stems and opens his great petals wide to the pale wintry sun. Looking into his open face, it seems as if he understood something of the sorrows by which we are encompassed. There was a time, so we are told, when man could not speak, when language and thought were not even dreamt of; perhaps these flowers are now as low in the scheme of evolution as we were then, and in another billion years they will have evolved a language that we can understand! If so, I think they will be able to tell us something we are burning to know.

Every one loves the Christmas roses, but few grow them in their gardens, although they are as hardy as the dock or thistle by the way-side; and few still know the legend of their birth. Listen to the story: Nineteen hundred years ago, when Jesus was born in Bethlehem, a little shepherd maiden stood without the stable gazing with rapt admiration at the rich vestments and jewels of the wise men from the East, who had brought rich treasures from afar for the infant Christ. She stood without, sorrowful, in that she had no gift to offer. As she wept, the Angel Gabriel appeared before her and asked her why she sorrowed. "I am so poor that I can bring no gift," she answered. The Angel, bending, struck the bare earth with his wand, and there before her blossomed the white flowers of the Christmas rose. "Gather them, little maid, and bear them in," the Angel said, "pure blossoms, emblem of a love as pure." And sorrow vanished from the face of the maid, and she plucked the flowers and took them in to the infant Saviour. We are not told what happened then, but we may imagine the infant Jesus casting away the precious stones and frankincense and myrrh that the wise men had given him, and grasping the glorious flowers tight in his tiny hands! So as we look into the flowers of the Christmas rose, let our sorrows vanish too, and peace and goodwill and faith, not in word but in deed, reign in their stead.—LORDSWOOD.

Correspondence.

The Editors do not hold themselves responsible for the opinions expressed by correspondents. No notice will be taken of anonymous communications, and correspondents are requested to write on one side of the paper only and give their real names and addresses, not necessarily for publication, but as a guarantee of good faith. Illustrations should be drawn on separate pieces of paper. We do not undertake to return rejected communications.

* * * *In order to facilitate reference, Correspondents, when speaking of any letter or query previously inserted will oblige by mentioning the number of the letter, as well as the page on which it appears.*

HORNETS.

AN INTERESTING EXPERIENCE WITH THEM.

[3111.] Mr. W. Loveday's remarks about hornets on page 494 of B.J. last week lead me to believe that some experiences of mine with these insects may be of interest to bee-keepers. Towards the end of May a pair of nuthatches excavated with much labour a hole in the decaying trunk of a greengage tree, and built in it the best substitute for a nest that they could devise. Shortly afterwards, although they had not been disturbed in any way, the nest was forsaken, and the birds sought out a new location. One sunny morning a hornet was seen hawking for flies among some raspberry bushes, and, on being watched, was seen to enter the nuthatches' nest. It was soon evident that she had taken possession of the

tree for nesting purposes, and the question arose whether a hornet's nest was permissible at a distance of only five yards from a row of hives. Numerous bee-books were consulted; but only in a German treatise could I find a few remarks on the subject, which were decidedly unfavourable to the hornets. I consulted a number of bee-friends, all of whom advised me to destroy the nest; but when I asked "why?" they one and all confessed that they had no personal experience in the matter. To gain such experience, I resolved to let the hornets live and watch their proceedings. For nearly a month no young hornets appeared; but the mother of the family was very active, especially during bright weather. She was very formidable in appearance, measuring $1\frac{1}{4}$ in. in length, but was extremely timid. When the young hornets began to fly they were carefully watched, and numbers of them were caught in a butterfly net, in order to ascertain what food they were carrying into the nest. It was not easy to catch them until a plan was adopted which may be of use to timid bee-keepers. A scarecrow was placed immediately in front of the nest, and to this the hornets became so accustomed that when it was removed one could stand in its place within a foot of the nest without disturbing them. The chief food of the hornets at first was the common blue-bottle fly and other varieties of diptera; but towards the end of summer quite 50 per cent. of their victims were wasps. In one solitary instance only did a hornet bring a bee home as food. All the insects had wings and legs removed, and were roughly masticated into a pellet which the hornet carried in its mouth. Several hundred hornets were caught and their prey examined, and this at all hours of the day, so that there can be no doubt that in this case they have done no injury whatever to the bees. Whenever the weather was fine enough for the hornets to be flying there were thousands of bees in their immediate neighbourhood, so that the selection of wasps for food must have been deliberate. On one occasion I saw a hornet catch a wasp on the wing among a number of bees in front of a bee-hive; but this year wasps have been very scarce in my garden, and the hornets must have flown some distance to find them. On an average it took a hornet about twenty minutes to find a wasp; bees could have been caught in any number in less than a minute. On the whole my experience is decidedly in favour of the hornets; they have slaughtered large numbers of the worst foes that attack my bees, and I can only bring one charge of apicide home to them. Should they appear again in my apiary I shall welcome them, but I fear they are getting scarce in this neighbourhood.

Most people imagine that hornets are very fierce, quarrelsome insects, but this is by no means the case. They are really shy, and do not attack unless their nest is threatened. Even then they are by no means so fierce as

wasps. On several occasions I have smoked out the whole population of hornets. Some of them flew round buzzing in a deep threatening note, which was rather disconcerting, until I found out it was all talk and no action followed. The others arranged themselves in a ring round the entrance to the nest, fanning vigorously. During a long acquaintance with them I was only stung once; this was my reward for experimenting on them at night with the X rays—they do not appreciate new-fangled notions. If any of your readers have had experience of hornets in this country it would be interesting to learn if it at all agrees with that of—W. F. REID, *Fieldside, Adlestone, December 17.*

BEES IN NATAL.

[3112.] The conditions under which bees exist in Natal are very favourable, as in ordinary seasons there is a supply of food all through the year, and breeding appears to increase or decrease in accordance with the amount of forage. The seasons are, however, rather irregular, and a few months of drought has a very bad effect on the bees, many stocks dying out or deserting the hive unless a little food is given.

The general routine of the year is for the spring rains to come in October; then ground crops of wild flowers come up in great abundance, and stocks increase very rapidly and a good series of flowers continues well into December, when some honey can generally be taken.

The weather then gets very hot and breeding almost ceases, the combs getting dry and brittle, and the bees spend most of the time hanging under the hives in the shade. There is little new comb built during January and February.

In March, however, a change takes place, and very heavy dews occur, so that the ground crops start again and many of the flowers that bloomed in the spring come in for the second time. This is especially the case with a small white flower shaped like the bluebell that is a great favourite both for pollen and honey.

The cool weather commences in May, and a good series of fruit trees such as the loquat, peach, mango and orange, carry on to August; the latter would give a good crop, but it flowers just at the time of the equinox, so that gales destroy the bees' chance.

Under these circumstances it would appear that the honey-crop should be heavy; such, however, is not the case; it is, in fact, the difference between continuous and rapid feeding, the bees breeding and swarming instead of storing. Perhaps some one may be able to give us a hint as to catching the crop!

The bee, which is plentifully distributed around the country, is about the size of the ordinary English bee, but it has generally two or three yellow bands on the body; these bands, however, vary from black to almost

yellow, even in the same hive. I should think they would be hybrid Ligurians.

The queens, which are very prolific, are generally light brown, and are easy to rear, as drones are always about, while the weather is rarely bad long enough to prevent their fertilisation.

Drones are black and very numerous. I trapped a hive that was not old and counted the slain drones, which numbered 740, and I frequently have got 200 to 300 from those with queens in their first year.

Appliances are not to be had unless imported, and this is an expensive and somewhat unsatisfactory way of working, as it takes three months to get anything delivered. One is, however, less apt to get overcrowded when each hive means so much carpentry. I use the Association standard frame myself, and single-wall hives, and several others do the same, and find it a very useful size.

I should like to have your opinion on the use of puff-ball in manipulating. It is very general among bee-keepers here; but I have discontinued it myself, as I find it unnecessary. Is it an obsolete method, and do you think it harms the young brood?—A. C. S., *Durban, Natal, November 26.*

[Puff-ball is never used now.—EDS.]

BEE NOTES FROM ROSS.

SENDING HONEY BY PARCELS POST.

[3113.] It seems to me that I can but manage to send a few bee notes once a year, and have been thinking of these till the year is nearly gone out. When last writing I mentioned the fact that "foul brood" was very bad round about here, but it is gratifying to record now that the plague has gone down somewhat, very little of the disease having been discovered this year amongst those who had it badly in 1896. I am, however, sorry to say that the danger still exists in the hives of a few negligent and careless bee-keepers (?). This shows, I think, a real need of the "Act" coming into force. My own two hives came through the winter all right, though neither were strong, and although I commenced feeding, only one came up to "full strength" in time for the honey flow, from which I got about 70 lb. The weather experienced here was much like that described by Mr. A. Sharp, on page 491. My strongest stock, although supered, swarmed, so I took off sections unfinished, and went in for making it into a strong stock for next year, as I knew there was a good young queen in the hive. My plan was to remove the two outside combs (full of honey) and put two frames of foundation in the centre. When the two other outside combs were full and ready for removal I did as before, and in this way got my hive nearly full of nice, new combs, and, as at the present time, it is crammed with bees, I hope to have a good account from it next season.

(Continued on page 506).

HOMES OF THE HONEY-BEE.

THE APIARIES OF OUR READERS.

The illustration below carries us to the North of Scotland and the bee-garden of Mr. Robert Kelly, a bee-keeper of some ten years' standing, and a reader of our Journals for nearly the whole period. From the appearance of the hives used it is clear that the most modern methods of management are followed, while the fact that they are all home-made adds to one's interest in them. On the extreme right of the picture we get a glimpse of what looks like a bit of "Scotia's mountains," and the tree-top just seen suggests a real need for the

interest to general readers. Although I have seen less or more of bees all my life, I took no interest in them until the beginning of 1887, when my father came to live with me and brought his bees with him in an old straw skep, which was set down in my garden. About a month later my experience began.

"It was on a bright, warm Sunday morning, after breakfast. I went out into the garden to enjoy a pipe; and observing the bees very busy carrying in loads of what I believed to be wax to build combs with, I sat down a few yards away to watch them. In less than two minutes, a bee came straight for me and commenced business under one of my eyes



MR. ROBT. KELLY'S APIARY, WINDYGATES, FIFE, N.B.

warm protection afforded to the bees from high winds coming from below, by the thick, tall-growing hedge in rear of the hives. The soncy Scotch lassie standing behind we learn is Mr. Kelly's daughter, and looks the very picture of a worker among the bees. Our friend has kindly sent us a few notes regarding himself, which, being both interesting and characteristic, we cannot do better than let them speak for us.

Mr. Kelly writes:—

"Being a railway surface-man, I am more accustomed to handle the pick and shovel than the pen, besides, it would require a 'Lordswood' to make my small experiences of any

Regarding this as an unprovoked assault on an innocent man, I felt strongly inclined to kick the blessed skep over and then run into the house. Though not usually guilty of using strong language, my remarks on that occasion had better remain private. However, as my eye was soon 'closed for repairs,' the beauty went out of that Sunday morning, and my pipe went out, too, as did every respect I might have previously entertained for the bees.

"However, as the season wore on and an occasional bee-man came to "talk bees," I got infected, and by the end of the season I was over head and ears in the hobby. There was

in this district at that time, a few frame-hives, but most of them had frames about 16 in. by 19 in., and scarcely any two of them alike. During the summer of 1888, however, I got scent of the 'Guide Book' and of the *Bee-keeper's Record*, I then began to make my own hives, using none but standard frames, all with double-walls and having sliding floor-boards I can tier up to any height. I find roofs with one slope to the back easiest kept water-tight as it runs the long way of the wood. I use glass quilts on supers and find them handy for inspecting progress without disturbing the bees. At first I had a deal of trouble with the whole sheets of foundation, some warping and others falling down altogether, but I got clear of that by boring a small hole in the ends of frames (about 4 in. from bottom) and running a wire along each side of foundation, then passing both ends through the same hole and fixing tight around the ends. It is a simple way of 'wiring,' but quite effectual, in fact I have never had a mishap since.

"I have caught some of the 'diseases' that inexperienced bee-keepers are liable to, and suffered in consequence. During the Carniolan 'boom,' for instance, I got infected, and in the autumn of 1890 I sent to England for two queens, which cost me 10s. Both were successfully introduced. One of them lived three weeks, when I found her lying dead in the 'feeder.' The other was thrown out of the hive after being there six weeks; neither queen having ever laid an egg! So I lost a good stock as well as the money.

"This effectually stopped my feverish desire for 'high-bred' queens. Again, in 1893, I was smitten with the 'Wells' 'fever,' from which I am not quite recovered yet, although it has been nearly as unprofitable as Carniolan queens.

"The best 'take' of honey from a single hive was in '89, when I got 110 lb. from one stock, my four hives in that year averaging over 60 lb. each. The following year was my worst, my capital stocks only yielding 13 lb. each. In '93 my average was about 80 lb. per hive. In '95 it went down to 60 lb. The year 1896 was a bad one, 32 lb. being my average.

"I work mostly with shallow and standard frames for extracting, as I get more honey, and can sell it readier than in the comb. My bees seldom swarm, and I find when I require a swarm it is more profitable to buy one. I tried artificial swarming after the honey season was past, but often failed to get queens fertilised.

"The photo sent was taken while I was at work, the figure standing beside the hives being that of my daughter. I, unfortunately, lost my wife last year, which put an end to any further extension of my apiary, as she used to do all the bottling, and also sold all the honey, and could have sold more through the winter if she had got it."

CORRESPONDENCE.

(Continued from page 504.)

My stocks now are seven in number, made up with driven bees which I have tramped a few miles for.

One day I drove three lots, one very strong, the others medium, so I joined the two weaker ones, intending to have two stocks from the three. In carrying out this intention I put the driven lots next to each other on their old stands, and went to cut the combs out of the skeps. Half an hour later I went to pack up the bees, and then, to my surprise, saw the bees of the strongest lot marching merrily into skep containing the other two lots. I suppose I lost the queen whilst driving, but with three in one it made up a splendid lot of bees. I put them into a large skep with a flat top. They will be stimulated by feeding in spring, to give me a good early swarm; failing that, I shall drive the bees out, and put them in a frame-hive.

Is it possible to get some "round" sections made? I should like to make a trial with some.

I have read with interest the discussion in your pages on packing sections for parcels post, and some writers put all the blame of breakage on officials. But why don't senders ask that the official red label, with the word FRAGILE printed on it, be affixed to their parcels? This will secure careful treatment from the P.O. people. I can assure you the P.O. officials are strictly careful with parcels having their red label on. I sent some sections to Yorkshire this year. They were tied in lots of three together, first wrapping in paper, then packed in a crate lined with brown paper, the only other packing being plenty of wood shavings at the bottom and all round. Having received no complaint about them, I conclude they arrived in good condition. Wishing you and all readers a happy Christmas and a prosperous new year.—D. H. F., *Ross, Herefordshire, December 18, 1897.*

[Circular sections had so little to recommend them that, although some tried them, they soon dropped out of sight.—EDS.]

PREVENTING SWARMING.

[3114.] Referring to letter of "H. S." in last issue (3103, p. 494), I notice your correspondent says he "tried a 'Conqueror' hive" and found it did not prevent swarming. It would be interesting to know the following items:—1st. Did "H. S." put full sheets of foundation in the frames of the lower chamber? I imagine he did from the fact that he states "the bees built out the wax foundation." Then he goes on to say "as I found at the end of the season, but had reared no brood" (the italics are mine). 2nd. What age was the queen?

It appears to me the principle of this hive has not been properly carried out, as the instructions given regarding it by the inventor

are that an *empty* space be provided between the brood nest and the entrance. This space is provided with frames and *narrow* strips of foundation, otherwise, should the bees build comb here it would be fixed in such a way as to prevent the frames of brood nest being moved, and the sole object of the wax guide is to ensure any comb that may be built being placed within the frames. So far as I understand the system it is not intended that any quantity of comb should be built here, and that should the bees build to any extent, through neglect to provide space above, it should be cut out and fixed in sections in place of super-foundation, and not allowed to remain to the end of the season.—D. G., *Ilminster, Dec. 18.*

BEEES IN ESSEX.

MY WORK FOR 1897.

[3115.] Under the above heading in B.J. of November 5, 1896 (page 446), I gave an account of my first year's work with bees. I now send a brief report of my second year's operations: From my No. 1 hive, which did well in 1896, I got a good swarm and thirty-eight 1 lb. sections. The swarm I put in a skep (not having a frame-hive ready); in fourteen days they filled the skep. I then put the latter in a frame-hive, with a hole in quilts, and the bees worked out and quite filled seven frames, leaving skep full of honey. No. 2 hive (a truant swarm which I took out of an old tree) gave me eighty-six sections, besides two frames to help a weaker lot. No. 3 (a driven lot of last year wintered in five frames) filled up their brood-nest to ten frames and gave me eighty-six sections. I took fifty-eight sections off these two hives one Thursday, and by the following Thursday fifty-two more were ready and secured. That is not bad, is it, sir? No. 4 were a lot driven late in September, and were very weak in numbers. They wintered on four frames, but completed the full ten frames and gave me four more to give to driven bees this year. No. 5, another lot driven same time as No. 4, were wintered in the skep and fed through hole in top. I put this skep on a frame-hive the second week in May, but they would not take kindly to the new home, but sent out a good swarm from which I got ten sections. The parent skep swarmed again the same day as the great storm in Essex, and these are a strong stock now in a skep. The old skep, however, failed to get its queen fertilised. The queen was a drone-breeder, so I united the bees with No. 4 and took their honey (about 9 lb.) to feed others. Altogether, I have had 240 lb. of honey and about 4 lb. wax, besides taking a couple of prizes. I sold all the honey I wished to at from 6d. to 10d. per lb. I started the summer £4 out of pocket, and, counting my honey at 6d. per lb., I got £6 for it, and have now seven strong lots of bees instead of five weak ones.

Our expert told me in spring I should get no honey this year, as my bees were so weak

when he came to see them in autumn. He was, however, surprised to see my harvest. I also learned that my honey was of the very best among all he had seen. My bees were all declared to be in first-class order, and now, with driven bees and two lots purchased, I am wintering eleven stocks (seven frame-hives and four skeps).

I am hoping to send a photo of my hives some day, and if you think it worth printing in the JOURNAL, I will be very pleased to see it there. Trusting for a real good time for the bees in 1898.—G. C. R. W., *Wickford, December 16.*

BUTTER AND HONEY.

[3116.] By way of illustration, and to show that butter and honey have ever been considered natural concomitants, or two things that go well together, I recently instanced the familiar passage, "*Butter and honey shall he eat that he may know to refuse the evil and choose the good.*"

In order to see the force of the original, I consulted Lowth, and as the doctor's comment is instructive, I quote it in case B.B.J. readers may be interested.

"The two products associated in the figure are indicative of a time of peace and plenty. The circumstance of a child eating butter and honey is explained by Jarchi as denoting a plentiful time: '*Butyrum et mel comedet infans iste, quoniam terra nostra plena erit omnis boni.*' Callimachus says: '*The infant Jupiter was tenderly nursed with goats' milk and honey.*' Homer writes of the orphan daughters of Pandarus:—

'Venus in tender delicacy rears

With honey, milk, and wine their infant years.'—(Pope.)

And Eustathius mentions that the Greek words are descriptive of *delicate* food."

Lowth says the Hebrew particle should be rendered by "*when*," instead of "*that*," thus—"Butter and honey shall he eat *when* he shall know to refuse evil and choose good;" in other words *before* (*vide* context) the child should arrive at a distinguishing age the enemy would be destroyed, and *when* he arrived at a distinguishing age, *i.e.*, in a few years, he would eat "butter and honey" owing to the peace and plenty that would follow the enemy's overthrow.—E. D. T., *Eynsford, July 11.*

SELLING BEESWAX AND HONEY.

[3117.] I am obliged to Mr. W. Loveday for his reply (3,097, p. 487), and also his offer to sell my beeswax, but having only 9 lb. I will hold it till another season. What I meant by a poor district was the prices we got for our honey. We have to sell good sections at 8d. to 9d. each retail, and 1-lb. screw-cap bottles at 9d. and 10d. That is why I send all my produce to London as I have never made less than 8d. wholesale to a large consumer there. He is sending me all bottles

and packages, and paying carriage.—Yours truly, D. J. C., *King's Lynn.*

BEE-KEEPING IN WILTS.

THE WORK OF THE W.B.K.A.

[3118.] Next time your correspondent "B. K. P. R." (3109, p. 498), passes through Woodford, near Salisbury, he will find that the innkeeper and blacksmith at the Bridge Inn now has ten or twelve frame-hives, and several of his neighbours have adopted them and joined the Wilts B.K.A. to ensure help another year. Two at least of them are very promising bee-keepers. If "B. K. P. R." refers to B.E.J. of October 21 (3025, p. 414) he will see that a good deal of work has been done in Wilts during the last season.—W. E. BURKITT, Hon. Sec. W.B.K.A., *December 17.*

WEATHER REPORT.

WESTBOURNE, SUSSEX, NOVEMBER, 1897.

Rainfall, 1.68 in.	Sunless Days, 8.
Heaviest fall, .46 on 27th.	Above Average, 1 hour.
Rain fell on 13 days.	Mean Maximum, 49.3°
Below average, 1.86 in.	Mean Minimum, 41.7°
Maximum Temperature, 59° on 1st.	Mean Temperature, 45.5°
Minimum Temperature, 24° on 30th.	Above average, 3.8°
Minimum on Grass, 20° on 30th.	Maximum Barometer, 30.78° on 21st.
Frosty Nights, 4.	Minimum Barometer, 29.25° on 28th.
Sunshine, 70 1 hours.	
Brightest Day, 2nd, 8.2 hours.	

L. B. BIRKETT.

Echoes from the Hives.

Newport, Essex, December 2, 1897.—I noticed several of my colonies of bees taking in pollen freely on Sunday, November 14. This is nine days later than I have ever known it done in the course of twenty years' observation; but this has been a phenomenal autumn.—E. W.

Hatfield Heath, Harlow, Essex, December 20.—The past indifferent honey season and the year itself now all but ended! The year; how short a space of time it seems when gone! Articles read in our Journal at the beginning of 1897 seem to have been before one's eyes but yesterday. The bees are not yet resting as they should be, for real winter still keeps away, though Christmas is here. My own bees have been flying quite frequently, and have, in consequence, been lost by hundreds through a death-trap in shape of a pond near my apiary. Queens, too, seldom cease laying so early as mine did this year. No colony left to itself having any brood in its combs in October, but those set apart for cleaning up

wet combs had small patches of brood in mid-November. Lots of flowers are still blooming here—wallflowers, polyanthus, violets, and garden daisies among others; while the catkins of hazel and palms look plump and promising. I see evidence of breeding in one hive whose queen took her rest early; so that while we have yet to finish the past, we have begun the future! Compliments of the season will be echoed and re-echoed among B.B.J. readers. For myself, may the New Year bring us happiness and a good time for the bees; and on opening our first number of the new volume for 1898 may a picture of our junior Editor greet us, as Mr. Cowan's did in 1897.—W. LOVEDAY.

Queries and Replies.

[1886.] *Opening Hives in Winter.*—*Revising Chilled Bees.*—May I again ask you a couple of bee questions? 1. In this country we are constantly subject to the sciroces, or south wind, and on such days my bees are largely out of the hives flying around as if about to swarm. This happens upwards of twenty to thirty days during the winter. The temperature is at such times about 60-62 deg. Fahrenheit. Would it be safe for me to uncover my hives and examine them then? or should I quietly leave them alone until the spring? The bees are gathering pollen each day. 2. In January we expect an occasional small frost, with a temperature of possibly 4 deg. or 5 deg. below freezing, but the days register almost regularly 56-58 deg. Many of my bees are frozen in the late afternoons, and I daily resuscitate a goodly number in my hand, though I am at a loss to know to which hive they belong, and so fear they are lost. Is there any means of avoiding this loss?—BURDETT MASON, *Près Bayonne, Basses Pyrénées, France, December 12.*

REPLY.—With any real need for opening a hive in winter and the temperature so high as stated, there need be no hesitation about doing it, so far as safety, but we should not disturb the bees unnecessarily, and do it as seldom as possible. 2. When bees are found chilled in large numbers through cold, as described, gather them into a wood box or any suitable receptacle. Cover the latter with a square of glass, and set it before the fire indoors. As the bees revive, allow such as become quite lively and strong to escape, when they will fly back each to their own hives. In a short time all that are not past recovery may thus be safely put back home.

[1887.] *Moving Bees.*—*Hybridising.*—Will you kindly give me advice on the following:—1. I am moving my bees to a new stand, distance about one mile from their present one. Would you recommend that they should be moved now or in April? 2. I have a stock of Italians, and wish to improve my bees by

crossing. For comb-honey and good temper which do you consider most satisfactory, the offspring of an Italian queen and black drone, or that of a black queen and Italian drone?—G. E. W., *Moniave*, December 18.

REPLY.—1. We advise moving a bee-location on the first opportunity after a cold spell which has kept the bees indoors for a month or more. 2. Hybrid, or cross-bred, bees can rarely be relied on for good temper during manipulation, at least in comparison with those of pure race. The general impression, however, is that the characteristics of the queen or mother bee are more strongly impressed upon the offspring than are those of the drone; so that the two points on which stress is laid, viz., comb-building and gentleness in disposition, cannot be realised in one and the same bee. In other words, the best cross for "comb-honey" would be a black queen and an Italian drone, and for "good temper" just the opposite.

THE FRENCH HONEY INDUSTRY.

BY EDWARD CONNER.

The rôle of honey was very important before the discovery of cane and sugar beet. To-day, it is very much in request, not only for alimentary, but for industrial ends. Great efforts are being made to develop honey-farming in many countries. In France, the Government has salaried professors to impart instruction in apiculture, not only respecting bee management, but in the extraction of the honey from the hive, and its preparation for the market. The Agricultural Societies award liberal prizes to encourage the production of honey, and the transport of bee-hives is assuming large proportions since the special parcel post facilities for agricultural produce have come into operation. Honey is a healthy aliment, and renders great services in the rural districts, the more so as sugar costs half a franc or 5d. or more per pound. It is eaten spread on bread with the morning *café au lait*, as is common also in Switzerland; it replaces butter on bread for children, and when mixed with water it forms hydromel, a grateful beverage formerly associated with wedding feasts, when it only was drank during a calendar month—hence the term "honey-moon." Attila, the terrible king of the Huns, drank so freely of hydromel on his wedding day, that it is related he died from suffocation. When fermented, honey produces an alcoholic beverage, very agreeable and hygienic, and that can be made more so if juniper berries or elder flowers be added. Honey can be employed in making beer by substituting it for the glucose usually used.

The delicate qualities of honey will be better comprehended by stating what honey is. At a part of the flower called the receptacle, a saccharine matter or nectar is secreted; the bee gathers this, converts it into honey by adding a secretion from the salivary glands, and then deposits it in the cells of the combs,

where it is intended to serve as food for the larvæ, and a provision for the general colony during the period when no flowers exist. The honey thus made by the bees is a semi-fluid mass, slightly yellow, consisting of dextrose and levulose, some free acids, and complex aromatic matters. The perfume or bouquet varies with the flowers, of course, on which the bees feed. Hence the reputation of some honeys, and why in trade the value of the honey is associated with its region of production. If the honey remains a long time in a hive where the temperature is high, it undergoes more or less alteration, and so suffers in the market. Again, the more larvæ and nymphs that remain after the young swarms have gone off, the more inferior will be the quality of the honey; the latter will be found then to possess an acrid taste and laxative properties. (We suppose if brood is mashed up with the honey.) In commerce these points are well known. When the combs are cut, they are spread upon hair strainers; what first drips out is the best, and when exposed to the sun is known as "virgin honey"; it is this quality which is served at table. After draining, the combs are pressed and the result is second quality; all the combs when pressed together yield third-class honey, and the residue is wax. The honey soon becomes cloudy, and "sets" after being gathered; this is due to granulation by the formation of sugar crystals. It then solidifies, and acquires its well-known consistency. Autumn-gathered honey contains least crystallisable sugar. About 21 lb. of honey are consumed by bees in producing 1 lb. of wax. The honey is subsequently run into barrels of 112 lb. capacity, or into earthen jars, or porcelain pots, covered with a linen cloth previously steeped in brandy; next, a piece of parchment over the linen and tied with string. A young swarm produces 5 to 6 lb. of honey.

In France the best honey comes from Narbonne, or rather Corbières, a district quite close to that city; the product from Gâtinas ranks second, and that of Saintonge third. The most esteemed foreign honeys are those from Hymettus, near Athens, in Greece; Ida, in Asia Minor; the Balearic Isles; and Chili. Narbonne honey is very aromatic, of an agreeable flavour, and the colour is more or less permanently of a straw yellow; that of Gâtinas is white, granular, and slightly aromatic; it has a less tendency to crystallise. Brittany produces much coarse honey, but it does not rank high; it is very liquid, strongly coloured, and of a disagreeable flavour, due, it is said, to the bees feeding on buckwheat flowers. Chili is the principal exporter of honey to France, where it arrives at Havre in strong iron-hooped barrels, and forms a welcome addition when home-yields prove deficient. The quality of Chili honey is very irregular; even in the same barrel the contents can vary in colour and in quality. It is also said to taste of smoke; this may be due

to the manner of expelling the bees from the hives, or to the habit of carbonising the interior of the barrels to counteract fermentation. The honey, none the less, can be made by importers to equal that of Gâtinas. Valparaiso honey possesses the important quality of withstanding heat without deteriorating; some has been found excellent after being preserved two and even three years, while home-raised honey ferments within a twelvemonth after gathering. Algerian honey is even inferior to that of Brittany.

Starch, flour, and sand are employed to adulterate honey by adding to its weight. Honey, however can be damaged as the consequence of defective preparation; the presence of wax is easily recognised; while dead larvae, or the straying of insects into the honey during the process of straining, being animal matter, causes active fermentation, sending up a scum, and communicating a disagreeable taste to the product. But glucose, or starch syrup, is the chief substance employed in the adulteration of honey, and which always contains sulphate of lime. White honey is heated to impart colour, and rosemary leaves to secure flavour or bouquet. Water is also employed to adulterate honey; the latter, naturally, contains from 16 to 25 per cent. of water, and bees drink a deal of water, regardless of its purity. Molasses, gelatine, and dragon gum, are also used for adulterating.

In 1893, France produced 7,454 tons of honey, valued at eleven millions of francs, at an average price of about 12 sous, or 6½d. per lb. That quantity of honey was produced by 1,592,929 hives. The department of the Cotes-du-Nord heads the list in honey-farming, having produced 530 tons; other departments harvested proportionally less. Thus the department of the Seine, of which Paris is the capital, produced only 1½ tons. In 1896, France imported 729 tons of honey, valued at 590,487 fr., and subject to a duty of 7 sous—3½d. per lb. Of this quantity, Chili sent 216 tons, Continental Spain 21 tons, her American possessions 362 tons, Turkey 42 tons, and Belgium 32 tons. Havre is the chief *entrepôt*, or warehouse, for the honey trade, and has generally 300 tons in bond. Including some home produce, France exported also in the year 1896, 1,583 tons of honey, valued at one and a quarter million francs. Of this there were shipped in tons: to England 55, Holland 694, Belgium 575, Switzerland 46, and to Algeria and the French Colonies 180; the rest to other countries.

Notices to Correspondents & Inquirers.

All queries forwarded will be attended to, and those only of personal interest will be answered in this column.

S. C. H. (Newmarket-on-Fergus).—*Moving Bees*.—The bees may be moved with safety to their new stands on the first opportunity after they have been confined for several

weeks through cold weather. As the distance (400 yards) is so short, however, we would make some marked change in the appearance of each hive entrance (a board or small branch of a tree will suffice), so as to draw the bees' attention as they first come out. After a few flights the article used may be removed.

W. W. (Liphook, Hants).—*Boxes for Sending Honey by Post or Rail*.—Our correspondent "Inquirer, Chester," in asking readers (on page 474) for the name and address of makers of such boxes does not seek the information for himself alone, but for the advantage of bee-keepers at large. It will, therefore, be in every way preferable that any useful information on the point be sent in the usual way for publication in our pages.

F. F. M. (Tewkesbury).—*Winter Stimulation. Varieties of Bees*.—1. Bees with plenty of stores at this season should on no account be "stimulated" by giving candy for three or four months to come. Nor is it at all wise for beginners to "have a peep into my hives to-day (December 11)," as stated by our correspondent. 2. The bees marked No. 1 show a slight tinge of the Carniolan element in them. No. 2 are the ordinary brown bee of the country.

R. FARMER (Enniskillen) and G. TURVEY (Liverpool).—*The Shamrock*.—In view of what was said on page 471 as to closing the discussion, and the full correspondence which has appeared in our pages on the subject, we trust it may be allowed to close—as stated on the page referred to—by "each selecting his own shamrock and, of course, giving our Irish friends first choice."

G. L. (Weybridge).—*Soft Candy*.—Full particulars for making this appear in our issue of February 4 last, to be had for 1½d. in stamps.

ERRATA.—Referring to the account of M. Schröder's apiary in our issue of the 9th inst. we regret having connected Count Kolowrat with the Rev. Mr. Cori so far as breeding Cyprian queens for sale. M. Schröder writes asking us to correct the mistake, which we gladly do, and apologise for our unfortunate slip. We may, however, explain that it arose through the slight uncertainty as to the words used by M. Schröder, who—although writing excellent English—will readily pardon the little "editing" which is inevitable when one is corresponding in other than his native tongue. It appears that Count Kolowrat, though acting in conjunction with the Rev. Mr. Cori in importing Cyprian bees and rearing these queens by hundreds for his own use and that of his friends, never sold a bee or a pound of honey in his life, and that the breeding of Cyprian queens for sale was confined to his colleague in their introduction, the Rev. Mr. Cori.—[EDS.]

Editorial, Notices, &c.

TO OUR READERS.

AT THE END OF TWENTY-FIVE YEARS.

The present issue of the BRITISH BEE JOURNAL completes its twenty-fifth volume, and marks the lapse of a quarter of a century since the first number appeared. We are also well within the mark in asserting that its popularity among those for whom it labours is to-day not less than at any period of its existence. This is no small achievement in these days of evanescent journalism, and the all too prevalent fickleness characteristic of a time when men are apt to hanker after new things. People are to-day inclined to regard as old-fashioned, or not "up to date," anything begun so long ago as the B.B.J., and so, as we say, it is in every way satisfactory to find no diminution either in its popularity or the loyal support of our readers. We say this in a spirit neither of unctuous rectitude, or of smug complacency, but with the consciousness that no one can truthfully declare that since the day the journal came into its present hands its influence has ever been used other than for the benefit of honest bee-keeping and the general good of the craft.

Nor can the history of the paper be called eventful. Beyond what was stated regarding it in the first number of the present volume there is little to add. Changes have come about as time marched on, but not many. The present senior editor was among its earliest readers, and the writer of these lines has before him a time-worn copy of the first number, for which he cheerfully paid his 10½d. twenty-five years ago, little dreaming then that he would see the BEE JOURNAL turned into a penny weekly, and find himself occupying one of the editorial chairs in 1897. Another interesting coincidence is the "Echo" on page 516 from the veteran bee-keeper, John Walton, whose interest in the bees has never flagged since he wrote his first query dated Weston, March 26, 1873, on page 16 of the first issue, nor shall we err in assuming that our esteemed old friend has read every line of the B.J. that has since appeared.

There is little need for claiming special merit for our journal's ripe manhood and strong constitution on behalf of those who have guided its policy during the twelve years of its present proprietorship. Its strength—and our pride—lies in the loyal support of contributors, readers, and advertisers. These combined enable us to occupy the almost unique position of a self-supporting bee-journal, untrammelled by having any trade interests of its own to serve.

With so much of what is necessarily behind the scenes—and perforce kept to ourselves—in managing the many conflicting interests of readers and advertisers, he would be a bold editor who hoped to please all while showing favour to none. It is, therefore, in the highest degree satisfactory to have tangible proofs, such as we possess, that the simple duty of trying to do what is just and right has retained for us the confidence of all whose goodwill is worth having.

Again thanking our many contributors for their valued help, and with sincere good wishes for the coming year, we subscribe ourselves,

Yours faithfully,
THE EDITORS.

MY NATIVE COUNTY.

EPILOGISTIC AND OTHERWISE (WITH APOLOGIES TO VARIOUS WRITERS IN LOCAL PAPERS).

Autumn never fought more bravely against the encroachments of winter. At the end of November the Japanese anemones opened their last flowers, while many roses blossomed, and tender herbs like dahlias and nasturtiums bore green and refreshing leaves. Could this mild air, this sweet gleamy sun, these hosts of flowers and buds, really belong to November? To dreary, desolate, foggy November? It seemed impossible. Chrysanthemums, double-autumn crocuses, ethereal blue, red stigmard crocuses from Greece and Asia Minor, red and blush China roses, mossy saxifrages cushioning the rocks and naked earth in vivid green. Surely it is but mid-October. But December came in with frost and a sprinkling of snow, and for two days smothered us in a very inferno of fog, from which the suburbs of the "workshop of the world" (for so this town is called) emerged dirty and begrimed, and foul as any alley in the Metropolis of the world!

My hives greasy and black, evergreens robbed of their fair name, all my plants dead, damp, unpleasant corpses, frost and rain, sleet and north-east winds; how shall we withstand

these thirty days of dead December? The only way is to keep the glance of the mind far, far ahead. Let us imagine the aconites coming. Let us see the grey-green of the snowdrop leaves and fair narcissus; or let us thrust the mind's eye back to the flowery days of summer, when the air was soft and warm, and a snowstorm of blossom (clover) lay upon the meadows of June, and music came softly from the wing-beat of the bees.

I love the summer, because then, even in suburbia, the gardens are beautiful. The summer wind sweeps the smoke from a million chimneys with such magnificent ease, that the sun shines down untrammelled and undimmed. Lilies and iris, carnations and roses, all the flowers we cultivate, then burst out of calyx and sheath in sudden splendour, and you might imagine, if you sat at ease amongst them in my garden, that the "workshop of the world" was very far away.

It is in the winter that the smoke resumes the mastery and the dread influence of the city sweeps over us. I hate the winter. A million chimneys breathe forth soot and smoke and poisonous fumes of all kinds, and no wind comes sweeping up to carry it away. It hangs about us for weeks, browning the evergreens, blackening the holes and branches of the trees, dulling the holly and ivy, dimming the yew. A greyness comes into the faces of the street children—a greyness that means want of warm clothing, hungeriness, want of comfort, want of all (not much for them) that summer freely gives. Desolation is in the sky and on all the earth under. Flowers, and bees, and butterflies are dead, or are sleeping. Everybody really hates the winter. As for me, I become gloomy and morose. My spirit droops in keeping with the trees and hedges, which drop tears incessantly. The absence of sun maddens me. Would that I had the time and money to escape to Algeria, or with the nightingale seek consolation in the orange groves of sunny Spain! And yet—and yet—while I am weeping, the wintry hours are going. We need not weep so long as we can see Orion gleaming in the south—so long as this huge globe keeps its accustomed path—so long as the sun is still burning summer will come again, and suburbia is not so spoiled but that it will right itself in spring. I have perhaps been hard on these outskirts of a mighty town, for if you walk towards the sun-setting you will traverse pleasant roads bordered by green trees and neatly clipped hedgerows. This is villadom. But keeping on you will come to a land of green meadows, in which are farmhouses and orchards nestling, and where there are stiles and narrow paths leading over the pastures, and steep wild banks, mossy, and covered over with white-flowered deadnettle, harebells, and speedwell. There are no lovely mountains rising into the clouds like the Old Man of Coniston, or the pikes of Langdale, or Blencathra. There are no lady ferns or bog-

myrtle, or heather, or sweet, rushing mountain streams as the Rotha or Bratha; but rising and falling to the horizon there are billows of rich fields cultivated to their tops and hiding sweet-wooded valleys and clustered cottages. And through all this land deep silent streams wander to and fro as though lost in the maze of country—as they really are—and all the banks and trees and hedgerows and sky are mirrored in the idle water.

And if you keep on and on, as you must, you will find primroses and cowslips, wood-sorrel and dog-violets, bluebells and anemones, in their season, along the road-sides; and at the same time as these—in spring—a snow-storm of apple and pear and damson blossom falls over the land, and the hedges are festooned, first with white may and then with pink dog-roses.

And there are broad highways leading to distant towns and narrow lanes and byways, all leading to somewhere delightful; and rose-campions and yellow dandelions grow on either side, so that these roads have red and gold edges like hymn-books, and the hymns that are sung there by the larks and the thrushes, and the cuckoos and nightingales, are the sweetest in the world. There is less sun than in many places in England, and the sea is as far off as it can be from people who live on an island. The east wind makes himself thoroughly at home, and gives hardihood and durability (?) to the natives, while he kills the strangers that come to reside within his domains. But for all that, and making deductions and allowances for its poverty in many things, this land that I call home is some of the *dearest* and *best* in all the world!

—LORDSWOOD.

P.S.—Some of it was sold the other day for £60 the square yard!

THE BEE AS A WEATHER-PROPHET.

The question whether various insects and animals have the powers popularly attributed to them of knowing in advance what the weather is going to be, and, in particular, of predicting the severity of a coming winter, has frequently been discussed. A correspondent of *Cosmos*, M. P. de Ridder, writes to that journal (September 18) that he believes the bee to possess this power beyond doubt, and he proceeds to give his reasons for that belief. We translate his letter below. Says M. de Ridder:—

"Every one knows that at the approach of winter certain birds leave northern regions and fly southward, seeking, under a warmer sky, a refuge against the cold and rigors of the north.

"But every one does not know of the admirable foresight shown by the bee about the time of the earliest cold weather. It also feels the approach of winter; nay, more, the bee seems to understand a long time in advance whether the winter is to be mild or

severe. Between the migratory birds and the bee there is this difference: the former are driven away by the cold and the bad weather from the regions where they are; the latter are guided by a special instinct of foresight, an instinct which I make bold to call the bee's meteorology.

"But the bee does not know how to flee before the approach of the winter, and cannot do so; he cannot abandon the store so laboriously laid up during the fine weather; he cannot leave the hive where he has put away the necessities of life for the coming winter.

"Many times have I witnessed the vigilance and foresight of the bee. Forty years ago bee-keepers were still using the old mitre-shaped straw hives with two openings or entrances. Well, I noticed that about the beginning of October the bees stopped up these two entrances with wax, so as to leave passage for only one bee at a time, thus giving a lesson to the bee-keeper who had neglected to put a board over the entrances to prevent the introduction of cold air.

"Certain persons think that the bee plasters up these openings as the cold increases; but this is an error. The bee knows enough to take his precautionary measure in good time, for when the temperature of the air falls to 5 deg. or 6 deg. (about 40 deg. F.), he does not leave the hive, and when the temperature approaches freezing, he cannot, without exposing himself to paralysis and death, separate himself from the mass of individuals, who then form a compact ball.

"There are others who believe that extraordinary precautionary measures taken by the bee are only the result of coincidence, and that chance plays the chief part in them. This hypothesis is not tenable. Besides, the bee-keepers of all countries agree in saying—and their attention must have been often called to the phenomenon—that every time that the bees have taken care to seal hermetically the entrances to the hive, so as to leave but a minute passage for air, the winter has been of extreme rigour. On the other hand, the years when the bees have done nothing to preserve themselves from the cold have been marked by relatively mild winters during which no heavy frosts have occurred.

"Here the question naturally presents itself: How can the bee foresee the weather so far in advance, when man with all his intelligence and his knowledge has not yet succeeded in doing this?

"In truth, I find no satisfactory answer to this question.

"Must we suppose that, toward the end of the summer, a rigorous winter is heralded by drafts of air of exceptionally low temperature, that escape our perceptions and our instruments, but are perceived by the bee, and utilised by it as signs that it must take measures, in due time, for protection against the cold?

"However it may be, before this instance

of prediction, whose exactness is not open to doubt, on the testimony of a large number of bee-keepers, every observer of meteorological phenomena should stand confounded and express his admiration for the mysterious meteorology of the bee."—*Translated for The Literary Digest.*

Correspondence.

The Editors do not hold themselves responsible for the opinions expressed by correspondents. No notice will be taken of anonymous communications, and correspondents are requested to write on one side of the paper only and give their real names and addresses, not necessarily for publication, but as a guarantee of good faith. Illustrations should be drawn on separate pieces of paper. We do not undertake to return rejected communications.

Communications relating to the literary department, reports of Associations, Shows, Meetings, Echoes, Queries, Books for Review, &c., must be addressed only to "The Editors of the 'British Bee Journal,' 17, King William-street, Strand, London, W.C." All business communications relating to Advertisements, &c., must be addressed to "THE MANAGER, 'British Bee Journal' Office, 17, King William-street, Strand, London, W.C."

**.* In order to facilitate reference, Correspondents, when speaking of any letter or query previously inserted will oblige by mentioning the number of the letter, as well as the page on which it appears.*

CURRENT TOPICS.

[3119.] With the thermometer at times reaching 60 deg. Fahr. for most of the time in the early weeks of December, bees seldom remained inactive until the last ten days of the month, consequently stores are diminishing at a greater rate than is quite pleasant to think of; besides, many bees were lost by being tempted abroad, only to waste their energies in making fruitless foraging excursions in search of nectar not to be found in December, no matter how warm the weather. Nor will a high temperature in the closing month of the year cause any rearing of young bees to take the places of old ones dying off or lost in the way mentioned. It is, therefore, satisfactory to find frost with us at last. It will save bee-life and bee-stores if winter has at last come to stay a while. Bees were flying as actively between the 14th and 17th inst. as if it had been June, and the manner of their going out and in led me to think that, on a recent visit to my two apiaries in Kent, some small quantity of honey was being collected from somewhere about. I therefore had a ramble in the adjacent woods, and found no fewer than fourteen different species of flowering plants in bloom, some of which might possibly contain a very small quantity of honey, but I saw no pollen taken in.

Excessive Swarming.—The accounts given by our friend Allen Sharp on page 493, and your correspondent "H. S.," whose letter follows, afford interesting descriptions of the troubles bee-keepers have to contend with at times in connection with excessive swarming. And yet, how differently this sort of bee-

trouble must affect different people! Why, to my mind, no phase of bee-keeping is so thoroughly enjoyable as having to test one's ingenuity in finding the best way out of a "hole" such as disposed "H. S." to give away his whole stock of bees to anyone offering to carry them off out of sight. Does it not also show the varying way in which bees act under different management, when I say that from all my stocks there issued no swarms whatever this season, and only two in 1896? If I posed as an inventor of some non-swarming principle, this result might be made something of, as a proof of the soundness of my particular views; but I don't take any such ground, though few have more reasons for desiring to control swarming, seeing that I have two large out-apiaries, and no special custodian for them at any time. I work mainly for extracted honey, however, and this lessens swarming; but a special swarm appliance is attached to all colonies in my out-apiaries so long as danger of swarming continues. The object is to effectually stop the queens from getting out or joining the swarm. This is all I aim at, while, bearing in mind the importance of hindering work and ventilation as little as possible. It creates a feeling of intense satisfaction to know that there will be no runaway swarms while the service of a watcher is dispensed with. Much as we may dislike any attachment about the hive entrance which appears to interfere with the free incoming and outgoing of worker bees in the busy season, I feel confident that appliances which prevent loss of swarms will sooner or later become part of every up-to-date bee-keeper's outfit.

Bees and X-Rays.—Without entering into a dissertation as to the nature of Rontgen's discovery, or attempting to deal with the peculiarities of the ultra-violet end of the spectrum, it is plainly apparent that there are rays of light of which but little is known even in this age of discoveries. Thinking of this, and after close observation, it has occurred to my mind that although human vision is apparently not endowed with such rays, some insects have the power of utilising them to a great extent. For example, the question arises—how is it that bees pass out into bright sunshine from the absolute darkness of a hive's interior and fly off without hesitating for a second, and evidently without any inconvenience from the sudden change? If we attempted the same thing our vision would be perceptibly affected for some minutes. Again, what power of vision enables bees to work with such beautiful accuracy in complete and utter darkness? Or, to go still further, place a sheet of foundation in a strong colony, and, when the comb is drawn out, watch how the queen will deposit a small patch of eggs (somewhere near the centre of the new comb) about as large as the palm of one's hand; then see how she will pass to the other side of the same comb, and, without hesitation, commence laying her eggs

in the cells whose bases occupy the other side of the septum or midrib, so that the brood would lie back to back, as it were, for mutual warmth. What power enables the queen to do this? Can she see through the wall of wax against which the cells are built? The same may be said of worker bees and honey-storing. With equal regularity do bees fill the cells on both sides of a comb. How is it done? Do they utilise the X-rays? I put these queries, in which there is a field of research for any one of a scientific turn, and I leave it for exploration during the dull season. Many other items in the economy of the hive clearly point to the peculiar and extraordinary range of vision possessed by bees, requiring study to throw light thereon.—HENRY W. BRICE, *Dale Park, Upper Norwood.*

NON-SWARMING HIVES.—HORNETS.

[3120.] Many thanks to D. G. for his letter in your last issue (3114, p. 506). His supposition that the safety chamber beneath the brood nest was provided with full sheets of foundation is quite correct. I think he also is right in saying that, to give the hive in question a perfectly fair trial, the lowest chamber should be provided only with "starters." I was, however, following the method which the inventor considers permissible, though he does not recommend it. He says, "In summer, as the bees become crowded, the stock body is moved higher, giving place to the lower chamber, with only guides in the frames, or shallow chambers with full sheets of foundation in frames or sections, as the case may be." I will certainly try the hive next year, as D. J. suggests, with only starters in the lowest chamber. I may add that the queen in my case was a young one.

A B. J. correspondent asks about hornets on p. 496. There are two or three nests in this neighbourhood every year, but they have caused me no trouble except in September, 1896. In that year there was by far the strongest nest I have ever seen about 300 yards away, and the hornets ate a large number of my bees. The hornets hovered just above the alighting board, and, as the bees were about to settle, they were seized and carried off. This was continued all day long, so that I became concerned for the bees; but, on a calculation, I made out that only about 250 bees a day were sacrificed, which, divided among ten hives, gives twenty-five per hive. As soon as the cold weather began the trouble was at an end. In corroboration of what is stated by Mr. W. F. Reid (3111, p. 503) about the quietness of hornets, I may state that though this nest was in a willow tree beside the road, and only sixty yards from the day school, not a person was stung by them the whole year.—H. S., *Winchfield, Hants, December 23.*

(Correspondence continued on page 516).

SKETCHES BY A ROVING BEE-KEEPER.—No. III.

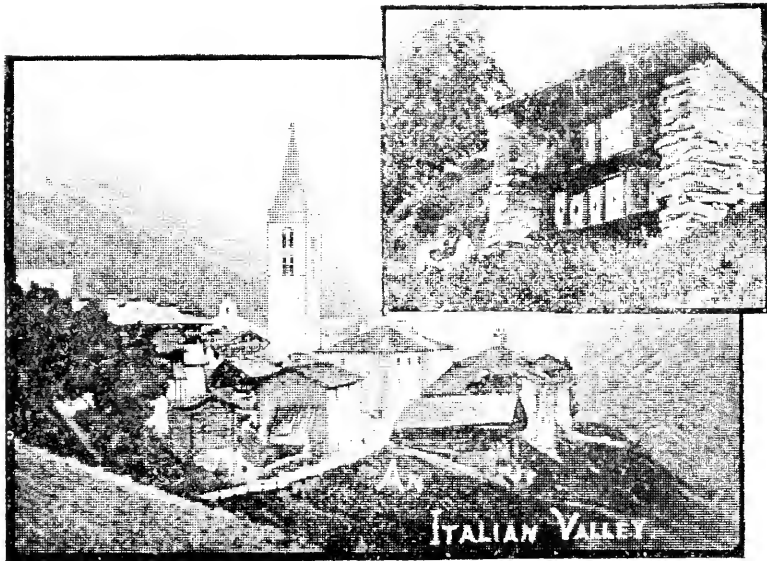

BY ALFRED WATKINS.

It was in the Val Formazza, a narrow valley branching out from the great Simplon road toward the heights of the great Pontine Alps.

We were in full marching order, and only the day before had started from the Swiss side of the mountain chain, where we had rested for the night at a little hamlet near the head of the Rhone Valley.

The usual difficulties of an Alpine pass had been surmounted, not without a spice of danger, for it was misty on the top, and in crossing the Gries ice field, where no track is, our boyish guide had completely lost his way, and had to be set right with the aid of map and compass. And so it was with some thankfulness that we hit upon the rugged track leading down into Italy; first over more snow, then came barren rocks, widening out into a cup-like valley, then banks of Alpine flowers, with Edelweiss (the Swiss bridal flower) to be found here and there.

In these upper valleys the descent is usually by means of steps or plateaux, perhaps a couple of miles apart, the road descending in steep zig-zags to the lower level.

A village or hamlet is often (as in our illustration) built on the verge of one of these steps; and at the spot where we rested for the night the valley stream leaped down the steep descent to its new bed far below, forming a cascade (the Tossa Falls) higher than the cross on St. Paul's Cathedral.

How striking was the gradation of vegetable life in that journey down the Formazza Valley, ranging from the utter bareness of

eternal snows to the warmth of Italian vineyards. First, the poor pasture above the tree line, where the stone cow-shed is occupied for three summer weeks only; then fir tree groves; then a patch of potatoes in the meagre gardens; of the scattered stone-built houses; and lower down a little wheat and rye. The valley widens, and deciduous trees appear, first the alder, then oak, apple, beech, and walnut; lower down, in a warmer climate, the chestnut ripens its fruit; crops of hemp succeed, and finally we find ourselves in the full blaze of Italian skies, among plots of maize and sloping vineyards. Many hamlets we pass without halting, many roadside chapels dedicated to the virgin, bedecked with cheap finery, while here and there are glimpses of upright bee-hives ranged against the houses.

Midway down the valley—at Poppiano—we catch sight of the bee-shed of our illustration. It is at a part where the beauty of the scenery is greatest, the tree clad cliffs on either side leaning towards each other across the narrow valley. We step into the little enclosure where the stone stands, and note the primitive upright box hives—they are about 9 in. square and 2 ft. in height—with their curious cross-shaped entrances half way up, the yellow-banded, pollen-laden bees busy at work, and their German-speaking peasant owner looking on; we manage to get a few words of explanation from him—a few miles lower down only Italian is spoken. How much honey did he get? "About three litres per hive when he took them in the autumn." Did he kill the bees? "Yes; the hives were beaten out into

water to get the honey." A curious way this of driving bees, we thought.

Lower down, at St. Rocco—where stands a mortuary chapel filled with piles of human bones and skulls, some dignified by a priest's cap, and all in full sight through a grated doorway, to the road—are more upright hives, tenanted this time with black bees; and later in the day, after joining the great Simplon road, range upon range of shelves, filled with large, flat-topped straw hives, line the gable end of a house near Iselle. Forty hives we count in all, some cold and empty, some with yellow Italians flying listlessly in and out, and there are no signs of straw caps or other supers about the rather forlorn-looking apiary.

It may be only fancy, but nowhere on the Italian side of the Alps do we notice the careful and orderly neatness which seems to make the Swiss bee-keeper successful under greater difficulties; for national character has probably much to do with profitable bee-keeping, and a warm-hearted, impulsive Italian or Irishman is not so likely to devote the requisite care and patience as the more phlegmatic Scot and Teuton.

CORRESPONDENCE.

(Continued from page 514.)

AUSTRALIAN HONEY.

A CHAT WITH A GOLD-DIGGING BEE-MAN.

[3121.] In the *Rural World* for December 18, the Australian correspondent of that paper says:—"The export of honey from Australia has never proved successful, although it has been tried in a great many ways." He also adds:—"Honey can be produced in quantity (in Australia) at twopence a pound; in fact, if twopence a pound could be guaranteed to the bee-keeper, we could produce thousands of tons a year." "The trouble is," he says, "to find a market." The writer goes on to say:—"Now, it seems to me that if our honey (which is without the slightest doubt pure and wholesome) were nicely put up in attractive packages, and well introduced to the British public for what it is—Australian eucalyptus honey—there would be a very large demand for it. There is money in the business for an enterprising Englishman."

I met in August last a genuine Australian gold-digger, who, to show his loyalty, had come over to the Old Country for the Jubilee in June. He bore about him all the usual picture-book characteristics of the "digger," minus pick and shovel. With twenty-six years' experience of Australia, he related to me, not without a bit of bluff, his experiences among bees in Queensland. How, when the ordinary bee-keeper there wishes to take his honey, he first procures a convenient box from the store, lights his pipe, turns up his box of bees, and drives them by rapping the box as we do our skeps, using his mouth for a smoker. As the climate is warm, and honey can be gathered nearly all the year round, the driven

bees fill their new box, and are driven again when honey is wanted. I got a lasting lesson in cleanliness from the rough and ready bee-keeping gold-digger. He said:—"Before I drive bees I change my clothes and have a wash all over; then the bees don't sting."

It is a good plan to wash the hands before manipulating bees, especially after working in the garden, where the hands are continually in contact with strong-smelling herbs and plants.—WM. LOVEDAY, *Hatfield House, Harlow, Essex, December 22, 1897.*

Echoes from the Hives.

Honey Cott, Weston, Leamington, December 23.—What a time it has been for the bees! We have had it quite warm here at a time when we expect the bees to be at rest and kept in the hives by cold. I am afraid their activity will have done a good deal in reducing stores, but, as there seems now to be coming signs of real winter, we must hope that no harm will come of the long spell of activity since September last. Wishing to all old and new friends a happy and prosperous year in 1898 and a good time for the bees,—JOHN WALTON.

Notices to Correspondents & Inquirers.

All queries forwarded will be attended to, and those only of personal interest will be answered in this column.

WEST SUSSEX (Chichester).—*Non-sectional Supers.*—1. This term applies to supers in which the combs are not separable into parts or sections without cutting. 2. It is quite a common practice to allow of an exhibitor taking two, or even more, prizes in the same class. As to this becoming a general rule we cannot say, but it is done at most important shows.

H. R. T. (Girvan).—*What Constitutes a Colony of Bees?*—In asking "Is it possible to establish or form a colony of bees without first having workers, queens, and drones?" you do not sufficiently define the question. For instance, all three sexes of bees named are necessary to start and carry on a normal colony; but if the queen is already fertile when received, drones are unnecessary, except for establishing future colonies, and they will be produced in due course, for that purpose, by the queen or mother-bee of the hive. The experiences of manipulating mentioned as being interesting for beginners will be very welcome for publication in our monthly, the *Record*, as suggested, so send them on please.

H. S. (Willingham).—*Divided Sections.*—Since you purpose showing them at the next *Conversazione* of the B.B.K.A., the description had better be deferred till such time as they have been inspected on the occasion referred to.

